

CONTROLS AND DISPLAYS

SECTION 3

CONTROLS AND DISPLAYS

(Controls and Displays Applicable to SC 106 and
Subs Unless Otherwise Noted)

3.1 INTRODUCTION.

This section identifies each control and display in the command module, and lists panel and area location, item nomenclature, positions and related functions, power source, and associated explanatory data. Controls and displays are presented in a tabulated list in numerical order by panel and area number. Panel numbers are those appearing on the main display console drawing (figure 3-1). The area designations are those alphabetical letters used for reference purposes only on the display panel and, in most instances, designate a specific system. The following is a detailed explanation of the columnar data presented in the tabulated list.

<u>Location</u>	Gives the location of a particular control or display by panel number.
<u>Area</u>	The larger panels are further divided into areas. In most instances, the area correlates to a specific spacecraft system. This breakdown will provide the user with a ready reference as to the specific system contained on a given panel and area.
<u>Grid</u>	Panels 1 through 16 (figure 3-1) have grid reference numerical marks horizontally (abscissa), and alphabetical reference marks vertically (ordinate) on the drawing. These grid location marks provide a means of specifically locating a switch, circuit breaker, light, gauge, etc., on the main display console. There are no grid location reference marks on the panels in the equipment bays.
<u>Name and Position</u>	Gives the exact nomenclature of a particular control or display and the control positions, as placarded on the panel. In the absence of a placard, a functional name is assigned and the positions are described physically ("up," "down," etc).

SM2A-03-BLOCK II-(1)
APOLLO OPERATIONS HANDBOOK

CONTROLS AND DISPLAYS

<u>Function</u>	Describes the function of each control in each position.
<u>Circuit Breaker</u>	Gives the name and location of the circuit breaker(s) for circuit protection and for controlling the electrical power to each control and display.
<u>Power Source</u>	Identifies the immediate bus or source supplying power to a particular control or display.

3.2

CONTROLS/DISPLAYS LOCATOR INDEX.

To aid in finding data within this section, a locator index precedes the tabulated list. The index is subdivided into spacecraft systems. Under each system is listed, in alphabetical order, all controls and displays associated with that particular system with cross reference to the panel on which the control or display is located. Where items, such as circuit breakers, are associated with more than one system, such items are repeated under each applicable system.

Panel, Area, and Grid Location

MDC	Main display console (panels 1 through 10, 12, 13, 15, and 16)
LEB	Lower equipment bay (panels 100, 101, 120, 121, 122, 140, 162, 163, and 180)
RHEB	Right-hand equipment bay (panels 225, 226, 227, 229, 250, 251, 252, 275, 276, and 278)
LHFEB	Left-hand forward equipment bay (panels 300 through 306)
LHEB	Left-hand equipment bay (panels 325, 326, 350, 351, 352, 375 through 382)
UEB	Upper equipment bay (panels 600, 601, and 602)

CONTROLS AND DISPLAYS

SM2A-03-BLOCK II-(1)
APOLLO OPERATIONS HANDBOOK

CONTROLS AND DISPLAYS

The controls/displays locator index is subdivided as follows:

	Page
Guidance and Navigation System	3-4
Stabilization and Control System	3-8
Service Propulsion System	3-12
Reaction Control System	3-15
Electrical Power System	3-20
Environmental Control System	3-28
Telecommunications	3-35
Sequential Systems (ELS, LES, EDS, SECS)	3-39
Caution and Warning System	3-41
Miscellaneous Systems	3-43
Docking System	3-47

CONTROLS AND DISPLAYS

SM2A-03-BLOCK II-(1)
APOLLO OPERATIONS HANDBOOK

GUIDANCE AND NAVIGATION SYSTEM - LOCATOR INDEX

Control/Display Nomenclature	Type	Panel Locator		
		Number	Area	Grid
ATTITUDE IMPULSE CONTROLLER	Control	122		LEB
ATTITUDE IMPULSE CONTROLLER - MARK REJECT UPLINK	Sw	122		LEB
CMC	Lt	2	A	C-32
CMC	Lt	122		LEB
CONDITION LAMPS - ON/OFF/TEST	Sw	122		LEB
DSKY (No placard)				
Keyboard				
CLR	Key	2	C	K-27
ENTR	Key	2	C	K-27
KEY RLSE	Key	2	C	L-27
NOUN	Key	2	C	L-24
RSET	Key	2	C	L-27
PRO	Key	2	C	K-27
VERB	Key	2	C	K-24
+	Key	2	C	K-25
-	Key	2	C	K-25
0 through 9	Keys	2	C	K-26
Register				
COMP ACTY	Lt	2	C	I-26
NOUN	Lt & Display	2	C	I-27
PROG	Lt & Display	2	C	I-27
REGISTER 1	Display	2	C	J-26
REGISTER 2	Display	2	C	J-26
REGISTER 3	Display	2	C	J-26
VERB	Lt & Display	2	C	I-26

GUIDANCE AND NAVIGATION SYSTEM - LOCATOR INDEX

SM2A-03-BLOCK II-(1)
 APOLLO OPERATIONS HANDBOOK

GUIDANCE AND NAVIGATION SYSTEM - LOCATOR INDEX

Control/Display Nomenclature	Type	Panel Locator		
		Number	Area	Grid
Status Lights				
GIMBAL LOCK	Lt	2	C	I-25
KEY REL	Lt	2	C	I-25
NO ATT	Lt	2	C	I-25
OPR ERR	Lt	2	C	J-25
PROG	Lt	2	C	I-25
RESTART	Lt	2	C	J-25
STBY	Lt	2	C	I-25
TEMP	Lt	2	C	I-25
TRACKER	Lt	2	C	J-25
UPLINK ACTY	Lt	2	C	I-25
DSKY (No placard)				
Keyboard				
CLR	Key	140		LEB
ENTR	Key	140		LEB
KEY REL	Key	140		LEB
NOUN	Key	140		LEB
RSET	Key	140		LEB
STBY	Key	140		LEB
VERB	Key	140		LEB
+	Key	140		LEB
-	Key	140		LEB
0 through 9	Keys	140		LEB
Register				
COMP ACTY	Lt	140		LEB
NOUN	Lt & Display	140		LEB

GUIDANCE AND NAVIGATION SYSTEM - LOCATOR INDEX

SM2A-03-BLOCKII-(1)
 APOLLO OPERATIONS HANDBOOK

GUIDANCE AND NAVIGATION SYSTEM - LOCATOR INDEX

Control/Display Nomenclature	Type	Panel Locator		
		Number	Area	Grid
PROG	Lt & Display	140		LEB
REGISTER 1	Display	140		LEB
REGISTER 2	Display	140		LEB
REGISTER 3	Display	140		LEB
VERB	Lt & Display	140		LEB
Status Lights				
GIMBAL LOCK	Lt	140		LEB
KEY REL	Lt	140		LEB
NO ATT	Lt	140		LEB
OPR ERR	Lt	140		LEB
PROG	Lt	140		LEB
RESTART	Lt	140		LEB
STBY	Lt	140		LEB
TEMP	Lt	140		LEB
TRACKER	Lt	140		LEB
UPLINK ACTY	Lt	140		LEB
G&N-COMPUTER-MNA	CB	5	D	M-57
G&N-COMPUTER-MNB	CB	5	D	M-57
G&N-IMU-MNA	CB	5	D	M-55
G&N-IMU-MNB	CB	5	D	M-56
G&N-IMU HTR-MNA	CB	5	D	M-57
G&N-IMU HTR-MNB	CB	5	D	M-57
G&N-OPTICS-MNA	CB	5	D	M-58
G&N-OPTICS-MNB	CB	5	D	M-58
G&N-POWER-AC1	CB	5	D	M-55
G&N-POWER-AC2	CB	5	D	M-55

GUIDANCE AND NAVIGATION SYSTEM - LOCATOR INDEX

SM2A-03-BLOCK II-(1)
 APOLLO OPERATIONS HANDBOOK

GUIDANCE AND NAVIGATION SYSTEM - LOCATOR INDEX

Control/Display Nomenclature	Type	Panel Locator		
		Number	Area	Grid
G/N POWER - IMU/OFF	Sw	100	B	LEB
G/N PWR - AC 1/OFF/AC 2	Sw	5	E	H-56
G/N POWER - OPTICS/OFF	Sw	100	B	LEB
IMU CAGE	Sw	1	G	P-15
ISS	Lt	2	A	D-33
ISS	Lt	122		LEB
LV GUIDANCE - IU/CMC	Sw	2	F	O-24
MARK	Sw	122		LEB
OPTICS-CONTROLLER-SPEED - HI/MED/LO	Sw	122		LEB
OPTICS-CONTROLLER-COUPLING - DIRECT/RSLV	Sw	122		LEB
OPTICS HAND CONTROLLER (not placarded)	Control	122		LEB
OPTICS-MODE - CMC/MAN	Sw	122		LEB
OPTICS-STAR ACQ	Lt	122		LEB
PGNS	Lt	122		LEB
RETICLE BRIGHTNESS	Thumbwheel	122		LEB
SCANNING TELESCOPE	Telescope	121		LEB
SEXTANT (Not placarded)	Sext	121		LEB
SHAFT	Manual Drive	121		LEB
SHAFT ANGLE	Indicator	121		LEB
TELTRUN-SLAVE TO SXT/0°/25°	Sw	122		LEB
TRUNNION	Manual Drive	121		LEB
TRUNNION ANGLE	Indicator	121		LEB
UP TELEMETRY - ACCEPT/BLOCK	Sw	122		LEB

GUIDANCE AND NAVIGATION SYSTEM - LOCATOR INDEX

SM2A-03-BLOCK II-(1)
 APOLLO OPERATIONS HANDBOOK

STABILIZATION AND CONTROL SYSTEMS - LOCATOR INDEX

Control/Display Nomenclature	Type	Panel Locator		
		Number	Area	Grid
ACCEL G	Meter	1	D	I-17
ALT SET	Control	13	A	C-7
ATT DEADBAND - MAX/MIN	Sw	1	D	K-16
ATT SET - IMU/GDC	Sw	1	D	J-17
ATTITUDE SET - PITCH	Thumbwheel & Display	1	D	P-14
ATTITUDE SET - ROLL	Thumbwheel & Display	1	D	O-14
ATTITUDE SET - YAW	Thumbwheel & Display	1	D	Q-14
BMAG 1 TEMP	Lt	2	A	C-30
BMAG 2 TEMP	Lt	2	A	C-30
BMAG MODE-PITCH - RATE 2/ATT 1 RATE 2/ RATE 1	Sw	1	D	N-14
BMAG MODE-ROLL - RATE 2/ATT 1 RATE 2/ RATE 1	Sw	1	D	N-13
BMAG MODE-YAW - RATE 2/ATT 1 RATE 2/ RATE 1	Sw	1	D	N-15
BMAG POWER-1 - OFF/WARM UP/ON	Sw	7	B	N-4
BMAG POWER-2 - OFF/WARM UP/ON	Sw	7	B	O-4
CMC ATT - IMU/GDC	Sw	1	D	I-16
CMC MODE - AUTO/HOLD/FREE	Sw	1	D	M-17
EARTH/LUNAR - EARTH/PWR OFF/LUNAR	Sw	13	A	C-5
EMS-MNA	CB	8	K	K-6
EMS-MNB	CB	8	K	K-7
ENTRY EMS ROLL up/OFF	Sw	1	H	P-16
ENTRY .05 up/OFF	Sw	1	H	P-16
ENTRY MONITOR (no placard)				
ΔV/EMS SET - INC/DECR	Sw	1	B	G-22

STABILIZATION AND CONTROL SYSTEMS - LOCATOR INDEX

SM2A-03-BLOCK II-(1)
 APOLLO OPERATIONS HANDBOOK

STABILIZATION AND CONTROL SYSTEMS - LOCATOR INDEX

Control/Display Nomenclature	Type	Panel Locator		
		Number	Area	Grid
MODE--NORAML/STBY/ ^{BACKUP} VHF RNG	Sw	1	B	F-19
GTA	Sw	1	B	E-22
ROLL ATTITUDE INDICATOR (no placard)	Meter	1	B	G-19
RANGE/ Δ V	Display	1	B	H-21
SPS THRUST	Lt	1	B	G-21
FUNCTION	Sw	1	B	E-19
VELOCITY	Indicator	1	B	F-21
.05 G	Lt	1	B	G-20
FDAI 1 - ORB RATE/INRTL	Sw	13	A	C-3
FDAI 2 - ORB RATE/INRTL	Sw	13	A	C-4
FDAI (no placard)	Indicator	1	D	J-19
FDAI (no placard)	Indicator	2	B	F-26
FDAI/GPI POWER - OFF/1/2/BOTH	Sw	7	B	N-7
FDAI-SCALE	Sw	1	D	J-15
FDAI-SELECT - 1/2-2-1	Sw	1	D	J-16
FDAI SOURCE - CMC/ATT SET/GDC	Sw	1	D	J-17
GDC ALIGN	Pushbutton	1	D	O-15
GPI	Indicator	1	E	M-20
LIGHTING - BRT/OFF/DIM	Sw	13	A	D-3
LIMIT CYCLE up/OFF	Sw	1	D	K-16
LOGIC POWER 2/3 - up/OFF	Sw	7	B	O-7
MANUAL ATTITUDE-PITCH - ACCEL CMD/RATE CMD/MIN IMP	Sw	1	D	K-15
MANUAL ATTITUDE-ROLL - ACCEL CMD/RATE CMD/MIN IMP	Sw	1	D	K-14
MANUAL ATTITUDE-YAW - ACCEL CMD/RATE CMD/MIN IMP	Sw	1	D	K-15

STABILIZATION AND CONTROL SYSTEMS - LOCATOR INDEX

SM2A-03-BLOCK II-(1)
APOLLO OPERATIONS HANDBOOK

STABILIZATION AND CONTROL SYSTEMS - LOCATOR INDEX

Control/Display Nomenclature	Type	Panel Locator		
		Number	Area	Grid
MODE - OPR/SLOW - HOLD/FAST	Sw	13	A	D-5
ORDEAL-AC2	CB	8	A	J-2
ORDEAL-MNB	CB	8	A	J-2
RATE - HIGH/LOW	Sw	1	D	K-17
ROT CONTR PWR-DIRECT 1-MNA/MNB-OFF-MNA	Sw	1	D	M-15
ROT CONTR PWR-DIRECT 2-MNA/MNB-OFF-MNB	Sw	1	D	M-15
ROT CONTR PWR-NORMAL-1 AC/DC-OFF-AC	Sw	1	D	M-13
ROT CONTR PWR-NORMAL-2 AC/DC-OFF-AC	Sw	1	D	M-14
ROTATIONAL CONTROLLERS (no placard)	Control (2)	LH COUCH, RH ARMREST RH COUCH, LH ARMREST		
SC CONT - CMC/SCS	Sw	1	D	M-16
SCS-AC 1	CB	8	A	H-2
SCS-AC 2	CB	8	A	H-3
SCS A/C ROLL - MNA	CB	8	A	I-5
SCS A/C ROLL - MNB	CB	8	A	I-5
SCS B/D ROLL - MNA	CB	8	A	I-6
SCS B/D ROLL - MNB	CB	8	A	I-6
SCS CONTR/AUTO-MNA	CB	8	A	J-3
SCS CONTR/AUTO-MNB	CB	8	A	J-3
SCS CONTR/DIRECT-1-MNA	CB	8	A	I-3
SCS CONTR/DIRECT-1-MNB	CB	8	A	I-3
SCS CONTR/DIRECT-2-MNA	CB	8	A	I-4
SCS CONTR/DIRECT-2-MNB	CB	8	A	I-4
SCS-DIRECT ULL-MNA	CB	8	A	I-2
SCS-DIRECT ULL-MNB	CB	8	A	I-2

STABILIZATION AND CONTROL SYSTEMS - LOCATOR INDEX

SM3A-03-BLOCK II-(1)
APOLLO OPERATIONS HANDBOOK

STABILIZATION AND CONTROL SYSTEMS - LOCATOR INDEX

Control/Display Nomenclature	Type	Panel Locator		
		Number	Area	Grid
SCS-ECA/TVC-AC 2	CB	8	A	I-2
SCS ELECTRONICS POWER - OFF/ECA/GDC/ECA	Sw	7	B	N-6
SCS-LOGIC BUS-MNA 1/2	CB	8	A	J-4
SCS-LOGIC BUS-MNA 3/4	CB	8	A	J-4
SCS-LOGIC BUS-MNA 1/4	CB	8	A	J-5
SCS-LOGIC BUS-MNB 2/3	CB	8	A	J-5
SCS-PITCH-MNA	CB	8	A	I-7
SCS-PITCH-MNB	CB	8	A	I-7
SCS SYSTEM-MNA	CB	8	A	J-5
SCS SYSTEM-MNB	CB	8	A	J-6
SCS-TVC-AC 1	CB	8	A	H-1
SCS YAW-MNA	CB	8	A	I-7
SCS YAW-MNB	CB	8	A	I-7
SCS TVC-PITCH - AUTO/RATE CMD/ACCEL CMD	Sw	1	D	O-16
SCS TVC-YAW - AUTO/RATE CMD/ACCEL CMD	Sw	1	D	O-17
SIG CONDR/DRIVER BIAS PWR-PWR SUP 1-AC1/ OFF/AC2	Sw	7	B	O-6
SIG CONDR/DRIVER BIAS PWR-PWR SUP 2-AC1/ OFF/AC2	Sw	7	B	O-6
SLEW - UP/DOWN	Sw	13	A	D-5
TRANS CONTR PWR/OFF	Sw	1	D	K-17
TRANSLATION CONTROLLER (TC) (no placard)	Control	LH COUCH, LH ARMREST		
TVC SERVO POWER-1 - AC1/MNA-OFF-AC2/MNB	Sw	7	B	N-8
TVC SERVO POWER-2 - AC1/MNA-OFF-AC2/MNB	Sw	7	B	N-8
ΔVCG-LM/CSM-CSM	Sw	1	J	O-20

STABILIZATION AND CONTROL SYSTEMS - LOCATOR INDEX

SM2A-03-BLOCK II-(1)
 APOLLO OPERATIONS HANDBOOK

SERVICE PROPULSION SYSTEM - LOCATOR INDEX

Control/Display Nomenclature	Type	Panel Locator		
		Number	Area	Grid
ΔV THRUST-A - NORMAL/OFF	Sw	1	E	N-17
ΔV THRUST-B - NORMAL/OFF	Sw	1	E	N-18
LV α/SPS Pc	Meter	1	E	M-18
LV TANK PRESS - S-II FUEL - S-IVB OXID	Meter	1	E	M-19
LV TANK PRESS - S-IVB FUEL	Meter	1	E	M-20
LV/SPS IND - α/Pc	Sw	1	E	P-17
LV/SPS IND - SII/SIVB/GPI	Sw	1	E	P-17
OXID FLOW VALVE MAX/MIN INDICATORS	Indicator	3	B	K-42
OXID FLOW VALVE -INCR/NORM/DECR	Sw	3	B	K-42
OXID FLOW VALVE - PRIM/SEC	Sw	3	B	K-43
PITCH GMBL 1	Lt	2	A	C-30
PITCH GMBL 2	Lt	2	A	C-30
PUG MODE - PRI/NORM/AUX	Sw	3	B	K-43
SPS ENGINE INJECTOR VALVES A-1	Indicator	3	B	H-42
SPS ENGINE INJECTOR VALVES A-2	Indicator	3	B	H-42
SPS ENGINE INJECTOR VALVES B-3	Indicator	3	B	H-43
SPS ENGINE INJECTOR VALVES B-4	Indicator	3	B	H-43
SPS-GAUGING - AC1	CB	8	D	L-3
SPS-GAUGING - AC2	CB	8	D	L-3
SPS GAUGING - MNA	CB	8	D	L-2
SPS GAUGING - MNB	CB	8	D	L-3
SPS GAUGING - AC1/OFF/AC2	Sw	4	A	N-57

SERVICE PROPULSION SYSTEM - LOCATOR INDEX

SM2A-03-BLOCK II-(1)
 APOLLO OPERATIONS HANDBOOK

SERVICE PROPULSION SYSTEM - LOCATOR INDEX

Control/Display Nomenclature	Type	Panel Locator		
		Number	Area	Grid
SPS GIMBAL MOTORS-PITCH 1 - START/ CENTER/OFF	Sw	1	E	0-18
SPS GIMBAL MOTORS-PITCH 2 - START/CENTER/ OFF	Sw	1	E	0-18
SPS GIMBAL MOTORS-YAW 1 - START/CENTER/ OFF	Sw	1	E	0-19
SPS GIMBAL MOTORS-YAW 2 - START/CENTER/ OFF	Sw	1	E	0-19
SPS GIMBAL-PITCH	Thumbwheel	1	E	N-19
SPS GIMBAL-YAW	Thumbwheel	1	E	N-20
SPS He VLV-1	Indicator	3	B	L-42
SPS He VLV-1 - AUTO/OFF/ON	Sw	3	B	M-42
SPS He VLV-2	Indicator	3	B	L-42
SPS He VLV-2 - AUTO/OFF/ON	Sw	3	B	M-42
SPS He VALVE-MNA	CB	8	D	L-4
SPS He VALVE-MNB	CB	8	D	L-4
SPS-LINE HTRS - A/B/OFF/A	Sw	3	B	M-43
SPS LINE HTRS-MNA	CB	229	G	RHEB
SPS LINE HTRS-MNB	CB	229	G	RHEB
SPS PILOT VLVS A MNA	CB	8	D	L-6
SPS PILOT VLVS B MNB	CB	8	D	L-7
SPS PITCH 1 - BAT A	CB	8	D	L-5
SPS PITCH 2 - BAT B	CB	8	D	L-5
SPS PRESS	Lt	2	A	C-33
SPS-PRESS IND - He/N2A/N2B	Sw	3	B	M-44
SPS PRPLNT TANKS-PRESS-FUEL	Meter	3	B	F-43
SPS PRPLNT TANKS-PRESS-He/N2	Meter	3	B	F-42

SERVICE PROPULSION SYSTEM - LOCATOR INDEX

SM2A-03-BLOCK II-(1)
 APOLLO OPERATIONS HANDBOOK

SERVICE PROPULSION SYSTEM - LOCATOR INDEX

Control/Display Nomenclature	Type	Panel Locator		
		Number	Area	Grid
SPS PRPLNT TANKS-PRESS-OXID	Meter	3	B	F-43
SPS PRPLNT TANKS-TEMP	Meter	3	B	F-42
SPS THRUST - DIRECT ON/NORMAL	Sw	1	E	N-15
SPS QUANTITY - OXID UNBAL	Meter	3	B	J-42
SPS QUANTITY - % FUEL	Display	3	B	I-43
SPS QUANTITY - % OXID	Display	3	B	I-43
SPS QUANTITY-TEST-1/CENTER/2	Sw	3	B	J-43
SPS YAW 1 - BAT A	CB	8	D	L-6
SPS YAW 2 - BAT B	CB	8	D	L-6
THRUST ON	Pushbutton	1	E	O-16
TVC GMBL DRIVE-PITCH - 1/AUTO/2	Sw	1	E	P-18
TVC GMBL DRIVE-YAW - 1/AUTO/2	Sw	1	E	P-18
YAW GMBL 1	Lt	2	A	C-30
YAW GMBL 2	Lt	2	A	C-30

SERVICE PROPULSION SYSTEM - LOCATOR INDEX

SM2A-03-BLOCK II-(1)
APOLLO OPERATIONS HANDBOOK

REACTION CONTROL SYSTEM - LOCATOR INDEX

Control/Display Nomenclature	Type	Panel Locator		
		Number	Area	Grid
ABORT SYSTEM-PRPLNT DUMP AUTO/RCS CMD	Sw	2	E	N-24
AUTO RCS SELECT A/C ROLL-A1-MNA/OFF/MNB	Sw	8	J	H-4
AUTO RCS SELECT A/C ROLL-C1-MNA/OFF/MNB	Sw	8	J	H-4
AUTO RCS SELECT A/C ROLL-A2-MNA/OFF/MNB	Sw	8	J	H-5
AUTO RCS SELECT A/C ROLL-C2-MNA/OFF/MNB	Sw	8	J	H-5
AUTO RCS SELECT B/D ROLL-B1-MNA/OFF/MNB	Sw	8	J	H-6
AUTO RCS SELECT B/D ROLL-D1-MNA/OFF/MNB	Sw	8	J	H-6
AUTO RCS SELECT B/D ROLL-B2-MNA/OFF/MNB	Sw	8	J	H-7
AUTO RCS SELECT B/D ROLL-D2-MNA/OFF/MNB	Sw	8	J	H-7
AUTO RCS SELECT PITCH-A3-MNA/OFF/MNB	Sw	8	J	H-8
AUTO RCS SELECT PITCH-C3-MNA/OFF/MNB	Sw	8	J	H-8
AUTO RCS SELECT PITCH-A4-MNA/OFF/MNB	Sw	8	J	H-9
AUTO RCS SELECT PITCH-C4-MNA/OFF/MNB	Sw	8	J	H-9
AUTO RCS SELECT YAW-B3-MNA/OFF/MNB	Sw	8	J	H-10
AUTO RCS SELECT YAW-D3-MNA/OFF/MNB	Sw	8	J	H-10
AUTO RCS SELECT YAW-B4-MNA/OFF/MNB	Sw	8	J	H-11
AUTO RCS SELECT YAW-D4-MNA/OFF/MNB	Sw	8	J	H-11
BAT A PWR ENTRY & POST LANDING	CB	250	B	RHEB
BAT B PWR ENTRY & POST LANDING	CB	250	B	RHEB
CM RCS LOGIC - CM RCS LOGIC/OFF	Sw	1	K	O-22
CM PRPLNT - DUMP/OFF	Sw	1	K	O-22
CM PRPLNT - PURGE/OFF	Sw	1	K	O-23
CM RCS 1	Lt	2	A	C-30
CM RCS 2	Lt	2	A	C-30
CM RCS He DUMP	Pushbutton	1	K	N-23

REACTION CONTROL SYSTEM - LOCATOR INDEX

SM2A-03-BLOCKII-(1)
 APOLLO OPERATIONS HANDBOOK

REACTION CONTROL SYSTEM - LOCATOR INDEX

Control/Display Nomenclature	Type	Panel Locator		
		Number	Area	Grid
CM RCS-He TEMP	Meter	2	I	H-28
CM RCS HTRS - OFF	Sw	101	B	LEB
CM RCS-PRESS-He	Meter	2	I	H-28
CM RCS-PRESS MANF	Meter	2	I	H-29
CM RCS - PRESS/OFF	Sw	2	I	I-29
CM RCS PRPLNT-1	Indicator	2	I	K-29
CM RCS PRPLNT-2	Indicator	2	I	K-29
CM RCS PRPLNT - 1/CENTER/OFF	Sw	2	I	L-29
CM RCS PRPLNT - 2/CENTER/OFF	Sw	2	I	L-30
DIRECT ULLAGE	Pushbutton	1	F	N-16
PYRO A-SEQ A	CB	250	A	RHEB
PYRO B-SEQ B	CB	250	A	RHEB
PYRO A-BAT BUS A TO PYRO BUS TIE	CB	250	A	RHEB
PYRO B-BAT BUS B TO PYRO BUS TIE	CB	250	A	RHEB
RCS-LOGIC-MNA	CB	8	C	K-6
RCS-LOGIC-MNB	CB	8	C	K-6
RCS-CMD - ON/CENTER/OFF	Sw	2	I	K-28
RCS-CM HEATERS 1 - MNA	CB	8	C	K-2
RCS-CM HEATERS 2 - MNB	CB	8	C	K-2
RCS-SM HEATERS A	CB	8	C	K-3
RCS-SM HEATERS B	CB	8	C	K-4
RCS-SM HEATERS C	CB	8	C	K-3
RCS-SM HEATERS D	CB	8	C	K-4
RCS INDICATORS-CM/SM	Sw	2	I	G-33
RCS-PRPLNT ISOL-MNA	CB	8	C	K-5

REACTION CONTROL SYSTEM - LOCATOR INDEX

SM2A-03-BLOCK II-(1)
 APOLLO OPERATIONS HANDBOOK

REACTION CONTROL SYSTEM - LOCATOR INDEX

Control/Display Nomenclature	Type	Panel Locator		
		Number	Area	Grid
RCS-PRPLNT ISOL-MNB	CB	8	C	K-5
RCS-TRNFR - CM/CENTER/SM	Sw	2	I	K-29
SM RCS A	Lt	2	A	D-30
SM RCS B	Lt	2	A	D-30
SM RCS C	Lt	2	A	D-31
SM RCS D	Lt	2	A	D-31
SM RCS HEATERS A - PRI/OFF/SEC	Sw	2	I	J-28
SM RCS HEATERS-B - PRI/OFF/SEC	Sw	2	I	J-29
SM RCS HEATERS-C - PRI/OFF/SEC	Sw	2	I	J-29
SM RCS HEATERS-D - PRI/OFF/SEC	Sw	2	I	J-30
SM RCS-HELIUM 1-A	Indicator	2	I	F-30
SM RCS-HELIUM 1-A OPEN/CENTER/CLOSE	Sw	2	I	G-30
SM RCS-HELIUM 1-B	Indicator	2	I	F-31
SM RCS-HELIUM 1 - B/OPEN/CENTER/CLOSE	Sw	2	I	G-31
SM RCS-HELIUM 1-C	Indicator	2	I	F-31
SM RCS-HELIUM 1 - C/OPEN/CENTER/CLOSE	Sw	2	I	G-31
SM RCS-HELIUM 1-D	Indicator	2	I	F-31
SM RCS-HELIUM 1 - D/OPEN/CENTER/CLOSE	Sw	2	I	G-31
SM RCS-HELIUM 2-A	Indicator	2	I	H-30
SM RCS-HELIUM 2 - A/OPEN/CENTER/CLOSE	Sw	2	I	I-30
SM RCS-HELIUM 2-B	Indicator	2	I	H-31
SM RCS-HELIUM 2 - B/OPEN/CENTER/CLOSE	Sw	2	I	I-31
SM RCS-HELIUM 2-C	Indicator	2	I	H-31
SM RCS-HELIUM 2 - C/OPEN/CENTER/CLOSE	Sw	2	I	I-31
SM RCS-HELIUM 2-D	Indicator	2	I	H-31

REACTION CONTROL SYSTEM - LOCATOR INDEX

SM2A-03-BLOCK II-(1)
APOLLO OPERATIONS HANDBOOK

REACTION CONTROL SYSTEM - LOCATOR INDEX

Control/Display Nomenclature	Type	Panel Locator		
		Number	Area	Grid
SM RCS-HELIUM 2 - D/OPEN/CENTER/CLOSE	Sw	2	I	I-31
SM RCS IND - HE TK TEMP/PRPLNT QTY	Sw	2	I	I-30
SM RCS-PRESS-He	Meter	2	I	F-28
SM RCS-PRESS/SEC FUEL	Meter	2	I	F-29
SM RCS PRPLNT A - OPEN/CENTER/CLOSE	Sw	2	I	J-30
SM RCS PRPLNT B - OPEN/CENTER/CLOSE	Sw	2	I	J-31
SM RCS PRPLNT C - OPEN/CENTER/CLOSE	Sw	2	I	J-31
SM RCS PRPLNT D - OPEN/CENTER/CLOSE	Sw	2	I	J-31
SM RCS PRPLNT EVENT INDICATORS - PRIM PRPLNT/A	Indicator	2	I	I-30
SM RCS PRPLNT EVENT INDICATORS - SEC PRPLNT/A	Indicator	2	I	K-30
SM RCS PRPLNT EVENT INDICATORS - PRIM PRPLNT/B	Indicator	2	I	I-31
SM RCS PRPLNT EVENT INDICATORS - SEC PRPLNT/B	Indicator	2	I	K-31
SM RCS PRPLNT EVENT INDICATORS - PRIM PRPLNT/C	Indicator	2	I	I-31
SM RCS PRPLNT EVENT INDICATORS - SEC PRPLNT/C	Indicator	2	I	K-31
SM RCS PRPLNT EVENT INDICATORS - PRIM PRPLNT/D	Indicator	2	I	I-31
SM RCS PRPLNT EVENT INDICATORS - SEC PRPLNT/D	Indicator	2	I	K-31
SM RCS-PRPLNT QTY - He/TK/TEMP	Meter	2	I	F-29
SM RCS SEC PRPLNT FUEL PRESS - A/OPEN/CENTER/CLOSE	Sw	2	I	L-30
SM RCS SEC PRPLNT FUEL PRESS - B/OPEN/CENTER/CLOSE	Sw	2	I	L-31

REACTION CONTROL SYSTEM - LOCATOR INDEX

SM2A-03-BLOCK II-(1)
 APOLLO OPERATIONS HANDBOOK

REACTION CONTROL SYSTEM - LOCATOR INDEX

Control/Display Nomenclature	Type	Panel Locator		
		Number	Area	Grid
SM RCS SEC PRPLNT FUEL PRESS - C/OPEN/ CENTER/CLOSE	Sw	2	I	L-31
SM RCS SEC PRPLNT FUEL PRESS - D/OPEN CENTER/CLOSE	Sw	2	I	L-31
SM RCS-TEMP PKG	Meter	2	I	F-28

REACTION CONTROL SYSTEM - LOCATOR INDEX

SM2A-03-BLOCK II-(1)
APOLLO OPERATIONS HANDBOOK

ELECTRICAL POWER SYSTEM - LOCATOR INDEX

Control/Display Nomenclature	Type	Panel Locator		
		Number	Area	Grid
AC BUS 1	Lt	2	A	C-34
AC BUS 2	Lt	2	A	C-34
AC BUS 1 OVERLOAD	Lt	2	A	C-34
AC BUS 2 OVERLOAD	Lt	2	A	C-34
AC INDICATOR - BUS 1/BUS 2	Sw	3	E	P-51
AC INVERTER - AC BUS 1 - RESET/CENTER/OFF	Sw	3	E	O-50
AC INVERTER - AC BUS 2 - RESET/CENTER/OFF	Sw	3	E	P-50
AC INVERTER-1 - MNA/OFF	Sw	3	E	N-49
AC INVERTER - AC BUS 1 - 1/OFF	Sw	3	E	O-49
AC INVERTER - AC BUS 2 - 1/OFF	Sw	3	E	P-49
AC INVERTER-2 - MNB/OFF	Sw	3	E	N-49
AC INVERTER - AC BUS 1 - 2/OFF	Sw	3	E	O-49
AC INVERTER - AC BUS 2 - 2/OFF	Sw	3	E	P-49
AC INVERTER-3 - MNA/OFF/MNB	Sw	3	E	N-50
AC INVERTER - AC BUS 1 - 3/OFF	Sw	3	E	O-50
AC INVERTER - AC BUS 2 - 3/OFF	Sw	3	E	P-50
AC VOLTS	Meter	3	E	O-51
BAT A PWR ENTRY/POST LANDING	CB	250	B	RHEB
BAT B PWR ENTRY/POST LANDING	CB	250	B	RHEB
BAT C PWR ENTRY/POST LANDING	CB	250	B	RHEB
BAT C TO BAT BUS A	CB	250	B	RHEB
BAT C TO BAT BUS B	CB	250	B	RHEB
BATTERY CHARGE - OFF/A/B/C	Sw	3	E	M-51
BAT CHGR - AC1/AC2	Sw	5	F	H-58
BATTERY CHARGER-AC PWR	CB	5	F	I-63

ELECTRICAL POWER SYSTEM - LOCATOR INDEX

SM2A-03-BLOCK II-(1)
 APOLLO OPERATIONS HANDBOOK

ELECTRICAL POWER SYSTEM - LOCATOR INDEX

Control/Display Nomenclature	Type	Panel Locator		
		Number	Area	Grid
BATTERY CHARGER-BAT B CHG	CB	5	F	I-61
BAT C BAT CHGR/EDS 2	CB	250	B	RHEB
BATTERY CHARGER-MNA	CB	5	F	I-61
BATTERY CHARGER-MNB	CB	5	F	I-62
BAT RLY BUS-BAT A	CB	5	F	H-62
BAT RLY BUS-BAT B	CB	5	F	H-63
CRYO PRESS	Lt	2	A	C-31
CRYOGENIC FAN MOTORS-TANK 1-AC 1 - ϕ A	CB	226	A	RHEB
CRYOGENIC FAN MOTORS-TANK 1-AC 1 - ϕ B	CB	226	A	RHEB
CRYOGENIC FAN MOTORS-TANK 1-AC 1 - ϕ C	CB	226	A	RHEB
CRYOGENIC FAN MOTORS-TANK 2-AC 2 - ϕ A	CB	226	A	RHEB
CRYOGENIC FAN MOTORS-TANK 2-AC 2 - ϕ B	CB	226	A	RHEB
CRYOGENIC FAN MOTORS-TANK 2-AC 2 - ϕ C	CB	226	A	RHEB
CRYOGENIC-H2 HTR 1-MNA	CB	226	A	RHEB
CRYOGENIC-H2 HTR 2-MNB	CB	226	A	RHEB
CRYOGENIC-O2 HTR 1-MNA	CB	226	A	RHEB
CRYOGENIC-O2 HTR 2-MNB	CB	226	A	RHEB
CRYOGENIC-QTY AMPL 1-AC 1	CB	226	A	RHEB
CRYOGENIC-QTY AMPL 2-AC 2	CB	226	A	RHEB
CRYOGENIC TANKS-PRESSURE H2-1 & 2	Meter	2	Q	F-37
CRYOGENIC TANKS-PRESSURE O2-1 & 2	Meter	2	Q	F-38
CRYOGENIC TANKS-QUANTITY H2-1 & 2	Meter	2	Q	F-39
CRYOGENIC TANKS-QUANTITY O2-1 & 2	Meter	2	Q	F-40

ELECTRICAL POWER SYSTEM - LOCATOR INDEX

SM2A-03-BLOCK II-(1)
 APOLLO OPERATIONS HANDBOOK

ELECTRICAL POWER SYSTEM - LOCATOR INDEX

Control/Display Nomenclature	Type	Panel Locator		
		Number	Area	Grid
DC AMPS	Meter	3	E	J-49
DC INDICATORS - FUEL CELL/MAIN BUS/BAT BUS/BAT CHARGER/BAT C/PYRO BAT	Sw	3	E	M-49
DC VOLTS	Meter	3	E	K-49
EPS-BAT BUS A	CB	229	F	RHEB
EPS-BAT BUS B	CB	229	F	RHEB
EPS-MN A-GROUP 1	CB	229	A	RHEB
EPS-MN B-GROUP 1	CB	229	A	RHEB
EPS-MN A-GROUP 2	CB	229	C	RHEB
EPS-MN B-GROUP 2	CB	229	C	RHEB
EPS-MN A-GROUP 3	CB	229	D	RHEB
EPS-MN B-GROUP 3	CB	229	D	RHEB
EPS-MN A-GROUP 4	CB	229	D	RHEB
EPS-MN B-GROUP 4	CB	229	D	RHEB
EPS-MN A-GROUP 5	CB	229	D	RHEB
EPS-MN B-GROUP 5	CB	229	D	RHEB
EPS SENSOR SIGNAL-AC1	CB	5	F	G-61
EPS SENSOR SIGNAL-AC2	CB	5	F	G-62
EPS SENSOR SIGNAL-MNA	CB	5	F	G-59
EPS SENSOR SIGNAL-MNB	CB	5	F	G-60
EPS SENSOR UNIT-AC BUS 1	CB	5	F	H-62
EPS SENSOR UNIT-AC BUS 2	CB	5	F	H-62
EPS SENSOR UNIT-DC BUS A	CB	5	F	H-61
EPS SENSOR UNIT-DC BUS B	CB	5	F	H-61

ELECTRICAL POWER SYSTEM - LOCATOR INDEX

SM2A-03-BLOCK II-(1)
 APOLLO OPERATIONS HANDBOOK

ELECTRICAL POWER SYSTEM - LOCATOR INDEX

Control/Display Nomenclature	Type	Panel Locator		
		Number	Area	Grid
FC 1	Lt	2	A	C-33
FC 2	Lt	2	A	C-34
FC 3	Lt	2	A	C-34
FC BUS DISCONNECT	Lt	2	A	C-33
FC RAD TEMP LOW	Indicator	3	E	G-46
FC REACS VALVES - NORM/LATCH	Sw	3	D	P-42
FLIGHT/POST LANDING-BAT BUS A	CB	275		RHEB
FLIGHT/POST LANDING-BAT BUS B	CB	275		RHEB
FLIGHT/POST LANDING-BAT C	CB	275		RHEB
FLIGHT/POST LANDING-MAIN A	CB	275		RHEB
FLIGHT/POST LANDING-MAIN B	CB	275		RHEB
FUEL CELL-FLOW-H2/O2	Meter	3	E	F-44
FUEL CELL HEATERS - 1/OFF	Sw	3	E	J-44
FUEL CELL HEATERS - 2/OFF	Sw	3	E	J-45
FUEL CELL HEATERS - 3/OFF	Sw	3	E	J-45
FUEL CELL INDICATOR - 1/2/3	Sw	3	E	I-47
FUEL CELL MAIN BUS A-1 - ON/CENTER/OFF	Sw	3	E	K-46
FUEL CELL MAIN BUS A-2 - ON/CENTER/OFF	Sw	3	E	K-46
FUEL CELL MAIN BUS A-3 - ON/CENTER/OFF	Sw	3	E	K-47
FUEL CELL MAIN BUS A-RESET/CENTER/OFF	Sw	3	E	K-48
FUEL CELL MAIN BUS A-1	Indicator	3	E	K-46
FUEL CELL MAIN BUS A-2	Indicator	3	E	K-46
FUEL CELL MAIN BUS A-3	Indicator	3	E	K-47

ELECTRICAL POWER SYSTEM - LOCATOR INDEX

SM2A-03-BLOCK II-(1)
 APOLLO OPERATIONS HANDBOOK

ELECTRICAL POWER SYSTEM - LOCATOR INDEX

Control/Display Nomenclature	Type	Panel Locator		
		Number	Area	Grid
FUEL CELL MAIN BUS B-1 ON/CENTER/OFF	Sw	3	E	M-46
FUEL CELL MAIN BUS B-2 ON/CENTER/OFF	Sw	3	E	M-46
FUEL CELL MAIN BUS B-3 ON/CENTER/OFF	Sw	3	E	M-47
FUEL CELL MAIN BUS B-RESET/CENTER/OFF	Sw	3	E	M-48
FUEL CELL MAIN BUS B - 1	Indicator	3	E	L-46
FUEL CELL MAIN BUS B - 2	Indicator	3	E	L-46
FUEL CELL MAIN BUS B - 3	Indicator	3	E	L-47
FUEL CELL-MODULE TEMP-SKIN/COND EXH	Meter	3	E	F-45
FUEL CELL PUMPS 1 - AC1/OFF/AC2	Sw	5	A	H-54
FUEL CELL PUMPS 2 - AC1/OFF/AC2	Sw	5	A	H-54
FUEL CELL PUMPS 3 - AC1/OFF/AC2	Sw	5	A	H-55
FUEL CELL PURGE-1 - H2/OFF/O2	Sw	3	E	K-44
FUEL CELL PURGE-2 - H2/OFF/O2	Sw	3	E	K-45
FUEL CELL PURGE-3 - H2/OFF/O2	Sw	3	E	K-45
FUEL CELL RADIATORS-1 - NORMAL/EMER BYPASS	Sw	3	E	I-44
FUEL CELL RADIATORS-1	Indicator	3	E	H-44
FUEL CELL RADIATORS-2 - NORMAL/EMER BYPASS	Sw	3	E	I-45
FUEL CELL RADIATORS-2	Indicator	3	E	H-45
FUEL CELL RADIATORS-3 - NORMAL/EMER BYPASS	Sw	3	E	I-45
FUEL CELL RADIATORS-3	Indicator	3	E	H-45
FUEL CELL REACTANTS-1/CENTER/OFF	Sw	3	E	M-44
FUEL CELL REACTANTS-1	Indicator	3	E	L-44
FUEL CELL REACTANTS-2/CENTER/OFF	Sw	3	E	M-45
FUEL CELL REACTANTS-2	Indicator	3	E	L-45

ELECTICAL POWER SYSTEM - LOCATOR INDEX

SM2A-03-BLOCK II-(1)
APOLLO OPERATIONS HANDBOOK

ELECTRICAL POWER SYSTEM - LOCATOR INDEX

Control/Display Nomenclature	Type	Panel Locator		
		Number	Area	Grid
FUEL CELL REACTANTS-3/CENTER/OFF	Sw	3	E	M-45
FUEL CELL REACTANTS-3	Indicator	3	E	L-45
FUEL CELL 1-BUS CONT	CB	226	A	RHEB
FUEL CELL 1-PUMPS-AC	CB	226	A	RHEB
FUEL CELL 1-PURGE	CB	226	A	RHEB
FUEL CELL 1-RAD	CB	226	A	RHEB
FUEL CELL 1-REACS	CB	226	A	RHEB
FUEL CELL 2-BUS CONT	CB	226	A	RHEB
FUEL CELL 2-PUMPS-AC	CB	226	A	RHEB
FUEL CELL 2-PURGE	CB	226	A	RHEB
FUEL CELL 2-RAD	CB	226	A	RHEB
FUEL CELL 2-REACS	CB	226	A	RHEB
FUEL CELL 3-BUS CONT	CB	226	A	RHEB
FUEL CELL 3-PUMPS-AC	CB	226	A	RHEB
FUEL CELL 3-PURGE	CB	226	A	RHEB
FUEL CELL 3-RAD	CB	226	A	RHEB
FUEL CELL 3-REACS	CB	226	A	RHEB
H2 HEATERS-1 AUTO/OFF/ON	Sw	2	Q	G-35
H2 HEATERS-2 AUTO/OFF/ON	Sw	2	Q	G-35
H2 FANS-1 - AUTO/OFF/ON	Sw	2	Q	G-38
H2 FANS-2 - AUTO/OFF/ON	Sw	2	Q	G-39
H2 PURGE - LINE HTR/OFF	Sw	3	D	P-42
INVERTER CONTROL-1	CB	5	F	H-59
INVERTER CONTROL-2	CB	5	F	H-60
INVERTER CONTROL-3	CB	5	F	H-60

ELECTRICAL POWER SYSTEM - LOCATOR INDEX

SM2A-03-BLOCK II-(1)
 APOLLO OPERATIONS HANDBOOK

ELECTRICAL POWER SYSTEM - LOCATOR INDEX

Control/Display Nomenclature	Type	Panel Locator		
		Number	Area	Grid
INVERTER POWER-1 - MAIN A	CB	275		RHEB
INVERTER POWER-2 - MAIN B	CB	275		RHEB
INVERTER POWER-3 - MAIN A	CB	275		RHEB
INVERTER POWER-3 - MAIN B	CB	275		RHEB
INV 1-TEMP HI	Lt	2	A	C-33
INV 2-TEMP HI	Lt	2	A	C-34
INV 3-TEMP HI	Lt	2	A	C-34
LM PWR-CSM/OFF/RESET	Sw	2	L	E-31
LM PWR-1/MNB	CB	5	F	G-63
LM PWR-2/MNB	CB	5	F	H-63
MAIN A-BAT BUS A	CB	275		RHEB
MAIN A-BAT C	CB	275		RHEB
MAIN B-BAT C	CB	275		RHEB
MAIN B-BAT BUS B	CB	275		RHEB
MAIN BUS TIE-BAT A/C - AUTO/OFF	Sw	5	F	H-57
MAIN BUS TIE-BAT B/C - AUTO/OFF	Sw	5	F	H-57
MN BUS A UNDERVOLT	Lt	2	A	D-34
MN BUS B UNDERVOLT	Lt	2	A	D-34
NONESS BUS - MNA/OFF/MNB	Sw	5	F	H-58
O2 FANS-1 - AUTO/OFF/ON	Sw	2	Q	G-39
O2 FANS-2 - AUTO/OFF/ON	Sw	2	Q	G-40
O2 HEATERS-1 - AUTO/OFF/ON	Sw	2	Q	G-36
O2 HEATERS-2 - AUTO/OFF/ON	Sw	2	Q	G-37
O2 PRESS IND - TANK 1/SURGE TANK	Sw	2	Q	G-37
O2 VAC ION PUMPS -MNA	CB	229	D	RHEB

ELECTRICAL POWER SYSTEM - LOCATOR INDEX

SM2A-03-BLOCK II-(1)
 APOLLO OPERATIONS HANDBOOK

ELECTRICAL POWER SYSTEM - LOCATOR INDEX

Control/Display Nomenclature	Type	Panel Locator		
		Number	Area	Grid
O2 VAC ION PUMPS - MNB	CB	229	D	RHEB
pH HI	Indicator	3	E	H-44
SYSTEMS TEST	Sw	101	A	LEB
SYSTEMS TEST	Sw	101	A	LEB
SYSTEMS TEST	Meter	101	A	LEB

ELECTRICAL POWER SYSTEM - LOCATOR INDEX

SM2A-03-BLOCK II-(1)
 APOLLO OPERATIONS HANDBOOK

ENVIRONMENTAL CONTROL SYSTEM - LOCATOR INDEX

Control/Display Nomenclature	Type	Panel Locator		
		Number	Area	Grid
ACCUM PRIM/SEC - QUANTITY (GLYCOL)	Meter	2	P	J-37
BATTERY VENT - VENT/CLOSED	Valve	252		RHEB
CABIN FAN 1 - 1/OFF	Sw	2	P	G-34
CABIN FAN 2 - 2/OFF	Sw	2	P	G-34
CABIN PRESSURE RELIEF-CLOSE/NORMAL/ BOOST ENTRY/DUMP	Valve	325		LHEB
CABIN REPRESS-OPEN/OFF	Valve	351		LHEB
CABIN TEMP - AUTO	Thumbwheel	2	P	K-40
CABIN TEMP - AUTO/MAN	Sw	2	P	K-38
CHLORINE INJECT PORT	Fitting	352		LHEB
C/M PRESSURE DIFFERENTIAL	Meter	12	A	P-29
CO2-ODOR ABSORBER A & B	Valve and canister assemblies	350		LHEB
CO2 PP HI	Lt	2	A	C-32
CREWMAN ELECTRICAL UMBILICAL CONNECTOR - C	Connector	BETWEEN 300 & 301		LHFEB
CREWMAN ELECTRICAL UMBILICAL CONNECTOR - L	Connector	BETWEEN 300 & 301		LHFEB
CREWMAN ELECTRICAL UMBILICAL CONNECTOR - R	Connector	BETWEEN 300 & 301		LHFEB
CRYOGENIC TANKS - PRESSURE-02 1 & 2	Meter	2	Q	F-38
DIRECT O2 - OPEN	Valve	7	C	P-6
DRINKING WATER SUPPLY - ON/OFF	Valve	304		LHFEB
ECS-CABIN FAN 1-AC1-φA	CB	5	C	K-61
ECS-CABIN FAN 1-AC1-φB	CB	5	C	K-61
ECS-CABIN FAN 1-AC1-φC	CB	5	C	K-61

ENVIRONMENTAL CONTROL SYSTEM - LOCATOR INDEX

SM2A-03-BLOCK II-(1)
APOLLO OPERATIONS HANDBOOK

ENVIRONMENTAL CONTROL SYSTEM - LOCATOR INDEX

Control/Display Nomenclature	Type	Panel Locator		
		Number	Area	Grid
ECS-CABIN FAN 2-AC2-φA	CB	5	C	K-62
ECS-CABIN FAN 2-AC2-φB	CB	5	C	K-62
ECS-CABIN FAN 2-AC2-φC	CB	5	C	K-62
ECS GLYCOL PUMPS	Sw	4	C	O-59
ECS GLYCOL PUMPS-AC1-φA	CB	4	C	P-61
ECS GLYCOL PUMPS-AC1-φB	CB	4	C	P-61
ECS GLYCOL PUMPS-AC1-φC	CB	4	C	P-61
ECS GLYCOL PUMPS-AC2-φA	CB	4	C	O-61
ECS GLYCOL PUMPS-AC2-φB	CB	4	C	O-61
ECS GLYCOL PUMPS-AC2-φC	CB	4	C	O-61
ECS-H2O ACCUM-MNA	CB	5	C	J-58
ECS-H2O ACCUM-MNB	CB	5	C	J-58
ECS INDICATORS - PRIM/SEC	Sw	2	P	I-33
ECS-POT H2O HTR-MNA	CB	5	C	J-57
ECS-POT H2O HTR-MNB	CB	5	C	J-57
ECS RADIATOR TEMP - PRIM/OUTLET	Meter	2	P	I-35
ECS RADIATOR TEMP - PRIM/SEC/INLET	Meter	2	P	I-34
ECS RADIATOR TEMP - SEC/OUTLET	Meter	2	P	I-36
ECS RADIATORS	Indicator	2	P	J-33
ECS RADIATORS-CONT/HTRS-MNA	CB	5	C	I-58
ECS RADIATORS-CONT/HTRS-MNB	CB	5	C	I-59
ECS RADIATORS-CONTROLLER-AC1	CB	5	C	I-58
ECS RADIATORS-CONTROLLER-AC2	CB	5	C	I-58
ECS RADIATORS-FLOW CONT - AUTO/1/2	Sw	2	P	J-33
ECS RADIATORS-FLOW CONT - PWR/CENTER/ MAN SEL MODE	Sw	2	P	J-33

ENVIRONMENTAL CONTROL SYSTEM - LOCATOR INDEX

SM2A-03-BLOCK II-(1)
APOLLO OPERATIONS HANDBOOK

ENVIRONMENTAL CONTROL SYSTEM - LOCATOR INDEX

Control/Display Nomenclature	Type	Panel Locator		
		Number	Area	Grid
ECS RADIATORS-HEATER - PRIM 1/CENTER/ PRIM 2	Sw	2	P	J-34
ECS RADIATORS-HEATER - SEC/OFF	Sw	2	P	J-35
ECS RADIATORS-HTRS OVLD-BAT A	CB	5	C	I-60
ECS RADIATORS-HTRS OVLD-BAT B	CB	5	C	I-60
ECS RADIATORS-MAN SEL - RAD 1/CENTER/RAD 2	Sw	2	P	J-34
ECS-SECONDARY COOLANT LOOP-AC1	CB	5	C	L-54
ECS-SECONDARY COOLANT LOOP-AC2	CB	5	C	L-55
ECS-SECONDARY COOLANT LOOP-RAD HTR MNA	CB	5	C	L-56
ECS-SECONDARY COOLANT LOOP-XDUCERS-MNA	CB	5	C	L-57
ECS-SECONDARY COOLANT LOOP-XDUCERS-MNB	CB	5	C	L-57
ECS-TRANSDUCER-PRESS GROUPS 1-MNA	CB	5	C	J-61
ECS-TRANSDUCER-PRESS GROUPS 1-MNB	CB	5	C	J-61
ECS-TRANSDUCER-PRESS GROUPS 2-MNA	CB	5	C	J-62
ECS-TRANSDUCER-PRESS GROUPS 2-MNB	CB	5	C	J-62
ECS-TRANSDUCER-TEMP-MNA	CB	5	C	J-63
ECS-TRANSDUCER-TEMP-MNB	CB	5	C	J-63
ECS-TRANSDUCER-WASTE/POT H2O-MNA	CB	5	C	J-60
ECS-TRANSDUCER-WASTE/POT H2O-MNB	CB	5	C	J-60
ECS-WASTE H2O/URINE-DUMP HTR-MNA	CB	5	C	K-58
ECS-WASTE H2O/URINE-DUMP HTR-MNB	CB	5	C	K-58
EMERGENCY CABIN PRESSURE-OFF/1/BOTH/2	Valve	351		LHEB
EMERGENCY CABIN PRESSURE - PRESS TO TEST	Valve	351		LHEB
EMERGENCY CABIN PRESSURE - GSE TEST PORT	Fitting	351		LHEB
EMERGENCY O2-OPEN/CLOSE	Valve	600		UEB

ENVIRONMENTAL CONTROL SYSTEM - LOCATOR INDEX

SM2A-03-BLOCK II-(1)
 APOLLO OPERATIONS HANDBOOK

ENVIRONMENTAL CONTROL SYSTEM - LOCATOR INDEX

Control/Display Nomenclature	Type	Panel Locator		
		Number	Area	Grid
EVAP WATER CONTROL-PRIMARY-AUTO/OFF	Valve	382		LHEB
EVAP WATER CONTROL-SECONDARY-AUTO/OFF	Valve	382		LHEB
FOOD PREPARATION WATER - COLD/HOT	Valve	305		LHFEB
GLY DISCH-PRIM/SEC-PRESS	Meter	2	P	I-38
GLY EVAP-H2O FLOW - AUTO/CENTER/ON	Sw	2	P	K-38
GLYCOL EVAPORATOR-PRIM/SEC-STEAM PRESS	Meter	2	P	I-37
GLYCOL EVAP-STEAM PRESS - AUTO/MAN	Sw	2	P	K-37
GLYCOL EVAP-STEAM PRESS - INCR/CENTER/DECR	Sw	2	P	K-37
GLYCOL EVAP - TEMP IN - AUTO/MAN	Sw	2	P	K-36
GLYCOL EVAP - TEMP IN	Valve	382		LHEB
GLYCOL EVAPORATOR-TEMP-PRIM/SEC-OUTLET	Meter	2	P	I-36
GLYCOL RESERVOIR-BYPASS-OPEN/CLOSE	Valve	326		LHEB
GLYCOL RESERVOIR-INLET-OPEN/CLOSE	Valve	326		LHEB
GLYCOL RESERVOIR-OUTLET-OPEN/CLOSE	Valve	326		LHEB
GLYCOL TEMP LOW	Lt	2	A	C-32
GLYCOL TO RADIATORS-SEC-NORMAL/BYPASS	Valve	377		LHEB
H2O-QUANTITY	Meter	2	P	J-37
H2O QTY IND - POT/WASTE	Sw	2	P	K-36
LM/CM PRESSURE DIFFENTIAL - PSI	Meter	12	A	P-29
LM TUNNEL VENT OFF/LM PRESS/LM-CM ΔP/LM TUNNEL VENT	Valve	12	A	O-29
MAIN REGULATOR (Oxygen) - "A" OPEN	Valve	351		LHEB
MAIN REGULATOR (Oxygen) - "B" OPEN	Valve	351		LHEB
O2 DEMAND REGULATOR-1/BOTH/2/OFF	Valve	380		LHEB

ENVIRONMENTAL CONTROL SYSTEM - LOCATOR INDEX

SM2A-03-BLOCK II-(1)
APOLLO OPERATIONS HANDBOOK

ENVIRONMENTAL CONTROL SYSTEM - LOCATOR INDEX

Control/Display Nomenclature	Type	Panel Locator		
		Number	Area	Grid
O2 FLOW	Meter	2	S	C-29
O2 FLOW HI	Lt	2	A	D-34
O2 PRESS IND - TANK 1/SURGE TANK	Sw	2	Q	G-37
OXYGEN-PLSS-ON/OFF/FILL	Valve	326		LHEB
OXYGEN REPRESS PRESSURE	Gage	602		UEB
OXYGEN REPRESS PRESSURE RELIEF-AUTO/OFF	Valve	602		UEB
OXYGEN-S/M SUPPLY-ON/OFF	Valve	326		LHEB
OXYGEN-SURGE TANK-ON/OFF	Valve	326		LHEB
PART PRESS CO2	Meter	2	P	I-40
PGA PRESSURE INDICATOR	Meter	LEFT ARM OF PRESSURE SUIT		
PLVC - NORMAL/OPEN	Sw	376		LHEB
PL VENT FLT/PL	CB	8	F	M-5
POST LANDING-VENT - HIGH/LOW/OFF	Sw	15	C	C-19
POT H2O HTR - MNA/OFF/MNB	Sw	2	P	K-32
POTABLE TANK INLET-OPEN/CLOSE	Valve	352		LHEB
PRESS-CABIN	Meter	2	P	I-40
PRESS-SUIT	Meter	2	P	I-39
PRESSURE EQUALIZATION VALVE	Valve	C/M TUNNEL HATCH		
PRESSURE RELIEF (Water)-DUMP A/DUMP B/ OFF/2	Valve	352		LHEB
PRIM ACCUM FILL-ON/OFF	Valve	379		LHEB
PRIMARY CABIN TEMP H/C	Valve	303		LHFEB
PRIMARY GLYCOL TO RADIATORS-PULL TO BYPASS	Valve	325		LHEB
PRIM GLYCOL ACCUM-OPEN/CLOSE	Valve	378		LHEB
PRIMARY GLYCOL EVAP INLET TEMP-MIN/MAX	Valve	382		LHEB

ENVIRONMENTAL CONTROL SYSTEM - LOCATOR INDEX

SM2A-03-BLOCK II-(1)
APOLLO OPERATIONS HANDBOOK

ENVIRONMENTAL CONTROL SYSTEM - LOCATOR INDEX

Control/Display Nomenclature	Type	Panel Locator		
		Number	Area	Grid
REPRESS O2-OPEN/CLOSE	Valve	601		UEB
SEC COOLANT LOOP - EVAP/CENTER/RESET	Sw	2	P	K-35
SEC COOLANT LOOP - PUMP AC 1/CENTER/AC 2	Sw	2	P	K-35
SECONDARY CABIN TEMP-OFF/COOL/MAX	Valve	303		LHFEB
SUIT/CABIN ΔP	Meter	2	S	C-28
SUIT CIRCUIT-HEAT EXCH - ON/CENTER/BYPASS	Sw	2	P	K-34
SUIT CIRCUIT-H2O ACCUM - AUTO 1/CENTER/ AUTO 2	Sw	2	P	K-33
SUIT CIRCUIT-H2O ACCUM - 1 ON/CENTER/2 ON	Sw	2	P	K-33
SUIT CIRCUIT RETURN-PULL TO OPEN/PUSH TO CLOSE	Valve	380		LHEB
SUIT COMPR ΔP	Meter	2	P	J-36
SUIT COMPRESSOR	Lt	2	A	D-35
SUIT COMPRESSOR-1 - AC1/OFF/AC2	Sw	4	C	O-60
SUIT COMPRESSOR-2 - AC1/OFF/AC2	Sw	4	C	N-60
SUIT COMPRESSORS-AC1-φA	CB	4	C	P-60
SUIT COMPRESSORS-AC1-φB	CB	4	C	P-60
SUIT COMPRESSORS-AC1-φC	CB	4	C	P-60
SUIT COMPRESSORS-AC2-φA	CB	4	C	O-61
SUIT COMPRESSORS-AC2-φB	CB	4	C	O-61
SUIT COMPRESSORS-AC2-φC	CB	4	C	O-61
SUIT FLOW CONTROL	Valve	300		LHFEB
SUIT FLOW CONTROL	Valve	301		LHFEB
SUIT FLOW CONTROL	Valve	302		LHFEB
SUIT HT EXCH PRIMARY GLYCOL - FLOW/ BYPASS	Valve	382		LHEB

ENVIRONMENTAL CONTROL SYSTEM - LOCATOR INDEX

SM2A-03-BLOCK II-(1)
 APOLLO OPERATIONS HANDBOOK

ENVIRONMENTAL CONTROL SYSTEM - LOCATOR INDEX

Control/Display Nomenclature	Type	Panel Locator		
		Number	Area	Grid
SUIT HT EXCH SECONDARY GLYCOL-FLOW/ BYPASS	Valve	382		LHEB
SURGE TANK PRESSURE RELIEF-OPEN/CLOSE	Valve	375		LHEB
TEMP-CABIN	Meter	2	P	I-39
TEMP-SUIT	Meter	2	P	I-38
TOOL STORAGE	Fitting	351		LHEB
URINE DUMP HTR - HTR A/OFF/HTR B	Sw	101		LEB
WASTE H ₂ O DUMP HTR HTRA/OFF/HTRB	Sw	101	C	LEB
WASTE MANAGEMENT - OVBD DRAIN DUMP/OFF	Valve	251		RHEB
WASTE TANK INLET-AUTO/CLOSE	Valve	352		LHEB
WASTE TANK SERVICING-OPEN/CLOSE	Valve & Fitting	352		LHEB
WATER ACCUMULATOR-1-MAN/OFF/RMTE	Valve	382		LHEB
WATER ACCUMULATOR-2-MAN/OFF/RMTE	Valve	382		LHEB
WATER & GLYCOL TANKS PRESSURE-REGULATOR- SELECTOR INLET-BOTH/1/OFF/2	Valve	351		LHEB
WATER & GLYCOL TANKS PRESSURE-RELIEF- SELECTOR OUTLET-BOTH/1/OFF/2	Valve	351		LHEB

ENVIRONMENTAL CONTROL SYSTEM - LOCATOR INDEX

APOLLO OPERATIONS HANDBOOK

TELECOMMUNICATIONS - CONTROLS/DISPLAYS - LOCATOR INDEX

Control/Display Nomenclature	Type	Panel Locator		
		Number	Area	Grid
AUDIO CONTROL - NORM/BACKUP	Sw	6	A	F-54
AUDIO CONTROL - NORM/BACKUP	Sw	9	A	E-10
AUDIO CONTROL - NORM/BACKUP	Sw	10	A	Q-33
CENTRAL TIMING EQUIP - MN A	CB	225		RHEB
CENTRAL TIMING EQUIP - MN B	CB	225		RHEB
FLT BUS - MNA	CB	225		RHEB
FLT BUS - MNB	CB	225		RHEB
HIGH GAIN ANT - POWER/STBY/OFF	Sw	2	R	O-39
HIGH GAIN ANT - SERVO ELEC - PRIM/SEC	Sw	2	R	O-40
HIGH GAIN ANTENNA - BEAM - WIDE/MED/NARROW	Sw	2	R	M-38
HIGH GAIN ANTENNA FLT BUS	CB	225		RHEB
HIGH GAIN ANTENNA GROUP 2	CB	225		RHEB
HIGH GAIN ANTENNA - PITCH	Meter	2	R	M-38
HIGH GAIN ANTENNA - PITCH POSITION	Sw	2	R	N-38
HIGH GAIN ANTENNA/S-BAND ANTENNA	Meter	2	R	M-39
HIGH GAIN ANTENNA - TRACK - AUTO/MAN/REACQ	Sw	2	R	M-37
HIGH GAIN ANTENNA - YAW	Meter	2	R	M-40
HIGH GAIN ANTENNA - YAW POSITION	Sw	2	R	N-40
INTERCOM-T/R/OFF/RCV/VOLUME	Sw/Thumbwheel	6	A	C-53
INTERCOM-T/R/OFF/RCV/VOLUME	Sw/Thumbwheel	9	A	B-13
INTERCOM-T/R/OFF/RCV/VOLUME	Sw/Thumbwheel	10	A	P-35
MASTER VOLUME	Thumbwheel	10	A	N-35
MASTER VOLUME	Thumbwheel	6	A	B-53

TELECOMMUNICATIONS - CONTROLS/DISPLAYS - LOCATOR INDEX

SM2A-03-BLOCK II-(1)
 APOLLO OPERATIONS HANDBOOK

TELECOMMUNICATIONS - CONTROLS/DISPLAYS - LOCATOR INDEX

Control/Display Nomenclature	Type	Panel Locator		
		Number	Area	Grid
MASTER VOLUME	Thumbwheel	9	A	A-13
MODE - INTERCOM/PTT/OFF/VOX	Sw	6	A	B-51
MODE - INTERCOM/PTT/OFF/VOX	Sw	9	A	A-12
MODE - INTERCOM/PTT/OFF/VOX	Sw	10	A	N-31
PAD COMM - T/R/OFF/RCV/VOLUME	Sw/Thumbwheel	6	A	C-51
PAD COMM - T/R/OFF/RCV/VOLUME	Sw/Thumbwheel	9	A	B-11
PAD - COMM - T/R/OFF/RCV/VOLUME	Sw/Thumbwheel	10	A	P-31
PCM BIT RATE-HIGH/LOW	Sw	3	C	P-47
PCM TLM-GROUP 1	CB	225		RHEB
PCM TLM-GROUP 2	CB	225		RHEB
PMP POWER FLT AUX BUS	CB	225		RHEB
PMP POWER FLT PRIM BUS	CB	225		RHEB
POWER - AUDIO/TONE/OFF/AUDIO	Sw	6	A	B-53
POWER - AUDIO/TONE/OFF/AUDIO	Sw	9	A	A-14
POWER - AUDIO/TONE/OFF/AUDIO	Sw	10	A	N-35
POWER-PMP - NORM/AUX	Sw	3	C	P-47
POWER-SCE - NORM/AUX	Sw	3	C	P-46
PWR AMPL	Indicator	3	C	N-48
RNDZ XPNDR FLT BUS	CB	225		RHEB
RNDZ XPNDR - PWR/OFF/HEATER	Sw	100	C	LEB
RNDZ XPNDR - TEST/OPERATE	Sw	100	A	LEB
S BAND ANTENNA OMNI/A/B/C	Sw	3	C	O-42
S BAND ANTENNA OMNI/D/HI GAIN	Sw	3	C	O-42
S BAND AUX-TAPE/OFF/DN VOICE BU	Sw	3	C	N-45

TELECOMMUNICATIONS - CONTROLS/DISPLAYS - LOCATOR INDEX

SM2A-03-BLOCK II-(1)
 APOLLO OPERATIONS HANDBOOK

TELECOMMUNICATIONS - CONTROLS/DISPLAYS - LOCATOR INDEX

Control/Display Nomenclature	Type	Panel Locator		
		Number	Area	Grid
S BAND AUX TV/OFF/SCI	Sw	3	C	N-46
S BAND FM XMTR-DATA STORAGE EQUIP-GROUP 1	CB	225		RHEB
S BAND FM XMTR-DATA STORAGE EQUIP-FLT BUS	CB	225		RHEB
S BAND NORMAL-PWR AMPL - HIGH/OFF/LOW	Sw	3	C	N-43
S BAND NORMAL-PWR AMPL - PRIM/OFF/SEC	Sw	3	C	N-42
S BAND NORMAL-MODE - VOICE/OFF/RELAY	Sw	3	C	N-43
S BAND NORMAL-MODE - RANGING/OFF	Sw	3	C	N-44
S BAND NORMAL-MODE - PCM/OFF/KEY	Sw	3	C	N-44
S BAND NORMAL-XPNDR - PRIM/OFF/SEC	Sw	3	C	N-42
S BAND PWR AMPL/PHASE MOD XPNDR 1-FLT BUS	CB	225		RHEB
S BAND PWR AMPL/PHASE MOD XPNDR 2-FLT BUS	CB	225		RHEB
S BAND PWR AMPL/PHASE MOD XPNDR 1-GROUP 1	CB	225		RHEB
S BAND PWR AMPL/PHASE MOD XPNDR 2-GROUP 2	CB	225		RHEB
S BAND SQUELCH-ENABLE/OFF (SC 106 & 107)	Sw	180		LEB
S BAND SQUELCH-ENABLE/OFF (SC 108 & subs)	Sw	3	C	O-47
S BAND-T/R/OFF/RCV/VOLUME	Sw/Thumbwheel	10	A	Q-31
S BAND-T/R/OFF/RCV/VOLUME	Sw/Thumbwheel	6	A	D-52
S BAND-T/R/OFF/RCV/VOLUME	Sw/Thumbwheel	9	A	C-11
SIG COND FLT BUS	CB	225		RHEB
SUIT - POWER/OFF	Sw	6	A	E-54
SUIT - POWER/OFF	Sw	9	A	E-11
SUIT - POWER/OFF	Sw	10	A	P-33
TAPE MOTION	Indicator	3	C	O-48
TAPE RECORDER-FWD/OFF/REWIND	Sw	3	C	P-46
TAPE RECORDER - PCM/ANLG/LM PCM	Sw	3	C	P-45

TELECOMMUNICATIONS - CONTROLS/DISPLAYS - LOCATOR INDEX

SM2A-03-BLOCK II-(1)
 APOLLO OPERATIONS HANDBOOK

TELECOMMUNICATIONS - CONTROLS/DISPLAYS - LOCATOR INDEX

Control/Display Nomenclature	Type	Panel Locator		
		Number	Area	Grid
TAPE RECORDER-RECORD/OFF/PLAY	Sw	3	C	P-45
TELCOM-GROUP 1 - AC1/OFF/AC2	Sw	4	B	O-58
TELCOM-GROUP 2 - AC1/OFF/AC2	Sw	4	B	N-58
UP TLM - IU ACCEPT/BLOCK	Sw	2	J	I-29
UDL FLT BUS	CB	225		RHEB
UP TLM-CM-ACCEPT/BLOCK	Sw	2	J	I-28
UP TLM-CMD - RESET/NORM/OFF	Sw	3	C	N-47
UP TLM - DATA/UP VOICE BU	Sw	3	C	N-46
VHF AM-A - DUPLEX/OFF/SIMPLEX	Sw	3	C	O-45
VHF AM-B - DUPLEX/OFF/SIMPLEX	Sw	3	C	O-45
VHF AM-RCV ONLY - B DATA/OFF/A	Sw	3	C	O-46
VHF AM - SQUELCH A	Thumbwheel	3	C	O-43
VHF AM - SQUELCH B	Thumbwheel	3	C	P-43
VHF AM - T/R/OFF/RCV/VOLUME	Sw/Thumbwheel	10	A	Q-35
VHF AM - T/R/OFF/RCV/VOLUME	Sw/Thumbwheel	6	A	D-54
VHF AM - T/R/OFF/RCV/VOLUME	Sw/Thumbwheel	9	A	D-13
VHF ANTENNA - SM/LEFT/RIGHT/RECY	Sw	3	A	D-42
VHF BCN - ON/OFF	Sw	3	C	O-46
VHF/CREW STATION AUDIO-L/CTR/R - FLT/POST LDG BUS 3	CB	225		RHEB
VHF - RANGING/OFF	Sw	3	C	O-47
VHF RNG-RESET/NORM	Sw	9	A	E-12
VOX SENS	Thumbwheel	6	A	B-51
VOX SENS	Thumbwheel	9	A	A-12
VOX SENS	Thumbwheel	10	A	N-32

SM2A-03-BLOCK II-(1)
 APOLLO OPERATIONS HANDBOOK
 SEQUENTIAL SYSTEMS - LOCATOR INDEX

Control/Display Nomenclature	Type	Panel Locator		
		Number	Area	Grid
ABORT	Lt	1	I	I-22
ABORT SYSTEM - LV RATES - AUTO/OFF	Sw	2	D	N-25
ABORT SYSTEM - TWR JETT 1/OFF/AUTO	Sw	2	D	N-26
ABORT SYSTEM - TWR JETT 2/OFF/AUTO	Sw	2	D	N-26
ABORT SYSTEM-2 ENG OUT - AUTO/OFF	Sw	2	D	N-25
ALTIMETER	Meter	1	A	C-22
APEX COVER JETT	Pushbutton	1	I	M-23
CANARD DEPLOY	Pushbutton	1	I	N-22
CSM/LM FINAL SEP 1	Sw	2	D	M-25
CSM/LM FINAL SEP 2	Sw	2	D	M-25
CSM/LV SEP	Pushbutton	1	I	N-22
CM/SM SEP - 1	Sw	2	D	M-26
CM/SM SEP - 2	Sw	2	D	M-26
DROGUE DEPLOY	Pushbutton	1	I	M-23
EDS - AUTO/OFF	Sw	2	D	M-24
EDS POWER/OFF	Sw	7	A	M-9
EDS-1-BAT A	CB	8	B	L-3
EDS-2-BAT C	CB	8	B	L-3
EDS-3-BAT B	CB	8	B	L-4
ELS - AUTO/MAN	Sw	1	I	O-21
ELS BAT A	CB	8	B	L-4
ELS BAT B	CB	8	B	L-4
ELS LOGIC	Sw	1	I	O-21
LAUNCH VEHICLE SII/SIVB-LV STAGE/OFF	Sw	2	D	O-24
LES MOTOR FIRE	Pushbutton	1	I	M-22

SEQUENTIAL SYSTEMS - LOCATOR INDEX

SM2A-03-BLOCK II-(1)
 APOLLO OPERATIONS HANDBOOK

SEQUENTIAL SYSTEMS - LOCATOR INDEX

Control/Display Nomenclature	Type	Panel Locator		
		Number	Area	Grid
LIFT OFF/NO AUTO ABORT	Lt/pushbutton	1	I	M-22
LV ENGINES 1 through 5	Lt	1	I	K-22
LV GUID	Lt	1	I	J-22
LV RATE	Lt	1	I	J-22
MAIN DEPLOY	Pushbutton	1	I	N-23
MAIN RELEASE	Sw	2	D	P-24
MAIN RELEASE PYRO A	CB	229	D	RHEB
MAIN RELEASE PYRO B	CB	229	D	RHEB
PYRO A - BAT A TO PYRO BUS TIE	CB	250	A	RHEB
PYRO A - SEQ A	CB	250	A	RHEB
PYRO B - BAT B TO PYRO BUS TIE	CB	250	A	RHEB
PYRO B - SEQ B	CB	250	A	RHEB
SII SEP	Lt	1	I	J-22
SIVB/LM SEP	Sw	2	D	M-27
SIVB/LM SEP-PYRO A	CB	278	B	RHEB
SIVB/LM SEP-PYRO B	CB	278	B	RHEB
SECS-ARM A-BAT A	CB	8	I	L-11
SECS-ARM B-BAT B	CB	8	I	L-11
SECS-LOGIC A-BAT A	CB	8	I	L-10
SECS-LOGIC B-BAT B	CB	8	I	L-10
SECS - LOGIC 1/OFF	Sw	8	I	K-10
SECS - LOGIC 2/OFF	Sw	8	I	K-10
SECS - PYRO ARM A/SAFE	Sw	8	I	K-11
SECS - PYRO ARM B/SAFE	Sw	8	I	K-11

SEQUENTIAL SYSTEMS - LOCATOR INDEX

SM2A-03-BLOCK II-(1)
 APOLLO OPERATIONS HANDBOOK

CAUTION AND WARNING SYSTEM - LOCATOR INDEX

Control/Display Nomenclature	Type	Panel Locator		
		Number	Area	Grid
AC BUS 1	Lt	2	A	C-34
AC BUS 2	Lt	2	A	C-34
AC BUS 1 OVERLOAD	Lt	2	A	C-34
AC BUS 2 OVERLOAD	Lt	2	A	C-34
BMAG 1 TEMP	Lt	2	A	C-30
BMAG 2 TEMP	Lt	2	A	C-30
CAUTION/WARNING - CSM/CM	Sw	2	O	F-35
CAUTION/WARNING - LAMP TEST	Sw	2	O	F-36
CAUTION/WARNING MNA	CB	5	G	G-62
CAUTION/WARNING MNB	CB	5	G	G-62
CAUTION/WARNING - NORMAL/BOOST/ACK	Sw	2	O	F-34
CAUTION/WARNING-POWER	Sw	2	O	F-35
CMC	Lt	2	A	D-33
CM RCS 1	Lt	2	A	C-30
CM RCS 2	Lt	2	A	C-30
CO2 PP HI	Lt	2	A	C-32
CREW ALERT	Lt	2	A	D-33
CRYO PRESS	Lt	2	A	C-31
C/W	Lt	2	A	D-33
FC1	Lt	2	A	C-33
FC2	Lt	2	A	C-34
FC3	Lt	2	A	C-34
FC BUS DISCONNECT	Lt	2	A	C-33
GLYCOL TEMP LOW LIMIT	Lt	2	A	C-32

CAUTION AND WARNING SYSTEM - LOCATOR INDEX

SM2A-03-BLOCK II-(1)
 APOLLO OPERATIONS HANDBOOK
 CAUTION AND WARNING SYSTEM - LOCATOR INDEX

Control/Display Nomenclature	Type	Panel Locator		
		Number	Area	Grid
INV 1 TEMP HI	Lt	2	A	C-33
INV 2 TEMP HI	Lt	2	A	C-34
INV 3 TEMP HI	Lt	2	A	C-34
ISS	Lt	2	A	D-33
MASTER ALARM	Lt/Sw	1	C	H-17
MASTER ALARM	Lt/Sw	3	F	J-46
MASTER ALARM	Lt/Sw	122		LEB
MN BUS A UNDERVOLT	Lt	2	A	D-34
MN BUS B UNDERVOLT	Lt	2	A	D-34
O2 FLOW HI	Lt	2	A	D-34
PITCH GMBL 1	Lt	2	A	C-30
PITCH GMBL 2	Lt	2	A	C-30
SM RCS A	Lt	2	A	D-30
SM RCS B	Lt	2	A	D-30
SM RCS C	Lt	2	A	D-31
SM RCS D	Lt	2	A	D-31
SPS PRESS	Lt	2	A	C-33
SUIT COMPRESSOR	Lt	2	A	D-35
YAW GMBL 1	Lt	2	A	C-30
YAW GMBL 2	Lt	2	A	C-30

CAUTION AND WARNING SYSTEM - LOCATOR INDEX

SM2A-03-BLOCK II-(1)
 APOLLO OPERATIONS HANDBOOK
 MISCELLANEOUS - LOCATOR INDEX

Control/Display Nomenclature	Type	Panel Locator		
		Number	Area	Grid
BATTERY VENT	Valve	252		RHEB
CABIN AIR CONTROL	Louvre	303		LHFEB
COAS POWER - COAS POWER/OFF	Sw	15	A	B-16
COAS POWER - COAS POWER/OFF	Sw	16	A	C-48
DIGITAL EVENT TIMER (no placard)	Display	1	I	J-22
DOCKING TARGET - BRIGHT/DIM/OFF	Sw & Recp	16	A	C-45
EVENT TIMER - MIN-TENS/CENTER/UNITS	Sw	1	L	P-22
EVENT TIMER - MIN-TENS/CENTER/UNITS	Sw	306		LHFEB
EVENT TIMER - RESET/UP/DOWN	Sw	1	L	P-21
EVENT TIMER - RESET/UP/DOWN	Sw	306		LHFEB
EVENT TIMER - SEC-TENS/CENTER/UNITS	Sw	1	L	P-23
EVENT TIMER - SEC-TENS/CENTER/UNITS	Sw	306		LHFEB
EVENT TIMER - START/CENTER/STOP	Sw	1	L	P-22
EVENT TIMER - MIN/SEC	Indicator	306		LHFEB
EVENT TIMER - START/CENTER/STOP	Sw	306		LHFEB
EXTERIOR LIGHTS-RNDZ/OFF/SPOT	Sw	2	K	E-30
EXTERIOR LIGHTS-RUN/EVA-OFF	Sw	2	K	E-29
FLOAT BAG 1L - FILL/OFF/VENT	Sw	8	H	K-8
FLOAT BAG 1-BAT A	CB	8	H	L-8
FLOAT BAG 2R - FILL/OFF/VENT	Sw	8	H	K-9
FLOAT BAG 2-BAT B	CB	8	H	L-9
FLOAT BAG 3 CTR - FILL/OFF/VENT	Sw	8	H	K-9

MISCELLANEOUS - LOCATOR INDEX

SM2A-03-BLOCK II-(1)
 APOLLO OPERATIONS HANDBOOK
 MISCELLANEOUS - LOCATOR INDEX

Control/Display Nomenclature	Type	Panel Locator		
		Number	Area	Grid
FLOAT BAG 3-FLT/PL	CB	8	H	L-9
FLOOD-DIM - 1/2	Sw	8	H	J-7
FLOOD-DIM - 1/2	Sw	100	A	LEB
FLOOD - FIXED/OFF/POST LDG	Sw	8	H	J-7
FLOOD - FIXED/OFF	Sw	100	A	LEB
INSTRUMENTS-ESS-MNA	CB	5	B	K-54
INSTRUMENTS-ESS-MNB	CB	5	B	K-54
INSTRUMENTATION POWER CONTROL OPERATIONAL-CB1	CB	276		RHEB
INSTRUMENTATION POWER CONTROL OPERATIONAL-CB2	CB	276		RHEB
INSTRUMENTATION POWER CONTROL OPERATIONAL-CB3	CB	276		RHEB
INSTRUMENTATION POWER CONTROL OPERATIONAL-CB4	CB	276		RHEB
INSTRUMENTS-SCI EQUIP-HATCH	CB	5	B	K-56
INSTRUMENTS-SCI EQUIP-NON ESS	CB	5	B	K-55
INSTRUMENTS-SCI EQUIP-SEB 1	CB	5	B	K-56
INSTRUMENTS-SCI EQUIP-SEB 2	CB	5	B	K-56
INTERIOR LIGHTS-FLOOD/OFF/BRT	Sw	5	B	I-55
INTERIOR LIGHTS-FLOOD/OFF/BRT	Sw	8	H	I-10
INTERIOR LIGHTS-FLOOD - DIM 1/2	Sw	5	B	I-56
INTERIOR LIGHTS-FLOOD - FIXED/OFF	Sw	5	B	I-57
INTERIOR LIGHTS-INTEGRAL/OFF/BRT	Sw	5	B	I-54
INTERIOR LIGHTS-INTEGRAL/OFF/BRT	Sw	8	H	I-11
INTERIOR LIGHTS-NUMERICS/OFF/BRT	Sw	8	H	I-8

MISCELLANEOUS - LOCATOR INDEX

SM2A-03-BLOCK II-(1)
 APOLLO OPERATIONS HANDBOOK
 MISCELLANEOUS - LOCATOR INDEX

Control/Display Nomenclature	Type	Panel Locator		
		Number	Area	Grid
LEB LIGHTS-FLOOD/OFF/BRT	Sw	100	A	LEB
LEB LIGHTS-INTEGRAL/OFF/BRT	Sw	100	A	LEB
LEB LIGHTS-NUMERICS/OFF/BRT	Sw	100	A	LEB
LIGHTING-FLOOD-FLT/PL	CB	226	B	RHEB
LIGHTING-FLOOD-MNA	CB	226	B	RHEB
LIGHTING-FLOOD-MNB	CB	226	B	RHEB
LIGHTING-NUMERICS/INTEGRAL/LEB-AC2	CB	226	C	RHEB
LIGHTING-NUMERICS/INTEGRAL/L-MDC-AC1	CB	226	C	RHEB
LIGHTING-NUMERICS/INTEGRAL/R-MDC-AC1	CB	226	C	RHEB
LIGHTING-RUN-EVA-TRGT-AC1	CB	226	D	RHEB
LIGHTING-RUN-EVA-TRGT-AC2	CB	226	D	RHEB
LIGHTING-COAS/TUNNEL/RNDZ/SPOT-MNA	CB	226	D	RHEB
LIGHTING-COAS/TUNNEL/RNDZ/SPOT-MNB	CB	226	D	RHEB
MISSION TIMER-HOURS/MIN/SEC	Indicator	2	N	E-34
MISSION TIMER-HOURS/MIN/SEC	Indicator	306		LHFEB
MISSION TIMER - HOURS-TENS/CENTER/UNITS	Sw	2	N	E-35
MISSION TIMER-HOURS-TENS/CENTER/UNITS	Sw	306		LHFEB
MISSION TIMER - MIN-TENS/CENTER/UNITS	Sw	2	N	E-36
MISSION TIMER - MIN-TENS/CENTER/UNITS	Sw	306		LHFEB
MISSION TIMER - SEC-TENS/CENTER/UNITS	Sw	2	N	E-36
MISSION TIMER - SEC-TENS/CENTER/UNITS	Sw	306		LHFEB
MISSION TIMER - START/STOP/RESET	Sw	306		LHFEB
MISSION TIMER - START/STOP/RESET	Sw	2	N	F-36
POST LANDING - BCN LT HI/BCN LT LO	Sw	15	B	B-18
POST LANDING - DYE MARKER	Sw	15	B	B-18

MISCELLANEOUS - LOCATOR INDEX

SM2A-03-BLOCK II-(1)
 APOLLO OPERATIONS HANDBOOK
 MISCELLANEOUS - LOCATOR INDEX

Control/Display Nomenclature	Type	Panel Locator		
		Number	Area	Grid
POST LANDING - VENT HI/LOW/OFF	Sw	15	C	B-19
SCI INST - PWR/OFF	Sw & Recp	227		RHEB
SCI INST - POWER/OFF	Sw & Recp	162		LEB
SCI/UTIL - POWER/OFF	Sw & Recp	163		LEB
SUIT FLOW RELIEF-AUTO/OFF	Valve	382		LHEB
SUIT TEST-PRESS/DEPRESS/OFF	Valve	380		LHEB
TIMERS-MNA	CB	229	B	RHEB
TIMERS-MNB	CB	229	B	RHEB
TUNNEL-LIGHTS/OFF	Sw	2	K	E-31
UPRIGHTING SYSTEM-COMPRESSOR 1	CB	278	A	RHEB
UPRIGHTING SYSTEM-COMPRESSOR 2	CB	278	A	RHEB
URINE DUMP-HTR A/OFF/HTR B	Sw	101	C	LEB
UTILITY POWER - POWER/OFF	Sw & Recp	15	A	B-17
UTILITY POWER - POWER/OFF	Sw & Recp	16	A	C-47
UTILITY R/L STA	CB	229	E	RHEB
UTILITY LEB	CB	229	E	RHEB
UTILITY-POWER/OFF	Sw & Recp	100	A	LEB
WASTE H2O DUMP-HTR A/OFF/HTR B	Sw	101	C	LEB
WASTE STOWAGE VENT - CLOSED/VENT	Valve	252		RHEB

MISCELLANEOUS - LOCATOR INDEX

SM2A-03-BLOCK II-(1)
 APOLLO OPERATIONS HANDBOOK
 DOCKING SYSTEM - LOCATOR INDEX

Control/Display Nomenclature	Type	Panel Locator		
		Number	Area	Grid
DOCK PROBE-MNA	CB	8	L	K-7
DOCK PROBE-MNB	CB	8	L	K-7
DOCKING PROBE INDICATOR A	Ind	2	H	D-28
DOCKING PROBE INDICATOR B	Ind	2	H	D-28
DOCKING PROBE-EXTD/REL/OFF/RETRACT	Sw	2	H	E-28
DOCKING PROBE-RETRACT-PRIM-1/CENTER/2	Sw	2	H	E-28
DOCKING PROBE-RETRACT-SEC-1/CENTER/2	Sw	2	H	E-29

DOCKING SYSTEM - LOCATOR INDEX

SM2A-03-BLOCK II-(1)
APOLLO OPERATIONS HANDBOOK

CONTROLS AND DISPLAYS

Location		Name and Position	Function	Circuit Breaker	Power Source	Remarks
Panel	Area Grid					
MDC-1						
1	A C-22	ALTIMETER	Indicates pressure altitude of command module up to 60,000 feet.			Altimeter is monitored to verify deployment of drogue and main parachutes at proper altitude. Adjustable marker on the dial is set prior to launch. Marker is used as reference for manual deployment of main parachutes during an abort below approximately 10,000 feet.
1	B	Entry Monitor Panel (no placard)		EMS-MNA and MNB (MDC-8)	DC main buses A & B	The two circuit breakers both supply power to EMS. They are separated by diodes.
1	B G-22	Δ V/EMS SET switch INCR	a. Drives Δ V/RANGE display in positive (increasing) direction. b. Slows velocity scroll up to 1 inch in positive (increasing) direction. (See Δ V/RANGE display and FUNCTION switch.)			
		DECR	Used to slow VELOCITY scroll right to left. Drives Δ V/RANGE display in negative direction (decreasing).			
1	B E-19	FUNCTION switch OFF EMS TEST	Deactivates EMS except for SPS THRUST ON light and roll attitude indicator. Tests EMS for de-acceleration < .05 G. (No lamps illuminated.) De-acceleration > .05 G. (.05 G lamp should illuminate.)			a. FUNCTION switch is used to select desired EMS operating function. b. MODE switch will be used in conjunction with FUNCTION switch where required.

MAIN DISPLAY CONSOLE--PANEL 1

SM2A-03-BLOCK II-(1)
APOLLO OPERATIONS HANDBOOK

CONTROLS AND DISPLAYS

Location		Name and Position	Function	Circuit Breaker	Power Source	Remarks
Panel	Area Grid					
MDC-1 (Cont)						
1	B	3	De-acceleration < .262 G a. .05 G lamp illuminates immediately. b. Ten seconds later bottom lamp on RAI is illuminated. c. Enables slewing of $\Delta V/RANGE$ display.	EMS-MNA and MNB (MDC-8)	DC main buses A & B	
		4	EMS system test. a. $\Delta V/RANGE$ display drives to zero ± 0.2 in 10 seconds. b. VELOCITY scroll drives right and left. c. G scribe drives down to 9 g in 10 seconds. d. .05 G lamp on.			
		5	De-acceleration > .262 G. a. Illuminates .05 G lamp immediately. b. Ten seconds later top lamp on RAI is illuminated. c. G scribe drives up to 0.22 \pm 0.1 G. d. Enables slewing scroll to 37,000 fps.			
		RNG SET	Enables slewing $\Delta V/RANGE$ display to initial condition using EMS/ ΔV SET switch. G scribe drives vertically to 0 \pm 0.1 G.			
		Vo SET	Enables slewing VELOCITY scroll to initial condition using EMS/ ΔV SET switch.			
		ENTRY	Operational position for EMS entry display functions.			

MAIN DISPLAY CONSOLE—PANEL 1

SM2A-03-BLOCK II-(1)
 APOLLO OPERATIONS HANDBOOK

CONTROLS AND DISPLAYS

Location		Name and Position	Function	Circuit Breaker	Power Source	Remarks
Panel Area	Grid					
MDC-1 (Cont)						
1	B	<p>ΔV TEST</p> <p>ΔV SET/VHF RNG</p>	<p>Verifies correct operation of:</p> <p>a. SPS THRUST lamp.</p> <p>b. ΔV display (and countdown electronics). (See ΔV SET position.)</p> <p>c. Thrust off command.</p> <p>a. Enables use of EMS/ΔV SET switch to slew ΔV/RANGE display to initial condition for ΔV TEST and SPS thrust monitoring.</p> <p>b. Provides VHF ranging information for ΔV/RANGE display.</p>	EMS-MNA and MNB (MDC-8)	DC main buses A & B	
1	B	<p>ΔV</p> <p>GTA switch</p>	<p>Correct position for SPS thrust monitoring (ΔV display).</p> <p>Bias signal used in ground tests to nullify Earth's gravitation.</p> <p>Bias signal is removed.</p>			EMS panel cover cannot be mounted when switch is in this position.
1	B	<p>NORMAL</p> <p>STBY</p> <p>BACKUP/VHF RNG</p>	<p>Normal position for ENTRY, ΔV, and TEST positions.</p> <p>Inhibits operations in all but ΔV SET, RNG SET, and Vo SET positions of FUNCTION switch.</p> <p>a. A manual backup to automatic .05 G trigger circuits that start scroll drive and RANGE integrator display drive circuits. Also backup to TVC MODES for velocity monitoring.</p>			

MAIN DISPLAY CONSOLE—PANEL 1

SM2A-03-BLOCK II-(1)
APOLLO OPERATIONS HANDBOOK

CONTROLS AND DISPLAYS

Location		Name and Position	Function	Circuit Breaker	Power Source	Remarks
Panel	Area Grid					
MDC-1 (Cont)						
1	B F-19		<p>b. Does not permit negative acceleration spikes into countdown circuits.</p> <p>c. Enables VHF ranging information to be displayed on ΔV/RANGE display.</p>	EMS-MNA and MNB (MDC-8)	DC main buses A & B	
1	B H-21	ΔV DISPLAY/PANEL	<p>a. Provides numerical readout of either range to go or ΔV remaining, depending on position of FUNCTION switch.</p> <p>b. Provides thrust off command to RJEC ON-OFF for SCS configuration.</p> <p>c. Provides readout of LM-CSM ranging during rendezvous.</p>			<p>a. Drive signal originates in EMS electronics and logic.</p> <p>b. Readout units are nautical miles (range) and feet per second (ΔV).</p>
1	B H-19	Roll attitude indicator (no placard) Pointer Top light Bottom light	<p>Indicates roll attitude (lift vector orientation). (Refer to Remarks.)</p> <p>If lit, approximately 10 seconds after .05 G light comes on, indicates de-acceleration $\geq .262$ G.</p> <p>If lit, approximately 10 seconds after .05 G light comes on, indicates de-acceleration $\geq .262$ G.</p>			<p>Drive signal for RAI is obtained from yaw-GDC channels. Signal is enabled when ENTRY-EMS switch is up (not OFF).</p> <p>a. Pointer on RAI should be (if not presently) directed toward lamp that is lit.</p> <p>b. Drive signal from corridor verification circuitry in EMS electronics.</p>
1	B G-21	SPS THRUST light	<p>When lit, indicates ground on low side of the SPS bipropellant solenoid control valves and SPS relays.</p> <p>When not lit, indicates no ground is provided to SPS solenoids.</p>			<p>RJEC ON-OFF logic circuitry normally supplies ground to SPS bipropellant solenoid control valves and SPS relays.</p>

MAIN DISPLAY CONSOLE—PANEL 1

CONTROLS AND DISPLAYS

Location		Name and Position	Function	Circuit Breaker	Power Source	Remarks
Panel	Area Grid					
MDC-1 (Cont)						
1	B	.05 G light	Provides, when illuminated, an indication of de-acceleration greater than .05 G.	EMS-MNA and MNB (MDC-8)	DC main buses A & B	MASTER ALARM lights on MDC-1, -3, and LEB-122 are simultaneously illuminated and an audio alarm tone is sent to each headset when any C/W light illuminates. Disabled by positioning CAUTION/WARNING-NORMAL-BOOST-ACK sw (MDC-2) to BOOST position. CAUTION/WARNING switch (MDC-2) is set to BOOST during ascent phase only, preventing this MASTER ALARM switch-light from illuminating in order to avoid confusion with adjacent red ABORT light. Switch-light loses its reset function during this time. MASTER ALARM switch-light contains an integral pushbutton switch. Pressing switch-light will reset master alarm circuit, extinguishing MASTER ALARM lights and shutting off audio alarm.
1	B	Velocity indicator (no placard)	Provides a display of acceleration (G-scribe) versus velocity (VELOCITY scroll) during entry.			
1	C	MASTER ALARM switch-light	Red light illuminates to alert crewman in LH couch of a malfunction or out-of-tolerance condition. This is indicated by illumination of applicable system status lights on MDC-2.	C/W-MNA MNB (MDC-5)		
1	D	ACCEL G meter	Mechanical device for measuring G-forces along the SC X-axis.	N/A	N/A	

MAIN DISPLAY CONSOLE—PANEL 1

SM2A-03-BLOCK II-(1)
APOLLO OPERATIONS HANDBOOK

CONTROLS AND DISPLAYS

Location		Name and Position	Function	Circuit Breaker	Power Source	Remarks
Panel	Area Grid					
MDC-1 (Cont)						
1	D K-16	ATT DEADBAND switch MAX	Not wired. (Refer to Remarks.)			A ±4-degree electrical deadband is normally part of ECA attitude control loops. This deadband is in addition to switching amplifier deadband and can be removed. (See MIN position this switch.)
		MIN	Switches (relays) the additional (#4 degrees) electrical deadband out of ECA attitude control loop in all three axes.	LOGIC BUS 1/4-MNB LOGIC BUS 1/2-MNA	DC main buses A & B	Logic power is routed directly from MDC-8 circuit breakers to MDC-1 switches.
1	D J-17	ATT SET switch IMU	Total attitude signals from IMU are routed to resolvers in ATTITUDE SET panel to generate Euler errors. These error signals can be displayed on FDAI error needles if selected. (See FDAI-SOURCE and FDAI-SELECT switches.)	LOGIC BUS 1/2-MNA LOGIC BUS 2/3-MNB (MDC-8)		Logic power is supplied to MDC-1 switches from SCS LOGIC BUS circuit breakers via LOGIC POWER 2/3 switch (MDC-7).
		GDC	a. Same concept as for IMU position except total attitude signals are obtained from GDC and Euler errors are transferred to body errors in GDC. b. This position is necessary for GDC alignment. (See GDC ALIGN pushbutton.)	LOGIC BUS 3/4-MNA LOGIC BUS 1/4-MNB (MDC-8)		Logic power is routed directly from MDC-8 circuit breakers to MDC-1 switches.
1	D O-14	ATTITUDE SET control panel ROLL thumbwheel and display	Rotating thumbwheel positions shaft of a resolver to electrical equivalent of angle readout on display adjacent to thumbwheel.	N/A	N/A	ATTITUDE SET resolvers are used for functions listed under ATT SET switch and GDC ALIGN pushbutton.

MAIN DISPLAY CONSOLE - PANEL 1

CONTROLS AND DISPLAYS

Location		Name and Position	Function	Circuit Breaker	Power Source	Remarks
Panel Area	Grid					
MDC-1 (Cont)						
1	D	PITCH thumbwheel and display		N/A	N/A	
	P-14	YAW thumbwheel and display				
1	D	BMAG MODE switches				
	N-13	ROLL				
		RATE 2	a. Sends 28 vdc to signal conditioner. b. Rate cages BMAG in GA-1, but rate output is not utilized. Logic circuits in ECA, EDA, and GDC, select rate signals from BMAG in GA-2 for control, display, and GDC drive.	LOGIC BUS 1/2-MNA LOGIC BUS 2/3-MNB (MDC-8)	DC main buses A & B	Logic power is supplied to MDC-1 switches from SCS LOGIC BUS circuit breakers via LOGIC POWER 2/3 switch (MDC-7).
		ATT 1 / RATE 2	a. Sends 28 vdc to signal conditioner. b. Enables logic circuits in ECA, EDA, and GDC so that: <ol style="list-style-type: none"> 1. BMAG in GA-2 supplies rate signals for control and display, and GDC update. 2. BMAG in GA-1 can provide attitude error signals for control and display. (See FDAI-SOURCE and SELECT switches.) 			

MAIN DISPLAY CONSOLE—PANEL 1

SM2A-03-BLOCK II-(1)
 APOLLO OPERATIONS HANDBOOK

CONTROLS AND DISPLAYS

Location		Name and Position	Function	Circuit Breaker	Power Source	Remarks
Panel	Area Grid					
MDC-1 (Cont)						
1	D N-13	RATE 1	Rate cages (electrically) BMAG in GA-1 and enables logic circuits in ECA, EDA, and GDC so that this BMAG supplies rate information for control and display, and drives GDC.	LOGIC BUS 1/4-MNB LOGIC BUS 1/2-MNA (MDC-8)	DC main buses A & B	Logic power is routed directly from MDC-8 circuit breakers to MDC-1 switches.
1	D N-14	PITCH RATE 2 ATT 1/ RATE 2	a. Sends 28 vdc to signal conditioner. b. Rate changes BMAG in GA-1, but rate output is not utilized. Logic circuits in ECA, EDA, and GDC select rate signals from BMAG in GA-2 for control, display, and GDC drive. a. Sends 28 vdc to signal conditioner. b. Enables logic circuits in ECA, EDA, and GDC so that: 1. BMAG in GA-2 supplies rate signals for control and display, and GDC update. 2. BMAG in GA-1 can provide attitude error signals for control and display. (See FDAI-SOURCE and SELECT switches on MDC-1.)	LOGIC BUS 3/4-MNA LOGIC BUS 2/3-MNB (MDC-8)		Logic power is supplied to MDC-1 switches from SCS LOGIC BUS circuit breakers via LOGIC POWER 2/3 switch (MDC-7).
		RATE 1	Rate cages (electrically) BMAG in GA-1, and enables logic circuits in ECA, EDA, and GDC so that this BMAG supplies rate information for control and display, and drives GDC.	LOGIC BUS 1/4-MNB LOGIC BUS 1/2-MNA (MDC-8)		Logic power is routed directly from MDC-8 circuit breakers to MDC-1 switches.

MAIN DISPLAY CONSOLE—PANEL 1

CONTROLS AND DISPLAYS

Location		Name and Position	Function	Circuit Breaker	Power Source	Remarks
Panel	Area Grid					
MDC-1 (Cont)		YAW RATE 2	a. Sends 28 vdc to signal conditioner. b. Rate cages BMAG in GA-1 but rate output is not utilized. Logic circuits in ECA, EDA, and GDC select rate signals from BMAG in GA-2 for control, display, and GDC drive. a. Sends 28 vdc to signal conditioner. b. Enables logic circuits in ECA, EDA, and GDC so that: 1. BMAG in GA-2 supplies rate signals for control and display, and GDC update. 2. BMAG in GA-2 can provide attitude error signals for control and display. (See FDAI-SOURCE and SELECT switches on MDC-1.)	LOGIC BUS 3/4-MNA LOGIC BUS 2/3-MNB (MDC-8)	DC main buses A & B	Logic power is supplied to MDC-1 switches from SCS LOGIC BUS circuit breakers via LOGIC POWER 2/3 switch (MDC-7).
1	D N-15					
		RATE 1	Rate cages (electrically) BMAG in GA-1 and enables logic circuits in ECA, EDA, and GDC so that this BMAG supplies rate information for control and display, and drives GDC.			

MAIN DISPLAY CONSOLE—PANEL 1

CONTROLS AND DISPLAYS

Location		Name and Position	Function	Circuit Breaker	Power Source	Remarks
Panel	Area Grid					
MDC-1 (Cont)						
1	D	CMC ATT switch	a. Required in logic that enables body to Euler transformation in GDC. b. Enables motor excitations to either or both FDAI balls, if FDAI/GPI POWER switch is not OFF. (See FDAI/GPI POWER switch on panel 7.) Not wired.	SCS LOGIC 3/4-MNA and 1/2-MNA and 1/4-MNB circuit breakers summed through diodes. Refer to Remarks. (MDC-8)	DC main buses A & B	Switch has redundant poles and output contacts. IMU position contacts are tied together through isolation diodes. SCS LOGIC BUS 4 supplies power to one pole. The other is supplied from SCS LOGIC BUS 1.
1	D	CMC MODE switch AUTO HOLD FREE	Provides disretes to CMC. No disretes to CMC. Provides disretes to CMC. Provides disretes to CMC.	N/A	CMC	Input channel 31, bit 13. Input channel 31, bit 14.
1	D	FDAI No. 1 (no placard) Rate Indicators Top Far right Bottom Attitude error indicators Top (below roll rate indicator)	Display of roll rate. Display of pitch rate. Display of yaw rate. Display of roll error.	Refer to Remarks, Power.	AC bus 1 DC main bus A	a. Power 1. Rate and error meters are servo-metric. Pot reference voltages comes from EDA power supply, which obtains phase A power from AC 1 circuit breaker through FDAI/GPI switch. 2. Power to motors is obtained from EDA which obtains a-c power from FDAI/GPI switch supplied from AC 1 circuit breaker, 28 vdc, bus A from SCS. SYSTEM MNA circuit breaker is also used.

MAIN DISPLAY CONSOLE—PANEL 1

SM2A-03-BLOCK II-(1)
APOLLO OPERATIONS HANDBOOK

CONTROLS AND DISPLAYS

Location		Name and Position	Function	Circuit Breaker	Power Source	Remarks
Panel Area	Grid					
MDC-1 (Cont)						
1	D	J-19	<p>Display of pitch error.</p> <p>Display of yaw error.</p> <p>The great semicircle under index indicates pitch Euler attitude.</p> <p>Small circle under index indicates yaw Euler attitude.</p> <p>Indicates roll Euler attitude or, after .05 G, indicates roll stability attitude "IF DRIVEN BY GDC."</p>	Refer to Remarks, Power.	AC bus 1 DC main bus A	<p>b. Rate</p> <ol style="list-style-type: none"> 1. Indicator consists of triangular marker with scale marked at 0, $\pm 1/5$, $\pm 2/5$, $\pm 3/5$, $\pm 4/5$, and full scale. Full-scale value depends on position of FDAI-SCALE switch. 2. Drive signals are obtained from EDA which obtains rate information from BMAGs in GA-2, normally. BMAGs in GA-1 will supply rate when selected by BMAG MODE switches. 3. Indicators are fly-to displays. <p>c. Error</p> <ol style="list-style-type: none"> 1. Indicator consists of needle-type pointer and scale marked as follows: <ol style="list-style-type: none"> (a) Roll scale marked at 0, $\pm 1/2$ and full scale. (b) Pitch and yaw marked at 0, $\pm 1/3$, $\pm 2/3$, and full scale. (c) Full scale value depends on position of FDAI-SCALE switch. 2. Drive signals are obtained from EDA. Input (source) to EDA is selectable among the following: <ol style="list-style-type: none"> (a) G&N CDUs (b) BMAGs in GA-1 (c) ATTITUDE set resolvers. 3. FDAI-SELECT, FDAI-SOURCE, and/or ATT SET switches determine which source is selected. 4. Indicators are fly-to displays.

MAIN DISPLAY CONSOLE—PANEL 1

SM2A-03-BLOCK II-(1)
 APOLLO OPERATIONS HANDBOOK

CONTROLS AND DISPLAYS

Location		Name and Position	Function	Circuit Breaker	Power Source	Remarks
Panel	Area Grid					
MDC-1 (Cont)						
1	D J-19			Refer to Remarks, Power.	AC bus 1 DC main bus A	d. Ball 1. Signals to motor come from servoamp in EDA. Signal source is either IMU or GDC as selected by panel switches. (See FDAI-SELECT, FDAI-SOURCE, and/or ATT SET switches.)
1	D J-15	FDAI switches SCALE ERR RATE 5 1	Not wired. Full scale on attitude error indicators (3) of both FDAIs is 5 degrees. Full scale on rate indicators is 1 deg per sec. Logic signal to EDA that selects signal flow gains so that full scale on rate indicators (3) of both FDAIs is 5 deg per sec. Logic signal to EDA that selects gains so that full scale indications on both FDAIs are: a. Roll error - 50 deg b. Roll rate - 50 deg per sec c. Pitch and yaw error - 15 deg d. Pitch and yaw rate - 10 deg per sec.	LOGIC BUS 1/2-MNA LOGIC BUS 2/3-MNB (MDC-8)	DC main buses A & B	Logic power is supplied to MDC-1 switches from SCS LOGIC BUS circuit breakers via LOGIC POWER 2/3 switch (MDC-7).
1	D J-16	SELECT				Logic power is obtained from SCS logic power circuit breakers.

MAIN DISPLAY CONSOLE—PANEL 1

SM2A-03-BLOCK II-(1)
APOLLO OPERATIONS HANDBOOK

CONTROLS AND DISPLAYS

Location		Name and Position	Function	Circuit Breaker	Power Source	Remarks
Panel	Area Grid					
MDC-1 (Cont)						
1	D J-16	1/2	Logic signal to EDA that selects specific sources for both FDAIs. The sources for each FDAI are: a. FDAI No. 1 IMU - CDU - BMAGs in GA-2. (See BMAG MODE switch.) b. FDAI No. 2 GDC - BMAGs in GA-1 - BMAGs in GA-2 (if BMAG MODE switch(es) are in ATT 1/RATE 2 position).	LOGIC BUS 3/4-MNA LOGIC BUS 1/4-MNB (MDC-8)	DC main buses A & B	NOTE FDAI-SOURCE switch has no function when this position is selected.
		2	Logic signal to GDA that inhibits signals to FDAI No. 1. Signal sources for FDAI No. 2 depends on positions of FDAI-SOURCE and/or ATT SET switches, excluding rate source. (See BMAG MODE switch.)	LOGIC BUS 3/4-MNA LOGIC BUS 2/3-MNB (MDC-8)		Logic power is supplied to MDC-1 switches from SCS LOGIC BUS circuit breakers via LOGIC POWER 2/3 switch (MDC-7) (applicable to switch positions 2 and 1).
		1	Logic signal to EDA that inhibits signals to FDAI No. 2. Signal sources for FDAI No. 1 depend on positions of FDAI-SOURCE and/or ATT SET switches, excluding rate source. (See BMAG MODE switch.)			
1	D J-17	SOURCE	NOTE This switch has no function if FDAI-SELECT switch is in the 1/2 position. Logic signal to EDA that selects IMU-attitude and CDU-error for display on that (1 or 2) FDAI switch selected. (Refer to note applying to SOURCE switch.)	LOGIC BUS 1/2-MNA LOGIC BUS 2/3-MNB (MDC-8)		Logic power is supplied to MDC-1 switches from SCS LOGIC BUS circuit breakers via LOGIC POWER 2/3 switch (MDC-7).
		CMC				

MAIN DISPLAY CONSOLE—PANEL 1

SM2A-03-BLOCK II-(1)
APOLLO OPERATIONS HANDBOOK

CONTROLS AND DISPLAYS

Location		Name and Position	Function	Circuit Breaker	Power Source	Remarks
Panel	Area Grid					
MDC-1 (Cont)						
1	D J-17	ATT SET	Logic signal to EDA that selects attitude set source for error display on FDAI. Source for total attitude (ball drive) is determined by position of ATT SET switch. (Refer to note applying to SOURCE switch.) Logic signal to EDA that selects GDC-attitude and BMAG-error for display on that FDAI selected. (Refer to note applying to SOURCE switch.)	LOGIC BUS 3/4-MNA LOGIC BUS 2/3-MNB (MDC-8)	DC main buses A & B	Logic power is supplied to MDC-1 switches from SCS LOGIC BUS circuit breakers via LOGIC POWER 2/3 switch (MDC-7).
1	D O-15	GDC ALIGN pushbutton Normal Depressed	Not wired. Logic signal to GDC that enables ATTITUDE SET output to drive GDC. (Refer to Remarks.)	LOGIC BUS 3/4-MNA LOGIC BUS 1/4-MNB (MDC-8)	Group 1 main A Group 3 main B	Logic power is routed directly from MDC-8 circuit breakers to MDC-1 switches. NOTE To obtain meaningful input to GDC (when aligning), ATT SET switch must be in GDC position.
1	D K-16	LIMIT CYCLE switch UP OFF	Not wired. (Refer to Remarks.) Inhibits pseudo-rate feedback circuits in ECA.	LOGIC BUS 1/4-MNB LOGIC BUS 1/2-MNA (MDC-8)	DC main buses A & B	Logic power is routed directly from MDC-8 circuit breakers to MDC-1 switches.
1	D K-15	MANUAL ATTITUDE switches PITCH ACCEL CMD	a. Logic signal to RJEC ON-OFF that disables CMC and/or ECA (SCS) control of RCS. b. Logic signal to pitch BMAG (attitude) uncage logic in ECA that inhibits uncaging of BMAG if SPS engine is not thrusting.			

MAIN DISPLAY CONSOLE—PANEL 1

SM2A-03-BLOCK II-(1)
 APOLLO OPERATIONS HANDBOOK

CONTROLS AND DISPLAYS

Location		Name and Position	Function	Circuit Breaker	Power Source	Remarks
Panel	Area Grid					
MDC-1 (Cont)						
1	D K-14	RATE CMD MIN IMP	Not wired. Logic signal to ECA that: a. Disables pitch switching amplifier outputs. b. Enables input to minimum impulse circuits from pitch breakout switches in RC (2). c. Inhibits uncaging of BMAG if SPS engine is not thrusting.	LOGIC BUS 1/4-MNB LOGIC BUS 1/2-MNA (MDC-8)	DC main buses A & B	Logic power is routed directly from MDC-8 circuit breakers to MDC-1 switches.
1	D K-14	ROLL ACCEL CMD	a. Logic signal to RJEC ON-OFF that disables CMC and/or ECA (SCS) control of RCS. b. Logic signal to ROLL BMAG (attitude) uncage logic in ECA that inhibits uncaging of BMAG if SPS engine is not thrusting. Not wired. Logic signal to ECA that: a. Disables roll switching amplifier outputs. b. Enables input to minimum impulse circuits from roll breakout switches in RC (2). c. Inhibits uncaging of BMAG if SPS engine is not thrusting.			
1	D K-15	YAW ACCEL CMD	a. Logic signal to RJEC ON-OFF that disables CMC and/or ECA (SCS) control of RCS.			

MAIN DISPLAY CONSOLE—PANEL 1

SM2A-03-BLOCK II-(1)
APOLLO OPERATIONS HANDBOOK

CONTROLS AND DISPLAYS

Location		Name and Position	Function	Circuit Breaker	Power Source	Remarks
Panel	Area Grid					
MDC-1 (Cont)						
1	D K-15	RATE CMD MIN IMP	<p>b. Logic signal to YAW BMAG (attitude) uncage logic in ECA that inhibits uncaging of BMAG if SPS engine is not thrusting.</p> <p>Not wired.</p> <p>Logic signal to ECA that:</p> <ol style="list-style-type: none"> Disables yaw switching amplifier outputs. Enables input to minimum impulse circuits from yaw breakout switches in RC (2). Inhibits uncaging of BMAG if SPS engine is not thrusting. 	LOGIC BUS 1/4-MNB LOGIC BUS 1/2-MNA (MDC-8)	DC main buses A & B	Logic power is routed directly from MDC-8 circuit breakers to MDC-1 switches.
1	D K-17	RATE switch HIGH LOW	<p>Logic signal to ECA that:</p> <ol style="list-style-type: none"> Selects low signal gains in both rate and attitude channels in all axes (roll, pitch, and yaw). Selects higher signal gain in roll manual control loop. (Refer to Remarks.) <p>Not wired. (Refer to Remarks.)</p>	LOGIC BUS 1/4-MNB LOGIC BUS 1/2-MNA (MDC-8)	DC main buses A & B	<p>a. Logic power is routed directly from MDC-8 circuit breakers to MDC-1 switches.</p> <p>b. in HIGH position ECA is configured for:</p> <ol style="list-style-type: none"> Switching amplifier deadband (all axes): Rate ± 2 deg per sec Attitude ± 4 deg Maximum proportional rate command capability: Pitch and yaw ± 7 deg per sec Roll ± 20 deg per sec <p>In LOW position ECA is configured for:</p> <ol style="list-style-type: none"> Switching amplifier deadband (all axes): Rate ± 0.2 deg per sec Attitude ± 0.2 deg Maximum proportional rate command capability (all axes) ± 0.7 deg per sec

MAIN DISPLAY CONSOLE—PANEL 1

SM2A-03-BLOCK II-(1)
APOLLO OPERATIONS HANDBOOK

CONTROLS AND DISPLAYS

Location		Name and Position	Function	Circuit Breaker	Power Source	Remarks
Panel	Area Grid					
MDC-1 (Cont)						
1	D	K-17 TRANS CONTR PWR	Applies 28 vdc, MNA and MNB to #X, #Y, #Z translational control switches through CM-SM transfer switches. Removes 28 vdc from translational control switches.	SCS CONTR/ AUTO MNA, MNB (MDC-8)	DC main buses A & B	
1	D	M-13 ROT CONTR PWR NORMAL-1 AC/DC	Applies 28 vdc MNA and MNB to breakout switches in number 1 rotation control through armed/locked switch. Applies 26v AC1 from the ECA to rotation control transducer. Removes dc and ac voltage to switches and transducer. Only AC1 applied to rotation control transducer.	SCS CONTR/ AUTO MNA, MNB (MDC-8) STAB CONTR SYSTEM AC1	AC bus 1	Enabled when SCS ELECTRONICS PWR SW (S5) is in ECA or GDC/ECA position.
1	D	M-14 NORMAL-2 AC/DC	Same dc as NORMAL-1. Applies 26v AC2 from ECA to rotation control transducer. See NORMAL-1 OFF. Only AC2 applied to rotation control transducer.	ECA/TVC AC2	AC bus 2	
			OFF			
			AC			

MAIN DISPLAY CONSOLE—PANEL 1

SM2A-03-BLOCK II-(1)
APOLLO OPERATIONS HANDBOOK

CONTROLS AND DISPLAYS

Location		Name and Position	Function	Circuit Breaker	Power Source	Remarks
Panel	Area Grid					
MDC-1 (Cont)		DIRECT-1 MNA/MNB OFF MNA	Applies 28 vdc, MNA and MNB to direct switches in rotation control 1. Removes 28 vdc from direct switches. Applies 28 vdc, MNA, to direct switches in rotation control 1.	SCS CONTR/ DIRECT-1 MNA, MNB (MDC-8)	DC main buses A & B	
1	D M-15					
MDC-2						
1	D M-15					
SC CONT switch		CMC	a. Logic signal to ECA, RJEC ON-OFF, and SA/TVP logic circuits. Inhibits SCS control functions "IF TC IS NOT CLOCKWISE (CW)." b. Logic signal to normally closed clockwise switch in TC. Signal from TC to CMC and PSA (28 vdc).	LOGIC BUS 1/2-MNA LOGIC BUS 2/3-MNB (MDC-8) N/A	DC main buses A & B	Logic power is supplied to MDC-1 switches from SCS LOGIC BUS circuit breakers via LOGIC POWER 2/3 switch (MDC-7). +28 vdc discretes to CMC CH 31-15 and PSA to enable TVC mode.
1	D M-16					

MAIN DISPLAY CONSOLE—PANEL 1

SM2A-03-BLOCK II-(1)
APOLLO OPERATIONS HANDBOOK

CONTROLS AND DISPLAYS

Location		Name and Position	Function	Circuit Breaker	Power Source	Remarks
Panel	Area Grid					
MDC-1 (Cont)		SCS TVC switches PITCH AUTO	Logic signal (28 vdc) to ECA and TVSA logic circuits. This position must be selected if SCS AUTO TVC control in PITCH is desired, either as backup to CMC or as primary selection.	LOGIC BUS 3/4-MNA LOGIC BUS 2/3-MNB (MDC-8)	DC main buses A & B	Logic power is supplied to MDC-1 switches from SCS LOGIC BUS circuit breakers via LOGIC POWER 2/3 switch (MDC-7).
1	D O-16					
		RATE CMD	Logic signal to ECA that must be present if MTVC-RATE CMD TVC control is desired in PITCH, either as backup to CMC or as primary selection.			
		ACCEL CMD	Logic signal to ECA. Similar to above functions but inhibits rate (BMAG) signals.			
1	D O-17	YAW AUTO	Logic signal (28 vdc) to ECA and TVSA logic circuits. This position must be selected if SCS AUTO TV control in YAW is desired, either as backup to CMC or as primary selection.			
		RATE CMD	Logic signal to ECA that must be present if MTVC-RATE CMD TV control is desired in YAW, either as backup to CMC or as primary selection.			
		ACCEL CMD	Logic signal to ECA. Similar to above functions but inhibits rate (BMAG) signals.			

MAIN DISPLAY CONSOLE—PANEL 1

SM2A-03-BLOCK II-(1)
 APOLLO OPERATIONS HANDBOOK

CONTROLS AND DISPLAYS

Location		Name and Position	Function	Circuit Breaker	Power Source	Remarks
Panel	Area Grid					
MDC-1 (Cont)		ΔV THRUST switches ΔV THRUST-A NORMAL	Receives power from SPS pilot valve MNA circuit breaker and applies power for SPS ready signal to CMC, enables power through FCSM SPS A switch to SPS thrust ON-OFF logic, and applies enabling power to SPS relays and solenoid control valves that are controlled by SPS thrust ON-OFF logic A. Receives power from SPS helium valve MNA circuit breaker, and applies power to injector pre-valve A. Removes power from FCSM SPS A switch and thrust ON-OFF logic, from SPS relays and solenoid control valves, ready signal to CMC, and de-energizes injector prevalve A.	SPS PILOT VLVS-MNA (MDC-8)	DC main bus A	Two-position toggle switch guarded to OFF position. NOTE FCSM SPS A and FCSM SPS B switches are not used, each is positioned and locked to a RESEAT/OVERRIDE position, a decal is placed over all nomenclature of both switches. FCSM power supply wires are stowed. Provides backup thrust OFF command to any ΔV mode of operation by removing power from SPS relays, solenoid control valves, and thrust ON-OFF logic.
1	E N-17					
1	E N-18	ΔV THRUST-B NORMAL	Receives power from SPS pilot valve MNB circuit breaker, and applies power for SPS ready signal to CMC, enable power through FCSM SPS B switch to SPS thrust ON-OFF logic, and applies enabling power to SPS relays and solenoid control valves that are controlled by SPS thrust ON-OFF logic B.	SPS PILOT VLVS-MNB (MDC-8)	DC main bus B	

MAIN DISPLAY CONSOLE—PANEL 1

SM2A-03-BLOCK II-(1)
APOLLO OPERATIONS HANDBOOK

CONTROLS AND DISPLAYS

Location		Name and Position	Function	Circuit Breaker	Power Source	Remarks
Panel	Area Grid					
MDC-1 (Cont)						
1	E N-18	OFF	<p>Receives power from SPS helium valve circuit breaker MNB, and applies power to injector pre-valve B.</p> <p>Removes power from FCSS SPS B switch and thrust ON-OFF logic, from SPS relays and solenoid control valves, ready signal to CMC, and de-energizes injector prevalve B.</p>	SPS He VALVE MNB (MDC-8)	DC main bus B	Provides backup thrust OFF command to any ΔV mode of operation by removing power from SPS relays, solenoid control valves, and thrust ON-OFF logic.
1	E O-16	THRUST ON pushbutton	<p>Switch actuation applies SPS-thrust-on command to SCS ΔV modes thrust-on logic, which energizes SPS relays and solenoid control valves. When pressed, a lock-up circuit in SCS logic locks command in, thus pushbutton is not depressed throughout SPS thrusting period.</p>	LOGIC BUS 1/4-MNB LOGIC BUS 1/2-MNA (MDC-8)	DC main buses A & B	<p>Pushbutton momentary contact-type switch does not contain a light. Used in SCS ΔV modes.</p> <p>Logic power is routed directly from MDC-8 circuit breakers to MDC-1 switches.</p>
1	E N-16	SPS THRUST DIRECT ON	<p>When ΔV THRUST NORMAL-A and ΔV THRUST NORMAL-B are placed in NORMAL position, applies power to THRUST DIRECT ON switch. The SPS THRUST DIRECT ON switch placed to DIRECT ON provides a ground to energize SPS relays and solenoid control valves of SPS system A and ground to energize SPS relays and solenoid control valves of SPS system B.</p>		N/A	Two-position toggle switch lever locked in either position.

MAIN DISPLAY CONSOLE—PANEL 1

SM2A-03-BLOCK II-(1)
APOLLO OPERATIONS HANDBOOK

CONTROLS AND DISPLAYS

Location		Name and Position	Function	Circuit Breaker	Power Source	Remarks
Panel	Area Grid					
MDC-1 (Cont)						
1	E N-16	NORMAL	Removes ground from SPS relays and solenoid control valves.		N/A	The ΔV THRUST NORMAL-A and -B switch to OFF provides thrust-off command by removing power to SPS relays and solenoids.
1	E P-17	LV/SPS IND switch α SPS P _c	Connects output of Q-ball to LV α /SPS P _c indicator. Connects output of SPS engine combustion chamber pressure sensor to LV α /SPS P _c indicator.	N/A		Two-position toggle switch which enables crew to select applicable input to LV α /SPS P _c indicator. Switch is placed in LV α position prior to lift-off, and in the SPS P _c position at approximately 1 minute and 40 seconds after lift-off.
1	E M-18	LV α /SPS P _c indicator	Time-shared indicator with input determined by position of LV/SPS IND switch a. LV α input: the indicator displays a percentage of ΔP measured by the Q-ball which is a function of pitch and yaw. b. SPS P _c : the indicator displays SPS chamber pressure in percent from chamber pressure transducer on injector of engine.		DC from S-IVB IU	Indicator range: 0 to 150 percent. Small changes in air pressures are sensed through eight holes in the Q-ball. The indicator is monitored from 50 seconds to approximately 1 minute and 40 seconds after lift-off. Injector range: 0 to 150 percent which correlates with 0 to 150 psia chamber pressure.
1	E P-17	LV/SPS IND switch	Provides display and control of S-II/S-IVB tank pressures or SPS gimbal position.	EDS 1 BAT A and EDS 3 BAT B (MDC-8)	EPS battery buses A & B	Two-position toggle switch which allows crew to monitor S-II/S-IVB tank pressures or GPI. Placed in SII/SIVB position prior to lift-off. Placed to GPI after separation from S-IVB or earlier if desired.

MAIN DISPLAY CONSOLE—PANEL 1

SM2A-03-BLOCK-II-(1)
 APOLLO OPERATIONS HANDBOOK

CONTROLS AND DISPLAYS

Location		Name and Position	Function	Circuit Breaker	Power Source	Remarks
Panel	Area Grid					
MDC-1 (Cont)						
1	E P-17	SII/SIVB	Applies power to relays allowing S-II fuel tank pressure to be displayed until staging of S-II/S-IVB, then S-IVB oxidizer tank pressure until CSM separation from S-IVB. S-IVB fuel tank pressure is displayed continuously until CSM separation. Removes power from relays allowing SPS yaw and pitch gimbal position to be displayed on redundant SPS gimbal position meters.	EDS 1 BAT A and EDS 3 BAT B (MDC-8)	EPS battery buses A & B	FDAI/GPI POWER switch (MDC-7) must be on for the display to respond correctly; both positions make entire displays active. SPS gimbal position will be displayed if proper power and switches are positioned.
1	E M-19	LV TANK PRESS indicators LV TANK PRESS SII FUEL/SIVB OXID, SIVB FUEL SII FUEL/ SIVB OXID	Indicates S-II fuel pressure on redundant readouts until staging of S-II/S-IVB occurs, providing LV/SPS IND switch on MDC-1 is in SII/SIVB position. Indicates S-IVB oxidizer pressure on redundant readouts at S-II/S-IVB staging, providing LV/SPS IND switch on MDC-1 is in SII/SIVB position, until CSM separates from S-IVB. Indicates S-IVB fuel pressure on redundant readouts at all times until CSM separates from S-IVB, providing LV/SPS IND switch on MDC-1 is in SII/SIVB position.	SCS AC1 and AC2 (MDC-8)	AC bus 1 or 2 3Ø	
1	E M-21	SIVB FUEL				

MAIN DISPLAY CONSOLE—PANEL 1

SM2A-03-BLOCK II-(1)
 APOLLO OPERATIONS HANDBOOK

CONTROLS AND DISPLAYS

Location		Name and Position	Function	Circuit Breaker	Power Source	Remarks
Panel	Area Grid					
MDC-1 (Cont)						
1	E M-20	SPS GIMBAL - PITCH/YAW	Indicates SPS engine gimbal position on redundant readouts for pitch and yaw in respective CSM pitch and yaw (body) axes respectively, providing LV/SPS IND switch on MDC-1 is in GPI position.	SCS AC1 and AC2 (MDC-8)	AC bus 1 or 2 3Ø	Yaw and pitch indicators are calibrated in 0.5° increments from -4° to +4°. Reading of 0° corresponds to yaw gimbal actuator position null offset of +1° to +Y thrust vector during SPS thrusting periods. Reading of 0° corresponds to pitch gimbal actuator position null offset of +2° to +Z thrust vector during SPS thrusting periods.
1	E O-18	SPS GIMBAL MOTORS switches	Four operationally identical switches.	SPS PITCH 1 BAT A PITCH 2 BAT B YAW 1 BAT A YAW 2 BAT B (MDC-8)	EPS battery buses A & B	Three-position toggle switch with upper (START) position spring-loaded to return switch to center position when released. PITCH 1 and YAW 1 switches control gimbal actuator primary drive motors. PITCH 2 and YAW 2 switches control gimbal actuator secondary drive motors.
1	E O-19	START	Energizes motor switch in applicable overcurrent relay, which, in turn, applies +28 vdc to applicable gimbal actuator drive motor.			Battery Bus A for YAW 1 and PITCH 1 motor switch and overcurrent relay, MN BUS A for gimbal motors YAW 1 and PITCH 1. Battery Bus B for YAW 2 and PITCH 2 motor switch and overcurrent relay MN BUS B for gimbal motors YAW 2 and PITCH 2. START position provides gimbal motor starting capability. Center position provides for overcurrent sensing. During primary channel operation, an overcurrent will automatically cause power to be removed from primary drive motor, and applicable GMBL DR FAIL status
		(No title position marked)	Applies +28 vdc to overcurrent sensing circuitry in applicable overcurrent relay.			

MAIN DISPLAY CONSOLE—PANEL 1

SM2A-03-BLOCK II-(1)
 APOLLO OPERATIONS HANDBOOK

CONTROLS AND DISPLAYS

Location		Name and Position	Function	Circuit Breaker	Power Source	Remarks
Panel	Area Grid					
MDC-1 (Cont)						
1	E O-18	OFF	Energizes motor switch in applicable overcurrent relay which removes +28 vdc from the current sensing circuitry and gimbal actuator drive motor.	SPS PITCH 1 BAT A PITCH 2 BAT B YAW 1 BAT A YAW 2 BAT B (MDC-8)	EPS battery buses A & B	indicator illuminates (MDC-2). With TVC GMBL DR switches in AUTO, clutch commands are switched to secondary channel.
1	E O-19					
1	E N-20	GIMBAL POSITION SPS thumbwheels	Provides display and manual control of gimballed SPS engine thrust axis orientation with respect to SC body axes when in the SCS ΔV mode. Provide manual yaw and pitch input commands to respective engine gimbal position servos for alignment of SPS engine thrust axis through SC CG, prior to SPS thrusting in SCS modes only.	SCS-TVC AC1 AC2 (MDC-8) and TVC SERVO POWER 1 and 2	AC bus 1 or 2 via display/ECA	Yaw thumbwheel is calibrated in 0.5° increments from -4° to +4°. Reading of 0° corresponds to yaw gimbal actuator position null offset of +1° to +Y thrust vector during SPS thrusting periods. Pitch indicator and thumbwheel are calibrated in 0.5° increments from -4° to +4°. Reading of 0° corresponds to pitch actuator position null offset of +2° to +Z thrust vector during SPS thrusting periods.
1	E N-20	YAW, PITCH thumbwheels				

MAIN DISPLAY CONSOLE—PANEL 1

SM2A-03-BLOCK II-(1)
 APOLLO OPERATIONS HANDBOOK

CONTROLS AND DISPLAYS

Location		Name and Position	Function	Circuit Breaker	Power Source	Remarks
Panel	Area Grid					
MDC-1 (Cont)						
1	E P-18	TVC GMBL DRIVE switches PITCH 1	Two operationally identical switches, one for controlling pitch actuator control and one for yaw actuator control. Allows only clutch commands to be applied to primary channel of gimbal actuator.	N/A	N/A	Three-position toggle switch. Allows crew to select specific channel for TVC control or allows automatic control of TVC channels. Permits checkout of primary gimbal motor and primary channel. If overcurrent is sensed on primary gimbal motor there is no switchover to secondary channel. If translation control is rotated clockwise, there is no switchover to secondary channel.
		AUTO	Allows primary gimbal motor overcurrent relay to control clutch commands to primary or secondary channel. Allows translation control, when rotated clockwise, to switch clutch commands from primary system to secondary system.	LOGIC BUS 1/4-MNB LOGIC BUS 1/2-MNA (MDC-8)	DC main buses A & B	Logic power is routed directly from MDC-8 circuit breakers to MDC-1 switches. Permits checkout of secondary gimbal motor and secondary channel. Logic power is supplied to MDC-1 switches from SCS LOGIC BUS circuit breakers via LOGIC POWER 2/3 switch (MDC-7).
		2	Allows only clutch commands to be applied to secondary channel of gimbal actuator.	LOGIC BUS 3/4-MNA LOGIC BUS 2/3-MNB (MDC-8)		
1	E P-18	YAW 1	Allows only clutch commands to be applied to primary channel of gimbal actuator.			Permits checkout of primary gimbal motor and primary channel. If overcurrent is sensed on primary gimbal motor, there is no switchover to secondary channel. If translation control is rotated clockwise, there is no switchover to secondary channel.

MAIN DISPLAY CONSOLE—PANEL 1

SM2A-03-BLOCK II-(1)
APOLLO OPERATIONS HANDBOOK

CONTROLS AND DISPLAYS

Location		Name and Position	Function	Circuit Breaker	Power Source	Remarks
Panel	Area Grid					
MDC-1 (Cont)		AUTO	<p>Allows primary gimbal motor overcurrent relay to control clutch commands to primary or secondary channel. Allows translation control when rotated clockwise to switch clutch commands from primary system to secondary system.</p> <p>Allows only clutch commands to be applied to secondary channel of gimbal actuator.</p>	<p>LOGIC BUS 1/4-MNB LOGIC BUS 1/2-MNA (MDC-8)</p> <p>LOGIC BUS 3/4-MNA LOGIC BUS 2/3-MNB (MDC-8)</p>	<p>DC main buses A & B</p>	<p>Logic power is routed directly from MDC-8 circuit breakers to MDC-1 switches.</p> <p>Permits checkout of the secondary gimbal motor and secondary channel.</p> <p>Logic power is supplied to MDC-1 switches from SCS LOGIC BUS circuit breakers via LOGIC POWER 2/3 switch (MDC-7).</p>
1	E P-18					
1	F N-16	DIRECT ULLAGE pushbutton	<p>Provides backup capability for initiating ullage (+X translation) prior to SPS burns.</p> <p>a. Energizes injector valve direct coils of four +X SM RCS engines.</p> <p>b. Disables the pitch and yaw auto coil command so that SCS or G&N automatic hold are disabled.</p> <p>c. Provides enabling logic signal to SCS/SPS on-off logic.</p>	<p>DIRECT ULLAGE MNA and MNB (MDC-8)</p> <p>LOGIC BUS 1/4-MNB LOGIC BUS 1/2-MNA (MDC-8)</p>	<p>Momentary-contact pushbutton switch which must be held engaged until ullage is completed.</p> <p>Translation control provides normal capability for initiating ullage.</p>	<p>Logic power is routed directly from MDC-8 circuit breakers to MDC-1 DIRECT ULLAGE pushbutton.</p>

MAIN DISPLAY CONSOLE—PANEL 1

SM2A-03-BLOCK II-(1)
APOLLO OPERATIONS HANDBOOK

CONTROLS AND DISPLAYS

Location		Name and Position	Function	Circuit Breaker	Power Source	Remarks
Panel	Area Grid					
MDC-1 (Cont)						
1	G P-15	IMU CAGE switch CAGE OFF (down)	Provides SC power to cage platform. Cages platform with all three angles at 0°. Removes d-c power from cage relays.	IMU OPERATE (2)		Guarded switch. Energizes cage relays in power servo assembly.
1	H P-16	ENTRY switches EMS ROLL Up Down .05 G switch Up	Sends logic signal to GDC that enables yaw channel to drive RSI on EMS display. Not wired. Provides logic signal (28 vdc) to ECA and GDC logic circuits to enable: a. Roll rate to yaw rate coupling in yaw control electronics. b. Electrical rate caging of BMAGs in GA-2. c. Summing roll and yaw rate BMAG signals in GDC to obtain roll stability attitude for display on RSI and FDAL. d. Disabling of pitch input to GDC and the yaw GDC output and the body to Euler transformation. e. The functions in c and d will not occur if GDC ALIGN pushbutton is pressed.	LOGIC BUS 3/4-MNA LOGIC BUS 1/4-MNB (MDC-8)		Logic power is routed directly from MDC-8 circuit breakers to MDC-1 switches.

MAIN DISPLAY CONSOLE—PANEL 1

CONTROLS AND DISPLAYS

Location		Name and Position	Function	Circuit Breaker	Power Source	Remarks
Panel	Area Grid					
MDC-1 (Cont)						
1	H P-16	Down	Sends logic signal to EDA to inhibit roll and yaw rate BMAG summing in EDA yaw rate signal flow.	LOGIC BUS 1/2-MNA LOGIC BUS 2/3-MNB (MDC-8)	DC main buses A & B	Logic power is supplied to MDC-1 switches from SCS LOGIC BUS circuit breakers via LOGIC POWER 2/3 switch (MDC-7).
1	I I-22	ABORT light	Illuminates red to indicate that abort has been requested by range safety officer or ground control.	EDS-1, -3 BAT A BAT B (MDC-8)	Battery buses A & B when EDS POWER switch is ON	Light serves to alert crew of emergency situation where abort is required immediately. Light is backup to voice communications from ground control. Redundant bulbs are controlled by redundant commands through UDL, real-time command system.
1	I I-22	EVENT TIMER	Digital event timer provides crew with means of monitoring and timing events. Event timer will start automatically when lift-off occurs.	GROUP 4 MNA MNB TIMERS MNA MNB (MDC-229)	DC main buses A & B	Timer located on MDC-1 will reset and restart automatically if any abort occurs. Group 4, MNA, and timers, MNA, circuit breakers in series. Group 4, MNB, and timers, MNB, circuit breakers in series.
1	I K-22	EDS Annunciator Assembly (no placard)	Provides LV status.	EDS-1, -3 BAT A and B (MDC-8)	Battery buses A & B when EDS POWER switch is ON	When annunciator assembly lights are illuminated for extended periods, temperature in excess of 150°F will result. Avoid body contact.
1	I K-22	LV RATE light	Illuminates red when LV angular rates exceed predetermined limits.			Indicates necessity for manually initiated abort when used in conjunction with angle-of-attack display and FDAI. Illuminates when an abort is initiated automatically.
		S-II SEP light	Illuminates red to indicate first-stage jettison and extinguishes when second-stage interstage skirt is jettisoned (second plane separation).			

MAIN DISPLAY CONSOLE—PANEL 1

CONTROLS AND DISPLAYS

Location		Name and Position	Function	Circuit Breaker	Power Source	Remarks
Panel	Area Grid					
MDC-1 (Cont)		LV GUID light	Illuminates red to indicate loss of attitude reference in LV guidance system.	EDS-1, -3 BAT A and B (MDC-8)	Battery buses A & B when EDS POWER switch is ON	Lights are monitored for possibility of having to manually initiate abort after auto abort capability has been inhibited. Staging sequence may also be monitored by these lights.
1	I K-22					
1	I K-22					
1	I L-21	LIFT-OFF and NO AUTO ABORT switch-lights	White light illuminates at lift-off and will be extinguished at commencement of first stage staging during ascent phase.			LIFT OFF/NO AUTO ABORT switch-light combination should be pressed if LIFT OFF light does not illuminate at lift-off. (Refer to malfunction procedures in AOH, volume 2.)

MAIN DISPLAY CONSOLE—PANEL 1

SM2A-03-BLOCK II-(1)
 APOLLO OPERATIONS HANDBOOK

CONTROLS AND DISPLAYS

Location		Name and Position	Function	Circuit Breaker	Power Source	Remarks
Panel	Area Grid					
MDC-1 (Cont)						
1	I K-21	NO AUTO ABORT	Switch-light will illuminate red at lift-off if either of LV-EDS auto abort systems has not been automatically enabled.	EDS-1, -3 BAT A and B (MDC-8)	Battery buses A & B when EDS POWER switch is ON	Astronaut will press switch-light which will electrically enable LV-EDS automatic abort system. If light still does not go out, it indicates that one or both of dual redundant EDS systems is not enabled. In this event, crew must be prepared to initiate a manual abort, if necessary.
1	I M-21	LES MOTOR FIRE switch	a. Backup switch to jettison LES tower in event tower jettison motor failed to ignite. b. Backup switch to fire launch escape motor on LES abort.	SEQ EVENTS CONT SYS A ARM B BAT A B/T B (MDC-8)	Battery buses A & B	LES motor is normally (automatically) fired by MESC approximately 0.1 second following abort initiation. It may be used for backup for tower jettison motor only after normal means of LET jettison has failed. This is assuming that LET separation nuts are fractured.
1	I N-21	CANARD DEPLOY switch	Backup switch to deploy canard when it does not deploy automatically during abort.			Push-type switch. Canard will normally (automatically) deploy 11 seconds after LES abort initiation.
1	I N-21	CSM/LV SEP switch	a. Switch for normal CSM/LV separation after ascent phase of mission. (Refer to SLA separation mechanism in section 2.) b. Backup switch for CSM/LV separation if it does not separate automatically during SPS abort. (Refer to SPS abort procedures.)			Push-type switch to separate SLA when SPS abort cannot be initiated with Commander's translation hand control. SPS ullage and firing would be manual functions.
1	I L-23	APEX COVER JETT switch	Backup switch to jettison CM apex cover.	ELS A - BAT A ELS B - BAT B (MDC-8)		Push-type switch to jettison CM apex cover if automatic system fails during abort or earth landing after normal mission.

MAIN DISPLAY CONSOLE - PANEL 1

SM2A-03-BLOCK II-(1)
APOLLO OPERATIONS HANDBOOK

CONTROLS AND DISPLAYS

Location		Name and Position	Function	Circuit Breaker	Power Source	Remarks
Panel	Area Grid					
MDC-1 (Cont)						
1	I M-23	DROGUE DEPLOY switch	Backup switch to deploy drogue parachutes.	ELS A - BAT A - ELS B - BAT B (MDC-8)	Battery buses A & B	Push-type switch. Drogue parachutes will normally (automatically) deploy 2 seconds after 24,000-foot baro switches close.
1	I N-23	MAIN DEPLOY switch	Backup switch to deploy main parachutes on normal descent phases. Switch for main parachute deployment on mode 1A LES aborts, if optional usage is desired.			Push-type switch. Main parachutes will normally (automatically) deploy when 10,000-foot baro switches close during descent. Switch may also be used to initiate manual deployment of main parachutes subsequent to aborts initiated prior to 42 seconds after lift-off.
1	I O-21	ELS switches	<p>LOGIC</p> <p>Provides battery voltage to ELS logic arm circuitry. Circuitry is automatically armed during LES abort if ELS-AUTO/MAN switch (MDC-2) is in AUTO position.</p> <p>OFF</p> <p>Removes battery voltage from ELS logic circuitry.</p> <p>AUTO</p> <p>a. Prepares ELS for automatic activate during LES abort. b. Allows ELS to function automatically during descent of CM.</p> <p>MAN</p> <p>Disconnects logic arming circuitry from ELS controller.</p>	N/A		<p>Logic switch is positioned up during entry or after SPS abort to arm ELS logic circuitry. This circuitry is armed automatically on LES aborts. ELS is controlled by baro switch closure and time-delay relays after being armed.</p> <p>Switch should never be positioned up during launch and ascent except as backup during LES abort. LES tower, apex cover, and parachutes might be jettisoned.</p> <p>Normal position of switch.</p> <p>Switch may be set to MAN position after drogue parachute deployment during abort initiated prior to 42 seconds after lift-off. Main parachutes must be deployed manually with MAIN DEPLOY pushbutton</p>

MAIN DISPLAY CONSOLE—PANEL 1

SM2A-03-BLOCK II-(1)
APOLLO OPERATIONS HANDBOOK

CONTROLS AND DISPLAYS

Location		Name and Position	Function	Circuit Breaker	Power Source	Remarks
Panel	Area Grid					
MDC-1 (Cont)						
1	I O-21			N/A	Battery buses A & B	(MDC-1) after switch is set to MAN position. If main parachutes are deployed manually, ELS switch must be set back to AUTO to allow main parachute 14-second time delays to arm MAIN RELEASE switch.
1	J O-20	LM/CSM CSM	Enables body-bending filters in SCS AUTO TVC control path. Enables different filtering in SC AUTO TVC control path.	SCS LOGIC BUS 3/4-MNA 2/3-MNA	DC main buses A & B	Power to switch is enabled through LOGIC 2/3 power switch on panel 7.
1	K O-22	CM RCS LOGIC (up)	Applies power to CM PRPLNT DUMP switch on MDC-1. Applies power to 0- to 42-second time delays (from lift-off). If an abort is initiated during this time, automatically initiates rapid oxidizer dump, followed 5 seconds later by rapid fuel dump, and followed 13 seconds later by purge. Applies power to relay contact points that are closed upon receipt of an abort signal (from 0 to tower jettison) or on CM SM separation which applies power automatically to RCS transfer motors. Applies power to the CM RCS HTRS switch (LEB-101).	RCS LOGIC MNB (MDC-8)		Two-position toggle switch. Switch must be in up position before power is available to the CM PRPLNT DUMP, PURGE, and CM RCS HTRS switches, and circuitry controlling automatic transfer of engine firing commands from SM RCS to CM RCS engines.

MAIN DISPLAY CONSOLE—PANEL 1

SM2A-03-BLOCK II-(1)
APOLLO OPERATIONS HANDBOOK

CONTROLS AND DISPLAYS

Location		Name and Position	Function	Circuit Breaker	Power Source	Remarks
Panel	Area Grid					
MDC-1 (Cont)		OFF	Removes power from CM PRPLNT DUMP and PURGE switches and CM RCS HTRS switch as well as RCS logic circuitry for automatic RCS transfer.	RCS LOGIC MNB (MDC-8)	DC main buses A & B	
1	K O-22	CM PRPLNT switches DUMP DUMP (up)	Enabled by CM RCS LOGIC switch. Energizes relays to energize 10 CM RCS engine-injector valves direct coils for propellant burn. Initiates two helium interconnect squib valves, one fuel interconnect squib valve, and one oxidizer interconnect squib valve. De-energizes relays removing power from CM RCS engine-injector valve direct coils allowing valves to close.	RCS LOGIC MNA and MNB (MDC-8)		Guarded two-position toggle switch (activates explosive-operated valves). During normal entry, switch is placed to DUMP (up) position at main parachute line stretch. Remaining propellants are then burned off through 10 of the 12 RCS engines (excluding +P). Dump switch not utilized in 0 to 42 second aborts (from lift-off), except as a possible backup to initiate interconnect squib valves.
1	K O-23	PURGE PURGE (up) OFF	Energizes relays required to initiate the two fuel and two oxidizer bypass squib valves for purge. De-energizes relays.			Guarded two-position toggle switch. Switch manually set to up position after CM RCS propellant burn has been completed (approximately 88 seconds after activation of DUMP switch, for 10-engine burn and 155 seconds for 5-engine burn) to deplete the helium source pressure as well as purge the system. (Purge operation approximately 14 seconds.) CM RCS LOGIC and CM PRPLNT DUMP switches must both be in up position before purge operation can be initiated.

MAIN DISPLAY CONSOLE—PANEL 1

SM2A-03-BLOCK II-(1)
APOLLO OPERATIONS HANDBOOK

CONTROLS AND DISPLAYS

Location		Name and Position	Function	Circuit Breaker	Power Source	Remarks
Panel	Area					
MDC-1 (Cont)						
1	K	O-23		RCS LOGIC MNA and MNB (MDC-8)	DC main buses A & B	Switch will not be utilized in 0 to 42 second aborts (from lift-off), except as a possible backup to initiate squib valves.
1	K	N-23	CM RCS He DUMP switch He DUMP (pressed) OFF (released)			Pushbutton guarded switch which provides backup capability for initiating helium purge operation in event of CM PRPLNT PURGE switch failure (MDC-1).
1	L	P-21	EVENT TIMER switches RESET/DOWN RESET CENTER DOWN START/STOP START CENTER STOP MIN TENS CENTER UNITS	TIMERS MNA MNB RHEB-229		
1	L	P-22				Event timer starts automatically when lift-off occurs. Switch is momentary on towards START position and maintained on in other two positions. Timer will reset and start counting up if any abort is initiated.
1	L	P-22				

MAIN DISPLAY CONSOLE—PANEL 1

CONTROLS AND DISPLAYS

Location		Name and Position	Function	Circuit Breaker	Power Source	Remarks
Panel	Area Grid					
MDC-1 (Cont)		SEC TENS CENTER UNITS	Runs SEC indicating drum in tens. No function. Runs SEC indicating drum in units.	TIMERS MNA MNB (RHEB-229)	DC main buses A & B	Control switches provide means of running event timer to any desired setting and are spring-loaded to center position. Indicates drums can be run up or down, depending on position of RESET/DOWN switch.
1	L					
	P-23					

MAIN DISPLAY CONSOLE—PANEL 1

SM2A-03-BLOCK II-(1)
APOLLO OPERATIONS HANDBOOK

CONTROLS AND DISPLAYS

Location		Name and Position	Function	Circuit Breaker	Power Source	Remarks
Panel Area	Grid					
<u>MDC-2</u>						
LEFT PANEL		System Status Lights (Caution and Warning)		C/W MNA MNB (MDC-5)	DC main buses A & B	Caution and warning light assemblies on panel 2 should be limited to 10 minutes of operation with all lamps on to avoid excessive heating of lamp assemblies.
2	A C-30	SCS status lights BMAG-1 TEMP	Light illuminates when temperature of any gyro in GA1 exceeds limits of $170^{\circ} \pm 2^{\circ}$.			Yellow lights. BMAG POWER 1 switch must be in WARM UP or ON position for light to operate (MDC-7).
2	A C-30	BMAG-2 TEMP	Light illuminates when temperature of any gyro in GA2 exceeds limits of $170^{\circ} \pm 2^{\circ}$.			BMAG POWER 2 switch must be in WARM UP or ON position for light to operate (MDC-7).
2	A C-30	SPS status lights PITCH GMBL 1 or 2	Indicates overcurrent has occurred in primary or secondary drive motor of pitch gimbal actuator.			Yellow lights. Overcurrent condition dependent on time and temperature.
2	A C-30	YAW GMBL 1 or 2	Indicates overcurrent has occurred in primary or secondary drive motor of yaw gimbal actuator.			
2	A C-30	RCS status lights CM RCS 1, 2	1 and 2 lights are identical in operation with their respective systems. Indicates an underpressure condition in regulator manifold prior to pressurization of respective system. Indicates over or under pressure condition (below 260 psia or above 330 psia nominal) in regulator manifold of respective pressurization system.			All lights are yellow. CM RCS 1 and 2 lights will not illuminate when CAUTION/WARNING mode switch is in CSM position. RCS INDICATORS select switch (MDC-2) will be utilized in conjunction with the following meter to determine malfunctions within a system. CM RCS-PRESS-MANF

MAIN DISPLAY CONSOLE—PANEL 2

SM2A-03-BLOCK II-(1)
APOLLO OPERATIONS HANDBOOK

CONTROLS AND DISPLAYS

Location		Name and Position	Function	Circuit Breaker	Power Source	Remarks
Panel	Area Grid					
MDC-2 (Cont)		SM RCS A, B, C, D	<p>A, B, C, or D lights are identical in operation within their respective quads.</p> <p>Indicates one of the following:</p> <p>a. Package temperature below 75°F or above 205°F (nominal).</p> <p>b. Secondary fuel pressure (SEC FUEL) below 145 psia or above 215 psia (nominal).</p>	C/W MNA MNB (MDC-5)	DC main buses A & B	<p>Yellow lights. RCS INDICATORS select switch on MDC-2 will be utilized in conjunction with the following meters to determine malfunctions within a particular RCS quad:</p> <p>SM RCS-TEMP PKG</p> <p>SM RCS-PRESS-SEC FUEL</p>
2	A D-30 D-31					
2	A C-31	<p>EPS status lights</p> <p>CRYO PRESS</p>	<p>Indicates tank pressures as follows:</p> <p>a. Hydrogen 220 psia or below 270 psia or above</p> <p>b. Oxygen 800 psia or below 950 psia or above</p>			<p>Yellow light will illuminate if either or both H₂ tanks are above or below proper pressure limits. Pressure in H₂ tanks can be monitored by meters on MDC-2. (CRYOGENIC TANKS-PRESSURE-H₂ 1 and 2)</p> <p>Yellow light will illuminate if either or both O₂ tanks are above or below proper pressure limits. Pressure in O₂ tanks can be monitored by meters on MDC-2. (CRYOGENIC TANKS-PRESSURE-O₂ 1 and 2)</p>
2	A C-32	<p>ECS status lights</p> <p>CO₂ PP HI</p> <p>GLYCOL TEMP LOW</p>	<p>Indicates when CO₂ partial pressure reaches 7.6 mm Hg.</p> <p>Indicates when water-glycol from primary space radiator outlet decreases to -30°F.</p>			<p>Yellow light. Continuous partial pressure is displayed by PART PRESS - CO₂ indicator (MDC-2).</p> <p>Yellow light. Continuous temperature is displayed by ECS RADIATOR TEMP-PRIM-OUTLET indicator (MDC-2).</p>

MAIN DISPLAY CONSOLE—PANEL 2

SM2A-03-BLOCK II-(1)
APOLLO OPERATIONS HANDBOOK

CONTROLS AND DISPLAYS

Location		Name and Position	Function	Circuit Breaker	Power Source	Remarks
Panel	Area Grid					
MDC-2 (Cont)						
RIGHT PANEL		System Status Lights (Caution and Warning)				
2	A D-33	G&N status lights CMC	<p>The CMC status light will illuminate if the following occurs:</p> <ol style="list-style-type: none"> Loss of prime power. Scaler fail - if scaler stage 17 fails to produce pulses. Counter fail - continuous requests or fail to happen following increment request. SCADBL - 100 pps scaler stage >200 pps. Parity fail - accessed word, whose address is octal 10 or greater, contains even numbers of ones. Interrupt - too long or infrequent - 140 ms to 300 ms. TC trap - too many TC or TCF instructions or TCF instructions too infrequent. Night watchman - computer fails to access address 67 within 64 sec to 1.92 sec. V fail - 4v supply >4.4v 4v supply <3.6v 14v supply >16.0v 14v supply <12.5v 28v supply <22.6v If oscillator stops. Standby. 	C/W MNA MNB (MDC-5)	DC main buses A & B	<p>Red light.</p> <p>Items e through k will cause restart in the CMC. This will also illuminate the RESTART & PGNS lights on LEB-122.</p> <p>The CMC light on LEB-122 will also be activated.</p>

MAIN DISPLAY CONSOLE—PANEL 2

SM2A-03-BLOCK II-(1)
APOLLO OPERATIONS HANDBOOK

CONTROLS AND DISPLAYS

Location		Name and Position	Function	Circuit Breaker	Power Source	Remarks				
Panel	Area Grid									
MDC-2 (Cont)		ISS	<p>The ISS status light will illuminate if the following occurs:</p> <p>a. IMU fail:</p> <ol style="list-style-type: none"> 1. IG servo error >2.9 mr for 2 sec. 2. MG servo error >2.9 mr for 2 sec. 3. OG servo error >2.9 mr for 2 sec. 4. 3200 cps <50%. 5. 800 wheel supply <50%. <p>b. PIPA fail:</p> <ol style="list-style-type: none"> 1. No pulse during 312.5 msec period. 2. If both + & - pulses occur during 312.5 msec period. 3. If no + & - pulses occur between 1.28 to 3.84 sec. <p>c. CDU fail:</p> <ol style="list-style-type: none"> 1. CDU fine error >1.0 vrms. 2. CDU coarse error >2.5 vrms. 3. Read counter limit >160 cps. 4. Cos ($\theta - \phi$) <2.0v. 5. +14 dc supply <50%. 	C/W MNA MNB (MDC-5)	DC main buses A & B	<p>Red light.</p> <p>IMU fail signal inhibited by CMC when in coarse align mode.</p> <p>ISS light on LEB-122 also illuminated.</p> <p>PIPA fail signal inhibited by CMC except during CMC-controlled translation or thrusting.</p> <p>PGNS and PROGRAM light on DSKY also illuminated.</p> <p>CDU fail signal by CMC during CDU zero mode.</p>				
2	A D-33						SPS status lights			
2	A C-33	SPS PRESS	Indicates oxidizer and/or fuel ullage tank pressures (regulated helium pressures) are not within proper operating range (157 to 200 psia nominal).			Yellow light. Continuous pressures are displayed by SPS PRPLNT TANKS-PRESS-FUEL and OXID indicators on MDC-3.				

MAIN DISPLAY CONSOLE—PANEL 2

SM2A-03-BLOCK II-(1)
APOLLO OPERATIONS HANDBOOK

CONTROLS AND DISPLAYS

Location		Name and Position	Function	Circuit Breaker	Power Source	Remarks
Panel	Area Grid					
MDC-2 (Cont)						
		EPS status lights				
2	A C-34	AC BUS 1	Indicates the following conditions exist in any of the three phases of the respective a-c bus: a. Undervoltage (95 vac or below) b. Overvoltage (130 vac or above)	C/W MNA MNB (MDC-5)	DC main buses A & B	The yellow a-c bus fail lights will not illuminate when affected a-c bus reset switch is in the OFF position. Inverters will not be disconnected from buses on undervoltage condition, but will be disconnected from bus on overvoltage. Light must be reset.
2	A C-34	AC BUS 2				
2	A D-34	AC BUS 1 OVERLOAD	Indicates an overload (3 ϕ , 27 amps total for 15 \pm 5 seconds or 1 ϕ , 11 amps for 5 \pm 1 seconds) exists on the respective a-c bus.			Time versus overload is 5 \pm 1 seconds for short circuit of 300-percent-rated current per phase and 10 to 20 seconds for short circuit of 250-percent-rated current.
2	A D-34	AC BUS 2 OVERLOAD				
2	A C-33	FC1	Indicates one of the following conditions exist in the respective fuel cell: a. H ₂ flow rate above 0.161 lb per hr. b. O ₂ flow rate above 1.276 lb per hr. c. pH factor of 9 or over. d. FC skin temperature below 360°F or above 475°F. e. FC condenser exhaust temperature below 150°F or above 175°F. f. FC outlet radiator temperature below -30°F.			Event indicators (elec/mech) PH HI and F/C RAD TEMP LOW (MDC-3) are also activated. FUEL CELL-FLOW-H ₂ and O ₂ and FUEL CELL-MODULE TEMP-SKIN and COND EXH meters on MDC-3 can be used to determine malfunctions in respective fuel cell. FUEL CELL INDICATORS selector switch would be utilized in conjunction with above.
2	A C-34	FC2				
2	A C-34	FC3				

MAIN DISPLAY CONSOLE—PANEL 2

SM2A-03-BLOCK II-(1)
APOLLO OPERATIONS HANDBOOK

CONTROLS AND DISPLAYS

Location		Name and Position	Function	Circuit Breaker	Power Source	Remarks			
Panel	Area Grid								
MDC-2 (Cont)		FC BUS DISCONNECT	Indicates a fuel cell has been automatically disconnected from d-c main bus or d-c main buses.	C/W MNA MNB (MDC-5)	DC main buses A & B	Yellow light illuminates when any fuel cell is automatically disconnected from SM d-c bus A and/or B. Overload and reverse current units on each fuel cell automatically disconnect fuel cell output from bus when reverse current >4 amps or forward current >75 amps is sensed. Lamp will not illuminate when affected fuel cell main bus switch is in off position. Talk back indicators above FUEL CELL-1, -2, and -3 MAIN BUS A and B switches indicate a striped display and which fuel cell is disconnected from which bus.			
2	A C-33								
2	A C-33						INV 1 TEMP HI	Indicates overtemperature (190°F or more) exists in respective inverter.	Yellow light.
2	A C-34						INV 2 TEMP HI		
2	A C-34						INV 3 TEMP HI		
2	A D-34						MN BUS A UNDERVOLT	Indicates transient or sustained d-c voltage drop below 26.25 vdc on respective d-c main bus.	Yellow main d-c bus undervoltage lights will not illuminate when affected main bus reset switch is in off position.
2	A D-34						MN BUS B UNDERVOLT		
2	A D-34						ECS status lights		
2	A D-34						O ₂ FLOW HI	Indicates when total ECS oxygen flow reaches 1 lb per hr for a period of time exceeding 16.5 seconds.	Red light illuminates at critical flow rate which, if continuous, indicates cabin leakage or oxygen subsystem leakage.
2	A D-35						SUIT COMPRESSOR	Indicates suit compressor differential pressure below 0.22 psia.	Continuous O ₂ flow is displayed by O ₂ FLOW indicator (MDC-2). Red light.
2	A D-34	CREW ALERT status light	Activated by real-time command from ground station through UDL.	System status light must be extinguished by ground command.					

MAIN DISPLAY CONSOLE - PANEL 2

SM2A-03-BLOCK II-(1)
 APOLLO OPERATIONS HANDBOOK

CONTROLS AND DISPLAYS

Location		Name and Position	Function	Circuit Breaker	Power Source	Remarks
Panel	Area Grid					
MDC-2 (Cont)						
2	A	D-33 C/W status light	Indicates when power supply voltage (positive or negative) is outside of 11.7 to 13.9 volts normal range.	C/W MNA MNB (MDC-5)	DC main buses A & B	Red light. Switching to redundant power sup will extinguish status light. Audio portion of master alarm circuit will not operate, as 12-volt tone generator power will be interrupted by power supply failure. MASTER ALARM light will illuminate.
2	B	F-26 FDAI No. 2 (no placard) Rate indicators Top Far right Bottom Attitude error indicators Top (below roll rate indicator) Right (left of pitch rate indicator) Bottom (above yaw rate indicator) Euler angle indicator (ball) (gimbal angle repeater) Great semicircles Small circles Roll bug and scale	Display of roll rate. Display of pitch rate. Display of yaw rate. Display of roll error. Display of pitch error. Display of yaw error. The great semicircle under index indicates pitch Euler attitude. The small circle under index indicates yaw Euler attitude. Indicates roll Euler attitude or, after .05 G, indicates roll stability attitude, if driven by GDC.	Refer to Remarks column, power.	AC bus 2 DC main bus B	<p>a. Power</p> <ol style="list-style-type: none"> Rate & error meters are servometric. The pot reference voltages come from EDA power supply, which obtains Phase A power from AC2 circuit breaker through SCS INDICATORS POWER switch. Power to the motors is obtained from the EDA which obtains a-c power from the SCS INDICATORS POWER switch supplied from AC2 circuit breaker. 28 VDC bus B from STABILIZATION CONTROL SYSTEM-SYSTEM MNB circuit breaker is also used. <p>b. Rate</p> <ol style="list-style-type: none"> Indicator consists of a triangular marker with scale marked at 0, $\pm 1/5$, $\pm 2/5$, $\pm 3/5$, $\pm 4/5$, and full scale. Full scale value depends on position of FDAI-SCALE switch. Drive signals are obtained from EDA which obtains rate information from BMAGs in GA-2, normally, BMAGs in GA-1 will supply rate when selected by BMAG MODE switches. Indicators are fly-to displays.

MAIN DISPLAY CONSOLE—PANEL 2

SM2A-03-BLOCK II-(1)
 APOLLO OPERATIONS HANDBOOK

CONTROLS AND DISPLAYS

Location		Name and Position	Function	Circuit Breaker	Power Source	Remarks
Panel	Area Grid					
MDC-2 (Cont)						
2	B F-26			Refer to Remarks column, power.	AC bus 2 DC main bus B	<p>c. Error</p> <p>1. Indicator consists of needle-type pointer and scale marked as follows:</p> <p>(a) Roll scale marked at 0, $\pm 1/2$, and full scale.</p> <p>(b) Pitch and yaw marked at 0, $\pm 1/3$, $\pm 2/3$, and full scale.</p> <p>Full-scale value depends on position of FDAI-SCALE switch.</p> <p>2. Drive signals are obtained from EDA. The input (source) to the EDA is selectable among the following:</p> <p>(a) G&N CDUs</p> <p>(b) BMAGs in GA-1</p> <p>(c) ATTITUDE SET resolvers.</p> <p>The FDAI-SELECT, FDAI-SOURCE, and/or the ATT SET switches determine which source is selected.</p> <p>3. Indicators are fly-to displays.</p> <p>d. Ball</p> <p>1. Signals to motor come from servoamp in EDA. The signal source is either the IMU or GDC as selected by panel switches (see FDAI-SELECT, FDAI-SOURCE, and/or ATT SET switches).</p>
		DSKY (no placard)		N/A	N/A	
		Keyboard				
2	C K-27	CLR	Pressing the clear button will blank the register being loaded.			
2	C K-27	ENTR	This informs the CMC that the assembled data is complete and/or execute the desired function.			

MAIN DISPLAY CONSOLE—PANEL 2

SM2A-03-BLOCK II-(1)
APOLLO OPERATIONS HANDBOOK

CONTROLS AND DISPLAYS

Location		Name and Position	Function	Circuit Breaker	Power Source	Remarks
Panel Area	Grid					
MDC-2 (Cont)						
2	C	KEY REL	Releases the DSKY displays initiated by keyboard action so that information supplied by a CMC program may be displayed.	N/A	N/A	
2	C	NOUN	Sets computer to accept next two digits as noun code.			Pressing the noun button will initially blank the noun window.
2	C	RSET	Extinguishes the status lamps that are controlled by the CMC.			In those areas where an error or malfunction exists, pressing the reset switch will not extinguish the status lamps.
2	C	PRO	Informs routing requesting the operator wishes the requesting routine to proceed without further inputs from the operator; or places the CMC in the standby mode when pressed, upon request from the CMC.			
2	C	VERB	Sets computer to accept next two digits as verb code.			Pressing verb button will initially blank verb window.
2	C	+	Denotes data to follow has positive decimal value.			
2	C	-	Denotes data to follow has negative decimal value.			
2	C	0 through 9	Switches 0 to 9 used to enter data, address codes, and action request codes into the CMC.			
		REGISTER				
2	C	COMP ACTY (light)	CMC is engaged in computation.			
2	C	NOUN (light & display)	A two-digit display, indicating noun code selected.			On-board data provides definition of PROGRAM and NOUN digits.
2	C	PROG (light & display)	A two-digit display, indicating number of the program (major mode) presently in progress.			

MAIN DISPLAY CONSOLE—PANEL 2

SM2A-03-BLOCK II-(1)
APOLLO OPERATIONS HANDBOOK

CONTROLS AND DISPLAYS

Location		Name and Position	Function	Circuit Breaker	Power Source	Remarks
Panel	Area Grid					
MDC-2 (Cont)						
2	C J-26	REGISTER 1 (display)	Displays contents of selected register or memory location. First component of extended-length data word, if applicable.	N/A	N/A	Displays may be selected manually or by CMC program.
2	C J-26	REGISTER 2 (display)	Displays contents of selected register or memory location. Second component of extended data word, if applicable.			
2	C J-26	REGISTER 3 (display)	Displays contents of selected register or memory location. Third component of extended data word, if applicable.			
2	C I-26	VERB (light & display)	A two-digit display, indicating verb code selected.			On-board data provides definition of VERB digits.
2	C I-25	DSKY Status Lights GIMBAL LOCK	Gimbaled lock-light will illuminate under computer control whenever the middle gimbaled angle of the platform exceeds 70 degrees.			Illumination of lights warns of pending gimbaled lock condition.
2	C I-25	KEY REL	Internal CMC program needs DSKY circuits to continue program. a. A crew keystroke is made when internal flashing display is currently on DSKY (exceptions: PRO, ENTR, RSET). b. Crew makes a keystroke on top of his selected monitor verb.			Request for operator to press KEY REL pushbutton.
2	C I-25	NO ATT	Light will illuminate whenever the inertial subsystem is not in a mode to provide an attitude reference.			

MAIN DISPLAY CONSOLE—PANEL 2

SM2A-03-BLOCK II-(1)
APOLLO OPERATIONS HANDBOOK

CONTROLS AND DISPLAYS

Location		Name and Position	Function	Circuit Breaker	Power Source	Remarks
Panel	Area Grid					
MDC-2 (Cont)						
2	C J-25	OPR ERR	Light will illuminate when an illegal keyboard entry is made into the CMC.	N/A	N/A	
2	C I-25	PROG	Light illuminates when additional functions, operations, or information is requested by computer to complete specific operation or function.			
2	C J-25	RESTART	Light will be illuminated whenever computer goes into restart program.			
2	C I-25	STBY	Light will be illuminated whenever computer subsystem is in standby mode of operation.			
2	C I-25	TEMP	Light will illuminate whenever temperature of stable platform deviates more than $\pm 5^{\circ}$ F from nominal.			Indicates out of tolerance temperature, plus or minus, on stable platform.
2	C J-25	TRACKER	Light illuminates whenever there is failure of one of optical CDU, or data good discrete not present after reading range from VHF DATA LINK (SC 106 only).			
2	C I-25	UPLINK ACTY	CMC is receiving data link information by up-telemetry.			
2	D N-25	ABORT SYSTEM switches 2 ENG OUT switch AUTO OFF	Activates EDS for a two-engine out automatic abort capability by de-energizing two-engine out auto abort deactivate relays. Deactivates EDS for a two-engine out automatic abort capability by energizing two-engine out auto abort deactivate relays.		LV-IU batteries	The two-engine out AUTO abort capability is also shut off automatically by IU prior to staging.

MAIN DISPLAY CONSOLE—PANEL 2

SM2A-03-BLOCK II-(1)
APOLLO OPERATIONS HANDBOOK

CONTROLS AND DISPLAYS

Location		Name and Position	Function	Circuit Breaker	Power Source	Remarks
Panel	Area Grid					
MDC-2 (Cont)						
2	D N-26	LV RATES switch AUTO OFF	Activates EDS for excessive rates automatic abort capability by de-energizing excessive rates auto abort deactivate relays. Deactivates EDS for excessive rates automatic abort capability by energizing excessive rates auto abort deactivate relays.	N/A	LV-IU batteries	Excessive rates auto abort capability is also shut off automatically by the IU prior to staging.
2	D N-26	TWR JETT switches 1 and 2 OFF AUTO	Either switch initiates normal jettison of LES tower and arms systems A and B of the SECS abort circuitry for SPS abort. Removes power to systems A and B SECS abort circuitry for LES abort. Provides for an automatic tower jettison subsequent to any LES abort.	SEQ EVENTS CONT SYS A LOGIC B BAT A and B (MDC-8) EDS 1 & 3 BAT A & BAT B (MDC-8)	a. Battery buses A and B when the SECS LOGIC/OFF switches are in the LOGIC position (MDC-8) b. EDS change-over bus when the EDS POWER switch is ON (MDC-7)	Three-position toggle switch with a maintain position to AUTO and to OFF and TWR JETT position is momentarily being spring-loaded to OFF position. After LES tower has been manually jettisoned, switch will spring back to neutral OFF position.
2	D M-24	EDS switch AUTO OFF	Prepares LV EDS auto abort circuitry for automatic enabling at lift-off. All auto abort capabilities are disabled.	EDS 1 & EDS 3 (MDC-8)	Battery buses A & B	Two-position toggle switch. Provides open or closed loop operation of EDS automatic abort enable circuitry.

MAIN DISPLAY CONSOLE—PANEL 2

SM2A-03-BLOCK II-(1)
APOLLO OPERATIONS HANDBOOK

CONTROLS AND DISPLAYS

Location		Name and Position	Function	Circuit Breaker	Power Source	Remarks
Panel	Area Grid					
MDC-2 (Cont)						
2	D	M-27 S-IVB/LM SEP switch	Initiates separation of LM from S-IVB stage.	SEQ EVENTS CONT SYS A ARM B BAT A and B (MDC-8)	Battery buses A & B	This is a toggle switch spring-loaded to down position.
2	D	M-25 CSM/LM FINAL SEP switches Switches 1 and 2	Either switch initiates abandonment of LM or jettisons the docking probe and ring subsequent to SPS abort. Backup to docking probe and ring automatic jettison during LES aborts.			
2	D	M-26 CM/SM SEP switches Switches 1 and 2	Either switch activates systems A and B to perform the following functions: a. CM-SM deadface b. CM-RCS pressurize c. CM-SM separation d. CM-SM separation pyro control cutout e. RCS control transfers (providing CM-RCS LOGIC is in CM-RCS LOGIC) f. SM jettison controller start.			Switch guards are diagonally stripped in yellow and black to caution against inadvertent switch actuation.
2	D	O-24 LAUNCH VEHICLE switches S-II/S-IVB LV STAGE OFF	Initiates S-II to S-IVB staging sequence of LV guidance program, in case it is required on S-V LV during S-II boost. No function.		IU EDS buses	Switch is provided to crew on S-V LV to enable emergency upstaging onto the S-IVB in case the S-II performance is out of tolerance.

MAIN DISPLAY CONSOLE—PANEL 2

SM2A-03-BLOCK II-(1)
 APOLLO OPERATIONS HANDBOOK

CONTROLS AND DISPLAYS

Location		Name and Position	Function	Circuit Breaker	Power Source	Remarks
Panel	Area Grid					
MDC-2 (Cont)						
2	D	P-24 MAIN RELEASE switch	Releases main parachute from command module.	SEQ EVENT CONT. SYS- A LOGIC B- BAT A & BAT B (MDC-8)	Battery buses A & B	Switch is electrically enabled when 10,000-foot baro switches close during normal descent and will release parachutes when actuated. Switch should never be moved to up (release) position until after splash-down. The switch is spring-loaded to the down position.
2	E	N-24 PRPLNT DUMP AUTO switch AUTO RCS CMD	Enables circuitry to 0 to 42 second timers, and if an abort is initiated from 0 to T + 42 seconds, CM RCS oxidizer is dumped followed 5 seconds later by CM RCS fuel dump, followed 13 seconds later by CM RCS purge of fuel and oxidizer systems. Disables auto oxidizer dump circuitry at T + 42 seconds. Allows RCS latching relay to be controlled automatically upon LES abort after T + 42 seconds to tower jettison, or upon SPS abort or CM/SM separation.	SEQ EVENT CONT - SYS LOGIC A BAT A LOGIC B BAT B (MDC-8)		The 42-second timers, enabled by the CM RCS LOGIC switch (MDC-1), start at lift-off. Auto dump capability is disabled after T + 42 seconds by crew placing switch to RCS CMD.
2	F	O-24 LAUNCH VEHICLE-GUIDANCE switch IU CMC	Selects control of launch vehicle guidance. Normal position for this switch. Allows Saturn guidance system to function normally and control flight of spacecraft. Will initiate Saturn guidance take-over mode of PGNCS.	IMU MNA & MNB (MDC-5) G/N POWER IMU SWITCH	28 vdc - IU and DC main buses A & B	Switching to this position enables manual attitude control of SIVB through use of rotation control, Used only during non-thrusting modes. Switch can be guarded in either IU or CMC position.

MAIN DISPLAY CONSOLE--PANEL 2

SM2A-03-BLOCK II-(1)
 APOLLO OPERATIONS HANDBOOK

CONTROLS AND DISPLAYS

Location		Name and Position	Function	Circuit Breaker	Power Source	Remarks
Panel	Area Grid					
MDC-2 (Cont)		DOCKING PROBE switches				
2	H E-28	EXTD/REL/OFF/ RETRACT	Applies d-c power to the probe extend latch release solenoid, capture latch release motor and indicators.	DOCK PROBE MNA & MNB (MDC-8)	DC main buses A & B	Capture latch sensing switches located in probe head will have to be closed to power LDEC relays.
		EXTD/REL	Removed d-c power.			
		OFF	Applies d-c power to the DOCKING PROBE-RETRACT-PRIM and SEC switches.			
		RETRACT				
		RETRACT switches				
2	H E-28	PRIM	Controls d-c power from bus to pyrotechnic initiator on No. 1 nitrogen bottle.		DC main bus A	
		1	OFF position.			
		CENTER				
		2	Controls d-c power from bus to pyrotechnic initiator on No. 2 nitrogen bottle.			
		SEC				
2	H E-29	1	Controls d-c power from bus to pyrotechnic initiator on No. 3 nitrogen bottle.		DC main bus B	
		CENTER	OFF position.			
		2	Controls d-c power from bus to pyrotechnic initiator on No. 4 nitrogen bottle.			

MAIN DISPLAY CONSOLE—PANEL 2

SM2A-03-BLOCK II-(1)
APOLLO OPERATIONS HANDBOOK

CONTROLS AND DISPLAYS

Location		Name and Position	Function	Circuit Breaker	Power Source	Remarks
Panel	Area Grid					
MDC-2 (Cont)		PROBE indicators				
2	H D-28	EXTD/RETR A	Striped-line display indicates probe in motion. Gray display indicates completed movement.	DOCK PROBE MNA	DC main buses A & B	Probe indicating switches will open at full extend or retract positions.
		EXTD/RETR B	Striped-line display indicates probe in motion. Gray display indicates completed movement.	DOCK PROBE MNB		
		CM RCS indicators				
2	I H-28	He TEMP	Indicates helium tank temperature of CM RCS system 1 or 2, as selected by RCS INDICATORS switch. (Meter range: 0° to 300° F.)	INSTRUMENTS ESS MNA & MNB (MDC-5)		Three indicators are identical in operation. Each one consists of d'Arsonval-type meter with fixed dial and movable pointer. Pointer movement is vertical, as observed from crew couch. Each indicator is capable of accepting input signals from CM or SM RCS. Displayed information is determined by position of RCS INDICATORS switch.
2	I H-28	PRESS-He	Indicates helium tank pressure of CM RCS system 1 or 2, as selected by RCS INDICATORS switch. (Meter range: 0 to 5000 psia.)			
2	I H-29	PRESS-MANF	Indicates regulator manifold pressure of CM RCS 1 or 2 after pressurization as selected by RCS INDICATORS switch. (Meter range: 0 to 400 psia.)			
2	I L-29	CM RCS PRPLNT switches	Two functionally identical switches. Each switch controls the opening or closing of fuel and oxidizer propellant isolation valve within its respective propellant system.	RCS-PROP ISOL MNA for SYS 1 & MNB for SYS 2 (MDC-8)		Each switch is three-position toggle switch spring-loaded, allowing it to return to center position after placing it to ON or OFF positions. Each valve contains position microswitch which completes circuit for operating valve position event indicator mechanism.

MAIN DISPLAY CONSOLE—PANEL 2

SM2A-03-BLOCK II-(1)
APOLLO OPERATIONS HANDBOOK

CONTROLS AND DISPLAYS

Location		Name and Position	Function	Circuit Breaker	Power Source	Remarks
Panel	Area Grid					
<u>MDC-2 (Cont)</u>						
2	1	1 & 2 CENTER OFF	Energizes propellant isolation valve solenoids to open position, magnetically latched open. Removes solenoid excitation; valves remain in last commanded position. Energizes propellant isolation valve solenoids to closed position; spring-loaded closed.	RCS-PROP ISOL MNA for SYS 1 and MNB for SYS 2 (MDC-8)	DC main buses A & B	Place to ON prior to lift-off; then to CENTER.
2	1	CM RCS PRPLNT-1 & 2 event indicators	Striped-line display indicates closed condition of valves controlled by switch located directly below event indicator. Gray display indicates open condition.	SM RCS HTRSB MNA for SYS 1 and SM RCS HTRSA MNB for SYS 2		Each indicator is two-position device with striped-line display, controlled by power application and gray display by power removed action. Both valves must be open before gray is displayed; either or both valves closed, display will show striped.
2	1	RCS CMD switch ON CENTER OFF	Energizes latching relay arm coil applying power to enable controller reaction jet on-off assembly through AUTO RCS SELECT switches. Allows SECS to automatically control latching relay. De-energizes latching relay safe coil removing power from controller reaction jet on-off assembly and AUTO RCS SELECT switches.	SEQ EVENT CONT SYS- ARM A BAT A ARM B BAT B (MDC-8)	EPS battery buses A & B	Three-position toggle switch, spring-loaded to center position. Switch allows manual enable-inhibit functions to controller reaction jet on-off assembly. Inhibit-enable functions provide direct control or backup capability to SECS automatic control of RCS latching relay. If LES abort occurs after T + 42 seconds, SECS automatically closes relay 1 second after abort initiation. If SPS abort occurs, SECS automatically closes relay 3.8 seconds after abort initiation. ELSC baro switch input automatically causes relay to open at approximately 24,000 feet during CM descent.

MAIN DISPLAY CONSOLE—PANEL 2

SM2A-03-BLOCK II-(1)
APOLLO OPERATIONS HANDBOOK

CONTROLS AND DISPLAYS

Location		Name and Position	Function	Circuit Breaker	Power Source	Remarks		
Panel	Area Grid							
MDC-2 (Cont)		RCS INDICATORS switch	<p>Selects inputs to propellant temperature, pressure gauges, CM selections 1 and 2 functions are identical within their respective systems. SM selections A, B, C, and D functions are identical within their respective systems.</p> <p>Connects CM RCS system 1 (2) signal outputs from temperature and pressure transducers to appropriate indicating devices.</p> <p>Connects SM RCS quad A (B, C, and D) signal outputs from temperature and pressure transducers to appropriate indicating devices.</p>	N/A	N/A	<p>Six-position rotary switch. CM selection of switch, positions 1 and 2, permit monitoring command module propellant systems 1 and 2. SM selection of switch, positions A, B, C, and D permit monitoring service module propellant systems of quads A, B, C, and D.</p>		
2	I						G-33	CM selection 1 & 2
								SM selection A, B, C, D
2	I	RCS TRNFR switch CM	<p>Energizes motor switch causing the following:</p> <p>a. Connects CM RCS engines to controller reaction jet on-off assembly.</p> <p>b. Removes power from translation control as far as translation maneuvers are concerned.</p> <p>Enables SECS automatic control of motor switch.</p> <p>Energizes motor switch, causing contacts to close which connect SM RCS engines to the controller reaction jet on-off assembly.</p>	RCS-LOGIC MNA & MNB (MDC-8)	DC main buses A & B	<p>Three-position switch, spring-loaded to center position. Switch provides manual backup for automatic transfer function, or allows transfer prior to automatic separation sequence.</p> <p>Must be in this position to start SM jettison controller at CM-SM separation.</p>		

MAIN DISPLAY CONSOLE—PANEL 2

SM2A-03-BLOCK II-(1)
APOLLO OPERATIONS HANDBOOK

CONTROLS AND DISPLAYS

Location		Name and Position	Function	Circuit Breaker	Power Source	Remarks
Panel	Area Grid					
MDC-2 (Cont)						
2	I	SM RCS HEATERS switches A PRIM	Applies power from d-c main bus B to a high-temperature thermostat in quad A which automatically controls quad A temperature.	RCS HTRS A MNB (MDC-8)	DC main bus B	Thermostat applies power to heater at 115°F and removes power from heater at 134°F.
			Removes power from thermostat.			
			Applies power from d-c main bus B to one high temperature thermostat which automatically controls quad A temperature.			
2	I	B PRIM	Applies power from d-c main bus A to a high-temperature thermostat in quad B which automatically controls quad B temperature.	RCS HTRS B MNA (MDC-8)	DC main bus A	Controlled at same temperature as in quad A.
			Removes power from thermostat.			
			Applies power from d-c main bus A to one high temperature thermostat in quad B temperature.			
2	I	C PRIM	Applies power from d-c main bus B to a high-temperature thermostat in quad C which automatically controls quad C temperature.	RCS HTRS C MNB (MDC-8)	DC main bus B	Controlled at same temperature as in quad A.
			Removes power from thermostat.			
			Applies power from d-c main bus B to one high temperature thermostat in quad C temperature.			

MAIN DISPLAY CONSOLE—PANEL 2

SM2A-03-BLOCK II-(1)
APOLLO OPERATIONS HANDBOOK

CONTROLS AND DISPLAYS

Location		Name and Position	Function	Circuit Breaker	Power Source	Remarks
Panel	Area Grid					
MDC-2 (Cont)						
2	I J-30	D PRIM OFF SEC	Applies power from d-c main bus A to a high-temperature thermostat switch in quad D which automatically controls quad D temperature. Removes power from thermostat switches. Applies power from d-c main bus A to one high temperature thermostat switch in quad D temperature.	RCS HTRS D MNA (MDC-8)	DC main bus A	Controlled at same temperature as in quad A.
2	I G-30/ G-31	SM RCS HELIUM 1 switches A, B, C, D ON CENTER OFF	Four functionally identical switches. Each switch controls one helium isolation valve in HELIUM 1 half of parallel helium pressurization system. Each of four RCS quads contains identical systems. Energizes helium isolation valve solenoid to open position and is magnetically latched open. Removes solenoid excitation; valve remains in last commanded position. Energizes helium isolation valve solenoid to closed position; spring-loaded closed.	RCS-PROP ISOL MNA for QUADS B & D, MNB for QUADS A & C (MDC-8)	DC main buses A & B	Each switch is three-position toggle switch, spring-loaded, allowing it to return to center position after positioning to ON or OFF position. Each valve contains position microswitch which completes circuit for operating valve position event indicator mechanism.
2	I F-30/ F-31	SM RCS HELIUM 1 event indicators A, B, C, D	Striped-line display indicates closed condition of valve controlled by switch located directly below event indicator. Gray display indicates open condition.	SM RCS HTRS B MNA for QUADS B & D and SM RCS HTRS A MNB for QUADS A & C (MDC-8)		Each indicator is two-position device with striped-line display controlled by power application and gray display by power removal.

MAIN DISPLAY CONSOLE - PANEL 2

SM2A-03-BLOCK II-(1)
APOLLO OPERATIONS HANDBOOK

CONTROLS AND DISPLAYS

Location		Name and Position	Function	Circuit Breaker	Power Source	Remarks		
Panel Area	Grid							
MDC-2 (Cont)		SM RCS HELIUM 2 switches A, B, C, D ON CENTER OFF	Four functionally identical switches. Each switch controls one helium isolation valve in HELIUM 2 half of parallel helium pressurization system. Each of four SM RCS quads contain identical systems. Energizes helium isolation valve solenoid to open position and is magnetically latched open. Removes solenoid excitation; valve remains in last commanded position. Energizes helium isolation valve solenoid to closed position; spring-loaded closed.	RCS PROP ISOL MNA for QUADS B & D, MNB for QUADS A & C (MDC-8)	DC main buses A & B	Each switch is three-position toggle switch, spring-loaded, allowing it to return to center position after placing it to ON or OFF position. Each valve contains position microswitch which completes circuit for operating valve position event indicator mechanism.		
2	I							
2	I							
2	H-30/ H-31	SM RCS HELIUM 2 event indicators A, B, C, D	Striped-line display indicates closed condition of valve controlled by switch located directly below event indicator. Gray display indicates open condition.	SM RCS HTRS B MNA for QUADS B & D and SM RCS HTRS A MNB for QUADS A & C (MDC-8)		Each indicator is two-position device with striped-line display controlled by power application and gray display by power removal.		
2	J-30/ J-31	SM RCS PROPELLANT switches A, B, C, D OPEN	Four functionally identical switches. Each switch controls four isolation valves (two fuel & two oxidizer) within each of SM RCS quads. Energizes two fuel and two oxidizer propellant isolation valves to open position and are magnetically latched open.	RCS PROP ISOL MNA for QUADS B & D, MNB for QUADS A & C (MDC-8)				Each switch is three-position toggle switch, spring-loaded, allowing it to return to center position after placing it to OPEN or CLOSE position. Each valve contains microswitch which completes circuit for operating valve position event indicator. Open in prelaunch.
2	J-30/ J-31							
2	J-30/ J-31							

MAIN DISPLAY CONSOLE—PANEL 2

SM2A-03-BLOCK II-(1)
APOLLO OPERATIONS HANDBOOK

CONTROLS AND DISPLAYS

Location		Name and Position	Function	Circuit Breaker	Power Source	Remarks
Panel	Area Grid					
MDC-2 (Cont)						
2	I	CENTER	Removes solenoid excitation; valves remain in last commanded position. Energizes two fuel and two oxidizer propellant isolation valves to closed position and are spring-loaded closed.	RCS PROP ISOL MNA for QUADS B & D, MNB for QUADS A & C (MDC-8)	DC main buses A & B	
2	I	CLOSE				
2	I	SM RCS PROPELLANT event indicators PRIM PRPLNT A, B, C, D	Striped line display indicates closed condition of two primary propellant isolation valves controlled by propellant switch located directly below event indicator. Gray indicates two primary valves open. Striped line display indicates closed condition of two secondary propellant isolation valves controlled by propellant switch located directly above event indicator. Gray indicates two secondary valves are open.	SM RCS HTRS B MNA for SM RCS QUADS B & D, SM RCS HTRS A MNB for SM RCS QUADS A & C (MDC-8)		Each indicator is two-position device with striped line display controlled by power application and gray display by power removal from PRIM PRPLNT indicators. SEC PRPLNT indicators striped-line display is controlled by power removal and gray display by power application. Both valves must be open before gray will be displayed in case of PRIM PRPLNT and/or SEC PRPLNT indicators; either or both valves closed in case of striped PRIM PRPLNT and/or SEC PRPLNT indicators.
2	I	SEC PRPLNT A, B, C, D				
2	I	SM RCS SEC PRPLNT FUEL PRESSURE switches SEC PRPLNT FUEL PRESS A, B, C, D OPEN	Four functionally identical switches. Each switch controls one secondary propellant fuel pressure valve, which when opened allows regulated helium pressure to secondary fuel tank. Each of four SM RCS quads contain identical systems. Energizes secondary propellant fuel pressure valve solenoid to open position and magnetically latch open.	RCS PRPLNT ISOL MNA for QUADS B & D, MNB for QUADS A & C (MDC-8)		Open in prelaunch to pressurize secondary fuel tank to system regulated pressure, then closed. Will be opened in flight when primary propellant fuel tank has expended its fuel supply allowing pressure in fuel

(cont)

MAIN DISPLAY CONSOLE—PANEL 2

SM2A-03-BLOCK II-(1)
APOLLO OPERATIONS HANDBOOK

CONTROLS AND DISPLAYS

Location		Name and Position	Function	Circuit Breaker	Power Source	Remarks
Panel	Area Grid					
MDC-2 (Cont)						
2	I		Removes solenoid excitation; valve remains in last commanded position.	RCS PRPLNT ISOL MNA for QUADS B & D, MNB for QUADS A & C (MDC-8)	DC main buses A & B	manifold to drop, triggering applicable SM RCS A, B, C or D caution/warning light along with SEC PRPLNT FUEL pressure readout on MDC-2, informing crew to open SEC PRPLNT FUEL PRESS valve allowing tank to remain pressurized for duration.
		CENTER				
		CLOSE	Energizes secondary propellant fuel pressure valve solenoid to closed position; spring-loaded closed.			
		SM RCS indicators		INSTRUMENTS—ESS MNA & MNB (MDC-5)		Three indicators are identical in operation. Each one consists of a d'Arsonval-type meter with a fixed dial and movable pointer. Pointer movement is vertical, as observed from crew couch. Each indicator is capable of accepting input signals from the CM or SM RCS. Displayed information is determined by the position of the RCS INDICATORS switch.
2	I	TEMP	Indicates temperature or pressure of SM RCS quad A, B, C, or D, as selected by the RCS INDICATORS switch. (Meter range: 0° to 300°F.)			
		PKG				
2	I	PRESS	Indicates helium tank pressure of SM RCS quad A, B, C, or D, as selected by the RCS INDICATORS switch. (Meter range: 0 to 5000 psia.)			
		He				
2	I	SEC FUEL	Indicates the primary fuel tank of the applicable SM RCS quad has expended its propellant as selected by the RCS INDICATORS select switch and informs the crew to open the applicable SM RCS quad SEC PRPLNT FUEL PRESS valve and return the SM RCS secondary fuel tank to its normal regulated pressure. (Meter range: 0 to 400 psia.)			This method is used to provide an inflight update as to the amount of propellant remaining in the applicable SM RCS quad.

MAIN DISPLAY CONSOLE—PANEL 2

SM2A-03-BLOCK II-(1)
APOLLO OPERATIONS HANDBOOK

CONTROLS AND DISPLAYS

Location		Name and Position	Function	Circuit Breaker	Power Source	Remarks
Panel	Area Grid					
MDC-2 (Cont)		PRPLNT QTY, He TK TEMP PRPLNT QTY IND HE TK TEMP	<p>Indicates propellant quantity remaining in % from the helium tank temperature/pressure ratio transducer of SM RCS quad A, B, C, or D if RCS INDICATOR select switch on MDC-2 is positioned to SM A, B, C, or D and SM RCS IND He TK TEMP & PRPLNT QTY switch on MDC-2 is in PRPLNT QTY position. (Meter range: 0 to 100°F.)</p> <p>Indicates helium tank temperature from helium temperature transducer of SM RCS quad A, B, C, or D if RCS INDICATOR select switch on MDC-2 is positioned to SM A, B, C, or D and SM RCS IND He TK TEMP & PRPLNT QTY switch on MDC-2 is in He TK TEMP position. Applicable SM RCS quad helium tank temperature is determined as well as helium source pressure and plotted on nomogram.</p> <p>Percent of propellant quantity for applicable quad can then be determined. This provides alternate method of determining propellant quantity remaining in SM RCS quads A, B, C, and D. (Meter range: 0 to 100°F.)</p>	INSTRUMENTS— ESS MNA & MNB (MDC-5)	DC main buses A & B	
2	1					
2	1	SM RCS IND He TK TEMP & PRPLNT QTY switch SM RCS IND He TK TEMP up position	Allows helium tank temperature transducer of each SM RCS quad (A, B, C, and D) to transmit to RCS INDICATORS select switch on MDC-2.			Two-position switch.

MAIN DISPLAY CONSOLE—PANEL 2

SM2A-03-BLOCK II-(1)
APOLLO OPERATIONS HANDBOOK

CONTROLS AND DISPLAYS

Location		Name and Position	Function	Circuit Breaker	Power Source	Remarks
Panel	Area Grid					
MDC-2 (Cont)						
2	I 1-30	PRPLNT QTY down position	Allows helium tank temperature/pressure ratio transducer of each SM RCS quad (A, B, C, and D) to transmit propellant quantity remaining to RCS INDICATOR select switch on MDC-2.	INSTRUMENTS - MNA & MNB (MDC-5)	DC main buses A & B	
2	I 1-29	CM RCS PRESS switch CM RCS PRESS up position down position	Activates two each helium isolation valves in both CM RCS systems 1 and 2. De-energizes relays removing power from squib valves.	SEQ EVENT SEQ CONT SYS - ARMA BAT A CB ARM B BAT B CB (MDC-8)	Battery buses A & B	SEQ EVENT CONT SYS PYRO ARM A switch and PYRO ARM B switch (MDC-8) for actual initiation of squib valves when relays are energized by CM RCS PRESS placed to CM RCS PRESS.
2	J 1-29	UP TLM switch (IU) ACCEPT BLOCK	Enables decoded and accepted UP TLM message from MSFN to pass from up-data link equipment to computer in instrumentation unit. Blocks UP TLM message from affecting the computer in instrumentation unit.			
2	J 1-28	UP TLM (CM) ACCEPT BLOCK	a. Enables decoded and accepted UP TLM message from MSFN to pass from up-data link equipment to CMC. b. Enables validation signal from UDL equipment to go to telemetering unit. a. Blocks UP TLM message from affecting CMC. b. Blocks validation signal from UDL equipment to telemetering unit.			

MAIN DISPLAY CONSOLE - PANEL 2

SM2A-03-BLOCK II-(1)
APOLLO OPERATIONS HANDBOOK

CONTROLS AND DISPLAYS

Location		Name and Position	Function	Circuit Breaker	Power Source	Remarks
Panel Area	Grid					
MDC-2 (Cont)						
2	K	E-29 EXTERIOR LIGHTS RUN/EVA switch RUN/EVA OFF	Furnishes power to running lights (external) and EVA floodlight. Removes power.	RUN/EVA TRGT AC1 & AC2 (RHEB-226)	AC buses 1 & 2	Exterior light switch controls light colored lights (4 amber, 2 green, and 2 red) located on exterior surface of service module.
2	K	E-30 RNDZ/SPOT switch RNDZ OFF SPOT	Applies power to rendezvous beacon. Removes power. Applies power to exterior spot-light and exterior door release actuator.	COAS/TUNNEL/RNDZ/SPOT (RHEB-226)	DC main bus A	3-position toggle switch; center is OFF.
2	K	E-31 TUNNEL LIGHT switch TUNNEL LIGHT OFF	Applies power to light fixture located in CM tunnel. Removes power.	LIGHTING-COAS/TUNNEL/RNDZ/SPOT MNA & MNB	DC main buses A & B	Six fixtures with two lamps each.
2	L	E-31 LM PWR CSM OFF RESET	Energizes relays in LM to connect CM power and CM dc negative to LM through two umbilicals and disconnect LM power from heater circuits. Disconnect power to LM. Momentary position opens relays in LM to disable CM circuit and connect LM power to heater circuits.	LM PWR - 2 MNA & LM PWR - 1 MNB (MDC-5)	DC main bus B	Controls power source for LM CONTINUOUS. Does not open controlling relays in LM.

MAIN DISPLAY CONSOLE—PANEL 2

SM2A-03-BLOCK II-(1)
APOLLO OPERATIONS HANDBOOK

CONTROLS AND DISPLAYS

Location		Name and Position	Function	Circuit Breaker	Power Source	Remarks
Panel	Area Grid					
MDC-2 (Cont)		MISSION TIMER				
2	N E-34	Indicator	Has capabilities to count up mission elapsed time.	Group 4 MNA & MNB	DC main buses A & B	Timer provides provisions for manual setting, count-up readout (hours, minutes, and seconds), and reset to zero by remote control.
2	N E-35	HOURS switch TENS CENTER UNITS	Changes HOURS numerical readout in tens and hundreds. No function. Changes HOURS numerical readout in units.	TIMERS MNA & MNB (RHEB-229)		Internal timing pulse is provided in case timing signal is lost. Clock is capable of timing from external or internal timing source without losing mission time. Group 4, MNA, and TIMERS, MNA, circuit breakers in series. Group 4, MNB, and TIMERS, MNB, circuit breakers in sequence.
2	N E-36	MIN switch TENS CENTER UNITS	Changes MIN numerical readout in tens. No function. Changes MIN numerical readout in units.			Mission timer can only slew up to add time.
2	N E-36	SEC switch TENS CENTER	Changes SEC numerical readout in tens. No function.			

MAIN DISPLAY CONSOLE—PANEL 2

SM2A-03-BLOCK II-(1)
 APOLLO OPERATIONS HANDBOOK

CONTROLS AND DISPLAYS

Location		Name and Position	Function	Circuit Breaker	Power Source	Remarks
Panel Area	Grid					
MDC-2 (Cont)						
2	N	UNITS	Changes SEC numerical readout in units.	Group 4 MNA & MNB	DC main buses A & B	
2	N	MISSION TIMER switch	Starts mission timer. Stops mission timer. Resets mission timer.	TIMERS MNA & MNB (RHEB-229)		Upon receipt of lift-off signal, timer will reset to zero and start counting up with switch in START position. Timer may be stopped at anytime by selecting STOP. To reset timer, momentarily hold switch to RESET position.
2	O	CAUTION/WARNING system switches	Selects SC systems to be monitored. Before separation and entry, systems in both CM and SM are monitored for malfunction or out-of-tolerance conditions with this switch in CSM position. After CSM separation, only systems in CM are monitored by placing switch in CM position.	C/W MNB	DC main buses A & B	Repositioning switch to CM position also prevents SC status lights and event indicators associated with SM system from remaining activated after separation.
2	O	LAMP TEST	Provides capability to test lamps of system status and MASTER ALARM lights. Tests illumination of left-hand group of status lights on MDC-2 and MASTER ALARM switch-light on MDC-1. Normal operating position. Tests illumination of right-hand group of status lights on MDC-2 and MASTER ALARM switch-light on MDC-3.	C/W MNA C/W MNB (MDC-5)		NOTE MASTER ALARM light on LEB-122 is tested by placing CONDITION LAMPS switch on LEB-122 to TEST.

MAIN DISPLAY CONSOLE—PANEL 2

SM2A-03-BLOCK II-(1)
APOLLO OPERATIONS HANDBOOK

CONTROLS AND DISPLAYS

Location		Name and Position	Function	Circuit Breaker	Power Source	Remarks
Panel	Area Grid					
MDC-2 (Cont)		NORMAL/BOOST/ ACK NORMAL BOOST ACK	Permits three modes of status and alarm light illumination. For most of the mission, the switch is set to the NORMAL position to give normal C&W light operation, upon receipt of abnormal condition signals, to all system status lights and MASTER ALARM switch-light capable of illumination. During the ascent phase, the switch is set to the BOOST position so that although all other C&W lights operate normally, the MASTER ALARM switch-light on MDC-1 will not illuminate. Breaks normal power path to system status lights.	C/W MNA C/W MNB (MDC-5)	DC main buses A & B	This prevents possible confusion on MDC-1 between the red MASTER ALARM switch-light and the adjacent red ABORT light. System status can be illuminated by pressing MASTER ALARM switch-light.
2	O F-34					
2	O F-35					
2	P G-34	CABIN FAN switches 1 ON	Applies a-c power to motor of No. 1 cabin air fan, directing air-flow through cabin heat exchanger.	ECS-CABIN FAN 1 ØA, ØB, ØC (MDC-5)	AC bus 1	Cabin air fans No. 1 and No. 2 are operated simultaneously to obtain adequate cooling. Output of fan is as follows: a. Prelaunch mode - 171.45 cfm. b. Normal mode - 170.67 cfm. c. Emergency mode - 0 cfm (fan off).

MAIN DISPLAY CONSOLE—PANEL 2

SM2A-03-BLOCK II-(1)
APOLLO OPERATIONS HANDBOOK

CONTROLS AND DISPLAYS

Location		Name and Position	Function	Circuit Breaker	Power Source	Remarks
Panel	Area Grid					
MDC-2 (Cont)						
2	P G-34	OFF	Removes a-c power from motor of No. 1 cabin air fan.	ECS-CABIN FAN 1 ØA, ØB, ØC (MDC-5)	AC bus 1	In event of malfunction, fan No. 1 is turned off and fan closure cover manually positioned over outlet to prevent backflow.
2	P G-34	2 ON	Applies a-c power to motor of No. 2 cabin air fan, directing airflow through cabin heat exchanger.	ECS-CABIN FAN 2 ØA, ØB, ØC (MDC-5)	AC bus 2	Cabin air fans No. 1 and No. 2 are operated simultaneously to obtain adequate cooling. Output of fan is as follows: a. Prelaunch mode - 171.45 cfm. b. Normal mode - 170.67 cfm. c. Emergency mode - 0 cfm (fan off). In event of malfunction, fan No. 2 is shut down and fan closure cover is manually positioned over outlet to prevent backflow.
2	P K-38	CABIN TEMP controls AUTO/MAN switch AUTO MAN	Applies a-c power to cabin temperature control unit to automatically regulate temperature of water-glycol flow through cabin heat exchanger. Removes a-c power from cabin temperature control unit, permitting manual override operation of the CABIN TEMP control valve (LHFEB-303) by properly positioning control knob.	ECS-CABIN FAN 2 ØC (MDC-5)		Temperature control unit sensor is located at inlet to cabin air fans; also, an anticipator (sensor) is located at outlet of cabin air fans. Cabin temperature control valve full travel requires 25 seconds (max). Manual control of cabin temperature control valve is required in event of failure of automatic control unit. There is a definite time lag in cabin temperature response following a manual adjustment; therefore, close coordination between manual adjustments and the TEMP-CABIN indicator (MDC-2) is not necessary.

MAIN DISPLAY CONSOLE—PANEL 2

SM2A-03-BLOCK II-(1)
APOLLO OPERATIONS HANDBOOK

CONTROLS AND DISPLAYS

Location		Name and Position	Function	Circuit Breaker	Power Source	Remarks
Panel	Area Grid					
MDC-2 (Cont)						
2	P K-40	AUTO control INCR (upward)	Thumbwheel permits manual adjustment of cabin temperature automatic control unit. Higher the number selected, greater the proportional increase in cabin temperature.	None	None	Cabin temperature can be selected between 70° and 80°F. Numbers on thumbwheel do not correspond to any temperature.
2	P I-33	ECS INDICATORS switch PRIM SEC	Selects primary ECS displays: a. ECS RADIATOR TEMP INLET b. GLYCOL EVAPORATOR STEAM PRESS c. GLYCOL DISCH PRESS d. GLYCOL ACCUM QUANTITY e. GLYCOL EVAPORATOR OUTLET TEMPERATURE Selects secondary ECS displays: a. GLYCOL EVAPORATOR OUTLET TEMPERATURE b. ECS RADIATOR TEMP INLET c. GLYCOL EVAPORATOR STEAM PRESS d. GLYCOL DISCH PRESS e. GLYCOL ACCUM QUANTITY			Switches output of primary and secondary transducers to shared indicators.
2	P I-34	ECS RAD TEMP PRIM/SEC - INLET meter	Displays water-glycol temperature entering primary or secondary space radiators, dependent on position of ECS INDICATORS selector switch two positions (PRIM SEC).	ECS RAD CONT HTR MNB, 5A for primary sys. ECS RAD SEC HTR MNA, 5A for secondary sys.	DC main buses A & B	Indicator range +60° to 120°F. Temperature sensor transducer output 0 to 5 vdc supplies power through respective ECS RAD HTR control switches - PRI 1, OFF, and PRI 2, ECS RAD-SEC OFF and SEC.

MAIN DISPLAY CONSOLE—PANEL 2

SM2A-03-BLOCK II-(1)
 APOLLO OPERATIONS HANDBOOK

CONTROLS AND DISPLAYS

Location		Name and Position	Function	Circuit Breaker	Power Source	Remarks
Panel	Area Grid					
MDC-2 (Cont)						
2	P	I-35 ECS RAD TEMP PRIM-OUTLET meter	Displays signal output of space radiator temperature sensor, primary.	ECS XDUCER TEMP MNA MNB	DC main buses A & B	Indicator range -50° to +100° F. Sensor transducer output 0 to 29.5 millivolts to indicator, PCM and caution and warning (GLY TEMP LOW LAMP) at -30° F. Power supply output to transducer amplifier: Excitation - 2.7v, 300 cps Supply - 18±1 vdc Bias - 0.5±0.2 vdc.
2	P	I-36 ECS RAD TEMP SEC-OUTLET meter	Displays the water-glycol temperature at the OUTLET of the secondary space radiators.	ECS RAD SEC		Indicator range 30° to 70° F. Temperature sensor transducer output 0 to 5 vdc. Supply power to temperature sensing and readout through ECS RAD HTRS selector switch. OFF or SEC signal goes to PCM.
2	P	J-34 ECS RADIATORS switches HEATER-PRIM PRIM 1 OFF PRIM 2	Selects primary heater control No. 1. Disables heater controllers. Selects primary heater control No. 2.	ECS RAD CONT/HTR MNB ECS RAD CONT/HTR MNA		CB70 supplies power to primary inlet temperature sensor through HEATER-PRIM switch in all positions.
2	P	J-35 HEATER-SEC SEC OFF	Selects secondary heater controller. Disables secondary heater controller.	SECONDARY COOLANT LOOP RAD HTR MNA	DC main bus A	CB71 supplies power to secondary radiator inlet, and outlet, temperature sensors through HEATER-SEC switch in both positions.

MAIN DISPLAY CONSOLE—PANEL 2

SM2A-03-BLOCK II-(1)
APOLLO OPERATIONS HANDBOOK

CONTROLS AND DISPLAYS

Location		Name and Position	Function	Circuit Breaker	Power Source	Remarks
Panel Area	Grid					
MDC-2 (Cont)		FLOW CONT-AUTO	Places radiator flow proportioning control in AUTO mode. Selects No. 1 flow proportioning control. Selects No. 2 flow proportioning control.	ECS RAD CONT/HTR MNA & MNB	DC main buses A & B	ECS RADIATOR CONTROLLER AC1 and AC2 circuit breakers supply a-c power for system operation.
2	P J-33	AUTO				
		1				
		2				
2	P J-33	FLOW CONT-PWR	Applies power to AUTO switch.	ECS RAD CONT/HTR MNA	DC main bus A	
		PWR	Applies power to MAN SEL switch.			
		OFF				
		MAN SEL MODE				
2	P J-33	ECS RADIATOR INDICATOR (talk-back)	Indicates flow proportioning control No. 1 is in operation. If POWER switch is in PWR position, indicates flow proportioning control No. 2 is in operation.		None	
		GRAY				
		2				
2	P J-34	MAN SEL switch	Closes RAD 2 isolation valves. Closes RAD 1 and RAD 2 isolation valves. Closes RAD 1 isolation valves.		DC main buses A & B	Circuit breakers ECS RADIATOR CONTROLLER AC1 and AC2 supply a-c power for valve operation. MAN-SEL switch controls four, d-c operated solid-state switches for switching a-c power to valve motors.
		RAD 1				
		CENTER				
		RAD 2				

MAIN DISPLAY CONSOLE—PANEL 2

CONTROLS AND DISPLAYS

Location		Name and Position	Function	Circuit Breaker	Power Source	Remarks
Panel	Area Grid					
MDC-2 (Cont)						
2	P J-37	ACCUM PRIM/SEC QUANTITY meter	Provides quantity indication of water glycol in primary and secondary accumulators.	PRIMARY ECS XDUCER GROUP 1 MNA & MNB SECONDARY ECS REDUNDANT XDUCER MNA & MNB	DC main buses A & B	Indicator range 0 to 100% transducer output signal 0 to 5 vdc operating. Operating range 0 to 25 psig signal goes to indicator through ECS indicator selector switch and to PCM. Secondary transducer signal goes to indicator through selector switch, no PCM.
2	P I-38	GLYCOL DISCH PRIM/SEC PRESS meter	Displays primary water-glycol pumps output pressures and secondary water-glycol pump output pressures.	PRIMARY SYSTEM ECS XDUCER Group 1 MNA, 5A MNB, 5A SECONDARY SYSTEM REDUNDANT XDUCER MNA, 5A MNB, 5A		Indicator range 0 to 80 psia, primary transducer PT-2 signal goes through selector switch to indicator. Transducer range 0 to 5 vdc. Secondary transducer PT-1 signal goes through selector switch to indicator.
2	P K-38	GLYCOL EVAP switches H ₂ O FLOW switch AUTO OFF (center)	a. Applies a-c power to steam press/wetness control unit. b. Closes circuit from control unit to water control valve for automatically regulating water inflow to water-glycol evaporator. Removes one source of a-c power from control unit and interrupts d-c power to water control valve.	ECS-GLYCOL PUMPS-AC2, 0A (MDC-4)	AC bus 2	Water control valve is solenoid-operated.

MAIN DISPLAY CONSOLE—PANEL 2

SM2A-03-BLOCK II-(1)
APOLLO OPERATIONS HANDBOOK

CONTROLS AND DISPLAYS

Location		Name and Position	Function	Circuit Breaker	Power Source	Remarks
Panel	Area Grid					
MDC-2 (Cont)						
2	P K-38	ON	Manual backup mode to apply d-c power to solenoid-operated water control valve, which opens valve and permits water to enter water-glycol evaporator.	ECS-POT H ₂ O HTR MNA & MNB (MDC-5)	DC main buses A & B	Switch position is momentary. Close coordination between switch actuation and GLY EVAP-OUTLET TEMP indicator (MDC-2) is necessary to obtain correct water-glycol temperature and/or to prevent flooding evaporator.
2	P K-37	STEAM PRESS group	<ul style="list-style-type: none"> a. Removes a-c power from GLYCOL EVAP-STEAM PRESS-INCR/DECR switch (MDC-2). b. Applies a-c power to steam pressure/wetness control unit. c. Closes circuit from control section to steam pressure control valve to automatically regulate steam pressure in evaporator. 	ECS-GLYCOL PUMPS-AC1 (MDC-4)	AC bus 1	Steam pressure control valve full travel required 58 seconds (max).
2	P K-37	AUTO/MAN switch AUTO				
		MAN	<ul style="list-style-type: none"> a. Removes one source of a-c power from steam pressure/wetness control unit. b. Opens circuit from control section to steam pressure control valve. c. Applies a-c power to GLYCOL EVAP-STEAM PRESS-INCR/DECR switch. 			Switch position selects manual backup mode, permitting manual operation of steam pressure control valve actuator in event of steam pressure control section malfunction.
2	P K-37	INCR/DECR switch INCR	Applies a-c power to actuator of steam pressure control valve, which moves valve in closed direction and increases steam pressure.	ECS-GLYCOL PUMPS-AC1 ØC (MDC-4)		Switch position is momentary. Until motor-driven steam pressure control valve reaches its maximum limit, short periods of switch activation result in proportional increases in steam pressure. Valve full travel requires 58 seconds (max).
		OFF (center)	Removes a-c power from valve actuator.			

MAIN DISPLAY CONSÓLE—PANEL 2

SM2A-03-BLOCK II-(1)
APOLLO OPERATIONS HANDBOOK

CONTROLS AND DISPLAYS

Location		Name and Position	Function	Circuit Breaker	Power Source	Remarks
Panel	Area Grid					
MDC-2 (Cont)		DECR	Applies a-c power to actuator of steam pressure control valve, which moves valve in open direction and decreases steam pressure.	ECS-GLYCOL PUMPS-AC1 ØC (MDC-4)	AC bus 1	Switch position is momentary. Until motor-driven steam pressure control valve reaches its maximum limit, short periods of switch activation result in proportional decreases in steam pressure. Valve full travel requires 58 seconds (max).
2	P K-37					
2	P K-36	TEMP IN switch AUTO MAN	Applies a-c power to water-glycol temperature control unit, which automatically regulates temperature of coolant entering evaporator by mixing hot and cold water-glycol. Removes a-c power from water-glycol temperature control unit, permitting manual override operation of GLYCOL EVAP TEMP IN valve (LHEB-382).	ECS-GLYCOL PUMPS-AC1 ØA (MDC-4)		Temperature control unit sensor is located at inlet to water-glycol evaporator. Water-glycol evaporator temperature control valve full travel requires 37.5 seconds (max). Manual control of water-glycol evaporator temperature control valve is required in event of failure of automatic control unit. Close coordination between valve adjustments and GLY EVAP-OUTLET TEMP and ECS RAD-OUTLET TEMP indicators (MDC-2) is necessary to obtain correct water-glycol temperature.
2	P I-37	GLY EVAP PRIM/SEC STEAM PRESS meter	Provides indication of steam pressure in water-glycol evaporator.	ECS XDUCER PRESS MNA, 5A MNB, 5A	DC main buses A & B	Normal steam pressure operating range is 0.97 psi to 0.145 psia.
2	P I-36	TEMP-OUTLET meter	Provides temperature indication of water-glycol at outlet of water-glycol evaporator.	ECS TRANS-DUCER TEMP-MNA & MNB		

MAIN DISPLAY CONSOLE—PANEL 2

SM2A-03-BLOCK II-(1)
APOLLO OPERATIONS HANDBOOK

CONTROLS AND DISPLAYS

Location		Name and Position	Function	Circuit Breaker	Power Source	Remarks
Panel	Area					
MDC-2 (Cont)						
2	P	J-37 H ₂ O QUANTITY meter	Provides quantity indication to waste water tank or potable water tank as selected by H ₂ O IND switch.	ECS-TRANS-DUCER WASTE/POT H ₂ O-MNA, 5A MNB, 5A	DC main buses A & B	Capacity of potable tank is 36 lbs. Capacity of waste tank is 56 lbs. Indicator range 0 to 100%.
2	P	K-36 H ₂ O QTY IND switch POT WASTE	Selects potable water tank quantity signal for display on WATER-QUANTITY indicator. Selects waste water tank quantity signal for display on WATER-QUANTITY indicator.	ECS-TRANS-DUCER WASTE/POT H ₂ O-MNA & MNB (MDC-5)		WATER-QUANTITY indicator is shared by two quantity signals.
2	P	I-40 PART PRESS CO ₂ meter	Provides partial pressure indication of CO ₂ in suit circuit atmosphere.	ECS-TRANS-DUCER-PRESS Group 2 MNA (MDC-5)	DC main bus A	CO ₂ sensor is located between inlet and outlet manifolds of suit circuit in LHEB. CO ₂ partial pressure normal metabolic operating range is 0.0 to 7.6 mm Hg, and the emergency metabolic operating range is 7.6 to 15.0 mm Hg. Both ranges are for unlimited length of time. CO ₂ PP HI system status light (MDC-2) illuminates at 7.6 mm Hg. This indicates CO ₂ level has risen to upper end of normal operating range.
2	P	K-32 POT H ₂ O HTR switch MNA OFF MNB	Supplies 28 vdc to potable water tank heaters from MNA. Removes 28 vdc power from potable water tank heaters. Supplies 28 vdc to potable water tank heaters from MNB.	POTABLE H ₂ O HTR MNA POTABLE H ₂ O HTR MNB	DC main buses A & B	Supplies power control to two heaters (20w & 25w); the heaters are controlled by thermostats.

MAIN DISPLAY CONSOLE—PANEL 2

SM2A-03-BLOCK II-(1)
APOLLO OPERATIONS HANDBOOK

CONTROLS AND DISPLAYS

Location		Name and Position	Function	Circuit Breaker	Power Source	Remarks
Panel Area	Grid					
MDC-2 (Cont)						
2	P	PRESS indicators (meters) SUIT	Provides pressure indication of suit circuit atmosphere.	ECS-TRANS-DUCER PRESS Group 1 MNA & MNB (MDC-5)	DC main buses A & B	Pressure measured at the compressor inlet. Normal suit circuit operating range indications are as follows: 14.7 psia during prelaunch, 4.7 to 5.3 psia during normal flight mode, and 3.75±0.25 psia during emergency flight mode.
2	P	CABIN	Provides pressure indication of cabin atmosphere.	ECS-TRANS-DUCER PRESS Group 2 MNA & MNB (MDC-5)		Pressure transducer is located inside LHFEB. Normal cabin operating range indications are as follows: 14.7 psia during prelaunch, 4.8 to 5.2 psia during normal space flight, and 0.0 psia during emergency space flight.
2	P	SEC COOLANT LOOP switches PUMP AC 1 OFF AC 2	Supplies 200-vac 3Ø power to secondary coolant loop pump from a-c bus 1. Removes power from pump. Supplies 200-vac 3Ø power to secondary coolant loop pump from a-c bus 2.	ECS SECONDARY COOLANT LOOP - AC1 ECS SECONDARY COOLANT LOOP - AC2	AC bus 1 AC bus 2	
2	P	EVAP EVAP OFF	Supplies 115-vac 1Ø power to secondary glycol evaporator temperature control. Removes power from control.	ECS SECONDARY COOLANT LOOP - AC1	AC bus 1 ØA	

MAIN DISPLAY CONSOLE—PANEL 2

SM2A-03-BLOCK II-(1)
APOLLO OPERATIONS HANDBOOK

CONTROLS AND DISPLAYS

Location		Name and Position	Function	Circuit Breaker	Power Source	Remarks
Panel	Area Grid					
MDC-2 (Cont)						
2	P K-35	RESET	Supplies 115-vac 1Ø power to motor of secondary glycol evaporator backpressure control valve to drive valve closed.	ECS SECONDARY COOLANT LOOP - AC1	AC bus 1 ØA	
2	P K-34	SUIT CIRCUIT switches HEAT EXCH ON CENTER BYPASS	Applies power to drive the SUIT HT EXCH PRIMARY GLYCOL valve to the FLOW position, allowing glycol to flow through suit heat exchanger. Off position. Applies power to drive valve to opposite position, thereby bypassing the glycol around the heat exchanger.	ECS GLYCOL PUMPS AC1 ØB	AC bus 1 ØB	Valve can be manually operated on panel 382.
2	P K-33	H ₂ O ACCUM AUTO 1/AUTO 2 switch AUTO 1 Center	a. Removes d-c power from H ₂ O ACCUM-1 ON/2 ON switch (MDC-2). b. Applies d-c power to No. 1 cyclic accumulator control unit to automatically time and actuate No. 1 cyclic accumulator valve for 10 seconds every 10 minutes. a. Removes d-c power from No. 1 and No. 2 cyclic accumulator control units. Applies d-c power to 1 ON/2 ON switch. b. Applies d-c power to H ₂ O ACCUM-1 ON/2 ON switch, permitting manual control of No. 1 or No. 2 cyclic accumulator valves.	ECS-H ₂ O ACCUM-MNA (MDC-5)	DC main bus A	In automatic mode, 10-second pulse signal for accumulator operation is received from CTE.
				ECS-H ₂ O ACCUM-MNA & MNB (MDC-5)	DC main buses A & B	Switch position selects manual backup mode, permitting manual cyclic accumulator valve actuation in event both cyclic accumulator automatic control units should fail.

MAIN DISPLAY CONSOLE—PANEL 2

SM2A-03-BLOCK II-(1)
APOLLO OPERATIONS HANDBOOK

CONTROLS AND DISPLAYS

Location		Name and Position	Function	Circuit Breaker	Power Source	Remarks
Panel	Area Grid					
MDC-2 (Cont)		AUTO 2	<p>a. Removes d-c power from H₂O ACCUM-1 ON/2 ON switch.</p> <p>b. Applies d-c power to No. 2 cyclic accumulator control unit to automatically time and actuate No. 2 cyclic accumulator valve for 10 seconds every 10 minutes.</p>	ECS - H ₂ O ACCUM-MNB (MDC-5)	DC main bus B	
2	P K-33					
2	P K-33	<p>1 ON/2 ON switch</p> <p>1 ON</p> <p>OFF (center)</p> <p>2 ON</p>	<p>Back up switch position to apply d-c power to solenoid valve of No. 1 cyclic accumulator, manually controlling oxygen flow to accumulator.</p> <p>Removes power from both solenoid valves, shutting off oxygen flow to either accumulator.</p> <p>Back up switch position to apply d-c power to solenoid valve of No. 2 cyclic accumulator, manually controlling oxygen flow to accumulator.</p>	ECS - H ₂ O ACCUM-MNA (MDC-5)	DC main bus A	Switch position is momentary to preclude possibility of expending oxygen needlessly. Switch may be operated when convenient or when suit humidity level becomes uncomfortable.
2	P I-38	TEMP indicators (meters) SUIT	Provides temperature indication of suit circuit atmosphere.	ECS TRANS-DUCER TEMP MNA & MNB (MDC-5)	DC main buses A & B	<p>Temperature sensor located in suit heat exchanger outlet duct.</p> <p>Normal suit circuit operating range indications are 45° to 55°F during prelaunch and in flight.</p>
2	P I-39	CABIN	Provides average temperature indication of cabin atmosphere.			<p>Sensor located near inlet to cabin air fans.</p> <p>Normal cabin operating range indications are 50° to 70°F during prelaunch and 70° to 80°F in flight.</p>

MAIN DISPLAY CONSOLE—PANEL 2

SM2A-03-BLOCK II-(1)
APOLLO OPERATIONS HANDBOOK

CONTROLS AND DISPLAYS

Location		Name and Position	Function	Circuit Breaker	Power Source	Remarks
Panel	Area Grid					
<u>MDC-2 (Cont)</u>						
2	P	SUIT COMPR ΔV meter	Displays differential pressure between the compressor inlet and outlet manifolds.	ECS XDUCER Group 1 MNA 5A MNB 5A		Indicator range 0-1 psi XDCR range 0-25 in. H ₂ O output signal to indicator, PCM and caution and warning system.
2	Q	CRYOGENIC TANKS indicators (meters) H ₂ PRESSURE Group Indicators 1 and 2	Display H ₂ tanks No. 1 and No. 2 pressure and are used as follows: a. Determine tank heater performance. b. Detect leaks.	INSTRUMENTATION POWER CONTROL OPERATIONAL CB 4 TANK 1 CB 3 TANK 2 (RHEB-276)	DC main buses A & B	Displays for H ₂ and O ₂ tanks No. 1 and 2 operate prior to CSM separation only. Indicator function is controlled by pressure transducers located in H ₂ tanks No. 1 and No. 2 outlet lines. These transducers are also connected to C&WS, operating the CRYO PRESS light on MDC-2 and to T/M. H ₂ operating range is 225 to 260 psia. Alarm trigger values are 220 psia low and 270 psia high.
2	Q	O ₂ PRESSURE Group Indicator 1	Displays pressure of O ₂ tank No. 1 or ECS surge tank as selected by O ₂ PRESS IND switch (MDC-2) and is used as follows: a. Determine tank heater performance. b. Detect leaks. c. Verify surge tank pressure.			With O ₂ PRESS IND switch at TANK 1, the indicator function is controlled by a pressure transducer located in O ₂ tank No. 1 outlet line. Transducer also connected to C&WS, operating CRYO PRESS light on MDC-2. O ₂ operating range is 865 to 935 psia. Alarm trigger values are 800 psia low and 950 psia high. With O ₂ PRESS IND switch at SURGE TANK position, indicator displays signal from ECS surge tank pressure transducer. Indicator function is controlled by pressure transducer located in O ₂ tank No. 2 outlet line.
		Indicator 2	Displays O ₂ tank No. 2 pressure and is used as follows: a. Determine tank heater performance. b. Detect leaks. c. Verify surge tank pressure.			

MAIN DISPLAY CONSOLE—PANEL 2

SM2A-03-BLOCK II-(1)
APOLLO OPERATIONS HANDBOOK

CONTROLS AND DISPLAYS

Location		Name and Position	Function	Circuit Breaker	Power Source	Remarks
Panel Area	Grid					
MDC-2 (Cont)		H ₂ QUANTITY Group Indicator 1	Displays quantity (% REMAINING) of H ₂ in tank No. 1.	CRYOGENIC SYSTEM - QTY AMPL 1 - AC1 (RHEB-226)	AC bus 1 ØC	H ₂ QUANTITY display range is 0 to 100%.
2	Q					
		H ₂ QUANTITY Group Indicator 2	Displays quantity (% REMAINING) of H ₂ in tank No. 2.	CRYOGENIC SYSTEM - QTY AMPL 2 - AC2 (RHEB-226)	AC bus 2 ØC	
2	Q					
		O ₂ QUANTITY Group Indicator 1	Displays quantity (% REMAINING) of O ₂ in tank No. 1.	CRYOGENIC QTY AMPL 1 - AC1 (RHEB-226)	AC bus 1 ØC	O ₂ QUANTITY display range is 0 to 100%.
2	Q					
		O ₂ QUANTITY Group Indicator 2	Displays quantity (% REMAINING) of O ₂ in tank No. 2.	CRYOGENIC QTY AMPL 2 - AC2 (RHEB-226)	AC bus 2 ØC	
2	Q					
		H ₂ FANS switches 1 and 2 AUTO OFF ON	Controls a-c power to H ₂ tanks No. 1 and 2 fan motors, respectively. Applies a-c power to contacts on motor switch which controls 3Ø a-c power to circulating fan motors in H ₂ tanks No. 1 and 2. Disconnects 3Ø a-c power from H ₂ tanks No. 1 and 2 circulating fan motors. Controls 3Ø a-c power directly to circulating fan motors in H ₂ tanks No. 1 and 2.	CRYOGENIC FAN MOTORS TANK 1 AC1 - ØA, ØB, ØC TANK 2 AC2 - ØA, ØB, ØC (RHEB-226)	AC bus 1 AC bus 2	Redundant fan motors in each H ₂ tank require 7W total. Switch at AUTO position will apply a-c voltage to H ₂ tanks No. 1 and 2 redundant fan motors when pressure switches in both tanks are in a low-pressure position at 225 psia or lower, and will remove a-c voltage when either pressure switch is in a high-pressure position at 260 psia or higher. Switch at ON (manual) position bypasses the pressure switches, applying a-c power directly to the same redundant H ₂ tank fan motors employed for automatic operation.
2	Q					
2	Q					

MAIN DISPLAY CONSOLE—PANEL 2

SM2A-03-BLOCK II-(1)
 APOLLO OPERATIONS HANDBOOK

CONTROLS AND DISPLAYS

Location		Name and Position	Function	Circuit Breaker	Power Source	Remarks
Panel	Area Grid					
MDC-2 (Cont)						
2	Q	G-35 H ₂ HEATERS switches 1 and 2	Controls d-c power to H ₂ tanks No. 1 and 2 heater elements, respectively. Enables automatic pressure switches to control d-c power to H ₂ tanks No. 1 and 2 heater elements. Disconnects d-c power from H ₂ tanks No. 1 and 2 heater elements. Controls d-c power directly to H ₂ tanks No. 1 and 2 heater elements.	CRYOGENIC H ₂ HTR MNA (RHEB-226) CRYOGENIC H ₂ HTR MNB (RHEB-226)	DC main bus A DC main bus B	Redundant heater elements in each H ₂ tank require 10 watts of power for each element (20W total). Switch at AUTO position will apply d-c voltage to H ₂ tanks No. 1 and 2 redundant heater elements when pressure switches in both tanks are in a low-pressure position at 225 psia or lower, and removes d-c voltage when either pressure switch is in a high-pressure position at 260 psia or higher. Switch at ON (manual) position bypasses the pressure switches applying d-c voltage directly to the same redundant heater elements employed for automatic operation.
2	Q	G-40 O ₂ FANS switches 1 and 2	Controls a-c power to O ₂ tanks No. 1 and 2 fan motors, respectively. Applies a-c power to contacts on motor switch which controls 3Ø a-c power to circulating fan motors in O ₂ tanks No. 1 and 2. Disconnects 3Ø a-c power from O ₂ tanks No. 1 and 2 circulating fan motors. Controls 3Ø a-c power directly to circulating fan motors in O ₂ tanks No. 1 and 2.	CRYOGENIC TANK FAN MOTORS TANK 1 AC1 - ØA, ØB, ØC (RHEB-226) CRYOGENIC TANK FAN MOTORS TANK 2 AC2 - ØA, ØB, ØC (RHEB-226)	AC bus 1 AC bus 2	Redundant fan motors in each O ₂ tank require 41W total. Switch at AUTO position will apply a-c power to O ₂ tanks No. 1 and 2 redundant fan motors when pressure switches in both tanks are in a low-pressure position at 865 psia or lower, and will remove a-c voltage when either pressure switch is in a high-pressure position at 935 psia or higher. Switch at ON (manual) position bypasses the pressure switches, applying a-c power directly to the same redundant O ₂ tank fan motors employed for automatic operation.

MAIN DISPLAY CONSOLE—PANEL 2

SM2A-03-BLOCK II-(1)
APOLLO OPERATIONS HANDBOOK

CONTROLS AND DISPLAYS

Location		Name and Position	Function	Circuit Breaker	Power Source	Remarks
Panel	Area Grid					
MDC-2 (Cont)						
2	Q G-37	O ₂ HEATERS switches 1 and 2 AUTO OFF ON	Controls d-c power to O ₂ tanks No. 1 and 2 heater elements, respectively. Enables automatic pressure switches to control d-c power to O ₂ tanks No. 1 and 2 heater elements. Disconnects d-c power from O ₂ tanks No. 1 and 2 heater elements. Controls d-c power directly to O ₂ tanks No. 1 and 2 heater elements.	CRYOGENIC O ₂ HTR 1 MNA O ₂ HTR 2 MNB (RHEB-226)	DC main bus A DC main bus B	Redundant heater elements in each O ₂ tank require 77.5 watts of power for each element (155W total). Switch at AUTO position will apply d-c voltage to O ₂ tanks No. 1 and 2 redundant heater elements when pressure switches in both tanks are in a low-pressure position at 865 psia or lower, and will remove d-c voltage when either pressure switch is in a high-pressure position at 935 psia or higher. Switch at ON (manual) position bypasses pressure switches, applying d-c voltage directly to same redundant heater elements employed for automatic operation.
2	Q G-37	O ₂ PRESS IND switch TANK 1 SURGE TANK	Connects output of O ₂ tank No. 1 pressure transducer to O ₂ tank No. 1 TANK PRESSURE indicator (MDC-2). Connects output of ECS SURGE TANK pressure transducer to O ₂ tank No. 1 TANK PRESSURE indicator.	INSTRUMENTATION POWER CONTROL OPERATIONAL CB 4 (RHEB-276) INSTRUMENTS - MNA and MNB (MDC-5)	DC main buses A & B	TANK PRESSURE-1-O ₂ indicator is shared by two pressure signals. Normal position of switch prior to CSM separation except for periodic surge tank readouts. Normal position of switch following CSM separation.

MAIN DISPLAY CONSOLE - PANEL 2

SM2A-03-BLOCK II-(1)
 APOLLO OPERATIONS HANDBOOK

CONTROLS AND DISPLAYS

Location		Name and Position	Function	Circuit Breaker	Power Source	Remarks		
Panel	Area Grid							
MDC-2 (Cont)		HIGH GAIN ANTENNA TRACK switch	<p>Antenna continues to point towards MSFN station automatically, provided MSFN station is within ±60 degrees of antenna boresight axis, and is not pointing beyond predetermined scan limits.</p> <p>In manual mode, antenna continues to point to position established by position angles set by PITCH and YAW controls.</p> <p>In automatic acquisition mode of operation, antenna will perform as in TRACK AUTO mode outside scan limits and automatically (internally) switch to MAN (manual) mode upon occurrence of scan limits. Antenna will remain in manual mode until it has arrived at indicated PITCH/YAW position and signal is present.</p> <p>With antenna positioned at manually preset positions, and with signal present, mode of operation reverts automatically (internally) to AUTO TRACK mode of operation. HI GAIN ANT SCAN LIMIT lamp disabled in REACQ position.</p>	HIGH GAIN ANTENNA FLT BUS & GROUP 2	Flight bus dc AC bus 1 or 2			
2	R						M-37	AUTO
								MAN
			REACQ					
2	R	M-38	HIGH GAIN ANTENNA BEAM switch	HIGH GAIN ANTENNA FLT BUS (RHEB-225)	Flight bus	Three-position assembly used to change tracking modes. Initial acquisition of primary ground station always occurs in coarse tracking mode. Logic and automatic switching allows continued automatic tracking in fine track mode, whenever RF beam-width selector switch is in medium or narrow transmit beam position. With (Cont)		

MAIN DISPLAY CONSOLE—PANEL 2

SM2A-03-BLOCK II-(1)
APOLLO OPERATIONS HANDBOOK

CONTROLS AND DISPLAYS

Location		Name and Position	Function	Circuit Breaker	Power Source	Remarks
Panel	Area Grid					
MDC-2 (Cont)						
2	R M-38	WIDE MED NARROW				RF beamwidth selector switch in wide transmit beam position, acquisition occurs and tracking continues in coarse track mode. The three positions are as follows: Selects wide RF beamwidth. Selects medium RF beamwidth. Selects narrow RF beamwidth.
2	R M-38	HIGH GAIN ANTENNA PITCH meter (Deg +90/0/-90)	Provides readout of antenna in PITCH degrees (relative to the spacecraft).		High gain antenna electronics	
2	R M-39	S-BAND ANT (TUNE FOR MAX) meter	Indicates S-band xponder receiver AGC level of selected xponder.		S-band xponder	Indicates AGC only in phase-locked condition using OMNI or high gain antennas.
2	R M-40	HIGH GAIN ANTENNA YAW meter (Deg 0 through 360)	Provides readout of antenna in YAW degrees (relative to the spacecraft).		High gain antenna electronics	
2	R N-39	PITCH-POSITION control switch	Allows manual positioning of HIGH GAIN antenna in PITCH plane (relative to the spacecraft) corresponding to settings in degrees shown on panel.			
2	R N-40	YAW-POSITION control switch	Allows manual positioning of HIGH GAIN antenna in YAW plane (relative to the spacecraft) corresponding to settings in degrees shown on panel.			
2	R O-39	HIGH GAIN ANT POWER switch POWER STBY		HIGH GAIN ANTENNA FLT BUS (RHEB-225)	Flight bus dc	This three-position assembly provides 115 vdc, 400 Hz, and 28 vdc power to the antenna equipment, and provides the following functions: Electrical power to antenna equipment. 28-vdc heater power to boom components only.

MAIN DISPLAY CONSOLE—PANEL 2

SM2A-03-BLOCK II-(1)
APOLLO OPERATIONS HANDBOOK

CONTROLS AND DISPLAYS

Location		Name and Position	Function	Circuit Breaker	Power Source	Remarks
Panel	Area Grid					
MDC-2 (Cont)						
2	R O-39	OFF				Both a-c and d-c voltages are removed from all HGA equipment.
2	R O-40	HIGH GAIN ANT SERV ELEC switch PRIM SEC		HIGH GAIN ANTENNA FLT BUS (RHEB-225)	Flight bus dc	Selects one of two redundant and identical electronics servo assemblies. Both are provided to increase total reliability of electronics of subsystem. Selects PRIMARY electronics/servo assembly. Selects SECONDARY electronics/servo assembly.
2	S C-28	SUIT CAB ΔP meter	Displays difference in pressure between suit circuit and cabin.	INSTRUMENTS ESS MNA 15A (MDC-5) or INSTRUMENTS ESS MNB 15A (MDC-5) and INSTRUMENTATION POWER CONTROL OPERATIONAL 5A (CB2) (RHEB-276)	DC main buses A & B	Indicator range +5.0 in. H ₂ O to -5.0 in. H ₂ O suit pressure relative to cabin.
2	S C-29	O ₂ FLOW meter	Provides total rate of flow indication of oxygen supplied to ECS downstream of main regulator.	ECS TRANSDUCER PRESS Group 1 MNA 5A MNB 5A		Indicator range 0.2 to 1.0 lb/hr. Signal goes to indicator, PCM, and to caution and warning lamps through a 16.5-sec time delay relay.
2	T C-36	POST LDG VENT VALVE UNLOCK handle PULL	Pulls safetywire from postlanding vent valve.	N/A	N/A	Safetywire keeps postlanding vent valve in closed position during mission. Do not pull until uprighted.

MAIN DISPLAY CONSOLE—PANEL 2

SM2A-03-BLOCK II-(1)
APOLLO OPERATIONS HANDBOOK

CONTROLS AND DISPLAYS

Location		Name and Position	Function	Circuit Breaker	Power Source	Remarks
Panel	Area Grid					
MDC-3	3	A D-42 VHF ANTENNA switch RECY SM LEFT SM RIGHT	Connects VHF recovery antenna No. 2 with the T/C subsystem.	SPS GAUGING MNA and MNB for d-c power MDC-8 AC1 or AC2 through SPS GAUGING switch (MDC-4)	DC main buses A & B AC bus 1 or 2	Two identical indicators. Each is a two-condition device controlled by servo action. When propellant utilization valve is in normal oxidizer flow rate position, gray display will appear in both indicator windows. Indicators are operative only during SPS THRUST-ON or during SPS QTY TEST.
			Connects left SM-VHF antenna into T/C subsystem.			
			Connects right SM-VHF antenna into T/C subsystem.			
3	B K-42	OXID FLOW position indicators Upper indicator Lower indicator	Max display indicates propellant utilization valve is in increased oxidizer flow rate position; gray display indicates it is not.			Three-position toggle switch used as required to regulate oxidizer flow rate to maintain proper propellant utilization. Remaining propellant SPS unbalance may be determined by monitoring UNBALANCE motor or by calculations, utilizing information displayed in percent-OXID and percent-FUEL quantity display windows.
			Min display indicates propellant utilization valve is in decreased oxidizer flow rate position; gray display indicates it is not.			
3	B K-42	OXID FLOW VALVE switch INCR NORM DECR	Applies increased signal to propellant utilization valve PRIM or SEC motor selected by VALVE switch.			Maximum PU valve response time from increase to decrease position is 3.5 seconds. Valve is operative only during SPS THRUST ON or during SPS QTY TEST.
			Supplies normal signal to propellant utilization valve PRIM or SEC motor selected by VALVE switch.			
			Supplies decreased signal to propellant utilization valve PRIM or SEC motor selected by VALVE switch.			

MAIN DISPLAY CONSOLE—PANEL 3

SM2A-03-BLOCK II-(1)
APOLLO OPERATIONS HANDBOOK

CONTROLS AND DISPLAYS

Location		Name and Position	Function	Circuit Breaker	Power Source	Remarks
Panel	Area Grid					
MDC-3 (Cont)						
3	B K-43	OXID FLOW VALVE switch PRIM SEC	Applies power to propellant utilization valve primary servo amplifier. Applies power to propellant utilization valve secondary servo amplifier.	SPS GAUGING MNA and MNB for d-c power MDC-8 AC1 or AC2 through SPS GAUGING switch (MDC-4)	DC main buses A & B AC bus 1 or 2	Two-position toggle switch which provides manual selection of primary or secondary gates in propellant utilization valve. Operative only during SPS THRUST ON or during SPS QTY TEST. PU valve secondary gate is capable of adjusting for increased, decreased, or normal or oxidizer flow area regardless of primary gate failure in any position.
3	B K-43	PUG MODE switch PRIM NORM AUX	Applies output from primary propellant quantity sensing system to propellant quantity indicating and warning devices. Applies outputs from both primary and auxiliary sensing systems to propellant quantity warning devices and output from primary propellant sensing system to propellant quantity indicating devices. Applies output from auxiliary propellant sensing system to propellant quantity indicating and warning devices.			Three-position toggle switch in NORM position during normal operation. This switch, when used in conjunction with TEST switch (MDC-3), can be useful in isolating malfunction in propellant quantity sensing system. Primary system display will not change for 4.0±1.0 seconds after SPS fire signal or during TEST 1 or 2. Auxiliary system will change display upon receipt of SPS fire signal and during receipt of TEST 1 or 2.
3	B H-42/ H-43	SPS ENGINE INJECTOR VALVES indicators A1 and 2 B3 and 4	Provides visual indication of SPS engine main propellant valves open or closed condition (one oxidizer and one fuel valve per pair and one indicator for each pair of valves).	INSTRUMENTS ESS MNA MNB (MDC-5)	DC main buses A & B	Four identical indicators. Each is needle-movement-type meter with inputs supplied by position potentiometer located in valve actuator. Left needle deflection indicates CLOSE; right deflection indicates OPEN.

MAIN DISPLAY CONSOLE—PANEL 3

SM2A-03-BLOCK II-(1)
APOLLO OPERATIONS HANDBOOK

CONTROLS AND DISPLAYS

Location		Name and Position	Function	Circuit Breaker	Power Source	Remarks
Panel	Area Grid					
MDC-3 (Cont)						
3	B	M-42 SPS He VLV 1 and 2 AUTO OFF ON	Two operationally identical switches. Provides for automatic application and removal of power from helium isolation valve solenoid. Removes power from helium isolation valve solenoid. Applies power to helium isolation valve solenoid.	SPS-He VALVE - MNA for HELIUM 1 and MNB for HELIUM 2 (MDC-8)	DC main buses A & B	Each switch is a three-way toggle switch. With this switch in AUTO position, valve opening and closing is controlled automatically by CMC system or SCS or SPS THRUST DIRECT ON. Complete manual control of valve position can be maintained by utilizing ON-OFF switch positions. Each switch controls helium flow to one of two redundant pressure regulator assemblies.
3	B	L-42 SPS He VLV event indicators (two)	Striped line display indicates closed condition of valve controlled by switch located directly below indicator. Gray display indicates open condition of valve.			Two identical indicators. Each is a two-condition device with gray display controlled by solenoid action, and striped line display controlled by permanent magnet action.
3	B	M-43 SPS-LINE HTRS A/B OFF A	Applies power to 6 SPS (12 elements) tank feed line and bipropellant valve heaters. Removes power from all SPS heaters. Applies power to 6 SPS tank feed line, engine feed line, and bipropellant valve heaters.	SPS LINE HTRS MNA and MNB (MDC-229)		Crew will determine from SPS propellant tanks temperature meter (MDC-3) as to when to place SPS heaters to A/B or A or OFF.
3	B	M-44 SPS-PRESS IND He	Connects SPS helium storage tank pressure output to He TANK PRESS indicator (MDC-3).	INSTRUMENTS ESS MNA MNB (MDC-5)		Three-position toggle switch used to select SPS helium or nitrogen tank pressure input to He TANK PRESS or N ₂ PRESS indicator on MDC-3.

MAIN DISPLAY CONSOLE—PANEL 3

SM2A-03-BLOCK II-(1)
APOLLO OPERATIONS HANDBOOK

CONTROLS AND DISPLAYS

Location		Name and Position	Function	Circuit Breaker	Power Source	Remarks
Panel	Area Grid					
MDC-3 (Cont)						
3	B M-44	N ₂ A N ₂ B	Connects SPS gaseous nitrogen storage tank pressure output of engine control valve system A to N ₂ A PRESS indicator (MDC-3). Connects SPS gaseous nitrogen storage tank pressure output of engine control valve system B to B PRESS indicator (MDC-3).	INSTRUMENTS ESS MNA MNB (MDC-5)	DC main buses A & B	
3	B F-43	SPS PROPELLANT TANKS meters PRESS-FUEL	Provides constant monitoring of SPS fuel tank regulated helium pressure.			Two indicators are identical in operation. Each consists of d'Arsonval-type meter with fixed dial and movable pointer. Pointer movement is vertical as observed from crew couch.
3	B F-43	PRESS-OXID	Provides constant monitoring of SPS oxidizer tank regulated helium pressure.			Each indicator is calibrated in psia with range of 0 to 300 psia.
3	B F-42	PRESS-He	Indicates SPS helium storage tank pressure when SPS TANK PRESS switch (MDC-3) is in He position.			Identical in operation but differ in calibration, each indicator consists of d'Arsonval-type meter with fixed dial and movable pointer. Pointer movement is vertical as observed from crew couch.
3	B F-42	PRESS-N ₂	Indicates SPS gaseous nitrogen storage tank pressure of engine pneumatic valve control system A or B when SPS TANK PRESS switch (MDC-3) is in N ₂ A or N ₂ B position, respectively.			Pressure indicator display is in psia, and range is 0 to 5000 psia.
3	B F-42	TEMP	Provide constant monitoring of SPS propellant line temperature.			Temperature indicator display is in degrees Fahrenheit and range is 0 to 200 °F.

MAIN DISPLAY CONSOLE—PANEL 3

SM2A-03-BLOCK II-(1)
APOLLO OPERATIONS HANDBOOK

CONTROLS AND DISPLAYS

Location		Name and Position	Function	Circuit Breaker	Power Source	Remarks
Panel	Area Grid					
MDC-3 (Cont)						
3	B J-42	SPS QUANTITY-OXID UNBAL meter	Indicates unbalance of remaining SPS propellants.	SPS GAUGING MNA and MNB for d-c power (MDC-8)	DC main buses A & B AC bus 1 or 2	Indicator is graduated into six major divisions, each representing 200 pounds of propellant unbalance. Upper half indicates increased oxidizer flow required; lower half, decreased flow. Indicator needle at 0 (horizontal position) indicates desired propellant ratio. Shaded area is considered normal unbalance.
3	B I-43	SPS QUANTITY display Percent FUEL Percent OXID	Digital counter display window indicating total fuel tank quantity remaining in percent. Digital counter display window indicating total oxidizer tank quantity remaining in percent.			Digital display in oxidizer quantity (OXID) window and fuel quantity (FUEL) window represent remaining tank quantities. Since desired oxidizer/fuel ratio is 1.6:1, digital display in both windows should be identical when propellant ratio is correct.
3	B J-43	SPS QUANTITY-TEST switch 1 (up) Center 2 (down)	Applies simulated input to propellant quantity gauging and utilization system control unit, causing digital display counters and UNBALANCE indicator to function for test check. Normal operating position and removes test stimuli. Applies simulated input for same purposes as TEST (up) position, except in reverse polarity.			Three-position toggle switch, spring-loaded to center position. TEST position allows for visual check of proper electrical and mechanical operation of propellant indicating devices. In addition to indicator checks, TEST position may be used to aid in isolating malfunction in either primary or auxiliary propellant quantity sensing system. Test of primary system will have to be held for 4.0±1.0 seconds before change in display occurs. Test of auxiliary system will respond immediately.

MAIN DISPLAY CONSOLE—PANEL 3

SM2A-03-BLOCK II-(1)
APOLLO OPERATIONS HANDBOOK

CONTROLS AND DISPLAYS

Location		Name and Position	Function	Circuit Breaker	Power Source	Remarks
Panel	Area Grid					
MDC-3 (Cont)		POWER switches PMP NORM OFF AUX	Energizes primary power supply of the PMP (premodulation processor). Switches PMP off. Energizes auxiliary power supply of PMP.	PMP POWER FLT BUS (MDC-225)	Flight bus	AUX selects not only auxiliary power supply, but also disconnects playback CM/PCM line from recorder and connects real time CM/PCM to transponder transmitter and, if DSE PCM/ANLG-LM/PCM switch is in PCM/ANLG, to FM transmitter.
3	C P-47					
4	C P-46					
		SCE NORM OFF AUX	Energizes SCE primary power supply and an error detection circuit which automatically switches SCE to redundant power supply if primary power supply voltages go out of tolerance. Switches SCE off. Provides manual switching of SCE power supplies by repeated selection of this position.	SIG COND FLT BUS (MDC-225)	Telecom & flight bus	
3	C N-48					
		POWER AMPL flag indicator	Activated when S-band power amplifier selected for use with xponder by PWR AMPL PRIM SEC switch is activated in its high- or low-level power mode.		S-band power amplifier equipment	

MAIN DISPLAY CONSOLE—PANEL 3

SM2A-03-BLOCK II-(1)
APOLLO OPERATIONS HANDBOOK

CONTROLS AND DISPLAYS

Location		Name and Position	Function	Circuit Breaker	Power Source	Remarks
Panel	Area Grid					
MDC-3 (Cont)		S-BAND ANTENNA OMNI A, B, C switches A B C	Selects omniantenna A which is located between spacecraft coordinates +Z and +Y, when S-BAND ANTENNA OMNI-D switch is in OMNI position. Selects omniantenna B which is located between spacecraft coordinates -Y and +Z, when S-BAND ANTENNA OMNI-D switch is in OMNI position. Selects omniantenna C which is located between spacecraft coordinates -Z and -Y, when S-BAND ANTENNA OMNI-D switch is in OMNI position.	S-BAND PWR AMPL PHASE MODULATED XPNDR	Flight bus	
3	C O-42					
		OMNI	Provides power to S-BAND ANTENNA OMNI A-B-C switch to enable selection of omniantenna A, B, or C.	RHEB-225 CB 17		
		D	Selects omniantenna D which is located between spacecraft coordinates +Y and -Z.	RHEB-225 CB 19		
		HIGH GAIN	Selects high gain antenna and disables selection of OMNI antennas A, B, and C.			
		S-BAND AUX switches	Activates FM transmitter of USBE and connects output to power amplifier NOT selected		PMP equipment	
3	C N-45	TAPE				

MAIN DISPLAY CONSOLE—PANEL 3

SM2A-03-BLOCK II-(1)
APOLLO OPERATIONS HANDBOOK

CONTROLS AND DISPLAYS

Location		Name and Position	Function	Circuit Breaker	Power Source	Remarks
Panel	Area Grid					
MDC-3 (Cont)		TAPE	by S-BAND NORMAL PWR AMPL PRIM-SEC switch. Activates power amplifier in high-level mode. Connects tape playback functions selected by TAPE RECORDER PCM/ANGL-LM PCM switch to FM transmitter. Selection of this mode will override S-BAND AUX TV OFF SCI switch. Selects no modes.		PMP equipment	
3	C N-45					
		OFF DN VOICE BU	Selects PM baseband voice mode of transponder selected by S-BAND NORMAL XPNDR PRIM OFF SEC switch.			
3	C N-46	TV	Activates FM transmitter of USBE and connects output to power amplifier NOT selected by S-BAND NORMAL PWR AMPL PRIM-SEC switch. Activates power amplifier in high-level mode. Connects output of TV to FM transmitter modulator. Selects no modes.			
		OFF SCI	As TV except, R/T SCI channels on their SCOs.			
		S-BAND NORMAL MODE switches	Selects real time PCM biphase modulator output for transmission via transponder selected by S-BAND NORMAL XPNDR PRIM-OFF-SEC switch. Selects no modes.			
3	C N-44	PCM OFF				

MAIN DISPLAY CONSOLE—PANEL 3

SM2A-03-BLOCK II-(1)
 APOLLO OPERATIONS HANDBOOK

CONTROLS AND DISPLAYS

Location		Name and Position	Function	Circuit Breaker	Power Source	Remarks
Panel	Area Grid					
MDC-3 (Cont)						
3	C N-44	KEY	Selects output of emergency key subcarrier for transponder selected by S-BAND NORMAL, XPNDR PRIM-OFF-SEC switch.		PMP equipment	
3	C N-44	RANGING	Retransmits received ranging signal via transponder selected by S-BAND NORMAL XPNDR PRIM-OFF-SEC switch.		S-band equipment	Breaks signal path between USBE wide-band receiver output and transponder transmitter modulator.
		OFF	Selects no modes.			
3	C N-43	VOICE	Selects voice mode subcarrier output for transmission via transponder selected by S-BAND NORMAL XPNDR PRIM-OFF-SEC switch.			
		OFF	Selects no modes.			
		RELAY	Connects received VHF-AM voice from LM or voice plus data from EVA to voice subcarrier oscillator. Selects voice subcarrier output for transmission via transponder selected by S-BAND NORMAL XPNDR PRIM-OFF-SEC switch. Also presents output of up-voice subcarrier demodulator to audio center No. 2 microphone input for relay to LM or EVA via VHF-AM equipment.			

MAIN DISPLAY CONSOLE—PANEL 3

SM2A-03-BLOCK II-(1)
APOLLO OPERATIONS HANDBOOK

CONTROLS AND DISPLAYS

Location		Name and Position	Function	Circuit Breaker	Power Source	Remarks
Panel	Area Grid					
MDC-3 (Cont)		S-BAND NORMAL - PWR AMPL switches	HIGH	Selects high-level mode of operation of power amplifier selected by S-BAND NORMAL PWR AMPL PRIM-SEC switch.		
3	C N-43		OFF	Selects bypass mode of operation for the transponder selected by S-BAND NORMAL XPNDR PRIM-OFF-SEC switch.		
			LOW	Selects low-level mode of operation of power amplifier selected by S-BAND NORMAL PWR AMPL PRIM-SEC switch.		
3	C N-42	PRIM	Selects No. 1 power amplifier of S-BAND power amplifier equipment for operation with transponder selected by S-BAND NORMAL XPNDR PRIM-OFF-SEC switch.			
		SEC	Selects No. 2 power amplifier of S-BAND power amplifier equipment for operation with transponder selected by S-BAND NORMAL XPNDR PRIM-OFF-SEC switch.			
3	C N-42	S-BAND NORMAL - XPNDR switch	PRIM	Actuates No. 1 transponder of unified S-BAND equipment (USBE).	S-BAND PWR AMPL PHASE MOD XPNDR (MDC-225)	When switching from PRIM to SEC positions, operator should pause at off position to preclude unwanted activation of both XPNDRS.
		OFF	Switches both transponders off.		Telecom flight bus	
		SEC	Actuates No. 2 transponder of the USBE.			

MAIN DISPLAY CONSOLE—PANEL 3

SM2A-03-BLOCK II-(1)
APOLLO OPERATIONS HANDBOOK

CONTROLS AND DISPLAYS

Location		Name and Position	Function	Circuit Breaker	Power Source	Remarks
Panel	Area Grid					
MDC-3 (Cont)						
3	C O-48	TAPE MOTION flag indicator	Activated whenever data storage equipment tape is in motion.		Data storage equipment	
3	C P-46	TAPE RECORDER switches FWD	Closes power circuit to tape transport for operation in forward direction.	S-BAND FM XMTR, DATA STORAGE EQUIP (MDC-225)	Telecom & flight bus	Forward speed is determined by DSE RECORD-PLAY switch, PCS HIGH-LOW switch, and data rate recorded on tape. RECORD in HIGH gives 15 ips, RECORD in LOW gives 3.75 ips. PLAY with HBR on tape gives 15 ips. PLAY with LBR on tape gives 120 ips.
		OFF	Closes power circuit so that tape transport will be in stationary position. Closes power circuit so that DSE electronics are disabled.			No record or play in this position.
		REWIND	Closes power circuit to tape transport for operation in rewind mode at 120 ips.			
3	C P-45	PCM/ANLG	(ANLG = Analog) Selects playback of recorded CSM PCM, CSM, and LM voice and three analog channels of scientific instrumentation.		DSE equipment	
		LM/PCM	Selects playback of recorder LM PCM of CSM DSE at 120 ips.			
3	C P-45	RECORD	Selects record mode.			Supplies power to PCM high-low switch which determines recording speed.
		OFF	Selects no modes.			
		PLAY	Selects playback mode.			Supplies power to PCM/ANLG LM PCM switch which determines playback speed.

MAIN DISPLAY CONSOLE—PANEL 3

SM2A-03-BLOCK II-(1)
APOLLO OPERATIONS HANDBOOK

CONTROLS AND DISPLAYS

Location		Name and Position	Function	Circuit Breaker	Power Source	Remarks
Panel	Area Grid					
MDC-3 (Cont)						
3	C P-47	PCM BIT RATE HIGH LOW	Selects normal PCM data mode equipment. Selects normal (15 ips) speed for recording on DSE. Selects narrow band TLM (minimum bit rate) mode in PCM equipment. Selects slow (3-3/4 ips) speed for recording on DSE.		PCM equipment	
3	C N-47	UP TLM switches CMD RESET NORMAL OFF DATA UP-VOICE BU	.Actuation resets all of real time command relays except bank "A." Actuation does not interrupt power to up-data link (UDL) equipment, "UP" throw position being spring-loaded for return to center position. Actuates power to UDL equipment. Disables power to UDL equipment. Selects up-voice and up-data demodulator for normal operation. Switches up-voice 30-kc sub-carrier demodulator to output of up-data 70-kc demodulator and connects to both audio center and up-data link.	PMP POWER FLT BUS (MDC-225)	Telecom & flight bus PMP equipment	MSFN must, in this mode of operation, time share up-data and voice information on 70-kc subcarrier.
3	C N-46					

MAIN DISPLAY CONSOLE—PANEL 3

CONTROLS AND DISPLAYS

Location		Name and Position	Function	Circuit Breaker	Power Source	Remarks
Panel Area	Grid					
MDC-3 (Cont)		VHF AM switches VHF AM-A DUPLX	Selects VHF-AM 296.8-mc transmitter and 259.7-mc receiver for voice and biomed data communication. Selects no modes. Selects 296.8-mc transmitter and receiver for voice only communication.	CREW STATION AUDIO-CTR (MDC-225)	Flight & postlanding bus	Provides for voice communications between CSM and EVA and reception of voice and biomed data from EVA. Reception of voice from LM or voice plus data from EVA for relay via CSM S-band equipment to MSFN.
3	C O-45					
		VHF AM-B DUPLX	Selects VHF-AM 259.7-mc transmitter and 296.8-mc receiver to receive voice. Selects no modes. Selects VHF-AM 259.7-mc transmitter and receiver for voice communication.			Provides for backup voice communications between CSM and EVA.
3	C O-45					
		RCV ONLY B DATA	Selects VHF-AM 259.7-mc receiver to receive low-bit rate PCM. Selects no modes. Selects VHF-AM 296.8-mc receiver only.		VHF AM equipment	Provides for backup voice communications between CSM and LM.
3	C O-46					
		OFF A				Provides for reception of low-bit rate PCM from LM, and channels receiver output to PMP. After clipping and amplifying, PMP provides LM PCM signal to DSE only for recording.
						Provides for monitoring during recovery phase.

MAIN DISPLAY CONSOLE—PANEL 3

CONTROLS AND DISPLAYS

Location		Name and Position	Function	Circuit Breaker	Power Source	Remarks
Panel	Area Grid					
MDC-3 (Cont)						
3	C O-43	SQUELCH A thumbwheel	Thumbwheel controls 5-k potentiometer assembly to adjust minimum RF level required to override squelch action of VHF-AM 296.8-mc receiver.			
3	C P-43	SQUELCH B thumbwheel	Thumbwheel controls 5-k potentiometer assembly to adjust minimum RF level required to override squelch action of VHF-AM 259.7-mc receiver.			
3	C O-46	VHF BCN switch ON OFF	Activates VHF beacon equipment. Disables all power to VHF beacon.	CREW STATION AUDIO-L (MDC-225)	Flight and postlanding bus	
3	C O-47	VHF RANGING RANGING OFF	Activates digital ranging generator. Disables all power to digital ranging generator.	VHF/CREW STATION AUDIO-R (MDC-225)		
3	C O-47	S-BAND SQUELCH (SC 108 and subs) ENABLE OFF	Activates squelch circuit in PMP up-link detector. Disables squelch circuit.			
3	D P-42	FC REACS VALVES NORM (up)	Maintaining switch disconnects holding voltage from reactant valves of all three fuel cells.		Battery relay bus	Maintaining switch provides holding voltage to open solenoid of FC reactant valves to prevent inadvertent closing of valves during launch, ascent, and orbital insertion.

MAIN DISPLAY CONSOLE—PANEL 3

SM2A-03-BLOCK II-(1)
APOLLO OPERATIONS HANDBOOK

CONTROLS AND DISPLAYS

Location		Name and Position	Function	Circuit Breaker	Power Source	Remarks
Panel	Area Grid					
MDC-3 (Cont)						
3	D P-42	LATCH (down)	Maintaining switch applies holding voltage to open solenoid of all FUEL CELL H ₂ and O ₂ reactant valves.	a. FUEL CELL 1-BUS CONT (RHEB-226) b. FUEL CELL 3-BUS CONT (RHEB-226)	Battery relay bus	a. FUEL CELL 1-BUS CONT circuit breaker provides circuit protection and voltage for FUEL CELL 1 and 2 reactant valves. b. FUEL CELL 3-BUS CONT circuit breaker provides circuit protection and voltage for FUEL CELL 3 reactant valves.
3	D P-42	H ₂ PURGE LINE HTR OFF (down)	Maintaining switch applies power to hydrogen purge line heaters.	a. FUEL CELL 1-PURGE (RHEB-226) b. FUEL CELL 2-PURGE (RHEB-226)	DC main buses A & B	Maintaining switch provides capability to apply voltage to redundant hydrogen purge line heater to prevent freezing during hydrogen purge.
3	E P-51	AC INDICATORS switch BUS 1 ØA ØB ØC	Provides means of monitoring voltage on AC buses. Applies a-c phase A voltage from a-c bus 1 to AC VOLTS meter. Applies a-c phase B voltage from a-c bus 1 to AC VOLTS meter. Applies a-c phase C voltage from a-c bus 1 to AC VOLTS meter.	EPS SENSOR SIGNAL - AC 1 (MDC-5)	AC bus 1	Normal operating range for phases A, B, and C is 115±2 vac.

MAIN DISPLAY CONSOLE—PANEL 3

CONTROLS AND DISPLAYS

Location		Name and Position	Function	Circuit Breaker	Power Source	Remarks
Panel	Area Grid					
MDC-3 (Cont)						
3	E	P-51	BUS 2	EPS SENSOR SIGNAL - AC 2 (MDC-5)	AC bus 2	
			ØA	Applies a-c phase A voltage from a-c bus 2 to AC VOLTS meter.		
			ØB	Applies a-c phase B voltage from a-c bus 2 to AC VOLTS meter.		
			ØC	Applies a-c phase C voltage from a-c bus 2 to AC VOLTS meter.		
AC INVERTER switches						
3	E	N-49	Switch 1	INVERTER CONTROL-1 (MDC-5)	Battery relay bus	Circuit breaker associated with delivering power to AC INVERTER 1 from d-c main bus A is INVERTER POWER-1 - MAIN A on main circuit breaker panel (RHEB-275).
			MNA	Controls d-c power to a-c inverter No. 1 by actuating a motor-driven switch which accomplishes actual switching function.		
			OFF	Applies d-c power to a-c inverter No. 1.		
				Disconnects d-c power from a-c inverter No. 1 and disconnects inverter 1 from a-c bus 1 and 2.		
3	E	N-49	Switch 2	INVERTER CONTROL-2 (MDC-5)		Circuit breaker associated with delivering power to AC INVERTER 2 from d-c main bus B is INVERTER POWER-2 - MAIN B on main circuit breaker panel (RHEB-275).
			MNB	Controls d-c power to a-c inverter No. 2 by actuating a motor-driven switch which accomplishes actual switching function.		
			OFF	Applies d-c power to a-c inverter No. 2.		
				Disconnects d-c power from a-c inverter No. 2 and disconnects inverter 2 from a-c bus 1 and 2.		

MAIN DISPLAY CONSOLE—PANEL 3

SM2A-03-BLOCK II-(1)
 APOLLO OPERATIONS HANDBOOK

CONTROLS AND DISPLAYS

Location		Name and Position	Function	Circuit Breaker	Power Source	Remarks
Panel	Area Grid					
MDC-3 (Cont)						
3	E N-50	Switch 3	Controls d-c power to a-c inverter No. 3 by actuating one of two motor-driven switches depending on bus selected. Applies d-c power from main bus A to a-c inverter No. 3. Disconnects d-c power from a-c inverter No. 3 and disconnects inverter 3 from a-c bus 1 and 2. Applies d-c power from main bus B to a-c inverter No. 3.	INVERTER CONTROL-3 (MDC-5)	Battery relay bus	Inverter No. 3 can receive power from either d-c main bus A or d-c main bus B. Associated circuit breakers are INVERTER POWER-3 - MAIN A and MAIN B (RHEB-275).
3	E O-49	AC INVERTER AC BUS 1 group Switch 1 ON OFF	Controls a-c output of inverter No. 1 to a-c bus 1. Applies a-c output of inverter No. 1 to a-c bus 1 and disconnects inverter No. 2 from a-c bus 1. Disconnects a-c output of inverter No. 1 from a-c bus 1 and allows inverter No. 2 to be connected.	INVERTER CONTROL-1 (MDC-5)		Actuates a motor-driven switch which accomplishes actual switching function. Interlocking circuitry between AC INVERTER 1, 2 and 3 - AC BUS 1 switches (MDC-3) prevents more than one inverter from being connected to a-c bus 1 at the same time.
3	E O-49	Switch 2 ON OFF	Controls a-c output of inverter No. 2 to a-c bus 1. Applies a-c output of inverter No. 2 to a-c bus 1 and disconnects inverter No. 3 from a-c bus 1. Disconnects a-c output of inverter No. 2 from a-c bus 1 and allows inverter No. 3 to be connected.	INVERTER CONTROL-2 (MDC-5)		

MAIN DISPLAY CONSOLE—PANEL 3

SM2A-03-BLOCK II-(1)
 APOLLO OPERATIONS HANDBOOK

CONTROLS AND DISPLAYS

Location		Name and Position	Function	Circuit Breaker	Power Source	Remarks
Panel	Area Grid					
MDC-3 (Cont)						
3	E O-50	Switch 3	Controls a-c output of inverter No. 3 to a-c bus 1. Applies a-c output of inverter No. 3 to a-c bus 1 and disconnects inverter No. 1 from a-c bus 1. Disconnects a-c output of inverter No. 3 to a-c bus 1 and allows inverter 1 to be connected.	INVERTER CONTROL-3 (MDC-5)	Battery relay bus	
		ON				
		OFF				
3	E O-50	RESET/OFF switch	Provides capability of resetting a-c bus 1 over-undervoltage and overload sensing unit. Also releases relay which reconnects the operating inverter to a-c bus 1, if it had been tripped off due to overvoltage. Momentary position resets a-c bus 1 over-undervoltage and overload sensing unit. Energizes a-c bus 1 over-undervoltage and overload sensing unit. Disconnects a-c bus 1 over-undervoltage and overload sensing unit from system.	EPS SENSOR UNIT AC BUS 1		Resetting a-c bus 1 over-undervoltage and overload sensing unit also turns AC BUS 1 and AC BUS 1 OVERLOAD caution and warning lights (MDC-2) off. Circuit breaker associated with a-c reset on a-c bus 1 is EPS SENSOR UNIT - AC BUS 1 (MDC-5).
		RESET				
		CENTER				
		OFF				
		AC BUS 2 group				
3	E P-49	Switch 1	Controls output of inverter No. 1 to a-c bus 2. Applies output of inverter No. 1 to a-c bus 2 and disconnects inverter No. 2 from a-c bus 2.	INVERTER CONTROL-2 (MDC-5)		Actuates a motor-driven switch which accomplishes actual switching function. Interlocking circuitry between AC INVERTER 1, 2, and 3 AC BUS 2
		ON				

MAIN DISPLAY CONSOLE—PANEL 3

SM2A-03-BLOCK II-(1)
APOLLO OPERATIONS HANDBOOK

CONTROLS AND DISPLAYS

Location		Name and Position	Function	Circuit Breaker	Power Source	Remarks
Panel	Area Grid					
MDC-3 (Cont)						
3	E P-49	OFF	Disconnects output of inverter No. 1 from a-c bus 2 and allows inverter No. 2 to be connected.	INVERTER CONTROL-2 (MDC-5)	Battery relay bus	switches (MDC-3) prevents more than one inverter from being connected to a-c bus 2 at the same time.
		Switch 2	Controls output of inverter No. 2 to a-c bus 2.	INVERTER CONTROL-3 (MDC-5)		
		ON	Applies output of inverter No. 2 to a-c bus 2 and disconnects inverter No. 3 from a-c bus 2.			
		OFF	Disconnects output of inverter No. 2 from a-c bus 2 and allows inverter No. 3 to be connected.			
3	E P-50	Switch 3	Controls output of inverter No. 3 to a-c bus 2.	INVERTER CONTROL-1 (MDC-5)		
		ON	Applies output of inverter No. 3 to a-c bus 2 and disconnects inverter No. 1 from a-c bus 2.			
		OFF	Disconnects output of inverter No. 3 from a-c bus 2 and allows inverter No. 1 to be connected.			
3	E P-50	RESET/OFF switch	Provides capability of resetting a-c bus 2 over-undervoltage and overload sensing unit. Also releases relay which reconnects the operating inverter to a-c bus No. 2 if it has been tripped off due to overvoltage. Resets a-c bus 2 over-undervoltage and overload sensing unit.	EPS SENSOR UNIT - AC BUS 2 (MDC-5)		Resetting a-c bus 2 over-undervoltage and overload sensing unit also turns AC BUS 2 and AC BUS 2 OVERLOAD caution and warning lights (MDC-2) OFF. Circuit breaker associated with reset on a-c bus 2 is EPS SENSOR UNIT - AC BUS 2 (MDC-5).

MAIN DISPLAY CONSOLE—PANEL 3

SM2A-03-BLOCK II-(1)
APOLLO OPERATIONS HANDBOOK

CONTROLS AND DISPLAYS

Location		Name and Position	Function	Circuit Breaker	Power Source	Remarks
Panel	Area Grid					
MDC-3 (Cont)						
3	E P-50	CENTER OFF	Energizes a-c bus 2 over-voltage and overload sensing unit. Disconnects a-c bus 2 over-voltage and overload sensing unit from the system.	EPS SENSOR UNIT - AC BUS 2 (MDC-5)	Battery relay bus	
3	E O-51	AC VOLTS meter	Indicates a-c voltage of selected source and phase.	EPS SENSOR SIGNAL - AC 1, AC 2 (MDC-5)	As selected by AC INDICATORS switch	Meter functions in conjunction with AC INDICATORS switch. AC VOLTS meter range is 90 to 130 vac.
3	E M-51	BATTERY CHARGE switch OFF	Controls a-c and d-c power to battery charger, and selects battery to be charged. Disconnects electrical power from battery charger.	BATTERY CHARGER MNA MNB AC PWR (MDC-5)	DC main buses A & B AC bus 1 or 2	Switch actuates battery charger input power control relay, routing a-c and d-c through relay contacts to battery charger. Current flow is 0.4 amps when a battery is fully charged. MAIN BUS TIE switches (MDC-5) for selected battery must be off before a battery can be charged. AC power for the battery charger is selected from a-c bus 1 or a-c bus 2 by the BAT CHGR AC1-AC2 switch (MDC-5). BAT RLY BUS - BAT A CB (MDC-5) should be opened when charging entry battery A. BAT RLY BUS - BAT B CB (MDC-5) should be opened when charging entry battery B.
		A	Controls a-c and d-c power to battery charger and routes output of battery charger to entry battery A thru battery bus A.	BAT A (MDC-5)		
		B	Controls a-c and d-c power to battery charger and routes output of battery charger to entry battery B thru battery bus B.	BAT B (MDC-5)		
		C	Controls a-c and d-c power to battery charger and routes output of battery charger to entry battery C.	BAT CHGR BAT C (RHEB-250)		

MAIN DISPLAY CONSOLE - PANEL 3

SM2A-03-BLOCK II-(1)
APOLLO OPERATIONS HANDBOOK

CONTROLS AND DISPLAYS

Location		Name and Position	Function	Circuit Breaker	Power Source	Remarks
Panel	Area Grid					
MDC-3 (Cont)						
3	E	K-49 DC VOLTS meter	Indicates d-c voltage of selected source, unit, or bus.		As selected by DC INDICATORS switch	Meter functions in conjunction with DC INDICATORS switch. DC VOLTS meter range is 20 to 45 vdc. Selectable sources are MAIN BUS A and B, BAT BUS A and B, BAT CHARGER, BAT C, and PYRO BAT A and B.
3	E	J-49 DC AMPS meter	Indicates d-c current of selected source, unit, or bus.			Meter functions in conjunction with DC INDICATORS switch. DC AMPS meter range is 0 to 100 amperes, 0 to 5 amperes expanded scale is battery charger output. Selectable sources are F/C 1, 2, 3, BAT BUS A and B, BAT CHARGER, and BAT C.
3	E	M-49 DC INDICATORS switch	Selects power source, bus, or unit to be monitored by DC VOLTS and DC AMPS meters.			In some cases, only current or voltage is indicated by DC VOLTS and DC AMPS meters. In other cases, both voltage and current are indicated. These are listed in the function column associated with each position. The DC VOLTS meter will read slightly below 20 vdc when not in use. The DC AMPS meter will read zero amperes when not connected to an input.
		FUEL CELL 1	Applies output of fuel cell No. 1 shunt to DC AMPS meter.		Fuel cell No. 1	
		2	Applies output of fuel cell No. 2 shunt to DC AMPS meter.		Fuel cell No. 2	
		3	Applies output of fuel cell No. 3 shunt to DC AMPS meter.		Fuel cell No. 3	
		MAIN BUS A	Applies voltage of d-c main bus A to DC VOLTS meter.	EPS SENSOR SIGNAL - DC BUS A (MDC-5)	DC main bus A	
		B	Applies voltage of d-c main bus B to DC VOLTS meter.	EPS SENSOR SIGNAL - DC BUS B (MDC-5)	DC main bus B	

MAIN DISPLAY CONSOLE--PANEL 3

SM2A-03-BLOCK II-(1)
APOLLO OPERATIONS HANDBOOK

CONTROLS AND DISPLAYS

Location		Name and Position	Function	Circuit Breaker	Power Source	Remarks
Panel	Area Grid					
3	E	MDC-3 (Cont)	BAT BUS A	Battery charger - BAT A - CHG (MDC-5)	Battery bus A & B	Listed circuit breaker controls d-c voltage indication and measurement for telemetry.
			BAT BUS B	Battery charger - BAT B - CHG (MDC-5)	Battery bus B	
		BAT CHARGER	Applies voltage output of battery charger to DC VOLTS meter and current output of battery charger shunt to DC AMPS meter (inner scale 0 to 5 amps).		Battery charger	Charger current output will be according to charge required by battery (up to 2.5 amps). Charger is disconnected at an ammeter indication of 0.4 amps.
		BAT C	Applies both voltage and current outputs of battery C to DC VOLTS and DC AMPS meters.	BAT C BAT CHGR and EDS 2 (RHEB-250)	Battery C	Listed circuit breaker controls d-c voltage indication and measurement for telemetry.
		PYRO BAT A	Applies output voltage of pyro bus A to DC VOLTS meter.	SEQ A (RHEB-250)	Pyro battery A	Since pyro batteries are not normally connected to a load, open circuit voltage will be indicated on voltmeter.
		PYRO BAT B	Applies output voltage of pyro bus B to DC VOLTS meter.	SEQ B (RHEB-250)	Pyro battery B	
3	E	I-47	FUEL CELL INDICATOR switch 1		Dependent on position	Indicators associated with switch are as follows: a. FLOW indicators H ₂ and O ₂ b. MODULE TEMP indicators SKIN and COND EXH c. pH HI d. F/C RAD TEMP LOW.

MAIN DISPLAY CONSOLE—PANEL 3

SM2A-03-BLOCK II-(1)
APOLLO OPERATIONS HANDBOOK

CONTROLS AND DISPLAYS

Location		Name and Position	Function	Circuit Breaker	Power Source	Remarks
Panel	Area Grid					
MDC-3 (Cont)						
3	E I-47	2 3	Applies selected outputs of fuel cell No. 2 to fuel cell display indicators. Applies selected outputs of fuel cell No. 3 to fuel cell display indicators.		Dependent on position	
3	E F-44	FUEL CELL meters FLOW group H ₂ O ₂	Indicates flow rate of H ₂ into selected fuel cell. Indicates flow rate of O ₂ into selected fuel cell.	INSTRUMENTATION POWER CONTROL OPERATIONAL CB 3 (RHEB-276)		Normal operating range (indicator green band) is 0.036 lb/hr to 0.163 lb/hr. Alarm limit to caution and warning system is 0.161 lb/hr upper. Sensors for the indicator are located in the F/C H ₂ inlet lines. Fuel cell to be monitored is selected by FUEL CELL INDICATORS switch (MDC-3). Normal operating range (indicator green band) is 0.288 lb/hr to 1.304 lb/hr. Alarm limit to caution and warning system is 1.276 lb/hr upper. Sensors for the indicator are located in the FUEL CELL O ₂ inlet lines. Fuel cell to be monitored is selected by FUEL CELL INDICATORS switch (MDC-3).
3	E F-45	MODULE TEMP group SKIN	Indicates skin temperature of selected fuel cell.	SIG COND FLT BUS (RHEB-225)		Normal indication is 385° to 450°F. Alarm limits to caution and warning system are 360°F lower, 475°F upper. Sensors for the indicator are located in the pressurized portion of the fuel cells. Fuel cell to be monitored is selected by FUEL CELL INDICATORS switch (MDC-3).

MAIN DISPLAY CONSOLE—PANEL 3

SM2A-03-BLOCK II-(1)
APOLLO OPERATIONS HANDBOOK

CONTROLS AND DISPLAYS

Location		Name and Position	Function	Circuit Breaker	Power Source	Remarks
Panel	Area Grid					
MDC-3 (Cont)						
3	E	F-45	COND EXH	INDICATES temperature of selected fuel cell condenser exhaust.	SIG COND FLT BUS (RHEB-225)	CONDENSER exhaust operating range is 150° to 175°F. Alarm limits to caution and warning system are below 150° or above 175°F. Sensors for the indicator are located in the exhaust manifolds of the fuel cell condensers. Fuel cell to be monitored is selected by FUEL CELL INDICATORS switch (MDC-3).
3	E	J-44	FUEL CELL HEATERS switches 1 UP OFF	ACTIVATES in-line heater circuit for automatic operation. DEACTIVATES in-line heater circuit.	Fuel cell No. 1	Allows in-line heater circuit to function normally. (Auto on - 385°±5°F) (Auto off - 390°±5°F) Totally disables in-line heater circuit.
3	E	J-45	2 UP OFF	ACTIVATES in-line heater circuit for automatic operation. DEACTIVATES in-line heater circuit.	Fuel cell No. 2	
3	E	J-45	3 UP OFF	ACTIVATES in-line heater circuit for automatic operation. DEACTIVATES in-line heater circuit.	Fuel cell No. 3	

MAIN DISPLAY CONSOLE--PANEL 3

SM2A-03-BLOCK II-(1)
 APOLLO OPERATIONS HANDBOOK

CONTROLS AND DISPLAYS

Location		Name and Position	Function	Circuit Breaker	Power Source	Remarks
Panel	Area Grid					
MDC-3 (Cont)		FUEL CELL group MAIN BUS A				
3	E K-47	Switches 1, 2 and 3	Controls fuel cells No. 1, 2 and 3 electrical output to d-c main bus A.	FUEL CELL 1 - BUS CONT (RHEB-226)	Battery relay bus	When fuel cell main bus switches are placed to ON position, power is applied to a motor-driven switch located in a power distribution box in the S/M. This accomplishes actual switching function required to apply output of selected fuel cell to d-c main bus A. Only one F/C BUS DISCONNECT status light (MDC-2) for all three FCs.
		ON	Momentary switch position connects electrical output of selected fuel cell to d-c main bus A.	FUEL CELL 2 - BUS CONT (RHEB-226)		
		CENTER	Connects C&W alarm and FC - BUS DISCONNECT indicator light (MDC-2) to selected fuel cell motor switch (normal position of switch).	FUEL CELL 3 - BUS CONT (RHEB-226)		
		OFF	Disconnects electrical output of selected fuel cell from d-c main bus A and disconnect C&W alarm. Activates talkback indicator to striped position.			
3	E K-48	RESET switch	Provides capability of resetting d-c main bus A undervoltage sensing circuit.	EPS SENSOR UNIT - DC BUS A (MDC-5)		DC main bus A undervoltage sensing circuit energizes MN BUS A UNDER-VOLT warning light (MDC-2) when d-c voltage drops below 26.25 vdc.
		RESET	Momentary switch position resets d-c main bus A undervoltage sensing unit and extinguishes DC undervoltage lamp.			
		CENTER	Connects MN BUS A UNDER-VOLT warning light and battery relay bus power to d-c bus A undervoltage sensing circuit.			

MAIN DISPLAY CONSOLE—PANEL 3

SM2A-03-BLOCK II-(1)
APOLLO OPERATIONS HANDBOOK

CONTROLS AND DISPLAYS

Location		Name and Position	Function	Circuit Breaker	Power Source	Remarks
Panel	Area Grid					
MDC-3 (Cont)						
3	E K-48	OFF	Disconnects MN BUS A UNDER-VOLT warning light and battery relay bus power from d-c bus A undervoltage sensing circuit.	EPS SENSOR UNIT - DC BUS A (MDC-5)	Battery relay bus	
3	E J-46	Event Indicators 1, 2 and 3 Striped-line display Gray display	Indicates when selected F/C is removed from d-c main bus A. Indicates selected F/C is connected to bus.	FUEL CELL 1 - BUS CONT (RHEB-226) FUEL CELL 2 - BUS CONT (RHEB-226) FUEL CELL 3 - BUS CONT (RHEB-226)		Event indicators function in conjunction with their respective switches located directly below.
3	E M-46/ M-47	FUEL CELL group MAIN BUS B Switches 1, 2, and 3 ON CENTER	Controls fuel cells No. 1, 2, and 3 electrical output to d-c main bus B. Momentary switch position connects electrical output of selected fuel cell to d-c main bus B. Connects C&W alarm and F/C BUS DISCONNECT indicator light (MDC-2) to selected fuel cell motor switch (normal position of switch).			When fuel cell main bus switches are placed to ON position, power is applied to a motor-driven switch located in a power distribution box in the SM. This accomplishes actual switching function required to apply output of selected fuel cell d-c main bus B. Only on F/C BUS DISCONNECT status light (MDC-2) for all three fuel cells.

MAIN DISPLAY CONSOLE—PANEL 3

SM2A-03-BLOCK II-(1)
APOLLO OPERATIONS HANDBOOK

CONTROLS AND DISPLAYS

Location		Name and Position	Function	Circuit Breaker	Power Source	Remarks
Panel	Area Grid					
MDC-3 (Cont)						
3	E M-47	OFF	Disconnects electrical output of selected fuel cell from d-c main bus B, disconnects C&W alarm and activates talkback indicator to striped position.	FUEL CELL 2 - BUS CONT (RHEB-226) FUEL CELL 3 - BUS CONT (RHEB-226)	Battery relay bus	
3	E M-48	RESET switch RESET CENTER OFF	Provides capability of resetting d-c main bus B undervoltage sensing circuit. Momentary switch position resets d-c main bus B undervoltage sensing circuit. Connects MN BUS B UNDER-VOLT warning light and battery relay bus power to d-c bus B undervoltage sensing circuit. Disconnects MN BUS B UNDER-VOLT warning and battery relay bus power from d-c bus B undervoltage sensing circuit.	EPS SENSOR UNIT - DC BUS B (MDC-5)		DC main bus B undervoltage sensing circuit energizes MN BUS B UNDER-VOLT warning light (MDC-2) when d-c voltage drops below 26.25 vdc.
3	E L-46	Event Indicators 1, 2, and 3 Striped-line display Gray display	Indicates when selected fuel cell is removed from d-c main bus B. Indicates selected fuel cell is connected to bus.	FUEL CELL 1 - BUS CONT (RHEB-226) FUEL CELL 2 - BUS CONT (RHEB-226) FUEL CELL 3 - BUS CONT (RHEB-226)		Event indicators function in conjunction with their respective switches located directly below.

MAIN DISPLAY CONSOLE—PANEL 3

SM2A-03-BLOCK II-(1)
 APOLLO OPERATIONS HANDBOOK

CONTROLS AND DISPLAYS

Location		Name and Position	Function	Circuit Breaker	Power Source	Remarks
Panel	Area Grid					
MDC-3 (Cont)		FUEL CELL PURGE switches Switches 1, 2, and 3 H ₂ PURGE CENTER (off) O ₂ PURGE	Accomplish purging of selected fuel cell. Opens purge valve on H ₂ side of selected fuel cell to purge impurities from H ₂ electrodes. Disconnects power from selected F/C O ₂ or H ₂ purge valve, closing valve (normal switch position). Opens purge valve on O ₂ side of selected fuel cell to purge impurities from O ₂ electrodes.	FUEL CELL 1 - PURGE (RHEB-226) FUEL CELL 2 - PURGE (RHEB-226) FUEL CELL 3 - PURGE (RHEB-226)	DC main buses A & B	When purging the selected fuel cell, the C&Ws will alarm if the reactants flow rate increases beyond the maximum normal flow rate. O ₂ purge time (switch ON) is 2 minutes and H ₂ purge time (switch ON) is 80 seconds. O ₂ and H ₂ maximum flow rates during purge are 0.6 and 0.67 lb/hr above normal flow rates, respectively.
3	E K-45					
3	E I-45					
		FUEL CELL RADIATORS Switches 1, 2, and 3 NORMAL CENTER EMER BYPASS	Control radiator area used by fuel cell. Momentary switch position operates radiator valve allowing use of full radiator for respective fuel cell. De-energizes talkback indicator. Valves remain in last selected position (normal switch position). Momentary switch position operates radiator valve to bypass 3/8 of radiator. Energizes talk-back indicator to striped indication.	FUEL CELL 1 - RAD (RHEB-226) FUEL CELL 2 - RAD (RHEB-226) FUEL CELL 3 - RAD (RHEB-226)	Battery relay bus	Three radiator panels on +Z axis are bypassed when it is desired to retain heat in fuel cells.

MAIN DISPLAY CONSOLE—PANEL 3

SM2A-03-BLOCK II-(1)
 APOLLO OPERATIONS HANDBOOK

CONTROLS AND DISPLAYS

Location		Name and Position	Function	Circuit Breaker	Power Source	Remarks
Panel	Area Grid					
MDC-3 (Cont)						
3	E H-45	Event Indicators 1, 2, and 3 Striped-line display Gray display	Indicates EPS radiator panels 6, 7, and 8 bypassed. Indicates full EPS radiator panel operation.	FUEL CELL 1 - RAD (RHEB-226) FUEL CELL 2 - RAD (RHEB-226) FUEL CELL 3 - RAD (RHEB-226)	Battery relay bus	
3	E G-46	FC RAD TEMP LOW event indicator Striped-line display Gray display	Indicates selected fuel cell glycol temperature at radiator outlet has dropped to -30°F or less. Indicates selected fuel cell glycol temperature at radiator outlet is above -30°F.	C/W MNA MNB (MDC-5)	DC main buses A & B	Glycol operating range is -50° to +300°F. Fuel cell to be monitored is selected by FUEL CELL INDICATORS switch (MDC-3). The FC RAD TEMP LOW event indicator is part of the C&Ws.
3	E M-45	FUEL CELL REACTANTS Switches 1, 2, and 3 ON CENTER	Provides ON - OFF control of reactant flow (H ₂ and O ₂) for selected fuel cells. Momentary switch position connects d-c power to selected fuel cell O ₂ and H ₂ shutoff valve actuators, driving valves to open position. Valves remain in last selected position (normal switch position).	FUEL CELL 1 - REACS (RHEB-226) FUEL CELL 2 - REACS (RHEB-226) FUEL CELL 3 - REACS (RHEB-226)	Battery relay bus	These switches control solenoid valves which accomplish control of reactant flow. Event indicators, located directly above their respective switches, display striped lines when both H ₂ and O ₂ shutoff valves are in closed (abnormal) position. WARNING Do not inadvertently position REACTANT switches OFF. Loss of fuel cell will result.

MAIN DISPLAY CONSOLE—PANEL 3

SM2A-03-BLOCK II-(1)
APOLLO OPERATIONS HANDBOOK

CONTROLS AND DISPLAYS

Location		Name and Position	Function	Circuit Breaker	Power Source	Remarks
Panel Area	Grid					
MDC-3 (Cont)						
3	E M-45	OFF	Momentary switch position connects d-c power to selected fuel cell O ₂ and H ₂ shutoff valve actuators, driving valves to closed position.	FUEL CELL 1 - REACS (RHEB-226) FUEL CELL 2 - REACS (RHEB-226) FUEL CELL 3 - REACS (RHEB-226)	Battery relay bus	
3	E L-45	Event Indicators 1, 2, and 3 Striped-line display Gray display	Indicates when H ₂ and O ₂ shutoff valves are closed on selected fuel cell. Indicates normal (open) position of valves.	FUEL CELL 1 - BUS CONT (RHEB-226) FUEL CELL 2 - BUS CONT (RHEB-226) FUEL CELL 3 - BUS CONT (RHEB-226)		Event indicators function in conjunction with their respective switches located directly below.
3	E H-44	pH HI event indicator Striped-line display Gray display	Indicates pH factor (alkalinity) of water from selected fuel cell is over 9. Indicates pH factor of water from selected fuel cell is below 9.	FUEL CELL 1, 2, 3 - PUMPS - AC (RHEB-226)	AC bus 1 or 2 ØA	A pH factor of 7 designates pure water (water is potable with a pH factor below 9). Fuel cell to be monitored is selected by FUEL CELL INDICATORS switch (MDC-3). The pH HI event indicator is part of the C&Ws. ØA power supplied through FUEL CELL PUMPS switches (MDC-5).

MAIN DISPLAY CONSOLE—PANEL 3

SM2A-03-BLOCK II-(1)
 APOLLO OPERATIONS HANDBOOK

CONTROLS AND DISPLAYS

Location		Name and Position	Function	Circuit Breaker	Power Source	Remarks
Panel	Area					
3	F	J-46	MDC-3 (Cont)	C/W MNA MNB (MDC-5)	DC main buses A & B	<p>MASTER ALARM lights on MDC-1, -3, and LEB 122 are simultaneously illuminated, and an audio alarm tone is sent to each headset.</p> <p>MASTER ALARM switchlight contains integral push-switch. Pressing switch-light will reset master alarm circuit, extinguishing all MASTER ALARM lights, and shutting off audio alarm.</p>
			<p>Red light illuminates to alert crewman in RH couch of a malfunction or out-of-tolerance condition. This is indicated by illumination of applicable system status lights on MDC-2.</p>			
		<p>MASTER ALARM switchlight</p>				

MAIN DISPLAY CONSOLE—PANEL 3

SM2A-03-BLOCK II-(1)
APOLLO OPERATIONS HANDBOOK

CONTROLS AND DISPLAYS

Location		Name and Position	Function	Circuit Breaker	Power Source	Remarks
Panel	Area Grid					
4	A	N-57 SPS GAUGING switch	<p>AC1</p> <p>Applies a-c power to the following:</p> <p>a. Quantity gauging system control unit self-test circuitry.</p> <p>b. Normally open contacts of SPS engine ignition relays.</p> <p>Removes all a-c power.</p> <p>AC2</p> <p>Applies a-c power to the following:</p> <p>a. Quantity gauging system control unit self-test circuitry.</p> <p>b. Normally open contacts of SPS engine ignition relays.</p>	SPS-GAUGING AC1, AC2 (MDC-8)	AC bus 1	Three-position toggle switch which controls application of a-c power to propellant quantity utilization and gauging system control unit. Power for control unit self-test circuitry is applied directly by switch. Power for propellant quantity measuring circuitry is applied only when engine ignition relays are energized by engine firing signal.
					AC bus 2	
4	B	O-58 TELECOM switches Group 1	<p>AC1</p> <p>Connects a-c bus 1 electrical power into Group 1 circuit breakers.</p> <p>OFF</p> <p>Disconnects a-c power from Group 1 circuit breakers.</p> <p>AC2</p> <p>Connects a-c bus 2 electrical power into Group 1 circuit breakers.</p>	N/A	AC bus 1	
					AC bus 2	

MAIN DISPLAY CONSOLE—PANEL 4

CONTROLS AND DISPLAYS

Location		Name and Position	Function	Circuit Breaker	Power Source	Remarks
Panel	Area Grid					
4	B	Group 2	Connects a-c bus 1 electrical power into Group 2 breakers. Disconnects power from Group 2 circuit breakers. Connects a-c bus 2 electrical power into Group 2 circuit breakers.	N/A	AC bus 1	
		AC1			AC bus 2	
		OFF				
		AC2				
4	C	ECS GLYCOL PUMPS selector switch	Applies a-c power to motor of No. 1 water-glycol pump from bus No. 2.	ECS-GLYCOL PUMPS-AC2 ØA ØB / ØC (MDC-4)	AC bus 2	Only one water-glycol pump can be operated at a time, with second pump for standby redundancy.
		PUMP 1				
		AC2				
		AC1	Applies a-c power to motor of No. 1 water-glycol pump from bus No. 1.	ECS-GLYCOL PUMPS-AC1 ØA ØB ØC (MDC-4)	AC bus 1	
		OFF	Removes a-c power from motors of water-glycol pumps.			
		PUMP 2	Applies a-c power to motor of No. 2 water-glycol pump from bus No. 1.			
		AC1				

MAIN DISPLAY CONSOLE—PANEL 4

SM2A-03-BLOCK II-(1)
APOLLO OPERATIONS HANDBOOK

CONTROLS AND DISPLAYS

Location		Name and Position	Function	Circuit Breaker	Power Source	Remarks
Panel	Area Grid					
MDC-4 (Cont)		AC2	Applies a-c power to motor of No. 2 water-glycol pump from bus No. 2.	ECS-GLYCOL PUMPS-AC2 ØA ØB ØC (MDC-4)	AC bus 2	
4	C P-61	ECS GLYCOL PUMPS circuit breakers AC1 ØA (2 amp) ØB (2 amp) ØC (2 amp)	Protects wire circuit to following: ØB - suit circuit heat exchanger. ØC - glycol primary evaporator steam pressure manual control and INCR-DECR selection. ØA - glycol temperature control valve. ØA, B and C to glycol pumps 1 and 2.		AC bus 1	
4	C O-61	AC2 ØA (2 amp) ØB (2 amp) ØC (2 amp)	Protects wiring circuit to following: ØA - to automatic water-glycol H ₂ O flow and glycol evaporator steam pressure controllers. ØA, B and C - to glycol pumps 1 and 2.		AC bus 2	
4	C O-60	SUIT COMPRESSOR SUIT COMPRESSOR 1 switch AC1	Applies a-c power to motor of suit compressor No. 1 from bus No. 1.	ECS-SUIT COMPRESSORS AC1 ØA ØB ØC (MDC-4)	AC bus 1	Output of each compressor is as follows: a. Prelaunch mode - 32.7 cfm and ΔP of 0.7 to 0.9 psi. b. Normal mode - 35 cfm and ΔP of 0.3 to 0.4 psi. c. Emergency mode - 33.6 cfm and P of 0.2 to 0.3 psi.

MAIN DISPLAY CONSOLE—PANEL 4

SM2A-03-BLOCK II-(1)
APOLLO OPERATIONS HANDBOOK

CONTROLS AND DISPLAYS

Location		Name and Position	Function	Circuit Breaker	Power Source	Remarks
Panel	Area Grid					
MDC-4 (Cont)		OFF	Removes a-c power from motors of suit compressors.		AC bus 1	
		AC2	Applies a-c power to motor of suit compressor No. 1 from bus No. 2.	ECS-SUIT COM-PRESSORS AC2 øA øB øC (MDC-4)	AC bus 2	
4	C N-60	SUIT COMPRESSOR 2 switch				
		AC1	Applies a-c power to motor of suit compressor No. 2 from bus No. 1.	ECS-SUIT COM-PRESSORS AC1 øA øB øC (MDC-4)	AC bus 1	
		OFF	Removes a-c power from motor of suit compressor.			
		AC2	Applies a-c power to motor of suit compressor No. 2 from bus No. 2.	ECS-SUIT COM-PRESSORS AC2 øA øB øC (MDC-4)	AC bus 2	

MAIN DISPLAY CONSOLE—PANEL 4

SM2A-03-BLOCK II-(1)
 APOLLO OPERATIONS HANDBOOK

CONTROLS AND DISPLAYS

Location		Name and Position	Function	Circuit Breaker	Power Source	Remarks
Panel	Area					
4	C	MDC-4 (Cont) SUIT COMPRESSOR circuit breakers	Protects wiring circuit to suit compressors No. 1 and No. 2.		AC bus 1	
	P-60	AC1 ØA (3 amp) ØB (3 amp) ØC (3 amp)				
4	C	AC2 ØA (3 amp) ØB (3 amp) ØC (3 amp)	Protects wiring circuit to suit compressors No. 2 and No. 1.		AC bus 2	
	O-61					

MAIN DISPLAY CONSOLE—PANEL 4

SM2A-03-BLOCK II-(1)
APOLLO OPERATIONS HANDBOOK

CONTROLS AND DISPLAYS

Location		Name and Position	Function	Circuit Breaker	Power Source	Remarks		
Panel	Area Grid							
MDC-5	5	A H-54 FUEL CELL PUMPS Switch 1	Is capable of selecting a-c bus No. 1, a-c bus No. 2, or off for fuel cell No. 1 pump motors and pH sensor. Connects power factor correction box to a-c bus 1 or a-c bus 2.	FUEL CELL 1-PUMPS - AC (RHEB-226)	AC bus 1	Two parallel pump motors are associated with each fuel cell. One motor drives H ₂ circulating pump and water separation centrifuge. Other motor drives glycol circulating pump. Switches are located between bus and circuit breakers.		
			Controls 3Ø a-c power from a-c bus No. 1 to fuel cell No. 1 pump motors and ØA to pH sensor. Connects power factor correction box to a-c bus 1.					
			Disconnects a-c power from pump motors and pH sensor and power factor correction box from all a-c buses.					
			AC2	Controls 3Ø a-c power from a-c bus No. 2 to fuel cell No. 1 pump motors and ØA to pH sensor. Connects power factor correction box to a-c bus 2.		AC bus 2		
	5	A H-54	Switch 2	Is capable of selecting a-c bus No. 1, a-c bus No. 2, or off for fuel cell No. 2 pump motors and pH sensor. Connects power factor correction box to a-c bus 1 or 2.	FUEL CELL 2-PUMPS - AC (RHEB-226)			
				Controls 3Ø a-c power from a-c bus No. 1 to fuel cell No. 2 pump motors and ØA to pH sensor. Connects power factor correction box to a-c bus 1.				AC bus 1
				Disconnects a-c power from pump motors and pH sensor and power factor correction box from all ac buses.				AC bus 2
			AC2	Controls 3Ø a-c power from a-c bus No. 2 to fuel cell No. 2 pump motors and ØA to pH sensor. Connects power factor correction box to a-c bus 2.				

MAIN DISPLAY CONSOLE—PANEL 5

SM2A-03-BLOCK II-(1)
APOLLO OPERATIONS HANDBOOK

CONTROLS AND DISPLAYS

Location		Name and Position	Function	Circuit Breaker	Power Source	Remarks	
Panel	Area Grid						
5	A	Switch 3	Is capable of selecting a-c bus No. 1, a-c bus No. 2, or off for fuel cell No. 3 pump motors and pH sensor. Connects power factor correction box to a-c bus 1 or a-c bus 2.	FUEL CELL 3-PUMPS - AC (RHEB-226)	AC bus 1		
		AC1	Controls 3Ø a-c power from a-c bus No. 1 to fuel cell No. 3 pump motors and ØA to pH sensors. Connects power factor correction box to a-c bus 1.				
		OFF	Disconnects a-c power from pump motors and pH sensor and power factor correction box from a-c bus 1 and 2.				
		AC2	Controls 3Ø a-c power from a-c bus No. 2 to fuel cell No. 3 pump motors and ØA to pH sensor. Connects power factor correction box to a-c bus 2.				
5	B	INTERIOR LIGHTS			DC main bus B		
		FLOOD rheostat	Removes power from LM pilot's floodlights.	LIGHTING-FLOOD MNB (RHEB-226)			Rheostat control may be adjusted for desired brightness of primary and/or secondary lighting dependent on position of DIM 1-2 switches.
		OFF	Indicates maximum floodlight brightness has been reached.				
5	B	FLOOD-DIM switch			DC main bus A		
		1	Applies rheostat control to LM pilot's primary floodlight lamps and on-off control to secondary lamps.	LIGHTING-FLOOD MNA MNB (RHEB-226)			Provides crew capability of shifting primary or secondary lamps to variable FLOOD light switch.
		2	Applies rheostat control to LM pilot's secondary floodlight lamps and on-off control to primary lamps.				

MAIN DISPLAY CONSOLE—PANEL 5

SM2A-03-BLOCK II-(1)
APOLLO OPERATIONS HANDBOOK

CONTROLS AND DISPLAYS

Location		Name and Position	Function	Circuit Breaker	Power Source	Remarks
Panel	Area Grid					
MDC-5 (Cont)						
5	B I-57	FLOOD-FIXED switch FIXED OFF	Turns ON lamps not controlled by rheostat. Removes power.	LIGHTING-FLOOD MNA (RHEB-226)	DC main bus A	Secondary when DIM switch on 1. Primary when DIM switch on 2.
5	B I-54	INTEGRAL rheostat OFF BRT	Removes power from LM pilot's area panels, 3, 4, 5, 6, 16, 275, and 229, and right part of panel 2. Indicates maximum brightness has been reached.	LIGHTING-NUMERICS/INTEGRAL R-MDC-AC1 CB34	AC bus 1 ØB	Integral lighting system controls EL lamps behind nomenclature on applicable panels. Mechanical stop prevents moving switch to OFF.
5	B K-54	INSTRUMENTS circuit breakers ESS-MNA (15 amp)	Applies d-c power from bus MNA to the four operational instrumentation breakers located on panel 276.	N/A	DC main bus A	
5	B K-54	ESS-MNB (15 amp)	Applies d-c power from bus MNB to the four operational instrumentation breakers located on panel 276.		DC main bus B	
5	B K-55	NONESS (15 amp)	Applies d-c power from noness bus MNA or MNB to SEB circuit breakers 1 and 2 and HATCH circuit breakers.		DC main bus A or B	
5	B K-56	SCI EQUIP SEB 1 (7.5 amp)	Applies d-c power from noness bus MNA or MNB to J5 outlet on LEB-162.			
5	B K-56	SEB 2 (7.5 amp)	Applies d-c power from noness bus MNA or MNB to a switch and outlet on LEB panels 162 and 163.			

MAIN DISPLAY CONSOLE - PANEL 5

SM2A-03-BLOCK II-(1)
APOLLO OPERATIONS HANDBOOK

CONTROLS AND DISPLAYS

Location		Name and Position	Function	Circuit Breaker	Power Source	Remarks
Panel	Area Grid					
MDC-5 (Cont)						
5	B	HATCH (7.5 amp)	Applies d-c power from noness bus MNA or MNB to left-hand switch and left-hand outlet on panel 227.	N/A	DC main bus A or B	
5	C	ENVIRONMENTAL CONTROL SYSTEM circuit breakers				
5	C	CABIN FAN-1 group AC1 ØA (2 amp) ØB (2 amp) ØC (2 amp)	Protects wiring to 3Ø cabin blower No. 1.		AC bus 1	
5	C	CABIN FAN-2 group AC2 ØA (2 amp) ØB (2 amp) ØC (2 amp)	Protects circuit to the following: cabin 3Ø blower No. 2, and CØ to auto cabin temperature control.		AC bus 2	
5	C	H ₂ O ACCUM-MNA (5 amp)	Protects wiring to cyclic accumulator control No. 1.	CB28	DC main bus A	
5	C	H ₂ O ACCUM MNB (5 amp)	Protects wiring circuit to cyclic accumulator control No. 2.	CB29	DC main bus B	
5	C	POT H ₂ O HTR MNA (5 amp)	Protects wiring to following circuits: manual control to glycol evaporator H ₂ O flow, and potable water heater A.	CB50	DC main bus A	
5	C	POT H ₂ O HTR MNB (5 amp)	Protects wiring to following circuits: manual control to glycol evaporator H ₂ O flow, and potable water heater B.	CB51	DC main bus B	
5	C	ECS RADIATORS-CONTROLLER-AC1 (2 amp)	Protects wiring to space radiators flow proportioning control system.		AC bus 1 ØC	
5	C	ECS RADIATORS-CONTROLLER-AC2 (2 amp)	Protects wiring to space radiators flow proportioning control system.		AC bus 2 ØC	

MAIN DISPLAY CONSOLE — PANEL 5

SM2A-03-BLOCK II-(1)
APOLLO OPERATIONS HANDBOOK

CONTROLS AND DISPLAYS

Location		Name and Position	Function	Circuit Breaker	Power Source	Remarks
Panel	Area Grid					
MDC-5 (Cont)						
5	C I-58	ECS RADIATORS-CONT/HTRS-MNA (5 amp)	Protects wiring circuit to primary and secondary space radiator and heater control circuits.	CB51	DC main bus A	
5	C I-59	ECS RADIATORS-CONT/HTRS-MNB (5 amp)	Protects wiring circuit to primary and secondary space radiator and heater control circuits.		DC main bus B	
5	C I-60	ECS RADIATORS HTRS OVL-D-BAT A (10 amp) (SC 103 & subs)	Protects wiring circuit to primary 1 radiator heater overload logic circuit.		Battery bus A	
5	C I-60	ECS RADIATORS-HTRS OVL-D-BAT B (10 amp) (SC 103 & subs)	Protects wiring circuit to primary 2 and secondary radiator heater overload logic circuit.		Battery bus B	
5	C L-54	ECS-SECONDARY COOLANT LOOP circuit breakers AC1 (2 amp) AC2 (2 amp)	Protects circuit wiring to: a. GLY PUMP SEC b. GLYCOL EVAPORATOR-TEMP (ØA only).	N/A	AC bus 1 AC bus 2	Three-phase ganged-type circuit breaker, single control reset. Overload on any phase trips all three phases.
5	C L-55					
5	C L-57	RAD HTR MNA (5 amp)	Protects circuit wiring to the RAD HTR, ECS RADIATOR TEMP-SEC-OUTLET ind, and ECS RADIATOR TEMP-PRIM SEC INLET ind.		DC main bus A	
5	C L-57	XDUCERS MNA (5 amp) MNB (5 amp)	Protects circuit wiring to the following: Secondary water-glycol pump output, secondary evaporator steam output, secondary glycol accumulator, quantity steam pressure sensor primary.		DC main buses A and B	
5	C L-57					

MAIN DISPLAY CONSOLE—PANEL 5

SM2A-03-BLOCK II-(1)
APOLLO OPERATIONS HANDBOOK

CONTROLS AND DISPLAYS

Location		Name and Position	Function	Circuit Breaker	Power Source	Remarks
Panel Area	Grid					
MDC-5 (Cont)						
5	C	WASTE H ₂ O/URINE-DUMP HTR circuit breakers MNA (5 amp) MNB (5 amp)	Protects circuit wiring to waste water, urine dump and steam duct heaters A. Protects circuit wiring to waste water, urine dump and steam duct heaters B.	N/A	DC main bus A DC main bus B	
5	C	ECS-TRANSDUCER-PRESS GROUPS-1 MNA (5 amp) MNB (5 amp)	Protects circuit wiring to the following: a. GLY ACCUM-QUANTITY b. GLY DISCH PRESS c. SUIT COMPR ΔP d. PRESS-SUIT inlet.		DC main buses A and B	
5	C	ECS-TRANSDUCER-PRESS GROUPS-2 circuit breakers MNA (5 amp) MNB (5 amp)	Protects circuit wiring to the following sensors: a. CABIN PRESSURE b. GLYCOL EVAPORATOR-STEAM PRESS c. PART PRESS CO ₂ d. O ₂ reg outlet (PCM only) e. O ₂ FLOW			
5	C	ECS-TRANSDUCER-TEMP MNA (5 amp) MNB (5 amp)	Protects following circuit wiring: Temperature Xducer power supply, cabin temperature, radiator temperature primary outlet, suit inlet temperature, steam outlet temperature (PCM only), and primary and secondary EVAP TEMP OUT.			
5	C	ECS-TRANSDUCER-WASTE/POT H ₂ O MNA (5 amp) MNB (5 amp)	Protects circuit wiring to potable and waste water quantity.			

MAIN DISPLAY CONSOLE—PANEL 5

SM2A-03-BLOCK II-(1)
APOLLO OPERATIONS HANDBOOK

CONTROLS AND DISPLAYS

Location		Name and Position	Function	Circuit Breaker	Power Source	Remarks
Panel	Area Grid					
MDC-5 (Cont)		GUIDANCE/NAVIGATION system circuit breakers COMPUTER	Provides d-c power from main bus A and circuit protection to energize the CMC.	N/A	DC main bus A	
5	D M-57					
		MNA (5 amp)	Provides d-c power from main bus B and circuit protection to energize the CMC.		DC main bus B	
		MNB (5 amp)				
		IMU	Provides power and protection from d-c main bus A to the inertial subsystem.		DC main bus A	CAUTION These breakers are not to be energized unless the corresponding IMU HTR circuit breakers are energized, as damage to the platform may result.
5	D M-56	MNA (25 amp)	Provides power and protection from d-c main bus B to the inertial subsystem.		DC main bus B	
		IMU HTR	Provides d-c power from main bus A and circuit protection to energize the standby thermal control system on the IMU and the excitation to the gyros and accelerometer magnetic output axis suspension.		DC main bus A	CAUTION These breakers must always be energized or accuracy of the platform may be impaired.
5	D M-57	MNA (7.5 amp)	Provides d-c power from main bus B and circuit protection to energize the standby thermal control system on the IMU and the excitation to the gyros and accelerometer magnetic output axis suspension.		DC main bus B	
		MNB (7.5 amp)				

MAIN DISPLAY CONSOLE—PANEL 5

SM2A-03-BLOCK II-(1)
APOLLO OPERATIONS HANDBOOK

CONTROLS AND DISPLAYS

Location		Name and Position	Function	Circuit Breaker	Power Source	Remarks
Panel	Area					
MDC-5 (Cont)						
5	D	M-58	OPTICS MNA (5 amp) MNB (5 amp)	N/A	DC main bus A DC main bus B	
5	D	M-55	POWER AC1 (2 amp) AC2 (2 amp)		AC bus 1 AC bus 2	
5	E	H-56	G/N PWR switch AC1 OFF AC2		AC bus 1 AC bus 2	
5	F	H-58	BAT CHGR switch AC1 AC2		AC bus 1 AC bus 2	Switch works with BATTERY CHARGE selector switch (MDC-3) to enable battery charger operation.

MAIN DISPLAY CONSOLE—PANEL 5

SM2A-03-BLOCK II-(1)
 APOLLO OPERATIONS HANDBOOK

CONTROLS AND DISPLAYS

Location		Name and Position	Function	Circuit Breaker	Power Source	Remarks
Panel	Area Grid					
MDC-5 (Cont)		BATTERY CHARGER circuit breakers BAT A CHG (10 amp) BAT B CHG (10 amp) MNA (5 amp) MNB (5 amp) AC PWR (2 amp)	Applies d-c power from battery bus A to MAIN BUS TIE - BAT A/C switch (MDC-5), to DC INDICATORS switch (MDC-3), and to telemetry. Connects output of BATTERY CHARGE switch position A to battery bus A for recharge of entry battery A. Applies d-c power from battery bus B to MAIN BUS TIE - BAT B/C switch (MDC-5), to DC INDICATORS switch (MDC-3), and to telemetry. Connects output of BATTERY CHARGE switch position B to battery bus B for recharge of entry battery B. Applies power from d-c main bus A, through an isolation diode, to BATTERY CHARGE selector switch (MDC-3) and d-c contacts of battery charger input-power control relay. Applies power from d-c main bus B, through an isolation diode, to BATTERY CHARGE selector switch (MDC-3) and d-c contacts of battery charger input-power control relay. Applies power from a-c bus No. 1 or a-c bus No. 2 to contacts of battery charger input-power control relay.	N/A	Battery bus A Battery bus B DC main bus A DC main bus B AC bus 1 3Ø	
5	F I-61					
5	F I-61					
5	F I-61					
5	F I-62					
5	F I-63					

MAIN DISPLAY CONSOLE—PANEL 5

SM2A-03-BLOCK II-(1)
APOLLO OPERATIONS HANDBOOK

CONTROLS AND DISPLAYS

Location		Name and Position	Function	Circuit Breaker	Power Source	Remarks
Panel	Area Grid					
MDC-5 (Cont)						
5	F	H-62 BAT RLY BUS circuit breakers BAT A (15 amp)	Applies d-c power from battery bus A through an isolation diode to battery relay bus.	N/A	Battery bus A	CB opened when charging battery A.
5	F	H-63 BAT B (15 amp)	Applies d-c power from battery bus B through an isolation diode to battery relay bus.	N/A	Battery bus B	CB opened when charging battery B.
5	F	G-59 EPS SENSOR SIGNAL circuit breakers DC group MNA (5 amp)	Applies signal and operating voltage from d-c main bus A to d-c undervoltage sensing units, DC INDICATORS switch and telemetry.		DC main bus A	
5	F	G-60 MNB (5 amp)	Applies signal and operating voltage from d-c main bus B to d-c undervoltage sensing units, DC INDICATORS switch and telemetry.		DC main bus B	
5	F	G-61 AC group AC1 (2 amp)	Applies voltage from a-c bus No. 1 to a-c over-undervoltage sensing unit and to AC INDICATORS switch (MDC-3).		AC bus 1 3Ø	
5	F	G-62 AC2 (2 amp)	Applies voltage from a-c bus No. 2 to a-c over-undervoltage sensing unit and to AC INDICATORS switch (MDC-3).		AC bus 2 3Ø	

MAIN DISPLAY CONSOLE—PANEL 5

SM2A-03-BLOCK II-(1)
 APOLLO OPERATIONS HANDBOOK

CONTROLS AND DISPLAYS

Location		Name and Position	Function	Circuit Breaker	Power Source	Remarks
Panel Area	Grid					
MDC-5 (Cont)		EPS SENSOR UNIT circuit breakers DC BUS group	Applies d-c power from battery relay bus through MAIN BUS A-RESET switch to d-c main bus A undervoltage sensing unit.	N/A	Battery relay bus	
5	H-61					
		B (5 amp)	Applies d-c power from battery relay bus through MAIN BUS B-RESET switch to d-c main bus B undervoltage sensing unit.			
		AC BUS group	Applies d-c power from battery relay bus through AC BUS 1-RESET switch to a-c bus No. 1 over-undervoltage sensing unit.			Sensing unit is inoperative when AC BUS 1-RESET switch is in the OFF position.
5	H-62	1 (5 amp)				
5	H-62	2 (5 amp)	Applies d-c power from battery relay bus through AC BUS 2-RESET switch to a-c bus No. 2 over-undervoltage sensing unit.			Sensing unit is inoperative when AC BUS 2-RESET switch is in the OFF position.
		INVERTER CONTROL circuit breakers	Applies d-c power from battery relay bus to AC INVERTER 1 dc and ac-1, and AC INVERTER 3 ac-2 switches (MDC-3).			
5	H-59	1 (10 amp)				
5	H-60	2 (10 amp)	Applies d-c power from battery relay bus to AC INVERTER 2 dc and ac-1, and AC INVERTER 1 ac-2 switches (MDC-3).			
5	H-60	3 (10 amp)	Applies d-c power from battery relay bus to AC INVERTER 3 dc and ac-1, and AC INVERTER 2 ac-2 switches (MDC-3).			

MAIN DISPLAY CONSOLE—PANEL 5

SM2A-03-BLOCK II-(1)
APOLLO OPERATIONS HANDBOOK

CONTROLS AND DISPLAYS

Location		Name and Position	Function	Circuit Breaker	Power Source	Remarks
Panel	Area Grid					
MDC-5 (Cont)		MAIN BUS TIE switches BAT A/C	<p>Allows manual control of bus tie motor switch to:</p> <p>a. Connect battery bus A to d-c main bus A and battery C to d-c main bus B.</p> <p>b. Disconnect BATTERY CHARGE selector switch position A (MDC-3) from battery bus A and position C from battery C.</p> <p>Connect entry batteries A and C to DC buses.</p>	BATTERY CHARGER-BAT A CHG (MDC-5)	Battery bus A	<p>Actuates motor-driven switch which accomplishes actual switching function.</p> <p>Automatically connects entry batteries A and C to the main d-c buses at CSM separation. (Used only during prelaunch.)</p>
5	F H-57					
MDC-5 (Cont)		BAT B/C	<p>Allows manual control of motor switches to:</p> <p>a. Disconnect battery bus A from d-c main bus A and battery C from d-c main bus B.</p> <p>b. Connect BATTERY CHARGE selector switch position A (MDC-3) to battery bus A and position C to battery C.</p> <p>Allows manual control of motor switches to:</p> <p>a. Disconnect battery bus A from d-c main bus A and battery C from d-c main bus B.</p> <p>b. Connect BATTERY CHARGE selector switch position A (MDC-3) to battery bus A and position C to battery C.</p>	BATTERY CHARGER-BAT B CHG (MDC-5)	Battery bus B	<p>Actuates motor-driven switch which accomplishes actual switching function.</p> <p>Automatically connects entry batteries B and C to the main d-c buses at CSM separation. (Used only during prelaunch.)</p>
5	F H-57					
MDC-5 (Cont)		AUTO	<p>Connect entry batteries B and C to d-c buses.</p>			

MAIN DISPLAY CONSOLE—PANEL 5

SM2A-03-BLOCK II-(1)
APOLLO OPERATIONS HANDBOOK

CONTROLS AND DISPLAYS

Location		Name and Position	Function	Circuit Breaker	Power Source	Remarks
Panel	Area Grid					
MDC-5 (Cont)						
5	F	OFF	Allows manual control of motor switch to: a. Disconnect battery bus B from d-c main bus B and battery C from d-c main bus A. b. Connect BATTERY CHARGE selector switch position B (MDC-3) to battery bus B and position C to battery C.	BATTERY CHARGER-BAT B CHG (MDC-5)	Battery bus B	
5	F	NONESS BUS switch MNA OFF MNB	Connects nonessential bus No. 1 and No. 2 to d-c main bus A. Disconnects nonessential buses from d-c main buses. Connects nonessential bus No. 1 and No. 2 to d-c main bus B.		DC main bus A DC main bus B	Equipment associated with this switch is: a. Special equipment bay No. 1 b. Special equipment bay No. 2 c. Special equipment hatch d. Nonessential instrumentation e. Voice recorder NON ESS BUS NO. 2 NON ESS BUS NO. 1
5	F	LM PWR-1 circuit breaker MNB (7.5 amp)	Protects circuit to first of two umbilicals providing power to LM through LM PWR sw (MDC-2).			
5	F	LM PWR-2 circuit breaker MNB (7.5 amp)	Protects circuit to second of two umbilicals providing power to LM through LM PWR sw (MDC-2).			
5	G	Caution and Warning system circuit breakers C/W-MNA (5 amp)	Provides circuit protection and a power path from d-c main bus A thru a diode to the caution and warning system.	N/A	DC main bus A	

MAIN DISPLAY CONSOLE - PANEL 5

SM2A-03-BLOCK II-(1)
APOLLO OPERATIONS HANDBOOK

CONTROLS AND DISPLAYS

Location		Name and Position	Function	Circuit Breaker	Power Source	Remarks
Panel	Area Grid					
5	G G-62	C/W-MNB (5 amp)	Provides circuit protection and a power path from d-c main bus B thru a diode to the caution and warning system.	N/A	DC main bus B	
MDC-5 (Cont)						

MAIN DISPLAY CONSOLE—PANEL 5

SM2A-03-BLOCK II-(1)
 APOLLO OPERATIONS HANDBOOK

CONTROLS AND DISPLAYS

Location		Name and Position	Function	Circuit Breaker	Power Source	Remarks
Panel	Area Grid					
6	A	INTERCOM switch	Enables, by a circuit closure, the headset to receive and transmit over the intercom system. Selects no modes.		Audio center equipment	
		T/R				
		OFF				
		RCV				
		VOLUME thumbwheel	A thumbwheel-type control which operates a 500k ohm potentiometer is provided to adjust the audio level from the intercom bus to the earphone amplifier.			
6	A	PAD COMM switch	Enables, by a circuit closure, the headset to receive and transmit over a hardline intercomm to launch operations. Selects no modes.	RHEB-225		
		T/R				
		OFF				
		RCV				
		VOLUME thumbwheel	A thumbwheel-type control which operates a 500k ohm potentiometer is provided to adjust the audio level from the hardline intercomm to the earphone amplifier.			

MAIN DISPLAY CONSOLE—PANEL 6

SM2A-03-BLOCK II-(1)
 APOLLO OPERATIONS HANDBOOK

CONTROLS AND DISPLAYS

Location		Name and Position	Function	Circuit Breaker	Power Source	Remarks
Panel	Area Grid					
MDC-6 (Cont)						
6	A B-53	MASTER VOLUME thumbwheel	A thumbwheel-type control which operates a 2.5k ohm potentiometer is provided to adjust the audio level from the earphone amplifier to the earphone.		Audio center equipment	
6	A B-51	MODE switch INTERCOM/ PTT PTT VOX	Applies power to audio center module, and provides hot mike operation and VOX operation for intercom and PTT operation for RF transmission. Applies power to audio center module and enables PTT operation for intercom and RF transmission. Applies power to the audio center module and provides VOX operation for both intercom and RF transmission. A thumbwheel-type control which operates a 25k ohm potentiometer is provided to adjust the sensitivity of the voice-operated relay in the audio center module.	CREW STATION AUDIO-L (MDC-225)	Flight and post-landing bus	
6	A D-52	S-BAND switch T/R OFF RCV	Enables, by a circuit closure, the headset to receive and transmit over the S-band equipment operating in the VOICE mode. Selects no modes. Enables by a circuit closure, the headset to receive (only) the output of the S-band equipment operating in the VOICE mode.		Audio center equipment	The VOICE mode includes not only the VOICE or RELAY mode positions, but also the VOICE BU positions of the S-BAND AUX and UP TLM sections, all with their attendant limitations.

MAIN DISPLAY CONSOLE — PANEL 6

SM2A-03-BLOCK II-(1)
APOLLO OPERATIONS HANDBOOK

CONTROLS AND DISPLAYS

Location		Name and Position	Function	Circuit Breaker	Power Source	Remarks
Panel	Area Grid					
MDC-6 (Cont)						
6	A D-52	VOLUME thumbwheel	A thumbwheel-type control which operates a 500k ohm potentiometer is provided to adjust the S-band receiver audio level to the earphone amplifier.		Audio center equipment	
6	A D-54	VHF AM switch T/R OFF RCV	Enables, by circuit closure, the headset to receive and transmit over the VHF AM equipment. Selects no modes. Enables, by a circuit closure, the headset to receive (only) the output of the VHF AM receiver. A thumbwheel-type control which operates a 500k ohm potentiometer is provided to adjust the audio level from the VHF AM receiver to the earphone amplifier.			
6	A E-54	SUIT switch POWER OFF	Applies power to the left and right hand microphones and the biomed preamplifiers in the suit associated with audio control panel No. 6. Removes power from the left and right hand microphones and the biomed preamplifiers in the suit associated with audio control panel No. 6.	CREW STATION AUDIO-CDR and NAV	Flight & postlanding bus	
6	A F-54	AUDIO CONTROL switch NORM	Routes LM pilot's audio signals through audio control panel No. 6 and associated audio module.			

MAIN DISPLAY CONSOLE--PANEL 6

SM2A-03-BLOCK II-(1)
APOLLO OPERATIONS HANDBOOK

CONTROLS AND DISPLAYS

Location		Name and Position	Function	Circuit Breaker	Power Source	Remarks
Panel Area	Grid					
MDC-6 (Cont)						
6	A	BACKUP	Routes LM pilot's audio signals through control panel No. 10 and associated audio center module.			Allows LM and CSM pilots to share same audio module and control panel in case of malfunction.
6	A	POWER switch	Provides primary power to the audio center module and enables the audible crew alarm signal to be heard at this astronaut station.	CREW STATION AUDIO-L (MDC-225)	Flight and postlanding bus	
		AUDIO/TONE	Removes all power to the audio center module and disables the audible crew alarm for this astronaut station.			
		OFF				
		AUDIO	Provides primary power to the audio center module but leaves the audible crew alarm circuit disabled at this station.			

MAIN DISPLAY CONSOLE—PANEL 6

SM2A-03-BLOCK II-(1)
APOLLO OPERATIONS HANDBOOK

CONTROLS AND DISPLAYS

Location		Name and Position	Function	Circuit Breaker	Power Source	Remarks
Panel	Area Grid					
7	A	EDS POWER/OFF switch	Supplies entry battery A, B, and C power to the EDS buses 1, 3, and 2 in the IU. Removes power from EDS buses 1, 2, and 3 in the IU.	EDS-1, 2, 3 BAT A BAT C and BAT B (MDC-8)	Battery buses A, B, and entry battery C	Closing of the EDS POWER switch provides power to the EDS display circuitry and also supplies power for EDS auto abort initiating circuitry.
		ON				
7	B	BMAG POWER-1 switch	No power supplied. Supplies 28 vdc to GA-1 for heaters and electronics. D-C power, same as in WARM UP. A-C power, supplies 3-phase power to GA-1.	SCS-SYSTEM MNA (MDC-8)	DC main bus A	WARM UP and ON poles of both BMAG POWER switches are tied together for d-c power switching.
		OFF				
		WARM UP				
7	B	BMAG POWER-2 switch	No power supplied. Supplies 28 vdc to GA-2 for heaters and electronics. D-C power, same as in WARM UP. A-C power, supplies 3-phase power to GA-2.	SCS-AC1 (MDC-8)	AC bus 1 3Ø	
		OFF				
		WARM UP				
7	O-4	BMAG POWER-2 switch	D-C power, same as in WARM UP. A-C power, supplies 3-phase power to GA-2.	SCS-SYSTEM MNB (MDC-8)	DC main bus B	
		ON				
7	O-4	BMAG POWER-2 switch	D-C power, same as in WARM UP. A-C power, supplies 3-phase power to GA-2.	SCS-AC2 (MDC-8)	AC bus 2 3Ø	
		ON				

MAIN DISPLAY CONSOLE—PANEL 7

SM2A-03-BLOCK II-(1)
APOLLO OPERATIONS HANDBOOK

CONTROLS AND DISPLAYS

Location		Name and Position	Function	Circuit Breaker	Power Source	Remarks
Panel Area	Grid					
MDC-7 (Cont)		SCS-ELECTRONICS POWER switch	<p>Not wired.</p> <p>a. Supplies phase A bus 1 power to ECA.</p> <p>b. Supplies phase A bus 2 power to ECA.</p> <p>c. Supplies 28 vdc to ECA.</p>	<p>STABILIZATION/ CONTROL SYSTEM- AC1 (MDC-8)</p> <p>STABILIZATION/ CONTROL SYSTEM- ECA/TVC- AC2 (MDC-8)</p> <p>STABILIZATION/ CONTROL SYSTEM- SYSTEM- MNA and MNB (MDC-8)</p> <p>STABILIZATION/ CONTROL SYSTEM- AC1 (MDC-8)</p> <p>STABILIZATION/ CONTROL SYSTEM- AC2 (MDC-8)</p>	<p>AC bus 1 ØA</p> <p>AC bus 2 ØA</p> <p>DC main bus A and B</p> <p>AC bus 1 ØA</p> <p>AC bus 2 ØA</p>	<p>A-C power to ECA is not only used for ECA power supplies, demod ref., etc. It is also routed through transformers (in ECA) to provide rotation controller (RC) transducer reference. AC1 goes to RC-1 and AC2 to RC-2.</p>
7	B					
	N-6					

MAIN DISPLAY CONSOLE—PANEL 7

SM2A-03-BLOCK II-(1)
APOLLO OPERATIONS HANDBOOK

CONTROLS AND DISPLAYS

Location		Name and Position	Function	Circuit Breaker	Power Source	Remarks
Panel	Area Grid					
MDC-7 (Cont)						
7	B N-6		c. Supplies 28 vdc to GDC.	STABILIZATION/CONTROL SYSTEM-MNA and MNB (MDC-8)	DC main bus A and B	
			d. Supplies phase A bus 1 power to ECA.	STABILIZATION/CONTROL SYSTEM-AC1 (MDC-8)	AC bus 1 0A	
			e. Supplies phase A bus 2 power to ECA.	STABILIZATION/CONTROL SYSTEM-ECA/TVC-AC2 (MDC-8)	AC bus 2 0A	
			f. Supplies 28 vdc to ECA.	STABILIZATION/CONTROL SYSTEM-MNA and MNB (MDC-8)	DC main bus A and B	
7	B N-7	FDAI/GPI POWER switch OFF	Not wired.			

MAIN DISPLAY CONSOLE—PANEL 7

SM2A-03-BLOCK II-(1)
APOLLO OPERATIONS HANDBOOK

CONTROLS AND DISPLAYS

Location		Name and Position	Function	Circuit Breaker	Power Source	Remarks
Panel	Area Grid					
7	B	1	a. Supplies 3-phase a-c power to EDA. b. Supplies 28 vdc to EDA.	STABILIZATION/CONTROL SYSTEM-AC1 (MDC-8)	AC bus 1	Provides power to electronics that drive indicators on FDAI No. 1. Supplies (through EDA) power to servometric potentiometers and motors (ball) on FDAI No. 1. Provides power to operate GPI meter movements. (PITCH 1 and YAW 1)
				STABILIZATION/CONTROL SYSTEM-MNA (MDC-8)	DC main bus A	
		2	a. Supplies 3-phase a-c power to EDA. b. Supplies 28 vdc to EDA.	STABILIZATION/CONTROL SYSTEM-AC2 (MDC-8)	AC bus 2	Provides power to electronics that drive indicators on FDAI No. 2. Supplies (through EDA) power to servometric potentiometers and motors (ball) on FDAI No. 2. Provides power to operate the redundant (pitch 2 and yaw 2) GPI meter movements.
				STABILIZATION/CONTROL SYSTEM-MNB (MDC-8)	DC main bus B	
		BOTH	Both functions for positions 1 and 2 are provided.			Both FDAIs are active. Total GPI displays active.
7	B	TVC SERVO POWER 1 switch	a. Supplies a-c phase A to both (pitch and yaw) primary servo channels in TVSA. b. Supplies 28-vdc power through TVSA to both (pitch and yaw) primary clutches (through normally closed relay contacts).	STABILIZATION/CONTROL SYSTEM-TVC-AC1 (MDC-8)	AC bus 1 \emptyset A	
				STABILIZATION/CONTROL SYSTEM-MNA (MDC-8)	DC main bus A	
		OFF	Not wired.			

MAIN DISPLAY CONSOLE—PANEL 7

SM2A-03-BLOCK II-(1)
APOLLO OPERATIONS HANDBOOK

CONTROLS AND DISPLAYS

Location		Name and Position	Function	Circuit Breaker	Power Source	Remarks
Panel	Area Grid					
7	B	AC2/MNB	a. Supplies a-c phase A to both (pitch and yaw) primary servo channels in TVSA.	STABILIZATION/CONTROL SYSTEM-AC2 (MDC-8)	AC bus 2 ØA	
			b. Supplies 28-vdc power through TVSA to both (pitch and yaw) primary clutches (through normally closed relay contacts).	STABILIZATION/CONTROL SYSTEM-MNB (MDC-8)	DC main bus B	
7	B	TVC SERVO POWER 2 switch AC1/MNA	a. Supplies a-c phase A to both (pitch and yaw) secondary servo channels in TVSA.	STABILIZATION/CONTROL SYSTEM-AC1 (MDC-8)	AC bus 1 ØA	
			b. Supplies 28-vdc power through TVSA (normally open relay contacts) for both secondary clutches.	STABILIZATION/CONTROL SYSTEM-MNA (MDC-8)	DC main bus A	
			Not wired.			
7	B	AC2/MNB	a. Supplies a-c phase A to both (pitch and yaw) secondary servo channels in TVSA.	STABILIZATION/CONTROL SYSTEM-ECA/TVC-AC2 (MDC-8)	AC bus 2 ØA	
			b. Supplies 28-vdc power through TVSA (normally open relay contacts) for both secondary clutches.	STABILIZATION/CONTROL SYSTEM-MNB (MDC-8)	DC main bus B	

MAIN DISPLAY CONSOLE—PANEL 7

SM2A-03-BLOCK II-(1)
APOLLO OPERATIONS HANDBOOK

CONTROLS AND DISPLAYS

Location		Name and Position	Function	Circuit Breaker	Power Source	Remarks
Panel	Area Grid					
<u>MDC-7 (Cont)</u>						
7	B	LOGIC POWER 2/3	Enables SCS logic buses 2 and 3 to MDC-1 switches.	SCS LOGIC BUS 3/4 MNA 1/2 MNA 2/3 MNA		Refer to logic bus circuit breakers for MDC-1 switches that are enabled from this switch.
		up				
		OFF	Removes power to MDC-1 switches.			
B	O-6	SIG CONDR/DRIVER BIAS PWR PWR SUP 1	Enables analog signal conditioning power supply in EDA and -4V No. 1 power supply in RJEC.	SCS AC1	AC bus 1	
		AC1	Removes power.			
		OFF	Same as AC1 position.	SCS AC2	AC bus 2	
		AC2				
B	O-6	SIG CONDR/DRIVER BIAS PWR PWR SUP 2	Enables -4V No. 2 power supply and analog signal conditioning power supply in the RJEC.	SCS AC1	AC bus 1	
		AC1	Removes power.			
		OFF	Same as AC1 position.	SCS AC2	AC bus 2	
		AC2				

MAIN DISPLAY CONSOLE — PANEL 7

SM2A-03-BLOCK II-(1)
 APOLLO OPERATIONS HANDBOOK

CONTROLS AND DISPLAYS

Location		Name and Position	Function	Circuit Breaker	Power Source	Remarks
Panel	Area Grid					
7	C	DIRECT O ₂ valve OPEN (ccw) Close (cw)	Permits controlled flow of oxygen directly into suit circuit. Shuts off flow of oxygen directly into suit circuit.			Valve has a shaft rotation of 1-3/4 turns from OPEN to close. Permanent knob installed to provide ready access. Valve is opened in event of contamination or inability of demand pressure regulator to maintain flow. It may also be opened for ventilation during descent, if necessary. In full open position flow rate is 0.66 pound/minute for approximately 8 minutes. Normal position of valve is closed.

MAIN DISPLAY CONSOLE—PANEL 7

SM2A-03-BLOCK II-(1)
APOLLO OPERATIONS HANDBOOK

CONTROLS AND DISPLAYS

Location		Name and Position	Function	Circuit Breaker	Power Source	Remarks
Panel	Area Grid					
MDC-8		STABILIZATION/CONTROL SYSTEM circuit breakers				
8	A H-2	AC 1 (2 amp - any phase)	Supplies: a. 3-phase power to: 1. BMAG POWER-1 switch (ON position) 2. FDAI/GPI POWER switch (1 and BOTH positions). b. Phase A power to: 1. TVC SERVO POWER-2 switch (AC1/MNA position). 2. SCS ELECTRONICS POWER switch (ECA and GDC/ECA positions). 3. SIG CONDR/DRIVER BIAS PWR - PWR SUP1.	N/A	AC bus 1 3Ø	
8	A H-3	AC 2 (2 amp - any phase)	Supplies: a. 3-phase power to: 1. BMAG POWER-2 switch (ON position). 2. FDAI/GPI POWER switch (2 and BOTH positions). b. Phase A power to: 1. SCS ELECTRONICS POWER switch (GDC/ECA position). 2. TVC SERVO POWER 1 (switch AC2/MNB position). 3. SIG CONDR/DRIVER BIAS PWR - PWR SUP2.		AC bus 2 3Ø	
8	A I-2	DIRECT ULL circuit breakers MNA & MNB CB (3 amp)	Applies 28 vdc, MNA and MNB, to direct ullage pushbutton on MDC-1.	Group 5 MNA & MNB (MDC-229)	DC main bus A & B	MNA to SM RCS engines B4 and D3 when DIRECT ULLAGE depressed. MNB to SM RCS engines A4 and C3 when DIRECT ULLAGE depressed.

MAIN DISPLAY CONSOLE—PANEL 8

SM2A-03-BLOCK II-(1)
APOLLO OPERATIONS HANDBOOK

CONTROLS AND DISPLAYS

Location		Name and Position	Function	Circuit Breaker	Power Source	Remarks
Panel Area	Grid					
MDC-8 (Cont)						
8	A	I-3 SCS CONTR/DIRECT-1 circuit breakers MNA (10 amp) MNB (5 amp)	Supplies 28 vdc power to ROT CONTR PWR-1 switch MNA/ MNB and MNA positions. Supplies 28 vdc power to ROT CONTR PWR-1 switch MNA/ MNB position.	Group 5 MNA (MDC-229) Group 5 MNB (MDC-229)	DC main bus A DC main bus B	
8	A	I-4 SCS CONTR/DIRECT-2 circuit breakers MNA (5 amp) MNB (10 amp)	Supplies 28 vdc power to ROT CONTR PWR-2 switch MNA/ MNB position. Supplies 28 vdc power to ROT CONTR PWR-2 switch MNA/ MNB and MNB positions.	Group 5 MNA (MDC-229) Group 5 MNB (MDC-229)	DC main bus A DC main bus B	
8	A	I-5 SCS A/C ROLL circuit breakers MNA (15 amp) MNB (15 amp)	Supplies 28 vdc power to AUTO RCS SELECT A/C ROLL switches, MNA positions. Same as above, except MNB positions supplied 28 vdc.	Group 4 MNA (MDC-229) Group 4 MNB (MDC-229)	DC main bus A DC main bus B	With switches in position A, circuit breaker supplies enabling voltage to auto coils on A-1, C-2, C-1 and A-2, and serves no function after CM-SM separation. With switches in position B, circuit breaker supplies enabling voltage to auto coils on A-1, C-2, C-1 and A-2, and serves no function after CM-SM separation.
8	A	I-6 SCS B/D ROLL circuit breakers MNA (15 amp)	Supplies 28 vdc power to AUTO RCS SELECT B/D ROLL switches, MNA positions.	Group 2 MNA (MDC-229)	DC main bus A	With switches in position A, circuit breaker supplies enabling voltage to auto coils on SM RCS B-1, D-2, D-1, and B-2, and when transferred to CM RCS, auto coils 11, 12, 21 and 22.

MAIN DISPLAY CONSOLE—PANEL 8

SM2A-03-BLOCK II-(1)
APOLLO OPERATIONS HANDBOOK

CONTROLS AND DISPLAYS

Location		Name and Position	Function	Circuit Breaker	Power Source	Remarks
Panel	Area Grid					
MDC-8 (Cont)						
8	A	MNB (15 amp)	Same as MNA, except MNB positions supplied 28 vdc.	Group 2 MNB (MDC-229)	DC main bus B	With switches in position B, circuit breaker supplies enabling voltage to auto coils on SM RCS B-1, D-2, D-1 and B-2, and when transferred to CM RCS, auto coils 11, 12, 21 and 22.
8	A	SCS PITCH circuit breakers MNA (15 amp)	Supplies 28 vdc power to AUTO RCS SELECT PITCH switches, MNA positions.	Group 1 MNA (MDC-229)	DC main bus A	With switches in position A, circuit breaker supplies enabling voltage to auto coils on C-3, A-4, A-3 and C-4, and when transferred to CM RCS, auto coils 13, 23, 14 and 24.
8	A	MNB (15 amp)	Same as above, except MNB positions supplied 28 vdc.	Group 1 MNB (MDC-229)	DC main bus B	With switches in position B, circuit breaker supplies enabling voltage to auto coils on C-3, A-4, A-3 and C-4, and when transferred to CM RCS, auto coils 13, 23, 14 and 24.
8	A	SCS YAW circuit breakers MNA (15 amp)	Supplies 28 vdc power to AUTO RCS SELECT YAW switches, MNA positions.	Group 3 MNA (MDC-229)	DC main bus A	With switches in position A, circuit breaker supplies enabling voltage to auto coils on D-3, B-4, B-3 and D-4, and when transferred to CM RCS, auto coils 15, 25, 16 and 26.
8	A	MNB (15 amp)	Same as above, except MNB positions supplied 28 vdc.	Group 3 MNB (MDC-229)	DC main bus B	With switches in position B, circuit breaker supplies enabling voltage to auto coils on D-3, B-4, B-3 and D-4, and when transferred to CM RCS, auto coils 15, 25, 16 and 26.

MAIN DISPLAY CONSOLE - PANEL 8

SM2A-03-BLOCK II-(1)
APOLLO OPERATIONS HANDBOOK

CONTROLS AND DISPLAYS

Location		Name and Position	Function	Circuit Breaker	Power Source	Remarks
Panel	Area Grid					
MDC-8 (Cont)						
8	A J-3	SCS CONTR/AUTO circuit breakers MNA (5 amp)	a. Supplies 28 vdc power to ROT CONTR PWR NORMAL -1 & 2 switches, AC/DC positions. b. Supplies 28 vdc power to TRANS CONTR PWR switch, ON position. c. Supplies 28 vdc power to SECS A for auto RCS driver enable power.	Group 1 MNA (MDC-229)	DC main bus A	
8	A I-2	MNB (5 amp) SCS-ECA/TVC-AC 2 circuit breaker (2 amp)	a. Same as above. b. Same as above. c. Same as above, except SECS B supplied 28 vdc. Supplies phase A to: a. SCS ELECTRONICS POWER switch (ECA and GDC/ECA positions). b. TVC SERVO POWER-2 switch (AC2/MNB position).	Group 1 MNB (MDC-229) N/A	DC main bus B AC bus 2 ØA	
8	A H-1	SCS-TVC circuit breaker AC 1 (2 amp)	Supplies a-c phase A power to TVC SERVO POWER-1 switch (AC1/MNA position).	N/A	AC bus 1 ØA	
8	A J-2	ORDEAL circuit breakers AC2 (2 amp) MNB (5 amp)	Enabling voltages for ORDEAL operation.		DC main bus B AC bus 2	

MAIN DISPLAY CONSOLE—PANEL 8

SM2A-03-BLOCK II-(1)
APOLLO OPERATIONS HANDBOOK

CONTROLS AND DISPLAYS

Location		Name and Position	Function	Circuit Breaker	Power Source	Remarks
Panel	Area Grid					
8	A	SCS LOGIC BUS circuit breakers	MNA 1/2 CB (3 amp)		DC main bus A	The respective logic buses supply the following switches: SCS LOGIC BUS NO. 1 SW NAME CMC ATT (IMU) MANUAL ATT-ROLL (MIN IMP & ACCEL CMD) MANUAL ATT-PITCH MANUAL ATT-YAW LIMIT CYCLE (OFF) ATT DEADBAND (MIN) RATE (HIGH) BMAG MODE - ROLL (RATE 1) BMAG MODE - PITCH (RATE 1) BMAG MODE - YAW (RATE 1) DIRECT ULLAGE (LOGIC FUNCTION) THRUST ON TVC GMBL DRIVE - PITCH (AUTO) TVC GMBL DRIVE - YAW (AUTO)
			MNA 3/4 CB (3 amp)			
			MNB 1/4 CB (3 amp)			
			MNB 2/3 CB (3 amp)			
8	A				DC main bus B	

MAIN DISPLAY CONSOLE—PANEL 8

SM2A-03-BLOCK II-(1)
 APOLLO OPERATIONS HANDBOOK

CONTROLS AND DISPLAYS

Location		Name and Position	Function	Circuit Breaker	Power Source	Remarks
Panel	Area Grid					
8	A	J-5	MDC-8 (Cont)			SCS LOGIC BUS NO. 2 SW NAME FDAI SCALE (5-5) FDAI SOURCE (CMC) ATT SET (IMU) SC CONTROL (CMC) BMAG MODE - ROLL (ATT 1/RATE 2 & RATE 2) ENTRY .05g (OFF) CLOCKWISE SWITCH SCS LOGIC BUS NO. 3 SW NAME FDAI SELECT (1 & 2) FDAI SOURCE (ATT SET & GDC) SC CONTROL (SCS) BMAG MODE - PITCH (ATT 1/ RATE 2 & RATE 2) BMAG MODE - YAW (ATT 1/ RATE 2 & RATE 2) TVC GMBL DRIVE - PITCH (2) TVC GMBL DRIVE - YAW (2) (AUTO, RATE CMD & ACCEL CMD) ΔV CG-(CSM & LM) SCS LOGIC BUS NO. 4 SW NAME CMC ATT (IMU) FDAI SCALE (50/15 - 50/10) FDAI SELECT (BOTH) ATT SET (GDC) GDC ALIGN ENTRY EMS ROLL (ON) ENTRY .05g (ON)

MAIN DISPLAY CONSOLE—PANEL 8

SM2A-03-BLOCK II-(1)
APOLLO OPERATIONS HANDBOOK

CONTROLS AND DISPLAYS

Location		Name and Position	Function	Circuit Breaker	Power Source	Remarks
Panel	Area Grid					
MDC-8 (Cont)		SCS SYSTEM circuit breaker				
8	A J-5	MNA (15 amp)	Supplies 28 vdc to: a. BMAG POWER -1 switch (WARMUP and ON positions). b. SCS ELECTRONICS POWER switch (ECA and GDC/ECA positions). c. FDAI/GPI POWER switch (1 and BOTH positions). d. TVC SERVO POWER -1 and -2 switches (AC1/MNA position).		DC main bus A	
8	A J-6	MNB (15 amp)	a. BMAG POWER -2 switch (WARMUP and ON positions). b. SCS ELECTRONICS POWER switch (ECA and GDC positions). c. FDAI/GPI power switch (2 and BOTH positions). d. TVC SERVO POWER -1 and -2 switches (AC2/MNB positions).		DC main bus B	
8	B L-3	EDS-1, 2, 3 circuit breakers BAT A (5 amp)	Applies d-c power from battery bus A to EDS POWER switch (MDC-7).	EPS BAT BUS A (RHEB-229)	Battery bus A	
8	B L-3	BAT C (5 amp)	Applies d-c power from entry battery C to EDS POWER switch (MDC-7).	BAT C BAT CHGR/EDS 2 (RHEB-250)	Battery bus C	
8	B L-4	BAT B (5 amp)	Applies d-c power from battery bus B to EDS POWER switch (MDC-7).	EPS BAT BUS B (RHEB-229)	Battery bus B	

MAIN DISPLAY CONSOLE - PANEL 8

SM2A-03-BLOCK II-(1)
APOLLO OPERATIONS HANDBOOK

CONTROLS AND DISPLAYS

Location		Name and Position	Function	Circuit Breaker	Power Source	Remarks
Panel Area	Grid					
MDC-8 (Cont)		ELS-A, B circuit breakers BAT A (10 amp)	Applies d-c power from battery bus A to the following: a. APEX COVER JETT switch (MDC-1). b. DROGUE DEPLOY switch (MDC-1). c. MAIN DEPLOY switch (MDC-1).	EPS BAT BUS A (RHEB-229)	Battery bus A	
8	B					
		BAT B (10 amp)	Applies d-c power from battery bus B to the following: a. APEX COVER JETT switch (MDC-1). b. DROGUE DEPLOY switch (MDC-1). c. MAIN DEPLOY switch (MDC-1).	EPS BAT BUS B (RHEB-229)	Battery bus B	
		REACTION CONTROL SYSTEM circuit breakers				
		RCS LOGIC				
8	C	MNA (15 amp)	Applies power from d-c main bus A to the following: a. RCS TRNFR switch (MDC-2). b. CM RCS LOGIC switch (MDC-1). c. CM RCS HTRS switch (RHFEB). d. CM RCS He DUMP pushbutton on MDC-1.	Group 5 MNA (MDC-229)	DC main bus A	Thermal, push-pull manual reset-type circuit breakers with the amperage rating of each denoted by a white placard.
		MNB (15 amp)	Applies power from d-c main bus B to the following: a. RCS TRNFR switch (MDC-2). b. CM RCS LOGIC switch (MDC-1). c. CM RCS HTRS switch (RHFEB). d. CM RCS He DUMP pushbutton on MDC-1.	Group 5 MNB (MDC-229)	+28 vdc DC main bus B	

MAIN DISPLAY CONSOLE—PANEL 8

SM2A-03-BLOCK II-(1)
APOLLO OPERATIONS HANDBOOK

CONTROLS AND DISPLAYS

Location		Name and Position	Function	Circuit Breaker	Power Source	Remarks
Panel	Area Grid					
MDC-8 (Cont)						
8	C	SM HEATERS circuit breakers A MNB (7.5 amp)	Applies power from d-c main bus B to the following: a. SM RCS HEATERS switch, quad A. b. SM RCS QUAD A & C helium and propellant isolation valve indicators and CM RCS system 2 propellant position indicator and CM RCS SYS 2 propellant isolation valves on a 0 to T + 42 second abort.	Group 3 MNB (MDC-229)	+28 vdc DC main bus B	Thermal push-pull manual reset-type circuit breakers with the amperage rating of each denoted by a white placard.
8	C	B MNA (7.5 amp)	Applies power from d-c main bus A to the following: a. SM RCS HEATERS switch, quad B. b. SM RCS QUAD A & C helium and propellant isolation valve indicators and CM RCS system 1 propellant position indicator and CM RCS SYS 1 propellant isolation valves on a 0 to T + 42 second abort.	Group 3 MNA (MDC-229)	DC main bus A	
8	C	C MNB (7.5 amp)	Applies power from d-c main bus B to quad C HEATER switch.	Group 1 MNB (MDC-229)	DC main bus B	
8	C	D MNA (7.5 amp)	Applies power from d-c main bus A to quad D HEATER switch.	Group 1 MNA (MDC-229)	DC main bus A	
8	C	CM HEATERS circuit breakers 1-MNA (20 amp)	Supplies 28 vdc to 12 CM RCS engine direct coils for CM RCS heating.	Group 5 MNA (MDC-229)	DC main bus A	Provides power to 12 CM RCS engines system A providing CM RCS HTRS switch placed to ON, on MDC-101, CM RCS LOGIC switch placed to LOGIC on MDC-1 and RCS LOGIC breaker A on MDC-8 is in.

MAIN DISPLAY CONSOLE—PANEL 8

SM2A-03-BLOCK II-(1)
APOLLO OPERATIONS HANDBOOK

CONTROLS AND DISPLAYS

Location		Name and Position	Function	Circuit Breaker	Power Source	Remarks
Panel Area	Grid					
MDC-8 (Cont)						
8	C	2-MNB (20 amp)	Supplies 28 vdc to 12 CM RCS 2 engine direct coils for CM RCS heating.	Group 5 MNB (MDC-229)	DC main bus B	Provides power to 12 CM RCS engines system 2 providing CM RCS HTRS switch placed to ON, on MDC-101, CM RCS LOGIC switch placed to CM RCS LOGIC on MDC-1 and RCS LOGIC breaker B on MDC-8 is in.
8	C	PRPLNT ISOL group circuit breakers MNA (10 amp)	Applies power from d-c main bus A to the following: a. SM RCS quads B and D HELIUM 1, HELIUM 2. SEC PRPLNT FUEL PRESS switches quads B and D. b. CM RCS-1 PROPELLANT switch.	Group 1 MNA (MDC-229)	DC main bus A	
8	C	MNB (10 amp)	Applies power from d-c main bus B to the following: a. SM RCS quads A and C HELIUM 1, HELIUM 2. SEC PRPLNT FUEL PRESS switches quads B and D. b. CM RCS-2 PROPELLANT switch.	Group 1 MNB (MDC-229)	DC main bus B	Thermal, pushpull manual reset-type circuit breakers with the amperage rating of each denoted by a white placard.
8	D	SPS circuit breakers GAUGING				
8	D	AC1 (2 amp)	Applies power from a-c bus No. 1 to AC1 of SPS GAUGING switch (MDC-4).		AC bus 1 ØC	
8	D	AC2 (2 amp)	Applies power from a-c bus No. 2 to AC2 of SPS GAUGING switch (MDC-4).		AC bus 2 ØC	

MAIN DISPLAY CONSOLE—PANEL 8

SM2A-03-BLOCK II-(1)
APOLLO OPERATIONS HANDBOOK

CONTROLS AND DISPLAYS

Location		Name and Position	Function	Circuit Breaker	Power Source	Remarks
Panel	Area Grid					
MDC-8 (Cont)						
8	D L-2	MNA (3 amp)	Applies d-c power to the following propellant utilization and gauging subsystem control unit circuits: a. Self-test. b. Primary power supply only when SPS engine ignition driver relay is energized.	Group 4 MNA (MDC-229)	DC main bus A	
8	D L-3	MNB (3 amp)	Applies d-c power to propellant utilization and gauging subsystem control unit when SPS engine ignition driver relay is energized.	Group 4 MNB (MDC-229)	DC main bus B	
		PITCH				
8	D L-5	1 - BAT A (15 amp)	Applies power from battery bus A to SPS GIMBAL MOTORS-PITCH 1 switch (MDC-1).	EPS BAT BUS A (MDC-229)	Battery bus A	
8	D L-5	2 - BAT B (15 amp)	Applies power from battery bus B to SPS GIMBAL MOTORS-PITCH 2 switch (MDC-1).	EPS BAT BUS B (MDC-229)	Battery bus B	
		YAW				
8	D L-6	1 - BAT A (15 amp)	Applies power from battery bus A to SPS GIMBAL MOTORS-YAW 1 switch (MDC-1).	EPS BAT BUS A (MDC-229)	Battery bus A	
8	D L-6	2 - BAT B (15 amp)	Applies power from battery bus B to SPS GIMBAL MOTORS-YAW 2 switch (MDC-1).	EPS BAT BUS B (MDC-229)	Battery bus B	
8	D L-4	He VALVE MNA (7.5 amp)	Applies d-c power to the following: a. 1 SPS HELIUM switch (MDC-3). b. ΔV THRUST-NORMAL-A switch for injector pre-valve A. c. 1 SPS HELIUM talkback indicator.	Group 4 MNA	DC main bus A	

MAIN DISPLAY CONSOLE—PANEL 8

SM2A-03-BLOCK II-(1)
APOLLO OPERATIONS HANDBOOK

CONTROLS AND DISPLAYS

Location		Name and Position	Function	Circuit Breaker	Power Source	Remarks
Panel Area	Grid					
MDC-8 (Cont)						
8	D	MNB (7.5 amp)	Applies d-c power to the following: a. 2 SPS HELIUM switch (MDC-3). b. ΔV THRUST-NORMAL-B switch for injector pre-valve B. c. 2 SPS HELIUM talkback indicator.	Group 4 MNB	DC main bus B	
8	D	PILOT VLVS A-MNA (10 amp)	Supplies 28 vdc to ΔV THRUST NORMAL switch A. Supplies 28 vdc to FCMS SPS A switch which is positioned and locked to RESET/OVERRIDE position.	Group 5 MNA (MDC-229)	DC main bus A	ΔV THRUST NORMAL switch placed to A, power provided to SPS A bank thrust on-off logic, SPS relays, and solenoid control valves.
8	D	B-MNB (10 amp)	Supplies 28 vdc to ΔV THRUST NORMAL switch B. Supplies 28 vdc to FCMS SPS B switch which is positioned and locked to RESET/OVERRIDE position.	Group 5 MNB (MDC-229)	DC main bus B	ΔV THRUST NORMAL switch placed to B, power provided to SPS B bank thrust on-off logic, SPS relays, and solenoid control valves.
8	F	PL VENT circuit breaker FLT/PL (5 amp)	Protects circuit wiring to post-landing vent valves No. 1 and 2, and PLV BLOWER.	N/A	Flight & postlanding bus	
		FLOAT BAG circuit breakers				
8	H	1-BAT A (5 amp)	Applies d-c power from bat bus A to float bag control valve No. 1.	EPS BAT BUS-A (Panel 229)	Battery bus A	
8	H	2-BAT B (5 amp)	Applies d-c power from bat bus B to float bag control valve No. 2.	EPS BAT BUS-B (Panel 229)	Battery bus B	
8	H	3-FLT/PL (5 amp)	Applies d-c power from flight and postlanding bus to float bag control valve No. 3.		Flight & postlanding bus	

MAIN DISPLAY CONSOLE—PANEL 8

SM2A-03-BLOCK II-(1)
 APOLLO OPERATIONS HANDBOOK

CONTROLS AND DISPLAYS

Location		Name and Position	Function	Circuit Breaker	Power Source	Remarks
Panel	Area Grid					
MDC-8 (Cont)		FLOAT BAG switches				
8	H K-8	1L FILL OFF VENT	Starts two compressors which inflate bag No. 1. Neutral (off) position. Disconnects 28 vdc from the two compressors and opens vent line to flotation bag No. 1.	POST-LANDING FLOAT BAG 1 BAT A (MDC-8)	Battery bus A	Lever lock-type switch. Flotation bag No. 1 is located on -Y axis in forward compartment of CM. Solenoid valve in "seal" mode. Switch must remain in VENT position during launch and throughout flight.
8	H K-9	2R FILL OFF VENT	Starts two compressors which inflate flotation bag No. 2. Neutral (off) position. Disconnects 28 vdc from the two compressors and opens vent line to flotation bag No. 2.	POST-LANDING FLOAT BAG 2 BAT B (MDC-8)	Battery bus B	Lever lock-type switch. Flotation bag No. 2 is located on the +Y axis in the forward compartment of the CM. Solenoid valve in "seal" mode. Switch must remain in VENT position during launch and throughout flight.
8	H K-9	3 CTR FILL OFF VENT	Starts two compressors which inflate flotation bag No. 3. Neutral (off) position. Disconnects 28 vdc from the two compressors and opens vent line to flotation bag No. 3.	POST-LANDING FLOAT BAG 3 FLT/PL (MDC-8)	Flight & postlanding bus	Lever lock-type switch. Flotation bag No. 3 is located on +Z axis in forward compartment of CM. Solenoid valve in "seal" mode. Switch must remain in VENT position during launch and throughout flight.
8	H J-7	FLOOD lights switches DIM DIM 1	Applies rheostat control to primary floodlights and on-off control to secondary floodlights.	LIGHTING FLOOD MNA MNB (RHEB-226)	DC main buses A & B	Provides crew capability of shifting primary or secondary lamps to variable FLOOD light switch.

MAIN DISPLAY CONSOLE - PANEL 8

SM2A-03-BLOCK II-(1)
APOLLO OPERATIONS HANDBOOK

CONTROLS AND DISPLAYS

Location		Name and Position	Function	Circuit Breaker	Power Source	Remarks
Panel Area	Grid					
MDC-8 (Cont)						
8	H	DIM 2	Applies rheostat control to secondary floodlights and on-off control to primary floodlights.	LIGHTING FLOOD MNA MNB (RHEB-226)	DC main buses A & B	
8	H	FIXED FIXED OFF POST LDG	Turns on lamps not controlled by rheostat. Removes power. Connects postlanding bus to commander's lights.	FLOOD MNB FLT/PL (RHEB-226)	DC main bus B & Flight & postlanding bus	On-off control of floodlights not on rheostat control. Secondary when DIM switch is on 1; primary when DIM switch is on 2. Illuminates lamps located on LH couch arm and LH inner mold line.
8	H	INTERIOR LIGHTS switches INTEGRAL rheostat OFF BRT	Removes power from commander's MDC-1, 7, 8, 9, and left part of panel 2. Integral rheostat SC 103 & subs. Removes power from commander's MDC-1, 7, 8, 9, 15, and left part of panel 2 (SC 103 & subs). Bright indicates maximum brightness has been reached.	LIGHTING NUMERICS/INTEGRAL L MDC-AC-1 (RHEB-226)	AC bus 1 ØA	Integral lighting system controls EL lamps behind nomenclature of applicable panels. Mechanical stop prevents positioning switch to OFF. Control exercised by use of circuit breakers.

MAIN DISPLAY CONSOLE—PANEL 8

SM2A-03-BLOCK II-(1)
APOLLO OPERATIONS HANDBOOK

CONTROLS AND DISPLAYS

Location		Name and Position	Function	Circuit Breaker	Power Source	Remarks
Panel Area	Grid					
MDC-8 (Cont)						
8	H	I-10 FLOOD rheostat OFF BRT	Removes power from commander's rheostat controlled floodlights. Indicates maximum floodlight brightness has been reached.	LIGHTING FLOOD MNA (RHEB-226)	DC main bus A	Primary when DIM switch is on 1; secondary when DIM switch is on 2.
8	H	I-8 NUMERICS rheostat OFF BRT	Removes power from numerals in MDC-DSKY; EMS range and delta V, and MDC mission timer. Indicates maximum brightness has been reached.	LIGHTING NUMERICS/INTEGRAL L MDC-AC-1 (RHEB-226)	AC bus 1	Numerics lighting system controls numerics or flashing numbers on DSKYS, EMS, and timers. Mechanical stop prevents positioning switch to OFF. Control exercised by use of circuit breakers.
8	I	K-10 SEQ EVENTS CONTROL SYSTEM LOGIC switches Switches 1 and 2 LOGIC OFF	Either switch energizes relays in both MESC which perform the following: a. Connects battery bus A to the MESC A logic bus A. b. Connects battery bus B to the MESC B logic bus B. Removes battery voltage from MESC logic buses A and B.	SEQ EVENTS CONT SYS A ARM B BAT A and BAT B (MDC-8)	Battery buses A & B	Lever lock-type switches.

MAIN DISPLAY CONSOLE—PANEL 8

SM2A-03-BLOCK II-(1)
APOLLO OPERATIONS HANDBOOK

CONTROLS AND DISPLAYS

Location		Name and Position	Function	Circuit Breaker	Power Source	Remarks
Panel	Area Grid					
MDC-8 (Cont)						
8	I K-11	PYRO ARM switches Switch A PYRO ARM	<p>Energizes motor switches in the LDEC which perform the following:</p> <ul style="list-style-type: none"> a. Connects pyro battery A to the MESC pyro bus A. b. Connects pyro battery A to the RCSC pyro bus A. c. Connects pyro battery A to the ELSC pyro bus A. d. Connects pyro battery A to the LDEC pyro bus A. e. Connects pyro battery A to S-IVB/LM SEP PYRO A circuit breaker on RHEB panel 278. f. Connects pyro battery A to MAIN RELEASE PYRO A circuit breaker. (RHEB-229) <p>Removes pyro battery power from system A pyro buses.</p>	SEQ EVENTS CONT SYS A ARM B BAT A & B (MDC-8)	Battery buses A & B	<p>Lever lock-type switches.</p> <p>Lock and guard assembly is placed over switches in SAFE position prior to pyrotechnic device hookup to prevent inadvertent arming of pyro buses.</p> <p>Lock and guard assembly must be unlocked with key prior to hatch closeout and removed from CM during launch countdown.</p>
8	I K-11	SAFE Switch B PYRO ARM	<ul style="list-style-type: none"> a. Connects pyro battery B to the MESC pyro bus B. b. Connects pyro battery B to the RCSC pyro bus B. c. Connects pyro battery B to the ELSC pyro bus B. d. Connects pyro battery B to the LDEC pyro bus B. e. Connects pyro battery B to S-IVB/LM SEP PYRO B circuit breaker on RHEB panel 278. f. Connects pyro battery B to MAIN RELEASE PYRO B circuit breaker. (RHEB-229) <p>Removes pyro battery power from system B pyro buses.</p>			

MAIN DISPLAY CONSOLE—PANEL 8

SM2A-03-BLOCK II-(1)
APOLLO OPERATIONS HANDBOOK

CONTROLS AND DISPLAYS

Location		Name and Position	Function	Circuit Breaker	Power Source	Remarks
Panel	Area Grid					
MDC-8 (Cont)		SEQ EVENTS CONT SYS circuit breakers ARM-A, B BAT A (5 amp)	Applies d-c power from battery bus A to the following switches: a. SEQ EVENTS CONT SYS-LOGIC switches 1 and 2 (MDC-8) b. SEQ EVENTS CONT SYS-PYRO ARM switches A and B (MDC-8) c. LES MOTOR FIRE switch (MDC-1) d. CANARD DEPLOY switch (MDC-1) e. CSM/LV SEP switch (MDC-1) f. CM RCS PRESS switch (MDC-2) g. RCS-CMD/ON/OFF switch (MDC-2) h. CM-SM SEP switches 1 and 2 (MDC-9) i. CSM/LM FINAL SEP switches 1 and 2 (MDC-2) j. SIVB/LM SEP switch (MDC-2)	EPS BAT BUS A RHEB-229	Battery bus A	
8	I L-11					
		BAT B (5 amp)	Applies d-c power from battery bus B to the following switches: a. SEQ EVENTS CONTROL SYSTEM-LOGIC switches 1 and 2 (MDC-8) b. SEQ EVENTS CONT SYS-PYRO ARM switches A and B (MDC-8)	EPS BAT BUS B RHEB-229	Battery bus B	

MAIN DISPLAY CONSOLE—PANEL 8

SM2A-03-BLOCK II-(1)
APOLLO OPERATIONS HANDBOOK

CONTROLS AND DISPLAYS

Location		Name and Position	Function	Circuit Breaker	Power Source	Remarks
Panel	Area Grid					
MDC-8 (Cont)						
8	I L-11		<p>c. LES MOTOR FIRE switch (MDC-1).</p> <p>d. CANARD DEPLOY switch (MDC-1).</p> <p>e. CSM/LV SEP switch (MDC-1).</p> <p>f. CM RCS PRESS switch (MDC-2).</p> <p>g. RCS-CMD/ON/OFF switch (MDC-2).</p> <p>h. CM/SM SEP switches 1 and 2 (MDC-9).</p> <p>i. CSM/LM FINAL SEP switches 1 and 2 (MDC-2).</p> <p>j. SIVB/LM SEP switch (MDC-2).</p>	EPS BAT BUS B RHEB-229	Battery bus A	
8	I L-10	LOGIC-A, B BAT A (15 amp)	<p>a. Applies d-c power from battery bus A to the logic A bus in the master event sequence controller when the SEQ EVENTS CONTROL SYSTEM switches 1 or 2 (MDC-8) are in the LOGIC position. The logic bus in turn provides power to the ABORT SYSTEM—TWR JETT switches 1 and 2 and, during LES aborts, to the ABORT SYSTEM—PRPLNT DUMP switch.</p> <p>b. Arms the abort switch in commander's translation hand control.</p> <p>c. Provides most of the power to the LES and SPS abort circuitry.</p>	EPS BAT BUS A (RHEB-229)	Battery bus A	

MAIN DISPLAY CONSOLE—PANEL 8

SM2A-03-BLOCK II-(1)
APOLLO OPERATIONS HANDBOOK

CONTROLS AND DISPLAYS

Location		Name and Position	Function	Circuit Breaker	Power Source	Remarks
Panel	Area Grid					
MDC-8 (Cont)						
8	J	B/D ROLL B1, D1, B2, D2	Same as preceding except B/D ROLL circuit breakers are utilized.	SCS B/D ROLL MNA & MNB (MDC-8)	DC main buses A & B	
8	J	PITCH A3, C3, A4, C4	Same as preceding except PITCH circuit breakers are utilized.	SCS PITCH MNA & MNB (MDC-8)		
8	J	YAW B3, D3, B4, D4	Same as preceding except YAW circuit breakers are utilized.	SCS YAW MNA & MNB (MDC-8)		
8	K	EMS circuit breakers MNA (5 amp)	Provides d-c power to EMS from MNA and circuit protection for EMS.	Group 3 MNA (Panel 229)	DC main bus A	Also supplies power to SPS THRUST ON light on EMS MDC-1.
8	K	MNB (5 amp)	Provides d-c power to EMS from MNB and circuit protection for EMS.	Group 3 MNB (Panel 229)	DC main bus B	
8	L	DOCK PROBE circuit breakers MNA (10 amp) MNB (10 amp)	Power to operate systems A & B capture latch motors, TBI and temp TLM.		DC main buses A & B	

MAIN DISPLAY CONSOLE—PANEL 8

SM2A-03-BLOCK II-(1)
APOLLO OPERATIONS HANDBOOK

CONTROLS AND DISPLAYS

Location		Name and Position	Function	Circuit Breaker	Power Source	Remarks
Panel	Area Grid					
9	A	B-13	INTERCOM switch T/R OFF RCV VOLUME thumbwheel		Audio center equipment	
		B-11	PAD COMM switch T/R OFF RCV VOLUME thumbwheel	RHEB-225		
		A-13	MASTER VOLUME thumbwheel			

MAIN DISPLAY CONSOLE—PANEL 9

SM2A-03-BLOCK II-(1)
 APOLLO OPERATIONS HANDBOOK

CONTROLS AND DISPLAYS

Location		Name and Position	Function	Circuit Breaker	Power Source	Remarks
Panel	Area Grid					
MDC-9 (Cont)						
9	A A-12	MODE switch INTERCOM/PTT	Applies power to audio center module, and provides hot mike operation and VOX operation for intercom and PTT operation for RF transmission.	CREW STATION AUDIO-R (MDC-225)	Flight and postlanding bus	
		PTT	Applies power to audio center module and enables PTT operation for intercom and RF transmission.			
		VOX	Applies power to audio center module, and provides VOX operation for both intercom and RF transmission.			
		VOX SENS thumbwheel	Thumbwheel-type control, which operates a 25-k potentiometer, is provided to adjust sensitivity of voice-operated relay in audio center module.			
9	A C-11	S BAND switch T/R OFF RVC VOLUME thumbwheel	Enables, by circuit closure, headset to receive and transmit over S-band equipment operating in VOICE mode. Selects no mode. Enables, by circuit closure, the headset to receive (only) output of S-band equipment operating in VOICE mode. Thumbwheel-type control, which operates a 500-k potentiometer, is provided to adjust S-band receiver audio level to earphone amplifier.		Audio center equipment	VOICE mode includes not only VOICE or RELAY mode positions, but also VOICE BU positions of S BAND AUX and UP TLM sections, all with their attendant limitations.

MAIN DISPLAY CONSOLE—PANEL 9

SM2A-03-BLOCK II-(1)
 APOLLO OPERATIONS HANDBOOK

CONTROLS AND DISPLAYS

Location		Name and Position	Function	Circuit Breaker	Power Source	Remarks
Panel	Area Grid					
MDC-9 (Cont)						
9	A	VHF AM switch	<p>Enables, by circuit closures, headset to receive and transmit over VHF-AM equipment.</p> <p>Selects no modes.</p> <p>Enables, by circuit closure, headset to receive (only) output of VHF-AM receiver.</p> <p>Thumbwheel-type control, which operates a 500-k potentiometer, is provided to adjust audio level from VHF-AM receiver to ear-phone amplifier.</p>		Audio center equipment	
		T/R				
		OFF				
		RCV				
		VOLUME thumbwheel				
9	A	POWER switch	<p>Provides primary power to audio center module and enables audible crew alarm signal to be heard at this astronaut station.</p> <p>Removes all power to audio center module and disables audible crew alarm for this astronaut station.</p> <p>Provides primary power to audio center module but leaves audible crew alarm circuit disabled at this station.</p>	CREW STATION AUDIO-R (MDC-225)	Flight and postlanding bus	
		AUDIO/TONE				
		OFF				
		AUDIO				

MAIN DISPLAY CONSOLE—PANEL 9

SM2A-03-BLOCK II-(1)
APOLLO OPERATIONS HANDBOOK

CONTROLS AND DISPLAYS

Location		Name and Position	Function	Circuit Breaker	Power Source	Remarks
Panel	Area Grid					
<u>MDC-9 (Cont)</u>						
9	A	SUIT switch POWER OFF	Applies power to the left and right microphone preamplifier in headset and biomed pre-amplifier in suit associated with audio control panel No. 9. Removes power from left and right microphone preamplifiers in headset and biomed pre-amplifier in suit associated with audio control panel No. 9.	CREW STATION AUDIO-R (MDC-225)	Flight & postlanding bus	
9	A	AUDIO CONTROL switch NORM BACKUP	Routes CMDR's audio signals through audio control panel No. 9 and associated audio module. Routes CMDR's audio signals through control panel No. 6 and associated audio module.			Allows CMDR and LM pilot to share same audio module and control panel in case of malfunction.
9	A	VHF RNG (ranging) switch RESET NORM	Initiates an automatic tracking phase. Initiates an automatic tracking phase.			Resets digital ranging generator. Allows digital ranging generator to develop ranging.

MAIN DISPLAY CONSOLE—PANEL 9

SM2A-03-BLOCK II-(1)
 APOLLO OPERATIONS HANDBOOK

CONTROLS AND DISPLAYS

Location		Name and Position	Function	Circuit Breaker	Power Source	Remarks	
Panel	Area Grid						
10	A	INTERCOM switch	Enables, by circuit closure, headset to receive and transmit over intercom system. Selects no modes.		Audio center equipment		
		T/R					
		OFF RCV	Enables, by circuit closure, headset to receive (only) output of intercom system.				
10	A	VOLUME thumbwheel	Thumbwheel-type control, which operates a 500-k potentiometer, is provided to adjust audio level from intercom bus to earphone amplifier.				
10	A	PAD COMM switch	Enables, by circuit closure, headset to receive and transmit over headline intercomm to launch operations. Selects no modes.	RHEB-225			
		T/R					
		OFF RCV	Enables, by circuit closure, headset to receive (only) output of headline intercomm from launch operations.				
10	A	VOLUME thumbwheel	Thumbwheel-type control, which operates a 500-k potentiometer, is provided to adjust audio level from headline intercomm to earphone amplifier.				

MAIN DISPLAY CONSOLE—PANEL 10

SM2A-03-BLOCK II-(1)
APOLLO OPERATIONS HANDBOOK

CONTROLS AND DISPLAYS

Location		Name and Position	Function	Circuit Breaker	Power Source	Remarks
Panel	Area Grid					
MDC-10 (Cont)						
10	A N-35	MASTER VOLUME thumbwheel	Thumbwheel-type control, which operates 2.5-k potentiometer, is provided to adjust audio level from earphone amplifier to earphone.		Audio center equipment	
10	A N-31	MODE switch INTERCOM/PTT PTT VOX	Applies power to audio center module, and provides hot mike operation and VOX operation for intercom and PTT operation for RF transmission. Applies power to audio center module and enables PTT operation for intercom and RF transmission. Applies power to audio center module and provides VOX operation for both intercom and RF transmission. Thumbwheel-type control, which operates 25-k potentiometer, is provided to adjust sensitivity of voice-operated relay in audio center module.	CREW STATION AUDIO-CTR (MDC-225)	Flight and postlanding bus	
10	A N-32	VOX SENS thumbwheel				
10	A Q-31	S BAND switch T/R OFF RCV	Enables, by circuit closure, headset to receive and transmit over S-band equipment operating in VOICE mode. Selects no modes. Enables, by circuit closure, headset to receive (only) output of S-band equipment operating in VOICE mode.		Audio center equipment	VOICE mode includes not only VOICE or RELAY mode positions, but also VOICE BU positions of S BAND AUX and UP TLM sections, all with their attendant limitations.

MAIN DISPLAY CONSOLE—PANEL 10

SM2A-03-BLOCK II-(1)
APOLLO OPERATIONS HANDBOOK

CONTROLS AND DISPLAYS

Location		Name and Position	Function	Circuit Breaker	Power Source	Remarks
Panel	Area Grid					
MDC-10 (Cont)						
10	A	Q-32 VOLUME thumbwheel	Thumbwheel-type control, which operates 500-k potentiometer, is provided to adjust S-band receiver audio level to earphone amplifier.		Audio center equipment	
10	A	N-35 POWER switch AUDIO/TONE OFF AUDIO	Provides primary power to audio center module and enables audible crew alarm signal to be heard at this astronaut station. Removes all power to audio center module and disables audible crew alarm for this astronaut station. Provides primary power to audio center module but leaves audible crew alarm circuit disabled at this station.	CREW STATION AUDIO-CTR bus (MDC-225)	Flight and postlanding bus	
10	A	Q-35 VHF AM switch T/R OFF RCV	Enables, by circuit closures, headset to receive and transmit over VHF-AM equipment. Selects no modes. Enables, by circuit closure, headset to receive (only) output of VHF-AM receiver.		Audio center equipment	
10	A	Q-34 VOLUME thumbwheel	Thumbwheel-type control, which operates a 500-k potentiometer, is provided to adjust audio level from VHF-AM receiver to earphone amplifier.			

MAIN DISPLAY CONSOLE—PANEL 10

SM2A-03-BLOCK II-(1)
APOLLO OPERATIONS HANDBOOK

CONTROLS AND DISPLAYS

Location		Name and Position	Function	Circuit Breaker	Power Source	Remarks
Panel	Area Grid					
MDC-10 (Cont)						
10	A P-33	SUIT switch POWER OFF	Applies power to left- and right-hand microphone preamplifiers and the suit biomed preamplifiers associated with audio control panel No. 10. Removes power from left- and right-hand microphone preamplifiers and the suit biomed preamplifiers associated with audio control panel No. 10.	CREW STATION AUDIO-CTR & L (MDC-225)	Flight and postlanding bus	
10	A Q-33	AUDIO CONTROL switch NORM BACKUP	Routes CSM pilot's audio signals through audio control panel No. 10 and associated audio module. Routes CSM pilot's audio signals through control panel No. 9 and associated audio center module.			Allows CSM pilot and CMDR to share same audio module and control panel in case of malfunction.

MAIN DISPLAY CONSOLE—PANEL 10

SM2A-03-BLOCK II-(1)
APOLLO OPERATIONS HANDBOOK

CONTROLS AND DISPLAYS

Location		Name and Position	Function	Circuit Breaker	Power Source	Remarks
Panel	Area Grid					
MDC-12						
12	A O-29	LM TUNNEL VENT valve OFF	All ports closed.	N/A	N/A	Manually controlled valve.
		LM PRESS	Connects CM cabin to LM tunnel.			Backup for pressurizing LM. Approx 10.5 hr to pressurize LM from 0 to 5 psia.
		LM/CM ΔP	Connects LM tunnel to ΔP gauge.			Used to determine difference in pressure between CM cabin and LM tunnel.
		LM TUNNEL VENT	Connects LM tunnel to ambient.			Used for depressurizing LM tunnel to check quality of CM forward hatch pressure seal.
12	A P-29	LM/CM PRESSURE DIFFERENTIAL gauge	Indicates pressure differential between LM tunnel and CM cabin.			Range -1.0 to +4.0 psid.
MDC-13						
13	A C-3	FDAI switches 1	Enables FDAI 1 (MDC-1) to display total attitude with respect to local horizontal in the pitch axis. Interfaces ORDEAL with the total attitude source on FDAI 1.			During launch and entry phases ORDEAL panel is stowed in UEB (U3). FDAI 1 and 2 switches must be in INRTL when ORDEAL panel is stowed.
		ORB RATE				
		INRTL	Enables FDAI 1 (MDC-1) to display inertial attitude in all axes. ORDEAL is bypassed.			

MAIN DISPLAY CONSOLE—PANELS 12 AND 13

CONTROLS AND DISPLAYS

Location		Name and Position	Function	Circuit Breaker	Power Source	Remarks
Panel Area	Grid					
MDC-13 (Cont)						
13	A	2 ORB RATE	Enables FDAI 2 (MDC-2) to display total attitude with respect to local horizontal in the pitch axis. Interfaces ORDEAL with the total attitude source on FDAI 2.			
	C-4	INRTL	Enables FDAI 2 (MDC-2) to display inertial attitude in all axes. ORDEAL is bypassed.			
13	A	EARTH/LUNAR switch EARTH PWR OFF LUNAR	Establishes basic orbital rate for Earth orbit. Disables power to ORDEAL. Establishes basic orbital rate for lunar orbit.	ORDEAL-AC2, MNB (MDC-8) ORDEAL-AC2, MNB (MDC-8)	DC main bus B AC bus 2	PWR OFF position removes power from ORDEAL, but does not isolate FDAIs from ORDEAL's angular bias. FDAI 1 and 2 switches control interface between ORDEAL and FDAIs.
13	A	LIGHTING switch BRT, OFF, DIM	Provides panels E-L back-lighting.	ORDEAL-AC2 (MDC-8)		
13	A	MODE switch OPR/SLOW HOLD/FAST	Normal position when operating ORDEAL. Permits slewing of ORDEAL at slow rate (16X orbital). Holds ORDEAL output constant except when setting up ORDEAL initially via fast slew (256X orbital).			

MAIN DISPLAY CONSOLE—PANEL 13

SM2A-03-BLOCK II-(1)
APOLLO OPERATIONS HANDBOOK

CONTROLS AND DISPLAYS

Location		Name and Position	Function	Circuit Breaker	Power Source	Remarks
Panel	Area Grid					
MDC-13 (Cont)						
13	A D-5	SLEW switch UP DOWN	Provides increasing ORDEAL output to FDAI (ball drives down) at either 16X or 256X orbital rate. Provides decreasing ORDEAL output to FDAI (ball drives up) at either 16X or 256X orbital rate.			
13	A C-7	ALT SET control	Enables ORDEAL output to be varied with altitude. ORDEAL output will be function of both EARTH/LUNAR switch and ALT SET control.			
MDC-15						
15	A B-16	COAS POWER switch COAS POWER OFF	Applies 28 vdc to receptacle located on COAS mount on left rendezvous window frame. Removes power from left COAS receptacle.	Panel 226 COAS/TUN/ RNDZ/SPOT MNA	DC main bus A	
15	A B-17	UTILITY POWER receptacle and switch Receptacle POWER OFF	Utility power receptacle for 16mm sequence camera and auxiliary urine dump nozzle. Applies 28 vdc to utility receptacle (panel 15). Removes power from POWER switch.	Panel 229 UTILITY R/L STA Panel 229 UTILITY R/L STA		

MAIN DISPLAY CONSOLE—PANELS 13 AND 15

SM2A-03-BLOCK II-(1)
APOLLO OPERATIONS HANDBOOK

CONTROLS AND DISPLAYS

Location		Name and Position	Function	Circuit Breaker	Power Source	Remarks
Panel	Area Grid					
MDC-15 (Cont)		POST LANDING switches				
15	B B-18	Beacon light switch BCN LT HI	Applies d-c power to flashing beacon light for fast flash rate.	FLOAT BAG 3 FLT/PL (MDC-8)	Flight & postlanding bus	
		(off)	Removes power to flashing beacon light.			Center position (not marked).
		BCN LT LO	Applies d-c power to flashing beacon light for slow flash rate.			
15	B B-18	Dye marker switch DYE MARKER	Applies d-c power to melting wire of actuator that causes pin to retract and jettisons dye marker overboard from forward compartment of CM after splashdown.			
		(off)	Removes power from dye marker circuitry.			
15	C B-19	Vent switch VENT HI	Applies d-c power to open both PL vent valves and drive fan at high rate (150 cfm).	PL VENT FLT/PL (MDC-8)		
		LOW	Applies d-c power to open both PL vent valves and drive fan at low rate (100 cfm).			
		OFF	Applies d-c power to close both PL vent valves and removes power from fan motor.			

MAIN DISPLAY CONSOLE—PANEL 15

SM2A-03-BLOCK II-(1)
APOLLO OPERATIONS HANDBOOK

CONTROLS AND DISPLAYS

Location		Name and Position	Function	Circuit Breaker	Power Source	Remarks
Panel	Area					
MDC-16						
16	A	C-45 DOCKING TARGET switch & receptacle BRIGHT DIM OFF Receptacle	Applies 115 vac to receptacle. Applies diminished vac to receptacle. Removes a-c power from receptacle. Power connection for LM active docking target.	Panel 226 RUN/EVA/ TGT AC 2	AC bus 2 ØB	
16	A	C-47 UTILITY POWER switch and receptacle POWER OFF Receptacle	Applies 28 vdc to utility receptacle (panel 16). Removes power from POWER switch. Utility power connector for 16 mm sequence camera and utility.	Panel 229 UTILITY R/L STA	DC main bus A	
16	A	C-48 COAS POWER switch POWER OFF	Applies 28 vdc to receptacle located on COAS mount on right rendezvous window frame. Removes power from right COAS receptacle.	Panel 226 COAS/TUN/ RNDZ/SPOT MNB	DC main bus B	

MAIN DISPLAY CONSOLE—PANEL 16

SM2A-03-BLOCK II-(1)
APOLLO OPERATIONS HANDBOOK

CONTROLS AND DISPLAYS

Location		Name and Position	Function	Circuit Breaker	Power Source	Remarks
Panel Area	Grid					
LEB-100	A	UTILITY receptacle and switch		(Panel 229) UTILITY LEB	DC main bus B	Receptacle has seven jacks.
		Receptacle (J5)	Receptacle for 16mm sequence camera and utility.			
		OFF	Removes power from adjacent receptacle (J5).			
A	A	POWER	Provides power to adjacent receptacle (J5).			
		FLOOD switches		LIGHTING FLOOD MNA & MNB RHEB PANEL 226	DC main buses A & B	Provides crew capability of shifting primary or secondary lamps to variable FLOODLIGHT switch for LEB area illumination.
		DIM	Applies rheostat control to LEB primary floodlights and on-off control to secondary floodlights.			
B	B	1	Applies rheostat control to LEB secondary floodlights and on-off control to primary floodlights.			
		2				
		FIXED	Turns on lamps not controlled by rheostat.	LIGHTING FLOOD MNB RHEB PANEL 226	DC main bus B	On-off control of floodlights not on rheostat control. Secondary when DIM switch is on 1; primary when DIM switch is on 2.
B	B	OFF	Removes power.			
		G/N POWER switches		G/N-IMU MNA & MNB (MDC-5)	DC main buses A & B	Switch can be guarded in either IMU or OFF position.
		IMU	Provides operating power to inertial subsystem.			
B	B	OFF	Removes operating power from inertial subsystem.			
		OPTICS	Provides operating power to optics subsystem.	G/N-OPTICS MNA & MNB (MDC-5)		
B	B	OFF	Removes operating power from optics subsystem.			

LOWER EQUIPMENT BAY—PANEL 100

SM2A-03-BLOCK II-(1)
APOLLO OPERATIONS HANDBOOK

CONTROLS AND DISPLAYS

Location		Name and Position	Function	Circuit Breaker	Power Source	Remarks	
Panel	Area Grid						
LEB-100 (Cont)	C	RNDZ XPNDR switch	Provides power for rendezvous transponder.	RNDZ XPNDR FLT BUS	Flight bus		
		PWR	Removes power from rendezvous transponder.				
		OFF	Provides heat to rendezvous transponder for standby power.				
		HEATER				HEATER position must provide power to warm tone filters from 60° to 160°F. This requires 24-minute minimum warmup time.	
A	LEB LIGHTS	NUMERICS rheostat	Removes power from numerals on panel 140 G&N DSKY, and caution & warning communicators and panel 306 mission timer.	LIGHTING NUMERICS/ INTEGRAL LEB AC-2 (RHEB 226)	AC bus 2 ØA	Numerics lighting system controls numerics or flashing numbers on LEB DSKY, caution & warning communicators, and EL on panel 306 mission timer. Mechanical stop prevents positioning switch to OFF. Control exercised by circuit breakers.	
		OFF	Indicates maximum brightness has been reached.				
		BRT					
		FLOOD rheostat	Removes power from CM LEB rheostat controlled floodlight.	LIGHTING FLOOD MNB RHEB PANEL 226	DC main bus B	Primary when DIM switch is on 1; secondary when DIM switch is on 2.	
		OFF	Indicates maximum floodlight brightness has been reached.				
		BRT					
A	INTEGRAL rheostat	OFF	Removes power to nomenclature on panels 10, 100, 101, 122, 225, 226, and event timer on 306.	LIGHTING NUMERICS/ INTEGRAL LEB AC-2 (RHEB PANEL 226)	AC bus 2 ØA	Integral lighting system controls EL lamps behind nomenclature of respective panels. Mechanical stop prevents positioning switch to OFF. Control exercised by use of circuit breakers.	
		BRT	Indicates maximum brightness has been reached.				

LOWER EQUIPMENT BAY—PANEL 100

SM2A-03-BLOCK II-(1)
 APOLLO OPERATIONS HANDBOOK

CONTROLS AND DISPLAYS

Location		Name and Position	Function	Circuit Breaker	Power Source	Remarks	
Panel	Area Grid						
LEB-101	A	SYSTEMS TEST meter	Indicates d-c voltage of selected measurement points.		Instrumentation signal conditioners	Meter functions in conjunction with two SYSTEMS TEST switches (alphabetical and numerical) located directly below meter. Meter range is 0 to 5 vdc.	
		SYSTEMS TEST switch (alphabetical)	Selects A, B, C, or D sections of test.				Two SYSTEMS TEST switches make possible measurement indications for the SYSTEMS TEST meter.
		A	Connects SYSTEMS TEST switch (numerical) and SYSTEMS TEST meter to section A.				
		B	Connects SYSTEMS TEST switch (numerical) and SYSTEMS TEST meter to section B.				
		C	Connects SYSTEMS TEST switch (numerical) and SYSTEMS TEST meter to section C.				
D	Connects SYSTEMS TEST switch (numerical) and SYSTEMS TEST meter to section D.						
A		SYSTEMS TEST switch (numerical)	Selects four groups of seven measurements, depending on position of SYSTEMS TEST switch (alphabetical).			N ₂ regulator out pressure 0 to 75 psia. O ₂ regulator out pressure 0 to 75 psia.	
		1 - A	N ₂ pressure FC 1				
		1 - B	N ₂ pressure FC 2				
		1 - C	N ₂ pressure FC 3				
		1 - D	O ₂ pressure FC 1				
		2 - A	O ₂ pressure FC 2				
		2 - B	O ₂ pressure FC 3				

LOWER EQUIPMENT BAY—PANEL 101

SM2A-03-BLOCK II-(1)
APOLLO OPERATIONS HANDBOOK

CONTROLS AND DISPLAYS

Location		Name and Position	Function	Circuit Breaker	Power Source	Remarks	
Panel	Area Grid						
LEB-101 (Cont)							
	A	2 - C	H ₂ pressure FC 1		Instrumentation signal conditioners	H ₂ regulator out pressure 0 to 75 psia.	
		2 - D	H ₂ pressure FC 2				
		3 - A	H ₂ pressure FC 3				
		3 - B	Rad outlet temperature FC 1				FC 1 radiator outlet temperature -50° to +300°F.
		3 - C	Rad outlet temperature FC 2				
		3 - D	Rad outlet temperature FC 3				
		4 - A	Battery pressure				Battery compartment manifold pressure 0 to 20 psia.
		4 - B	Battery relay bus				0 to 45 vdc.
		4 - C					No connection.
		4 - D	LM power				0 to 10 amps.
		5 - A	SPS OX temperature				0° to +200°F.
		5 - B					
		5 - C	-P24				-50° to +50°F.
		5 - D	+Y25				
		6 - A	CCW12				
		6 - B	-P14				
		6 - C	-Y16				
		6 - D	CW21				
		7 - A	NONE			Open contacts.	
		7 - B	NONE			Open contacts.	

LOWER EQUIPMENT BAY—PANEL 101

SM2A-03-BLOCK II-(1)
APOLLO OPERATIONS HANDBOOK

CONTROLS AND DISPLAYS

Location		Name and Position	Function	Circuit Breaker	Power Source	Remarks
Panel	Area Grid					
LEB-101 (Cont)						
A		7 - C 7 - D XPNDR-A XPNDR-B XPNDR-C XPNDR-D	NONE NONE XMTR power output AGC FREQ lockup AGC		Instrumentation signal conditioners	Open contacts. Open contacts. Self test. Self test. Self test. Normal.
A		RNDZ XPNDR TEST OPERATE	Activates self-test oscillator within RRT. Disables self-test oscillator.			This is a momentary position to enable testing of RRT. (Not to be used during rendezvous.) Allows normal operation of RRT. (Spring-loaded to this position.)
B		CM RCS HTRS switch	Activates relays which apply +28 vdc to direct coils of all CM RCS engine solenoid injector valve direct coils. Deactivates relays which remove +28 vdc from the direct coils of all CM RCS engine solenoid injector valves.	RCS-HEATERS 1 MNA 2 MNB (MDC-8)	DC main buses A & B	Two-position toggle switch, used to preheat all CM RCS engine valves if required in order to preclude propellant freezing when system is pressurized prior to entry. Switch is enabled by CM RCS LOGIC switch (MDC-1) in the ON (up) position.
B		CM RCS HTRS (up) OFF				

LOWER EQUIPMENT BAY—PANEL 101

SM2A-03-BLOCK II-(1)
 APOLLO OPERATIONS HANDBOOK

CONTROLS AND DISPLAYS

Location		Name and Position	Function	Circuit Breaker	Power Source	Remarks
Panel	Area Grid					
LEB-101 (Cont)		URINE DUMP HTR A OFF HTR B	Applies d-c power to water/urine dump nozzle heater A (5.7w). De-energizes power to water/urine dump nozzle heaters. Applies d-c power to water/urine dump nozzle heater B (5.7w).	ECS-STEAM/URINE DUCT HTR-MNA	DC main bus A	Heaters keep water/urine dump nozzle (aluminum) warm to prevent urine or water from freezing and clogging nozzle when dumped overboard.
C						
C		WASTE H ₂ O DUMP HTR A OFF HTR B	Applies d-c power to waste water dump nozzle heater A (5.7w). De-energizes power to waste water dump nozzle heaters. Applies d-c power to waste water dump nozzle heater B (5.7w).	ECS-WASTE H ₂ O URINE DUMP HTR A	DC main bus A	Heaters keep waste water dump nozzle (aluminum) warm to prevent waste water from freezing and clogging the nozzle when dumped overboard.
LEB-120		Blank panel	SXT and SCT eyepiece storage.			

LOWER EQUIPMENT BAY—PANELS 101 AND 120

SM2A-03-BLOCK II-(1)
 APOLLO OPERATIONS HANDBOOK

CONTROLS AND DISPLAYS

Location		Name and Position	Function	Circuit Breaker	Power Source	Remarks
Panel	Grid					
LEB-121		Scanning Telescope (no placard)	Optical instrument used primarily for acquiring targets initially.	G/N-OPTICS-MNA and MNB	DC main buses A & B	Power for sextant is routed from buses through G/N-OPTICS ON and OFF switch, located on panel 100. The sextant has 1.8-degree field of view with magnification of 28. Scanning telescope has 60-degree field of view and magnification of one. In event of power failure scanning telescope may be manually positioned, using universal tool.
		Sextant (no placard)	Optical instrument utilized for making fine angular measurements.			Power for sextant is routed from buses through G/N-OPTICS ON and OFF switch, located on panel 100. Sextant has 1.8-degree field of view with magnification of 28.
		SHAFT ANGLE display	Provides mechanical readout of scanning telescope shaft angle.	N/A	N/A	
		Shaft Angle Manual Drive Access (no placard)	Facilitates use of universal tool to position manually telescope shaft.			While manually positioning scanning telescope shaft, angle may be read out on shaft angle display.
		TRUNNION ANGLE display	Provides mechanical readout of scanning telescope trunnion angle.			
		Trunnion Angle Manual Drive Access (no placard)	Facilitates use of universal tool to position manually telescope trunnion.			While manually positioning scanning telescope trunnion, angle may be read out on trunnion angle display.

LOWER EQUIPMENT BAY—PANEL 121

SM2A-03-BLOCK II-(1)
 APOLLO OPERATIONS HANDBOOK

CONTROLS AND DISPLAYS

Location		Name and Position	Function	Circuit Breaker	Power Source	Remarks
Panel	Grid					
LEB-122		ATTITUDE IMPULSE CONTROLLER switch	This 3-axis controller provides navigator with capability of spacecraft minimum impulse control through CMC when PGNCSS is in free mode of operation.	N/A	CMC	The controller is used to apply one or any combination of pitch, roll, or yaw minimum thrust impulse to the spacecraft. One pulse is produced each time the control is moved from the center position.
		CONDITION LAMPS switch	Provides means for checking out condition lamps and enabling condition lamp circuitry.			
		ON	Supplies power to lower equipment bay annunciator lamps.			
		OFF	Removes power from annunciator lamp circuit.			
		TEST	Lights navigation station master warning and star acquired lamps.	G&N AC1 and AC2	AC buses 1 & 2	
		CAUTION & WARNING lights (no placard)	CMC status light will illuminate if the following occurs: a. Loss of prime power. b. Scaler fail - if scaler stage 17 fails to produce pulses. c. Counter fail - continuous requests or fail to happen following increment request. d. SCADBL - 100 pps scaler stage 200 pps. e. Parity fail - accessed word, whose address is octal 10 or greater, contains even number of ones. f. Interrupt too long or infrequent - 140 ms to 300 ms. g. TC trap - too many TC or TCF instructions or TCF instructions too infrequent.	C/W MNA and MNB (MDC-5)	DC main buses A & B	Items e through k will cause restart in the CMC.

LOWER EQUIPMENT BAY—PANEL 122

SM2A-03-BLOCK II-(1)
APOLLO OPERATIONS HANDBOOK

CONTROLS AND DISPLAYS

Location		Name and Position	Function	Circuit Breaker	Power Source	Remarks
Panel	Area Grid					
LEB-122 (Cont)		ISS	<p>h. Night watchman - computer fails to access address 67 within 64 seconds to 1.92 seconds.</p> <p>i. V fail - 4v supply 4.4v 4v supply 3.6v 14v supply 16.0v 14v supply 12.5v 28v supply 22.6v</p> <p>j. If oscillator stops.</p> <p>k. Standby.</p> <p>The ISS status light will illuminate if the following occurs:</p> <p>a. IMU fail:</p> <ol style="list-style-type: none"> 1. IG servo error 2.9 mr for 2 sec. 2. MG servo error 2.9 mr for 2 sec. 3. OG servo error 2.9 mr for 2 sec. 4. 3200 cps 50%. 5. 800 wheel supply 50%. <p>b. PIPA fail:</p> <ol style="list-style-type: none"> 1. No pulse during 312.5 ms period. 2. If both + and - pulses occur during 312.5 ms period. 3. If no + and - pulses occur between 1.28 to 3.84 sec. <p>c. CDU fail:</p> <ol style="list-style-type: none"> 1. CDU fine error 1.0v rms. 2. CDU coarse error 2.5v rms. 3. Read counter limit 160 cps. 4. Cos (θ - 0) 2.0v. 5. +14 dc supply 50%. 	C/W MNA and MNB (MDC-5)	DC main buses A & B	<p>IMU fail signal inhibited by CMC when in coarse align mode.</p> <p>PIPA fail signal inhibited by CMC except during CMC-controlled translation or thrusting.</p> <p>CDU fail signal by CMC during CDU zero mode.</p>

LOWER EQUIPMENT BAY—PANEL 122

SM2A-03-BLOCK II-(1)
 APOLLO OPERATIONS HANDBOOK

CONTROLS AND DISPLAYS

Location		Name and Position	Function	Circuit Breaker	Power Source	Remarks
Panel	Area Grid					
LEB-122 (Cont)		MASTER ALARM switch-light	Red light illuminates to alert crewman of malfunction or out-of-tolerance condition. This is indicated by illumination of applicable system status lights on MDC-2.	C/W MNA and MNB (MDC-5)	DC main buses A & B	MASTER ALARM lights on MDC-1, -3, and LEB-122 are simultaneously illuminated, and an audio alarm tone is sent to each headset. MASTER ALARM switch-light contains integral push-switch. Pressing switch-light will reset master alarm circuit, extinguishing the MASTER ALARM lights and shutting off audio alarm.
		PGNS	PGNS status light will illuminate if the following occurs: a. CMC restart during operation. b. IMU temp 126.3 °F. c. IMU temp 134.3 °F. d. Middle gimbal angle greater than 70°. e. Program alarm. Caused by variety of situations in each program.			Under program control, CMC inhibits PROG alarm for 10 sec after system turn-on.
		Mark pushbutton	Signals computer to record SHAFT and TRUNNION angles and time.			Used in conjunction with optical sightings.
		MARK REJECT pushbutton	Signals CMC to reject last mark.			
		Optics hand controller (no placard)	Provides electrical commands to optics shaft and trunnion drive motor.			This is 5-position switch spring-loaded to center off position.
		OPTICS switches COUPLING	Optics controller signals X and Y drive shaft and trunnion control directly.			
		DIRECT	Optics controller signals X and Y are resolved into X and Y motions in the field of view.			
		RSLV				

LOWER EQUIPMENT BAY-PANEL 122

CONTROLS AND DISPLAYS

Location		Name and Position	Function	Circuit Breaker	Power Source	Remarks
Panel	Area Grid					
LEB-122 (Cont)		SPEED	Selects gain of optics controller to line-of-sight motion. Provides maximum drive rate of line-of-sight in respect to optics controller displacement. Provides medium drive rate of line-of-sight in respect to optics controller displacement. Provides minimum drive rate of line-of-sight in respect to optics controller displacement.	N/A	N/A	
		HI				
		MED				
		LO				
		MODE	Selects optics mode of operation. Optics under computed program control. Optics under astronaut's manual control using the optics controller.			
		CMC				
		MAN				
		ZERO	Optics driven to zero shaft and trunnion.			
		STAR ACQ light	This light is not active.			
		TELTRUN				
		SLAVE to SXT	Slave SCT trunnion axis to SXT trunnion. Drives SCT trunnion to zero independent of sextant. Drives SCT trunnion to 25 degrees offset from shaft axis.			Zero position is parallel to SXT shaft axis. This is a fixed 25-degree independent of sextant trunnion position.
		0°				
		25°				

LOWER EQUIPMENT BAY—PANEL 122

SM2A-03-BLOCK II-(1)
APOLLO OPERATIONS HANDBOOK

CONTROLS AND DISPLAYS

Location		Name and Position	Function	Circuit Breaker	Power Source	Remarks
Panel	Grid					
LEB-122 (Cont)		RETICLE BRIGHTNESS thumbwheel	Adjusts brightness of sextant and scanning telescope reticles, and telescope angle counters.	G/N AC1 and AC2	AC buses 1 & 2	
		UP TLM switch ACCEPT BLOCK	Computer accepts telemetry data. Computer does not accept up-telemetry data.			There are two up-telemetry switches, one on LEB-122 and the other on MDC-2. These switches are wired in series and either switch in BLOCK position will block up-telemetry information into CMC.
LEB-140		DSKY (no placard) Keyboard CLR	Depression of the clear button will blank register being loaded.	N/A	N/A	
		ENTR	Informs CMC that assembled data is complete and/or to execute desired function.			
		KEY REL	Releases DSKY displays initiated by keyboard action so that information supplied by CMC program may be displayed.			
		NOUN	Sets computer to accept next two digits as noun code.			Pressing noun button will initially blank noun window.
		RSET	Extinguishes status lamps that are controlled by CMC.			In those areas where error or malfunction exists, pressing reset switch will not extinguish status lamps.
		PRO	Informs routine requesting operator's response that operator wishes requesting routine to proceed without further inputs from the operator; or places the CMC in standby mode when pressed, upon request from CMC.			

LOWER EQUIPMENT BAY - PANELS 122 AND 140

SM2A-03-BLOCK II-(1)
 APOLLO OPERATIONS HANDBOOK

CONTROLS AND DISPLAYS

Location		Name and Position	Function	Circuit Breaker	Power Source	Remarks
Panel	Area Grid					
LEB-140 (Cont)		VERB	Sets computer to accept next two digits as verb code.	N/A	N/A	Pressing verb button will initially blank verb window.
		+	Denotes data to follow has positive decimal value.			
		-	Denotes data to follow has negative decimal value.			
		0 through 9	Switches 0 to 9 are used to enter data, address code, and action request codes into CMC.			
		Registers	CMC is energized in computation.			
		COMP ACTY (light)	Two-digit display indicating noun code selected.			On-board data provides definition of PROGRAM and NOUN digits.
		NOUN (light & display)	Two-digit display indicating number of program (major mode) presently in progress.			
		PROG (light & display)	Displays contents of selected register or memory location. First component of extended data word, if applicable.			Displays may be commanded manually or by CMC.
		REGISTER 1 (display)	Displays contents of selected register or memory location. Second component of extended data word, if applicable.			
		REGISTER 2 (display)	Displays contents of selected register or memory location. Third component of extended data word, if applicable.			
	REGISTER 3 (display)	Two-digit display indicating verb code selected.			On-board data provides definition of VERB digits.	

LOWER EQUIPMENT BAY—PANEL 140

SM2A-03-BLOCK II-(1)
 APOLLO OPERATIONS HANDBOOK

CONTROLS AND DISPLAYS

Location Panel Area Grid	Name and Position	Function	Circuit Breaker	Power Source	Remarks
LEB-140 (Cont)	Status lights	Gimbald lock-light will illuminate under computer control whenever middle gimbald angle of platform exceeds 70 degrees.	N/A	DSKY	Illumination of lights warns of pending gimbald lock condition.
	GIMBAL LOCK	Internal CMC program needs DSKY circuits to continue program.		N/A	Request for operator to press KEY REL pushbutton.
	KEY REL	A crew keystroke is made when internal flashing display is currently on DSKY (exceptions: PRO, ENTR, RESET).			
		Crew makes keystroke on top of his selected monitor verb.			
	NO ATT	Light will illuminate whenever inertial subsystem is not in mode to provide attitude reference.			
	OPR ERR	Light will illuminate when an illegal keyboard entry is made into the CMC.			
	PROG	Light illuminates when additional functions, operations, or information is requested by computer to complete specific operation or function.			
	RESTART	Light will be illuminated whenever the computer goes into restart program.			
	STBY	Light will be illuminated whenever computer subsystem is in standby mode of operation.			

LOWER EQUIPMENT BAY—PANEL 140

SM2A-03-BLOCK II-(1)
APOLLO OPERATIONS HANDBOOK

CONTROLS AND DISPLAYS

Location		Name and Position	Function	Circuit Breaker	Power Source	Remarks
Panel	Area Grid					
LEB-140 (Cont)		TEMP	Light will illuminate whenever temperature of stable platform deviates more than $\pm 5^{\circ}\text{F}$ from nominal.	N/A	N/A	Indicates out-of-tolerance temperature, plus or minus, on stable platform.
		TRACKER	Light will illuminate whenever there is failure of one of the optical CDU. Data good discrete not present after reading range from VHF DATA LINK.			
		UPLINK ACTY	CMC is receiving data link information by up-telemetry.			
LEB-162		SCI INST POWER receptacle and switch	Power outlet.	SCI EQUIP SEB 2 (MDC-5)	NON ESS Bus 2 DC main bus A or B	
		POWER OFF	Applies 28-vdc power to receptacle on panel 162. Removes power.			
LEB-163		SCI/UTIL-POWER receptacle and switch	Power outlet.			
		POWER OFF	Applies 28-vdc power to receptacle on panel 163. Removes power.			

LOWER EQUIPMENT BAY—PANELS 140, 162 AND 163

SM2A-03-BLOCK II-(1)
 APOLLO OPERATIONS HANDBOOK

CONTROLS AND DISPLAYS

Location		Name and Position	Function	Circuit Breaker	Power Source	Remarks
Panel	Grid					
LEB	180	S-BAND SQUELCH (SC 106 & 107 only)	Activates squelch circuit in 30 KHz subcarrier demodulator of PMP. Disables squelch circuit.		PMP Equipment	Removes unwanted noise from S-band up-link signal.
		ENABLE				
		OFF				
LEB	180	CB41 (on entry battery A case)	Protects wiring from entry battery A to circuit breaker BAT A PWR ENTRY/POSTLANDING (RHEB-250).		Entry battery A	100-amp circuit breaker.
		CB42 (on entry battery B case)	Protects wiring from entry battery B to circuit breaker BAT B PWR ENTRY/POST-LANDING (RHEB-250).		Entry battery B	100-amp circuit breaker.
		CB43 (on entry battery C case)	Protects wiring from entry battery C to circuit breaker BAT C PWR ENTRY/POST-LANDING (RHEB-250).		Entry battery C	100-amp circuit breaker.

LOWER EQUIPMENT BAY—PANEL 180

SM2A-03-BLOCK II-(1)
APOLLO OPERATIONS HANDBOOK

CONTROLS AND DISPLAYS

Location		Name and Position	Function	Circuit Breaker	Power Source	Remarks
Panel Area	Grid					
RHEB-225		TELECOMMUNICATIONS circuit breakers				
		CENTRAL TIMING EQUIP group				
		MNA (5 amp)	Provides d-c power from main bus A to CTE.		Main bus A	
		MNB (5 amp)	Provides d-c power from main bus B to CTE.		Main bus B	
		VHF/CREW STATION AUDIO group				
		L (5 amp)	Provides d-c power from flight and postlanding bus to Commander's audio center and microphone amplifier, the VHF recovery BCN, and emergency power to CSM pilot's microphone amplifier.		Flight & postlanding bus	
		CTR (5 amp)	Provides d-c power from flight and postlanding bus to CSM pilot's audio center and microphone amplifier, the VHF AM, and emergency power to LM pilot's microphone amplifier.			
		R (5 amp)	Provides d-c power from flight and postlanding bus to LM pilot's audio center and microphone amplifier, digital ranging generator and emergency power to Commander's microphone amplifier.			
	FLT BUS group					
	MNA (20 amp)	Provides power from main d-c bus A to the flight bus.			Main bus A	

RH EQUIPMENT BAY—PANEL 225

SM2A-03-BLOCK II-(1)
 APOLLO OPERATIONS HANDBOOK

CONTROLS AND DISPLAYS

Location		Name and Position	Function	Circuit Breaker	Power Source	Remarks
Panel	Area Grid					
RHEB-225 (Cont)		MNB (20 amp)	Provides power from main d-c bus B to the flight bus.		Main bus B	
		HIGH GAIN ANTENNA				
		FLT BUS (5 amp)	Provides d-c power from the flight bus to the high gain antenna circuitry.		Flight bus	
		GROUP 2 (2 amp)	Provides a-c power from the telecom group 2 bus to the high gain antenna circuitry.		AC bus 1 or 2 3Ø	
		PCM TLM group				
		GROUP 1 (2 amp)	Provides power from the group 1 telecom a-c bus to the PCM.			
		GROUP 2 (2 amp)	Provides power from the group 2 telecom a-c bus to the PCM.			
		PMP POWER				
		FLT BUS			Flight bus	
		PRIM (5 amp)	Provides d-c power to the PMP primary power supply.			
		AUX (5 amp)	Provides d-c power to the PMP auxiliary power supply.			
		RNDZ XPNDR				
		FLT BUS (5 amp)	Provides d-c power from the flight bus to the RRT.			

RH EQUIPMENT BAY—PANEL 225

SM2A-03-BLOCK II-(1)
 APOLLO OPERATIONS HANDBOOK

CONTROLS AND DISPLAYS

Location		Name and Position	Function	Circuit Breaker	Power Source	Remarks	
Panel	Area Grid						
RHEB-226	A	CRYOGENIC circuit breakers			DC main bus A & B		
		H ₂ HTR	Applies power from d-c main bus A to H ₂ HEATERS 1 switch (MDC-2).				
		1 MNA (5 amp)	Applies power from d-c main bus B to H ₂ HEATERS 2 switch (MDC-2).				
		2 MNB (5 amp)					
	A	O ₂ HTR				AC bus 1 ØC	
		1 MNA (15 amp)	Applies power from d-c main bus A to O ₂ HEATERS 1 switch (MDC-2).				
	A	2 MNB (15 amp)	Applies power from d-c main bus B to O ₂ HEATERS 2 switch (MDC-2).			AC bus 1 ØC	
		QTY AMPL					
	A	1 AC 1 (2 amp)	Applies power from a-c bus No. 1 (ØC) to H ₂ and O ₂ No. 1 tanks signal conditioning boxes.			AC bus 1 ØA	
		2 AC 2 (2 amp)	Applies power from a-c bus No. 2 (ØC) to H ₂ and O ₂ No. 2 tanks signal conditioning boxes.				
A	CRYOGENIC FAN MOTORS circuit breakers				AC bus 1 ØA		
	AC 1 group ØA (2 amp)	Applies a-c ØA power from a-c bus No. 1 to: a. H ₂ FANS - 1 switch (MDC-2). b. O ₂ FANS - 1 switch (MDC-2).					

RH EQUIPMENT BAY—PANEL 226

SM2A-03-BLOCK II-(1)
APOLLO OPERATIONS HANDBOOK

CONTROLS AND DISPLAYS

Location		Name and Position	Function	Circuit Breaker	Power Source	Remarks
Panel Area	Grid					
RHEB-226 (Cont)						
A		ØB (2 amp)	Applies a-c ØB power from a-c bus No. 1 to: a. H ₂ FANS - 1 switch (MDC-2). b. O ₂ FANS - 1 switch (MDC-2).		AC bus 1 ØB	
		ØC (2 amp)	Applies a-c ØC power from a-c bus No. 1 to: a. H ₂ FANS - 1 switch (MDC-2). b. O ₂ FANS - 1 switch (MDC-2).		AC bus 1 ØC	
		AC 2 group				
		ØA (2 amp)	Applies a-c ØA power from a-c bus No. 2 to: a. H ₂ FANS - 2 switch (MDC-2). b. O ₂ FANS - 2 switch (MDC-2).		AC bus 2 ØA	
		ØB (2 amp)	Applies a-c ØB power from a-c bus No. 2 to: a. H ₂ FANS - 2 switch (MDC-2). b. O ₂ FANS - 2 switch (MDC-2).		AC bus 2 ØB	
		ØC (2 amp)	Applies a-c ØC power from a-c bus No. 2 to: a. H ₂ FANS - 2 switch (MDC-2). b. O ₂ FANS - 2 switch (MDC-2).		AC bus 2 ØC	
		FUEL CELL 1 circuit breakers				
A		PUMPS - AC (2 amp)	a. Applies 3Ø power from a-c bus No. 1 or 2 through FC PUMPS-1 switch to CB, and to H ₂ /water separator and glycol pump motors in fuel cell 1. b. Provides ØA power to FC 1 pH sensor probe. c. Provides connection for FC 1 power factor correction circuit to either AC bus.		AC bus 1 or 2 3Ø	

RH EQUIPMENT BAY—PANEL 226

SM2A-03-BLOCK II-(1)
APOLLO OPERATIONS HANDBOOK

CONTROLS AND DISPLAYS

Location		Name and Position	Function	Circuit Breaker	Power Source	Remarks
Panel	Area Grid					
RHEB-226 (Cont)		REACS (10 amp) BUS CONT (10 amp)	Applies d-c power from battery relay bus to FUEL CELL REACTANTS 1 switch (MDC-3). a. Applies d-c power from battery relay bus to FC 1 bus control through FUEL CELL - MAIN BUS A-1 and MAIN BUS B-1 switches (MDC-3). b. Provides power to FC 1 reactants event indicator. c. Applies power to FC REACS VALVES switch (MDC-3). d. Supplies input to SYSTEM TEST METER (LEB 10), BAT RLY BUS voltage and to telemetry.		Battery relay bus	
A	A					
A		PURGE (5 amp)	a. Applies power from d-c main bus A to FC 1 purge valves through FUEL CELL PURGE 1 switch (MDC-3). b. Applies power to H ₂ PURGE LINE HTR switch.		DC main buses A & B	NOTE A fuse (5 amp) protects MAIN BUS B power to the PURGE VALVE CONTROL switch.
A		RAD (5 amp)	Applies power to FUEL CELL RADIATORS-1 switch (MDC-3).		Battery relay bus	
A		FUEL CELL 2 circuit breakers PUMPS - AC (3 amp)	a. Applies power from a-c bus No. 1 or 2 through FUEL CELL PUMPS-2 switch to CB, and to H ₂ water sep and glycol pump motors in fuel cell 2. b. Provide ØA power to FC 2 pH sensor probe. c. Provides connection of FC 2 power factor correction circuit to either AC bus.		AC bus 1 or 2 3Ø	

RH EQUIPMENT BAY—PANEL 226

SM2A-03-BLOCK II-(1)
APOLLO OPERATIONS HANDBOOK

CONTROLS AND DISPLAYS

Location		Name and Position	Function	Circuit Breaker	Power Source	Remarks
Panel	Area Grid					
RHEB-226 (Cont)						
	A	REACS (10 amp)	Applies d-c power from battery relay bus to FUEL CELL REACTANTS-2 switch (MDC-3).		Battery relay bus	
	A	BUS CONT (10 amp)	a. Applies d-c power from battery relay bus to FC 2 bus control through FUEL CELL - MAIN BUS A-2 and MAIN BUS B-2 switches (MDC-3). b. Provides power to reactants event indicator.			
	A	PURGE (5 amp)	a. Applies power from d-c main bus B to FC 2 purge valves through FUEL CELL PURGE-2 switch (MDC-3). b. Applies power to H ₂ PURGE LINE HTR switch.		DC main bus B	NOTE Fuse (5A) protects MAIN BUS A PWR to the PURGE VALVE control switch.
	A	RAD (5 amp)	Applies power to FUEL CELL RADIATORS-2 switch (MDC-3).		Battery relay bus	
	A	FUEL CELL 3 circuit breakers PUMPS - AC (3 amp)	a. Applies power from a-c bus No. 1 or 2 through FC PUMP-3 switch to CB, and to H ₂ water sep and glycol pump motors in fuel cell 3. b. Provides ØA power to FC 3 pH sensor probe. c. Provides connection for FC 3 power factor correction circuit to either AC bus.		AC bus 1 or 2	
	A	REACS (10 amp)	Applies d-c power from battery relay bus to FUEL CELL 3 - REACTANTS switch (MDC-3).		Battery relay bus	

RH EQUIPMENT BAY—PANEL 226

SM2A-03-BLOCK II-(1)
 APOLLO OPERATIONS HANDBOOK

CONTROLS AND DISPLAYS

Location		Name and Position	Function	Circuit Breaker	Power Source	Remarks
Panel	Area Grid					
RHEB-226 (Cont)						
	A	BUS CONT (10 amp)	a. Applies d-c power from battery relay bus to FC 3 bus control through FUEL CELL 3 MAIN BUS A and MAIN BUS B switches (MDC-3). b. Provides power to reactants event indicator. c. Applies power to FC REACTS VALVES switch (MDC-3).		Battery relay bus	
	A	PURGE (5 amp)	Applies power from d-c main bus B to FC purge valves through FUEL CELL PURGE-3 switch (MDC-3).		DC main bus B	NOTE Fuse (5A) protects MAIN BUS A power to the PURGE VALVE CONTROL switch.
	A	RAD (5 amp)	Applies power to FUEL CELL RADIATORS-3 switch (MDC-3).		Battery relay bus	
	B	LIGHTING circuit breakers LIGHTING-FLOOD group circuit breakers MNA (15 amp)	Connects power from DC BUS A to FLOOD rheostat switches (MDC-8), FLOOD FIXED switch (MDC-5), and FLOOD rheostat switch (LEB panel 100).		DC main bus A	
	B	MNB (15 amp)	Connects power from DC BUS B to FLOOD - FIXED/OFF/POST LDG switch (MDC-8), FLOOD rheostat switch (MDC-5), and FLOOD - FIXED/OFF switch (LEB panel 100).		DC main bus B	
	B	FLT/PL (5 amp)	Connects power from postlanding bus to FLOOD - FIXED/OFF/POST LDG switch (MDC-8).		Postlanding batteries	

RH EQUIPMENT BAY—PANEL 226

SM2A-03-BLOCK II-(1)
APOLLO OPERATIONS HANDBOOK

CONTROLS AND DISPLAYS

Location		Name and Position	Function	Circuit Breaker	Power Source	Remarks	
Panel	Area Grid						
RHEB-226 (Cont)		LIGHTING (NUMERICS/ INTEGRAL) group circuit breakers LEB - AC 2 (2 amp)	Connects AC BUS 2 to INTEGRAL and NUMERICS variable transformers (LEB panel 100).	N/A	AC bus 2 ØA		
C	C						Connects AC BUS 1 to INTEGRAL and NUMERICS variable transformers (MDC-8).
C	C						Connects AC BUS 1 to INTEGRAL variable transformer (MDC-5).
D	D	RUN/EVA/TRGT circuit breakers AC 1 (2 amp)	Connects AC BUS 1 to EXTERIOR LIGHTS - RUN/EVA switch on MDC-2.		AC bus 1		
		AC 2 (2 amp)	Connects AC BUS 2 to EXTERIOR LIGHTS - RUN/EVA switch on MDC-2 and DOCKING TARGET switch on MDC-16.		AC bus 2		
D	D	LIGHTING COAS/TUNNEL/ RNDZ SPOT circuit breakers MNA (5 amp)	Provides circuit protection for COAS switches on MDC-15 and -16; TUNNEL, RNDZ, SPOT switches on MDC-2.		DC main bus A		
		MNB (5 amp)	Provides circuit protection for COAS switches on MDC-15 and -16; TUNNEL, RNDZ, SPOT switches on MDC-2.		DC main bus B		

RH EQUIPMENT BAY—PANEL 226

SM2A-03-BLOCK II-(1)
 APOLLO OPERATIONS HANDBOOK

CONTROLS AND DISPLAYS

Location		Name and Position	Function	Circuit Breaker	Power Source	Remarks
Panel Area	Grid					
RHEB-227		SC INST switch and receptacle	Applies 28 vdc power to receptacle. Removes power.	HATCH (CB 25) (MDC-5)	NON-ESS bus 2 DC main buses A & B	
		PWR OFF				
RHEB-229	A	EPS-MNA, MNB - GROUP 1 circuit breakers	Applies power to MDC-8 circuit breakers: a. STABILIZATION CONTROL SYSTEM-PITCH-MNA. b. REACTION CONTROL SYSTEM - SM HEATERS - MNA-D. c. REACTION CONTROL SYSTEM - PRPLNT ISOL - MNA. d. SCS - LOGIC BUS 3/4 MNA. e. SCS - CONTR/AUTO MNA.		DC main bus A	
		MNA (30 amp)				
	A	MNB (30 amp)	Applies power to MDC-8 circuit breakers: a. STABILIZATION CONTROL SYSTEM-PITCH-MNB. b. REACTION CONTROL SYSTEM - SM HEATERS - MNB-C. c. REACTION CONTROL SYSTEM - PRPLNT ISOL - MNB. d. SCS LOGIC BUS 2/3 MNB. e. SCS CONTR/AUTO MNB.		DC main bus B	

RH EQUIPMENT BAY - PANELS 227 AND 229

SM2A-03-BLOCK II-(1)
 APOLLO OPERATIONS HANDBOOK

CONTROLS AND DISPLAYS

Location		Name and Position	Function	Circuit Breaker	Power Source	Remarks
Panel	Area Grid					
RHEB-229 (Cont)						
	B	TIMERS MNA and MNB circuit breakers MNA (5 amp) MNB (5 amp)	Connects power from d-c main bus A to event timers on panel 306 and MDC-1, and mission timer on MDC-2. Connects power from d-c main bus B to event timer on MDC-1 and LHEB-306 and mission timer LHEB-306.		DC main bus A DC main bus B	
	C	EPS - MNA, MNB - GROUP 2 circuit breakers MNA (30 amp) MNB (30 amp)	Applies power to MDC-8 circuit breakers: a. STABILIZATION CONTROL SYSTEM - SYSTEM MNA. b. STABILIZATION CONTROL SYSTEM - AC ROLL MNA. Applies power to MDC-8 circuit breakers: a. STABILIZATION CONTROL SYSTEM - SYSTEM MNB. b. STABILIZATION CONTROL SYSTEM-A/C ROLL-MNB.		DC main bus A DC main bus B	
	D	EPS - MNA, MNB - GROUP 3 circuit breakers MNA (30 amp)	Applies power to MDC-8 circuit breakers: a. STABILIZATION CONTROL SYSTEM-YAW - MNA. b. REACTION CONTROL SYSTEM-SM HEATERS-B MNA. c. SCS LOGIC BUS 1/2 MNA.		DC main bus A	

RH EQUIPMENT BAY—PANEL 229

SM2A-03-BLOCK II-(1)
 APOLLO OPERATIONS HANDBOOK

CONTROLS AND DISPLAYS

Location		Name and Position	Function	Circuit Breaker	Power Source	Remarks
Panel	Area Grid					
RHEB-229 (Cont)						
	D	MNB (30 amp)	Applies power to MDC-8 circuit breakers: a. STABILIZATION CONTROL SYSTEM-YAW - MNB. b. REACTION CONTROL SYSTEM-SM HEATERS-A MNB. c. SCS-LOGIC PWR-1/4 - MNB. d. ORDEAL-MNB.		DC main bus B	
	D	EPS - MNA, MNB - GROUP 4 circuit breakers MNA (30 amp)	Applies power to MDC-8 circuit breakers: a. STABILIZATION CONTROL SYSTEM-B/D ROLL-MNA. b. SERVICE PROPULSION SYSTEM-GAUGING-MNA. c. SERVICE PROPULSION SYSTEM-He VALVE-MNA. d. EMS MNA. e. DOCK PROBE MNA.		DC main bus A	
	D	MNB (30 amp)	Applies power to MDC-8 circuit breakers: a. SERVICE PROPULSION SYSTEM-GAUGING - MNB. b. STABILIZATION CONTROL SYSTEM-B/D ROLL-MNB. c. EMS MNB. d. SERVICE PROPULSION SYSTEM-He VALVE-MNB. e. DOCK PROBE - MNB.		DC main bus B	
	D	EPS - MNA, MNB - GROUP 5 circuit breakers MNA (30 amp)	Applies power to MDC-8 circuit breakers: a. REACTION CONTROL SYSTEM-RCS LOGIC-MNA.		DC main bus A	

RH EQUIPMENT BAY—PANEL 229

SM2A-03-BLOCK II-(1)
 APOLLO OPERATIONS HANDBOOK

CONTROLS AND DISPLAYS

Location		Name and Position	Function	Circuit Breaker	Power Source	Remarks
Panel	Area Grid					
RHEB-229 (Cont)						
	D	MNA (30 amp)	b. REACTION CONTROL SYSTEM-CM HEATERS-1 - MNA. c. SPS-PILOT VALVES-MNA. d. SCS-CONTR/DIRECT-1 MNA. e. SCS-CONTR/DIRECT-2 MNA. f. SCS-DIRECT ULL-MNA.		DC main bus A	
	D	MNB (30 amp)	Applies power to MDC-8 circuit breakers: a. REACTION CONTROL SYSTEM-RCS LOGIC-MNB. b. REACTION CONTROL SYSTEM-CM HEATERS-2 - MNB. c. SPS-PILOT VLVS-MNB. d. SCS-CONTR/DIRECT 1 MNB. e. SCS-CONTR/DIRECT 2 MNB. f. SCS-DIRECT ULL MNB.		DC main bus B	
	D	O ₂ VAC ION PUMPS circuit breakers				
		MNA (5 amp)	Connects power from d-c main bus A to O ₂ tank 1 vac ion pump.		DC main bus A	Used to disable circuit when necessary.
		MNB (5 amp)	Connects power from d-c main bus B to O ₂ tank 2 vac ion pump.		DC main bus B	
	D	MAIN RELEASE PYRO A and B circuit breakers				
		PYRO A (5 amp)	Applies SECS pyro bus A power to system A main chute release pyro circuits.	SEQ A (RHEB-250)	Pyro battery bus A	Normally open during flight. Closed after splashdown.
		PYRO B (5 amp)	Applies SECS pyro bus B power to system B main chute release pyro circuits.	SEQ B (RHEB-250)	Pyro battery bus B	

RH EQUIPMENT BAY—PANEL 229

SM2A-03-BLOCK II-(1)
 APOLLO OPERATIONS HANDBOOK

CONTROLS AND DISPLAYS

Location		Name and Position	Function	Circuit Breaker	Power Source	Remarks
Panel Area	Grid					
RHEB-229 (Cont)		UTILITY circuit breakers		N/A		
E		R/L STA (2 amp)	Applies 28 vdc to UTILITY switch and connectors on panels 15 and 16 and provides circuit protection.		DC main bus A	
E		LEB (2 amp)	Applies 28 vdc to UTILITY switch and connector on panel 100 and provides circuit protection.		DC main bus B	
F		EPS BAT BUS circuit breakers A (20 amp)	Applies d-c power from battery bus A to following circuit breakers on MDC-8: a. SERVICE PROPULSION b. SYSTEM-PITCH 1 - BAT A. c. SERVICE PROPULSION d. SYSTEM-YAW 1 - BAT A. e. SEQ EVENTS CONT f. SYSTEM ARM A - BAT A. g. SEQ EVENTS CONT h. SYSTEM LOGIC A - BAT A. i. ELS-BAT A. j. EDS 1 - BAT A. k. FLOAT BAG 1 - BAT A.		Battery bus A	
F		B (20 amp)	Applies d-c power from battery bus B to the following circuit breakers on MDC-8. a. SERVICE PROPULSION b. SYSTEM-PITCH 2 - BAT B. c. SERVICE PROPULSION d. SYSTEM-YAW 2 - BAT B. e. SEQ EVENTS CONT f. SYSTEM - ARM B - BAT B. g. SEQ EVENTS CONT h. SYSTEM LOGIC B - BAT B. i. ELS - BAT B. j. EDS 3 - BAT B. k. FLOAT BAG 2 - BAT B.		Battery bus B	

RH EQUIPMENT BAY - PANEL 229

SM2A-03-BLOCK II-(1)
APOLLO OPERATIONS HANDBOOK

CONTROLS AND DISPLAYS

Location		Name and Position	Function	Circuit Breaker	Power Source	Remarks
Panel	Area Grid					
RHEB-229 (Cont)		SPS LINE HTRS MNA and MNB (10 amp) circuit breakers	Applies 28 vdc to SPS LINE HTRS switch on MDC-8.	N/A	DC main buses A & B	
	G					
RHEB-250		Pyro battery circuit breakers PYRO A group SEQ A (20 amp)	Applies d-c power from pyro battery A to SECS pyro bus A when SEQ EVENTS CONTROL SYSTEM switch A or B (MDC-8) is in PYRO ARM position. Applies pyro battery A voltage to DC INDICATORS switch.	N/A	Pyro battery A	Must be opened if pyro battery A fails.
	A					
	A	BAT BUS A TO PYRO BUS TIE (20 amp)	Applies d-c power from battery bus A to above circuits.		Entry battery A	Normally open in flight. Closed only if pyro battery A fails.
	A	PYRO B group SEQ B (20 amp)	Applies d-c power from pyro battery B to SECS pyro bus B when SEQ EVENTS CONTROL SYSTEM switch A or B (MDC-8) is in PYRO ARM position. Applies pyro battery B voltage to DC INDICATORS switch.		Pyro battery B	Must be opened if pyro battery B fails.
	A	BAT BUS B TO PYRO BUS TIE (20 amp)	Applies d-c power from battery bus B to above circuits.		Entry battery B	Normally open in flight. Closed only if pyro battery B fails. Colored yellow. Should not be closed if SEQ B CB is closed.

RH EQUIPMENT BAY—PANELS 229 AND 250

SM2A-03-BLOCK II-(1)
APOLLO OPERATIONS HANDBOOK

CONTROLS AND DISPLAYS

Location		Name and Position	Function	Circuit Breaker	Power Source	Remarks
Panel	Area Grid					
RHEB-250 (Cont)						
	B	BAT A PWR ENTRY/POST LANDING circuit breaker (80 amp)	Applies d-c power from entry battery A to battery bus A. (CB 41 on battery case between battery A and this CB.)		Entry battery A	
	B	BAT B PWR ENTRY/POST LANDING circuit breaker (80 amp)	Applies d-c power from entry battery B to battery bus B. (CB 42 on battery case between battery B and this CB.)		Entry battery B	
	B	BAT C PWR ENTRY/POST LANDING circuit breaker (80 amp)	Applies d-c power from entry battery C to battery C circuits. (CB 43 on battery case between battery C and this CB.)		Entry battery C	
	B	BAT C-BAT CHGR/EDS 2 circuit breaker (10 amp)	Applies connection from battery C to: a. BATTERY CHARGER selector switch, position C. b. DC INDICATORS selector switch (BAT C). c. EDS bus 2.			
	B	BAT C TO BAT BUS A circuit breaker (80 amp)	Applies d-c power from entry battery C to battery bus A.			Normally open circuit breaker that provides backup in event of failure of entry battery A.
	B	BAT C TO BAT BUS B circuit breaker (80 amp)	Applies d-c power from entry battery C to battery bus B.			Normally open circuit breaker that provides backup in event of failure of entry battery B.

RH EQUIPMENT BAY—PANEL 250

SM2A-03-BLOCK II-(1)
APOLLO OPERATIONS HANDBOOK

CONTROLS AND DISPLAYS

Location		Name and Position	Function	Circuit Breaker	Power Source	Remarks
Panel	Area Grid					
RHEB-275 (Cont)		MAIN A circuit breakers				
		BAT BUS A (80 amp)	Applies d-c power from battery bus A to d-c main bus A through contacts of BAT A/C BUS TIE motor switch and isolation diode.		Battery bus A	
		BAT C (80 amp)	Applies d-c power from battery C to d-c main bus A through contacts of BAT B/C BUS TIE motor switch and isolation diode.		Battery bus C	NOTE Normally open in flight; closed for entry prior to CSM separation.
		MAIN B circuit breakers				
		BAT C (80 amp)	Applies d-c power from battery C to d-c main bus B through contacts of BAT A/C BUS TIE motor switch and isolation diode.		Battery bus C	
		BAT BUS B (80 amp)	Applies d-c power from battery bus B to d-c main bus B through contacts of BAT B/C BUS TIE motor switch and isolation diode.		Battery bus B	

RH EQUIPMENT BAY—PANEL 275

SM2A-03-BLOCK II-(1)
 APOLLO OPERATIONS HANDBOOK

CONTROLS AND DISPLAYS

Location		Name and Position	Function	Circuit Breaker	Power Source	Remarks
Panel	Area Grid					
RHEB-276		INSTRUMENTATION POWER CONTROL OPERATIONAL circuit breakers CB1 (5 amp)	Provides d-c power to essential instrumentation.	INST ESS MNA and MNB (MDC-5)	DC main buses A & B	CB1 supplies d-c power for the following instrumentation: H2O Dump Temp CF 0461T CM He Tk A Press CR 0001P CM He Tk A Temp CR 0003T CM He Manif 1 Press CR 0035P CM He Manif 2 Press CR 0038P Temp 16 Eng Inj Sys 1 CR 2103T Temp 12 Eng Inj Sys 1 CR 2114T
		CB2 (5 amp)	Provides d-c power to essential instrumentation.			CB2 supplies d-c power for the following instrumentation: Temp Crew Ablator CA 1820T Surf Loc 1A Temp Crew Ablator CA 1821T Surf Loc 4A Temp Crew Ablator CA 1822T Surf Loc 7A Temp Crew Ablator CA 1823T Surf Loc 10A Press Batt Comprtmnt (Manif) CC 0188P Drogue Dep Relay A CE 0001X Drogue Dep Relay B CE 0002X Main Dep Relay A CE 0003X Main Dep Relay B CE 0004X Main Chute Disc Relay A CE 0321X Main Chute Disc Relay B CE 0322X Suit Cabin Delta Press CF 0003P Surge Tank Press CF 0006P H2O Tank-Glycol Res Press CF 0120P

RH EQUIPMENT BAY—PANEL 276

SM2A-03-BLOCK II-(1)
APOLLO OPERATIONS HANDBOOK

CONTROLS AND DISPLAYS

Location		Name and Position	Function	Circuit Breaker	Power Source	Remarks
Panel	Area Grid					
RHEB-276	(Cont)	CB2 (Cont)		INST ESS MNA and MNB (MDC-5)	DC main buses A & B	Prim Glycol Flow Rate CF 0157R Prim Evap Inlet Temp CF 0181T Urine Dump Nozzle Temp CF 0460T Astro 1 EKG Axis 1 CJ 0060J Astro 2 EKG Axis 1 CJ 0061J Astro 3 EKG Axis 1 CJ 0062J Astro 1 Respir CJ 0200R Astro 2 Respir CJ 0201R Astro 3 Respir CJ 0202R CM X Axis Accel CK 0026A AM Y Axis Accel CK 0027A CM Z Axis Accel CK 0028A Dosimeter 1 Radiation CK 1051K Dosimeter 2 Radiation CK 1052K Dosimeter Rate CK 1053K CM He Tk B Press CR 0002P CM He Tk B Temp CR 0004T CM He Manif 2 Press CR 0036P CM He Manif 1 Press CR 0037P Temp 14 Eng Inj Sys 1 CR 2100T Temp 24 Eng Inj Sys 2 CR 2110T Temp 25 Eng Inj Sys 2 CR 2116T Temp 21 Eng Inj Sys 2 CR 2119T Docking Probe Temp CS 0220T
		CB3 (5 amp)	Provides d-c power to essential instrumentation.			CB3 supplies d-c power for the following instrumentation: Temp Bay 2 Ox Tk Surf SA 2377T Temp Bay 5 Fuel Tk SA 2379T Surf Ox Trnsfr Line Entry SA 2400T Sump Tk

RH EQUIPMENT BAY—PANEL 276

SM2A-03-BLOCK II-(1)
 APOLLO OPERATIONS HANDBOOK

CONTROLS AND DISPLAYS

Location		Name and Position	Function	Circuit Breaker	Power Source	Remarks
Panel	Area Grid					
RHEB-276	(Cont)	CB3 (Cont)		INST ESS MNA and MNB (MDC-5)	DC main buses A & B	O ₂ Tk 2 Press SC 0038P H ₂ Tk 2 Press SC 0040P FC 2 N ₂ Press SC 2061P FC 3 N ₂ Press SC 2062P FC 2 O ₂ Press SC 2067P FC 3 O ₂ Press SC 2068P FC 2 H ₂ Press SC 2070P FC 3 H ₂ Press SC 2071P FC 2 Rad Out Temp SC 2088T FC 3 Rad Out Temp SC 2089T FC 2 Rad In Temp SC 2091T FC 3 Rad In Temp SC 2092T FC 2 H ₂ Flow SC 2140R FC 3 H ₂ Flow SC 2141R FC 2 O ₂ Flow SC 2143R FC 3 O ₂ Flow SC 2144R He Tk Press SP 0001P Ox Tks Press SP 0003P Position Fu/Ox Viv 1 Pot B SP 0022H Position Fu/Ox Viv 3 Pot B SP 0024H Position Fu/Ox Viv 2 Pot A SP 0027H Position Fu/Ox Viv 4 Pot A SP 0029H Temp Fuel Eng Feed Line SP 0048T Temp 1 Oxidizer Distr Line SP 0054T SPS Prplnt Tanks N ₂ A Press SP 0600P Eng Chamber Press SP 0661P Fuel SM/Eng Interface Press SP 0930P SM He Tk A Press SR 5001P SM He Tk C Press SR 5003P SM He Tk A Temp SR 5013T SM He Tk C Temp SR 5015T

RH EQUIPMENT BAY—PANEL 276

SM2A-03-BLOCK II-(1)
APOLLO OPERATIONS HANDBOOK

CONTROLS AND DISPLAYS

Location		Name and Position	Function	Circuit Breaker	Power Source	Remarks
Panel	Area Grid					
RHEB-276	(Cont)	CB3 (Cont)		INST ESS MNA and MNB (MDC-5)	DC main buses A & B	Qty SM Propellant Sys A SR 5025Q Qty SM Propellant Sys C SR 5027Q SM Eng Package A SR 5065T Temp SM Eng Package C SR 5067T Temp SM He Manf Sys A SR 5729P Press SM Ox Manf Sys A SR 5733P Press SM Fuel Manf Sys A SR 5737P Press SM He Manf Sys C SR 5817P Press SM Ox Manf Sys C SR 5820P Press SM Fuel Manf Sys C SR 5822P Press Proton Ct Rate Chan 1 ST 0820K Proton Ct Rate Chan 2 ST 0821K Proton Ct Rate Chan 3 ST 0822K Proton Ct Rate Chan 4 ST 0823K Alpha Ct Rate Chan 1 ST 0830K Alpha Ct Rate Chan 2 ST 0831K Alpha Ct Rate Chan 3 ST 0832K Proton Integ Ct Rate ST 0838K
		CB4 (5 amp)	Provides d-c power to essential instrumentation.			CB4 supplies d-c power for the following instrumentation. Temp Bay 3 Ox Tk Surf SA 2378T Temp Bay 6 Fuel Tk SA 2380T Surf Fuel Trnsfr Line Entry SA 2401T Sump Tk O2 Tk 1 Press SC 0037P H2 Tk 1 Press SC 0039P FC 1 N2 Press SC 2060P FC 1 O2 Press SC 2066P

RH EQUIPMENT BAY—PANEL 276

SM2A-03-BLOCK II-(1)
APOLLO OPERATIONS HANDBOOK

CONTROLS AND DISPLAYS

Location		Name and Position	Function	Circuit Breaker	Power Source	Remarks
Panel	Area Grid					
RHEB-276	(Cont)	CB4 (Cont)		INST ESS MNA and MNB (MDC-5)	DC main buses A & B	FC 1 H ₂ Press SC 2069P FC 1 Rad Out Temp SC 2087T FC 1 Rad In Temp SC 2091T FC 1 H ₂ Flow SC 2139R FC 1 O ₂ Flow SC 2142R He Tk Temp SP 0002T Fu Tks Press SP 0006P Position Fu/Ox Vlv 2 Pot B SP 0023H Position Fu/Ox Vlv 4 Pot B SP 0025H Position Fu/Ox Vlv 1 Pot A SP 0026H Position Fu/Ox Vlv 3 Pot A SP 0028H He Tk Press Display SP 0035P Temp Eng Vlv Body SP 0045T Temp Ox Eng Feed Line SP 0049T Temp 1 Fuel Distr Line SP 0057T SPS Prplnt Tanks N B Press SP 0601P Ox SM/Eng Interface Press SP 0931P SM He Tk B Press SR 5002P SM He Tk D Press SR 5004P SM He Tk B Temp SR 5014T SM He Tk D Temp SR 5016T Qty SM Propellant Sys B SR 5026Q Qty SM Propellant Sys D SR 5028Q SM Eng Package B Temp SR 5066T SM Eng Package D Temp SR 5068T SM He Manf Sys B Press SR 5776P

RH EQUIPMENT BAY—PANEL 276

SM2A-03-BLOCK II-(1)
APOLLO OPERATIONS HANDBOOK

CONTROLS AND DISPLAYS

Location		Name and Position	Function	Circuit Breaker	Power Source	Remarks	
Panel	Grid						
RHEB-276 (Cont)		CB4 (Cont)		INST ESS MNA and MNB (MDC-5)	DC main buses A & B	SM Ox Manf Sys B Press	
						SR 5780P	
RHEB-278		UPRIGHTING SYSTEM circuit breakers				SM Fuel Manf Sys B Press	
						SR 5784P	
		COMPRESSOR 1 (25 amp)	Connects power from battery bus A to motor through control relays.			Battery bus A	SM Ox Manf Sys D Press
							SR 5821P
		COMPRESSOR 2 (25 amp)	Connects power from battery bus B to motor through control relays.			Battery bus B	SM Fuel Manf Sys D Press
							SR 5823P
SIVB/LM SEP circuit breakers		PYRO A (7.5 amp)	Connects power from SECS pyro bus A to SIVB/LM separation relays.		SEQ A circuit breaker (RHEB-250)	SM He Manf Sys D Press	
		PYRO B (7.5 amp)				Connects power from SECS pyro bus B to SIVB/LM separation relays.	SR 5830P
						Nuclear Particle Det Temp	
						ST 0840T	
						Nuclear Particle Anal Temp	
						DT 0841T	

RH EQUIPMENT BAY—PANELS 276 AND 278

SM2A-03-BLOCK II-(1)
APOLLO OPERATIONS HANDBOOK

CONTROLS AND DISPLAYS

Location		Name and Position	Function	Circuit Breaker	Power Source	Remarks
Panel	Area Grid					
LHFEB-300 LHFEB-301 LHFEB-302		Suit flow control valve(s) OFF	Closes valve, shutting off flow of oxygen to and from suit connector.	N/A	N/A	Suit hose may be connected or disconnected only with valve in OFF position.
		CABIN FLOW	Partially opens valve, permitting oxygen flow into cabin (or suit) at rate compatible to requirements of one crewman.			This valve position may be used for reduced flow to PGA (suit connected), or for normal flow to cabin for shirt-sleeve mode (suit not connected). Suit hose is not disconnected from suit connector panel when going to shirtsleeve mode.
		SUIT FULL FLOW	Fully opens valve, permitting oxygen flow to suit at rate compatible to requirements of one crewman.			With valve in SUIT FULL FLOW position (suit connected), flow is at rate of 17 lb/hr minimum. However, flow rate will vary along suit flow adjustment range from SUIT FULL FLOW to CABIN FLOW positions.
Located between LHFEB-300 and LHFEB-301		CREWMAN ELECTRICAL UMBILICAL CONNECTOR(S) (3) R-L-C	These connectors interface with crewman electrical umbilicals.		Audio center equipment	These connectors provide access to audio center, audio warning system, and provides path for crewman biomedical information to go to telemetering unit.

LH FORWARD EQUIPMENT BAY—PANELS 300, 301, AND 302

SM2A-03-BLOCK II-(1)
 APOLLO OPERATIONS HANDBOOK

CONTROLS AND DISPLAYS

Location		Name and Position	Function	Circuit Breaker	Power Source	Remarks
Panel	Area					
LHFEB-303		Cabin air control louver	Manually operated louver for adjusting direction of airflow from cabin air fans.	N/A	N/A	
		PRIMARY CABIN TEMP control valve H (heat)	Manual backup mode position of cabin temperature control valve to increase cabin temperature.			Motor-operated valve is manually controlled by integral knob. Rotational movement from H to C is approximately 1/2 turn. Backup mode control knob is used in event of malfunction of cabin temperature control components. This is a dual valve on a single shaft permitting water-glycol flow to heat exchanger to be regulated. Rotation toward H (heat) position results in proportional increase in cabin temperature by directing warm water-glycol to cabin heat exchanger. There is definite time lag in cabin temperature response following manual adjustment; therefore, close coordination between manual adjustments and TEMP-CABIN indicator MDC-2 is not necessary.
		C (cool)	Manual backup mode position of cabin temperature control valve to decrease cabin temperature.			Rotation towards C (cool) position results in proportional decrease in cabin temperature by directing cool water-glycol to cabin heat exchanger. There is definite time lag in cabin temperature response following manual adjustment; therefore, close coordination between manual adjustments and TEMP-CABIN indicator MDC-2 is not necessary.

LH FORWARD EQUIPMENT BAY—PANEL 303

SM2A-03-BLOCK II-(1)
APOLLO OPERATIONS HANDBOOK

CONTROLS AND DISPLAYS

Location		Name and Position	Function	Circuit Breaker	Power Source	Remarks
Panel	Area Grid					
LHFEB-303	(Cont)	SECONDARY CABIN TEMP valve OFF COOL MAX	Prevents flow of water-glycol to cabin heat exchanger. Meters water-glycol flow through cabin heat exchanger from OFF to MAX. Full flow of secondary water-glycol system through cabin heat exchanger.	N/A	N/A	Manual control valve.
LHFEB-304		DRINKING WATER SUPPLY shutoff valve ON OFF	Permits flow of potable water to water delivery unit. Turns off flow of potable water to water delivery unit.	N/A	N/A	Shutoff valve manually controlled by permanently installed knob. Normal position of valve is ON. Valve is closed in event of leak in water delivery unit.
LHFEB-305		FOOD PREPARATION WATER supply unit COLD valve HOT valve	Upon actuation, permits metered amount of cold water (50°F) to food reconstitution nozzle. Upon activation, permits metered amount of hot water (154±4°F) to food reconstitution nozzle.	N/A	N/A	To actuate, pull on syringe-type finger grips. Cold or hot water is metered at rate of 1.00±0.05 ounce per valve actuation. Upon release, valves return to closed position.

LH FORWARD EQUIPMENT BAY—PANELS 303, 304, AND 305

SM2A-03-BLOCK II-(1)
 APOLLO OPERATIONS HANDBOOK

CONTROLS AND DISPLAYS

Location		Name and Position	Function	Circuit Breaker	Power Source	Remarks
Panel	Area Grid					
LHFEB-306		EVENT TIMER MIN-SEC indicators	Digital event timer provides crew with means of monitoring and timing events. Timer will start automatically when lift-off occurs.	TIMERS MNA and MNB (RHEB-229)	DC main buses A & B	Control switches provide means of running event timer to any desired setting and are spring-loaded to center position. Indicating drums can be run up or down, depending on position of RESET/UP/DOWN switch.
		EVENT TIMER switches				
		MIN switch	Runs MIN indicating drum in tens.			
		TENS	No function.			
		CENTER	Runs MIN indicating drum in units.			
		UNITS				
		SEC switch	Runs SEC indicating drum in tens.			
		TENS	No function.			
		CENTER	Runs SEC indicating drum in units.			
		UNITS				
		RESET/UP/DOWN	ET resets to zero and stops counting.			
		RESET	ET counts up when running or slewing.			
		UP	ET counts down when running or slewing.			
		DOWN				

LH FORWARD EQUIPMENT BAY—PANEL 306

SM2A-03-BLOCK II-(1)
 APOLLO OPERATIONS HANDBOOK

CONTROLS AND DISPLAYS

Location		Name and Position	Function	Circuit Breaker	Power Source	Remarks
Panel	Area Grid					
LHFEB-306	(Cont)	START/STOP switch START CENTER STOP	Starts event timer. No function. Stops event timer.	TIMERS MNA and MNB (RHEB-229)	DC main buses A & B	Event timer starts automatically when lift-off occurs. Switch is momentary on toward START position, and maintained on in other two positions.
		MISSION TIMER - HOURS/ MIN/SEC indicators	Has capabilities to count up mission elapsed time.			Timer provides provisions for manual setting, count-up readout (hours, minutes, and seconds), and reset to zero by remote control at lift-off. Internal timing pulse is provided in case timing signal is lost. Clock is capable of timing from external or internal timing source without losing mission time.
		MISSION TIMER switches HOURS switch TENS CENTER UNITS MIN switch TENS CENTER UNITS	Changes hour numerical readout in tens. No function. Changes hour numerical readout in units. Changes MIN numerical readout in tens. No function. Changes MIN numerical readout in units.			MISSION TIMER can only slew up to add time.

LH FORWARD EQUIPMENT BAY—PANEL 306

SM2A-03-BLOCK II-(1)
 APOLLO OPERATIONS HANDBOOK

CONTROLS AND DISPLAYS

Location		Name and Position	Function	Circuit Breaker	Power Source	Remarks
Panel	Area Grid					
LHFEB-306 (Cont)		SECOND switch	Changes second numerical read-out in tens.	TIMERS MNA and MNB (RHEB-229)	DC main buses A & B	Upon receipt of lift-off signal, timer will reset to zero and start counting up with switch in START position. Timer may be stopped at anytime by selecting STOP. To reset timer, momentarily hold switch to RESET position.
		TENS	No function.			
		CENTER	Changes second numerical read-out in units.			
LHEB-325		UNITS		N/A	N/A	There are two cabin pressure-relief valves that normally operate automatically to provide positive and negative cabin pressure relief. The upper manual control (three-valve position) and the lower manual control (four-valve position) can override their corresponding relief valves to CLOSE and NORMAL positions, while only lower manual control can override its corresponding relief valve to DUMP position. Horizontal pressure must be applied to move controls out of detent.
		START/STOP/RESET	Starts MISSION TIMER. Stops MISSION TIMER. Resets MISSION TIMER.			
		START				
		STOP				
		RESET				
		CABIN PRESSURE RELIEF valves				

LH FORWARD EQUIPMENT BAY AND LH EQUIPMENT BAY—PANELS 306 AND 325

SM2A-03-BLOCK II-(1)
 APOLLO OPERATIONS HANDBOOK

CONTROLS AND DISPLAYS

Location		Name and Position	Function	Circuit Breaker	Power Source	Remarks
Panel	Area Grid					
LHEB-325 (Cont)		CLOSE	Manual override position to close either cabin pressure-relief valve.			<p>Both relief valves are closed for prelaunch checkout and during CM RCS propellant dump, whereas either one or both relief valves are closed in flight in event of valve malfunction.</p> <p>Normal position of controls for flight period between ascent and entry. Valves are limited to the partially open position to prevent rapid cabin decompression in event valves fail open.</p> <p>Except for time required to dump RCS propellants during descent, both controls are normally set to BOOST ENTRY position for ascent and entry phases.</p> <p>Valve is opened to intentionally vent cabin to outside atmosphere in event of contamination or fire. Mechanical safety latch must be off to set lever in dump position.</p> <p>Valve remotely controlled through "Teleflex" cable.</p>
		NORMAL	Manual override position to partially restrict travel of either cabin pressure-relief valve in automatic mode.			
		BOOST ENTRY	Neutral position of override mechanism to permit both cabin pressure-relief valves full travel in automatic mode.			
		DUMP	Manual override position of lower control to open corresponding cabin pressure-relief valve.			
		PRIMARY GLYCOL TO RADIATOR PULL TO BYPASS PUSH	Directs flow of primary glycol to bypass radiators. Directs flow of primary glycol through radiators.			

LH EQUIPMENT BAY—PANEL 325

SM2A-03-BLOCK II-(1)
 APOLLO OPERATIONS HANDBOOK

CONTROLS AND DISPLAYS

Location		Name and Position	Function	Circuit Breaker	Power Source	Remarks
Panel	Grid					
LHEB-326		GLYCOL RESERVOIR valves INLET valve OPEN	Permits flow of water-glycol from system into reservoir.	N/A	N/A	Shutoff valve is manually controlled by knob. Valve is opened to direct water-glycol flow through reservoir during prelaunch and ascent phases and is operated in conjunction with GLYCOL RESERVOIR OUTLET and GLYCOL RESERVOIR BYPASS valves.
		CLOSE	Shuts off flow of water-glycol from system into reservoir.			Valve is closed upon completion of ascent phase to isolate reservoir from system.
		BYPASS valve OPEN	Opens bypass line permitting flow around water-glycol reservoir.			Shutoff valve is manually controlled by knob. Valve is opened upon completion of ascent phase to bypass and isolate reservoir from system, and is operated in conjunction with GLYCOL RESERVOIR OUTLET and GLYCOL RESERVOIR INLET valves.
		CLOSE	Close bypass line that permits flow around water-glycol reservoir.			Valve is closed to direct water-glycol flow through reservoir during prelaunch and ascent phases.
		OUTLET valve OPEN	Permits flow of water-glycol from outlet of reservoir into system.			Shutoff valve is manually controlled by knob. Valve is opened to direct water-glycol flow through reservoir during prelaunch and ascent phases, and is operated in conjunction with GLYCOL RESERVOIR INLET and GLYCOL RESERVOIR BYPASS valves.

LH EQUIPMENT BAY—PANEL 326

SM2A-03-BLOCK II-(1)
APOLLO OPERATIONS HANDBOOK

CONTROLS AND DISPLAYS

Location		Name and Position	Function	Circuit Breaker	Power Source	Remarks
Panel Area	Grid					
LHEB-326 (Cont)		CLOSE	Shuts off flow of water-glycol from outlet of reservoir into system.	N/A	N/A	Valve is closed upon completion of ascent phase to isolate reservoir from system.
		OXYGEN valves				Shutoff valve is manually controlled by knob.
		REPRESS PKG VALVE				Valve furnishes 3 pounds of oxygen as a redundant supply to the normal surge tank quantity of 3.7 pounds.
		ON	Permits flow from three 1-lb oxygen tanks into CM oxygen supply subsystem through check valve.			
		OFF	Shuts off flow between three 1-lb tanks and CM oxygen supply subsystem.			
		FILL	Permits flow from CM oxygen supply subsystem to bypass the check valve and thus fill three 1-lb tanks. It also allows flow from the surge tank to the bypass check valve during cabin repressurization.			
		SM SUPPLY valve				Shutoff valve is manually controlled by knob.
		ON	Permits flow of oxygen to CM from supply in SM.			Normal position of valve is ON.
		OFF	Shuts off flow of oxygen to CM from supply in SM.			Valve is closed prior to CSM separation to prevent CM entry oxygen supply from flowing overboard in event of check valve failure.

LH EQUIPMENT BAY—PANEL 326

SM2A-03-BLOCK II-(1)
 APOLLO OPERATIONS HANDBOOK

CONTROLS AND DISPLAYS

Location		Name and Position	Function	Circuit Breaker	Power Source	Remarks
Panel	Area Grid					
LHEB-326 (Cont)		SURGE TANK valve ON	Permits flow of oxygen to and from surge tank. Shuts off flow of oxygen to and from surge tank.	N/A	N/A	Shutoff valve is manually controlled by knob. Normal position of valve is ON, permitting surge tank to carry out function of supplying additional oxygen beyond the normal maximum flow capability from the SM, and for entry. Set O ₂ PRESS IND switch (MDC-2) to SURGE TANK to obtain indication. Valve is closed to preserve surge tank supply in event cryogenic oxygen tank pressure drops to 900 psig or below.
LHEB-350		CO ₂ -odor absorber A & B diverter valve UP Center Down	Shuts off suit circuit flow to canister B and diverts full flow to canister A. Neutral position of valve permitting equal suit circuit flow to each canister. Shuts off suit circuit flow to canister A and diverts full flow to canister B.	N/A	N/A	Diverter valve linkage includes mechanical interlock that assures cover removal of only the canister that has been isolated from suit flow.

LH EQUIPMENT BAY—PANELS 326 AND 350

SM2A-03-BLOCK II-(1)
 APOLLO OPERATIONS HANDBOOK

CONTROLS AND DISPLAYS

Location		Name and Position	Function	Circuit Breaker	Power Source	Remarks
Panel	Area Grid					
LHEB-351		<p>OXYGEN CONTROL PANEL</p> <p>CABIN REPRESS manual valve</p> <p>OPEN (cw)</p> <p>OFF (ccw)</p> <p>EMERGENCY CABIN PRESSURE</p> <p>Selector valve</p> <p>BOTH</p> <p>1</p> <p>OFF</p> <p>2</p>	<p>Directs oxygen into cabin up to the maximum flow rate of 7.2 lb per hr. Poppet-type valve is an independent unit of the cabin pressure regulator assembly.</p> <p>Shuts off oxygen flow into cabin.</p> <p>Directs regulated oxygen (100±10 psig) to No. 1 and No. 2 emergency cabin pressure regulators.</p> <p>Directs regulated oxygen (100±10 psig) to No. 1 emergency cabin pressure regulator.</p> <p>Shuts off regulated oxygen (100±10 psig) to No. 1 and No. 2 emergency cabin pressure regulators.</p> <p>Directs regulated oxygen (100±10 psig) to No. 2 emergency cabin pressure regulator.</p>	N/A	N/A	<p>Shutoff valve is manually controlled by integral knob. Rotational movement from OPEN to close is approximately 3/4 turn.</p> <p>Will pressurize CM cabin from zero to 5 psia in 75 to 90 minutes.</p> <p>Selector valve is manually controlled by T-handle tool.</p> <p>Both emergency regulators are selected for simultaneous use under normal conditions, for redundancy in event of emergency decompression as result of cabin wall puncture.</p> <p>Valve set to position 1 in event of malfunction of No. 2 emergency regulator.</p> <p>Valve is set to OFF position whenever all crewmen are suited. With valve in OFF position, both emergency regulators are isolated from regulated oxygen supply.</p> <p>Valve set to position 2 in event of malfunction of No. 1 emergency regulator.</p>

LH EQUIPMENT BAY—PANEL 351

SM2A-03-BLOCK II-(1)
 APOLLO OPERATIONS HANDBOOK

CONTROLS AND DISPLAYS

Location		Name and Position	Function	Circuit Breaker	Power Source	Remarks
Panel	Area Grid					
LHEB-351	(Cont)	PRESS TO TEST pushbutton	Permits No. 1 and No. 2 emergency cabin pressure regulators to be simultaneously tested for operational verification.	N/A	N/A	With pushbutton pressed, the vents to reference pressure chambers of both regulators are closed off. This allows artificial reference pressure to build up, which results in regulator operation. This test may be accomplished at ground checkout or during flight.
		MAIN REGULATOR valves	Directs supply of oxygen from SM to main pressure regulators A and B and relief valves.			Regulators A and B are selected for simultaneous use under normal conditions.
		"A" OPEN	Directs supply of oxygen from SM to main pressure regulator A and relief valve.			
		"B" OPEN	Directs supply of oxygen from SM to main regulator B and relief valve.			
		TOOL STORAGE receptacle	Flush-mounted receptacle for storing handle adapter (E-tool) used in positioning numerous manually operated valves.			
		WATER AND GLYCOL TANKS PRESSURE controls				Selector valve is manually controlled by E-tool.
		REGULATOR-SELECTOR INLET valve				
		BOTH	Directs regulated oxygen (100±10 psig) to No. 1 and No. 2 tank pressure regulators for reduction to 20±2-psig tank pressure.			Both tank pressure regulators are selected for simultaneous use under normal conditions for redundancy in event of one regulator malfunctioning.

LH EQUIPMENT BAY—PANEL 351

SM2A-03-BLOCK II-(1)
 APOLLO OPERATIONS HANDBOOK

CONTROLS AND DISPLAYS

Location		Name and Position	Function	Circuit Breaker	Power Source	Remarks
Panel	Area Grid					
LHEB-351 (Cont)		1	Directs regulated oxygen (100±10 psig) to No. 1 tank pressure regulator for reduction to 20±2-psig tank pressure.	N/A	N/A	<p style="text-align: center;">NOTE</p> <p>If SELECTOR INLET valve is placed to position 1 or 2, the SELECTOR OUTLET valve should be placed to corresponding position for proper operation.</p> <p>Valve is set to position 1 in event of malfunction of No. 2 tank pressure regulator.</p> <p>With valve in OFF position, tank pressurization system is isolated from regulated oxygen supply.</p> <p>Valve is set to position 2 in event of malfunction of No. 1 tank pressure regulator.</p>
		OFF	Shuts off regulated oxygen (100±10 psig) to No. 1 and No. 2 tank pressure regulators.			
		2	Directs regulated oxygen (100±10 psig) to No. 2 tank pressure regulator for reduction to 20±2-psig tank pressure.			
		RELIEF-SELECTOR OUTLET valve BOTH	Directs oxygen pressure from potable and waste water tanks to No. 1 and No. 2 tank pressure regulator relief valves.			<p>Selector valve is manually controlled by E-tool.</p> <p>Both tank pressure-relief valves are selected for simultaneous use under normal conditions for redundancy in event of one relief valve malfunctioning.</p> <p>There is no meter to indicate pressurization of potable and waste water tanks and glycol reservoir.</p>

LH EQUIPMENT BAY—PANEL 351

SM2A-03-BLOCK II-(1)
APOLLO OPERATIONS HANDBOOK

CONTROLS AND DISPLAYS

Location		Name and Position	Function	Circuit Breaker	Power Source	Remarks
Panel	Grid					
LHEB-351 (Cont)		1	Directs oxygen pressure from potable and waste water tanks to No. 1 tank pressure regulator relief valve.	N/A	N/A	<p>NOTE</p> <p>If SELECTOR OUTLET valve is placed to position 1 or 2, SELECTOR INLET valve should be placed to corresponding position for proper operation.</p> <p>Valves set to position 1 in event of malfunction of No. 2 tank pressure regulator relief valve.</p> <p>With valve in OFF position, any increase in oxygen pressure is trapped and cannot be relieved.</p> <p>Valve set to position 2 in event of malfunction of No. 1 tank pressure regulator relief valve.</p>
		OFF	Shuts off oxygen pressure from potable and waste water tanks to No. 1 and No. 2 tank pressure regulator relief valves.			
		2	Directs oxygen pressure from potable and waste water tanks to No. 2 tank pressure regulator relief valve.			
LHEB-352		WATER CONTROL PANEL WASTE TANK SERVICING valve	Permits flow of water into waste water tank from ground servicing connection. Shuts off flow of water into waste water tank from ground servicing connection.	N/A	N/A	<p>Shutoff valve is manually controlled by E-tool.</p> <p>Valve is opened when used in conjunction with adjacent WASTE TANK SERVICING connector.</p>

LH EQUIPMENT BAY—PANELS 351 AND 352

SM2A-03-BLOCK II-(1)
APOLLO OPERATIONS HANDBOOK

CONTROLS AND DISPLAYS

Location		Name and Position	Function	Circuit Breaker	Power Source	Remarks
Panel	Area Grid					
LHEB-352 (Cont)		<p>PRESSURE RELIEF selector valve</p> <p>DUMP A</p> <p>DUMP B</p> <p>OFF</p> <p>2</p>	<p>Permits excess water to be dumped overboard manually.</p> <p>Permits excess water to be dumped overboard manually.</p> <p>Shut off flow of excess potable and waste water to No. 1 and No. 2 pressure relief valves.</p> <p>Directs flow of excess potable and waste water to No. 2 pressure relief valve.</p>	N/A	N/A	<p>With valve in OFF position, excess water cannot be dumped overboard.</p> <p>Valve set to position 2 to provide automatic pressure relief function.</p>
		<p>POTABLE TANK INLET valve</p> <p>OPEN</p> <p>CLOSE</p>	<p>Permits flow of water from fuel cells into potable water tank.</p> <p>Shuts off flow of water from fuel cells into potable water tank.</p>			<p>Shutoff valve is manually controlled by E-tool.</p> <p>Normal position of valve is OPEN.</p> <p>Valve set to CLOSE position to isolate potable water tank in event water from fuel cells becomes contaminated.</p>
		<p>WASTE TANK INLET valve</p> <p>AUTO</p> <p>CLOSE</p>	<p>Permits flow of water from fuel cells into waste water tank when relief valve differential pressure reaches 6.0±0.5 psi.</p> <p>Shuts off flow of water from fuel cells to differential pressure-relief valve and waste water tank.</p>			<p>Shutoff function of this relief-shutoff valve is manually controlled by T-handle tool.</p> <p>Normal position of valve is AUTO. If potable water tank is full or waste tank is empty, water from fuel cells will flow into waste water tank when relief valve reaches 6.0±0.5 psid.</p> <p>Valve set to CLOSE position in event relief valve fails open.</p>

LH EQUIPMENT BAY—PANEL 352

SM2A-03-BLOCK II-(1)
 APOLLO OPERATIONS HANDBOOK

CONTROLS AND DISPLAYS

Location		Name and Position	Function	Circuit Breaker	Power Source	Remarks
Panel	Area Grid					
LHEB-375		OXYGEN SURGE TANK PRESSURE RELIEF shutoff valve OPEN (CW) CLOSE (CCW)	Opens line from surge tank to relief valve permitting relief function. Closes line from surge tank to relief valve eliminating relief function.	N/A	N/A	Shutoff valve is manually controlled by T-handle tool. Rotational movement from OPEN to close is 1/4 turn. OPEN position enables relief valve to function when surge tank pressure increases to 1045±25 psig. Valve is closed only if surge tank relief valve fails open.
LHEB-376		PLVC switch NORMAL OPEN	Applies d-c power to pendulum-type attitude sensing switch of PLV system during normal postlanding operations. Applies d-c power directly to PLV valves, placing valves in open position in event of abnormal postlanding operations.	PL VENT FLT/PL (MDC-8)	Flight & postlanding bus	Switch set to NORMAL position to permit normal operation of attitude sensing switch (to close PLV valves) when CM becomes inverted or tilts beyond a specified limit. Switch set to OPEN position in event of attitude sensing switch failure, or to aid crew to escape from inverted CM.

LH EQUIPMENT BAY—PANELS 375 AND 376

SM2A-03-BLOCK II-(1)
APOLLO OPERATIONS HANDBOOK

CONTROLS AND DISPLAYS

Location		Name and Position	Function	Circuit Breaker	Power Source	Remarks
Panel Area	Grid					
LHEB-377		GLYCOL TO RADIATORS SEC NORMAL BYPASS	Directs water-glycol flow to the secondary space radiator. Directs water-glycol flow to bypass the secondary space radiator.	N/A	N/A	Manual control valve only. NORMAL position CW rotation.
LHEB-378		PRIM GLYCOL ACCUM Open (ccw) CLOSE (cw)	Permits flow of water-glycol from system to and from water-glycol accumulator. Shuts off flow of water-glycol from system to water-glycol accumulator.	N/A	N/A	Shutoff valve is manually controlled by use of the adapter handle (E-tool). Normal position of valve is open, permitting accumulator to carry out function of damping surges, thermal expansions and maintaining pump inlet pressure. Valve is closed to isolate a leaking accumulator from water glycol system.
LHEB-379		PRIM ACCUM FILL valve ON OFF	Directs water-glycol flow into primary system to make up supply and fill accumulator from reservoir. Isolates reservoir from system when reservoir is not in line.	N/A	N/A	Manual control valve. ON position CCW, OFF position CW.

LH EQUIPMENT BAY—PANELS 377, 378, AND 379

SM2A-03-BLOCK II-(1)
 APOLLO OPERATIONS HANDBOOK

CONTROLS AND DISPLAYS

Location		Name and Position	Function	Circuit Breaker	Power Source	Remarks
Panel	Area					
LHEB-380		SUIT TEST valve	Routes regulated oxygen flow (100±10 psig) directly into suit circuit through pressurization orifice at maximum buildup rate of 4 psig per minute for PGA/suit circuit tests.	N/A	N/A	Valve is operated by an integral lever. With valve in PRESS position, suit circuit will increase 4.1 to 4.5 psi above cabin pressure. Approximately 75 seconds must be allowed for suit circuit pressure to reach maximum. This test may be performed at ground checkout or during flight.
		PRESS				
		DEPRESS	Shuts off O ₂ flow to suit circuit upon completion of test, permitting reduction of pressure buildup at average bleedoff rate of 4 psig per minute.			Approximately 75 seconds must be allowed for the increased suit circuit pressure to bleed back to nominal 5.0±0.3 psia.
		OFF	Permits normal O ₂ flow to suit circuit through suit demand pressure regulator.			Normal position of valve when not conducting PGA/suit circuit test. Valve must not be set to off position before suit circuit has returned to nominal pressure.
		O ₂ DEMAND REGULATOR				Valve is manually controlled by permanent knob.
		1	Directs regulated oxygen (100±10 psig) to No. 1 suit demand pressure regulator.			Valve set to position 1 in event of malfunction of No. 2 demand pressure regulator.
		BOTH	Directs regulated oxygen (100±10 psig) to No. 1 and No. 2 suit demand pressure regulators.			Both demand pressure regulators are selected for simultaneous use under normal conditions for redundancy in event of one regulator malfunctioning.
		2	Directs regulated oxygen (100±10 psig) to No. 2 suit demand pressure regulator.			Valve set to position 2 in event of malfunction of No. 1 demand pressure regulator.

LH EQUIPMENT BAY—PANEL 380

SM2A-03-BLOCK II-(1)
APOLLO OPERATIONS HANDBOOK

CONTROLS AND DISPLAYS

Location		Name and Position	Function	Circuit Breaker	Power Source	Remarks
Panel	Grid					
LHEB-380 (Cont)		OFF	Shuts off regulated oxygen (100±10 psig) to No. 1 and No. 2 suit demand pressure regulators.	N/A	N/A	Valve set to OFF position only if both suit demand pressure regulators malfunction.
		SUIT CIRCUIT RETURN VALVE PULL TO OPEN PUSH TO CLOSE	Permits flow of cabin gases to enter suit circuit for processing. Shuts off flow of cabin gases entering suit circuit.			Shutoff valve is manually controlled. The valve is closed when all three astronauts are suited.
LHEB-382		COOLANT CONTROL PANEL EVAP WATER CONTROL valves (2) PRIMARY and SECONDARY AUTO OFF	Permits H ₂ O flow into primary and secondary water-glycol evaporators by operation of the water-glycol evaporators automatic control systems. Manual selection to OFF position prevents water from entering evaporators.	N/A	N/A	Manually operated valves only.

LH EQUIPMENT BAY—PANELS 380 AND 382

SM2A-03-BLOCK II-(1)
APOLLO OPERATIONS HANDBOOK

CONTROLS AND DISPLAYS

Location		Name and Position	Function	Circuit Breaker	Power Source	Remarks
Panel	Area Grid					
LHEB-382 (Cont)		PRIMARY GLYCOL EVAP INLET TEMP valve	Manual backup mode position of water-glycol temperature control valve to increase temperature of water-glycol entering evaporator.	N/A	N/A	Motor-operated valve is manually controlled by E-tool (PUSH TO ENGAGE). Rotational movement from HEAT to COOL is 90°.
		MAX (cw)				Backup mode is used in event of malfunction of water-glycol temperature control components. Rotation toward MIN position results in proportional temperature increase by changing mixture ratio of hot-to-cold water-glycol. Close coordination between valve adjustments and GLY EVAP - OUTLET TEMP indicator is necessary to obtain correct water-glycol temperature.
		MIN (ccw)	Manual backup mode position of water-glycol temperature control valve to decrease temperature of water-glycol entering evaporator.			Rotation toward MIN position results in proportional temperature decrease by changing mixture ratio of cold-to-hot water-glycol. Close coordination between valve adjustments and GLY EVAP - OUTLET TEMP indicator is necessary to obtain correct water-glycol temperature.
		SUIT FLOW RELIEF valve				Valve is manually controlled by E-tool.
		AUTO	Removes override lever from poppet valve, permitting automatic pressure-relief action to take place at a ΔP of 5 (+0.6, -0.2) inches H ₂ O.			Normal position of valve is AUTO to maintain constant suit flow in event of suit circuit flow resistance fluctuations.
		OFF	Applies override lever to poppet valve, holding valve in closed position.			Valve is manually closed in event of its failure to close when in the automatic mode.

LH EQUIPMENT BAY—PANEL 382

SM2A-03-BLOCK II-(1)
 APOLLO OPERATIONS HANDBOOK

CONTROLS AND DISPLAYS

Location		Name and Position	Function	Circuit Breaker	Power Source	Remarks	
Panel	Area Grid						
LHEB-382 (Cont)		SUIT HT EXCH PRIMARY GLYCOL valve	Permits water-glycol system flow through the suit heat exchanger.	GLYCOL PUMPS (MDC-4)	AC 1, ØB	CCW position permits flow through suit heat exchanger; manually override, PUSH TO ENGAGE.	
		FLOW	Prevents flow of water-glycol through suit heat exchanger.			Normally valve is electrically operated from MDC-2.	
		BYPASS	Valve is manually controlled.	N/A	N/A	CW position BYPASS, CCW position is FLOW.	
		SUIT HI EXCH SECONDARY GLYCOL valve	Permits secondary water-glycol system flow through suit heat exchanger.				
		FLOW	Direct secondary water-glycol system flow to bypass suit heat exchanger.				
		BYPASS					
		WATER ACCUMULATOR selector valves (2)	Routes regulated oxygen (100±10 psig) to No. 1 cyclic accumulator, bypassing solenoid shutoff valve.			Valves manually controlled by E-tool. Valve position is selected only when No. 2 accumulator has failed; and No. 1 solenoid shutoff valve cannot be operated automatically or by manually selected electrical impulse. Valve will then be positioned to MAN for approximately 10 seconds every 10 minutes.	
		Valve 1					
		MAN					

LH EQUIPMENT BAY—PANEL 382

SM2A-03-BLOCK II-(1)
APOLLO OPERATIONS HANDBOOK

CONTROLS AND DISPLAYS

Location		Name and Position	Function	Circuit Breaker	Power Source	Remarks
Panel	Area Grid					
LHEB-382	(Cont)	OFF	Shuts off regulated oxygen (100±10 psig) to solenoid shutoff valve and bypass line to No. 1 cyclic accumulator.	N/A	N/A	Normal position of valve is RMTE, permitting automatic (CTE) or manually selected electrical impulse to operate solenoid shutoff valve. Manually selected electrical operation is used in event of automatic control unit malfunction.
		RMTE	Routes regulated oxygen (100±10 psig) to solenoid shutoff valve of No. 1 cyclic accumulator.			
		Valve 2				Valve position is selected only when No. 1 accumulator has failed and No. 2 solenoid shutoff valve cannot be operated automatically or by manually selected electrical impulse. Valve will be positioned to MAN for approximately 10 seconds every 10 minutes.
		MAN	Routes regulated oxygen (100±10 psig) to No. 2 cyclic accumulator, bypassing solenoid shutoff valve.			
		OFF	Shuts off regulated oxygen (100±10 psig) to solenoid shutoff valve and bypass line to No. 2 cyclic accumulator.			Normal position of valve is RMTE permitting automatic CTE or manually selected electrical impulse to operate solenoid shutoff valve. Manually selected electrical operation is used in event of automatic control unit malfunction.
		RMTE	Routes regulated oxygen (100±10 psig) to solenoid shutoff valve of No. 2 cyclic accumulator.			

LH EQUIPMENT BAY—PANEL 382

SM2A-03-BLOCK II-(1)
 APOLLO OPERATIONS HANDBOOK

CONTROLS AND DISPLAYS

Location		Name and Position	Function	Circuit Breaker	Power Source	Remarks
Panel	Grid					
UEB-600		EMERGENCY O ₂ VALVE OPEN	Permits oxygen to flow to emergency breathing oxygen regulator.	N/A	N/A	Supplies oxygen to crew through oxygen masks when cabin gases become contaminated.
		CLOSED	Shuts off flow of oxygen to emergency breathing oxygen regulator.			
UEB-601		REPRESS O ₂ VALVE OPEN	Dumps oxygen into cabin at very high flow rate (approx 5.4 lb in 1.0 minute).	N/A	N/A	Can be used for repressurizing the CM rapidly.
		CLOSED	Shut off.			
UEB-602		OXYGEN REPRESS PRESSURE gauge	Indicates pressure in oxygen repressurization tanks.	N/A	N/A	Range 0-1200 psig full at 900±35 psig. Manually operated with E-tool.
		OXYGEN REPRESS PRESSURE RELIEF valve AUTO OFF	Permits relief of O ₂ excessive pressure. Permits positive closing of valve once it is opened.			

UPPER EQUIPMENT BAY—PANELS 600, 601, AND 602

SM2A-03-BLOCK II-(1)
APOLLO OPERATIONS HANDBOOK

CONTROLS AND DISPLAYS

Location		Name and Position	Function	Circuit Breaker	Power Source	Remarks
Panel	Area Grid					
LH armrest LH couch		<p>Translation Controller (no placard) control</p> <p>Locking mechanism</p> <p>LOCKED</p> <p>ARMED</p> <p>T-handle (Refer to Remarks)</p> <p>Push (X axis)</p> <p>Pull (X axis)</p> <p>Push limbs of T-handle to right.</p> <p>Push limbs of T-handle to left.</p> <p>Push limbs of T-handle up.</p> <p>Push limbs of T-handle down.</p> <p>Rotate clockwise</p>	<p>Mechanically locks control T-handle so that translation commands (only) cannot be made.</p> <p>Releases mechanical lock on T-handle.</p> <p>Switch closures provide logic signals for:</p> <p>SC plus X-axis acceleration.</p> <p>SC minus X-axis acceleration.</p> <p>SC plus Y-axis acceleration.</p> <p>SC minus Y-axis acceleration.</p> <p>SC minus Z-axis acceleration.</p> <p>SC plus Z-axis acceleration.</p> <p>a. Inhibits CMC (if active). Engages SCS backup configuration selected. (Refer to Remarks.)</p> <p>b. Transfers from SCS-AUTO TVC (if active) to MTVC-RATE CMD.</p>	N/A	DC main buses A & B	<p>a. Orientation of TC in spacecraft (SC) is such that stem of T-handle is approximately parallel to SC X axis and limbs are approximately parallel to SC Z axis. This information will be used in defining motions and functions.</p> <p>b. Acceleration command switches in TC receive power from SCS CONTR/AUTO MNA and MNB circuit breakers through TRANSLATION CONTR POWER switch on MDC-1.</p>
					LOGIC BUS 1/2-MNA 2/3-MNB (MDC-8)	<p>a. CW rotation opens a normally closed switch which removes G&N power signal from SC CONT switch (CMC position).</p> <p>b. Normally open switch is closed and routes SCS LOGIC BUS 2 for a CW signal to ECA and TVSA, and RJEC.</p>

LH ARMREST—LH COUCH

SM2A-03-BLOCK II-(1)
 APOLLO OPERATIONS HANDBOOK

CONTROLS AND DISPLAYS

Location		Name and Position	Function	Circuit Breaker	Power Source	Remarks
Panel	Area Grid					
LH armrest (Cont) LH couch (Cont)		Rotate counterclockwise (CCW switch)	Abort initiation. Redundant switches close sending 28 vdc to a. MESC A b. MESC B	EPS BAT BUS A and B cb (MDC-229) and SEQ EVENTS CONT SYSTEM LOGIC A and B (MDC-8)	Battery buses A & B	Power to (redundant) TC-CCW switches routed from MDC-8 circuit breakers and SEQ EVENTS CONT SYSTEM LOGIC 1 and 2 switches.
RH armrest LH couch (Will also be used at G&C control station in Lower Equipment Bay)		Rotational Controller - No. 2 control (no placard) Locking mechanism LOCKED ARMED Push-to-talk trigger switch Not actuated (less than 5 degrees travel)	Inhibits (mechanically) all functions except push-to-talk communications switch. Removes power from breakout switches. All functions mechanically enabled. Enables power to breakout switches. No function.	N/A		

LH ARMREST - LH COUCH
 RH ARMREST - LH COUCH

SM2A-03-BLOCK II-(1)
 APOLLO OPERATIONS HANDBOOK

CONTROLS AND DISPLAYS

Location		Name and Position	Function	Circuit Breaker	Power Source	Remarks
Panel	Area Grid					
RH armrest (Cont) LH couch (Cont)		<p>Actuated (5 to 20 degrees travel)</p> <p>Hand control motions (nominal locations in EITHER direction)</p> <p>Rotated about Y-axis</p> <p>Less than 1.5 degrees</p> <p>1.5 degrees</p>	<p>Switch actuation closes a ground through audio center to enable commander's communications.</p> <p>Refer to Remarks.</p> <p>a. No input when under RCS control.</p> <p>b. Supplies proportional (to put magnitude to controller travel) input to pitch MTVC electronics when selected.</p> <p>Breakout switch actuation that has the following functions when MANUAL ATTITUDE-PITCH switch is in position indicated (has no function for MTVC):</p> <p>a. ACCEL CMD - input (28 vdc) to pitch-jet select logic that causes continuous pitch acceleration (plus or minus).</p> <p>b. RATE CMD - electrically rate cages pitch attitude BMAG (if uncaged). Enables manual control loop in ECA.</p> <p>c. MIN IMP - input (28 vdc) to ECA that brings about one minimum impulse firing of pitch jets (plus or minus).</p>	N/A	N/A	<p>Hand control has rotational freedom about 3 axes that are parallel (approximately) to SC axes. Motions about an axis, or axes, will cause SC rotations about the corresponding axis or axes.</p> <p>The 28-vdc breakout switch power is routed through MDC-229 GROUP 1 circuit breakers (MNA and MNB), the MDC-8 STABILIZATION CONTROL SYSTEM CONTROL/AUTO circuit breakers (MNA and MNB), the ROT CONTR PWR NORMAL 2 switch (AC/DC position), and RHC-2 LOCK/ARM switch.</p> <p>AC voltage for RC transducer(s) reference is obtained from an ECA transformer that is switched (primary) by SCS ELECTRONICS POWER switch (ECA and GDC/ECA positions) supplied from STABILIZATION/CONTROL SYSTEM ECA/TVC AC 2 circuit breaker (MDC-8).</p> <p>The 26 vac (from the ECA transformer) is then routed to RHC-2 via AC/DC or AC position of the STABILIZATION CONTROL SYSTEM CONTR/AUTO NORMAL 2 switch.</p>

RH ARMREST—LH COUCH

SM2A-03-BLOCK II-(1)
 APOLLO OPERATIONS HANDBOOK

CONTROLS AND DISPLAYS

Location		Name and Position	Function	Circuit Breaker	Power Source	Remarks
Panel	Area Grid					
RH armrest (Cont) LH couch (Cont)		1.5 to 10 degrees	Supplies proportionally (to control travel) increasing input to ECA for either RCS-RATE CMD control or MTVC.	N/A	DC main buses A & B AC bus 2	
		11 degrees	A switch closure occurs so that, if DIRECT RCS is up (not OFF): a. 28 vdc is supplied to direct coils on pitch jets (plus or minus). b. Pitch (plus and minus) auto coil solenoid drivers are disabled.		DC main bus A &/or B	The 28 vdc direct switch power is supplied via MDC-229 Group 5 circuit breakers (MNA and MNB), MDC-8 SCS CONTR/DIRECT 2 circuit breakers (MNA and MNB), and ROT CONTR PWR DIRECT 2 switch (MNA and B or MNB position).
		Rotated about Z-axis Less than 1.5 degrees	a. No input when under RCS control. b. Supplies proportional (input magnitude to controller travel) input to pitch MTVC electronics when selected.			
		1.5 degrees	Breakout switch actuation that has the following functions when MANUAL ATTITUDE - YAW switch is in position indicated (has no function for MTVC): a. ACCEL CMD - input (28 vdc) to yaw-jet select logic that causes continuous yaw acceleration (plus or minus).		DC main buses A & B AC bus 2	The 28 vdc breakout switch power is routed through MDC-229 Group 1 circuit breakers (MNA and MNB), the MDC-8 STABILIZATION CONTROL SYSTEM CONTR/AUTO circuit breakers (MNA and MNB), the ROT CONTR PWR NORMAL 2 switch (AC/DC position), and RHC-2 LOCK/ARM switch. AC voltage for RC transducer(s) reference is obtained from an ECA transformer that is switched (primary) by SCS ELECTRONICS POWER switch (ECA and GDC/ECA)

RH ARMREST—LH COUCH

SM2A-03-BLOCK II-(1)
 APOLLO OPERATIONS HANDBOOK

CONTROLS AND DISPLAYS

Location		Name and Position	Function	Circuit Breaker	Power Source	Remarks
Panel	Area Grid					
RH armrest (Cont) LH couch (Cont)		<p>1.5 to 10 degrees</p> <p>11 degrees</p> <p>Rotated about X axis</p> <p>Less than 1.5 degrees</p>	<p>b. RATE CMD - electrically rate cages yaw attitude BMAG (if uncaged). Enables manual control loop in ECA.</p> <p>c. MIN IMP - input (28 vdc) to ECA that brings about one minimum impulse firing of yaw-jets (plus or minus).</p> <p>Supplies proportionally (to control travel) increasing input to ECA for either RCS-RATE CMD control or MTVC.</p> <p>A switch closure occurs so that, if DIRECT RCS is up (not OFF):</p> <p>a. 28 vdc is supplied to direct coils on yaw-jets (plus or minus).</p> <p>b. Yaw (plus and minus) auto coil solenoid drivers are disabled.</p> <p>a. No input when under RCS control.</p> <p>b. Supplies proportional (input magnitude to controller travel) input to pitch MTVC electronics when selected.</p>	N/A	<p>DC main buses A & B AC bus 2</p> <p>DC main bus A &/or B</p>	<p>positions) supplied from STABILIZATION/CONTROL SYSTEM ECA/TVC AC 2 circuit breaker (MDC-8).</p> <p>The 26 vdc (from the ECA transformer) is then routed to RHC-2 via AC/DC or AC position of the STABILIZATION CONTROL SYSTEM CONTR/AUTO NORMAL 2 switch.</p> <p>The 28 vdc direct switch power is supplied via MDC-229 Group 5 circuit breakers (MNA and MNB), MDC-8 SCS CONTR/DIRECT 2 circuit breakers (MNA and MNB), and ROT CONTR PWR DIRECT 2 switch (MNA and B or MNB position).</p>

RH ARMREST—LH COUCH

SM2A-03-BLOCK II-(1)
APOLLO OPERATIONS HANDBOOK

CONTROLS AND DISPLAYS

Location		Name and Position	Function	Circuit Breaker	Power Source	Remarks
Panel Area	Grid					
RH armrest (Cont) LH couch (Cont)		1.5 degrees	<p>Breakout switch actuation that has the following functions when MANUAL ATTITUDE-ROLL switch is in position indicated (has no function for MTVC).</p> <p>a. ACCEL CMD - input (28 vdc) to roll-jet select logic that causes continuous roll acceleration (plus or minus).</p> <p>b. RATE CMD - electrically rate cages roll attitude BMAG (if uncaged). Enables manual control loop in ECA.</p> <p>c. MIN IMP - input (28 vdc) to ECA that brings about one minimum impulse firing of roll-jets (plus or minus).</p> <p>Supplies proportionally (to control travel) increasing input to ECA for either RCS-RATE CMD control or MTVC.</p>	N/A	DC main buses A & B AC bus 2	<p>The 28 vdc breakout switch power is routed through MDC-229 Group 1 circuit breakers (MNA and MNB), the MDC-8 STABILIZATION CONTROL SYSTEM CONTR/AUTO circuit breakers (MNA and MNB), the ROT CONTR PWR NORMAL 2 switch (AC/DC), and the RHC-2 LOCK/ARM switches.</p> <p>AC voltage for RC transducer(s) reference is obtained from an ECA transformer that is switched (primary) by SCS ELECTRONICS POWER switch (ECA and GDC/ECA positions) supplied from STABILIZATION/CONTROL SYSTEM ECA/TVC AC 2 circuit breaker (MDC-8).</p> <p>The 26 vdc (from the ECA transformer) is then routed to RHC-2 via AC/DC or AC position of the STABILIZATION CONTROL SYSTEM CONTR/AUTO NORMAL 2 switch.</p>
		1.5 to 10 degrees	<p>A switch closure occurs so that, if DIRECT RCS is up (not OFF):</p> <p>a. 28 vdc is supplied to direct coils on roll-jets (plus or minus).</p> <p>b. Roll (plus and minus) auto coil solenoid drivers are disabled.</p>		DC main bus A &/or B	<p>The 28 vdc direct switch power is supplied via MDC-229 Group 5 circuit breakers (MNA and MNB), MDC-8 SCS CONTR/DIRECT 2 circuit breakers (MNA and MNB), and ROT CONTR PWR DIRECT 2 switch (MNA and B or MNB position).</p>
		11 degrees				

RH ARMREST—LH COUCH

SM2A-03-BLOCK II-(1)
 APOLLO OPERATIONS HANDBOOK

CONTROLS AND DISPLAYS

Location		Name and Position	Function	Circuit Breaker	Power Source	Remarks
Panel	Area Grid					
LH armrest RH couch		ROTATIONAL CONTROLLER - No. 1 control (no placard) Position of switches and control travel same as for RC-2.	Provides same functions as RC-2 except push-to-talk enables CSM pilot's communications. Refer to Power Sources and Remarks columns.	N/A	DC main buses A &/or B AC bus 1	<p>The 28 vdc breakout switch power is routed through the MDC-229 Group 1 circuit breakers (MNA and MNB), the MDC-8 STABILIZATION CONTROL SYSTEM CONTR/AUTO circuit breakers (MNA and MNB), the ROT CONT PWR NORMAL 1 switch (AC/DC position), and RHC-1 LOCK/ARM switch.</p> <p>AC voltage for RC transducer(s) reference is from ECA and SCS ELECTRONICS POWER switch (ECA and GDC/ECA positions) supplied by STABILIZATION/CONTROL SYSTEM AC 1 circuit breaker (MDC-8).</p> <p>The 26 vac (from ECA transformer) is then routed to RHC-1 via AC/DC or AC position of STABILIZATION CONTROL SYSTEM CONTR/AUTO NORMAL 1 switch.</p> <p>The 28 vdc direct switch power is supplied via MDC-229 Group 5 circuit breakers (MNA and MNB), MDC-8 SCS CONTR/DIRECT 1 circuit breakers (MNA and MNB), and ROT CONTR PWR DIRECT 1 switch (MNA/MNB or MNB position).</p>

LH ARMREST—RH COUCH

SM2A-03-BLOCK II-(1)
 APOLLO OPERATIONS HANDBOOK

CONTROLS AND DISPLAYS

Location		Name and Position	Function	Circuit Breaker	Power Source	Remarks
Panel	Area Grid					
Pressure Garment Assembly		PGA pressure indicator	Indicates differential oxygen pressure inside pressure garment assembly.	None	None	The indicator is located on the right sleeve between wrist and elbow, on top of arm. The indicator range is from 2.5 to 5 psia.

PRESSURE GARMENT ASSEMBLY

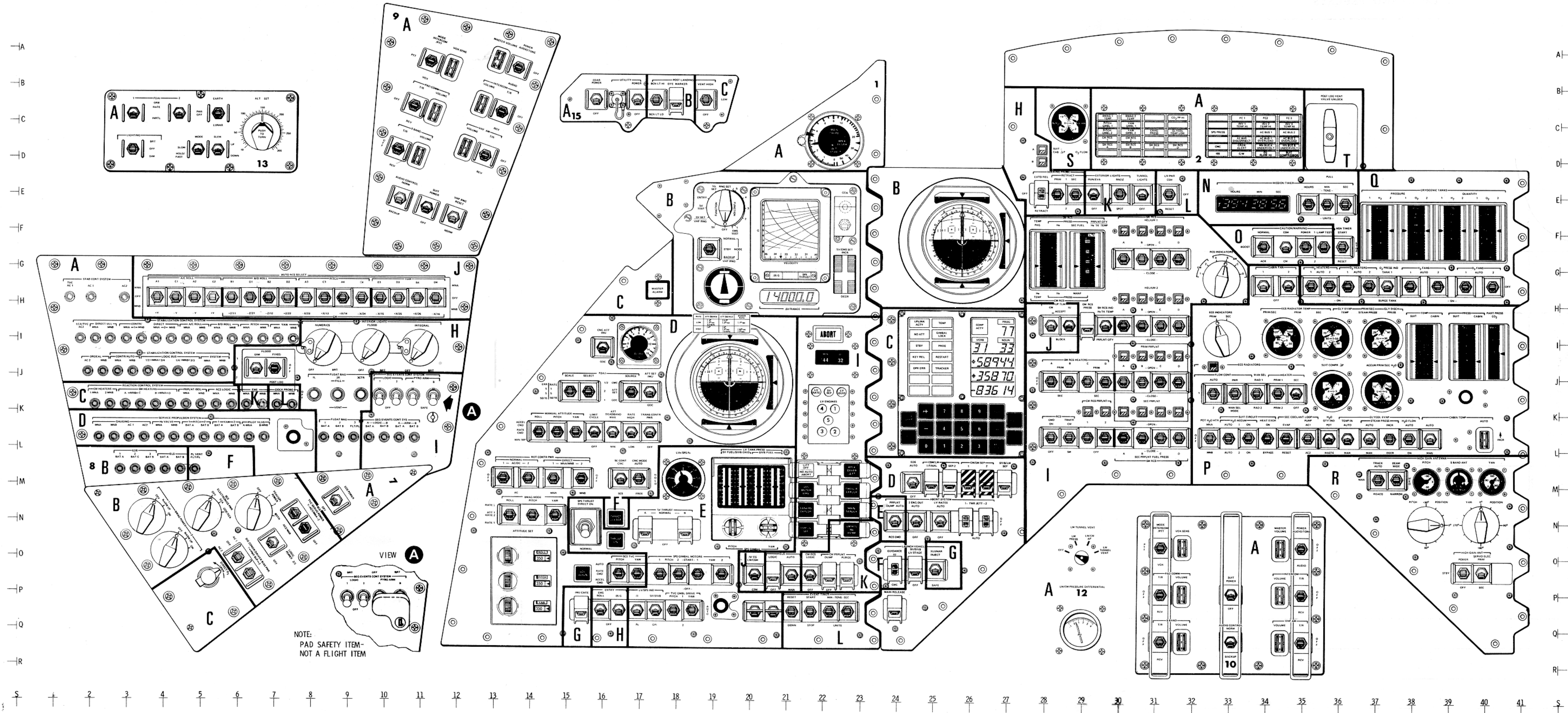
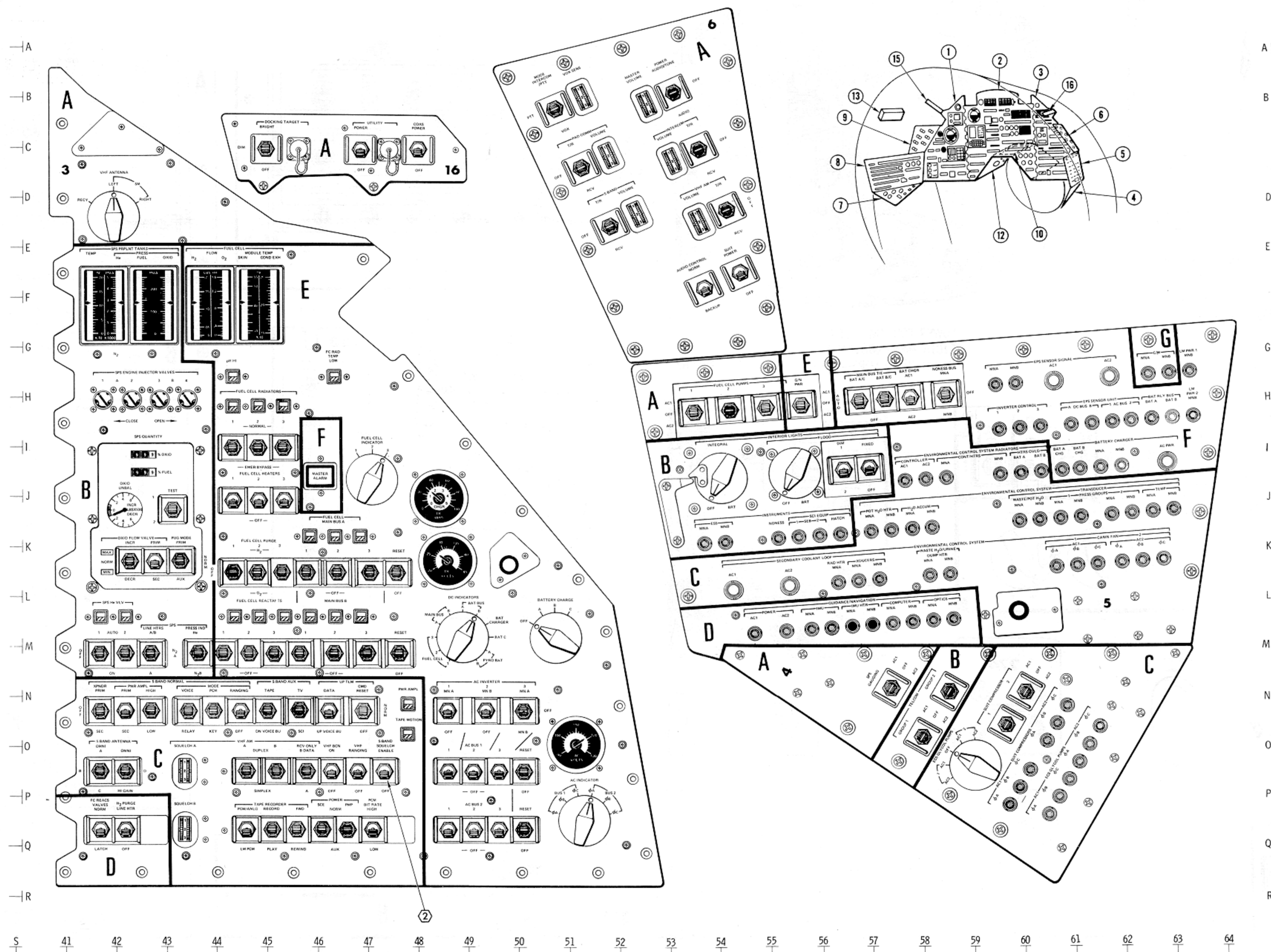

Figure 3-1. Controls and Displays, SC 106 and Subs (Sheet 1 of 4)



CONTROLS AND DISPLAYS INDEX BY SYSTEM

PANEL NO.	AREA	GRID	PANEL NO.	AREA	GRID	PANEL NO.	AREA	GRID	PANEL NO.	AREA	GRID	PANEL NO.	AREA	GRID	PANEL NO.	AREA	GRID
CAUTION AND WARNING			ENVIRONMENTAL CONTROL			ELECTRICAL POWER			MISCELLANEOUS			SERVICE PROPULSION			STABILIZATION & CONTROL		
1	C	H-17	2	P	L-32	2	L	E-32	2	K	E-30	1	E	N-19	1	B	E-18
2	A	C-32	2	S	D-29	2	Q	E-37	5	B	I-53	3	B	I-41	2	D	I-18
2	O	F-33	2	T	D-36	3	D	Q-42	8	H	I-12	4	A	N-54	3	E	N-19
3	F	I-46	4	C	M-62	3	E	E-46	15	A	B-17	7	B	N-3	4	F	N-17
5	G	G-62	5	C	L-53	5	A	H-53	15	B	B-18	8	D	K-2	7	H	Q-16
			5	B	K-54	5	B	J-53	16	A	B-45	101	A		8	J	P-20
			5	C	Q-5	5	F	H-56	100	A		229	A		2	B	E-24
			7	C	L-5	8	H	I-11	101	C		229	A		7	B	M-3
			8	F	L-5	100	A		162			229	D		8	A	G-2
			15	A	P-28	101	A		163			229	F		8	J	H-12
			15	C	B-19	225	A		226	D		276	G		8	K	K-6
COMMUNICATIONS			8	F	L-5	226	A		227	E		276			13	A	C-3
2	J	I-28	101	C	B-19	226	A		229	A					229	A	
2	R	M-36	251			226	A		229	B					229	C	
3	A	B-41	252			226	B		229	E					229	A	
3	C	O-43	300			226	C		278	A					229	C	
4	B	N-58	301			226	D		278	B							
6	A	A-53	302			229	A										
9	A	A-12	303			229	B										
10	A	O-34	304			229	C										
100	A		305			229	D										
101	A		325			229	E										
180	A		326			229	F										
225	A		350°			229	G										
276	A		351			250	A										
			352			250	B										
			375			275	A										
			376			276	B										
			377														
DOCKING (DKG)			378			GUIDANCE & NAVIGATION											
2	H	D-28	379			1	G	Q-15	101	J	H-12	1	F	N-17	1	A	B-23
8	L	K-7	380			2	C	I-21	101	A		1	K	P-23	1	L	Q-22
16	A	B-45	382°			2	F	O-24	101	B		2	E	M-24	2	D	M-24
226	D		600			2	G	O-26	229	A		7	N	E-33	7	A	N-10
			601			5	D	M-53	250	B		8	I	L-2	8	B	L-11
			602			5	E	H-55	250	A		8	F		8	I	
						100	B		278	C		229	A		229	F	
						120			306	D							
						121											
						122											
						140											
						226	C										

PANEL NO. 2 C/W LIGHTS INDEX BY SYSTEM

SCS	SCS		ECS		EPS	EPS	EPS
SPS	SPS				EPS	EPS	EPS
SPS	SPS	EPS	ECS	SPS		EPS	EPS
RCS	RCS				EPS	EPS	EPS
RCS	RCS	RCS	RCS	G&N	C&W	EPS	EPS
				G&N	C&W	ECS	ECS

NOTE: AREA IDENTIFICATION IS FOR REFERENCE ONLY, AND IS NOT ON THE SC MDC (AREA "M" NOT USED ON PANEL 2 (AREA "E" & "G" NOT USED ON PANEL 8))

○ FIRE EXTINGUISHER ACCESS PORTS

* BEHIND HINGED PANELS

EFFECTIVITY
 CSM 106 AND SUBS UNLESS OTHERWISE NOTED

① CSM 106 AND 107

② CSM 108 AND SUBS

Figure 3-1. Controls and Displays, SC 106 and Subs (Sheet 2 of 4)

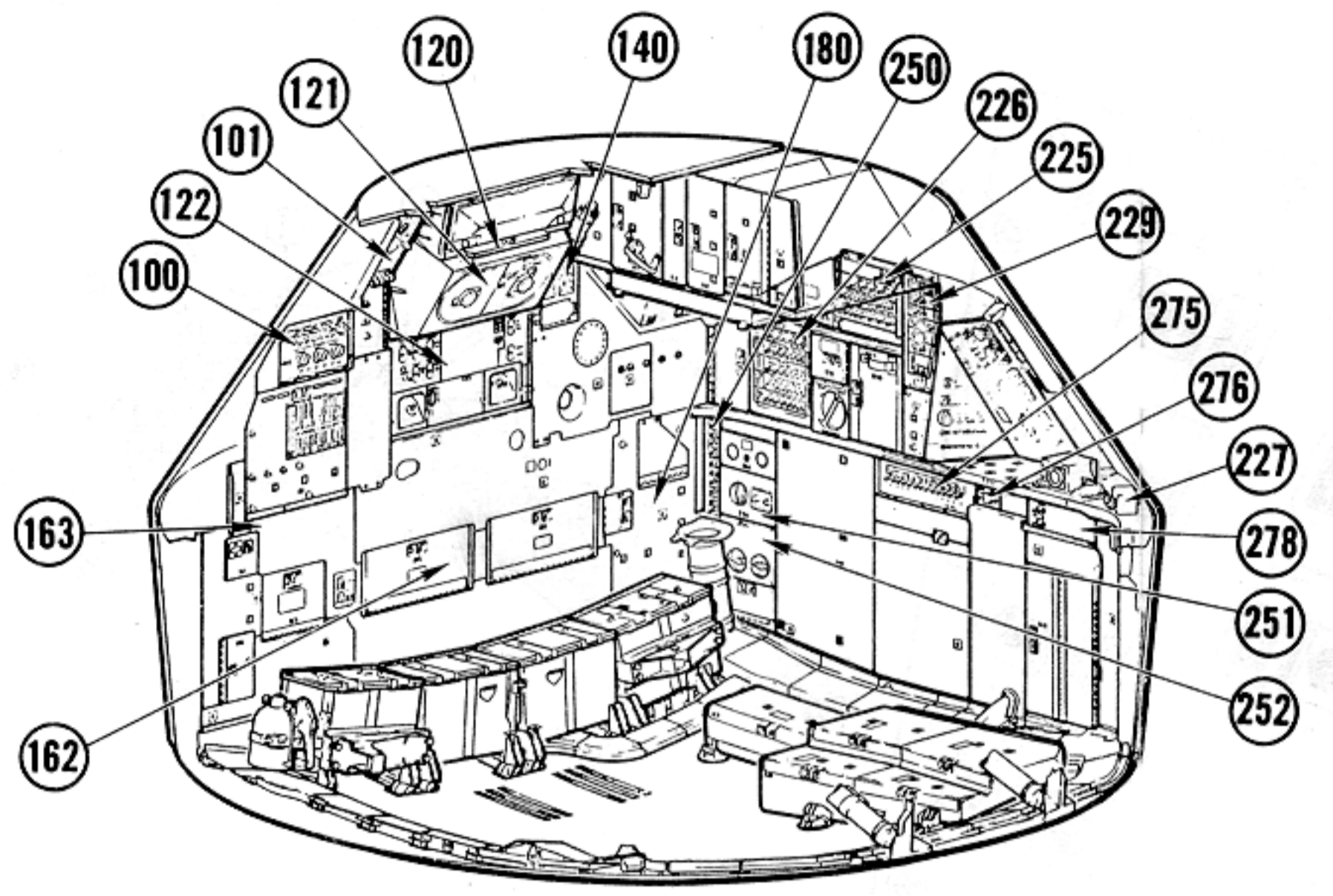
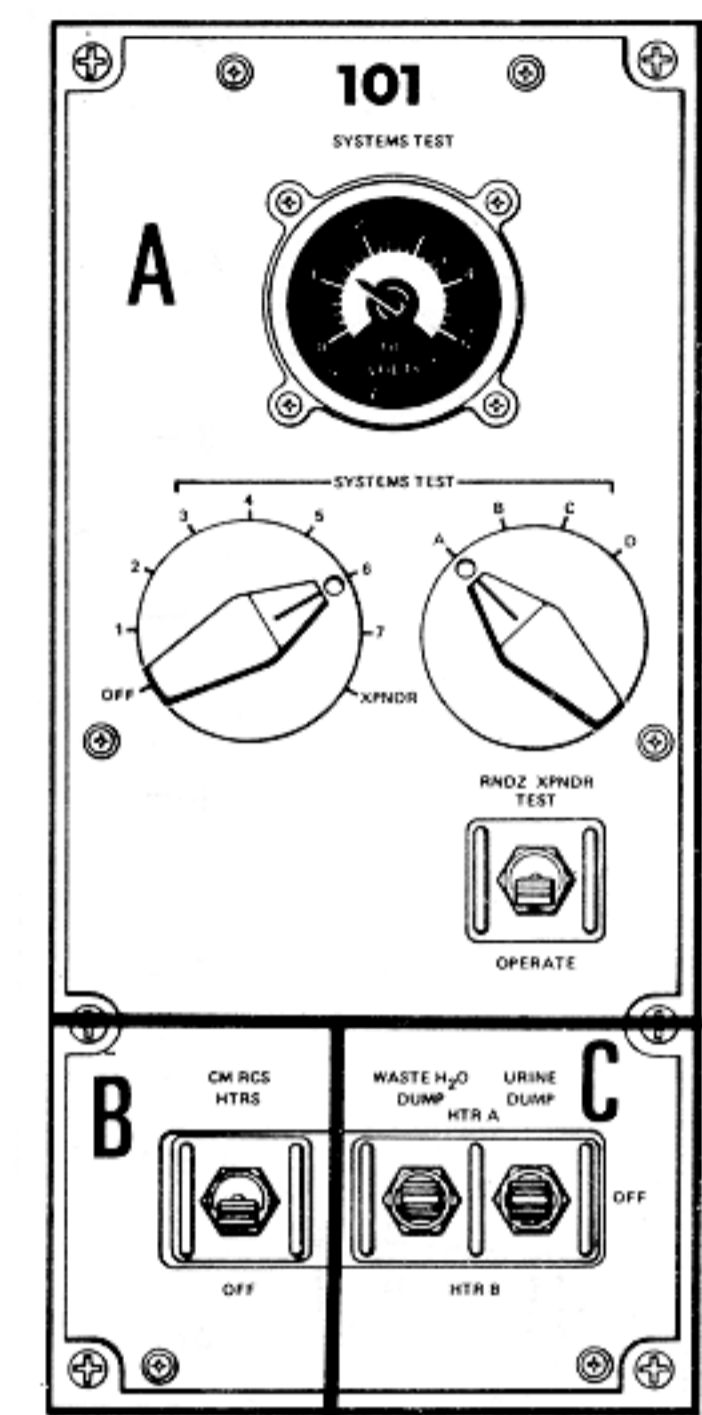
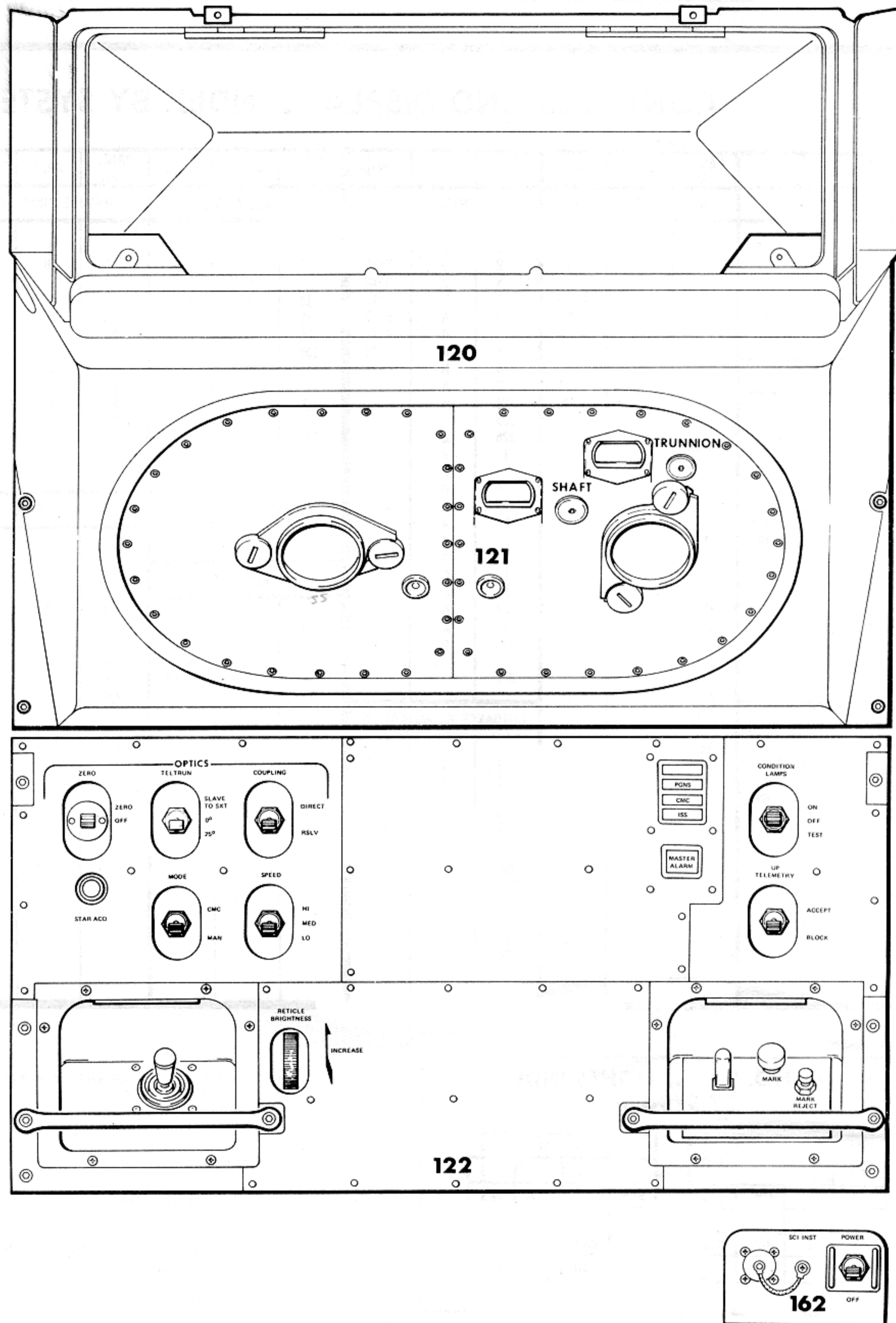

LOWER EQUIPMENT BAY (LEB)
 RIGHT HAND EQUIPMENT BAY (RHEB)
 RIGHT HAND FORWARD EQUIPMENT BAY (RHFE)

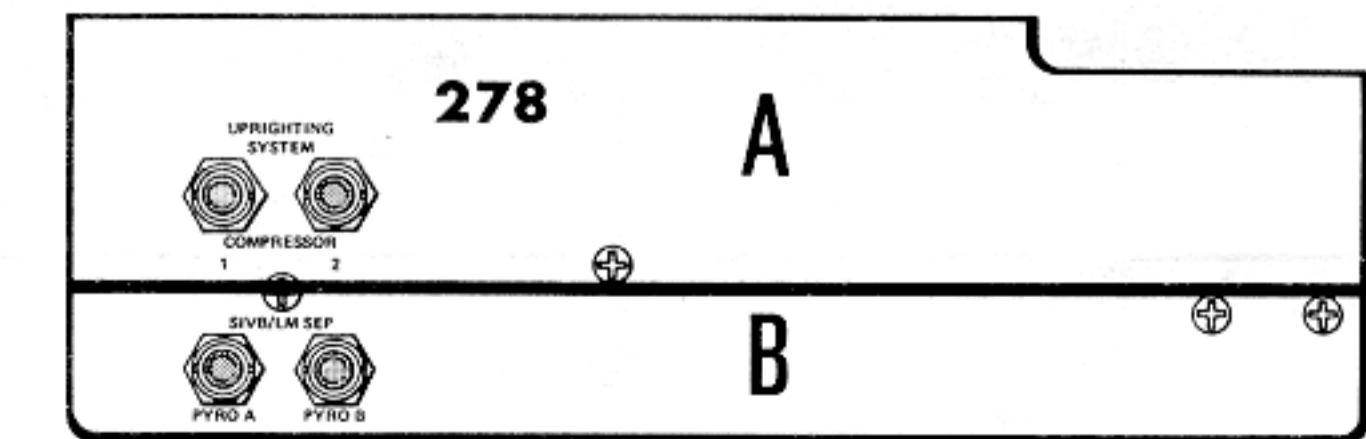
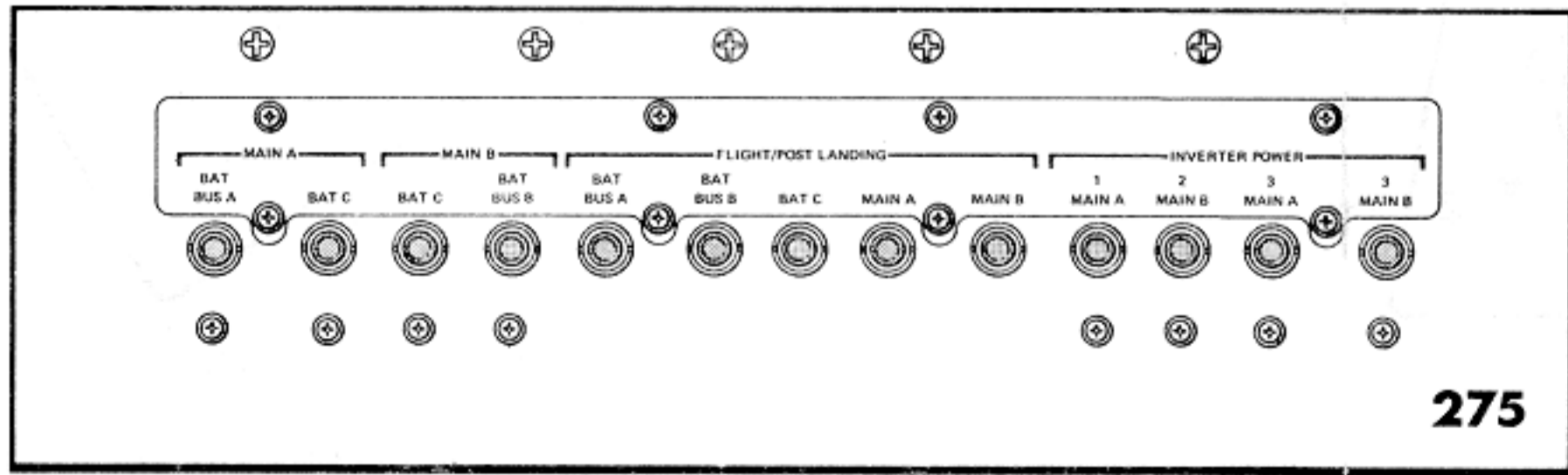
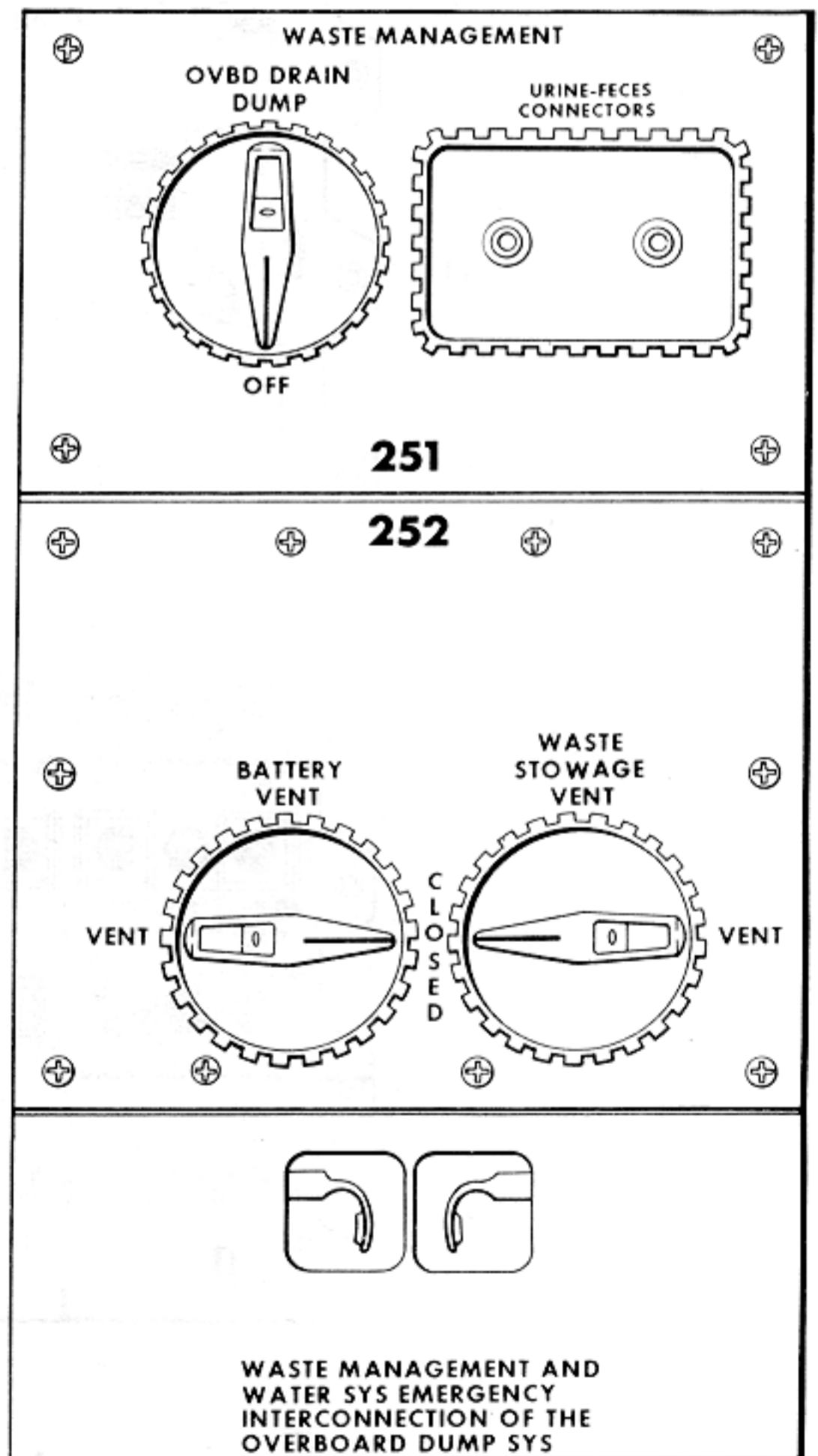
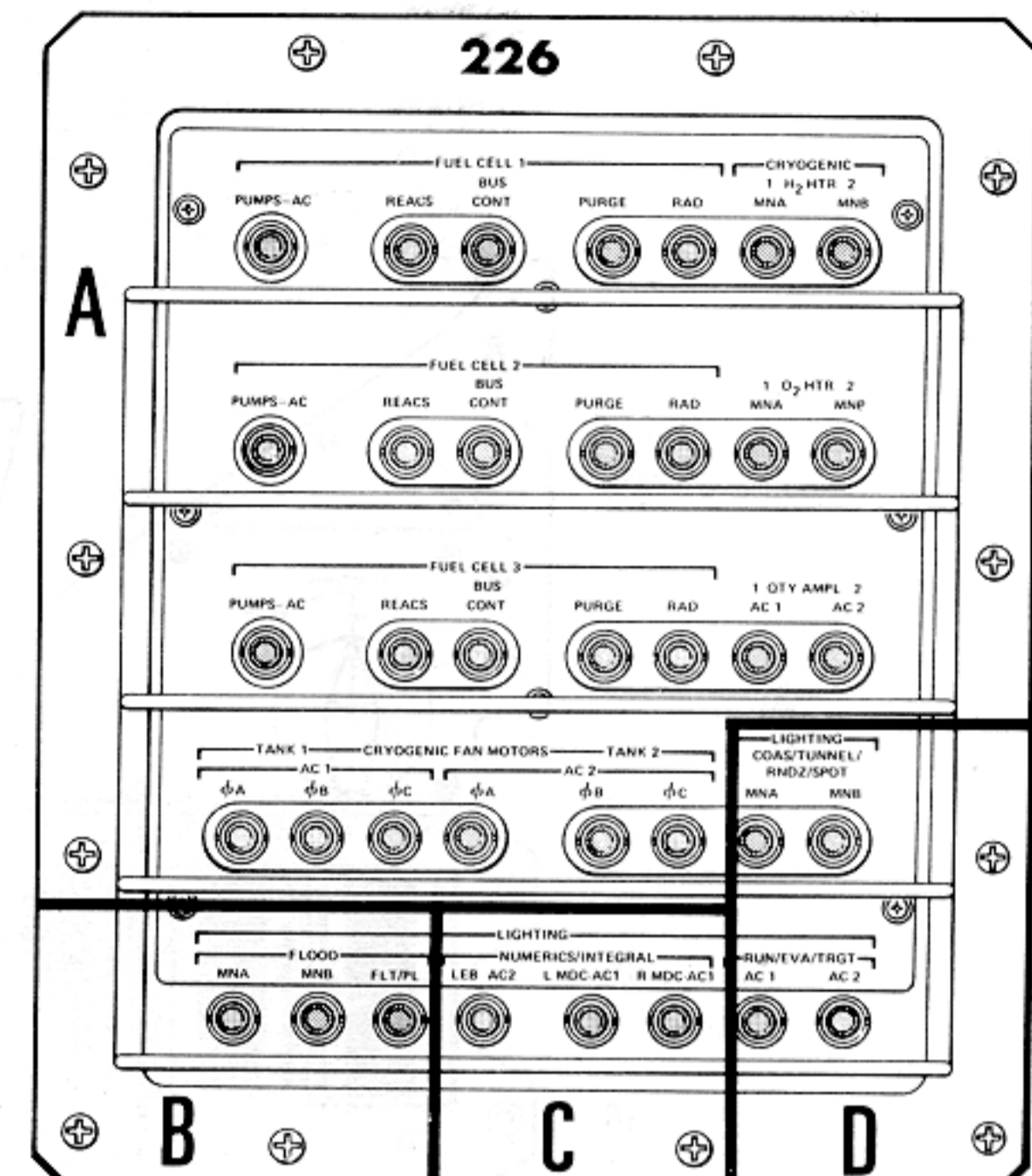
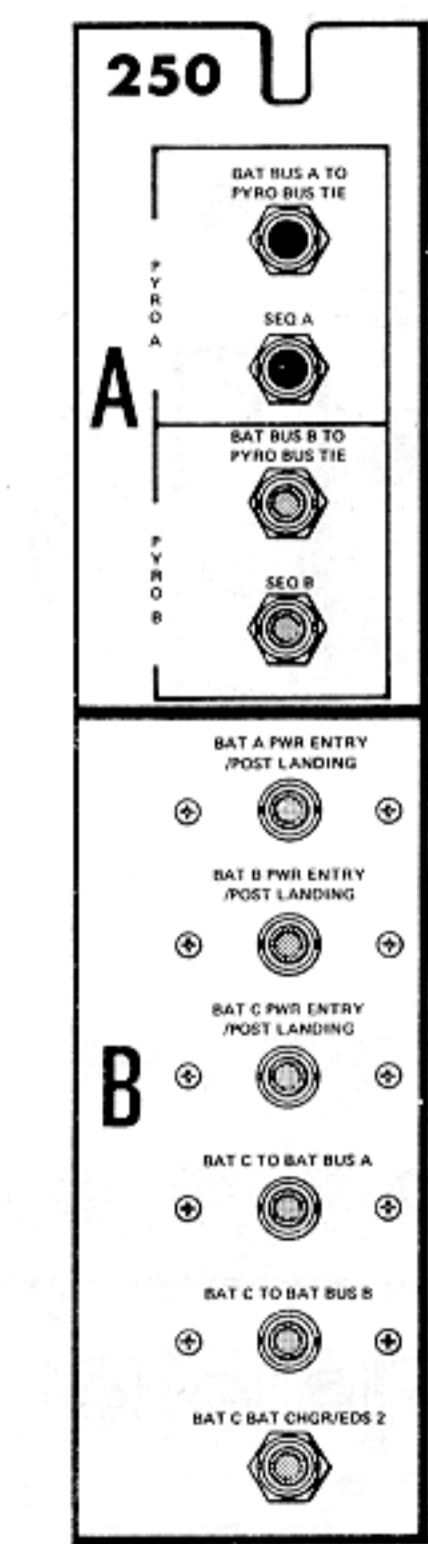
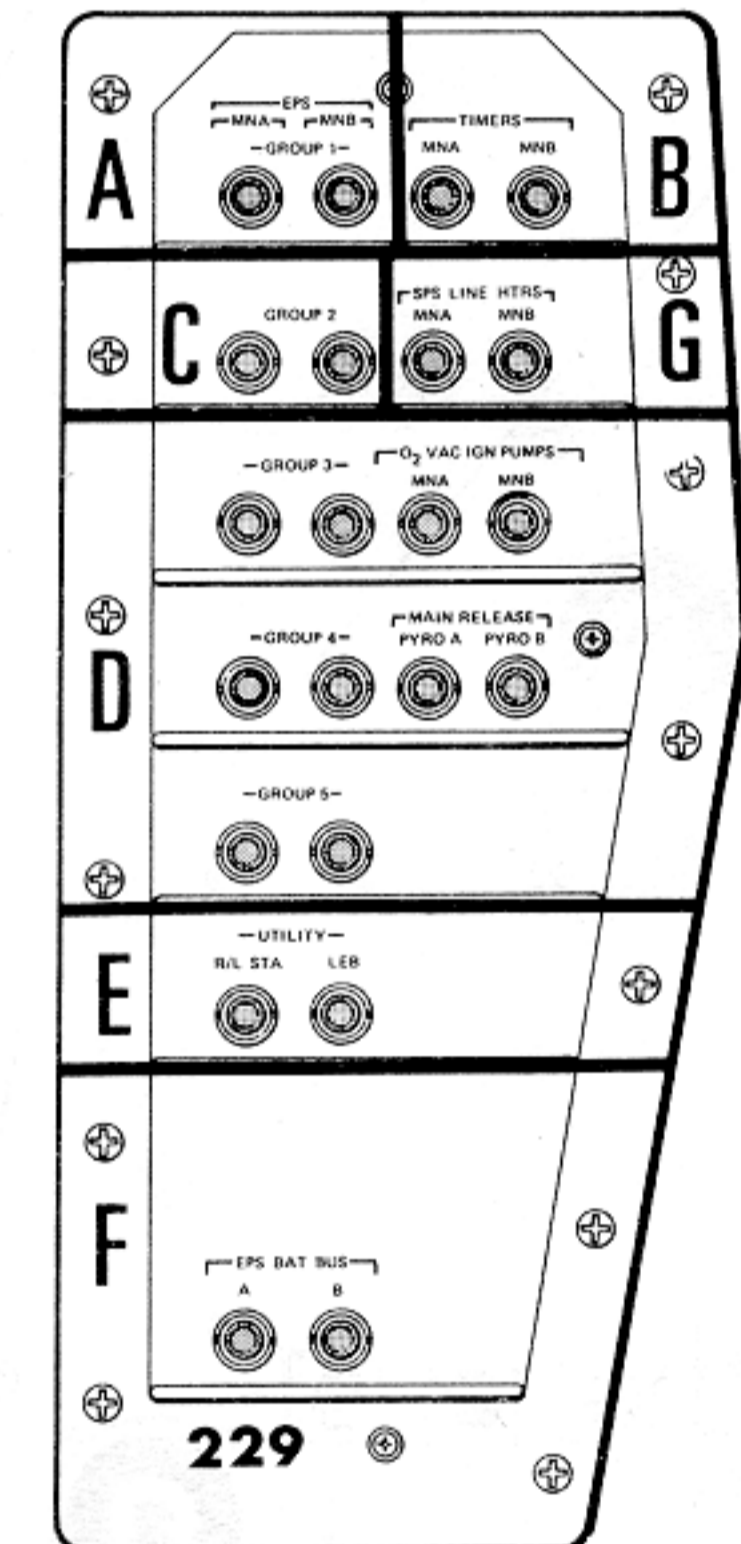
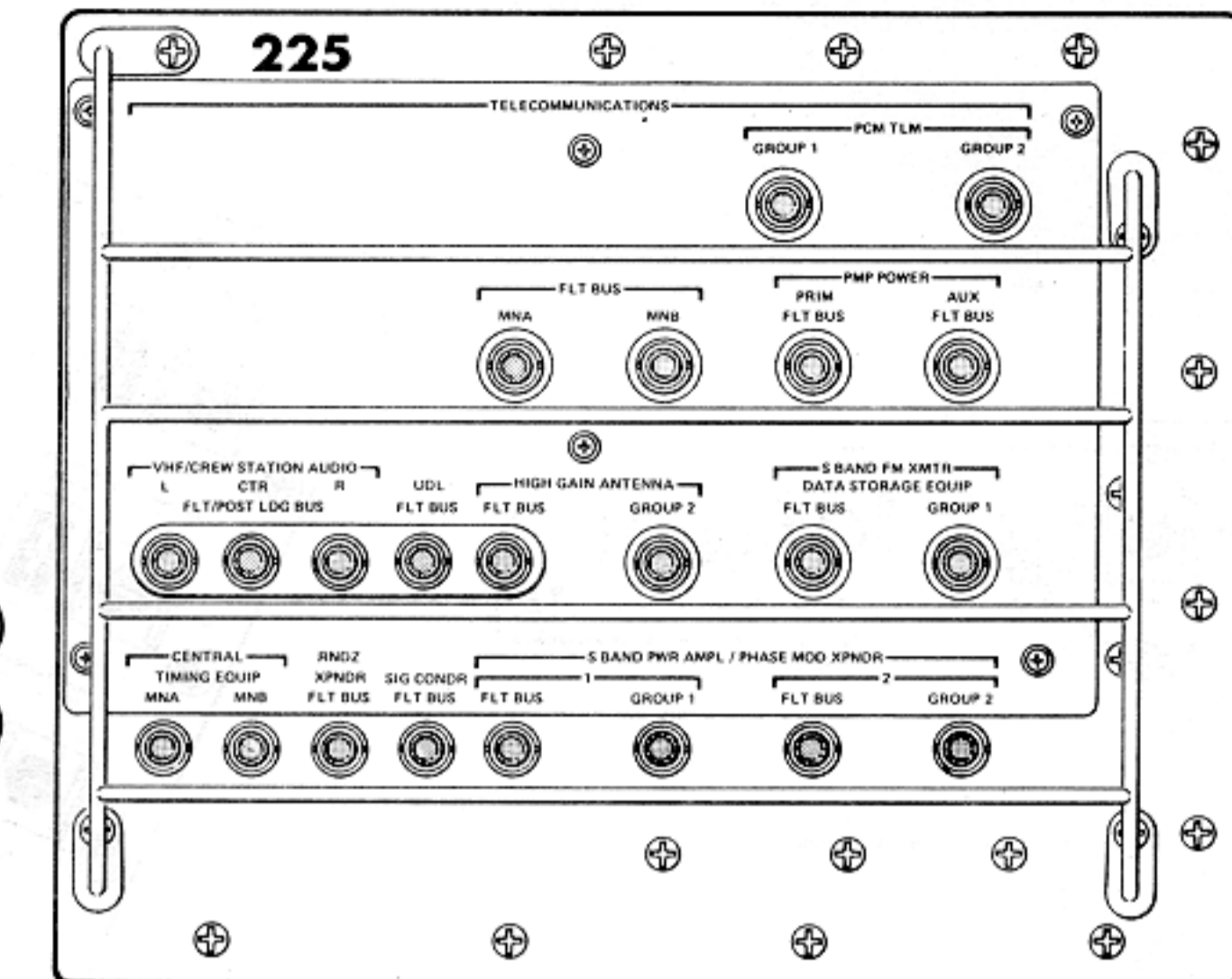
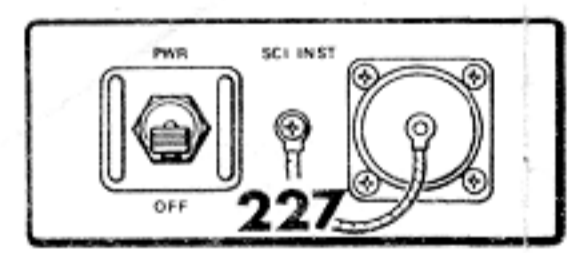
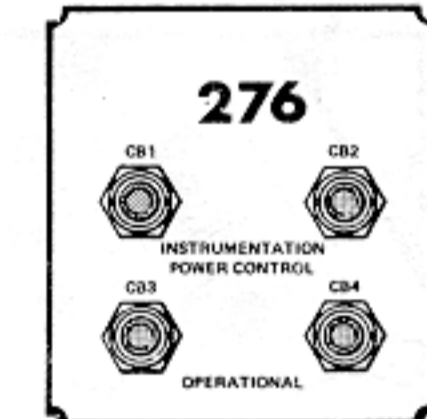
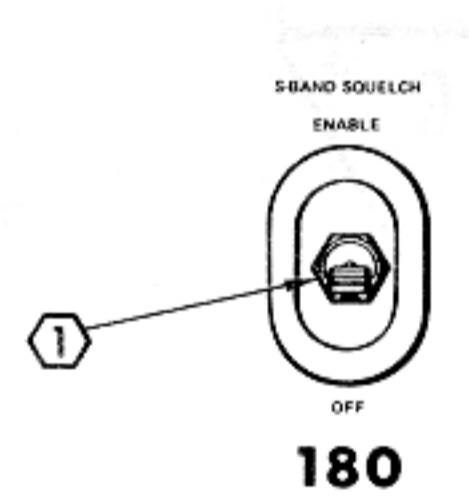
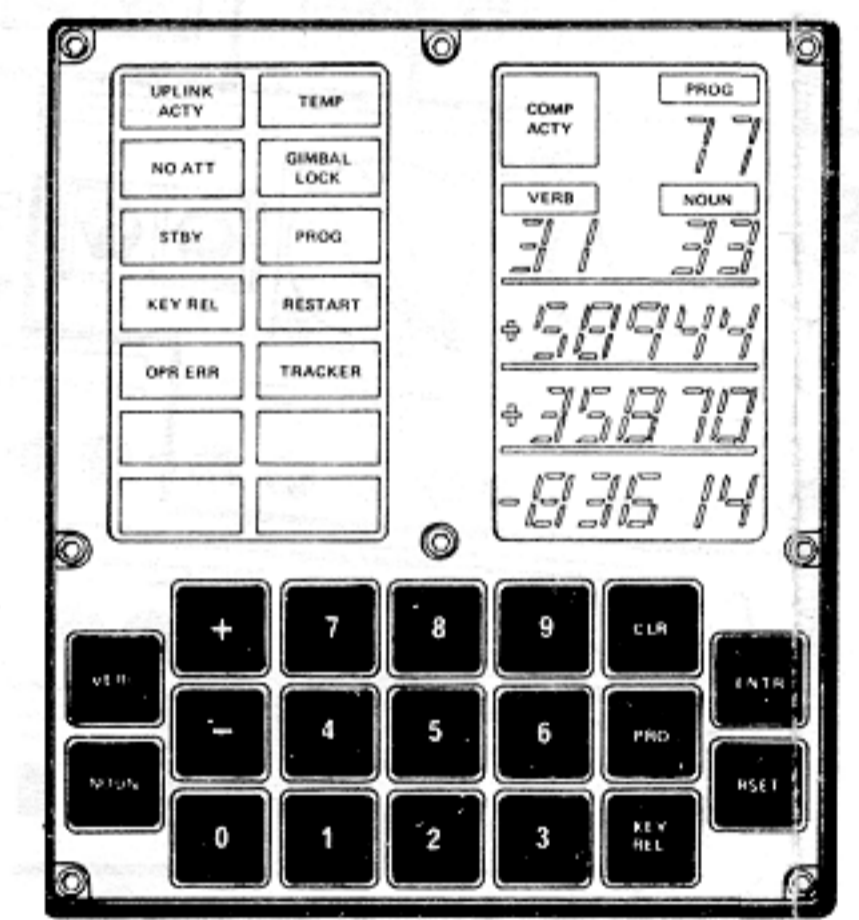
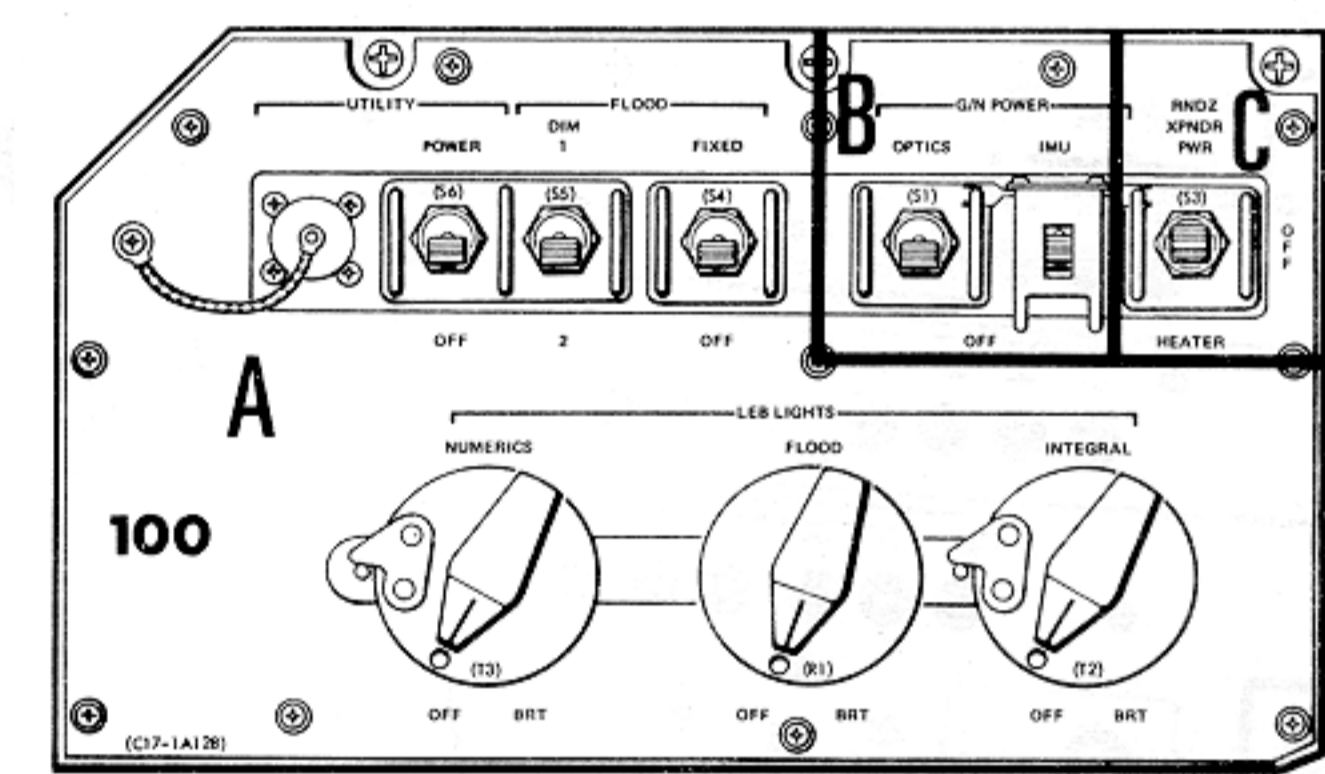

Figure 3-1. Controls and Displays, SC 106 and Subs (Sheet 3 of 4)

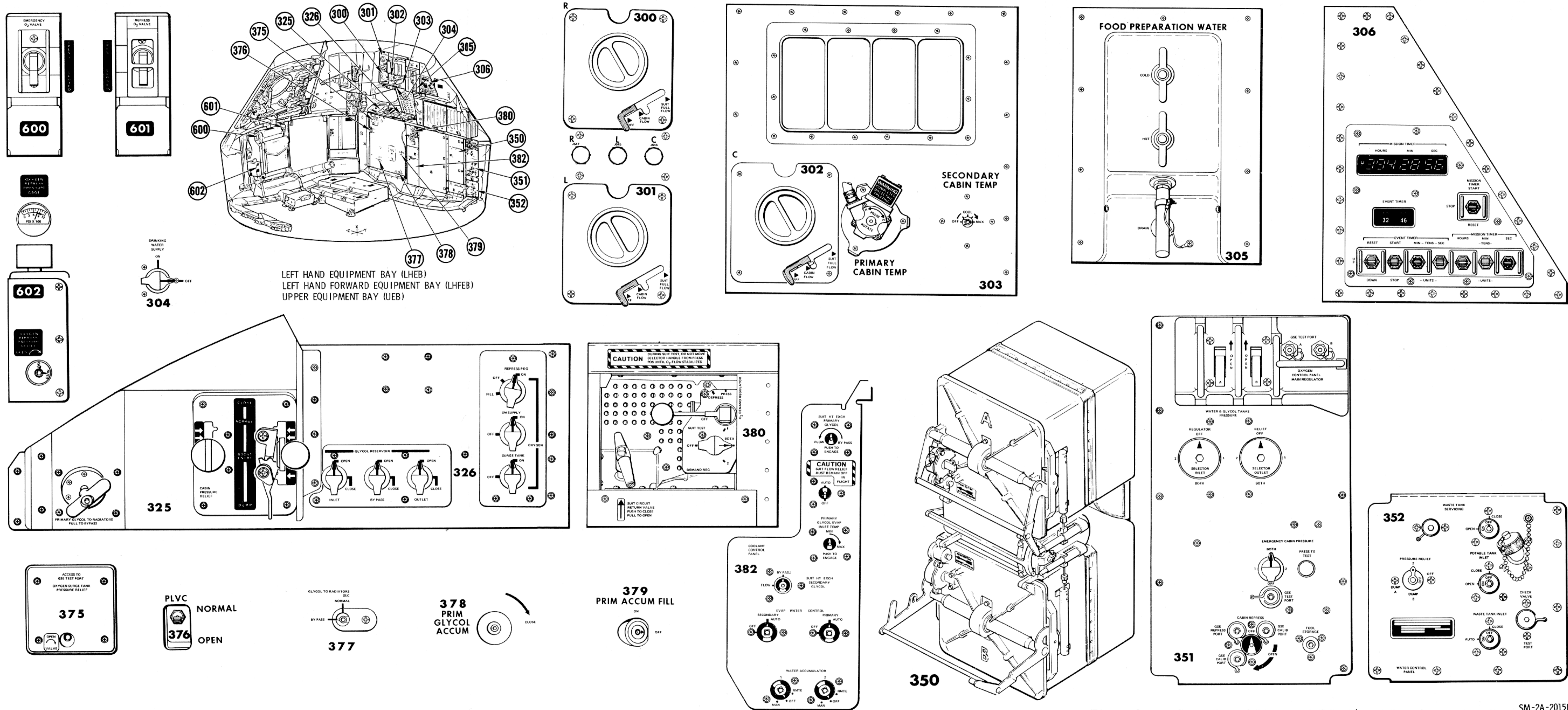

Figure 3-1. Controls and Displays, SC 106 and Subs (Sheet 4 of 4) SM-2A-2015B