

# Memorandum

TO : See Addressees  
Through: ~~Mr. Gaglio, R-ASTR-DU~~ *FAK 5/23/66* DATE : May 19, 1966  
FROM : Chief, Guidance and Control Systems Analysis Branch, R-ASTR-NG In reply refer to:  
R-ASTR-NG-74-66  
ECSmith/vjd/876-5942  
4595  
SUBJECT: Control System Information for SA-203

- Purpose: This memorandum presents the control system information for Saturn IB/203. (See Appendix 9 for references).
- Definitions of Symbols: Definitions of symbols used in this memorandum are given in Appendix 1.
- General Description: A general description of the guidance and control system and discussion of its operation are given in Appendix 2 with a general block diagram shown in Figure 1.
- Control System Diagrams: Block diagrams of the control system dynamics are shown in Sheets 1, 2, 3, and 4 of Drawing 50M34204. These diagrams are intended to be mathematical descriptions of the control system for simulation purposes. Detailed diagrams of the control system are shown on Sheets 1, 2, and 3 of Drawing 50M34207.
- Polarity Definitions: Vehicle polarity definitions are given in Drawing Number 50M35036.
- Control System Equations: The essential equations which define the con-  
positive actuator motion, and resultant thrust position as a function  
idual actuator motions are contained in Appendix 3. The auxiliary  
on system equations are described in Appendix 7 with the aid of Figures  
n 10 and Sheets 1 and 2, Drawing Number 50M34204.  
Factors, Tolerances, and Characteristics: The scale factors, tolerances,  
r data are tabulated in Appendix 4 for flight control, Appendix 5 for  
, Appendix 6 for BSE, and servo characteristics are given on sheet  
wing 50M34207.  
Control Computer Compensation Networks: Typical 203 compensation networks  
in Sheet 4 of Drawing Number 50M34204.  
Control System Redundancy: Appendix 8 contains information pertaining to the  
y switching threshold and components being switched.

*S. M. Seltzer*  
S. M. Seltzer

N67-82490

(THRU)  
(CODE)  
(CATEGORY)  
(ACCESSION NUMBER)  
(PAGES)  
(NASA CR OR TMX OR AD NUMBER)  
10 61 P  
11 TM-X-59479

## APPENDIX 1

### Definitions of Symbols

$\beta_{pc}, \beta_{yc}, \beta_{rc}$	Commanded thrust direction ( $\beta$ command) in pitch, yaw, and roll respectively,
$\beta_{p1c}, \beta_{p2c}, \beta_{p3c}, \beta_{p4c}$ $\beta_{y1c}, \beta_{y2c}, \beta_{y3c}, \beta_{y4c}$	Commanded actuator motions for individual actuators.
$\beta_p, \beta_y, \beta_r$	Resultant position of thrust vector due to individual actuator motions.
$\beta_{p1}, \beta_{p2}, \beta_{p3}, \beta_{p4}$ $\beta_{y1}, \beta_{y2}, \beta_{y3}, \beta_{y4}$	Individual actuator motions,
$\beta_A/\beta_C$	Ratio of $\beta$ actuator to $\beta$ command,
$\ddot{\beta}$	Acceleration of actuator piston,
$\dot{\beta}$	Velocity of actuator piston,
$C_x$	The minimum value of $\beta$ error signal in degrees required to <b>cause</b> full flow in the servo hydraulic valve, (Applies to S-PB only).
$\Delta_i$	Differential current output of the S-IB magnetic amplifiers of the control computer used to drive the H-1 engine servo.
$i_v$	Current output of the S-IVB magnetic amplifiers of the control computer used to drive the J-2 engine servo,
$\ddot{\phi}_p, \ddot{\phi}_y, \ddot{\phi}_r$	Vehicle angular acceleration in pitch, yaw, and roll, (deg/sec <sup>2</sup> ).
$\psi_p, \psi_y, \psi_r$	Vehicle attitude error in pitch, yaw, and roll respectively (sometimes referred to as $\Delta\phi_p, \Delta\phi_y,$ and $\Delta\phi_r$ ).
$\dot{\phi}_p, \dot{\phi}_y, \dot{\phi}_r$	Vehicle attitude rate in pitch, yaw, and roll respectively,
$\ddot{Y}_p, \ddot{Y}_y$	Vehicle lateral acceleration perpendicular to the vehicle longitudinal axis in pitch and yaw respectively,
$a_o^t$	Control computer attitude error gain,
$a_o$	Control system attitude error gain,
$a_1$	Control system attitude rate gain.
$g_2$	Control system accelerometer control gain,

Enclosure 1

APPENDIX 1 (Continued)

$K_p, K_y, K_r$	Digital computer attitude error gain constants in pitch, yaw, and roll respectively,
$\ddot{X}_I, \ddot{Y}_I, \ddot{Z}_I$	Inertial accelerations in the X, Y, and Z space-fixed directions, respectively,
$\Delta\dot{X}_I, \Delta\dot{Y}_I, \Delta\dot{Z}_I$	Incremental inertial velocity outputs of the platform accelerometer encoders, corresponding respectively to the $\ddot{X}_I, \ddot{Y}_I, \ddot{Z}_I$
$\chi_x, \chi_y, \chi_z$	Vehicle attitude commands in Euler angles calculated by the LVDC,
$\epsilon_p, \epsilon_{Y-R}, \epsilon_{Y+R}$	Spatial amplifier error command in pitch and yaw-roll mixed,
$\tau_f$	Spatial amplifier lag network time constant (seconds)
$\pm_p, \pm(Y+R), \pm(Y-R)$	Engine functions of the APS system,
$E_c$	Cut-on level (volts) of spatial amplifier
$E_o$	Output of the spatial amplifier, 28 V return channel
$K_f$	Spatial amplifier lag network gain,
$K_i$	The amount of $\beta$ in degrees caused by 1 ma of $i_v$ input to the J=2 valves,
$K_o$	Spatial amplifier hysteresis network gain,
$T_p, T_y, T_r$	Resultant thrust of the APS system in the pitch, yaw, and roll axes respectively,
$T_f$	Time of flight in seconds,
$I_p, III_p, III_{II}, III_{IV}, I_{II}, I_{IV}$	Engine numbers of the APS system,
$T_1$	Time base #1: Initiated at liftoff,
$T_2$	Time base #2: Initiated by the actuation of the S-IB propellant level sensors.
$T_3$	Time base #3: Initiated by S-IB engine cutoff, Time base #4: Initiated within the digital computer when S-IVB cutoff conditions are satisfied or forced by a discrete signal at a premature S-IVB engine cutoff.
$T_3 + 1$	Time of event: Command Flight Control Computer S-IVB burn mode on,

APPENDIX 1 (Continued)

$T_4 + 5$

Time of event: Command Flight Control Computer  
S-IVB Bum Mode Off (Begin Coast Phase)

$V_i$

Current output of the spatial amplifiers of the  
control computer used to operate the attitude  
control engines.

Enclosure 1<sup>3</sup>

## APPENDIX 2

### GENERAL DESCRIPTION OF THE GUIDANCE AND CONTROL SYSTEM FOR SATURN IB/203

1, General: The general operation of the guidance and control system for Saturn IB/203 is discussed with the aid of Figure 1,

2, Guidance System:

a, The purpose of the guidance system is to perform navigation evaluations, to issue discrete commands, to initiate certain guidance and control functions, and to steer the vehicle in a manner to satisfy mission requirements. This is accomplished by means of a guidance program compiled for a particular mission and stored in the Launch Vehicle Digital Computer (LVDC) memory. The LVDC is provided the input data prior to launch and throughout flight from which it determines the prescribed steering signals and discrete outputs. The inputs during the flight consist of inertial velocities and discrettes, and the outputs consist of attitude commands and discrettes,

b. The vehicle inertial accelerations are sensed by the acceferometers of the stabilized platform (ST-124M). The signals are sent to the Launch Vehicle Data Adapter (LVDA), processed by the LVDA and passed to the LVDC where they are utilized in guidance computations. The attitude signals are detected by the ST-124M platform gimbals, processed by the platform electronics, and sent to the crossover detectors (COD's) of the LVDA where they are further processed to obtain gimbal angles. Gimbal angles are then utilized by the LVDC to compute guidance and control commands,

c. The LVDC calculates the vehicle attitude commands in Euler angles ( $X_x, X_y, X_z$ ) as a function of time during S-IB flight and as closed loop steering commands during S-IVB flight. These commanded angles are compared with the ST-124M gimbal angles ( $\theta_x, \theta_y, \theta_z$ ) which represent the vehicle position. The  $X$ 's and  $\theta$ 's are differenced to obtain the attitude errors which are then transformed into the vehicle coordinate system, converted from digital to analog form, and issued to the control computer approximately 25 times per second as attitude error commands ( $\psi_p, \psi_y, \psi_r$ ). The  $X$ 's are calculated approximately every 1.0 second for S-IB stage and every 17 seconds for S-IVB stage, and the  $\theta$ 's are sampled approximately 25 times a second,

3, Control System:

a. The control system maintains the vehicle attitude and reduces vehicle aerodynamic loading by detecting the vehicle attitude, attitude rate, and lateral accelerations, processing these data, and issuing commands to position the control engines or fire the Auxiliary Propulsion System (APS) engines,

b. The control computer analog inputs consist of the attitude error signals ( $\psi_p, \psi_y, \psi_r$ ) from the LVDA, the attitude rate signals ( $\dot{\phi}_p, \dot{\phi}_y, \dot{\phi}_r$ ) from the control rate gyros and Control Signal Processor (CSP), the lateral acceleration signals ( $\gamma_p, \gamma_y$ ) from the control accelerometers, and the S-IB stage actuator positions ( $\beta_{1p}, \beta_{2p}, \beta_{3p}, \beta_{4p}, \beta_{1y}, \beta_{2y}, \beta_{3y}, \beta_{4y}$ ) from potentiometers on these actuators. There are no inputs from the S-IVB stage actuators since these actuators have mechanical feedback to their respective valves. The control computer performs the logic switching, gain changing, and filtering of the input signals to control the effects of bending and sloshing on the control system, to control the effects of the sampling rate and quantization of the attitude error signals and to maintain proper control system stability. It then mixes

APPENDIX 2 (Continued)

the  $\psi$ ,  $\phi$ , and  $\ddot{\gamma}$  signals to form the actuator position commands which are compared with the actuator positions on the S-HB stage to produce error signals ( $\Delta i_{1p}$ ,  $\Delta i_{2p}$ ,  $\Delta i_{3p}$ ,  $\Delta i_{4p}$ ,  $\Delta i_{1y}$ ,  $\Delta i_{2y}$ ,  $\Delta i_{3y}$ ,  $\Delta i_{4y}$ ) which are sent to the servovalves to position the actuators of the S-IB stage. To position the S-IVB engine, the input commands ( $\psi$  and  $\phi$ ) form the actuator position commands which are issued to the servovalve as  $i_v$ . These servos have mechanical feedback within the valves and actuators rather than electrical  $\beta$  feedback to the control computer,

c. Engines 1 through 4 on the S-PB stage are utilized for vehicle control, Pitch and roll signals are mixed on the four pitch actuators, and yaw and roll are mixed on the four yaw actuators to obtain the required engine gimbal angles ( $\beta_p, \beta_y, \beta_r$ ), or thrust vector components, and resulting control torques. For the S-IVB stage, there is only one engine which is gimballed in pitch and yaw. The pitch signals go to the pitch actuator and the yaw signals go to the yaw actuator to produce the required engine gimbal angles ( $\beta_p, \beta_y$ ) or pitch and yaw thrust vector components. The roll signals are processed by the APS system to produce the required roll thrust vector components. Thus, the required pitch, yaw, and roll control torques are produced during the S-IVB powered phase. During the S-IVB coast phase, the APS system accepts  $\psi$  and  $\phi$  input commands, multiplies these signals by the proper gains, mixes the yaw and roll signals, and produces output signals from the spatial amplifier which are pseudo rate modulated. For example, for an input  $0 \leq \epsilon < \epsilon_1$  ( $\epsilon_1 = 1^\circ$ ), the spatial amplifier output is zero. For an input  $\epsilon \geq \epsilon_2$  ( $\epsilon_2 = 1.6^\circ$ ), the spatial amplifier is full on. For an input  $\epsilon_1 \leq \epsilon < \epsilon_2$  the spatial amplifier output is pulse width and pulse rate modulated, the width and rate depending on the input signal level. The output of the spatial amplifier drives the control relays which activate the solenoid-valves. These cause the hypergolic engines to ignite producing thrust in the required direction,

d. The control accelerometers are used only during the S-IB stage flight. There are two rate gyro cases: one using the emergency detection system (EDS) rate gyros and associated CSP, and another using the control rate gyros and their build-in demodulators. The control rate gyros can be utilized only on S-IB stage flight; however, the EDS rate gyro package and CSP may be utilized during any or all phases of flight. The EDS rate gyros will be used on the SA-283 flight. The attitude commands will come only from the Instrument Unit (IU) system (not the spacecraft) during the entire 203 flight,

e. It should be noted that on the Saturn IB vehicles the EVDC is an integral part of the control system, whereas the guidance computer (ASC-15) of Saturn I was not. This results in the attitude loop being digitized with the effects of quantization, sampling rate, and transport lag being introduced in the attitude loop. Transport lag is given in Sheet 3, Drawing Number 50M34204 and Figure 2,

f. It should be noted that  $a_0$ ,  $a_1$ , and  $g_2$  are calculated from the following equations:

$$a_0 = \frac{\beta E}{\psi} = \frac{\text{degrees of engine movement}}{\text{degree of attitude error}} \quad \text{for the S-IB stage and for powered pitch and yaw of the S-IVB stage,}$$

Enclosure 2<sup>2</sup>

APPENDIX 2 (Continued)

$$a_0 = \frac{\epsilon}{\psi K} = \frac{\text{degrees of spatial attitude command}}{\text{degree of attitude error} \times \text{digital computer attitude gain factor}}$$

for the S-IVB powered roll and pitch, yaw, and roll during the coast phase.

$$a_1 = \frac{\beta_E}{\delta} = \frac{\text{degrees of engine movement}}{\text{degree per second of attitude rate}}$$

for the S-PB stage and for powered pitch and yaw of the S-IVB stage,

$$a_1 = \frac{\epsilon}{\dot{\phi}} = \frac{\text{degrees of spatial attitude command}}{\text{degree per second of attitude rate}}$$

for the S-IVB powered roll and pitch, yaw, and roll during the coast phase.

$$g_2 = \frac{\beta_E}{\gamma} = \frac{\text{degree of engine movement}}{\text{meter per second per second of lateral acceleration}}$$

$g_2$  applies only to the S-IB stage,  $g_2$  relays close at  $T_1 + 28 \pm 1$  second and open at  $T_1 + 110 \pm 1$  second,

$g_0$ . The S-IB stage servo-valve is limited to full flow at 8 ma of  $\Delta_i$  by a mechanical stop which limits the travel of the valve spool. The valves were originally designed for 12 ma full flow,

### APPENDIX 3

#### CONTROL SYSTEM EQUATIONS (ACTUATOR SYSTEMS)

1, The control law for actuator systems is represented by the following equations which give the commanded thrust direction ( $\beta$  command). Symbols used are defined in Appendix 1,

$$\begin{aligned} \text{Pitch:} \quad & \beta_{pc} = a_{0p}\psi_p + a_{1p}\dot{\phi}_p + g_{2p}\ddot{\gamma}_p \\ \text{Yaw:} \quad & \beta_{yc} = a_{0y}\psi_y + a_{1y}\dot{\phi}_y + g_{2y}\ddot{\gamma}_y \\ \text{Roll:} \quad & \beta_{rc} = a_{0r}\psi_r + a_{1r}\dot{\phi}_r \end{aligned}$$

2. The following equations define the individual commanded actuator motions in terms of commanded thrust direction for the S-IB stage,

$$\begin{aligned} \beta_{p1c} &= \beta_{pc} - \beta_{rc}/\sqrt{2} \\ \beta_{p2c} &= \beta_{pc} - \beta_{rc}/\sqrt{2} \\ \beta_{p3c} &= \beta_{pc} + \beta_{rc}/\sqrt{2} \\ \beta_{p4c} &= \beta_{pc} + \beta_{rc}/\sqrt{2} \\ \beta_{y1c} &= \beta_{yc} + \beta_{rc}/\sqrt{2} \\ \beta_{y2c} &= \beta_{yc} - \beta_{rc}/\sqrt{2} \\ \beta_{y3c} &= \beta_{yc} - \beta_{rc}/\sqrt{2} \\ \beta_{y4c} &= \beta_{yc} + \beta_{rc}/\sqrt{2} \end{aligned}$$

3, The following equations define the individual commanded actuator motions in terms of commanded thrust direction for the S-IVB stage,

$$\begin{aligned} \beta_{p1c} &= \beta_{pc} \\ \beta_{y1c} &= \beta_{yc} \end{aligned}$$

4, The following equations represent the resultant thrust position as a function of the individual actuator motion for the S-IB stage,



APPENDIX 3 (Continued)

$$\beta_p = 1/4 (\beta_{p1} + \beta_{p2} + \beta_{p3} + \beta_{p4})$$

$$\beta_y = 1/4 (\beta_{y1} + \beta_{y2} + \beta_{y3} + \beta_{y4})$$

$$\beta_r = \sqrt{2}/8 (\beta_{y1} - \beta_{p1} - \beta_{y2} - \beta_{p2} - \beta_{y3} + \beta_{p3} + \beta_{y4} + \beta_{p4})$$

5, The following equations represent the resultant thrust position as a function of the individual actuator motion for the S-IVB stage,

$$\beta_p = \beta_p$$

$$\beta_y = \beta_y$$

6, The preceding equations are approximations which are valid only as frequency approaches zero since all hardware dynamics are neglected. Even at control frequency, use of these equations in control system studies may give erroneous results. It is suggested that bending mode filters and engine position servo dynamics be examined before any attempt is made to use the idealized equations given here. The degree of accuracy of a particular study depends upon these dynamics,

APPENDIX I

CONTROL SYSTEM SPECIFICATIONS  
ATTITUDE ERROR CHANNEL  
(PITCH, YAW, AND ROLL)

SUB-SYSTEM OR COMPONENT SPECIFICATION



SYSTEM SPECIFICATION

SCALE FACTOR & TOLERANCE	MAX. RANGE	NULL	S-TH STAGE	TOLERANCE			NOTES
				±5%	±10%	±10%	
0.00279 °/bit fine	±5.625 deg. fine (64:1)	±0.1 deg. fine	ST-124 RESOLVERS	±5%	±10%	±10%	1,13
0.08929 °/bit backup	±180 degrees backup(2:1)	±1.0 deg. backup	CROSS-OVER DETECTORS & REGISTER				1,13
			MINOR LOOP				
ψ = .8v/deg. ± 2% from 0 to ±2.5° ± 4% " ±2.5° to ±15.8° Quantization level is .06deg./bit	± 15.3 deg.		LADDERS				
			SCALING AMPLIFIER				
-1% 3.0 v/deg	GAIN=3.75	±30 mv (±.01°)	FILTER				
1%			SERVO AMP				11,13
1%			INPUT				
2%		0.6 ma. (± 0.075°)	FEED- BACK				
			OUTPUT				
1.5%	±12ma.	0.6 ma. (± 0.075°)	VALVE				9,13
1.5%			ACTUATOR				
β = 2.58 volts/deg. 3%	± 8 deg.	± 178.2mv. (±.069deg.)	ACTUATOR POTS CONT. TELE.				8,13



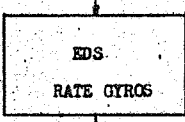
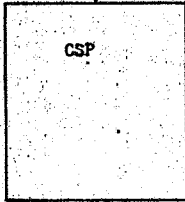

ENCLOSURE 4

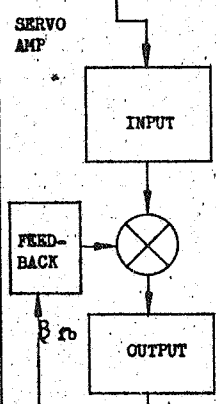
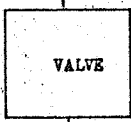
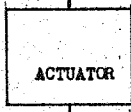
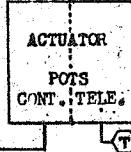
CLOSED LOOP SERVO

APPENDIX 1  
CONTROL SYSTEM SPECIFICATIONS  
ATTITUDE RATE CHANNEL  
(PITCH, YAW, AND ROLL)

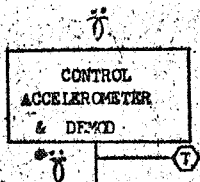
SUB-SYSTEM OR COMPONENT SPECIFICATION			SYSTEM SPECIFICATION		
SCALE FACTOR & TOLERANCE	MAX. RANGE	NULL	S-IB STAGE	TOLERANCE	NOTES
$\beta = 4.5 \text{ v/deg./sec.}$ 8%	$\pm 10 \text{ deg./sec}$	$\pm 563 \text{ mv}$ ( $\pm .125\%$ )	 <p style="text-align: center;">EDS RATE GYROS</p>	$\pm 8\%$ $\pm 13.5\%$ $\pm 10\%$	3,4,6,13
↓	↓	↓	 <p style="text-align: center;">CSP</p>	↓	3,4,6,13
↓	↓	↓	 <p style="text-align: center;">FILTER</p>	↓	4
↓	↓	↓	 <p style="text-align: center;">SERVO AMP</p> <p style="text-align: center;">INPUT</p> <p style="text-align: center;">FEED- BACK</p> <p style="text-align: center;">OUTPUT</p>	↓	11,13
↓	↓	↓	 <p style="text-align: center;">VALVE</p>	OPEN LOOP SERVO	9,13
↓	↓	↓	 <p style="text-align: center;">ACTUATOR</p>	↓	
↓	↓	↓	 <p style="text-align: center;">ACTUATOR POTS CONT. TELE.</p>	CLOSED LOOP SERVO	8,13

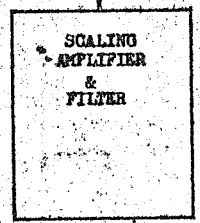
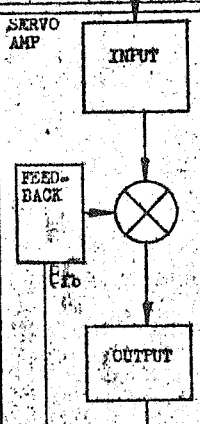
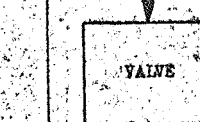
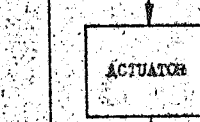
APPENDIX 4  
CONTROL SYSTEM SPECIFICATIONS  
ACCELEROMETER CHANNEL  
(PITCH AND YAW)

SUB-SYSTEM OR COMPONENT SPECIFICATION			SYSTEM SPECIFICATION		
SCALE FACTOR & TOLERANCE	MAX. RANGE	NULL	S-IB STAGE	TOLERANCE	NOTES
$\delta = 1.0 \text{ v/m/s}^2$ $\pm 6\%$	$\pm 10 \text{ m/s}^2$	$\pm 80 \text{ mv}$ ( $\pm .08 \text{ m/s}^2$ )	 <p style="text-align: center;">CONTROL ACCELEROMETER &amp; DEMOD</p>	$\pm 6\%$	$g_2$ $\pm 10\%$
$3\%$			 <p style="text-align: center;">CONTROL ATTENUATION TIMER</p>		
$1\%$	$g_2 \text{ Gain} = 6$		 <p style="text-align: center;">SCALING AMPLIFIER &amp; FILTER</p>		7,8,13
$1\%$ $1\%$ $2\%$		$\pm 0.6 \text{ ma}$ ( $\pm 0.075^\circ$ )	 <p style="text-align: center;">SERVO AMP</p>		11,13
$1.5\%$	$\pm 12 \text{ ma}$	$\pm 0.6 \text{ ma}$ ( $\pm 0.075^\circ$ )	 <p style="text-align: center;">VALVE</p>	OPEN LOOP SERVO	9,13
$1.5\%$			 <p style="text-align: center;">ACTUATOR</p>		
$\beta = 2.58 \text{ v/deg.}$ $3\%$	$\pm 8 \text{ deg.}$	$\pm 178.2 \text{ mv}$ ( $\pm .069 \text{ deg.}$ )	 <p style="text-align: center;">ACTUATOR POTS CONT. TELE.</p>	CLOSED LOOP SERVO	8,13

CONTROL SYSTEM SPECIFICATIONS  
ATTITUDE ERROR CHANNEL  
(PITCH AND YAW)

SUB-SYSTEM OR COMPONENT SPECIFICATION			SYSTEM SPECIFICATION		
SCALE FACTOR & TOLERANCE	MAX. RANGE	NULL	S-IVB STAGE (POWERED)	TOLERANCE	NOTES
.00279 deg./bit Fine	± 5.625 deg. Fine (64:1)	± 0.1 deg. Fine	ST-124 RESOLVERS	± 5% ± 7% ± 10%	1,13
.08929 deg./bit Backup	± 180 deg. Backup (2:1)	± 1.0 deg. Backup	CROSS-OVER DETECTORS & REGISTER		1,13
			MINOR LOOP		
$\psi = .8v/deg.$ 2% from 0° to ± 2.5° ± 4% " ± 2.5° ± 15.3° Quantization level is .06deg./bit	± 15.3 deg.		LADDERS		
1% 3.0v/deg	Gain = 3.75	± .30 mv. (± .01°)	SCALING AMPLIFIER		2,13
1%			FILTER		14
1%	± 60 ma.	± 0.7 ma. (± .0119 deg)	SERVO AMPLIFIER		
$K_c = 0.1196 \text{ deg./ma.}$ 1.5%	± 16.7 ma.	± 1 ma. (± .114°)	VALVE		
1.5%			ACTUATOR		
3%		(± .21 deg.)	ACTUATOR POT	NOT USED FOR CONTROL	

APPENDIX 4  
CONTROL SYSTEM SPECIFICATIONS  
ATTITUDE RATE CHANNEL  
(PITCH AND YAW)

SUB-SYSTEM OR COMPONENT SPECIFICATION			SYSTEM SPECIFICATION				
SCALE FACTOR & TOLERANCE	MAX. RANGE	NULL	S-IV STAGE (POWERED)	TOLERANCE			NOTES
$\dot{\theta} = 4.5 \text{ } \checkmark/\text{deg./sec.}$	$\pm 10 \text{ deg./sec.}$	$\pm 563 \text{ mv}$ ( $\pm .125 \text{ } \checkmark/\text{s}$ )	$\Phi$ 	+8%	10.5%	$\Delta_1$ +10%	3,4,6,13
8%							3,4,6,13
1.5%							14
1%	$\pm 60 \text{ ma}$	$\pm 0.7 \text{ ma}$ ( $\pm 0.1049 \text{ deg}$ )					12,13
$K_i = 0.1496 \text{ /ma}$	$\pm 46.7 \text{ ma}$	$\pm 1 \text{ ma}$ ( $\pm .14^\circ$ )					
1.5%							
5%		( $\pm 21 \text{ deg.}$ )		NOT USED FOR CONTROL			

APPENDIX 4

CONTROL SYSTEM SPECIFICATIONS  
 ATTITUDE ERROR CHANNEL  
 (PITCH & YAW - COAST)  
 (ROLL - POWERED OR COAST)

SUB-SYSTEM OR COMPONENT SPECIFICATION			SYSTEM SPECIFICATION		
SCALE FACTOR & TOLERANCE	MAX. RANGE	NULL	S-IVB STAGE	TOLERANCE	NOTES
.00279 deg./bit fine	± 5.625 deg. fine (64:1)	± 0.1 deg. fine	⊖ ST-124 RESOLVER	± 5% ± 10% ± 10%	1,13
.08929 deg./bit backup	± 180 deg. backup (2:1)	± 1.0 deg. backup	CROSS-OVER DETECTORS & REGISTER		1,13
			MINOR LOOP		
ψ = .8v/deg. ± 2% from 0 to ± 2.5 ± 4% " ± 2.5 to ± 15.3 Quantization level is .06 deg./bit	± 15.3 deg.		LADDERS -Kψ		
1%	Gain = 3.75	± 30 mv. (± .01°)	SCALING AMPLIFIER		2,13
Triggering Threshold = ± 0.8v ± 6% Full on Threshold = ± 1.28v ± 6% Minimum Pulse Duration = 65ms ± 10%		± 10 mv.	⊖ SPATIAL AMPLIFIER Vi ⊖	triggering threshold ± 0.8v ± 10% full on, threshold ± 1.28v ± 10% Minimum pulse duration 65ms ± 10%	
0 or + 28 volts ± 2 volts 3 ms. delay			CONTROL RELAY PACKAGE	Same as the spatial amplifier	
			⊖ SOLENOIDS & VALVES		15

APPENDIX 4

CONTROL SYSTEM SPECIFICATIONS  
ATTITUDE RATE CHANNEL  
(PITCH & YAW - COAST)  
(ROLL - POWERED OR COAST)

SUB-SYSTEM OR COMPONENT SPECIFICATION			SYSTEM SPECIFICATION		
SCALE FACTOR & TOLERANCE	MAX. RANGE	NULL	S-IVB	TOLERANCE	NOTES
0 = 4.5 v/deg./sec.  8%		$\pm 563 \text{ mv}$ ( $\pm .125^\circ/\text{s}$ )	$\phi$ <div style="border: 1px solid black; padding: 5px; width: fit-content; margin: 5px auto;">EDS RATE CYROS</div>	+ 8%    ±11% $\phi$ ±10%	3,4,6,13
			<div style="border: 1px solid black; padding: 5px; width: fit-content; margin: 5px auto;">CSP</div> $\phi$		3,4,6,13
1%	Gain = 5	$\pm 30 \text{ mv}$ ( $\pm .0013^\circ/\text{s}$ )	<div style="border: 1px solid black; padding: 5px; width: fit-content; margin: 5px auto;">SCALING AMPLIFIER</div>		2,13
Triggering Threshold = $\pm .9 \text{ v} \pm 6\%$ Full on Threshold = $\pm 1.1 \text{ v} \pm 6\%$ Minimum Pulse Duration = $65 \text{ ms} \pm 10\%$		$\pm 10 \text{ mv}$	$V_i$ <div style="border: 1px solid black; padding: 5px; width: fit-content; margin: 5px auto;">SPATIAL AMPLIFIER</div>	triggering threshold $\pm 0.9 \text{ v} \pm 10\%$ full on threshold $\pm 1.1 \text{ v} \pm 10\%$ Minimum pulse duration $65 \text{ ms} \pm 10\%$	
0 or +28 volts $\pm 2 \text{ v}$ 3 ms delay			<div style="border: 1px solid black; padding: 5px; width: fit-content; margin: 5px auto;">CONTROL RELAY PACKAGE</div>	Same as the spatial amplifier	
			<div style="border: 1px solid black; padding: 5px; width: fit-content; margin: 5px auto;">SOLENOIDS &amp; VALVES</div>		15



APPENDIX 4 (Continued)

NOTES: 1. The gimbal angles ( $\theta$ 's) are sensed by means of two constant amplitude, constant frequency, phase-shifted signals from the gimbal angle resolvers. These signals are converted to a digital pulse count by the Crossover Detectors (COD's) in the LVDA. Complete error analysis due to quantization and hardware tolerances is discussed in IBM document 64-208-008H dated 24 December 1964,

2. The attitude error signal ( $\psi$ ) is active at all times during flight unless overridden by a manual signal from the command service module (CSM) of the Apollo spacecraft which will not be possible until SA-204. The  $\psi$  signal to the control computer is the result of a D/A conversion in the LVDA and has a quantization level of 0.06 deg/bit. The change of this signal is limited by the flight program in the LVDC to a maximum value of 0.48 degree per sampling period of approximately 40 milliseconds,

3. Only one rate gyro package will be active throughout flight — the EDS rate gyro package.

4. The attitude rate signals are obtained from the rate gyro demodulator output.

5. Rate gyro nulls include zero off-set, hysteresis, mass unbalance, and temperature variation,

6. The attitude rate signals are obtained from the demodulator output of the control signal processor. Tolerances are the sum of the rate gyro and control signal processor tolerances, and both units have pair/spare redundancy. The control signal processor provides signals to the EDS distributor from preset rate switches. The  $\dot{\phi}_p$  and  $\dot{\phi}_y$  switches are set for  $\pm 5.0^\circ/\text{s}$   $\pm 1.5^\circ/\text{s}$  and the  $\dot{\phi}_r$  is set for  $\pm 20^\circ/\text{s}$   $\pm 1.5^\circ/\text{s}$ . Two of the three rate gyros in either the pitch, yaw or roll axis must exceed the nreset value in order to issue an abort signal,

7. The control accelerometers are active only during S-IB flight. The lateral acceleration signals are obtained from the accelerometer signal conditioners,

8. Both the telemetry and control potentiometers are 5k ohms resistance. There is an individual 60 volt power supply for each control potentiometer and a common 5 volt supply for the eight telemetry potentiometers. The tolerance on the scale factor includes effects of pot loading. The  $\beta$  null is determined with the actuator mechanical locks in position. This value represents the null due to the pot and the mechanical locks. For a closed Poop servo, the  $\beta$  null due to all control computer inputs at maximum gain with specified limits is determined to be 0.6 degrees at lift-off. This null neglects mechanical misalignments of stages and sensors,

9. The valve null shift is measured by the amount of  $\Delta_i$  or  $\beta$  required to cancel it. For the S-IB stage, the valve was designed for 12 ma to cause full flow,

P0. Same as note 9, except that the S-IVB valve was designed for 46.7 ma to cause full actuator extension or retraction,

Enclosure 4<sup>8</sup>

APPENDIX 4 (Continued)

11. The magnetic summing amplifier saturates at approximately  $\pm 23$  ma. The null shift is based on zero input to the control computer. This null shift may be represented by an equivalent  $\beta$ .

12. Same as Note 13, except the S-IVB magamp saturates at  $\pm 60$  ma.

13. Control system unit output = nominal output value  $\pm$  the gain tolerance  $\pm$  the null shift.

14. See drawing 50M34204 sheet 4 for filter characteristics.

15. See drawing 50M34207 sheet 2 for valve and solenoid characteristics.

APPENDIX 5  
TELEMETRY FUNCTIONS  
ATTITUDE ERROR CHANNEL  
(PITCH, YAW, AND ROLL)

SUB-SYSTEM OR COMPONENT SPECIFICATION

SYSTEM SPECIFICATION

SCALE FACTOR & TOLERANCE	MAX. RANGE	NULL	S-SUB STAGE	TOLERANCE	NOTES
	±15 deg.	± 0.1 deg fine ± 1.0 deg backup	ST-12L RESOLVERS	±5% ±11% 0.0% ±10%	
			CROSS-OVER DETECTORS & REGISTER		
			MINOR LOOP		
$\psi = 0.8v/deg$ (± 1%)			LADDERS		
1% 3.0v/deg	Gain = 3.75	+ 30 mv. (± 0.1°)	SCALING AMPLIFIER K $\psi$		1,4,7
(1.0%)			FILTER		8
1%			SERVO AMP INPUT ⊗ FEED- BACK OUTPUT		
1%					4,5,7
3% A <sub>i</sub> = 0.1v/ma		± 0.6 ma (± 0.075°)			
	± 11 ma	± 0.6 ma (± 0.075°)	VALVE	OPEN LOOP SERVO	4
1.5%			ACTUATOR		
0.212 v/deg. ± 5%	± 8 deg.	± 11.63 mv (± 0.069°)	ACTUATOR POTS CONT. TELE.	CLOSED LOOP SERVO	4,5,7

APPENDIX 5  
TELEMETRY FUNCTIONS  
ATTITUDE RATE CHANNEL  
(PITCH, YAW, AND ROLL)

SUB-SYSTEM OR COMPONENT SPECIFICATION			SYSTEM SPECIFICATION		
SCALE FACTOR & TOLERANCE	MAX. RANGE	HULL	S-IB. STAGE	TOLERANCE	NOTES
$\phi = 4.5 \text{ v/deg/sec}$ $\pm 12\%$	$\pm 10 \text{ deg/sec}$	$\pm 563 \text{ mv}$ ( $\pm 0.125^\circ/\text{sec}$ )		$\pm 12\%$ $\pm 18.5\%$ $\pm 10\%$	
↓		↓		↓	7
1.5%					8
1%					4, 5, 7
1% 3% $\Delta i = 0.1 \text{ v/deg}$		$\pm 0.6 \text{ ma}$ ( $\pm 0.075^\circ$ )		↓	
	$\pm 14 \text{ ma}$	$\pm 0.6 \text{ ma}$ ( $\pm 0.075^\circ$ )		OPEN LOOP SERVO	4
1.5%					
$0.212 \text{ v/deg}$ $\pm 5\%$	$\pm 8 \text{ deg.}$	$\pm 14.63 \text{ mv}$ ( $\pm 0.069^\circ$ )		CLOSED LOOP SERVO	4, 5, 7

APPENDIX 5  
TELEMETRY FUNCTIONS  
ACCELEROMETER CHANNEL  
(PITCH AND YAW)

SUB-SYSTEM OR COMPONENT SPECIFICATION

SYSTEM SPECIFICATION

SCALE FACTOR & TOLERANCE	MAX. RANGE	NULL	S-S IS STAGE	TOLERANCE	NOTES
$\ddot{\alpha} = 1.0 \text{ v/m/s}^2$ $\pm 9\%$	$\pm 5 \text{ m/s}^2$	$\pm 80 \text{ mv}^c$ $(\pm 0.08 \text{ m/s}^2)$		$\pm 9\%$ $\pm 18\%$ $\pm 10\%$	3,4,7
$3\%$					
$1\%$	$g_2 \text{ Gain} = 6$				8
$1\%$ $1\%$ $3\%$ $\Delta i = 0.1 \text{ v/deg}$		$0.6 \text{ ma}$ $(\pm 0.075^\circ)$			4,5,7
	$\pm 11 \text{ ma}$	$\pm 0.6 \text{ ma}$ $(\pm 0.075^\circ)$		OPEN LOOP SERVO	4
$1.5\%$					
$.212 \text{ v/deg.}$ $\pm 5\%$	$\pm 8 \text{ deg}$	$\pm 11.63 \text{ mv}$ $(\pm 0.069 \text{ deg})$		CLOSED LOOP SERVO	4,5,7







APPENDIX 5  
TELEMETRY FUNCTIONS  
ATTITUDE ERROR CHANNEL  
(PITCH AND YAW)

SUB-SYSTEM OR COMPONENT SPECIFICATION			SYSTEM SPECIFICATION		
SCALE FACTOR & TOLERANCE	MAX. RANGE	NULL	S-IVB STAGE (POWERED)	TOLERANCE	NOTES
	$\pm 15$ deg.	$\pm 0.1$ deg fine $\pm 1.0$ deg backup	⊖ ST-124 RESOLVERS	$\pm 6\%$ $\pm 9\%$ $\pm 10\%$	
			↓ CROSS-OVER DETECTORS & REGISTER		
			↓ MINOR LOOP		
$0.8$ v/deg 1%			↓ LADDERS		
			↓ K $\psi$		
2% 3.0v/deg	Gain = 3.75	$\pm 30$ mv ( $\pm .01^\circ$ )	↓ SCALING AMPLIFIER		7
1%			↓ ① FILTER		8
$G_v = .02$ v/ma 2%	$\pm 50$ ma	$\pm 0.7$ ma ( $\pm 0.1019^\circ$ )	↓ SERVO AMPLIFIER		4,5,7
			↓ I $v$ ①		
$K_t = 0.1196$ v/ma 1.5%	$\pm 46.7$ ma	$\pm 1$ ma ( $\pm 0.11^\circ$ )	↓ VALVE		
1.5%			↓ ACTUATOR		
$\beta = .339$ v/deg. $\pm 5\%$	$\pm 7$ deg.	$\pm 52.25$ mv ( $\pm .154$ deg)	↓ ACTUATOR POT ①		4,5,7

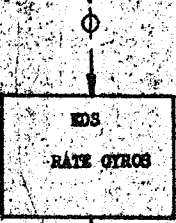
APPENDIX 5  
TELEMETRY FUNCTIONS  
ATTITUDE RATE CHANNEL  
(PITCH AND YAW)

SUB-SYSTEM OR COMPONENT SPECIFICATION

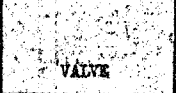
SYSTEM SPECIFICATION

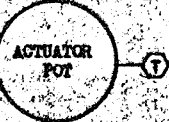
SCALE FACTOR & TOLERANCE	MAX. RANGE	NULL	S-IV STAGE (POWERED)	TOLERANCE	NOTES
$\beta = 1.5 \text{ v/deg/sec}$ $\pm 12\%$	$\pm 10 \text{ deg/sec}$	$\pm 563 \text{ mv}$ ( $\pm 125 \text{ %/sec}$ )		$\pm 12\%$ $\pm 15.5\%$ $\pm 10\%$	
↓		↓		↓	7
1.5%					8
$i_v = .02 \text{ v/ma}$ 2%	$\pm 50 \text{ ma}$	$\pm 0.7 \text{ ma}$ ( $\pm 0.1019\%$ )		↓	7
$K_t = 0.1196 \text{ %/ma}$ 1.5%	$\pm 46.7 \text{ ma}$	$\pm 1 \text{ ma}$ ( $\pm 1.14\%$ )			4, 5
1.5%					
$0.339 \text{ v/deg}$ $\pm 5\%$	$\pm 7 \text{ deg}$	$\pm 52.25 \text{ mv}$ ( $\pm 15.4\%$ )		↓	4, 5, 7

ENCLOSURE 55

APPENDIX 5

TELEMETRY FUNCTIONS  
ATTITUDE ERROR CHANNEL  
(PITCH & YAW - COAST)  
(ROLL - POWERED OR COAST)

SUB-SYSTEM OR COMPONENT SPECIFICATION			SYSTEM SPECIFICATION				
SCALE FACTOR & TOLERANCE	MAX. RANGE	NULL	S-IEE STAGE	TOLERANCE			NOTES
	± 15 deg.	± 0.1 deg. fine ± 1.0 deg. backup	<p>6</p> <p>ST-121 RESOLVER</p>	±6%	±10%	±10%	
			CROSS-OVER DETECTORS & REGISTER				
			MINOR LOOP				
0.8 v/deg 4%			LADDERS				
			KΨ				
2% 3.0 v/deg	Gain = 3.75	+ 30 mv. (±0.01°)	SCALING AMPLIFIER				7
triggering = ±0.8v threshold ±6%  full on = ±1.28v threshold ±6%  Minimum pulse duration = 65ms ± 15%		± 10 mv	<p>Ⓟ</p> <p>SPATIAL AMPLIFIER</p>	triggering threshold ±0.8v ±10%  full on threshold ±1.28v ±10%  Minimum pulse duration 65ms ± 15%			4,5       7
			V <sub>i</sub>				
0 or + 28 volts ± 2 volts 3 ms delay			CONTROL RELAY PACKAGE	Same as the spatial amplifier			7
			<p>Ⓟ</p> <p>SOLENOIDS &amp; VALVES</p>				9



APPENDIX 5  
 TELEMETRY FUNCTIONS  
 ATTITUDE RATE CHANNEL  
 (PITCH & YAW - COAST)  
 (ROLL - POWERED OR COAST)

SUB-SYSTEM OR COMPONENT SPECIFICATION

SYSTEM SPECIFICATION

SCALE FACTOR & TOLERANCE	MAX. RANGE	NULL	S-IVB	TOLERANCE	NOTES
$\dot{\phi} = 4.5 \text{ v/deg/sec}$ $\pm 12\%$	$\pm 10 \text{ deg/sec}$	$\pm 563 \text{ mv}$ $(\pm 125 \text{ deg/s})$	$\phi$ EDS RATE CYROS	$\pm 12\%$ $\pm 10\%$ $\pm 10\%$	
			CSP		7
1%	Gain = 5	$+ 30 \text{ mv}$ $(\pm 0.00133\%/s)$	SCALING AMPLIFIER		
triggering-9.9 v threshold $\pm 6\%$ full on $\pm 1.4 \text{ lv}$ threshold $\pm 4\%$ Minimum pulse duration $65 \text{ ms} \pm 15\%$		$\pm 10 \text{ mv}$	SPATIAL AMPLIFIER $V_i$	triggering threshold $\pm 0.9 \text{ v} \pm 10\%$ full on threshold $\pm 1.4 \text{ lv} \pm 10\%$ Minimum pulse duration $65 \text{ ms} \pm 15\%$	4, 7
0 or + 28 volts $\pm 2 \text{ volts}$ 3 ms delay			CONTROL RELAY PACKAGE	Same as spatial amplifier	7
			SOLENOIDS & VALVES		9

APPENDIX 5 (Continued)

SATURN IB/SA-203 TELEMETRY FUNCTIONS

1. Available on control computer connector Y-9 pins n and p for pitch, k and m for yaw, and i and j for roll,
2. Available on control computer connector J-9 pins u and v for pitch, s and t for yaw, and q and r for roll,
3. Available on control computer connector Y-9 pins y and z for pitch, and w and x for yaw,
4. Control system unit output = nominal output value  $\pm$  the gain tolerance  $\pm$  the null shift.
4. It should be noted that these measurements are made at the telemetry outputs of the flight control computer and not in the blockhouse,
6. On Enclosure 5<sup>8</sup> of this Appendix are the tolerances for measurements being made in the blockhouse,
7. When telemetry outputs are measured in the blockhouse, refer to enclosure 5<sup>9</sup>.
8. See drawing 50M34204 sheet 4 for filter characteristics.
9. See drawing 50M34207 sheet 2 for valve and solenoid characteristics.

Enclosure 5<sup>8</sup>

# FLIGHT CONTROL SYSTEM MEASUREMENT BLOCK DIAGRAM

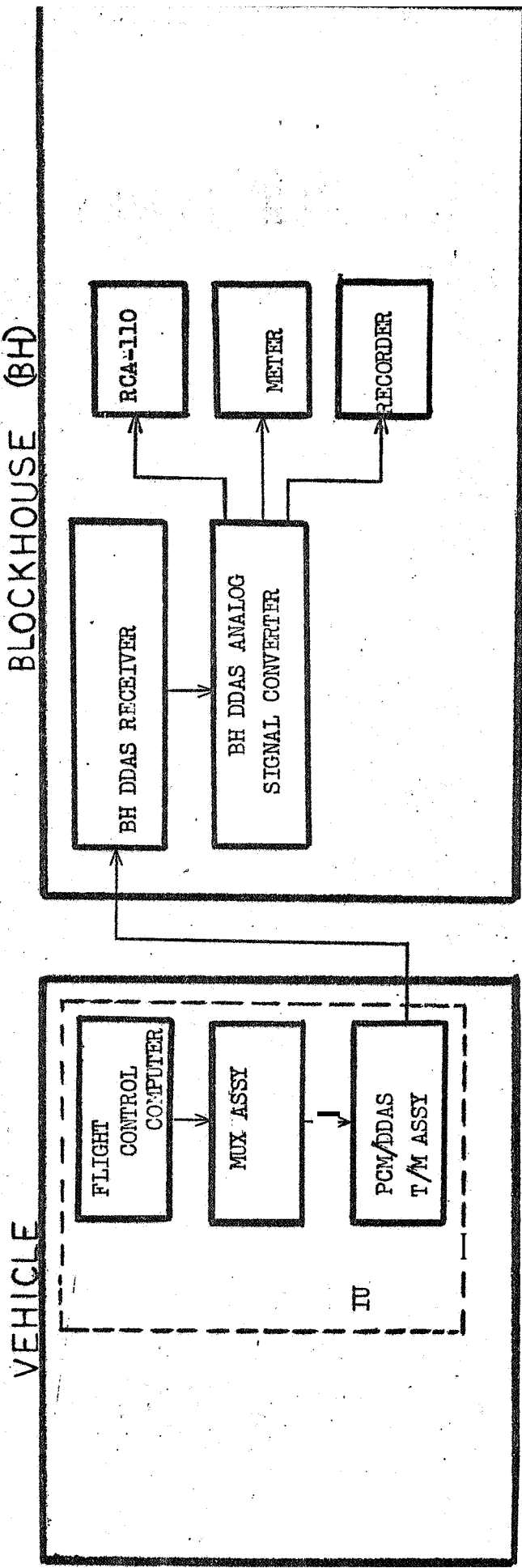

**NOTE:**

Measured Output = Theoretical output plus the larger of;

- (a)  $\pm 20\%$  of the theoretical output or,
- (b)  $\pm 10\%$  of the maximum range.

These tolerances include control and measuring system tolerance, bias, and noise effects.

## APPENDIX 6

SATURN IB/SA-203 ESE INPUT FUNCTIONS

<u>PARAMETER</u>	<u>UNIT</u>	<u>RAMP GENERATOR SCALE FACTOR</u>	<u>MAXIMUM RANGE</u>	<u>TORQUER SCALE FACTOR</u>	<u>REMARKS (SEE NOTES)</u>
$\psi$	Attitude Error substitute input to control com- puter	0.8 v/deg	$\pm 15.3$ deg	None	
$\dot{\phi}$	Attitude rate substitute input to control com- puter	4.5 v/deg	$\pm 10$ deg/s	None	
$\dot{\phi}$	EDS rate gyro	None	$\pm 10$ deg/s	8 mafdegfs (160 ma max.)	P
$\ddot{Y}$	Lateral accelera- tion substitute input to control computer	1.0 v/meter/s <sup>2</sup>	$\pm 10$ m/s <sup>2</sup>	None	
$\ddot{Y}$	Control accelero- meter	None	+10 mfs <sup>2</sup>	17 ma/m/s <sup>2</sup> (170 ma max.)	2,3

## NOTES:

1. Resistance of torquing coils is 135  $\pm 15$  OHMS.
2. Resistance of torquing coils is 150  $\pm 10$  OHMS.
3. Accelerometers with serial numbers 1 through 9 have a torquer scale factor of 15 ma/meter/s<sup>2</sup>.

Enclosure 6

APPENDIX 7

AUXILIARY PROPULSION SYSTEM (APS)

1. The control law for the APS system is represented by the following equations which give error command ( $\epsilon$ ) to the pseudo rate modulafor (spatial amplifier).

$$\text{Pitch: } \epsilon_p = a_{op}\psi_p + a_{1p}\dot{\phi}_p$$

Yaw - Roll Mixed;

$$\epsilon_{Y-R} = a_{oy}\psi_y - a_{or}\psi_r + a_{1y}\dot{\phi}_y - a_{1r}\dot{\phi}_r$$

$$\epsilon_{Y+R} = a_{oy}\psi_y + a_{or}\psi_r + a_{1y}\dot{\phi}_y + a_{1r}\dot{\phi}_r$$

2. The following table illustrates the polarity of the signal required to cause each engine to fire,

<u>Error signal</u>	<u>Engine on</u>
1. $+\epsilon_p$	I <sub>p</sub> (+P)
2. $-\epsilon_p$	III <sub>p</sub> (-P)
3. $+\epsilon_{Y-R}$	III <sub>II</sub> (+Y, -R)
4. $-\epsilon_{Y-R}$	III <sub>IV</sub> (-Y, +R)
5. $+\epsilon_{Y+R}$	I <sub>II</sub> (+Y, +R)
6. $-\epsilon_{Y+R}$	I <sub>IV</sub> (-Y, -R)

3. The following equations represent the "on-off-modulation" characteristics of the spatial amplifiers, where  $E_o$  is the spatial amplifier output and  $\epsilon$  is the attitude command in degrees:

$$\text{for } \epsilon < |\pm 1^\circ|, E_o = 0$$

$$\text{for } \epsilon = |\pm 1^\circ|, E_o = \text{minimum pulse width and frequency,}$$

$$\text{for } |\pm 1^\circ| < \epsilon < |\pm 1.6^\circ|, E_o = \text{pseudo rate modulated signal,}$$

$$\text{for } \epsilon \geq |\pm 1.6^\circ|, E_o = 28_v \text{ constant}$$

Enclosure 7

APPENDIX 7 (Continued)

4, The above equations do not represent the dynamics of the spatial amplifier nor the rest of the auxiliary control system. However, they do describe the steady-state characteristics. The dynamic characteristics may be obtained from other references, if desired. An approximation is given in Sheet 1 and 2, Drawing Number 50M34204.

5, Table I gives the angular accelerations for S-IVB burn and coast phases due to various engines firing.

6, Figure 7B and 7C are phase plane plots of S-IVB 203 pitch, yaw and roll deadbands. The maneuvering rate ledge for S-IVB 203 has been set at:

$$\dot{\psi} \pm 0.30^\circ/\text{s for pitch and yaw where } T_f > T_4 + 5$$

$$\dot{\psi} \pm 0.50^\circ/\text{s for roll where } T_f > T_3 + 1$$

7. Spatial amplifier tolerance

a,  $\psi$  triggering threshold  $\pm 0.8\text{v} \pm 6\%$   
 $\pm 1^\circ$

b,  $\psi$  full on threshold  $\pm 1.28\text{v} \pm 6\%$   
 $\pm 1.6^\circ$

c,  $\dot{\phi}$  triggering threshold  $\pm 0.9\text{v} \pm 6\%$   
 $\pm 0.2^\circ/\text{s}$

d,  $\dot{\phi}$  full on threshold  $\pm 1.44\text{v} \pm 6\%$   
 $\pm 0.32^\circ/\text{s}$

e, Minimum pulse duration 65 ms  $\pm 10$

8, Figures 8A, 8B, 9A, 9B, 10A, and 10B are curves for an ideal pseudo rate modulator (spatial amplifier).

a, Figures 8A and 8B - Input signal (volts) versus switching frequency,

b, Figures 9A and 9B - Input signal (volts) versus percent on time,

c, Figures 10A and 10B - Input signal (volts) versus on-time pulse width,

APPENDIX 7 (Continued)

TABLE 1

SA-203 S-IVB AUXILIARY  
PROPULSION SYSTEM CHARACTERISTICS

MISSION PHASE	APS ENGINES FIRED	ANGULAR ACCELERATION = DEG/S <sup>2</sup>		
		PITCH	YAW	ROLL
S-IVB BURN $T_f = T_3 + 1$	I <sub>II</sub> , I <sub>IV</sub> , III <sub>II</sub> , or III <sub>IV</sub>	*	*	0.904
S-IVB BURN $T_f = T_3 + 457$	I <sub>II</sub> , I <sub>IV</sub> , III <sub>II</sub> , or III <sub>IV</sub>	*	*	0.929
S-IVB COAST (Fuel Aft)	I <sub>P</sub> or III <sub>P</sub>	0.125	*	*
	I <sub>II</sub> or III <sub>IV</sub>	0.013	0.120	0.929
	I <sub>IV</sub> or III <sub>II</sub>	0.013	0.120	0.929
S-IVB COAST (Fuel Fore)	I <sub>P</sub> or III <sub>P</sub>	0.161	*	*
	I <sub>II</sub> or III <sub>IV</sub>	0.016	0.156	0.930
	I <sub>IV</sub> or III <sub>II</sub>	0.016	0.156	0.930

- NOTES: 1. All  $\ddot{\phi}$ 's are for unmanned type mission,  
 2.  $\ddot{\phi}$ 's in table are for single engine firings.  
 3.  $\ddot{\phi}_R$  during S-IVB burn does not include 230 ft-lb roll torque due to 9-2 swirl,  
 4.  $\ddot{\phi} = \frac{NFdK}{\phi}$  deg/s<sup>2</sup> where  
 N = number of engines firing  
 F = thrust component = 150 lb x sin or cos 6"  
 d = moment arm in inches  
 $\phi$  = mass moment of inertia in  $K_g = M - s^2$   
 K = proportionality constant =  $0.66 \frac{lb-in}{kg-M}$   
 5. Symbol \* indicates negligible accelerations,  
 6. CG off-set not considered,  
 7. The AFS engines during S-IVB burn are activated by  $\psi$  roll and  $\dot{\phi}$  roll inputs only,

## APPENDIX 8

### CONTROL SYSTEM REDUNDANCY

#### 1. Platform Resolvers

a. Each platform axis has **two** resolvers associated with it to provide backup modes of operation should one fail during flight,

b. A **fine (64:1)** resolver **system** is used in the prime mode and a backup **(2:1)** system is used if three **(3)** unreasonable values occur in the fine resolver system during one **computation cycle**. The resolvers are read and checked once each minor loop (40 ms). If the difference between the Past reading and the new reading is  $\geq 0.4^\circ$ , the change is considered **unreasonable**.

#### 2. Switch selector

a. The **reset, stage select, and read command relays**, each, consist of two **parallel relays** (both coils and contacts) offering improved reliability,

b. The switch selector **register** is protected from failure by allowing the code or its **complement** to operate the same **output** relay driver, The LVDC sends an 8-bit code to the selected **register**. The eight complement Pines are **returned** to the LVDC via the LVDA and the transmitted code is checked, In the event an error is detected, the register is reset and the **complement** code is transmitted,

Using this code or complement-type operation allows the switch selector to work around an inoperative relay,

#### 3. LVDA D/A convertor channels.

a. Channels A & B in conjunction with the reference channel **provide** redundancy for the attitude error ( $\psi$ ) inputs to the control computer,

b. Channel A is the **prime** channel, Channel "B" will be selected for use if the reference ladder output and the Channel "A" ladder output differ by an amount  $\geq 0.117^\circ$  (0.094v) or when the LVDA output (sample & hold circuit) to the control computer and the reference ladder output differ by an amount 20.469" (0.375v). (Each channel consists of the ladder registers, ladder, sample & hold multiplier, sample & hold circuit and the selection circuits).

#### 4. Control signal processor and EDS rate gyros.

a. The EDS command E spare rate gyros, with their demodulators, in conjunction with the EDS reference **rate** gyros and its demodulator provide redundancy for the attitude **rate** ( $\dot{\phi}$ ) input to the control computer,

b. The **command** gyros and their demodulators are used until the outputs of the demodulators for the command and reference gyros differ by an amount  $> 1.64^\circ/\text{s}$   $\pm 0.222 \text{ deg/s}$  then the spare gyros and their demodulators are selected for use,



## APPENDIX 8 (Continued)

### 5. 50 ma servo amplifier channel (pitch or yaw)

a. The 50 ma command and spare servo amplifier channels in conjunction with the reference servo amplifier channel provide redundancy for S-IVB actuator control.,

b. The command servo amplifier is the prime channel, The spare amplifier channel is used if the outputs of the reference and command amplifiers differ by an amount  $>8 \text{ ma} \pm 3\%$ . The 50 ma servo amplifier channel consists of the servo, amplifier,  $\psi$  and  $\phi$  filters and the  $\psi$  scaling amplifiers.

### 6. Spatial amplifier channels (pitch or yaw/roll)

a. The command and spare channels in conjunction with the reference channel provide control computer attitude control (output) signal redundancy for the roll axis during S-IVB burn phase and for pitch, and yaw/roll during coast phases,

b. The command spatial amplifier channel is used until its output and the output of the reference channel differ by an amount from forty per cent to sixty per cent duty cycle then the spare channel output is selected for use. (See Sheet 2, Drawing 50M34207; spatial amplifier channel consists of the spatial amplifiers and the  $\psi$  and  $\phi$  scaling amplifiers),

### 7. Control Relay Package

The control relay package design takes advantage of the quad redundant valves by putting relay coils in parallel to control the series parallel valves. (refer to Astrionics Systems Handbook dated Aug 1, 1965 and Sheet 2, Drawing 50M34207 for more information on control relay package & valve redundancy).

## APPENDIX 9

### REFERENCES

- Memo, "**Status of Saturn IB/201 Control Computer Design,**" December 2, 1964, R-ASTR-NF-368-64
- Memo, "**Saturn I - Block PI Control System Block Diagram, Scale Factors and Steady-State Equations,**" February 13, 1963, M-ASTR-N-171
- Memo, "**Steady-State Equations for Saturn V Control System During Powered Flight Phase,**" May 14, 1964, R-ASTR-NG-10
- Report, "**Hardware Description and Error Analysis of the Attitude Control System for the Saturn IB/V Vehicle,**" December 24, 1964, IBM Control No, 64-208-0008I-1
- Memo, "**The Linear Equations and Nonlinear Models for Saturn IB Thrust Vector Control System,**" March 19, 1965, R-ASTR-NFM-128-65
- Astrionics Systems Handbook, "**Saturn Launch Vehicles,**" August 1, 1965
- Memo, "**Flight Sequence for SA-203,**" March 7, 1966 R-ASTR-EAA
- Memo, "**Saturn V/S-IU Guidance & Control Information,**"\* September 22, 1965 R-ASTR-NG-92-65
- Memo, "**Control Gains and Shaping Networks for Saturn SA-283, SHB and S-IVB Stages,**" July 15, 1965 R-ASTR-F-65-110
- Memo, "**Control System Tolerances,**" August 13, 1965 R-ASTR-NFE-208-65
- Memo, "**Control System Specifications for SA-202 and SA-203,**" R-ASTR-NFS-161-66, May 17, 1966

VEHICLE and VEHICLE DYNAMICS

FIGURE 1. GUIDANCE AND CONTROL SYSTEM GENERAL DIAGRAM

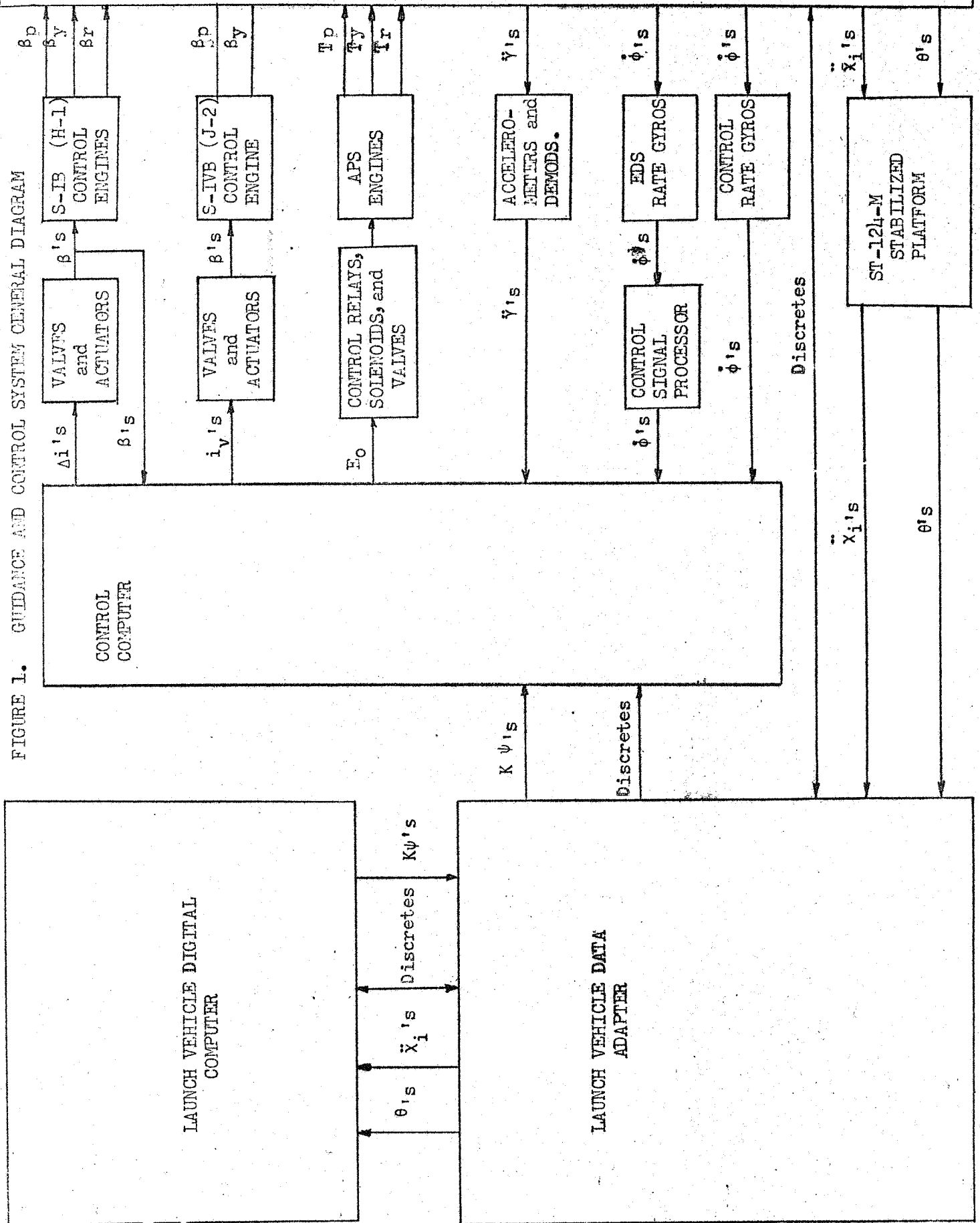

TRANSPORT DELAY FROM GIMBAL P.I.O. TO CONTROL COMPUTER INPUT

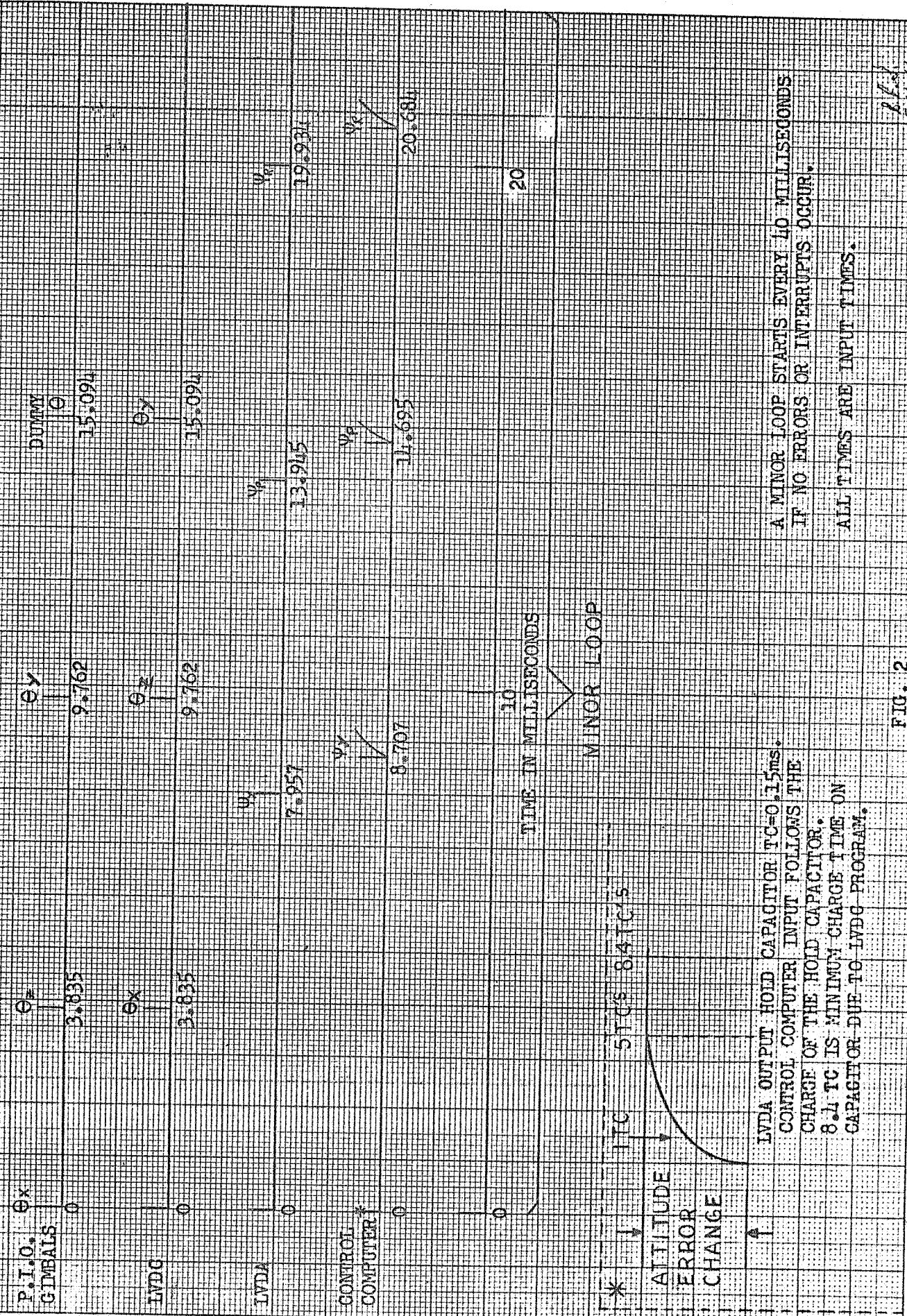

A MINOR LOOP STARTS EVERY 40 MILLISECONDS IF NO ERRORS OR INTERRUPTS OCCUR. ALL TIMES ARE INPUT TIMES.

LVDA OUTPUT HOLD CAPACITOR TC=0.15ms. CONTROL COMPUTER INPUT FOLLOWS THE CHARGE OF THE HOLD CAPACITOR. 8.4 TC IS MINIMUM CHARGE TIME ON CAPACITOR DUE TO LVDC PROGRAM.

FIG. 2

8/6/61  
5-11-66

Saturn IB/SA-203  
 Attitude Error Control Gains

First Stage Flight  
 Fig. 3

$\alpha_0$  TOLERANCE IS  $\pm 10\%$  OR  $\pm 1$  SECOND AT THE SWITCH POINTS

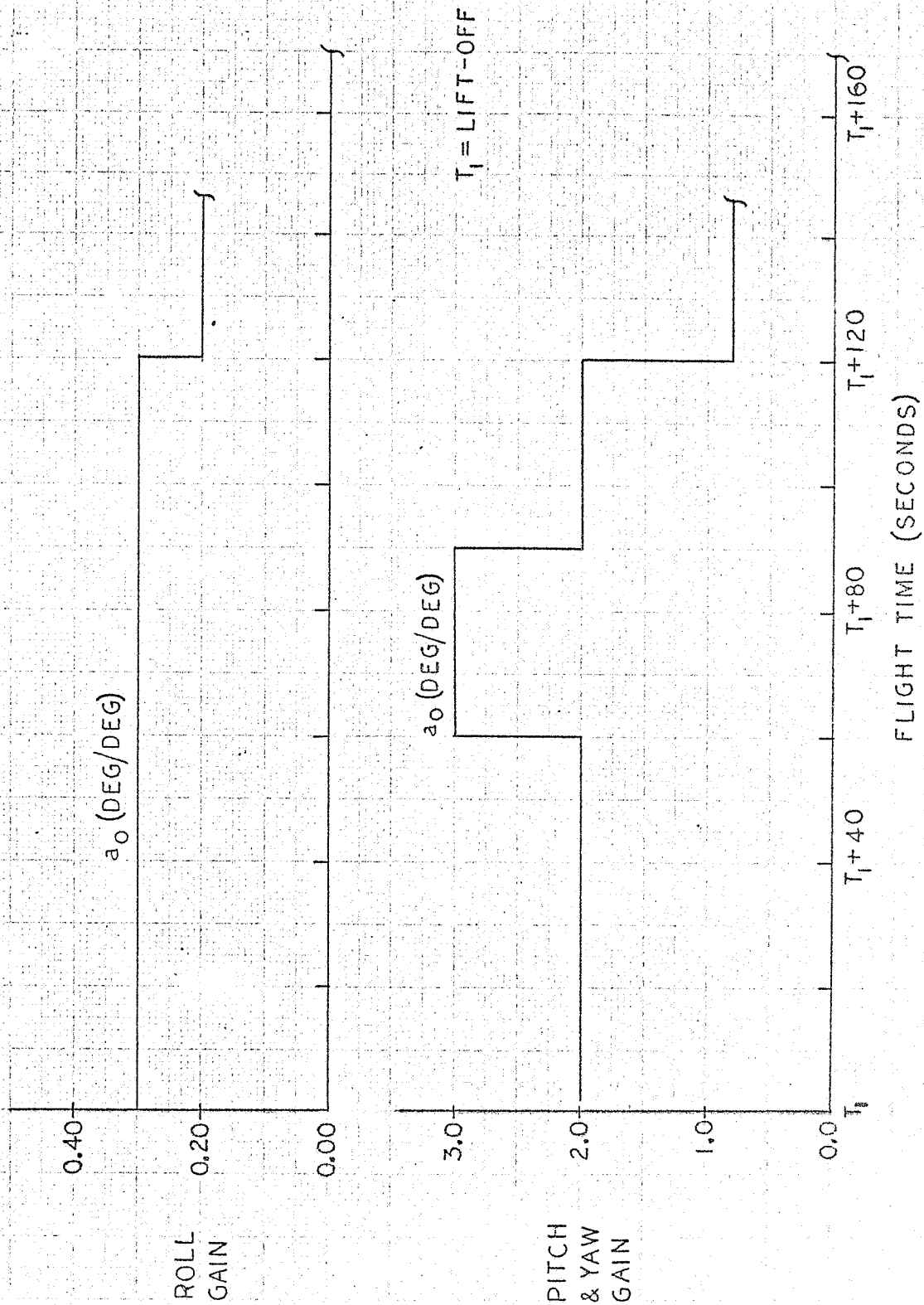

$Q_1$  TOLERANCE IS  $\pm 10\%$  OR  $\pm 1$  SECOND AT THE SWITCH POINTS

Saturn IB/SA-203  
Attitude Rate Control Gains  
First Stage Flight  
Fig. 4

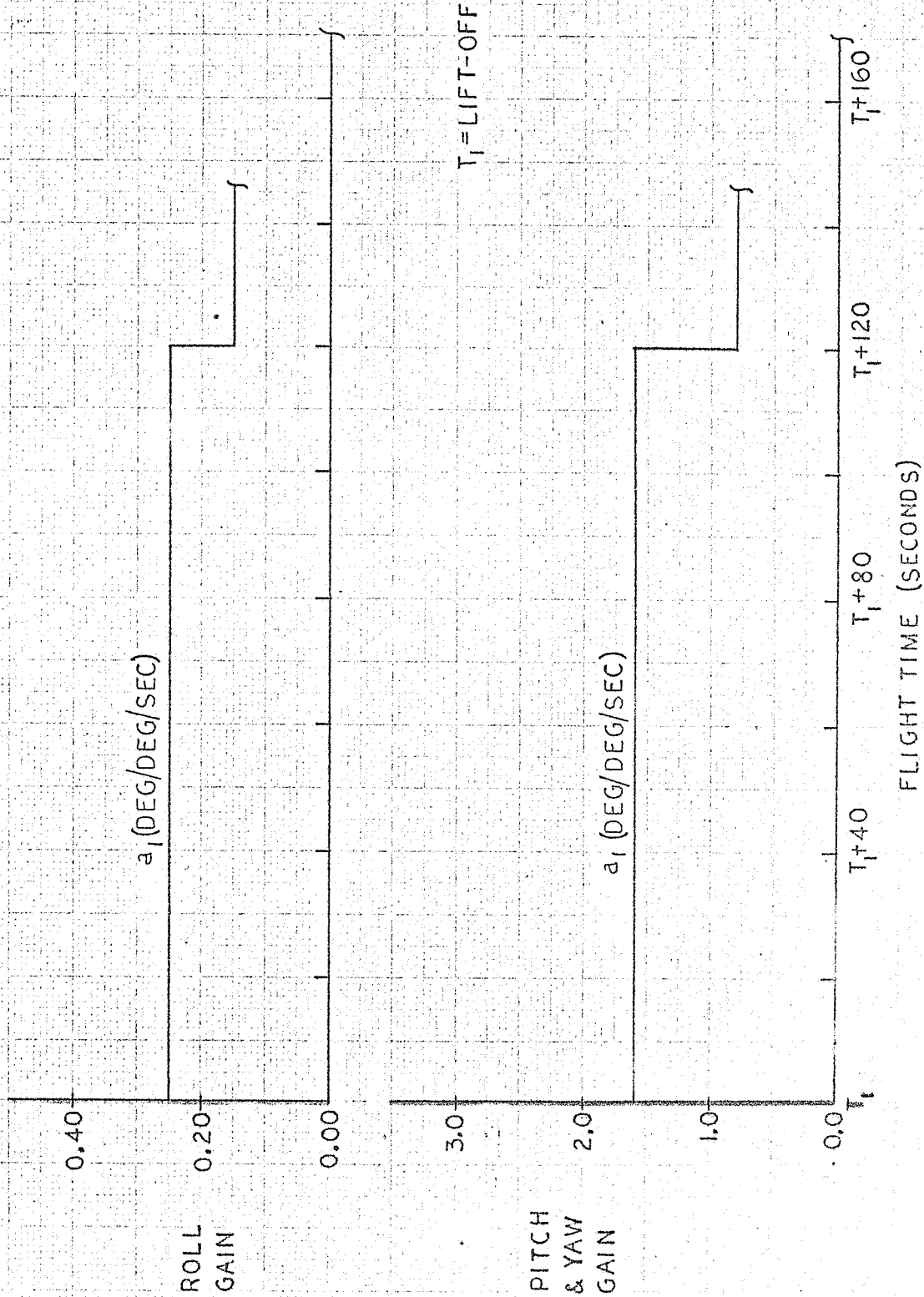

Subd.  
1-31-66

Saturn IB/SA-203  
 Lateral Acceleration Control Gain  
 First Stage Flight  
 Fig. 5

$g_2$  TOLERANCE IS  $\pm 10\%$  OR  $\pm 1$  SECOND AT THE SWITCH POINTS

$g_2$  (DEG/METER/SEC<sup>2</sup>)

PITCH  
& YAW  
GAIN

$T_1 = \text{LIFT-OFF}$

FLIGHT TIME (SECONDS)

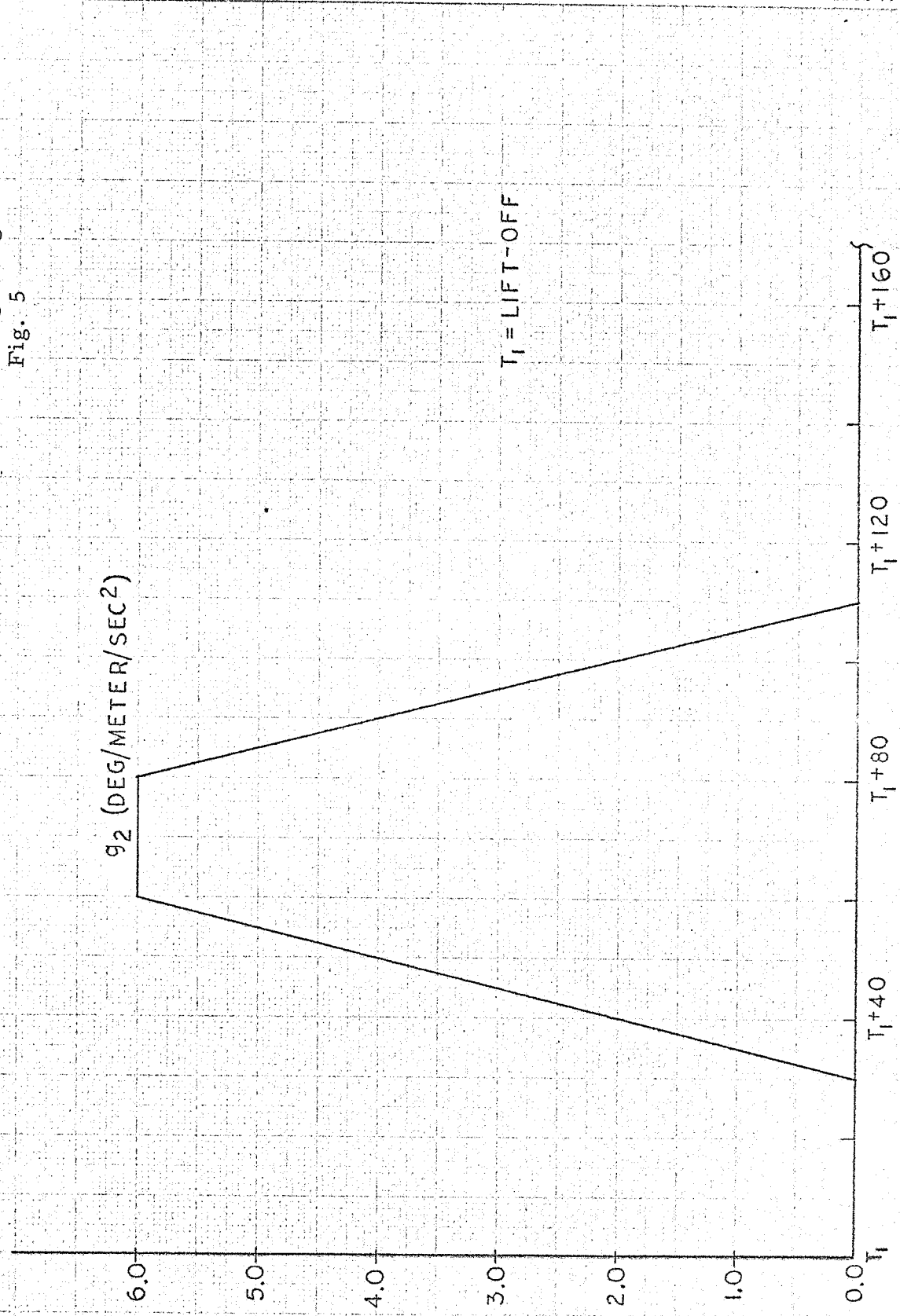

$a_0$  TOLERANCE  $\pm 10\%$  OR  $\pm 1$  SECOND AT THE SWITCH POINTS

Saturn IB/SA-203  
Attitude Error Control Gains  
Second Stage Flight  
Fig. 6A

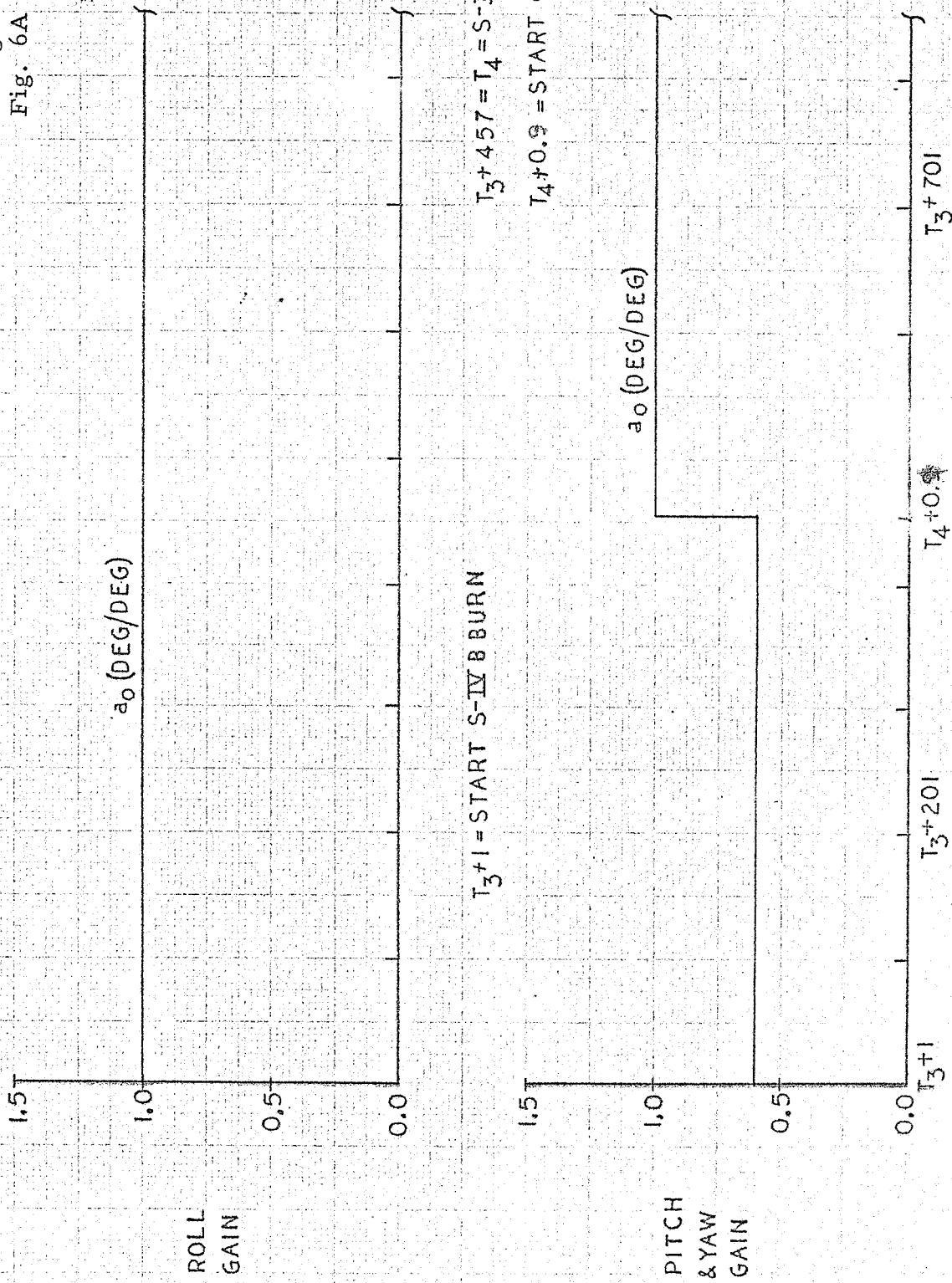

FLIGHT TIME (SECONDS)

662  
1-31-65



$\alpha_1$  TOLERANCE IS  $\pm 10\%$  OR  $\frac{1}{4}$  SECOND AT THE SWITCH POINTS.

Saturn IB/SA-203  
Attitude Rate Control Gains  
Second Stage Flight  
Fig. 6B

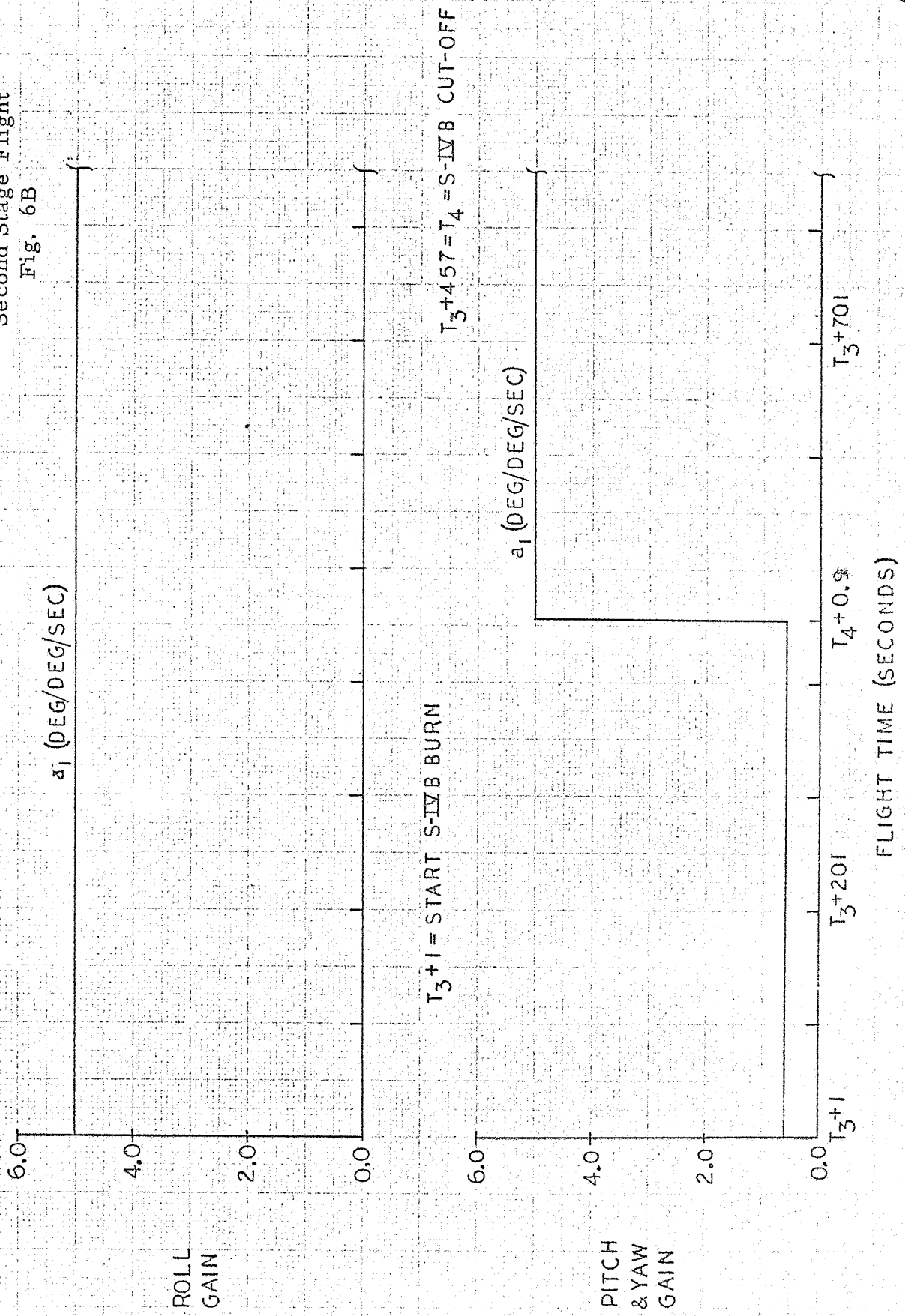

8.68  
1-31-66

# FLIGHT CONTROL COMPUTER APS CONTROL

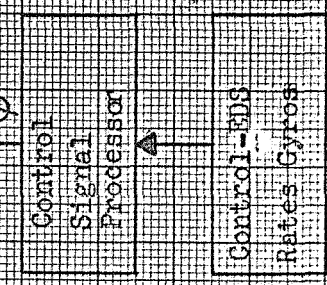
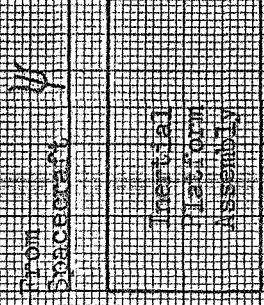
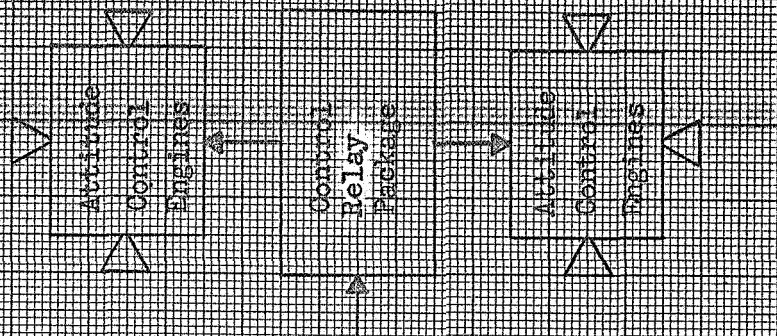
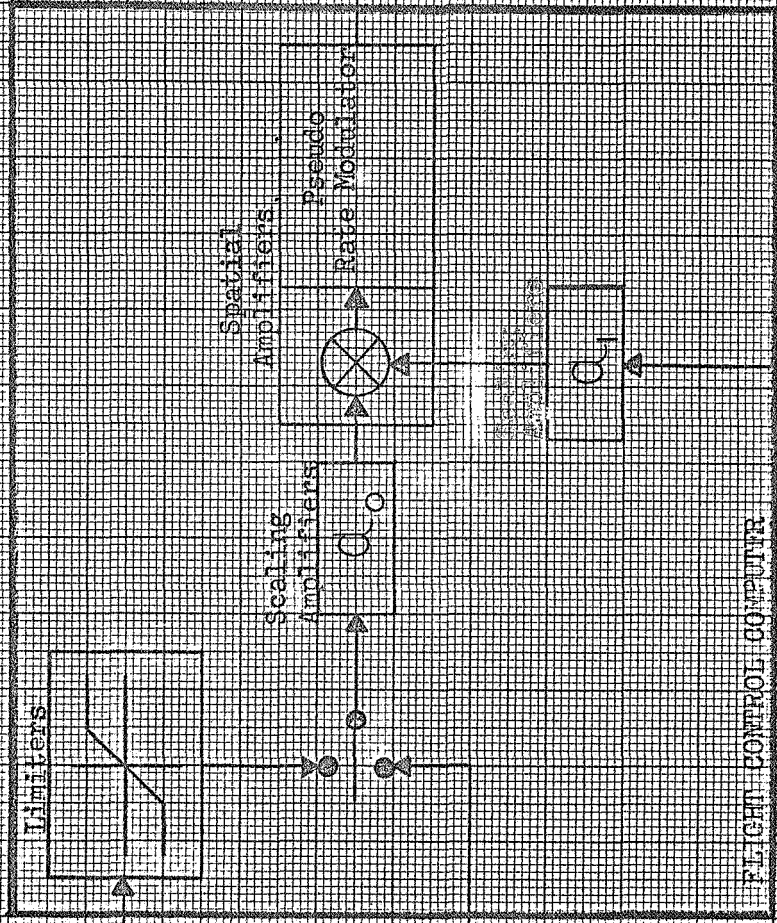
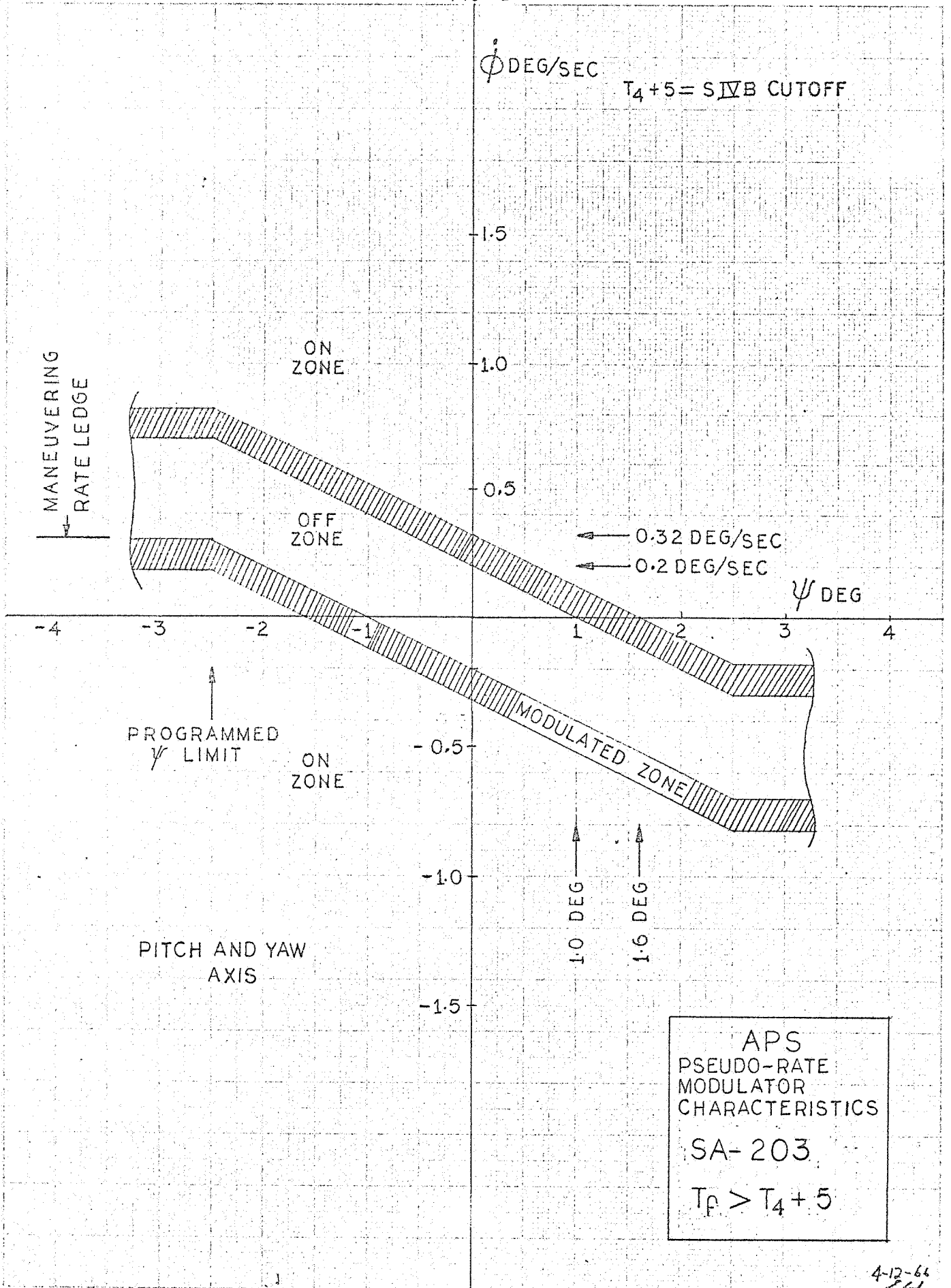

FIG. 7A

FIG 7B



4-12-66  
EGL

FIG. 7C

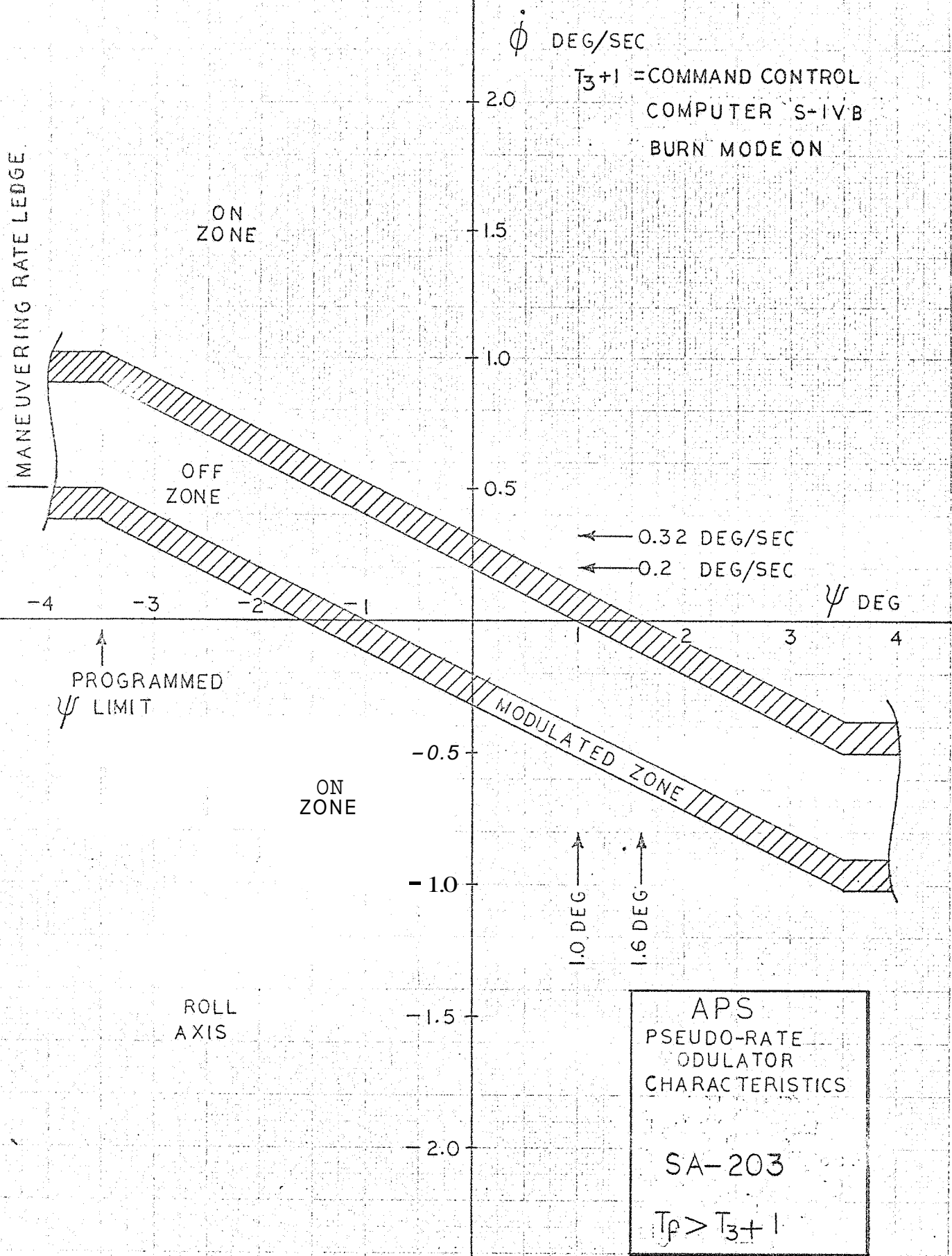

4-12-66  
868

FIG 8A

SPATIAL AMPLIFIER PULSE OUTPUT FREQUENCY  
 VERSUS  $\psi$  INPUT VOLTAGE  
 Theoretical Curve

FREQUENCY IN C.P.S.

$\psi$  INPUT VOLTS

4.0

3.0

2.0

1.0

.8

1.0

1.2

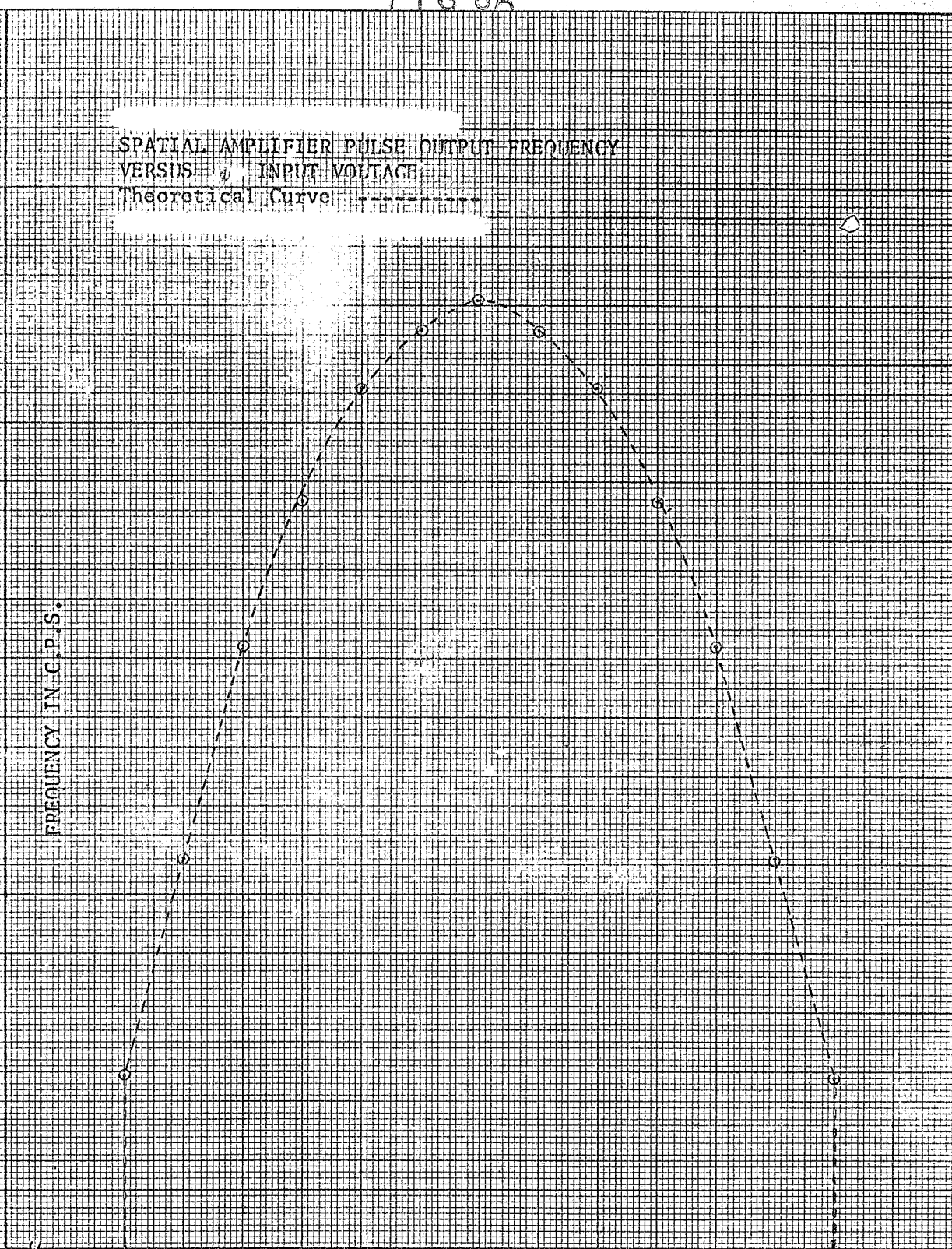

FIG 8B

SPATIAL AMPLIFIER OUTPUT FREQUENCY  
 VERSUS INPUT VOLTAGE  
 Theoretical Curve -----

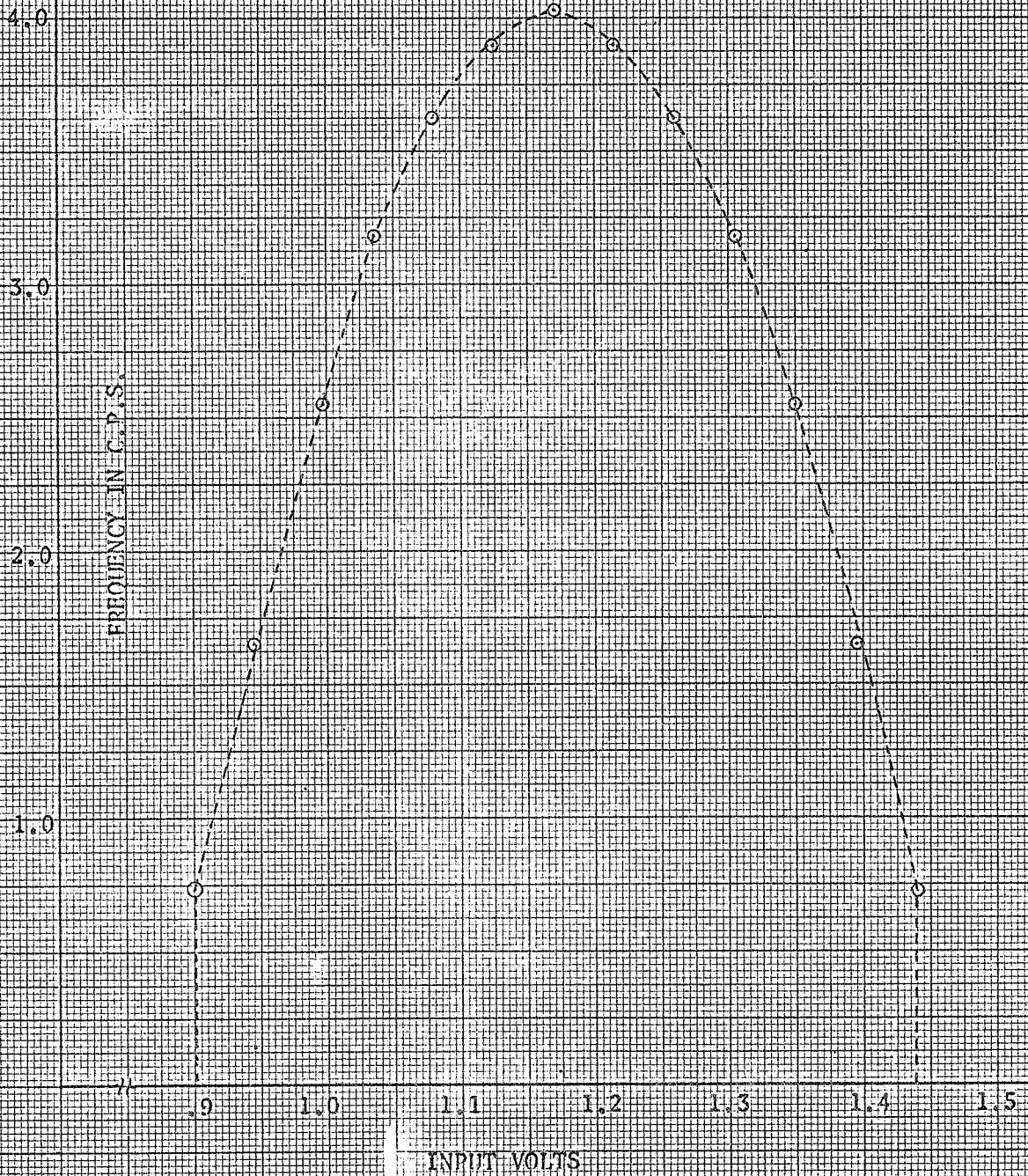

FIG 9A

SPATIAL AMPLIFIER "ON TIME" VERSUS  
INPUT VOLTAGE

Theoretical Curve

PERCENT "ON TIME"

100

80

60

40

20

.8

1.0

1.2

INPUT VOLTS

0-20765  
12

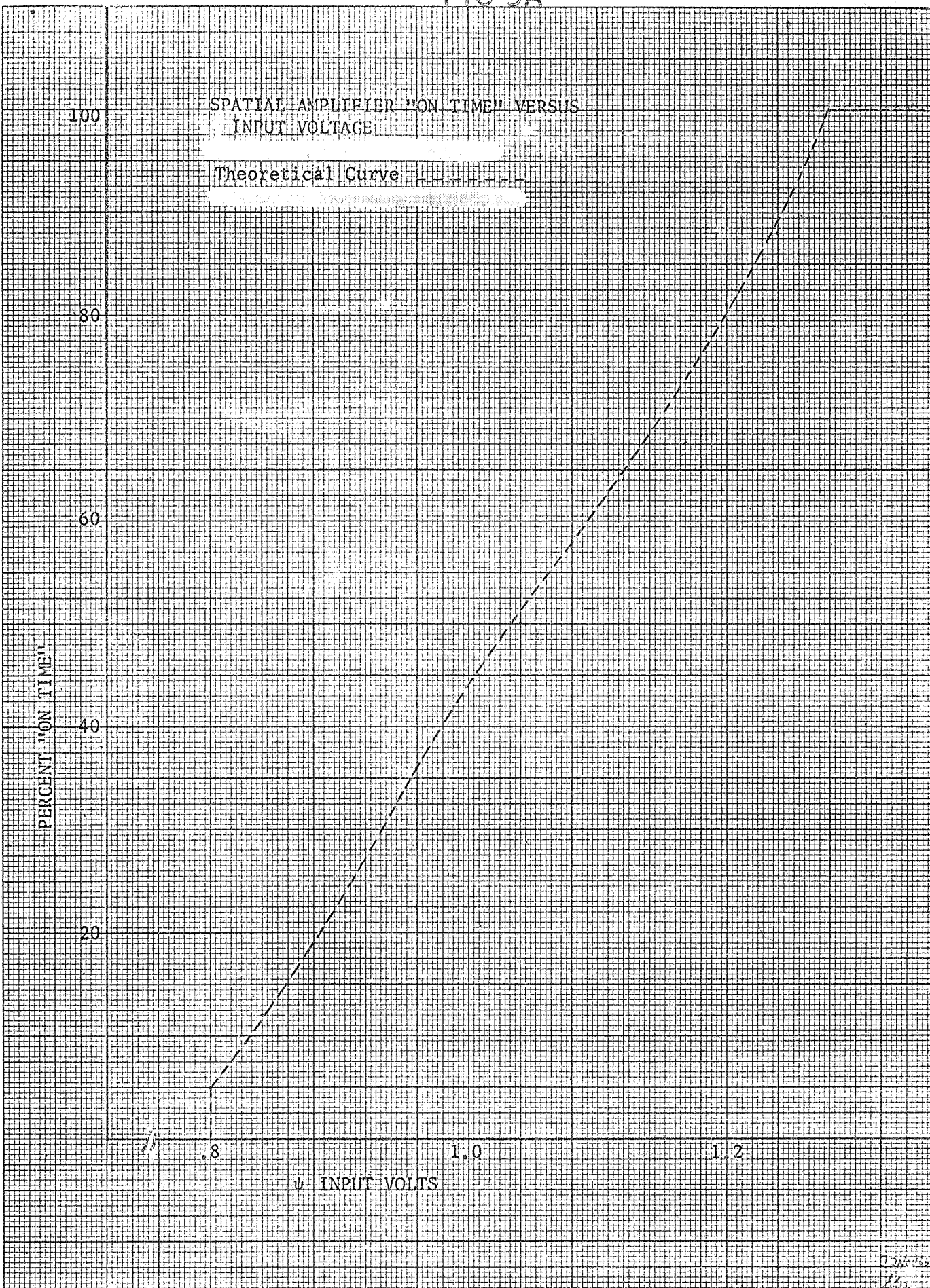

FIG 9B

SPATIAL AMPLIFIER "ON TIME" VERSUS  
INPUT VOLTAGE

Theoretical Curve - - - - -

PERCENT "ON TIME"

100  
80  
60  
40  
20  
0

.9 1.0 1.1 1.2 1.3 1.4 1.5

INPUT VOLTS

228-16  
662



FIG 10A

SPATIAL AMPLIFIER OUTPUT PULSE WIDTH  
VERSUS INPUT VOLTAGE

400

Theoretical Curve - - - - -

300

200

100

MILLISECONDS - PULSE WIDTH

.8

1.0

1.2

V INPUT VOLTS

22/11/55  
1/10

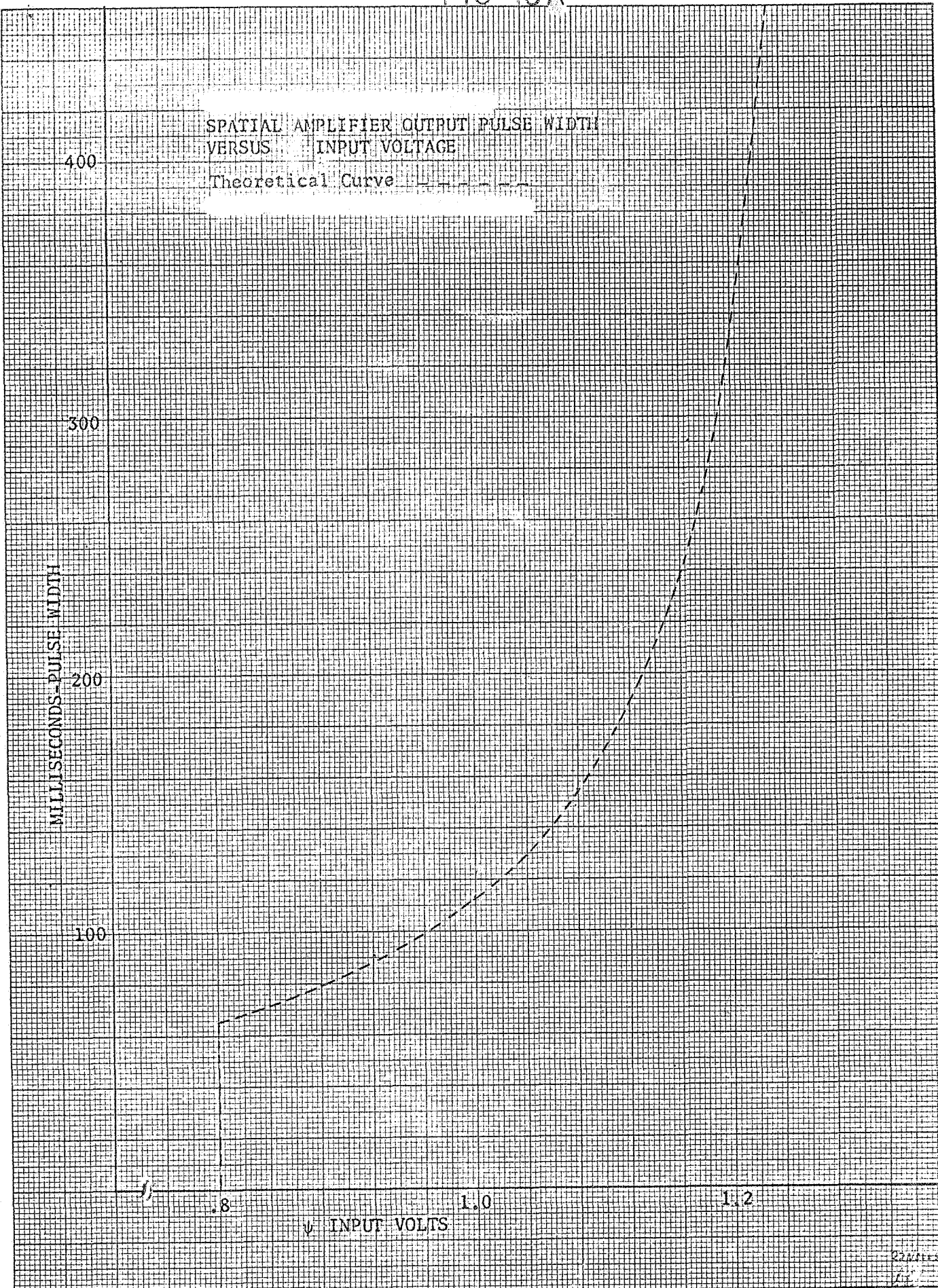

FIG 10 B

SPATIAL AMPLIFIER OUTPUT PULSE WIDTH  
VERSUS INPUT VOLTAGE  
Theoretical Curve - - - - -

MILLISECONDS - PULSE WIDTH

400

300

200

100

.9

1.0

1.1

1.2

1.3

1.4

1.5

$\phi$  INPUT VOLTS

201116  
150

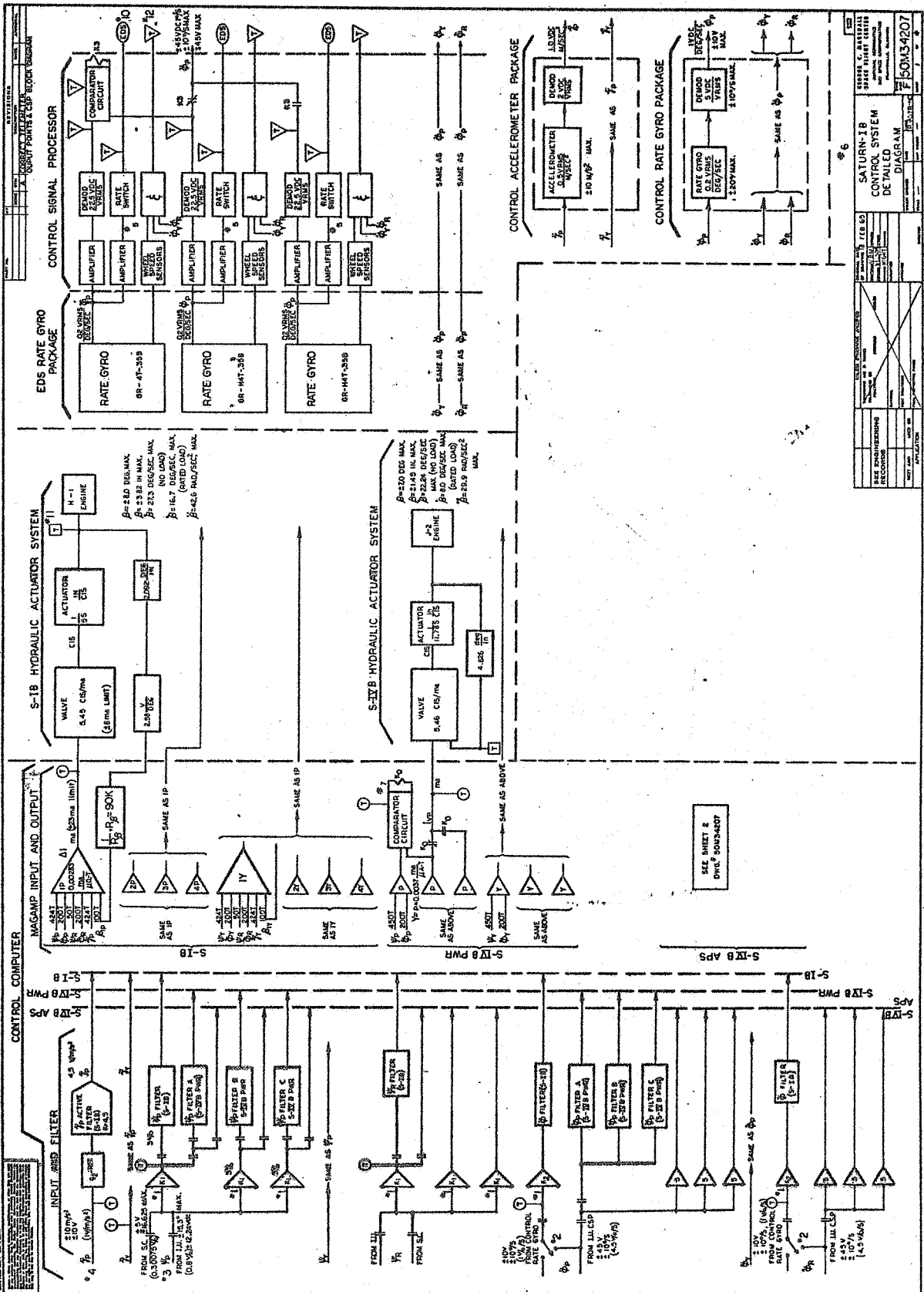

REVISIONS	
NO.	DESCRIPTION
1	INITIAL DESIGN
2	REVISED FOR MANUFACTURING
3	REVISED FOR TESTING
4	REVISED FOR PRODUCTION

DATE	BY	APP.	REVISION

SATURN-1B CONTROL SYSTEM DE TAILED DIAGRAM	
DATE	BY

FORM 34207

1. This diagram is a detailed diagram of the control system for the engine system. It shows the electrical connections between the engine system and the control system. The engine system is shown on the right side of the diagram, and the control system is shown on the left side. The diagram is divided into three sections: S-IV B APS #13, 14; CONTROL RAY PAC #32; and H-IV E # P R Q L IC ENGINE SYS #1 E. The diagram shows the electrical connections between the engine system and the control system. The engine system is shown on the right side of the diagram, and the control system is shown on the left side. The diagram is divided into three sections: S-IV B APS #13, 14; CONTROL RAY PAC #32; and H-IV E # P R Q L IC ENGINE SYS #1 E.

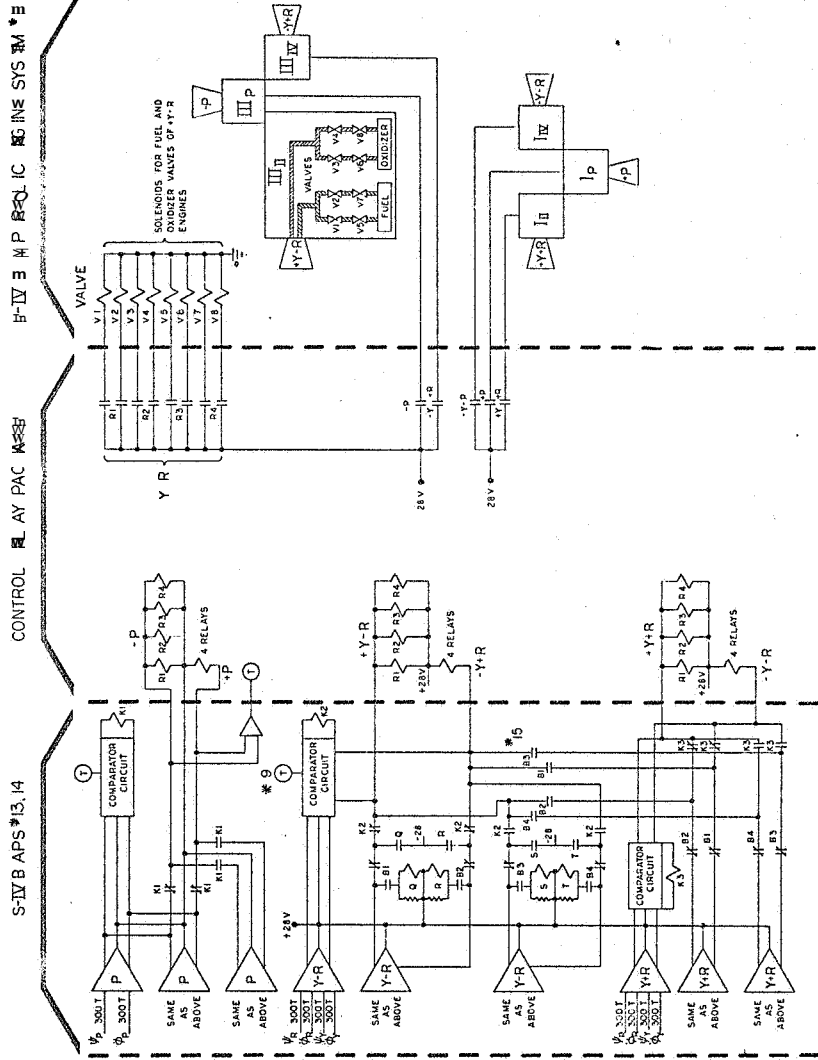

SEE ENGINEERING RECORDS 1. SEE ENGINEERING RECORDS 2. SEE ENGINEERING RECORDS 3. SEE ENGINEERING RECORDS 4. SEE ENGINEERING RECORDS 5. SEE ENGINEERING RECORDS 6. SEE ENGINEERING RECORDS 7. SEE ENGINEERING RECORDS 8. SEE ENGINEERING RECORDS 9. SEE ENGINEERING RECORDS 10. SEE ENGINEERING RECORDS 11. SEE ENGINEERING RECORDS 12. SEE ENGINEERING RECORDS 13. SEE ENGINEERING RECORDS 14. SEE ENGINEERING RECORDS 15. SEE ENGINEERING RECORDS 16. SEE ENGINEERING RECORDS 17. SEE ENGINEERING RECORDS 18. SEE ENGINEERING RECORDS 19. SEE ENGINEERING RECORDS 20. SEE ENGINEERING RECORDS 21. SEE ENGINEERING RECORDS 22. SEE ENGINEERING RECORDS 23. SEE ENGINEERING RECORDS 24. SEE ENGINEERING RECORDS 25. SEE ENGINEERING RECORDS 26. SEE ENGINEERING RECORDS 27. SEE ENGINEERING RECORDS 28. SEE ENGINEERING RECORDS 29. SEE ENGINEERING RECORDS 30. SEE ENGINEERING RECORDS 31. SEE ENGINEERING RECORDS 32. SEE ENGINEERING RECORDS 33. SEE ENGINEERING RECORDS 34. SEE ENGINEERING RECORDS 35. SEE ENGINEERING RECORDS 36. SEE ENGINEERING RECORDS 37. SEE ENGINEERING RECORDS 38. SEE ENGINEERING RECORDS 39. SEE ENGINEERING RECORDS 40. SEE ENGINEERING RECORDS 41. SEE ENGINEERING RECORDS 42. SEE ENGINEERING RECORDS 43. SEE ENGINEERING RECORDS 44. SEE ENGINEERING RECORDS 45. SEE ENGINEERING RECORDS 46. SEE ENGINEERING RECORDS 47. SEE ENGINEERING RECORDS 48. SEE ENGINEERING RECORDS 49. SEE ENGINEERING RECORDS 50. SEE ENGINEERING RECORDS 51. SEE ENGINEERING RECORDS 52. SEE ENGINEERING RECORDS 53. SEE ENGINEERING RECORDS 54. SEE ENGINEERING RECORDS 55. SEE ENGINEERING RECORDS 56. SEE ENGINEERING RECORDS 57. SEE ENGINEERING RECORDS 58. SEE ENGINEERING RECORDS 59. SEE ENGINEERING RECORDS 60. SEE ENGINEERING RECORDS 61. SEE ENGINEERING RECORDS 62. SEE ENGINEERING RECORDS 63. SEE ENGINEERING RECORDS 64. SEE ENGINEERING RECORDS 65. SEE ENGINEERING RECORDS 66. SEE ENGINEERING RECORDS 67. SEE ENGINEERING RECORDS 68. SEE ENGINEERING RECORDS 69. SEE ENGINEERING RECORDS 70. SEE ENGINEERING RECORDS 71. SEE ENGINEERING RECORDS 72. SEE ENGINEERING RECORDS 73. SEE ENGINEERING RECORDS 74. SEE ENGINEERING RECORDS 75. SEE ENGINEERING RECORDS 76. SEE ENGINEERING RECORDS 77. SEE ENGINEERING RECORDS 78. SEE ENGINEERING RECORDS 79. SEE ENGINEERING RECORDS 80. SEE ENGINEERING RECORDS 81. SEE ENGINEERING RECORDS 82. SEE ENGINEERING RECORDS 83. SEE ENGINEERING RECORDS 84. SEE ENGINEERING RECORDS 85. SEE ENGINEERING RECORDS 86. SEE ENGINEERING RECORDS 87. SEE ENGINEERING RECORDS 88. SEE ENGINEERING RECORDS 89. SEE ENGINEERING RECORDS 90. SEE ENGINEERING RECORDS 91. SEE ENGINEERING RECORDS 92. SEE ENGINEERING RECORDS 93. SEE ENGINEERING RECORDS 94. SEE ENGINEERING RECORDS 95. SEE ENGINEERING RECORDS 96. SEE ENGINEERING RECORDS 97. SEE ENGINEERING RECORDS 98. SEE ENGINEERING RECORDS 99. SEE ENGINEERING RECORDS 100. SEE ENGINEERING RECORDS		DATE: FEB 55 DRAWN BY: [Name] CHECKED BY: [Name] APPROVED BY: [Name] TITLE: [Title] DEPARTMENT: [Department] PROJECT: [Project] SHEET NO.: [Sheet No.] TOTAL SHEETS: [Total Sheets]
---	--	---

SATURN-1B CONTROL SYSTEM DETAILED DIAGRAM  
 FORM 3-207

\*NOTES

1,  $K_1$  and  $K_2$  versus signal source

$K_1$	$K_2$	Signal Source
3.75	=	IU LVDA
10.00		APOI/O SC
-	1.00	IU CSP (For $K_2 = 1$ The amplifier will be removed)
	4.50	CONTROL RG

2, The EDS Rate Gyros will be used during the entire flight for SA-202 & 203,

3, Spacecraft control will not be utilized before Saturn IB Vehicle 206,

4, The control accelerometers are utilized only during S-IB flight, These filters will be active,

5. A telemetry signal available for  $\dot{\phi}_R$  only,

6. This diagram does not include dynamics, Values in each block are steady-state values.

7, The 50 ma magamps and the spatial amplifiers have pair/spare redundancy, A "no compare" signal will pick the relay and switch amplifiers,

8, The yaw and roll nozzles are canted  $6^\circ$ . The three nozzles of each module do not lie in the same plane,

9. The symbol  $\textcircled{T}$  indicates a telemetry signal available from the control computer at the indicated points,,

10, The symbol  $\textcircled{EDS}$  indicates rate switch outputs to the emergency detection system, These signals are not voted by the control signal processor and are not limited to the demodulator limit of  $\pm 90$  degrees per second,

11. The symbol  $\textcircled{T}$  indicates a telemetry signal available from the actuators,

12, The symbol  $\nabla$  indicates a telemetry signal available from the control signal processor,

13, In S-IVB burn mode both Y,R spatial amplifiers fire simultaneously.

14, In S-IVB burn mode the yaw signal is inhibited from reaching the spatial amplifier.

15. Relay-Contacts  $B_1, B_2, B_3,$  and  $B_4$  are activated by S-IVB burn DISCRETE FROM LVDA.

		ORIGINAL DATE 18 FEB 65		Saturn-IB Control System Detailed Diagram	GEORGE C. MARSHALL SPACE FLIGHT CENTER NATIONAL AERONAUTICS & SPACE ADMINISTRATION	
		DFMN	CHK Smith, E.C.			
		ENGR Hight, H.H.	ENGR			
SYM	DESCRIP	DATE			A	50M34207
REVISIONS						

A

16. Magamp winding resistance is 22.64 ohms per 100 turns. The stage, channel, turns per winding, number of windings in series, total turns, and resistance that each filter output sees is tabulated below:

Stage	Channel	Turns per Winding	Number Windings in Series	Total Turns	Total Resistance (Ohms)
	$\beta$	100	1	100	22.64
S-IB	$\psi_p$	424	4	1696	383.97
	$\psi_y$	424	4	1696	383.97
	$\psi_r$	50	8	400	90.56
	$\phi_p$	200	4	800	181.12
	$\phi_y$	200	4	800	181.12
	$\phi_r$	200	8	1600	362.24
	$\dot{Y}_p$	424	4	1696	383.97
	$\dot{Y}_y$	424	4	1696	383.97
S-IVB PWR	$\psi_p$	450	1	450	101.88
	$\psi_y$	450	1	450	101.88
	$\phi_p$	200	1	200	45.28
	$\phi_y$	200	1	200	45.28
S-IVB APS	$\psi_p$	300	1	300	67.32
	$\psi_y$	300	2	600	135.84
	$\psi_r$	300	2	600	135.84
	$\phi_p$	300	1	300	67.92
	$\phi_y$	300	2	600	135.84
	$\phi_r$	300	2	600	135.84

		ORIGINAL DATE		Saturn - IB Control System Detailed Diagram	GEORGE C. MARSHALL SPACE FLIGHT CENTER	
		18 FEB 65				
		DFMN	CHK Barton		NATIONAL AERONAUTICS & SPACE ADMINISTRATION	
		ENGR	ENGR			
		Hight		A 50M34207		
MF	SYM	DESCRIP	DATE	REVISIONS		
				SHEET 4 OF 4		











REVISIONS

NO.	DATE	DESCRIPTION

TYPICAL ENGINE DEFLECTION TO CORRECT FOR POSITIVE VEHICLE MOVEMENTS

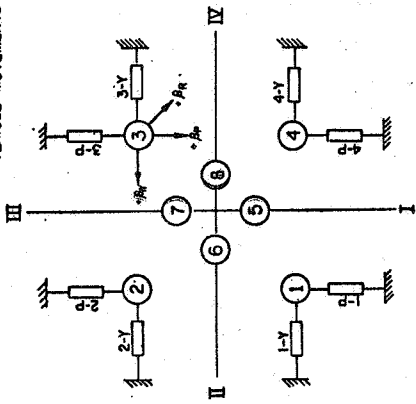

S-IB ACTUATOR LAYOUT

S-IB POLARITY TABLE

ACTUATOR	SIGNAL	EXTENSION	W/VEHICLE	W/O VEHICLE
1-Y	RET	RET	RET	RET
2-Y	RET	RET	RET	RET
3-Y	RET	RET	RET	RET
4-Y	RET	RET	RET	RET
5-Y	RET	RET	RET	RET
6-Y	RET	RET	RET	RET
7-Y	RET	RET	RET	RET
8-Y	RET	RET	RET	RET

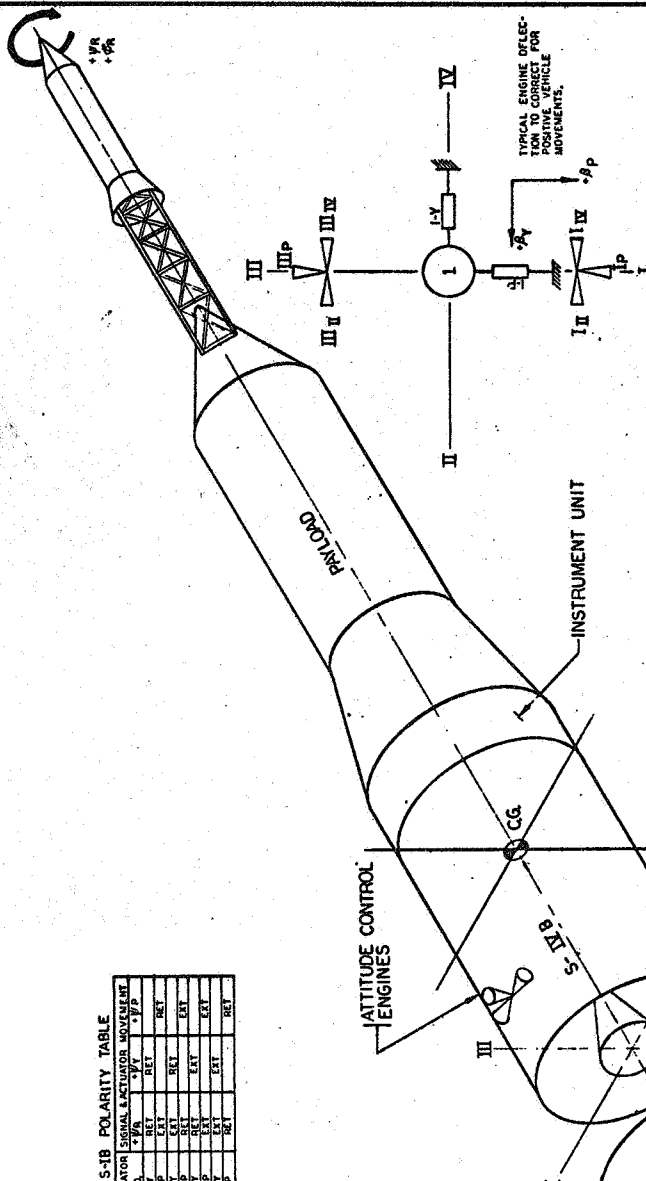

TYPICAL ENGINE DEFLECTION TO CORRECT FOR POSITIVE VEHICLE MOVEMENTS

S-IVB POLARITY TABLE

ACTUATOR	SIGNAL	EXTENSION	W/VEHICLE	W/O VEHICLE
1-Y	RET	RET	RET	RET
2-Y	RET	RET	RET	RET
3-Y	RET	RET	RET	RET
4-Y	RET	RET	RET	RET
5-Y	RET	RET	RET	RET
6-Y	RET	RET	RET	RET
7-Y	RET	RET	RET	RET
8-Y	RET	RET	RET	RET

CONDITIONS DURING COAST

ACTUATOR	1-Y	2-Y	3-Y	4-Y	5-Y	6-Y	7-Y	8-Y
I	F	F	F	F	F	F	F	F
II	F	F	F	F	F	F	F	F
III	F	F	F	F	F	F	F	F
IV	F	F	F	F	F	F	F	F

S-IVB ACTUATOR & CONTROL ENGINE LAYOUT

- NOTES:
1. ALL SIGNAL ARROWS INDICATE POSITIVE VEHICLE MOVEMENTS.
  2. WORKING POSITION IS SHOWN BY TILTS OVER POSITION I.
  3. ENGINE ACTUATOR & CONTROL ENGINE LAYOUTS SHOWN AS VIEWED FROM AFT END OF VEHICLE.
  4. DIRECT-JOGS & P/LARITIES SHOWN ARE TYPICAL FOR -LL STAGES.
  5. Y INDICATES ENGINE DEFLECTION REQUIRED TO CORRECT POSITIVE VEHICLE MOVEMENT.
  6. Y INDICATES CONTROL ENGINE FIRING REQUIRED TO CORRECT FOR POSITIVE VEHICLE MOVEMENT.
  7. ACTUATOR MOVEMENTS AND CONTROL ENGINE DEFLECTIONS ARE CHARACTERISTIC FOR ALL INPUT SIGNALS OF LINE POLARITY.

W-31252

100000 L. B. BARTON  
SUPER PATENT ENGINEER  
MEMPHIS, TENNESSEE

SATURN IB  
POLARITY CHART  
S-IB & S-IVB

FORM 350336