

Prepared for the  
GEORGE C. MARSHALL  
SPACE FLIGHT CENTER  
Huntsville, Alabama

5 May 1975

Contract No. NAS8-14000  
MSFC-DRL-008  
Line Item No. 032  
IBM No. 75W-00077

**Final Flight Simulation Report  
For Flight Control Computer  
S/N 0104-I (ASTP)**

(NASA-CR-143851) FLIGHT SIMULATION FOR N75-24762  
FLIGHT CONTROL COMPUTER S/N 0104-1 (ASTP)  
Final Report (International Business  
Machines Corp.) 296 p HC \$8.75 CSCL 14B Unclas  
G3/09 24747



**IBM**

2-7574

Prepared for the  
GEORGE C. MARSHALL  
SPACE FLIGHT CENTER  
Huntsville, Alabama

5 May 1975

Contract No. NAS8-14000  
MSFC-DRL-008  
Line Item No. 032  
IBM No. 75W-00077

**Final Flight Simulation Report  
For Flight Control Computer  
S/N 0104-1 (ASTP)**

Classification and Content Approval

Larry A. Wilson

Data Manager Approval

Stanley Radzowski

Program Office Approval

J. E. H.

## ABSTRACT

Flight Control Computer (FCC) 0104-I has been designated the prime unit for the SA-210 launch vehicle. This report documents the results of the Final Flight Simulation for FCC S/N 0104-I; these results verify satisfactory implementation of the design release and proper interfacing of the FCC with flight-type control sensor elements and simulated thrust vector control system.

## TABLE OF CONTENTS

<u>Section</u>	<u>Title</u>	<u>Page</u>
	ABSTRACT.....	i
	TABLE OF CONTENTS.....	ii
1	INTRODUCTION.....	1-1
	1.1 Mission Definition.....	1-1
	1.2 Final Flight Simulation of FCC S/N 0104-I.....	1-1
	1.2.1 Purpose.....	1-1
	1.2.2 Authorization.....	1-1
	1.2.3 Specific Test.....	1-1
	1.3 Results.....	1-3
	1.4 Conclusions.....	1-3
2	S-IB STAGE TEST RESULTS AND ANALYSIS.....	2-1
	2.1 Tabulation.....	2-1
	2.2 Results.....	2-6
3	S-IVB STAGE TEST RESULTS AND ANALYSIS.....	3-1
	3.1 Tabulation.....	3-1
	3.2 Results.....	3-5
4	S-IVB STAGE, AUXILIARY PROPULSION SYSTEM, TEST RESULTS AND ANALYSIS.....	4-1
	4.1 Tabulation.....	4-1
	4.2 Results.....	4-3
 <u>Appendix</u>		
A	SWITCHPOINT UTILIZATION.....	A-1
B	SPACECRAFT CONTROL.....	B-1
C	SERVO AMPLIFIER NOISE WITH 28-VOLT POWER SUPPLY VARIATION....	C-1
D	SERVO AMPLIFIER NULL AND NOISE CHARACTERISTICS.....	D-1
E	SIM LAB RG/CSP AND ACCELEROMETER FREQUENCY RESPONSES.....	E-1

Section 1

INTRODUCTION

## Section 1

### INTRODUCTION

#### 1.1 MISSION DEFINITION

The Saturn IB launch vehicle is a two-stage booster consisting of the S-IB and S-IVB stages. Its purpose is to insert into Earth orbit an Apollo Command and Service Module (CSM). The Instrument Unit (IU) and associated control system components are located atop the S-IVB stage.

Located within the IU, the Flight Control Computer (FCC) is responsible for controlling the flight path and providing vehicle stability during lift-off, S-IB boost, S-IVB boost, and S-IVB coast. FCC S/N 0104-I has been designated the prime unit for the SA-210 launch vehicle - the vehicle which will fly the ASTP mission.

#### 1.2 FINAL FLIGHT SIMULATION OF FCC S/N 0104-I

##### 1.2.1 Purpose

Final flight simulation is a comprehensive testing routine developed to verify satisfactory implementation of the FCC design release and proper interfacing of the FCC with flight-type control sensor elements and simulated thrust-vector control system. This testing routine is followed for each design implementation or design or component change in the FCC.

##### 1.2.2 Authorization

The checkout of FCC S/N 0104-I was performed in accordance with IBM responsibilities as defined in Appendix 9 of Contract NAS8-14000. The Simulation Laboratory tests were based on the "Final Flight Simulation Plan (AS-205 Control Computer Checkout Document)" submitted by MSFC (S&E-ASTR-FD) and specific tests agreed upon by S&E-ASTR-FD and IBM. The tests were primarily directed to an assessment of the flightworthiness of the FCC from the viewpoint of control engineers.

##### 1.2.3 Specific Tests

An FCC is subjected to a series of tests (simulation verification) to determine what deviations, if any, exist between predicted and actual computer performance. The following test requirement checkoff list was developed for FCC S/N 0104-I:

- Static null, noise and null drift (S-IB and S-IVB)
- Maximum noise characteristics with 28-volt power supply variations (S-IB and S-IVB)

- Switchpoint utilization (S-IB and S-IVB)
- $G_2$  versus time (C.A.T. profile) (S-IB)
- Spacecraft, attitude error channel gain change (S-IB and S-IVB)
- Gain, linearity, mixing and polarity (S-IB and S-IVB)
- Saturation (magnetic amplifier, S-IB; servo amplifier, S-IVB)
- Magnetic amplifier frequency responses (S-IB)
- Open-loop channel frequency responses (S-IB and S-IVB)
- Channel common mode (S-IB and S-IVB)
- Cross-axis coupling (S-IB and S-IVB)
- Nyquist frequency responses and closed-loop transients:
  - S-IB T=0 sec P/Y (Nyquist)
  - S-IB T=80 sec P/Y (Nyquist and transient)
  - S-IB T=120- sec P/Y (Nyquist and transient)
  - S-IB T=140.6 sec P/Y (Nyquist)
  - S-IB T=0 sec Roll (Nyquist and transient)
  - S-IB T=140.6 sec Roll (Nyquist and transient)
  - S-IVB T=18.9- sec P/Y (Nyquist and transient)
  - S-IVB T=200- sec P/Y (Nyquist and transient)
  - S-IVB T=300 sec P/Y (Nyquist and transient)
- Wind transient response (S-IB)
- Simulation Laboratory control sensor frequency responses
- S-IVB APS system test:
  - Spatial amplifier deadband and polarity (IU and S/C)
  - Spatial amplifier operational characteristics:
    - On-time
    - Pulse width
    - Pulse frequency
    - Threshold and full-on
  - Channel time delay
  - 18 Hz attitude rate spatial filter frequency responses

### 1.3 RESULTS

This report is the collection of test results of the final Flight Simulation for FCC S/N 0104-I as outlined in the checkoff list. IBM testing began 19 November 1974 and was completed 29 January 1975. The test data presented in this document was reviewed with MSFC (S&E-ASTR-FD) representatives on 29 January 1975.

### 1.4 CONCLUSIONS

A detailed analysis of the checkout results for FCC S/N 0104-I led to the following conclusions:

- A proper interface of the FCC with SA-210 flight-type control sensor elements and thrust vector control system will be accomplished.
- An acceptable implementation of the design release was accomplished in the FCC.



**Section 2**

**S-IB STAGE TEST RESULTS AND ANALYSIS**

Section 2

FCC S/N 0104-I TEST RESULTS AND ANALYSIS  
S-IB STAGE

TABULATION

Table 2 outlines the results of the tests performed on FCC S/N 0104-I. The table serves as a ready guide to the following pertinent areas:

- Location of the specific test results.
- Statement as to whether IBM considers the FCC acceptable or unacceptable for flight.
- Reference to the location of further analysis on a given test.

Test Performed	Results (Page No.)	Acceptable	Analysis and Comments
Magnetic Amplifier Null and Null and Drift (Power Supply @ 28 vdc)	2-7 D-1	Yes	All magnetic amplifier null and null drift values were acceptable. The maximum null was +56 mv in the 4Y mag amp with the FCC on for 30 minutes and the C.A.T. @ 70 seconds (spare inverter). The worst case null drift over a 3-hour period was -83 mv in the 4Y mag amp with the C.A.T. @ 0 seconds (prime inverter).

TABLE 2. RESULTS AND ANALYSIS OF FCC S/N 0104-I, S-IB STAGE

Test Performed	Results (Page No.)	Acceptable	Analysis and Comments
Magnetic Amplifier Noise (Power Supply @ 28 vdc)	2-7 D-1	Yes	All magnetic amplifier noise levels were acceptable. The maximum noise characteristic was 20 mvp-p in the 4Y mag amp with the FCC on for 30 and 210 minutes and the C.A.T. @ 70 seconds (prime and spare inverters).
Magnetic Amplifier Noise with 28-volt Power Supply Variation	C-1	Yes	Magnetic amplifier noise caused by 28-volt power supply variations was within acceptable limits. The maximum noise characteristic was 58 mvp-p in the 1Y mag amp with a 24,200 vdc power supply setting and the C.A.T. @ 70 seconds (spare inverter).
Channel Cross Coupling	2-11	Yes	Cross coupled signals were within the 125 mvp-p guideline at all test frequencies with attitude error inputs; the worst case was 61 mvp-p with a $\psi$ p input coupling into the 4Y mag amp. No cross coupled signals were observed with attitude rate and lateral acceleration inputs.
Channel Common Mode	2-17	Yes	<p>Prominent common mode signals exceeding the 380 mvp-p guideline were present with the following input signals:</p> <ul style="list-style-type: none"> <li>• <math>\psi</math>p - 468 mvp-p at 15 Hz in the 1P mag amp</li> <li>• <math>\psi</math>p - 455 mvp-p at 20 Hz in the 4P mag amp</li> <li>• <math>\psi</math>y - 520 mvp-p at 15 Hz in the 1Y mag amp</li> <li>• <math>\psi</math>y - 490 mvp-p at 15 Hz in the 4Y mag amp</li> <li>• <math>\dot{\psi}</math>p - 405 mvp-p at 30 Hz in the 1P mag amp</li> <li>• <math>\dot{\psi}</math>y - 453 mvp-p at 20 Hz in the 1Y mag amp</li> <li>• <math>\dot{\psi}</math>y - 415 mvp-p at 20 Hz in the 4Y mag amp</li> </ul> <p>This is considered an acceptable condition over the 15 to 60 Hz range, since the expected TVC attenuation is 20 db. Common mode signals were within acceptable limits with roll attitude error and pitch, yaw, and roll attitude rate input signals.</p>

TABLE 2,  
(Cont'd)

RESULTS AND ANALYSIS OF FCC S/N 0104-I, S-1B STAGE

Test Performed	Results (Page No.)	Acceptable	Analysis and Comments
Magnetic Amplifier Linearity and Signal Mixing	2-27	Yes	All magnetic amplifiers summed correctly and were linear throughout the design operating range for various levels of biased attitude errors or lateral accelerations combined with ramped attitude rate inputs.
Magnetic Amplifier Linearity and Saturation	2-47	Yes	All magnetic amplifiers saturated in excess of $\pm 12$ ma when driven through the $\beta$ FB winding with a ramp input and were linear throughout the $\pm 12$ ma range.
Magnetic Amplifier Relative Polarities	2-48	Yes	Polarity convention for each of the magnetic amplifiers was correct as determined from the Linearity/Mixing plots and the Switchpoint Utilization plots.
Static Control Gains	2-49	Yes	The $A_0$ , $A_1$ , and $G_2$ gains were all within the 4% tolerance. Worst case deviations were: <ul style="list-style-type: none"> <li>• <math>A_0</math> - +0.974% in the 4P mag amp with a <math>\Psi_r</math> input at SP #0</li> <li>• <math>A_1</math> - +0.865% in the 4Y mag amp with a <math>\dot{\phi}_r</math> input at SP #2</li> <li>• <math>G_2</math> - +2.475% in the 4P mag amp with a <math>\ddot{\gamma}_p</math> input (C.A.T. max)</li> </ul>
Switchpoint Utilization	A-1	Yes	Switchpoint gain changes were implemented correctly when the relays were energized. Graphical representation is given for a fixed level of input in each channel.
Spacecraft Control	B-1	Yes	The FCC honored the spacecraft attitude error inputs in the S-IB burn mode, and the correct $A_0$ gain changes were made when switching from IU to S/C control.

TABLE 2  
(Cont'd)

RESULTS AND ANALYSIS OF FCC S/N 0104-I, S-IB STAGE

Test Performed	Results (Page No.)	Acceptable	Analysis and Comments
Open-Loop Channel Frequency Response	2-50	Yes	<p>The responses taken were acceptable with minor deviations from theoretical values accounted for by:</p> <ul style="list-style-type: none"> <li>• Magnetic amplifier peaking in frequency response</li> <li>• Rate gyro frequency response</li> <li>• Inadequate calibration of the "signal analyzer"</li> <li>• Noise</li> <li>• Channel common mode</li> </ul> <p>A number of frequency responses deviated noticeably from theoretical at frequencies of 20 Hz and above. The primary contributor to these deviations is channel common mode. In a system configuration, the attenuation provided by the TVC system can be expected to reduce the peaking seen in the Sim Lab to acceptable levels.</p>
Magnetic Amplifier Open-Loop Frequency Response (Bode)	2-149	N/A	<p>The <math>\beta_{fb}</math> input windings were used to obtain frequency responses of the magnetic amplifiers; this information was to be used in analyzing the channel open-loop frequency responses. However, since no correlation exists between the magnetic amplifier and channel open-loop frequency responses, the magnetic amplifier frequency responses are included for information purposes only.</p>
Nyquist Frequency Response	2-130	Yes	<p>The Nyquist responses were acceptable. Deviations from the theoretical could be explained upon examination of:</p> <ul style="list-style-type: none"> <li>• The Bode frequency responses</li> <li>• The sensor frequency responses</li> </ul>
Closed-Loop Transient Responses with a Step Forcing Function	2-165	Yes	<p>Hardware (FCC in the loop) closely matched the total simulation runs. The transients with hardware in the loop were well behaved in response to a 2-degree step attitude error input.</p>

TABLE 2.  
(Cont'd)

RESULTS AND ANALYSIS OF FCC S/N 0104-I, S-IB STAGE

Test Performed	Results (Page No.)	Acceptable	Analysis and Comments
Closed-Loop Transient Response with Wind as a Forcing Function	2-172	Yes	Hardware runs closely matched the total simulation runs. The responses with hardware in the loop were well behaved.
$G_2$ vs. Time	2-181	Yes	The C.A.T. timing, gains, and relative polarities for each mag amp were correct.
RG/CSP and Accelerometer Frequency Response (Bode)	E-1	N/A	Frequency responses for the Sim Lab RG/CSP subsystem and Control Accelerometers are included for information purposes only. See Appendix E for additional comments.

2-5

TABLE 2.  
(Cont'd)

RESULTS AND ANALYSIS OF FCC S/N 0104-I, S-IB STAGE

2.2 RESULTS

2.2.1 The results of the S-IB Stage study are presented on the following pages. To assist in the interpretation of the results, the following vehicle orientation is used.

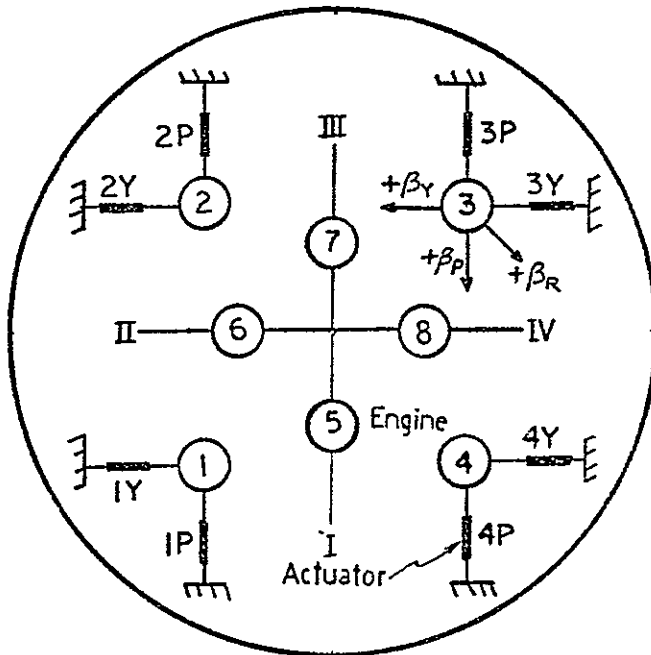

S-IB STAGE (AFT)  
ACTUATOR LAYOUT

ORIGINAL PAGE IS  
OF POOR QUALITY

## NULL AND NOISE

Prime Inverter  
C. A. T. @ 0 Seconds

SW. PT.	MEASUREMENT	SERVO AMP							
		1P	2P	3P	4P	1Y	2Y	3Y	4Y
0	30 min. Noise (mv p-p)	14	10	8	9	11	11	9	12
	210 min. Noise (mv p-p)	14	10	9	9	11	10	8	14
	30 min. Null (mv)	-15	+45	-1	+23	+6	+29	+18	+40
	210 min. Null (mv)	-17	+16	+6	+16	-13	-18	+18	-43
	3 hr. Drift (mv)	-2	-29	+7	-7	-19	-47	0	-83
2	30 min. Noise (mv p-p)	14	10	8	9	10	12	9	13
	210 min. Noise (mv p-p)	14	10	9	9	11	11	7	14
	30 min. Null (mv)	-15	+46	-1	+23	+6	+29	+13	+34
	210 min. Null (mv)	-17	+14	+6	+15	-14	-19	+13	-46
	3 hr. Drift (mv)	-2	-32	+7	-8	-20	-48	0	-80
3	30 min. Noise (mv p-p)	14	8	8	8	9	10	8	12
	210 min. Noise (mv p-p)	12	10	9	9	10	11	7	10
	30 min. Null (mv)	-15	+46	-1	+21	+3	+28	+10	+26
	210 min. Null (mv)	-15	+14	+6	+15	-15	-19	+9	-52
	3 hr. Drift (mv)	0	-32	+7	-6	-18	-47	-1	-78

Data Recorded: 1/6/75

NOTES: (1) Mag amp output impedance = 100  $\Omega$  ; signals recorded at J9 telemetry output.

(2) Peripheral sensors powered off.

(3) Specifications:

- Null  $\leq$  90 mv
- Null drift  $\leq$  135 mv over a 3-hour period.
- Noise  $\leq$  100 mv p-p for each servo amp and 60 mv p-p average for each axis at frequencies  $\leq$  30 Hz.

FCC S/N	0104-I
STAGE	S-IB
S.P. #	0, 2, 3



## NULL AND NOISE

Prime Inverter  
C. A. T. @ 70 Seconds

SW. PT.	MEASUREMENT	SERVO AMP							
		1P	2P	3P	4P	1Y	2Y	3Y	4Y
0	30 min. Noise (mv p-p)	17	10	10	14	16	12	11	20
	210 min. Noise (mv p-p)	18	11	11	12	15	12	9	20
	30 min. Null (mv)	-14	+22	-2	+25	+12	+32	+24	+48
	210 min. Null (mv)	-15	+15	+5	+17	-7	-15	+23	-30
	3 hr. Drift (mv)	-1	-7	+7	-8	-19	-47	-1	-78
2	30 min. Noise (mv p-p)	17	10	9	14	16	12	11	20
	210 min. Noise (mv p-p)	18	11	11	12	14	12	9	20
	30 min. Null (mv)	-14	+22	-2	+25	+11	+31	+18	+42
	210 min. Null (mv)	-15	+14	+5	+17	-8	-15	+19	-34
	3 hr. Drift (mv)	-1	-8	+7	-8	-19	-46	+1	-76
3	30 min. Noise (mv p-p)	17	10	9	14	16	12	11	20
	210 min. Noise (mv p-p)	18	11	11	12	14	12	9	20
	30 min. Null (mv)	-14	+22	-2	+25	+10	+31	+16	+37
	210 min. Null (mv)	-15	+14	+5	+17	-9	-15	+16	-38
	3 hr. Drift (mv)	-1	-8	+7	-8	-19	-46	+0	-75

Data Recorded: 1/6/75

NOTES: (1) Mag amp output impedance = 100  $\Omega$ ; signals recorded at J9 telemetry output.

(2) Peripheral sensors powered off.

(3) Specifications:

- Null  $\leq$  90 mv
- Null drift  $\leq$  135 mv over a 3-hour period.
- Noise  $\leq$  100 mv p-p for each servo amp and 60 mv p-p average for each axis at frequencies  $\leq$  30 Hz.

FCC S/N	0104-I
STAGE	S-IB
S.P. #	0, 2, 3

## NULL AND NOISE

Spare Inverter  
C.A.T. @ 0 seconds

SW. PT.	MEASUREMENT	SERVO AMP							
		1P	2P	3P	4P	1Y	2Y	3Y	4Y
0	30 min. Noise (mv p-p)	14	10	8	9	12	10	9	16
	210 min. Noise (mv p-p)	13	10	8	9	11	10	8	14
	30 min. Null (mv)	-12	+45	+7	+22	+4	+38	+22	+40
	210 min. Null (mv)	-16	+11	+13	+13	-14	-11	+16	-37
	3 hr. Drift (mv)	-4	-34	+6	-9	-18	-49	-6	-77
2	30 min. Noise (mv p-p)	14	8	8	9	11	10	9	15
	210 min. Noise (mv p-p)	13	10	8	9	11	10	7	14
	30 min. Null (mv)	-12	+44	+7	+22	+2	+32	+17	+35
	210 min. Null (mv)	-16	+10	+12	+13	-15	-13	+11	-42
	3 hr. Drift (mv)	-4	-34	+6	-9	-17	-50	-6	-77
3	30 min. Noise (mv p-p)	13	8	8	8	11	10	8	12
	210 min. Noise (mv p-p)	13	11	8	9	10	10	7	14
	30 min. Null (mv)	-11	+44	+7	+22	+0	+37	+13	+28
	210 min. Null (mv)	-16	+9	+12	+13	-17	-14	+8	-46
	3 hr. Drift (mv)	-5	-33	+5	-9	-17	-51	-5	-74

Data Recorded: 1/6/75

NOTES: (1) Mag amp output impedance = 100  $\Omega$ ; signals recorded at J9 telemetry output.

(2) Peripheral sensors powered off.

(3) Specifications:

- Null  $\leq$  90 mv
- Null drift  $\leq$  135 mv over a 3-hour period.
- Noise  $\leq$  100 mv p-p for each servo amp and 60 mv p-p average for each axis at frequencies  $\leq$  30 Hz.

FCC S/N	0104-I
STAGE	S-IB
S.P. #	0, 2, 3

## NULL AND NOISE

Spare Inverter  
C.A.T. @ 70 Seconds

SW. PT.	MEASUREMENT	SERVO AMP							
		1P	2P	3P	4P	1Y	2Y	3Y	4Y
0	30 min. Noise (mv p-p)	18	9	11	12	17	12	10	20
	210 min. Noise (mv p-p)	20	11	10	12	17	14	12	20
	30 min. Null (mv)	-11	+45	+7	+24	+13	+20	+29	+56
	210 min. Null (mv)	-15	+12	+14	+12	-5	-6	+24	-24
	3 hr. Drift (mv)	-4	-33	+7	-12	-18	-26	-5	-80
2	30 min. Noise (mv p-p)	18	8	11	12	17	12	10	20
	210 min. Noise (mv p-p)	19	11	9	12	17	13	13	20
	30 min. Null (mv)	-11	+44	+6	+24	+11	+18	+24	+49
	210 min. Null (mv)	-15	+11	+14	+12	-6	-7	+19	-29
	3 hr. Drift (mv)	-4	-33	+8	-12	-17	-25	-5	-78
3	30 min. Noise (mv p-p)	18	8	10	12	15	12	10	18
	210 min. Noise (mv p-p)	18	11	10	12	17	13	12	20
	30 min. Null (mv)	-11	+44	+6	+24	+10	+18	+22	+45
	210 min. Null (mv)	-15	+11	+13	+12	-8	-7	+16	-33
	3 hr. Drift (mv)	-4	-33	+7	-12	-18	-25	-6	-78

Data Recorded: 1/6/75

NOTES: (1) Mag amp output impedance = 100  $\Omega$ ; Signals recorded at J9 telemetry output.

(2) Peripheral sensors powered off.

(3) Specifications:

- Null  $\leq$  90 mv
- Null drift  $\leq$  135 mv over a 3-hour period.
- Noise  $\leq$  100 mv p-p for each servo amp and 60 mv p-p average for each axis at frequencies  $\leq$  30 Hz.

FCC S/N	0104-I
STAGE	S-IB
S.P. #	0, 2, 3

## CROSS COUPLING

FREQUENCY (Hz)	SERVO AMP OUTPUT (mv p-p)				
	Driven:	1P	1Y	2Y	3Y
$\left\{ \begin{array}{l} 0.05, \quad 0.1, \quad 0.6, \\ 0.8, \quad 0.9, \quad 1.0, \\ 1.1, \quad 1.2, \quad 1.3, \\ 1.4, \quad 1.5, \quad 1.6, \\ 1.7, \quad \quad \quad 3 \end{array} \right\}$	-	0	0	0	0
5	2450	2	0	1	4
6	2500	5	2	3	6
7	2550	6	2	3	9
10	2430	13	5	7	17
15	2500	20	12	10	28
20	2500	30	14	10	45
30	1270	31	24	7	43
40	800	35	33	17	61
50	930	48	34	24	52
60	960	54	27	30	36

Data Recorded: 12/6/74

- NOTES: (1) Mag amp output impedance = 100Ω.  
 (2) Cross coupled signal does not include noise.  
 (3) Maximum input signal:

- $\ddot{\gamma} = 10 \text{ v}, \psi = 12 \text{ v}, \text{ or } \dot{\phi} = 45 \text{ v}.$
- Or when  $\Delta i = 12 \text{ ma}$  or  $\beta_{\text{Engine}} = 7.5 \text{ deg}.$

- (4) Guideline:

- Cross coupling  $\leq 125 \text{ mvp-p}$  at mag amp.

FCC S/N	0104-I
STAGE	S-IB
CHAN	$\psi$ Pitch
S.P.#	0

### CROSS COUPLING

FREQUENCY (Hz)	SERVO AMP OUTPUT (mv p-p)				
	Driven: 1Y	1P	2P	3P	4P
$\left\{ \begin{array}{l} 0.05, \quad 0.1, \quad 0.6, \\ 0.8, \quad 0.9, \quad 1.0, \\ 1.1, \quad 1.2, \quad 1.3, \\ 1.4, \quad 1.5, \quad 1.6, \\ 1.7, \quad 3 \end{array} \right\}$	-	0	0	0	0
5	2500	2	0	0	2
6	2430	5	0	0	3
7	2400	5	2	2	5
10	2450	9	2	5	9
15	2400	19	3	7	16
20	2480	25	5	10	20
30	1060	27	5	9	22
40	788	34	3	12	28
50	904	33	1	12	28
60	920	23	5	7	23

Data Recorded: 12/6/74

- NOTES: (1) Mag amp output impedance =  $100\Omega$ .  
 (2) Cross coupled signal does not include noise.  
 (3) Maximum input signal:

- $\ddot{\gamma} = 10 \text{ v}, \psi = 12 \text{ v}, \text{ or } \dot{\phi} = 45 \text{ v}.$
- Or when  $\Delta i = 12 \text{ ma}$  or  $\beta_{\text{Engine}} = 7.5 \text{ deg}.$

(4) Guideline:

- Cross coupling  $\leq 125 \text{ mvp-p}$  at mag amp.

FCC S/N	0104-I
STAGE	S-IB
CHAN	$\psi$ Yaw
S.P.#	0

## CROSS COUPLING

FREQUENCY (Hz)	SERVO AMP OUTPUT (mv p-p)				
	Driven: 1P	1Y	2Y	3Y	4Y
$\left\{ \begin{array}{lll} 0.05, & 0.1, & 0.6, \\ 0.8, & 0.9, & 1, \\ 1.1, & 1.2, & 1.3, \\ 1.4, & 1.5, & 1.6, \\ 1.7, & 2, & 2.7, \\ 3, & 5, & 7, \\ 10, & 15, & 20, \\ 30, & 40, & 50, \\ 60 \end{array} \right\}$	-	0	0	0	0

Date Recorded: 12/6/74

- NOTES: (1) Mag amp output impedance = 100Ω.  
 (2) Cross coupled signal does not include noise.  
 (3) Maximum input signal:
- $\ddot{\gamma} = 10 \text{ v}, \psi = 12 \text{ v}, \text{ or } \dot{\phi} = 45 \text{ v}.$
  - Or when  $\Delta i = 12 \text{ ma}$  or  $\beta_{\text{Engine}} = 7.5 \text{ deg}.$
- (4) Guideline:
- Cross coupling  $\leq 125 \text{.mvp-p}$  at mag amp.

FCC S/N	0104-I
STAGE	S-IB
CHAN	⊕ Pitch
S.P.#	0

### CROSS COUPLING

FREQUENCY (Hz)	SERVO AMP OUTPUT (mv p-p)				
	Driven: 1Y	1P	2P	3P	4P
$\left\{ \begin{array}{l} 0.05, 0.1, 0.6, \\ 0.8, 0.9, 1, \\ 1.1, 1.2, 1.3, \\ 1.4, 1.5, 1.6, \\ 1.7, 2, 2.7, \\ 3, 5, 7, \\ 10, 15, 20, \\ 30, 40, 50, \\ 60 \end{array} \right\}$	-	0	0	0	0

Date Recorded: 12/6/74

- NOTES: (1) Mag amp output impedance =  $100\Omega$ .
- (2) Cross coupled signal does not include noise.
- (3) Maximum input signal:
- $\ddot{\gamma} = 10 \text{ v}, \psi = 12 \text{ v}, \text{ or } \dot{\phi} = 45 \text{ v}.$
  - Or when  $\Delta i = 12 \text{ ma}$  or  $\beta_{\text{Engine}} = 7.5 \text{ deg}.$
- (4) Guideline:
- Cross coupling  $\leq 125 \text{ mvp-p}$  at mag amp.

FCC S/N	0104-I
STAGE	S-IB
CHAN	$\dot{\phi}$ Yaw
S.P.#	0

## CROSS COUPLING

C.A.T. @ 70 Seconds

FREQUENCY (Hz)	SERVO AMP OUTPUT (mv p-p)				
	Driven: 1P	1Y	2Y	3Y	4Y
$\left( \begin{array}{ccc} 0.01, & 0.06, & 0.1, \\ 0.6, & 0.8, & 0.9, \\ 1, & 1.1, & 1.2, \\ 1.3, & 1.4, & 1.5, \\ 1.6, & 1.7, & 3, \\ 6, & 8, & 10, \\ 15, & 20, & 30, \\ 40, & 50, & 60 \end{array} \right)$	-	0	0	0	0

Date Recorded: 12/6/74

- NOTES: (1) Mag amp output impedance =  $100\Omega$ .  
 (2) Cross coupled signal does not include noise.  
 (3) Maximum input signal:
- $\ddot{\gamma} = 10 \text{ v}$ ,  $\psi = 12 \text{ v}$ , or  $\dot{\phi} = 45 \text{ v}$ .
  - Or when  $\Delta i = 12 \text{ ma}$  or  $\beta_{\text{Engine}} = 7.5 \text{ deg}$ .
- (4) Guideline:
- Cross coupling  $\leq 125 \text{ mvp-p}$  at mag amp.

FCC S/N	0104-I
STAGE	S-IB
CHAN	$\ddot{\gamma}$ Pitch
S.P.#	0



## CROSS COUPLING

C.A.T. @ 70 Seconds

FREQUENCY (Hz)	SERVO AMP OUTPUT (mv p-p)				
	Driven: 1Y	1P	2P	3P	4P
$\left\{ \begin{array}{lll} 0.01, & 0.06, & 0.1, \\ 0.6, & 0.8, & 0.9, \\ 1, & 1.1, & 1.2, \\ 1.3, & 1.4, & 1.5, \\ 1.6, & 1.7, & 3, \\ 6, & 8, & 10, \\ 15, & 20, & 30, \\ 40, & 50, & 60 \end{array} \right\}$	-	0	0	0	0

Date Recorded: 12/6/74

- NOTES: (1) Mag amp output impedance =  $100\Omega$ .  
 (2) Cross coupled signal does not include noise.  
 (3) Maximum input signal:

- $\ddot{\gamma} = 10 \text{ v}$ ,  $\psi = 12 \text{ v}$ , or  $\dot{\phi} = 45 \text{ v}$ .
- Or when  $\Delta i = 12 \text{ ma}$  or  $\beta_{\text{Engine}} = 7.5 \text{ deg}$ .

(4) Guideline:

- Cross coupling  $\leq 125 \text{ mvp-p}$  at mag amp.

FCC S/N	0104-I
STAGE	S-IB
CHAN	$\dot{\gamma}$ Yaw
S.P.#	0

COMMON MODE

FREQUENCY (Hz)	SERVO AMP OUTPUT (mv p-p)			
	1P	2P	3P	4P
0.05	6	1	2	5
0.1	7	2	2	6
0.6	22	7	11	21
0.8	29	9	12	28
0.9	35	11	15	32
1	38	11	16	33
1.1	40	12	17	36
1.2	45	10	18	38
1.3	46	11	20	42
1.4	54	11	22	46
1.5	55	12	22	48
1.6	56	13	23	52
1.7	62	14	24	54
3	108	19	38	91
5	173	33	66	150
6.5	218	40	84	188
7	230	42	88	200
10	320	62	120	260
15	468	94	170	380
20	610	133	198	455
30	790	200	248	550
40	880	183	320	650
50	870	166	340	660
60	860	152	340	640

Data Recorded: 12/10/74

- NOTES: (1) Mag amp output impedance = 100 Ω.  
 (2) Common mode signal does not include noise.  
 (3) Input signal = 5 v peak.  
 (4) Guideline;

• Common mode  $\leq$  380 mvp-p at mag amp.

FCC S/N	0104-I
STAGE	S-IB
CHAN	ψ Pitch
S. P. #	0

COMMON MODE

FREQUENCY (Hz)	SERVO AMP OUTPUT (mv p-p)			
	1Y	2Y	3Y	4Y
0.05	6	1	3	6
0.1	6	3	3	7
0.6	27	10	11	26
0.8	36	13	13	34
0.9	38	14	15	37
1	40	16	16	42
1.1	50	20	17	48
1.2	53	21	19	50
1.3	58	22	20	54
1.4	62	24	21	60
1.5	66	26	23	62
1.6	72	28	24	67
1.7	72	29	26	71
3	129	54	47	120
5	205	87	76	194
6.5	264	113	95	250
7	280	120	103	262
10	365	155	143	360
15	520	220	198	490
20	650	280	233	600
30	820	362	283	730
40	860	370	319	800
50	860	362	325	800
60	820	342	320	790

Data Recorded: 12/10/74

- NOTES: (1) Mag amp output impedance = 100  $\Omega$ .  
 (2) Common mode signal does not include noise.  
 (3) Input signal = 5 v peak.  
 (4) Guideline:  
 • Common mode  $\leq$  380 mvp-p at mag amp.

FCC S/N	0104-I
STAGE	S-IB
CHAN	$\psi$ Yaw
S. F #	0

COMMON MODE

FREQUENCY (Hz)	SERVO AMP OUTPUT (mv p-p)			
	1P	2P	3P	4P
0.05	0	0	0	0
0.1	0	0	0	1
0.6	1	0	1	3
1	2	1	3	4
3	2	3	4	9
5	4	3	7	13
6	5	4	8	14
7	6	5	8	15
9	9	6	11	20
10	11	7	12	22
15	19	15	20	30
20	30	23	31	46
30	48	40	34	41
40	39	29	22	23
50	38	25	11	19
60	34	23	1	20

Data Recorded: 12/10/74

- NOTES: (1) Mag amp output impedance = 100  $\Omega$ .  
 (2) Common mode signal does not include noise.  
 (3) Input signal = 5 v peak.  
 (4) Guideline:  
 • Common mode  $\leq$  380 mvp-p at mag amp.

FCC S/N	0104-I
STAGE	S-IB
CHAN	$\psi$ Roll
S.P. #	0

COMMON MODE

FREQUENCY (Hz)	SERVO AMP OUTPUT (mv p-p)			
	1Y	2Y	3Y	4Y
0.05	0	0	0	0
.0.1	0	0	0	0
0.6	3	0	0	2
1	4	1	0	4
3	10	2	0	8
5	13	2	0	10
6	16	2	1	12
7	19	3	1	14
9	22	4	2	16
10	23	5	2	17
15	27	9	3	18
20	30	10	4	18
30	32	14	4	20
40	44	20	7	30
50	48	21	8	33
60	51	14	8	36

Data Recorded: 12/10/74

- NOTES: (1) Mag amp output impedance = 100  $\Omega$ .  
 (2) Common mode signal does not include noise.  
 (3) Input signal = 5 v peak.  
 (4) Guideline:  
 • Common mode  $\leq$  380 mvp-p at mag amp.

FCC S/N	0104-I
STAGE	S-IB
CHAN	$\psi$ Roll
S.P. #	0

COMMON MODE

FREQUENCY (Hz)	SERVO AMP OUTPUT (mv p-p)			
	1P	2P	3P	4P
0.05	1	0	0	0
0.1	2	1	0	1
0.6	5	2	3	4
0.8	7	3	4	5
0.9	7	3	4	7
1	7	3	4	7
1.1	8	3	4	7
1.2	8	3	4	8
1.3	11	4	4	8
1.4	11	5	5	9
1.5	11	5	5	9
1.6	12	5	5	10
1.7	12	6	5	10
2	13	6	5	11
2.7	17	6	7	13
3	15	4	9	16
5	26	6	11	20
7	36	7	12	24
10	48	8	14	27
15	62	9	15	31
20	86	16	18	44
30	125	26	38	66
40	155	24	64	100
50	185	22	78	123
60	205	25	90	140

Data Recorded: 12/10/74

- NOTES: (1) Mag amp output impedance = 100  $\Omega$ .  
 (2) Common mode signal does not include noise.  
 (3) Input signal = 5 v peak.  
 (4) Guideline:

- Common mode  $\leq$  380 mvp-p at mag amp.

FCC S/N	0104-I
STAGE	S-IB
CHAN	$\phi$ Pitch
S. P. #	0

COMMON MODE

FREQUENCY (Hz)	SERVO AMP OUTPUT (mv p-p)			
	1Y	2Y	3Y	4Y
0.05	0	0	0	0
0.1	2	1	0	2
0.6	6	3	1	6
0.8	7	4	1	7
0.9	8	5	2	7
1	9	5	2	8
1.1	9	5	2	9
1.2	9	5	3	10
1.3	10	5	4	11
1.4	10	5	4	12
1.5	11	5	4	13
1.6	12	5	5	14
1.7	12	5	6	15
2	13	5	7	18
2.7	22	13	7	19
3	25	14	4	16
5	33	19	5	32
7	51	28	7	41
10	60	32	7	52
15	78	46	7	66
20	108	60	7	72
30	123	71	29	113
40	145	72	41	163
50	165	79	48	188
60	165	77	51	185

Data Recorded: 12/10/74

- NOTES: (1) Mag amp output impedance = 100  $\Omega$ .  
 (2) Common mode signal does not include noise.  
 (3) Input signal = 5 v peak.  
 (4) Guideline:

- Common mode  $\leq$  380 mvp-p at mag amp.

FCC S/N	0104-I
STAGE	S-IB
CHAN	$\phi$ Yaw
S. P. #	0

COMMON MODE

FREQUENCY (Hz)	SERVO AMP OUTPUT (mv p-p)			
	1P	2P	3P	4P
0.05	0	0	0	0
0.1	1	0	0	1
0.6	2	1	2	2
1	4	1	3	3
3	4	3	5	6
3.6	6	3	6	8
5	7	6	6	10
7	10	8	10	13
10	18	12	12	15
15	28	18	17	20
20	42	23	27	28
30	58	39	38	34
40	48	32	28	26
50	48	26	19	16
60	50	23	11	2

Data Recorded: 12/10/74

- NOTES: (1) Mag amp output impedance = 100  $\Omega$ .  
 (2) Common mode signal does not include noise.  
 (3) Input signal = 5 v peak.  
 (4) Guideline:  
 • Common mode  $\leq$  380 mvp-p at mag amp.

FCC S/N	0104-I
STAGE	S-IB
CHAN	$\phi$ Roll
S.P. #	0



COMMON MODE

FREQUENCY (Hz)	SERVO AMP OUTPUT (mv p-p)			
	1Y	2Y	3Y	4Y
0.05	0	0	0	0
0.1	1	0	0	0
0.6	1	1	1	1
1	3	1	1	1
3	5	2	3	2
3.6	5	2	3	3
5	7	3	4	3
7	10	4	5	4
10	12	6	8	5
15	13	9	14	4
20	17	10	18	4
30	13	22	22	6
40	12	33	24	4
50	11	37	26	8
60	6	38	30	12

Data Recorded: 12/10/74

- NOTES: (1) Mag amp output impedance = 100  $\Omega$ .  
 (2) Common mode signal does not include noise.  
 (3) Input signal = 5 v peak.  
 (4) Guideline:  
 • Common mode  $\leq$  380 mvp-p at mag amp.

FCC S/N	0104-I
STAGE	S-IB
CHAN	$\phi$ Roll
S.P. #	0

## COMMON MODE

C. A. T. @ 70 Seconds

FREQUENCY (Hz)	SERVO AMP OUTPUT (mv p-p)			
	1P	2P	3P	4P
0.01	10	10	10	7
0.06	26	28	28	19
0.1	27	30	29	22
0.6	24	28	30	28
0.8	24	25	31	30
0.9	24	24	32	32
1	23	22	32	33
1.1	23	21	32	35
1.2	24	20	35	37
1.3	25	19	35	38
1.4	27	18	35	41
1.5	28	16	38	44
1.6	29	15	37	44
1.7	30	15	37	46
3	72	8	47	67
6	150	16	68	113
8	195	24	87	143
10	235	30	100	165
15	300	41	125	203
20	355	60	138	230
30	405	83	135	230
40	385	69	148	225
50	345	55	140	205
60	280	42	113	178

Data Recorded: 12/11/74

- NOTES: (1) Mag amp output impedance = 100  $\Omega$ .  
 (2) Common mode signal does not include noise.  
 (3) Input signal = 5 v peak.  
 (4) Guideline:

- Common mode  $\leq$  380 mvp-p at mag amp.

FCC S/N	0104-I
STAGE	S-IB
CHAN	$\gamma$ Pitch
S. P. #	0

COMMON MODE

C. A. T. @ 70 Seconds

FREQUENCY (Hz)	SERVO AMP OUTPUT (mv p-p)			
	1Y	2Y	3Y	4Y
0.01	1	1	1	2
0.06	2	3	3	5
0.1	4	3	4	7
0.6	18	9	9	19
0.8	23	10	9	24
0.9	24	11	12	26
1	27	14	12	27
1.1	42	16	13	34
1.2	45	17	14	36
1.3	48	19	17	38
1.4	51	20	17	41
1.5	54	22	19	46
1.6	57	22	20	48
1.7	62	24	22	51
3	100	42	37	95
6	185	80	73	178
8	250	108	93	235
10	293	128	118	280
15	380	160	150	355
20	453	195	170	415
30	548	240	193	480
40	548	232	205	500
50	508	215	195	476
60	440	180	168	380

Data Recorded: 12/11/74

- NOTES: (1) Mag amp output impedance = 100  $\Omega$ .  
 (2) Common mode signal does not include noise.  
 (3) Input signal = 5 v peak.  
 (4) Guideline:  
 • Common mode  $\leq$  380 mvp-p at mag amp.

FCC S/N	0104-I
STAGE	S-IB
CHAN	$\dot{\gamma}$ Yaw
S. P. #	0

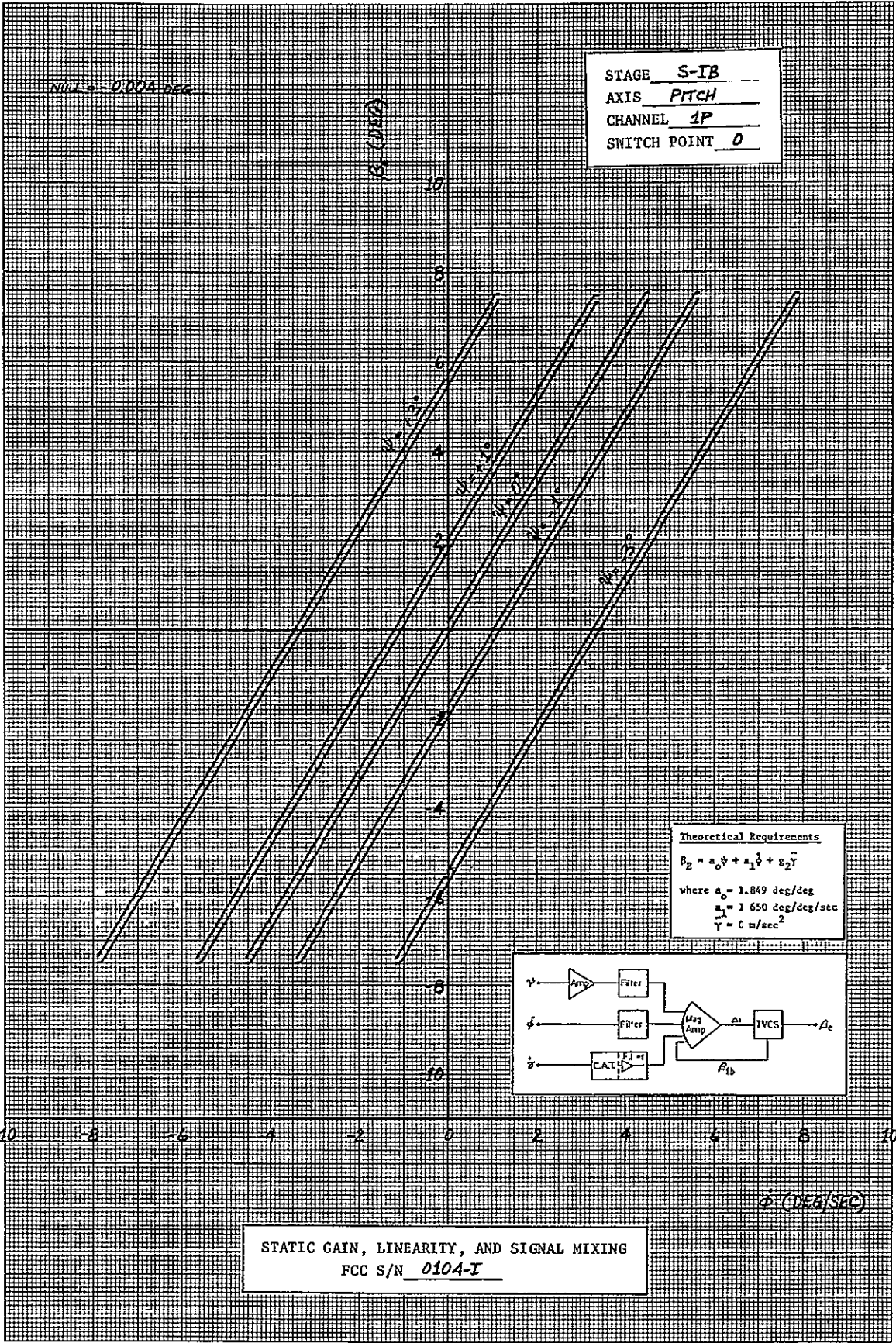

ORIGINAL PAGE IS  
 OF POOR QUALITY

NOTE = +0.010 DEG

STAGE S-1B  
 AXIS PITCH  
 CHANNEL 3P  
 SWITCH POINT 0

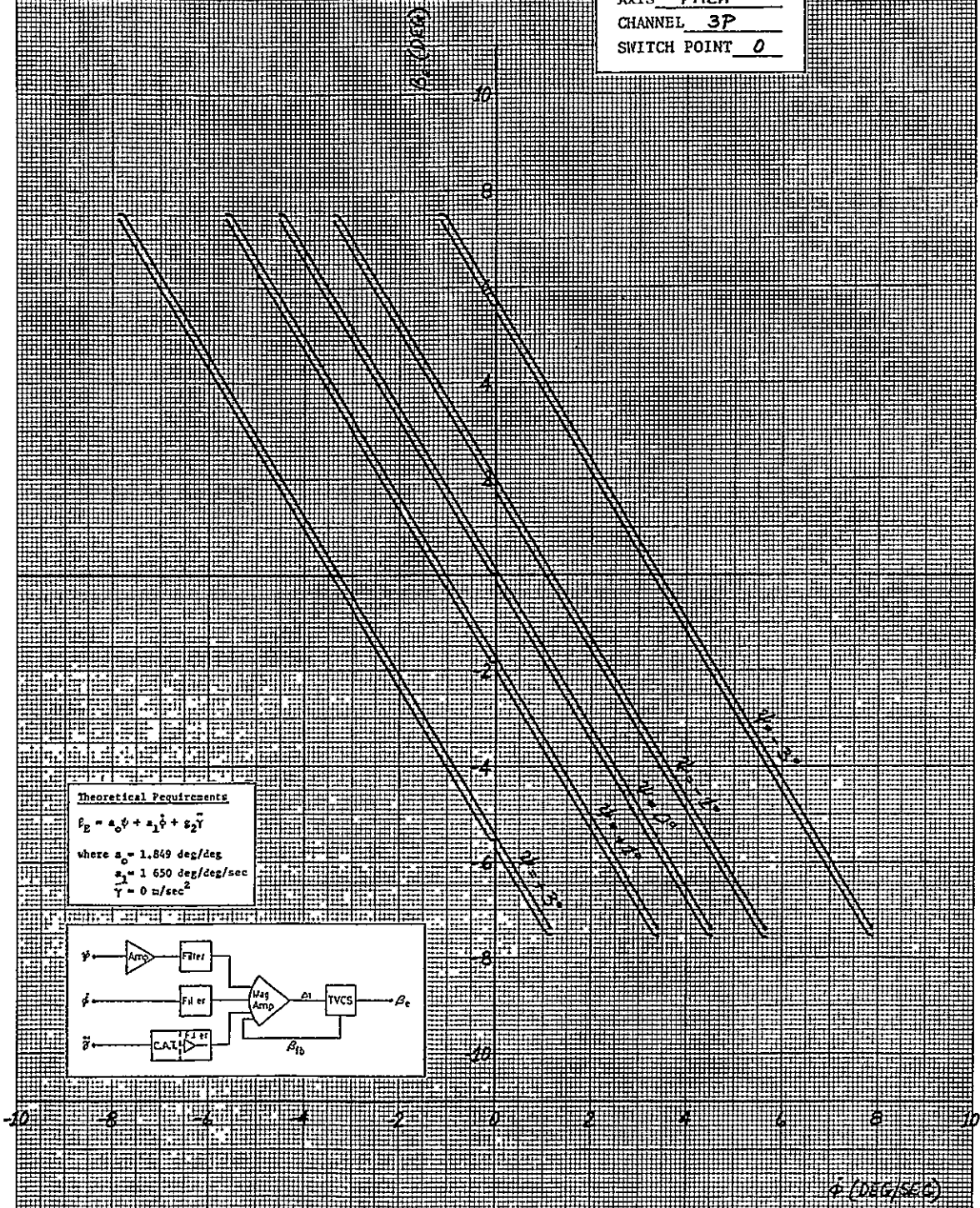

**Theoretical Requirements**  

$$\beta_c = a_0\psi + a_1\dot{\psi} + a_2\ddot{\psi}$$
 where  $a_0 = 1.849 \text{ deg/deg}$   
 $a_1 = 1.650 \text{ deg/deg/sec}$   
 $a_2 = 0 \text{ in/sec}^2$

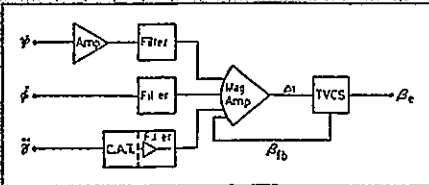

STATIC GAIN, LINEARITY, AND SIGNAL MIXING  
 FCC S/N 010A-I

NOISE = 0.002 DEG

STAGE S-1B  
 AXIS YAN  
 CHANNEL 1Y  
 SWITCH POINT 0

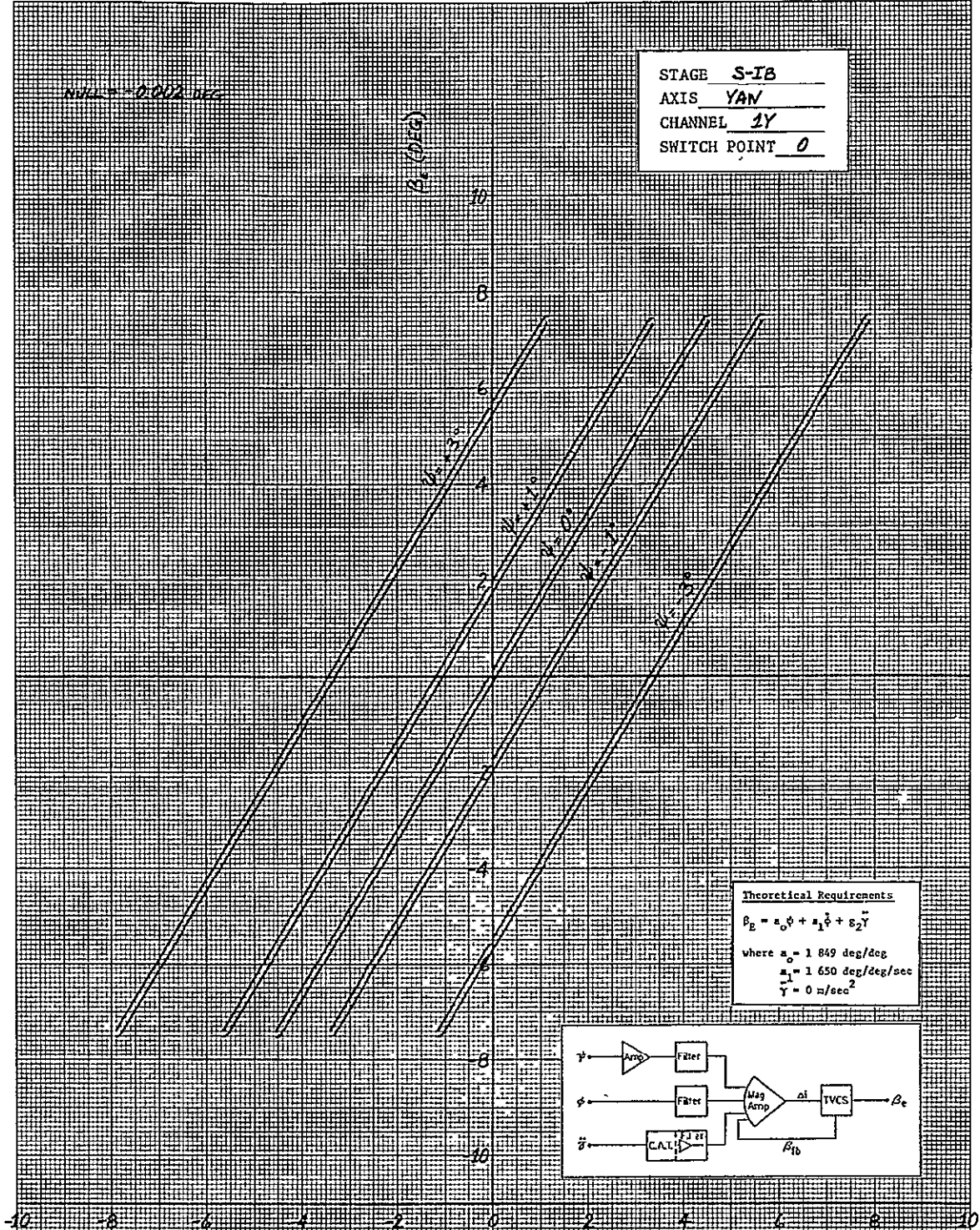

Theoretical Requirements  
 $\beta_e = a_0\phi + a_1\psi + a_2\gamma$   
 where  $a_0 = 1.849 \text{ deg/deg}$   
 $a_1 = 1.650 \text{ deg/deg/sec}$   
 $a_2 = 0 \text{ m/sec}^2$

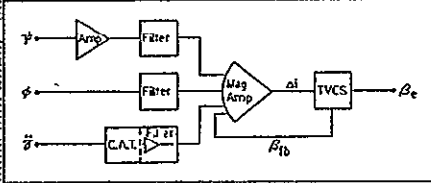

$\phi$  (DEG/SEC)

STATIC GAIN, LINEARITY, AND SIGNAL MIXING  
 FCC S/N 0104-I

ORIGINAL PAGE IS  
 OF POOR QUALITY

FILE # 70013 JRC

STAGE S-IB  
 AXIS YAW  
 CHANNEL 4Y  
 SWITCH POINT 0

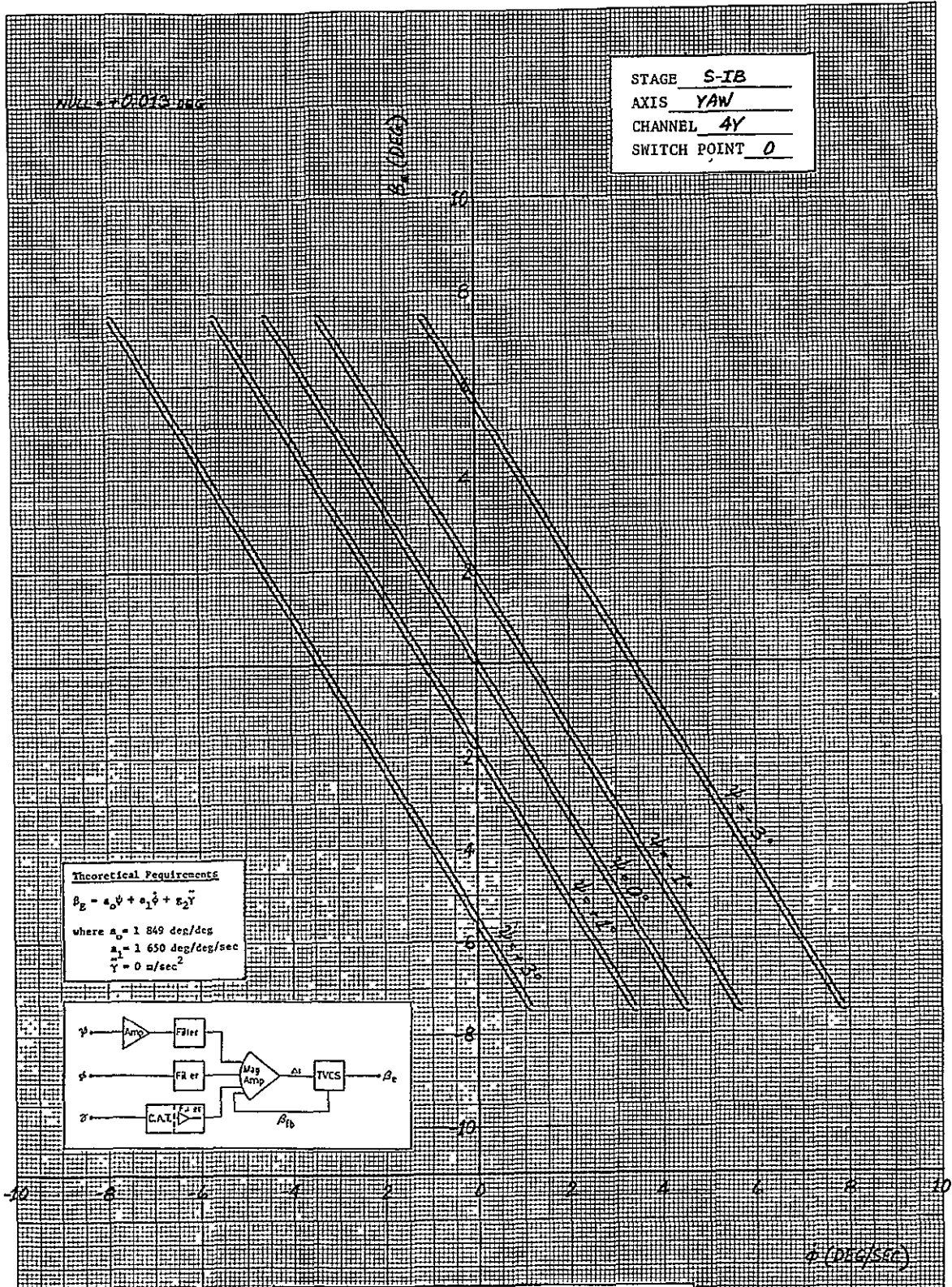

**Theoretical Requirements**  

$$\beta_E = a_0 \dot{\psi} + a_1 \ddot{\psi} + a_2 \ddot{\psi}^2$$
 where  $a_0 = 1.849 \text{ deg/deg}$   
 $a_1 = 1.650 \text{ deg/deg/sec}$   
 $a_2 = 0 \text{ deg/sec}^2$

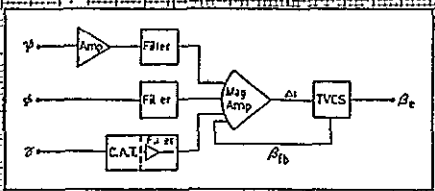

STATIC GAIN, LINEARITY, AND SIGNAL MIXING  
 FCC S/N 0104-I

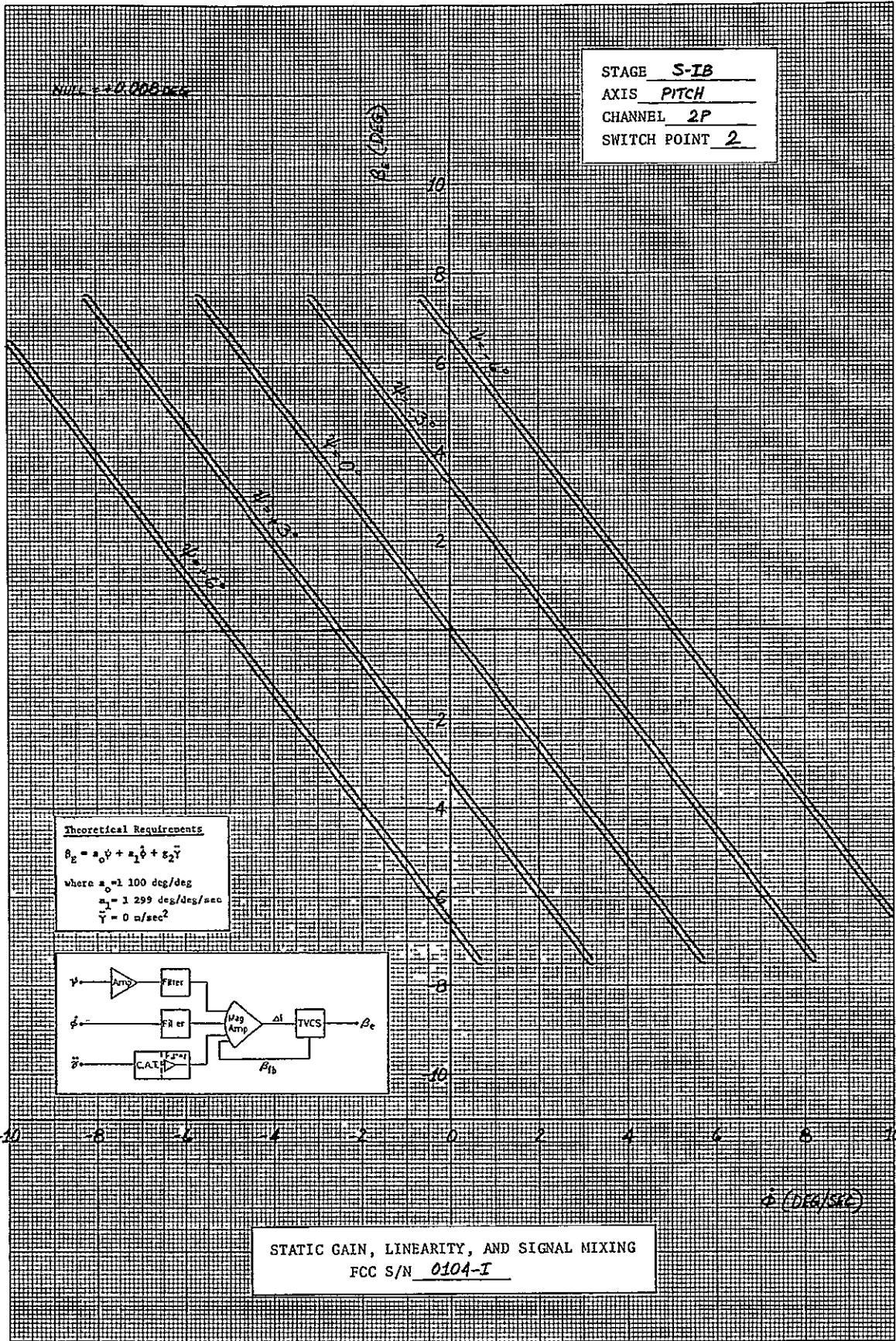

NULL = +0.000 DEG

STAGE S-1B  
 AXIS PITCH  
 CHANNEL 2P  
 SWITCH POINT 2

**Theoretical Requirements**  
 $\beta_e = a_0 \dot{\psi} + a_1 \dot{\phi} + a_2 \ddot{\gamma}$   
 where  $a_0 = 100 \text{ deg/deg}$   
 $a_1 = 1299 \text{ deg/deg/sec}$   
 $a_2 = 0 \text{ m/sec}^2$

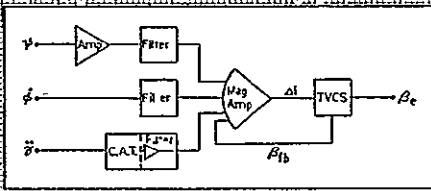

STATIC GAIN, LINEARITY, AND SIGNAL MIXING  
 FCC S/N 0104-I

ORIGINAL PAGE IS  
 OF POOR QUALITY



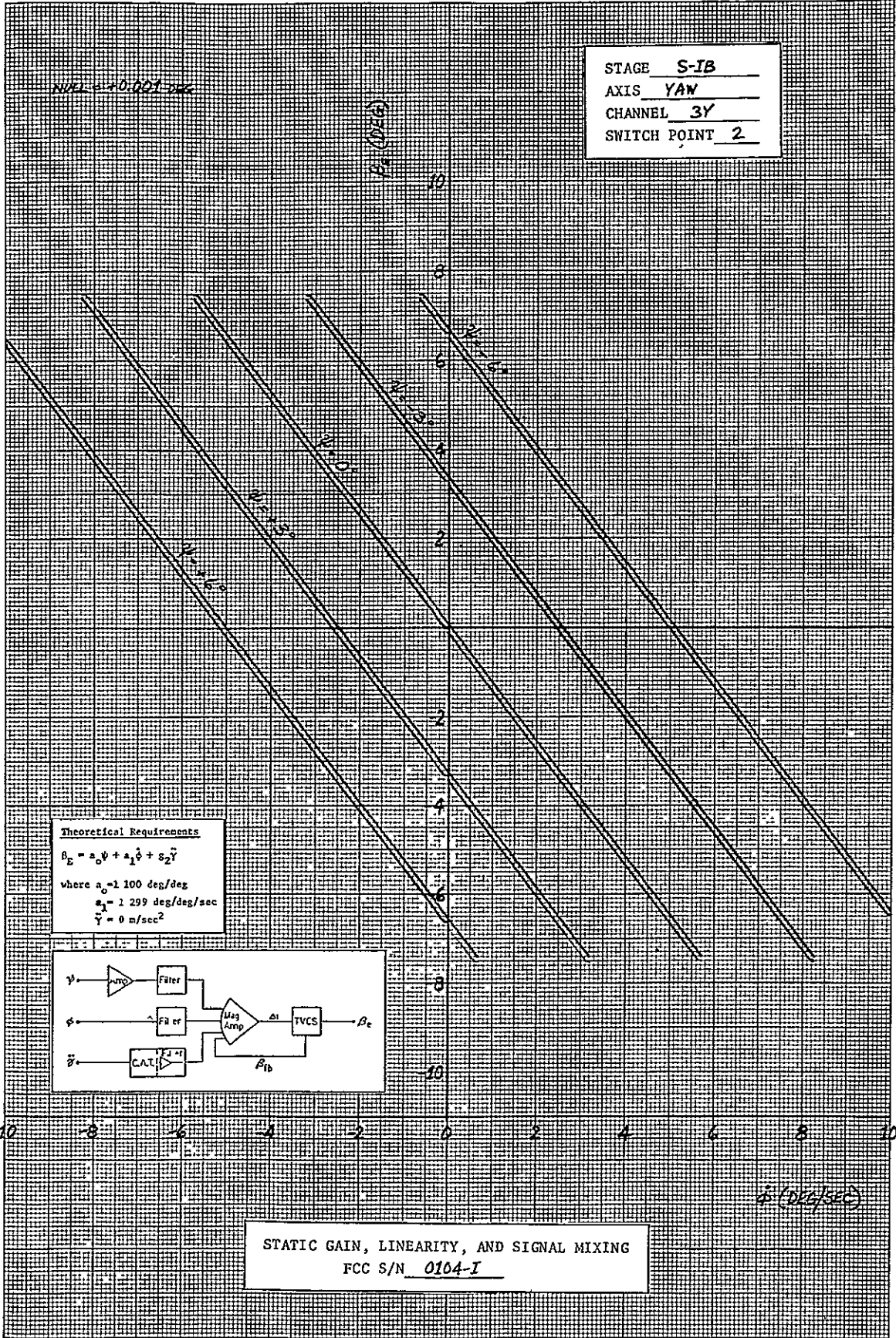

$NUL = +0.001 \text{ DEG}$

STAGE S-1B  
 AXIS YAW  
 CHANNEL 3Y  
 SWITCH POINT 2

**Theoretical Requirements**  
 $\beta_E = a_0 \psi + a_1 \dot{\psi} + a_2 \ddot{\psi}$   
 where  $a_0 = 1.100 \text{ deg/deg}$   
 $a_1 = 1.299 \text{ deg/deg/sec}$   
 $a_2 = 0 \text{ m/sec}^2$

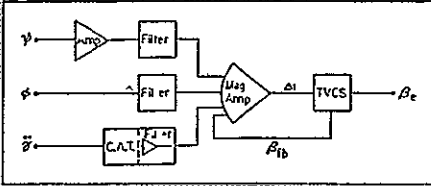

STATIC GAIN, LINEARITY, AND SIGNAL MIXING  
 FCC S/N 0104-I

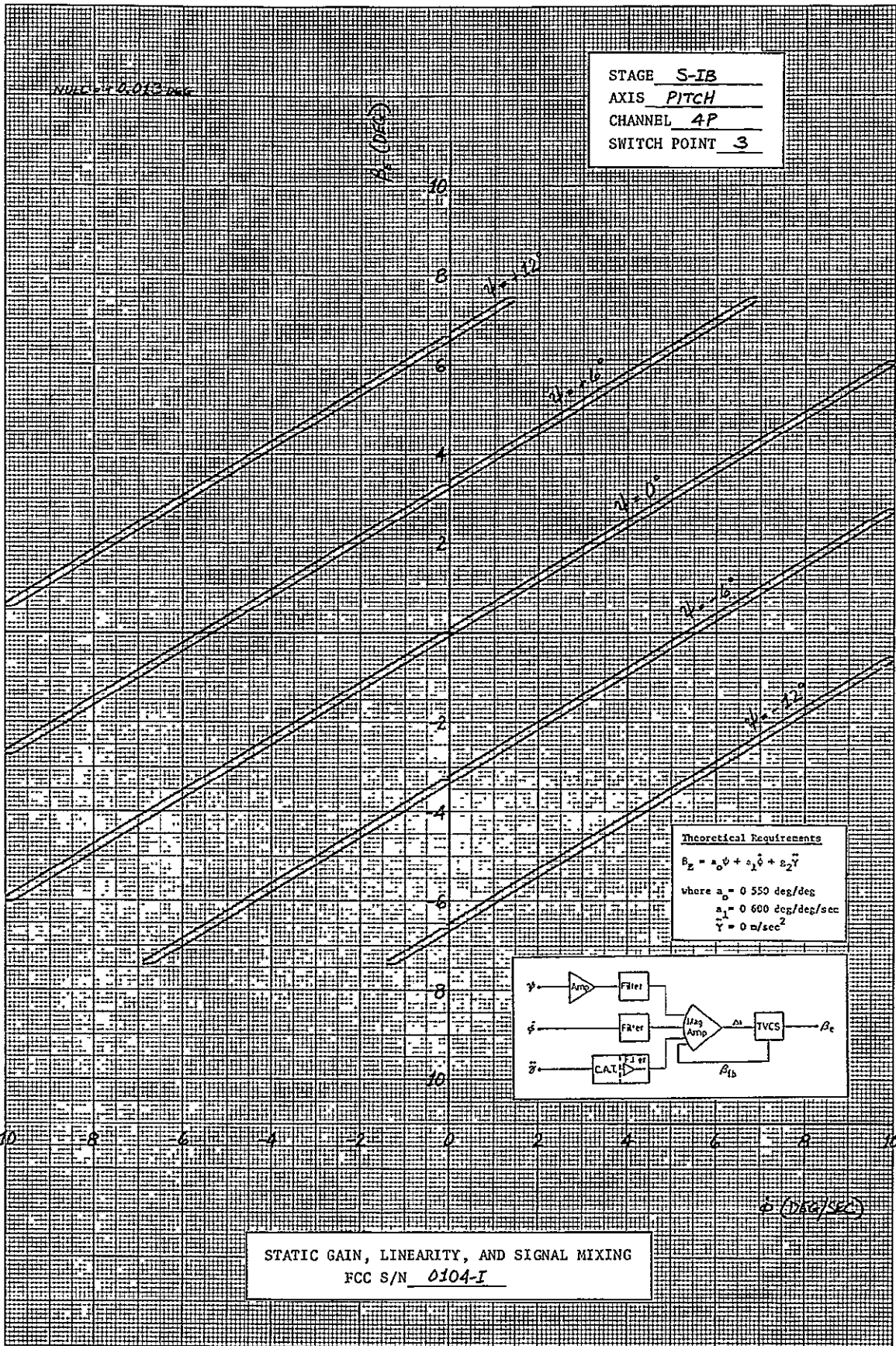

ROLL = 0.016 deg

STAGE S-1B  
 AXIS YAW  
 CHANNEL 2Y  
 SWITCH POINT 3

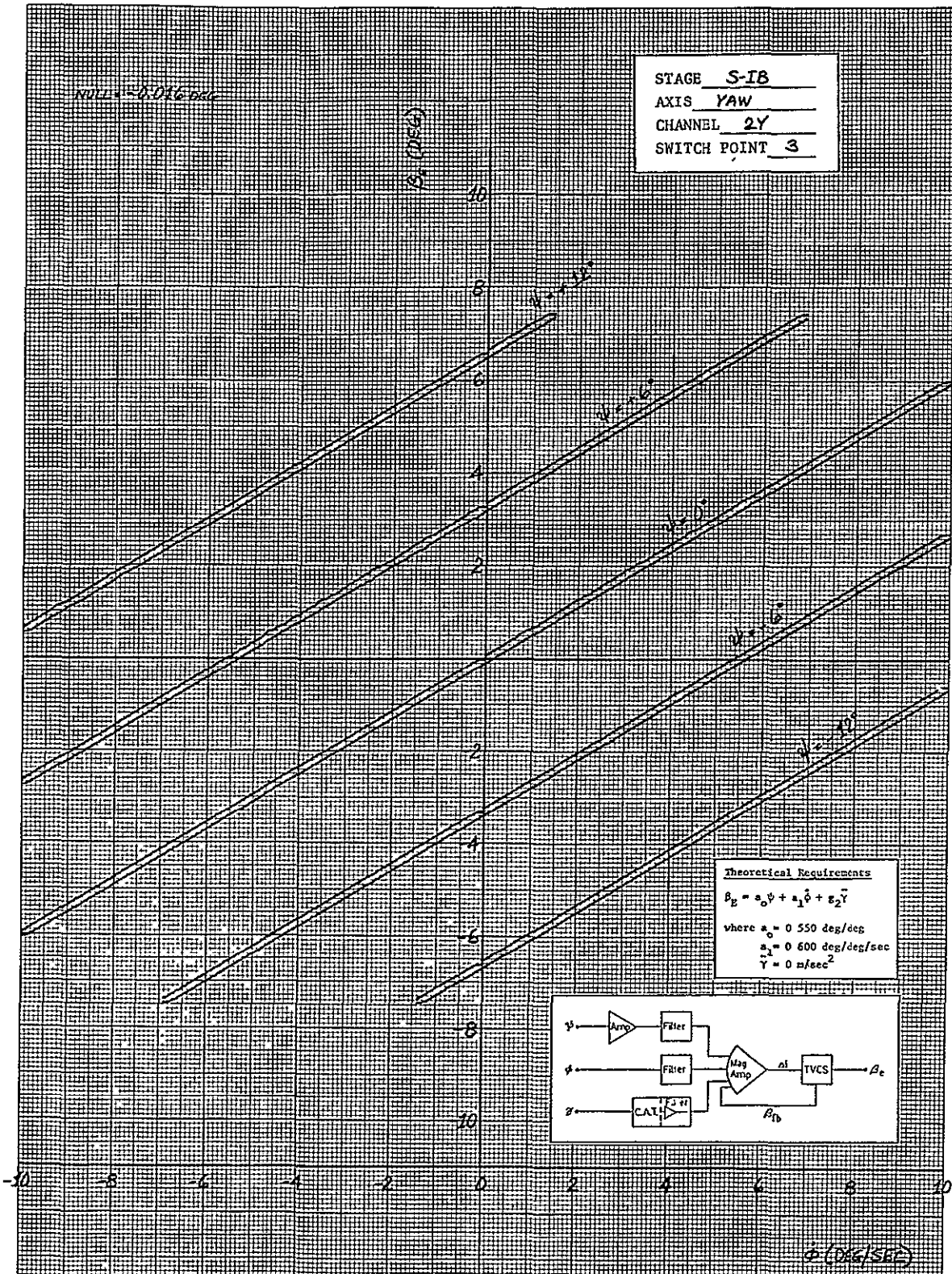

Theoretical Requirements  

$$\beta_E = a_0 \psi + a_1 \dot{\psi} + a_2 \ddot{\psi}$$
 where  $a_0 = 0.550 \text{ deg/deg}$   
 $a_1 = 0.600 \text{ deg/deg/sec}$   
 $a_2 = 0 \text{ m/sec}^2$

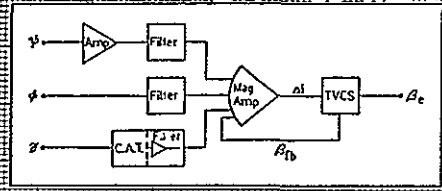

STATIC GAIN, LINEARITY, AND SIGNAL MIXING  
 FCC S/N 0104-I

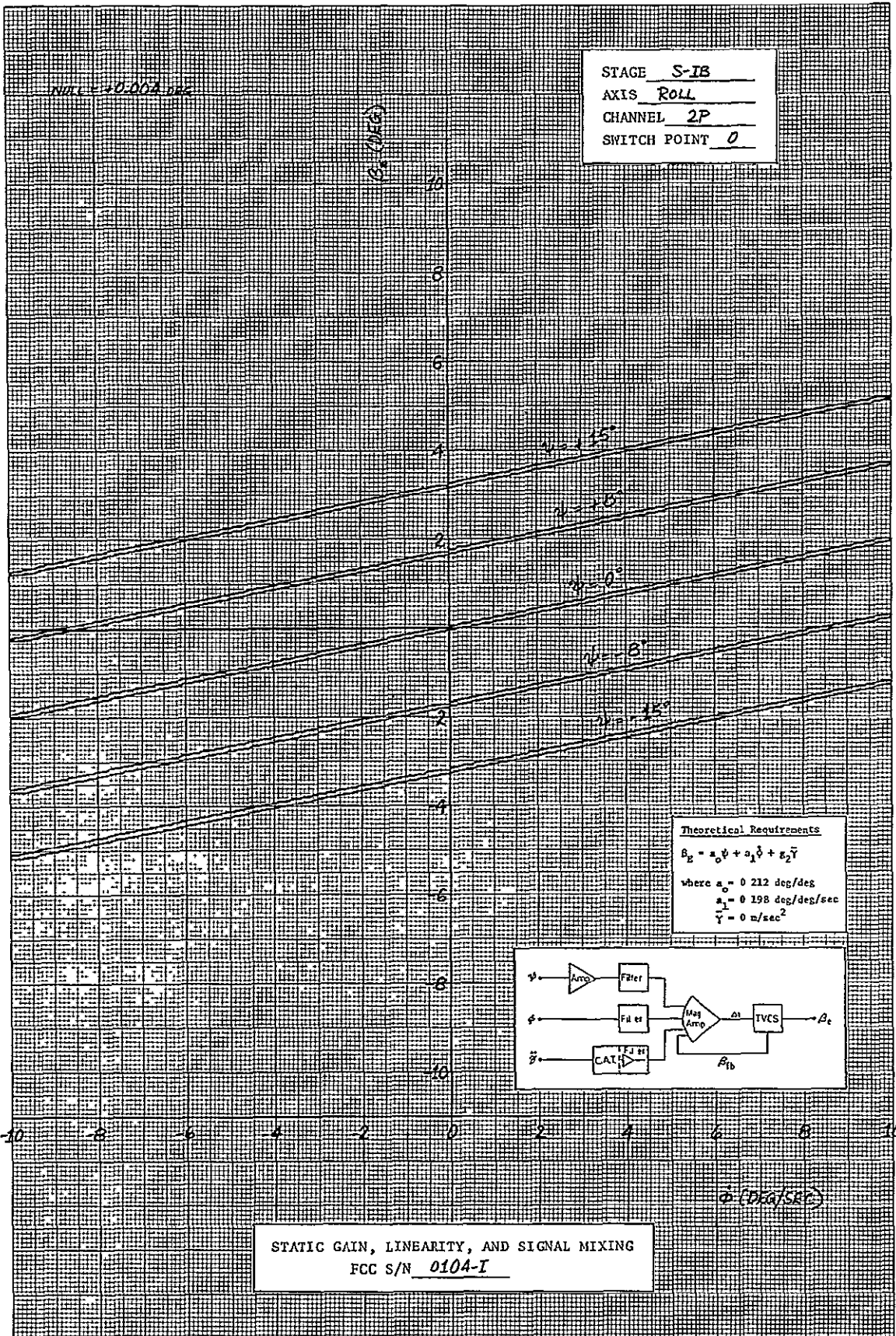

NULL = +0.011 DEG

STAGE S-1B  
 AXIS ROLL  
 CHANNEL 4P  
 SWITCH POINT 0

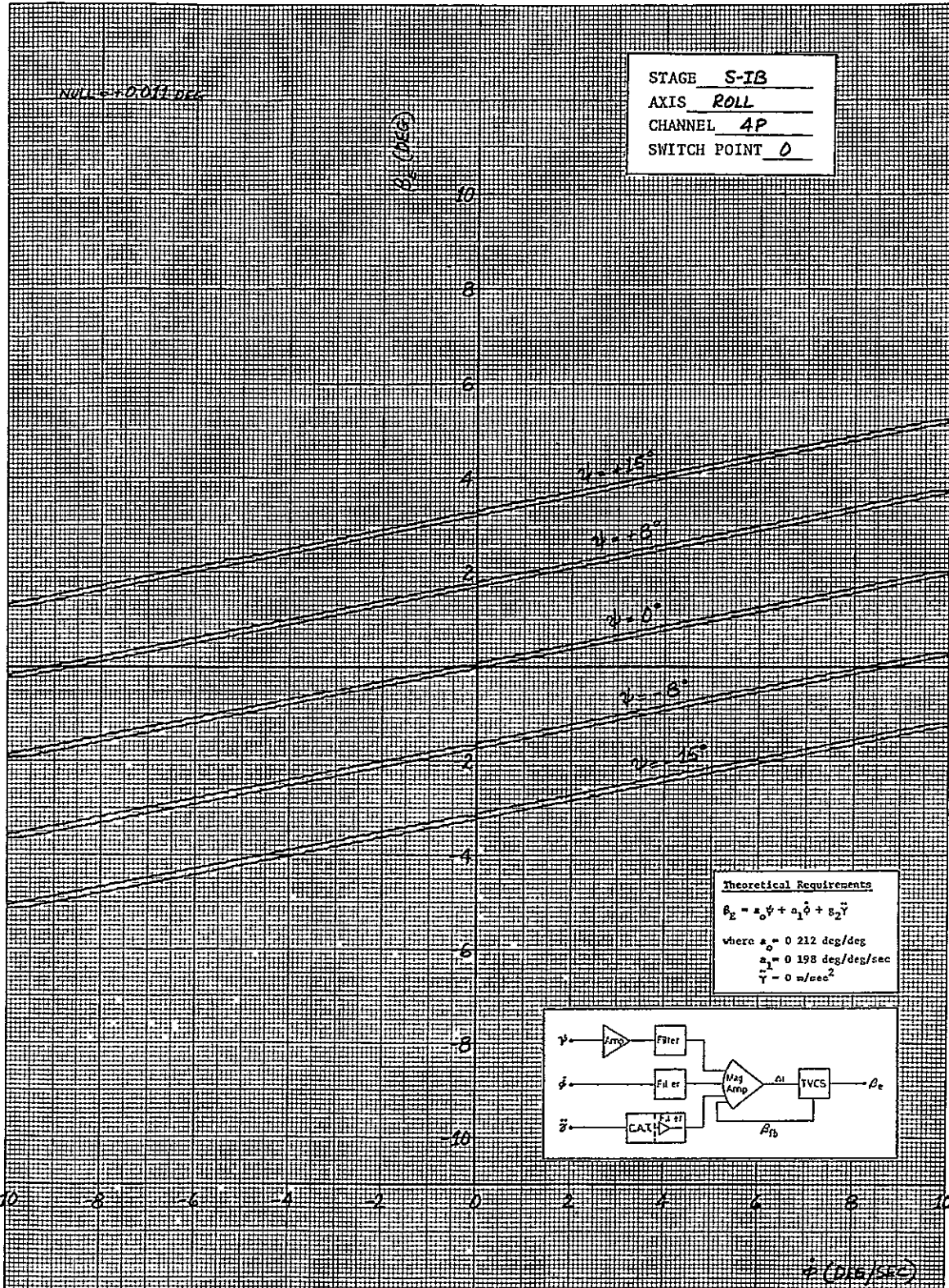

Theoretical Requirements  
 $\beta_e = a_0 \psi + a_1 \dot{\psi} + a_2 \ddot{\psi}$   
 where  $a_0 = 0.212 \text{ deg/deg}$   
 $a_1 = 0.198 \text{ deg/deg/sec}$   
 $a_2 = 0 \text{ w/sec}^2$

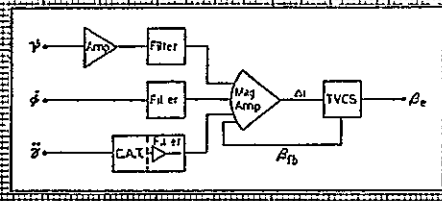

STATIC GAIN, LINEARITY, AND SIGNAL MIXING  
 FCC S/N 0104-I

ORIGINAL PAGE IS  
 OF POOR QUALITY

NOTE: -0.013 DEG

STAGE S-1B  
 AXIS ROLL  
 CHANNEL 1Y  
 SWITCH POINT 0

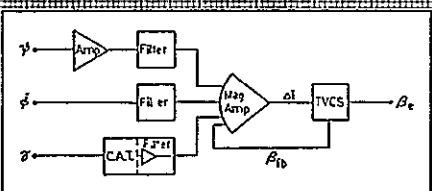
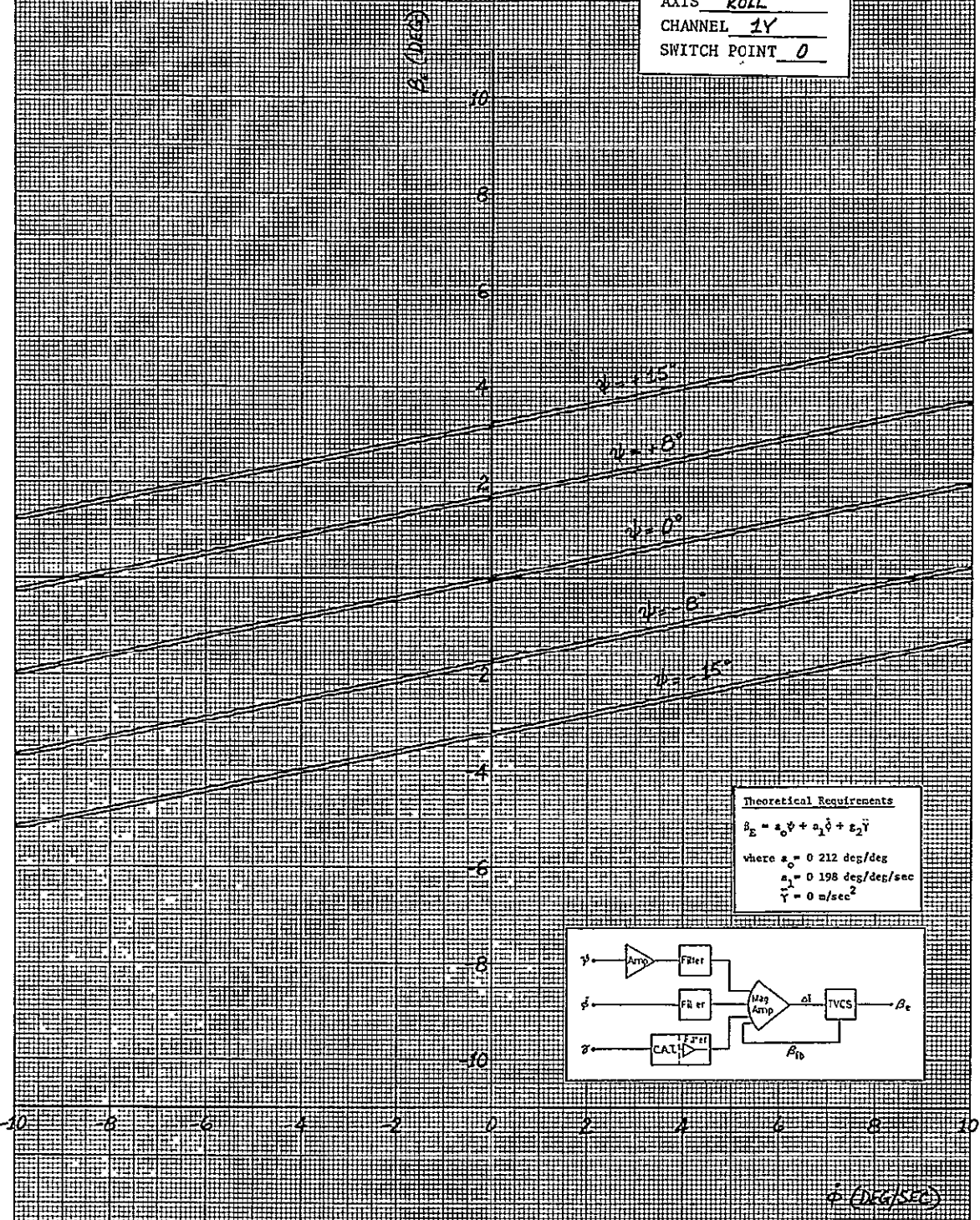

STATIC GAIN, LINEARITY, AND SIGNAL MIXING  
 FCC S/N 0104-I

$K_{\text{LINE}} = 0.008 \text{ DEG}$

STAGE S-IB  
 AXIS ROLL  
 CHANNEL 3Y  
 SWITCH POINT 0

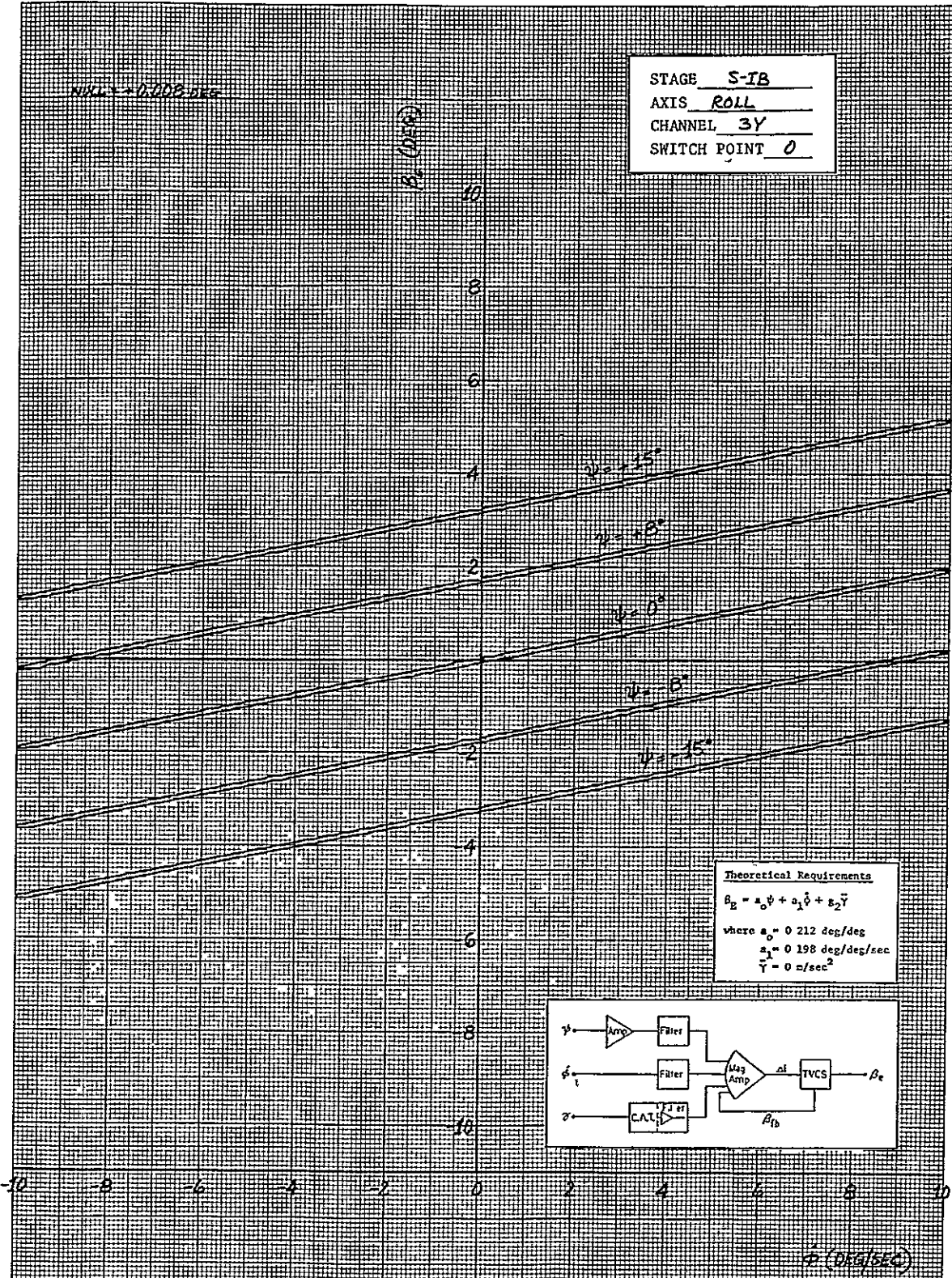

STATIC GAIN, LINEARITY, AND SIGNAL MIXING  
 FCC S/N 0104-I

NULL = 0.015 DEG

STAGE S-IB  
 AXIS ROLL  
 CHANNEL 1P  
 SWITCH POINT 2

E<sub>c</sub> (DEG)

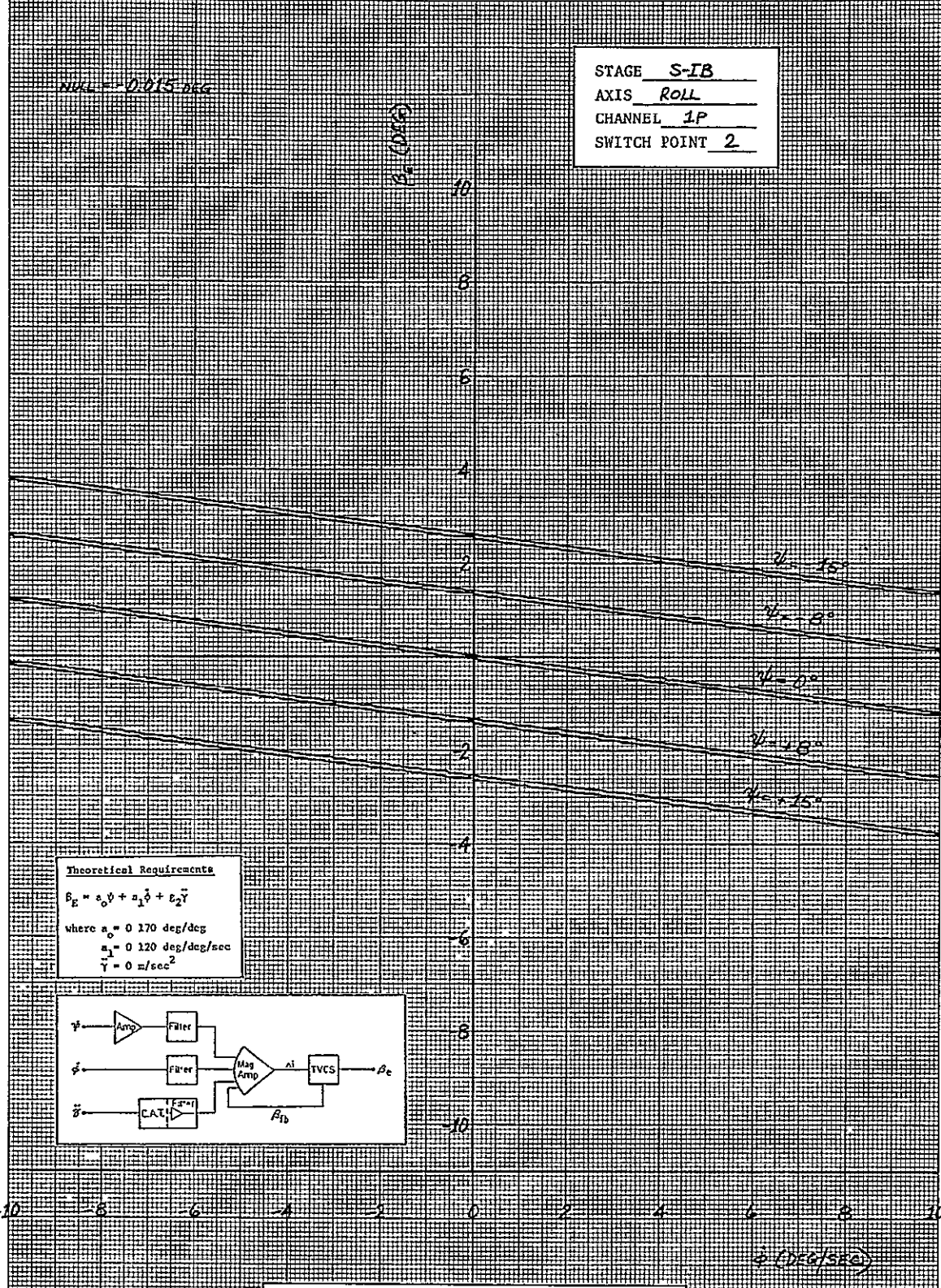

**Theoretical Requirements**  
 $E_c = a_0 \dot{\psi} + a_1 \ddot{\psi} + E_2 \ddot{\psi}$   
 where  $a_0 = 0.170$  deg/deg  
 $a_1 = 0.120$  deg/deg/sec  
 $E_2 = 0$  sec<sup>2</sup>/deg

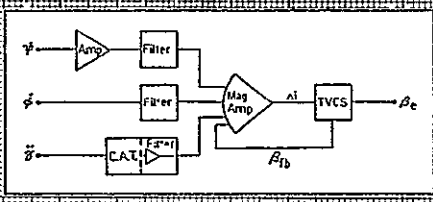

STATIC GAIN, LINEARITY, AND SIGNAL MIXING  
 FCC S/N 0104-I

ORIGINAL PAGE IS  
 OF POOR QUALITY



NULL = 0.000 DEG

STAGE S-1B  
 AXIS ROLL  
 CHANNEL 2Y  
 SWITCH POINT 2

A (DEG)

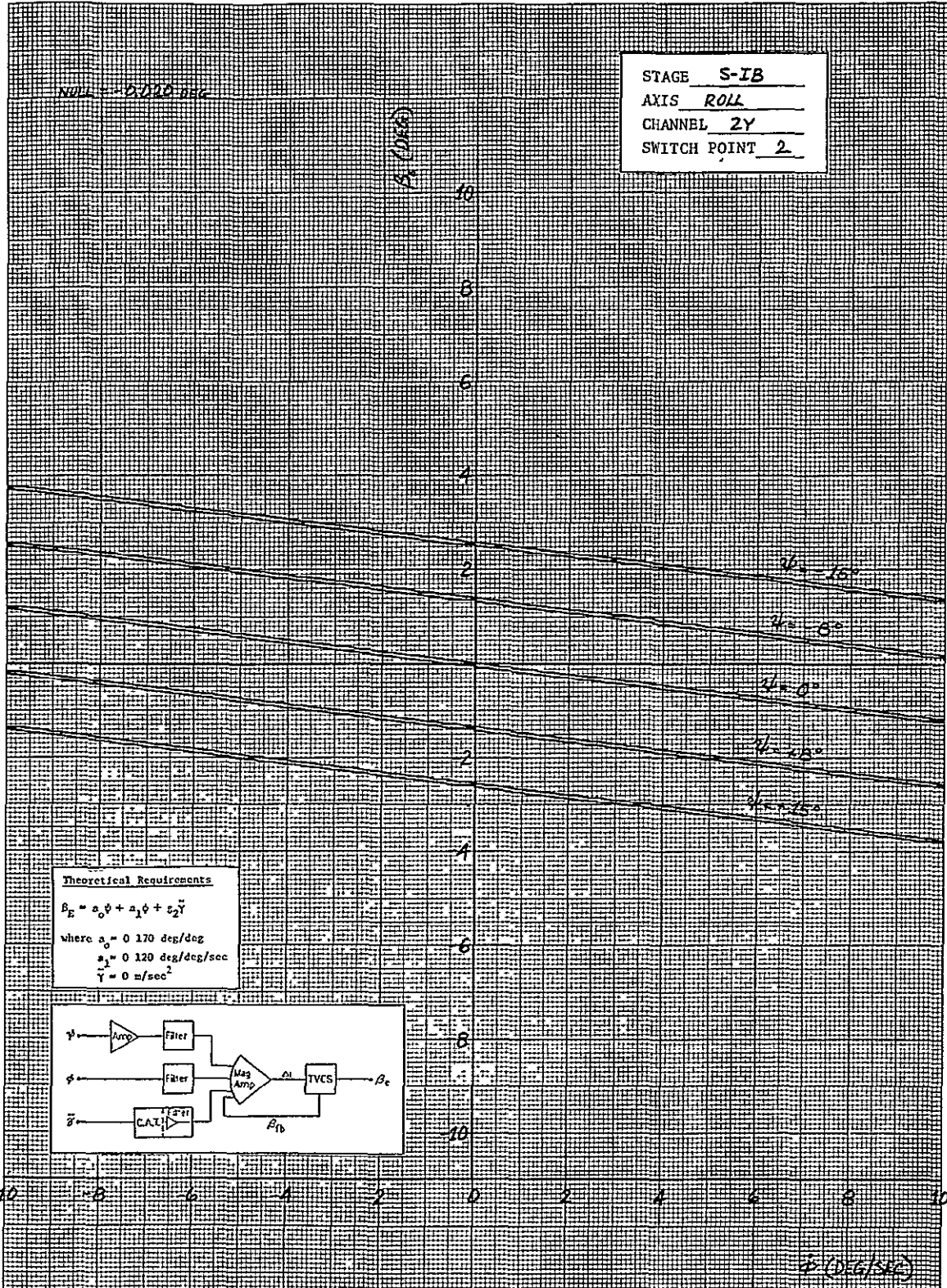

**Theoretical Requirements**  
 $\beta_E = a_0 \psi + a_1 \dot{\psi} + a_2 \ddot{\psi}$   
 where  $a_0 = 0.170 \text{ deg/deg}$   
 $a_1 = 0.120 \text{ deg/deg/sec}$   
 $a_2 = 0 \text{ m/sec}^2$

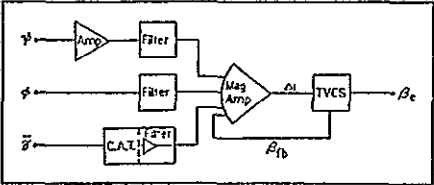

STATIC GAIN, LINEARITY, AND SIGNAL MIXING  
 FCC S/N 010A-I

NOISE = +0.005 DEG

STAGE S-IB  
 AXIS ROLL  
 CHANNEL 3P  
 SWITCH POINT 2

$\beta$  (DEG)

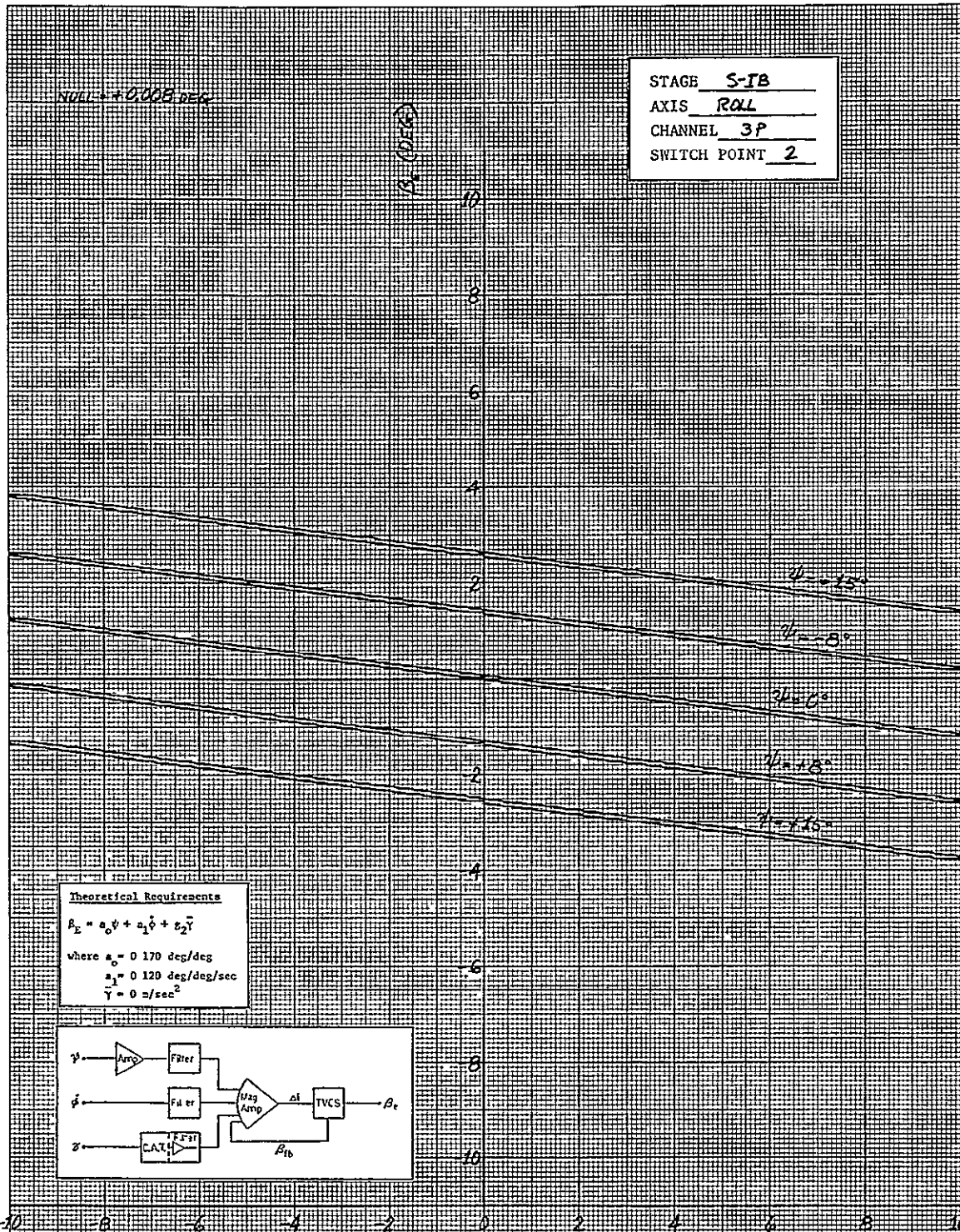

**Theoretical Requirements**  

$$\beta_E = a_0 \psi + a_1 \dot{\psi} + a_2 \ddot{\psi}$$
 where  $a_0 = 0.170 \text{ deg/deg}$   
 $a_1 = 0.120 \text{ deg/deg/sec}$   
 $a_2 = 0 \text{ m/sec}^2$

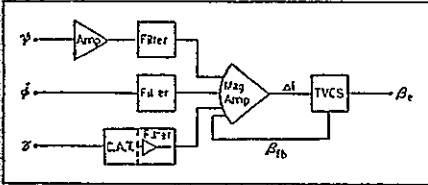

STATIC GAIN, LINEARITY, AND SIGNAL MIXING  
 FCC S/N 0104-I

N104-1-0104-I

STAGE S-1B  
 AXIS ROLL  
 CHANNEL AY  
 SWITCH POINT 2

$\beta_e$  (DEG)

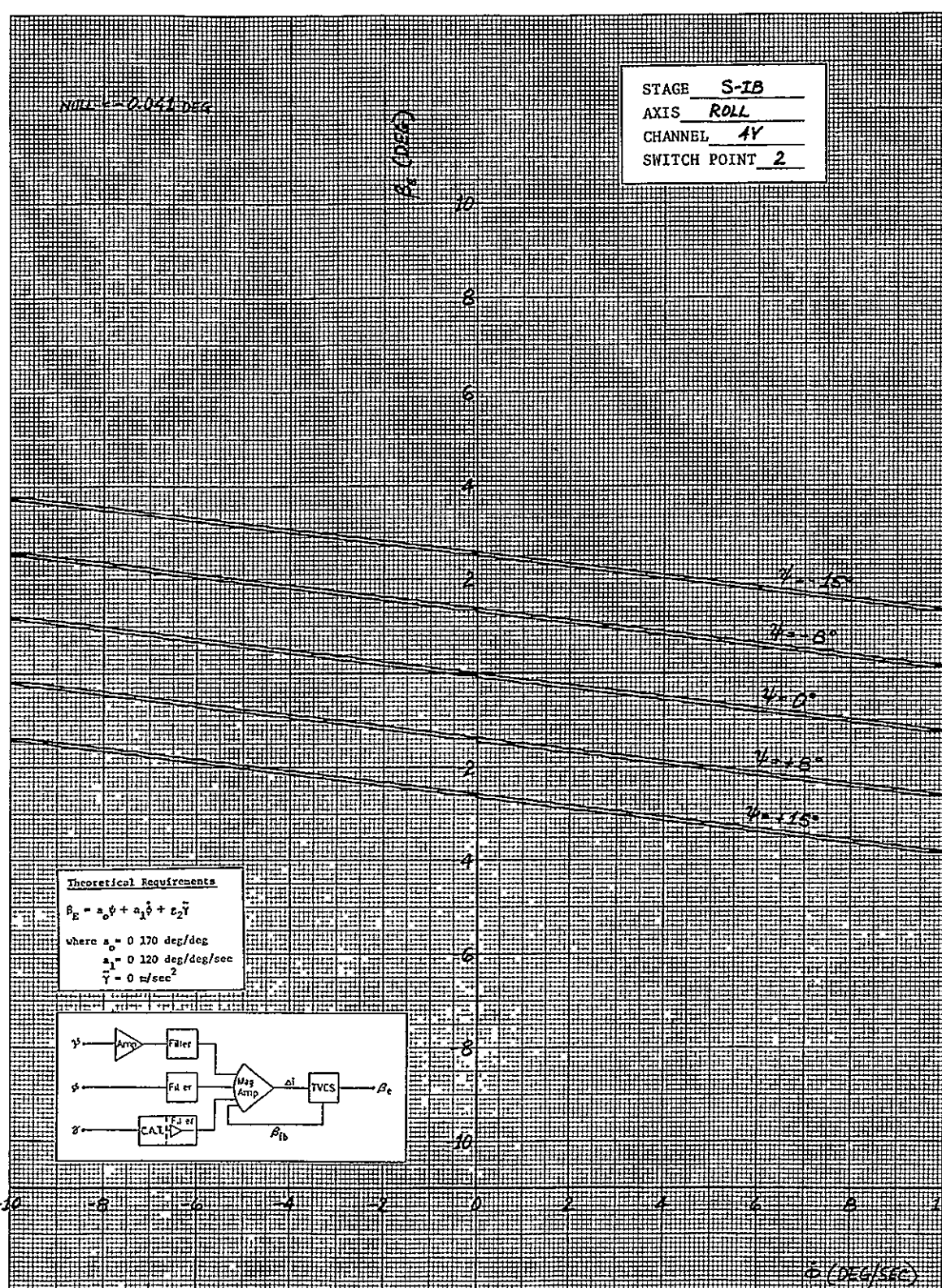

**Theoretical Requirements**  
 $\beta_e = a_0\phi + a_1\dot{\phi} + a_2\ddot{\phi}$   
 where  $a_0 = 0.170$  deg/deg  
 $a_1 = 0.120$  deg/deg/sec  
 $a_2 = 0$  w/sec<sup>2</sup>

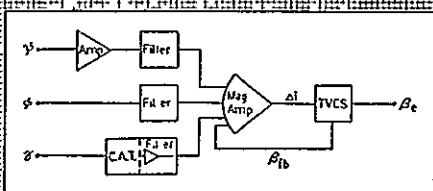

STATIC GAIN, LINEARITY, AND SIGNAL MIXING  
 FCC S/N 0104-I

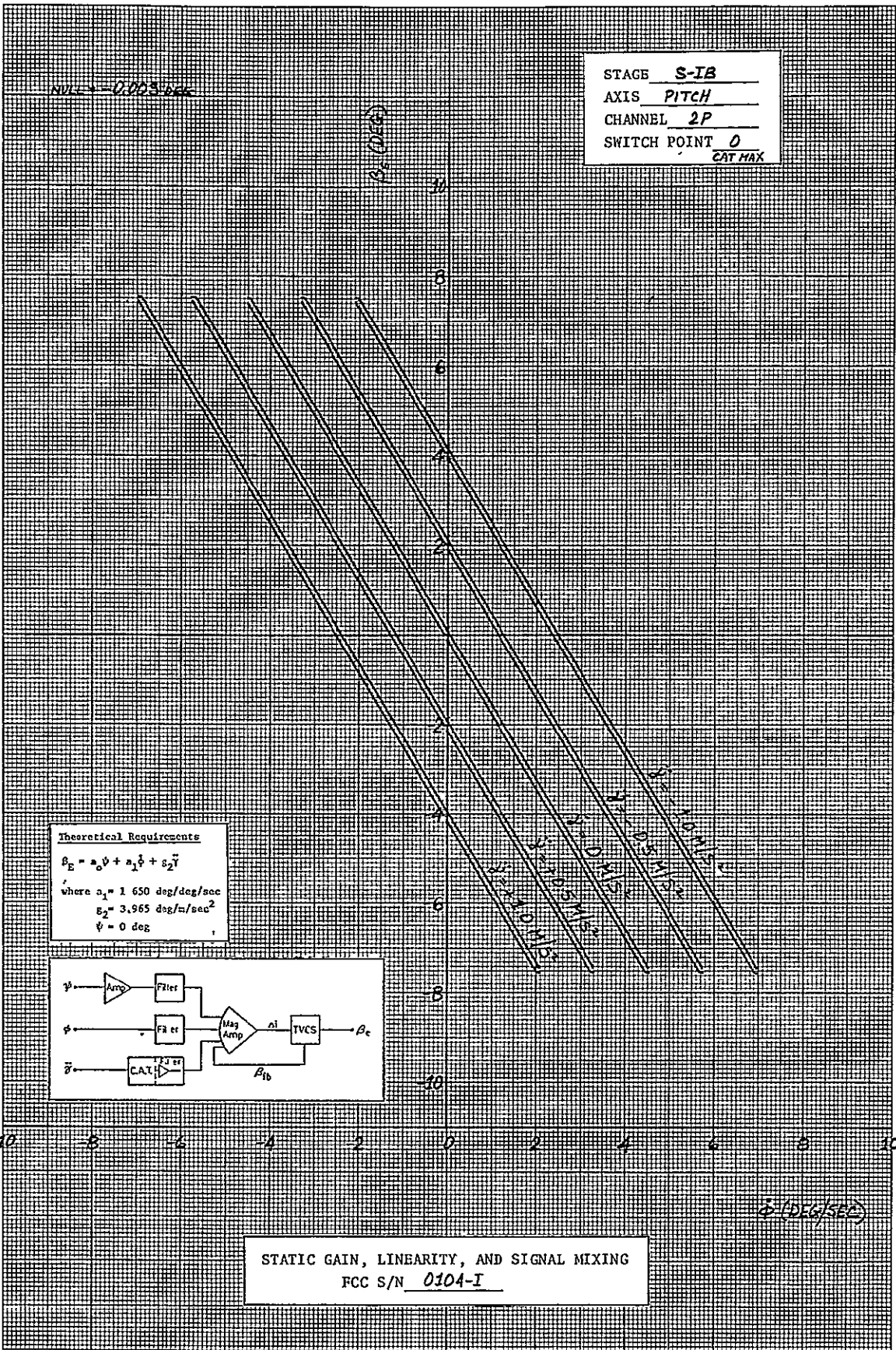

ORIGINAL PAGE IS  
 OF POOR QUALITY

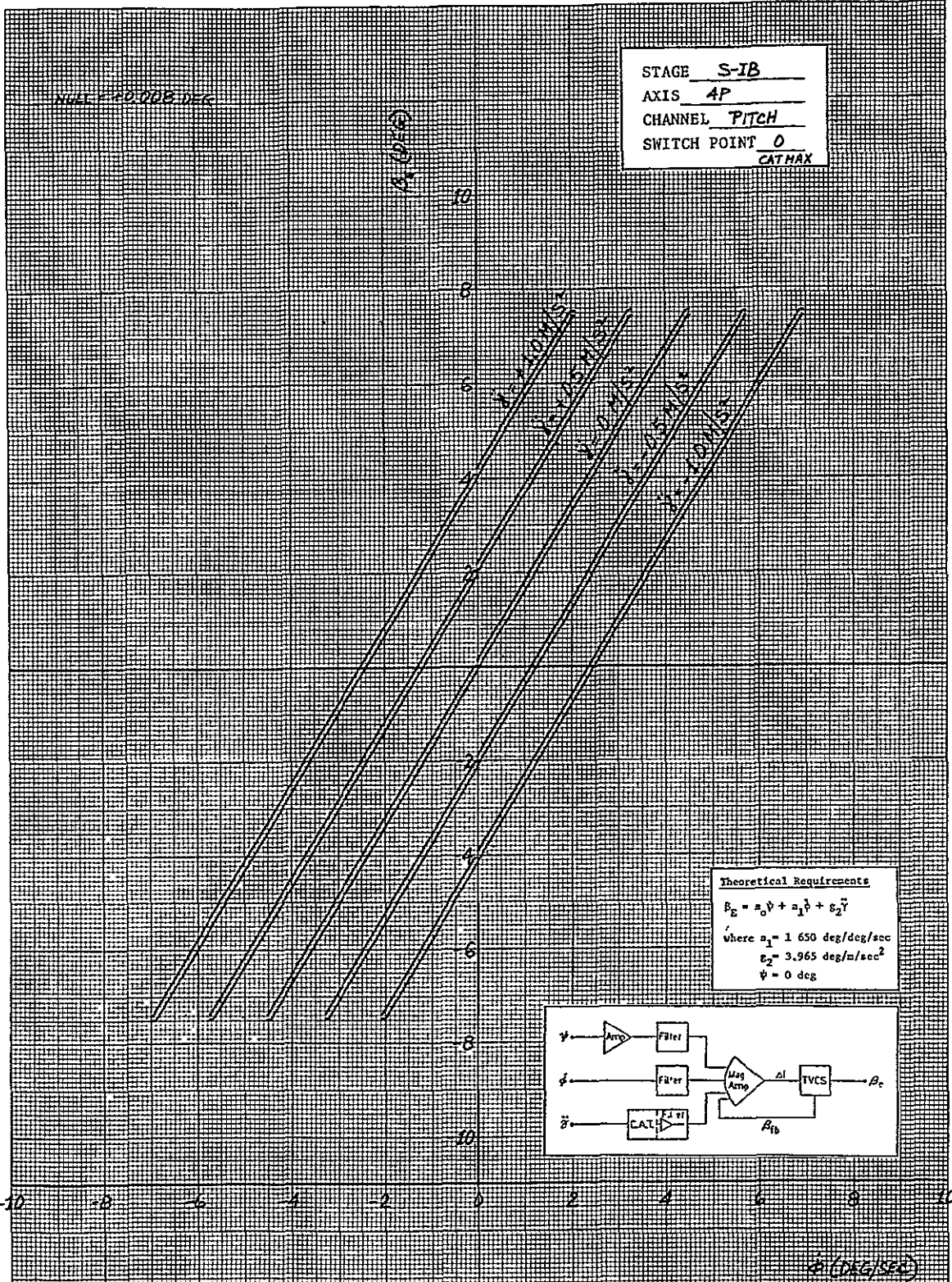

STAGE S-1B  
 AXIS 4P  
 CHANNEL PITCH  
 SWITCH POINT 0  
 CAT MAX

Theoretical Requirements  
 $E_E = a_0 \dot{\psi} + a_1 \dot{\phi} + a_2 \dot{\gamma}$   
 where  $a_1 = 1.650 \text{ deg/deg/sec}$   
 $a_2 = 3.965 \text{ deg/m/sec}^2$   
 $\psi = 0 \text{ deg}$

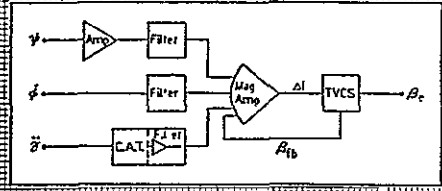

STATIC GAIN, LINEARITY, AND SIGNAL MIXING  
 FCC S/N 0104-I

NUCL-0102-100

STAGE S-1B  
 AXIS YAW  
 CHANNEL 2Y  
 SWITCH POINT 0  
 CAT MAX

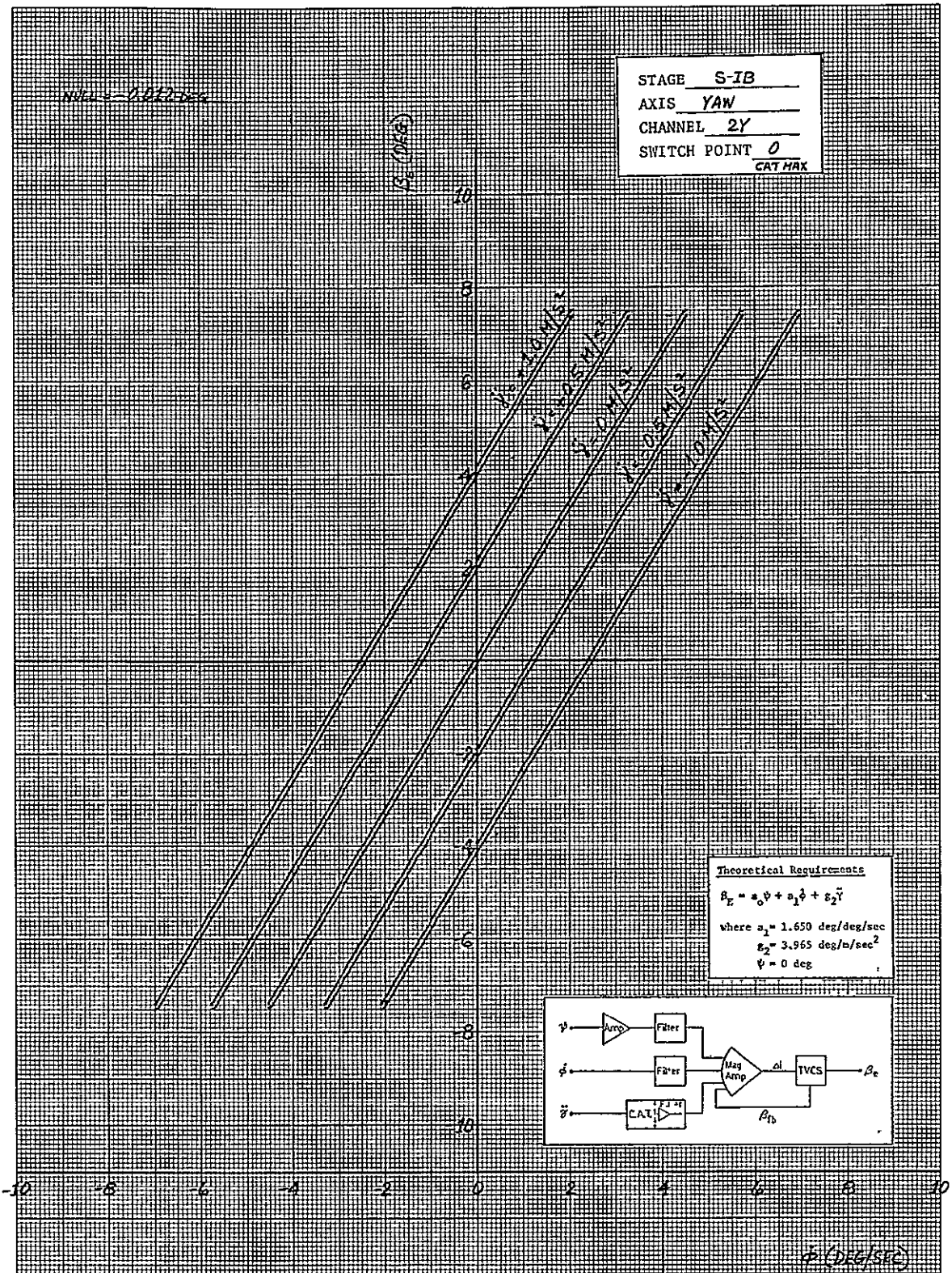

**Theoretical Requirements**  
 $\beta_e = a_0 \psi + a_1 \dot{\psi} + a_2 \ddot{\psi}$   
 where  $a_1 = 1.650 \text{ deg/deg/sec}$   
 $a_2 = 3.965 \text{ deg/deg/sec}^2$   
 $\psi = 0 \text{ deg}$

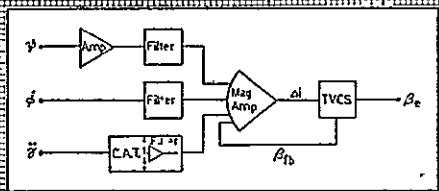

STATIC GAIN, LINEARITY, AND SIGNAL MIXING  
 FCC S/N 010A-I

NULL = 0.011 DEG

STAGE S-1B  
 AXIS YAW  
 CHANNEL 3Y  
 SWITCH POINT 0  
 CAT MAX

A (DEG)

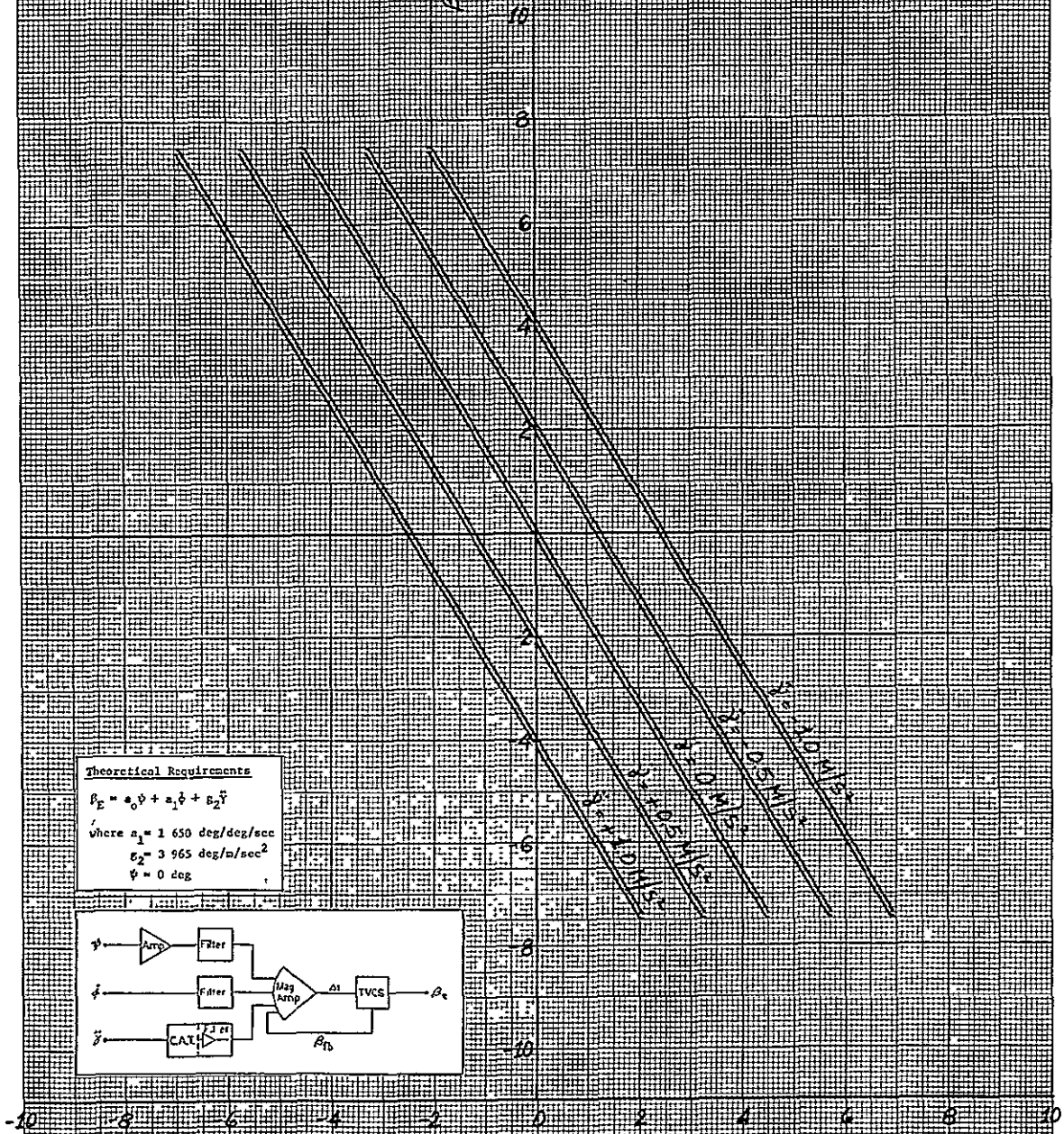

**Theoretical Requirements**  
 $\beta_E = a_0 \dot{\psi} + a_1 \ddot{\psi} + a_2 \ddot{\psi}$   
 where  $a_1 = 1.650 \text{ deg/deg/sec}$   
 $a_2 = 3.965 \text{ deg/a/sec}^2$   
 $\psi = 0 \text{ deg}$

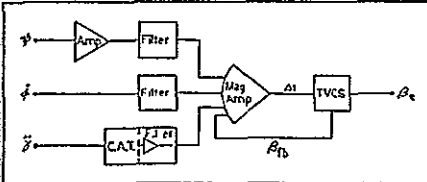

STATIC GAIN, LINEARITY, AND SIGNAL MIXING  
 FCC S/N 0104-I

D (DEG/SEC)

ORIGINAL PAGE IS  
OF POOR QUALITY

2-47

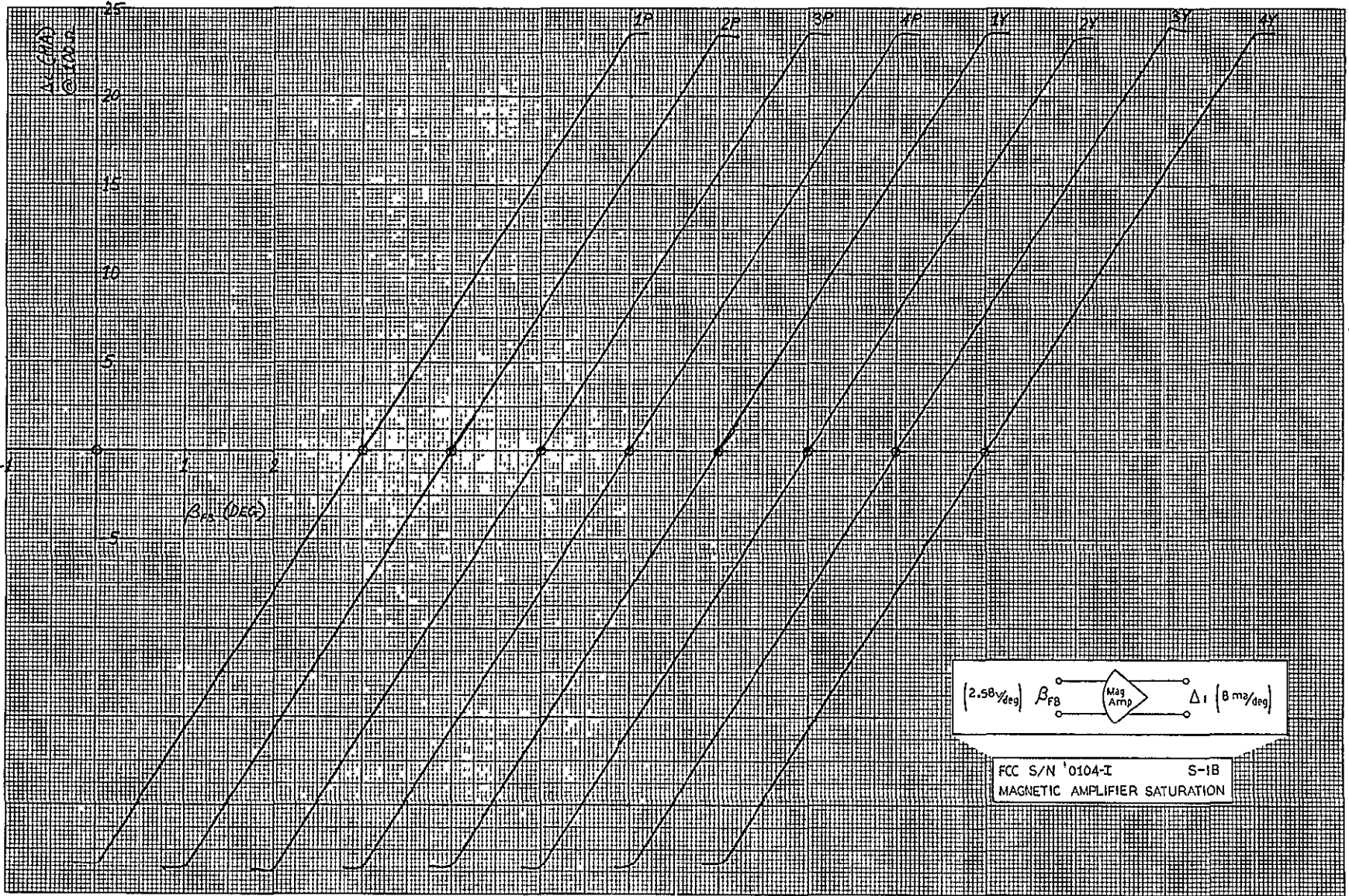



## S-IB STAGE

## RELATIVE POLARITY

Channel	Servo Amp	POLARITY						Theoretical
		SPUT Data			L/M Data			
		SP 0	SP 2	SP 3	SP 0	SP 2	SP 3	
$\psi$ P/Y	1P	+	+	+	+			+
	2P	-	-	-		-		-
	3P	-	-	-	-			-
	4P	+	+	+			+	+
$\psi$ Roll	1Y	+	+	+	+			+
	2Y	+	+	+			+	+
	3Y	-	-	-		-		-
	4Y	-	-	-	-			-
$\phi$ P/Y	1P	-	-	-		-		-
	2P	+	+	+	+			+
	3P	-	-	-		-		-
	4P	+	+	+			+	+
$\phi$ Roll	1Y	+	+	+	+			+
	2Y	+	+	+			+	+
	3Y	-	-	-		-		-
	4Y	-	-	-	-			-

- NOTES: (1) Polarity of the Servo Amp output for a positive input to the FCC; input and output are referenced at first pin minus (low pin low); + actuator retracts, - actuator extends.
- (2) SPUT refers to "switch point utilization" test data; L/M refers to "linearity and mixing" test data.

STATIC GAINS (SIM LAB)

VEHICLE AS-210 FCC S/N 1041

S-IB STAGE

AXIS	OUTPUT WINDING	SP	A0 GAIN (DEG/DEG)			A1 GAIN (DEG/DEG/SEC)		
			THEOR.	ACTUAL	PERCENT DEV.	THEOR.	ACTUAL	PERCENT DEV.
P-Y	1P	0	1.8493	1.8623	0.7069	1.6497	1.6564	0.4107
P-Y	1Y	0	1.8493	1.8627	0.7272	1.6497	1.6612	0.7028
P-Y	3P	0	1.8493	1.8614	0.6596	1.6497	1.6561	0.3933
P-Y	4Y	0	1.8493	1.8611	0.6393	1.6497	1.6613	0.7037
P-Y	2P	2	1.0997	1.1044	0.4351	1.2992	1.3049	0.4403
P-Y	3Y	2	1.0997	1.1031	0.3176	1.2992	1.3079	0.6757
P-Y	4P	3	0.5498	0.5508	0.1903	0.6005	0.6056	0.8639
P-Y	2Y	3	0.5498	0.5501	0.0640	0.6005	0.6048	0.7301
ROLL	2P	0	0.2122	0.2140	0.8575	0.1980	0.1991	0.5575
ROLL	1Y	0	0.2122	0.2140	0.8793	0.1980	0.1992	0.6433
ROLL	4P	0	0.2122	0.2142	0.9737	0.1980	0.1993	0.6716
ROLL	3Y	0	0.2122	0.2138	0.7993	0.1980	0.1972	0.3940
ROLL	1P	2	0.1700	0.1713	0.7825	0.1202	0.1211	0.7910
ROLL	2Y	2	0.1700	0.1711	0.6659	0.1202	0.1209	0.6579
ROLL	3P	2	0.1700	0.1713	0.7876	0.1202	0.1210	0.7401
ROLL	4Y	2	0.1700	0.1714	0.8822	0.1202	0.1212	0.8649

AXIS	OUTPUT WINDING	SP	G2 GAIN (DEG/M/SEC <sup>2</sup> )			A1 GAIN (DEG/DEG/SEC)		
			THEOR.	ACTUAL	PERCENT DEV.	THEOR.	ACTUAL	PERCENT DEV.
P-Y	2P	0	3.9655	4.0586	2.3493	1.6497	1.6569	0.4392
P-Y	2Y	0	3.9655	4.0540	2.2337	1.6497	1.6562	0.3990
P-Y	4P	0	3.9655	4.0636	2.4754	1.6497	1.6623	0.7640
P-Y	3Y	0	3.9655	4.0604	2.3955	1.6497	1.6596	0.6040

NOTES: (1) allowable static gain deviation is ±4%  
 (2) roll gain equals channel hardware gain

OPEN LOOP FREQUENCY RESPONSE  
SA-210 S-IB STAGE

P - Y ATTITUDE ERROR FILTER x 12MA SA

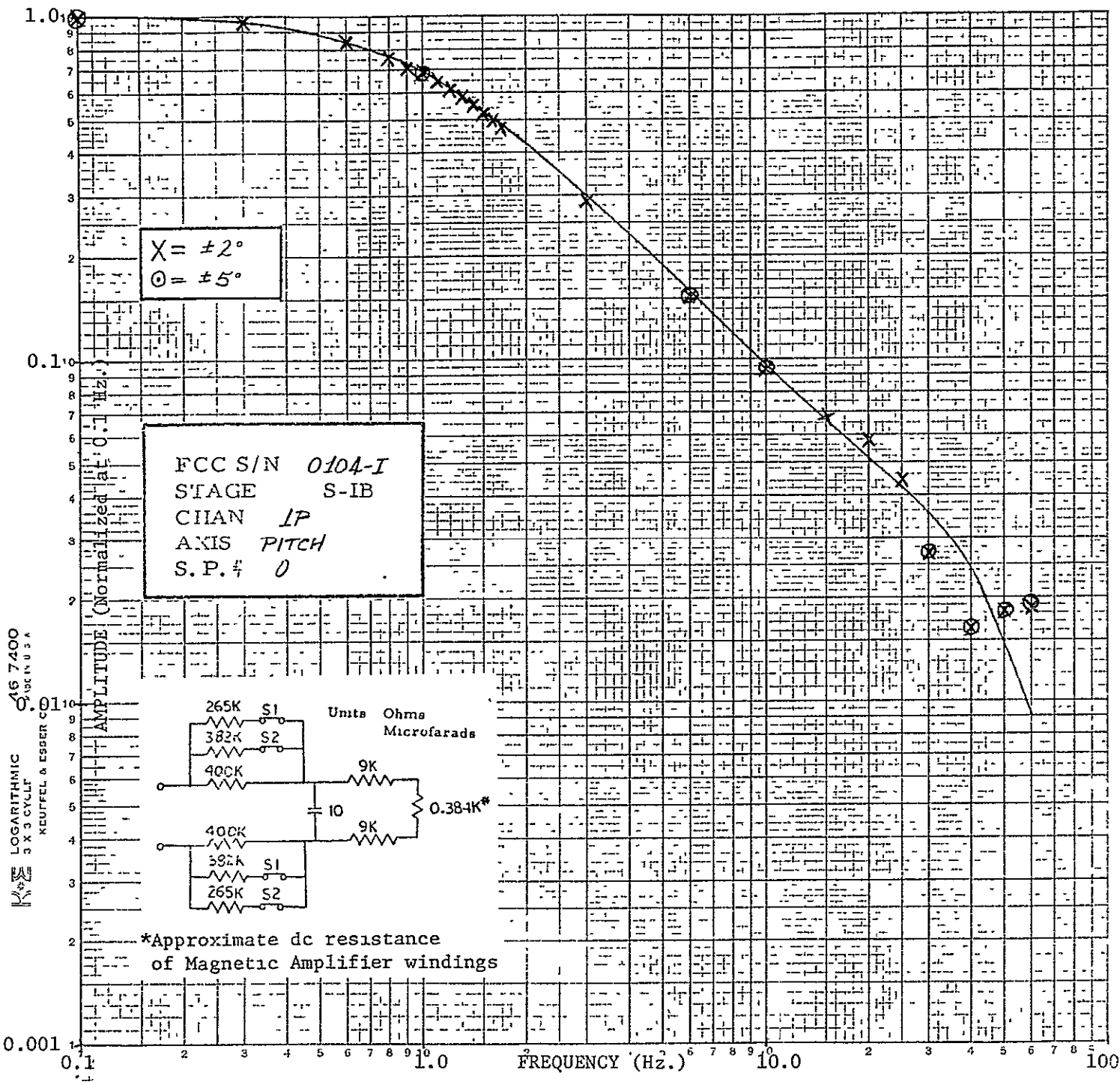

LOGARITHMIC  
3 X 3 CYCLE  
KEUFFEL & ESSER CO.

ORIGINAL PAGE IS  
OF POOR QUALITY

OPEN LOOP FREQUENCY RESPONSE  
SA-210, S-IB STAGE

P - Y ATTITUDE ERROR FILTER x 12MA SA

X = ± 2°  
O = ± 5°

FCC S/N D104-I  
STAGE S-IB  
CHAN 1P  
AXIS PITCH  
S.P.# 0

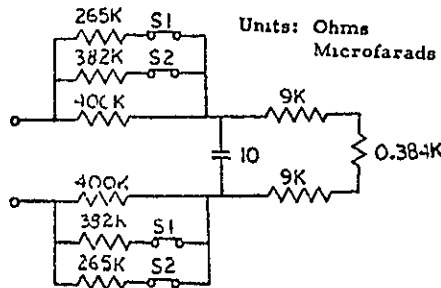

\*Approximate dc resistance  
of Magnetic Amplifier windings

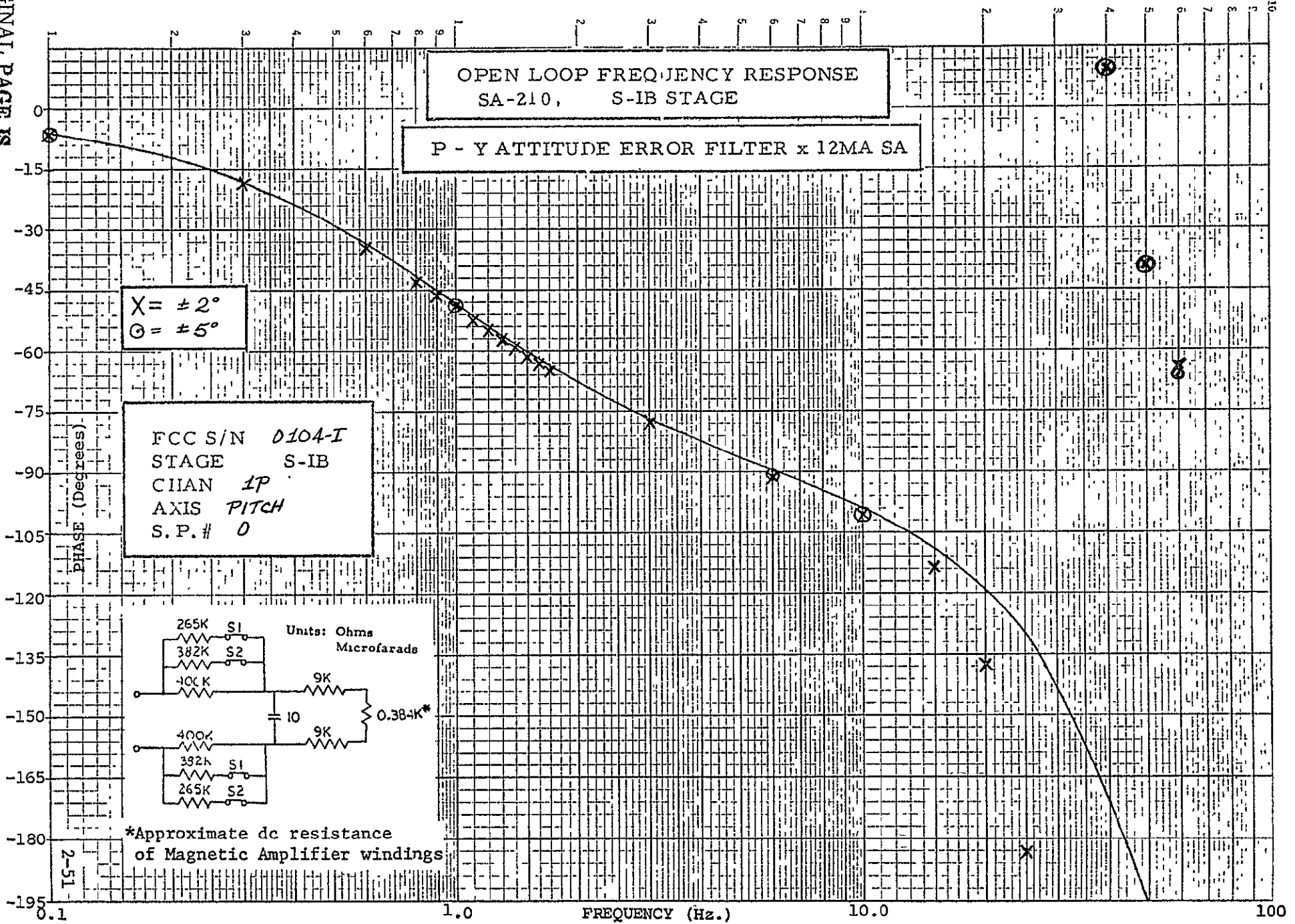

2-51

OPEN LOOP FREQUENCY RESPONSE  
SA-210 S-IB STAGE

P - Y ATTITUDE ERROR FILTER x 12MA SA

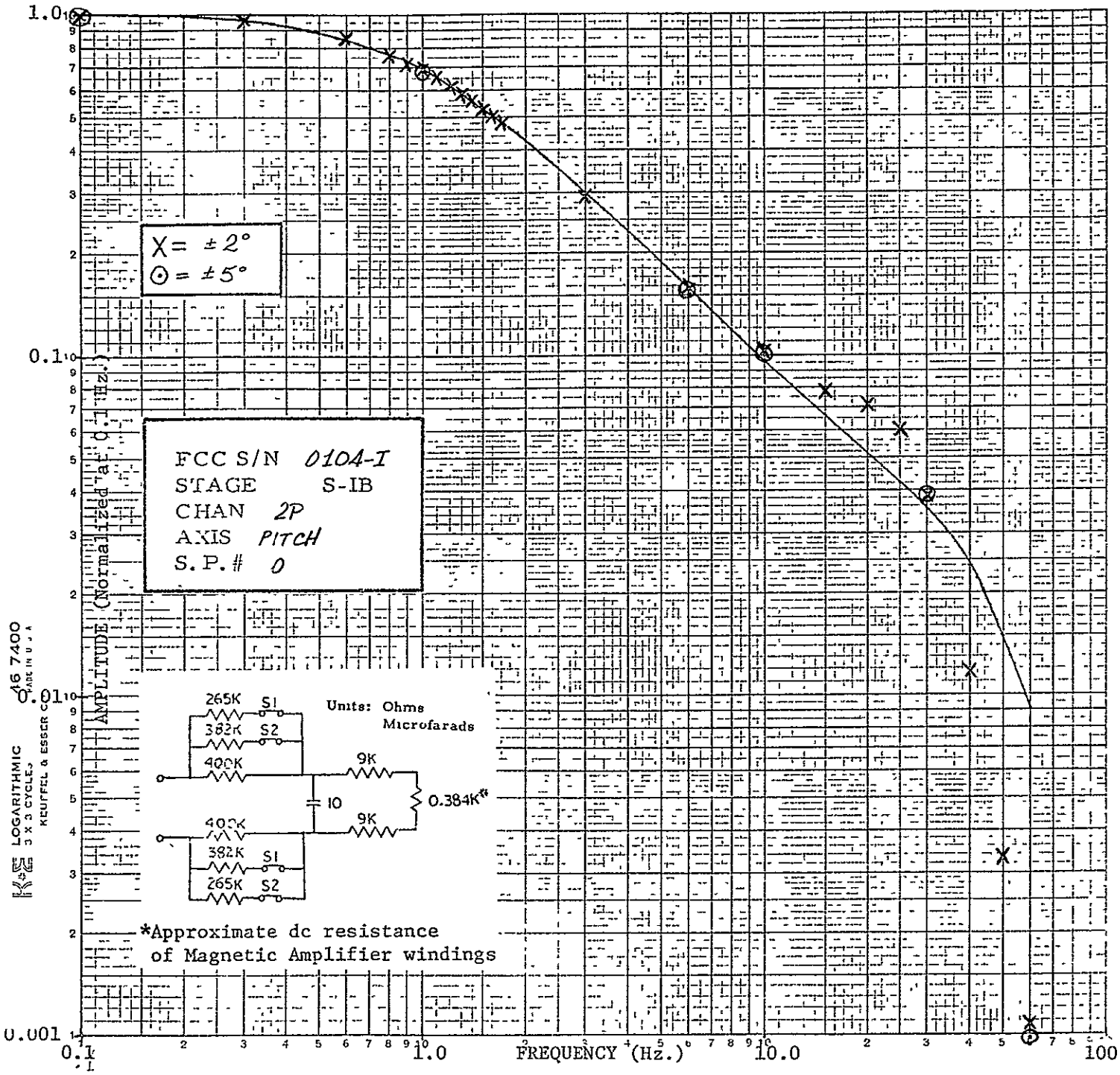

46 7400  
 MADE IN U.S.A.  
 KEUFFEL & ESSER CO.  
 LOGARITHMIC  
 3 X 3 CYCLE

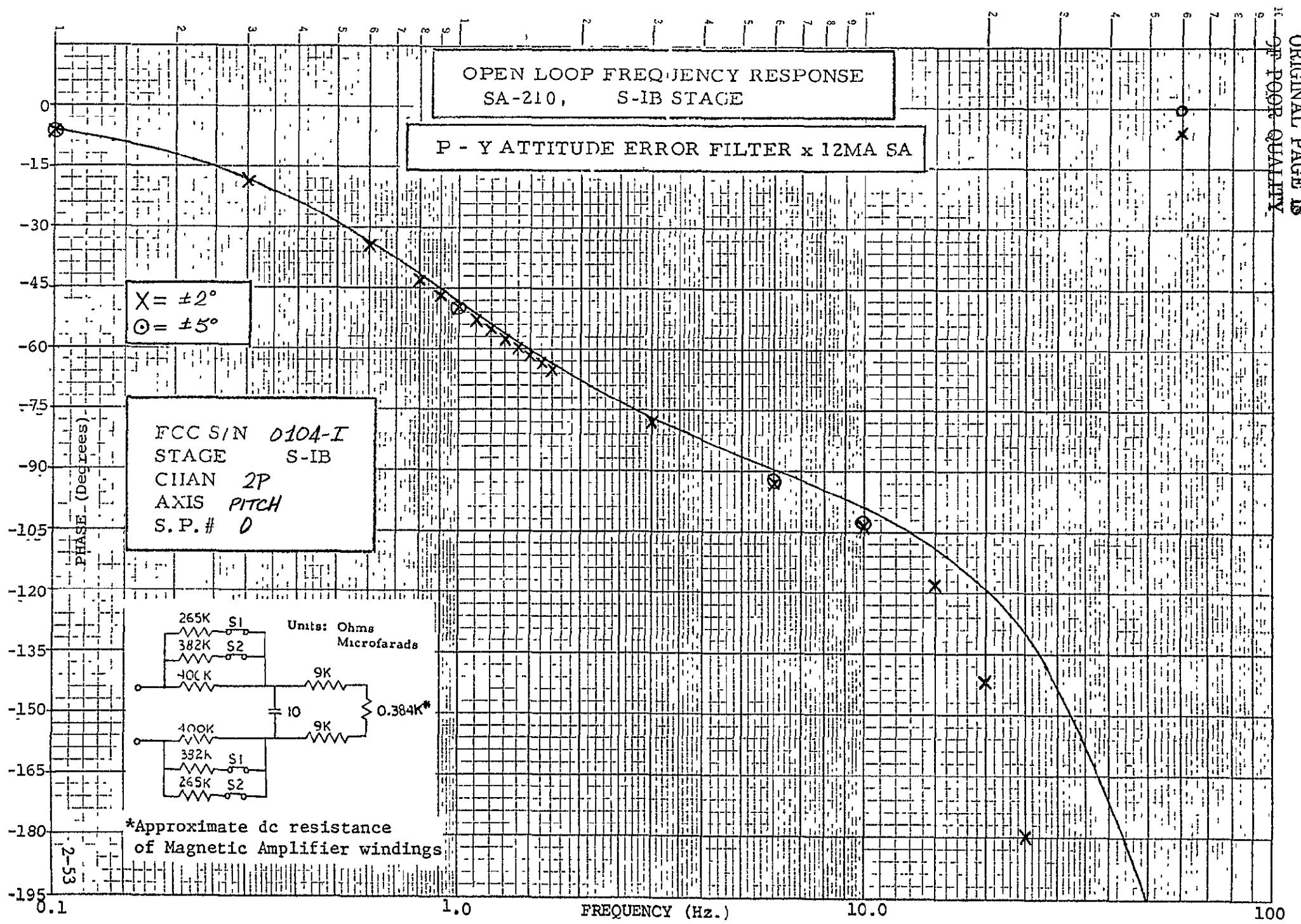

FCC SIN 0104-I  
STAGE S-IB  
CHAN 2P  
AXIS PITCH  
S.P.# 0

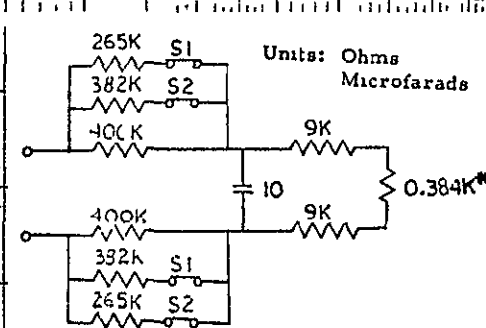

\*Approximate dc resistance  
of Magnetic Amplifier windings

55-53

OPEN LOOP FREQUENCY RESPONSE  
SA-210 S-IB STAGE

P - Y ATTITUDE ERROR FILTER x 12MA SA

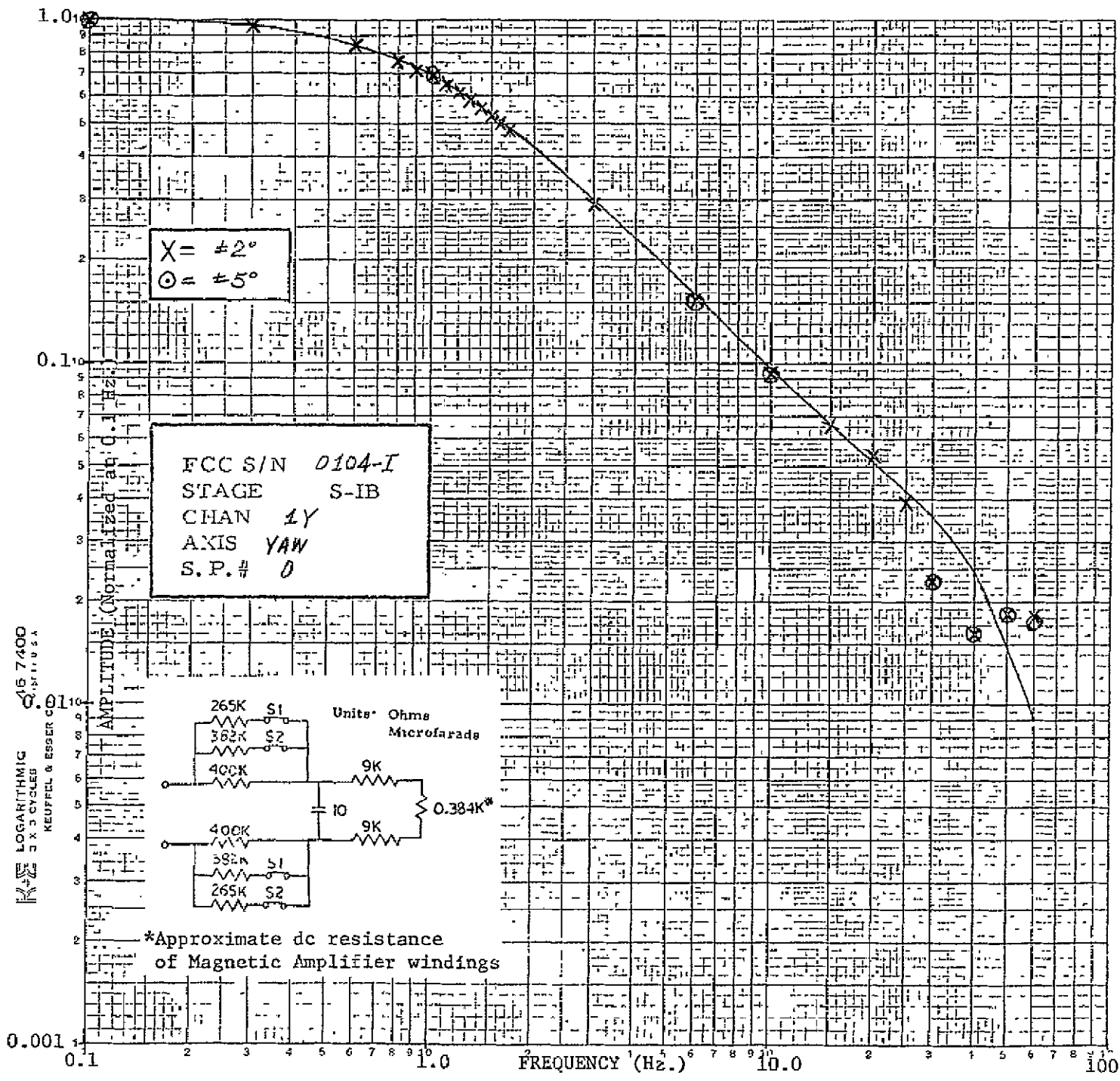

OPEN LOOP FREQUENCY RESPONSE  
SA-210, S-IB STAGE

P - Y ATTITUDE ERROR FILTER x 12MA SA

X = ±2°  
O = ±5°

FCC S/N 010A-I  
STAGE S-IB  
CHAN 1Y  
AXIS YAW  
S.P.# 0

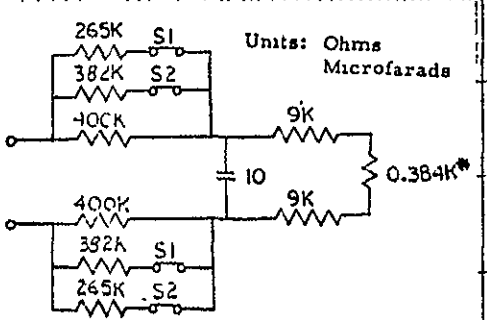

\*Approximate dc resistance  
of Magnetic Amplifier windings

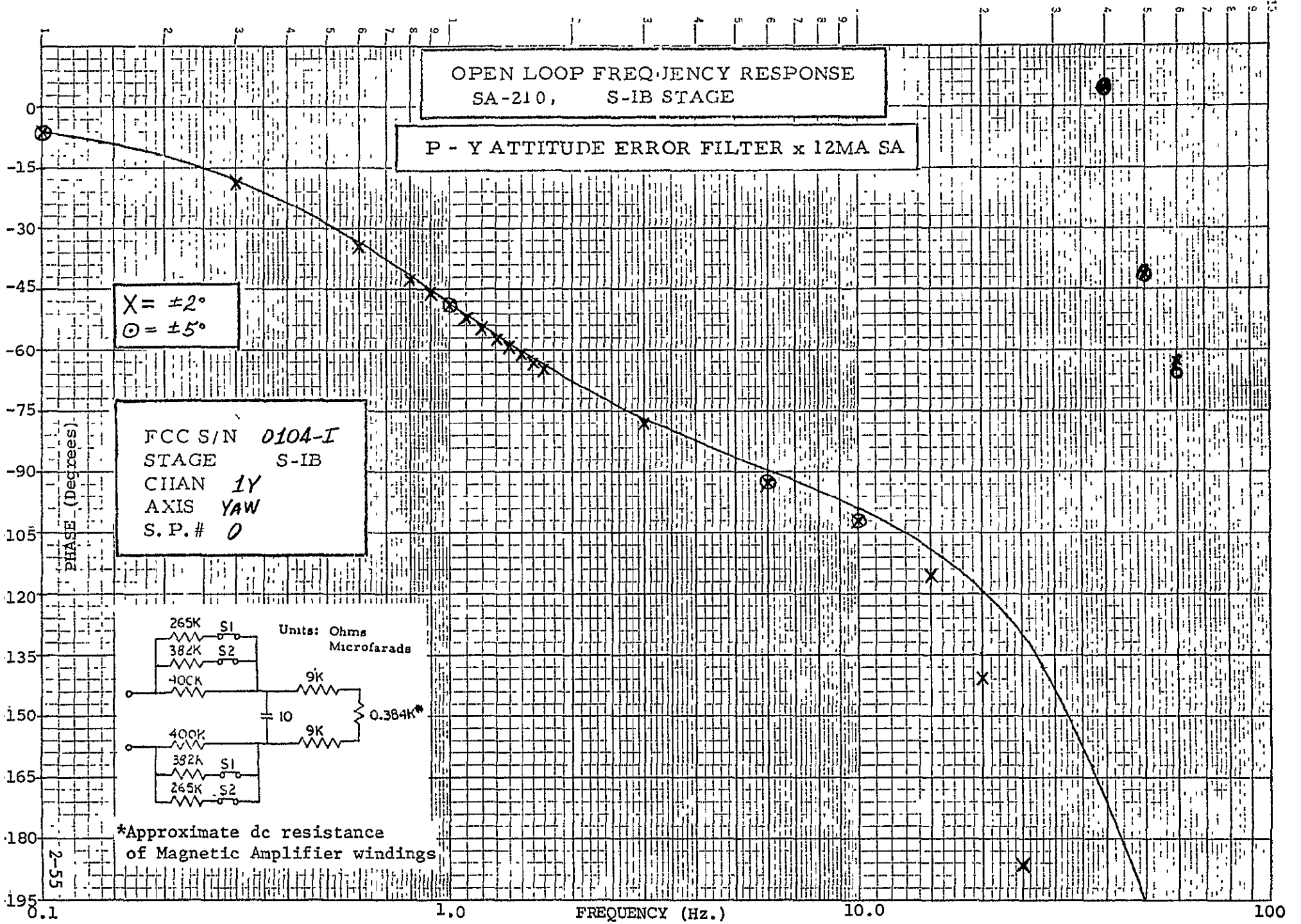



OPEN LOOP FREQUENCY RESPONSE  
SA-210 S-IB STAGE

P - Y ATTITUDE ERROR FILTER x 12MA SA

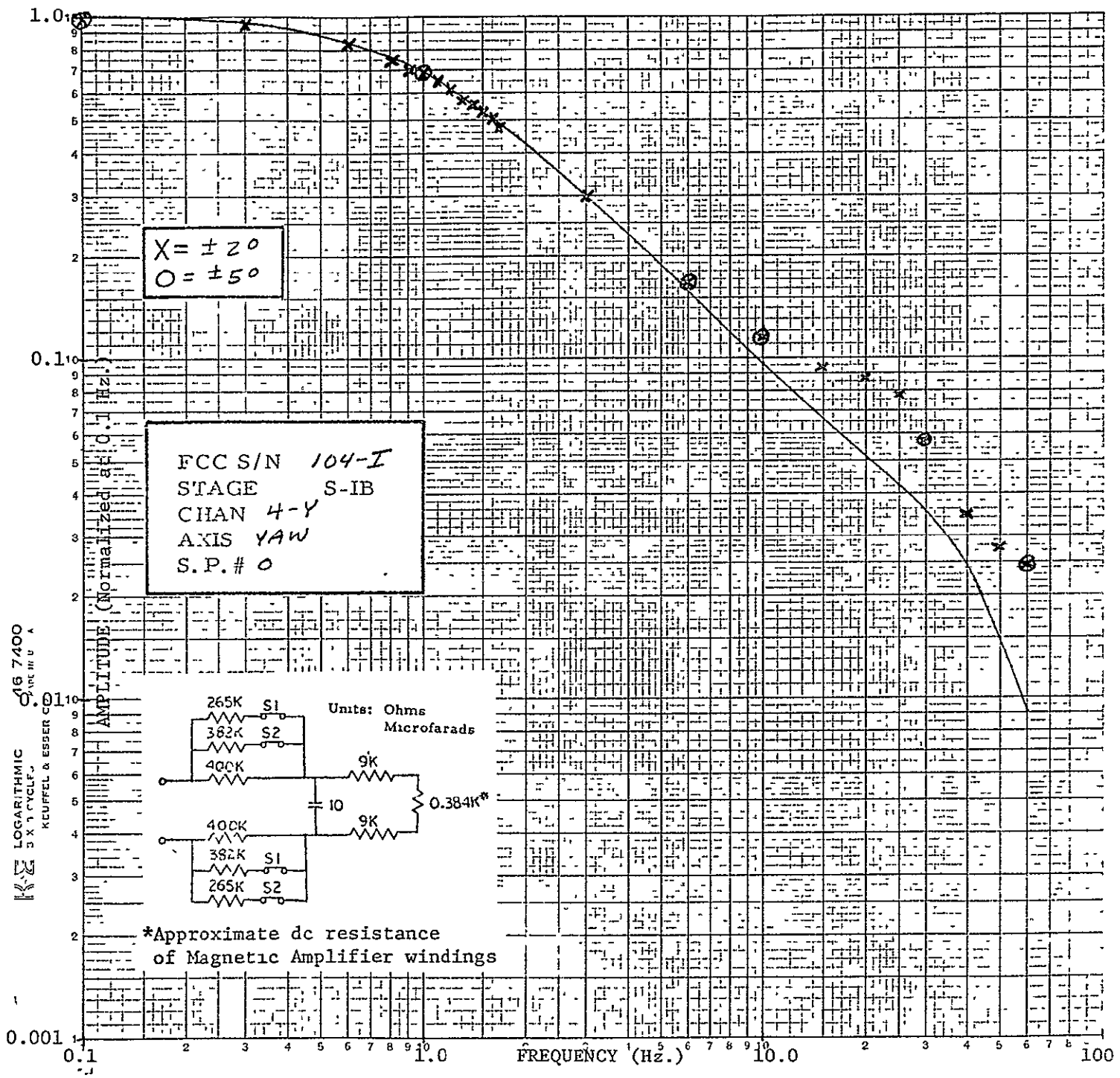

LOGARITHMIC KEUFFEL & ESSER CO. 16 7400

ORIGINAL PAGE IS  
OF POOR QUALITY

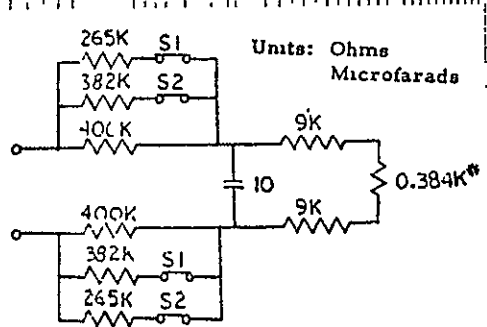
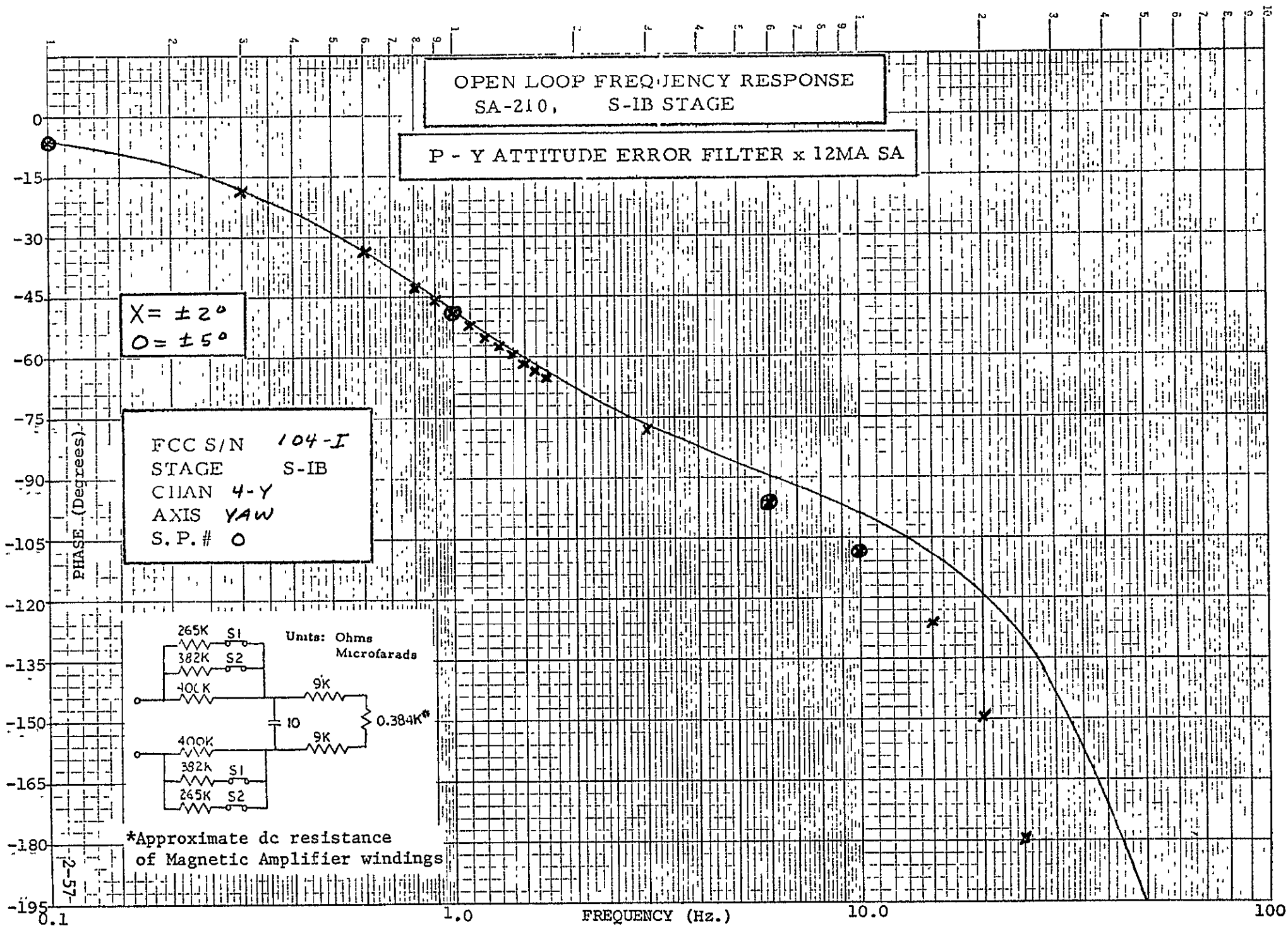

\*Approximate dc resistance of Magnetic Amplifier windings

2-57

OPEN LOOP FREQUENCY RESPONSE  
SA-210 S-IB STAGE

P - Y ATTITUDE ERROR FILTER x 12MA SA

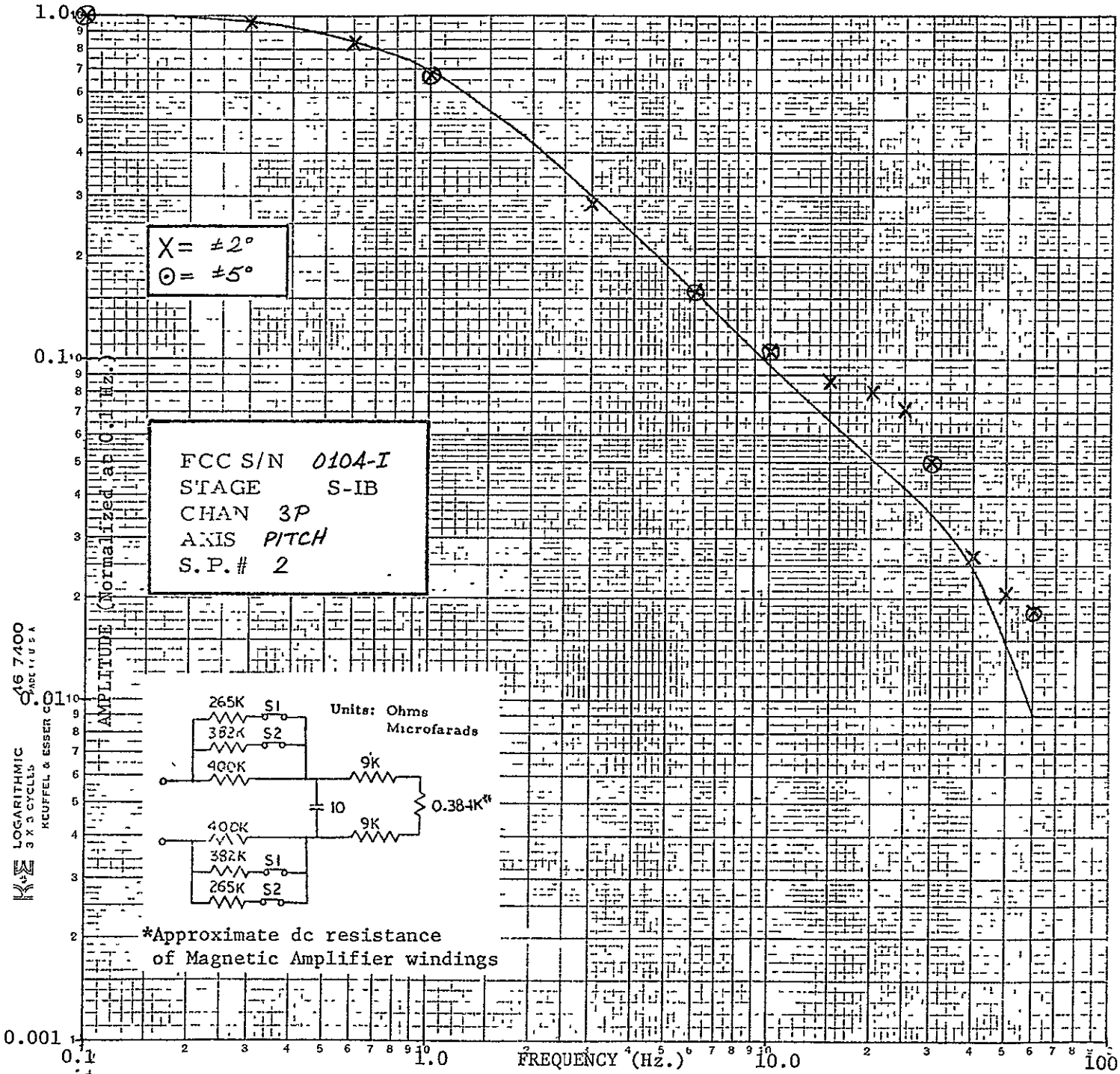

16 7400  
 LOGARITHMIC  
 3 X 3 CYCLES  
 KEUFFEL & ESSER CO.

ORIGINAL PAGE IS  
OF POOR QUALITY

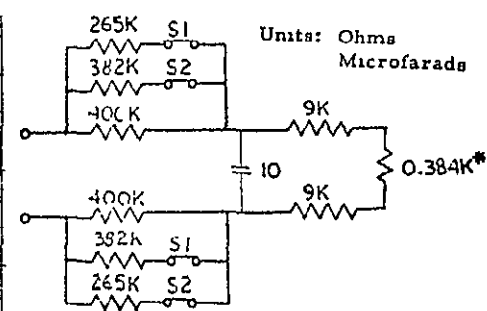
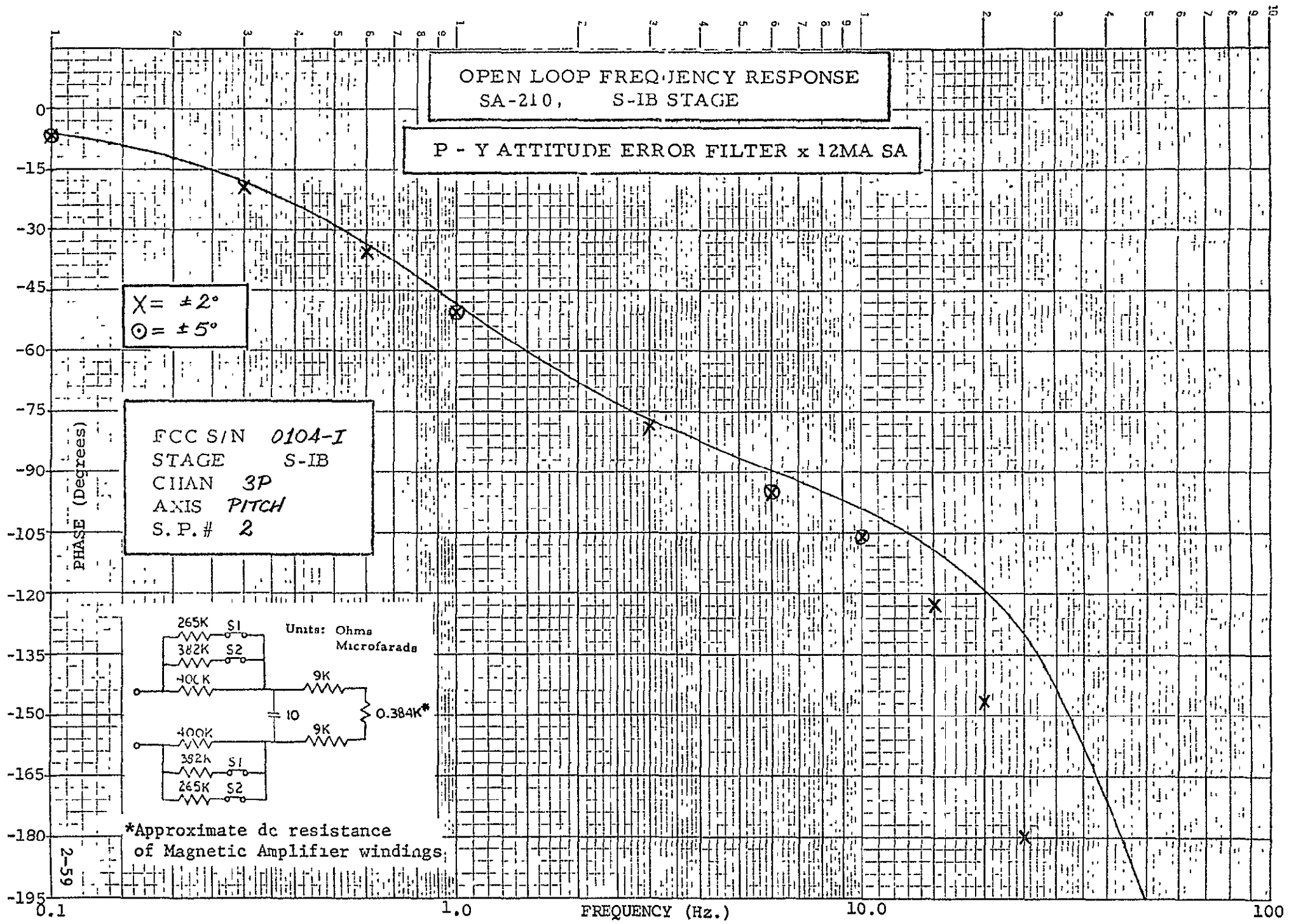

2-59

OPEN LOOP FREQUENCY RESPONSE  
SA-210 S-IB STAGE

P - Y ATTITUDE ERROR FILTER x 12MA SA

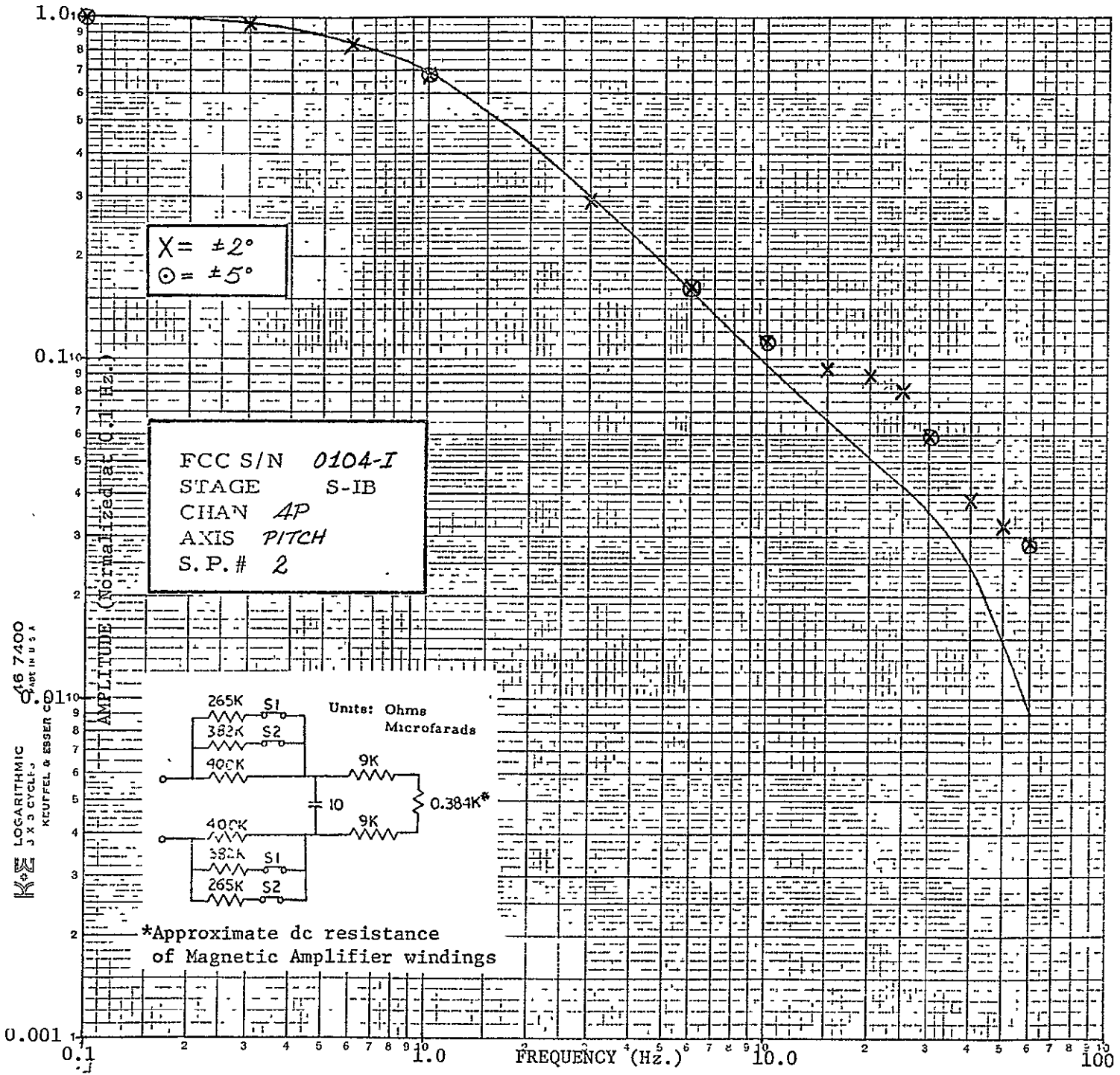

ORIGINAL PAGE IS  
OF POOR QUALITY

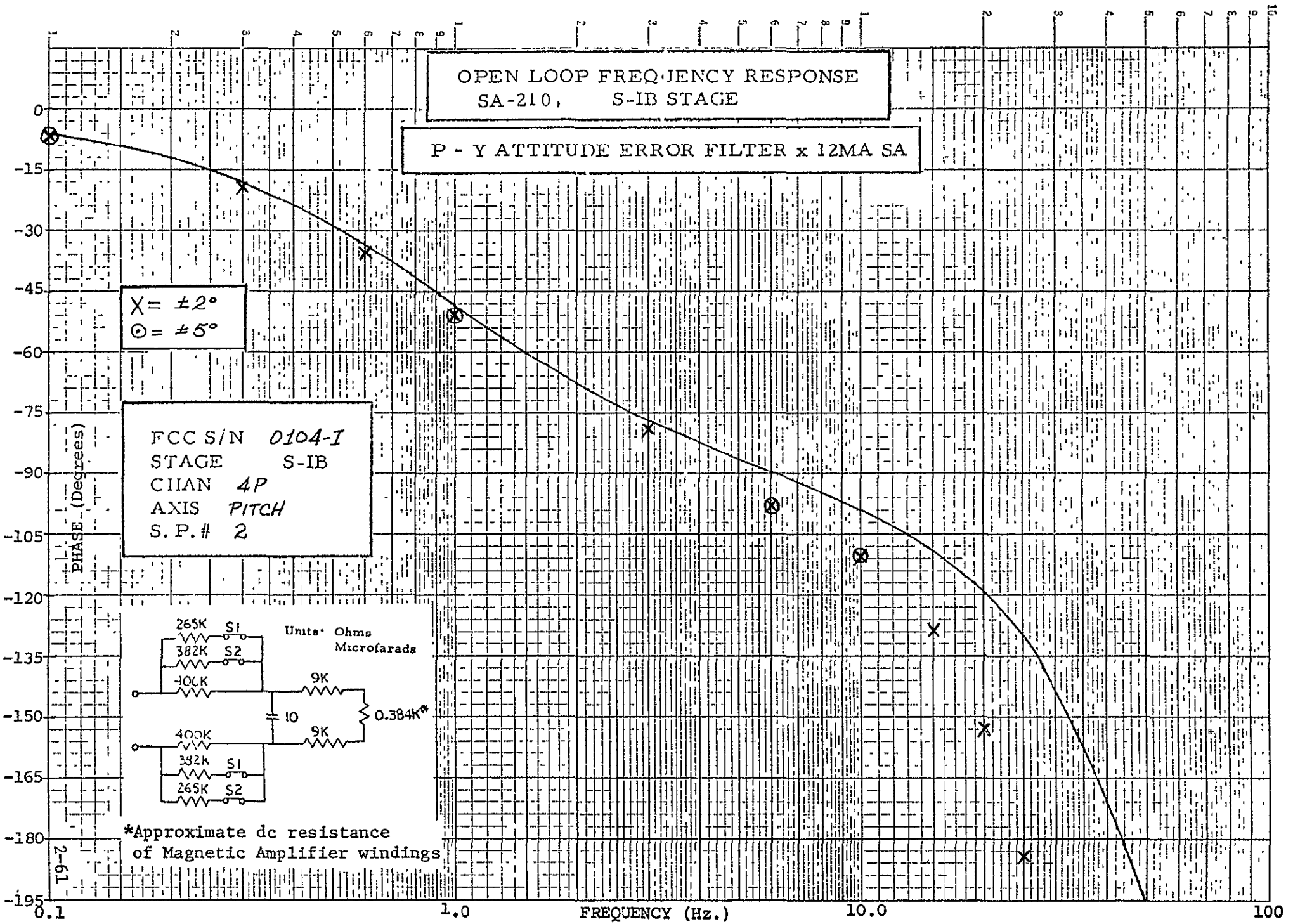

X = ±2°  
⊗ = ±5°

FCC S/N 0104-I  
STAGE S-IB  
CHAN 4P  
AXIS PITCH  
S. P. # 2

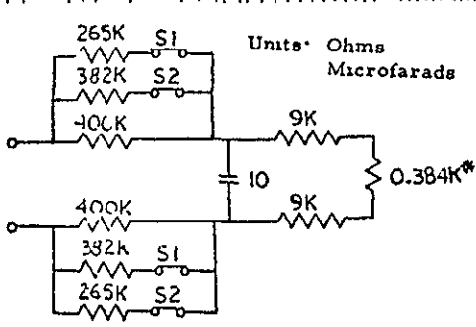

\*Approximate dc resistance of Magnetic Amplifier windings

OPEN LOOP FREQUENCY RESPONSE  
SA-210 S-IB STAGE

P - Y ATTITUDE ERROR FILTER x 12MA SA

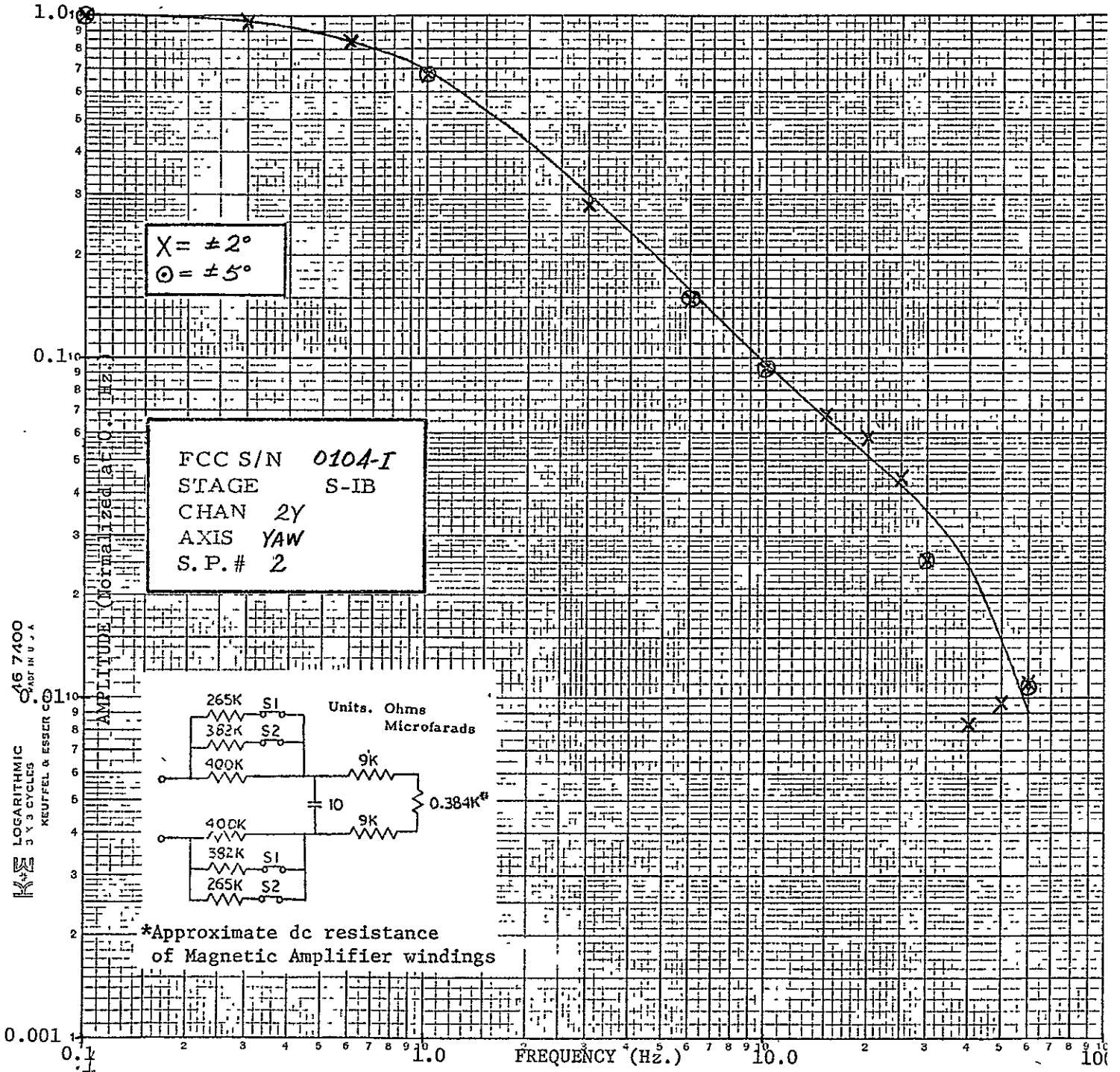

ORIGINAL PAGE IS  
OF POOR QUALITY

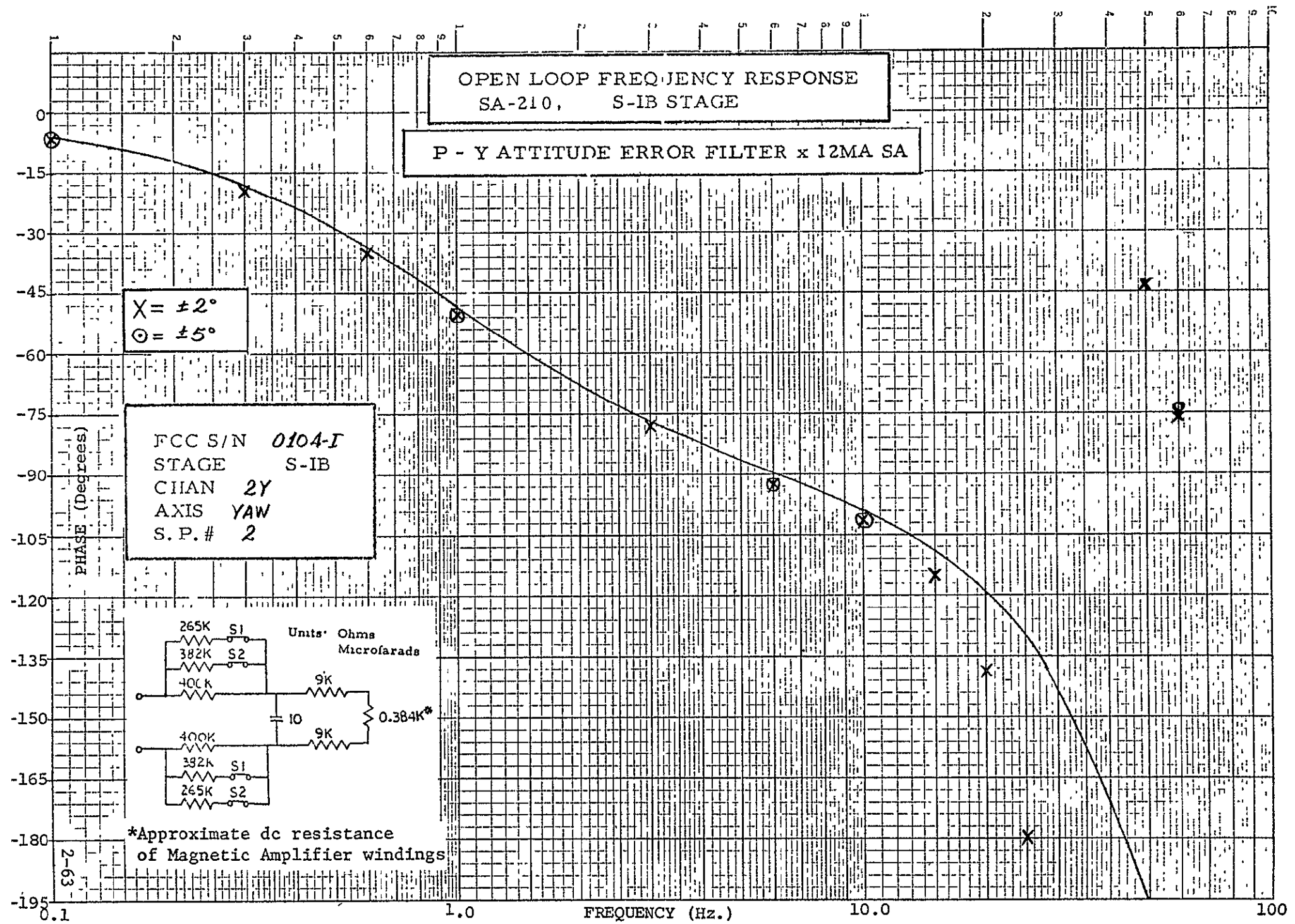



OPEN LOOP FREQUENCY RESPONSE  
SA-210 S-IB STAGE

P - Y ATTITUDE ERROR FILTER x 12MA SA

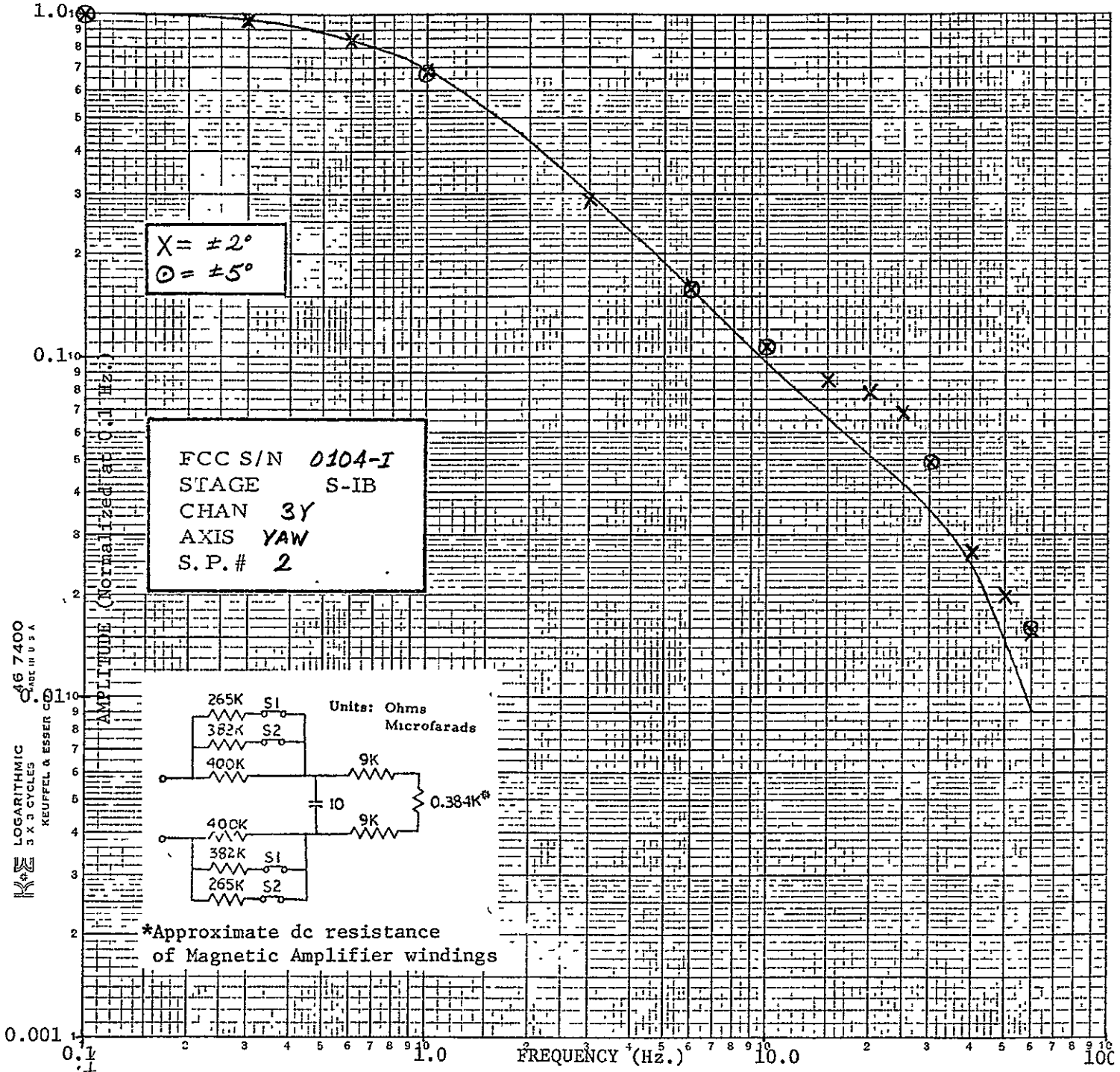

KE LOGARITHMIC MADE IN U.S.A. KEUFFEL & ESSER CO.

ORIGINAL PAGE IS OF POOR QUALITY

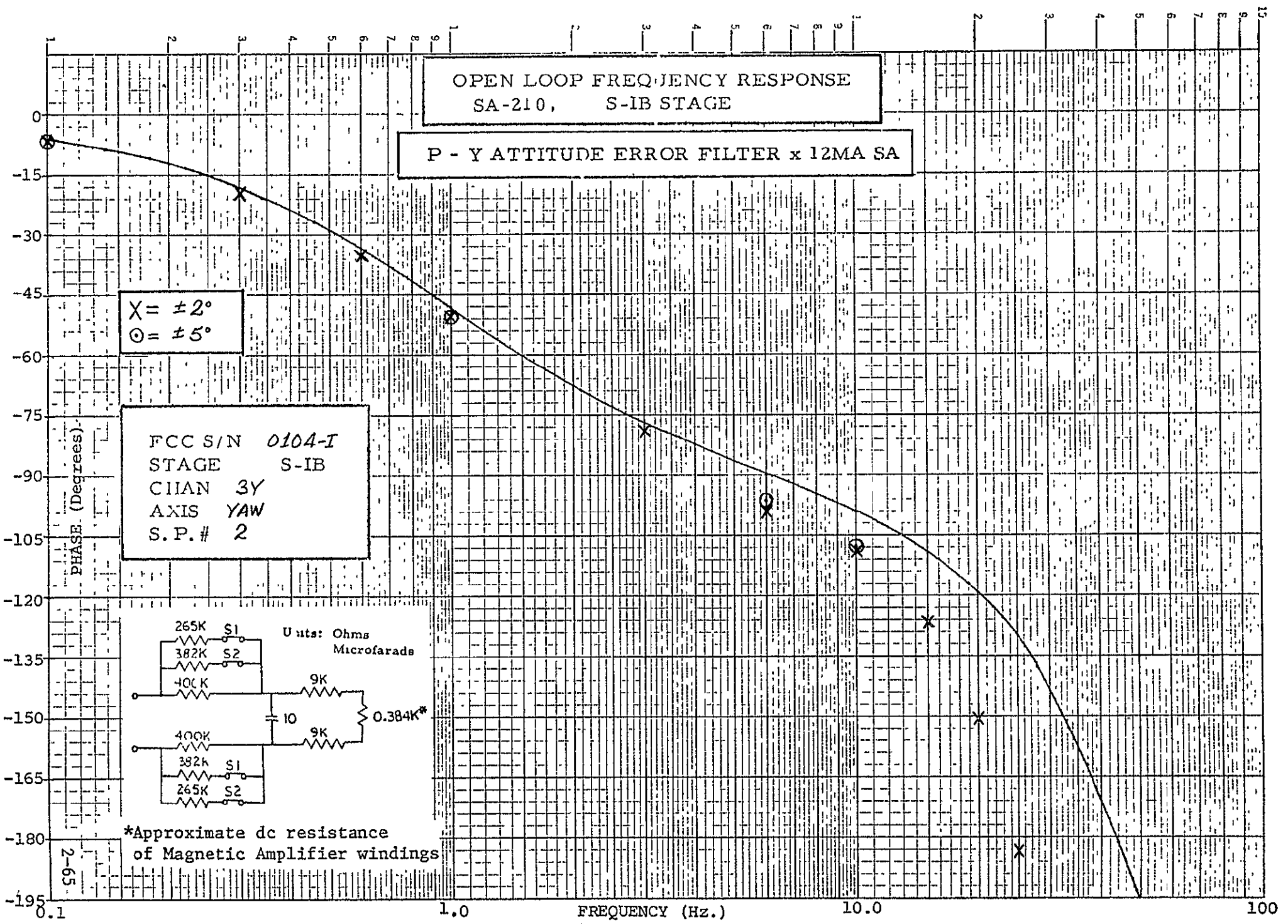

OPEN LOOP FREQUENCY RESPONSE  
SA-210 S-IB STAGE

P - Y ATTITUDE ERROR FILTER x 12MA SA

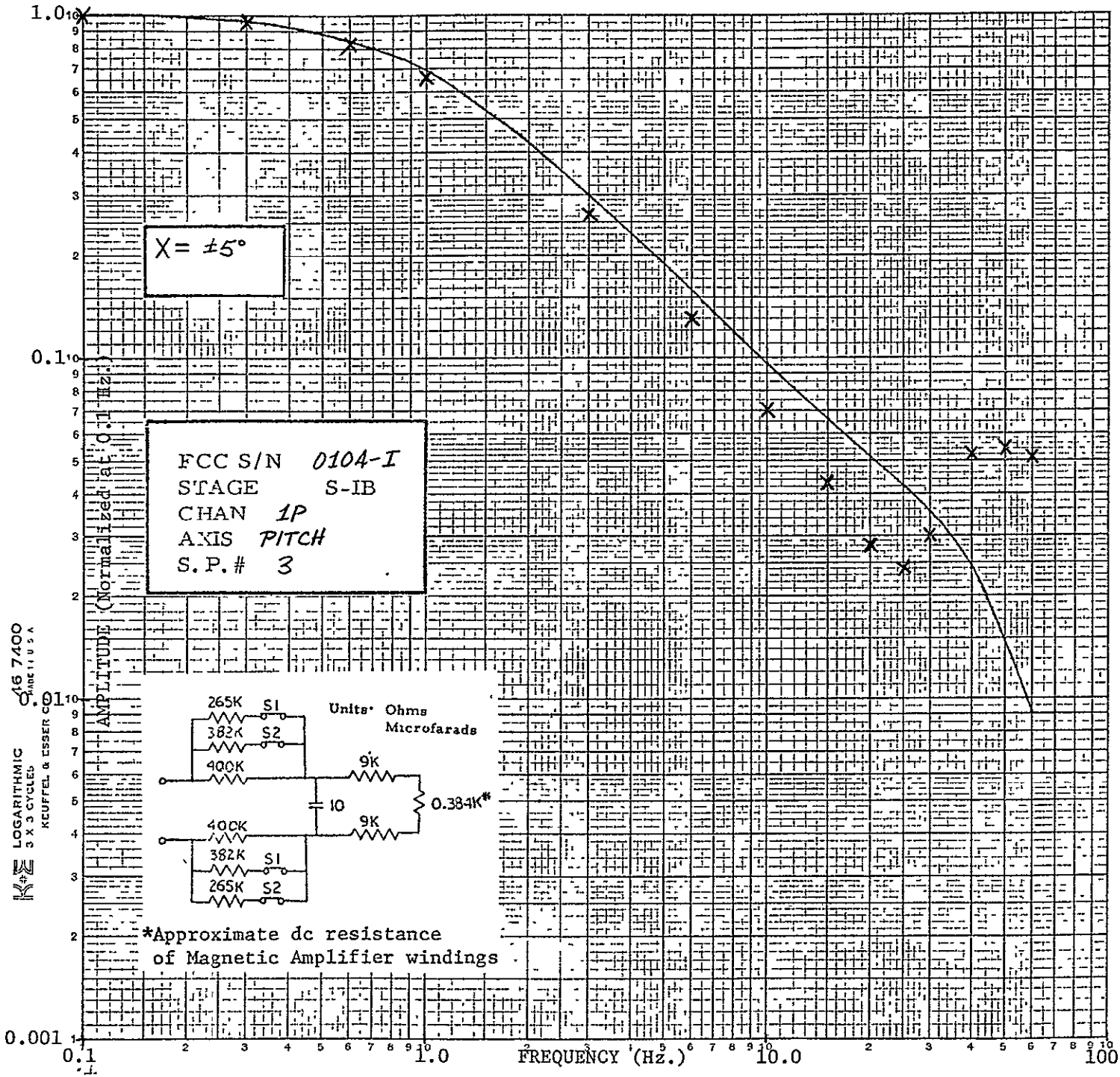

LOGARITHMIC  
3 X 3 CYCLES  
KEUFFEL & ESSER CO.  
16 7400  
MADE IN U.S.A.

ORIGINAL PAGE IS  
OF POOR QUALITY

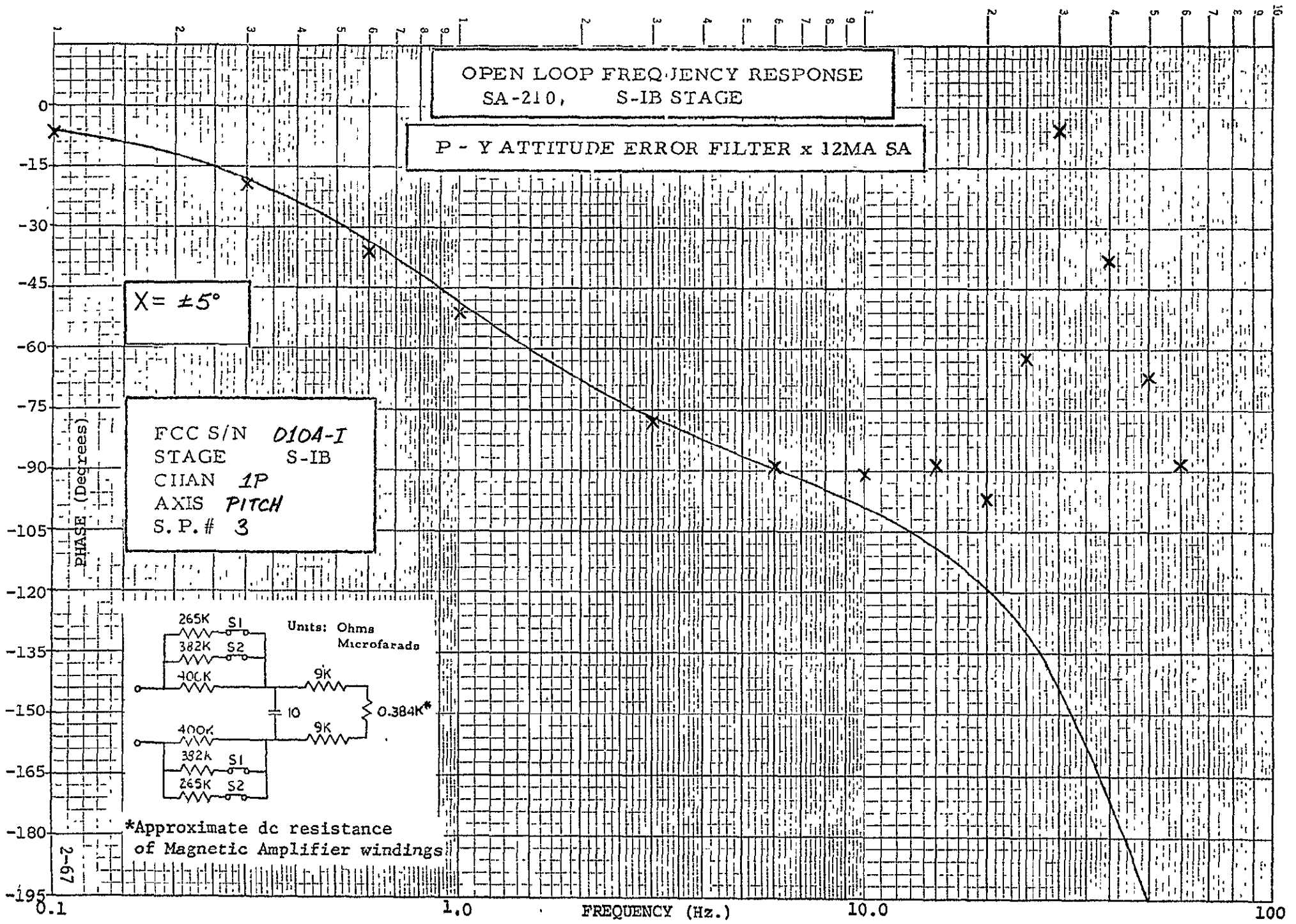

OPEN LOOP FREQUENCY RESPONSE  
SA-210 S-IB STAGE

P - Y ATTITUDE ERROR FILTER x 12MA SA

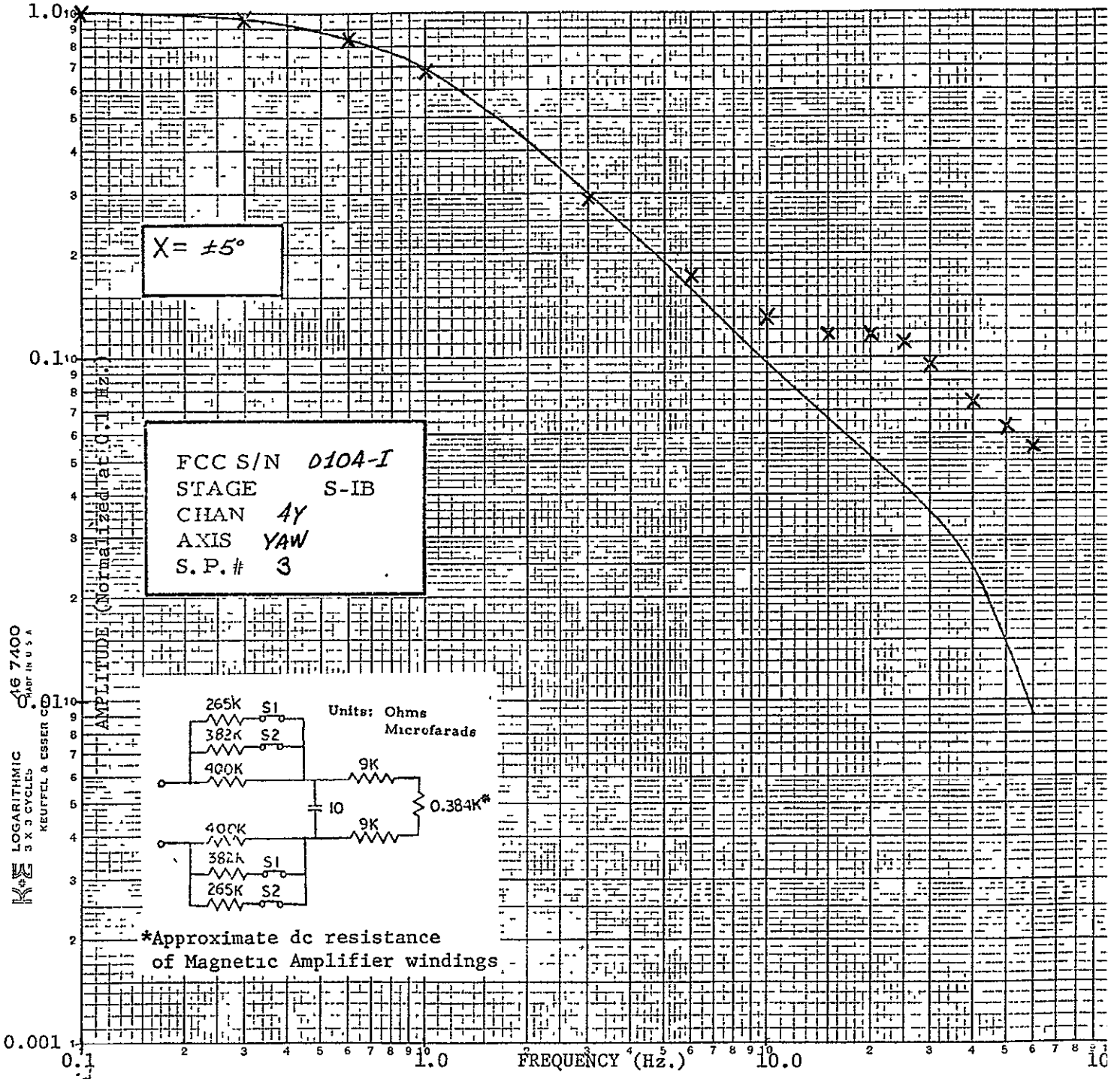

LOGARITHMIC  
3 X 3 CYCLES  
KEUFFEL & ESSER CO.  
16 7400  
MADE IN U.S.A.

ORIGINAL PAGE IS  
OF POOR QUALITY

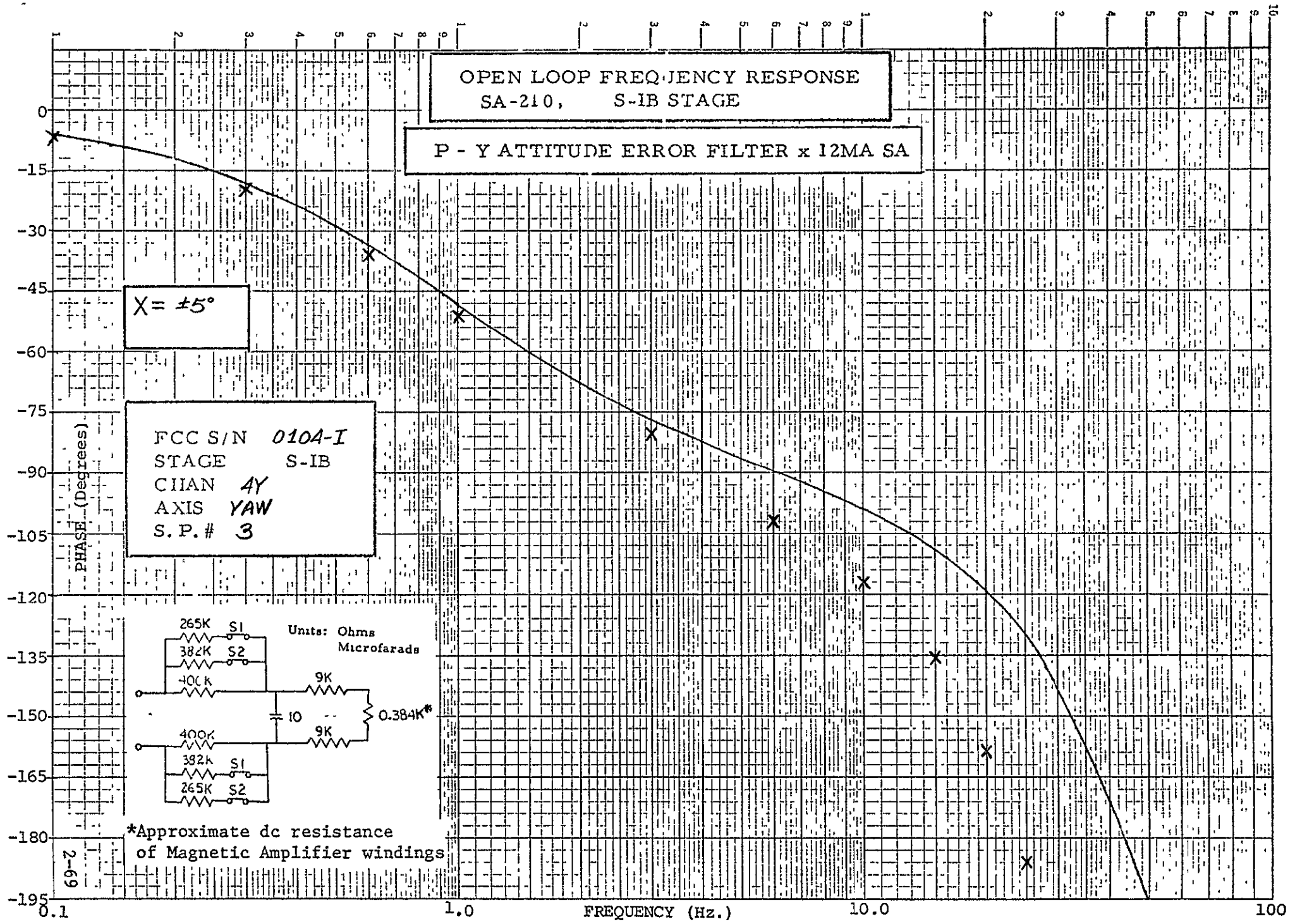

OPEN LOOP FREQUENCY RESPONSE  
SA-210, S-IB STAGE

ROLL ATTITUDE ERROR FILTER x 12MA SA

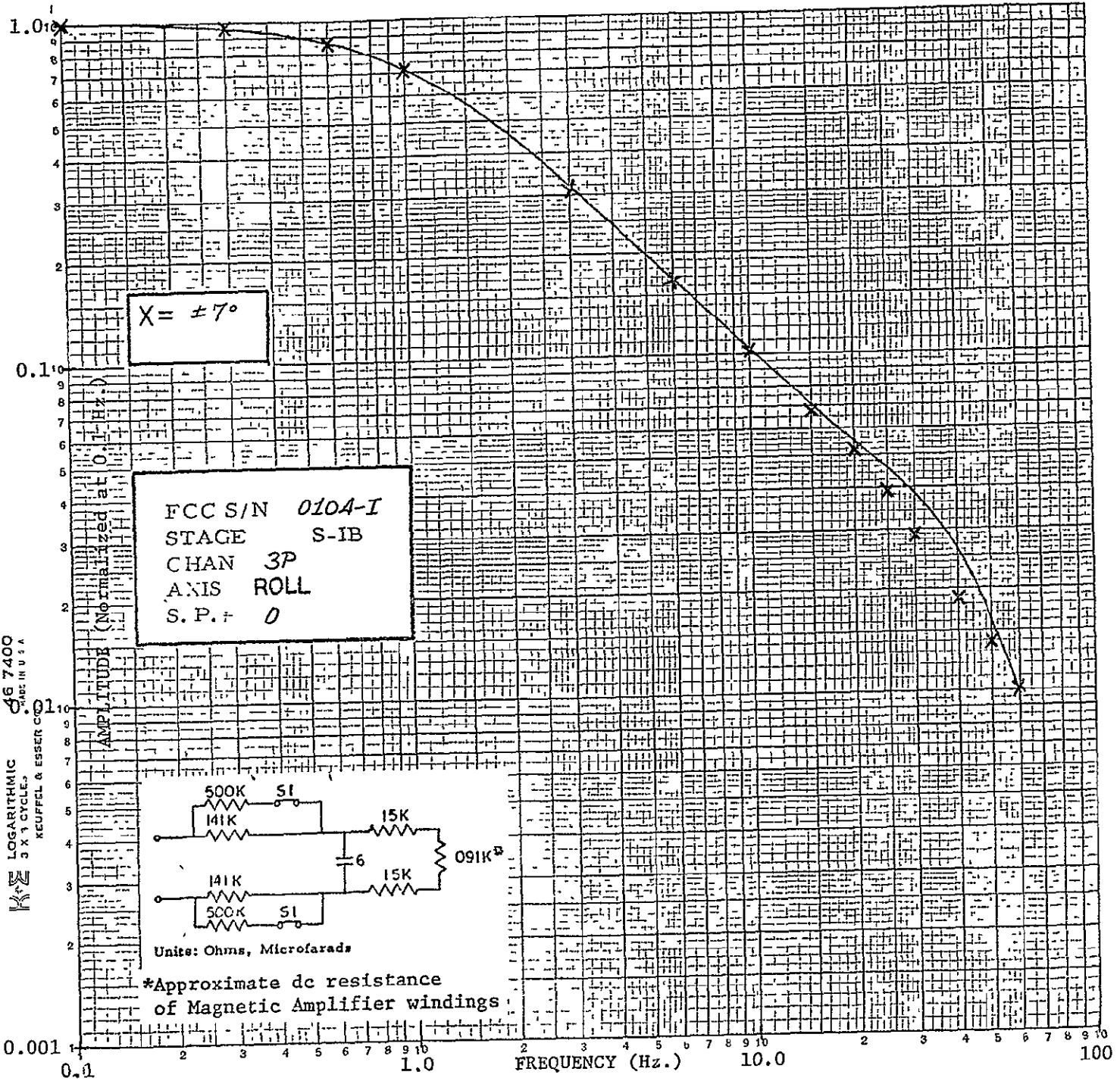

KEUFELE & ESSER CO.  
 LOGARITHMIC  
 3 X 1 CYCLE  
 MADE IN U.S.A.  
 67400

ORIGINAL PAGE IS  
OF POOR QUALITY

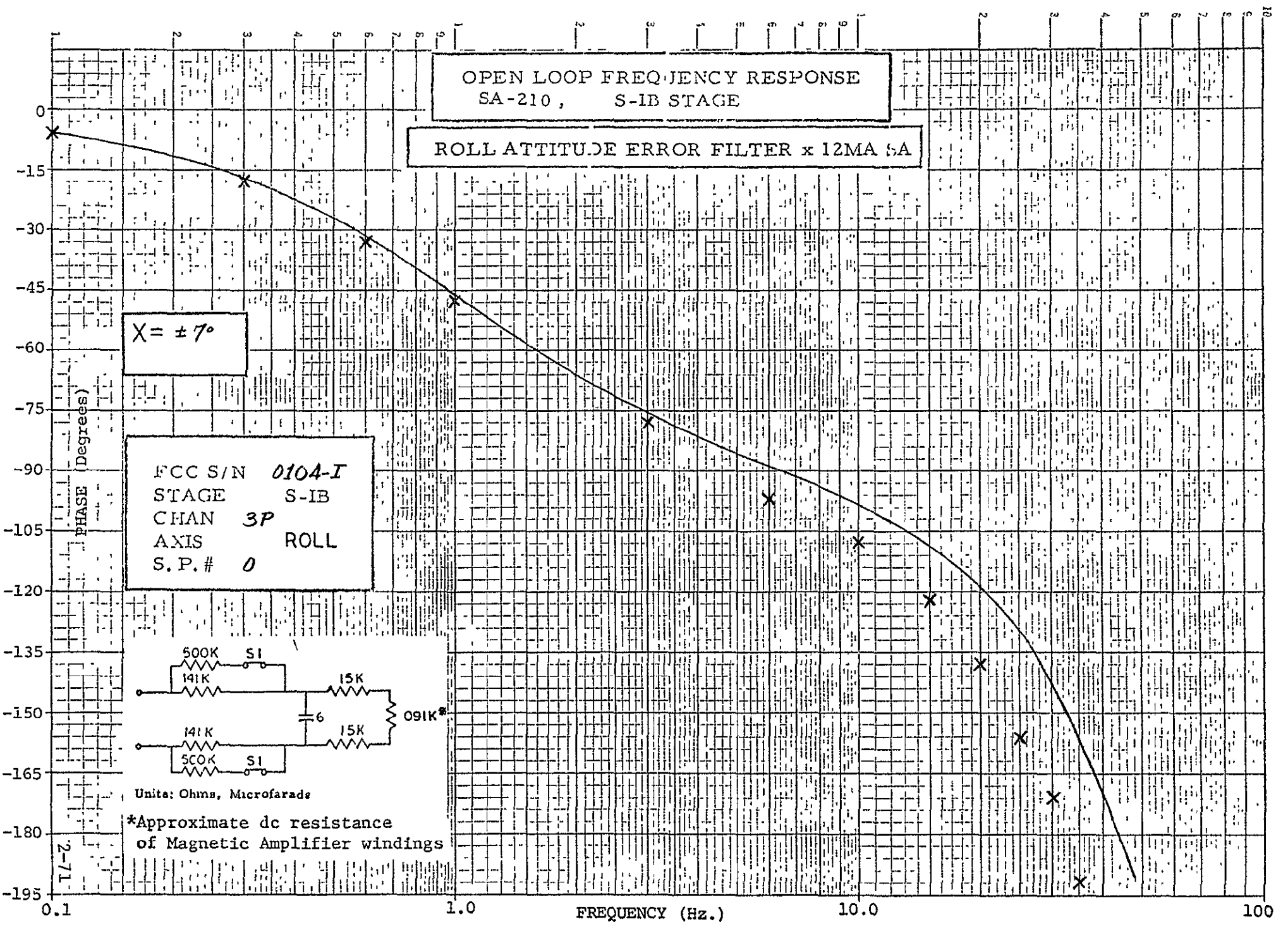

2-71



OPEN LOOP FREQUENCY RESPONSE  
SA-210, S-1B STAGE

ROLL ATTITUDE ERROR FILTER x 12MA SA

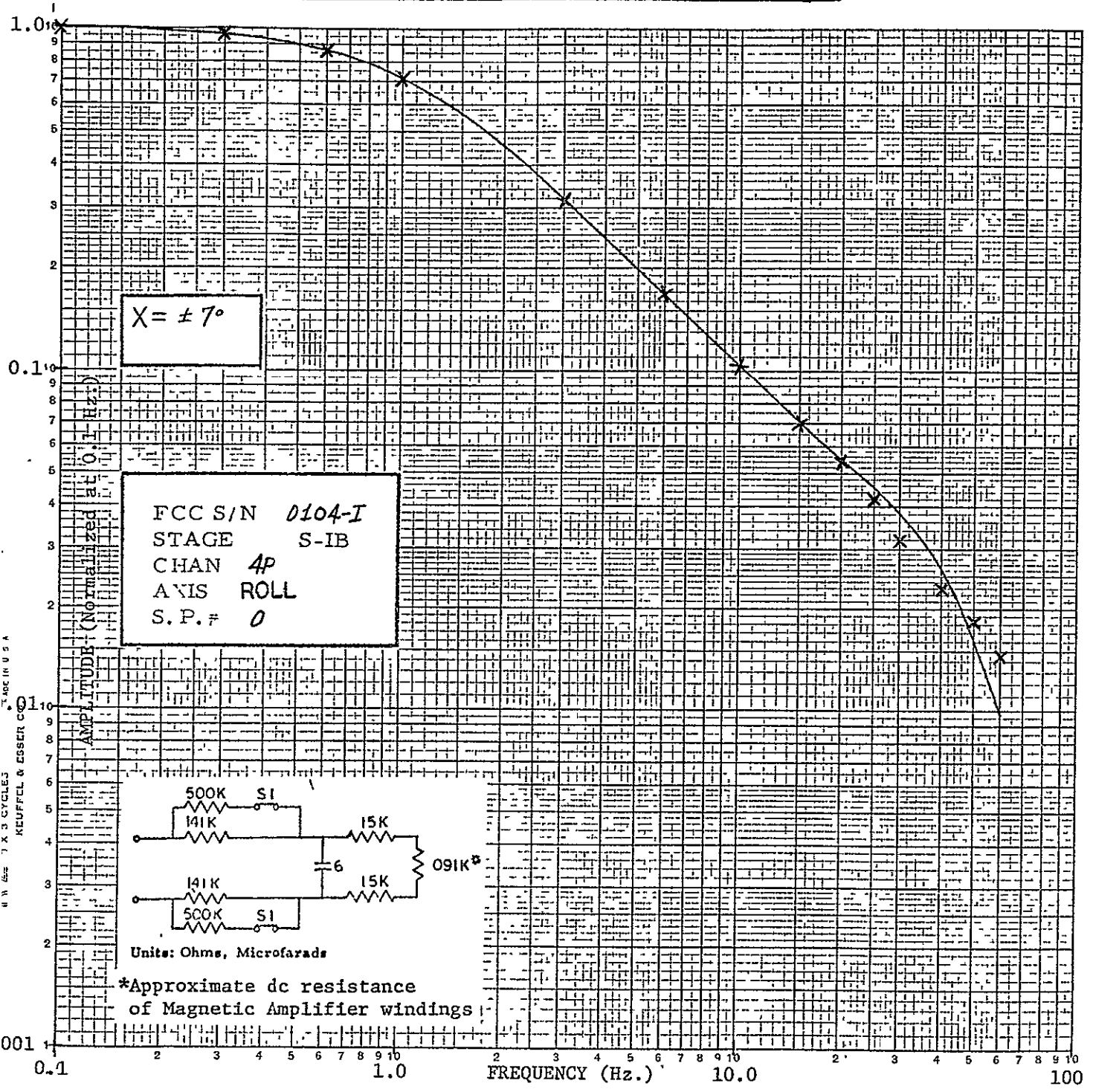

ORIGINAL PAGE IS  
OF POOR QUALITY

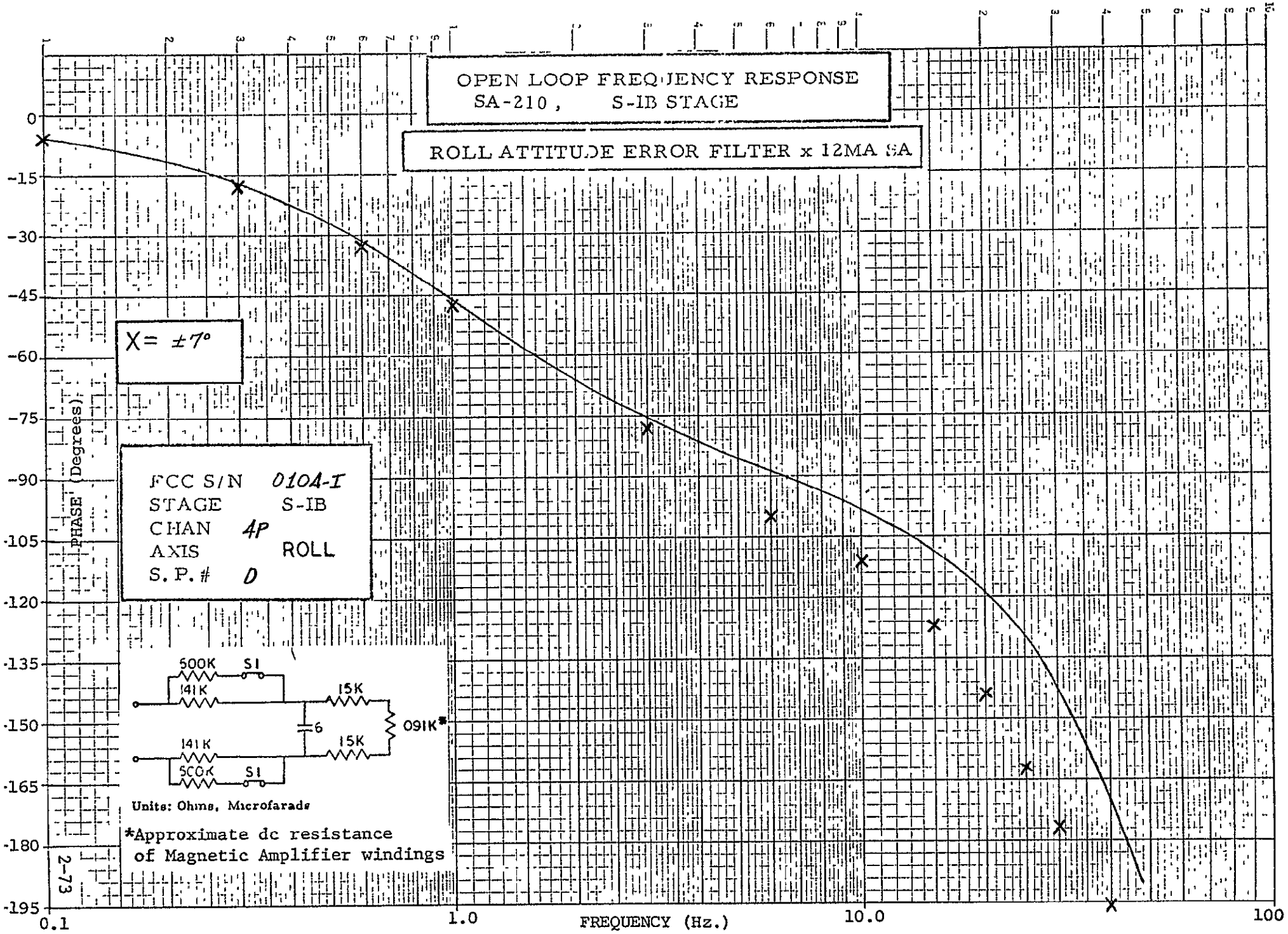

OPEN LOOP FREQUENCY RESPONSE  
SA-210, S-1B STAGE

ROLL ATTITUDE ERROR FILTER x 12MA SA

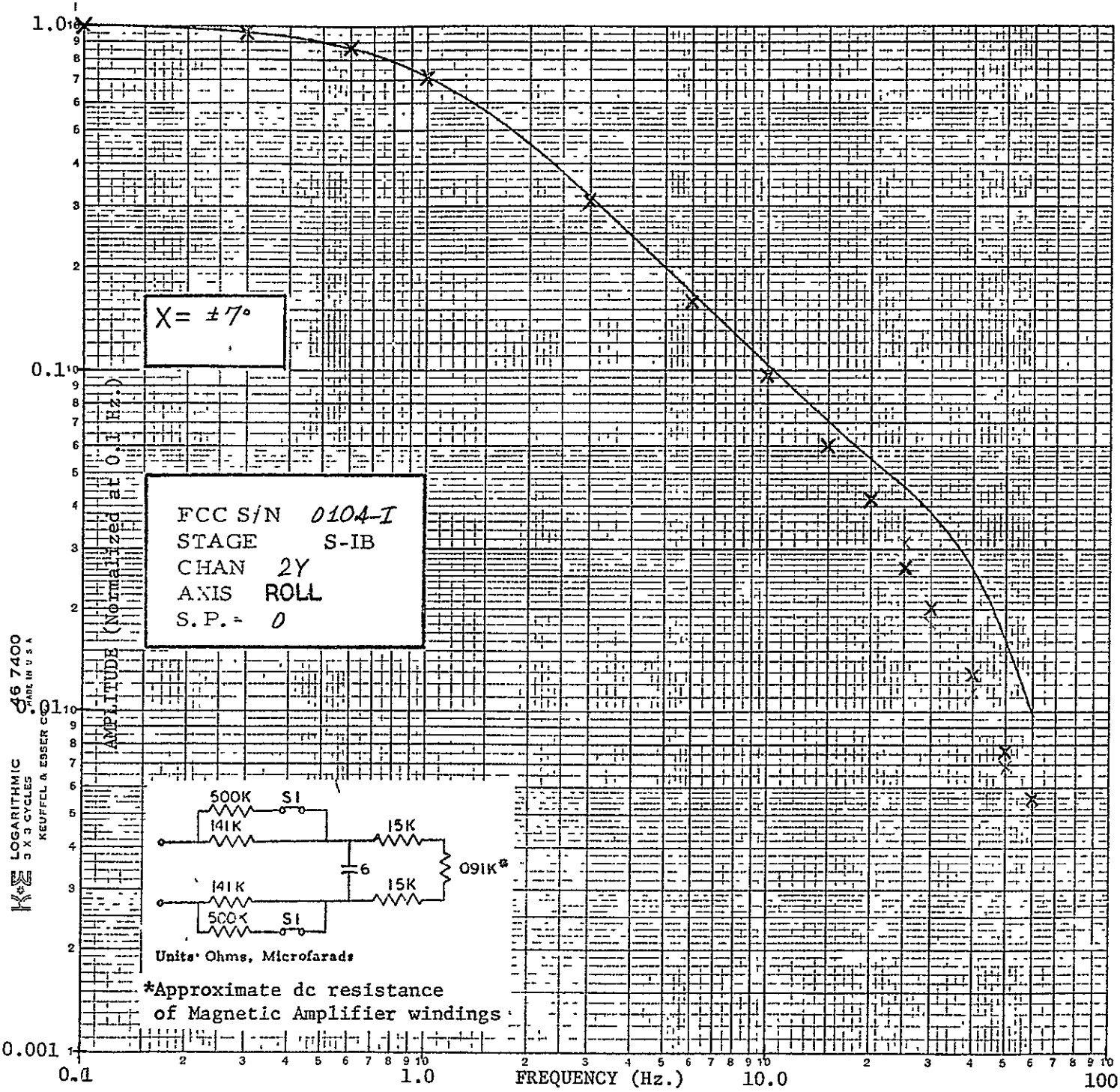

LOGARITHMIC  
3 X 3 CYCLES  
KEUFFEL & ESSER CO.  
46 7400  
MADE IN U.S.A.

ORIGINAL PAGE IS  
OF POOR QUALITY

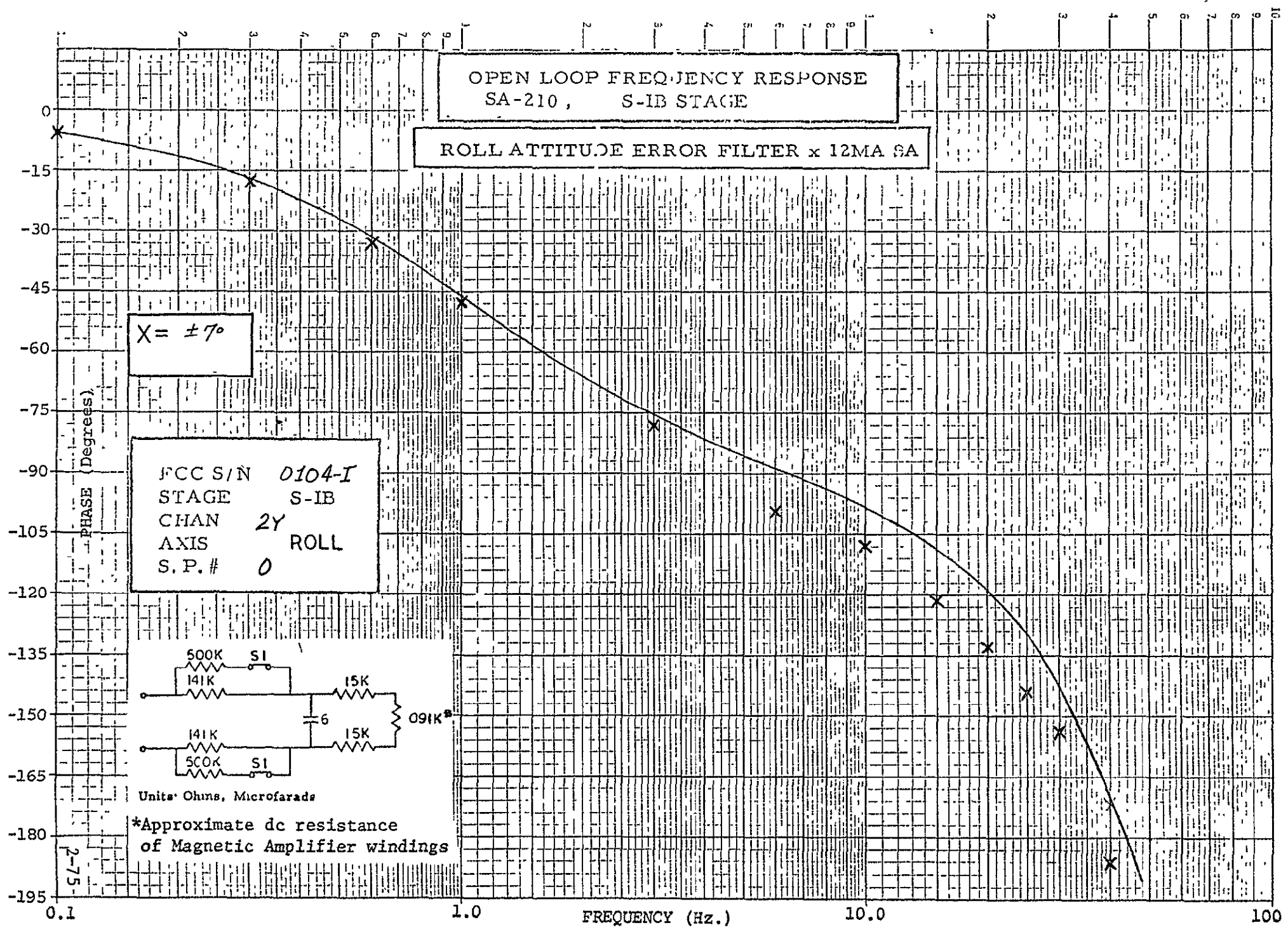

OPEN LOOP FREQUENCY RESPONSE  
SA-210, S-1B STAGE

ROLL ATTITUDE ERROR FILTER x 12MA SA

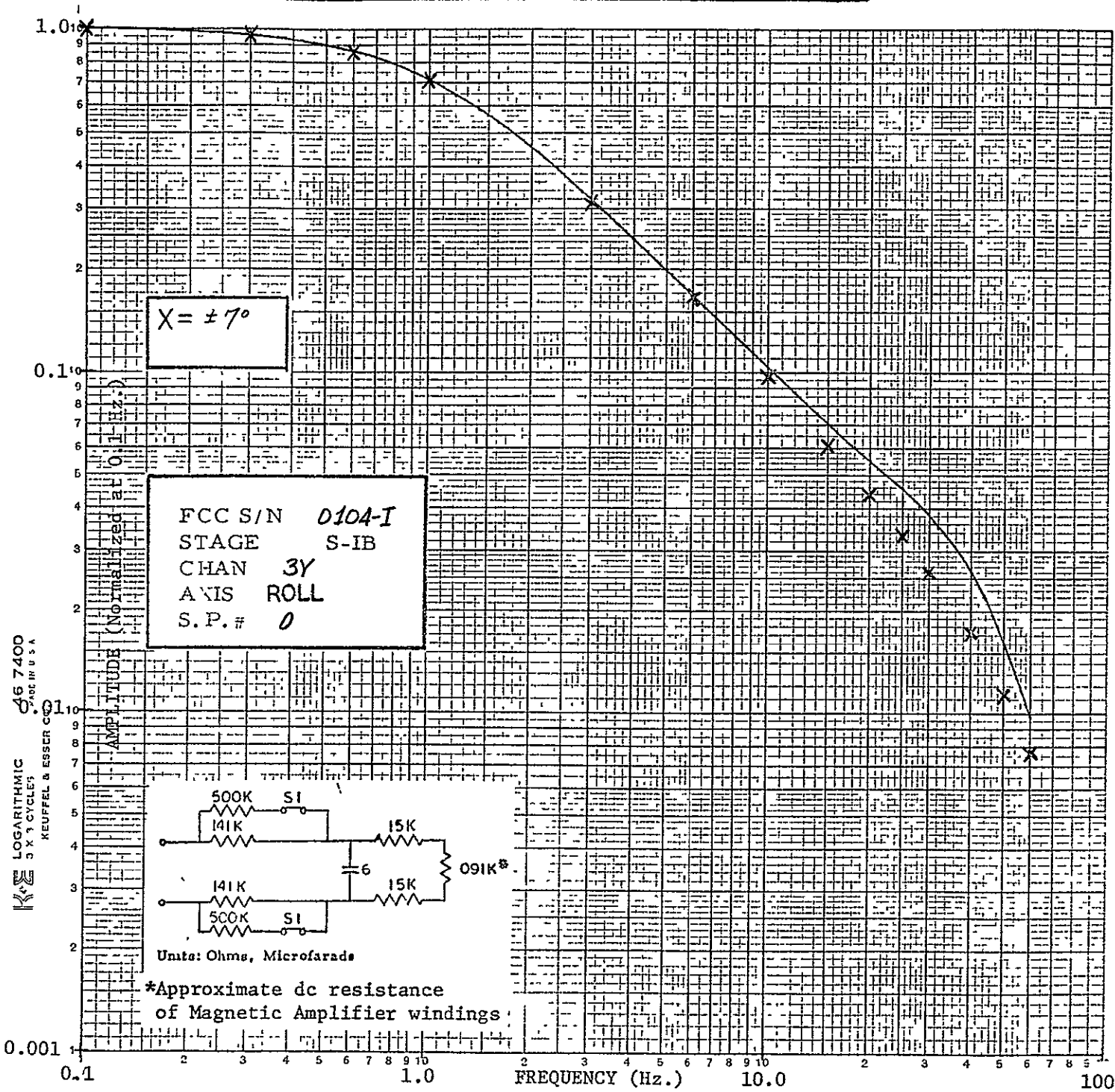

ORIGINAL PAGE IS  
OF POOR QUALITY

OPEN LOOP FREQUENCY RESPONSE  
SA-210, S-IB STAGE

ROLL ATTITUDE ERROR FILTER x 12MA SA

$\chi = \pm 7^\circ$

FCC S/N D104-I  
STAGE S-IB  
CHAN 3Y  
AXIS ROLL  
S.P.# 0

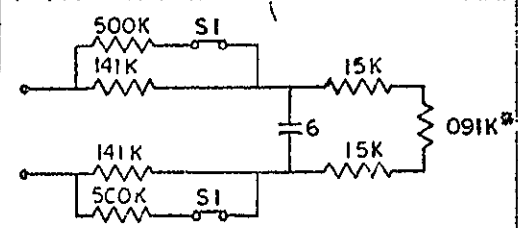

Units. Ohms, Microfarads

\*Approximate dc resistance  
of Magnetic Amplifier windings

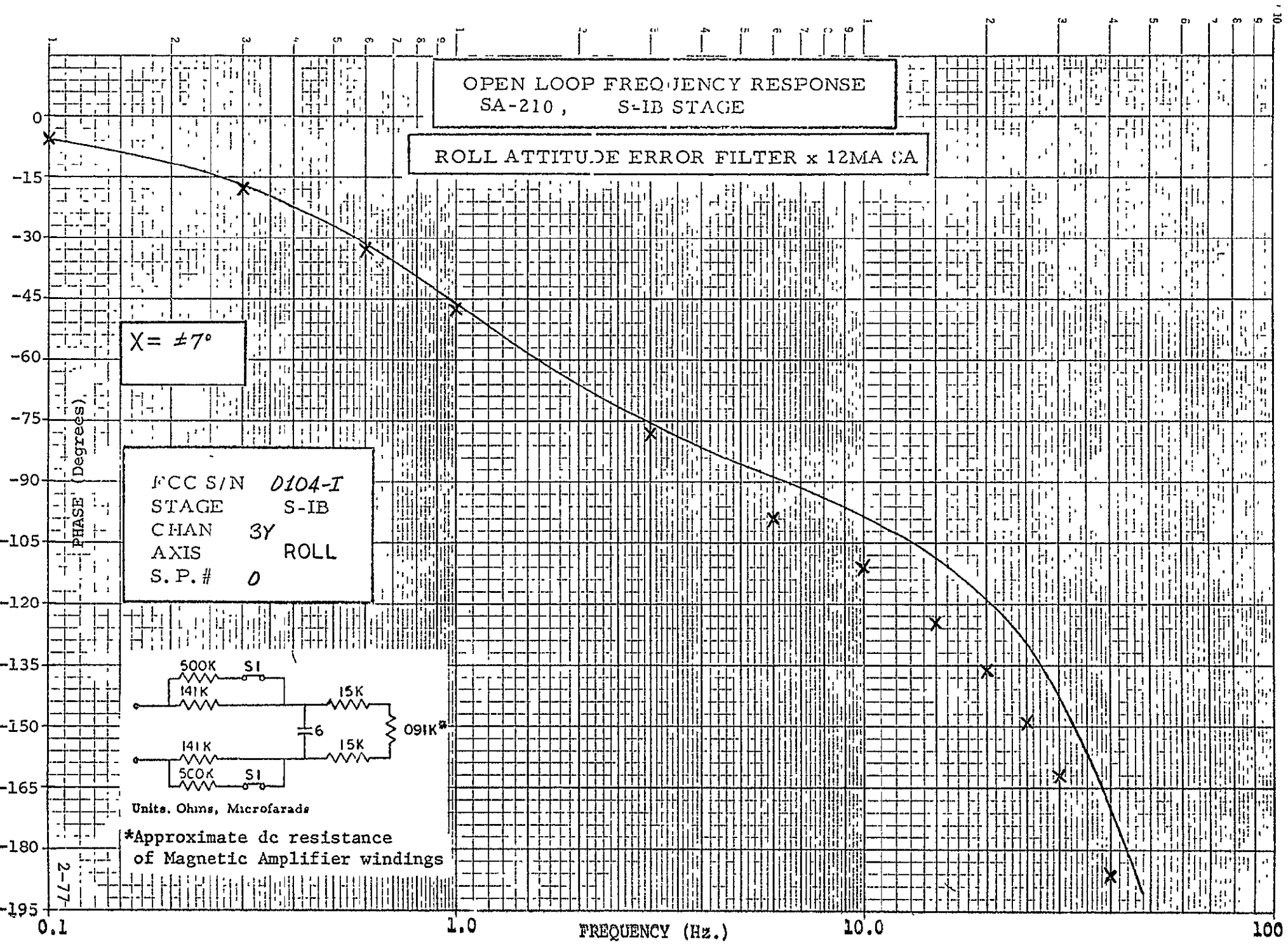

2-77

OPEN LOOP FREQUENCY RESPONSE  
SA-210, S-IB STAGE

ROLL ATTITUDE ERROR FILTER x 12MA SA

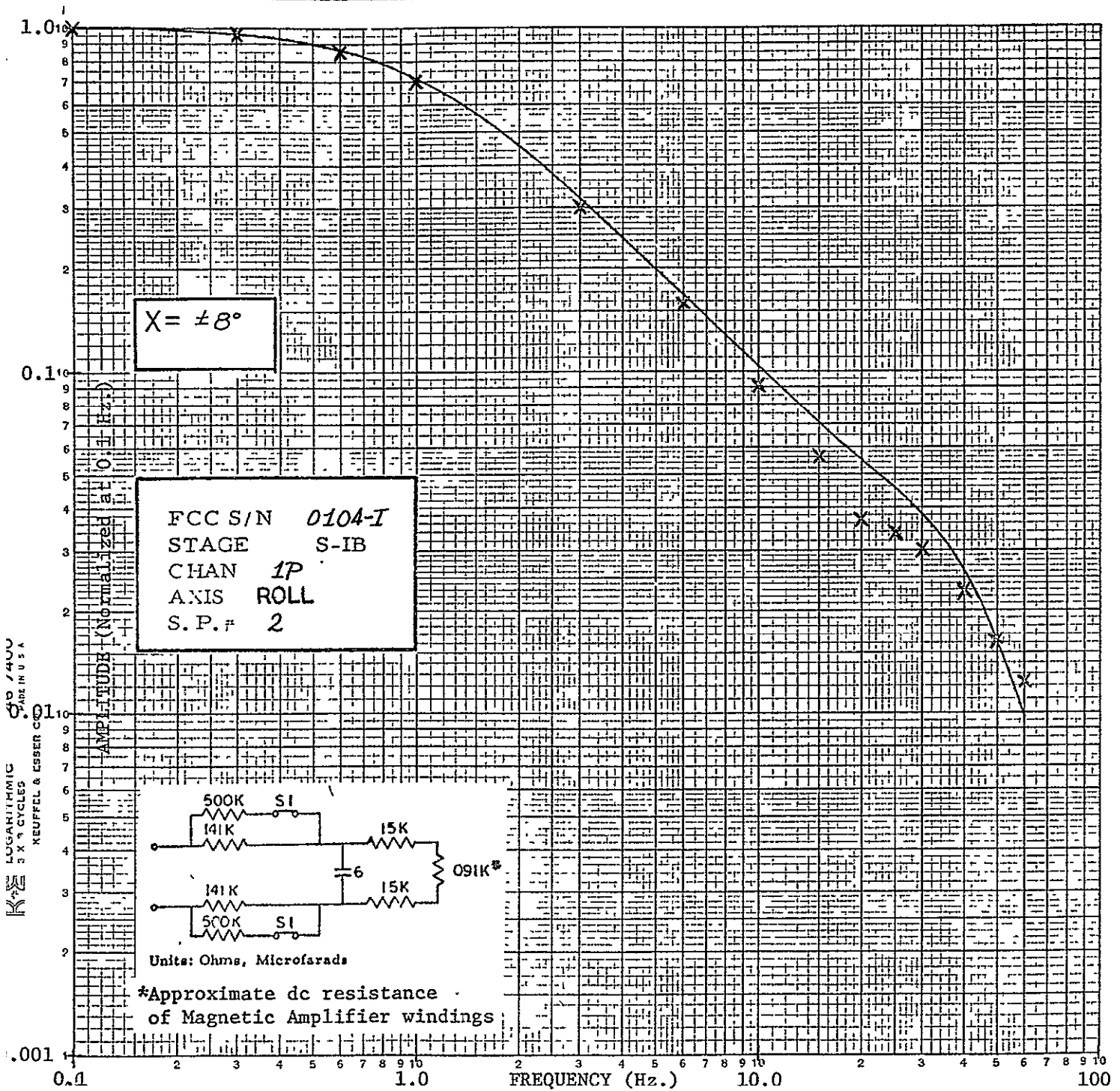

LOGARITHMIC  
 5 X 5 CYCLES  
 KEUFFEL & ESSER CO.  
 1400  
 S. W. WASHINGTON  
 PHILADELPHIA, PA. U.S.A.

ORIGINAL PAGE IS  
OF POOR QUALITY

OPEN LOOP FREQUENCY RESPONSE  
SA-210, S-IB STAGE

ROLL ATTITUDE ERROR FILTER x 12MA SA

$\chi = \pm 8^\circ$

FCC S/N 0104-I  
STAGE S-IB  
CHAN 1P  
AXIS ROLL  
S.P.# 2

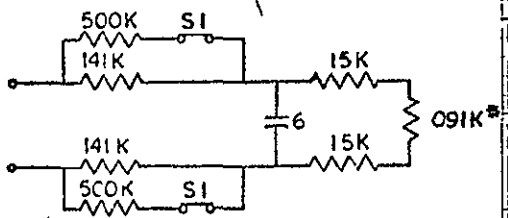

Units: Ohms, Microfarads

\*Approximate dc resistance of Magnetic Amplifier windings

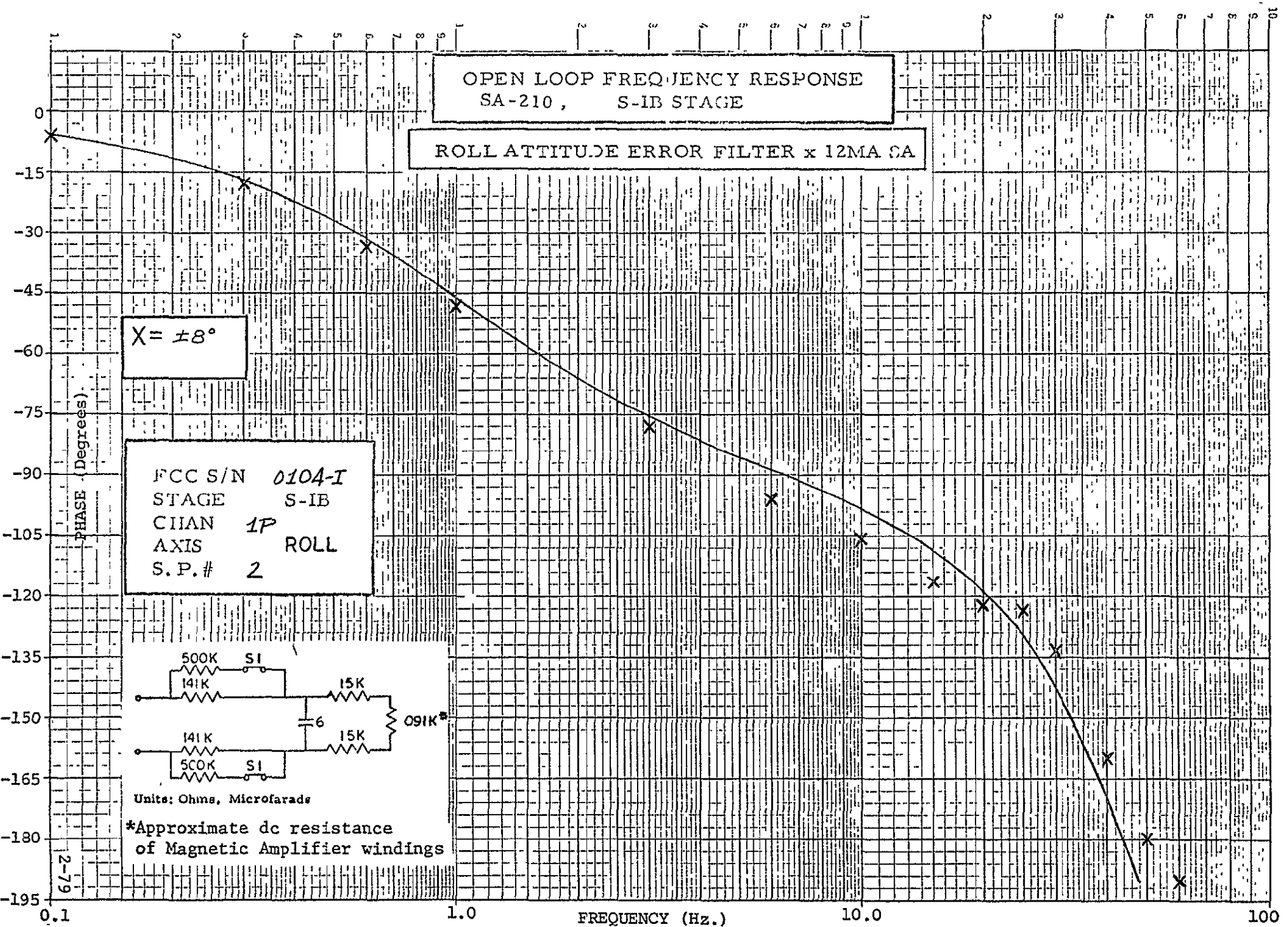

2-79



OPEN LOOP FREQUENCY RESPONSE  
SA-210, S-IB STAGE

ROLL ATTITUDE ERROR FILTER x 12MA SA

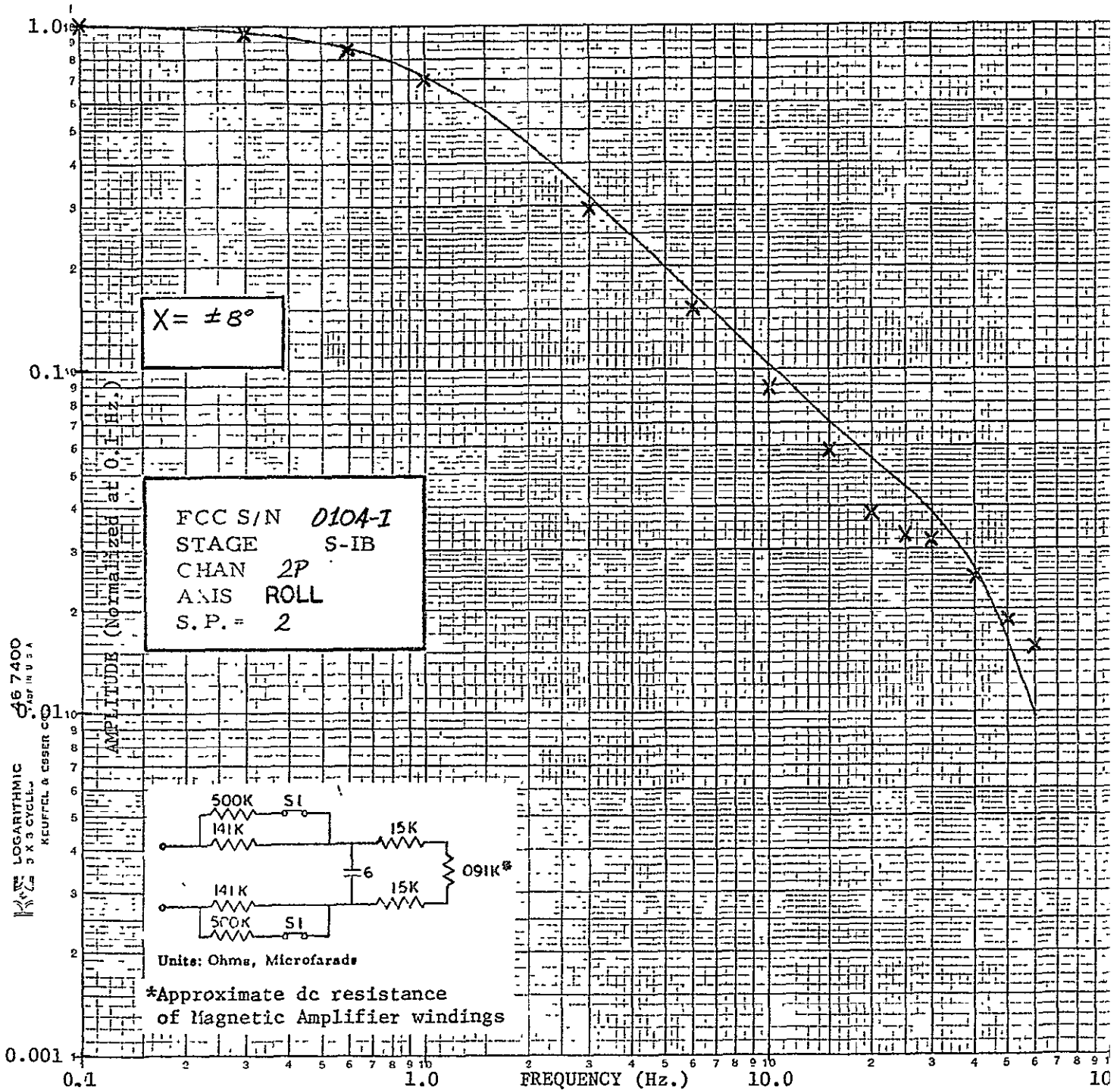

ORIGINAL PAGE IS  
OF POOR QUALITY

OPEN LOOP FREQUENCY RESPONSE  
SA-210, S-IB STAGE

ROLL ATTITUDE ERROR FILTER x 12MA SA

$X = \pm 8^\circ$

FCC S/N 0104-I  
STAGE S-IB  
CHAN 2P  
AXIS ROLL  
S.P.# 2

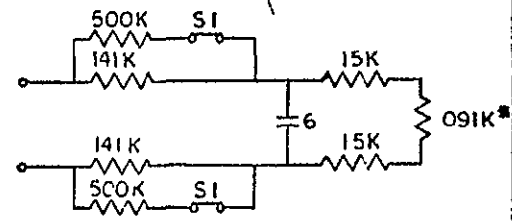

Units: Ohms, Microfarads

\*Approximate dc resistance  
of Magnetic Amplifier windings

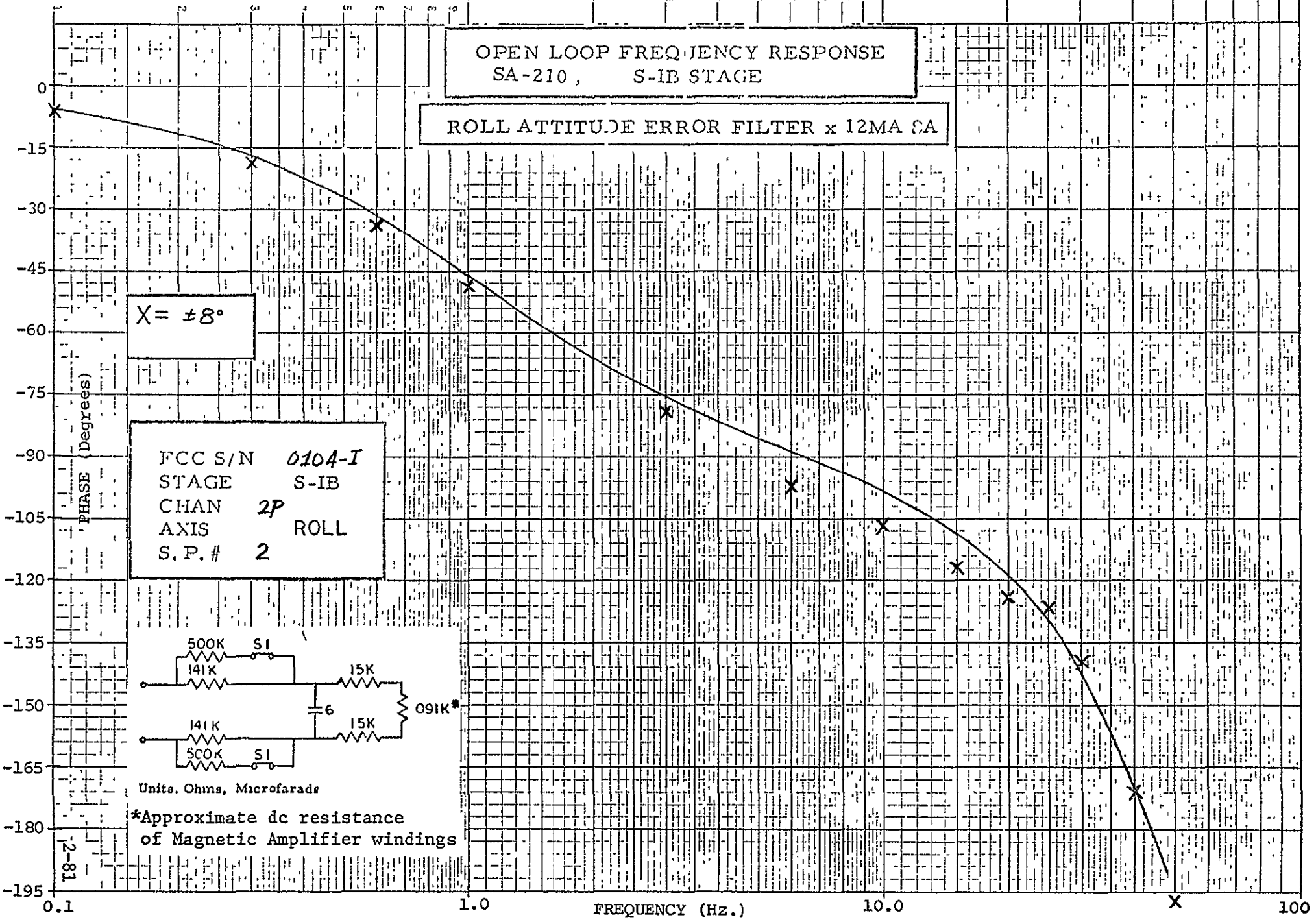

2-81

OPEN LOOP FREQUENCY RESPONSE  
SA-210, S-1B STAGE

ROLL ATTITUDE ERROR FILTER x 12MA SA

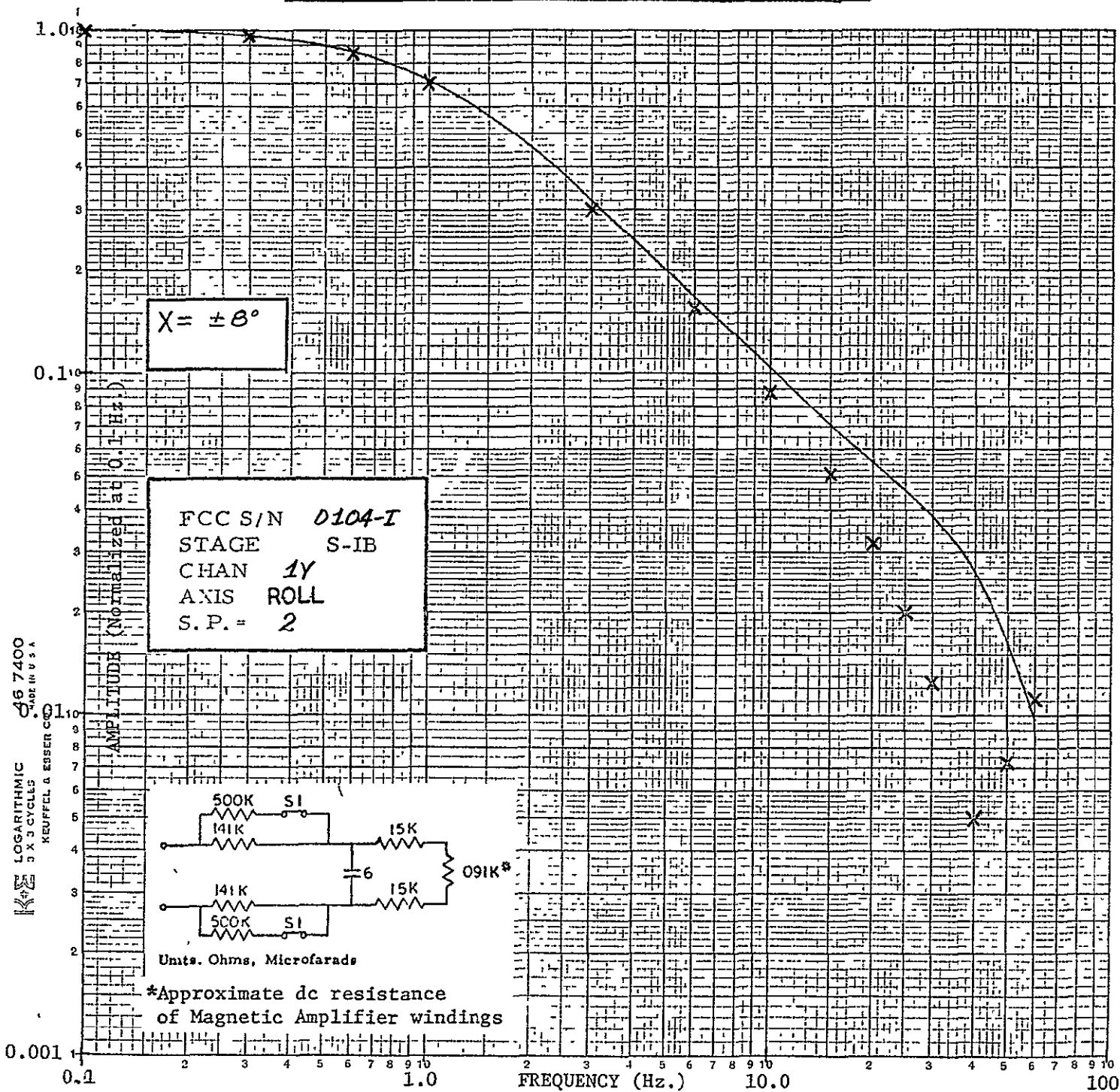

KEUFFEL & ESSER CO.  
 LOGARITHMIC  
 3 X 3 CYCLES  
 46 7400  
 MADE IN U.S.A.

ORIGINAL PAGE IS  
OF POOR QUALITY

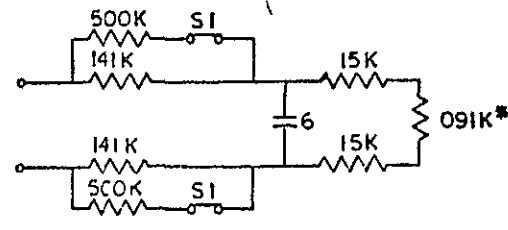
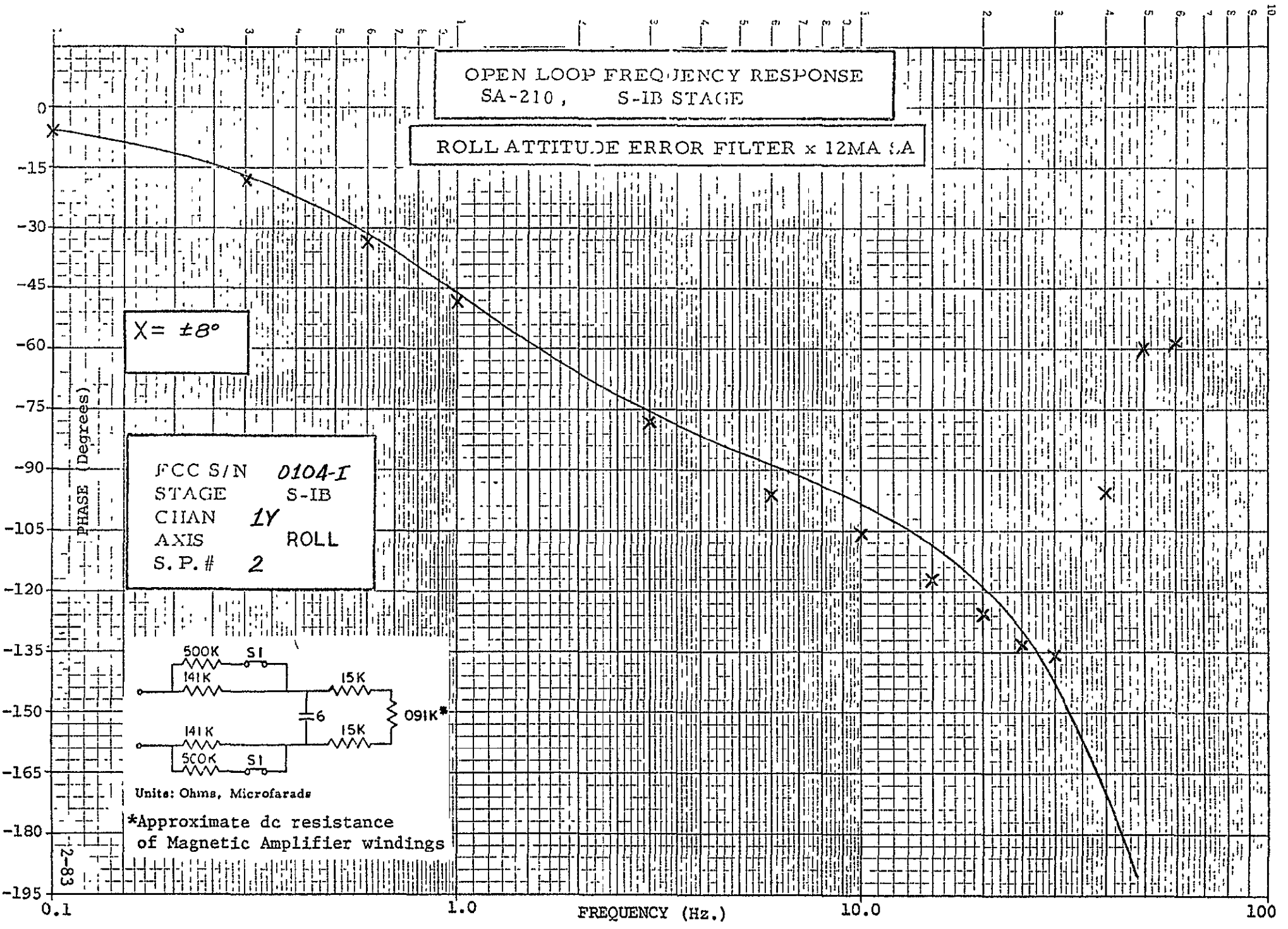

Units: Ohms, Microfarads

\*Approximate dc resistance of Magnetic Amplifier windings

58-2-83

OPEN LOOP FREQUENCY RESPONSE  
SA-210, S-IB STAGE

ROLL ATTITUDE ERROR FILTER  $\times 12MA SA$

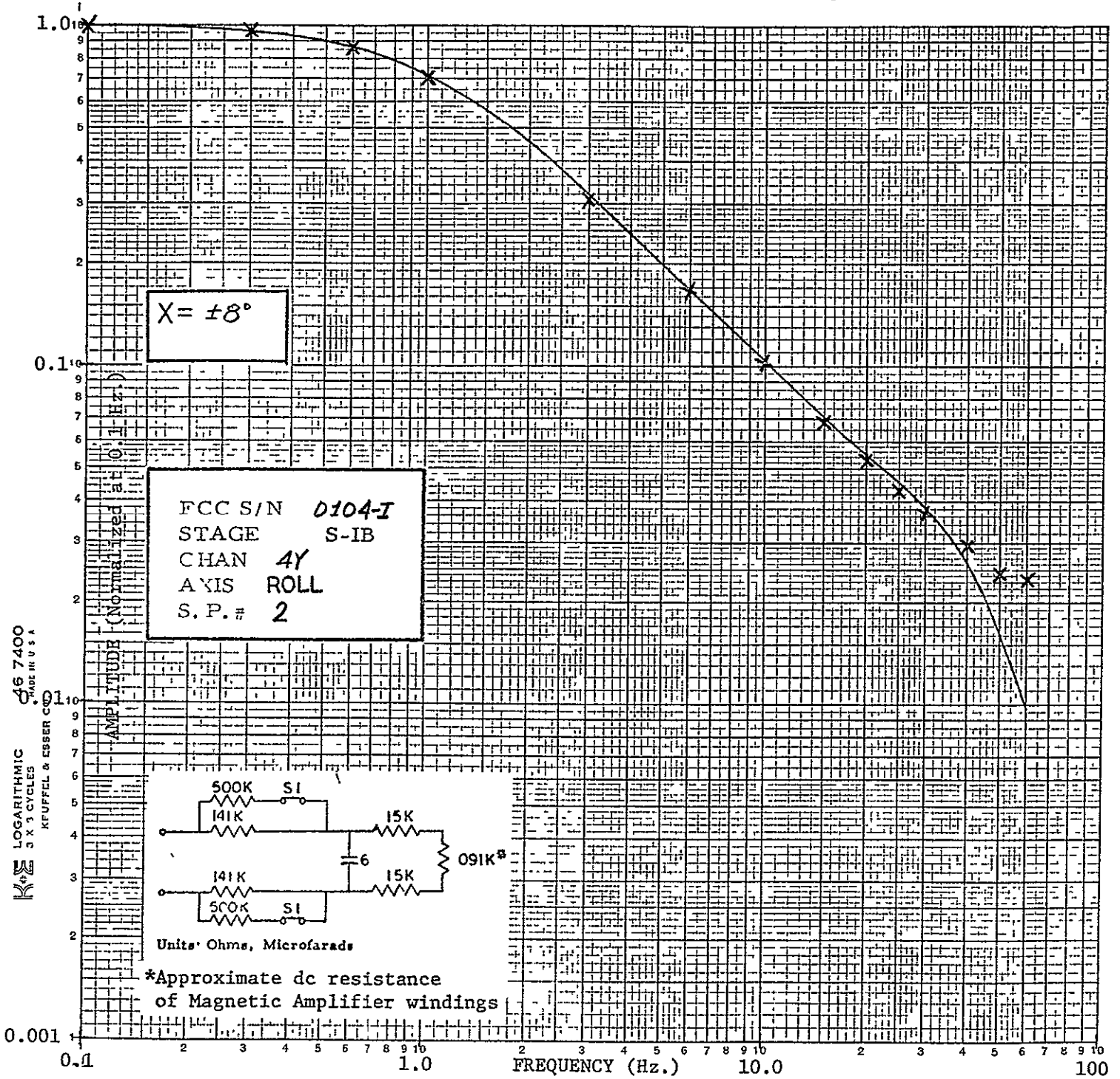

ORIGINAL PAGE IS  
OF POOR QUALITY

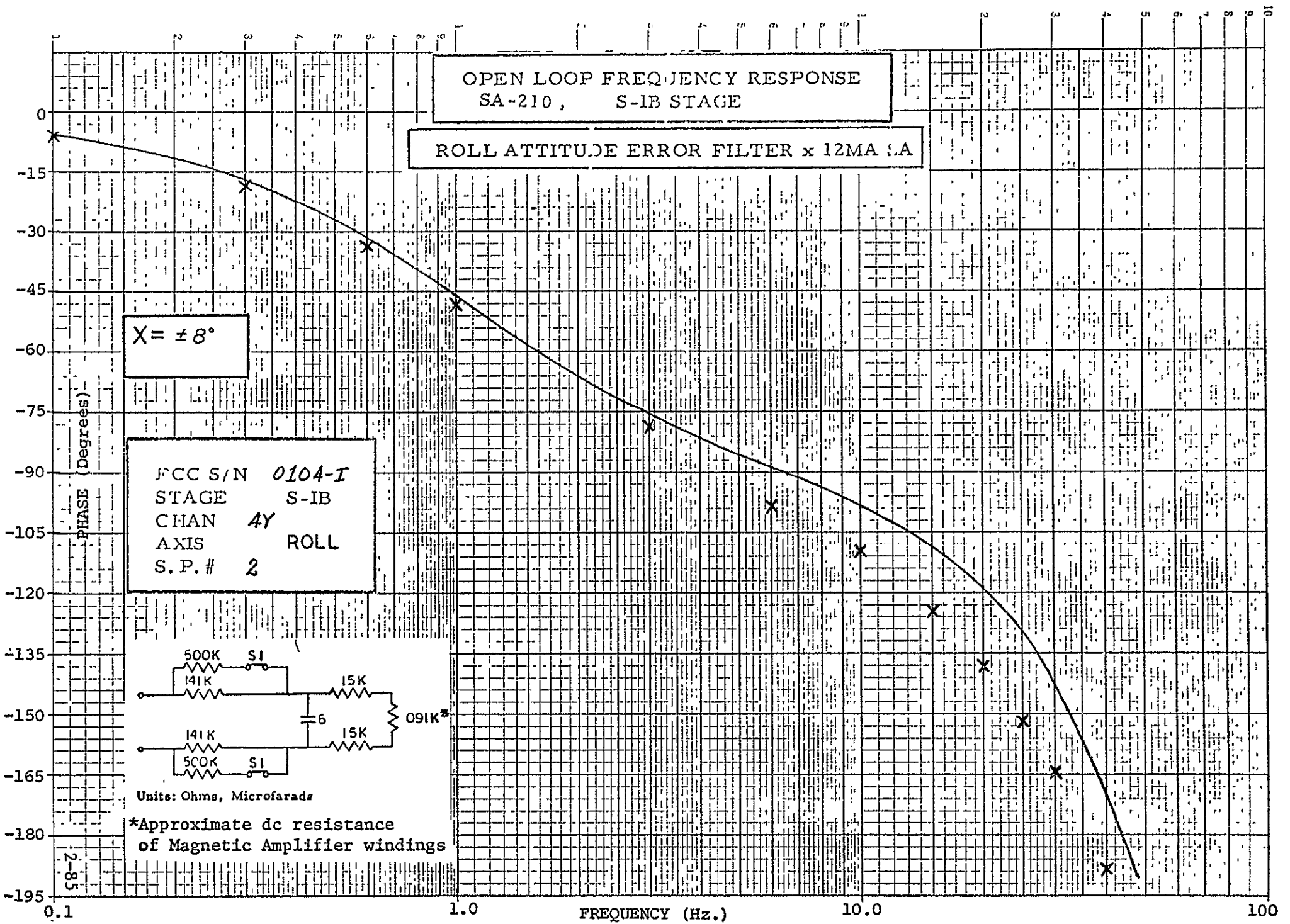

OPEN LOOP FREQUENCY RESPONSE  
SA-210, S-IB STAGE

P - Y ATTITUDE RATE FILTER x RATE GYRO/CSP x 12MA SA

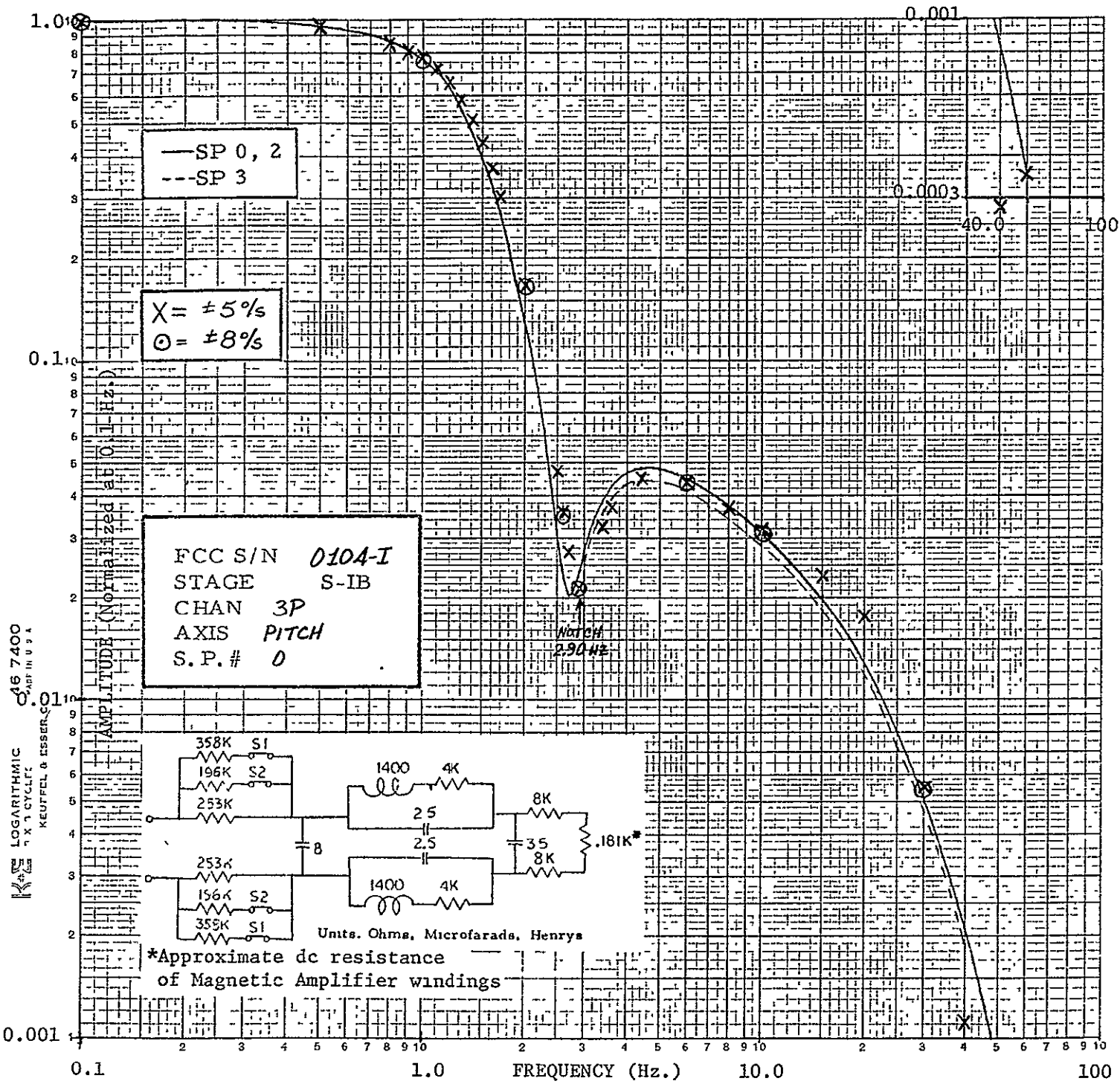

ORIGINAL PAGE IS  
OF POOR QUALITY

OPEN LOOP FREQUENCY RESPONSE  
SA-210, S-IB STAGE

P - Y ATTITUDE RATE FILTER x RATE GYRO/CSP x 12MA SA

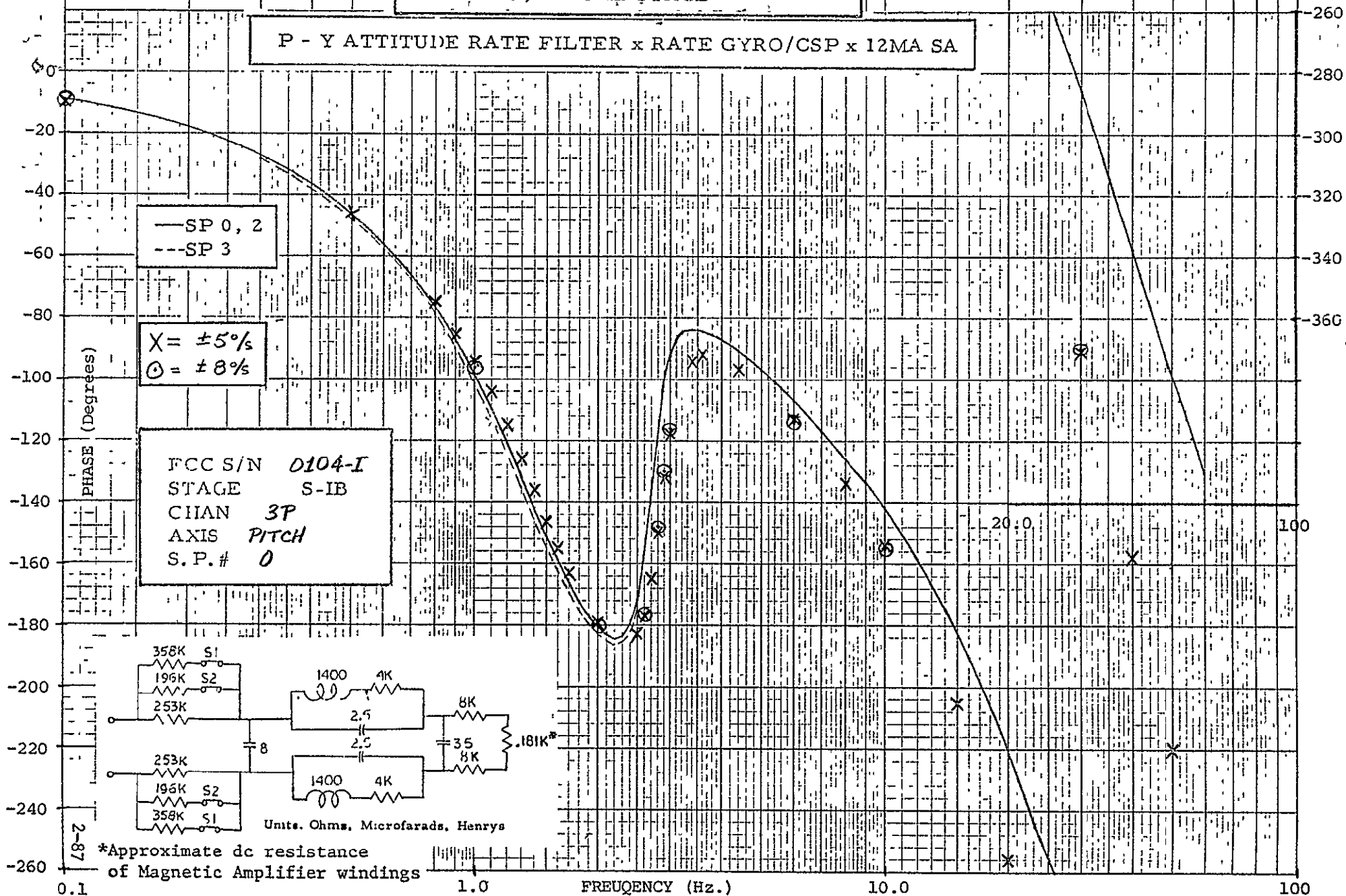

— SP 0, 2  
--- SP 3

X = ±5%  
O = ±8%

FCC S/N 0104-I  
STAGE S-IB  
CHAN 3P  
AXIS PITCH  
S.P.# 0

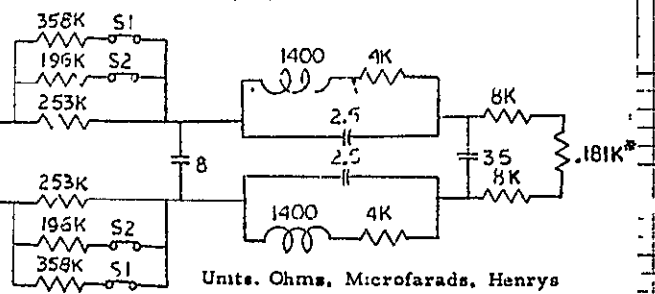

Units. Ohms, Microfarads, Henrys

\*Approximate dc resistance of Magnetic Amplifier windings

0.1 1.0 10.0 100 FREQUENCY (Hz.)



OPEN LOOP FREQUENCY RESPONSE  
SA-210, S-IB STAGE

P - Y ATTITUDE RATE FILTER x RATE GYRO/CSP x 12MA SA

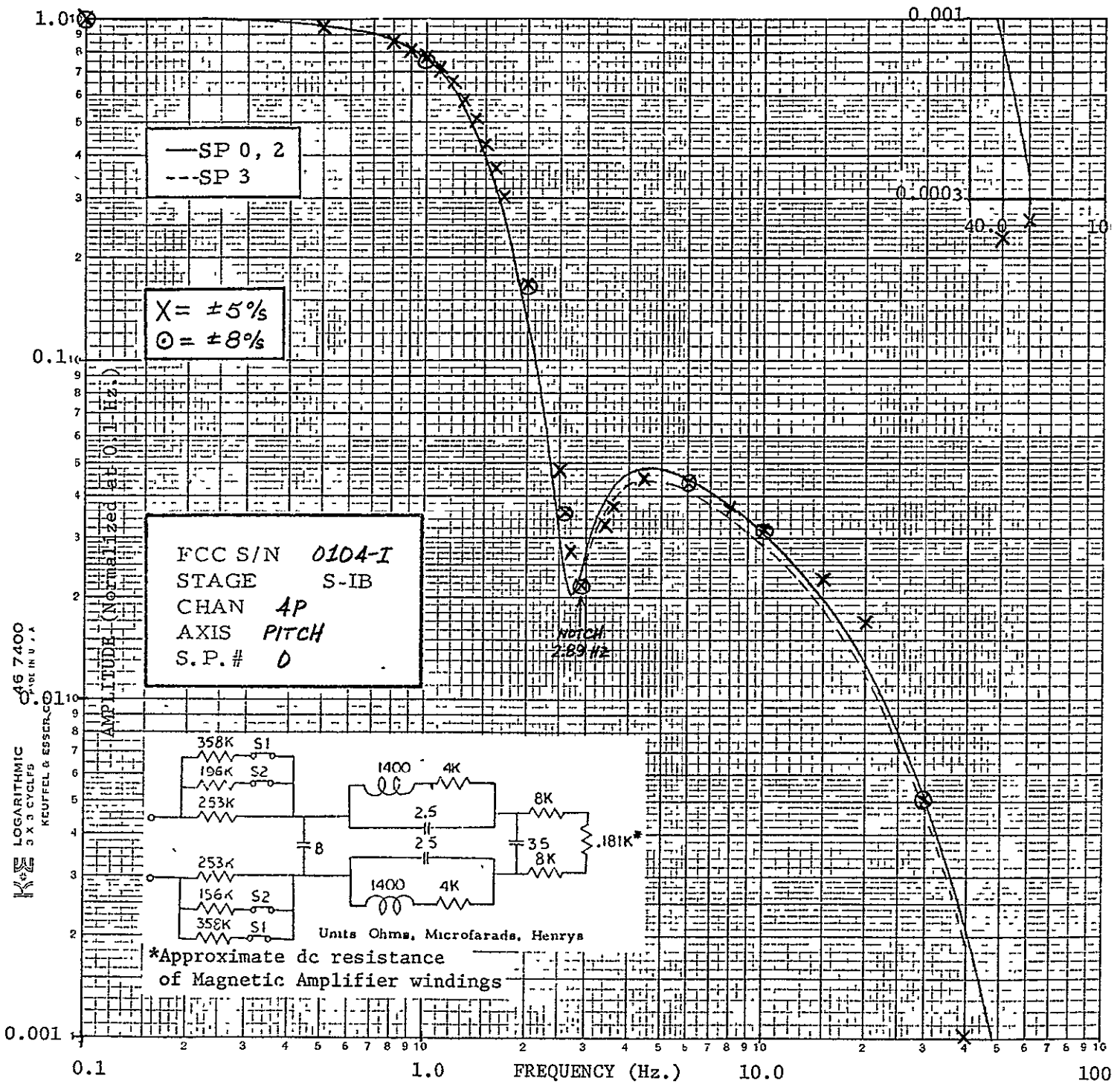

LOGARITHMIC  
3 X 3 CYCLFS  
KEUFFEL & ESSER, CO.  
MADE IN U.S.A.  
616 7400

ORIGINAL PAGE IS  
OF POOR QUALITY

C2

OPEN LOOP FREQUENCY RESPONSE  
SA-210, S-IB STAGE

P - Y ATTITUDE RATE FILTER x RATE GYRO/CSP x 12MA SA

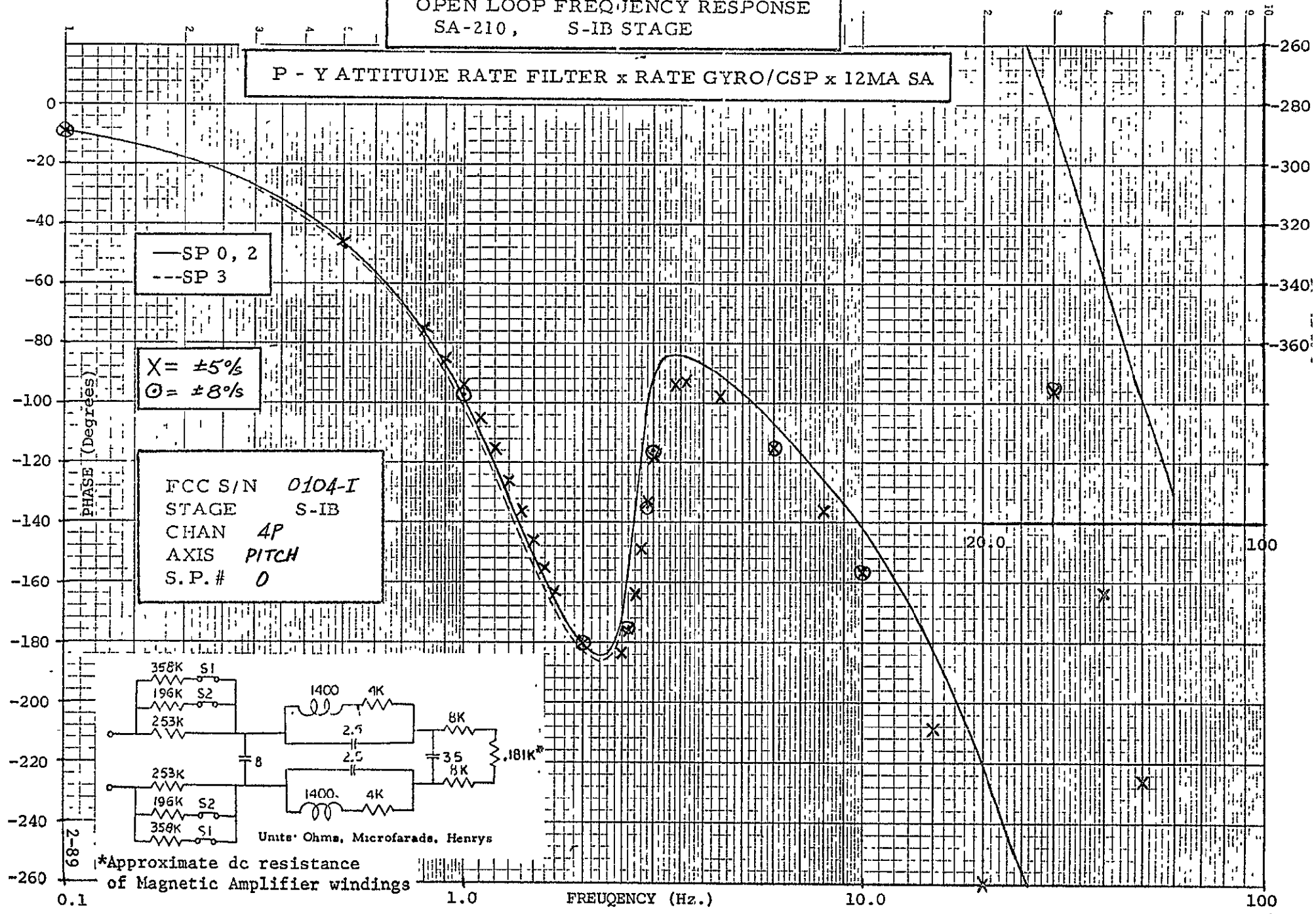

OPEN LOOP FREQUENCY RESPONSE  
SA-210, S-IB STAGE

P - Y ATTITUDE RATE FILTER x RATE GYRO/CSP x 12MA SA

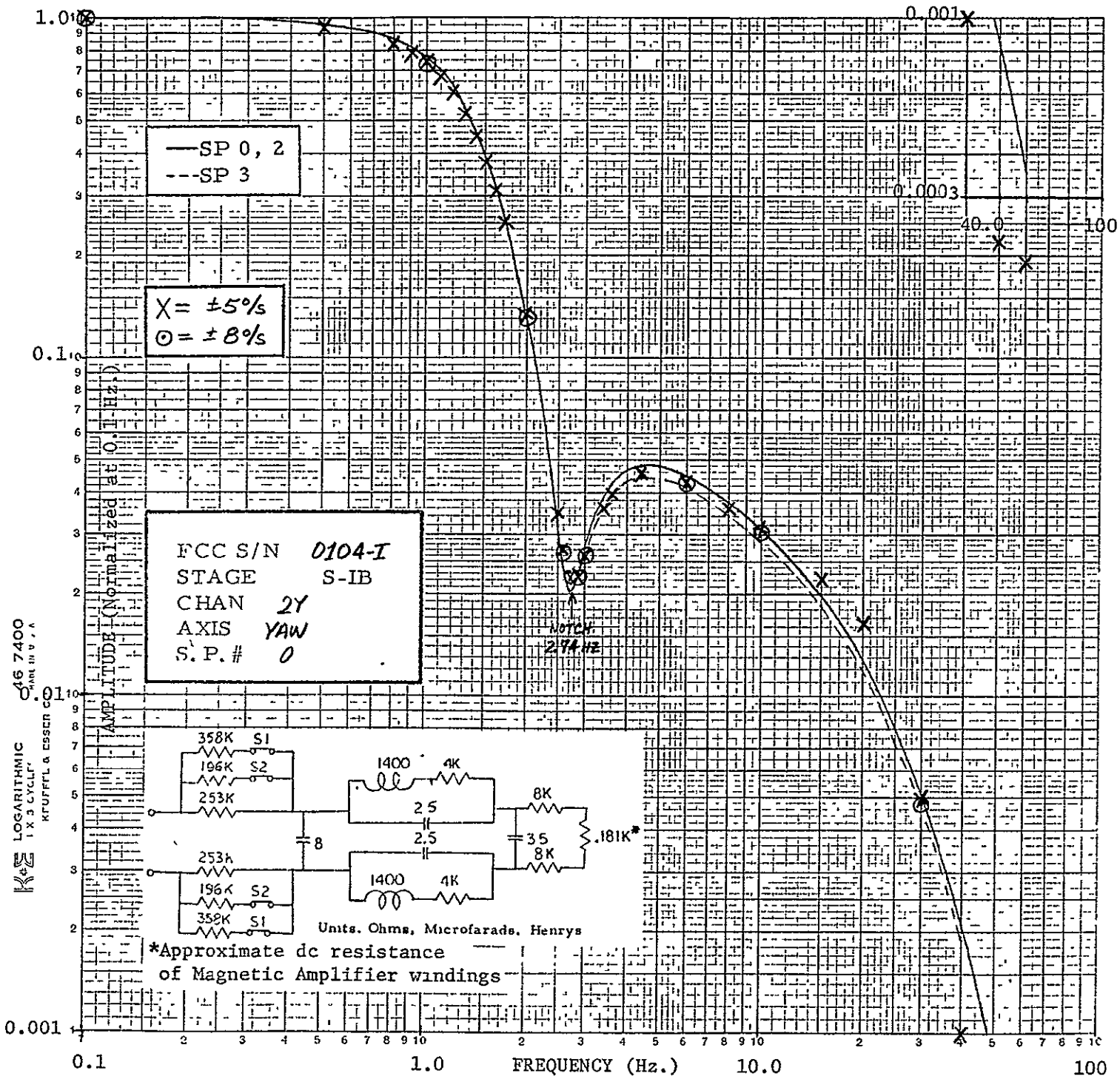

16 7400  
 LOGARITHMIC  
 1 X 3 CYCL.  
 KRUEFFEL & ESSER CO.

OPEN LOOP FREQUENCY RESPONSE  
SA-210, S-IB STAGE

P - Y ATTITUDE RATE FILTER x RATE GYRO/CSP x 12MA SA

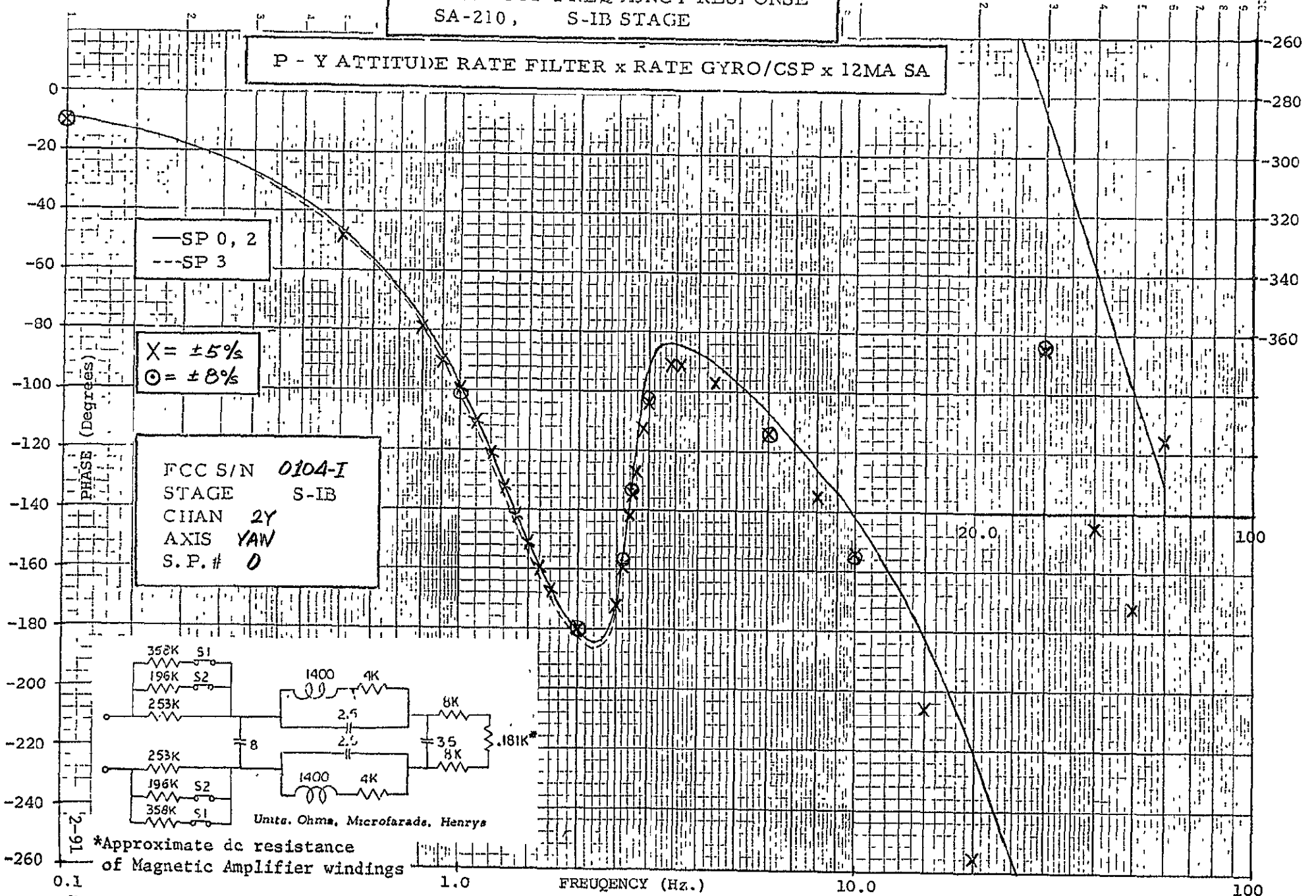

**OPEN LOOP FREQUENCY RESPONSE**  
SA-210, S-IB STAGE

**P - Y ATTITUDE RATE FILTER x RATE GYRO/CSP x 12MA SA**

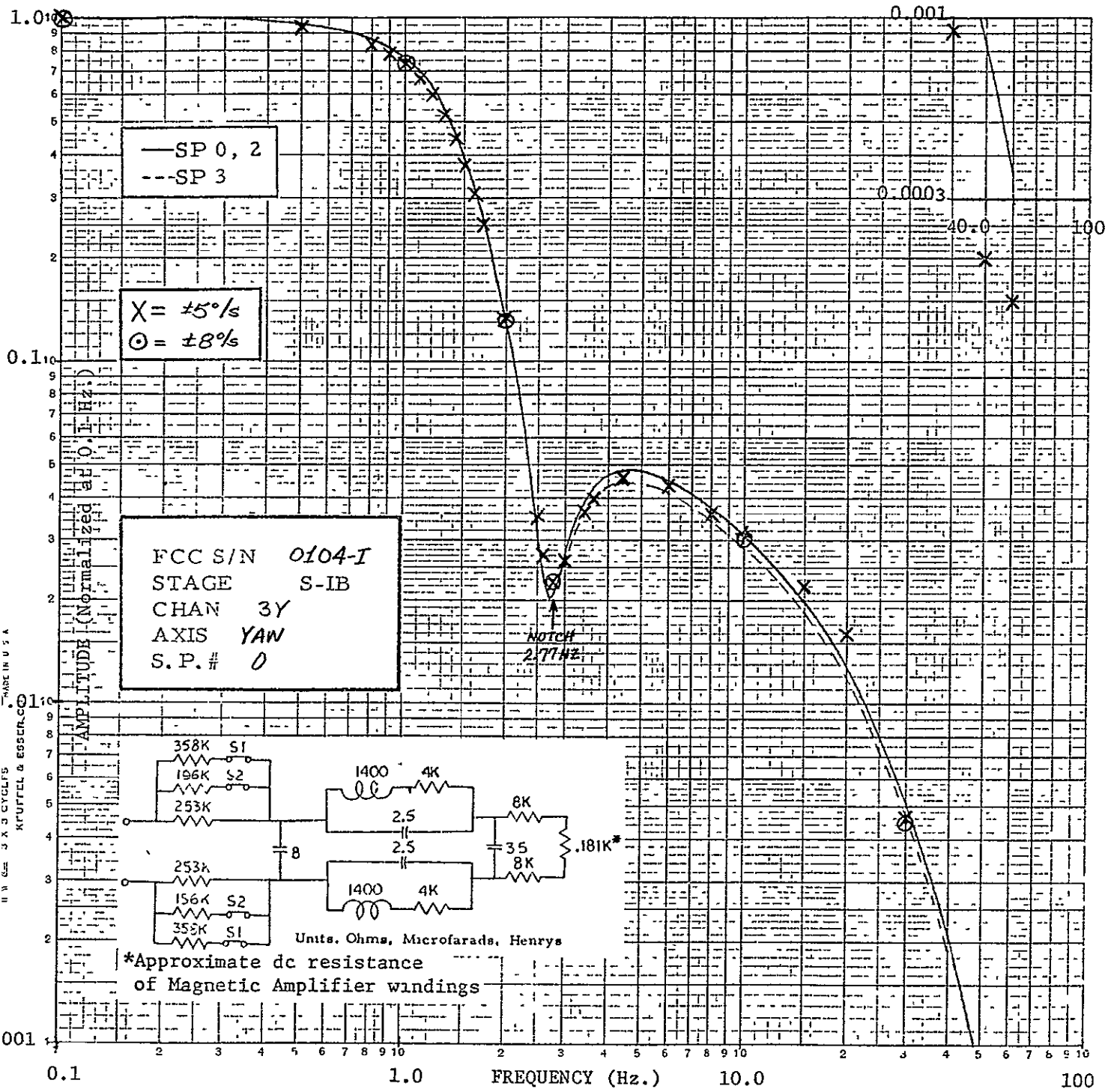

ORIGINAL PAGE IS  
OF POOR QUALITY

OPEN LOOP FREQUENCY RESPONSE  
SA-210, S-IB STAGE

P - Y ATTITUDE RATE FILTER x RATE GYRO/CSP x 12MA SA

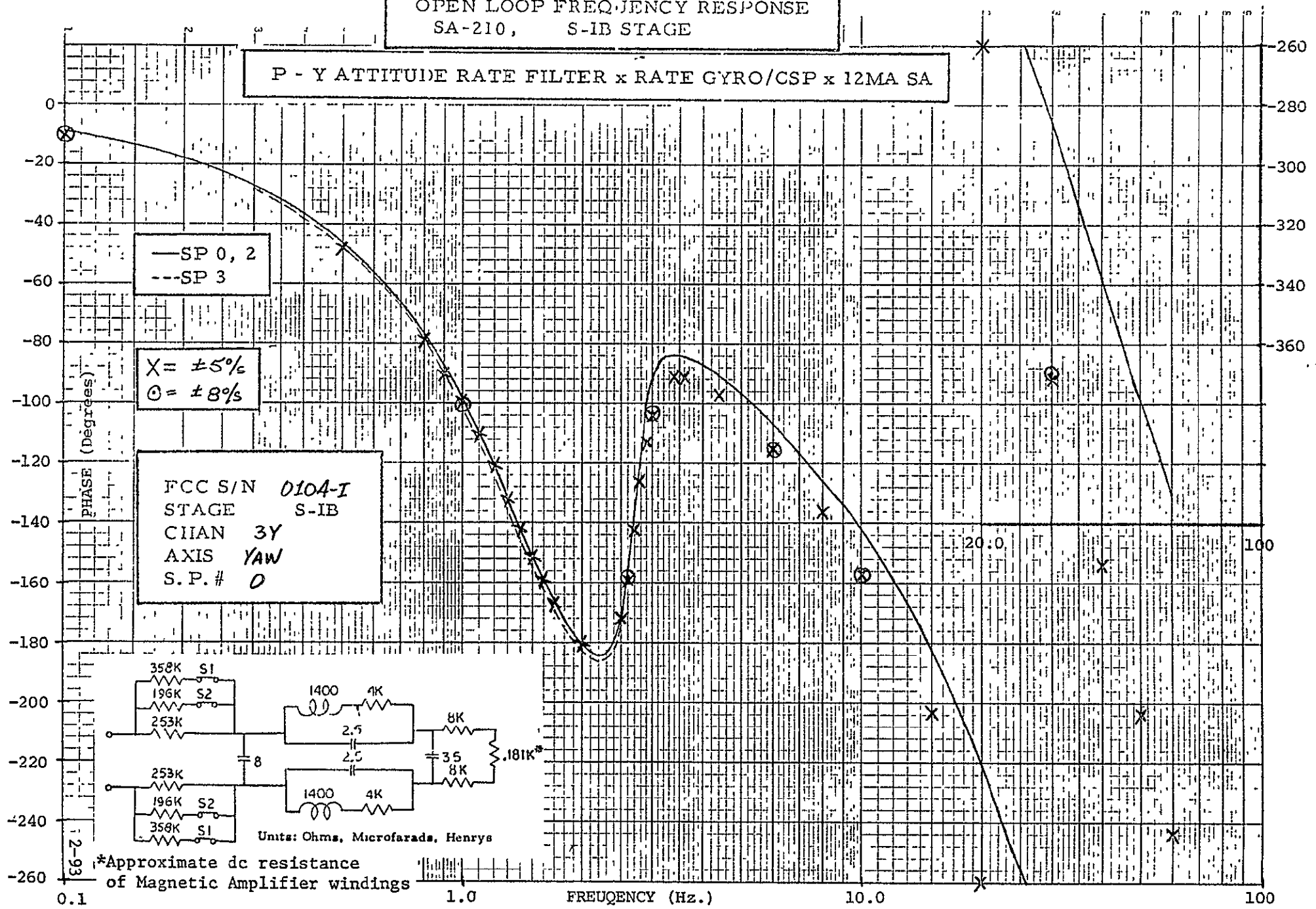

— SP 0, 2  
--- SP 3

X = ±5%  
O = ±8%

FCC S/N 0104-I  
STAGE S-IB  
CHAN 3Y  
AXIS YAW  
S.P.# 0

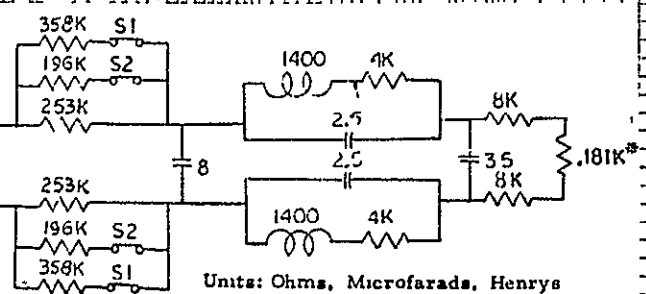

\*Approximate dc resistance of Magnetic Amplifier windings

OPEN LOOP FREQUENCY RESPONSE  
SA-210, S-IB STAGE

P - Y ATTITUDE RATE FILTER x RATE GYRO/CSP x 12MA SA

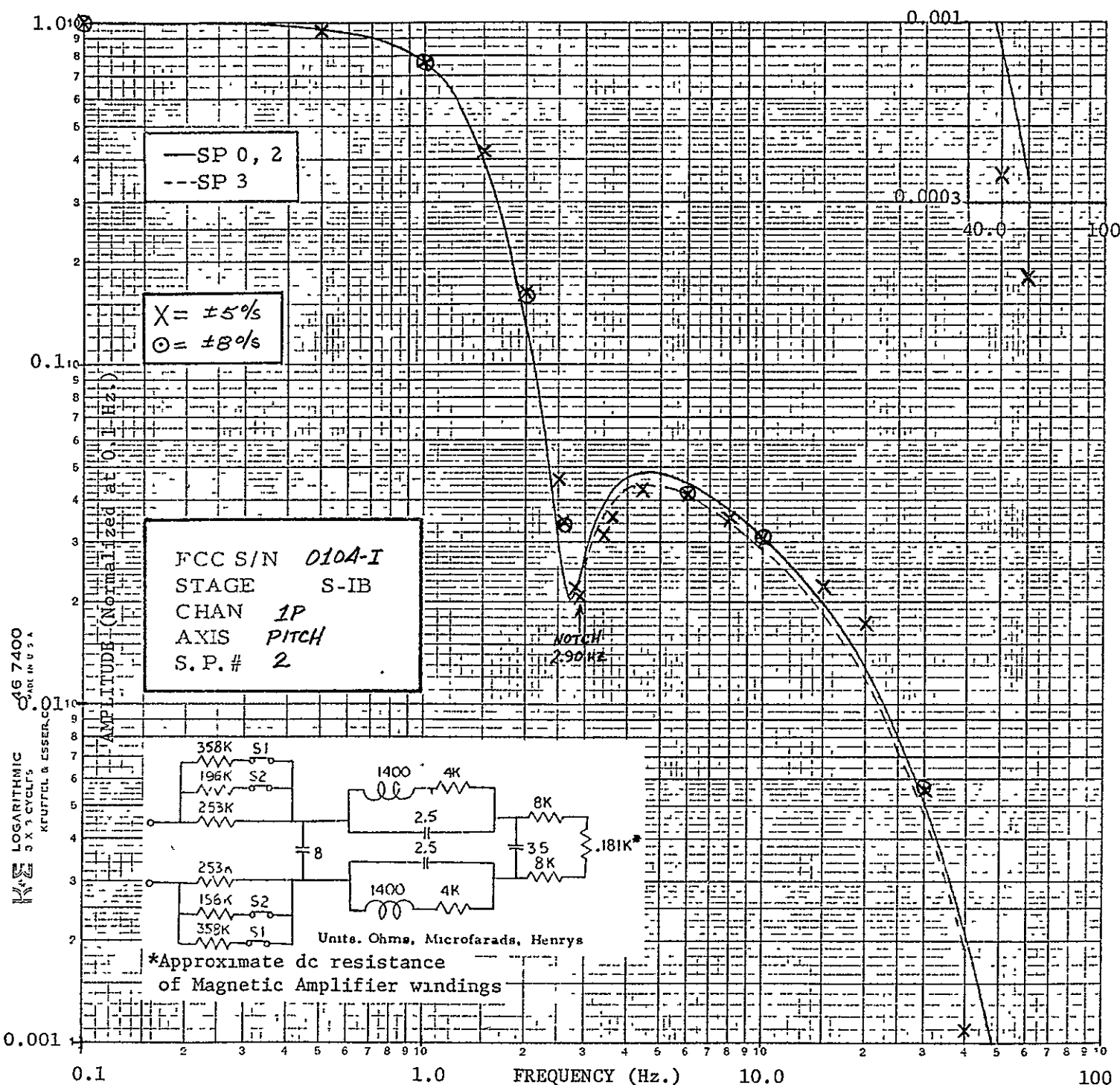

ORIGINAL PAGE IS  
OF POOR QUALITY

OPEN LOOP FREQUENCY RESPONSE  
SA-210, S-IB STAGE

P - Y ATTITUDE RATE FILTER x RATE GYRO/CSP x 12MA SA

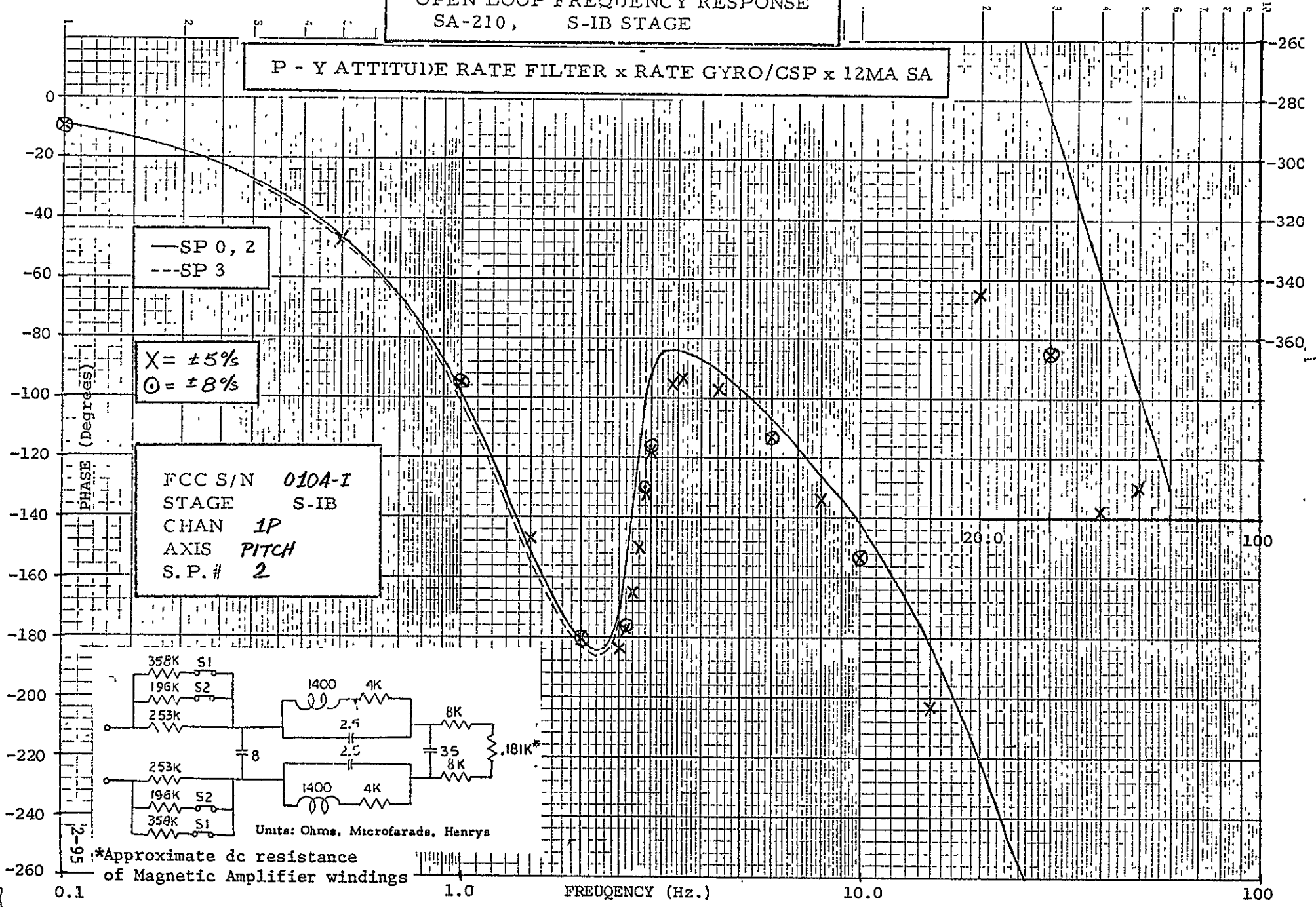

— SP 0, 2  
--- SP 3

X = ±5%  
O = ±8%

FCC S/N 010A-I  
STAGE S-IB  
CHAN 1P  
AXIS PITCH  
S. P. # 2

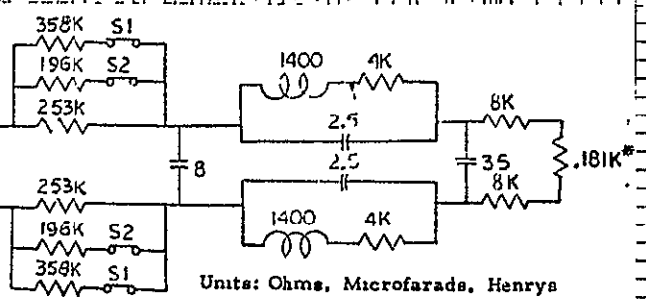

Units: Ohms, Microfarads, Henrys

\*Approximate dc resistance of Magnetic Amplifier windings



OPEN LOOP FREQUENCY RESPONSE  
SA-210, S-IB STAGE

P - Y ATTITUDE RATE FILTER x RATE GYRO/CSP x 12MA SA

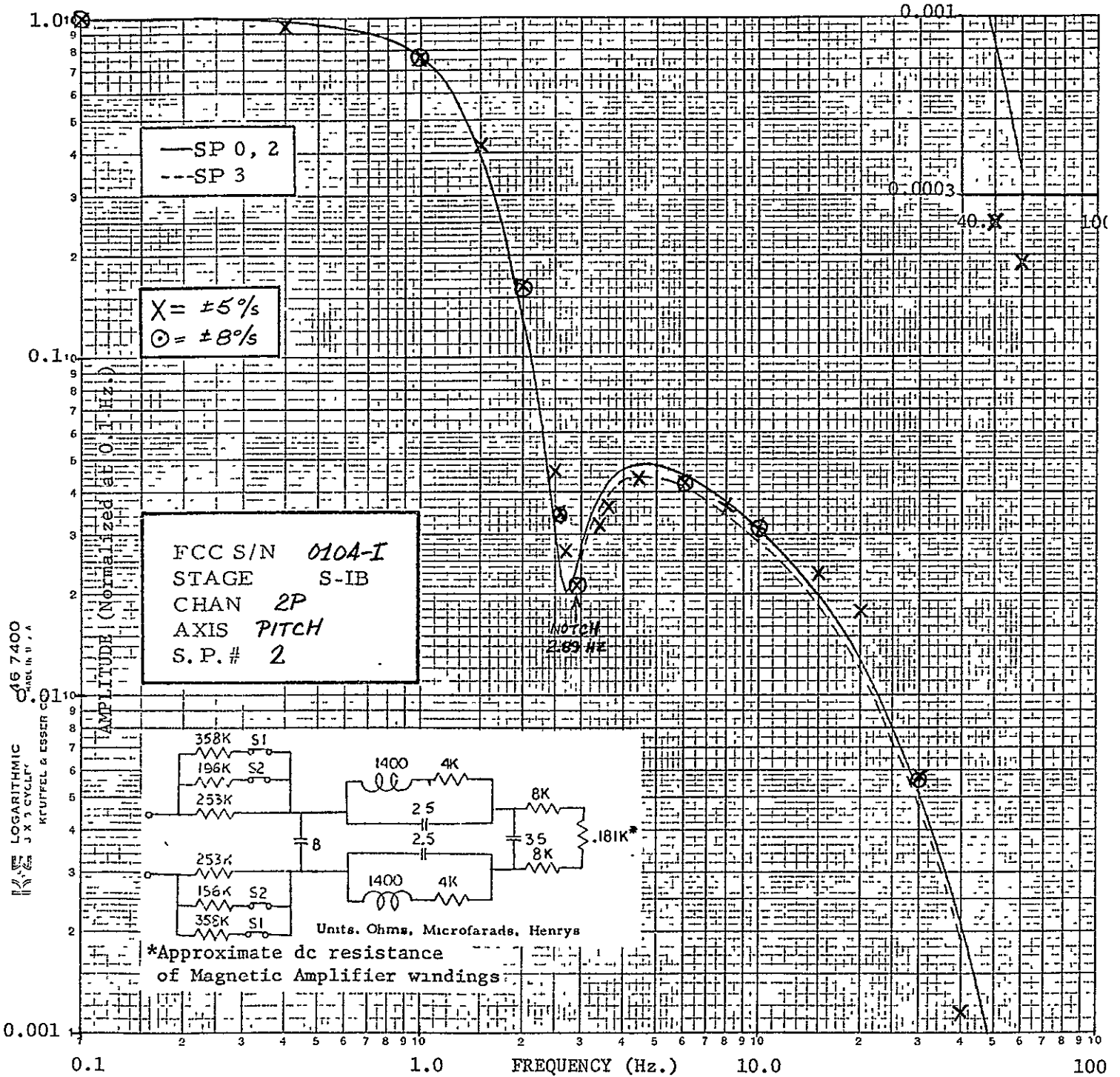

LOGARITHMIC  
3 X 5 CYCLE  
KEUFFEL & ESSER CO.

ORIGINAL PAGE IS  
OF POOR QUALITY

OPEN LOOP FREQUENCY RESPONSE  
SA-210, S-IB STAGE

P - Y ATTITUDE RATE FILTER x RATE GYRO/CSP x 12MA SA

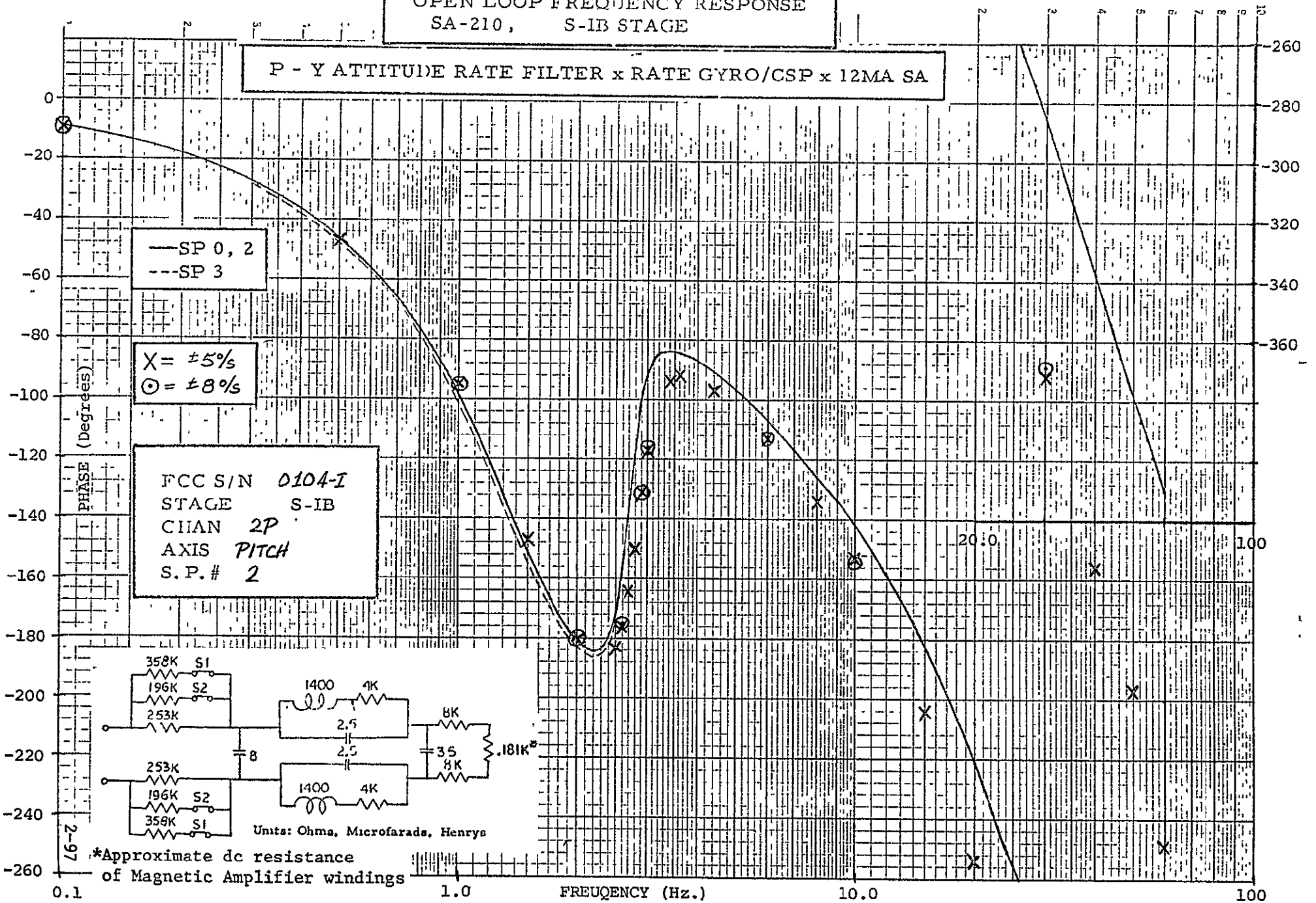

FCC S/N 0104-I  
STAGE S-IB  
CHAN 2P  
AXIS PITCH  
S.P.# 2

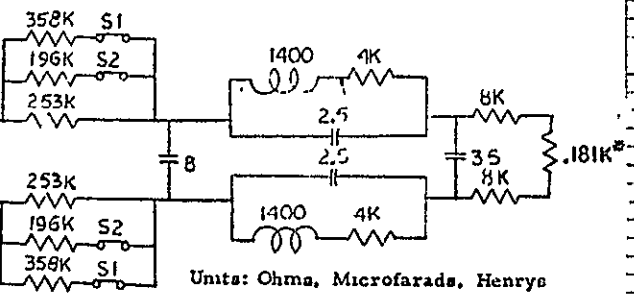

Units: Ohms, Microfarads, Henrys

\*Approximate dc resistance of Magnetic Amplifier windings

**OPEN LOOP FREQUENCY RESPONSE**  
SA-210, S-IB STAGE

**P - Y ATTITUDE RATE FILTER x RATE GYRO/CSP x 12MA SA**

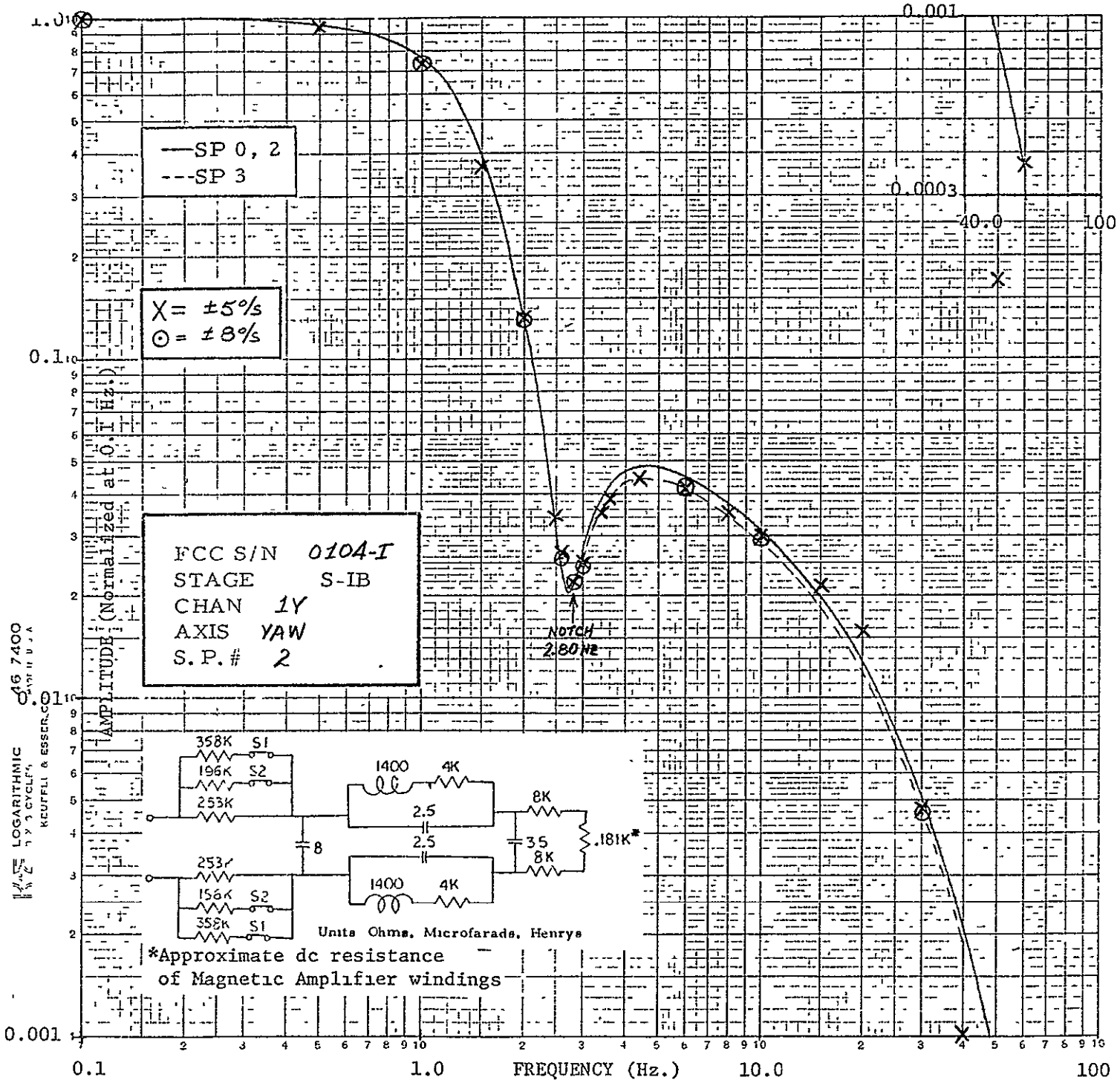

ORIGINAL PAGE IS  
OF POOR QUALITY

OPEN LOOP FREQUENCY RESPONSE  
SA-210, S-1B STAGE

P - Y ATTITUDE RATE FILTER x RATE GYRO/CSP x 12MA SA

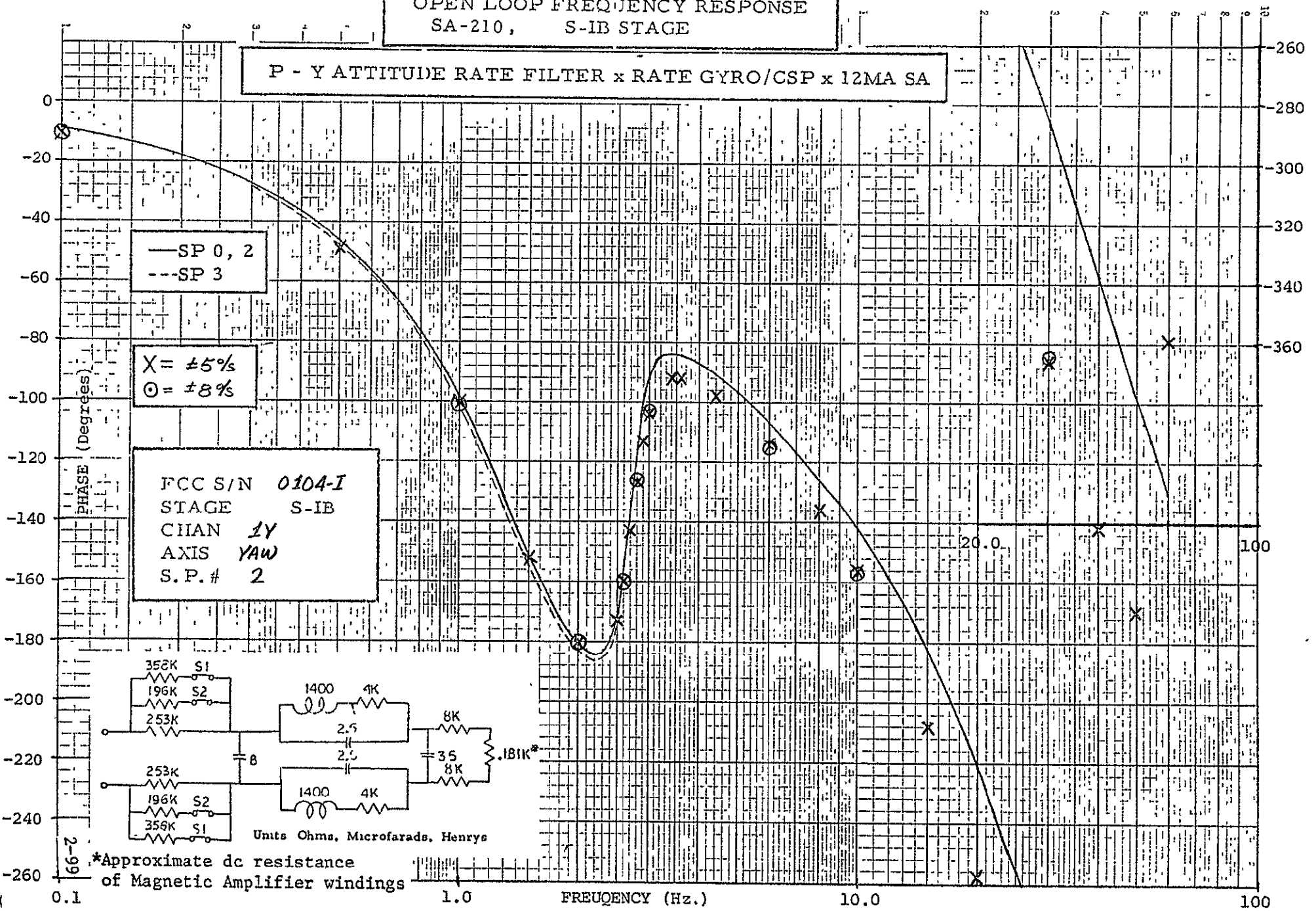

— SP 0, 2  
- - - SP 3

X = ±5%  
O = ±8%

FCC S/N 0104-I  
STAGE S-1B  
CHAN 1Y  
AXIS YAW  
S.P.# 2

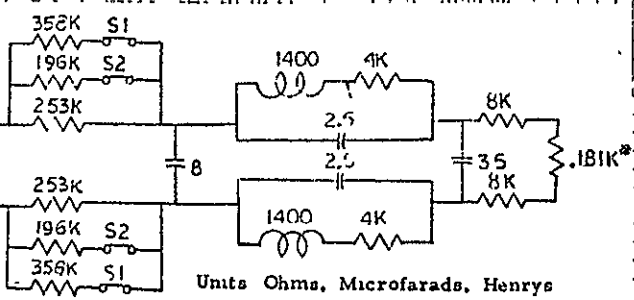

\*Approximate dc resistance of Magnetic Amplifier windings

2-99

OPEN LOOP FREQUENCY RESPONSE  
SA-210, S-IB STAGE

P - Y ATTITUDE RATE FILTER x RATE GYRO/CSP x 12MA SA

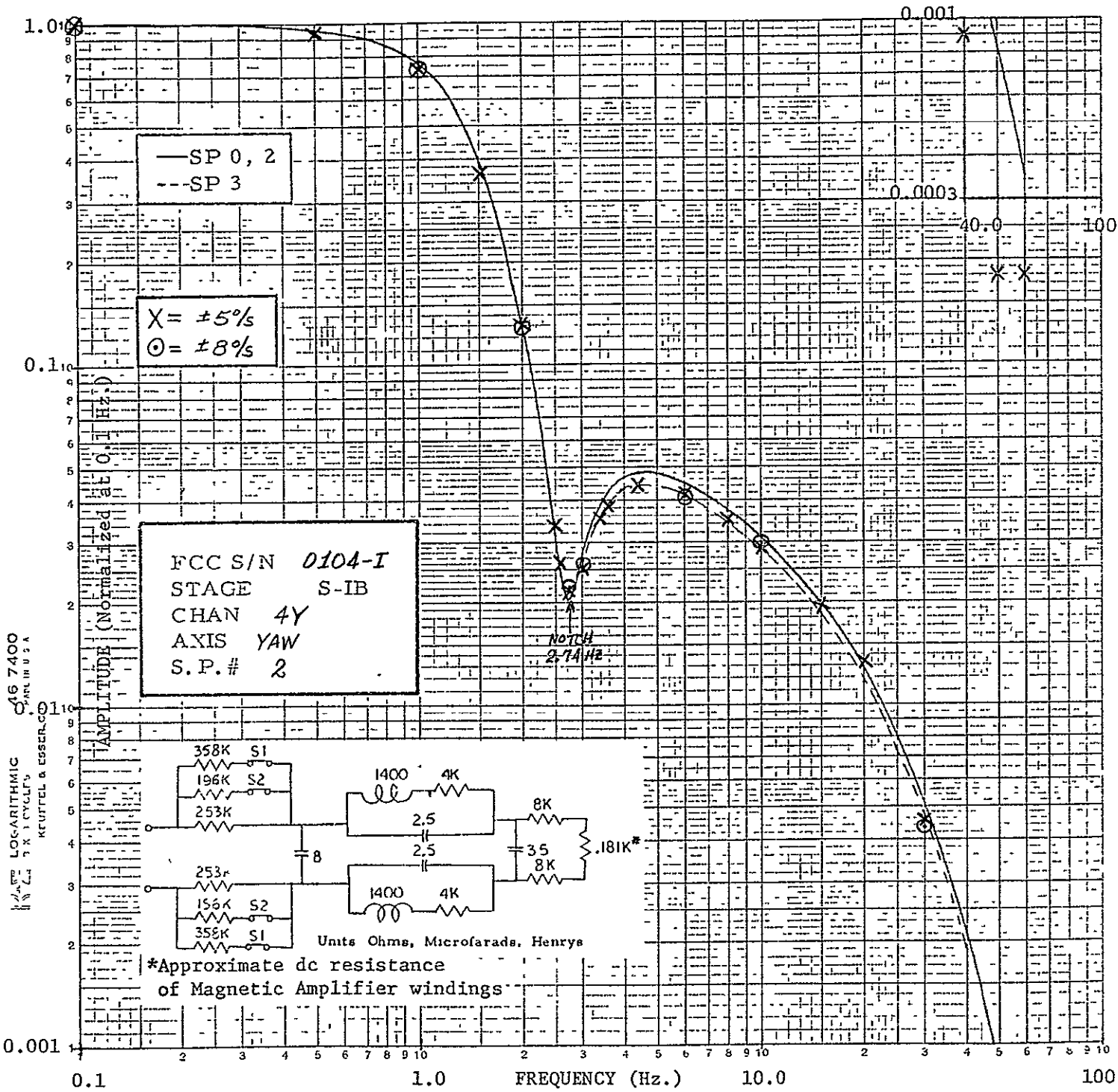

ORIGINAL PAGE IS  
OF POOR QUALITY

OPEN LOOP FREQUENCY RESPONSE  
SA-210, S-IB STAGE

P - Y ATTITUDE RATE FILTER x RATE GYRO/CSP x 12MA SA

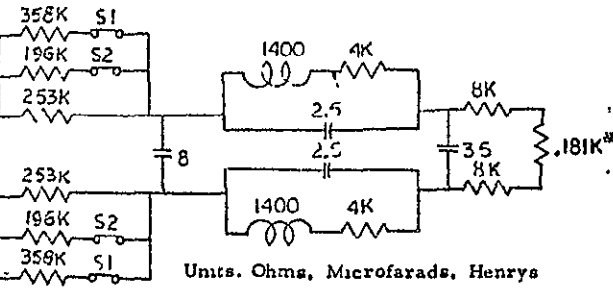
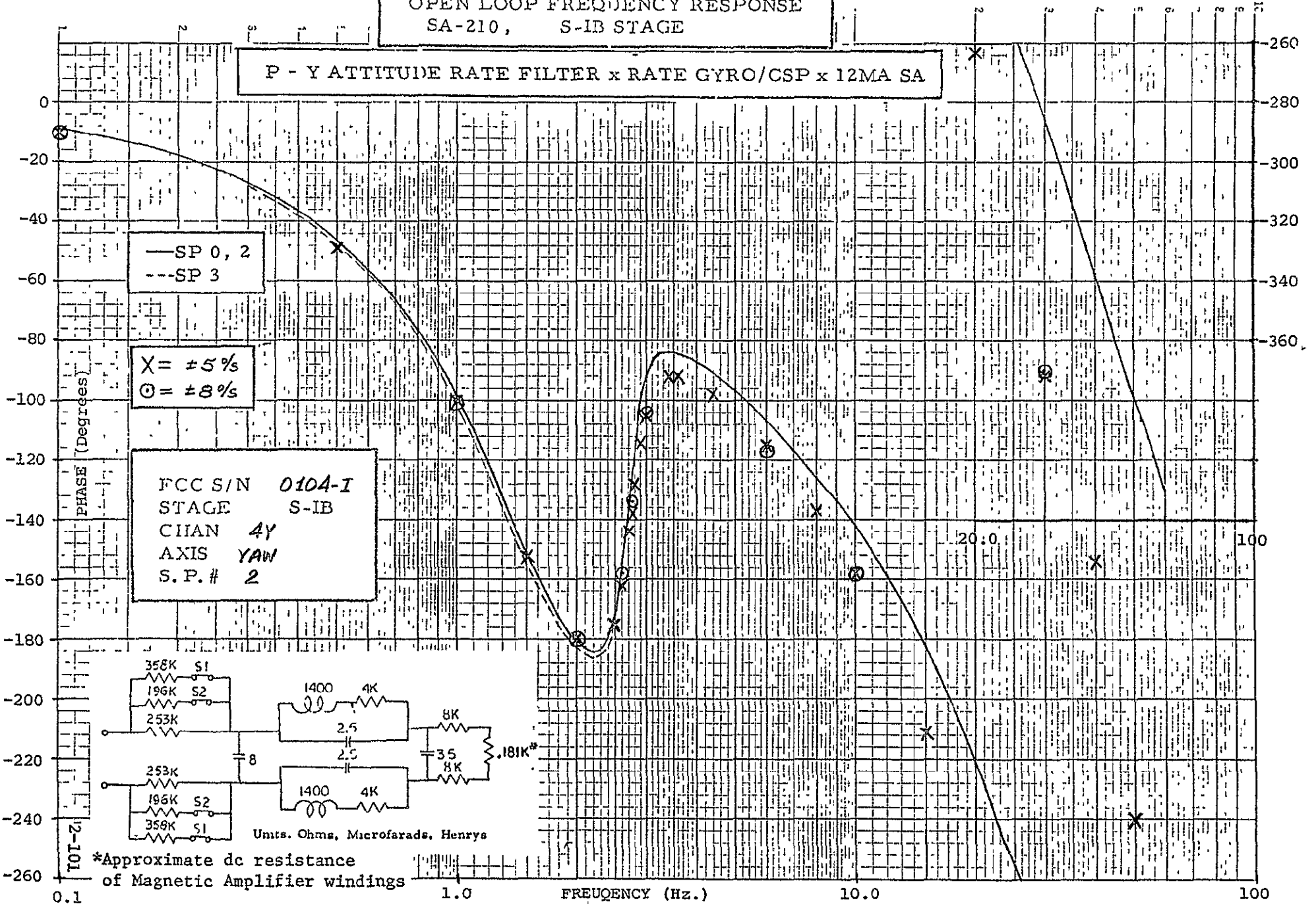

OPEN LOOP FREQUENCY RESPONSE  
SA-210, S-IB STAGE

P - Y ATTITUDE RATE FILTER x RATE GYRO/CSP x 12MA SA

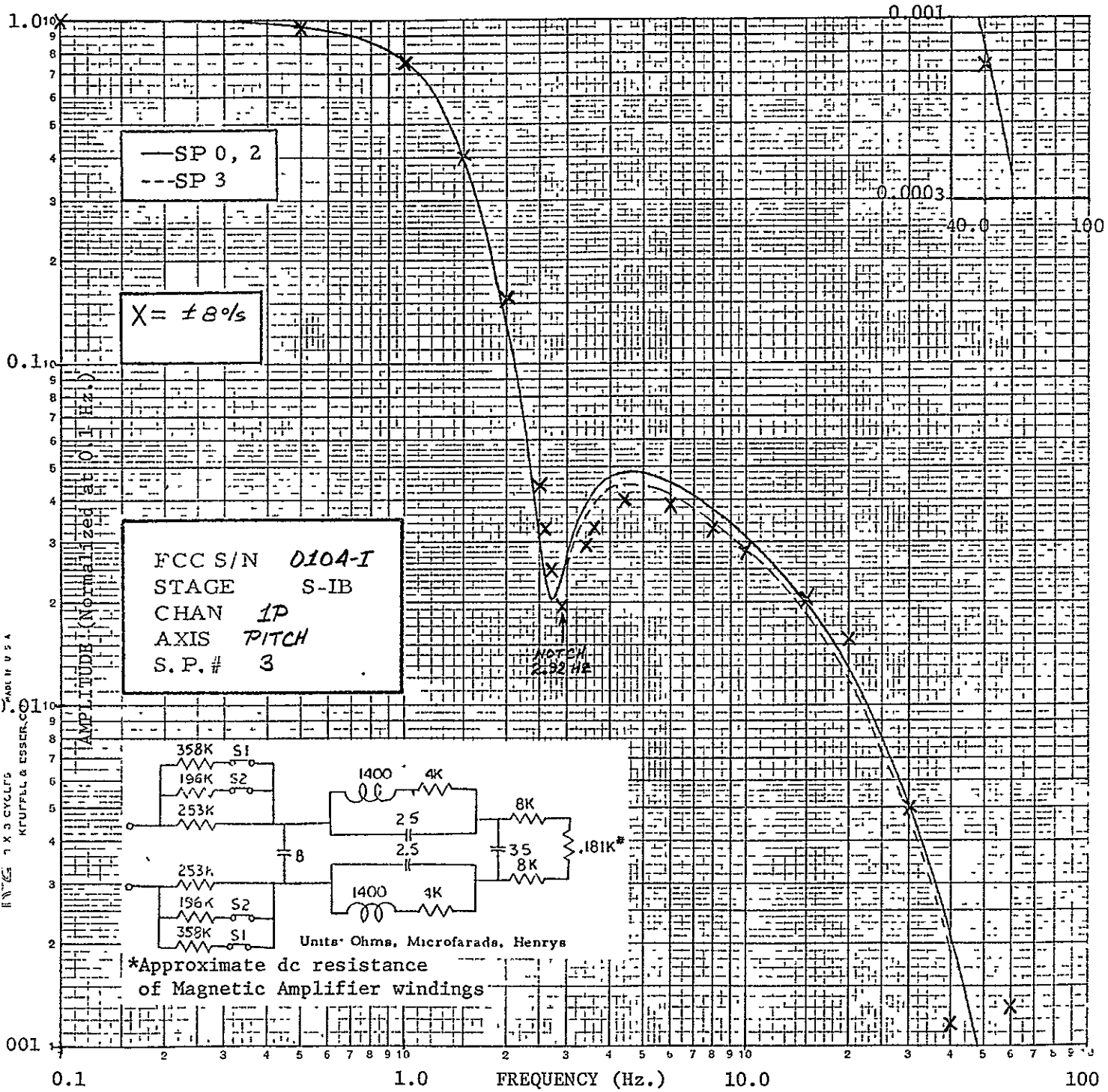

ORIGINAL PAGE IS  
OF POOR QUALITY

OPEN LOOP FREQUENCY RESPONSE  
SA-210, S-IB STAGE

P - Y ATTITUDE RATE FILTER x RATE GYRO/CSP x 12MA SA

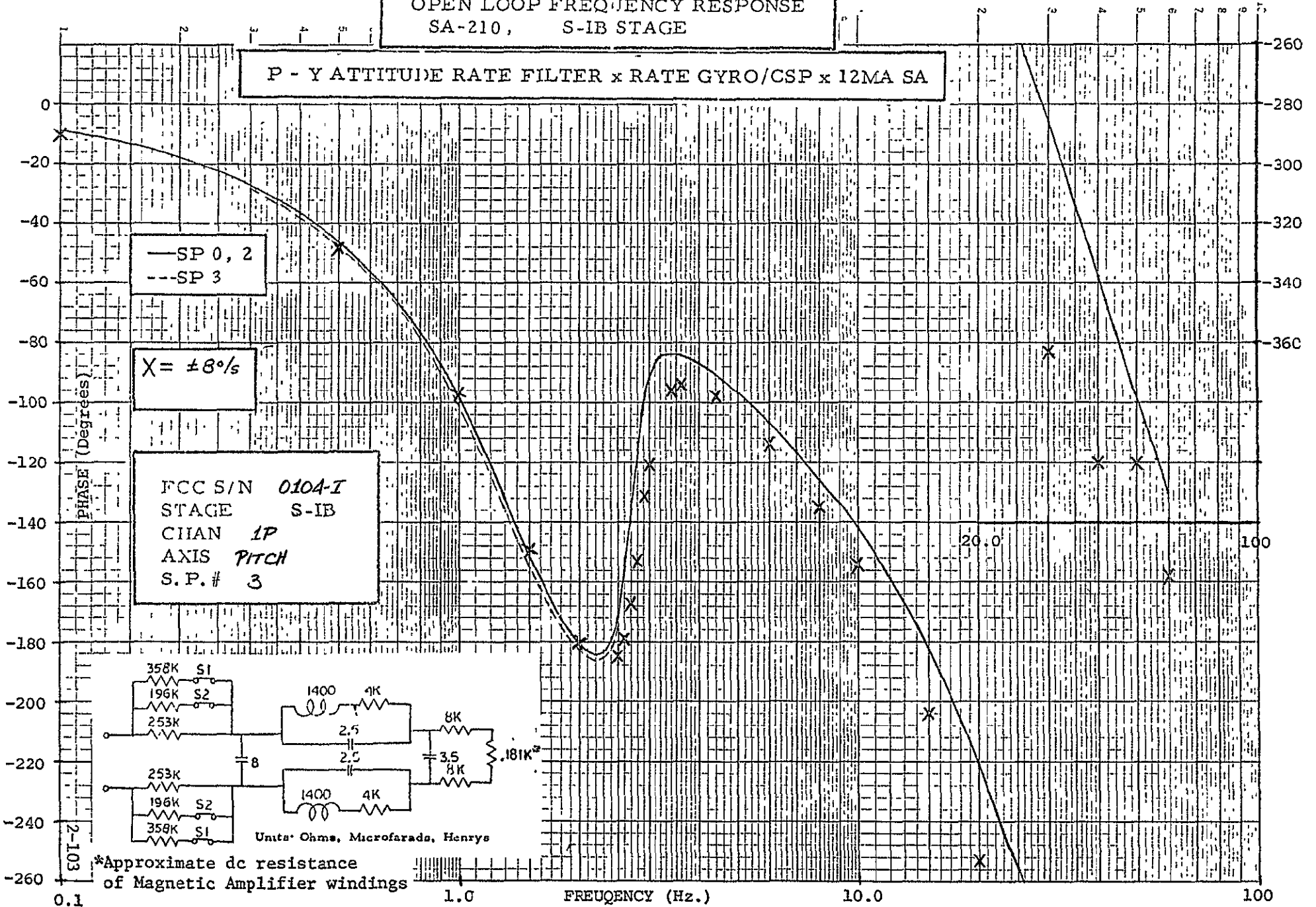



**OPEN LOOP FREQUENCY RESPONSE**  
SA-210, S-IB STAGE

**P - Y ATTITUDE RATE FILTER x RATE GYRO/CSP x 12MA SA**

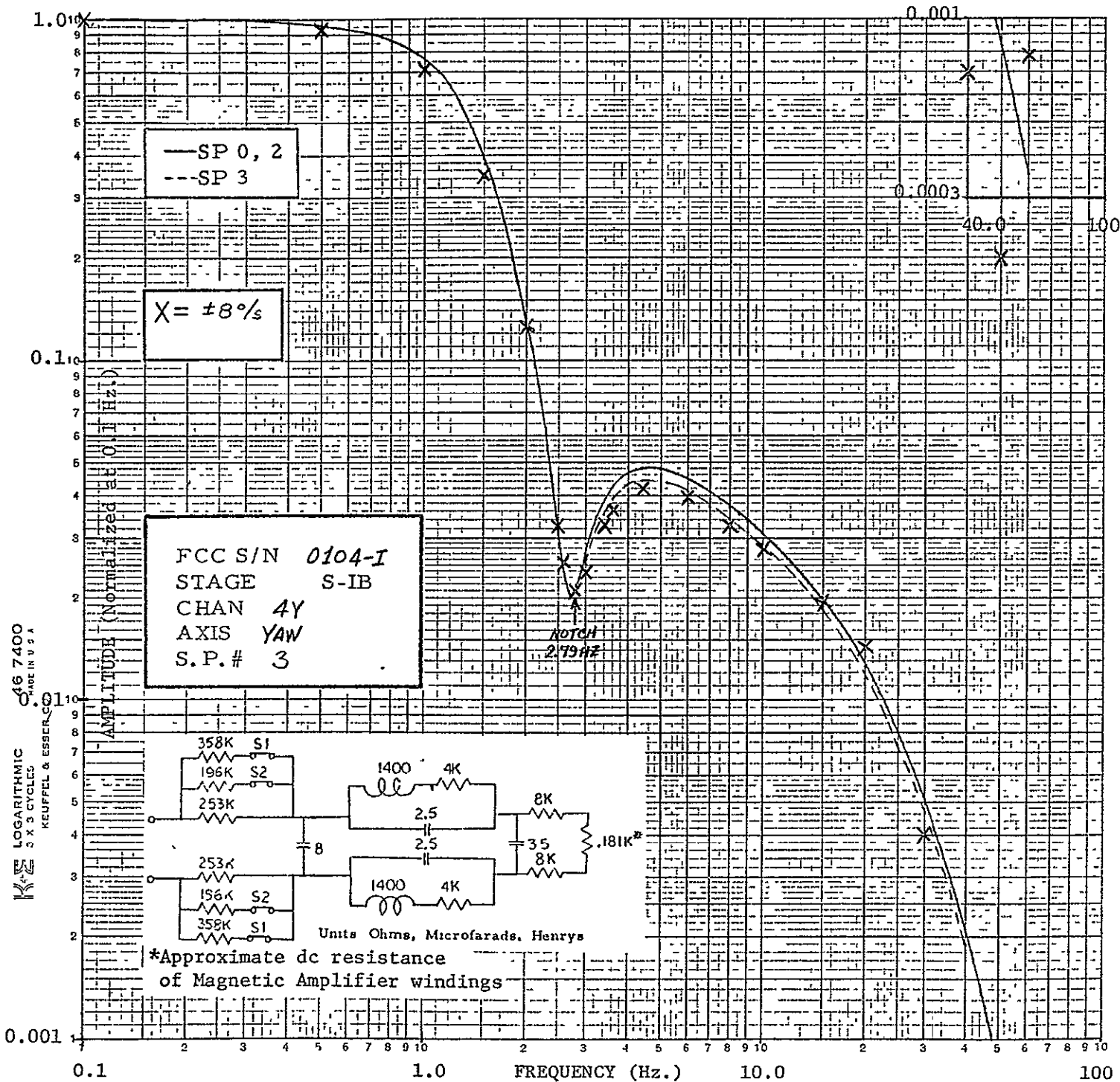

ORIGINAL PAGE IS  
OF POOR QUALITY

OPEN LOOP FREQUENCY RESPONSE  
SA-210, S-IB STAGE

P - Y ATTITUDE RATE FILTER x RATE GYRO/CSP x 12MA SA

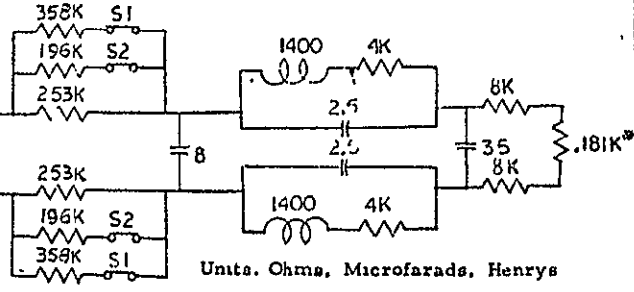
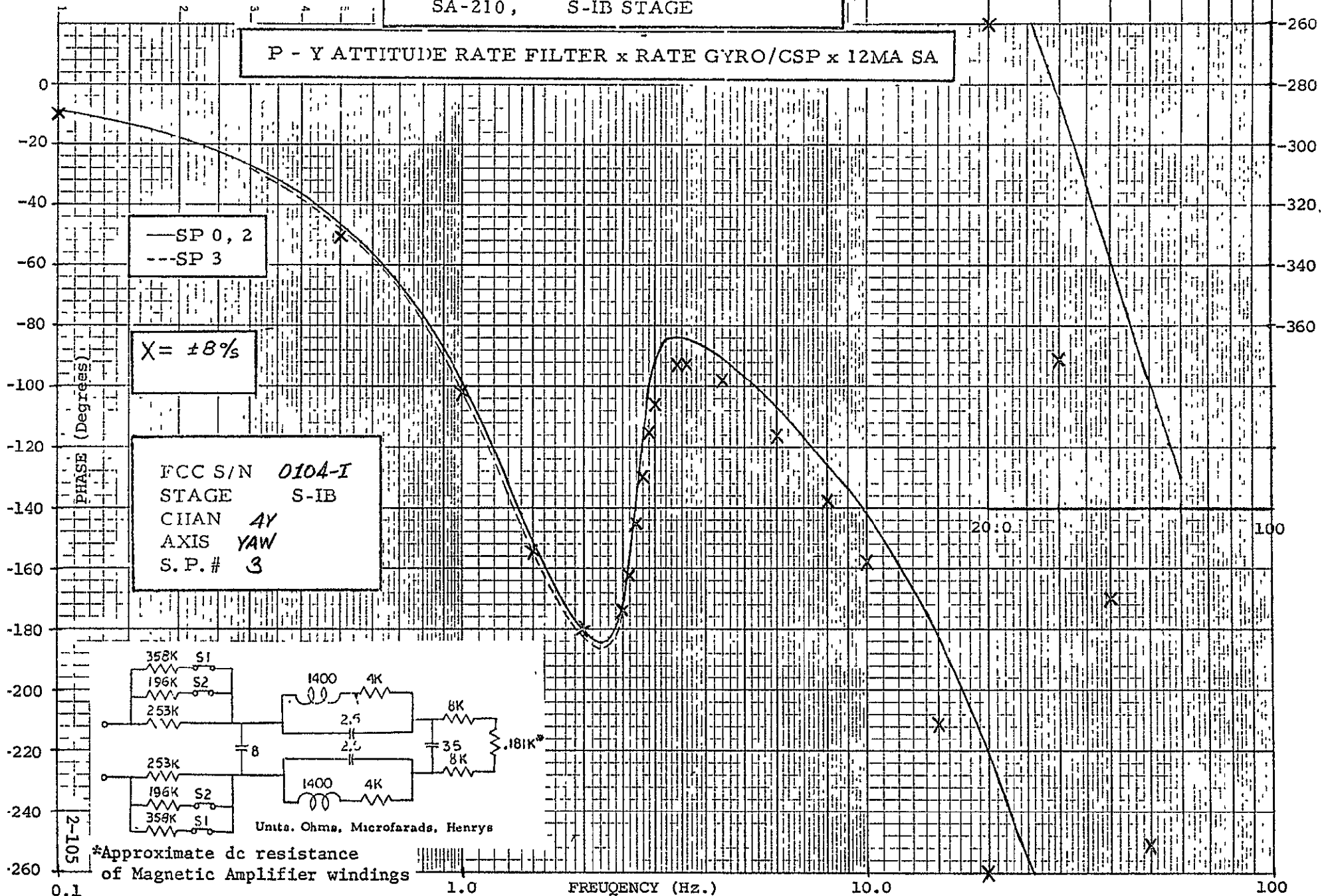

OPEN LOOP FREQUENCY RESPONSE  
SA-210, S-IB STAGE

ROLL ATTITUDE RATE FILTER x RATE GYRO/CSP x 12MA SA

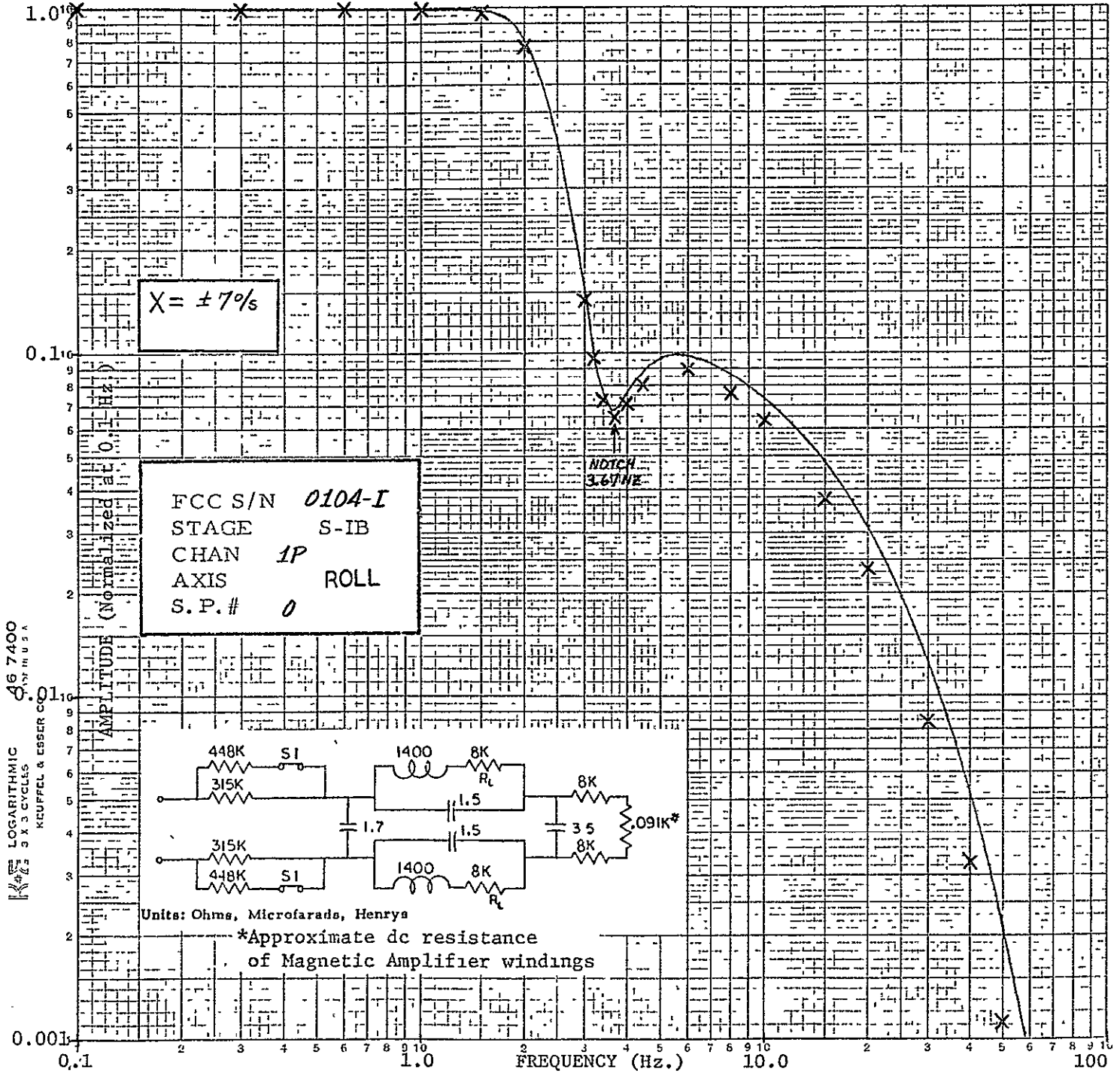

46 7400  
 LOGARITHMIC  
 KEUFFEL & ESSER CO.

ORIGINAL PAGE IS  
OF POOR QUALITY

OPEN LOOP FREQUENCY RESPONSE  
SA-210, S-IB STAGE

ROLL ATTITUDE RATE FILTER x RATE GYRO/CSP x 12MA SA

$\chi = \pm 7\%$

FCC S/N 0104-I  
STAGE S-IB  
CHAN 1P  
AXIS ROLL  
S.P.# 0

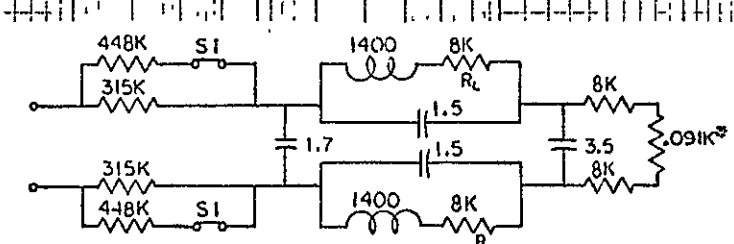

Units: Ohms, Microfarads, Henrys

\*Approximate dc resistance of Magnetic Amplifier windings

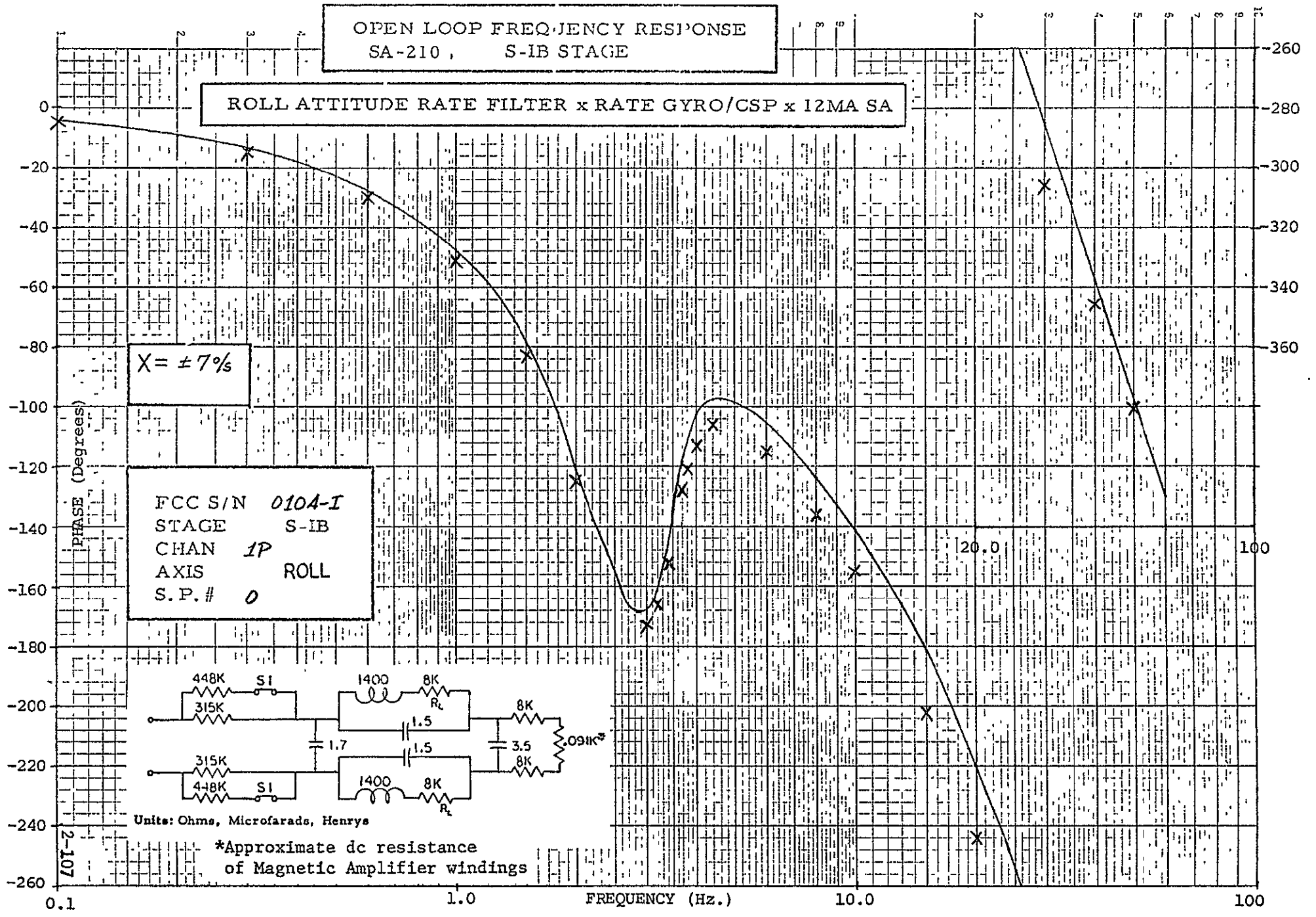

OPEN LOOP FREQUENCY RESPONSE  
SA-210, S-1B STAGE

ROLL ATTITUDE RATE FILTER x RATE GYRO/CSP x 12MA SA

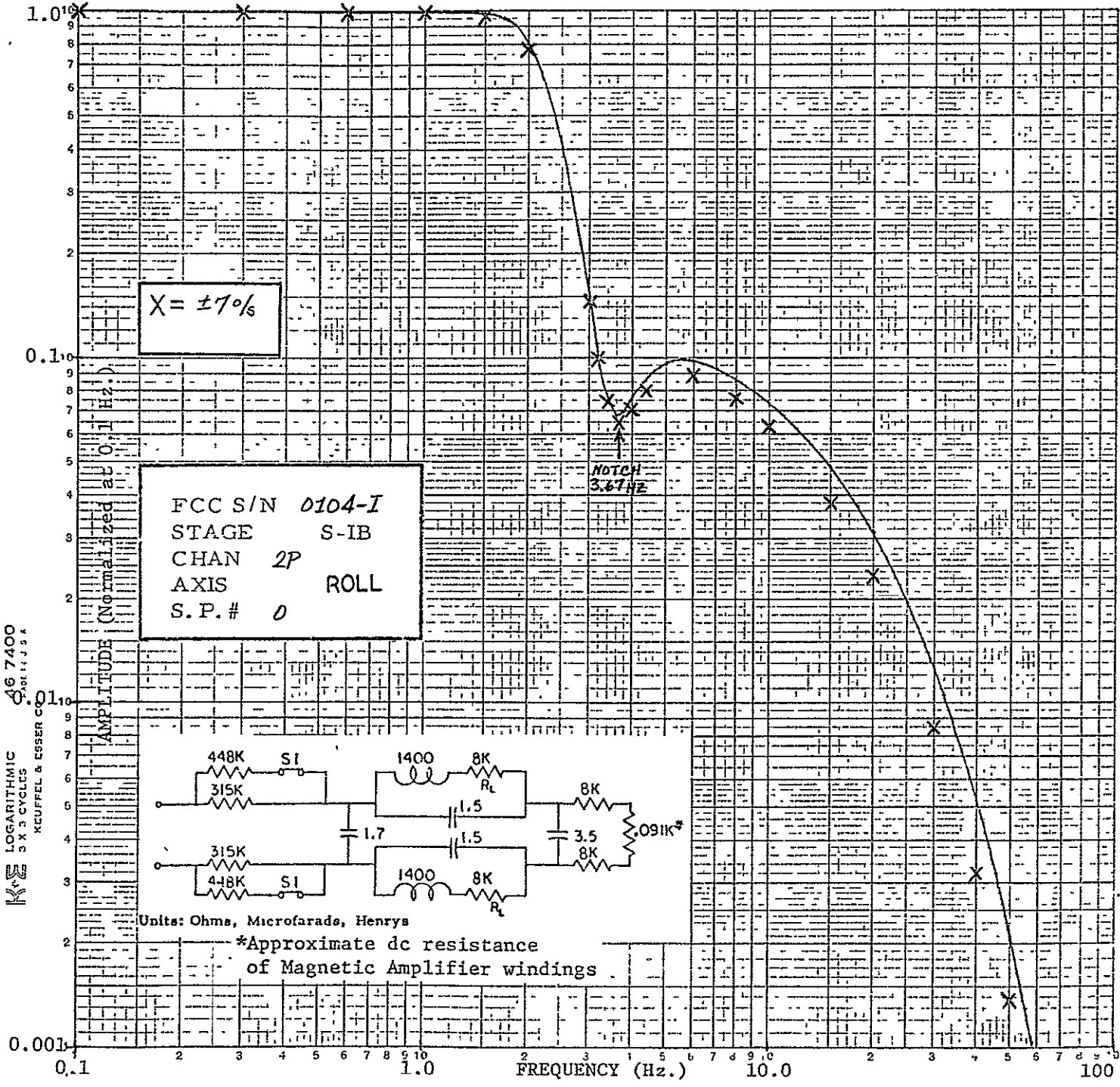

KE LOGARITHMIC  
 3 X 3 CYCLES  
 KEUFFEL & ESSER CO.  
 46 7400  
 S.A.B. 1, J.S.A.

ORIGINAL PAGE IS  
OF POOR QUALITY

OPEN LOOP FREQUENCY RESPONSE  
SA-210, S-IB STAGE

ROLL ATTITUDE RATE FILTER x RATE GYRO/CSP x 12MA SA

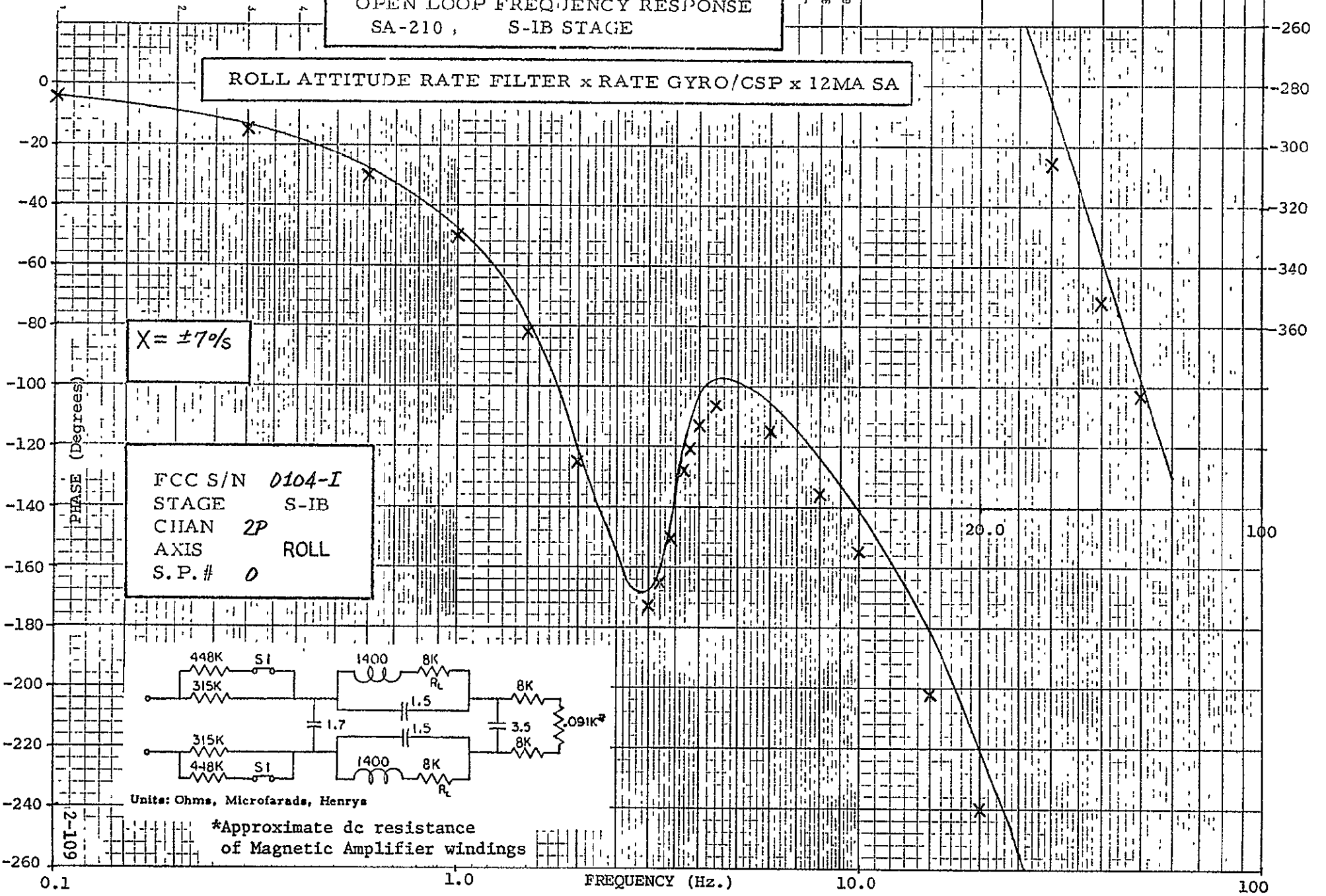

OPEN LOOP FREQUENCY RESPONSE  
SA-210, S-1B STAGE

ROLL ATTITUDE RATE FILTER x RATE GYRO/CSP x 12MA SA

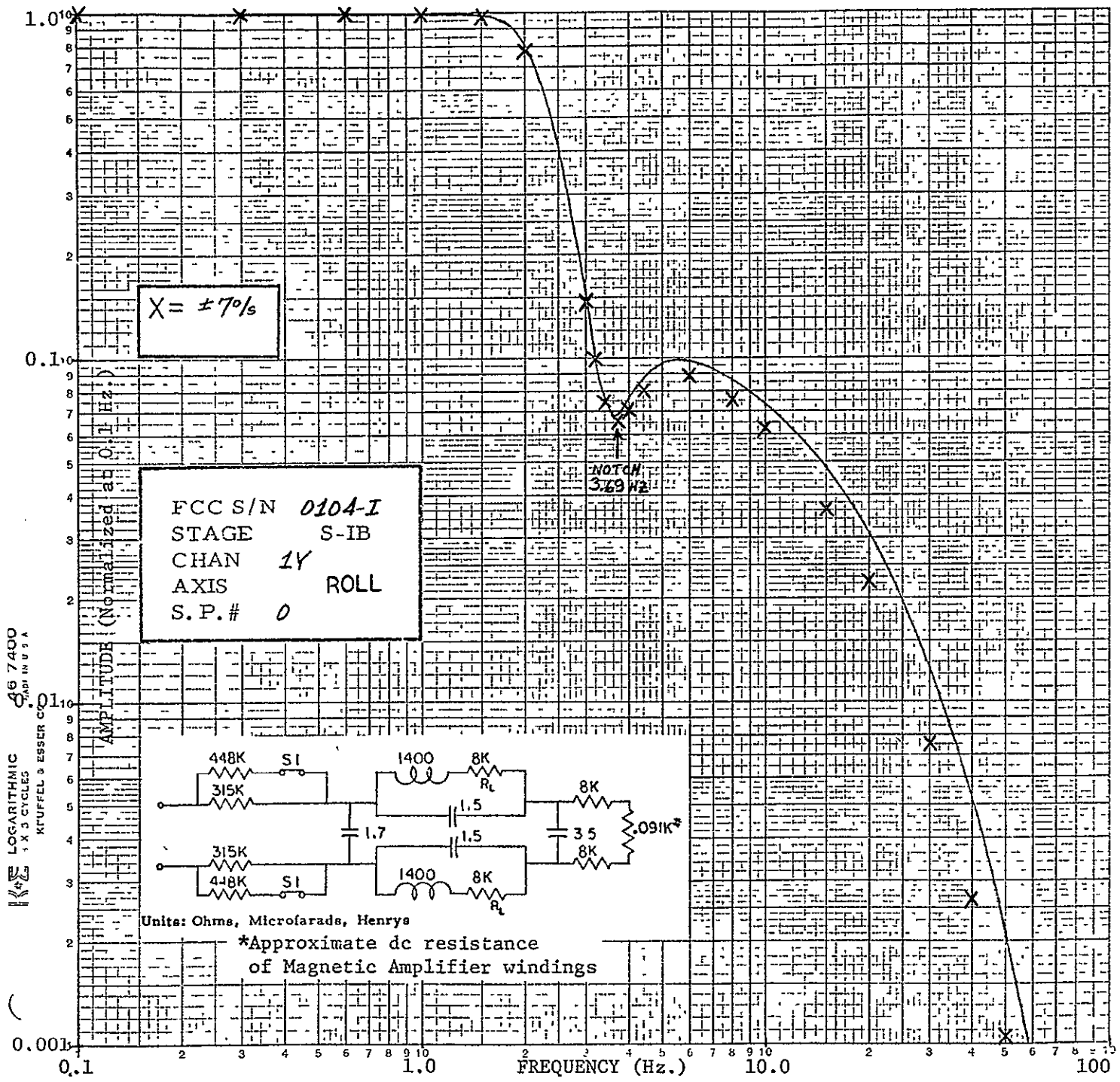

OPEN LOOP FREQUENCY RESPONSE  
SA-210, S-IB STAGE

ROLL ATTITUDE RATE FILTER x RATE GYRO/CSP x 12MA SA

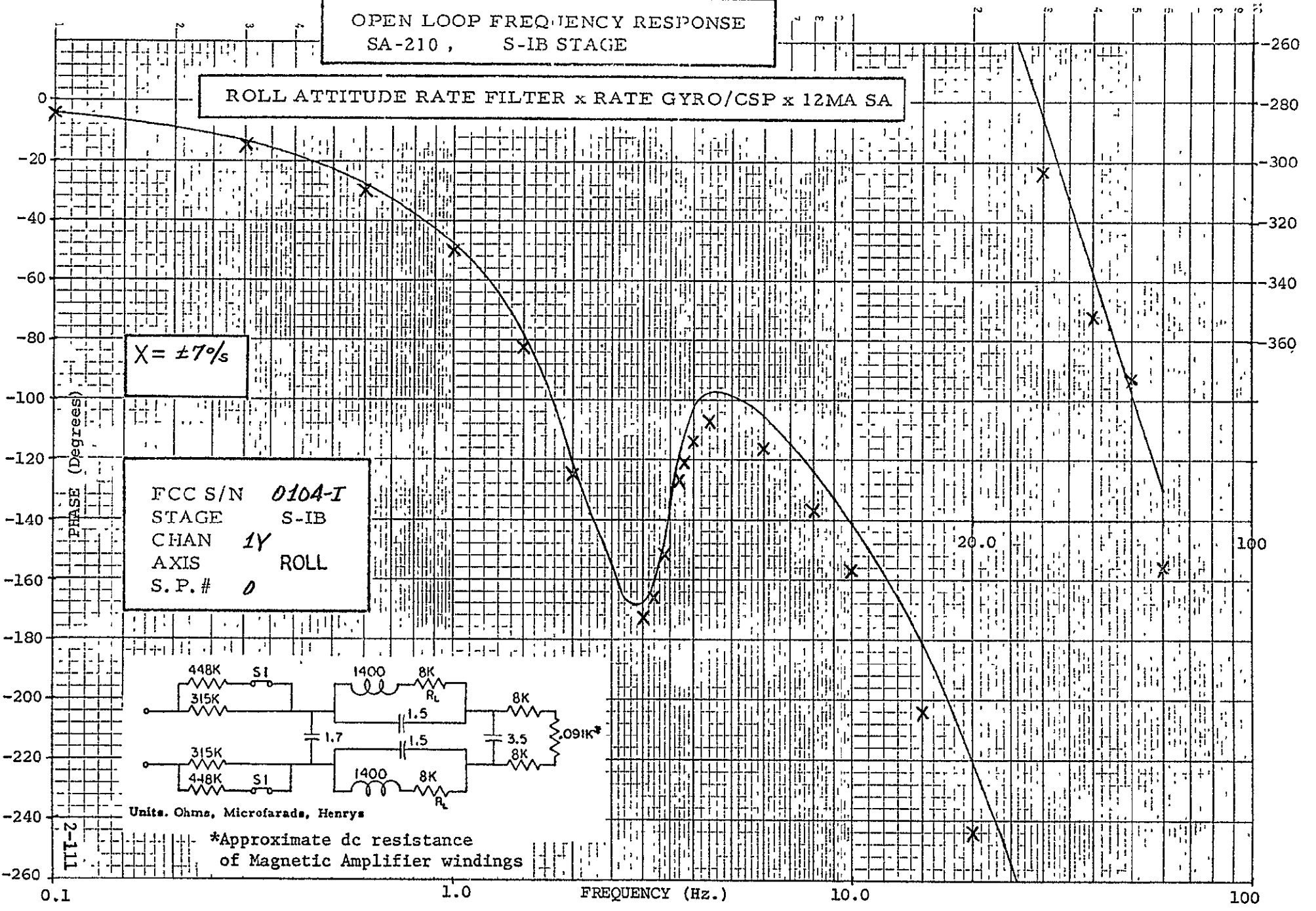

$X = \pm 7\%/s$

FCC S/N 0104-I  
STAGE S-IB  
CHAN 1Y  
AXIS ROLL  
S.P.# 0

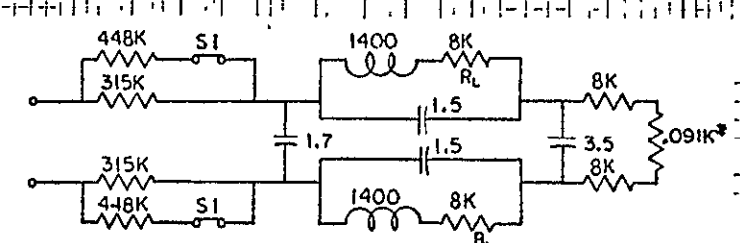

Units. Ohms, Microfarads, Henrys

\*Approximate dc resistance  
of Magnetic Amplifier windings

2-111



OPEN LOOP FREQUENCY RESPONSE  
SA-210, S-1B STAGE

ROLL ATTITUDE RATE FILTER x RATE GYRO/CSP x 12MA SA

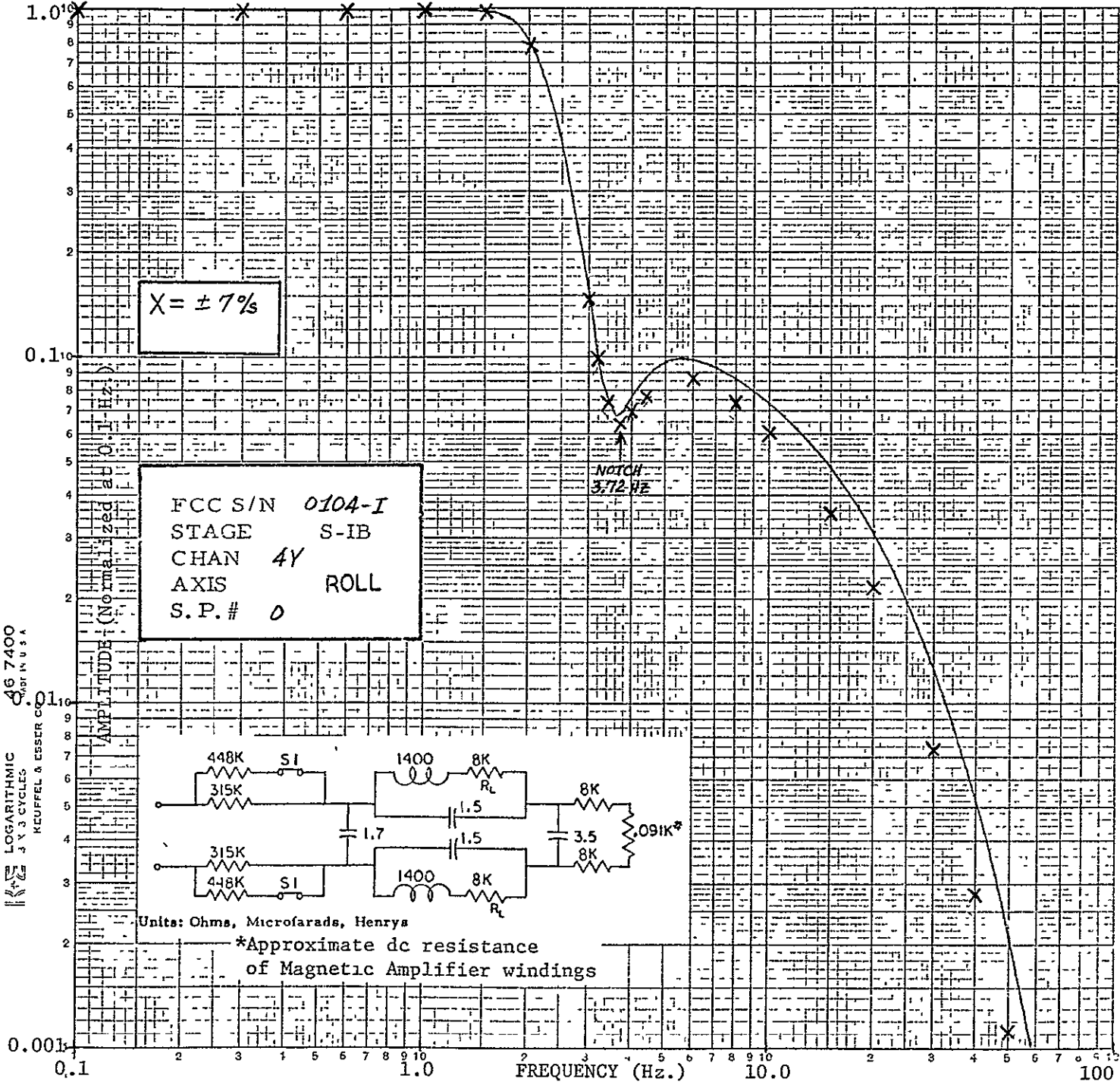

LOGARITHMIC KEUFFEL & ESSER CO. 46 7400 MADE IN U.S.A.

ORIGINAL PAGE IS  
OF POOR QUALITY

OPEN LOOP FREQUENCY RESPONSE  
SA-210, S-1B STAGE

ROLL ATTITUDE RATE FILTER x RATE GYRO/CSP x 12MA SA

$\chi = \pm 7\%$

FCC S/N 0104-I  
STAGE S-1B  
CHAN 4Y  
AXIS ROLL  
S.P.# 0

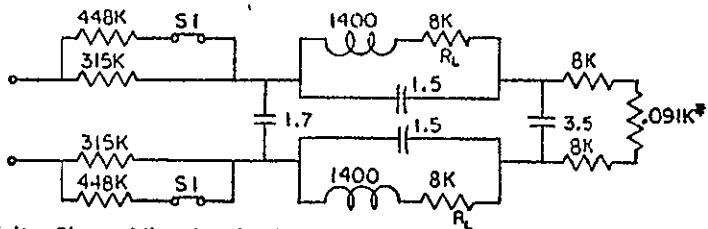

Units: Ohms, Microfarads, Henrys

\*Approximate dc resistance  
of Magnetic Amplifier windings

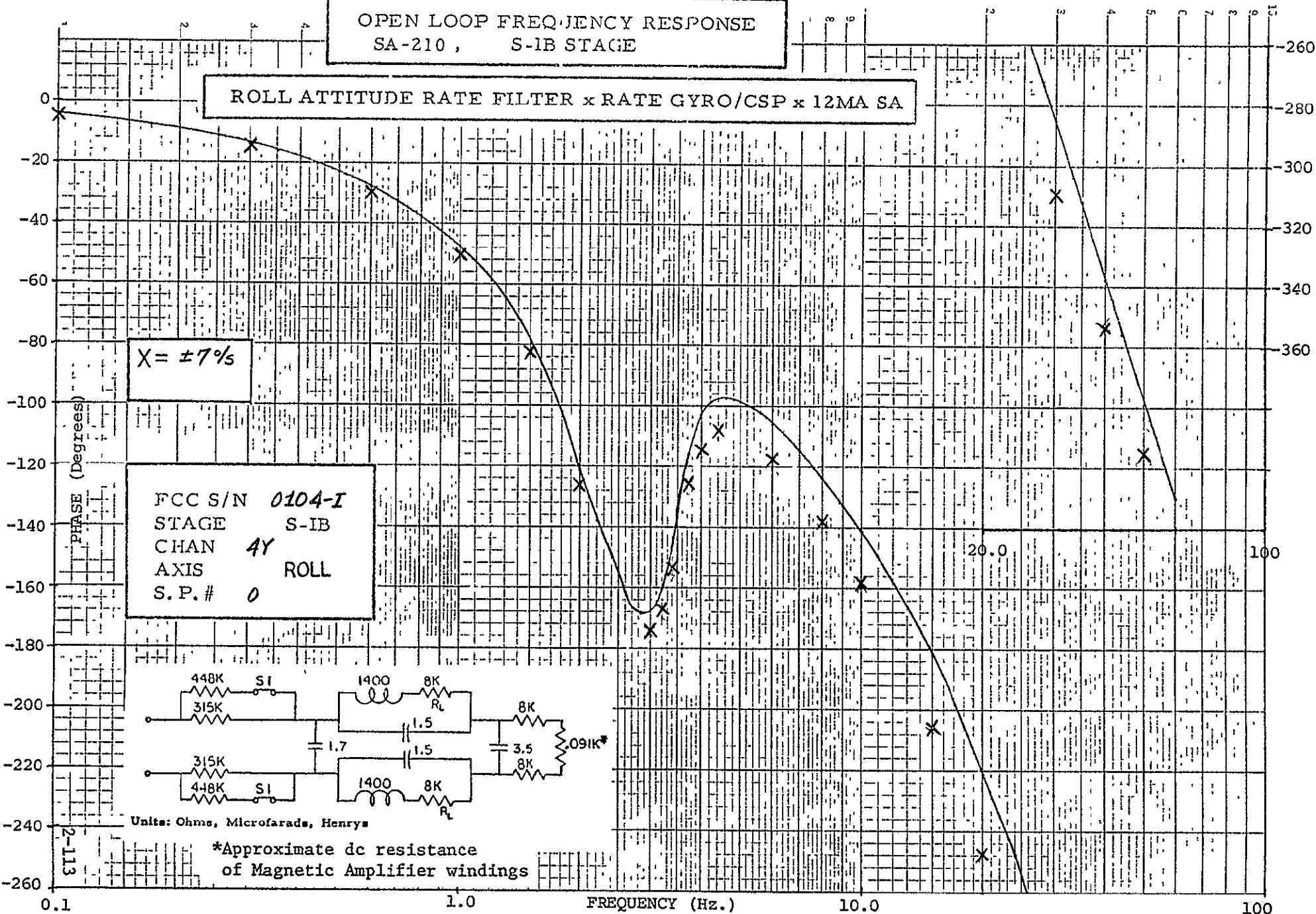

2-113

OPEN LOOP FREQUENCY RESPONSE  
SA-210, S-1B STAGE

ROLL ATTITUDE RATE FILTER x RATE GYRO/CSP x 12MA SA

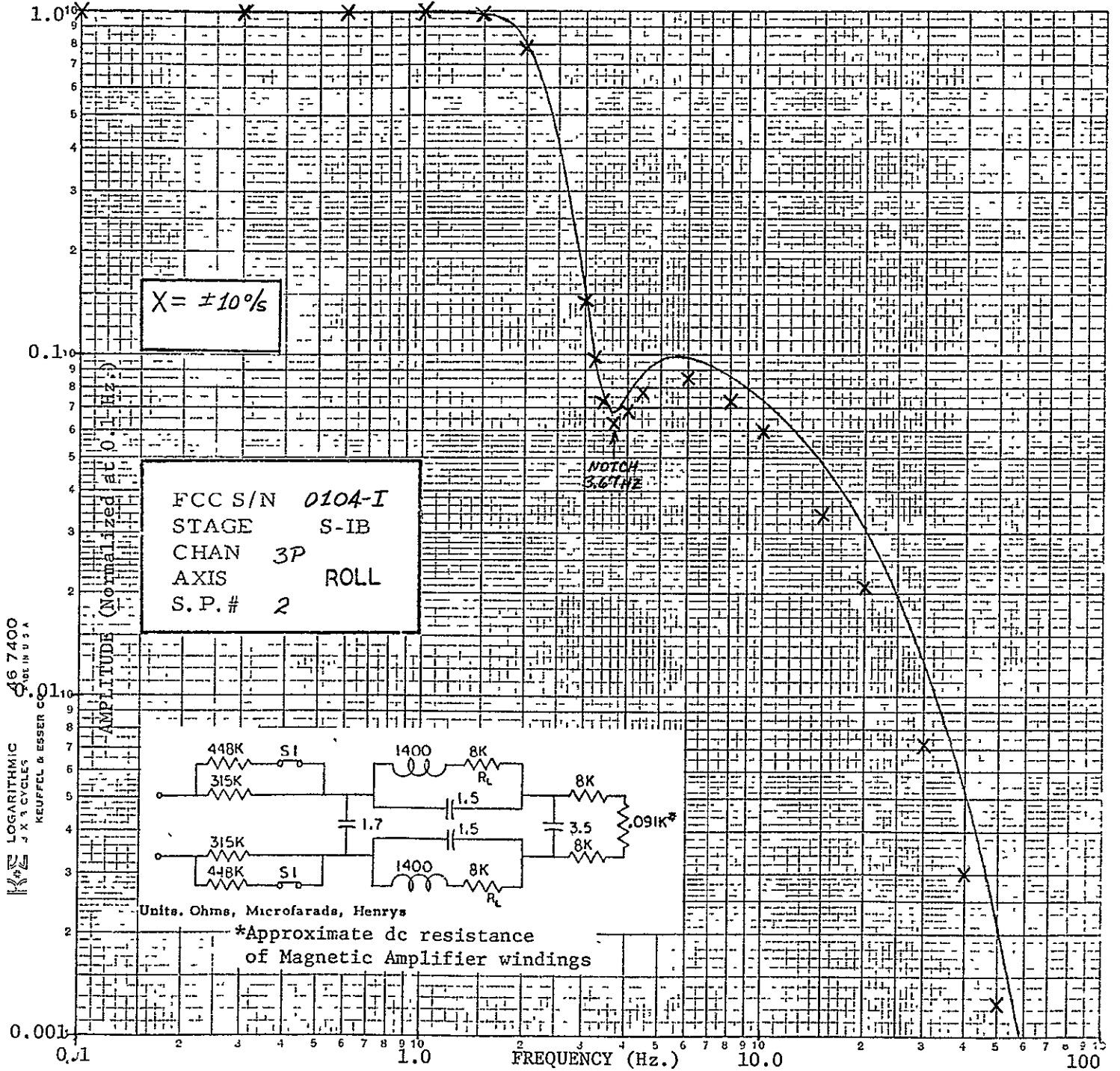

ORIGINAL PAGE IS  
OF POOR QUALITY

OPEN LOOP FREQUENCY RESPONSE  
SA-210, S-IB STAGE

ROLL ATTITUDE RATE FILTER x RATE GYRO/CSP x 12MA SA

$\chi = \pm 10\%$

FCC S/N 0104-I  
STAGE S-IB  
CHAN 3P  
AXIS ROLL  
S. P. # 2

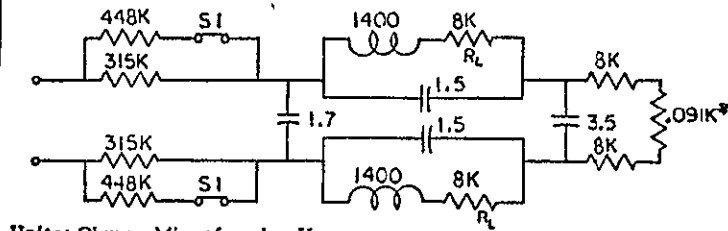

Units: Ohms, Microfarads, Henrys

\*Approximate dc resistance  
of Magnetic Amplifier windings

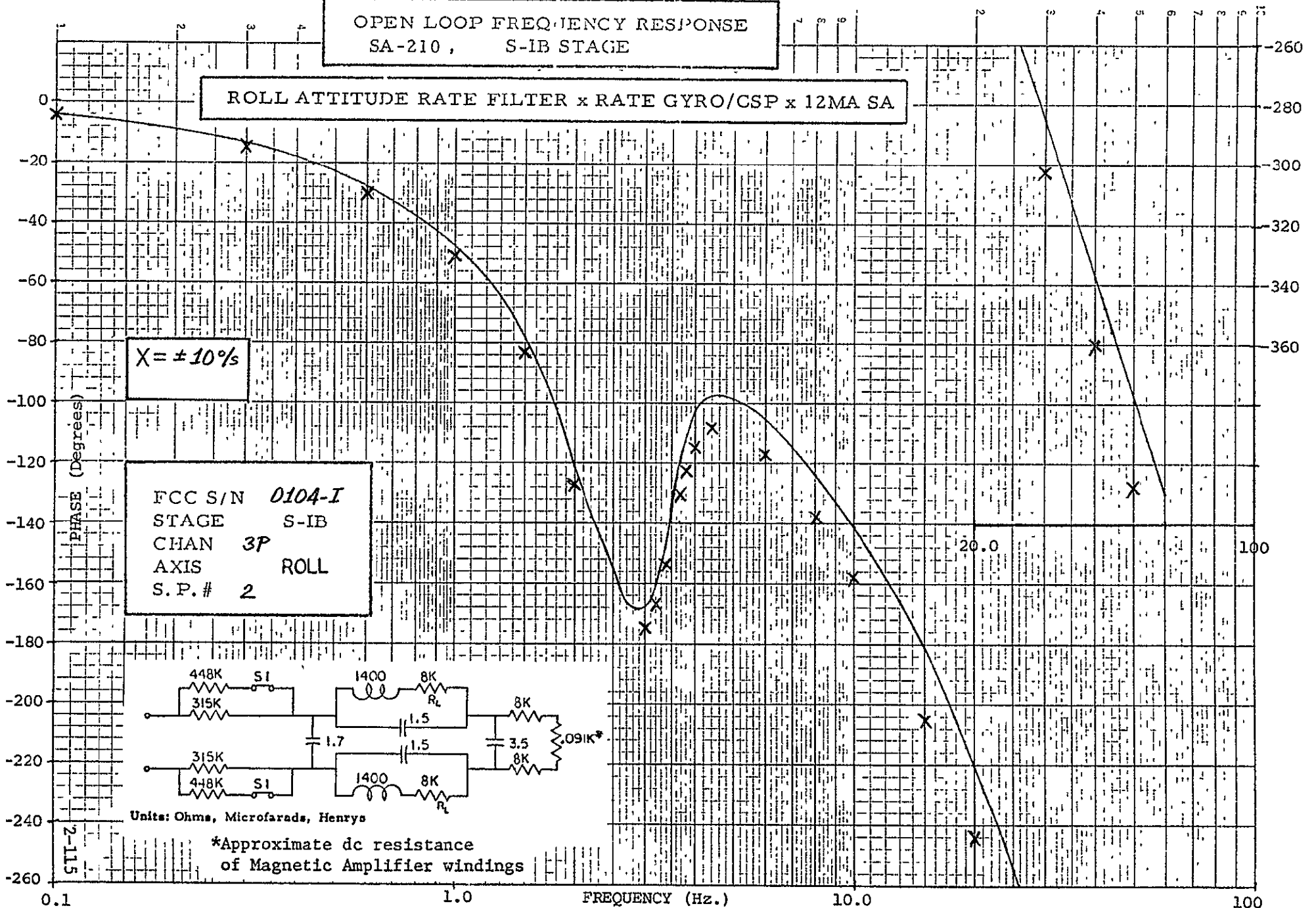

OPEN LOOP FREQUENCY RESPONSE  
SA-210, S-1B STAGE

ROLL ATTITUDE RATE FILTER x RATE GYRO/CSP x 12MA SA

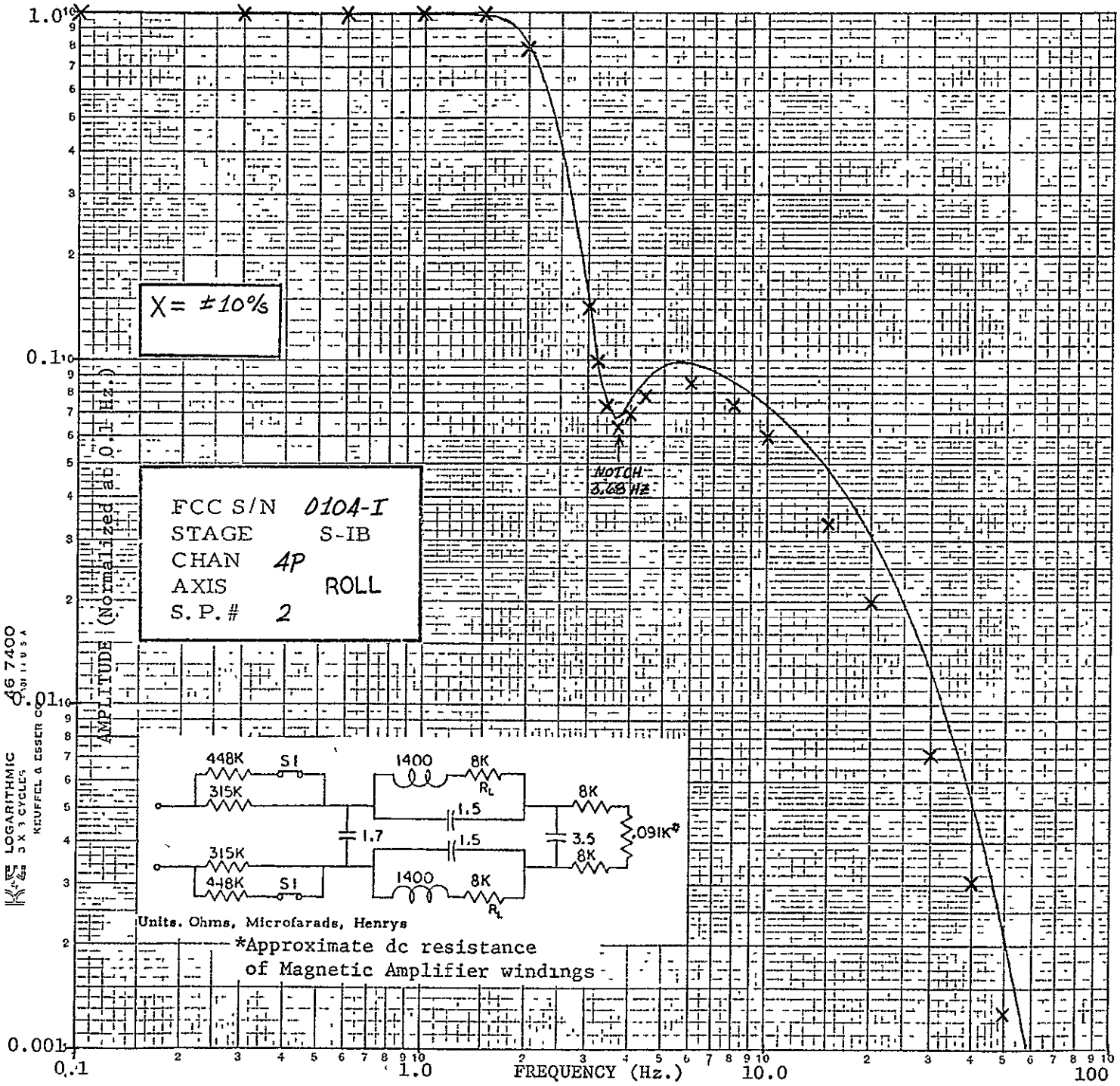

66 7400  
 KEUFFEL & ESSER CO.  
 LOGARITHMIC  
 3 X 3 CYCLES

ORIGINAL PAGE IS  
OF POOR QUALITY

OPEN LOOP FREQUENCY RESPONSE  
SA-210, S-IB STAGE

ROLL ATTITUDE RATE FILTER x RATE GYRO/CSP x 12MA SA

$\chi = \pm 10\%$

FCC S/N 0104-I  
STAGE S-IB  
CIAN 4P  
AXIS ROLL  
S.P.# 2

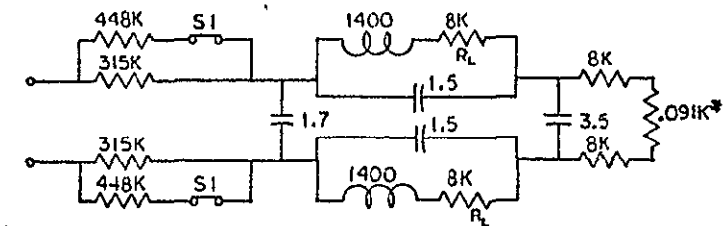

Units: Ohms, Microfarads, Henrys

\*Approximate dc resistance  
of Magnetic Amplifier windings

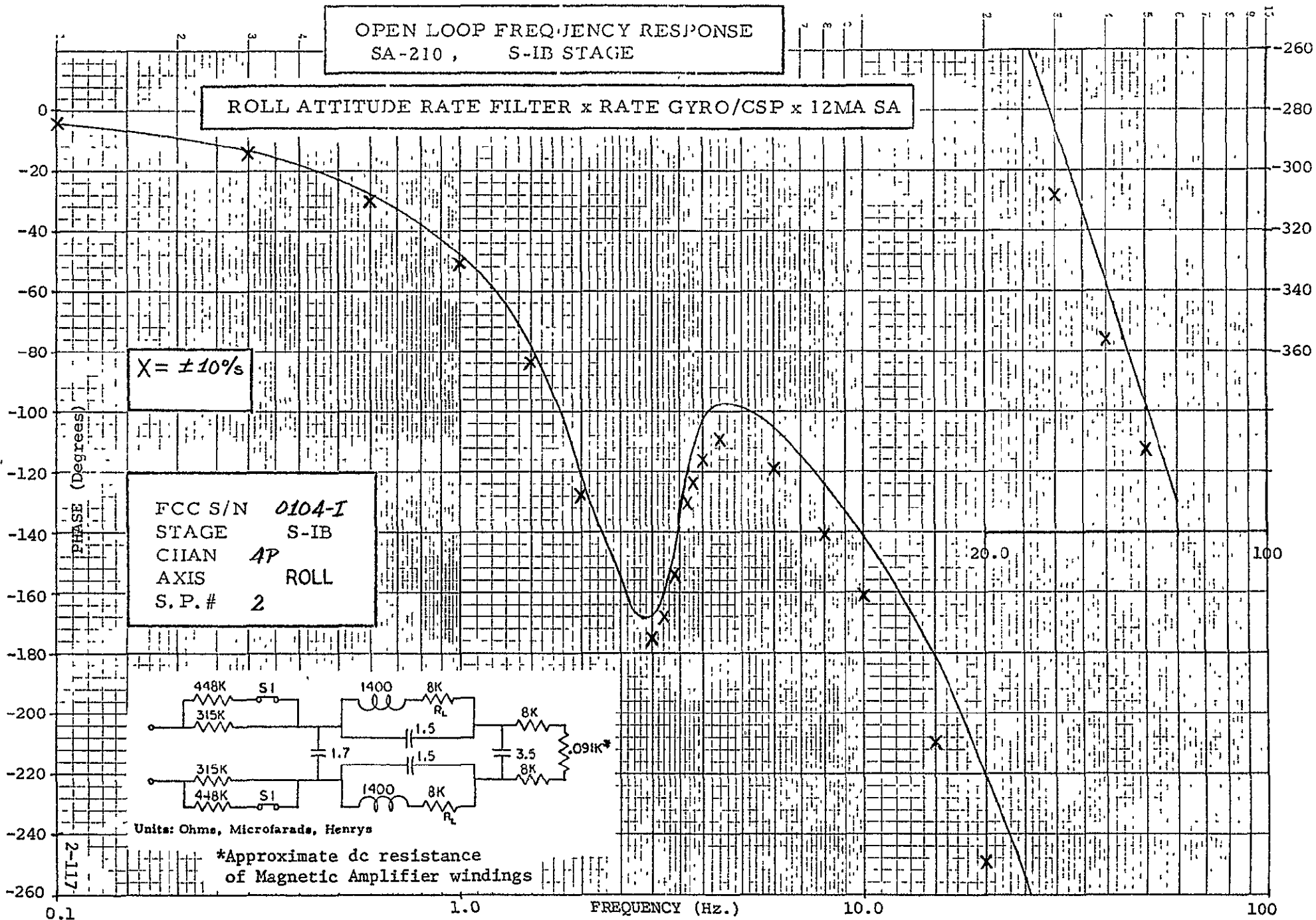

OPEN LOOP FREQUENCY RESPONSE  
SA-210, S-1B STAGE

ROLL ATTITUDE RATE FILTER x RATE GYRO/CSP x 12MA SA

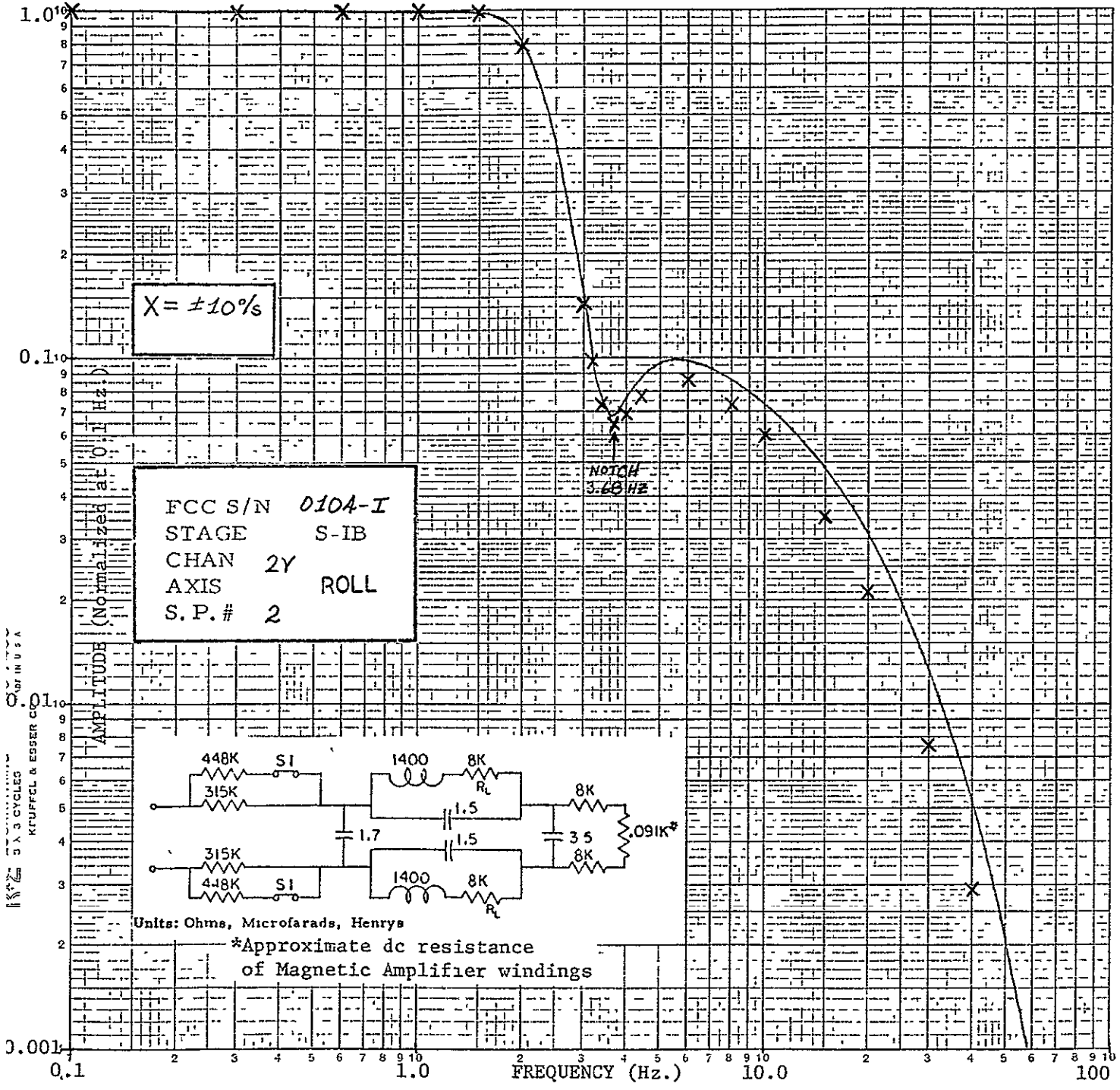

ORIGINAL PAGE IS  
OF POOR QUALITY

OPEN LOOP FREQUENCY RESPONSE  
SA-210, S-IB STAGE

ROLL ATTITUDE RATE FILTER x RATE GYRO/CSP x 12MA SA

$\chi = \pm 10\%$

FCC S/N 0104-I  
STAGE S-IB  
CHAN 2Y  
AXIS ROLL  
S.P.# 2

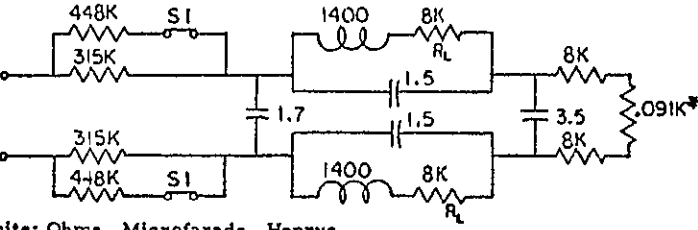

Units: Ohms, Microfarads, Henrys

\*Approximate dc resistance  
of Magnetic Amplifier windings

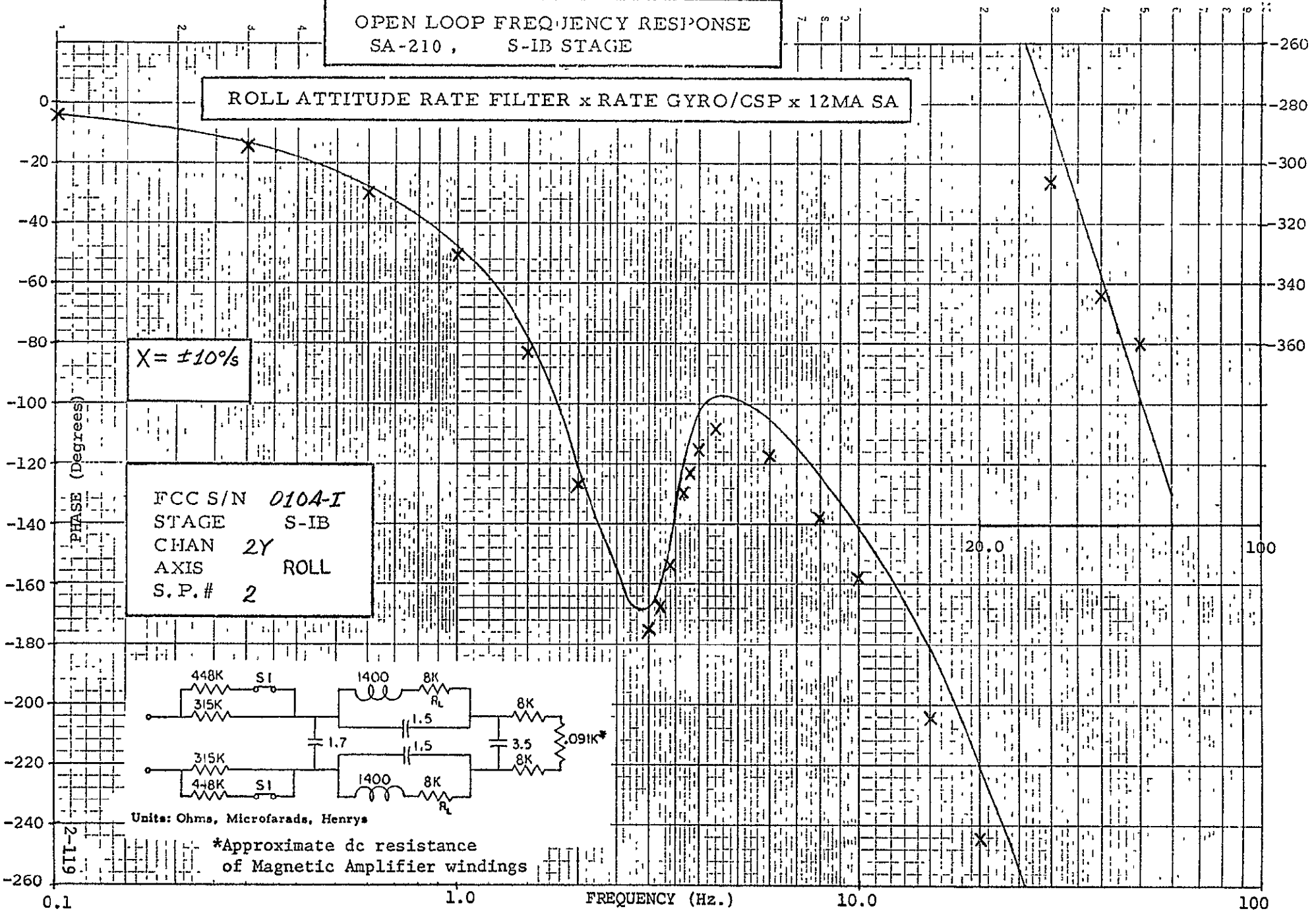

2-119



OPEN LOOP FREQUENCY RESPONSE  
SA-210, S-1B STAGE

ROLL ATTITUDE RATE FILTER x RATE GYRO/CSP x 12MA SA

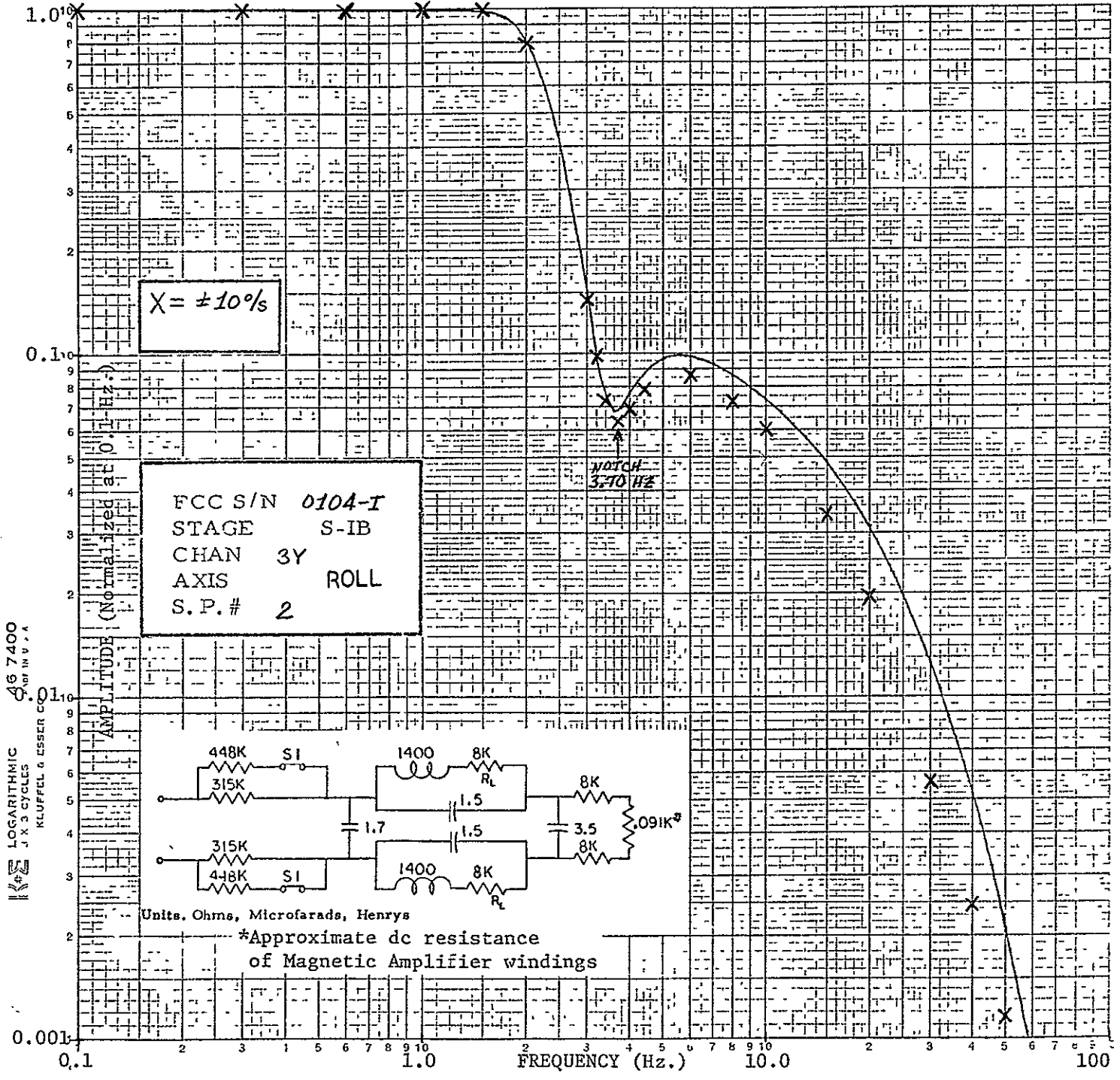

LOGARITHMIC  
 J X 3 CYCLES  
 KLUFFEL & ESSER CO.

46 7400  
 G. of IN. V. A.

OPEN LOOP FREQUENCY RESPONSE  
SA-210, S-IB STAGE

ROLL ATTITUDE RATE FILTER  $\times$  RATE GYRO/CSP  $\times$  12MA SA

$X = \pm 10\%$

FCC S/N 0104-I  
STAGE S-IB  
CHAN 3Y  
AXIS ROLL  
S.P.# 2

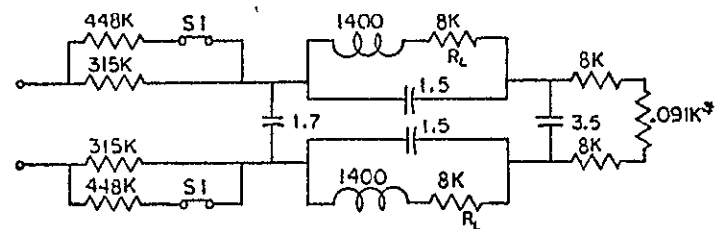
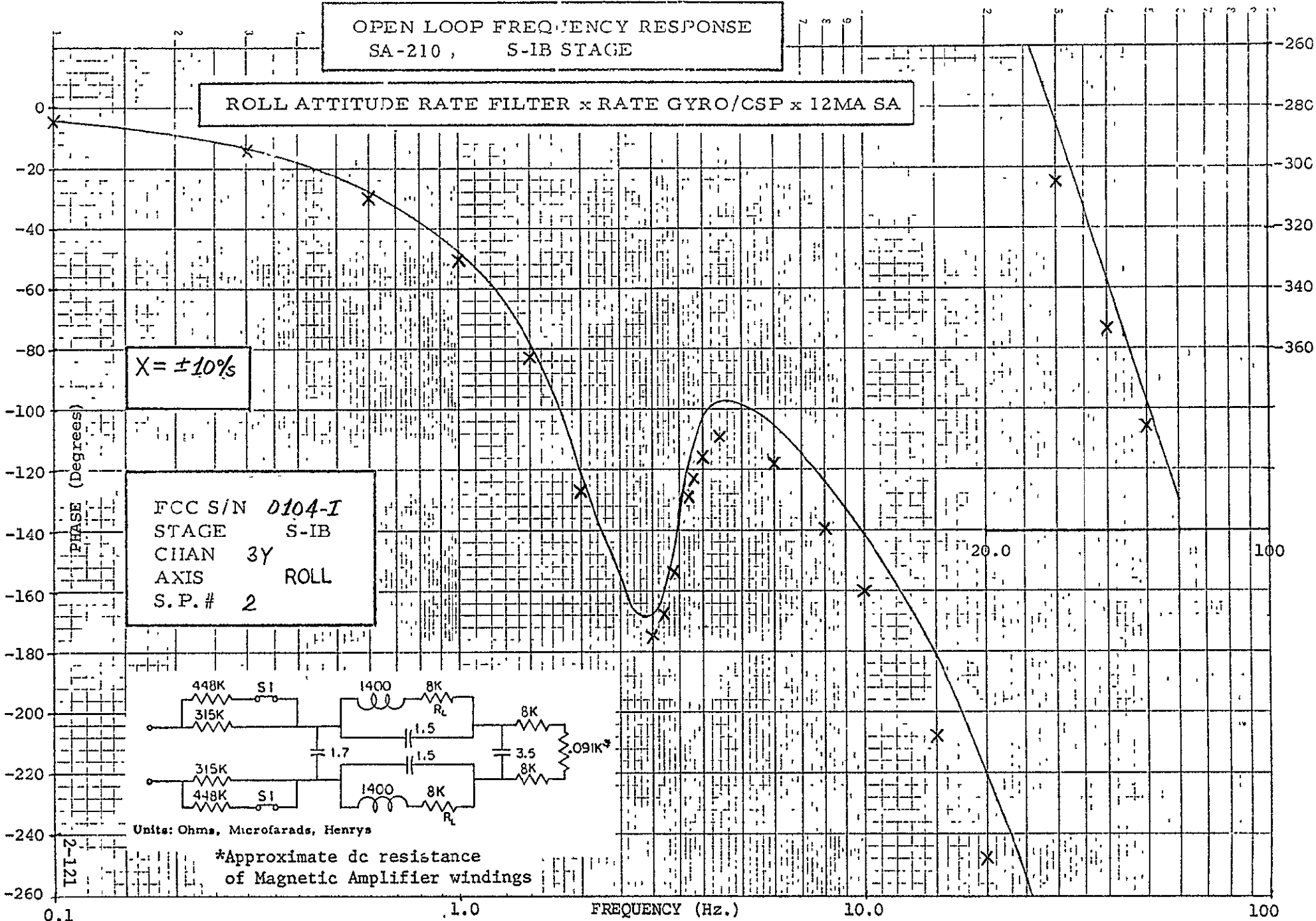

Units: Ohms, Microfarads, Henrys

\*Approximate dc resistance  
of Magnetic Amplifier windings

2-121

OPEN LOOP FREQUENCY RESPONSE  
SA-210 , S-IB STAGE

P - Y NORMAL ACCELERATION FILTER x ACCELEROMETER x 12MA SA

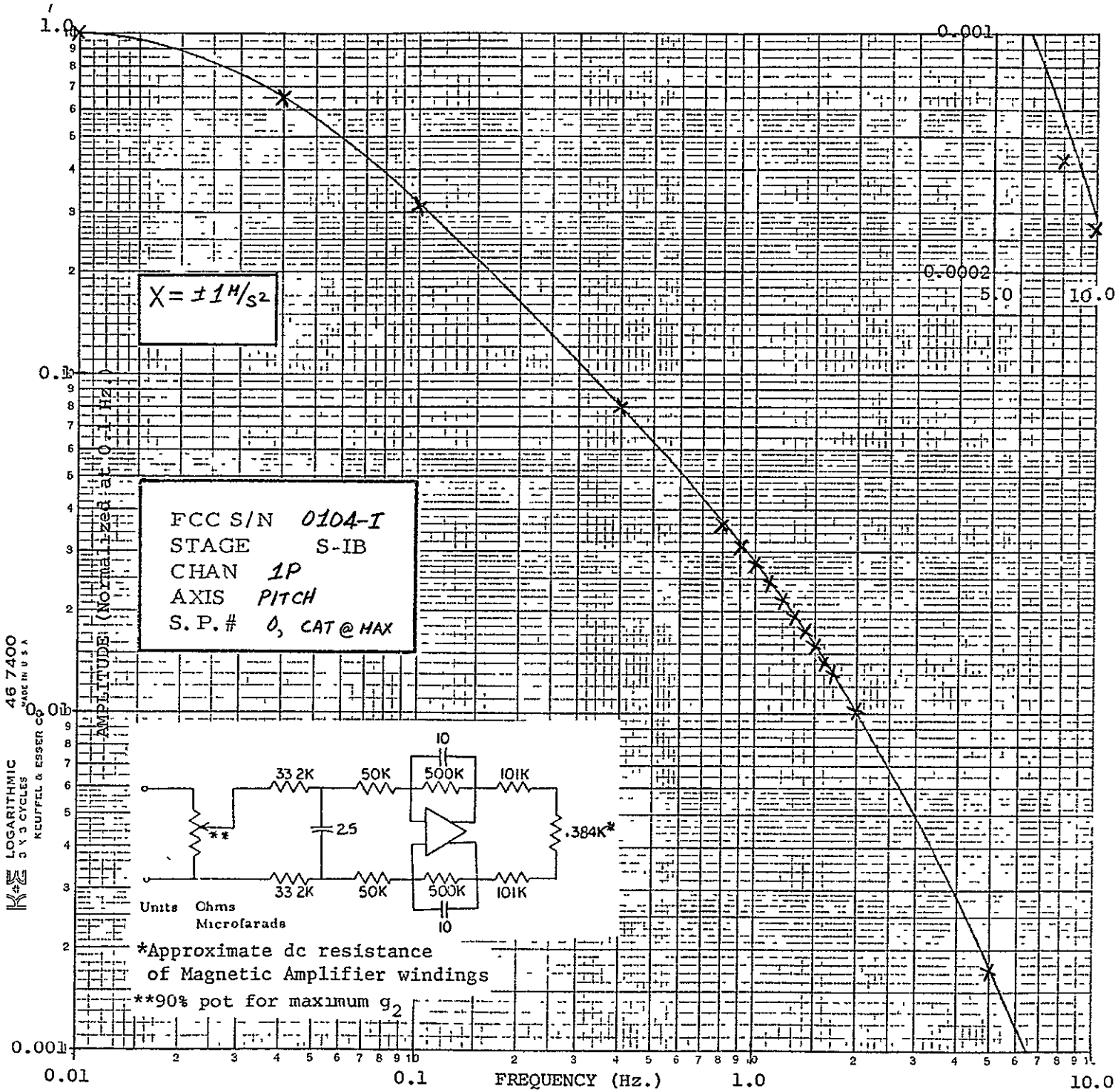

OPEN LOOP FREQUENCY RESPONSE  
SA-210., S-IB STAGE

P - Y NORMAL ACCELERATION FILTER x ACCELEROMETER x 12MA SA

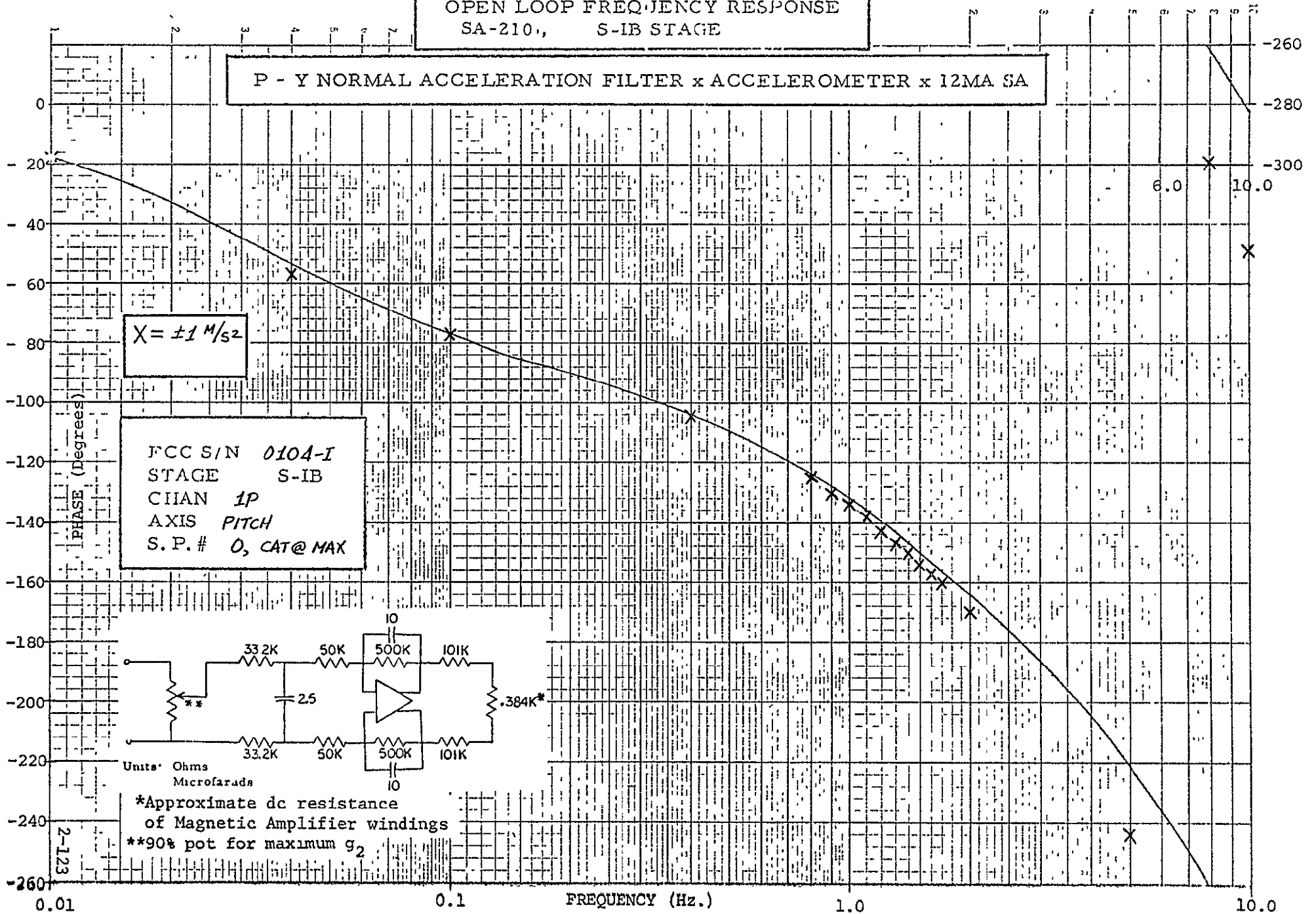

OPEN LOOP FREQUENCY RESPONSE  
SA-210 , S-IB STAGE

P - Y NORMAL ACCELERATION FILTER x ACCELEROMETER x 12MA SA

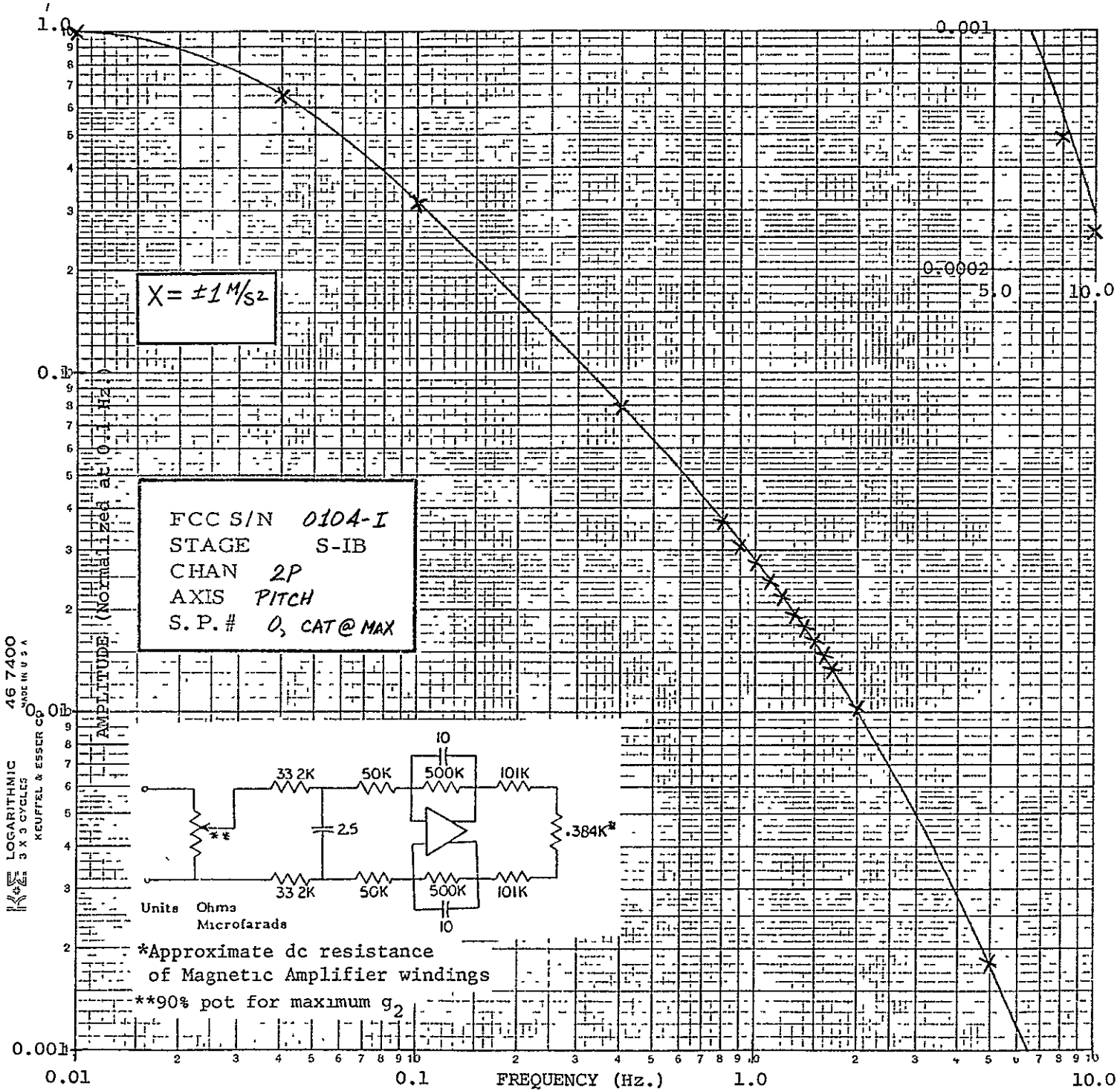

46 7400  
LOGARITHMIC  
3 X 3 CYCLES  
KEUFFEL & ESSER CO  
MADE IN U.S.A.

ORIGINAL PAGE IS  
OF POOR QUALITY

OPEN LOOP FREQUENCY RESPONSE  
SA-210., S-IB STAGE

P - Y NORMAL ACCELERATION FILTER x ACCELEROMETER x 12MA SA

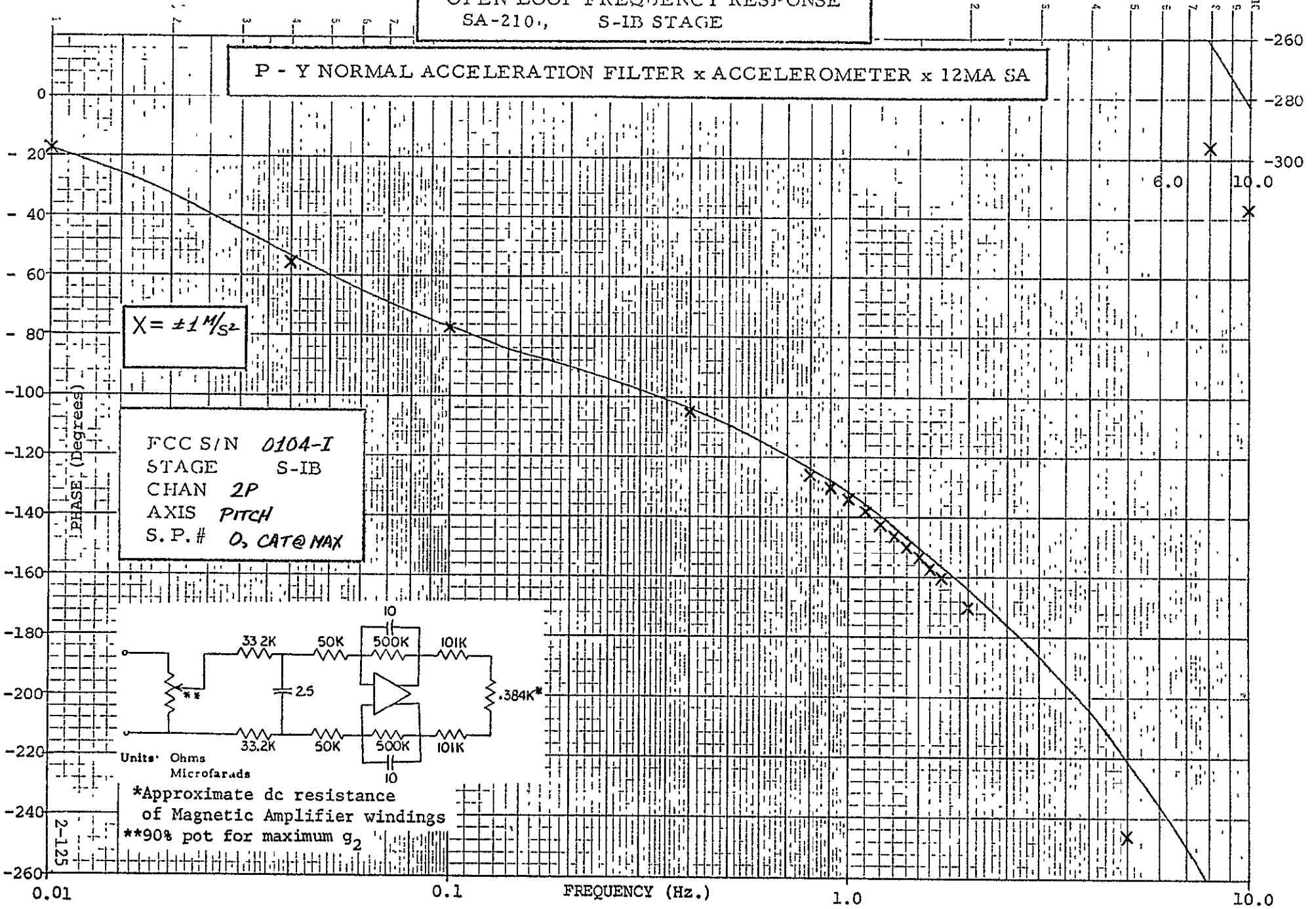

$X = \pm 1 M/S^2$

FCC S/N 010A-I  
STAGE S-IB  
CHAN 2P  
AXIS PITCH  
S.P.# 0, CAT@MAX

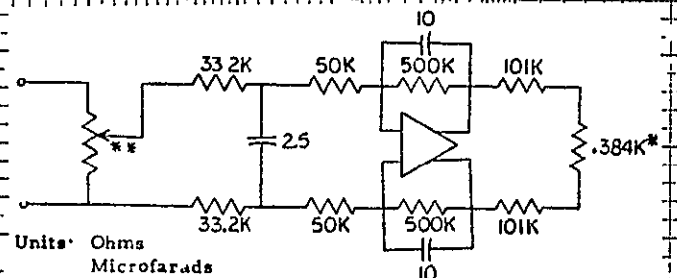

Units: Ohms  
Microfarads  
\*Approximate dc resistance  
of Magnetic Amplifier windings  
\*\*90% pot for maximum  $g_2$

2-125

OPEN LOOP FREQUENCY RESPONSE  
SA-210 , S-IB STAGE

P - Y NORMAL ACCELERATION FILTER x ACCELEROMETER x 12M4 SA

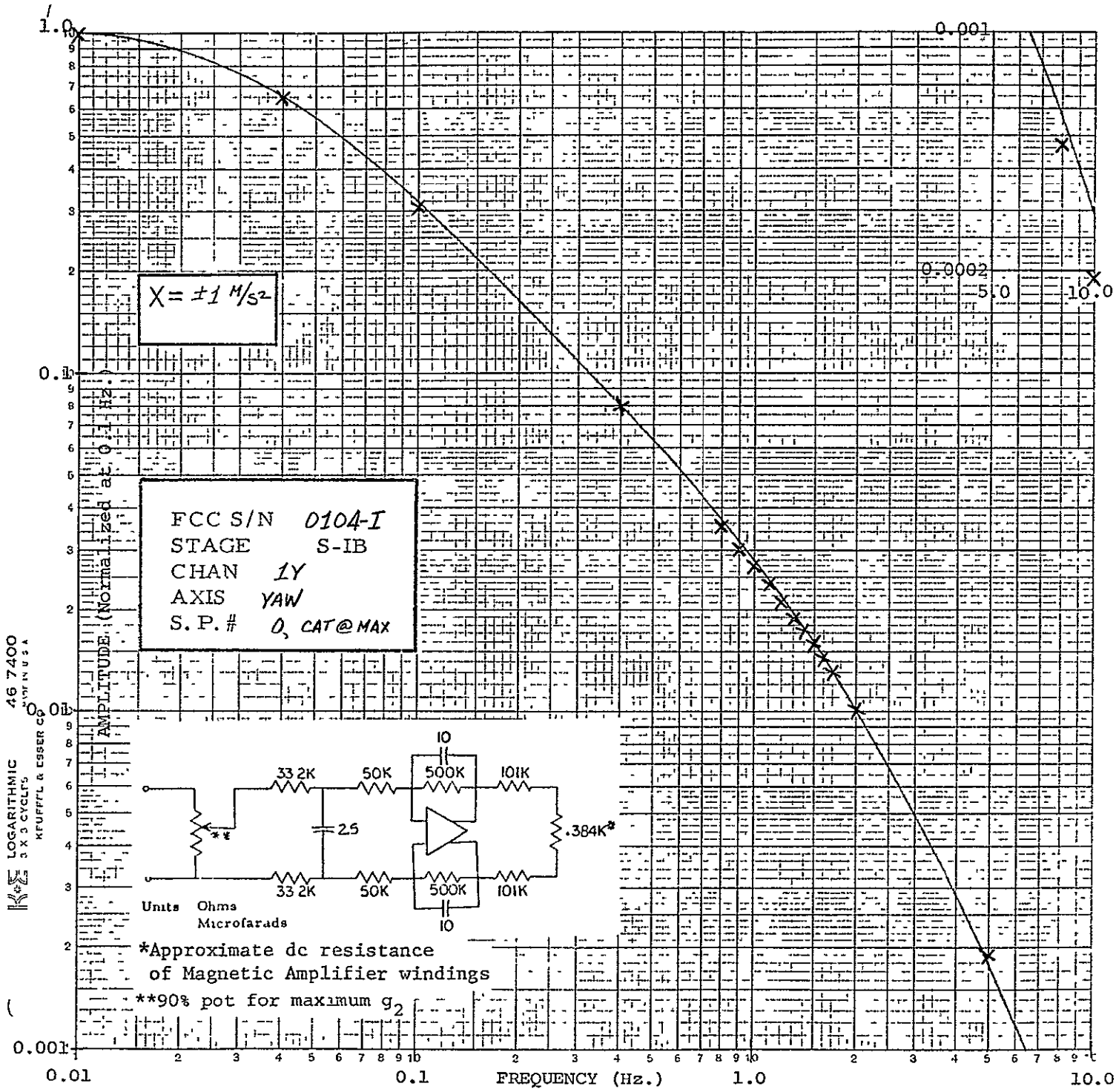

OPEN LOOP FREQUENCY RESPONSE  
SA-210, S-IB STAGE

P - Y NORMAL ACCELERATION FILTER x ACCELEROMETER x 12MA SA

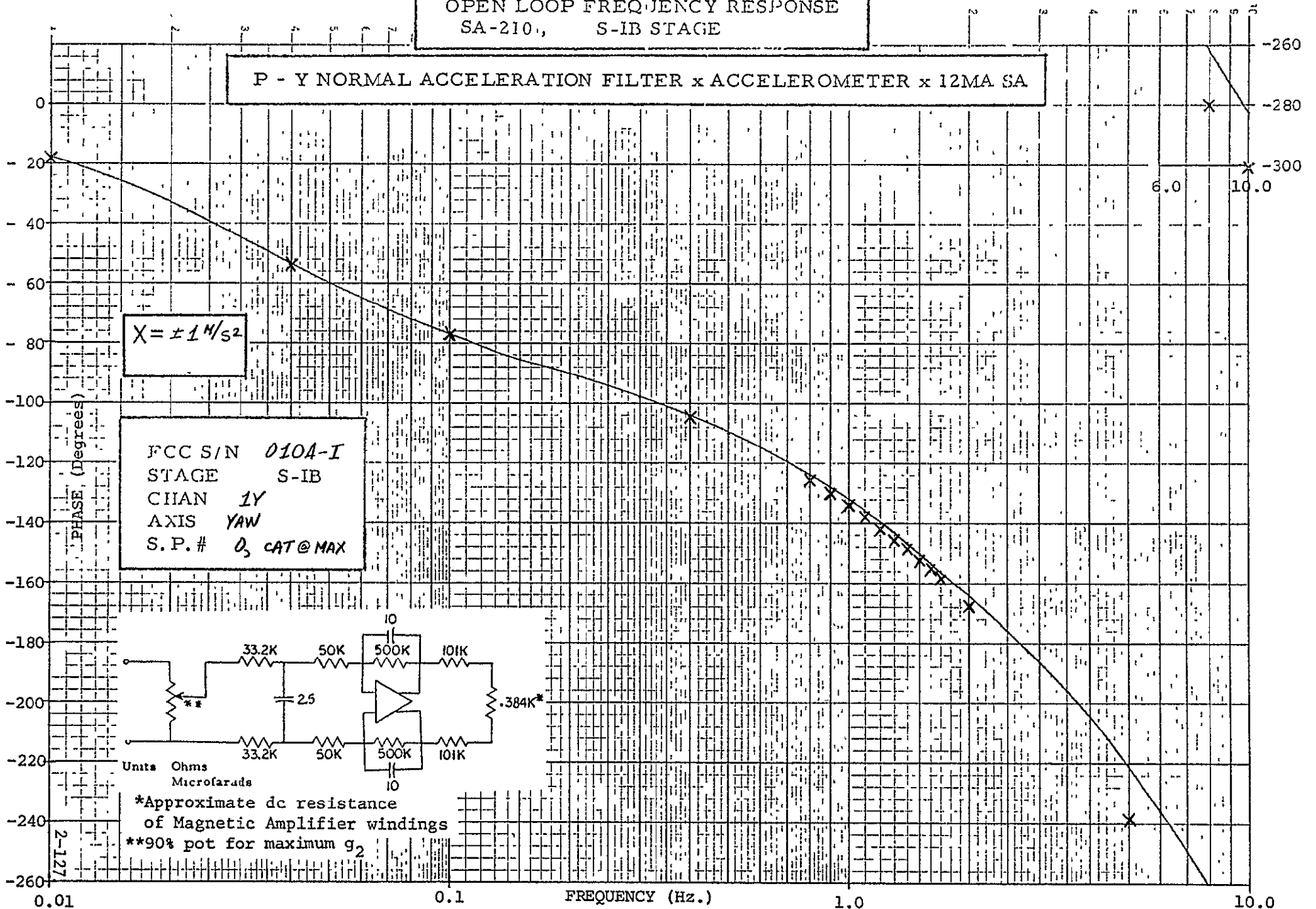

FCC S/N 010A-I  
STAGE S-IB  
CHAN 1Y  
AXIS YAW  
S.P.# 0, CAT@MAX

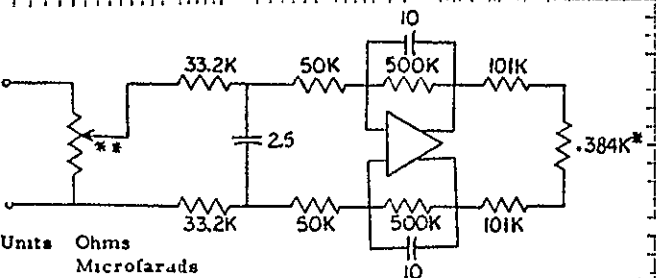

\*Approximate dc resistance of Magnetic Amplifier windings  
\*\*90% pot for maximum  $g_2$

2-127



**OPEN LOOP FREQUENCY RESPONSE**  
SA-210 , S-IB STAGE

**P - Y NORMAL ACCELERATION FILTER x ACCELEROMETER x 12MA SA**

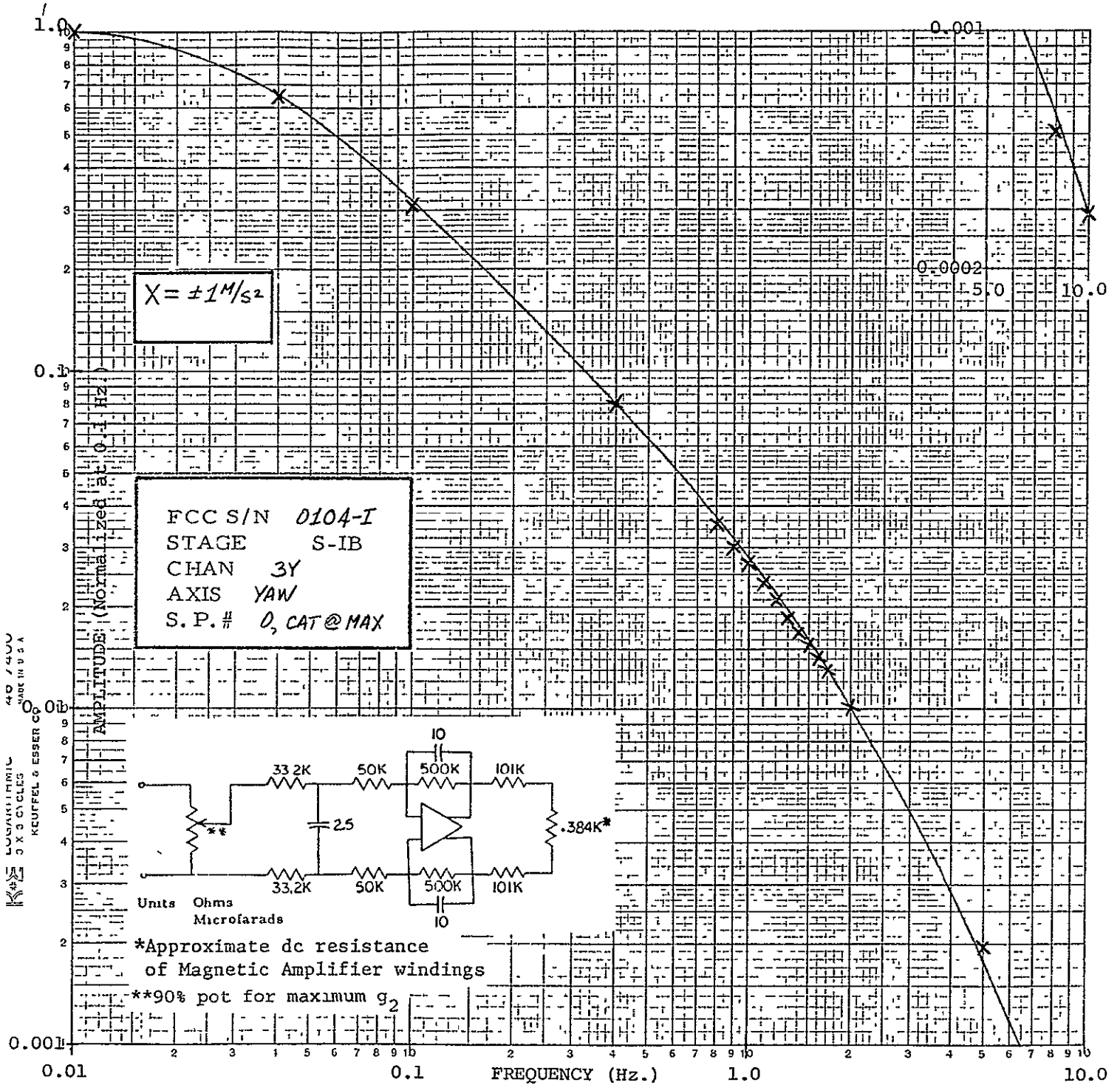

OPEN LOOP FREQUENCY RESPONSE  
SA-210, S-1B STAGE

P - Y NORMAL ACCELERATION FILTER x ACCELEROMETER x 12MA SA

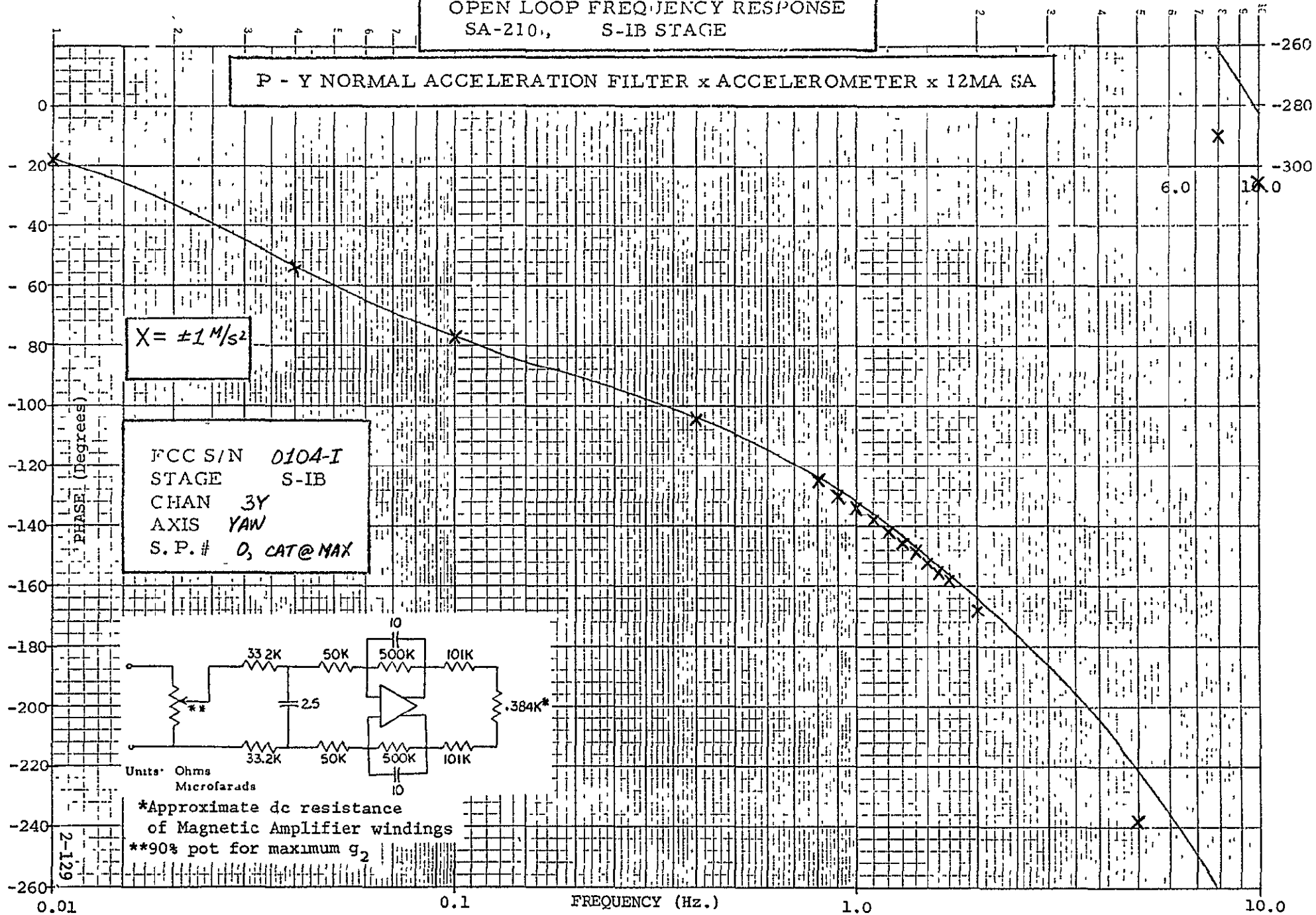

FCC S/N 0104-I  
STAGE S-1B  
CHAN 3Y  
AXIS YAW  
S.P.# 0, CAT@MAX

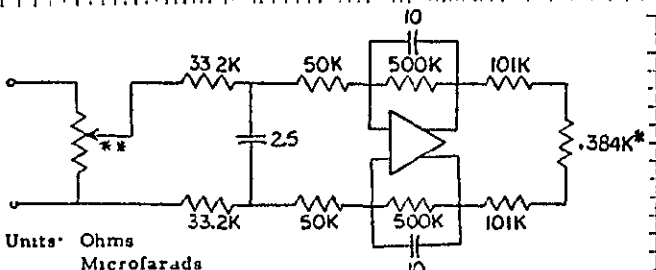

Units: Ohms  
Microfarads  
\*Approximate dc resistance  
of Magnetic Amplifier windings  
\*\*90% pot for maximum g<sub>2</sub>

2-129

AS-210 S-IB FCC VERIFY T=0.000 SECPITCH W/O SLOSH WITH CSP

T	0.0	A0	0.184930E 01	A1	0.164970E 01	G2	0.0	
C1	0.0	C2	0.756510E 00	K3	0.121720E 02	K4	0.603590E 01	
K5	0.111110E 01	K7	0.0	K8	0.237710E 02	FLCG	0.163830E 02	
FM	0.587760E 06	FMOI	0.764290E 08	SIG	0.330480E 04	THE	0.455730E 04	
FA	0.111110E 10	ZETA	0.100000E 01	FRGY	0.200000E 02	ZRGY	0.700000E 00	
RP	0.354760E 07							

POLYNOMIAL COEFFICIENTS

PHIF	NUMERATOR							
0.10000E 01	0.0	0.0	0.0	0.0	0.0	0.0	0.0	0.0
0.0	0.0	0.0	0.0	0.0	0.0	0.0	0.0	0.0
PHIF	DENOMINATOR							
0.10000E 01	0.17000E 00	0.0	0.0	0.0	0.0	0.0	0.0	0.0
0.0	0.0	0.0	0.0	0.0	0.0	0.0	0.0	0.0
PHIDF	NUMERATOR							
0.10000E 01	0.88440E-02	0.34880E-02	0.40554E-05	0.0	0.0	0.0	0.0	0.0
0.0	0.0	0.0	0.0	0.0	0.0	0.0	0.0	0.0
PHIDF	DENOMINATOR							
0.10000E 01	0.2464E 00	0.28859E-01	0.17132E-02	0.19468E-05	0.0	0.0	0.0	0.0
0.0	0.0	0.0	0.0	0.0	0.0	0.0	0.0	0.0
GDDF	NUMERATOR							
0.10000E 01	0.0	0.0	0.0	0.0	0.0	0.0	0.0	0.0
0.0	0.0	0.0	0.0	0.0	0.0	0.0	0.0	0.0
GDDF	DENOMINATOR							
0.10000E 01	0.50998E 01	0.49889E 00	0.0	0.0	0.0	0.0	0.0	0.0
0.0	0.0	0.0	0.0	0.0	0.0	0.0	0.0	0.0
WSS(BS)	NUMERATOR							
0.10000E 01	0.0	0.0	0.0	0.0	0.0	0.0	0.0	0.0
0.0	0.0	0.0	0.0	0.0	0.0	0.0	0.0	0.0
WSS(BS)	DENOMINATOR							
0.10000E 01	0.63000E-01	0.12323E-02	0.26847E-04	0.16694E-06	0.57735E-09	0.92928E-12	0.0	0.0
0.0	0.0	0.0	0.0	0.0	0.0	0.0	0.0	0.0
WSS(AS)	NUMERATOR							
0.10000E 01	0.0	0.0	0.0	0.0	0.0	0.0	0.0	0.0
0.0	0.0	0.0	0.0	0.0	0.0	0.0	0.0	0.0
WSS(AS)	DENOMINATOR							
0.10000E 01	0.63000E-01	0.12323E-02	0.26847E-04	0.16694E-06	0.57735E-09	0.92928E-12	0.0	0.0
0.0	0.0	0.0	0.0	0.0	0.0	0.0	0.0	0.0

FCC S/N 0104-I  
 STAGE S-IB  
 CHAN 4P, 2Y  
 AXIS PITCH, YAW  
 S.P.# 0

ORIGINAL PAGE IS  
 OF POOR QUALITY

T = 0.0 Sec. P-Y  
 VEHICLE PARAMETERS

NYQUIST FREQUENCY RESPONSE  
 SA-210, S-IB STAGE, PITCH AXIS DATA

AS-210 S-IB FCC VERIFY T=0.000 SECFITCH W/O SLOSH WITH CSP

BENDING DATA

MODE	1	2	3	4	5	6
FBM	1.1831E 00	1.6780E 10	2.0040E 00	2.1520E 00	2.5050E 10	3.1680E 10
ZM	6.8476E 03	6.2091E 04	1.2207E 04	3.0394E 03	6.5743E 04	1.1347E 05
ZB	1.0000E-02	1.0000E-02	1.0000E-02	1.0000E-02	1.0000E-02	1.0000E-02
YB	1.3436E-01	-6.4925E-02	-4.7817E-02	-3.9379E-02	1.9431E-01	-1.1327E-01
YFB	6.3484E-03	4.0704E-03	6.8597E-03	-3.6244E-03	1.8948E-02	-5.4545E-02
YFP	-1.4935E-02	-2.0790E-03	5.5334E-03	9.5693E-03	8.2567E-03	2.3832E-02
YA	6.5880E-02	-3.7943E-02	-9.9405E-02	-1.0667E-01	8.9382E-03	-6.3423E-02
YFRG	-1.4935E-02	-2.0790E-03	5.5334E-03	9.5693E-03	8.2567E-03	2.3832E-02

MODE	7	8	9	10	11	12
FBM	3.4670E 00	4.3430E 00	5.0040E 10	5.9840E 10	6.6520E 00	6.9780E 10
ZM	6.4899E 04	7.7074E 04	2.7414E 08	5.5987E 04	8.9156E 04	8.9086E 04
ZB	1.0000E-02	1.0000E-02	1.0000E-02	1.0000E-02	1.0000E-02	1.0000E-02
YB	3.4102E-01	7.3612E-02	-5.5359E-01	-2.2309E-01	-7.5348E-01	-2.8021E-04
YFB	9.5311E-02	-5.0335E-02	-1.7506E-01	-1.0634E-02	-9.6673E-02	2.0324E-02
YFP	4.3397E-02	5.1240E-02	5.3386E-02	6.0671E-03	3.1921E-02	6.1937E-03
YA	7.4190E-02	2.0433E-01	3.2507E-01	6.0681E-02	3.8478E-01	8.2494E-01
YFRG	4.3397E-02	5.1240E-02	5.3386E-02	6.0671E-03	3.1921E-02	6.1937E-03

MODE	13	14	15	16	17	18
FBM	7.5630E 10	0.0	0.0	0.0	0.0	0.0
ZM	1.8523E 05	0.0	0.0	0.0	0.0	0.0
ZB	1.0000E-02	0.0	0.0	0.0	0.0	0.0
YB	1.4822E-02	0.0	0.0	0.0	0.0	0.0
YFB	-2.5906E-02	0.0	0.0	0.0	0.0	0.0
YFP	1.2073E-02	0.0	0.0	0.0	0.0	0.0
YA	1.8122E-01	0.0	0.0	0.0	0.0	0.0
YFRG	1.2073E-02	0.0	0.0	0.0	0.0	0.0

SLOSHING DATA

MODE	1	2	3	4	5	6
FFS	7.9497E-01	7.9497E-01	6.5364E-01	4.2398E-01	6.8014E-01	9.9280E-01
ZS	3.1500E-02	6.0000E-02	2.0000E-03	5.0000E-05	5.0000E-02	5.0000E-02
FMS	8.0000E 02	1.1450E 03	3.8500E 03	3.4300E 03	1.2200E 04	1.3000E 03
XSS	-2.0236E 00	-2.2956E 00	-2.0456E 00	-1.7945E 01	-1.1722E 01	-1.1272E 01

FCC S/N 0104-I  
 STAGE S-IB  
 CHAN 4P, 2Y  
 AXIS PITCH, YAW  
 S.P.# 0

T = 0.0 Sec. P-Y  
 VEHICLE PARAMETERS

NYQUIST FREQUENCY RESPONSE  
 SA-210, S-IB STAGE, PITCH AXIS DATA

AG-210 S-IB FCC VERIFY T=0.000 SEC  
 PITCH W/O BLOOM WITH CBP

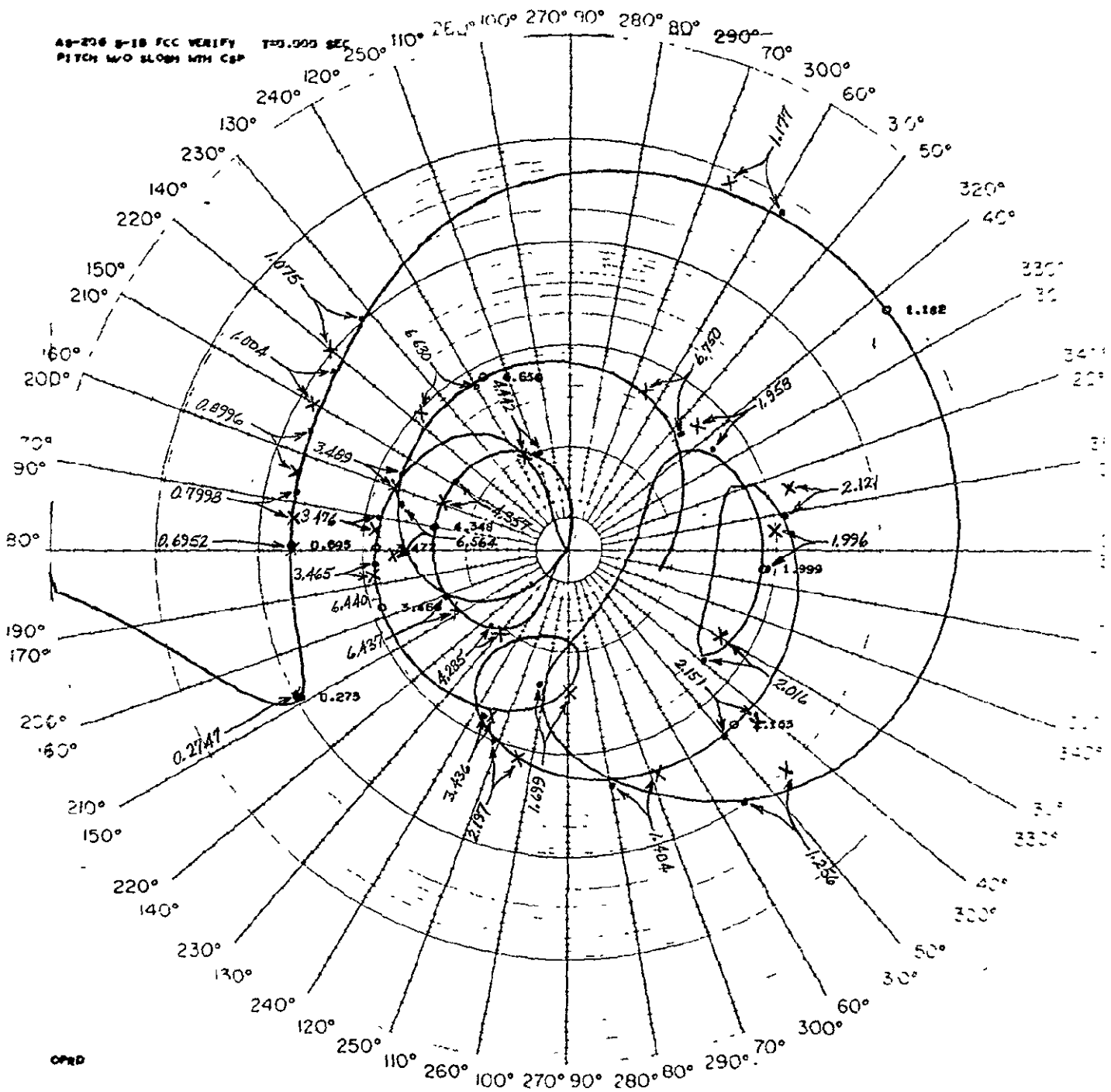

FCC S/N 0104-I  
 STAGE S-IB  
 CHAN AP  
 AXIS PITCH  
 S.P.# 0

◉ SIMULATION  
 x HARDWARE

T = 0.0 Sec, P-Y  
 OPEN AT ACTUATOR  
 NOMINAL CASE

NYQUIST FREQUENCY RESPONSE  
 SA-210, S-IB STAGE, PITCH AXIS DATA

ORIGINAL PAGE IS  
 OF POOR QUALITY

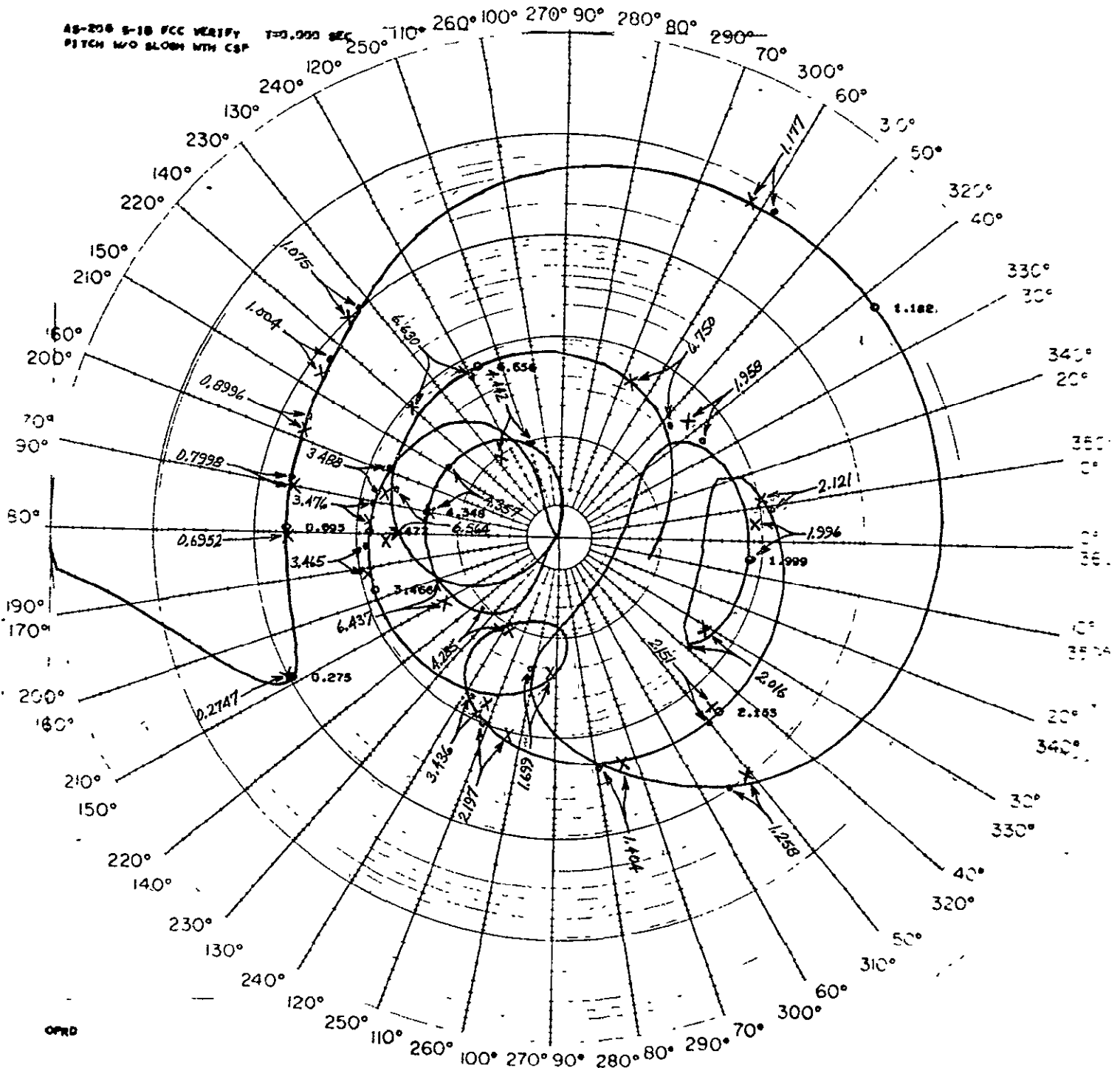

FCC S/N 0104-I  
STAGE S-IB  
CHAN 2Y  
AXIS YAW  
S.P.# 0

● SIMULATION  
x HARDWARE

T = 0.0 Sec. P-Y  
OPEN AT ACTUATOR  
NOMINAL CASE

NYQUIST FREQUENCY RESPONSE  
SA-210, S-IB STAGE, PITCH AXIS DATA

AS-206 S-IB FCC VERIFY T=80.00 SECPITCH W/O SLOSH WITH CSP

T	0.800000E 02	AD	0.184930E 01	A1	0.164970E 01	G2	0.692118E-01
C1	-0.773995E 00	C2	0.954487E 00	K3	0.215080E 02	K4	0.114300E 02
K5	0.187890E-02	K7	0.160040E 02	K8	0.229000E 02	FLCG	0.172540E 02
FH	0.356570E 06	FMOI	0.736720E 08	SIG	0.330480E 04	THE	0.455070E 04
FA	0.900000E 01	ZETA	0.800000E 00	FRGY	0.200000E 02	ZRGY	0.700000E 00
RP	0.407580E 07						

POLYNOMIAL COEFFICIENTS

PHIF NUMERATOR							
0.10000E 01	0.0	0.0	0.0	0.0	0.0	0.0	0.0
0.0	0.0	0.0	0.0	0.0	0.0	0.0	0.0
PHIF DENOMINATOR							
0.10000E 01	0.17000E 00	0.0	0.0	0.0	0.0	0.0	0.0
0.0	0.0	0.0	0.0	0.0	0.0	0.0	0.0
PHIDF NUMERATOR							
0.10000E 01	0.88438E-02	0.34882E-02	-0.40554E-05	0.0	0.0	0.0	0.0
0.0	0.0	0.0	0.0	0.0	0.0	0.0	0.0
PHIDF DENOMINATOR							
0.10000E 01	0.24640E 00	0.28859E-01	0.17132E-02	0.19468E-05	0.0	0.0	0.0
0.0	0.0	0.0	0.0	0.0	0.0	0.0	0.0
GDDF NUMERATOR							
0.10000E 01	0.0	0.0	0.0	0.0	0.0	0.0	0.0
0.0	0.0	0.0	0.0	0.0	0.0	0.0	0.0
GDDF DENOMINATOR							
0.10000E 01	0.51014E 01	0.50604E 00	0.0	0.0	0.0	0.0	0.0
0.0	0.0	0.0	0.0	0.0	0.0	0.0	0.0
WSS (BS) NUMERATOR							
0.10000E 01	0.0	0.0	0.0	0.0	0.0	0.0	0.0
0.0	0.0	0.0	0.0	0.0	0.0	0.0	0.0
WSS (BS) DENOMINATOR							
0.10000E 01	0.63080E-01	0.12323E-02	0.26847E-04	0.16694E-06	0.57735E-09	0.92928E-12	0.0
0.0	0.0	0.0	0.0	0.0	0.0	0.0	0.0
WSS (AS) NUMERATOR							
0.10000E 01	0.0	0.0	0.0	0.0	0.0	0.0	0.0
0.0	0.0	0.0	0.0	0.0	0.0	0.0	0.0
WSS (AS) DENOMINATOR							
0.10000E 01	0.63080E-01	0.12323E-02	0.26847E-04	0.16694E-06	0.57735E-09	0.92928E-12	0.0
0.0	0.0	0.0	0.0	0.0	0.0	0.0	0.0

FCC S/N 0104-I  
 STAGE S-IB  
 CHAN 1P, 1Y  
 AXIS PITCH, YAW  
 S.P.# 0

T = 80 Sec. P-Y  
 VEHICLE PARAMETERS

NYQUIST FREQUENCY RESPONSE  
 SA-210, S-IB STAGE, PITCH AXIS DATA

AS-206 S-IB FCC VERIFY T=80.00 BECPITCH W/O SLOSH WITH CSP

BENDING DATA

MODE	1	2	3	4	5	6
FBM	1.3260E 00	2.3270E 00	2.6230E 00	3.2560E 00	4.2970E 00	4.9250E 10
ZM	4.4540E 03	2.7804E 03	2.6820E 04	4.2950E 04	2.4519E 04	3.9818E 04
ZB	1.0000E-02	1.0000E-02	1.0000E-02	1.0000E-02	1.0000E-02	1.0000E-02
YB	6.2872E-02	-3.9317E-02	6.1512E-02	5.5151E-02	3.2276E-01	5.3159E-01
YPB	5.4671E-03	-1.6961E-03	-3.2129E-03	-2.6698E-02	5.8733E-02	8.8198E-02
YPP	-1.2490E-02	1.4793E-02	6.5995E-03	8.3091E-03	3.4825E-03	1.7880E-02
YA	1.1302E-02	-1.0643E-01	-2.2581E-02	-9.5487E-03	3.2116E-02	1.2045E-01
YPRG	-1.2490E-02	1.4793E-02	6.5995E-03	8.3091E-03	3.4825E-03	1.7880E-02

MODE	7	8	9	10	11	12
FBM	5.5490E 10	6.5320E 00	0.0	0.0	0.0	0.0
ZM	4.0251E 04	3.1950E 04	0.0	0.0	0.0	0.0
ZB	1.0000E-02	1.0000E-02	0.0	0.0	0.0	0.0
YB	-2.5502E-01	-1.0455E-02	0.0	0.0	0.0	0.0
YPB	-9.6503E-02	-6.4500E-02	0.0	0.0	0.0	0.0
YPP	2.3756E-03	2.6019E-02	0.0	0.0	0.0	0.0
YA	9.2003E-03	4.7220E-01	0.0	0.0	0.0	0.0
YPRG	2.3756E-03	2.6019E-02	0.0	0.0	0.0	0.0

MODE	13	14	15	16	17	18
FBM	0.0	0.0	0.0	0.0	0.0	0.0
ZM	0.0	0.0	0.0	0.0	0.0	0.0
ZB	0.0	0.0	0.0	0.0	0.0	0.0
YB	0.0	0.0	0.0	0.0	0.0	0.0
YPB	0.0	0.0	0.0	0.0	0.0	0.0
YPP	0.0	0.0	0.0	0.0	0.0	0.0
YA	0.0	0.0	0.0	0.0	0.0	0.0
YPRG	0.0	0.0	0.0	0.0	0.0	0.0

SLOSHING DATA

MODE	1	2	3	4	5	6
FFS	1.0600E 00	1.0600E 00	8.7153E-01	5.6532E-01	9.0686E-01	1.3662E 00
ZS	1.2500E-02	1.2500E-02	6.0000E-02	5.0000E-03	5.0000E-02	5.0000E-02
FMS	8.0000E 02	1.1450E 03	3.8500E 03	3.4300E 03	1.2200E 04	1.3000E 03
XBS	7.8466E 00	7.7746E 00	8.0746E 00	-1.7074E 01	-1.0651E 01	-1.0401E 01

FCC S/N 0104-I  
 STAGE S-IB  
 CHAN 1P, 1Y  
 AXIS PITCH, YAW  
 S.P.# 0

T = 80 Sec. P-Y  
 VEHICLE PARAMETERS

NYQUIST FREQUENCY RESPONSE  
 SA-210, S-IB STAGE, PITCH AXIS DATA



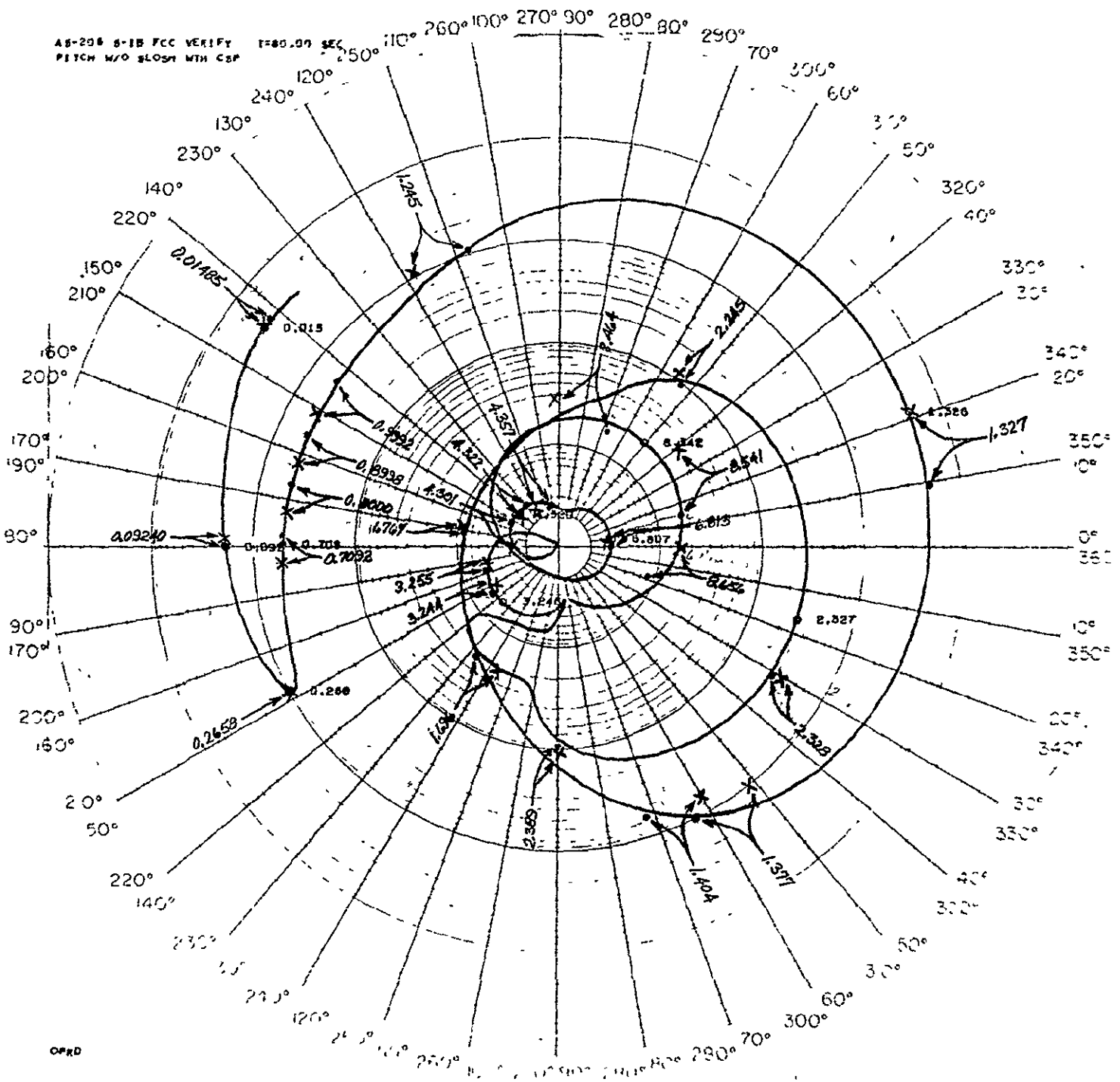

FCC S/N 010A-I  
 STAGE S-IB  
 CHAN 1P  
 AXIS PITCH  
 S. P. # 0

○ SIMULATION  
 x HARDWARE

T = 80 Sec. P-Y  
 OPEN AT ACTUATOR  
 NOMINAL CASE

NYQUIST FREQUENCY RESPONSE  
 SA-210, S-IB STAGE, PITCH AXIS DATA

AG-206 S-IB FCC VERIFY  
PITCH W/O BLOSH WTH CSP

T=80.00 SEC

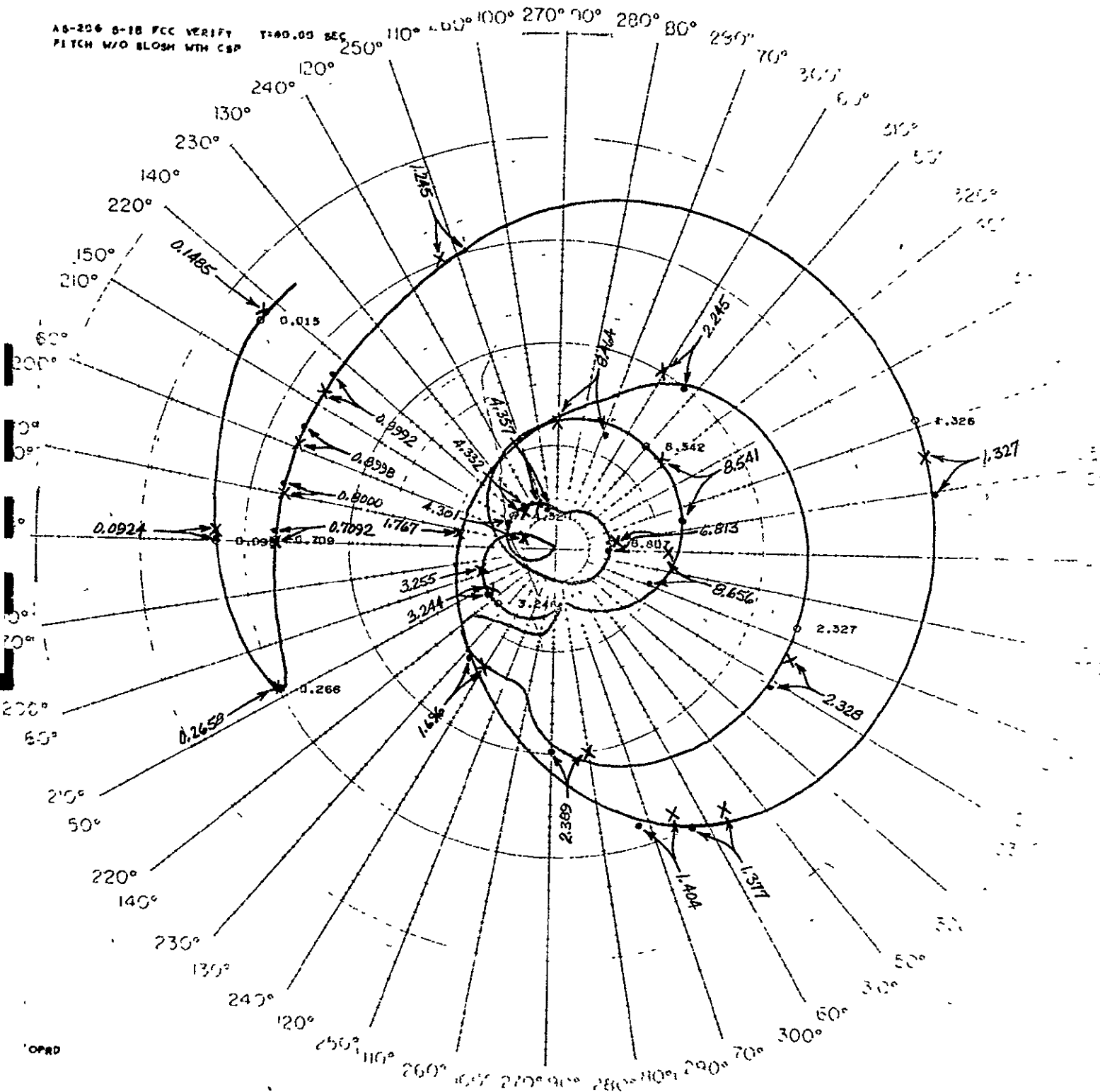

FCC S/N 0104-I  
STAGE S-IB  
CHAN 1Y  
AXIS YAN  
S.P.# 0

o SIMULATION  
x HARDWARE

T = 80 Sec. P-Y  
OPEN AT ACTUATOR  
NOMINAL CASE

NYQUIST FREQUENCY RESPONSE  
SA-210, S-IB STAGE, PITCH AXIS DATA

AS-210 S-IB FCC VERIFY T=120.- SECFITCH W/O SLOSH WITH CSP

T	0.120000E 03	A1	0.109970E 01	A1	0.129320E 01	G2	0.0
C1	-0.726307E-01	C2	0.148650E 01	K3	0.335310E 02	K4	0.169620E 02
K5	0.735900E-03	K7	0.281930E 01	K8	0.185950E 02	FLCG	0.21559 10 02
FM	0.241190E 06	FMO1	0.593350E 03	SIG	0.330480E 04	THE	0.459330E 04
FA	0.100000E 10	ZETA	0.100000E 01	FRGY	0.200000E 02	ZRGY	0.700000E 00
XF	0.409110E 07						

BENDING DATA

MODE	1	2	3	4	5	6
FBM	1.3380E 00	2.3410E 00	5.8430E 00	7.5080E 00	7.7100E 00	9.1540E 00
ZM	4.4353E 03	2.7631E 03	5.3045E 03	2.2441E 04	8.4267E 03	2.2001E 04
ZB	1.0000E-02	1.0000E-02	1.0000E-02	1.0000E-02	1.0000E-02	1.0000E-02
YB	9.7277E-02	-3.3782E-02	5.8644E-02	-3.5400E-01	2.4831E-01	-1.9562E-01
YPB	9.9919E-03	-1.7821E-03	2.6408E-04	-1.5497E-01	5.4829E-02	-6.8164E-02
YFP	-1.2153E-02	1.5180E-02	2.0051E-03	6.5314E-04	1.0402E-02	2.2374E-02
YA	9.9367E-03	-1.0599E-01	1.9172E-02	8.1641E-03	1.6234E-01	4.4827E-01
YPRG	-1.2153E-02	1.5180E-02	2.0051E-03	6.5314E-04	1.0402E-02	2.2374E-02

SLOSHING DATA

MODE	1	2	3	4	5	6
FS	1.3250E 00	1.3250E 00	1.0894E 00	7.0665E-01	1.1336E 00	1.7077E 00
ZS	6.0000E-02	6.0000E-02	6.0000E-02	5.0000E-05	5.0000E-02	5.0000E-02
FMS	8.0000E 02	1.1490E 03	3.8000E 03	3.4303E 03	1.2200E 04	1.3000E 03
YDS	1.6302E 01	1.6630E 01	1.6930E 01	-1.2769E 01	-6.5456E 00	-6.0956E 00

POLYNOMIAL COEFFICIENTS

PHIF NUMERATOR

0.100000E 01	0.0	0.0	0.0	0.0	0.0	0.0
0.0	0.0	0.0	0.0	0.0	0.0	0.0

PHIF DENOMINATOR

0.100000E 01	0.172000E 00	0.0	0.0	0.0	0.0	0.0
0.0	0.0	0.0	0.0	0.0	0.0	0.0

PHIDF NUMERATOR

0.100000E 01	0.88438E-02	0.34882E-02	0.40554E-05	0.0	0.0	0.0
0.0	0.0	0.0	0.0	0.0	0.0	0.0

PHIDF DENOMINATOR

0.100000E 01	0.24950E 00	0.29453E-01	0.17640E-02	0.20048E-05	0.0	0.0
0.0	0.0	0.0	0.0	0.0	0.0	0.0

GDDF NUMERATOR

0.100000E 01	0.0	0.0	0.0	0.0	0.0	0.0
0.0	0.0	0.0	0.0	0.0	0.0	0.0

GDDF DENOMINATOR

0.100000E 01	0.50998E 01	0.49880E 00	0.0	0.0	0.0	0.0
0.0	0.0	0.0	0.0	0.0	0.0	0.0

WSS (DS) NUMERATOR

0.100000E 01	0.0	0.0	0.0	0.0	0.0	0.0
0.0	0.0	0.0	0.0	0.0	0.0	0.0

WSS (DS) DENOMINATOR

0.100000E 01	0.63080E-01	0.12323E-02	0.26047E-04	0.16694E-06	0.57735E-09	0.92928E-12
0.0	0.0	0.0	0.0	0.0	0.0	0.0

WSS (AS) NUMERATOR

0.100000E 01	0.0	0.0	0.0	0.0	0.0	0.0
0.0	0.0	0.0	0.0	0.0	0.0	0.0

WSS (AS) DENOMINATOR

0.100000E 01	0.63080E-01	0.12323E-02	0.26047E-04	0.16694E-06	0.57735E-09	0.92928E-12
0.0	0.0	0.0	0.0	0.0	0.0	0.0

FCC S/N 0104-I  
 STAGE S-IB  
 CHAN 3P, 3Y  
 AXIS PITCH, YAW  
 S.P.# 2

T = 120- Sec. P-Y  
 VEHICLE PARAMETERS

NYQUIST FREQUENCY RESPONSE  
 SA-210, S-IB STAGE, PITCH AXIS DATA

ORIGINAL PAGE IS  
 OF POOR QUALITY

AS-210 S-IB FCC VERIFY T=120- SEC  
PITCH W/O BLOSS WITH CSP

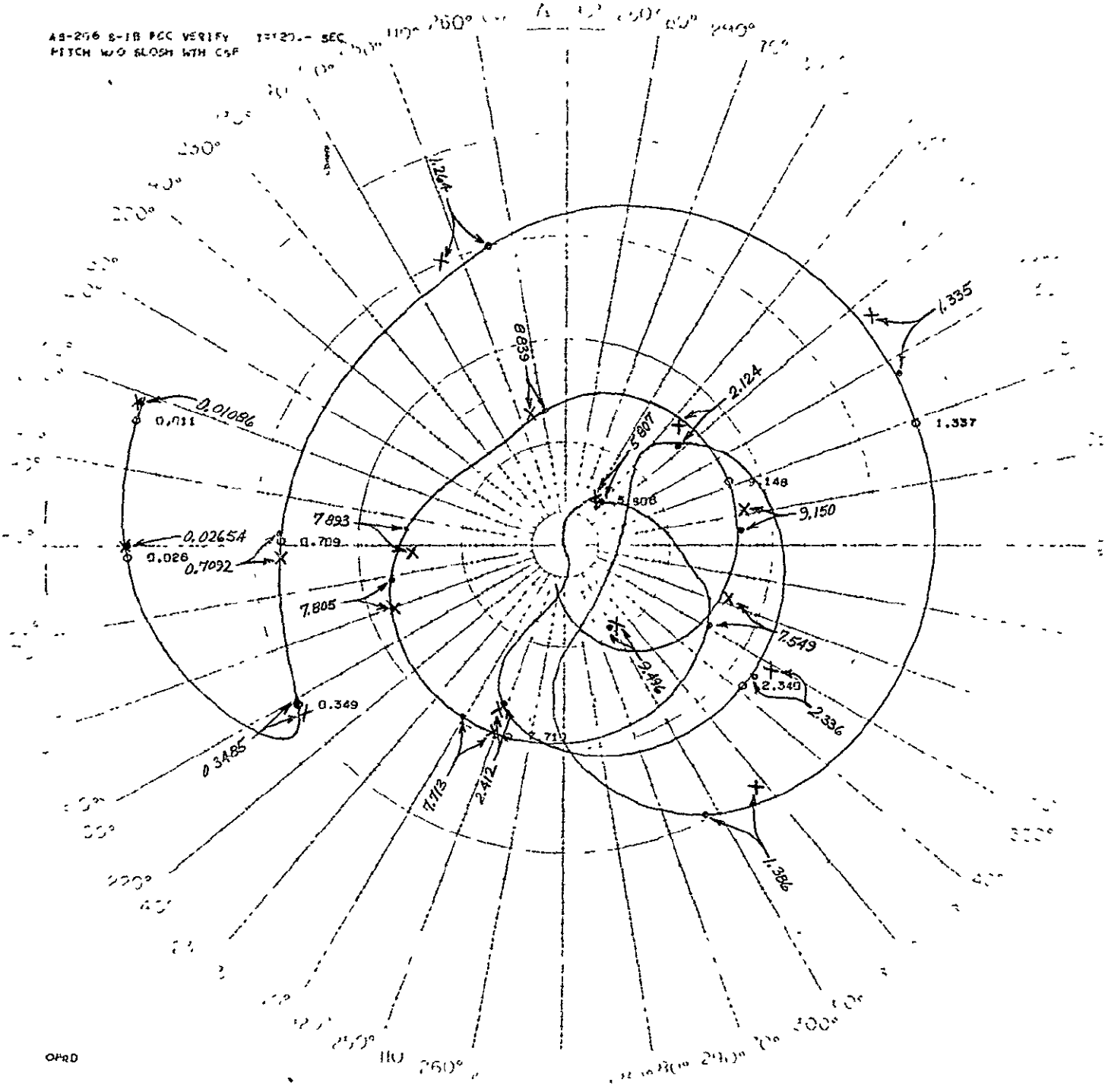

FCC S/N 0104-I  
 STAGE S-IB  
 CHAN 3P  
 AXIS PITCH  
 S.P.# 2

○ SIMULATION  
 x HARDWARE

T = 120- Sec., P-Y  
 OPEN AT ACTUATOR  
 NOMINAL CASE

NYQUIST FREQUENCY RESPONSE  
 SA-210, S-IB STAGE, PITCH AXIS DATA

AS-210 S-IB FCC VERIFY  
 FETCH W/O BLOKH WITH CSP

T=120- SEC

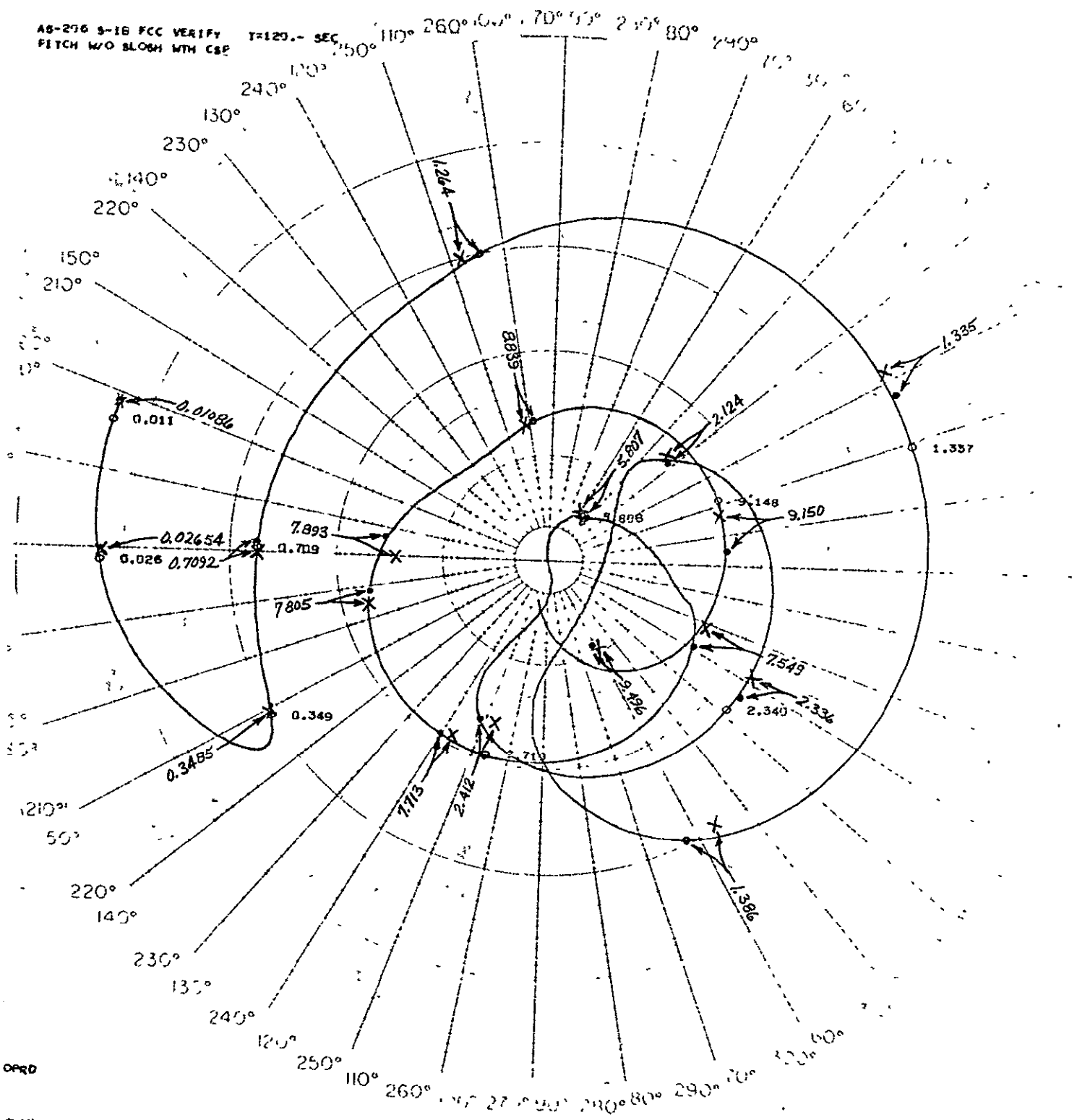

OPRD

FCC S/N 0104-I  
 STAGE S-IB  
 CHAN 3Y  
 AXIS YAW  
 S. P. # 2

○ SIMULATION  
 x HARDWARE

T = 120- Sec., P-Y  
 OPEN AT ACTUATOR  
 NOMINAL CASE

NYQUIST FREQUENCY RESPONSE  
 SA-210, S-IB STAGE, PITCH AXIS DATA

SA-210 S-IB FCC VERIFY T=140.6 SEC FITCH W/O SLOSH WITH CSP

T	0.140600E 03	A0	0.544870E 00	A1	0.600500E 00	K2	0.0
C1	-0.383400E -01	C2	0.122940E 01	K3	0.195630E 02	K4	0.972400E 01
K5	0.494340E -03	K7	0.890750E 00	K8	0.136110E 02	FLC6	0.265430E 02
FM	0.185830E 06	FMOE	0.390030E 06	SIG	0.330480E 04	THE	0.455030E 04
FA	0.100000E 10	ZETA	0.100000E 01	FR6Y	0.200000E 02	ZRGY	0.700000E 00
RP	0.140700E 07						

BENDING DATA

MODE	1	2	3	4	5	6
FBN	1.3990E 00	2.3560E 00	8.3320E 00	1.0465E 01	0.0	0.0
ZH	4.2833E 03	2.8736E 03	9.3039E 03	1.6342E 03	0.0	0.0
ZB	1.0000E -02	1.0000E -02	1.0000E -02	1.0000E -02	0.0	0.0
YB	1.5919E -01	-5.8518E -02	1.1544E -01	-7.1570E -03	0.0	0.0
YFB	8.9427E -03	-2.9111E -03	2.5773E -02	1.5995E -03	0.0	0.0
YFP	-1.0494E -02	1.5544E -02	1.7414E -02	1.9105E -03	0.0	0.0
YA	1.0000E 00	3.7204E -01	1.0349E -03	-1.0680E -01	0.0	0.0
YFRG	-1.0494E -02	1.5544E -02	1.7414E -02	1.9105E -03	0.0	0.0

SLOSHING DATA

MODE	1	2	3	4	5	6
FFS	0.0214E -01	1.2068E 00	1.9385E 00	0.0	0.0	0.0
ZS	5.0000E -05	5.0000E -02	5.0000E -02	0.0	0.0	0.0
FMS	3.4300E 03	1.2200E 04	1.3000E 03	0.0	0.0	0.0
XBS	-7.7848E 00	-1.5618E 00	8.8882E 00	0.0	0.0	0.0

POLYNOMIAL COEFFICIENTS

PHIF NUMERATOR

0.10000E 01	0.0	0.0	0.0	0.0	0.0	0.0
0.0	0.0	0.0	0.0	0.0	0.0	0.0

PHIF DENOMINATOR

0.10000E 01	0.17700E 00	0.0	0.0	0.0	0.0	0.0
0.0	0.0	0.0	0.0	0.0	0.0	0.0

PHIDF NUMERATOR

0.10000E 01	0.88438E -02	0.34882E -02	0.47554E -05	0.0	0.0	0.0
0.0	0.0	0.0	0.0	0.0	0.0	0.0

PHIDF DENOMINATOR

0.10000E 01	0.25582E 00	0.30657E -01	0.18675E -02	0.21232E -05	0.0	0.0
0.0	0.0	0.0	0.0	0.0	0.0	0.0

GODF NUMERATOR

0.10000E 01	0.0	0.0	0.0	0.0	0.0	0.0
0.0	0.0	0.0	0.0	0.0	0.0	0.0

GODF DENOMINATOR

0.10000E 01	0.50996E 01	0.49880E 00	0.0	0.0	0.0	0.0
0.0	0.0	0.0	0.0	0.0	0.0	0.0

WSS (BS) NUMERATOR

0.10000E 01	0.0	0.0	0.0	0.0	0.0	0.0
0.0	0.0	0.0	0.0	0.0	0.0	0.0

WSS (BS) DENOMINATOR

0.10000E 01	0.63080E -01	0.12323E -02	0.26847E -04	0.16694E -06	0.57735E -09	0.92928E -12
0.0	0.0	0.0	0.0	0.0	0.0	0.0

WSS (AS) NUMERATOR

0.10000E 01	0.0	0.0	0.0	0.0	0.0	0.0
0.0	0.0	0.0	0.0	0.0	0.0	0.0

WSS (AS) DENOMINATOR

0.10000E 01	0.63080E -01	0.12323E -02	0.26847E -04	0.16694E -06	0.57735E -09	0.92928E -12
0.0	0.0	0.0	0.0	0.0	0.0	0.0

FCC S/N 010A-I  
 STAGE S-IB  
 CHAN 2P, 4Y  
 AXIS PITCH, YAW  
 S.P.# 3

T = 140.6 Sec. P-Y  
 VEHICLE PARAMETERS

NYQUIST FREQUENCY RESPONSE  
 SA-210, S-IB STAGE, PITCH AXIS DATA

ORIGINAL PAGE IS  
 OF POOR QUALITY

AS-210 S-IB FCC VERIFY  
 FITCH W/O SLOSH WITH CSP

T=140.6 SEC

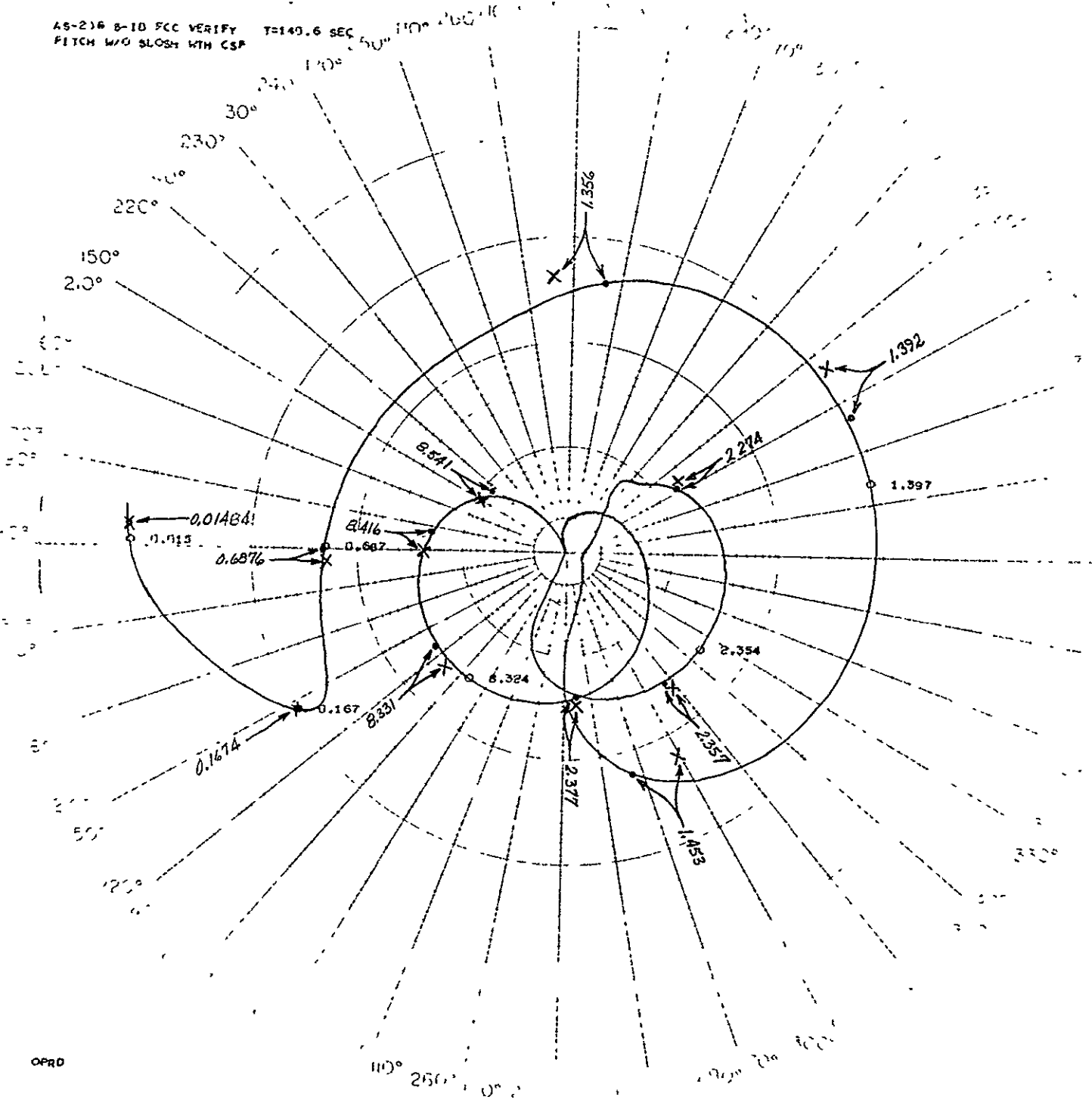

OPRD

FCC S/N 010A-I  
 STAGE S-IB  
 CHAN 2P  
 AXIS PITCH  
 S.P.# 3

○ SIMULATION  
 x HARDWARE

T = 140.6 Sec, P-Y  
 OPEN AT ACTUATOR  
 NOMINAL CASE

NYQUIST FREQUENCY RESPONSE  
 SA-210, S-IB STAGE, PITCH AXIS DATA

AS-210 S-IB FCC VERIFY  
 PITCH W/O BLOSH WITH CSP

T=140.6 SEC

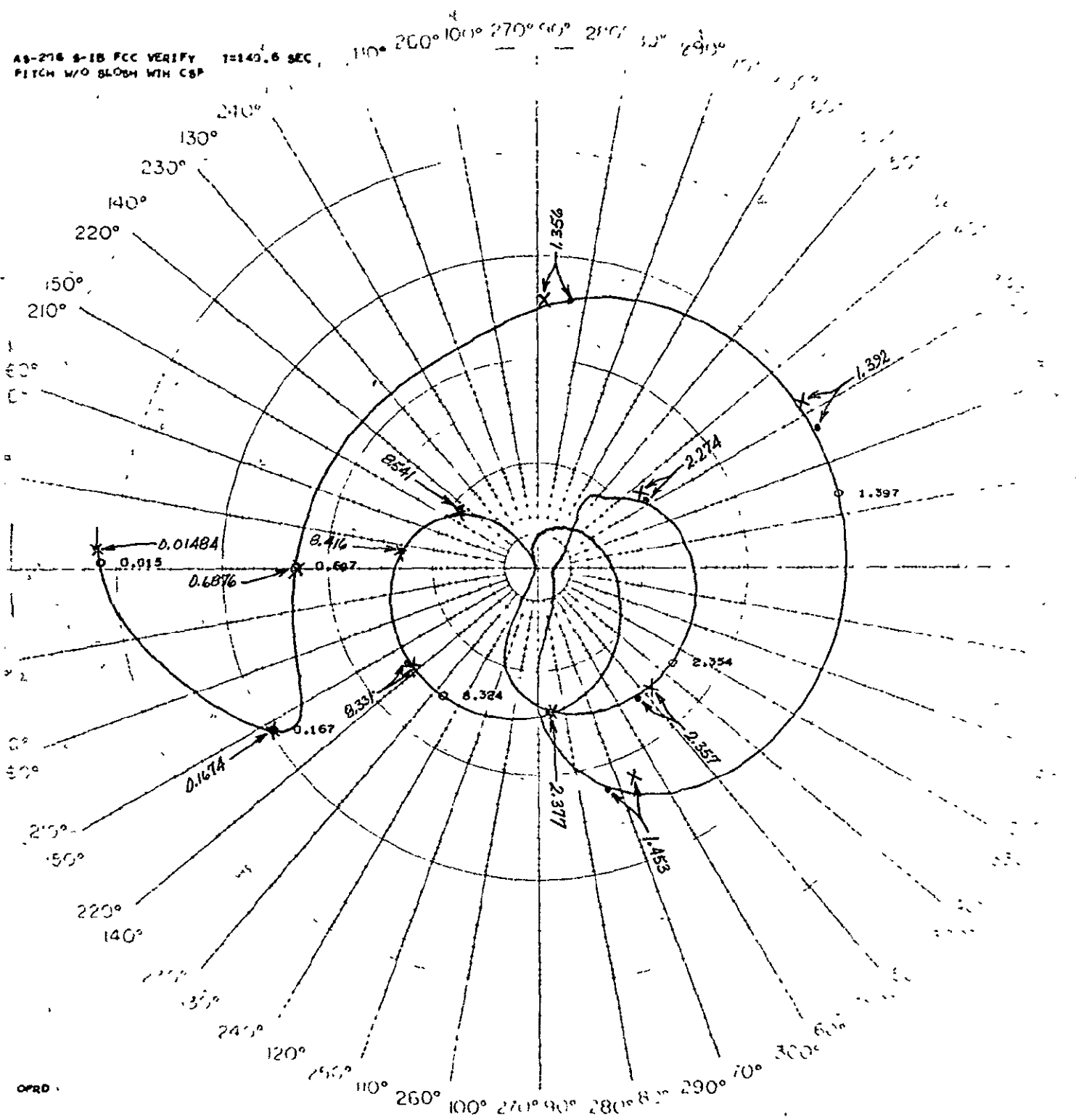

FCC S/N 0104-I  
 STAGE S-IB  
 CHAN 4Y  
 AXIS YAW  
 S.P.# 3

○ SIMULATION  
 x HARDWARE

T = 140.6 Sec, P-Y  
 OPEN AT ACTUATOR  
 NOMINAL CASE

NYQUIST FREQUENCY RESPONSE  
 SA-210, S-IB STAGE, PITCH AXIS DATA

ORIGINAL PAGE IS  
 OF POOR QUALITY



SA-210 S-IB FCC VERIFY T=0.000 SEC ROLL W/O SLOSH WITH CSP

T	0.0	A0	0.371197E 00	A1	0.280000E 00	G2	0.0
C1	0.0	C2	0.404040E 01	K3	0.0	K4	0.0
K5	0.0	K7	0.0	K8	0.0	FLCG	0.0
FM	0.58716E 06	FM01	0.211870E 07	SIG	0.797450E 04	THE	0.0
FA	0.100000E 10	ZETA	0.100000E 01	FRGY	0.200000E 02	ZRGY	0.700000E 00
RP	0.856140E 07						

BENDING DATA

MODE	1	2	3	4	5	6
FBM	2.1940E 00	3.3620E 00	4.4550E 00	6.6490E 00	6.7870E 00	1.0370E 01
ZM	5.0362E 05	3.6539E 05	1.3132E 05	6.2550E 03	2.7104E 04	5.9539E 04
ZB	1.0000E-02	1.0000E-02	1.0000E-02	1.0000E-02	1.0000E-02	1.0000E-02
YB	-5.7120E-02	-5.2760E-01	3.8570E-01	-3.2760E-02	3.0120E-02	2.6350E-01
YFB	0.0	0.0	0.0	0.0	0.0	0.0
YFP	-1.5680E-01	6.5300E-01	4.3360E-01	-1.5280E-02	4.1750E-02	-3.6780E-01
YA	0.0	0.0	0.0	0.0	0.0	0.0
YPRG	-1.5680E-01	6.5300E-01	4.3360E-01	-1.5280E-02	4.1750E-02	-3.6780E-01

SLOSHING DATA

MODE	1	2	3	4	5	6
FFS	7.9497E-01	7.9497E-01	6.5364E-01	4.2398E-01	6.8014E-01	9.9280E-01
ZS	3.1500E-02	6.0000E-02	2.0000E-03	5.0000E-05	5.0000E-02	5.0000E-02
FMS	8.0000E 02	1.1450E 03	3.8500E 03	3.4300E 03	1.2200E 04	1.3000E 03
XBS	2.4130E 00	2.4130E 00	0.0	0.0	0.0	0.0

POLYNOMIAL COEFFICIENTS

PHIF NUMERATOR						
0.10000E 01	0.0	0.0	0.0	0.0	0.0	0.0
0.0	0.0	0.0	0.0	0.0	0.0	0.0
PHIF DENOMINATOR						
0.10000E 01	0.15800E 00	0.0	0.0	0.0	0.0	0.0
0.0	0.0	0.0	0.0	0.0	0.0	0.0
PHIDF NUMERATOR						
0.10000E 01	0.10841E-01	0.20861E-02	0.24334E-05	0.0	0.0	0.0
0.0	0.0	0.0	0.0	0.0	0.0	0.0
PHIDF DENOMINATOR						
0.10000E 01	0.12391E 00	0.92646E-02	0.41893E-03	0.47319E-06	0.0	0.0
0.0	0.0	0.0	0.0	0.0	0.0	0.0
GDDF NUMERATOR						
0.10000E 01	0.0	0.0	0.0	0.0	0.0	0.0
0.0	0.0	0.0	0.0	0.0	0.0	0.0
GDDF DENOMINATOR						
0.10000E 01	0.0	0.0	0.0	0.0	0.0	0.0
0.0	0.0	0.0	0.0	0.0	0.0	0.0
WSS(BS) NUMERATOR						
0.10000E 01	0.0	0.0	0.0	0.0	0.0	0.0
0.0	0.0	0.0	0.0	0.0	0.0	0.0
WSS(BS) DENOMINATOR						
0.10000E 01	0.63080E-01	0.12323E-02	0.26847E-04	0.16694E-06	0.57735E-09	0.92928E-12
0.0	0.0	0.0	0.0	0.0	0.0	0.0
WSS(AS) NUMERATOR						
0.10000E 01	0.0	0.0	0.0	0.0	0.0	0.0
0.0	0.0	0.0	0.0	0.0	0.0	0.0
WSS(AS) DENOMINATOR						
0.10000E 01	0.63080E-01	0.12323E-02	0.26847E-04	0.16694E-06	0.57735E-09	0.92928E-12
0.0	0.0	0.0	0.0	0.0	0.0	0.0

FCC S/N 0101  
 STAGE S-IB  
 CHAN 4P, 1Y  
 AXIS ROLL  
 S.P.# 0

T = 0.0 Sec. Roll  
 VEHICLE PARAMETERS

NYQUIST FREQUENCY RESPONSE  
 SA-210, S-IB STAGE, ROLL AXIS DATA

ORIGINAL PAGE IS  
 OF POOR QUALITY

AS-210 S-IB FCC VERIFY  
ROLL W/O BLOSH WITH CSP

T=0.000 SEC

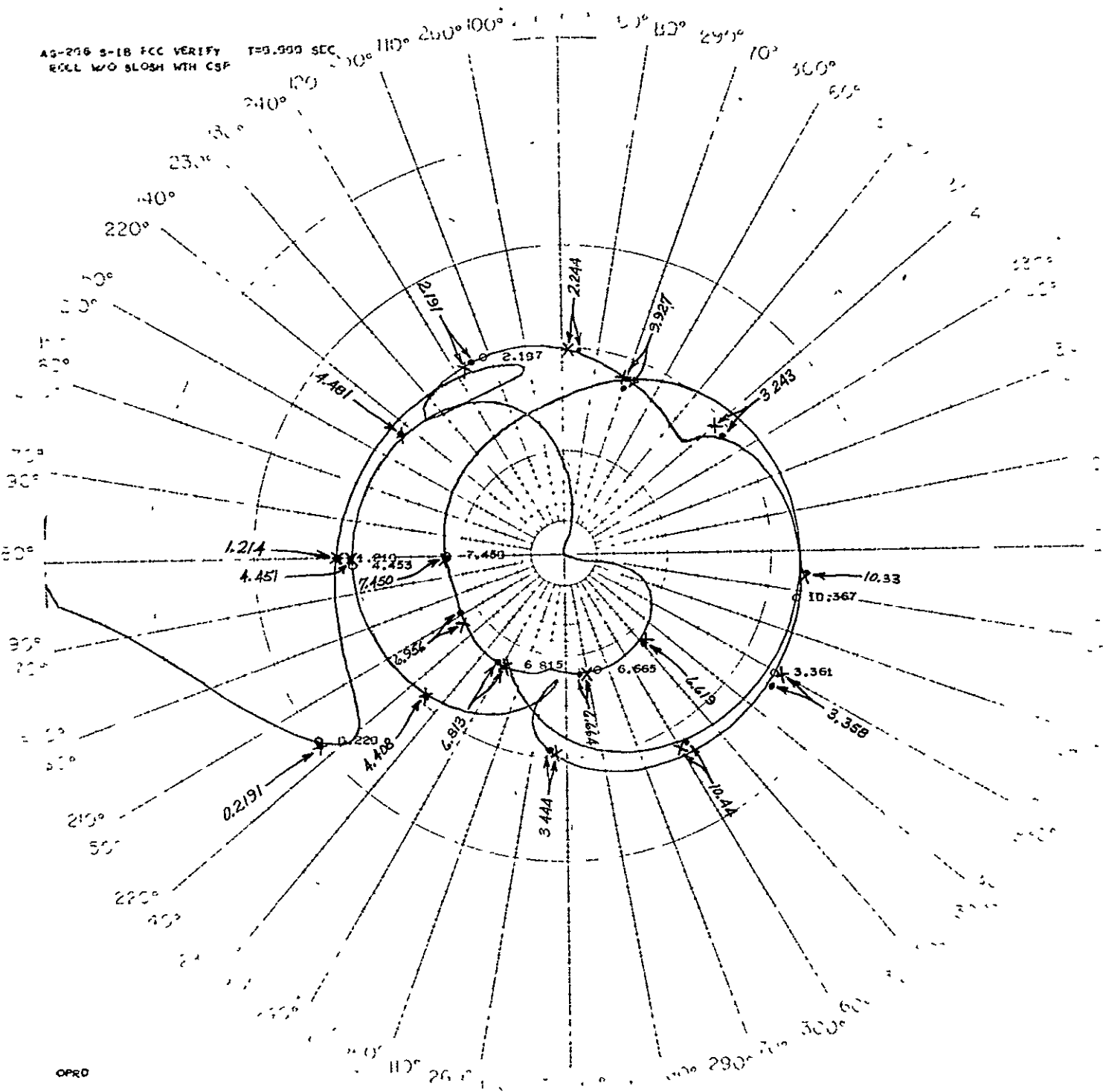

OPRO

FCC S/N	D104-I
STAGE	S-IB
CHAN	4P
AXIS	ROLL
S.P.#	0

o	SIMULATION
x	HARDWARE

T = 0.0 Sec. Roll OPEN AT ACTUATOR NOMINAL CASE
---

NYQUIST FREQUENCY RESPONSE  
SA-210, S-IB STAGE, ROLL AXIS DATA

AS-210 S-IB FCC VERIFY  
ROLL W/O SLOSH WTH CSP

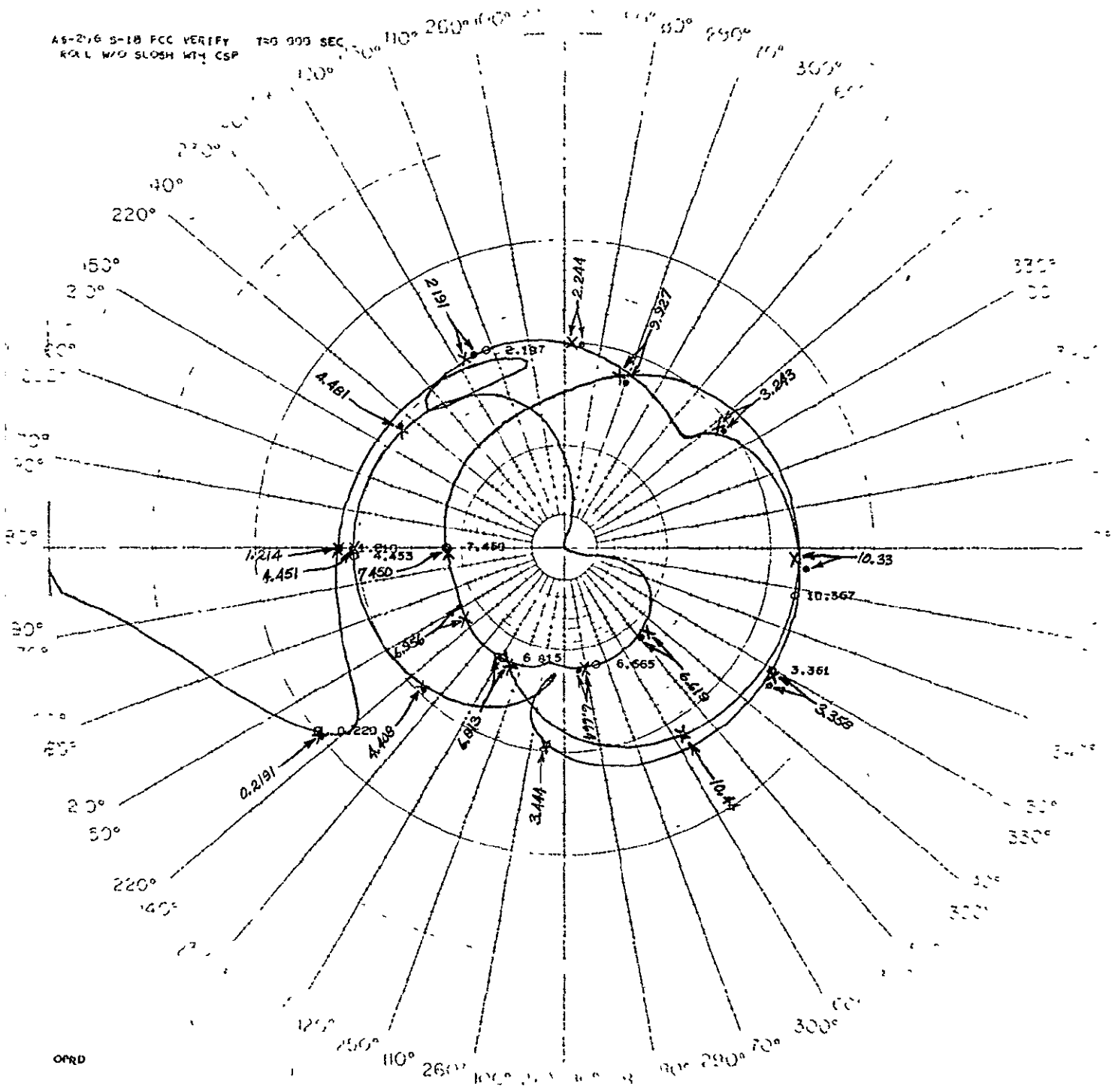

FCC S/N	010A-I
STAGE	S-IB
CHAN	1Y
AXIS	ROLL
S.P.#	0

o	SIMULATION
x	HARDWARE

T = 0.0 Sec. Roll OPEN AT ACTUATOR NOMINAL CASE
---

NYQUIST FREQUENCY RESPONSE  
SA-210, S-IB STAGE, ROLL AXIS DATA

ORIGINAL PAGE IS  
OF POOR QUALITY

AS-216 S-IB FCC VERIFY T=140.6 SEC ROLL W/O SLOSH WTH CSP

T	0.141691E 03	A7	0.241400E 00	A1	0.170000E 00	G2	0.0
C1	0.0	C2	0.102760E 02	K3	0.0	K4	0.0
K5	0.0	K7	0.0	K8	0.0	FLCG	0.0
FM	0.185830E 06	FMO1	0.424320E 06	SIG	0.797450E 04	IME	0.0
FA	0.107000E 10	ZETA	0.100000E 01	FRGY	0.200000E 02	ZRGY	0.700000E 00
RF	0.436030E 07						

BENDING DATA

MODE	1	2	3	4	5	6
FBN	0.1330E 00	0.9230E 00	1.3120E 01	0.0	0.0	0.0
ZM	0.9777E 04	0.2510E 03	1.0406E 04	0.0	0.0	0.0
Z0	1.0000E-02	1.0000E-02	1.0000E-02	0.0	0.0	0.0
Y0	-3.2880E-01	3.5250E-02	-4.5850E-02	0.0	0.0	0.0
YF0	0.0	0.0	0.0	0.0	0.0	0.0
YFP	2.8950E-01	-6.5570E-02	-3.1880E-02	0.0	0.0	0.0
YA	0.0	0.0	0.0	0.0	0.0	0.0
YFYG	2.8950E-01	-6.5570E-02	-3.1880E-02	0.0	0.0	0.0

SLOSHING DATA

MODE	1	2	3	4	5	6
FF0	0.0214E-01	1.2860E 00	1.9385E 00	0.0	0.0	0.0
ZS	5.0000E-05	5.0000E-02	5.0000E-02	0.0	0.0	0.0
FMS	3.4300E 03	1.2200E 04	1.3000E 03	0.0	0.0	0.0
XSS	2.4130E 00	2.4130E 00	0.0	0.0	0.0	0.0

POLYNOMIAL COEFFICIENTS

PHIF NUMERATOR							
0.10000E 01	0.0	0.0	0.0	0.0	0.0	0.0	0.0
0.0	0.0	0.0	0.0	0.0	0.0	0.0	0.0
PHIF DENOMINATOR							
0.10000E 01	0.16300E 00	0.0	0.0	0.0	0.0	0.0	0.0
0.0	0.0	0.0	0.0	0.0	0.0	0.0	0.0
PHIDF NUMERATOR							
0.10000E 01	0.10841E-01	0.20861E-02	0.24334E-05	0.0	0.0	0.0	0.0
0.0	0.0	0.0	0.0	0.0	0.0	0.0	0.0
PHIDF DENOMINATOR							
0.10000E 01	0.12395E 00	0.93720E-02	0.43297E-03	0.48931E-06	0.0	0.0	0.0
0.0	0.0	0.0	0.0	0.0	0.0	0.0	0.0
GDDF NUMERATOR							
0.10000E 01	0.0	0.0	0.0	0.0	0.0	0.0	0.0
0.0	0.0	0.0	0.0	0.0	0.0	0.0	0.0
GDDF DENOMINATOR							
0.10000E 01	0.0	0.0	0.0	0.0	0.0	0.0	0.0
0.0	0.0	0.0	0.0	0.0	0.0	0.0	0.0
WSS (BS) NUMERATOR							
0.10000E 01	0.0	0.0	0.0	0.0	0.0	0.0	0.0
0.0	0.0	0.0	0.0	0.0	0.0	0.0	0.0
WSS (BS) DENOMINATOR							
0.10000E 01	0.63080E-01	0.12323E-02	0.26847E-04	0.16694E-06	0.57735E-09	0.92928E-12	0.0
0.0	0.0	0.0	0.0	0.0	0.0	0.0	0.0
WSS (AS) NUMERATOR							
0.10000E 01	0.0	0.0	0.0	0.0	0.0	0.0	0.0
0.0	0.0	0.0	0.0	0.0	0.0	0.0	0.0
WSS (AS) DENOMINATOR							
0.10000E 01	0.63080E-01	0.12323E-02	0.26847E-04	0.16694E-06	0.57735E-09	0.92928E-12	0.0
0.0	0.0	0.0	0.0	0.0	0.0	0.0	0.0

FCC S/N 0104-I  
 STAGE S-IB  
 CHAN 1P  
 AXIS ROLL  
 S.P.# 3

T = 140.6 Sec. Roll  
 VEHICLE PARAMETERS

NYQUIST FREQUENCY RESPONSE  
 SA-210, S-IB STAGE, ROLL AXIS DATA

45-218 S-1B FCC VERIFY T=140.6 SEC  
 KILL W/O SLUSH WITH CS

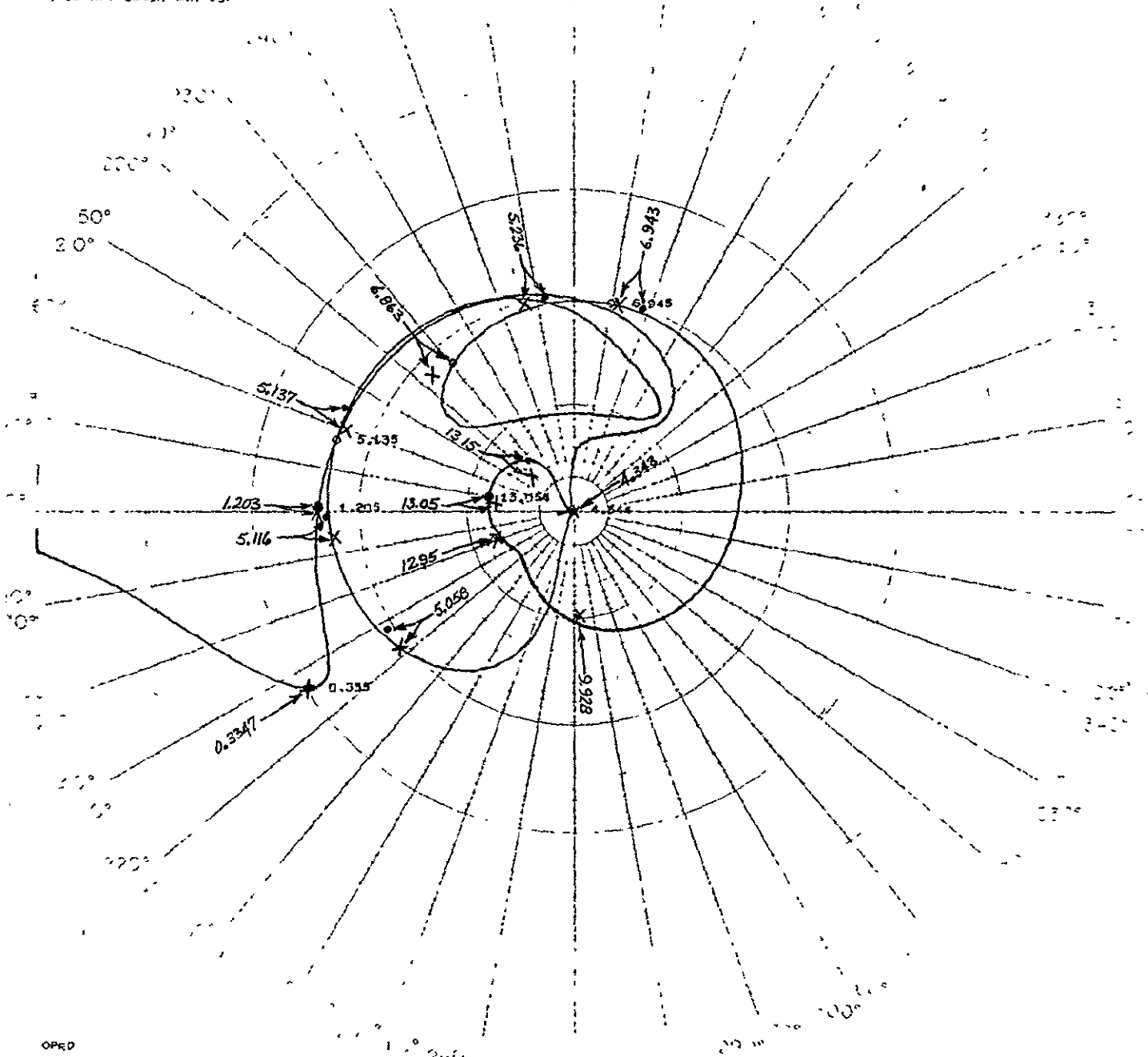

OPRD

FCC S/N 0104  
 STAGE S-1B  
 CHAN 1P  
 AXIS ROLL  
 S.P.# 3

o SIMULATION  
 x HARDWARE

T = 140.6 Sec. Roll  
 OPEN AT ACTUATOR  
 NOMINAL CASE

NYQUIST FREQUENCY RESPONSE  
 SA-210, S-1B STAGE, ROLL AXIS DATA

ORIGINAL PAGE IS  
 OF POOR QUALITY

12 MA. SERVO AMPLIFIER OPEN LOOP  
FREQUENCY RESPONSE REQUIREMENTS

NOMINAL  
 •  $f_n = 43 \text{ Hz.}$   
 •  $\zeta = 0.52$

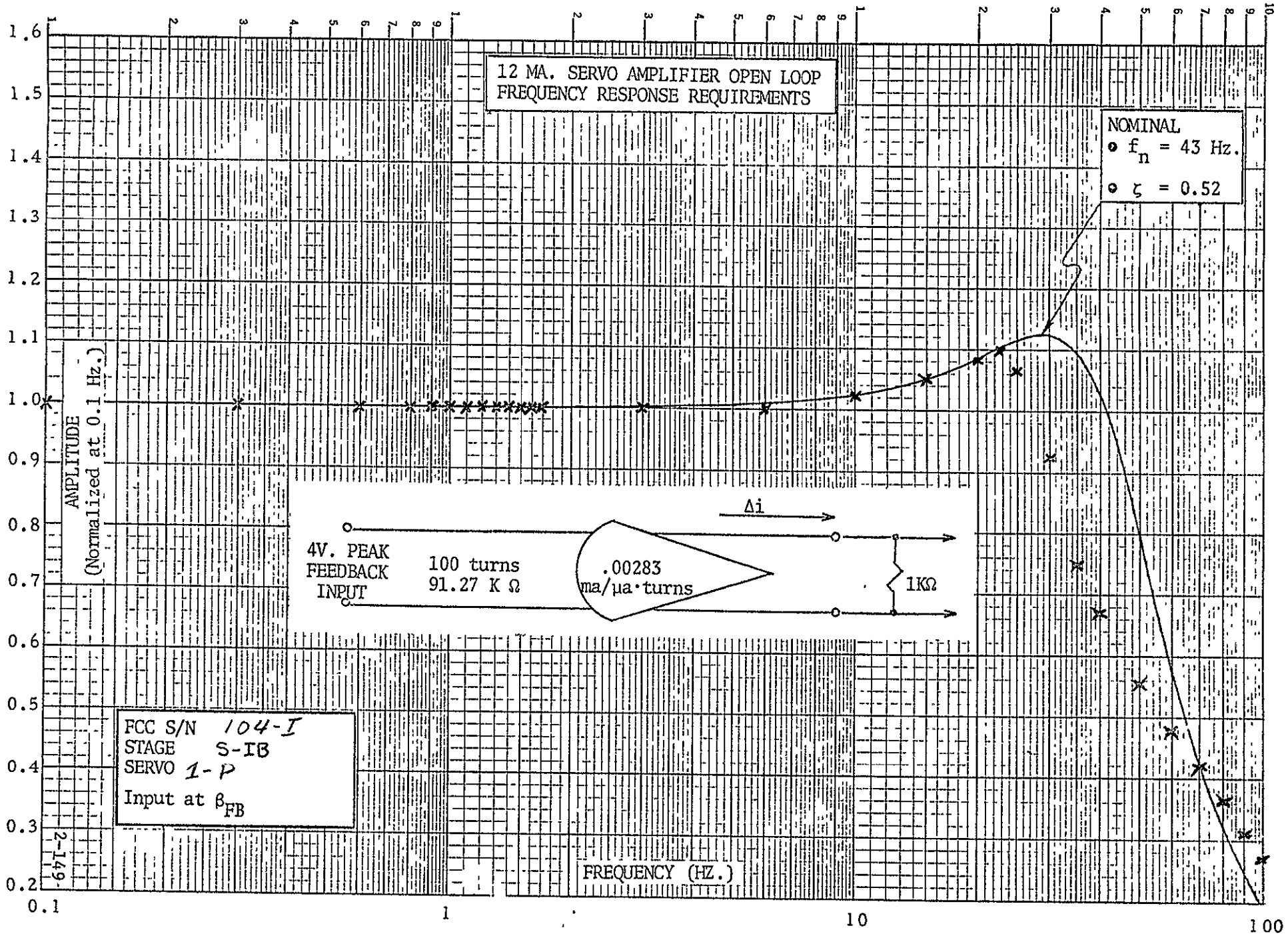

12 MA. SERVO AMPLIFIER OPEN LOOP  
FREQUENCY RESPONSE REQUIREMENTS

NOMINAL  
 $f_n = 43 \text{ Hz.}$   
 $\zeta = 0.52$

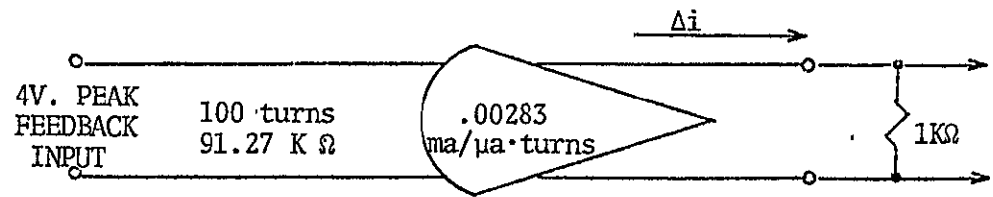
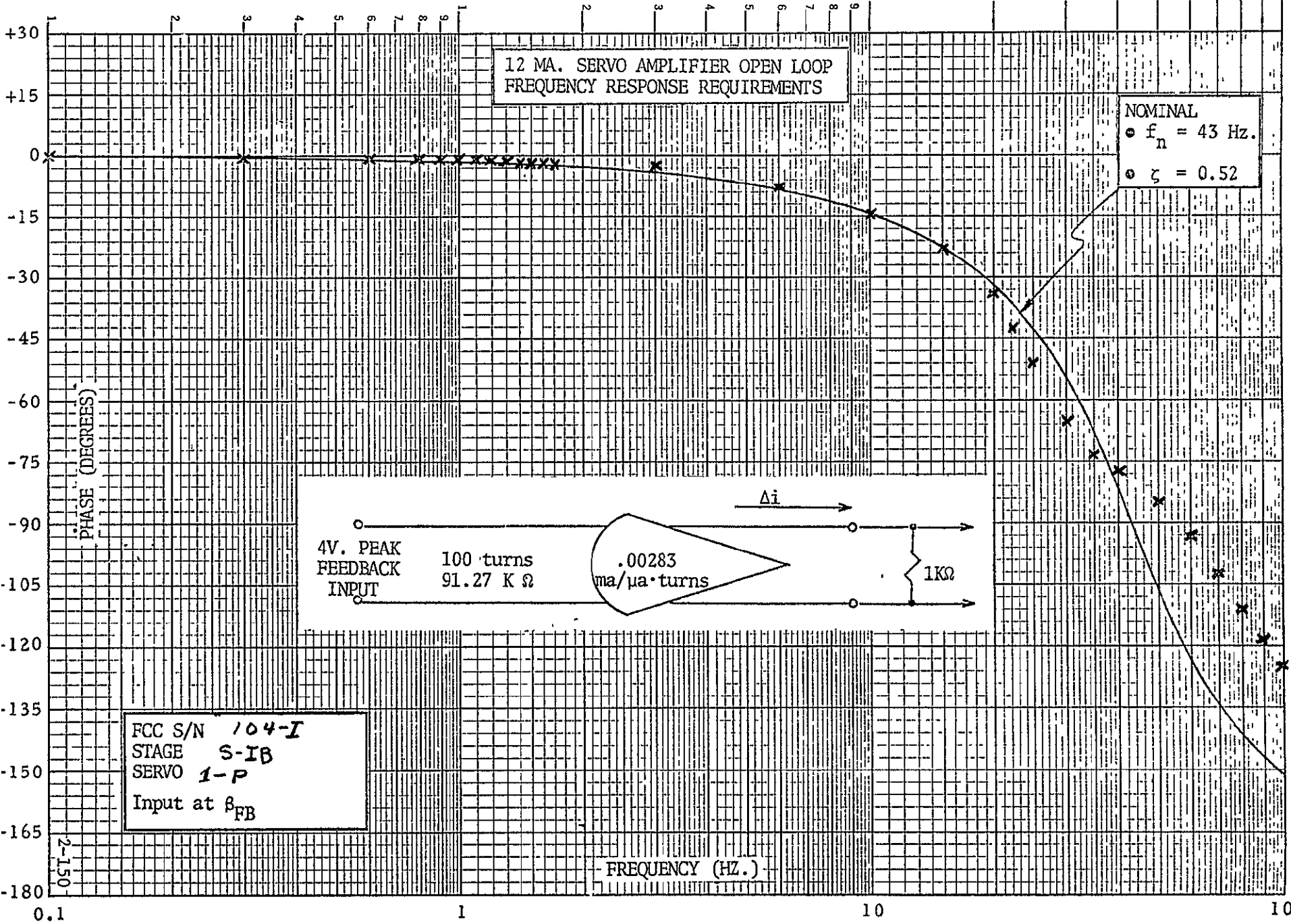

FCC S/N 104-I  
 STAGE S-IB  
 SERVO 1-P  
 Input at  $\beta_{FB}$

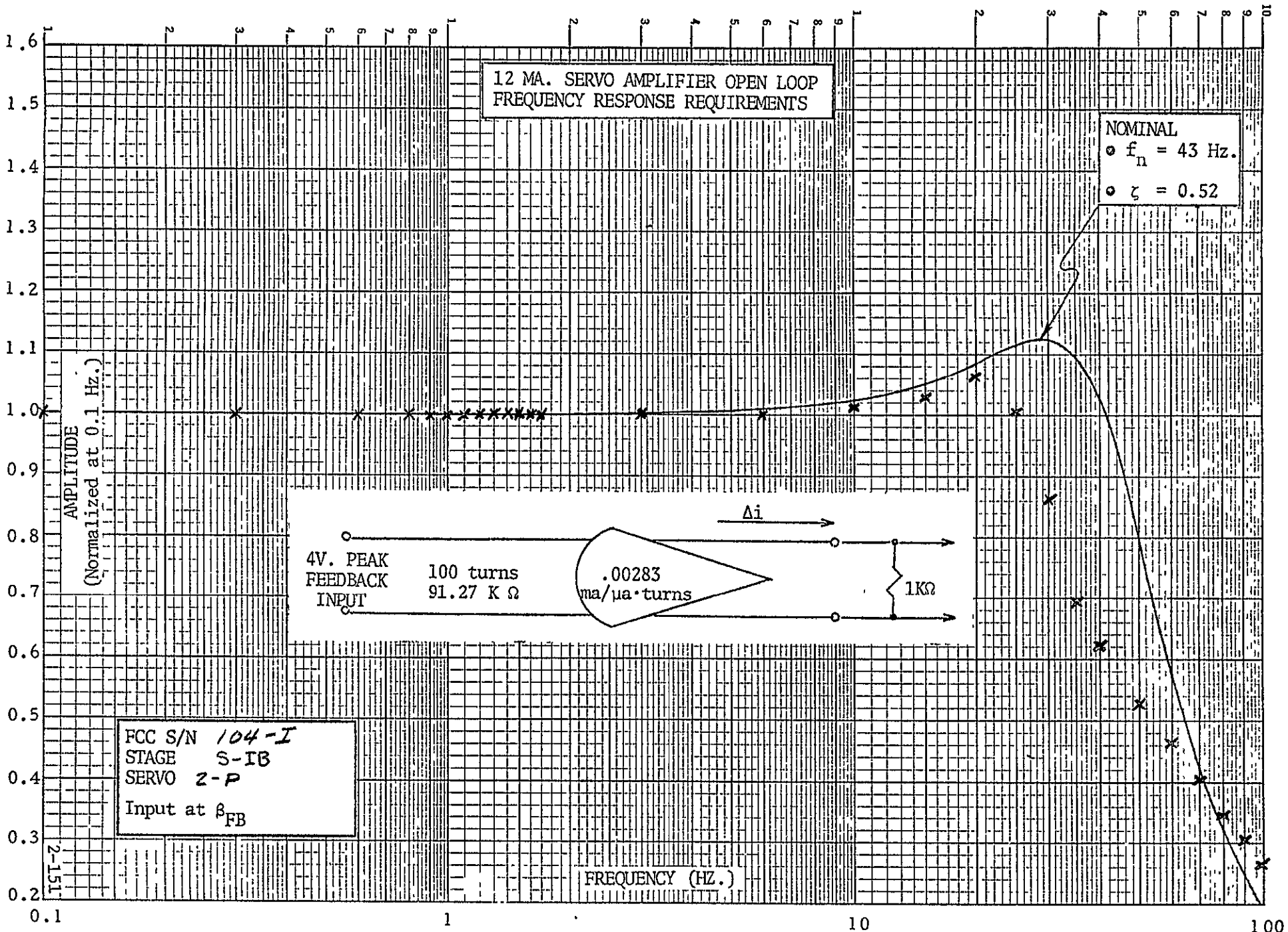



12 MA. SERVO AMPLIFIER OPEN LOOP  
FREQUENCY RESPONSE REQUIREMENTS

NOMINAL  
 •  $f_n = 43 \text{ Hz.}$   
 •  $\zeta = 0.52$

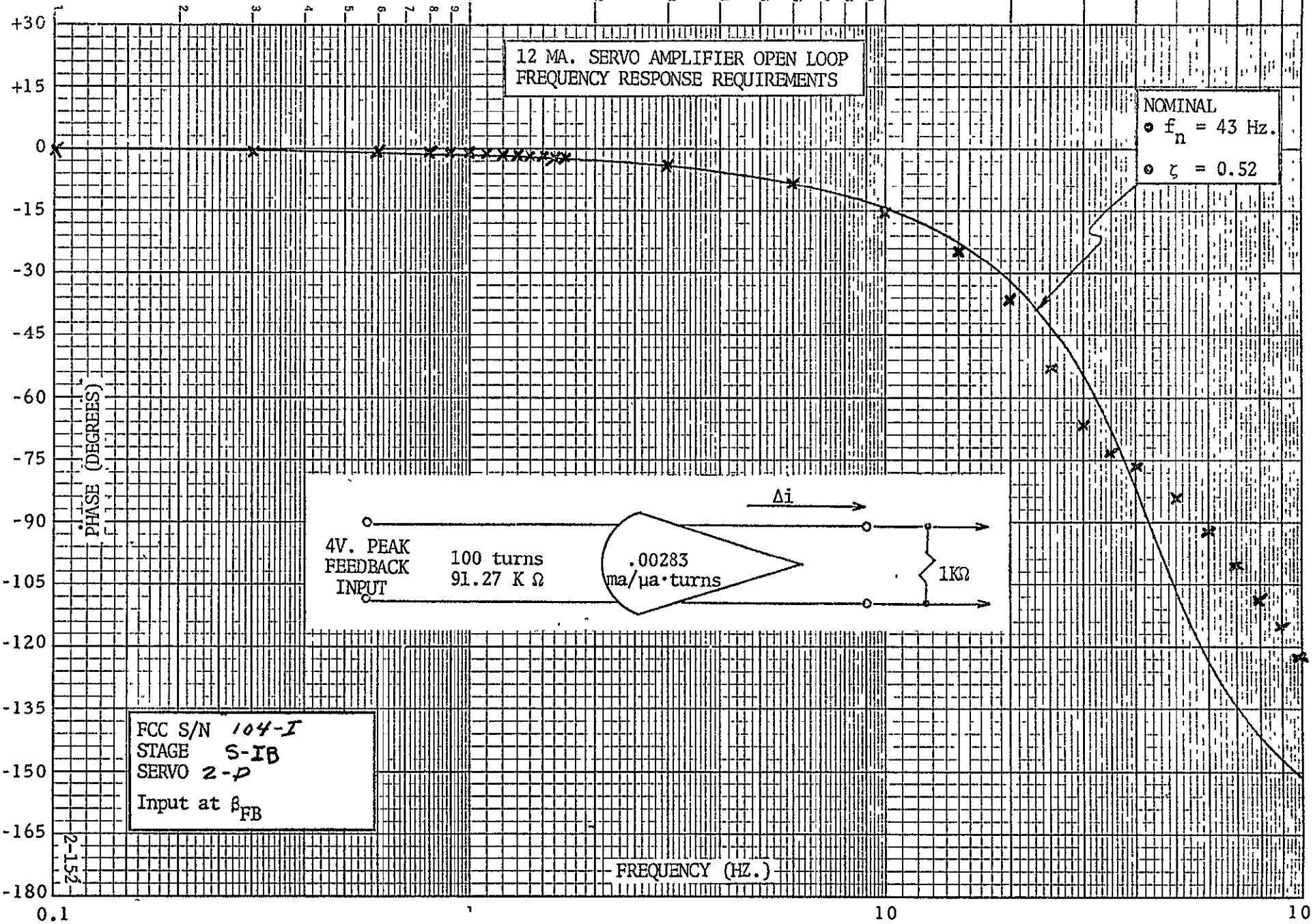

FCC S/N 104-I  
 STAGE S-IB  
 SERVO 2-P  
 Input at  $\beta_{FB}$

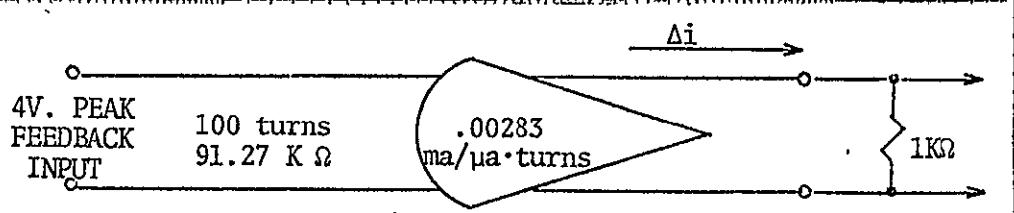

12 MA. SERVO AMPLIFIER OPEN LOOP  
FREQUENCY RESPONSE REQUIREMENTS

NOMINAL  
 $f_n = 43 \text{ Hz.}$   
 $\zeta = 0.52$

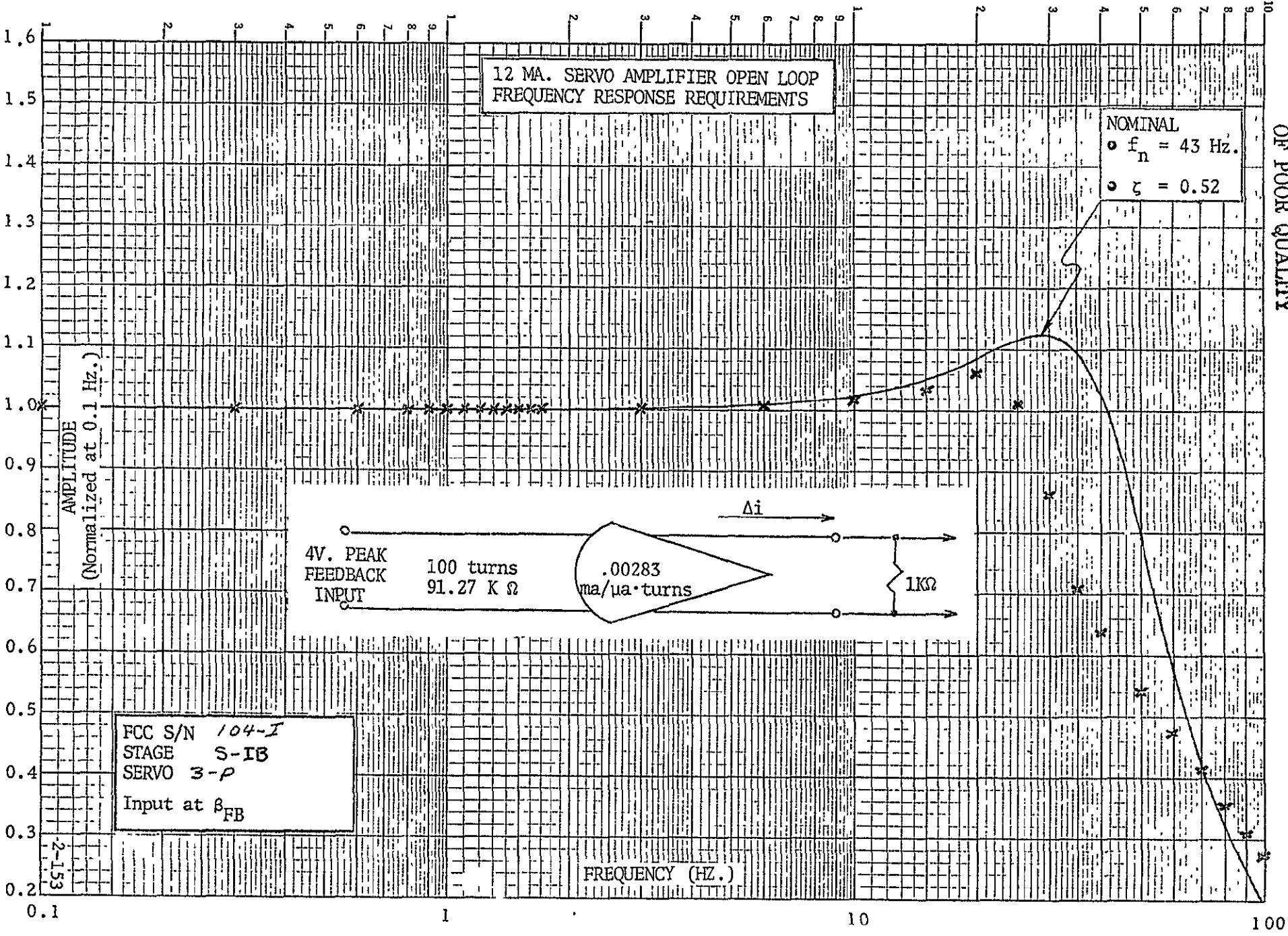

2-153

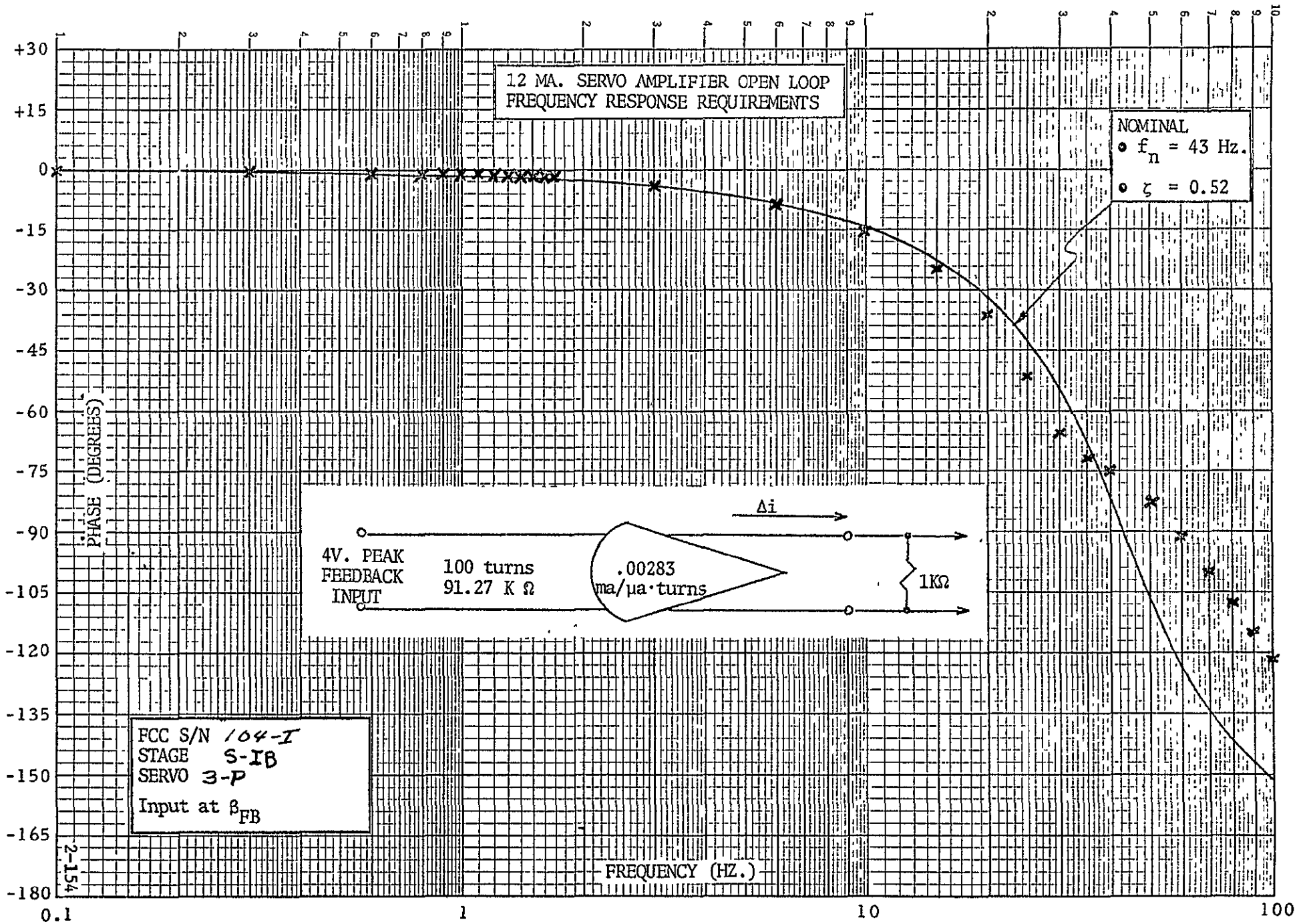

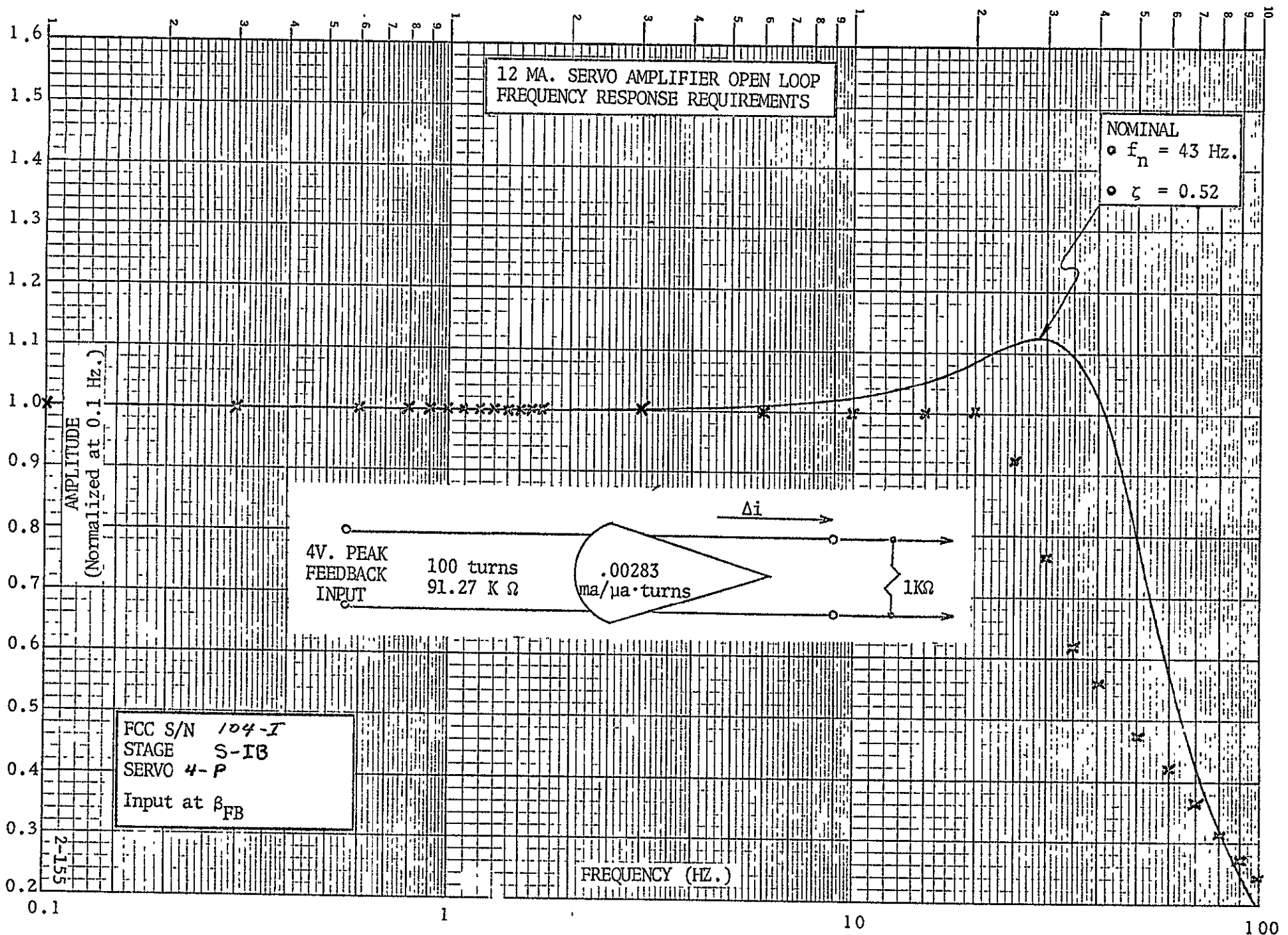

12 MA. SERVO AMPLIFIER OPEN LOOP  
FREQUENCY RESPONSE REQUIREMENTS

NOMINAL  
 •  $f_n = 43 \text{ Hz.}$   
 •  $\zeta = 0.52$

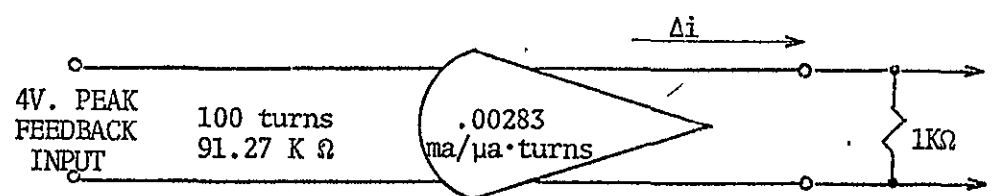
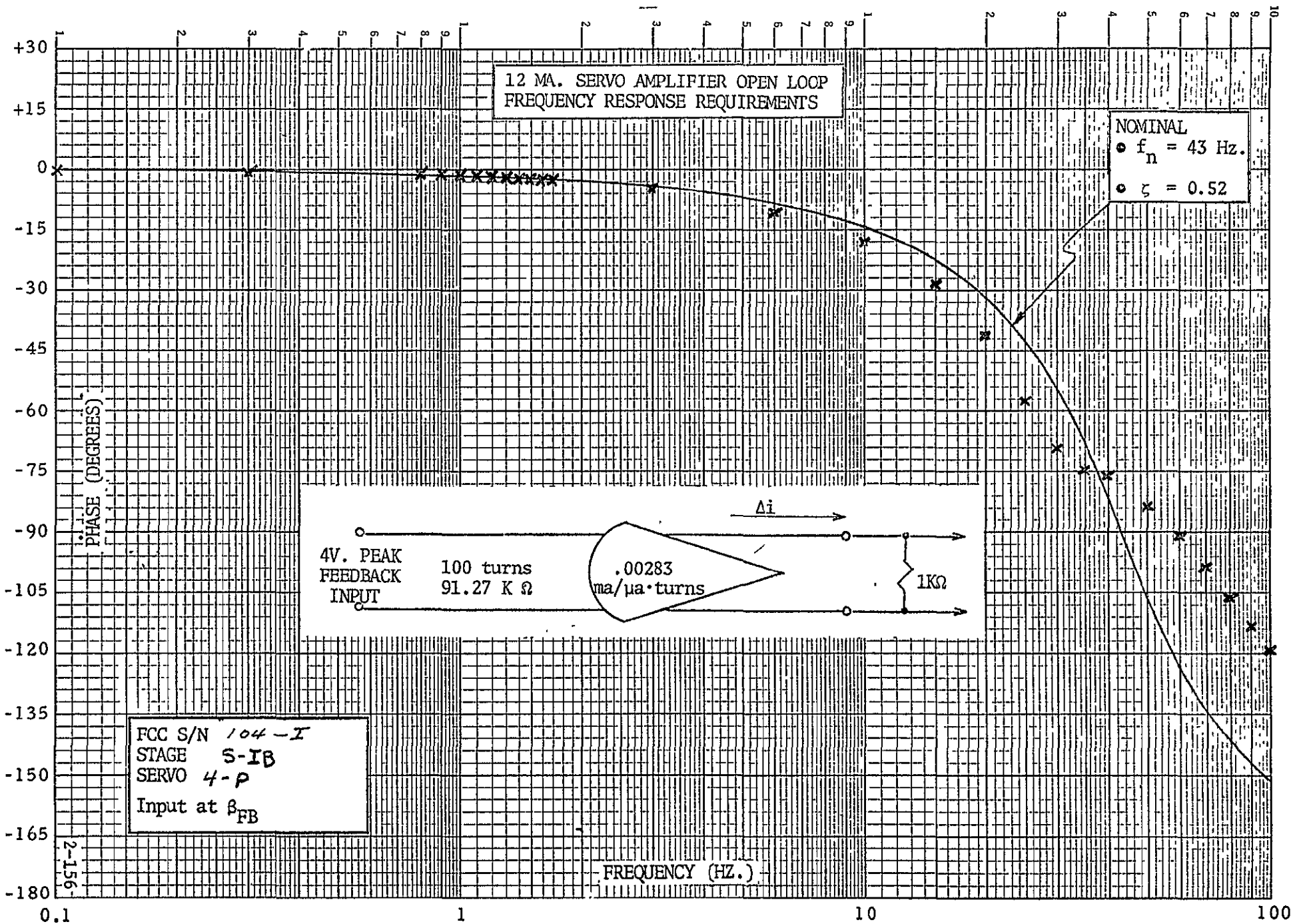

FCC S/N 104-I  
 STAGE S-IB  
 SERVO 4-P  
 Input at  $\beta_{FB}$

FREQUENCY (HZ.)

2-156

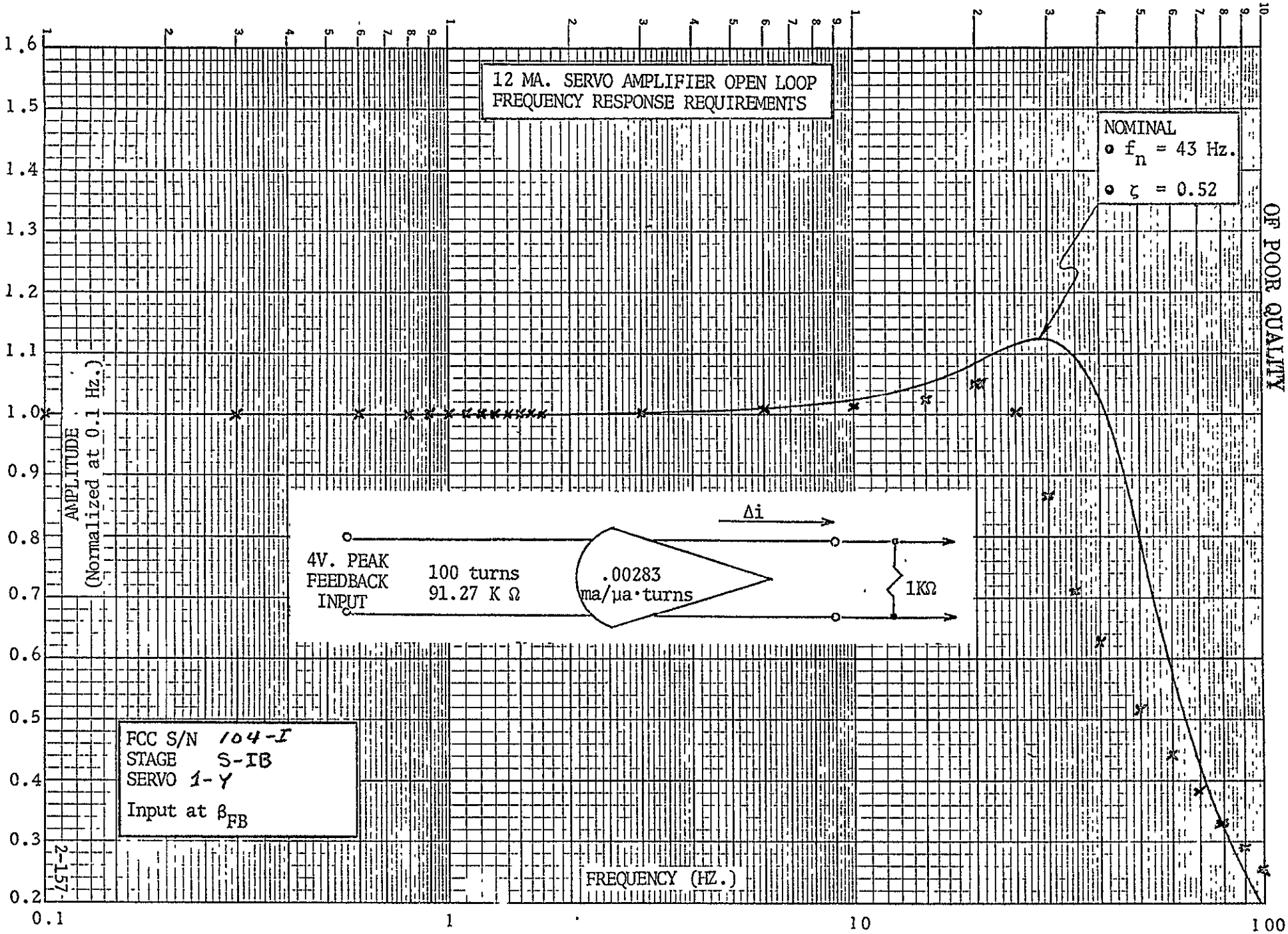

ORIGINAL PAGE IS OF POOR QUALITY

2-157

12 MA. SERVO AMPLIFIER OPEN LOOP  
FREQUENCY RESPONSE REQUIREMENTS

NOMINAL  
 •  $f_n = 43 \text{ Hz.}$   
 •  $\zeta = 0.52$

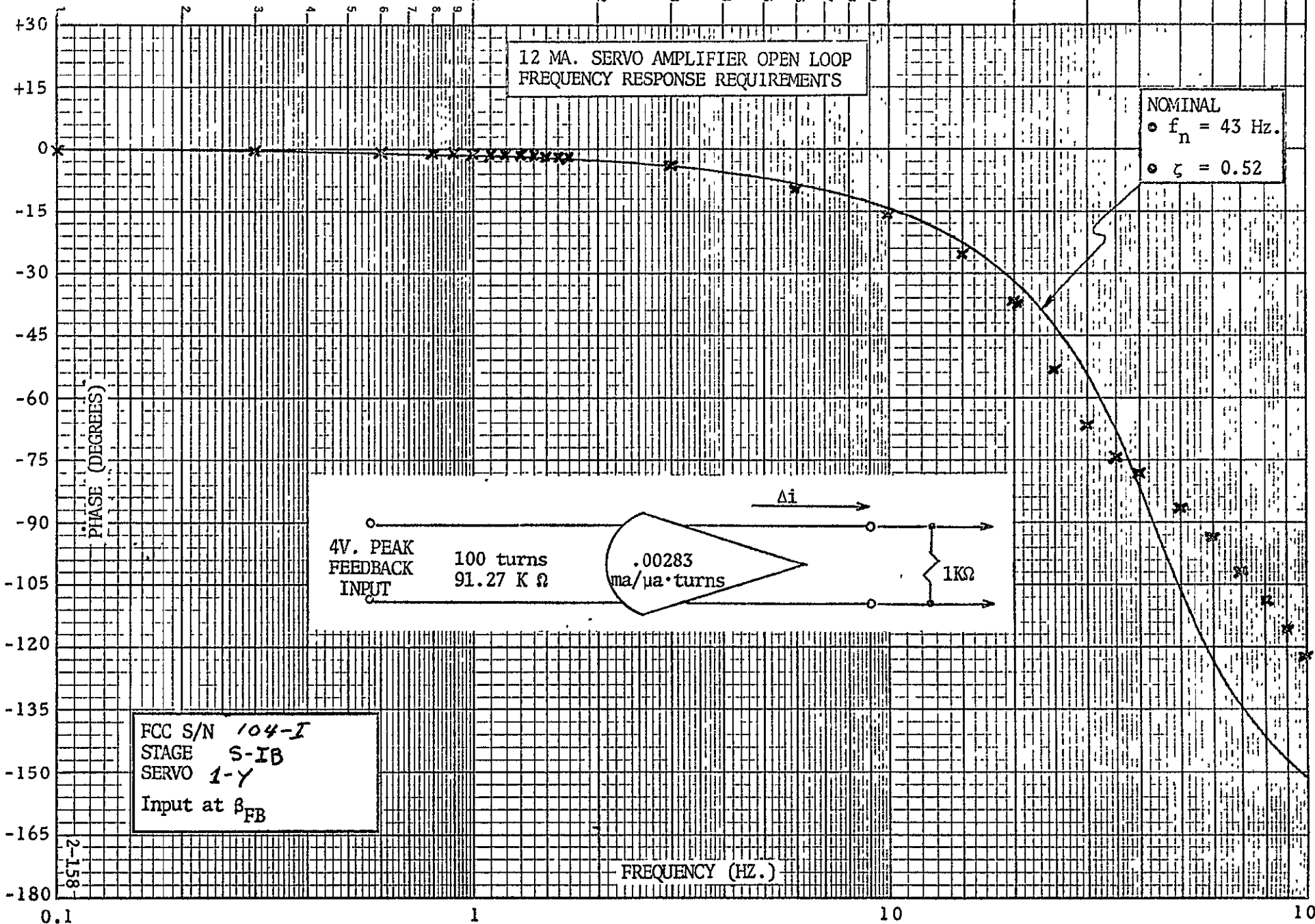

FCC S/N 104-I  
 STAGE S-IB  
 SERVO 1-Y  
 Input at  $\beta_{FB}$

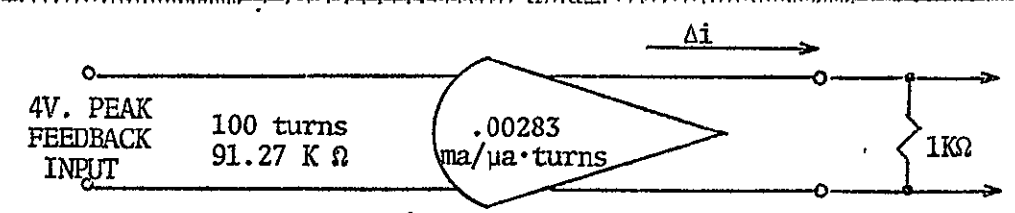

2-158

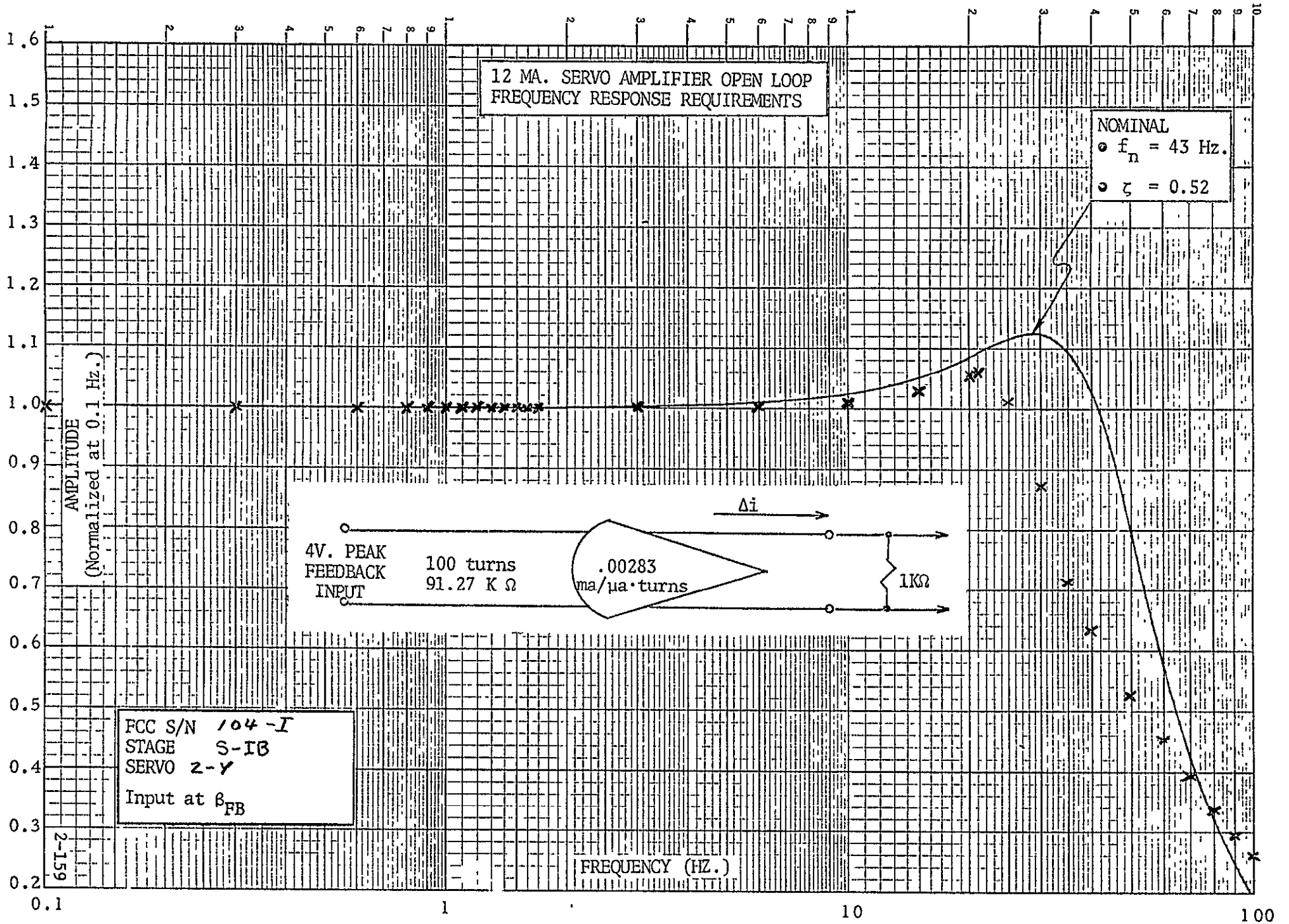



12 MA. SERVO AMPLIFIER OPEN LOOP  
FREQUENCY RESPONSE REQUIREMENTS

NOMINAL  
 •  $f_n = 43 \text{ Hz.}$   
 •  $\zeta = 0.52$

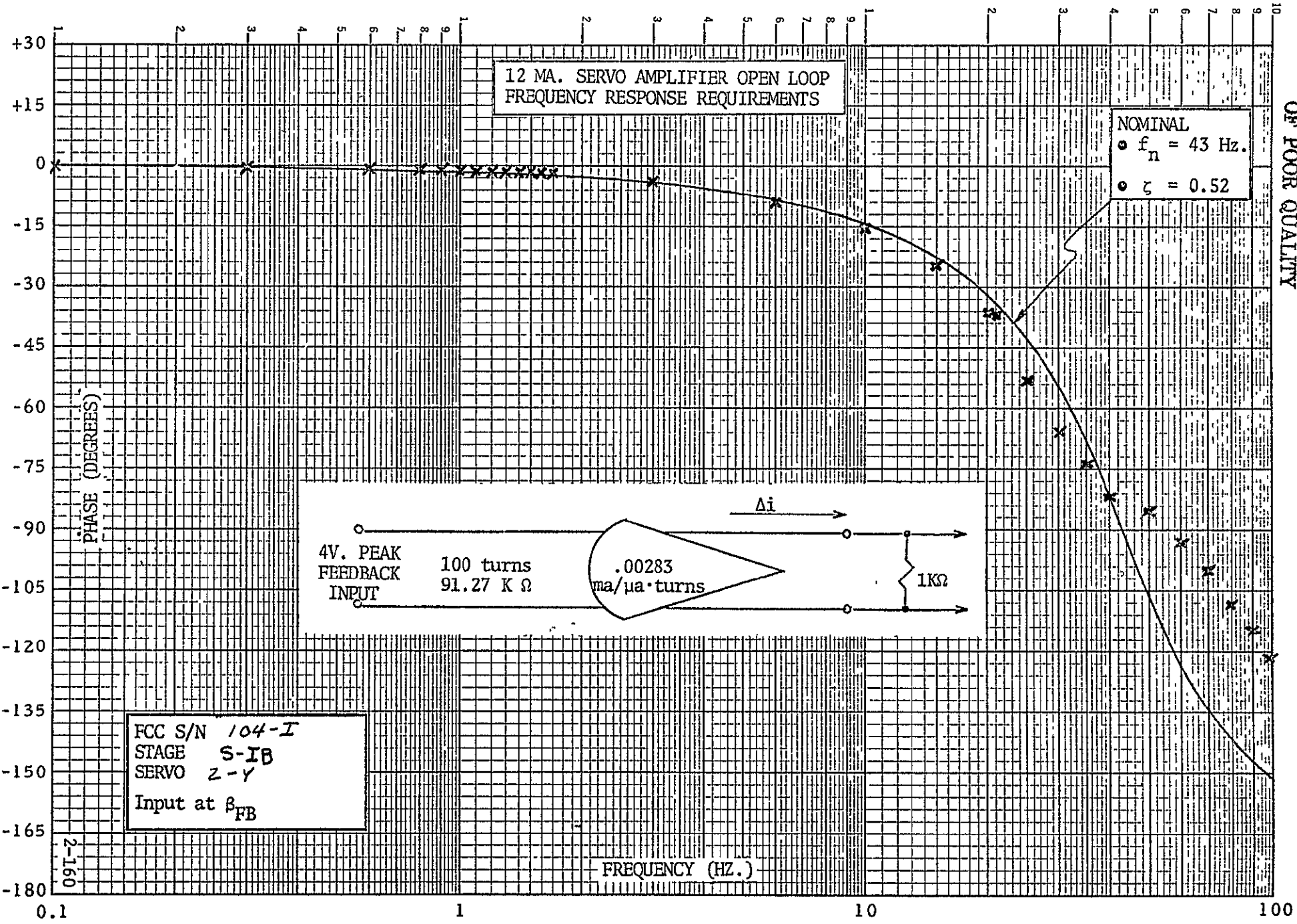

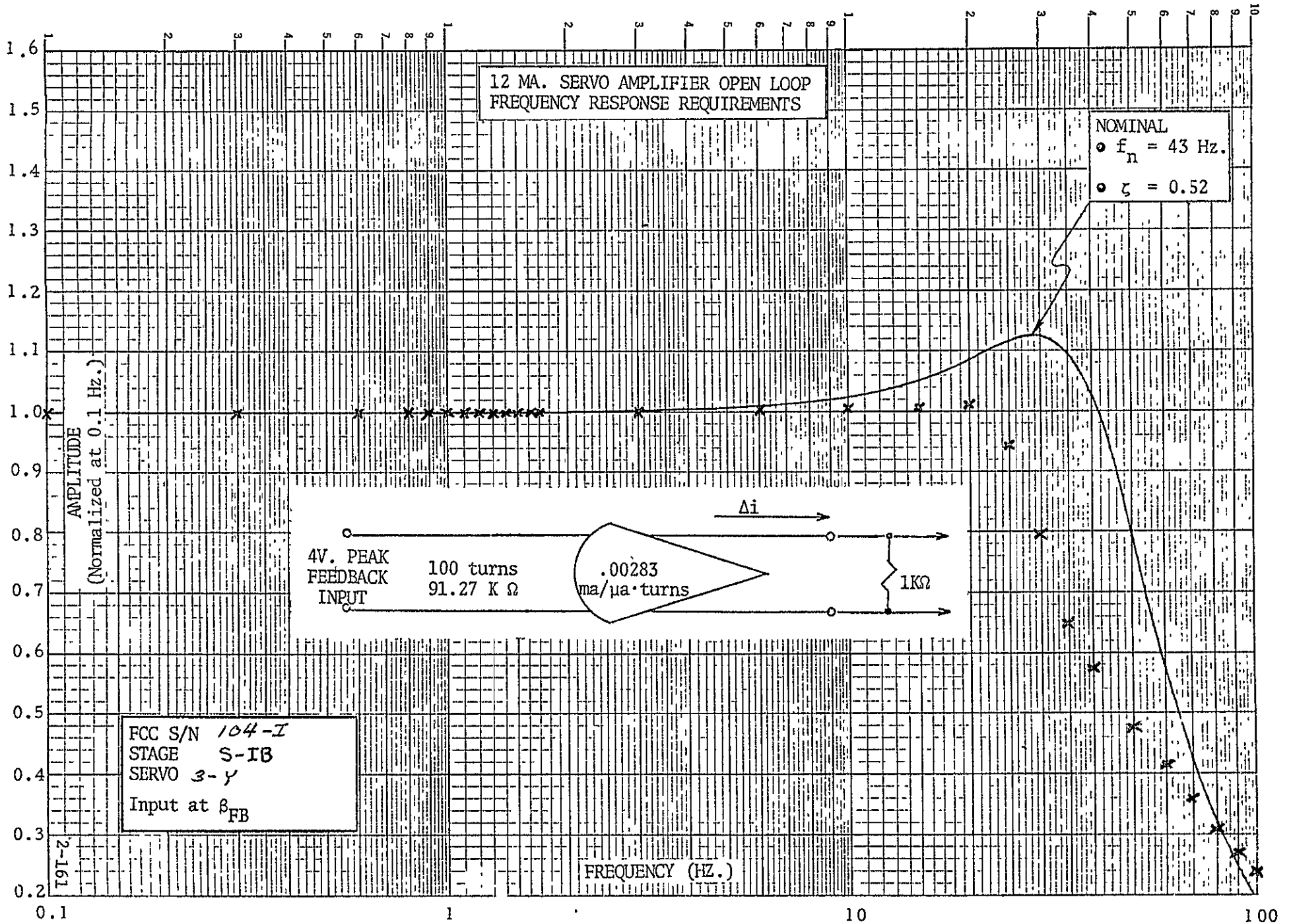

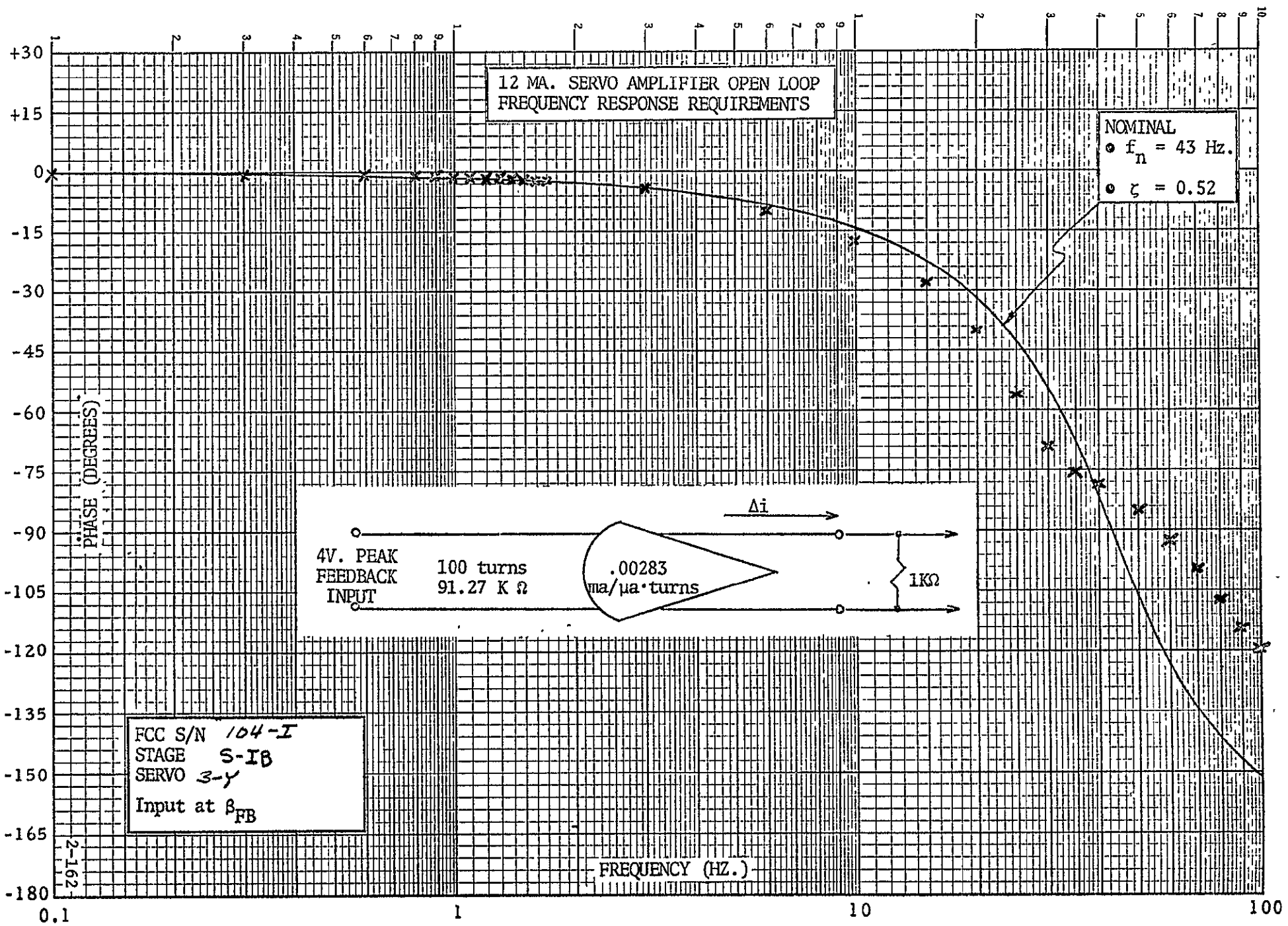

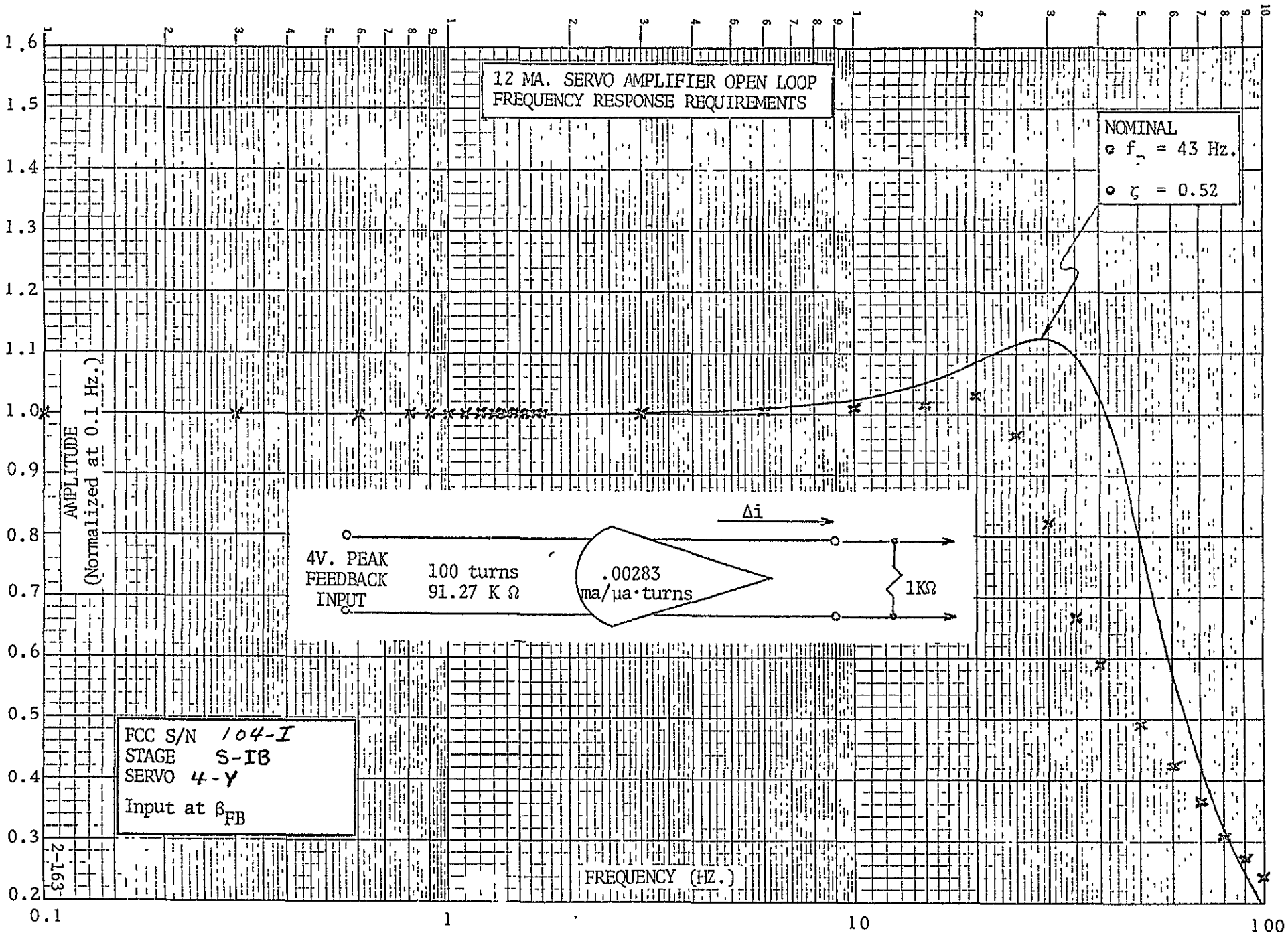

ORIGINAL PAGE IS  
OF POOR QUALITY

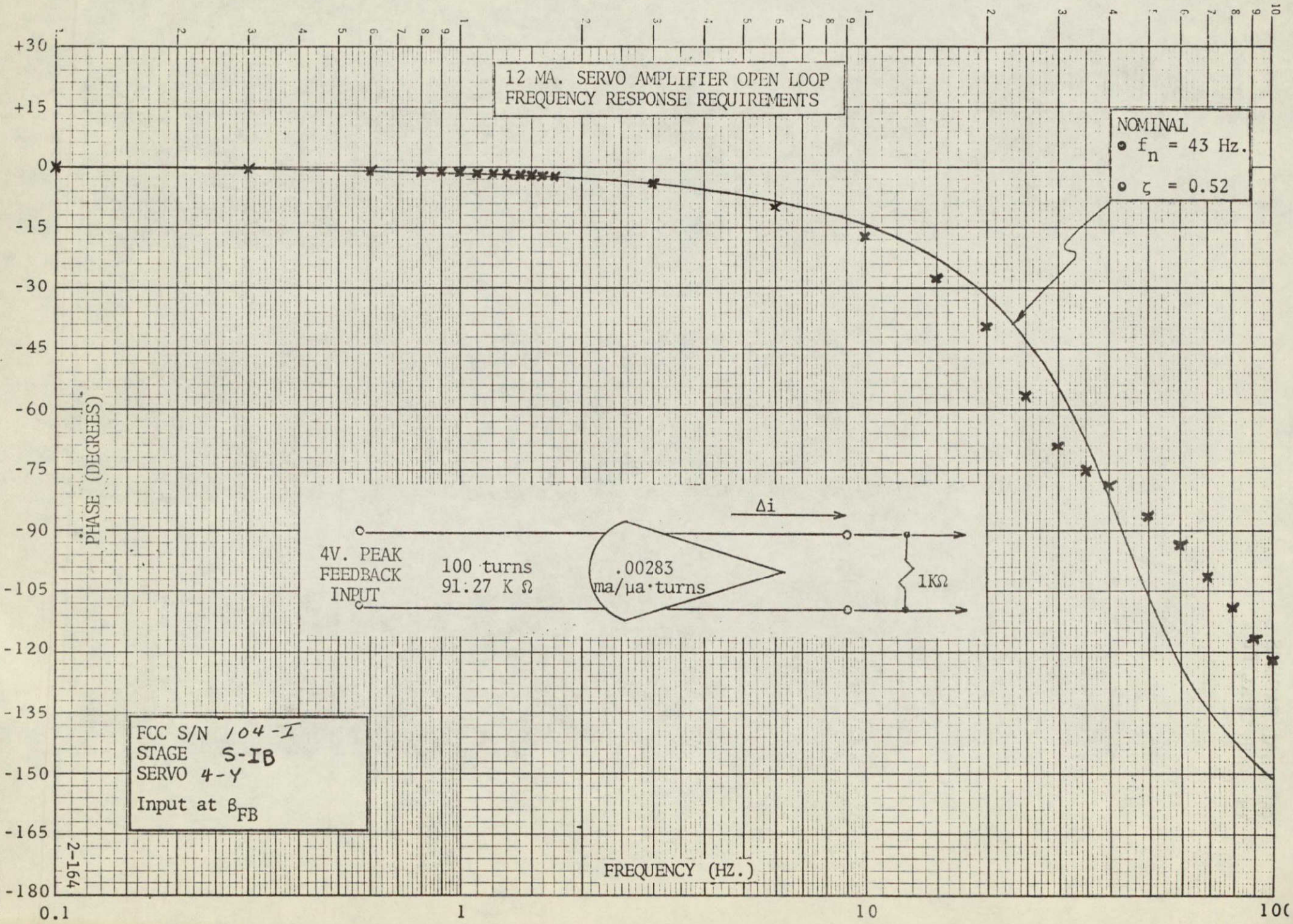

ORIGINAL PAGE IS  
OF POOR QUALITY

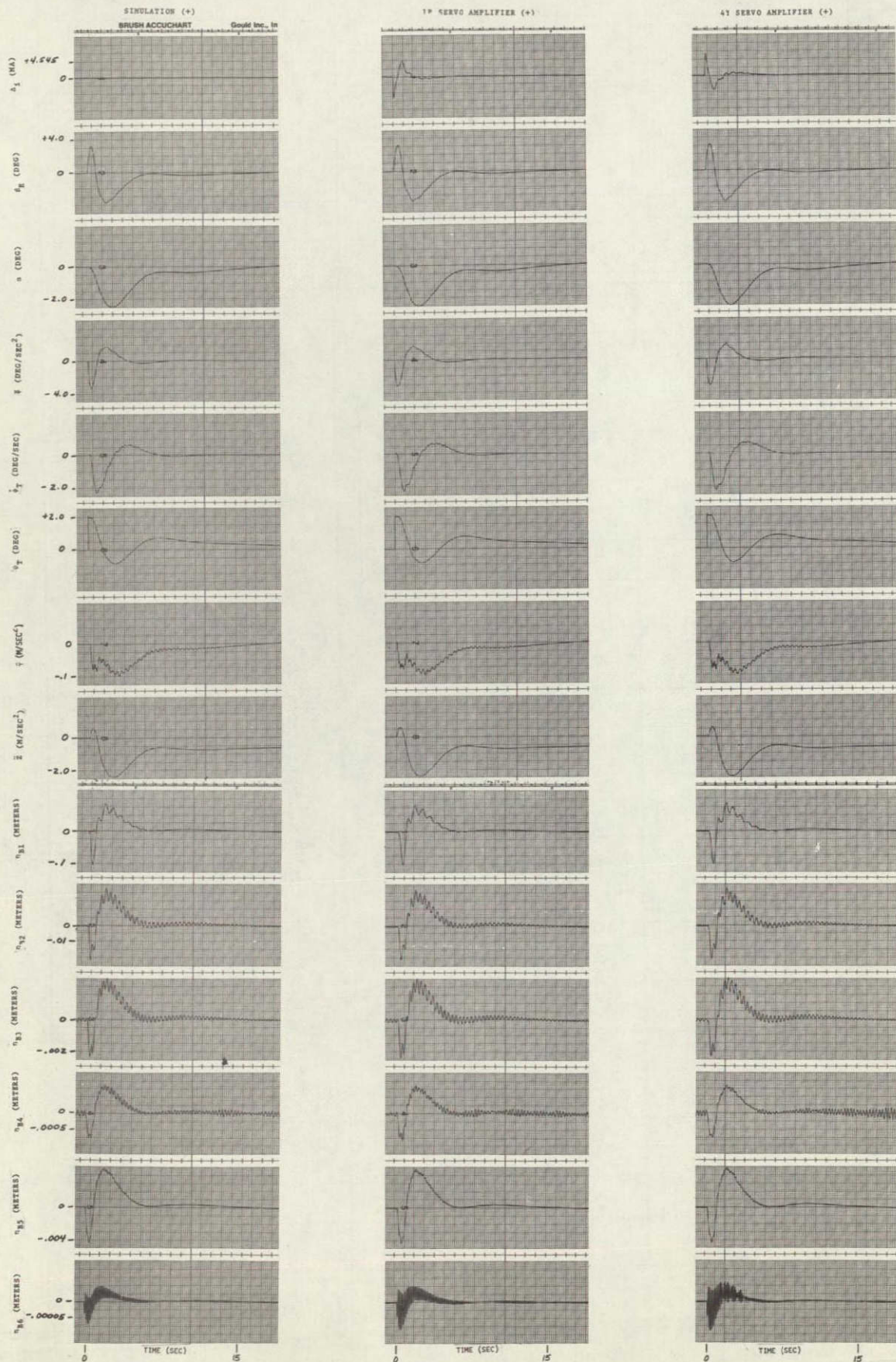

CLOSED LOOP TRANSIENT RESPONSE  
TO A STEP INPUT  $\theta = -2$  DEGREES  
 $T = 80$  SEC FITCH-TAW AXIS

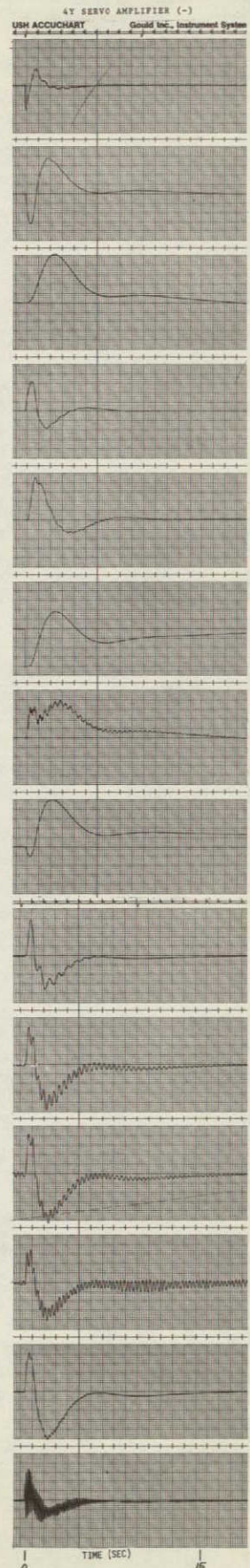
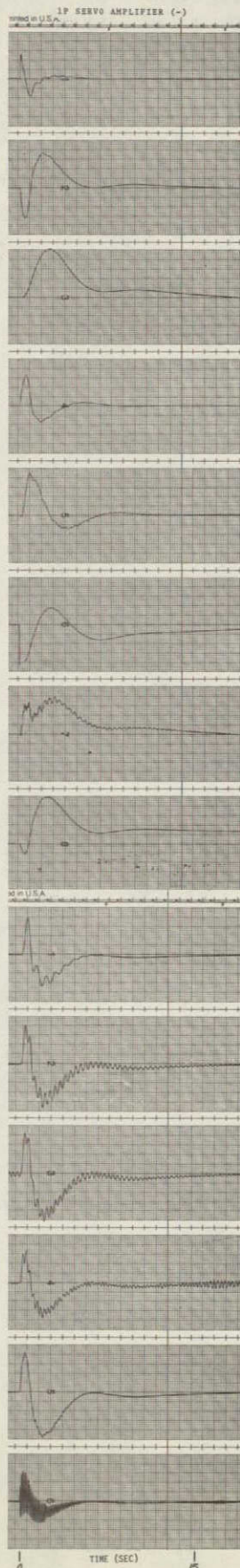
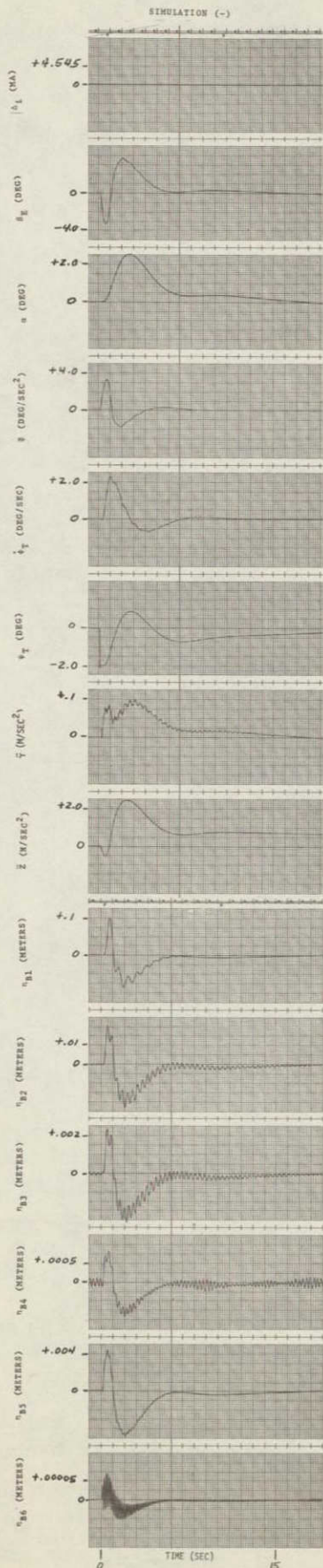

CLOSED LOOP TRANSIENT RESPONSE  
TO A STEP INPUT  $\theta = +2$  DEGREES  
 $T = 80$  SEC PITCH-YAW AXIS

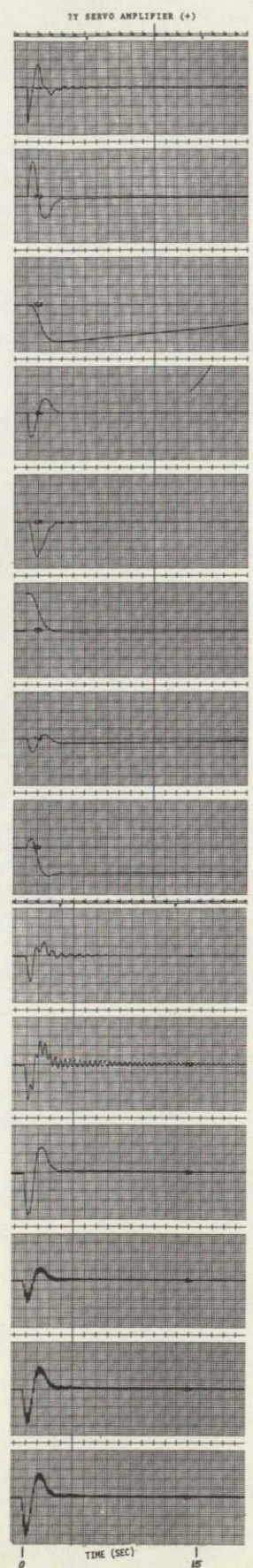
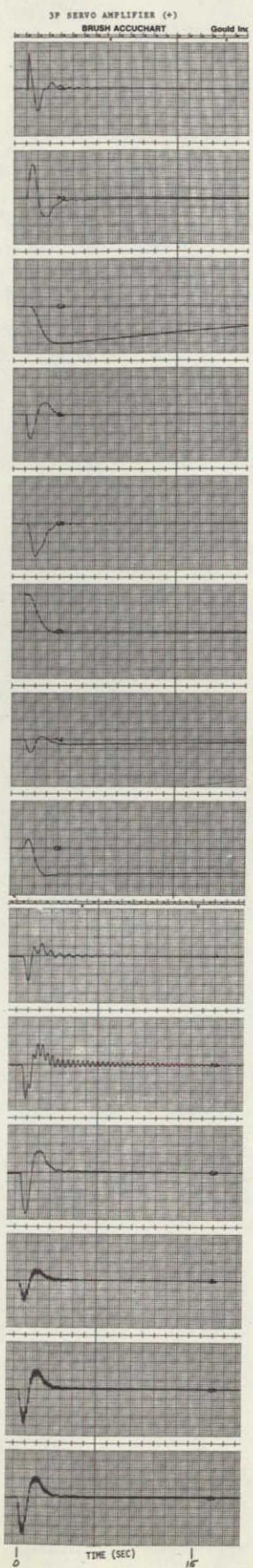
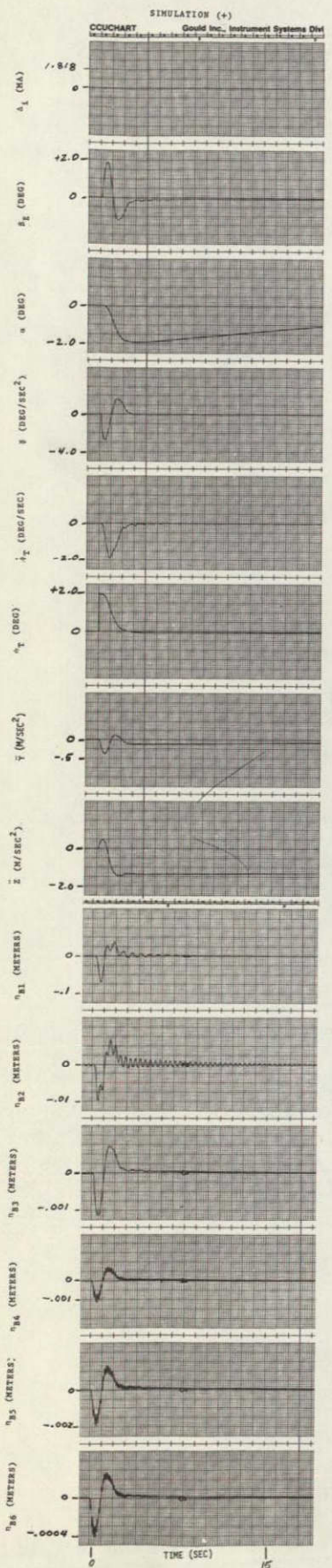

ORIGINAL PAGE IS  
OF POOR QUALITY

CLOSED LOOP TRANSIENT RESPONSE  
TO A STEP INPUT  $\theta = \pm 2$  DEGREES  
 $T = 120$  SEC. PITCH-TAW AXIS



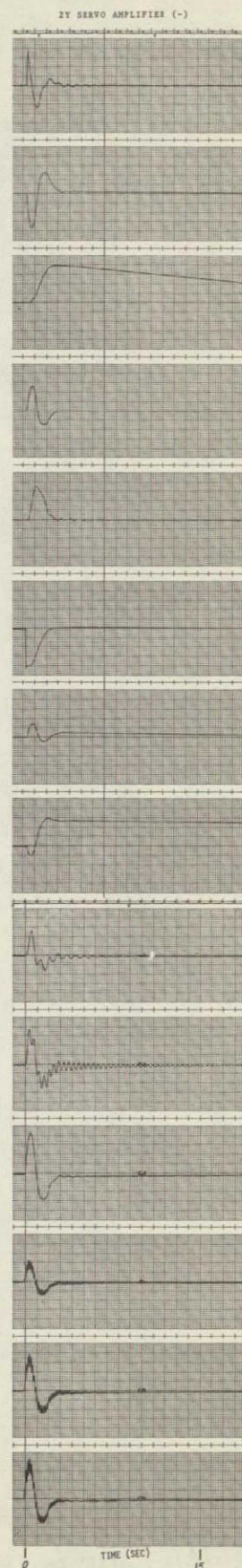
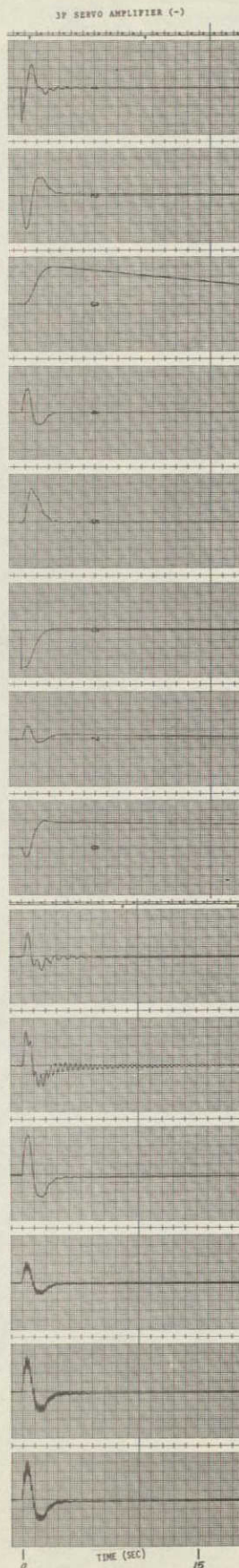
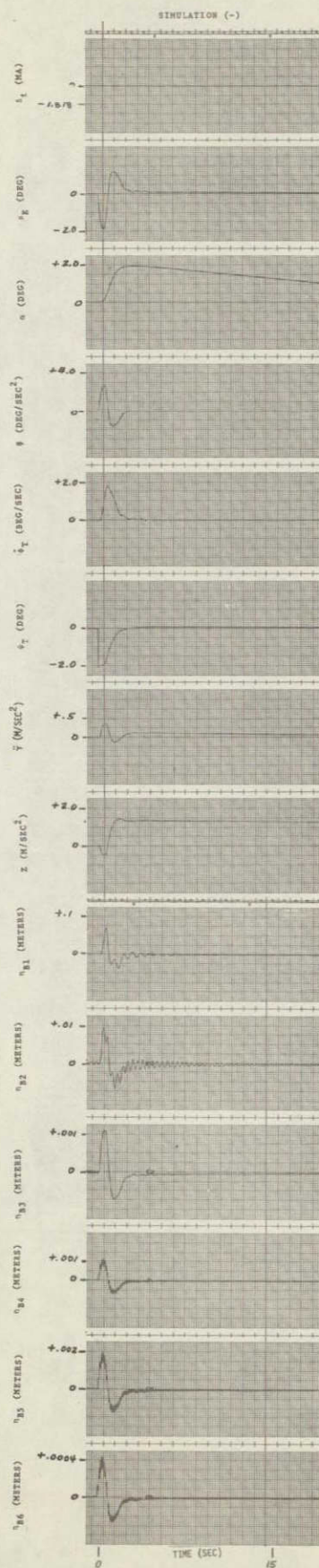

CLOSED LOOP TRANSIENT RESPONSE  
TO A STEP INPUT  $\phi = -2$  DEGREES  
 $T = 120$ - SEC. PITCH-TAN AXIS

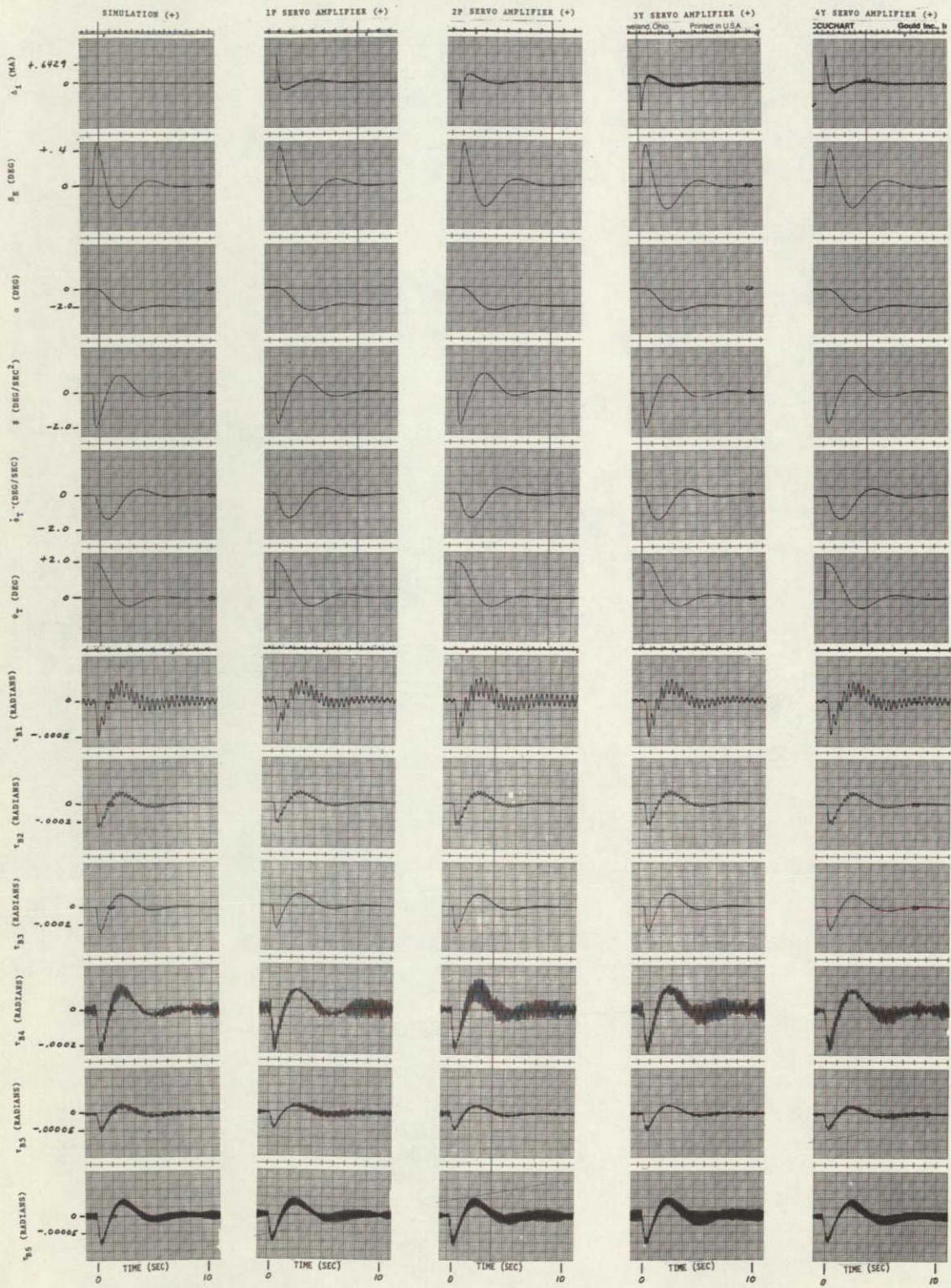

CLOSED LOOP TRANSIENT RESPONSE  
 TO A STEP INPUT  $\theta = +2$  DEGREES  
 $T = 0$  SEC. ROLL AXIS

ORIGINAL PAGE IS  
 OF POOR QUALITY

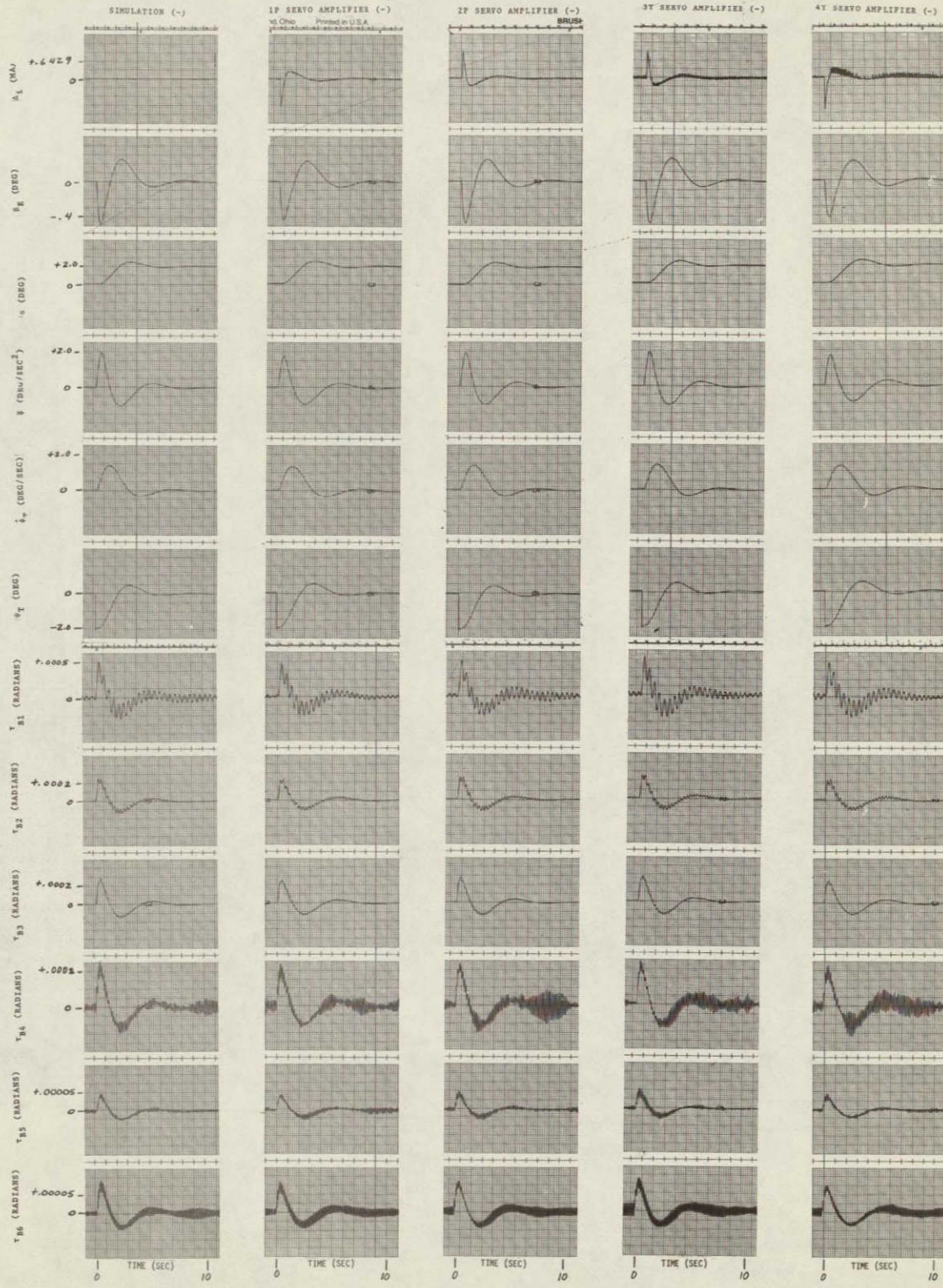

CLOSED LOOP TRANSIENT RESPONSE  
 TO A STEP INPUT  $\phi = +2$  DEGREES  
 $T = 0$  SEC. HOLE AXIS

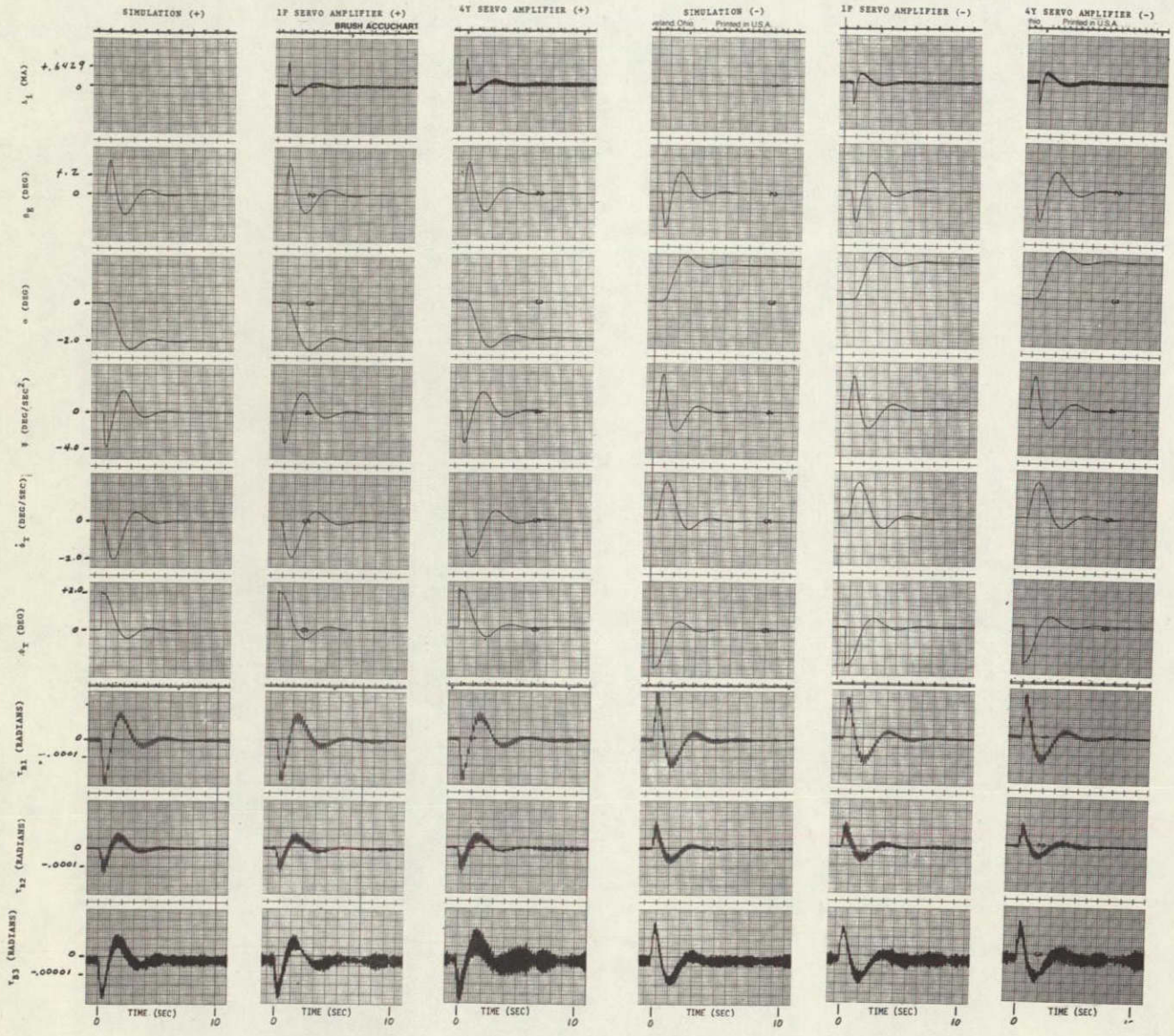

CLOSED LOOP TRANSIENT RESPONSE  
 TO A STEP INPUT  $\theta = -2$  DEGREES  
 $T = 140.6$  SEC. ROLL

ORIGINAL PAGE IS  
 OF POOR QUALITY

SIMULATION

BRUSH ACCUCHART Gould Inc., Instrument Systems Division Cleveland, Ohio Printed in U.S.A.

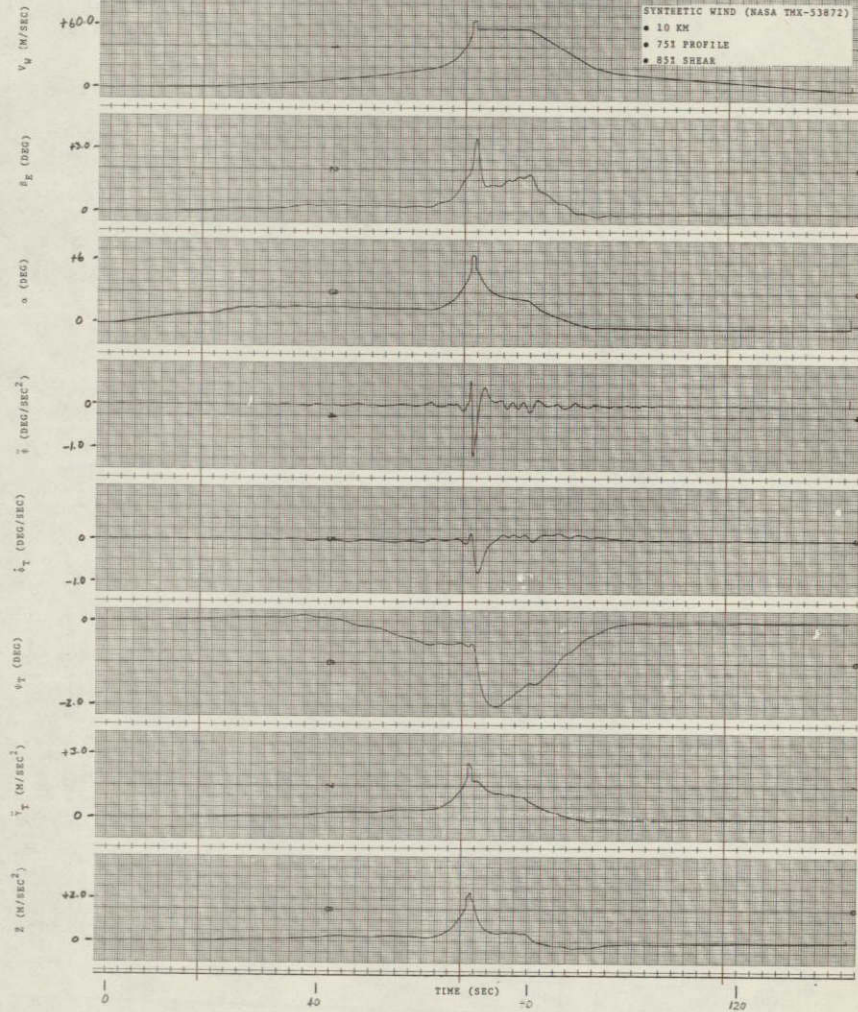

WIND RESPONSE WITH GAIN SWITCH POINTS

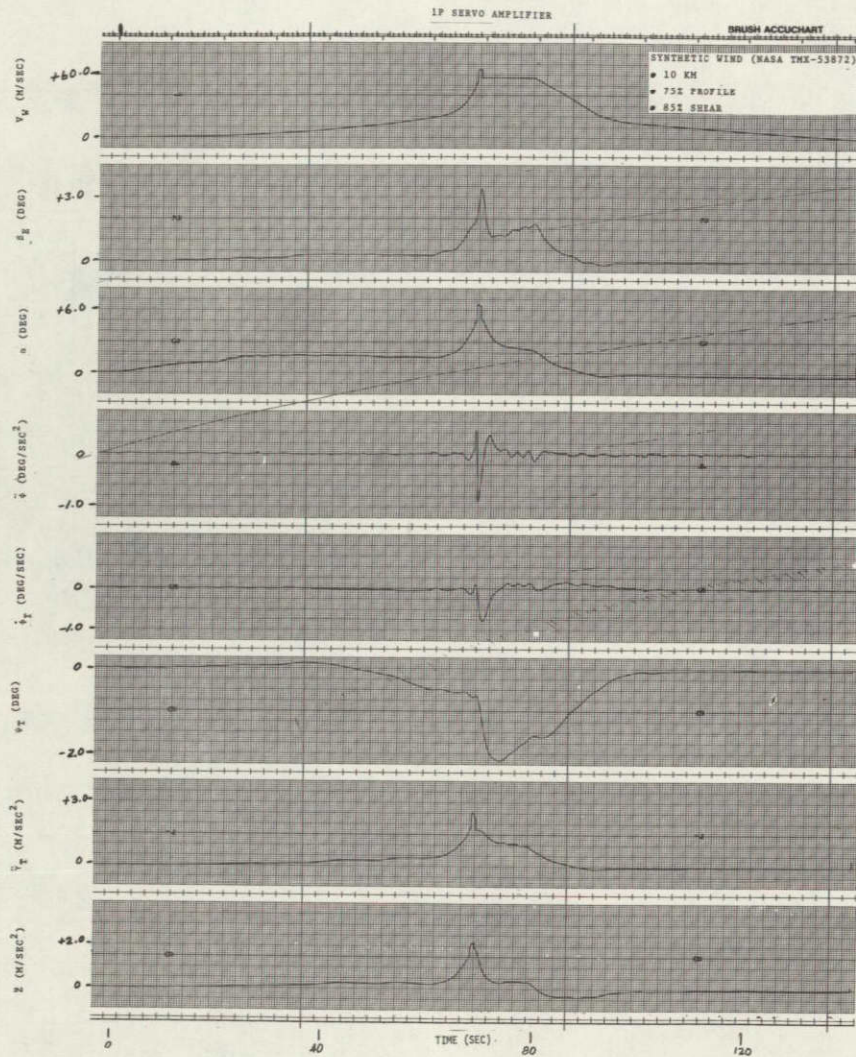

WIND RESPONSE WITH GAIN SWITCH POINTS

ORIGINAL PAGE IS  
OF POOR QUALITY

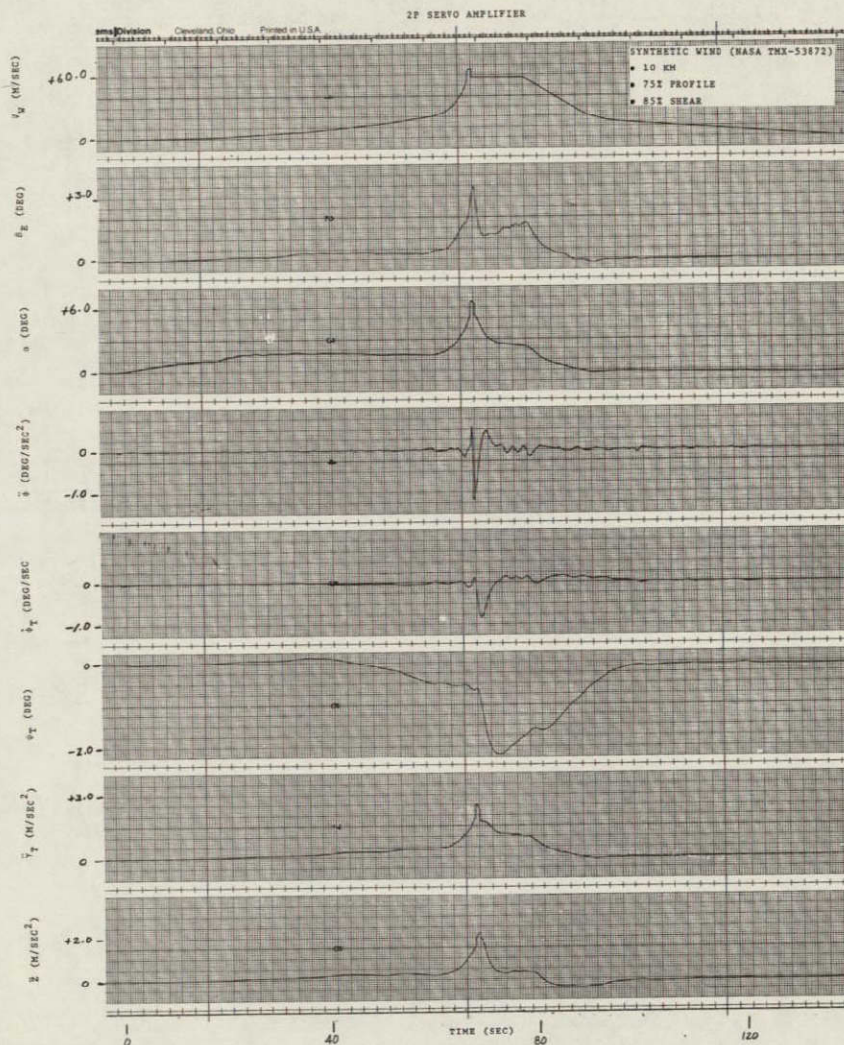

WIND RESPONSE WITH GAIN SWITCH POINTS

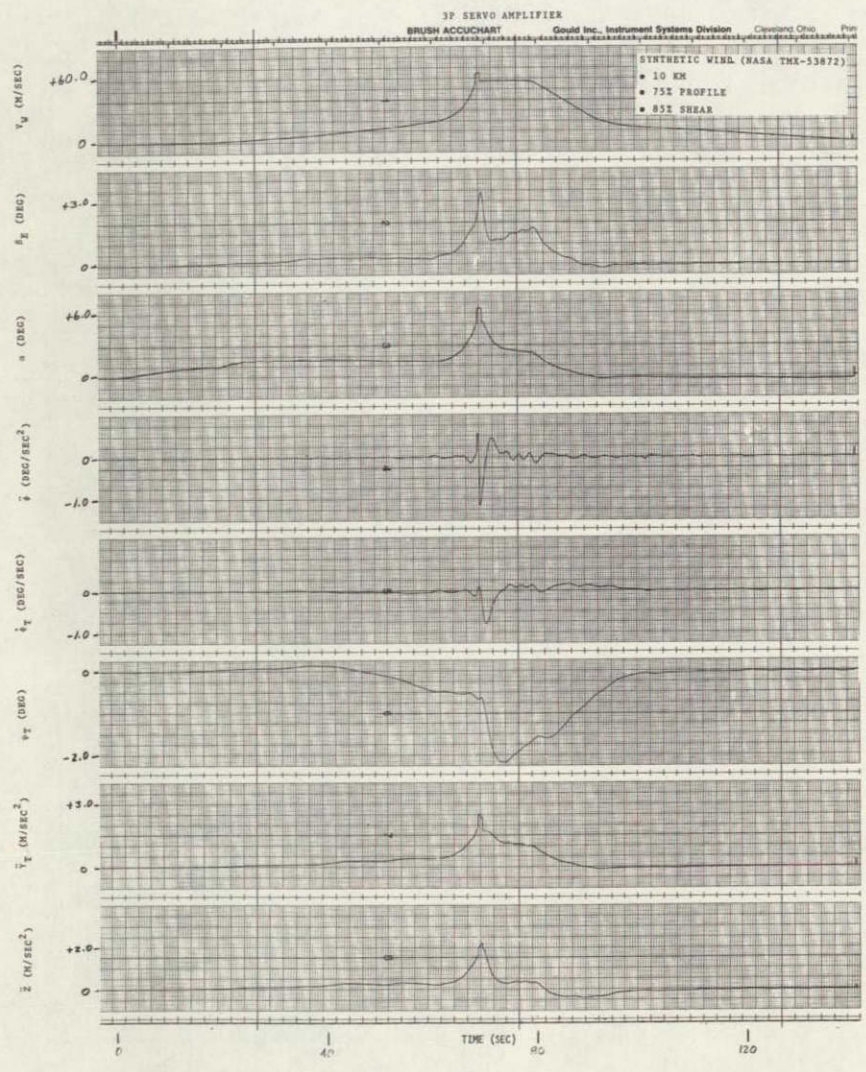

WIND RESPONSE WITH GAIN SWITCH POINTS



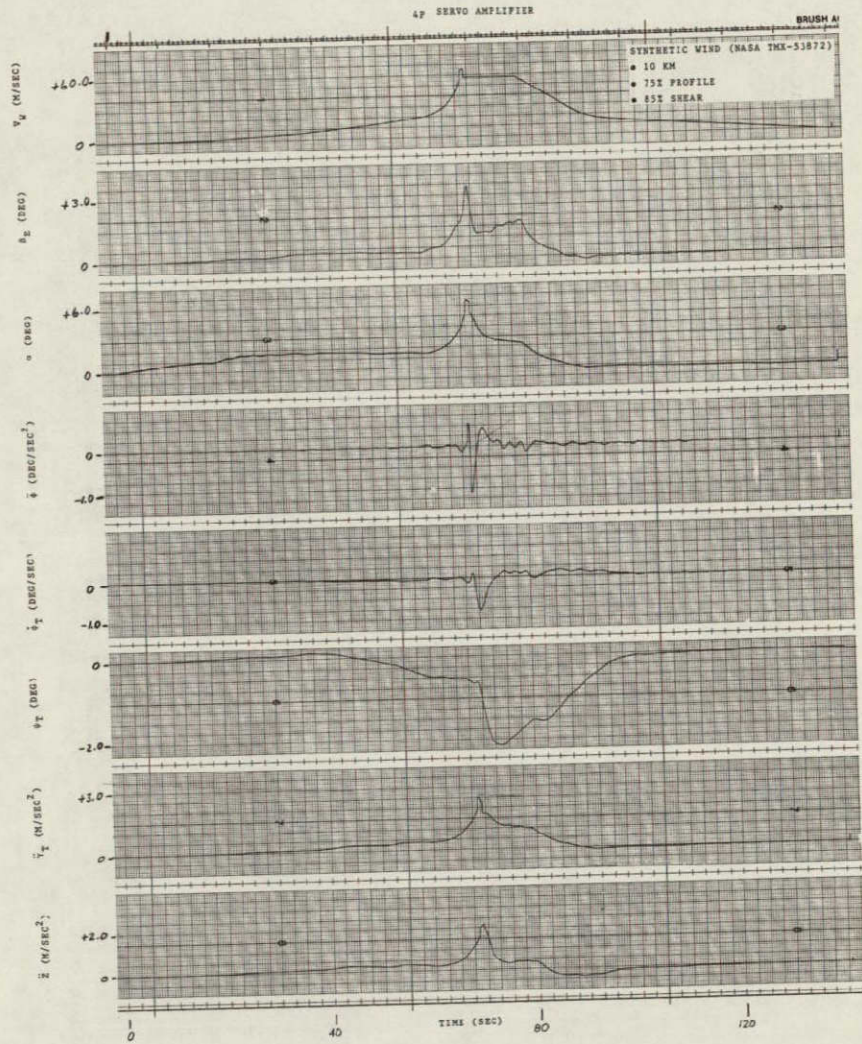

WIND RESPONSE WITH GAIN SWITCH POINTS

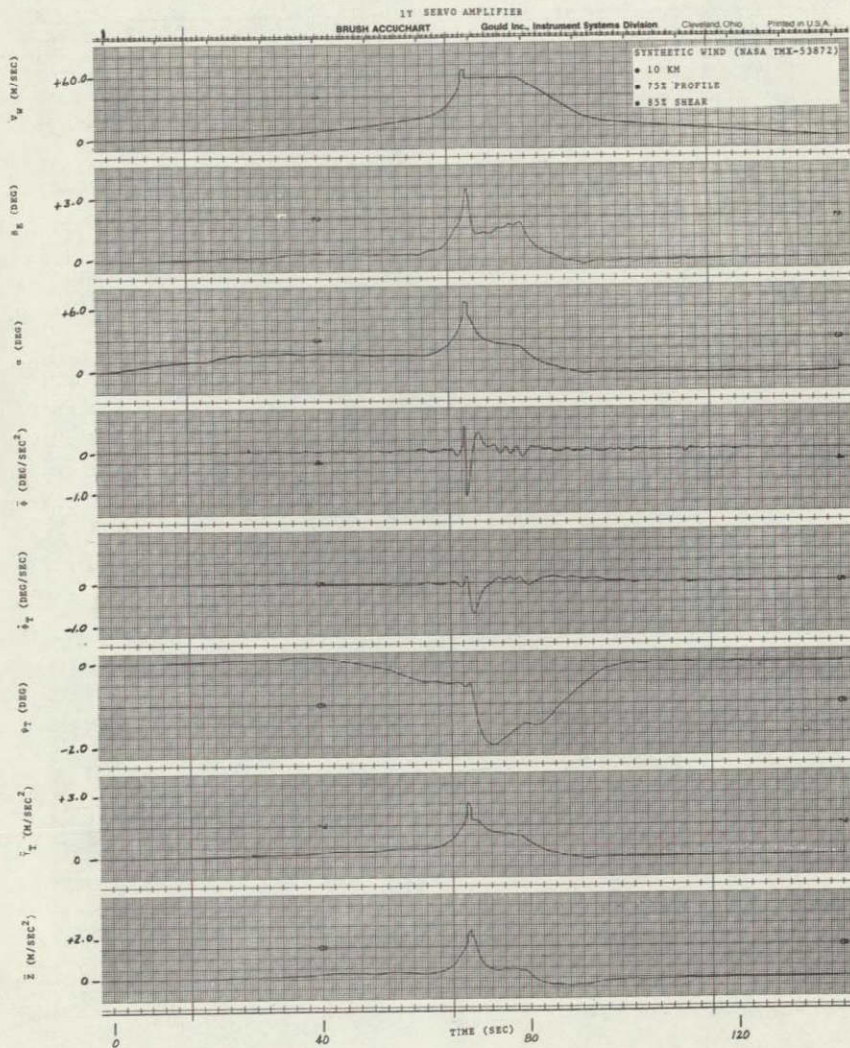

WIND RESPONSE WITH GAIN SWITCH POINTS

ORIGINAL PAGE IS  
OF POOR QUALITY

ZY SERVO AMPLIFIER

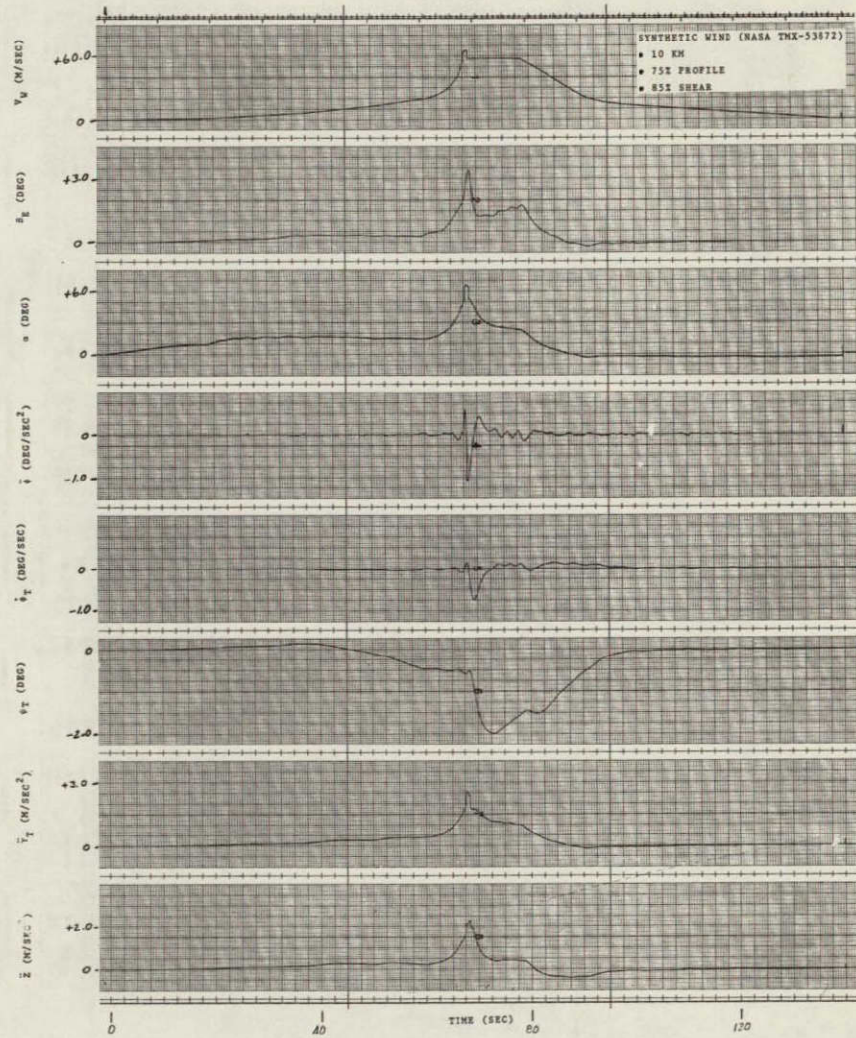

WIND RESPONSE WITH GAIN SWITCH POINTS

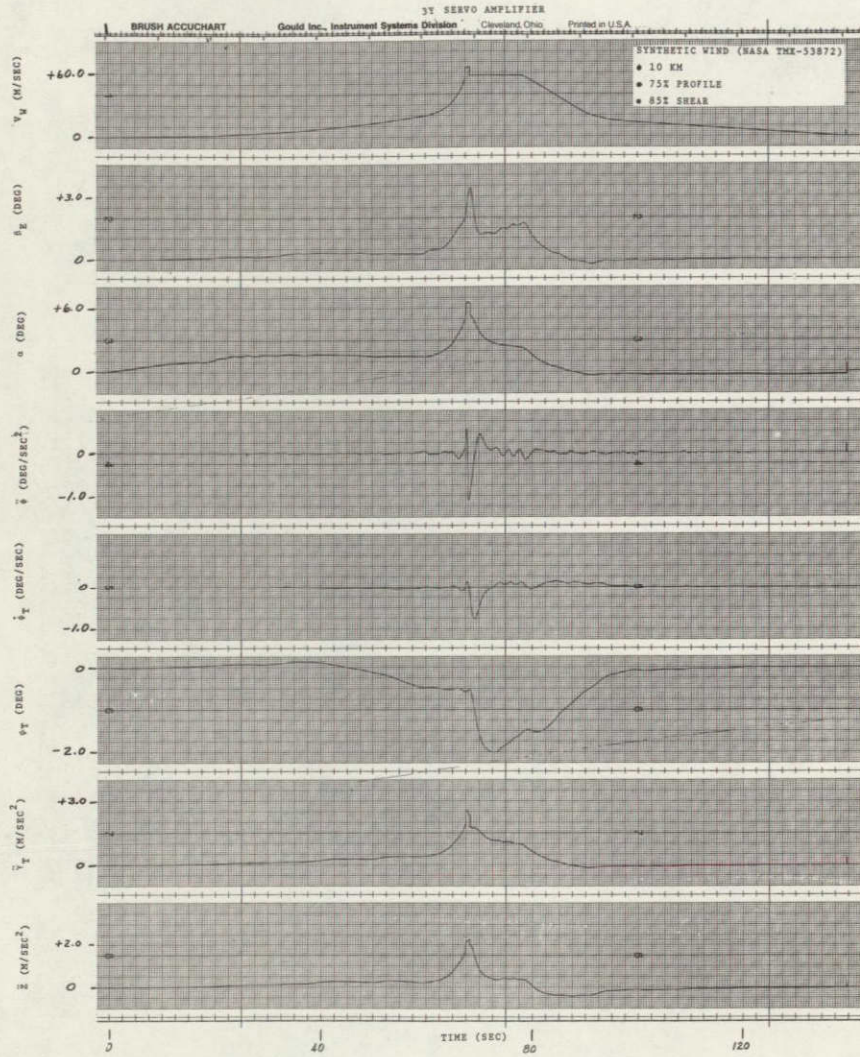

WIND RESPONSE WITH GAIN SWITCH POINTS

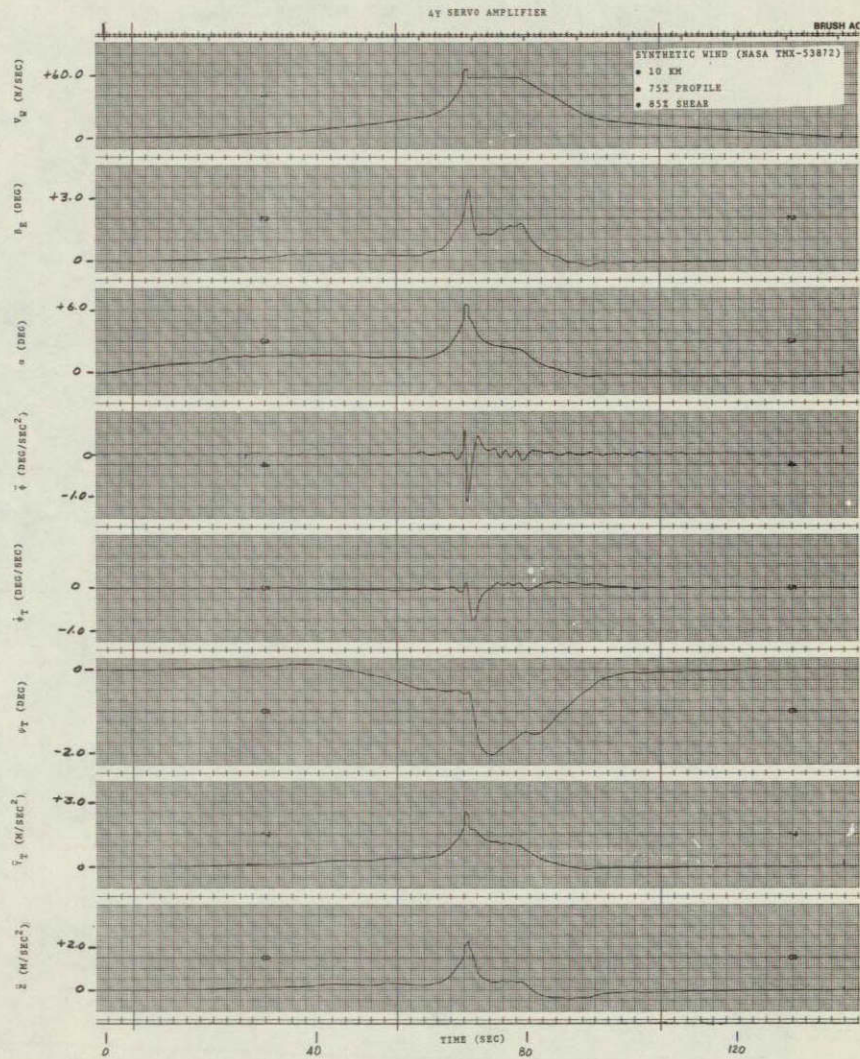

WIND RESPONSE WITH GAIN SWITCH POINTS

Cleveland Printed in U.S.A.  
G<sub>2</sub> GAIN PROFILE

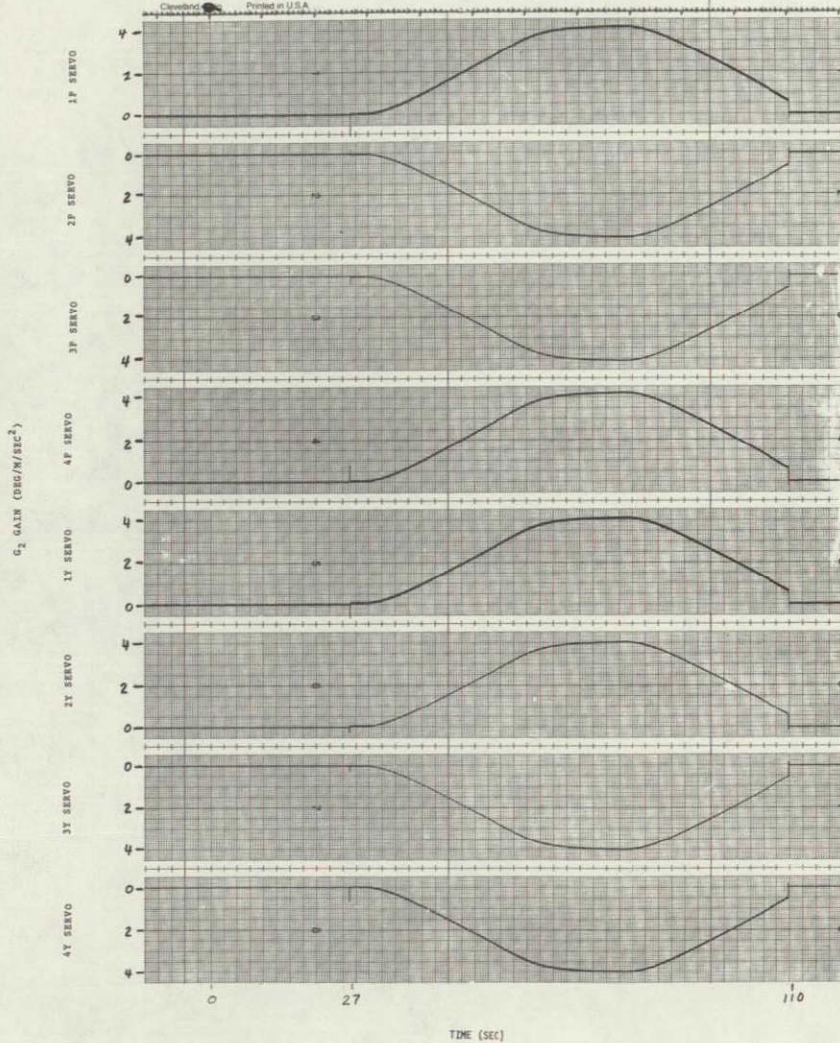

**Section 3**

**S-IVB STAGE TEST RESULTS AND ANALYSIS**

Section 3

FCC S/N 0104-I TEST RESULTS AND ANALYSIS  
S-IVB STAGE

TABULATION

Table 3 outlines the results of the tests performed on FCC S/N 0104-I. The table serves as a ready guide to the following pertinent areas:

- Location of the specific test results.
- Statement as to whether IBM considers the FCC acceptable or unacceptable for flight.
- Reference to the location of further analysis on a given test.

Test Performed	Results (Page No.)	Acceptable	Analysis and Comments
Servo Amplifier Null and Null Drift (Power Supply @ 28 vdc)	3-6 D-1	Yes	All servo amplifier null and null drift values were acceptable. The maximum null was +9.0 mv in the B-Y servo amp with the FCC on for 210 minutes. The worst case null drift over a 3-hour period was +12.0 mv in the B-Y servo amp.
Servo Amplifier Noise (Power Supply @ 28 vdc)	3-6 D-1	Yes	All servo amplifier noise levels were acceptable. The maximum noise characteristic was 3.0 mvp-p in the B-P, C-P, and B-Y servo amps with FCC power on for 30 minutes.

TABLE 3. RESULTS AND ANALYSIS OF FCC S/N 0104-I, S-IVB STAGE



Test Performed	Results (Page No.)	Acceptable	Analysis and Comments
Servo Amplifier Noise with 28-volt Power Supply Variation	C-1	Yes	Servo amplifier noise did not vary as the input power supply voltage was varied from 28 to 32 vdc.
Channel Cross Coupling	3-8	Yes	Cross coupled signals were within the 5 mvp-p guideline at all test frequencies with attitude error inputs; the worst case was 4 mvp-p with a $\psi_y$ input coupling into the C-P servo amp. No cross coupled signals were observed with attitude rate inputs at SP #3 and #4.
Channel Common Mode	3-20	Yes	<p>Prominent common mode signals exceeding the 15 mvp-p guideline were present with the following input signals:</p> <ul style="list-style-type: none"> <li>• <math>\psi_p</math> - 18 mvp-p at 20 Hz in the B-P servo amp</li> <li>• <math>\psi_p</math> - 24 mvp-p at 30 Hz in the C-P servo amp</li> <li>• <math>\psi_y</math> - 22 mvp-p at 30 Hz in the B-Y servo amp</li> <li>• <math>\psi_y</math> - 16 mvp-p at 15 Hz in the C-Y servo amp</li> <li>• <math>\phi_p</math> - 19 mvp-p at 30 Hz in the B-P servo amp</li> <li>• <math>\phi_p</math> - 26 mvp-p at 30 Hz in the C-P servo amp</li> <li>• <math>\phi_y</math> - 16 mvp-p at 20 Hz in the B-Y servo amp</li> <li>• <math>\phi_y</math> - 17 mvp-p at 30 Hz in the C-Y servo amp</li> </ul> <p>This is considered an acceptable condition over the 15 to 60 Hz range, since the expected TVC attenuation is greater than 25 db.</p>
Servo Amplifier Linearity and Signal Mixing	3-23	Yes	All servo amplifiers summed properly and had linear responses for various levels of biased attitude error inputs combined with ramped attitude rate inputs.
Servo Amplifier Linearity and Saturation	3-35	Yes	With a biased level of $+15^\circ$ of attitude error input and ramped attitude rate input, the servo amplifiers were linear over the $\pm 50$ ma range and saturated in excess of $\pm 50$ ma.

TABLE 3.  
(Cont'd)

RESULTS AND ANALYSIS OF FCC S/N 0104-I, S-IVB STAGE

Test Performed	Results (Page No.)	Acceptable	Analysis and Comments
Servo Amplifier Relative Polarities	3-37	Yes	Relative channel polarities were found to be correct in the S-IVB burn mode as observed from the Linearity/Mixing plots and the Switchpoint Utilization plots.
Static Control Gains	3-38	Yes	All $A_0$ and $A_1$ static gain deviations were less than the allowable $\pm 2\%$ . Worst case deviations were: <ul style="list-style-type: none"> <li>• <math>A_0</math> - -1.390% in the C-P servo amp with a <math>\psi_p</math> input at SP #3</li> <li>• <math>A_1</math> - -1.650% in the C-P servo amp with a <math>\phi_p</math> input at SP #3</li> </ul>
Switchpoint Utilization	A-1	Yes	Proper gain changes were observed at each switchpoint for every channel in the S-IVB stage.
Spacecraft Control	B-1	Yes	The FCC honored the spacecraft attitude error inputs in the S-IVB burn mode, and the correct $A_0$ gain changes were made when going from IU to S/C control.
Open-Loop Channel Frequency Response (Bode)	3-39	Yes	All S-IVB stage channel frequency responses were acceptable with deviations from theoretical values accounted for by: <ul style="list-style-type: none"> <li>• Rate gyro frequency response</li> <li>• Inadequate calibration of the "signal analyzer"</li> <li>• Channel common mode</li> </ul>
Nyquist Frequency Response	3-71	Yes	The Nyquist responses were acceptable. Deviations from the theoretical values were accounted for by component frequency responses.
Closed-Loop Transient Response to a Step Forcing Function	3-82	Yes	Hardware runs closely matched the total simulation runs. The system responded satisfactorily to a 2-degree step attitude error input.

TABLE 3.  
(Cont'd)

RESULTS AND ANALYSIS OF FCC S/N 0104-I, S-IVB STAGE



Test Performed	Results (Page No.)	Acceptable	Analysis and Comments
RG/CSP Frequency Response (Bode)	E-1	N/A	Frequency responses for the Sim Lab RG/CSP subsystem are included for information purposes only. See Appendix E for additional comments.

3-4

TABLE 3.  
(Cont'd)

RESULTS AND ANALYSIS OF FCC S/N 0104-I, S-IVB STAGE

## 3.2 RESULTS

3.2.1 The results of the S-IVB Stage study are presented on the following pages. To assist in the interpretation of the results, the following vehicle orientation is used.

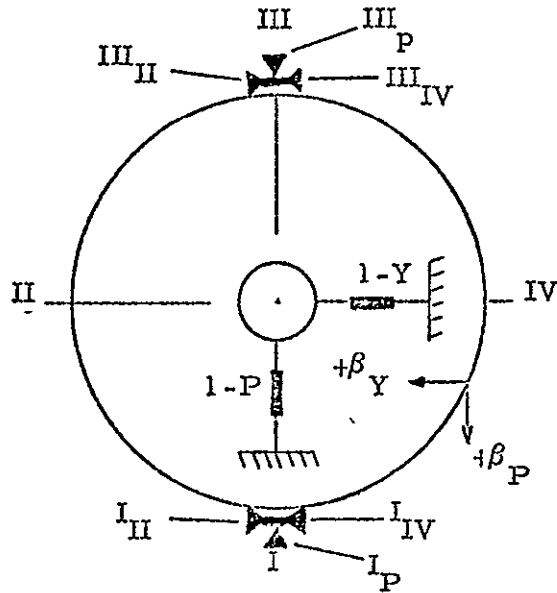

S-IVB STAGE (AFT)  
ACTUATOR AND APS NOZZLE LAYOUT

## NULL AND NOISE

SW. PT.	MEASUREMENT	SERVO AMP			
		B-P	C-P	B-Y	C-Y
3	30 min. Noise (mv p-p)	3.0	3.0	3.0	2.5
	210 min. Noise (mv p-p)	2.0	2.5	2.5	2.5
	30 min. Null (mv)	+7.0	-1.0	-3.0	-0.5
	210 min. Null (mv)	-2.5	-4.5	+9.0	+3.0
	3 hr. Drift (mv)	-9.5	-3.5	+12.0	+3.5
4	30 min. Noise (mv p-p)	3.0	3.0	3.0	2.5
	210 min. Noise (mv p-p)	2.0	2.5	2.5	2.5
	30 min. Null (mv)	+7.0	-1.0	-3.0	-0.5
	210 min. Null (mv)	-2.5	-4.5	+9.0	+3.0
	3 hr. Drift (mv)	-9.5	-3.5	+12.0	+3.5
5	30 min. Noise (mv p-p)	3.0	3.0	3.0	2.5
	210 min. Noise (mv p-p)	2.0	2.5	2.5	2.5
	30 min. Null (mv)	+7.0	-1.0	-3.0	-1.0
	210 min. Null (mv)	-2.5	-4.5	+9.0	+3.0
	3 hr. Drift (mv)	-9.5	-3.5	+12.0	+4.0

Data Recorded: 1/6/75

- NOTES: (1) Servo amp output impedance =  $20 \Omega$  ; signals recorded at comparator output. Actuator drive load =  $100 \Omega$  .
- (2) C channel readings were obtained with comparator voted.
- (3) Peripheral sensors powered off.
- (4) Specifications:
- Null  $\leq 30$  mv
  - Null drift  $\leq 45$  mv over a 3-hour period.
  - Noise  $\leq 5$  mv p-p at frequencies  $\leq 30$  Hz.

FCC S/N	0104-I
STAGE	S-IVB
S.P. #	3, 4, 5

## NULL AND NOISE

With Simulated Telemetry Load

SW. PT.	MEASUREMENT	SERVO AMP			
		B-P	C-P	B-Y	C-Y
3	30 min. Noise (mv p-p)	0.5	0.5	1.5	1.5
	210 min. Noise (mv p-p)	1.0	1.0	1.5	1.5
	30 min. Null (mv)	+16.5	+11.0	-19.5	-14.5
	210 min. Null (mv)	+7.0	+5.5	-7.0	-10.5
	3 hr. Drift (mv)	-9.5	-5.5	+12.5	+4.0
4	30 min. Noise (mv p-p)	0.5	0.5	1.5	1.5
	210 min. Noise (mv p-p)	1.0	1.0	1.5	1.5
	30 min. Null (mv)	+16.5	+11.0	-19.5	-14.5
	210 min. Null (mv)	+7.0	+5.5	-7.0	-10.5
	3 hr. Drift (mv)	-9.5	-5.5	+12.5	+4.0
5	30 min. Noise (mv p-p)	0.5	0.5	1.5	1.5
	210 min. Noise (mv p-p)	1.0	1.0	1.5	1.5
	30 min. Null (mv)	+17.0	+11.0	-20.0	-15.0
	210 min. Null (mv)	+7.5	+5.5	-7.0	-10.5
	3 hr. Drift (mv)	-9.5	-5.5	+13.0	+4.5

Data Recorded: 1/6/75

- NOTES: (1) Servo amp output impedance =  $20 \Omega$  ; signals recorded at comparator output. Actuator drive load =  $100 \Omega$ .
- (2) C channel readings were obtained with comparator voted.
- (3) Peripheral sensors powered off.
- (4) Specifications:
- Null  $\leq 30$  mv
  - Null drift  $\leq 45$  mv over a 3-hour period.
  - Noise  $\leq 5$  mv p-p at frequencies  $\leq 30$  Hz.

FCC S/N	0104-I
STAGE	S-IVB
S.P. #	3, 4, 5

### CROSS COUPLING

FREQUENCY (Hz)	SERVO AMP OUTPUT (mv p-p)			
	Driven: B-P	B-Y	Driven: B-P	C-Y
$\left. \begin{matrix} 0.05, & 0.1, & 0.6, \\ 1, & 3, & 7, \\ 10, & 15 \end{matrix} \right\}$	-	0	-	0
20	100	1	92	2
30	60	2	48	2
40	33	3	29	3
50	27	3	26	3
60	17	3	25	3

Data Recorded: 12/6/74

- NOTES: (1) Servo amp output impedance = 20  $\Omega$  ; signals recorded at comparator output.
- (2) C channel readings were obtained with comparator voted.
- (3) Cross coupled signal does not include noise.
- (4) Maximum input signal:
- $\psi = 12$  v or  $\phi = 45$  v.
  - Or when  $i_v = 50$  ma
- (5) Guideline:
- With maximum input signal, cross coupling  $\leq 5$  mvp-p for all frequencies.

FCC S/N	0104-I
STAGE	S-IVB
CHAN	$\psi$ Pitch
S.P.#	3

### CROSS COUPLING

FREQUENCY (Hz)	SERVO AMP OUTPUT (mv p-p)			
	Driven: C-P	B-Y	Driven: C-P	C-Y
$\left. \begin{matrix} 0.05, & 0.1, & 0.6, \\ 1, & 3, & 7, \\ 10 \end{matrix} \right\}$	-	0	-	0
15	133	1	135	1
20	95	1	95	1
30	58	2	58	2
40	37	2	36	2
50	29	3	28	3
60	25	3	25	3

Data Recorded: 12/6/74

- NOTES: (1) Servo amp output impedance = 20  $\Omega$  ; signals recorded at comparator output.
- (2) C channel readings were obtained with comparator voted.
- (3) Cross coupled signal does not include noise.
- (4) Maximum input signal:
- $\psi = 12$  v or  $\phi = 45$  v.
  - Or when  $i_v = 50$  ma
- (5) Guideline:
- With maximum input signal, cross coupling  $\leq 5$  mvp-p for all frequencies.

FCC S/N	0104-I
STAGE	S-IVB
CHAN	$\psi$ Pitch
S.P.#	3



### CROSS COUPLING

FREQUENCY (Hz)	SERVO AMP OUTPUT (mv p-p)			
	Driven: B-Y	B-P	Driven: B-Y	C-P
$\left. \begin{matrix} 0.05, & 0.1, & 0.6, \\ 1, & 3, & 7, \\ 10 \end{matrix} \right\}$	-	0	-	0
15	-	0	140	1
20	92	1	100	1
30	48	2	60	2
40	28	2	34	3
50	25	2	23	3
60	25	2	19	3

Data Recorded: 12/6/74

- NOTES: (1) Servo amp output impedance =  $20 \Omega$  ; signals recorded at comparator output.
- (2) C channel readings were obtained with comparator voted.
- (3) Cross coupled signal does not include noise.
- (4) Maximum input signal:
- $\psi = 12 \text{ v}$  or  $\phi = 45 \text{ v}$ .
  - Or when  $i_v = 50 \text{ ma}$
- (5) Guideline:
- With maximum input signal, cross coupling  $\leq 5 \text{ mvp-p}$  for all frequencies.

FCC S/N	0104-I
STAGE	S-IVB
CHAN	$\psi$ Yaw
S.P.#	3

### CROSS COUPLING

FREQUENCY (Hz)	SERVO AMP OUTPUT (mv p-p)			
	Driven: C-Y	B-P	Driven: C-Y	C-P
$\left. \begin{matrix} 0.05, & 0.1, & 0.6, \\ 1, & 3, & 7, \\ 10, & 15 \end{matrix} \right\}$	-	0	-	0
20	87	1	85	2
30	43	2	43	2
40	30	3	30	4
50	35	3	36	4
60	37	3	36	3

Data Recorded: 12/6/74

- NOTES: (1) Servo amp output impedance = 20  $\Omega$  ; signals recorded at comparator output.
- (2) C channel readings were obtained with comparator voted.
- (3) Cross coupled signal does not include noise.
- (4) Maximum input signal:
- $\psi = 12$  v or  $\phi = 45$  v.
  - Or when  $i_v = 50$  ma
- (5) Guideline:
- With maximum input signal, cross coupling  $\leq 5$  mvp-p for all frequencies.

FCC S/N	0104-I
STAGE	S-IVB
CHAN	$\psi$ Yaw
S.P.#	3

### CROSS COUPLING

FREQUENCY (Hz)	SERVO AMP OUTPUT (mv p-p)			
	Driven B-P	B-Y	Driven: B-P	C-Y
$\left\{ \begin{array}{lll} 0.05, & 0.1, & 0.6, \\ 1, & 2, & 2.3, \\ 3, & 4, & 6, \\ 10, & 15, & 20, \\ 30, & 40, & 50, \\ 60 \end{array} \right\}$	-	0	-	0

Date Recorded: 12/6/74

- NOTES: (1) Servo amp output impedance =  $20 \Omega$  ; signals recorded at comparator output.
- (2) C channel readings were obtained with comparator voted.
- (3) Cross coupled signal does not include noise.
- (4) Maximum input signal:
- $\psi = 12 \text{ v}$  or  $\phi = 45 \text{ v}$ .
  - Or when  $i_v = 50 \text{ ma}$
- (5) Guideline:
- With maximum input signal, cross coupling  $\leq 5 \text{ mvp-p}$  for all frequencies.

FCC S/N	0104-I
STAGE	S-IVB
CHAN	$\phi$ Pitch
S.P.#	3

## CROSS COUPLING

FREQUENCY (Hz)	SERVO AMP OUTPUT (mv p-p)			
	Driven: C-P	B-Y	Driven: C-P	C-Y
$\left\{ \begin{array}{lll} 0.05, & 0.1, & 0.6, \\ 1, & 2, & 2.3, \\ 3, & 4, & 6, \\ 10, & 15, & 20, \\ 30, & 40, & 50, \\ 60 \end{array} \right\}$	-	0	-	0

Date Recorded: 12/6/74

- NOTES: (1) Servo amp output impedance =  $20 \Omega$  ; signals recorded at comparator output.
- (2) C channel readings were obtained with comparator voted.
- (3) Cross coupled signal does not include noise.
- (4) Maximum input signal:
- $\psi = 12 \text{ v}$  or  $\phi = 45 \text{ v}$ .
  - Or when  $i_v = 50 \text{ ma}$
- (5) Guideline:
- With maximum input signal, cross coupling  $\leq 5 \text{ mvp-p}$  for all frequencies.

FCC S/N	0104-I
STAGE	S-IVB
CHAN	$\phi$ Pitch
S.P.#	3

## CROSS COUPLING

FREQUENCY (Hz)	SERVO AMP OUTPUT (mv p-p)			
	Driven: B-Y	B-P	Driven: B-Y	C-P
$\left\{ \begin{array}{lll} 0.05, & 0.1, & 0.6, \\ 1, & 2, & 2.3, \\ 3, & 4, & 6, \\ 10, & 15, & 20, \\ 30, & 40, & 50, \\ 60 \end{array} \right\}$	-	0	-	0

Date Recorded: 12/6-9/74

- NOTES: (1) Servo amp output impedance =  $20 \Omega$  ; signals recorded at comparator output.
- (2) C channel readings were obtained with comparator voted.
- (3) Cross coupled signal does not include noise.
- (4) Maximum input signal:
- $\psi = 12 \text{ v}$  or  $\dot{\phi} = 45 \text{ v}$ .
  - Or when  $i_v = 50 \text{ ma}$
- (5) Guideline:
- With maximum input signal, cross coupling  $\leq 5 \text{ mvp-p}$  for all frequencies.

FCC S/N	0104-I
STAGE	S-IVB
CHAN	$\dot{\phi}$ Yaw
S.P.#	3

## CROSS COUPLING

FREQUENCY (Hz)	SERVO AMP OUTPUT (mv p-p)			
	Driven: C-Y	B-P	Driven: C-Y	C-P
$\left( \begin{array}{ccc} 0.05, & 0.1, & 0.6, \\ 1, & 2, & 2.3, \\ 3, & 4, & 6, \\ 10, & 15, & 20, \\ 30, & 40, & 50, \\ 60 \end{array} \right)$	-	0	-	0

Date Recorded: 12/9/74

- NOTES: (1) Servo amp output impedance = 20  $\Omega$  ; signals recorded at comparator output.
- (2) C channel readings were obtained with comparator voted.
- (3) Cross coupled signal does not include noise.
- (4) Maximum input signal:
- $\psi = 12$  v or  $\phi = 45$  v.
  - Or when  $i_v = 50$  ma
- (5) Guideline:
- With maximum input signal, cross coupling  $\leq 5$  mvp-p for all frequencies.

FCC S/N	0104-1
STAGE	S-IVB
CHAN	$\phi$ Yaw
S.P.#	3

### CROSS COUPLING

FREQUENCY (Hz)	SERVO AMP OUTPUT (mv p-p)			
	Driven: B-P	B-Y	Driven: B-P	C-Y
<div style="display: flex; justify-content: space-between;"> <div style="border-left: 1px solid black; border-right: 1px solid black; padding: 0 5px;">                     { 0.05, 1, 5, 10, 30, 60 }                 </div> <div style="border-left: 1px solid black; border-right: 1px solid black; padding: 0 5px;">                     { 0.1, 2, 6.6, 15, 40 }                 </div> <div style="border-left: 1px solid black; border-right: 1px solid black; padding: 0 5px;">                     { 0.6, 3, 8, 20, 50 }                 </div> </div>	-	0	-	0

Date Recorded: 12/6/74

- NOTES: (1) Servo amp output impedance = 20  $\Omega$  ; signals recorded at comparator output.
- (2) C channel readings were obtained with comparator voted.
- (3) Cross coupled signal does not include noise.
- (4) Maximum input signal:
- $\psi = 12\text{ v}$  or  $\dot{\phi} = 45\text{ v}$ .
  - Or when  $i_v = 50\text{ ma}$
- (5) Guideline:
- With maximum input signal, cross coupling  $\leq 5\text{ mvp-p}$  for all frequencies.

FCC S/N	0104-I
STAGE	S-IVB
CHAN	$\dot{\phi}$ Pitch
S.P.#	4

## CROSS COUPLING

FREQUENCY (Hz)	SERVO AMP OUTPUT (mv p-p)			
	Driven: C-P	B-Y	Driven: C-P	C-Y
$\left\{ \begin{array}{lll} 0.05, & 0.1, & 0.6, \\ 1, & 2, & 3, \\ 5, & 6.6, & 8, \\ 10, & 15, & 20, \\ 30, & 40, & 50, \\ 60 \end{array} \right\}$	-	0	-	0

Date Recorded: 12/6/74

- NOTES: (1) Servo amp output impedance =  $20 \Omega$  ; signals recorded at comparator output.
- (2) C channel readings were obtained with comparator voted.
- (3) Cross coupled signal does not include noise.
- (4) Maximum input signal:
- $\psi = 12 \text{ v}$  or  $\phi = 45 \text{ v}$ .
  - Or when  $i_v = 50 \text{ ma}$
- (5) Guideline:
- With maximum input signal, cross coupling  $\leq 5 \text{ mvp-p}$  for all frequencies.

FCC S/N	0104-I
STAGE	S-IVB.
CHAN	$\phi$ Pitch
S.P.#	4



## CROSS COUPLING

FREQUENCY (Hz)	SERVO AMP OUTPUT (mv p-p)			
	Driven: B-Y	B-P	Driven: B-Y	C-P
$\left\{ \begin{array}{lll} 0.05, & 0.1, & 0.6, \\ 1, & 2, & 3, \\ 5, & 6.6, & 8, \\ 10, & 15, & 20, \\ 30, & 40, & 50, \\ 60 \end{array} \right\}$	-	0	-	0

Date Recorded: 12/6-9/74

- NOTES: (1) Servo amp output impedance =  $20 \Omega$  ; signals recorded at comparator output.
- (2) C channel readings were obtained with comparator voted.
- (3) Cross coupled signal does not include noise.
- (4) Maximum input signal:
- $\psi = 12 \text{ v}$  or  $\phi = 45 \text{ v}$ .
  - Or when  $i_v = 50 \text{ ma}$
- (5) Guideline:
- With maximum input signal, cross coupling  $\leq 5 \text{ mvp-p}$  for all frequencies.

FCC S/N	0104-I
STAGE	S-IVB
CHAN	$\phi$ Yaw
S.P.#	4

### CROSS COUPLING

FREQUENCY (Hz)	SERVO AMP OUTPUT (mv p-p)			
	Driven: C-Y	B-P	Driven: C-Y	C-P
$\left. \begin{array}{lll} 0.05, & 0.1, & 0.6, \\ 1, & 2, & 3, \\ 5, & 6.6, & 8, \\ 10, & 15, & 20, \\ 30, & 40, & 50, \\ 60 \end{array} \right\}$	-	0	-	0

Date Recorded: 12/9/74

- NOTES: (1) Servo amp output impedance = 20  $\Omega$  ; signals recorded at comparator output.
- (2) C channel readings were obtained with comparator voted.
- (3) Cross coupled signal does not include noise.
- (4) Maximum input signal:
- $\psi = 12$  v or  $\dot{\phi} = 45$  v.
  - Or when  $i_v = 50$  ma
- (5) Guideline:
- With maximum input signal, cross coupling  $\leq 5$  mvp-p for all frequencies.

FCC S/N	0104-I
STAGE	S-IVB
CHAN	$\dot{\phi}$ Yaw
S.P.#	4

COMMON MODE

FREQUENCY (Hz)	SERVO AMP OUTPUT (mv p-p)			
	B-P	C-P	B-Y	C-Y
0.05	0	0	0	0
0.1	0	0	0	0
0.6	1	0	1	1
1	1	1	2	1
3	3	2	2	4
7	6	4	5	7
10	7	7	8	11
15	12	11	10	16
20	18	14	14	23
30	27	24	22	35
40	35	35	28	44
50	37	37	27	46
60	32	30	24	42

Data Recorded: 11/27/74

- NOTES: (1) Servo amp output impedance =  $20 \Omega$ ; signals recorded at comparator output.  
 (2) C channel readings were obtained with comparator voted.  
 (3) Common mode signal does not include noise.  
 (4) Input signal = 5 v peak.  
 (5) Guideline:

- Common mode  $\leq 15$  mvp-p at servo amp.

FCC S/N	0104-I
STAGE	S-IVB
CHAN	$\psi$ Pitch-Yaw
S.P.#	3

COMMON MODE

FREQUENCY (Hz)	SERVO AMP OUTPUT (mv p-p)			
	B-P	C-P	B-Y	C-Y
0.05	0	0	0	0
0.1	0	0	0	0
0.6	1	1	1	0
1	1	1	1	1
2	1	1	2	1
2.3	1	2	2	1
3	2	2	2	2
4	3	3	3	2
6	3	4	4	4
10	6	7	8	5
15	9	11	11	7
20	12	15	16	10
30	19	26	26	17
40	25	39	34	22
50	27	43	36	25
60	26	39	32	24

Data Recorded: 11/26/74 (B-P, B-Y)  
11/27/74 (C-P, C-Y)

- NOTES: (1) Servo amp output impedance = 20  $\Omega$ ; signals recorded at comparator output.  
 (2) C channel readings were obtained with comparator voted.  
 (3) Common mode signal does not include noise.  
 (4) Input signal = 5 v peak.  
 (5) Guideline:

- Common mode  $\leq$  15 mvp-p at servo amp.

FCC S/N	0104-I
STAGE	S-IVB
CHAN	$\phi$ Pitch-Yaw
S.P.#	3

COMMON MODE

FREQUENCY (Hz)	SERVO AMP OUTPUT (mv p-p)			
	B-P	C-P	B-Y	C-Y
0.05	0	0	0	0
0.1	0	0	0	0
0.6	1	0	1	1
1	1	1	1	1
2	2	1	2	2
3	2	2	3	2
5	2	3	4	3
6.6	3	4	5	3
8	4	5	6	4
10	5	5	8	5
15	8	9	12	7
20	11	15	16	11
30	19	26	26	17
40	24	38	34	23
50	28	43	35	25
60	26	38	33	23

Data Recorded: 11/26/74 (B-P, B-Y,  
C-P)  
11/27/74 (C-Y)

- NOTES: (1) Servo amp output impedance = 20  $\Omega$  ; signals recorded at comparator output.  
 (2) C channel readings were obtained with comparator voted.  
 (3) Common mode signal does not include noise.  
 (4) Input signal = 5 v peak.  
 (5) Guideline:

- Common mode  $\leq 15$  mvp-p at servo amp.

FCC S/N	0104-I
STAGE	S-IVB
CHAN	$\phi$ Pitch-Yaw
S.P.#	4

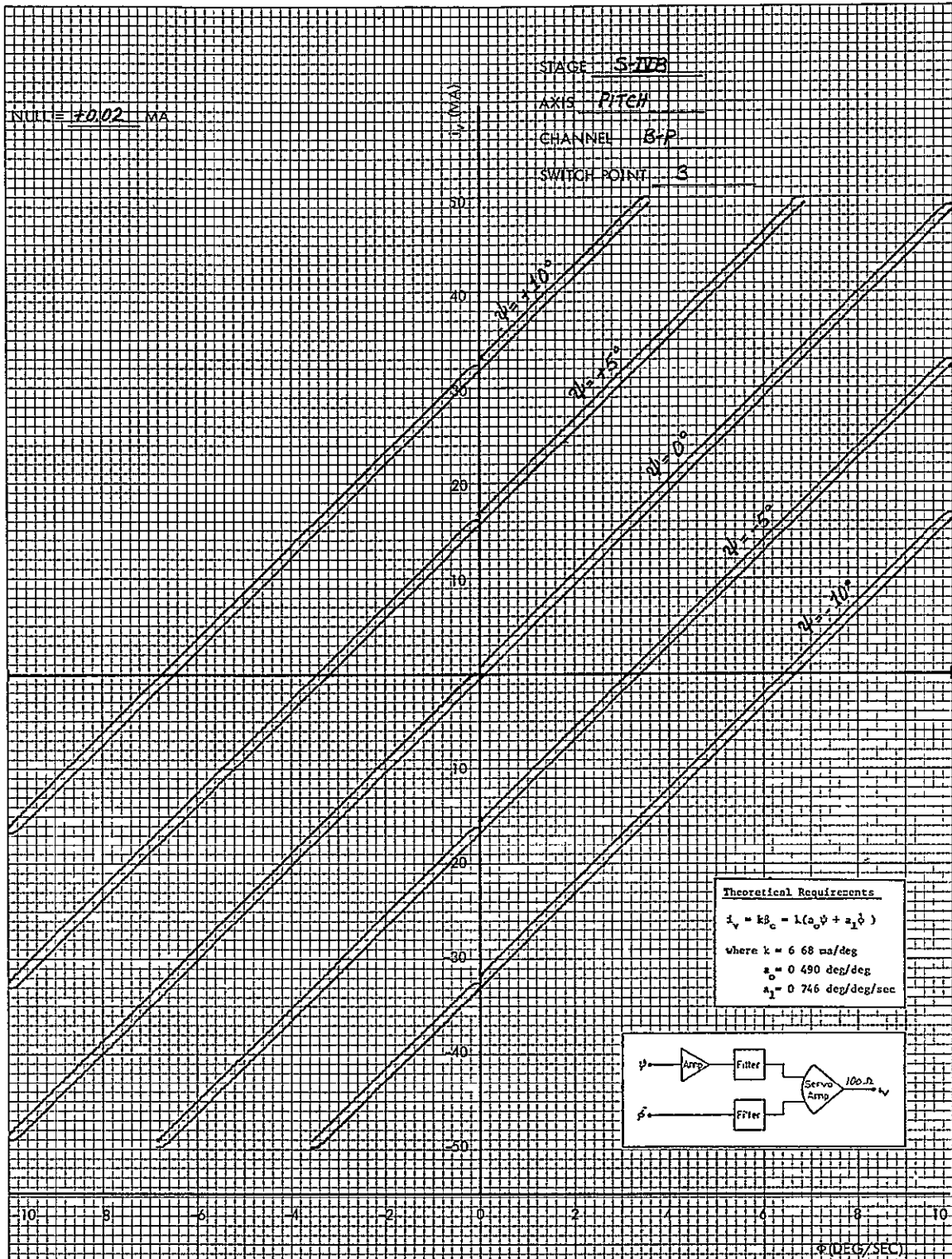
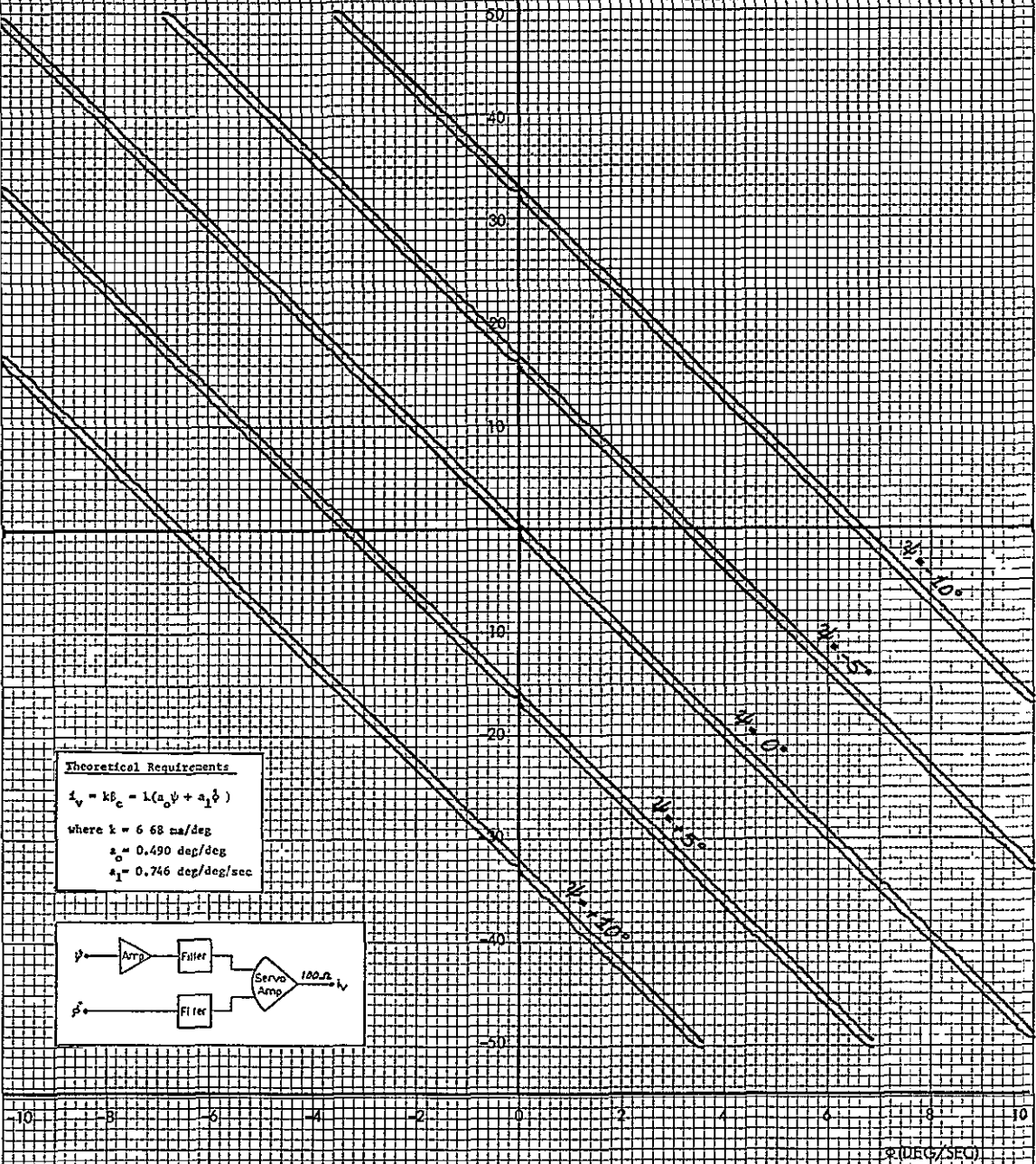

FIGURE  
 STATIC GAIN, LINEARITY, AND SIGNAL MIXING

AS 210 S/N 0104-I

NOTE:  $\pm 0.01$  MA

STAGE S/TB  
 AXIS YAW  
 CHANNEL B-Y  
 SWITCH POINT 3



**Theoretical Requirements**  
 $i_v = k\beta_c - l(a_0\psi + a_1\dot{\phi})$   
 where  $k = 6.68$  ma/deg  
 $a_0 = 0.490$  deg/deg  
 $a_1 = 0.746$  deg/deg/sec

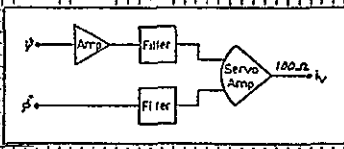

FIGURE  
 STATIC GAIN, LINEARITY, AND SIGNAL MIXING  
 AS: 210 S/N: 010A-I

NULL =  $1 - 0.17$  MA

STAGE S-DB  
 AXIS PITCH  
 CHANNEL C-F  
 SWITCH POINT 3

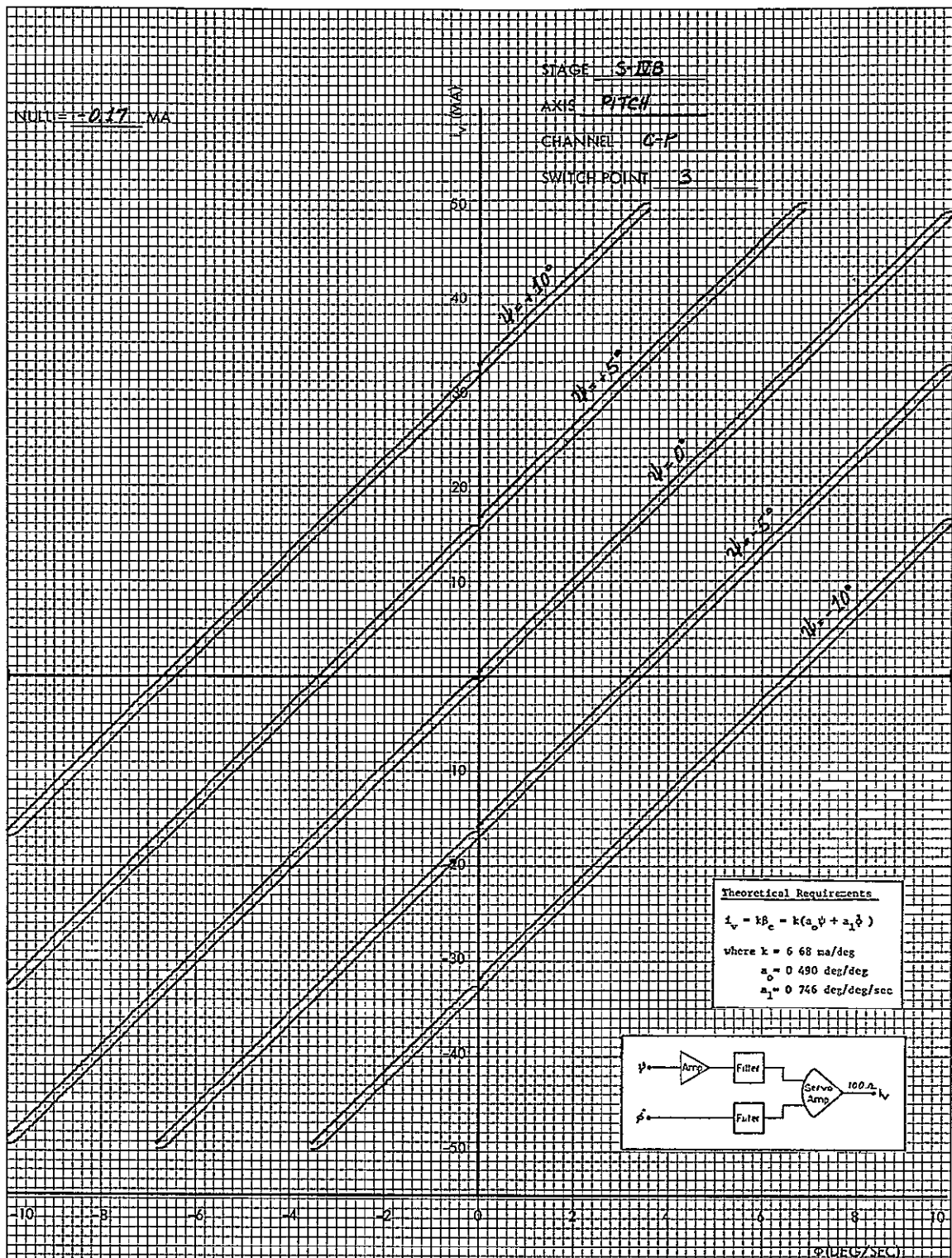

FIGURE  
 STATIC GAIN, LINEARITY, AND SIGNAL MIXING  
 AS: 210 S/N: 0104-E



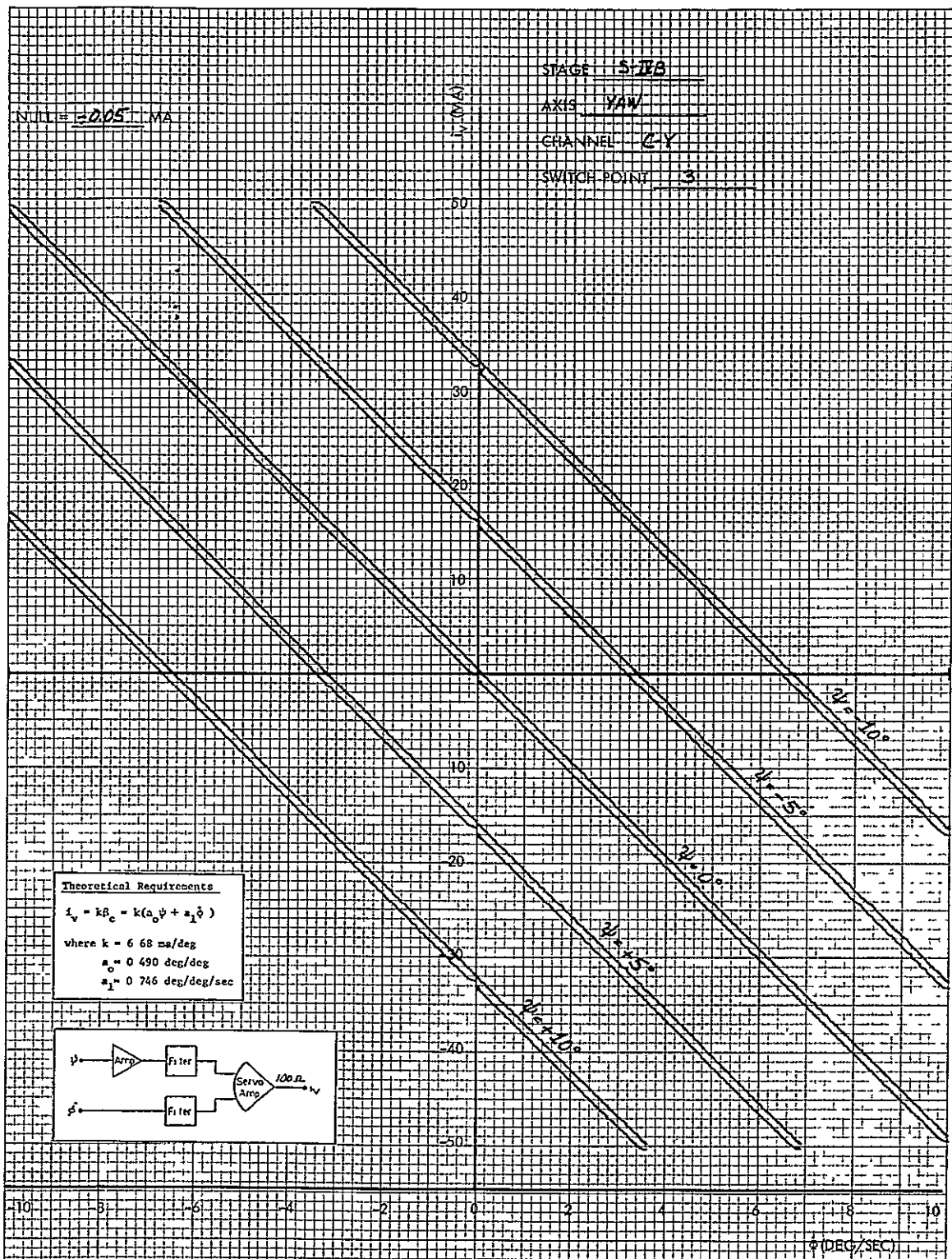

FIGURE  
 STATIC GAIN, LINEARITY, AND SIGNAL MIXING  
 AS 210 S/N 0104-F

ORIGINAL PAGE IS  
 OF POOR QUALITY

NULL = -0.03 MA

STAGE S-17B  
 AXIS PITCH  
 CHANNEL B-P  
 SWITCH POINT 4

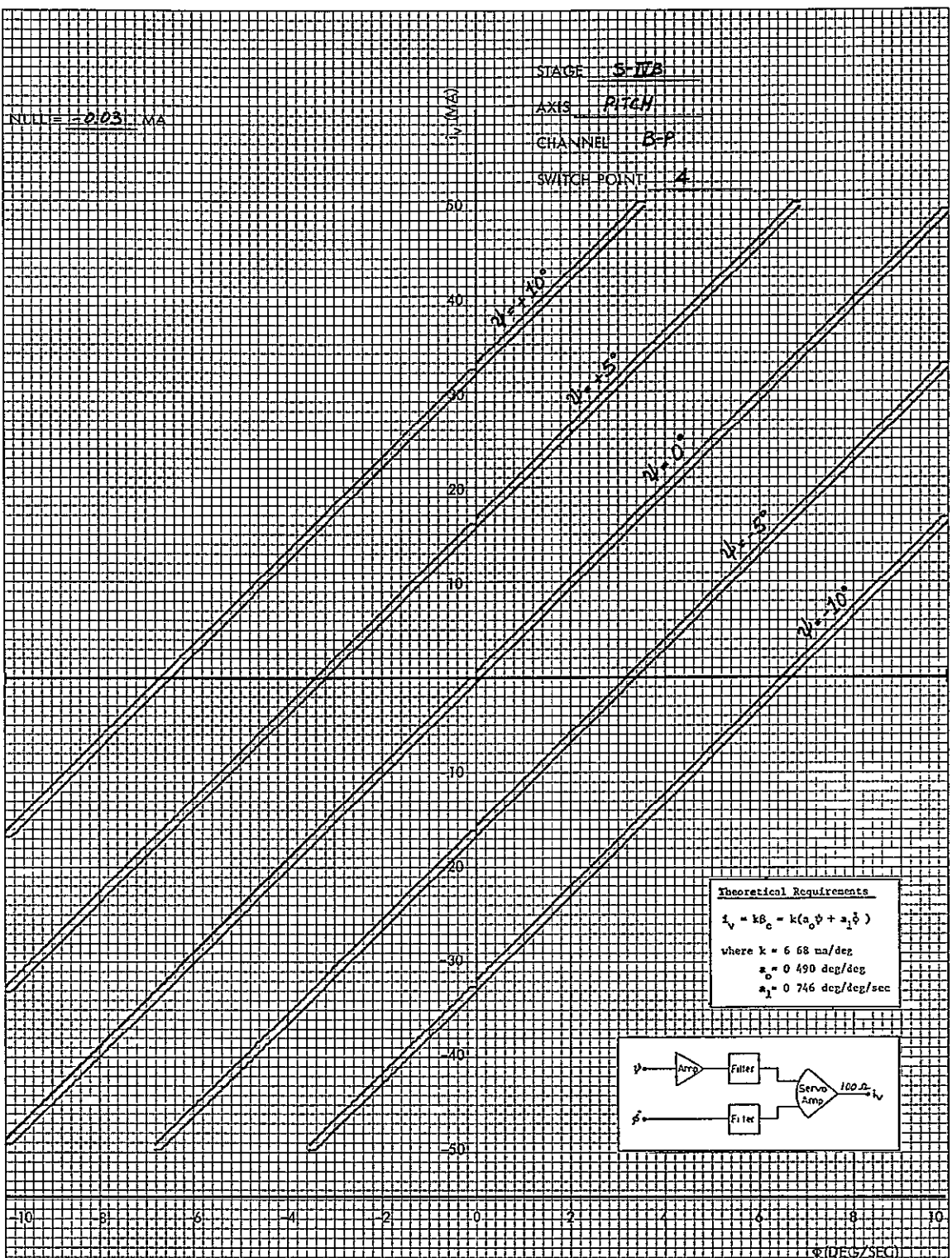

FIGURE  
 STATIC GAIN, LINEARITY, AND SIGNAL MIXING

AS 210 S/N 0104-T

NULL  $\pm 0.08$  MA

STAGE SUB

AXIS YAW

CHANNEL B-Y

SWITCH POINT 4

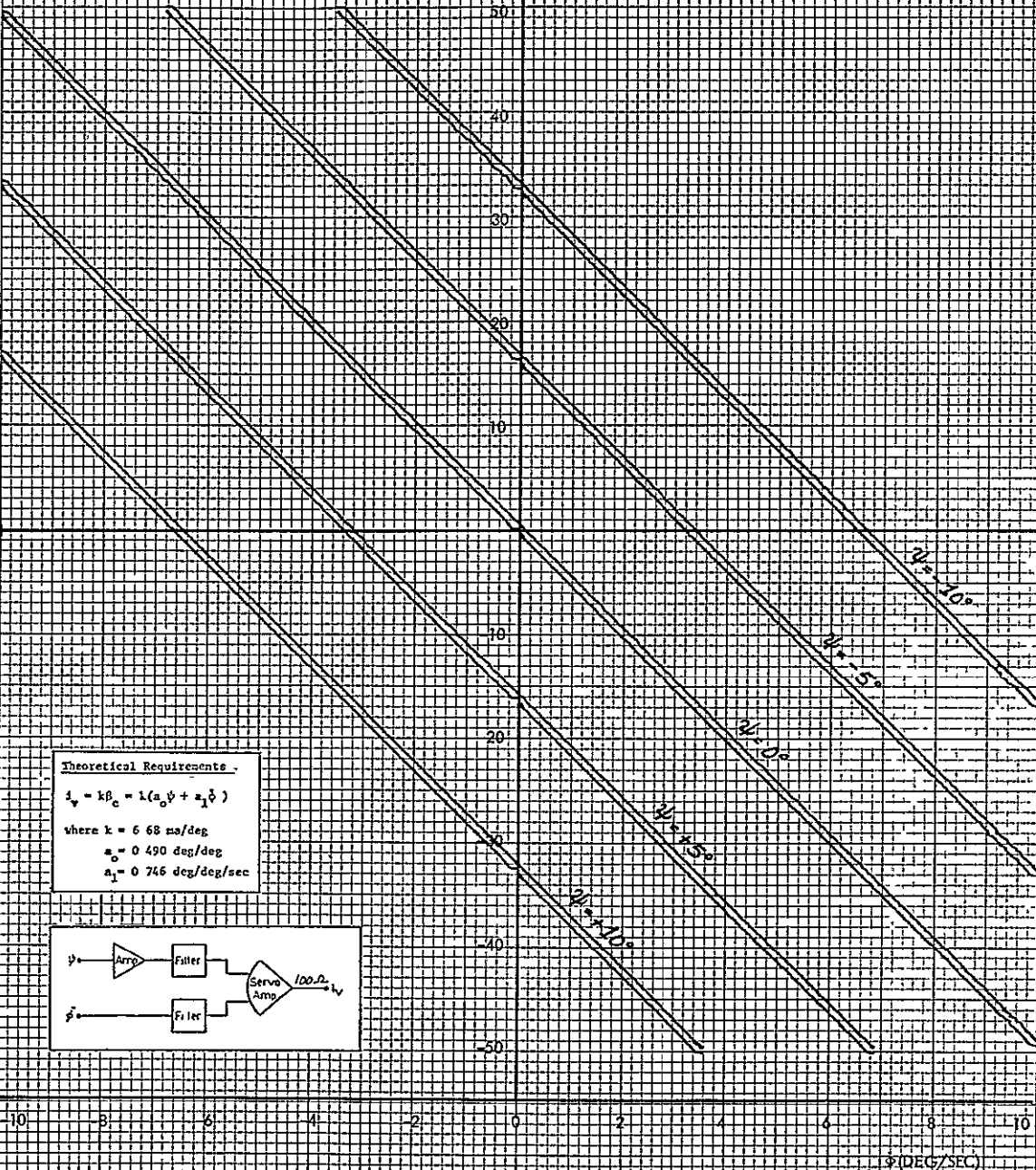

FIGURE  
 STATIC GAIN, LINEARITY, AND SIGNAL MIXING

AS 210 S/N 0104-1

$I_{NUL} = -0.19 \text{ MA}$

STAGE S-11B  
 AXIS FITCH  
 CHANNEL CP  
 SWITCH POINT 4

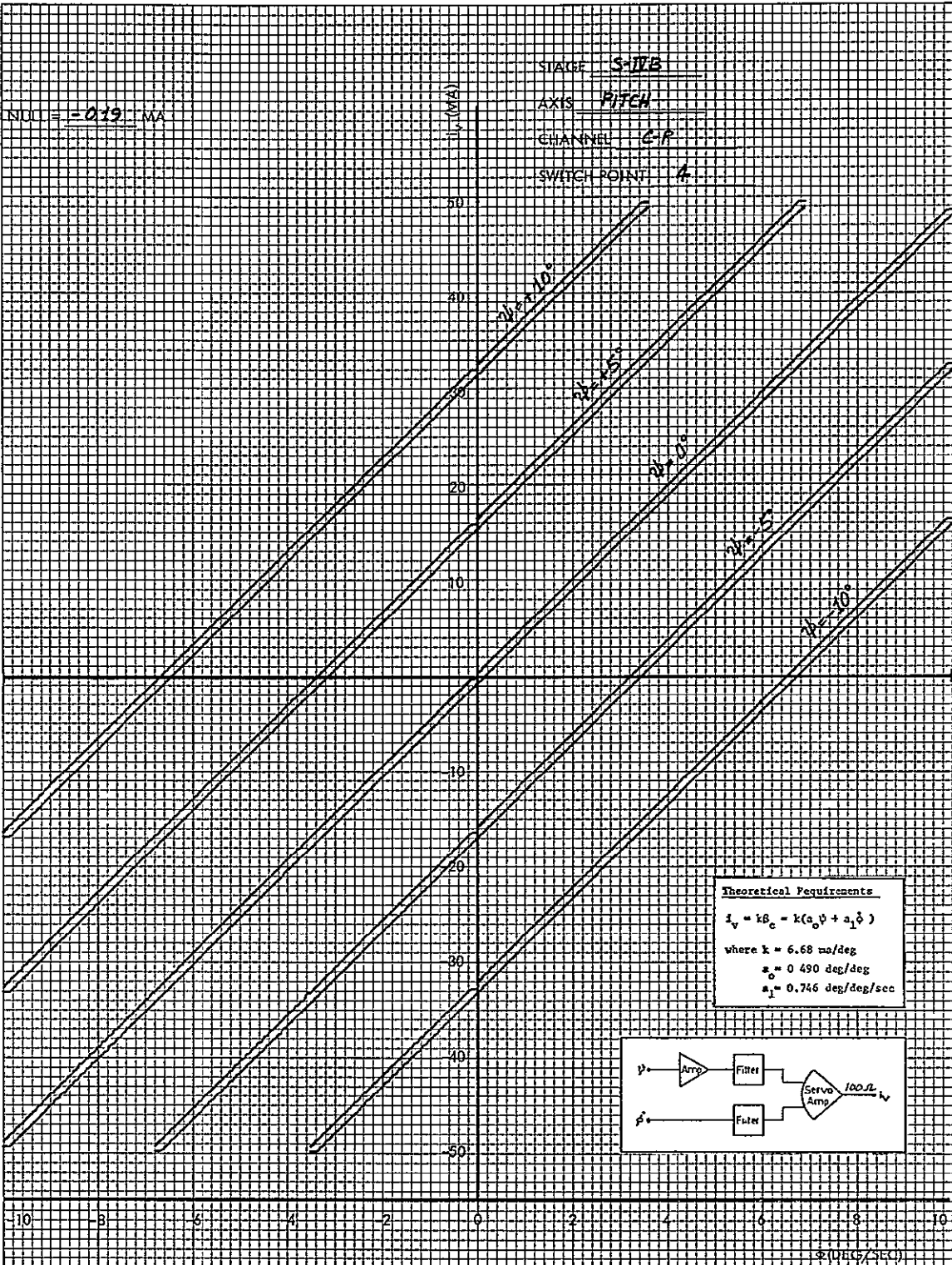

FIGURE  
 STATIC GAIN, LINEARITY, AND SIGNAL MIXING

AS 210 S/S 0104-I

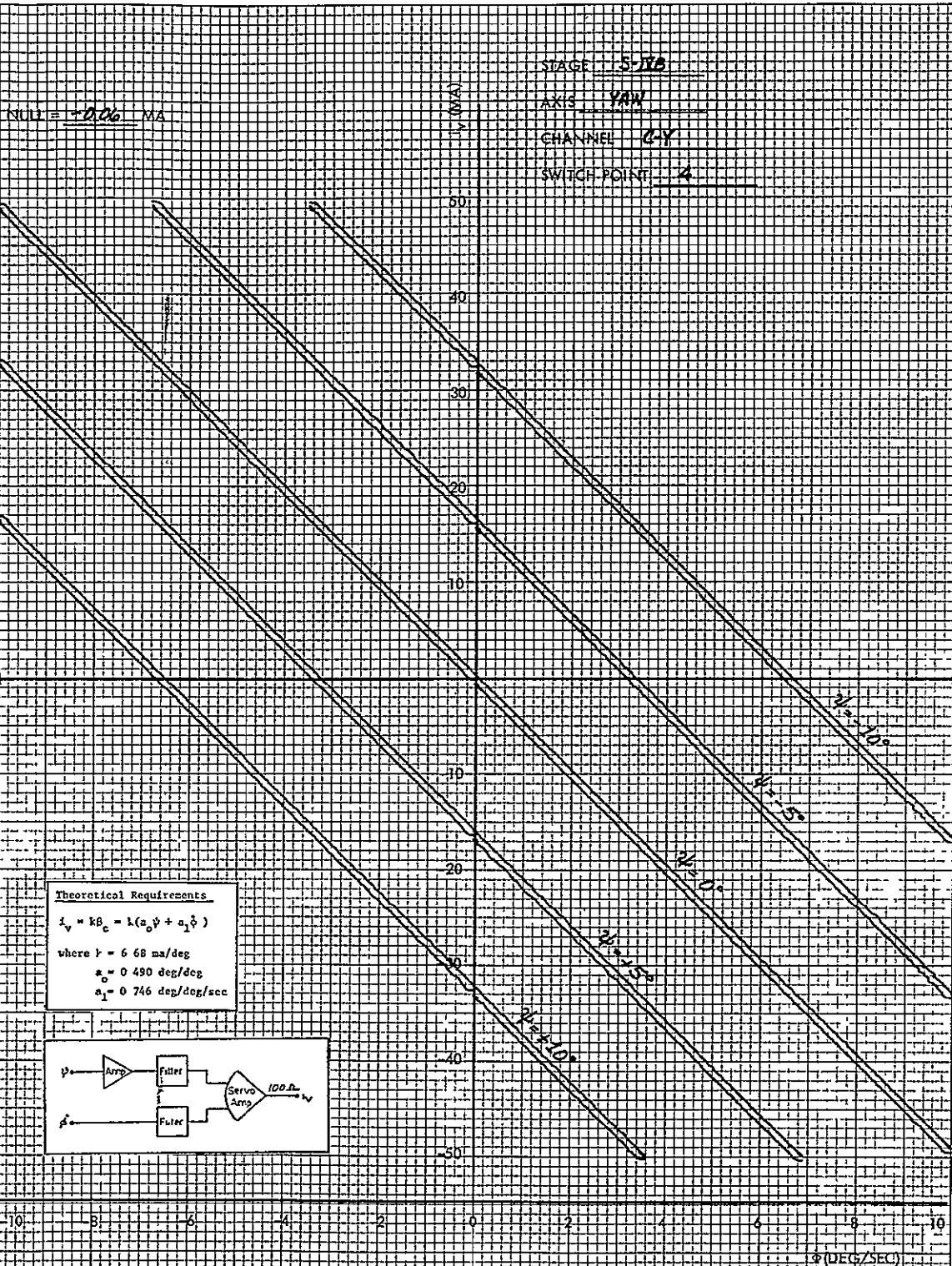

FIGURE  
 STATIC GAIN, LINEARITY, AND SIGNAL MIXING

AS 210 S/N 010A-1

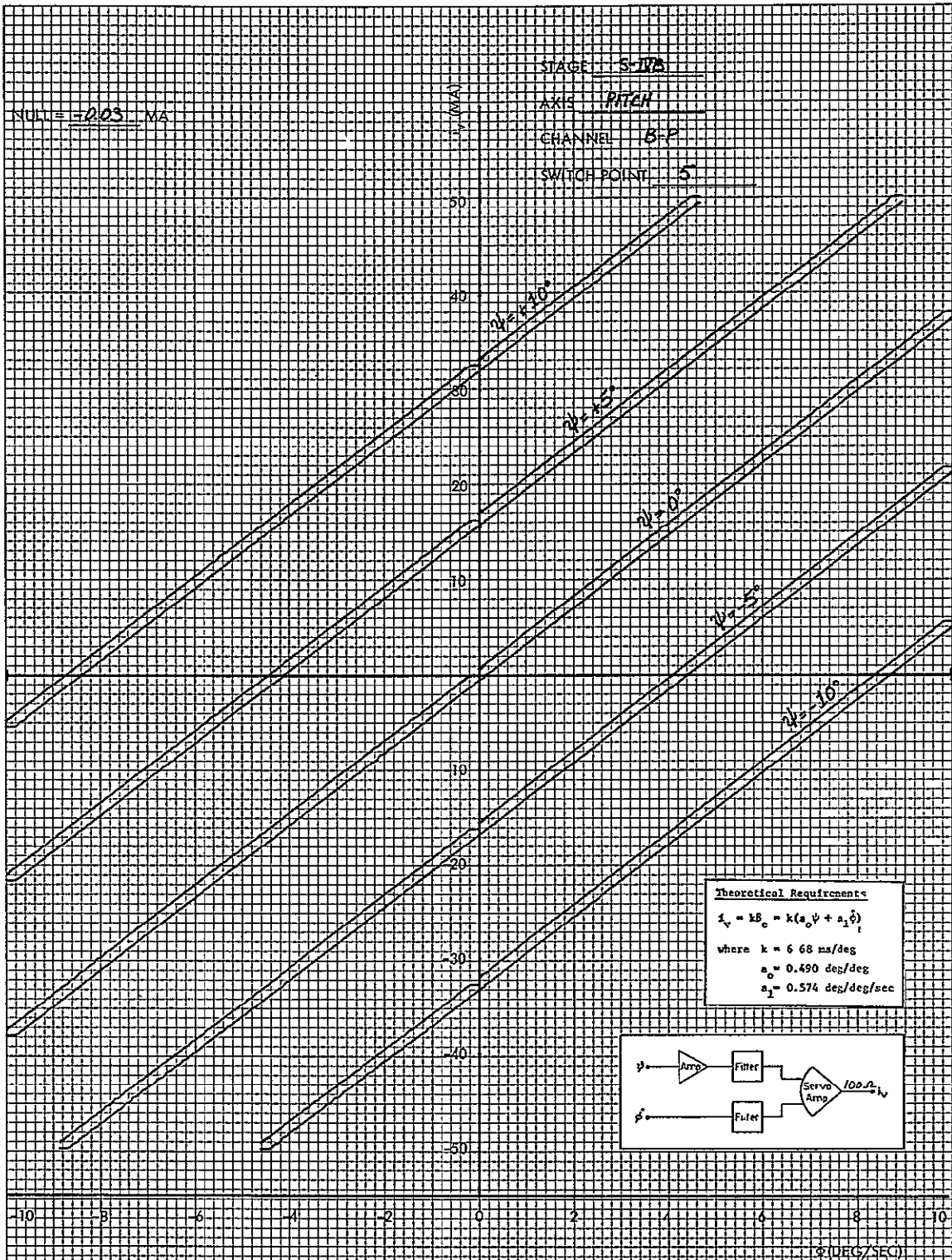
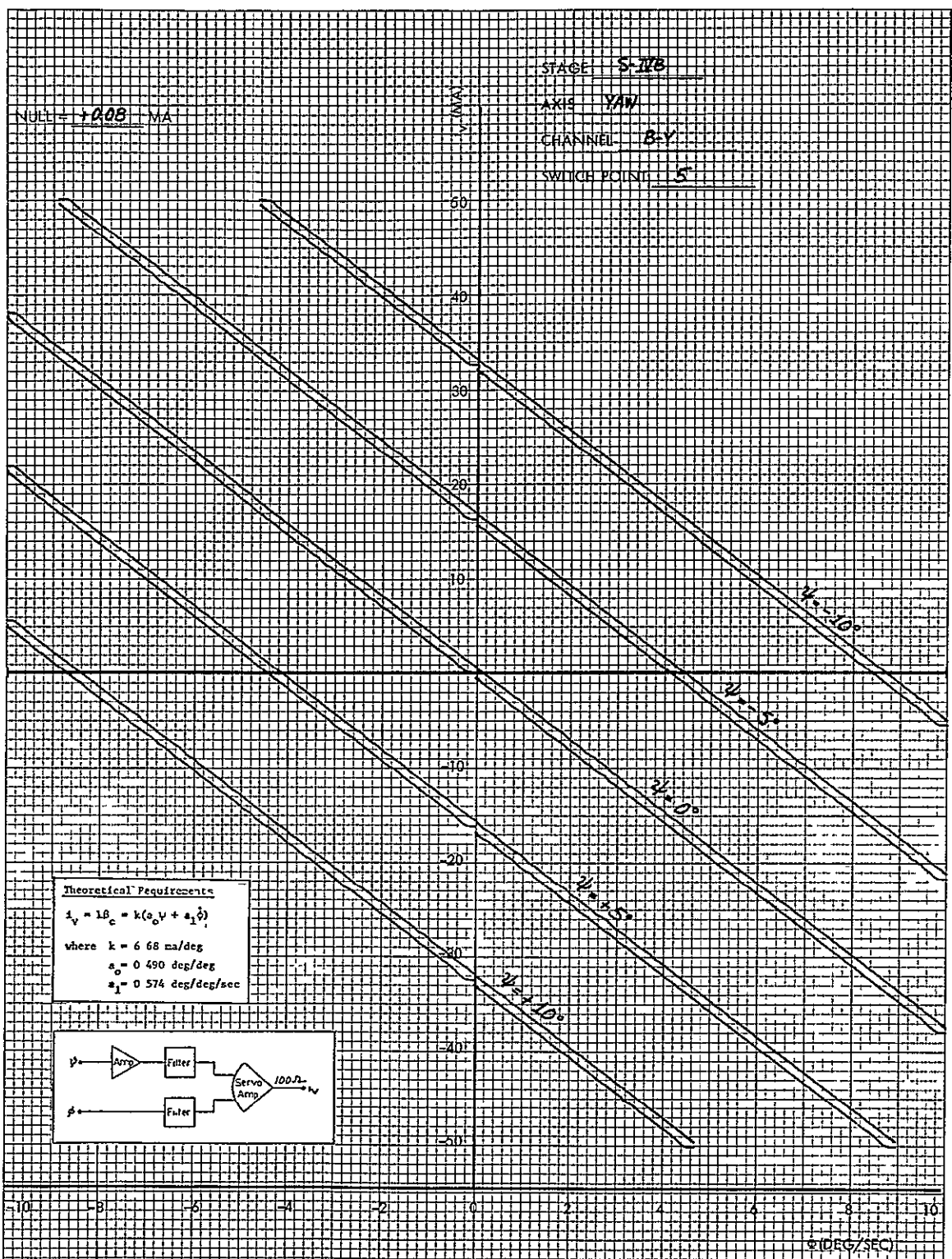

FIGURE  
 STATIC GAIN, LINEARITY, AND SIGNAL MIXING

AS 210 S/N 0104-1

ORIGINAL PAGE IS  
 OF POOR QUALITY



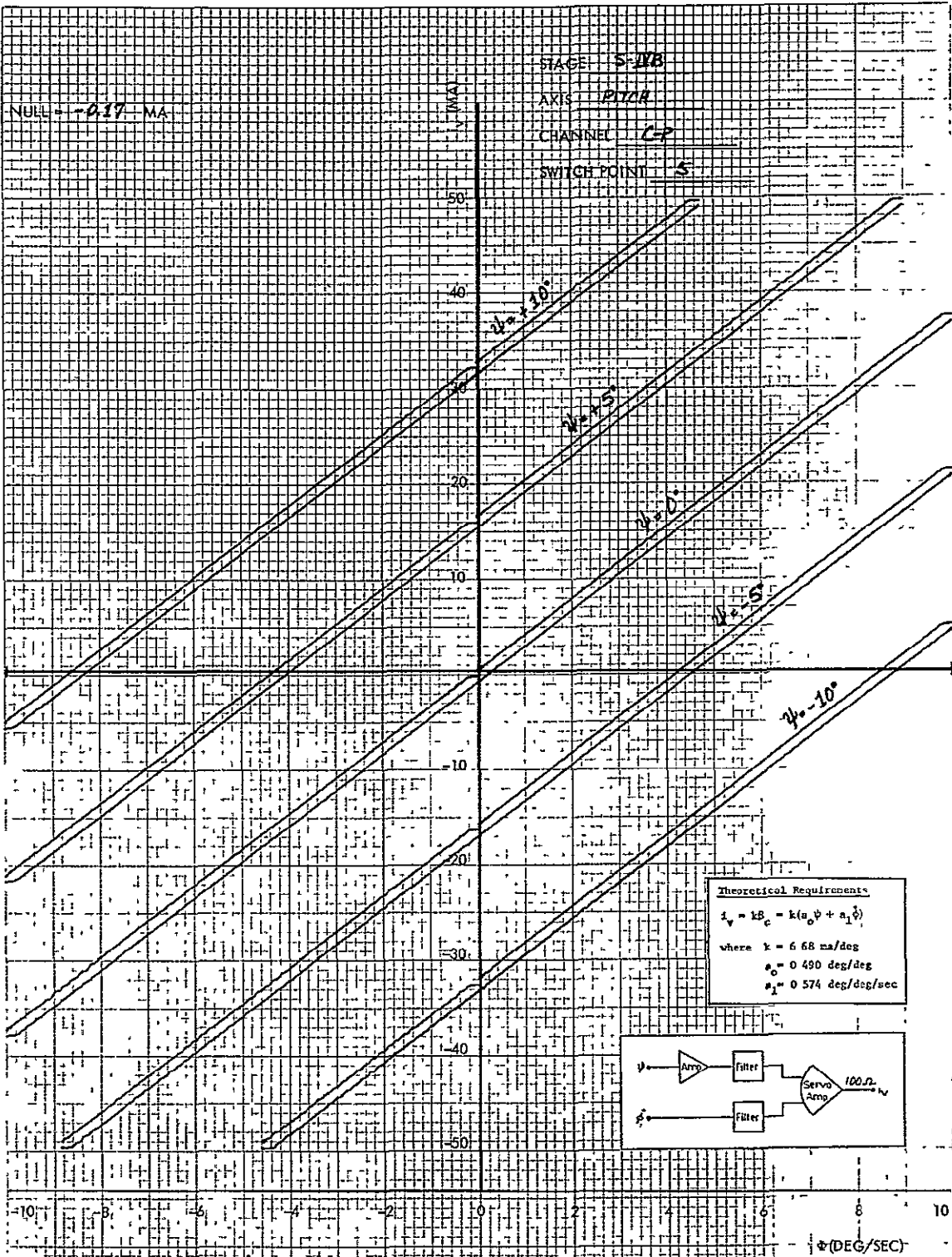

FIGURE  
 STATIC GAIN, LINEARITY, AND SIGNAL MIXING  
 AS - 210 - S/N - 0104-I



ORIGINAL PAGE IS  
OF POOR QUALITY

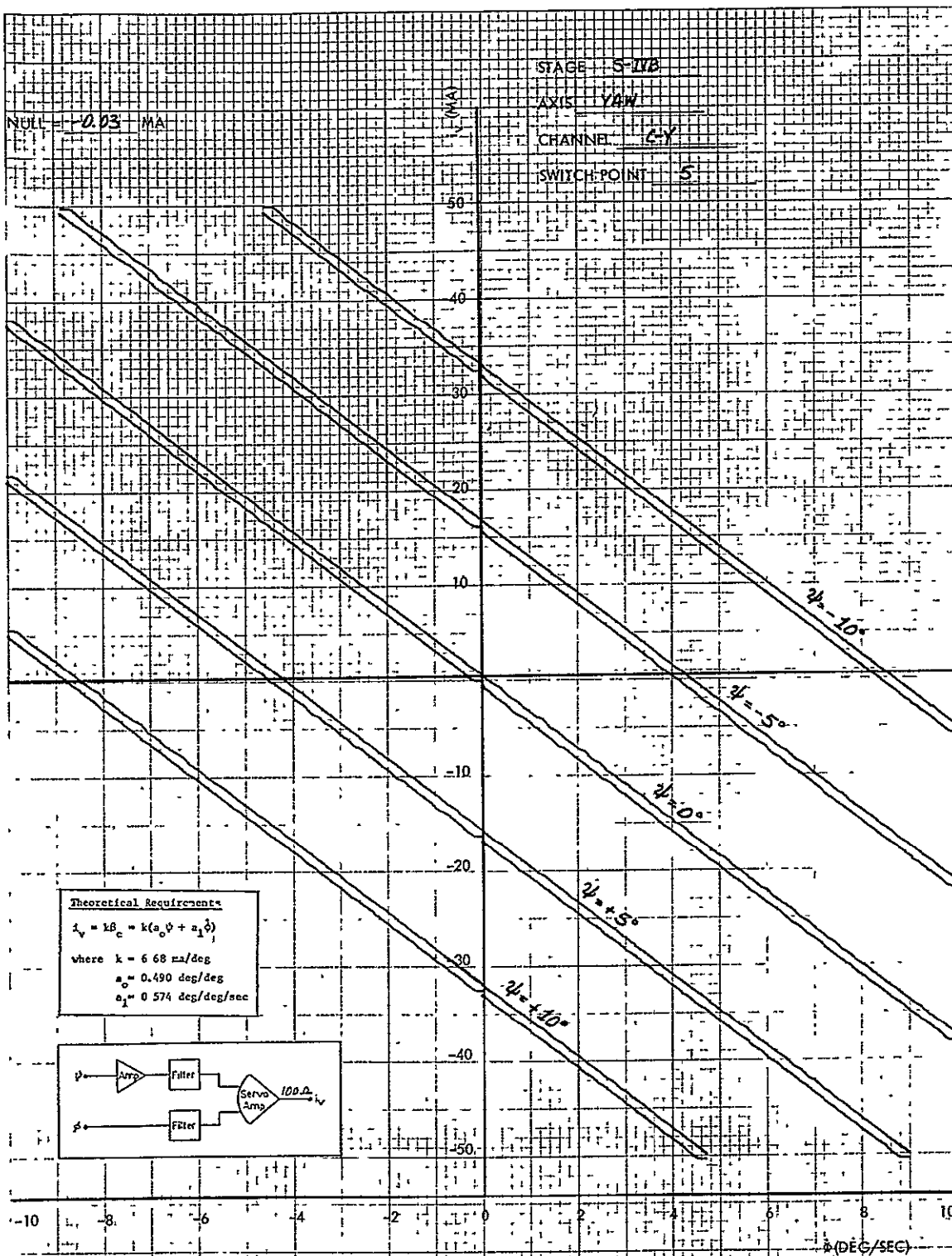
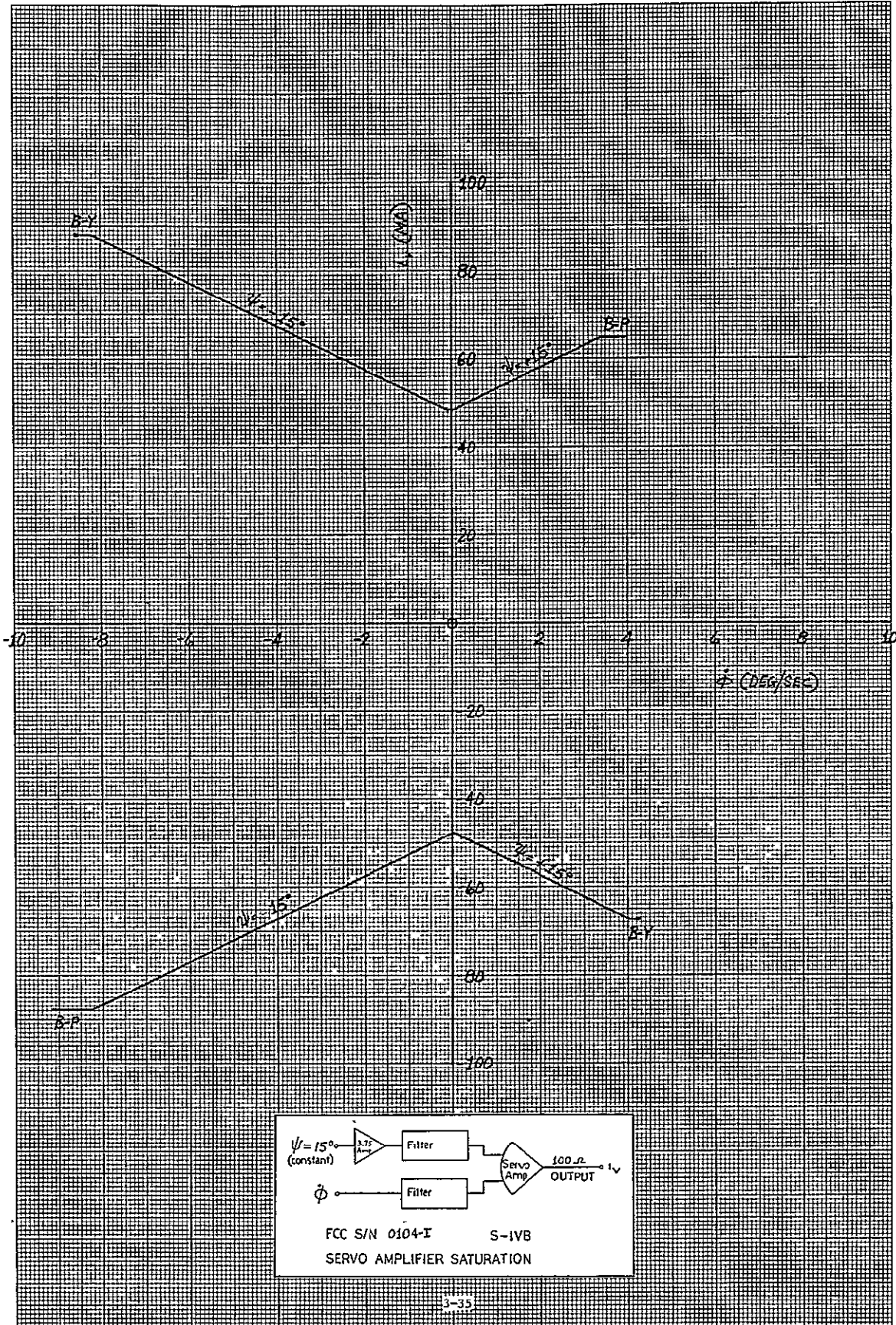
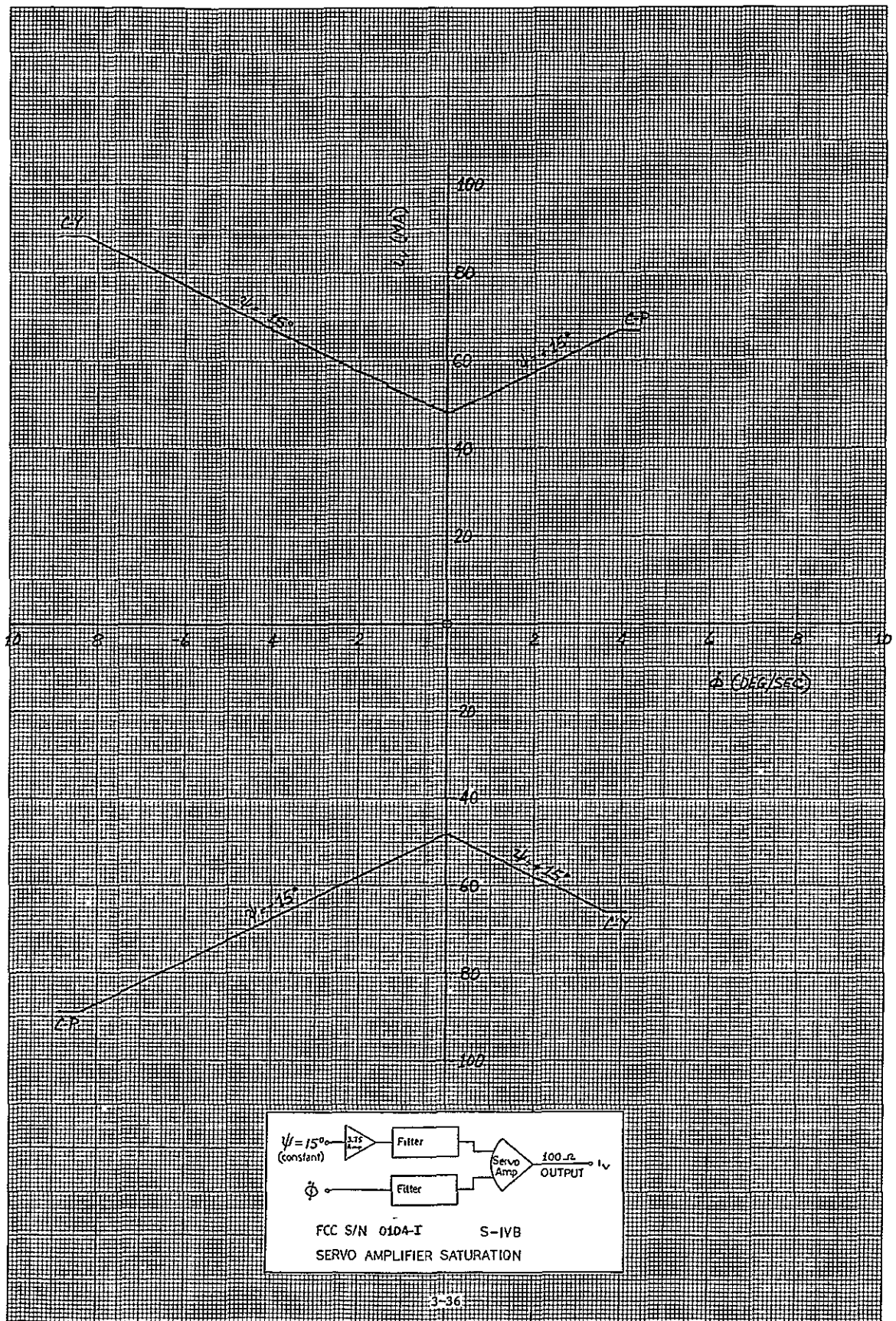

FIGURE  
STATIC GAIN, LINEARITY, AND SIGNAL MIXING

AS 210 S/N 0104-1





ORIGINAL PAGE IS  
OF POOR QUALITY

RELATIVE POLARITY

S-IVB STAGE

Channel	Servo Amp	POLARITY						Theo.
		SPUT Data			L/M Data			
		SP 3	SP 4	SP 5	SP 3	SP 4	SP 5	
$\psi$ P-Y	B-P	+	+	+	+	+	+	+
	C-P	+	+	+	+	+	+	+
	B-Y	-	-	-	-	-	-	-
	C-Y	-	-	-	-	-	-	-
$\phi$ P-Y	B-P	+	+	+	+	+	+	+
	C-P	+	+	+	+	+	+	+
	B-Y	-	-	-	-	-	-	-
	C-Y	-	-	-	-	-	-	-

NOTES: (1) Polarity of the servo amp outputs reflect a positive input to the FCC; a "+" actuator retracts and a "-" actuator extends.

(2) SPUT refers to "switch point utilization" test data; L/M refers to "linearity and mixing" test data.

STATIC GAINS (SIM LAB)  
 VEHICLE AS-210 FCC S/N 104I

S-IVB STAGE

AXIS	OUTPUT WINDING	SP	AO GAIN (DEG/DEG)			AI GAIN (DEG/DEG/SEC)		
			THEOR.	ACTUAL	PERCENT DEV.	THEOR.	ACTUAL	PERCENT DEV.
P-Y	BP	3	0.4905	0.4852	-1.0724	0.7465	0.7364	-1.3476
P-Y	BY	3	0.4905	0.4853	-1.0546	0.7465	0.7366	-1.3187
P-Y	CP	3	0.4905	0.4836	-1.3901	0.7465	0.7341	-1.6498
P-Y	CY	3	0.4905	0.4843	-1.2579	0.7465	0.7361	-1.3895
P-Y	BP	4	0.4905	0.4852	-1.0775	0.7465	0.7370	-1.2680
P-Y	BY	4	0.4905	0.4853	-1.0597	0.7465	0.7367	-1.3059
P-Y	CP	4	0.4905	0.4838	-1.3596	0.7465	0.7348	-1.5614
P-Y	CY	4	0.4905	0.4846	-1.1868	0.7465	0.7359	-1.4074
P-Y	BP	5	0.4905	0.4851	-1.0826	0.5745	0.5681	-1.1049
P-Y	BY	5	0.4905	0.4852	-1.0724	0.5745	0.5670	-1.3016
P-Y	CP	5	0.4905	0.4837	-1.3698	0.5745	0.5655	-1.5546
P-Y	CY	5	0.4905	0.4844	-1.2376	0.5745	0.5671	-1.2793

NOTE: allowable static gain deviation is  $\pm 2\%$

ORIGINAL PAGE IS  
 OF POOR QUALITY

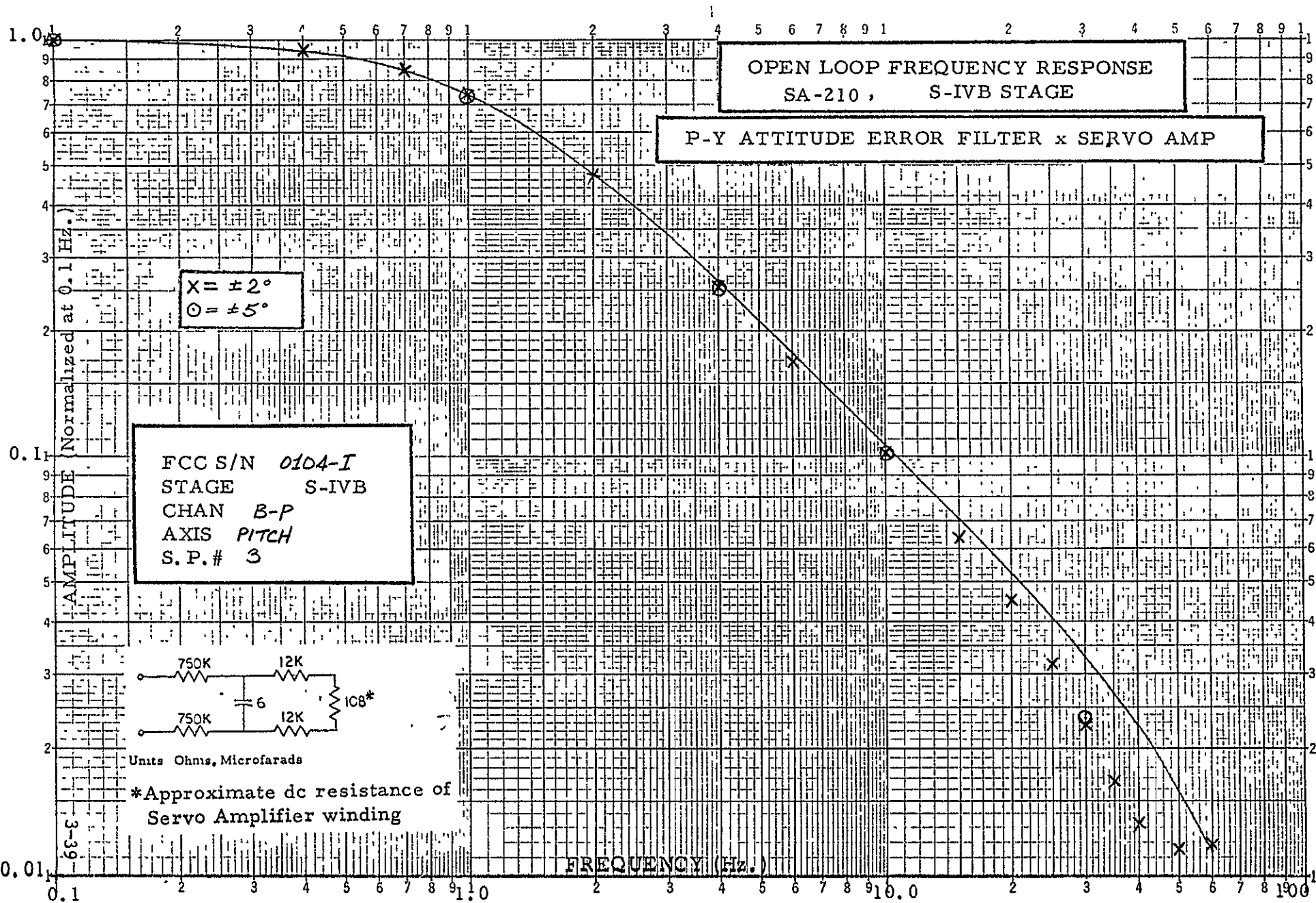

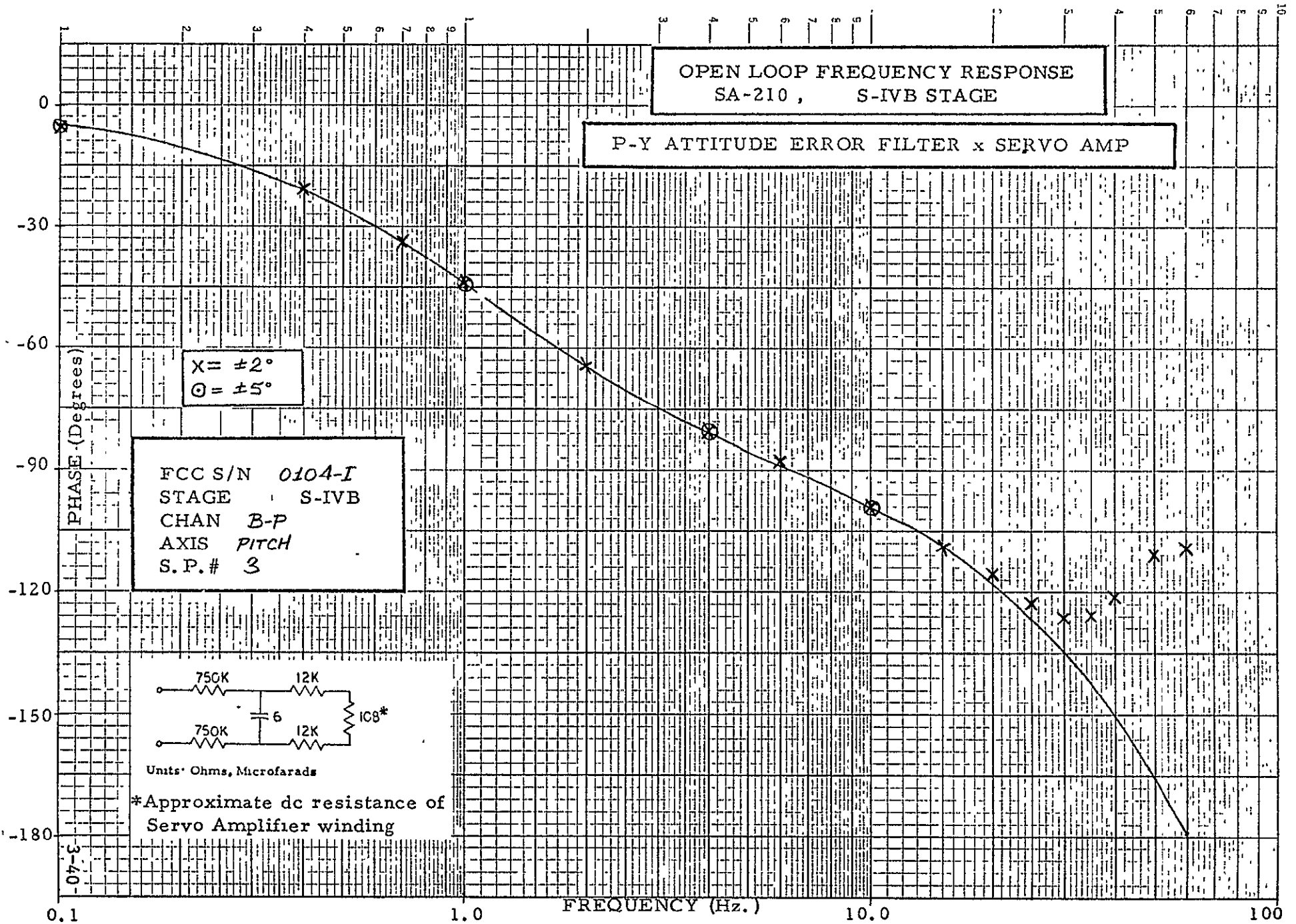

ORIGINAL PAGE IS  
OF POOR QUALITY

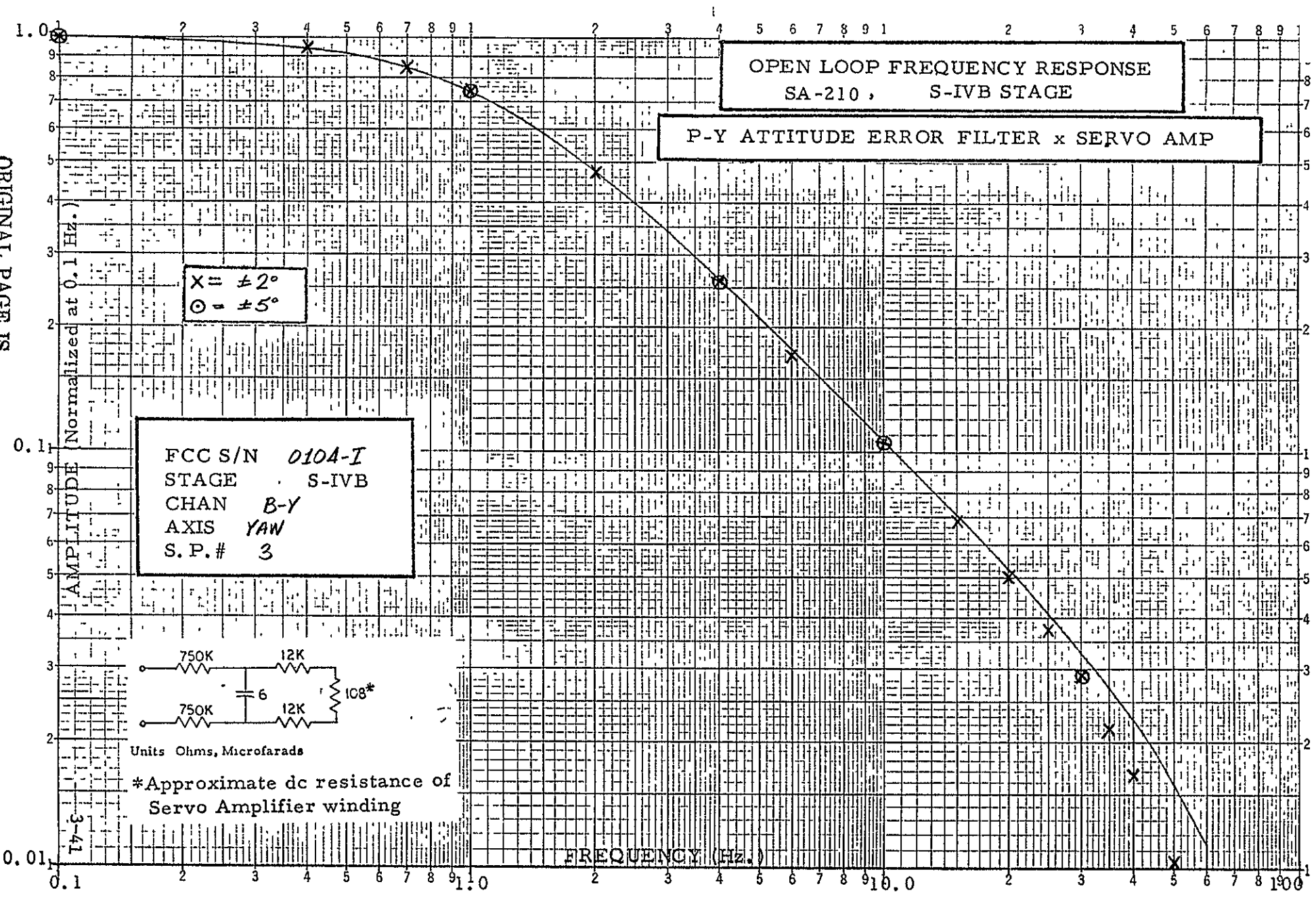



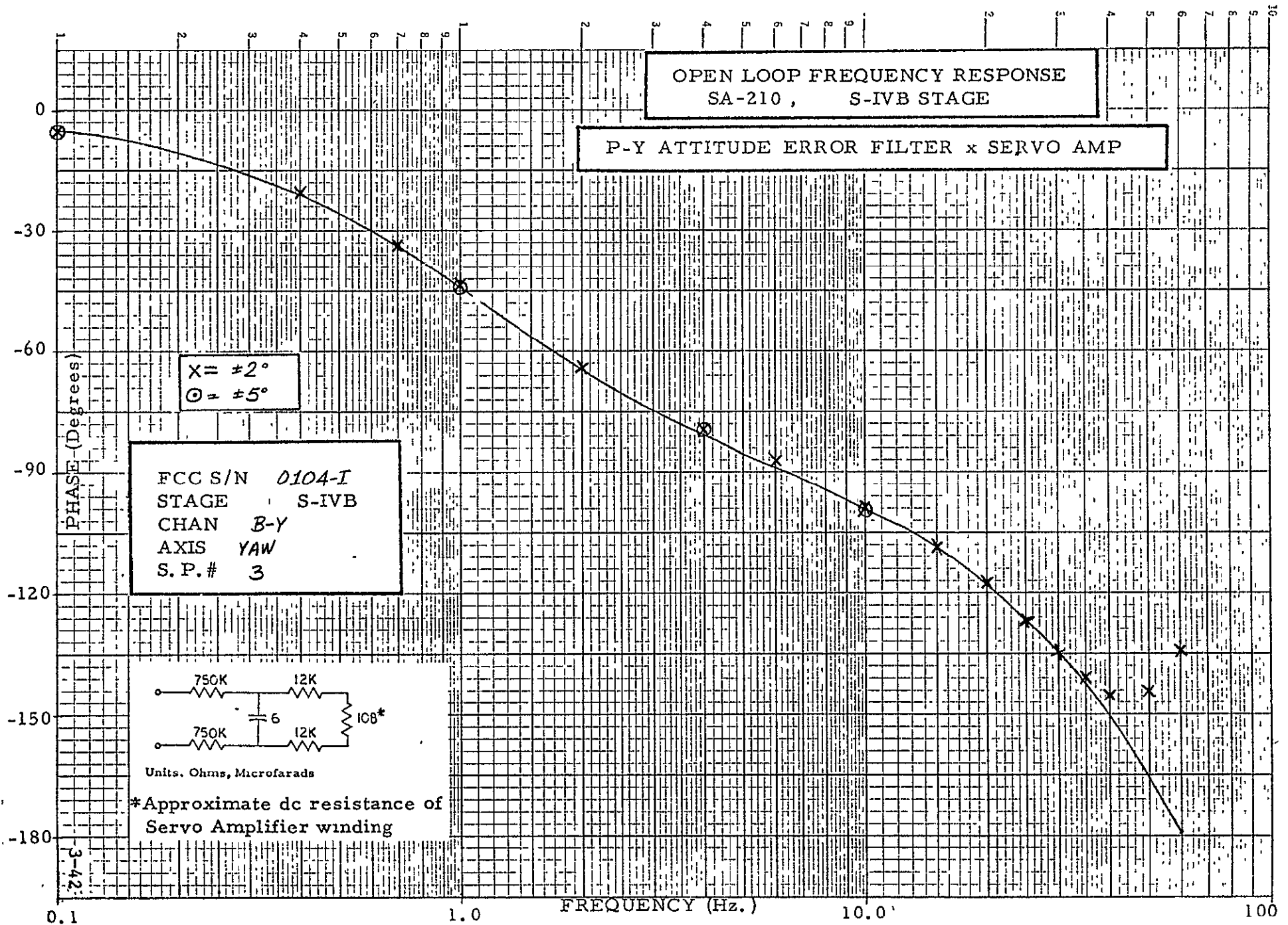

3-42

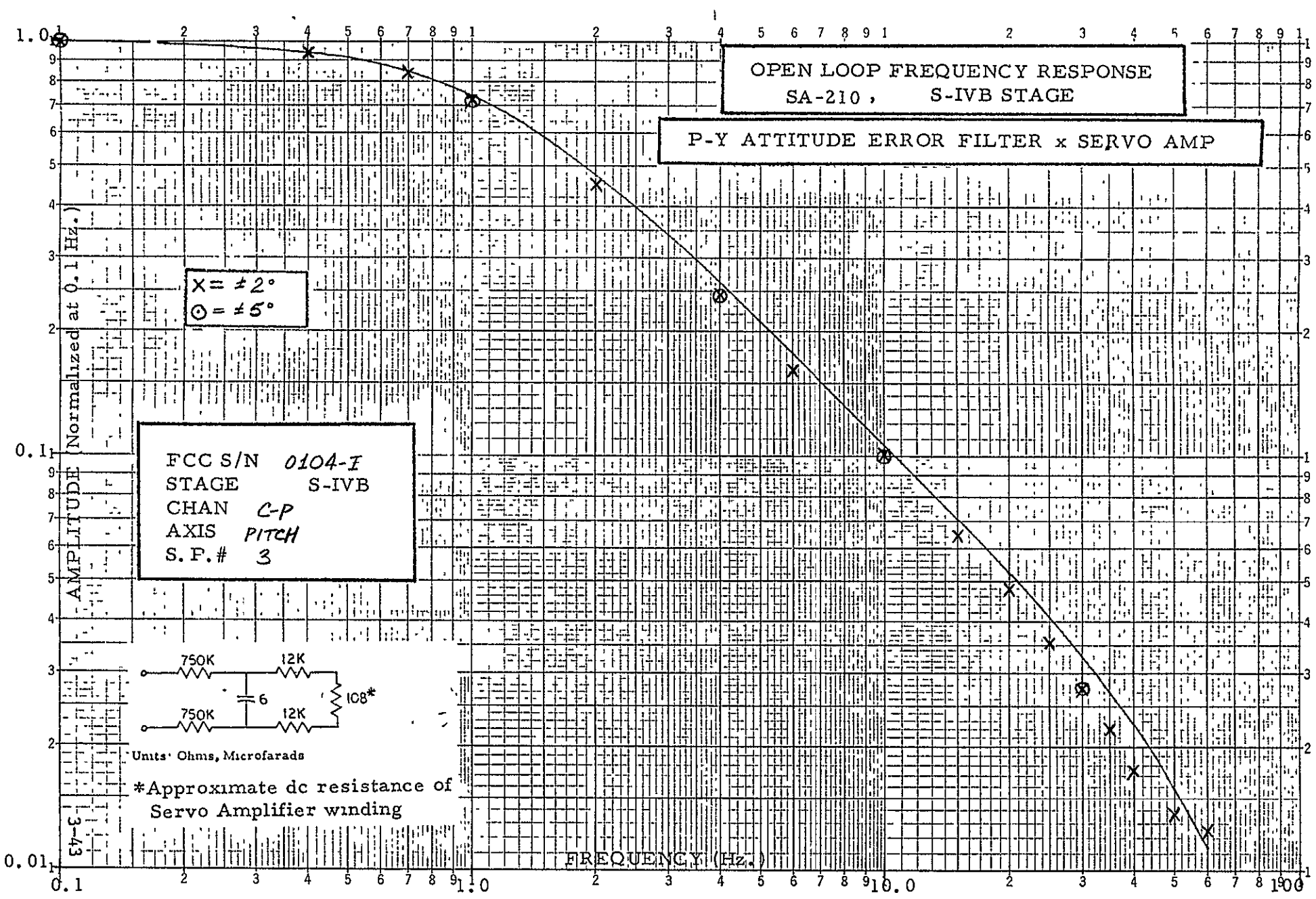

57-3  
3-43

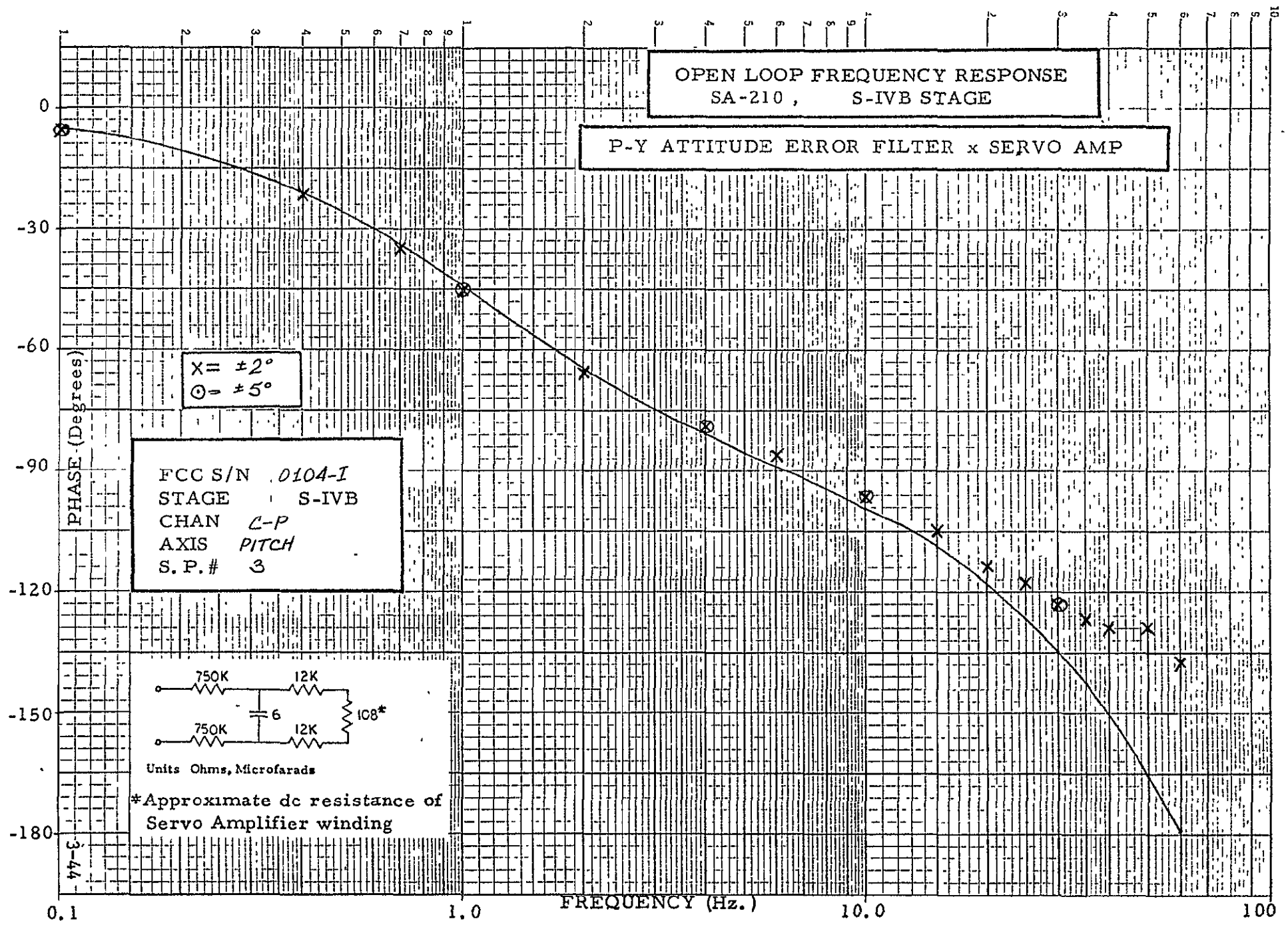

ORIGINAL PAGE IS  
OF DDDDD AVIATION

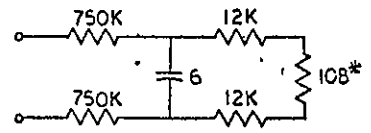
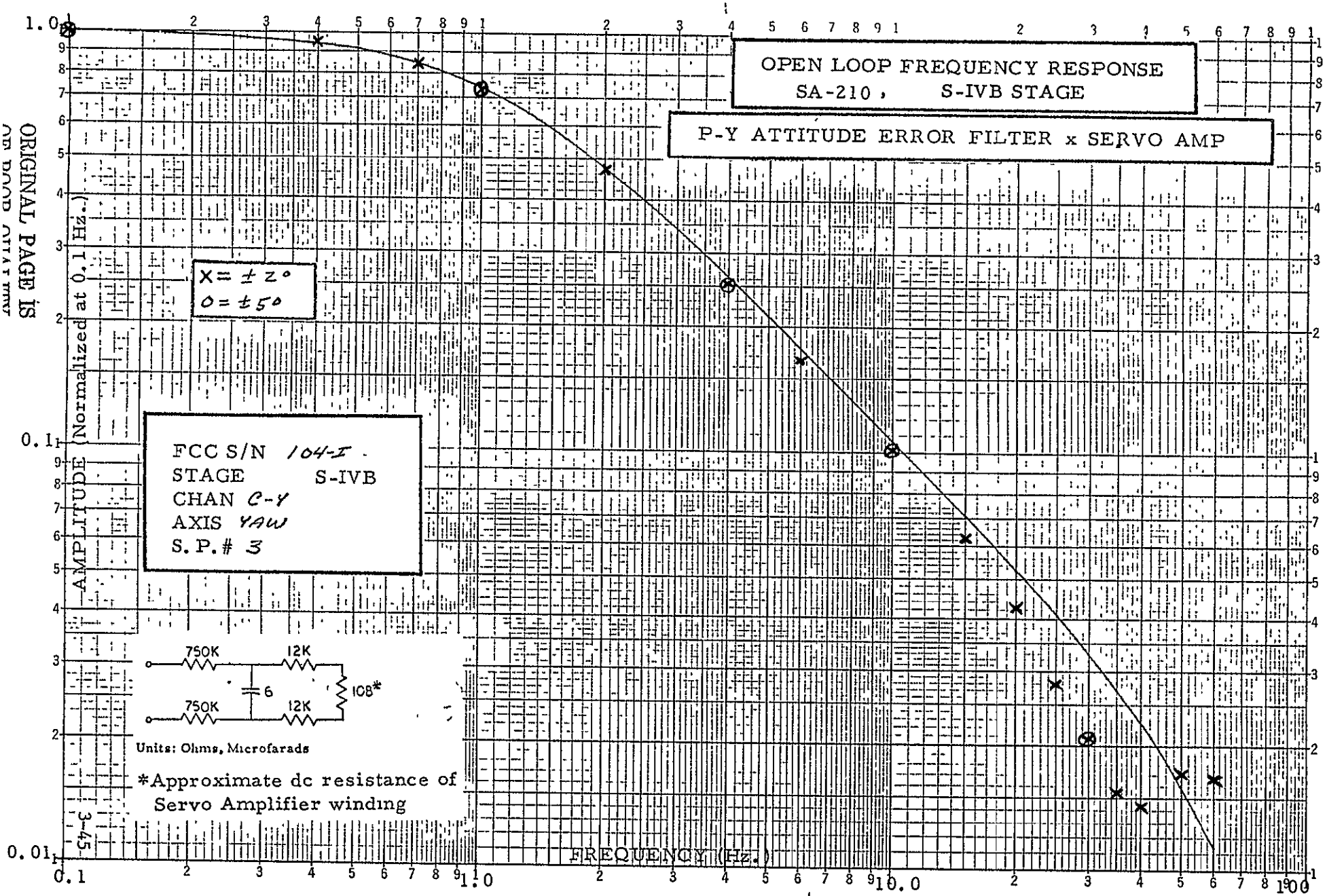

Units: Ohms, Microfarads

\*Approximate dc resistance of Servo Amplifier winding

57-3

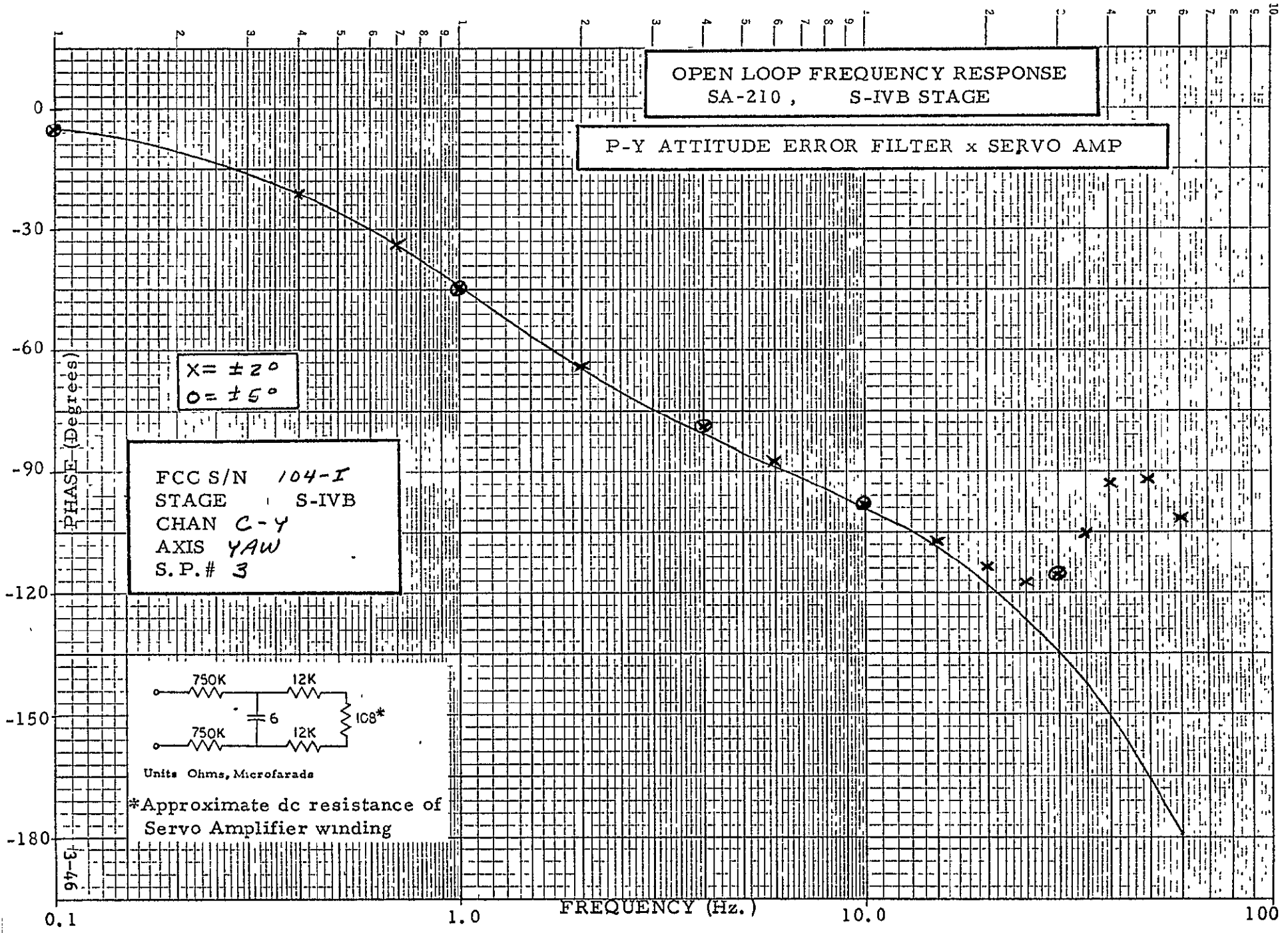

97-5

**OPEN LOOP FREQUENCY RESPONSE**  
SA-210, S-IVB STAGE

**P-Y ATTITUDE RATE FILTER x RATE GYRO/CSP x SERVO AMP**

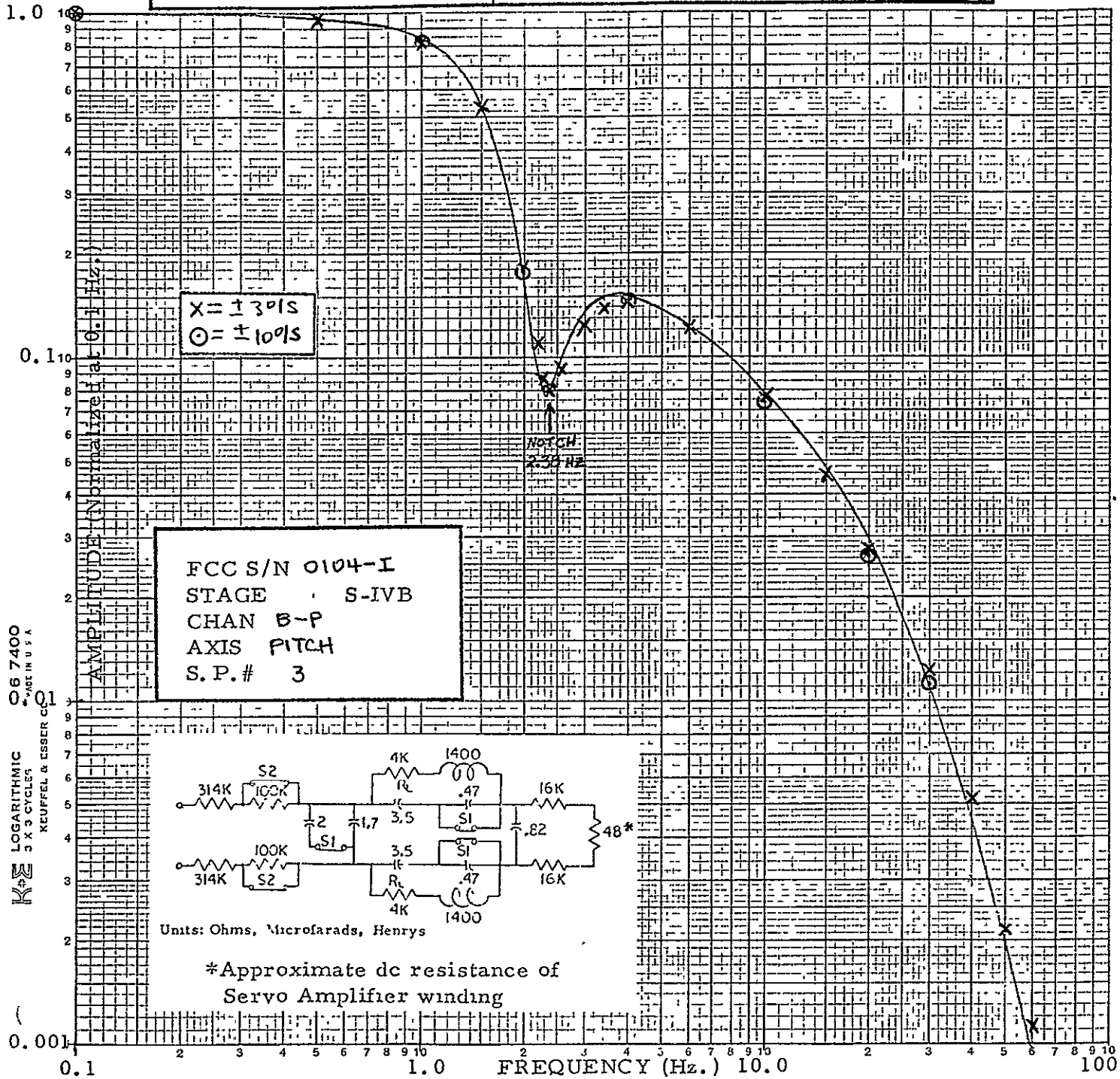

06 7400  
 LOGARITHMIC  
 KEUFFEL & ESSER CO.

ORIGINAL PAGE IS  
OF POOR QUALITY

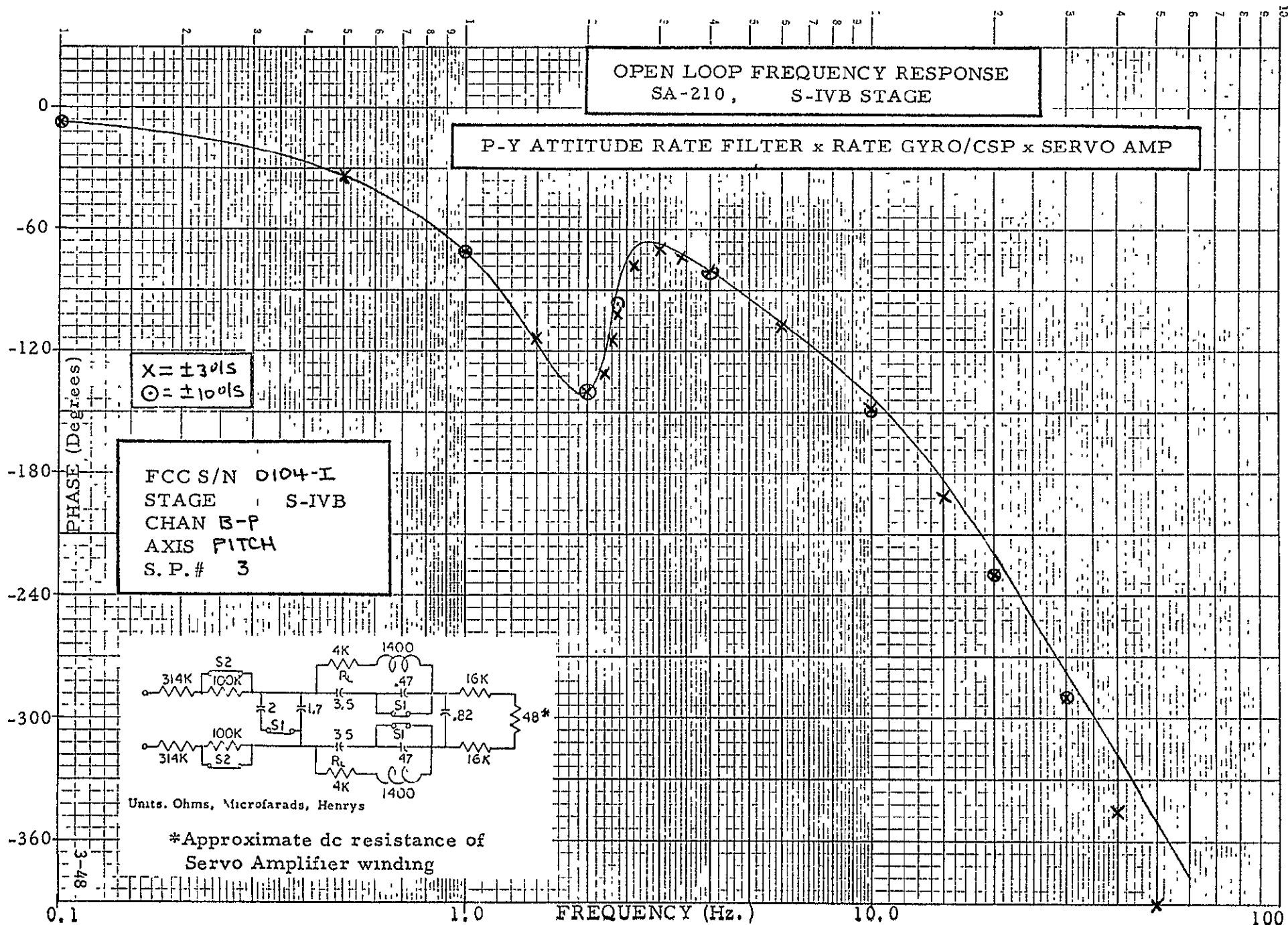

OPEN LOOP FREQUENCY RESPONSE  
SA-210 , S-IVB STAGE

P-Y ATTITUDE RATE FILTER x RATE GYRO/CSP x SERVO AMP

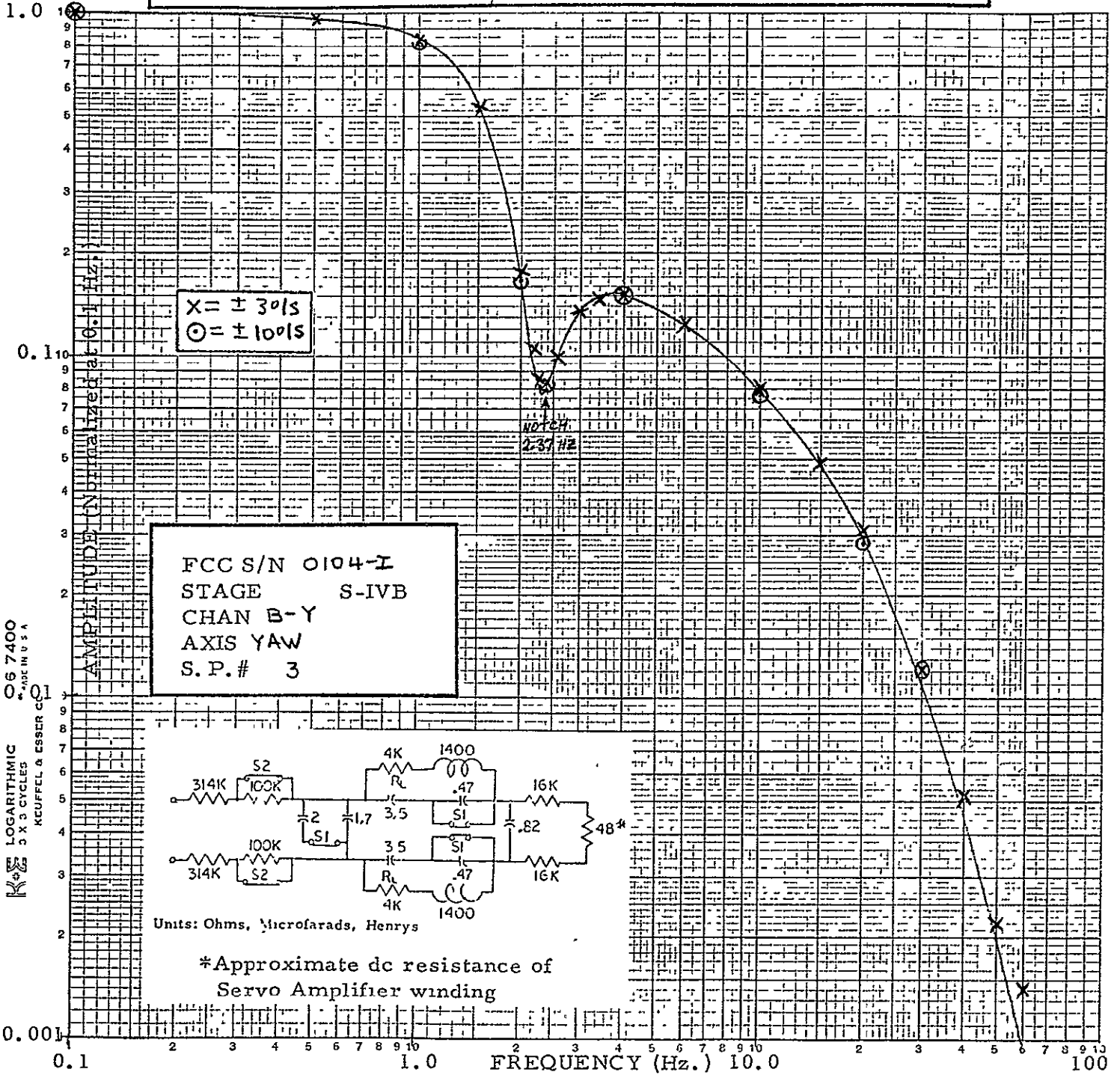

LOGARITHMIC  
 3 X 3 CYCLES  
 KEUFFEL & ESSER CO  
 06 7400  
 MADE IN U.S.A.

ORIGINAL PAGE IS  
OF POOR QUALITY



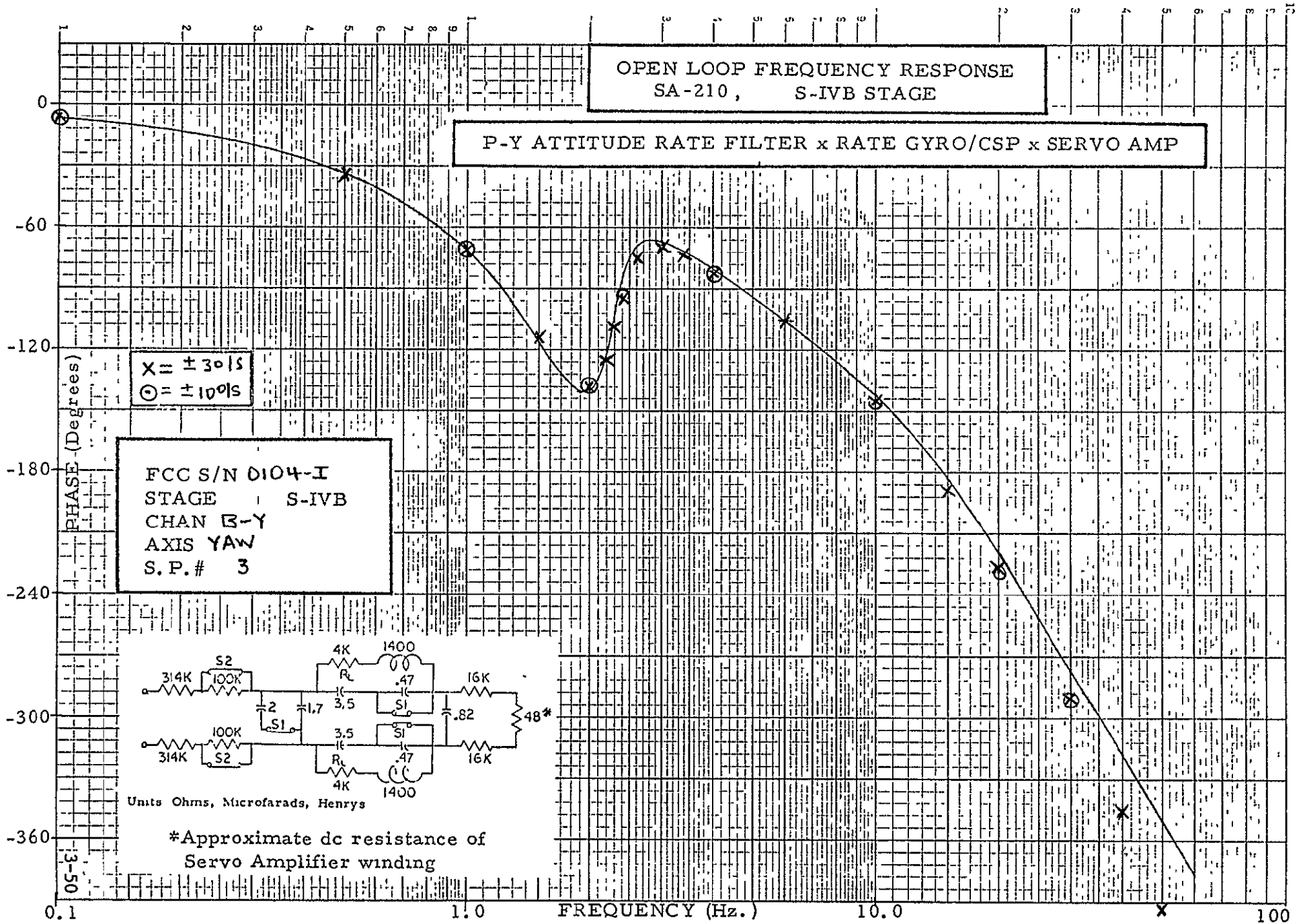

**OPEN LOOP FREQUENCY RESPONSE**  
SA-210 , S-IVB STAGE

**P-Y ATTITUDE RATE FILTER x RATE GYRO/CSP x SERVO AMP**

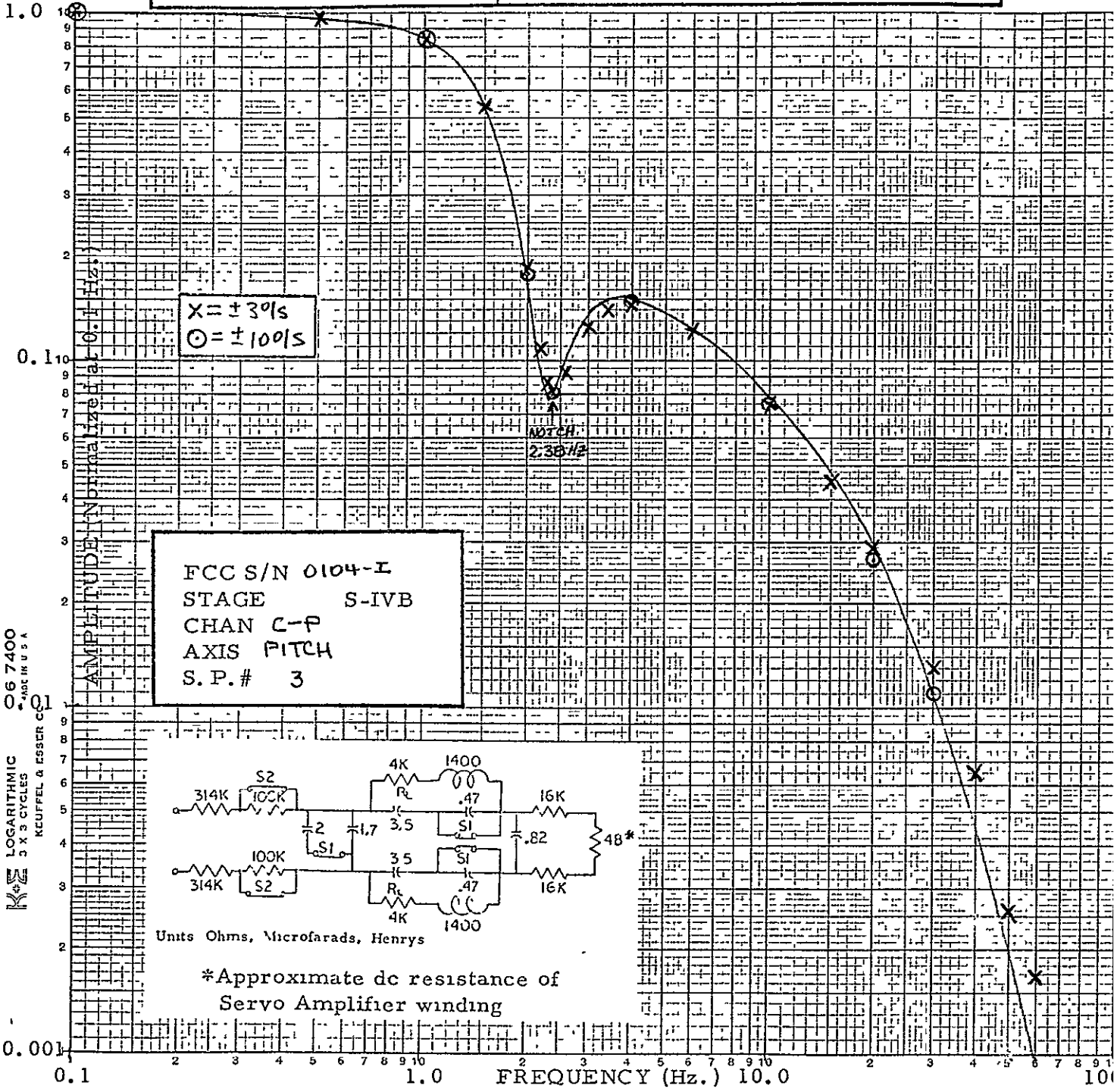

067400  
 LOGARITHMIC  
 KEUFFEL & ESSER CO.

ORIGINAL PAGE IS  
OF POOR QUALITY.

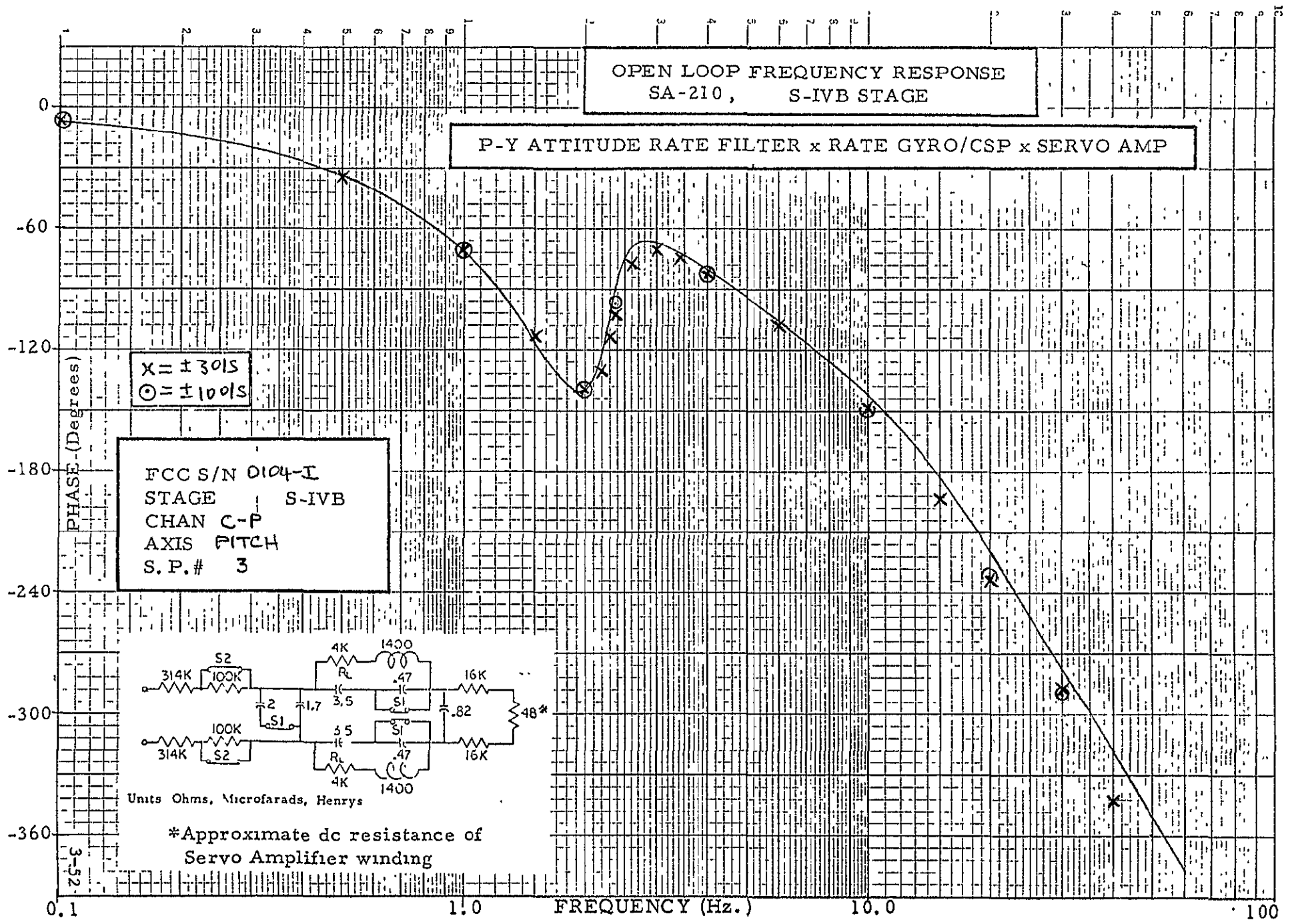



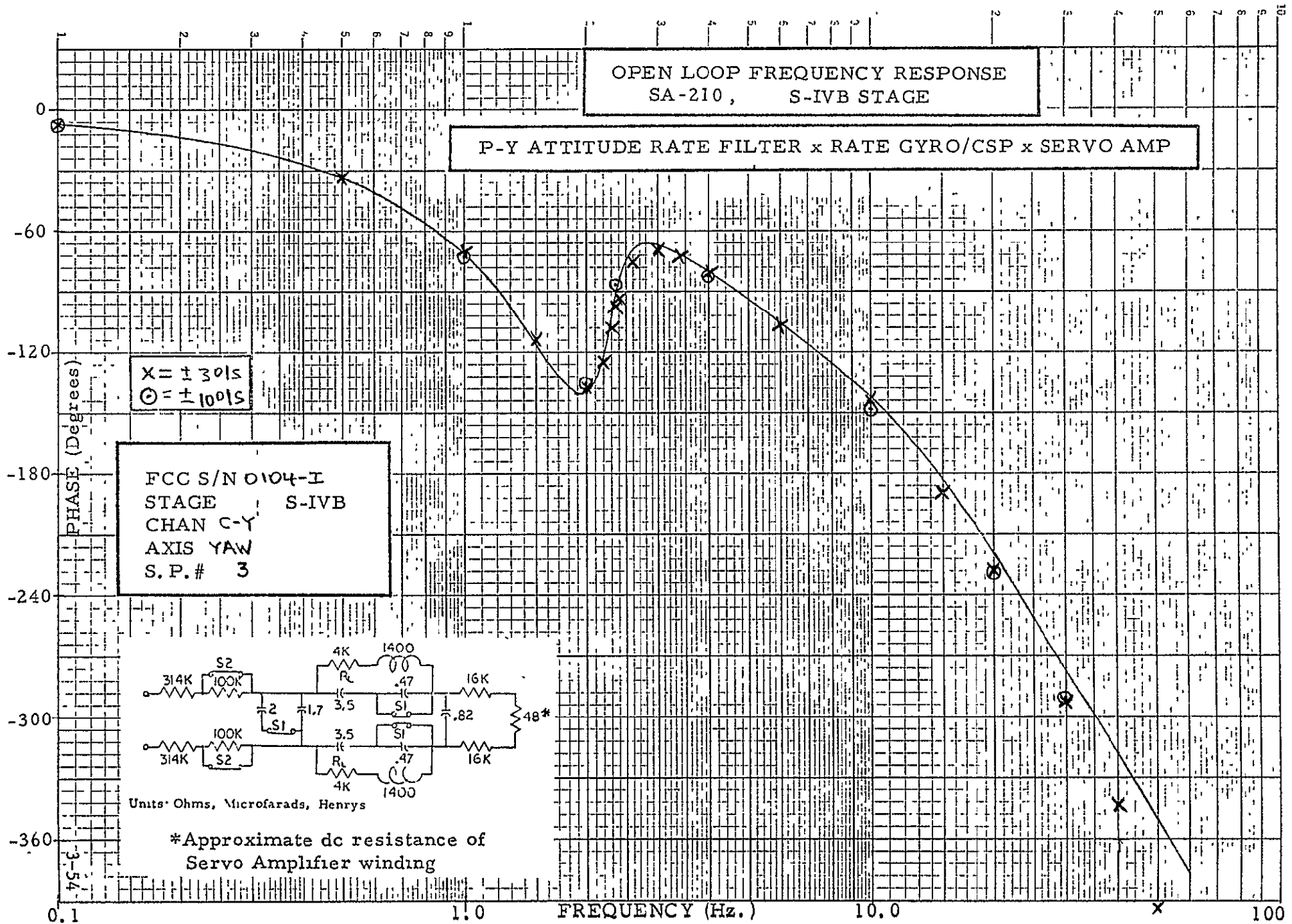

OPEN LOOP FREQUENCY RESPONSE  
SA-210, S-IVB STAGE

P-Y ATTITUDE RATE FILTER x RATE GYRO/CSP x SERVO AMP

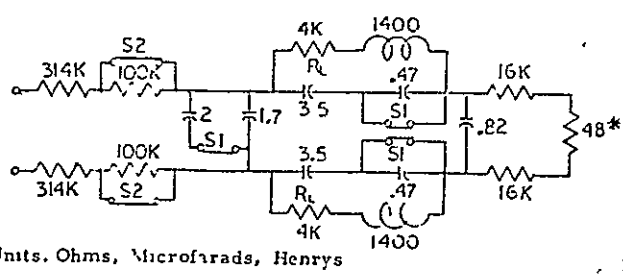
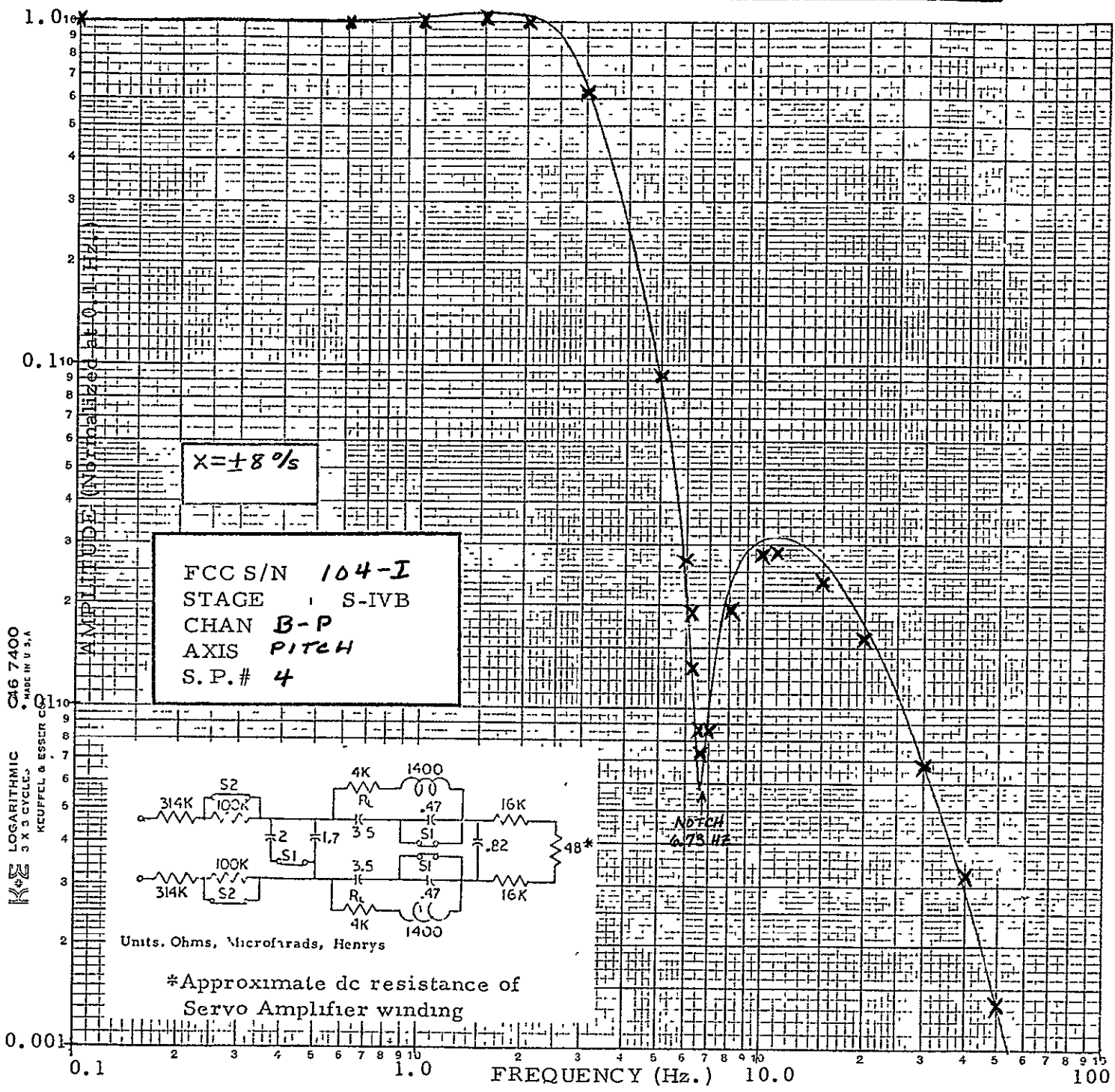

\*Approximate dc resistance of Servo Amplifier winding

ORIGINAL PAGE IS  
OF POOR QUALITY

OPEN LOOP FREQUENCY RESPONSE  
 SA-210, S-IVB STAGE

P-Y ATTITUDE RATE FILTER x RATE GYRO/CSP x SERVO AMP

X = ± 8%

FCC S/N 104-I  
 STAGE S-IVB  
 CHAN B-P  
 AXIS PITCH  
 S.P.# 4

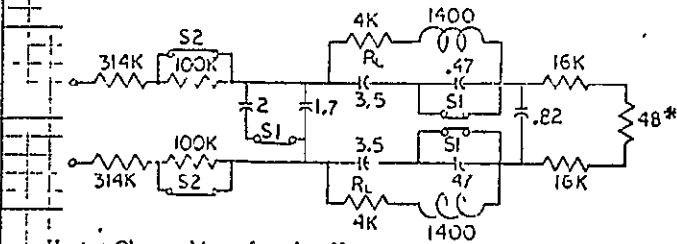

Units: Ohms, Microfarads, Henrys

\*Approximate dc resistance of  
 Servo Amplifier winding

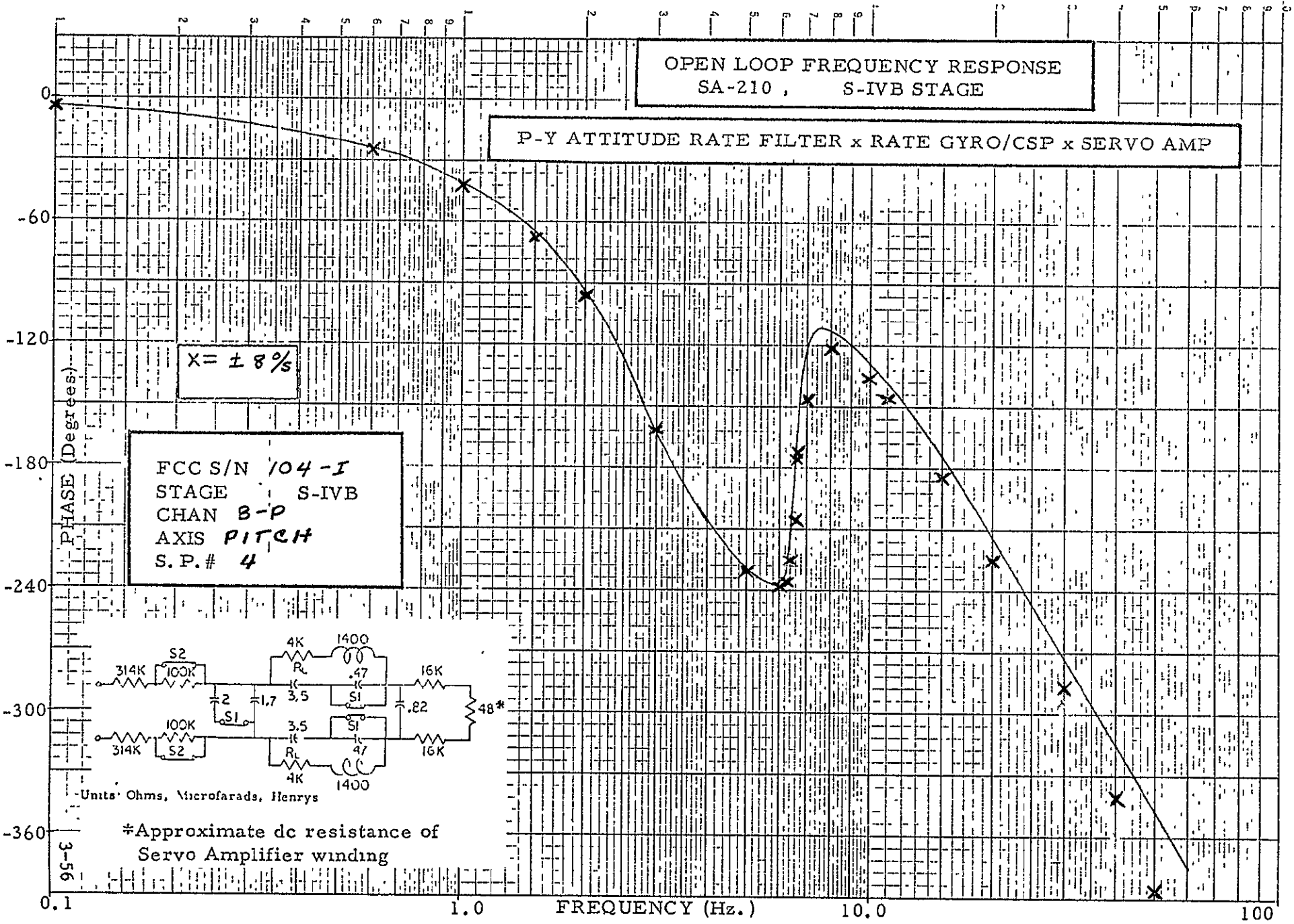

95-3

OPEN LOOP FREQUENCY RESPONSE  
SA-210, S-IVB STAGE

P-Y ATTITUDE RATE FILTER x RATE GYRO/CSP x SERVO AMP

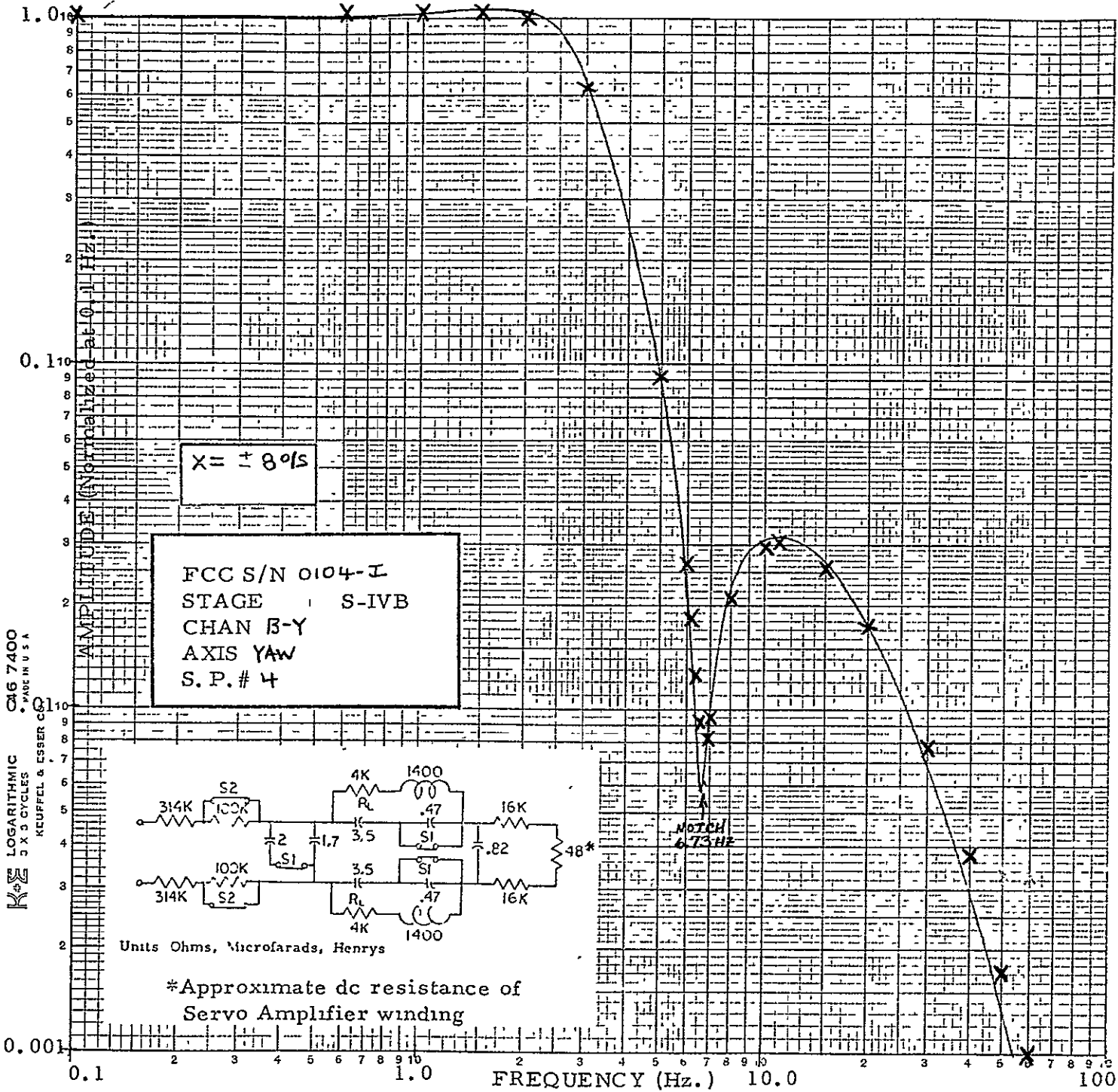

CA6 7400  
LOGARITHMIC  
3 X 3 CYCLES  
KEUFFEL & ESSER CO.  
MADE IN U.S.A.

ORIGINAL PAGE IS  
OF POOR QUALITY



OPEN LOOP FREQUENCY RESPONSE  
 SA-210, S-IVB STAGE

P-Y ATTITUDE RATE FILTER x RATE GYRO/CSP x SERVO AMP

$x = \pm 801s$

FCC S/N 0104-I  
 STAGE S-IVB  
 CHAN B-Y  
 AXIS YAW  
 S.P.# 4

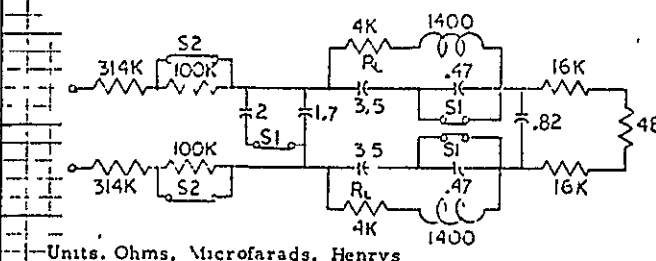

Units. Ohms, Microfarads, Henrys

\*Approximate dc resistance of Servo Amplifier winding

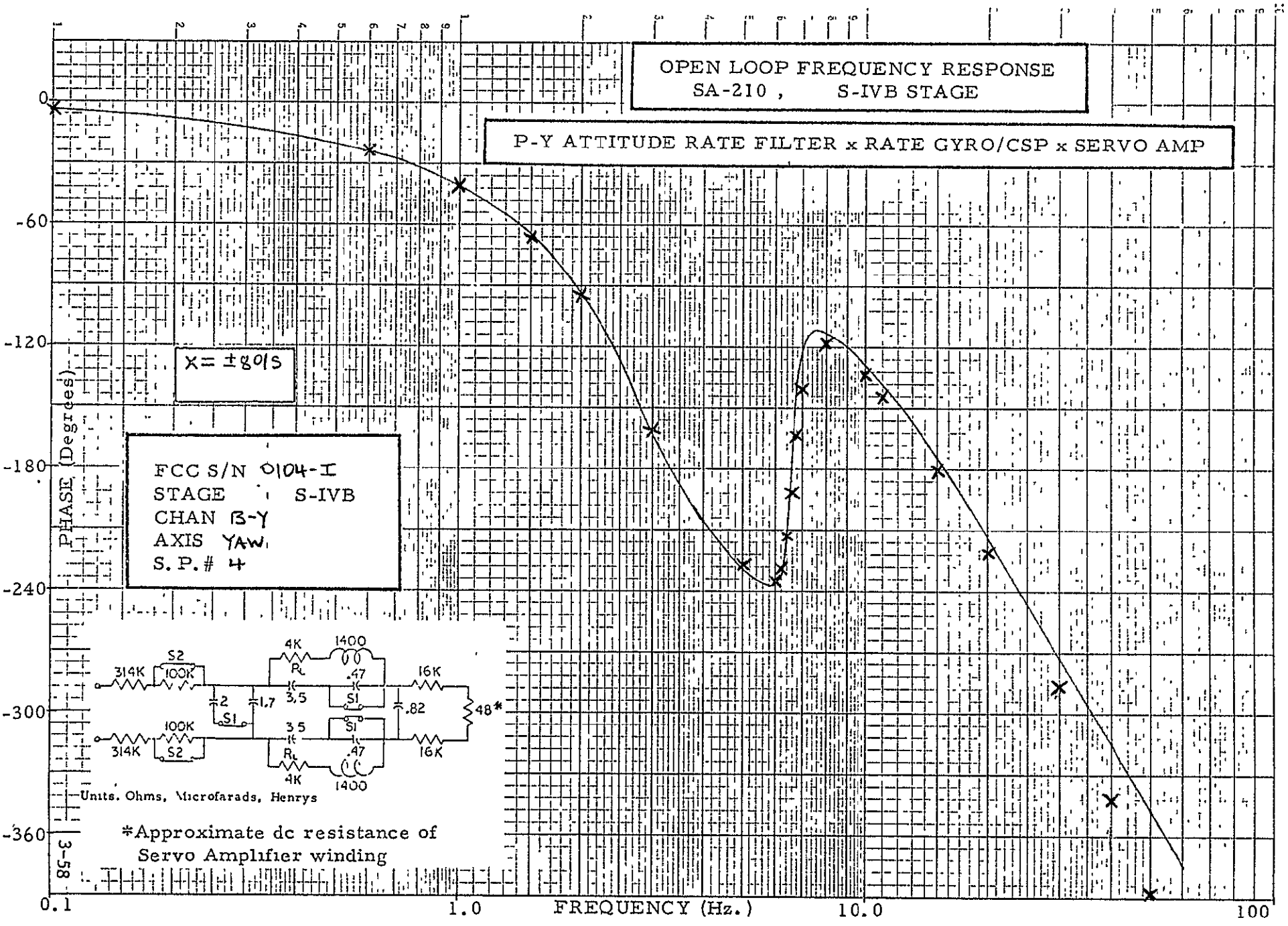

85-3

OPEN LOOP FREQUENCY RESPONSE  
SA-210, S-IVB STAGE

P-Y ATTITUDE RATE FILTER x RATE GYRO/CSP x SERVO AMP

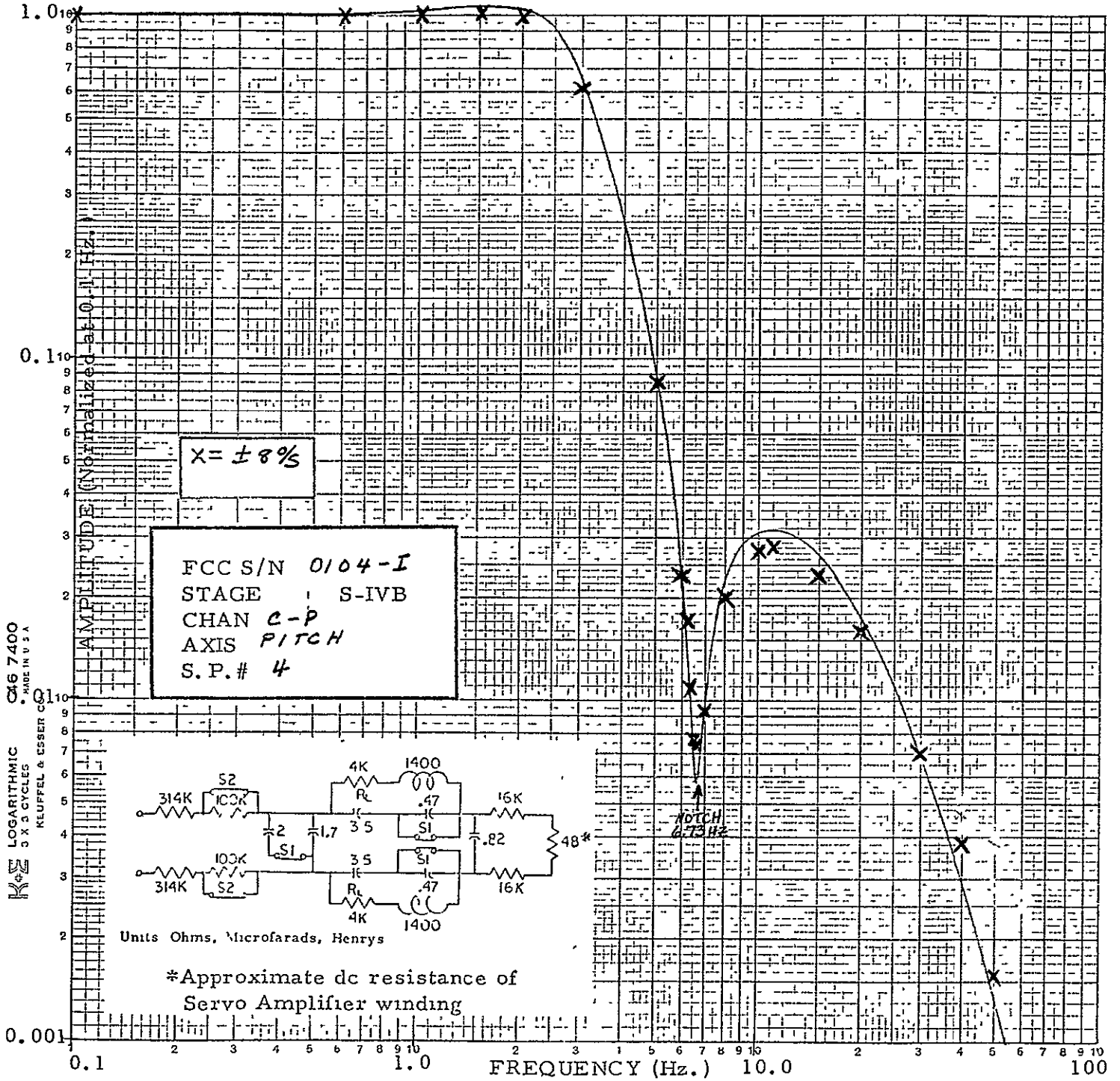

ORIGINAL PAGE IS  
OF POOR QUALITY

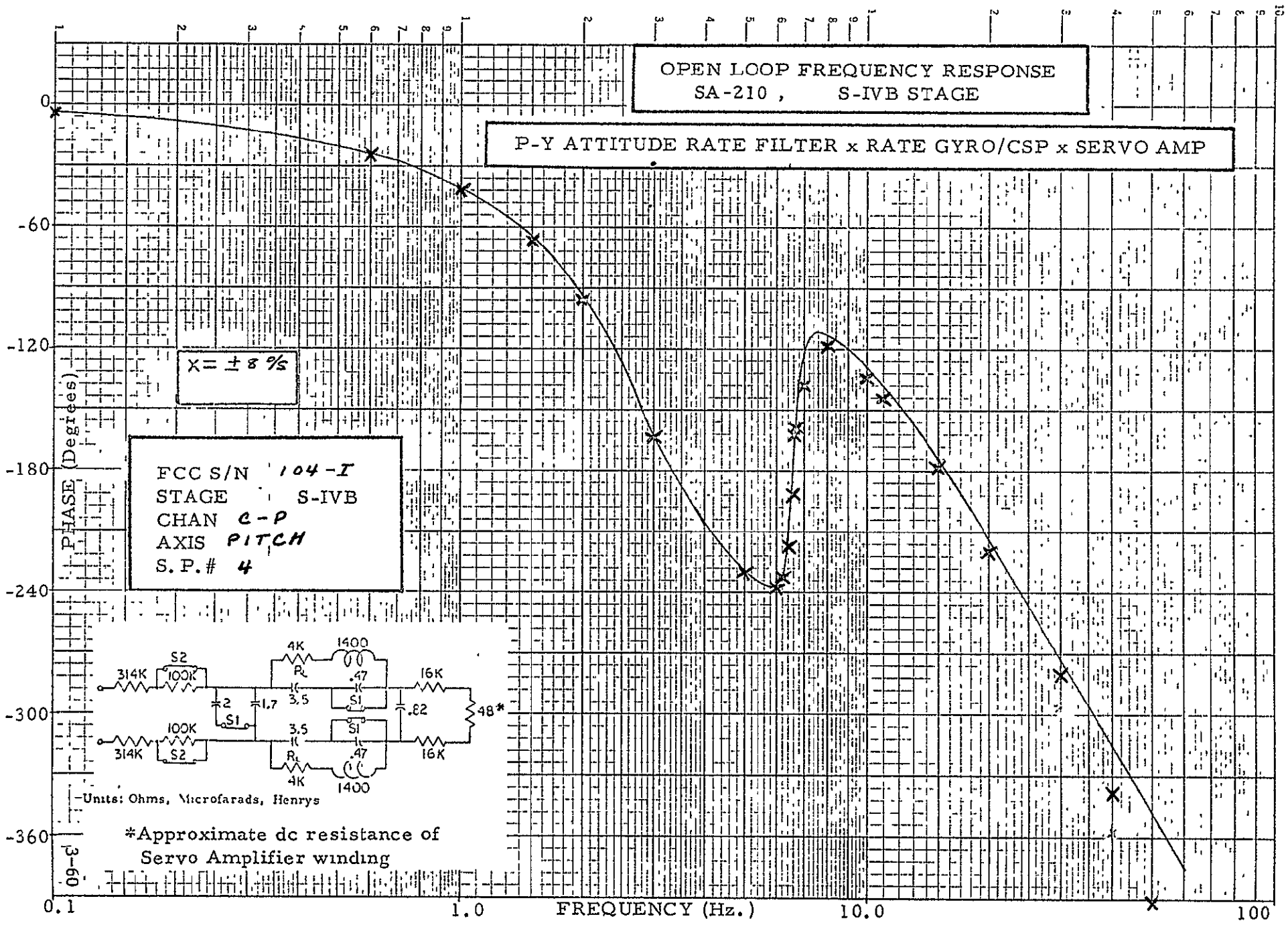

OPEN LOOP FREQUENCY RESPONSE  
SA-210, S-IVB STAGE

P-Y ATTITUDE RATE FILTER x RATE GYRO/CSP x SERVO AMP

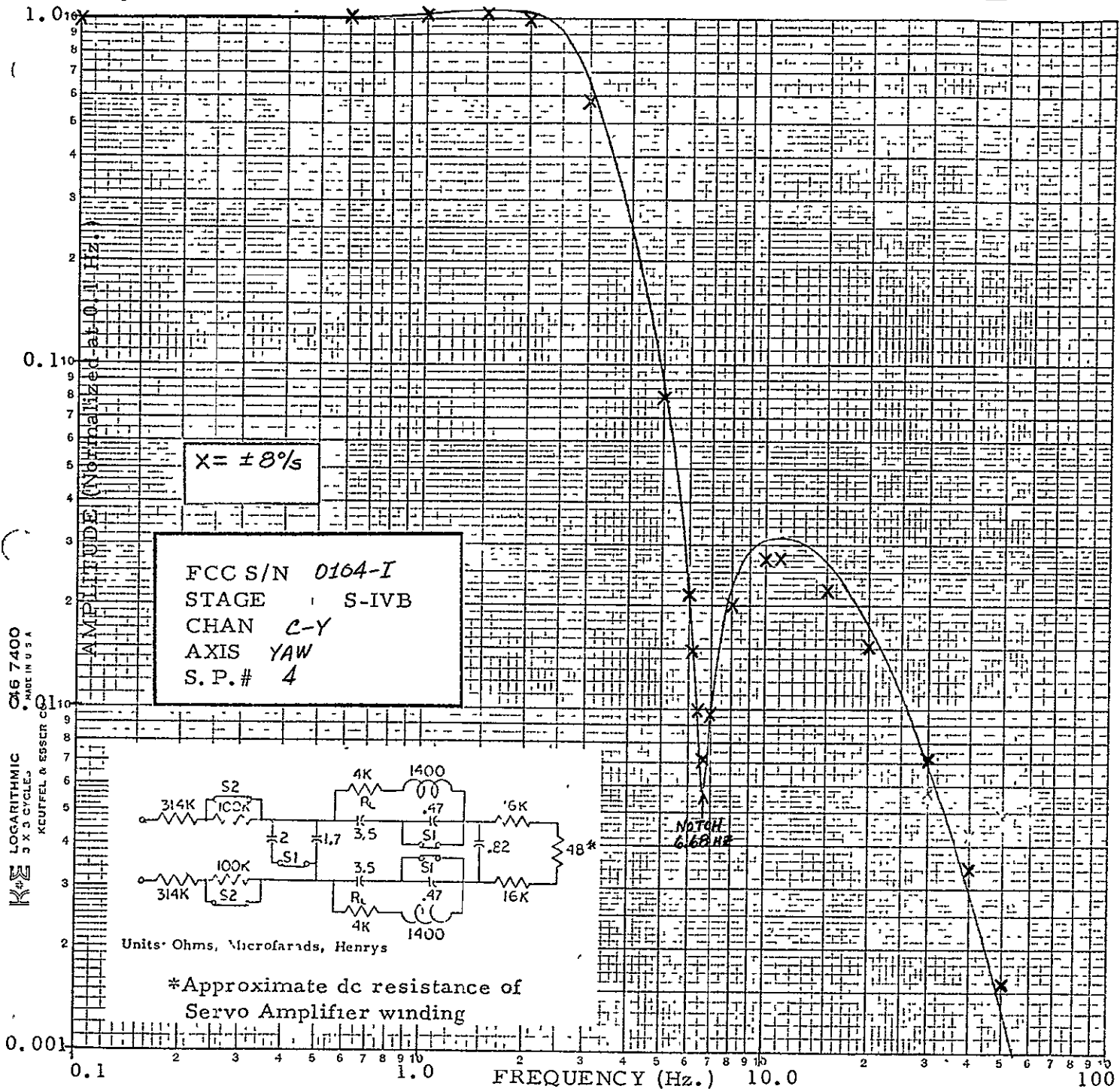

ORIGINAL PAGE IS  
OF POOR QUALITY

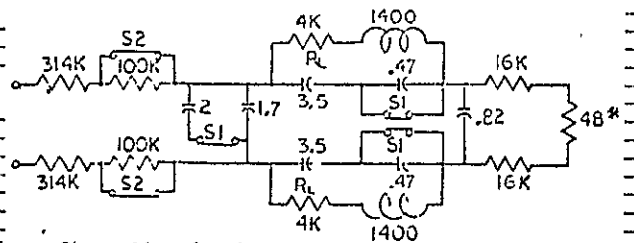
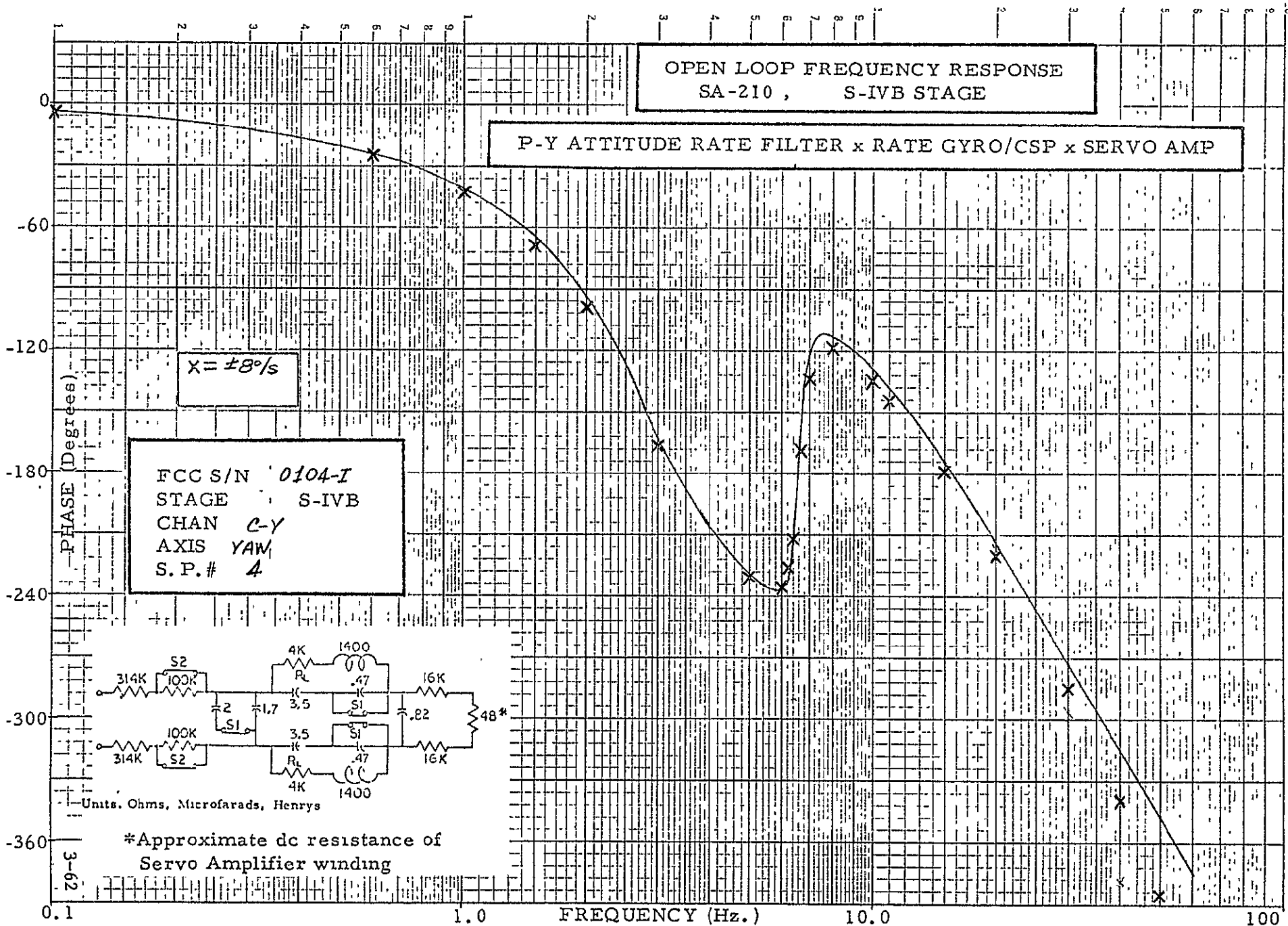

\*Approximate dc resistance of Servo Amplifier winding

OPEN LOOP FREQUENCY RESPONSE  
SA-210, S-IVB STAGE

P-Y ATTITUDE RATE FILTER x RATE GYRO/CSP x SERVO AMP

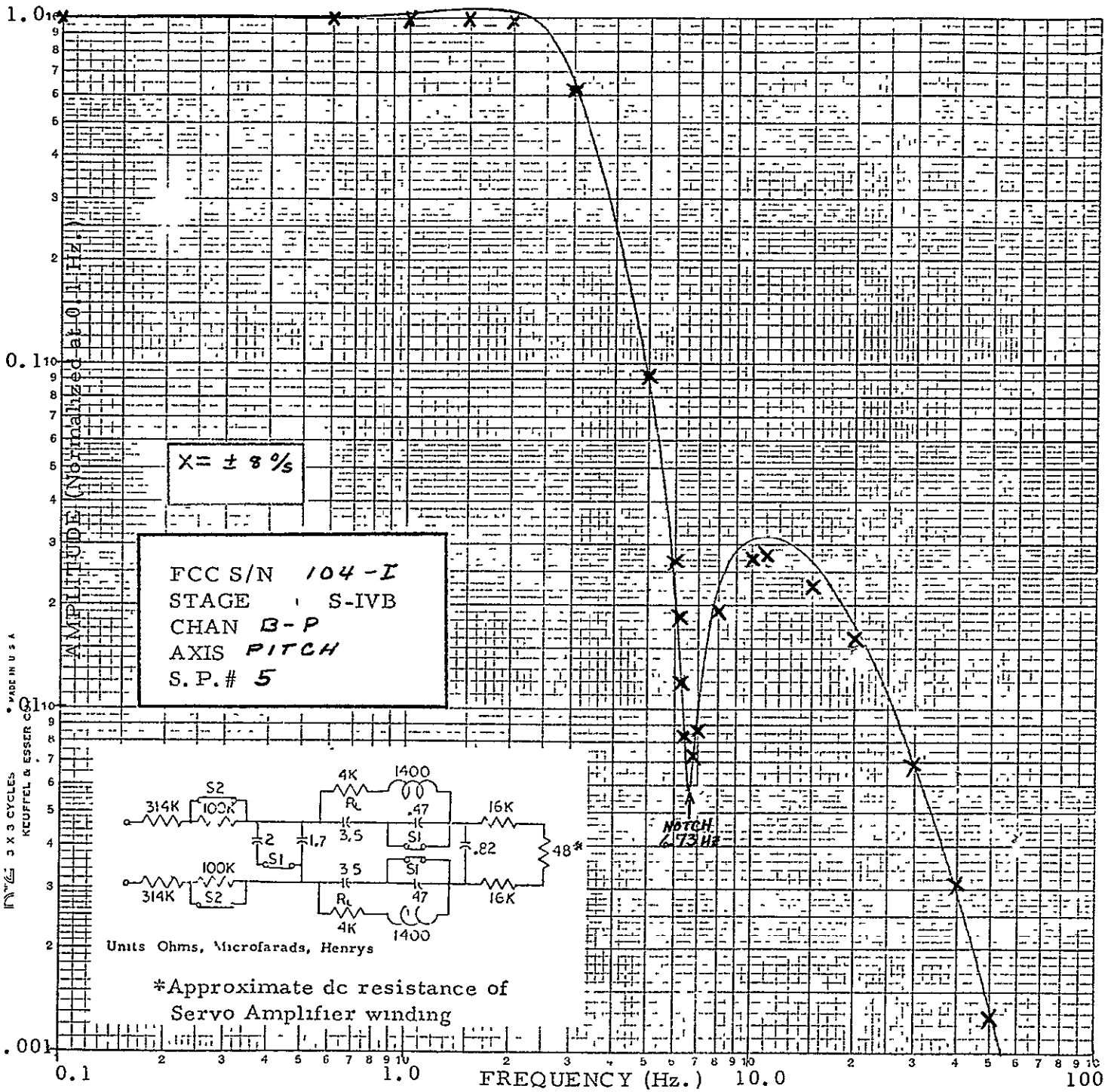

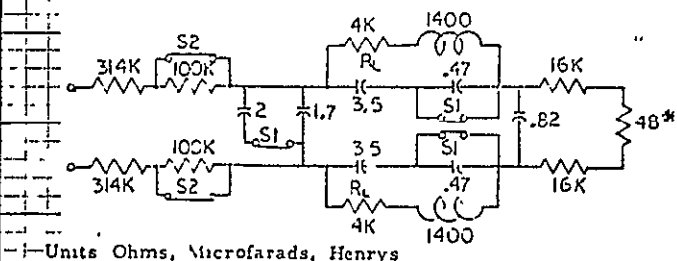
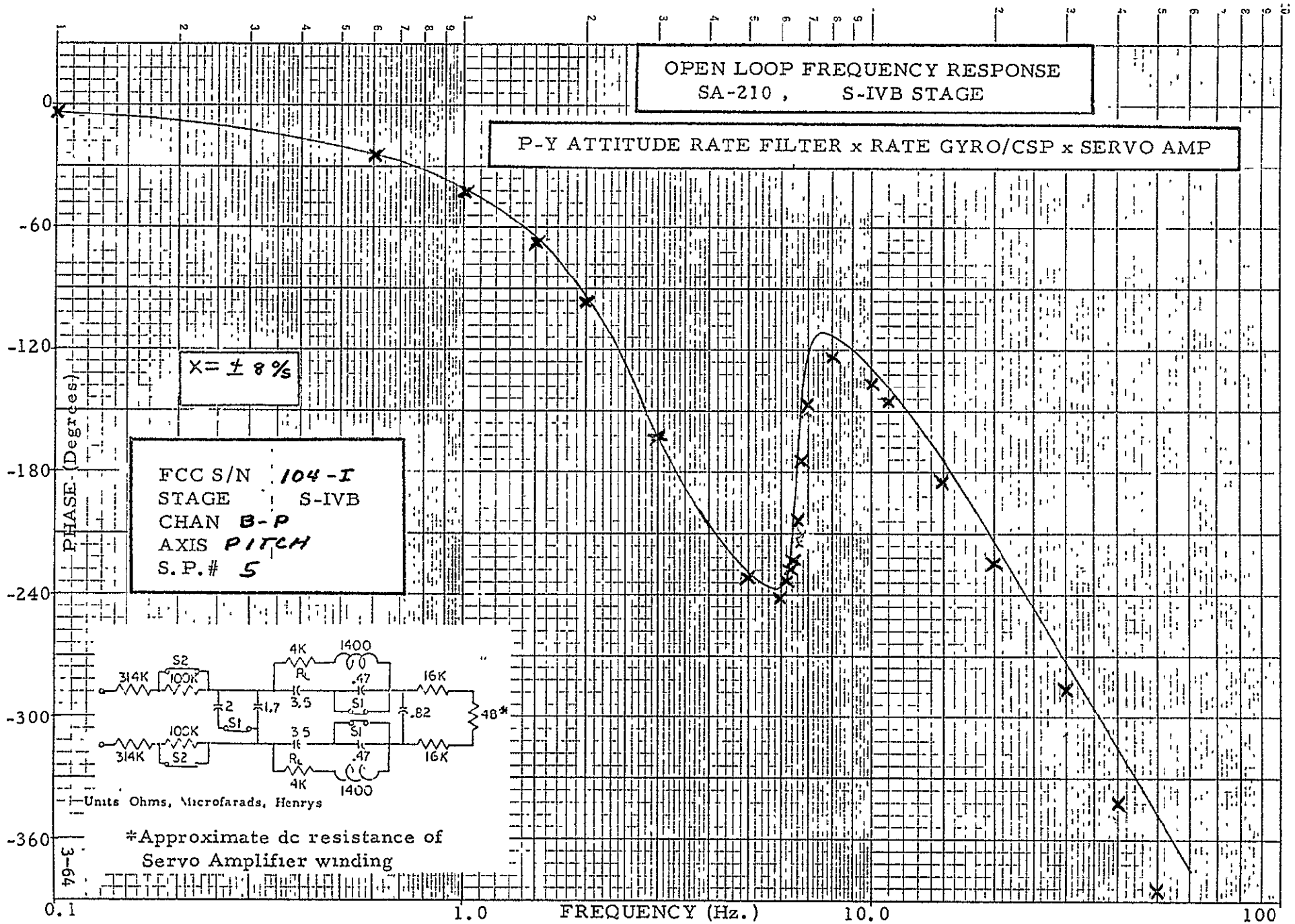

\*Approximate dc resistance of Servo Amplifier winding

OPEN LOOP FREQUENCY RESPONSE  
SA-210, S-IVB STAGE

P-Y ATTITUDE RATE FILTER x RATE GYRO/CSP x SERVO AMP

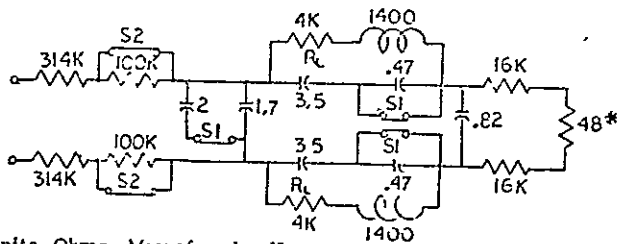
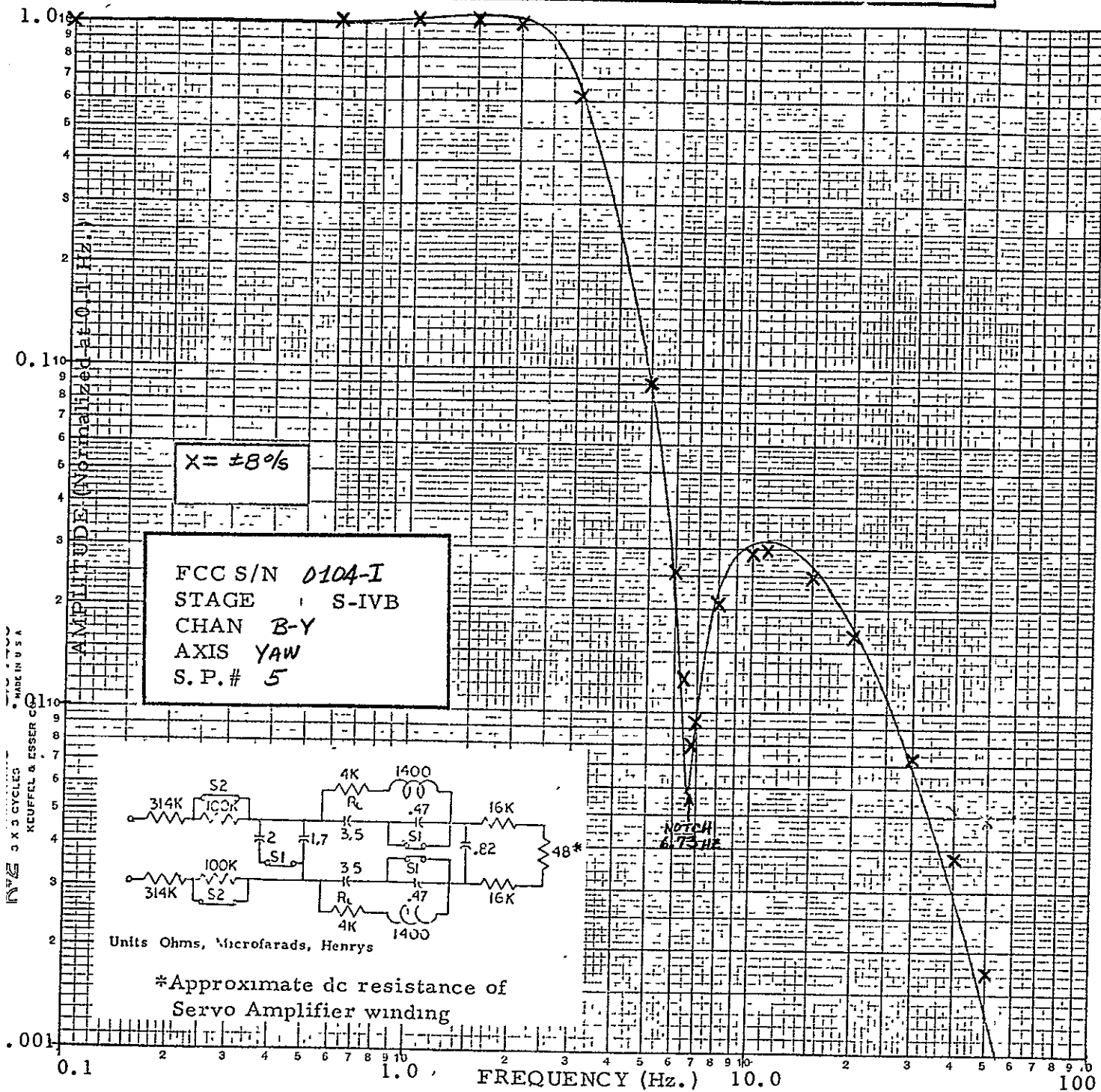

ORIGINAL PAGE IS  
OF POOR QUALITY.



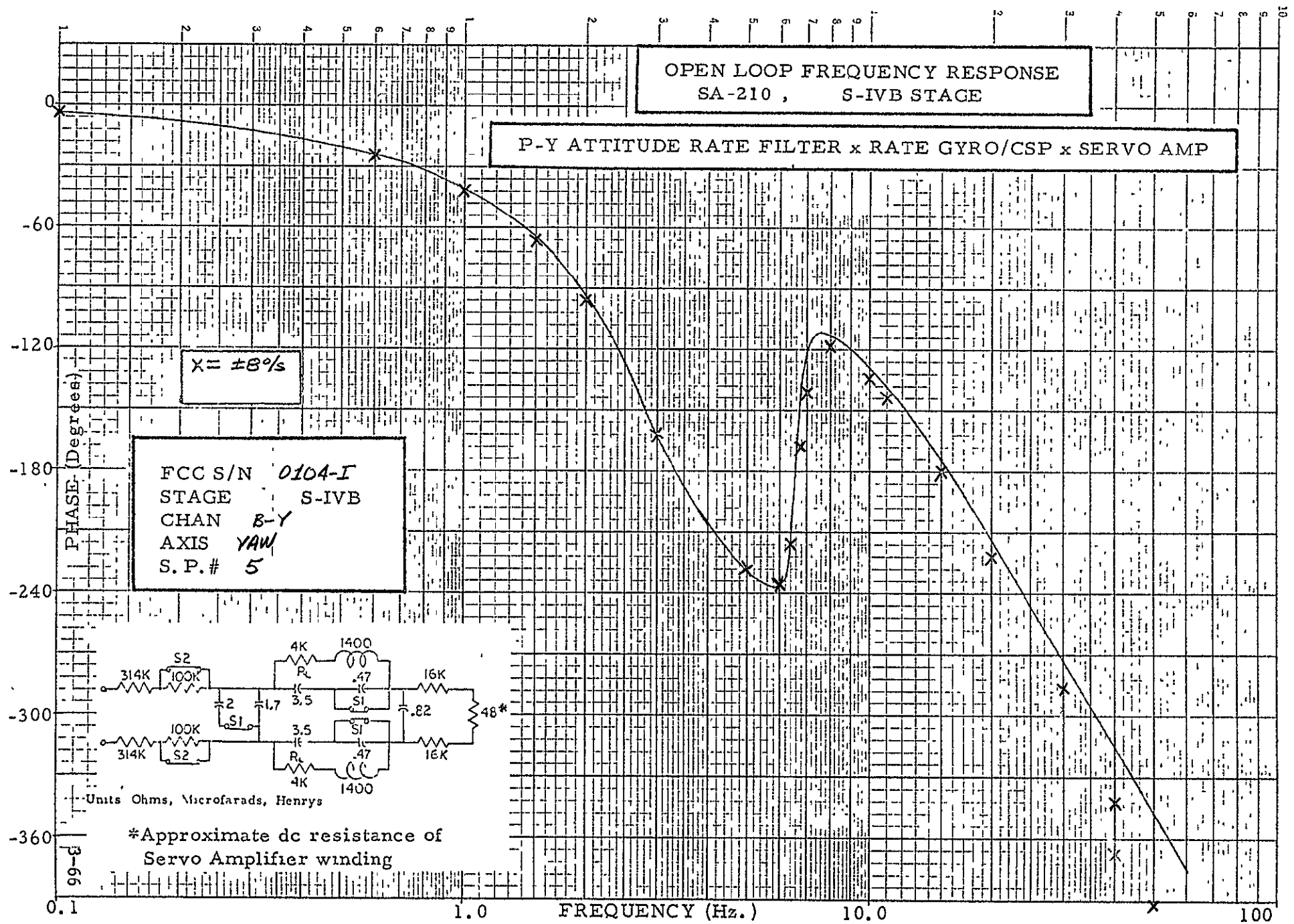

99-66

OPEN LOOP FREQUENCY RESPONSE  
SA-210, S-IVB STAGE

P-Y ATTITUDE RATE FILTER x RATE GYRO/CSP x SERVO AMP

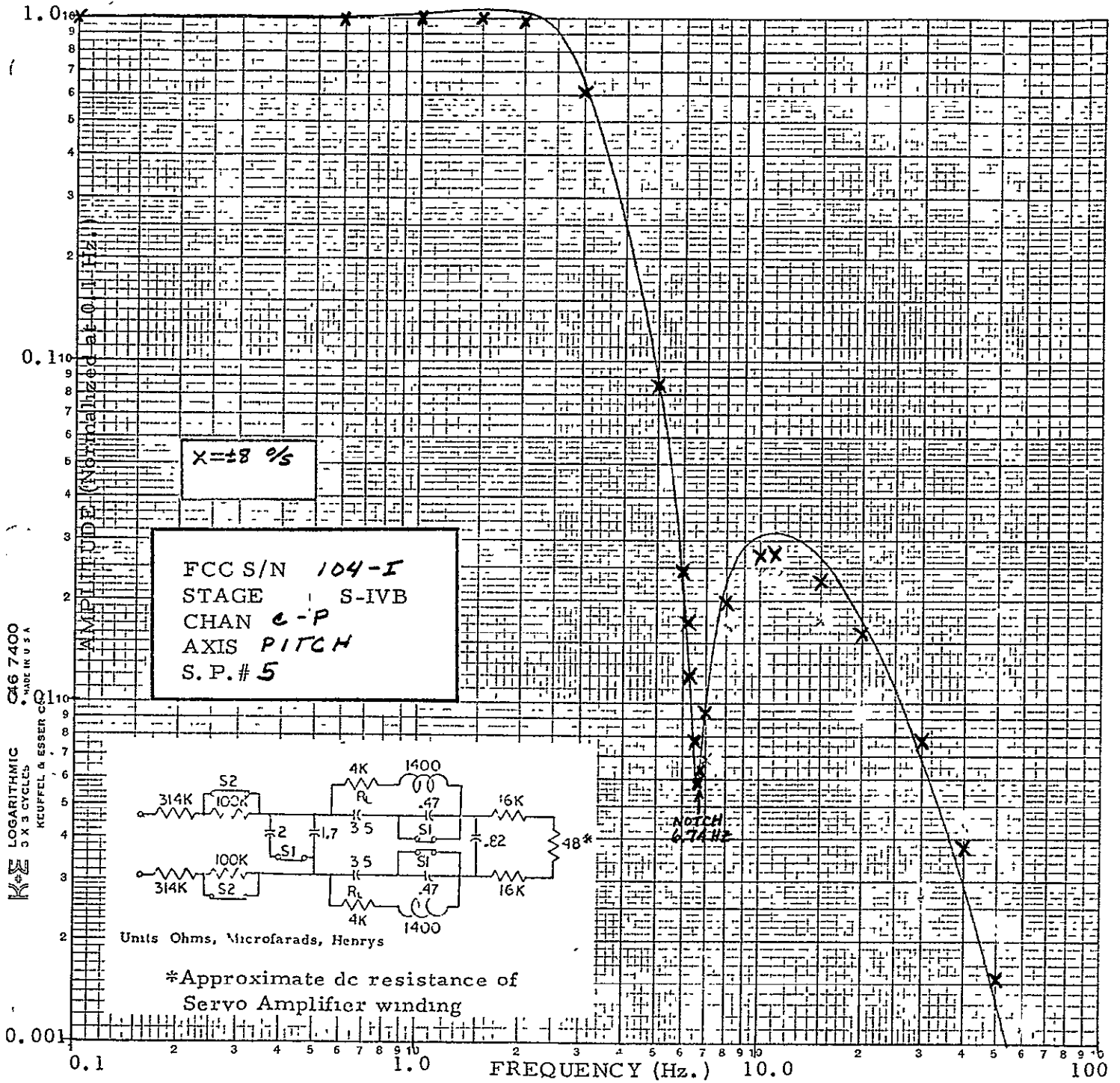

ORIGINAL PAGE IS  
OF POOR QUALITY

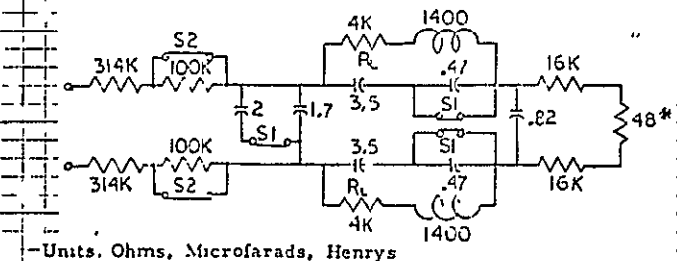
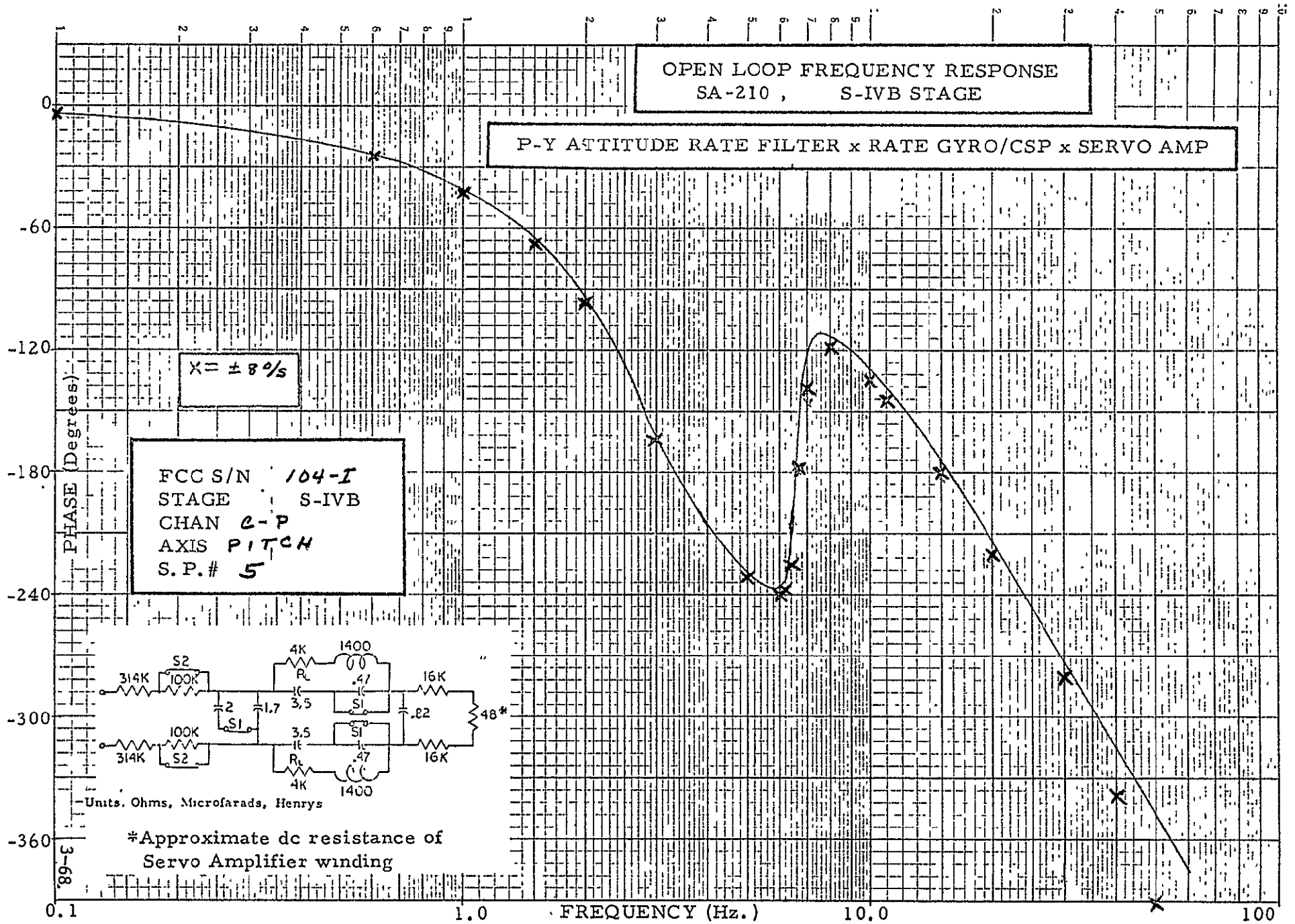

OPEN LOOP FREQUENCY RESPONSE  
SA-210, S-IVB STAGE

P-Y ATTITUDE RATE FILTER x RATE GYRO/CSP x SERVO AMP

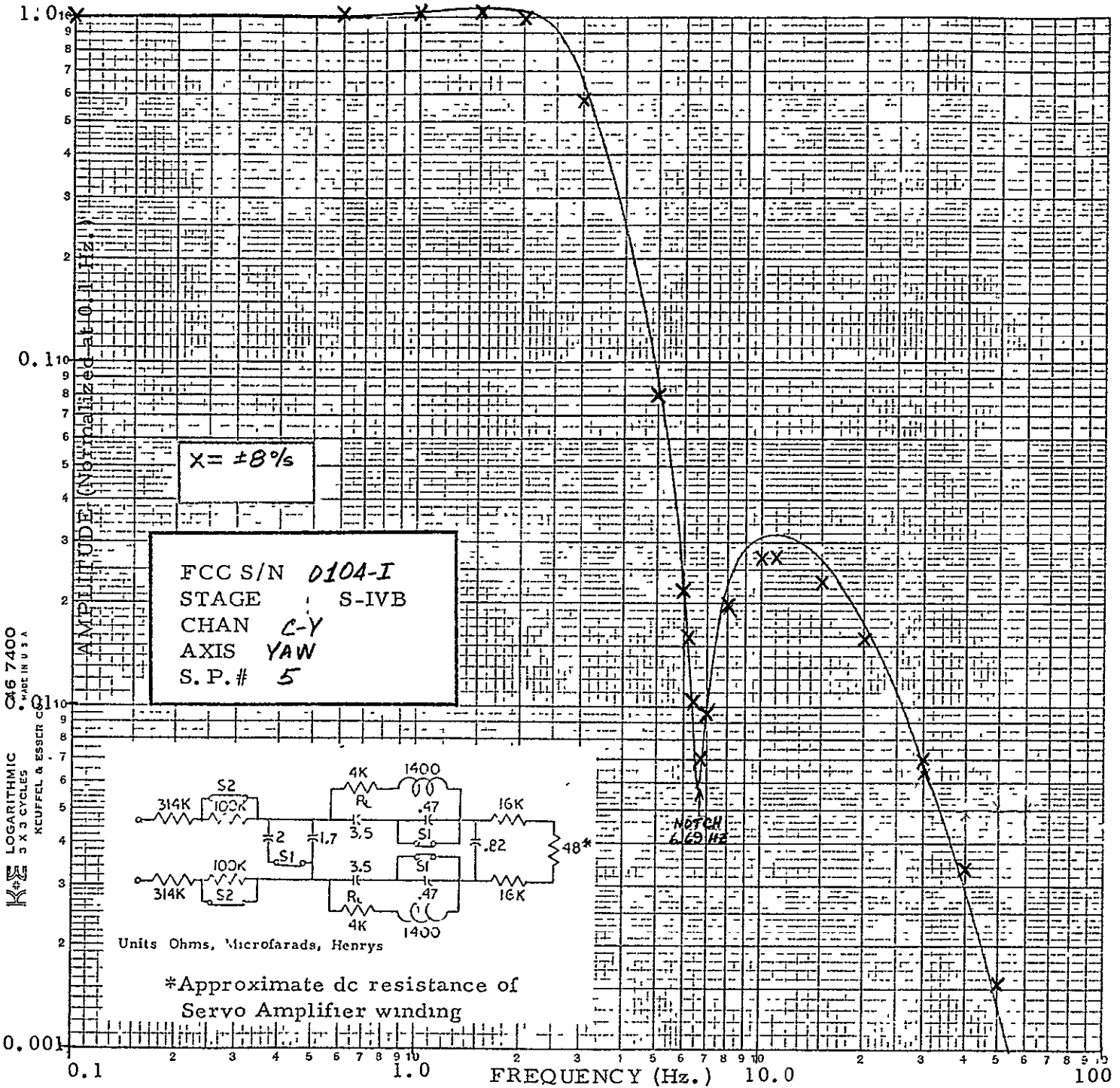

ORIGINAL PAGE IS  
OF POOR QUALITY

OPEN LOOP FREQUENCY RESPONSE  
 SA-210, S-IVB STAGE

P-Y ATTITUDE RATE FILTER x RATE GYRO/CSP x SERVO AMP

$\chi = \pm 8^\circ/s$

FCC S/N 0104-I  
 STAGE S-IVB  
 CHAN C-Y  
 AXIS YAW  
 S.P.# 5

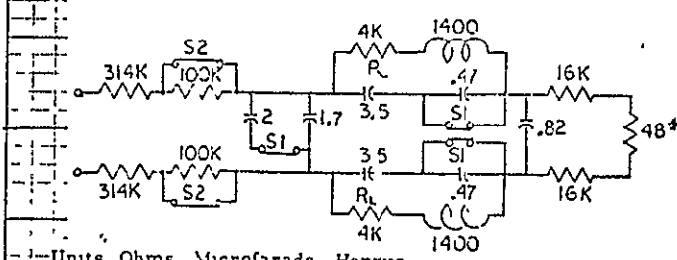
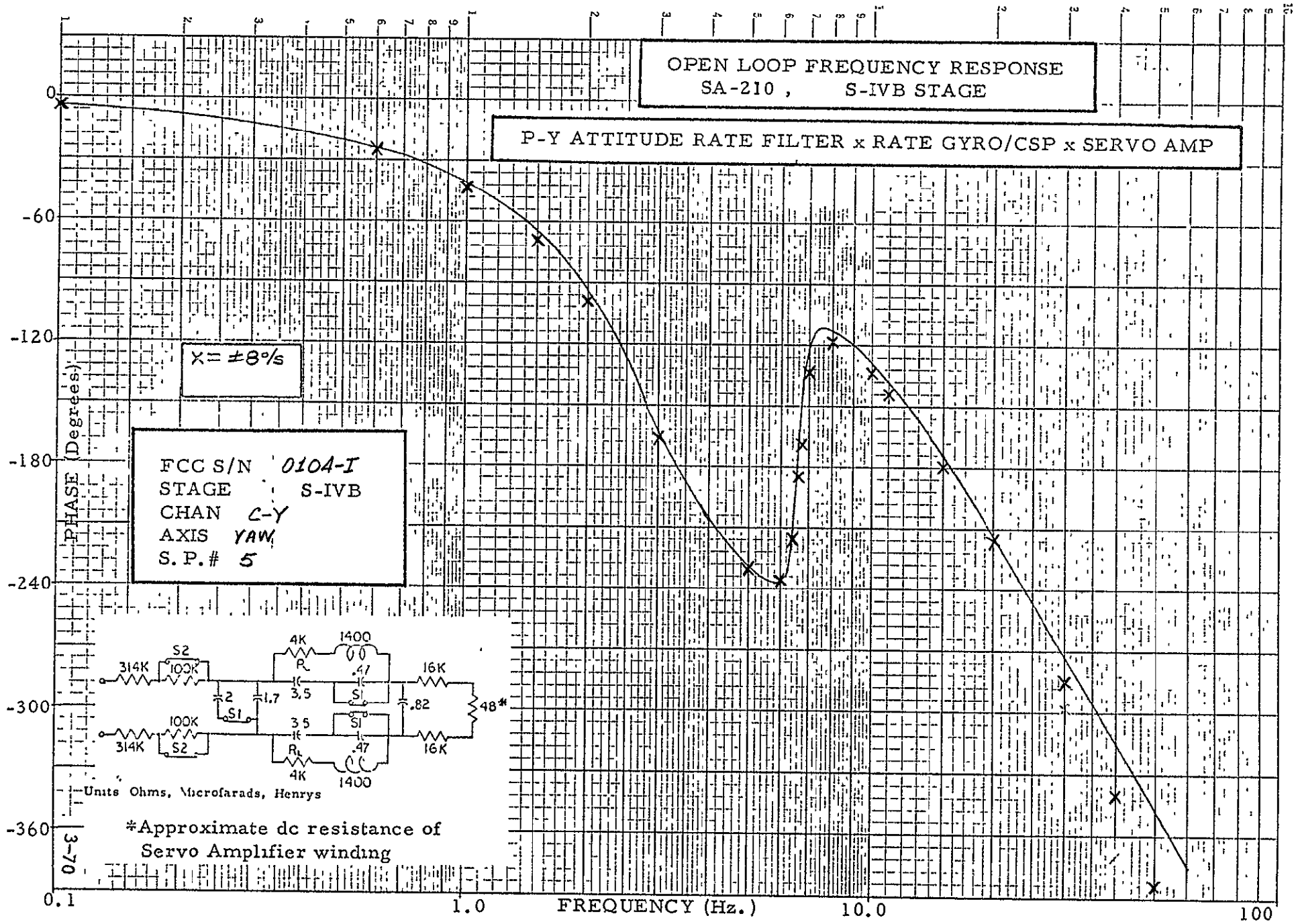

Units Ohms, Microfarads, Henrys

\*Approximate dc resistance of Servo Amplifier winding

3-70

AS-206 SIVB FCCVERIF T=18.9- SEC P/YT=0.000 BEND W/SL W/ CSP

Y	0.189000E 02	AD	0.490500E 00	A1	0.746500E 00	G2	0.0
C1	0.0	C2	0.750890E 00	K3	0.759210E 01	K4	0.759210E 01
K5	0.484340E-03	K7	0.0	K8	0.690010E 01	FLCG	0.820590E 01
PH	0.133790E 06	FHOI	0.111000E 08	SIG	0.121980E 04	THE	0.212850E 04
FA	0.100000E 10	ZETA	0.100000E 01	FRGY	0.200000E 02	ZRGY	0.700000E 00
RP	0.101580E 07						

POLYNOMIAL COEFFICIENTS

PHIF	NUMERATOR						
0.10000E 01	0.0	0.0	0.0	0.0	0.0	0.0	0.0
0.0	0.0	0.0	0.0	0.0	0.0	0.0	0.0
PHIF	DENOMINATOR						
0.10000E 01	0.14754E 00	0.0	0.0	0.0	0.0	0.0	0.0
0.0	0.0	0.0	0.0	0.0	0.0	0.0	0.0
PHIDF	NUMERATOR						
0.10000E 01	0.12842E-01	0.48838E-02	0.56779E-05	0.0	0.0	0.0	0.0
0.0	0.0	0.0	0.0	0.0	0.0	0.0	0.0
PHIDF	DENOMINATOR						
0.10000E 01	0.18330E 00	0.17536E-01	0.94195E-03	0.10682E-05	0.0	0.0	0.0
0.0	0.0	0.0	0.0	0.0	0.0	0.0	0.0
GDDF	NUMERATOR						
0.10000E 01	0.0	0.0	0.0	0.0	0.0	0.0	0.0
0.0	0.0	0.0	0.0	0.0	0.0	0.0	0.0
GDDF	DENOMINATOR						
0.10000E 01	0.0	0.0	0.0	0.0	0.0	0.0	0.0
0.0	0.0	0.0	0.0	0.0	0.0	0.0	0.0
WSS(BS)	NUMERATOR						
0.10000E 01	0.0	0.0	0.0	0.0	0.0	0.0	0.0
0.0	0.0	0.0	0.0	0.0	0.0	0.0	0.0
WSS(BS)	DENOMINATOR						
0.10000E 01	0.10815E 00	0.54782E-02	0.18779E-03	0.73902E-06	0.11671E-08	0.0	0.0
0.0	0.0	0.0	0.0	0.0	0.0	0.0	0.0
WSS(AS)	NUMERATOR						
0.10000E 01	0.0	0.0	0.0	0.0	0.0	0.0	0.0
0.0	0.0	0.0	0.0	0.0	0.0	0.0	0.0
WSS(AS)	DENOMINATOR						
0.10000E 01	0.75576E-01	0.25899E-02	0.46883E-04	0.31980E-06	0.88650E-09	0.10417E-11	0.0
0.0	0.0	0.0	0.0	0.0	0.0	0.0	0.0

FCC S/N 0104-I  
 STAGE S-IVB  
 CHAN B-P, C-Y  
 AXIS PITCH, YAW  
 S.P.# 3

ORIGINAL PAGE IS  
 OF POOR QUALITY

T = 18.9 - sec. P-Y  
 VEHICLE PARAMETERS

NYQUIST FREQUENCY RESPONSE  
 SA-210, S-IVB STAGE, PITCH AXIS DATA

AS-206 SIVB FCCVERIF T=18.9- SEC P/YT=0.000 BEND W/SL W/ CSP

BENDING DATA

MODE	1	2	3	4	5	6
FBN	2.1770E 00	6.0720E 10	9.8020E 00	1.3646E 01	1.4191E 11	1.6068E 11
ZM	1.8362E 03	1.0129E 04	8.0546E 03	1.3220E 04	3.4932E 04	3.1078E 04
ZB	5.0000E-03	5.0000E-03	5.0000E-03	5.0000E-03	5.0000E-03	5.0000E-03
YB	5.3760E-02	-2.5250E-01	-2.2260E-01	-2.8750E-01	-3.6430E-02	7.8360E-03
YPB	9.9170E-03	-5.1340E-02	-4.3340E-02	-4.8160E-02	-7.0530E-03	1.5520E-03
YPP	9.0590E-03	-2.7610E-02	2.8240E-03	4.5070E-02	-1.1360E-02	2.6760E-02
YA	0.0	0.0	0.0	0.0	0.0	0.0
YPRG	8.6470E-03	-3.9290E-03	5.4210E-02	1.4440E-01	1.0110E-01	-2.7560E 00

MODE	7	8	9	10	11	12
FBN	1.6221E 01	1.7131E 11	1.8358E 11	1.9076E 01	1.9193E 11	2.0024E 11
ZM	4.7102E 03	4.4279E 04	1.9996E 04	2.3641E 03	1.2667E 03	6.4793E 04
ZB	5.0000E-03	5.0000E-03	5.0000E-03	5.0000E-03	5.0000E-03	5.0000E-03
YB	-4.0460E-02	-7.6730E-03	2.6410E-02	4.0740E-02	-8.1420E-03	-6.4980E-02
YPB	-6.4420E-03	-1.2870E-03	3.3030E-03	4.4270E-03	-8.7220E-04	-5.4620E-03
YPP	-1.8730E-02	-3.9900E-02	-2.8540E-02	1.3210E-02	9.1200E-03	-4.9830E-03
YA	0.0	0.0	0.0	0.0	0.0	0.0
YPRG	-1.9050E-01	2.6150E 00	-6.3940E-01	7.7480E-02	6.7110E-02	2.0510E 00

MODE	13	14	15	16	17	18
FBN	2.0762E 01	2.1616E 11	2.2212E 11	0.0	0.0	0.0
ZM	3.5103E 03	2.1985E 03	1.5894E 03	0.0	0.0	0.0
ZB	5.0000E-03	5.0000E-03	5.0000E-03	0.0	0.0	0.0
YB	1.2310E-01	5.7640E-02	9.6740E-03	0.0	0.0	0.0
YPB	7.3660E-03	2.0730E-03	-3.0170E-04	0.0	0.0	0.0
YPP	3.1040E-02	-1.2620E-03	-9.6290E-02	0.0	0.0	0.0
YA	0.0	0.0	0.0	0.0	0.0	0.0
YPRG	8.1020E-01	2.4290E-01	-5.1860E-01	0.0	0.0	0.0

SLOSHING DATA

MODE	1	2	3	4	5	6
FFS	3.2983E-01	4.6499E-01	7.1989E-01	0.0	0.0	0.0
ZS	5.4000E-05	2.8300E-02	2.8300E-02	0.0	0.0	0.0
FMS	3.5650E 03	1.9975E 04	1.8390E 03	0.0	0.0	0.0
XBS	-2.9409E-01	5.4149E 00	5.3849E 00	0.0	0.0	0.0

FCC S/N 0104-I  
 STAGE S-IVB  
 CHAN B-P, C-Y  
 AXIS PITCH, YAW  
 S.P.# 3

T = 18.9 - Sec. P-Y  
 VEHICLE PARAMETERS

NYQUIST FREQUENCY RESPONSE  
 SA-210, S-IVB STAGE, PITCH AXIS DATA







AS-206 SIVB FCCVERIF T=200.- SEC F/YT=220.0 BEND W/SL W/ CSP

T	0.200000E 03	A0	0.490500E 00	A1	0.746500E 00	G2	0.0
C1	0.0	C2	0.117860E 01	K3	0.120760E 02	K4	0.120760E 02
K5	0.281740E-03	K7	0.0	K8	0.673710E 01	FLCG	0.836890E 01
FH	0.848250E 05	FHOI	0.727310E 07	SIG	0.121980E 04	THE	0.212850E 04
FA	0.100000E 10	ZETA	0.100000E 01	FRGY	0.200000E 02	ZRGY	0.700000E 00
RP,	0.182430E 07						

POLYNOMIAL COEFFICIENTS

PHIF	NUMERATOR						
0.10000E 01	0.0	0.0	0.0	0.0	0.0	0.0	0.0
0.0	0.0	0.0	0.0	0.0	0.0	0.0	0.0
PHIF	DENOMINATOR						
0.10000E 01	0.14754E 00	0.0	0.0	0.0	0.0	0.0	0.0
0.0	0.0	0.0	0.0	0.0	0.0	0.0	0.0
PHIDF	NUMERATOR						
0.10000E 01	0.49868E-03	0.57817E-03	0.67218E-06	0.0	0.0	0.0	0.0
0.0	0.0	0.0	0.0	0.0	0.0	0.0	0.0
PHIDF	DENOMINATOR						
0.10000E 01	0.25899E-01	0.57290E-02	0.16791E-03	0.18702E-06	0.0	0.0	0.0
0.0	0.0	0.0	0.0	0.0	0.0	0.0	0.0
GDDF	NUMERATOR						
0.10000E 01	0.0	0.0	0.0	0.0	0.0	0.0	0.0
0.0	0.0	0.0	0.0	0.0	0.0	0.0	0.0
GDDF	DENOMINATOR						
0.10000E 01	0.0	0.0	0.0	0.0	0.0	0.0	0.0
0.0	0.0	0.0	0.0	0.0	0.0	0.0	0.0
WSS(BS)	NUMERATOR						
0.10000E 01	0.0	0.0	0.0	0.0	0.0	0.0	0.0
0.0	0.0	0.0	0.0	0.0	0.0	0.0	0.0
WSS(BS)	DENOMINATOR						
0.10000E 01	0.10815E 00	0.54782E-02	0.18779E-03	0.73902E-06	0.11671E-08	0.0	0.0
0.0	0.0	0.0	0.0	0.0	0.0	0.0	0.0
WSS(AS)	NUMERATOR						
0.10000E 01	0.0	0.0	0.0	0.0	0.0	0.0	0.0
0.0	0.0	0.0	0.0	0.0	0.0	0.0	0.0
WSS(AS)	DENOMINATOR						
0.10000E 01	0.75576E-01	0.25899E-02	0.46883E-04	0.31980E-06	0.88650E-09	0.10417E-11	0.0
0.0	0.0	0.0	0.0	0.0	0.0	0.0	0.0

FCC S/N 0104-I  
 STAGE S-IVB  
 CHAN C-P, B-Y  
 AXIS PITCH, YAW  
 S.P.# 4

T = 200 - Sec. P-Y  
 VEHICLE PARAMETERS

NYQUIST FREQUENCY RESPONSE  
 SA-210, S-IVB STAGE, PITCH AXIS DATA

AS-206 SIYB FCCVERIF T=200.- SEC P/YT=220.0 BEND W/SL W/ CSP

BENDING DATA

MODE	1	2	3	4	5	6
FBN	7.0310E 10	1.4101E 11	1.4488E 01	1.6067E 01	1.6346E 11	1.7131E 11
ZM	6.4275E 03	2.5457E 04	2.1625E 04	2.8265E 04	4.0118E 03	4.115.E 04
ZB	5.0000E-03	5.0000E-03	5.0000E-03	5.0000E-03	5.0000E-03	5.0000E-03
YB	2.2690E-01	2.4860E-01	-4.5250E-01	1.4970E-02	-7.1290E-02	-1.4450E-02
YPB	4.9840E-02	5.1660E-02	-9.6030E-02	3.4350E-03	-1.5390E-02	-3.2610E-03
YPP	2.8540E-02	-3.3610E-02	3.9770E-02	2.0480E-02	-1.4470E-02	-3.7960E-02
YA	0.0	0.0	0.0	0.0	0.0	0.0
YPRG	-2.2060E-03	-1.1530E-01	3.8990E-01	-2.6650E 00	-5.7170E-02	2.5310E 00

MODE	7	8	9	10	11	12
FBN	1.8365E 01	1.9159E 11	1.9226E 01	2.0030E 11	2.1093E 01	2.1816E 11
ZM	2.7245E 04	9.7499E 02	9.6255E 03	4.6567E 04	5.8125E 03	1.0417E 03
ZB	5.0000E-03	5.0000E-03	5.0000E-03	5.0000E-03	5.0000E-03	5.0000E-03
YB	3.1630E-02	1.2690E-02	-6.4150E-02	-3.6140E-02	1.0340E-01	3.4840E-02
YPB	6.5610E-03	2.5840E-03	-1.2840E-02	-6.9150E-03	1.7140E-02	5.6530E-03
YPP	-3.5350E-02	1.1130E-02	5.7700E-03	-3.0280E-04	4.0740E-02	1.2480E-02
YA	0.0	0.0	0.0	0.0	0.0	0.0
YPRG	-8.0330E-01	3.8540E-02	2.0400E-01	1.9340E 00	7.0470E-01	2.8580E-01

MODE	13	14	15	16	17	18
FBN	2.2171E 11	2.4037E 11	2.4730E 01	0.0	0.0	0.0
ZM	1.5111E 03	4.1865E 04	1.9194E 04	0.0	0.0	0.0
ZB	5.0000E-03	5.0000E-03	5.0000E-03	0.0	0.0	0.0
YB	3.1090E-03	-9.6040E-02	-3.0790E-01	0.0	0.0	0.0
YPB	-1.3140E-04	-1.2220E-02	-3.5120E-02	0.0	0.0	0.0
YPP	-9.3530E-02	4.6850E-01	1.8080E-01	0.0	0.0	0.0
YA	0.0	0.0	0.0	0.0	0.0	0.0
YPRG	-5.2570E-01	3.4000E-01	-1.6550E 00	0.0	0.0	0.0

SLOSHING DATA

MODE	1	2	3	4	5	6
FFS	4.0632E-01	3.5156E-01	7.0841E-01	0.0	0.0	0.0
ZS	5.4000E-05	9.5000E-05	9.5000E-05	0.0	0.0	0.0
FMS	3.5140E 03	3.4350E 04	4.9500E 02	0.0	0.0	0.0
XBS	2.1589E 00	6.1659E 00	4.6329E 00	0.0	0.0	0.0

FCC S/N 0104-I  
 STAGE S-IVB  
 CHAN C-P, B-Y  
 AXIS PITCH, YAW  
 S.P.# 4

T = 200 - Sec. P-Y  
 VEHICLE PARAMETERS

NYQUIST FREQUENCY RESPONSE  
 SA-210, S-IVB STAGE, PITCH AXIS DATA

A3-206 SIVB FCC VERIF T=200.--SEC P/Y  
 T=220.0 BEND W/S/L W/ CSP

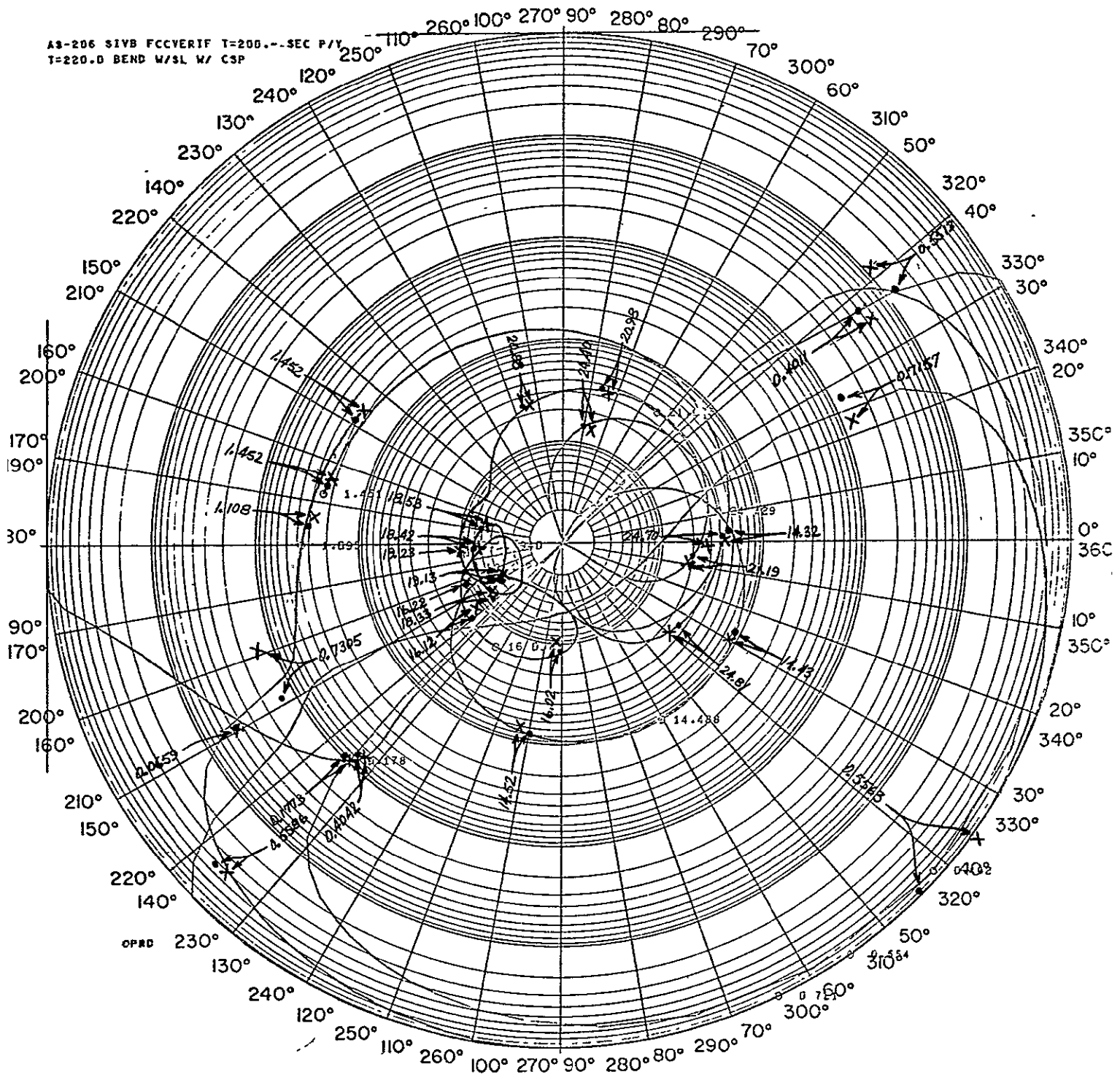

FCC S/N 0104-I  
 STAGE S-IVB  
 CHAN C-P  
 AXIS PITCH  
 S.P.# 4

o SIMULATION  
 x HARDWARE

T = 200 - Sec. P-Y  
 OPEN AT ACTUATOR  
 NOMINAL CASE

NYQUIST FREQUENCY RESPONSE  
 SA-210, S-IVB STAGE, PITCH AXIS DATA

ORIGINAL PAGE IS  
 OF POOR QUALITY



AS-206 SIVB FCCVERIF T=300.0 SEC P/YT=442.5 BEND W/SL W/ CSP

T	0.300000E 03	A0	0.490500E 00	A1	0.574500E 00	G2	0.0
C1	0.0	C2	0.157120E 01	K3	0.170080E 02	K4	0.170080E 02
K5	0.202440E-03	K7	0.0	K8	0.499230E 01	FLCG	0.101140E 02
FM	0.601180E 05	FMOI	0.658140E 07	SIG	0.121980E 04	THE	0.212850E 04
FA	0 100000E 10	ZETA	0.160000E 01	FRGY	0.200600E 02	ZRGY	0.700000E 00
RP	0 102250E 07						

POLYNOMIAL COEFFICIENTS

PHIF	NUMERATOR						
0.10000E 01	0.0	0.0	0.0	0.0	0.0	0.0	0.0
0.0	0.0	0.0	0.0	0.0	0.0	0.0	0.0
PHIF	DENOMINATOR						
0.10000E 01	0.14754E 00	0.0	0.0	0.0	0.0	0.0	0.0
0.0	0.0	0.0	0.0	0.0	0.0	0.0	0.0
PHICF	NUMERATOR						
0.10000E 01	0.49868E-03	0.57817E-03	-0.67218E-06	0.0	0.0	0.0	0.0
0.0	0.0	0.0	0.0	0.0	0.0	0.0	0.0
PHIDF	DENOMINATOR						
0.10000E 01	0.96163E-01	0 57778E-02	0.17033E-03	0.18976E-06	0.0	0.0	0.0
0.0	0.0	0.0	0.0	0.0	0.0	0.0	0.0
GDDF	NUMERATOR						
0.10000E 01	0 0	0.0	0.0	0.0	0.0	0.0	0.0
0.0	0.0	0.0	0.0	0.0	0.0	0.0	0.0
GDDF	DENOMINATOR						
0.10000E 01	0.0	0.0	0.0	0.0	0.0	0.0	0.0
0.0	0.0	0.0	0.0	0.0	0.0	0.0	0.0
WSS(BS)	NUMERATOR						
0.10000E 01	0.0	0.0	0.0	0.0	0.0	0.0	0.0
0 0	0 0	0.0	0.0	0.0	0.0	0.0	0.0
WSS(BS)	DENOMINATOR						
0 10000E 01	0 10815E 00	0.54782E-02	0.18779E-03	0 73902E-06	0.11671E-08	0.0	0.0
0.0	0 0	0.0	0.0	0.0	0.0	0.0	0.0
WSS(AS)	NUMERATOR						
0 10000E 01	0 0	0.0	0.0	0.0	0.0	0.0	0.0
0.0	0.0	0.0	0.0	0.0	0.0	0.0	0.0
WSS(AS)	DENOMINATOR						
0.10000E 01	0.73576E-01	0.25899E-02	0.46883E-04	0.31980E-06	0.88650E-09	0.10417E-11	0.0
0.0	0.0	0.0	0.0	0.0	0.0	0.0	0.0

FCC S/N 0104-I  
 STAGE S-IVB  
 CHAN C-Y  
 AXIS YAW  
 S.P.# 5

ORIGINAL PAGE IS  
 OF POOR QUALITY

T = 300 Sec. P-Y  
 VEHICLE PARAMETERS

NYQUIST FREQUENCY RESPONSE  
 SA-210, S-IVB STAGE, PITCH AXIS DATA

AS-206 SIVB FCCVERIF T=300.0 SEC P/YT=442.5 BEND W/SL W/ CSP

BENDING DATA

MODE	1	2	3	4	5	6
FBN	7.6790E 00	1.4171E 11	1.5776E 01	1.0069E 11	1.6887E 01	1.7135E 01
ZH	6.1730E 03	3.3667E 04	1.7417E 04	2.5114E 04	3.3569E 03	2.6489E 04
ZB	5.0000E-03	5.0000E-03	5.0000E-03	5.0000E-03	5.0000E-03	5.0000E-03
YB	5.2650E-01	1.3460E-01	6.0980E-01	4.5840E-02	-3.0240E-01	-1.1190E-01
YPB	6.1310E-02	1.4540E-02	8.4320E-02	7.0230E-03	-4.6030E-02	-1.7730E-02
YPP	4.5150E-02	-1.2270E-02	-3.2590E-02	1.5460E-02	-9.2580E-03	-3.3160E-02
YA	0.0	0.0	0.0	0.0	0.0	0.0
YPRG	1.7370E-02	5.4640E-02	-2.8180E-01	-2.5410E 00	9.5100E-02	2.0860E 00

MODE	7	8	9	10	11	12
FBN	1.8373E 11	1.9172E 11	1.9330E 01	2.0035E 11	2.1377E 11	2.2147E 01
ZH	4.5255E 04	9.2641E 02	2.7804E 05	3.2824E 04	1.0133E 05	2.7227E 04
ZB	5.0000E-03	5.0000E-03	5.0000E-03	5.0000E-03	5.0000E-03	5.0000E-03
YB	1.0500E-01	9.0010E-03	-7.9160E-01	-5.0640E-02	5.1060E-01	1.9820E-01
YPB	1.7700E-02	1.6760E-03	-1.4160E-01	-9.3920E-03	8.5500E-02	4.0130E-02
YPP	-4.4730E-02	1.0820E-02	-4.1180E-02	1.3170E-05	1.7490E-01	4.0730E-01
YA	0.0	0.0	0.0	0.0	0.0	0.0
YPRG	-1.1240E 00	4.5560E-02	1.8550E 00	1.7450E 00	1.0460E 00	2.6670E 00

MODE	13	14	15	16	17	18
FBN	2.2228E 11	2.4060E 11	2.5040E 11	0.0	0.0	0.0
ZH	5.4261E 02	3.2848E 04	2.7021E 03	0.0	0.0	0.0
ZB	5.0000E-03	5.0000E-03	5.0000E-03	0.0	0.0	0.0
YB	5.0810E-02	-6.0110E-02	3.6350E-03	0.0	0.0	0.0
YPB	8.5950E-03	-1.1720E-02	-3.3400E-03	0.0	0.0	0.0
YPP	-1.4220E-02	3.7480E-01	1.4950E-02	0.0	0.0	0.0
YA	0.0	0.0	0.0	0.0	0.0	0.0
YPRG	-2.5800E-02	5.4570E-01	-9.8200E-02	0.0	0.0	0.0

SLOSHING DATA

MODE	1	2	3	4	5	6
FFS	4.5639E-01	4.0521E-01	8.6373E-01	0.0	0.0	0.0
ZS	8.7000E-05	1.1700E-04	1.1700E-04	0.0	0.0	0.0
FMS	3.0100E 03	2.1400E 04	1.5500E 02	0.0	0.0	0.0
XBS	4.7537E 00	8.1247E 00	6.1657E 00	0.0	0.0	0.0

FCC S/N 0104-I  
 STAGE S-IVB  
 CHAN C-Y  
 AXIS YAW  
 S.P.# 5

T = 300 Sec. P-Y  
 VEHICLE PARAMETERS

NYQUIST FREQUENCY RESPONSE  
 SA-210, S-IVB STAGE, PITCH AXIS DATA

AS-206 S1VB FCCVERIF T=300.0 SEC P/Y  
 T=442.5 BEND W/SL W/ CSP

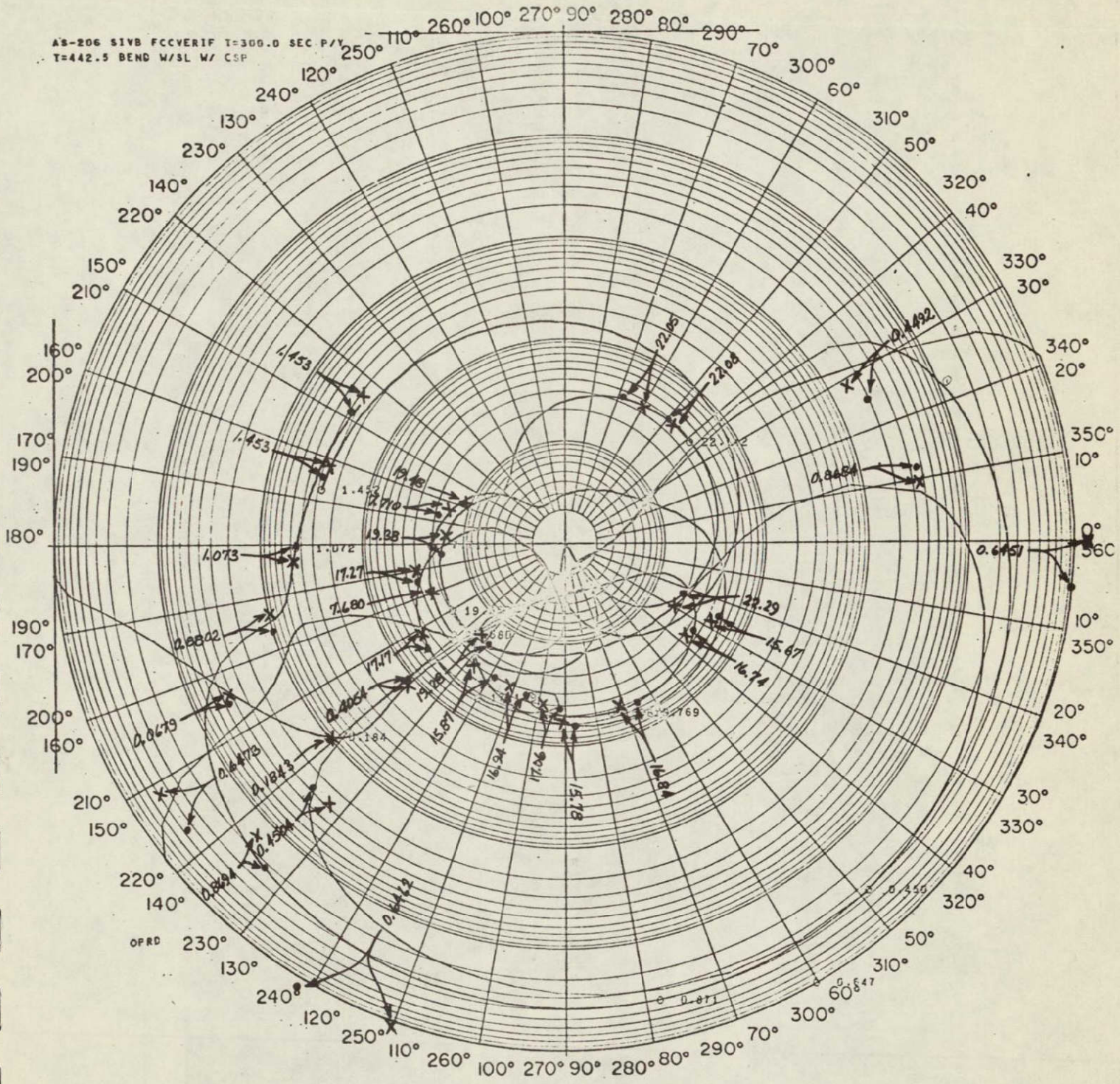

FCC S/N D10A-I  
 STAGE S-IVB  
 CHAN C-Y  
 AXIS YAW  
 S. P. # 5

○ SIMULATION  
 x HARDWARE

T = 300 Sec. P-Y  
 OPEN AT ACTUATOR  
 NOMINAL CASE

NYQUIST FREQUENCY RESPONSE  
 SA-210, S-IVB STAGE, PITCH AXIS DATA



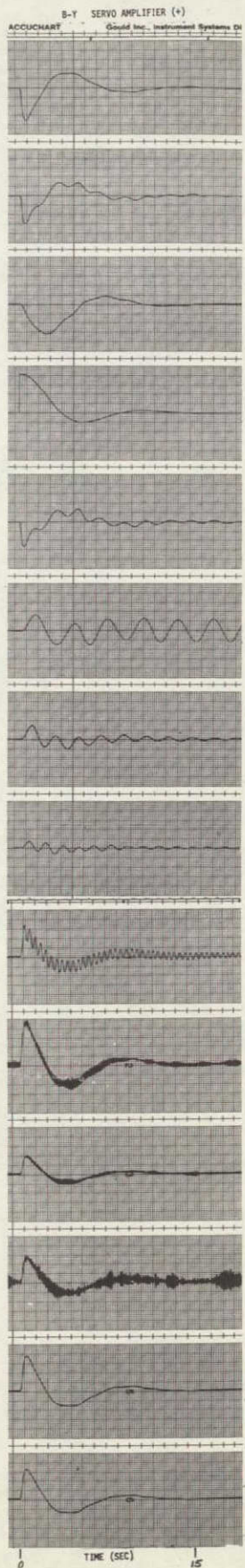
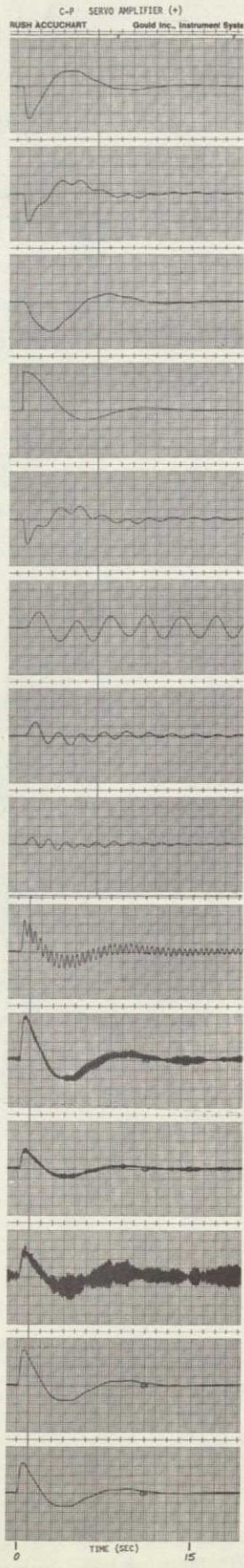
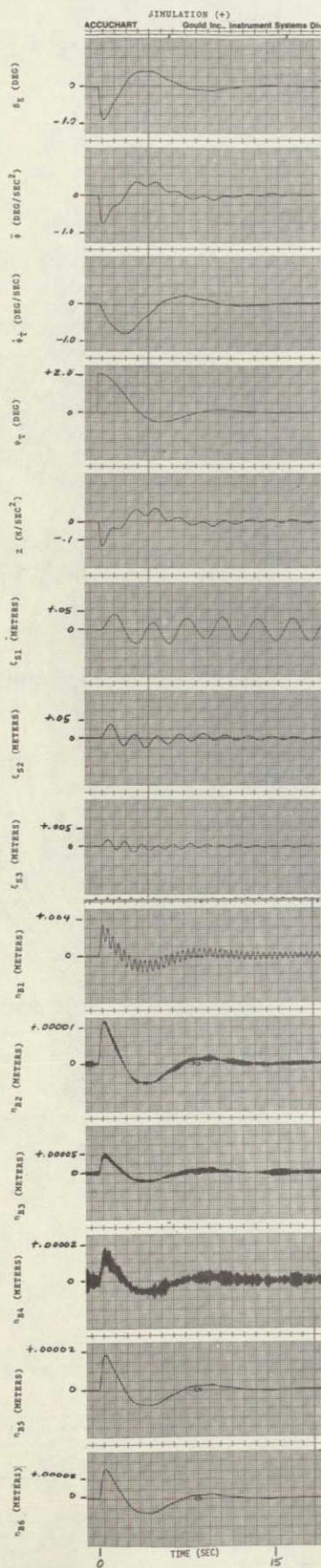

CLOSED LOOP TRANSIENT RESPONSE  
TO A STEP INPUT  $\theta = +2$  DEGREES  
 $T = 18.9$  SEC. YAW AXIS

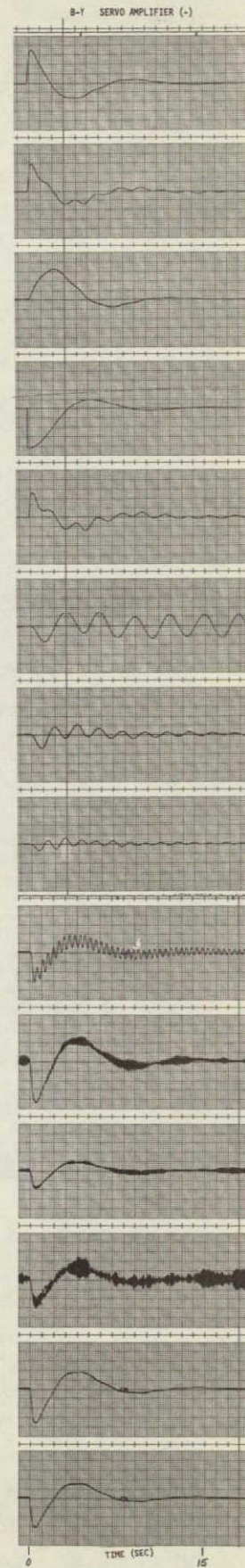
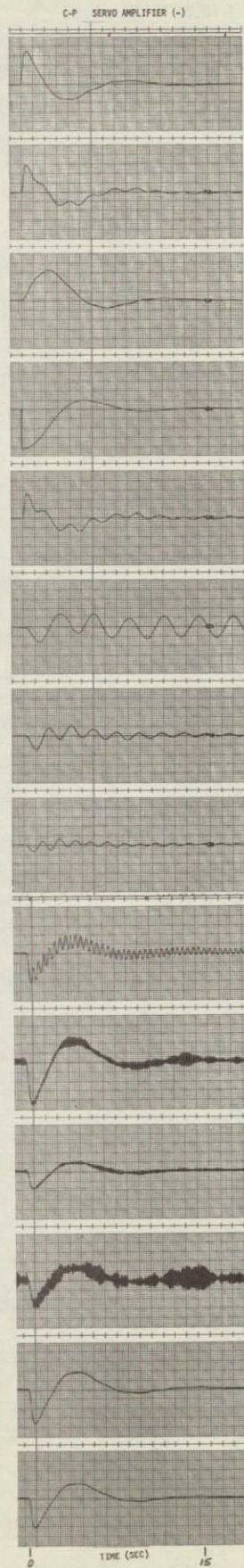
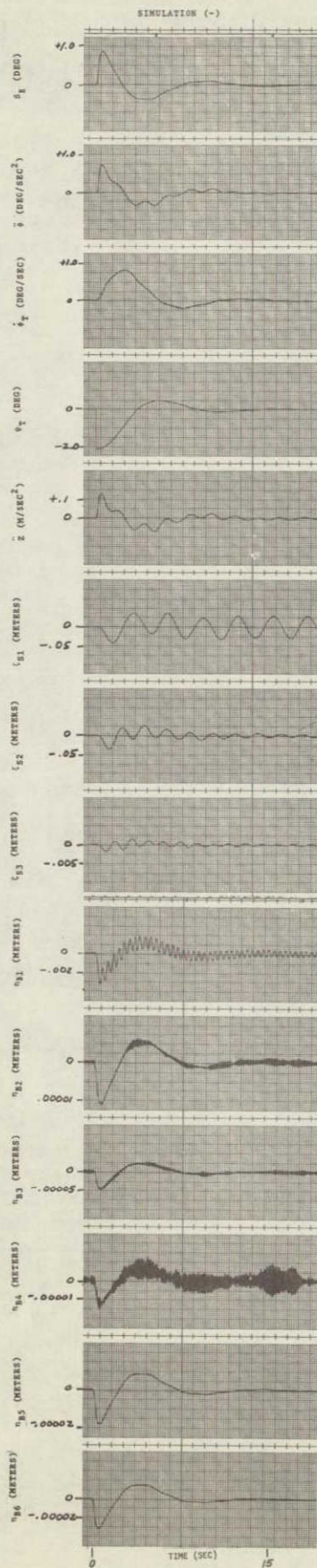

CLOSED LOOP TRANSIENT RESPONSE  
TO A STEP INPUT  $\theta = 2$  DEGREES  
 $T = 18.9$  SEC. PITCH AXIS

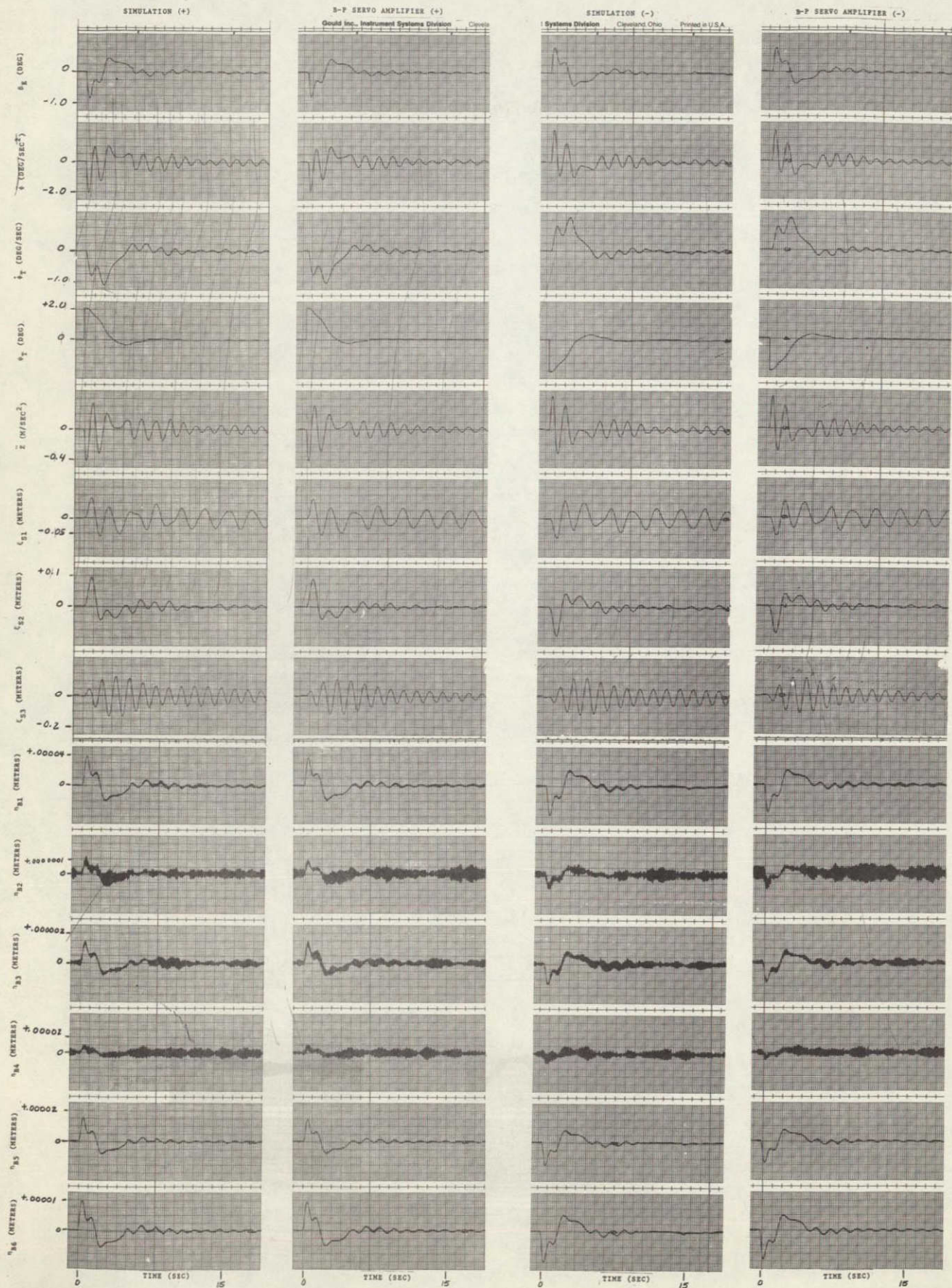

CLOSED LOOP TRANSIENT RESPONSE  
 TO A STEP INPUT  $\theta = \pm 2$  DEGREES  
 $T = 100$ -SEC. PITCH AXIS

ORIGINAL PAGE IS  
 OF POOR QUALITY

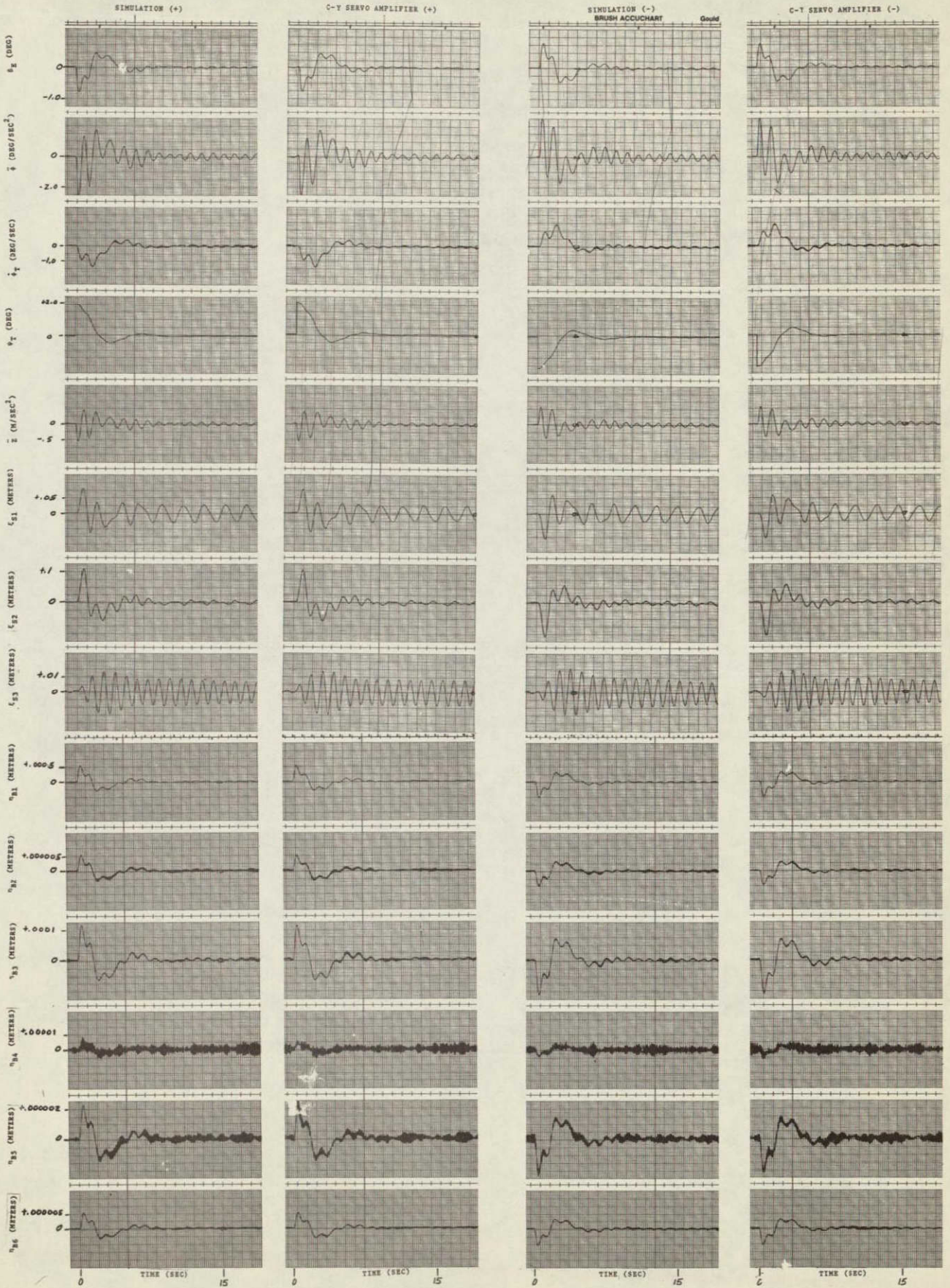

CLOSED LOOP TRANSIENT RESPONSE  
 TO A STEP INPUT  $\Psi = 12$  DEGREE  
 $T = 300$  SEC. YAW AXIS

Section 4

S-IVB, AUXILIARY PROPULSION SYSTEM  
TEST RESULTS AND ANALYSIS

Section 4

FCC S/N 0104-I TEST RESULTS AND ANALYSIS

S-IVB STAGE

AUXILIARY PROPULSION SYSTEM

TABULATION

Table 4 outlines the results of the tests performed on FCC S/N 0104-I. The table serves as a ready guide to the following pertinent areas:

- Location of the specific test results.
- Statement as to whether IBM considers the FCC acceptable or unacceptable for flight.
- Reference to the location of further analysis on a given test.

Test Performed	Results (Page No.)	Acceptable	Analysis and Comments
Spatial Amplifier Deadband and Polarity - IU and S/C Control	4-4	Yes	All amplifier deadbands, modulated zones, and full-on characteristics were within requirements of linearity scaling, and signal mixing. The spacecraft $\psi$ channel gains and limiters are correctly implemented.

TABLE 4: TEST RESULTS AND ANALYSIS OF FCC S/N 0104-I, S-IVB STAGE, APS

Test Performed	Results (Page No.)	Acceptable	Analysis and Comments
Spatial Amplifier Operational Characteristics <ul style="list-style-type: none"> <li>● On-Time</li> <li>● Pulse Width</li> <li>● Pulse Frequency</li> <li>● Threshold and Full-On</li> </ul>	4-20	Yes	<p>The spatial amplifiers exhibit acceptable on-times, pulse widths, and pulse frequencies when operating within the modulated firing zones. All engines fired continuously when input signals were applied above the modulated zones. All threshold and full-on values were within the <math>\pm 5\%</math> tolerance. Worst case deviations were:</p> <ul style="list-style-type: none"> <li>● <math>\psi</math> threshold - +1.875% in the I<sub>IV-R</sub> spare spatial amplifier</li> <li>● <math>\psi</math> full-on - +1.172% in the I<sub>IV-R</sub> spare spatial amplifier</li> <li>● <math>\phi</math> threshold - +2.444% in the III<sub>P</sub> prime spatial amplifier</li> <li>● <math>\phi</math> full-on - +1.875% in the III<sub>P</sub> prime spatial amplifier</li> </ul> <p>Spatial amplifier threshold and full-on gain changes of 10/3.75 in pitch and yaw and 20/3.75 in roll were observed when switching from IU to S/C control.</p>
Channel Time Delay to Command APS	4-57	Yes	All $\psi$ channel delays were within the 40 to 70 millisecond range, and all $\phi$ channel delays were within the 240 to 270 millisecond range.
18 Hz Attitude Rate Spatial Filter Frequency Response	4-58	Yes	Only minor deviations were seen at all frequencies; all noise signals $\geq 18$ Hz will be attenuated by 40 db in the APS system.

TABLE 4.  
(Cont'd)

RESULTS AND ANALYSIS OF FCC S/N 0104-1, S-IVB STAGE APS

4.2 RESULTS

4.2.1 The results of the S-IVB Stage study are presented on the following pages. To assist in the interpretation of the results, the following vehicle orientation is used.

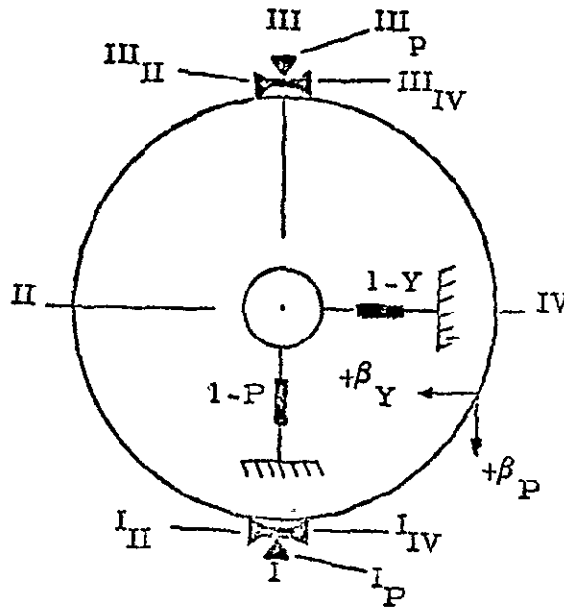

S-IVB STAGE (AFT)  
ACTUATOR AND APS NOZZLE LAYOUT



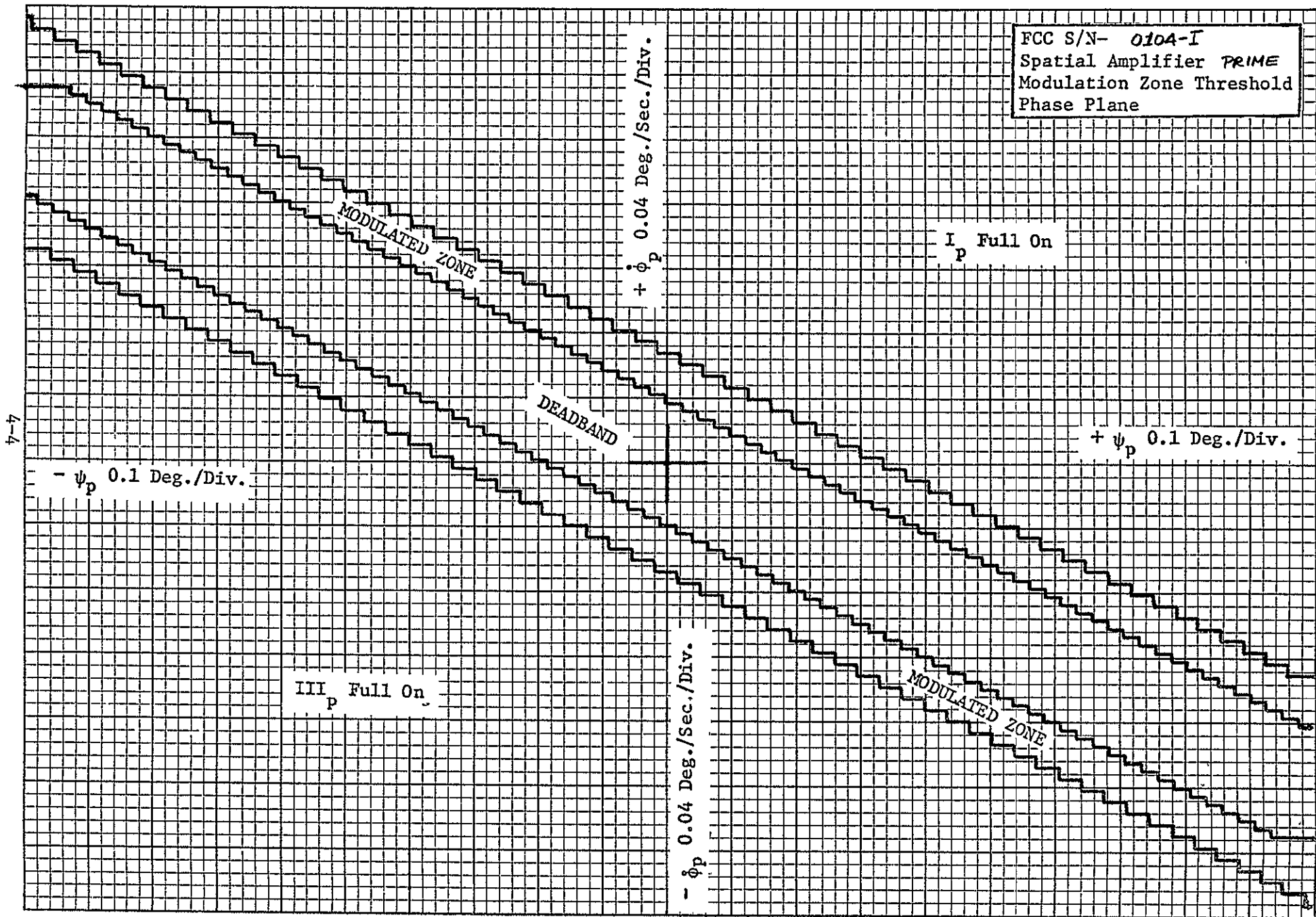

4-7

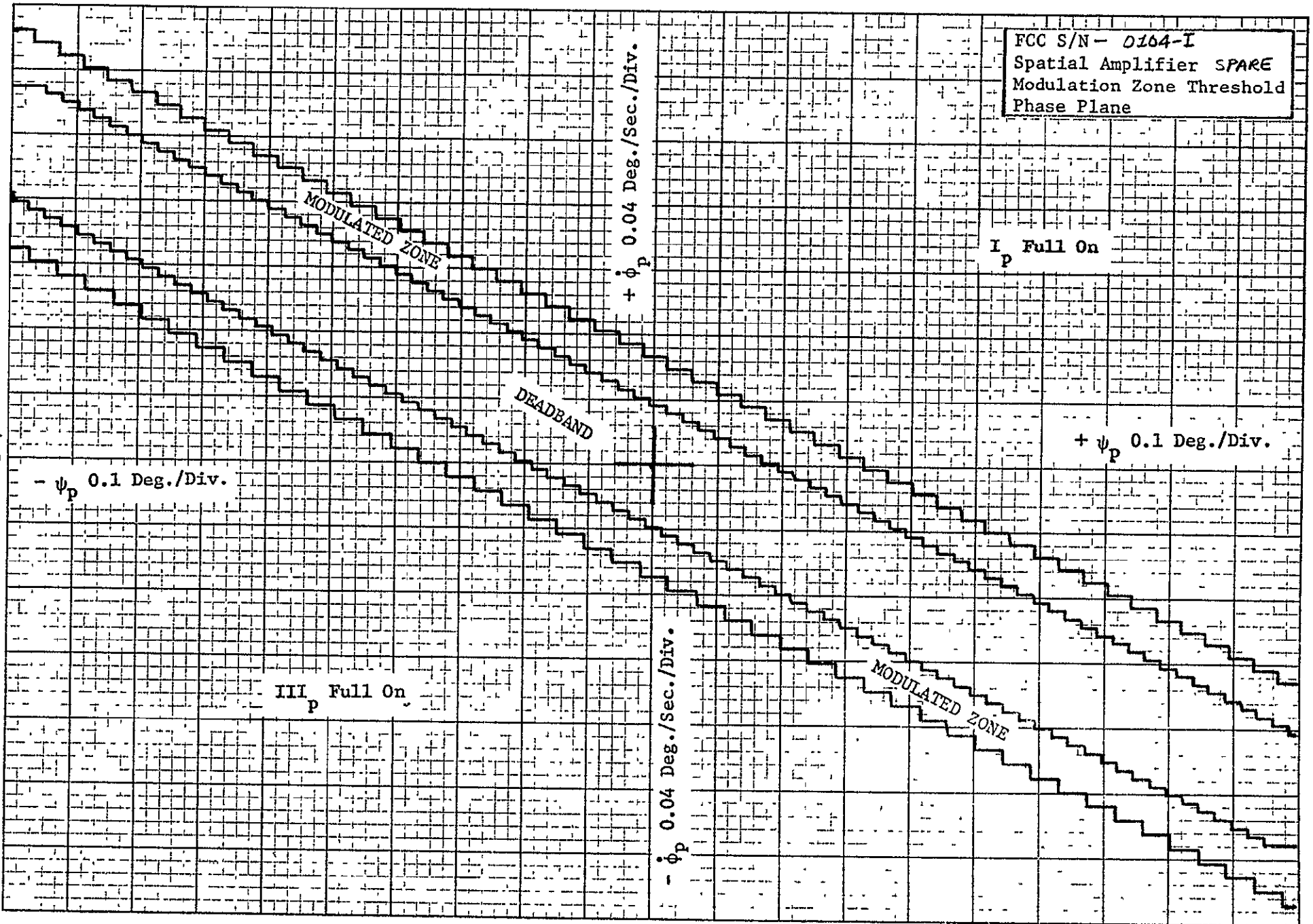

9-7

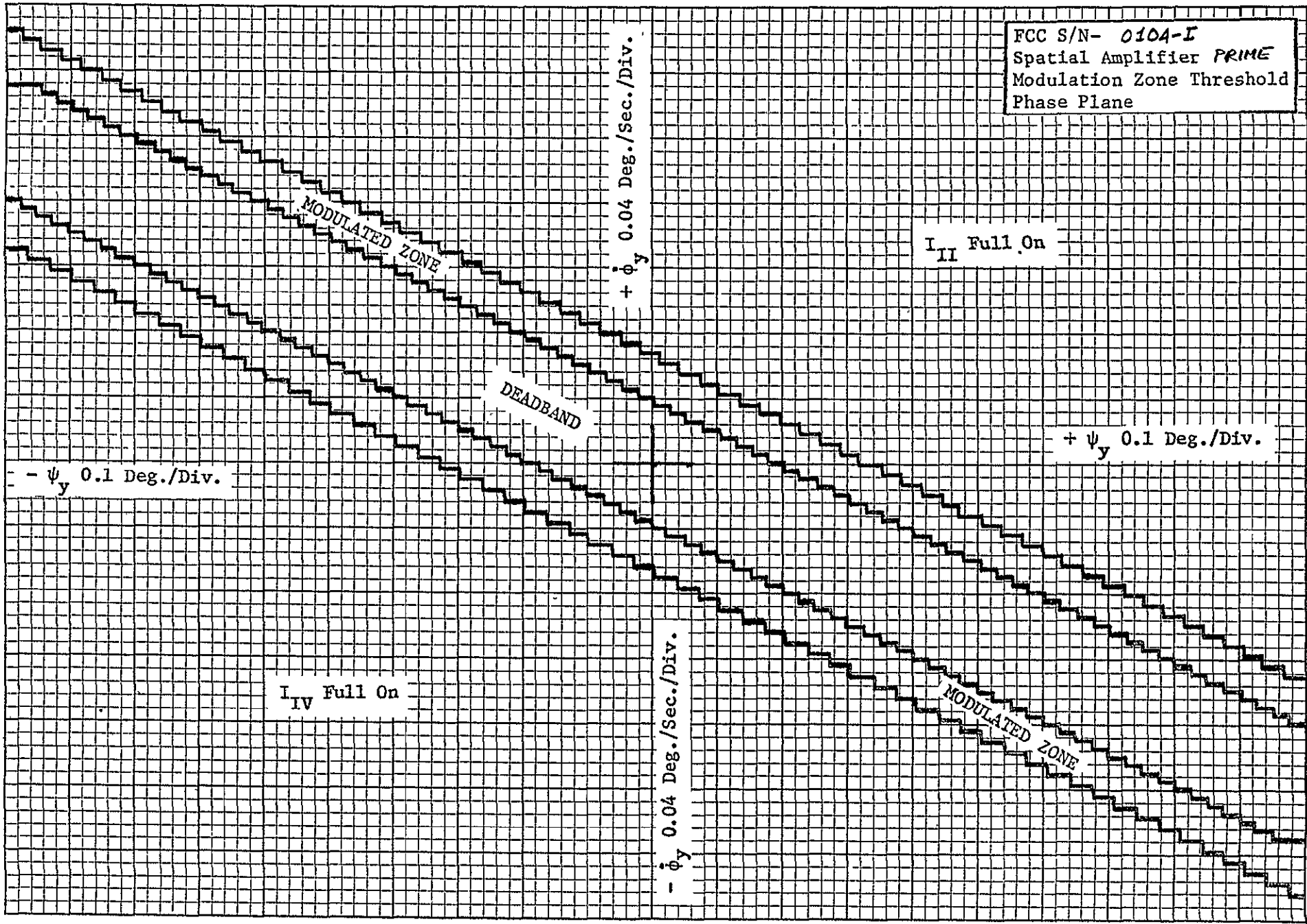

FCC S/N- 0104-I  
Spatial Amplifier SPARE  
Modulation Zone Threshold  
Phase Plane

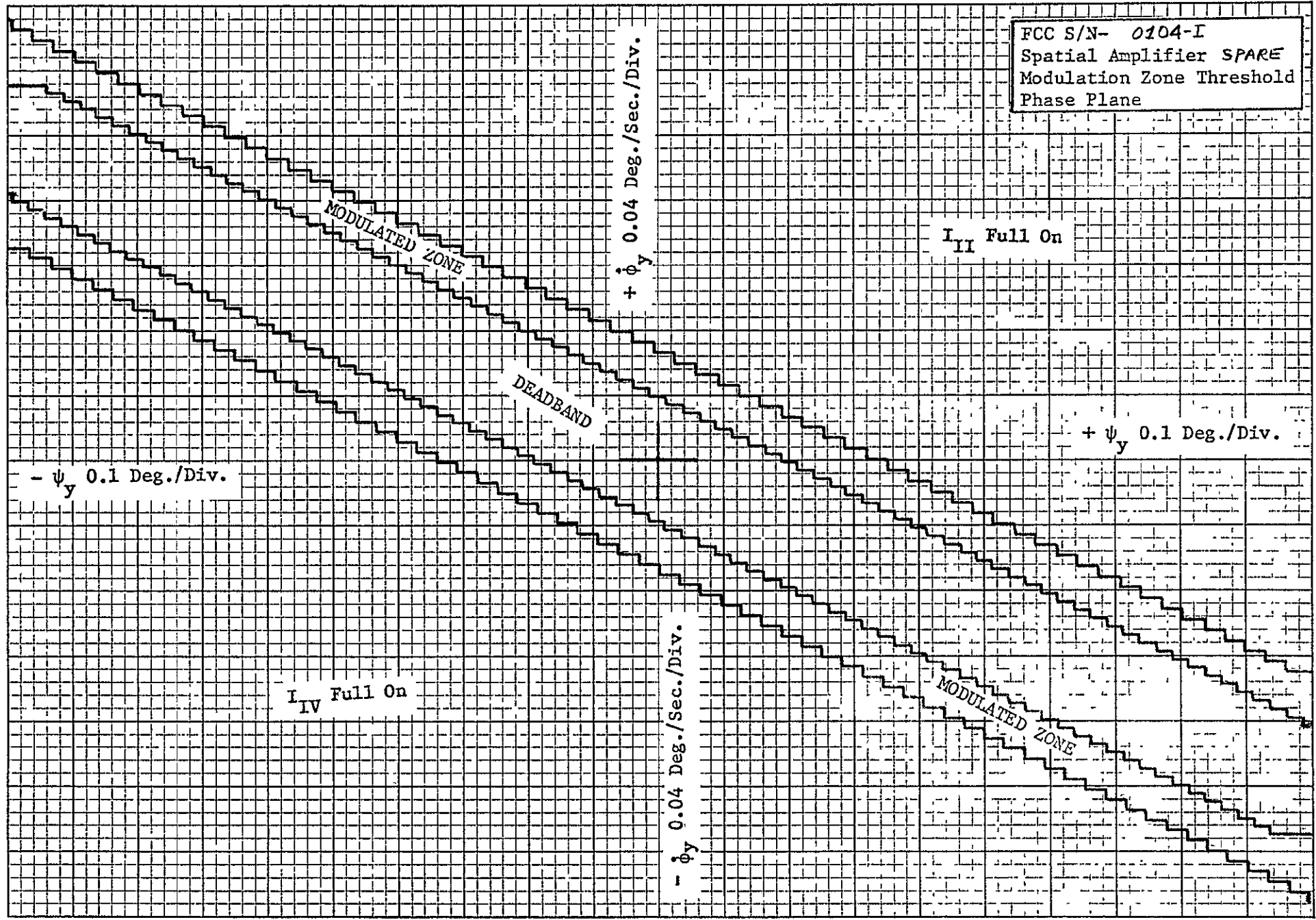

L-7

$-\psi_y$  0.1 Deg./Div.

$+\dot{\phi}_y$  0.04 Deg./Sec./Div.

$+\psi_y$  0.1 Deg./Div.

$-\dot{\phi}_y$  0.04 Deg./Sec./Div.

I<sub>IV</sub> Full On

MODULATED ZONE

I<sub>II</sub> Full On

MODULATED ZONE

DEADBAND

8-7

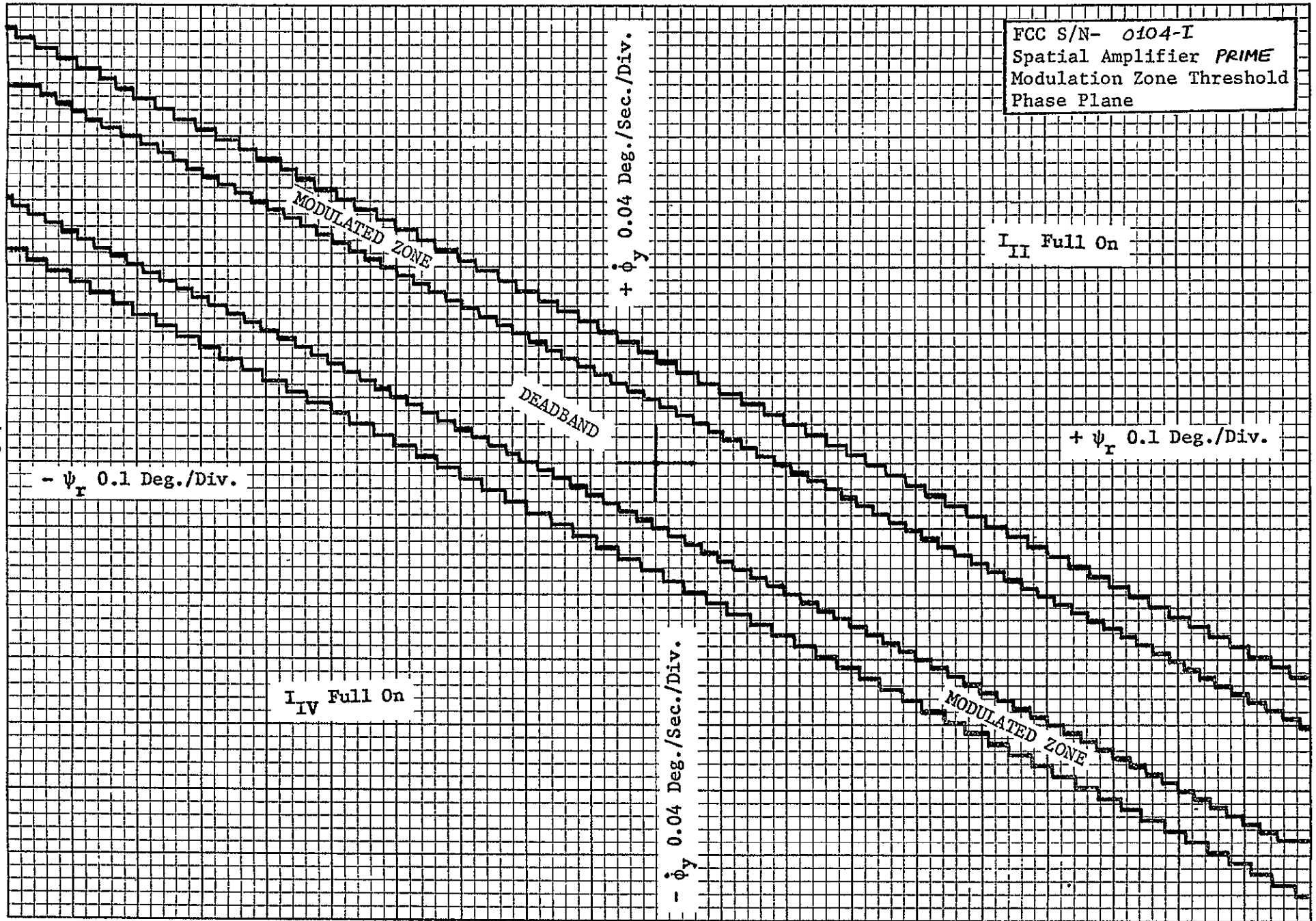

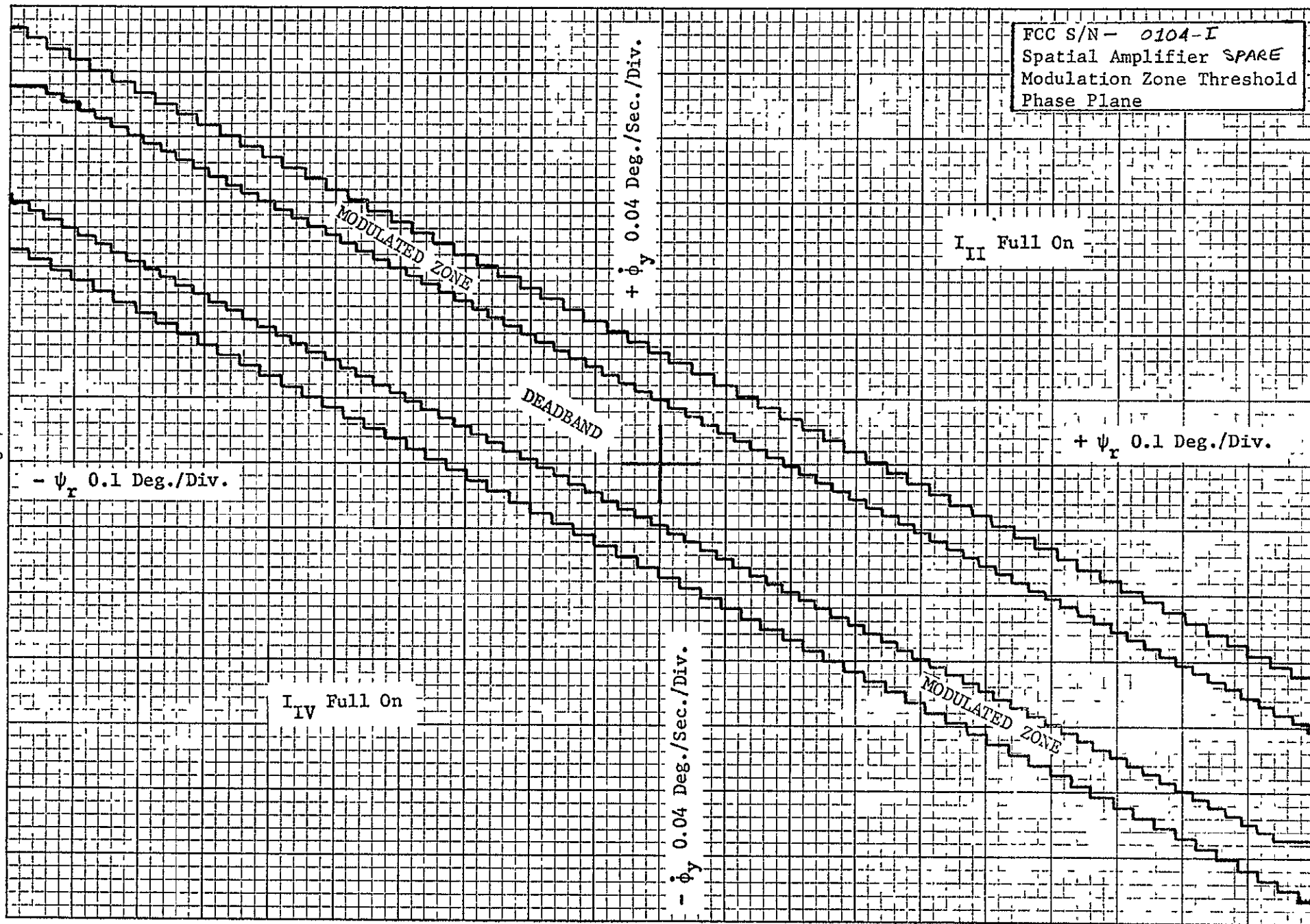

FCC S/N- 010A-I  
Spatial Amplifier PRIME  
Modulation Zone Threshold  
Phase Plane

01-7

III<sub>IV</sub> Full On

+  $\dot{\phi}_r$  0.04 Deg./Sec./Div.

-  $\psi_y$  0.1 Deg./Div.

+  $\psi_y$  0.1 Deg./Div.

-  $\dot{\phi}_r$  0.04 Deg./Sec./Div.

III<sub>II</sub> Full On

MODULATED ZONE

MODULATED ZONE

DEADBAND

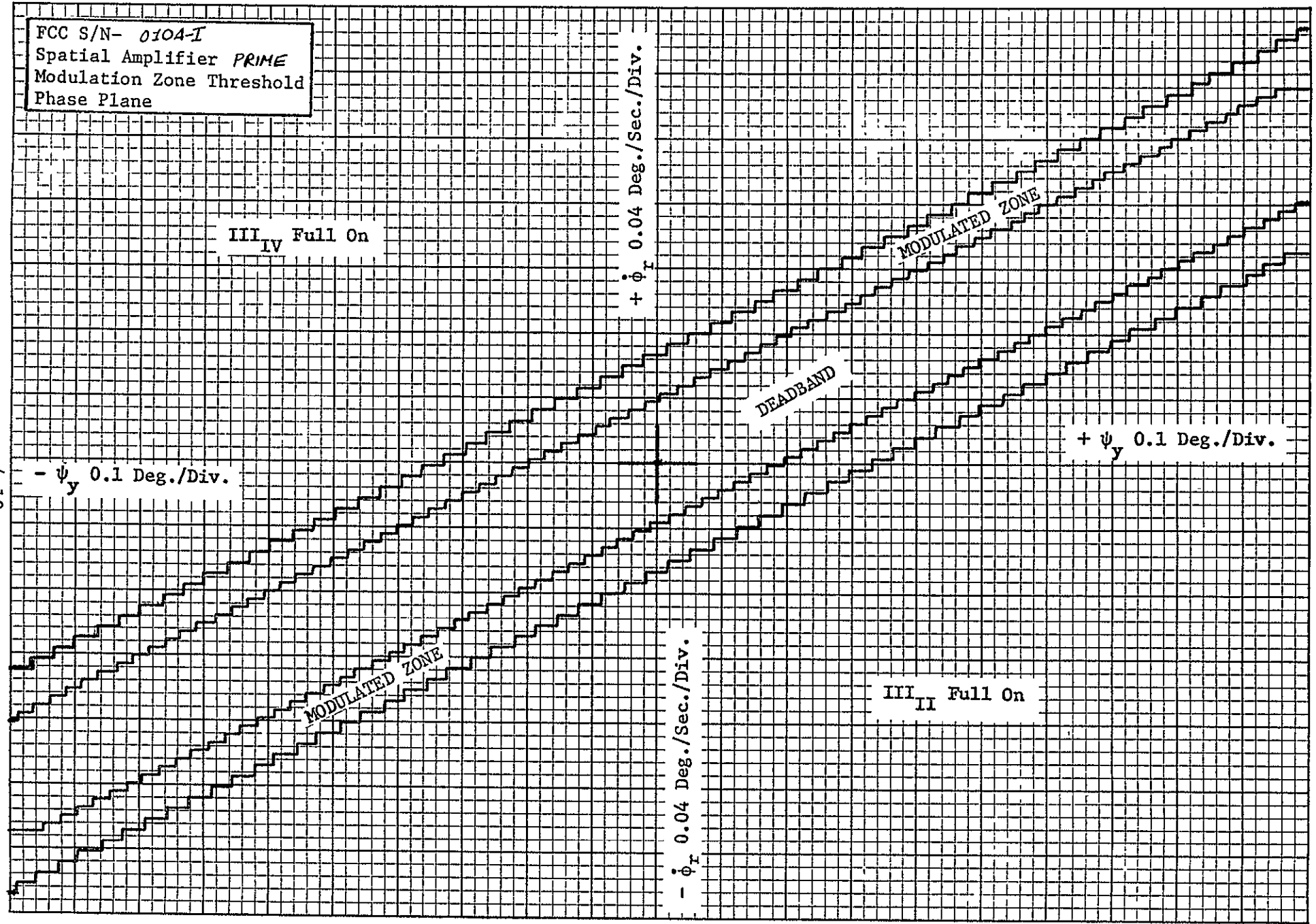

FCC S/N - 0104-I  
Spatial Amplifier SPARE  
Modulation Zone Threshold  
Phase Plane

III<sub>IV</sub> Full On

$+\dot{\phi}_r$  0.04 Deg./Sec./Div.

MODULATED ZONE

DEADBAND

$+\psi_y$  0.1 Deg./Div.

II-7

$-\psi_y$  0.1 Deg./Div.

MODULATED ZONE

$-\dot{\phi}_r$  0.04 Deg./Sec./Div.

III<sub>II</sub> Full On

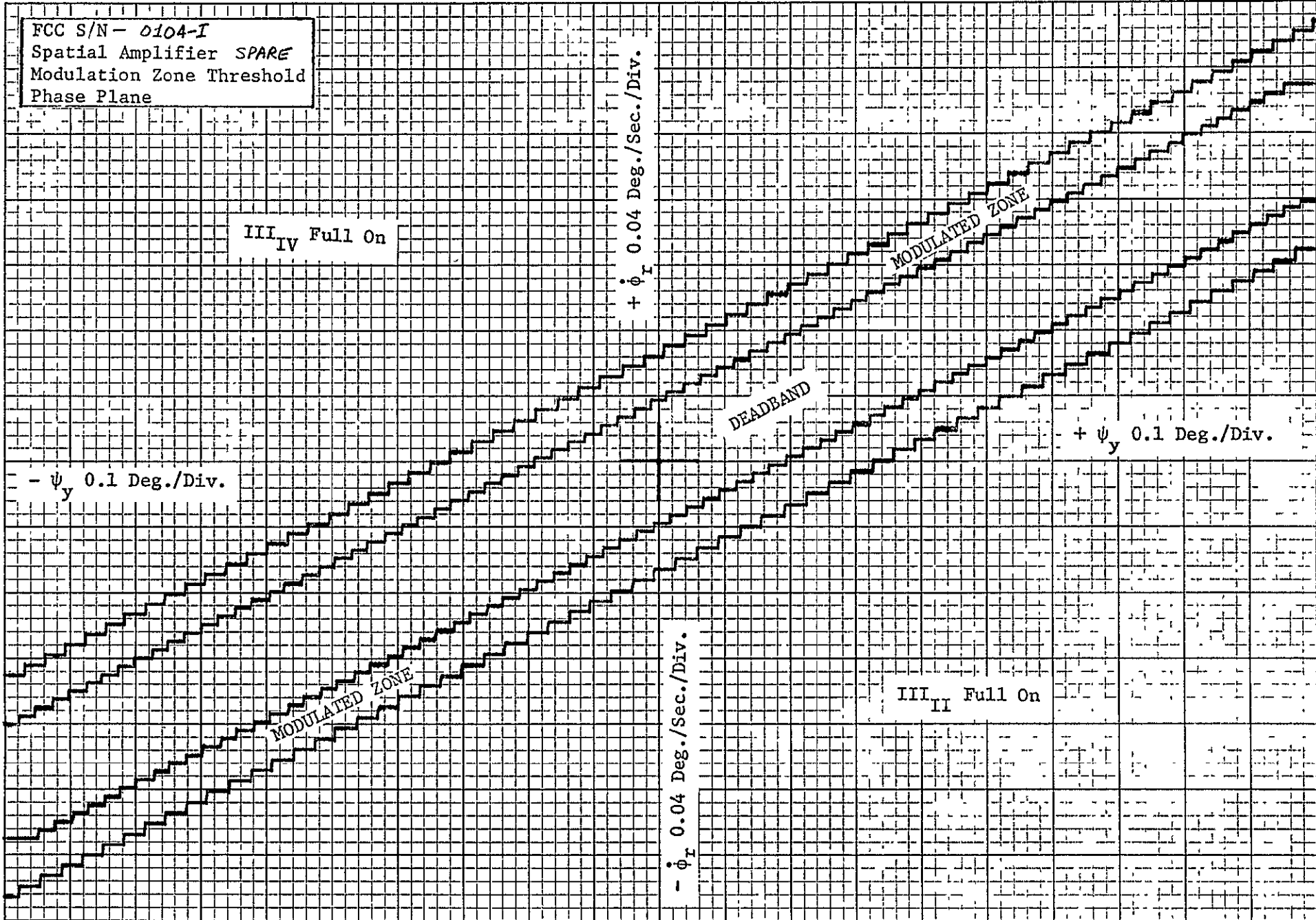



4-12

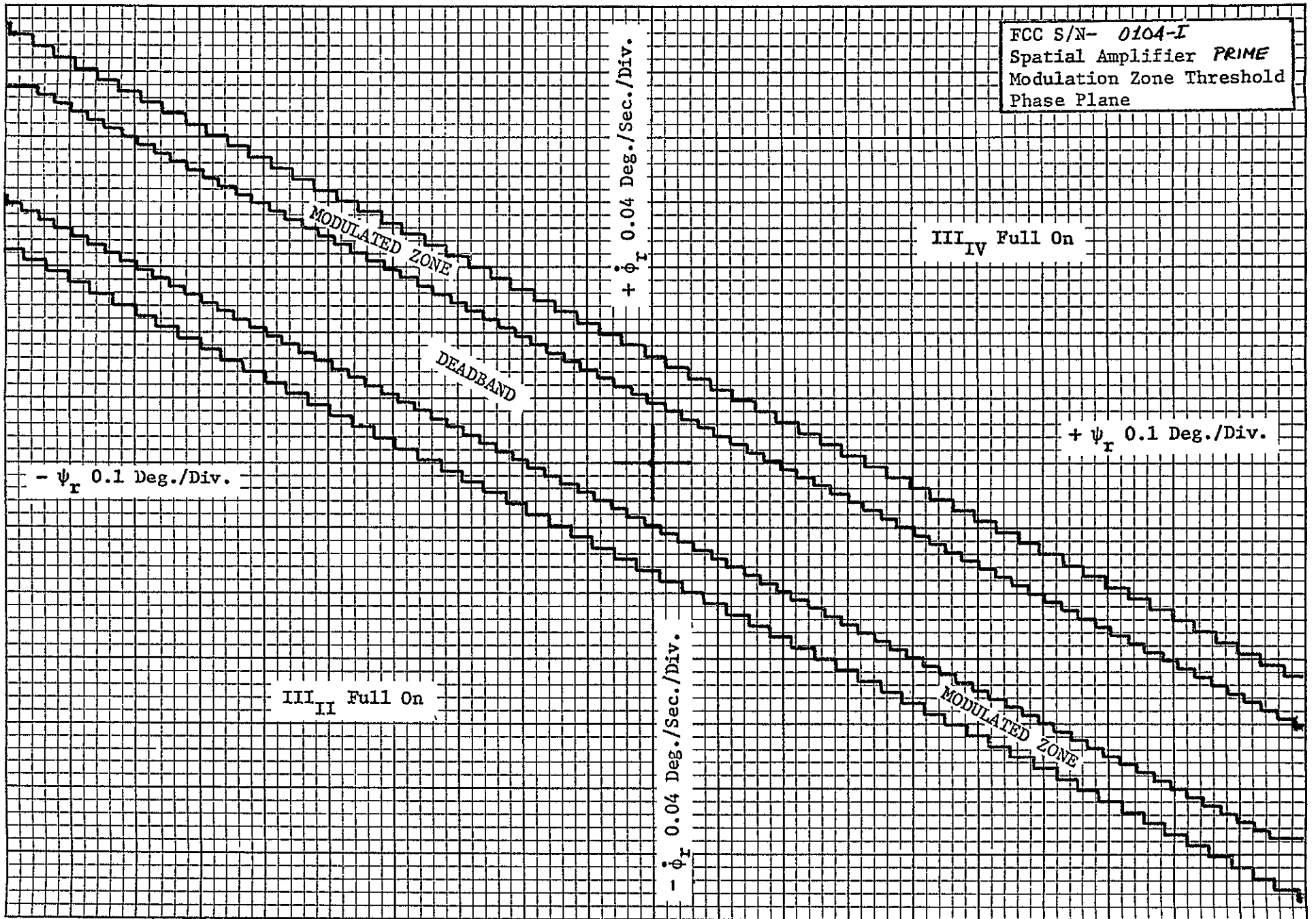

4-13

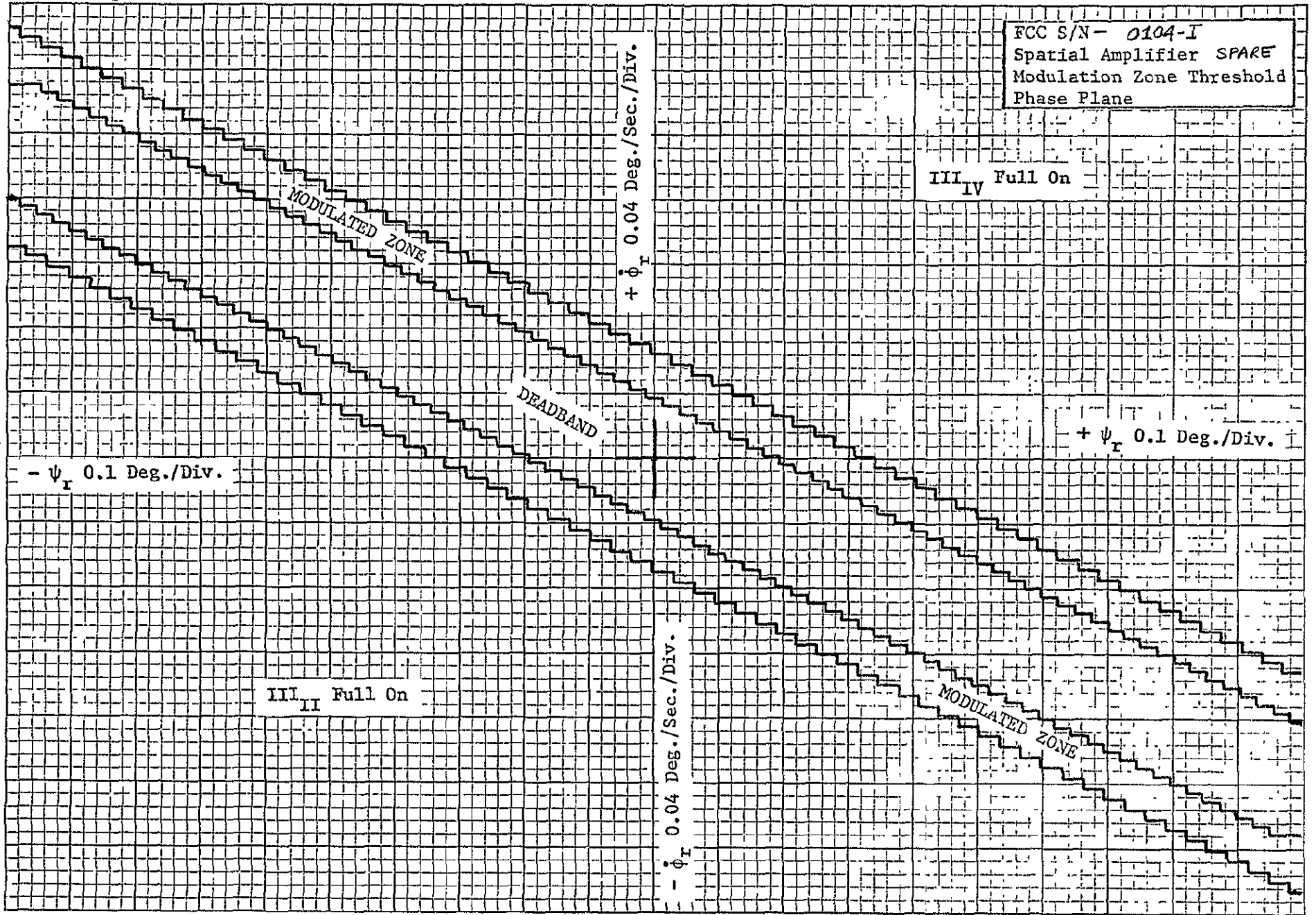

FCC S/N- 0104-I  
Spatial Amplifier PRIME  
Modulation Zone Threshold  
Phase Plane with Spacecraft  
Gains and Limiters Active

4-14

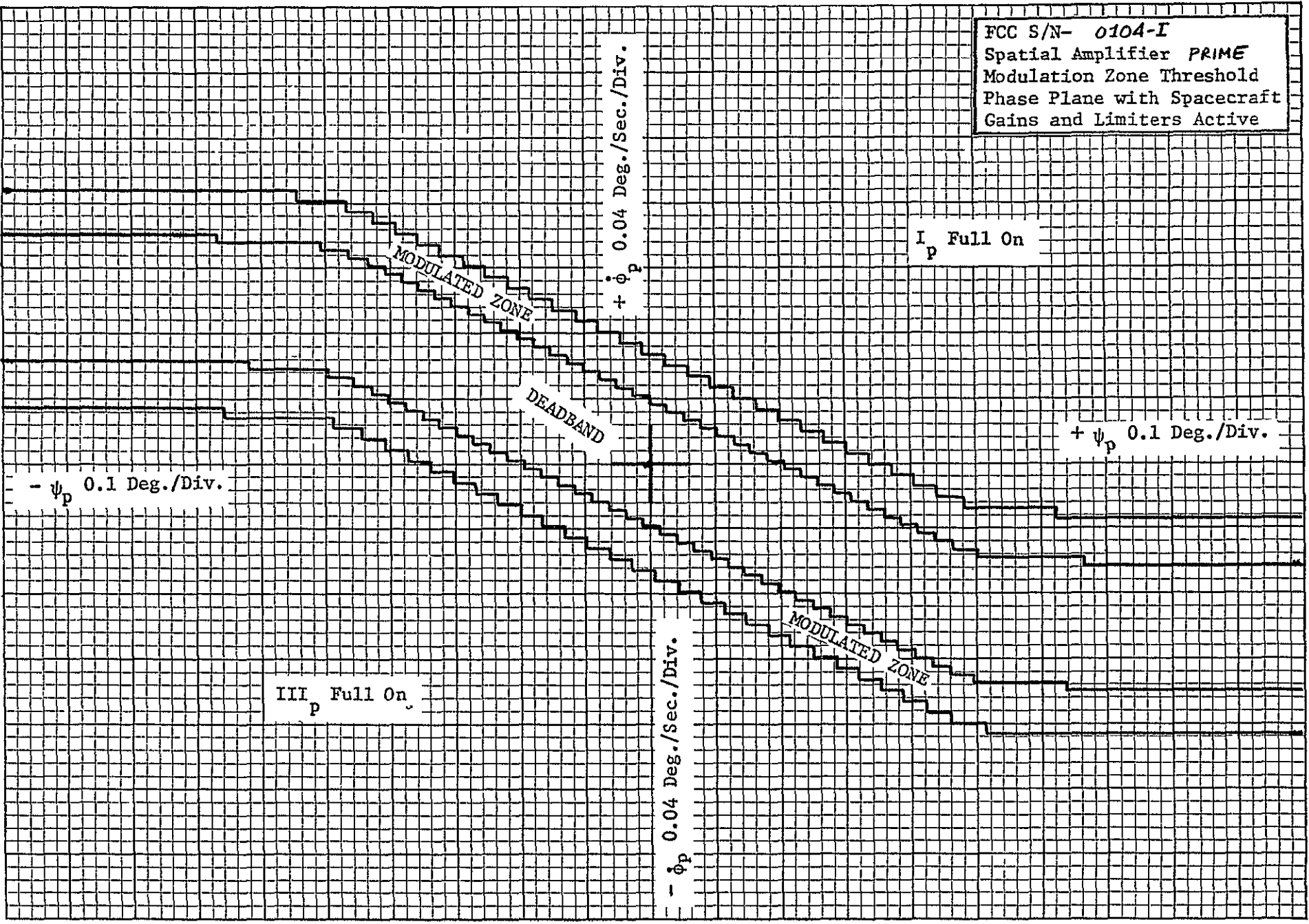

$I_p$  Full On

$+\psi_p$  0.1 Deg./Div.

$-\psi_p$  0.1 Deg./Div.

$III_p$  Full On

$+\dot{\phi}_p$  0.04 Deg./Sec./Div.

$-\dot{\phi}_p$  0.04 Deg./Sec./Div.

MODULATED ZONE

DEADBAND

MODULATED ZONE

64

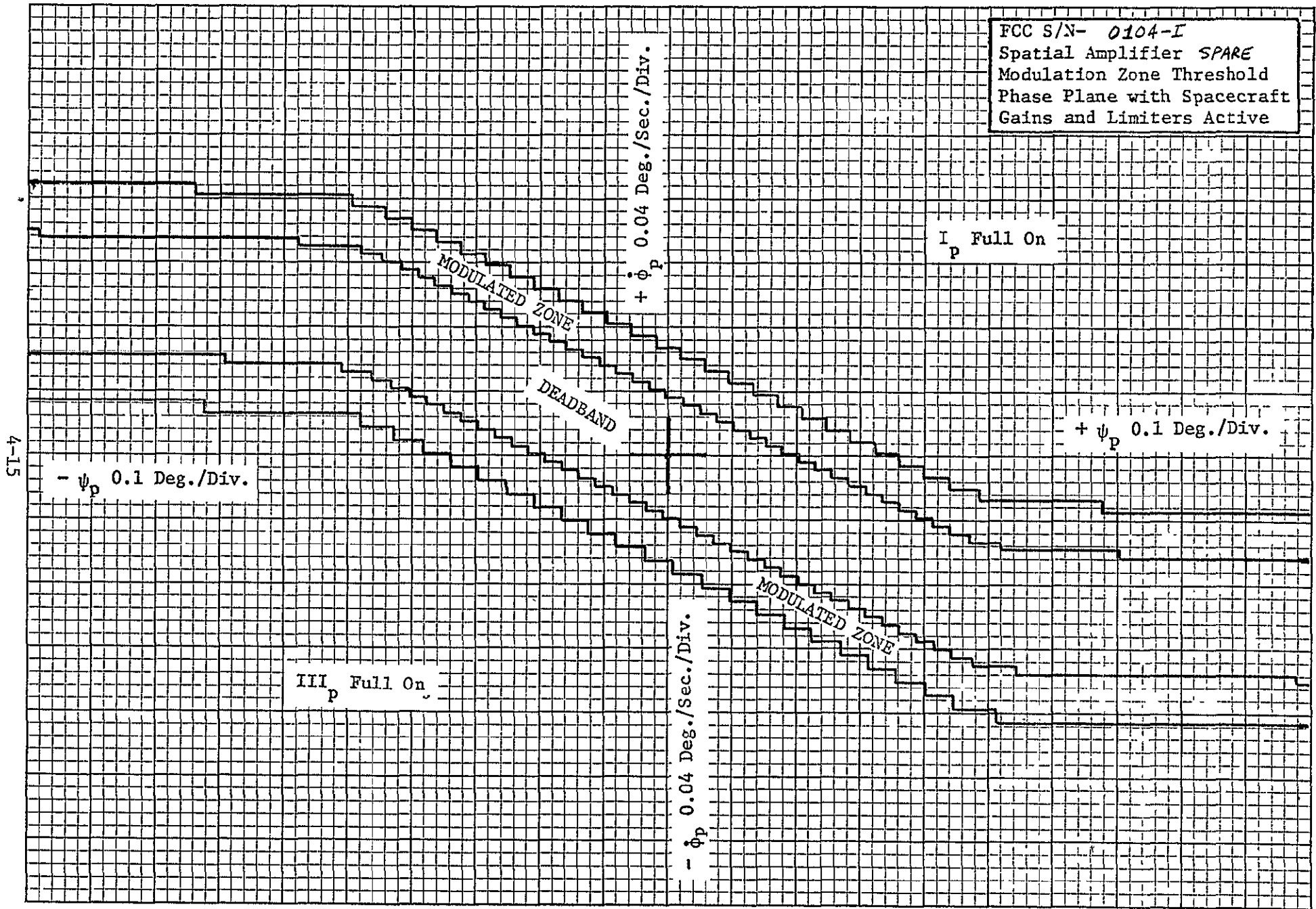

FCC S/N- 0104-I  
Spatial Amplifier PRIME  
Modulation Zone Threshold  
Phase Plane with Spacecraft  
Gains and Limiters Active

41-4

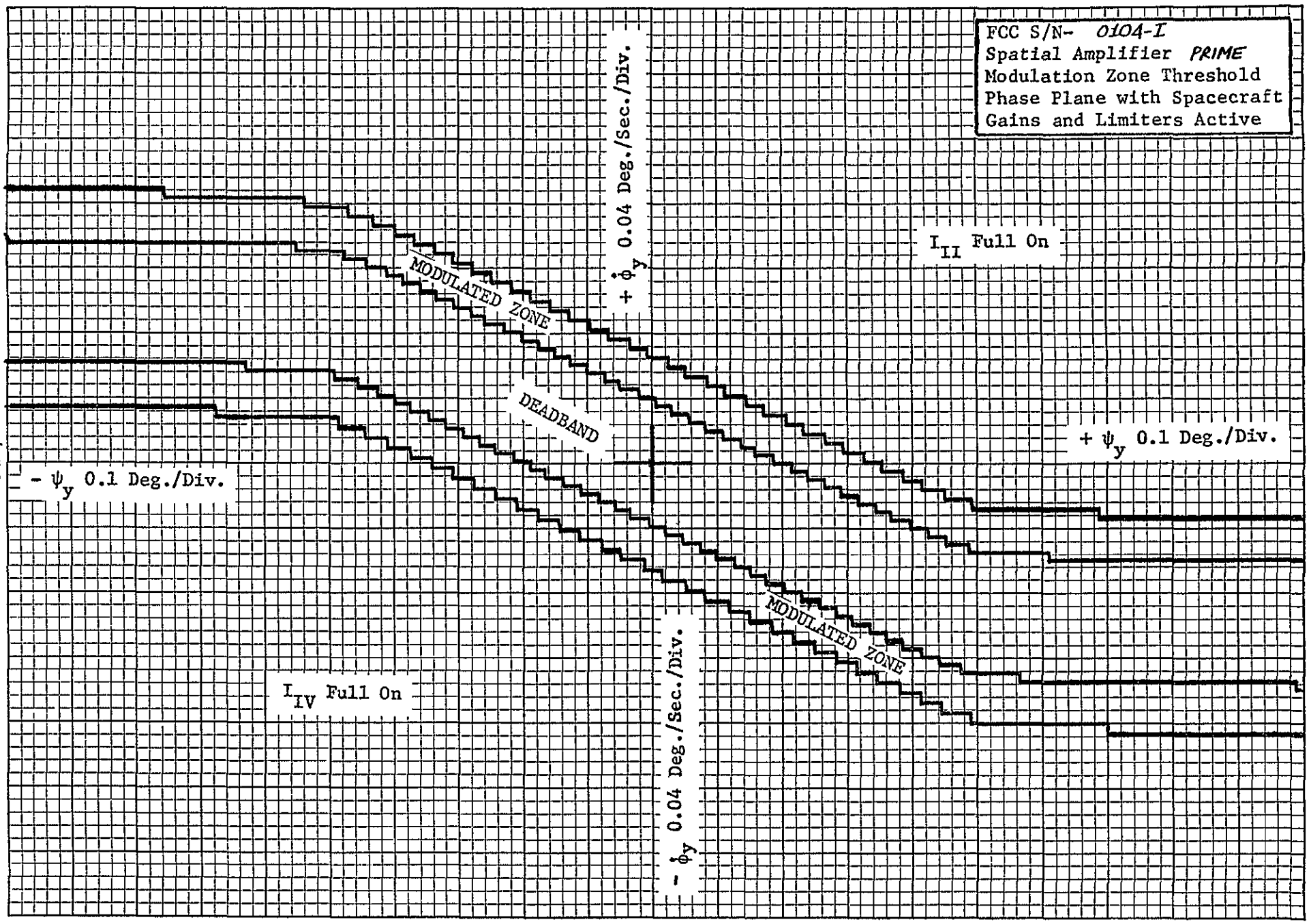

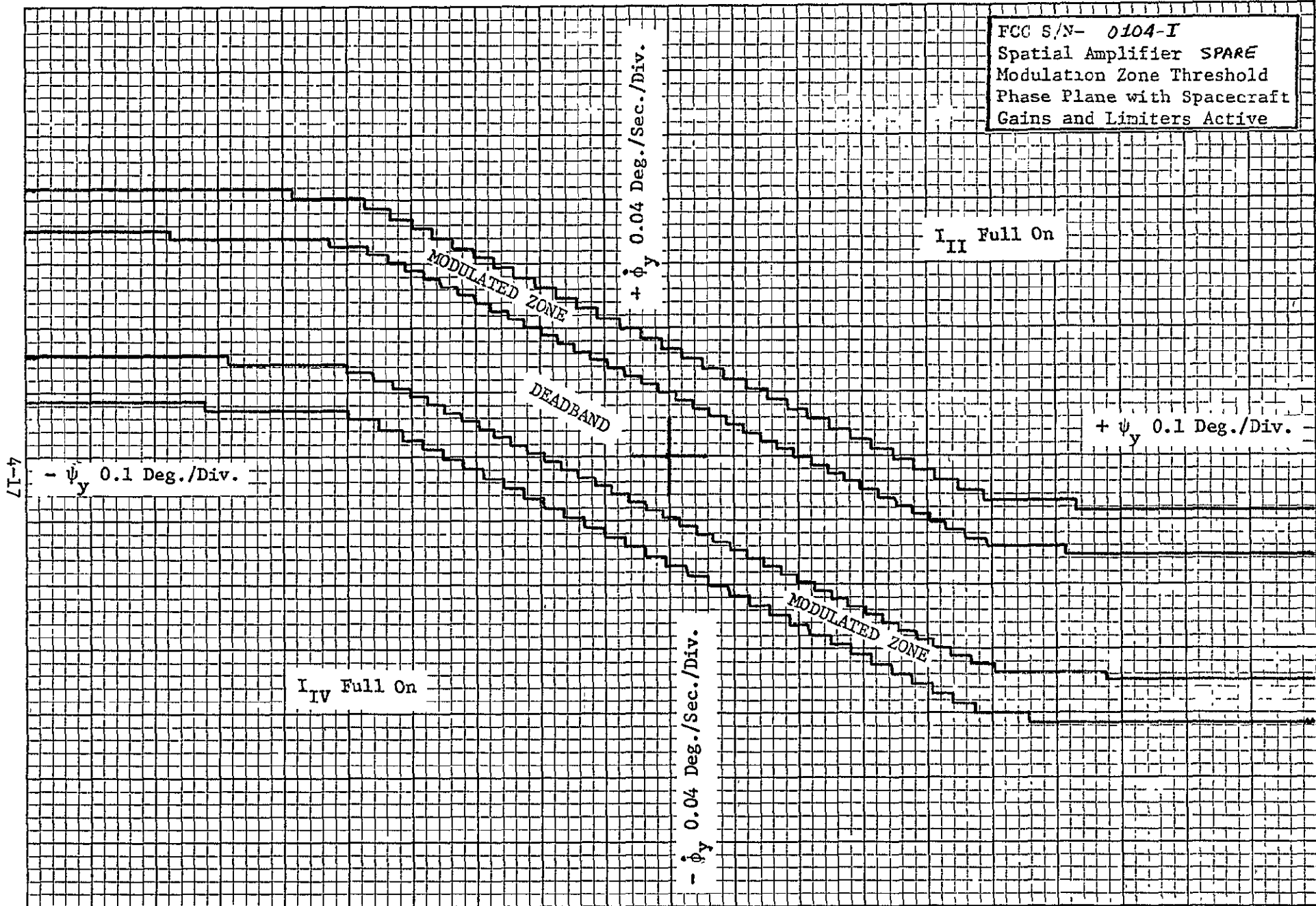

4-17

8I-7

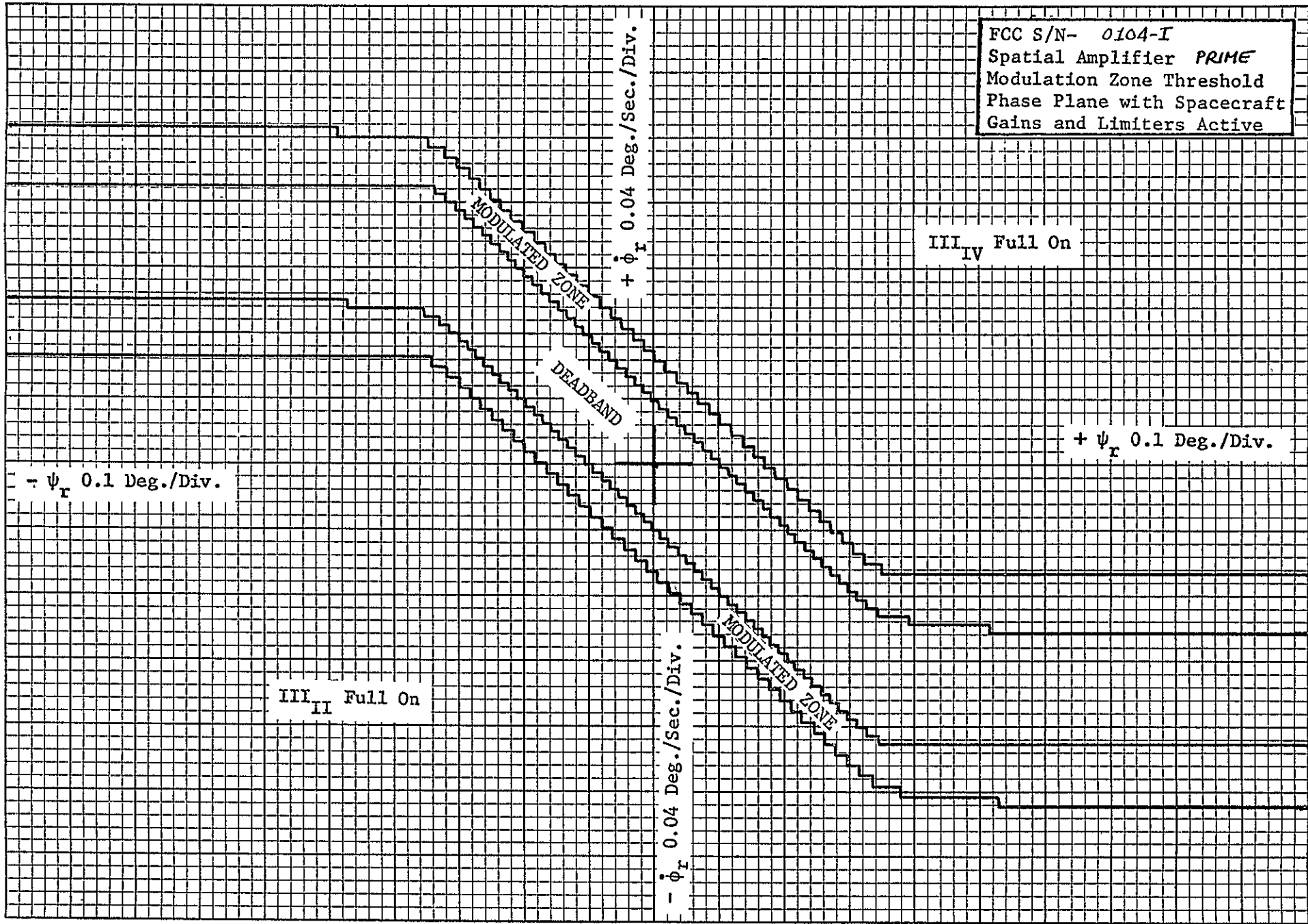

6I-7

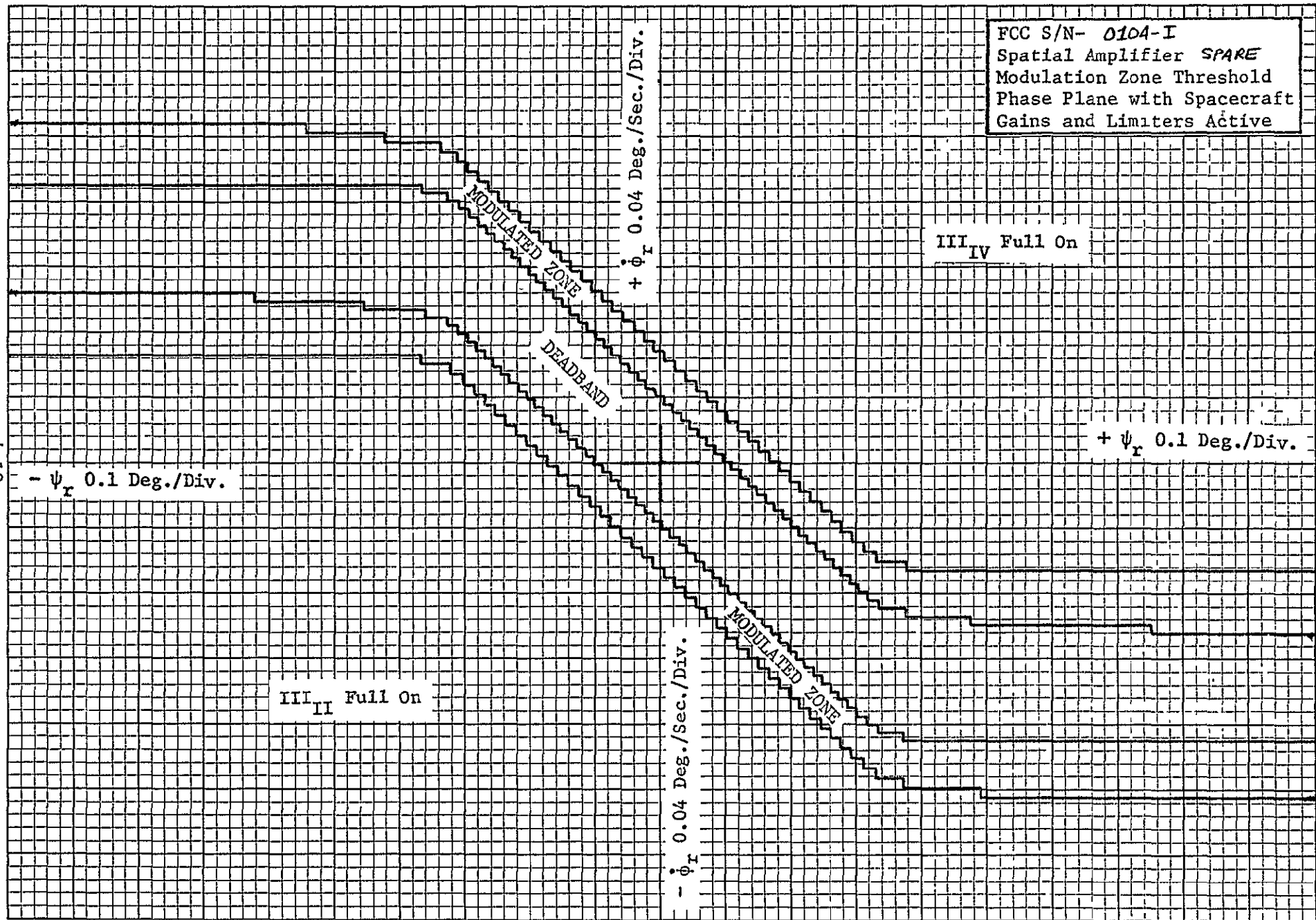



SPATIAL AMPLIFIER  $I_p$  PRIME

SPATIAL AMPLIFIER "GAIN TIME" VERSUS  
 INPUT VOLTAGE  
 SA-210 CONTROL COMPUTER #0104-I

Theoretical Curve ———— ○  
 Dynamic Curve ———— ×

PERCENT ON TIME

200  
80  
60  
40  
20  
0

+5% TOL.

$\psi$  INPUT VOLTS

+5% TOL.

0.8

1.0

1.2

SPATIAL AMPLIFIER  $I_p$  PRIME

SA-210  
FLC-010A-I

SPATIAL AMPLIFIER OUTPUT PULSE WIDTH  
VERSUS INPUT VOLTAGE

Theoretical Curve — (O)  
Dynamic Curve — (X)

MULTISCOPE — PULSE WIDTH

400  
300  
200  
100  
0

Tolerance at Threshold

0

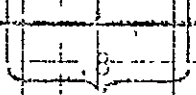

1.5 TOL.  $\sqrt{\text{INPUT VOLTS}}$

SPATIAL AMPLIFIER  
Output Frequency  
Versus  $V_{in}$  Input Voltage

$I_P$  PRIME

SA-216  
CC #0104-I

THEORETICAL C. 75  
DYNAMIC CURVE

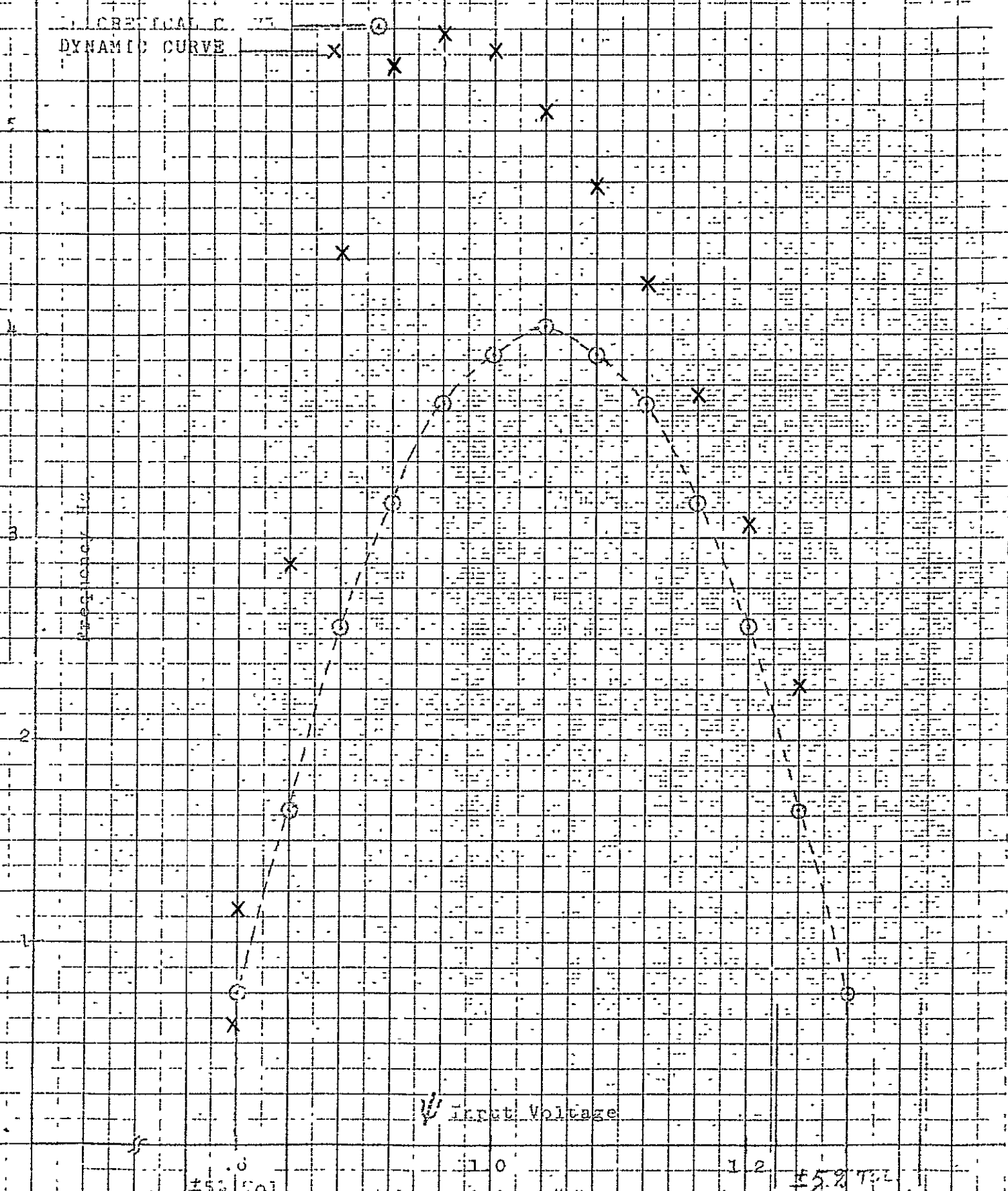

Input Voltage

±5% Tol

±5% Tol

SPATIAL AMPLIFIER III BY PRIME

SA- CONTROL COMPUTER

Theoretical Curve — ○  
 Dynamic Curve — ×

PERCENT ON TIME

80

60

40

20

0.8  
 +5% TOL.

1.0

1.2

$\psi$  INPUT VOLTS

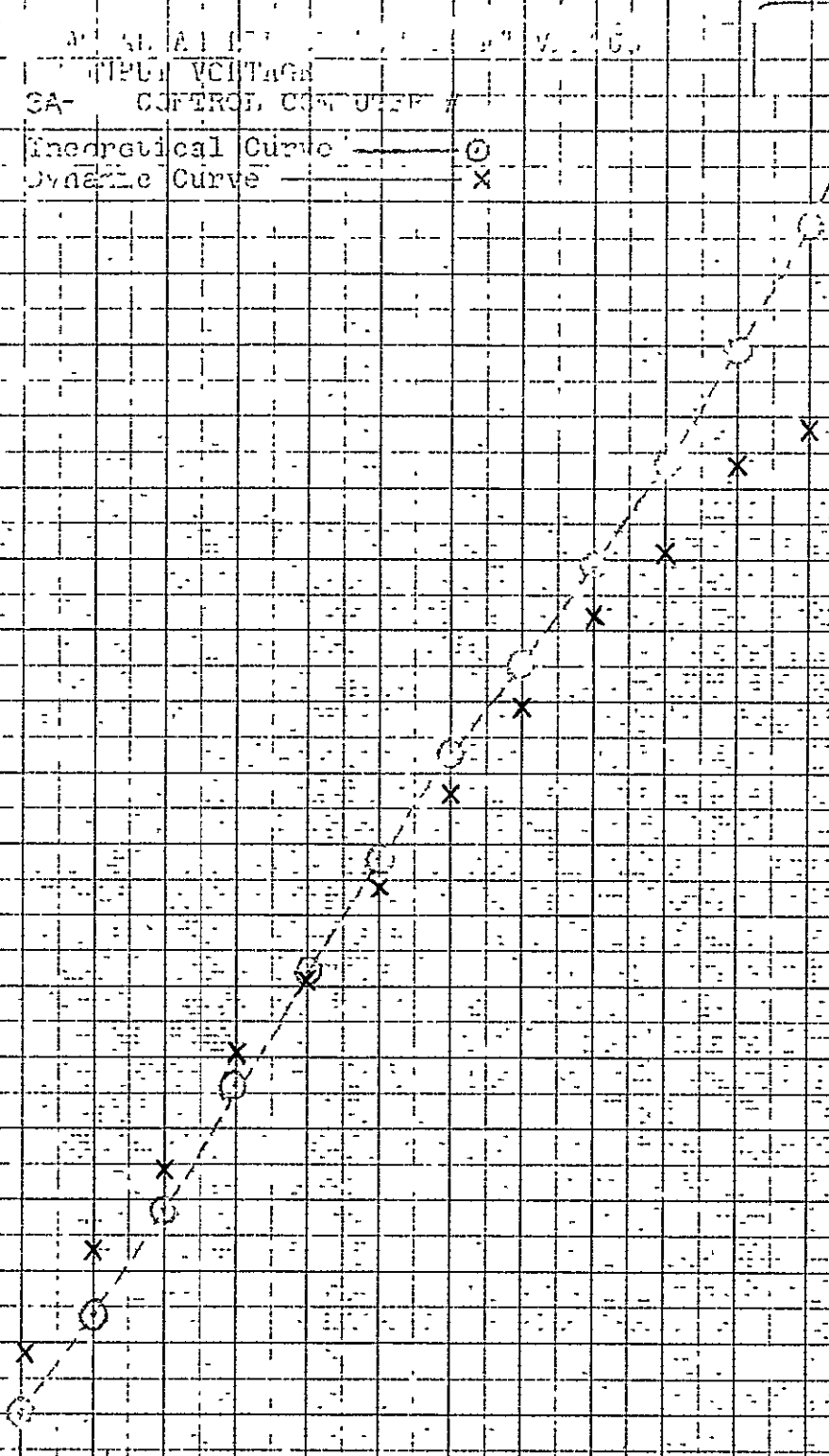
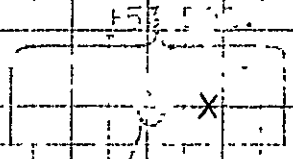

COPY INTO VHS

SPATIAL AMPLIFIER OUTPUT PULSE WIDTH  
VERSUS  $\psi$  INPUT VOLTAGE

Theoretical Curve ———— ⊙  
Dynamic Curve ———— ×

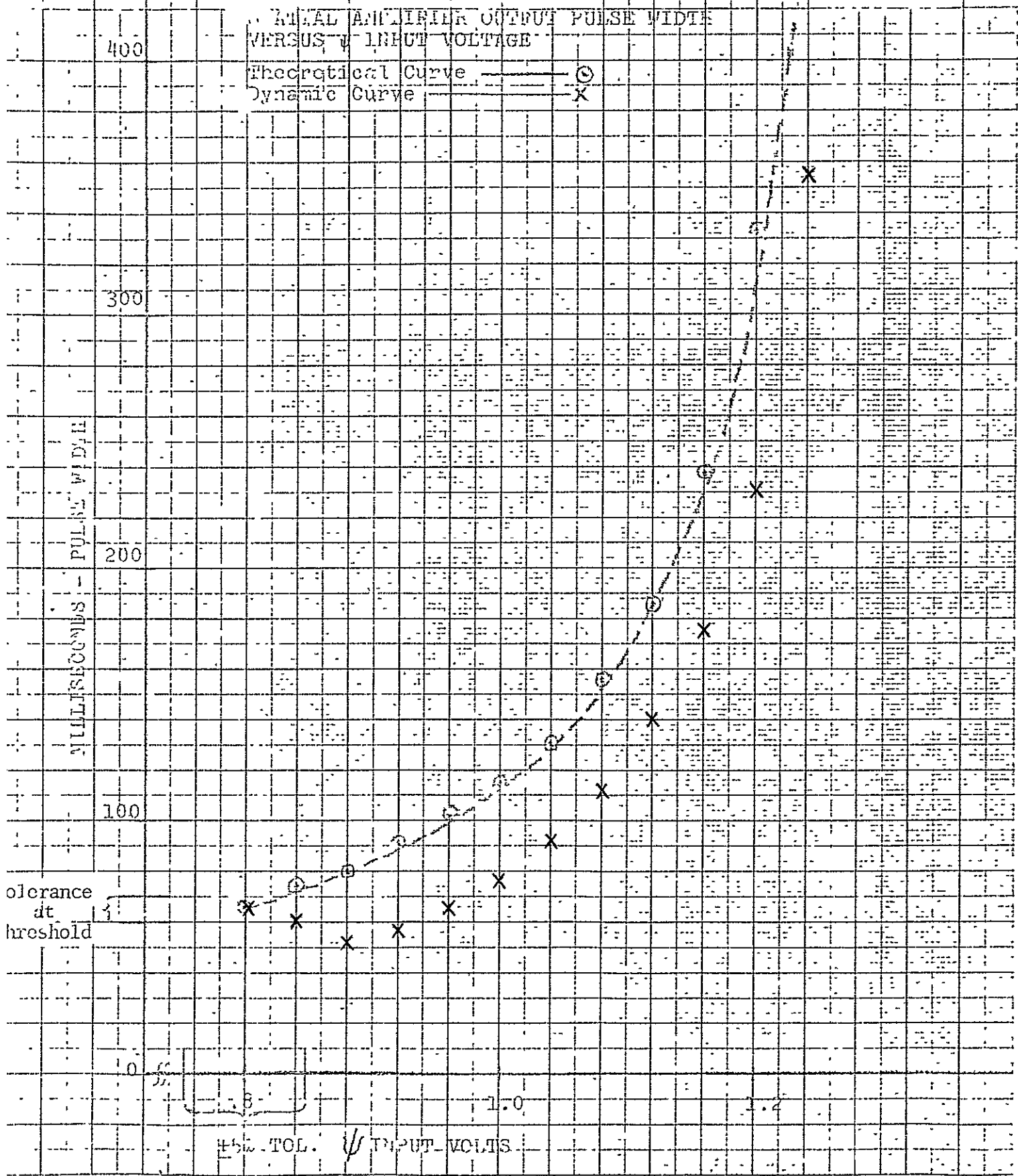

SPATIAL AMPLITUDE  
 Output Frequency  
 Versus  $\psi$  Input Voltage

III IV PRIME

SA-210  
 CC # 0104-I

CH. CR. 1000 C  
 DYNAMIC CURVE

Frequency Hz

$\psi$  Input Voltage

±5% Tol

±5% Tol

SPATIAL AMPLIFIER INTR PRIME

SPATIAL AMPLIFIER "ON" "OFF" VOLTS

INPUT VOLTAGE  
SA-210 CONTROL COMPUTER # 0104-1

Theoretical Curve ———— O  
Dynamic Curve ———— X

PERCENT "ON TIME"

100  
80  
60  
40  
20

0.8 1.0 1.2

+5% TOL.  $\psi$  INPUT VOLTS

+5% TOL.

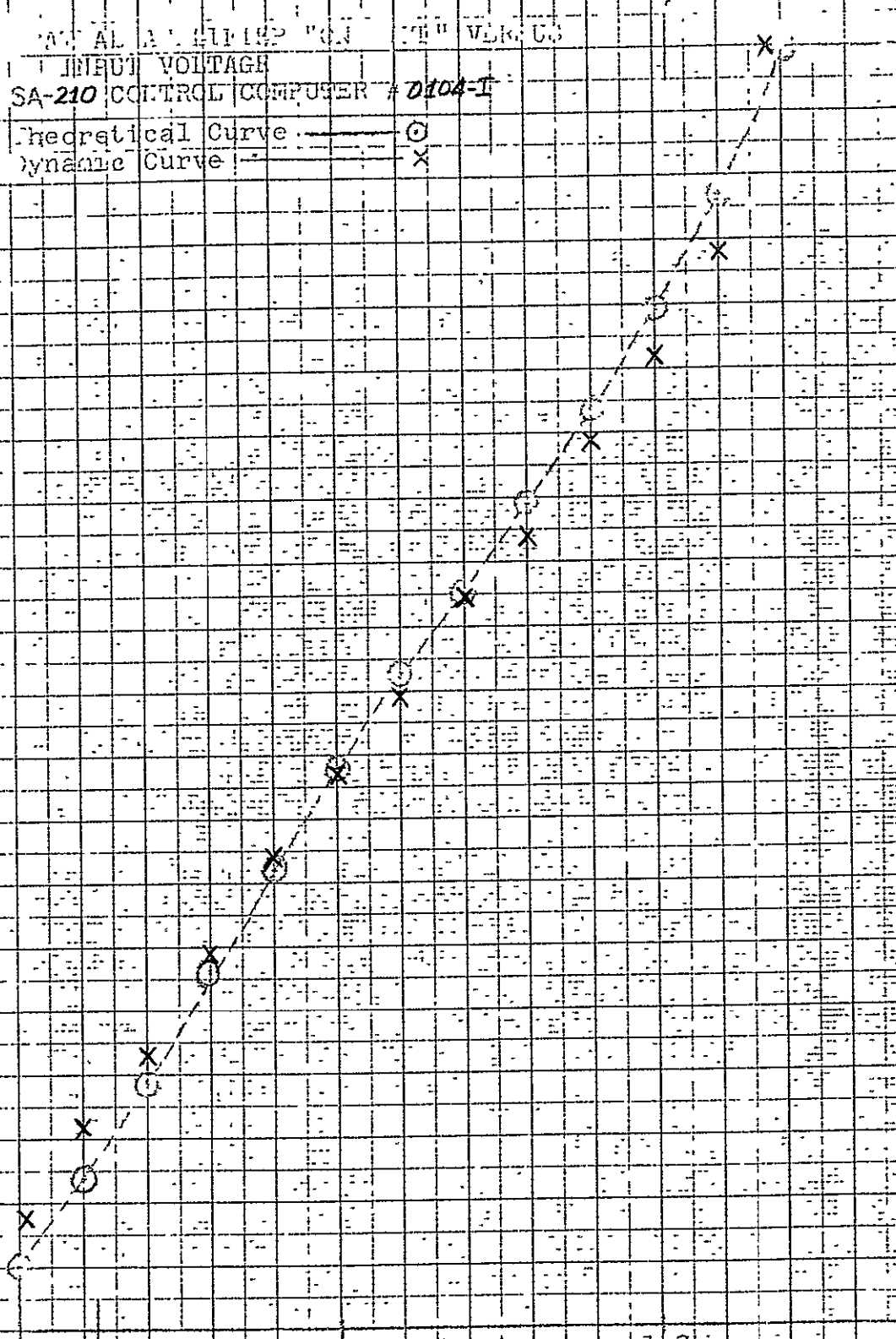

SPATIAL AMPLIFIER 1<sup>st</sup> PRIME

SA-210  
FCC # 010A-I

400

SPATIAL AMPLIFIER OUTPUT PULSE WIDTH  
VERSUS  $\psi$  INPUT VOLTAGE

Theoretical Curve ———— ○  
Dynamic Curve ———— X

MILLISECONDS - PULSE WIDTH

300

200

100

Tolerance  
at  
Threshold

0

0.5

1.0

1.5

±5% TOL.  $\psi$  INPUT VOLTS



SPATIAL MULTIPLE  
Output Frequency  
Versus  $\psi$  Input Voltage

IIR PRIME

SA-210  
CC# 0104-I

11.8 11.8 11.8  
DYNAMIC CURVE

5

4

3

2

1

0

0

Indicated Hz

$\psi$  Input Voltage

±5% TOL      .8      1.0      1.2      ±5% TOL

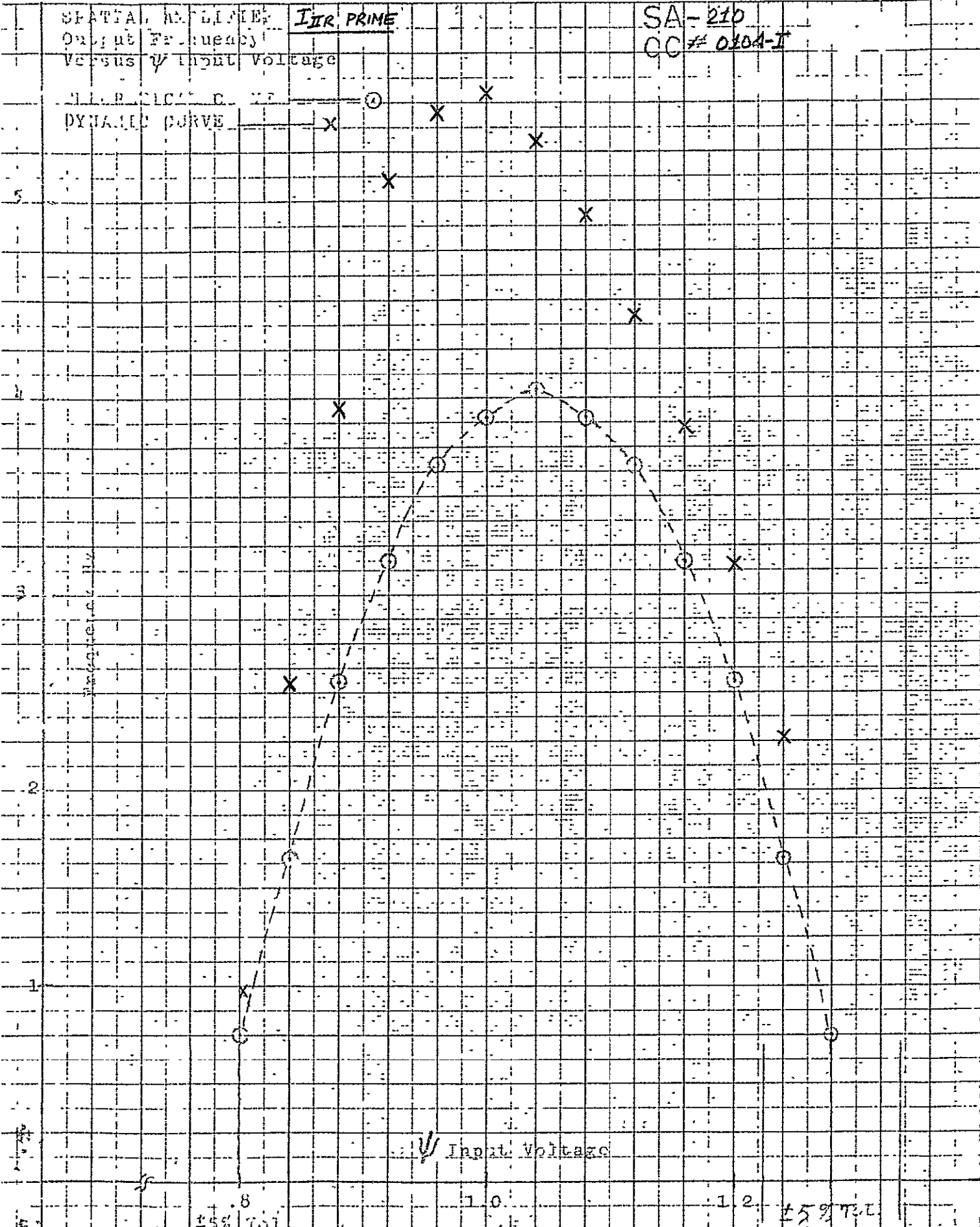

SPATIAL AMPLIFIER III SPARE

SPATIAL AMPLIFIER "ON" 2" V. 3005  
 INPUT VOLTAGE  
 SA-210 CONTROL COMPUTER #0104-I  
 Theoretical Curve — ○  
 Dynamic Curve — X

PERCENT ON TIME

100  
80  
60  
40  
20

0.8

1.0

1.2

+5% TOL.

INPUT VOLTS

+5% TOL.

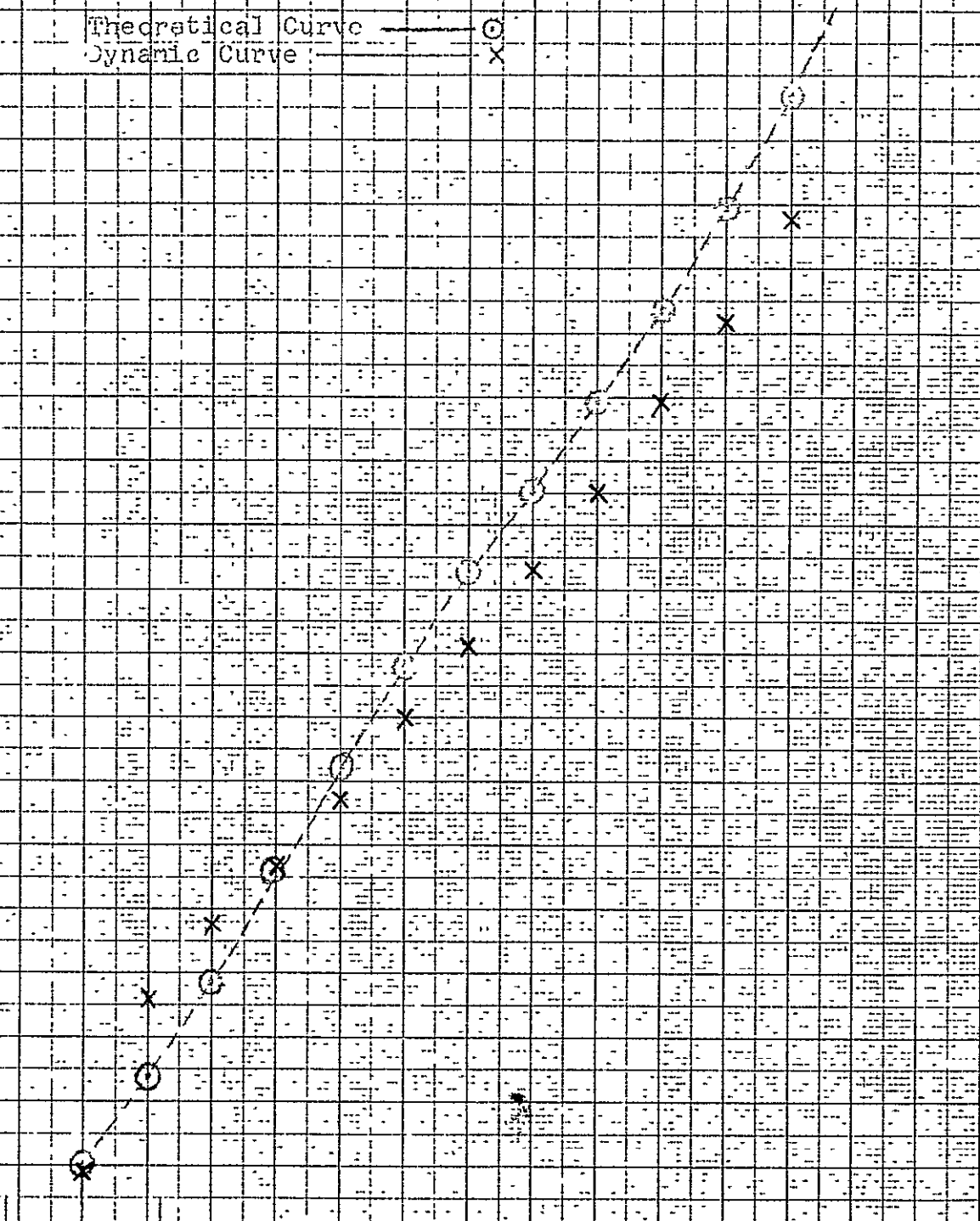

SPATIAL AMPLIFIER OUTPUT PULSE WIDTH  
VERSUS  $\psi$  INPUT VOLTAGE

Theoretical Curve ———— (O)  
Dynamic Curve ———— (X)

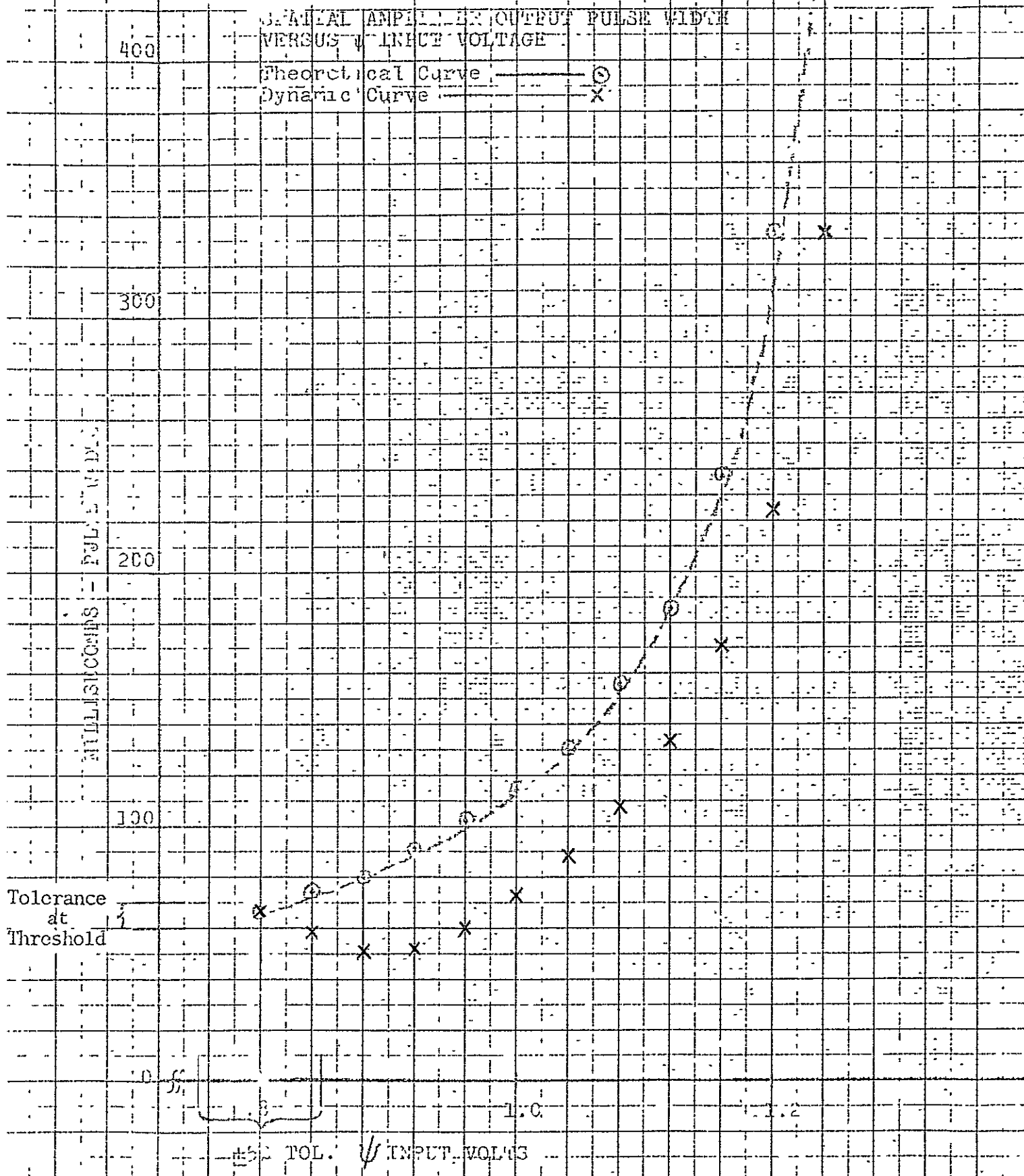

SPATIAL AMPLITUDE  
 OUTPUT FREQUENCY  
 VERSUS W LIGHT VOLTAGE

III<sub>P</sub> SPARE

SA-210  
 CC # MDA-I

REPERIMENTAL  
 DYNAMIC CURVE

VF ———— X X X X X

5

3

2

1

Frequency

ψ Input Voltage

±5% 101

1.0

1 2 ±5% TSE

ORIGINAL PAGE IS  
 OF POOR QUALITY

Cros mic 37

SPATIAL AMPLIFIER III TY. SPARE

AMPLIFIER "ON LINE" VERSUS  
 INPUT VOLTAGE  
 SA-210 CONTROL COMPUTER # 0104-I

Theoretical Curve — ○  
 Dynamic Curve — x

PERCENT ON LINE

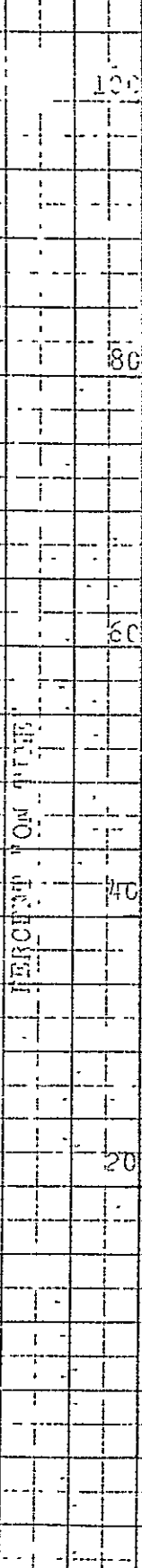

SPATIAL AMPLIFIER GAIN PULSE WIDTH  
VERSUS INPUT VOLTAGE

Theoretical Curve ———— ⊙  
Dynamic Curve ———— X

MILLISECONDS - PULSE WIDTH

400  
300  
200  
100  
0

Tolerance  
at  
Threshold

±5% TOL.

INPUT VOLTS

1.0

1.2

SPATIAL APPLICATOR  
Output Frequency  
Versus  $\psi$  Input Voltage

III IVY SPARE

SA-210  
CG # 0104-I

10000 VE  
DYNAMIC CURVE

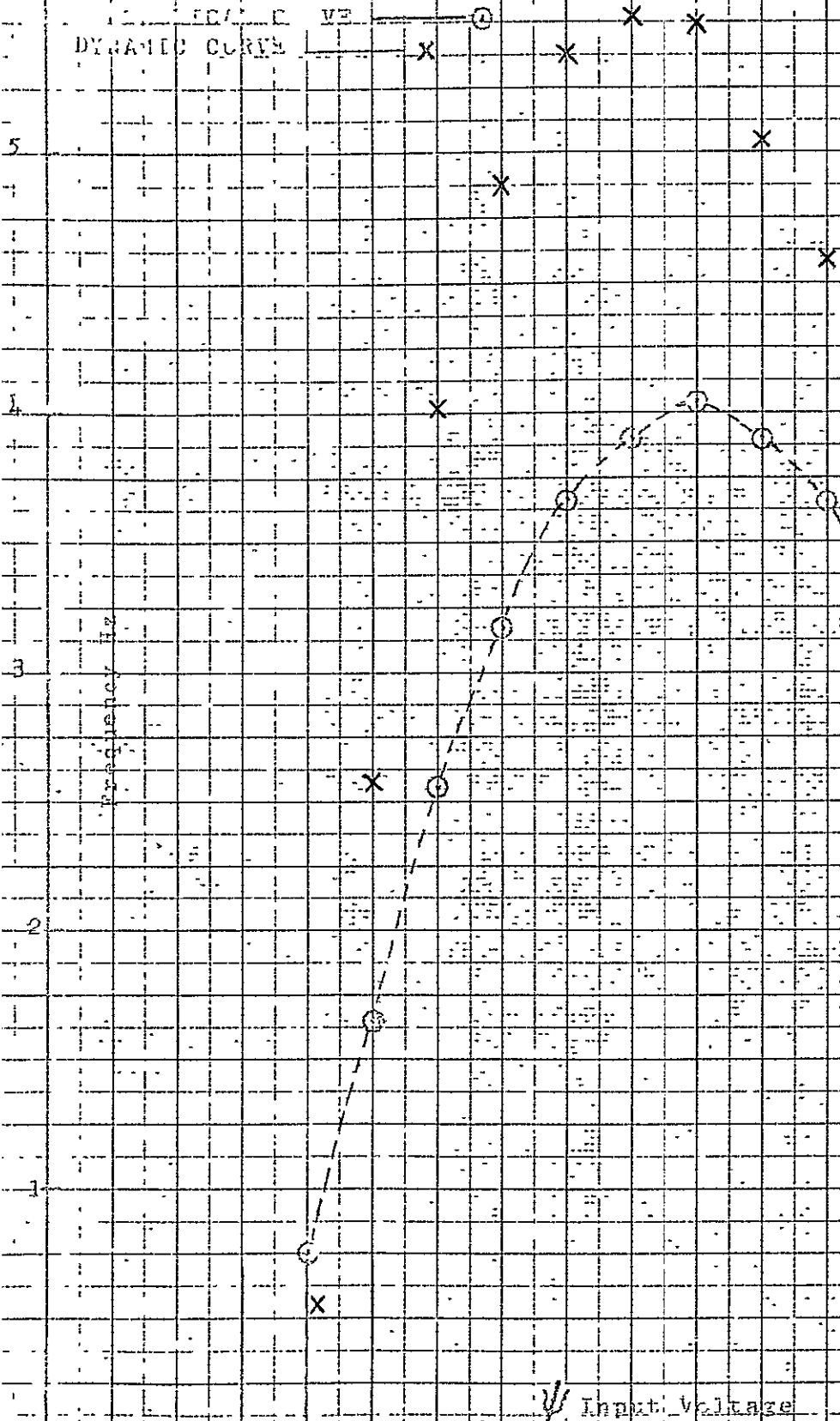

$\psi$  Input Voltage

±5% Tol

±5% Tol

SPATIAL AMPLIFIER TYPE SPARE

PERCENT CONVERSION VERSUS

INPUT VOLTAGE  
SA-210 CONTROL COMPUTER 0104-I

Theoretical Curve — ○  
Dynamic Curve — X

PERCENT CONVERSION

100

80

60

40

20

0.8

1.0

1.2

+5% TOL.

INPUT VOLTS

+5% TOL.

SA-210 CONTROL COMPUTER

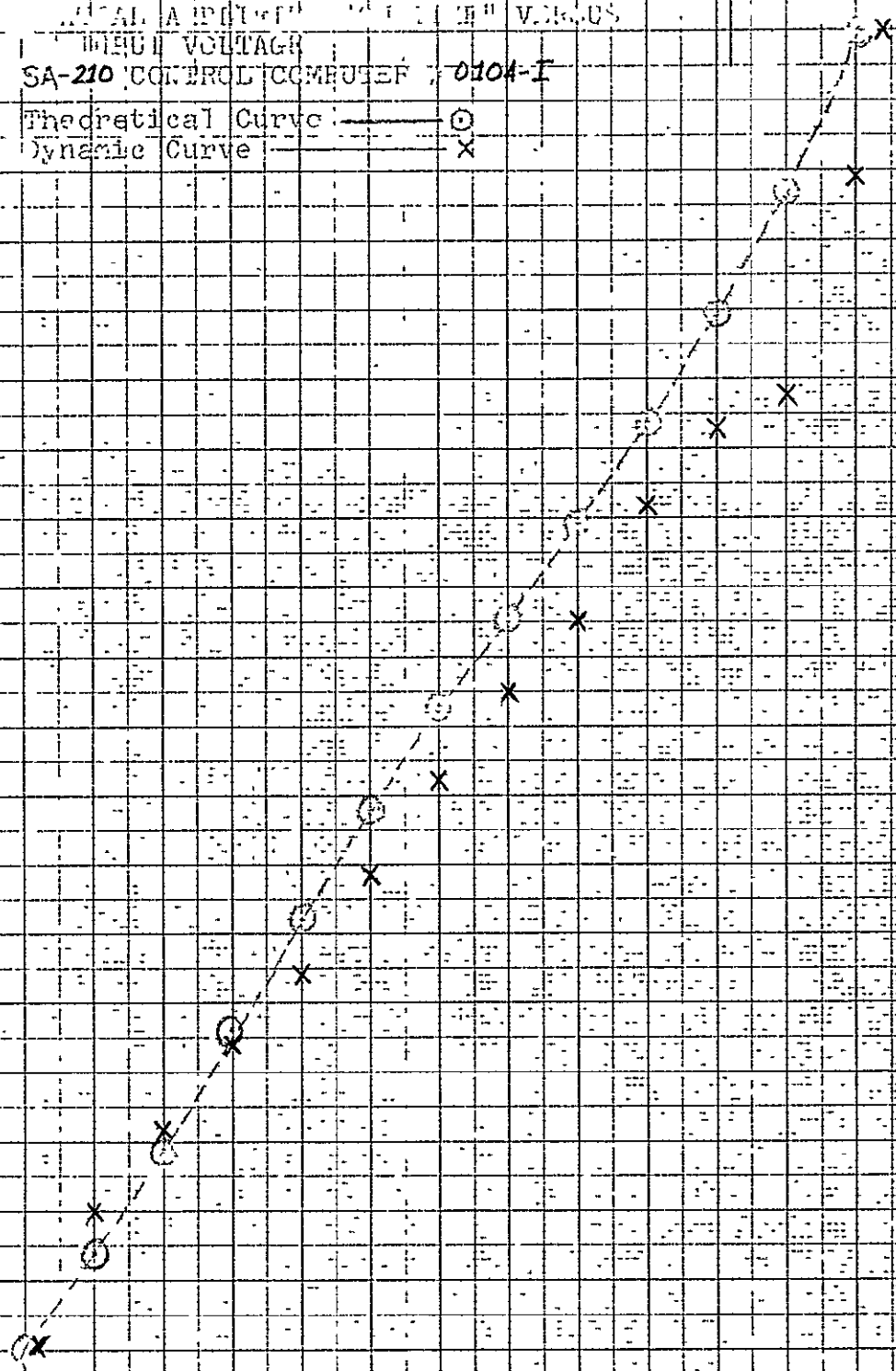



SPATIAL AMPLIFIER I TR SPARE

SA-210  
FCC #010A-I

SPATIAL AMPLIFIER OUTPUT PULSE WIDTH  
VERSUS INPUT VOLTAGE

Theoretical Curve ———— ⊙  
Dynamic Curve ———— X

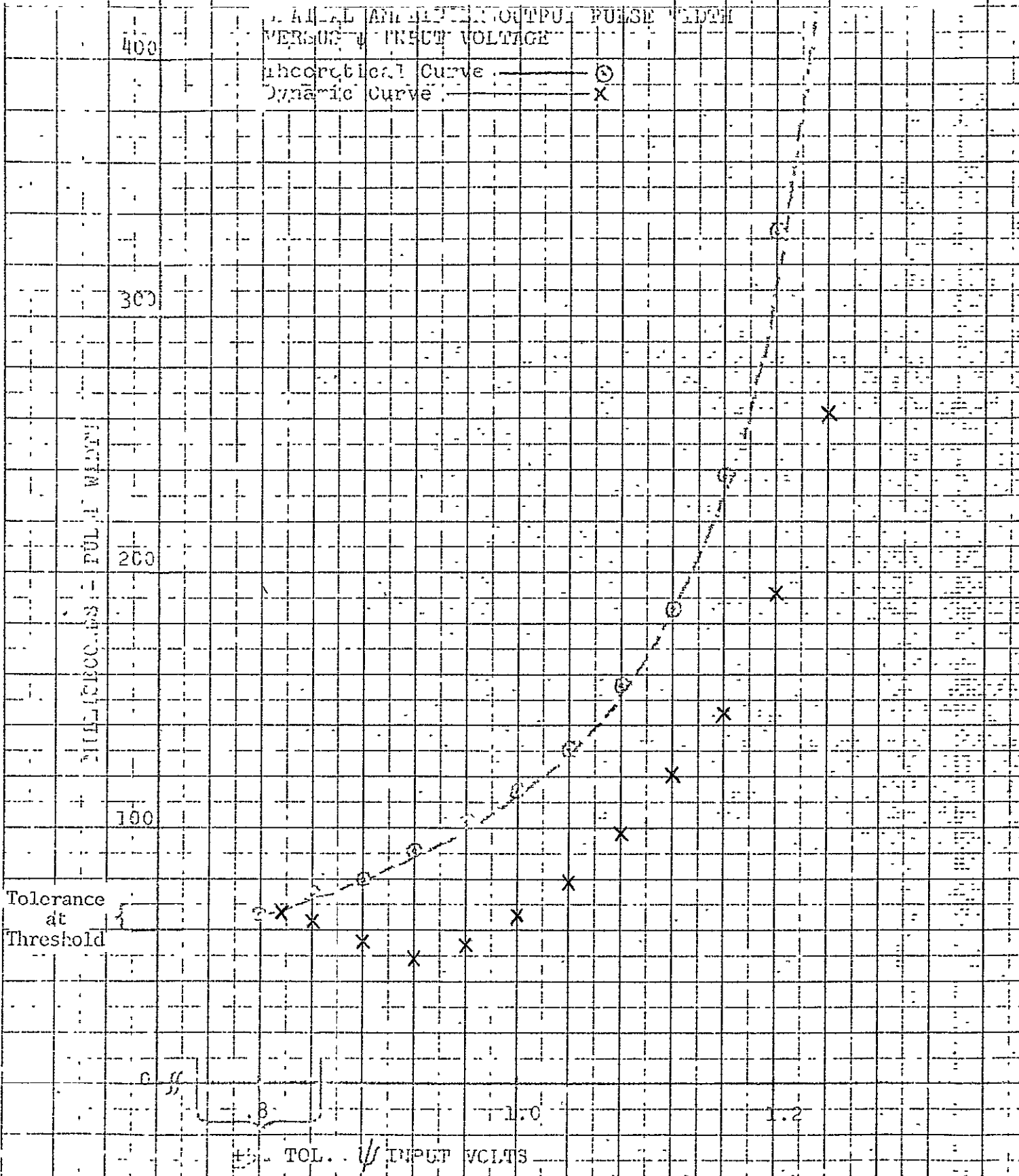

ORIGINAL PAGE IS  
OF POOR QUALITY

SPATIAL AMPLIFIER  
 Output Frequencies  
 Versus  $\psi$  Input Voltage  
 THEORETICAL CURVE  
 DYNAMIC CURVE

IBR SPARE

\* \* \*

SA-210  
 CC #0104-I

Frequency Hz

$\psi$  Input Voltage

8  
 ±5% 101

10

12  
 ±5% 701

SPATIAL AMPLIFIER III PRIME

32-210 FCC S/N 0104-I

+5% TOL.

SPATIAL AMPLIFIER  
PER CENT ON-TIME VERSUS  
INPUT VOLTAGE

THEORETICAL CURVE — ○ —  
DYNAMIC CURVE — × —

PER CENT ON-TIME

100  
80  
60  
40  
20  
0

0.9 1.0 1.1 1.2 1.3 1.4 1.5

+5% TOL.

INPUT VOLTS

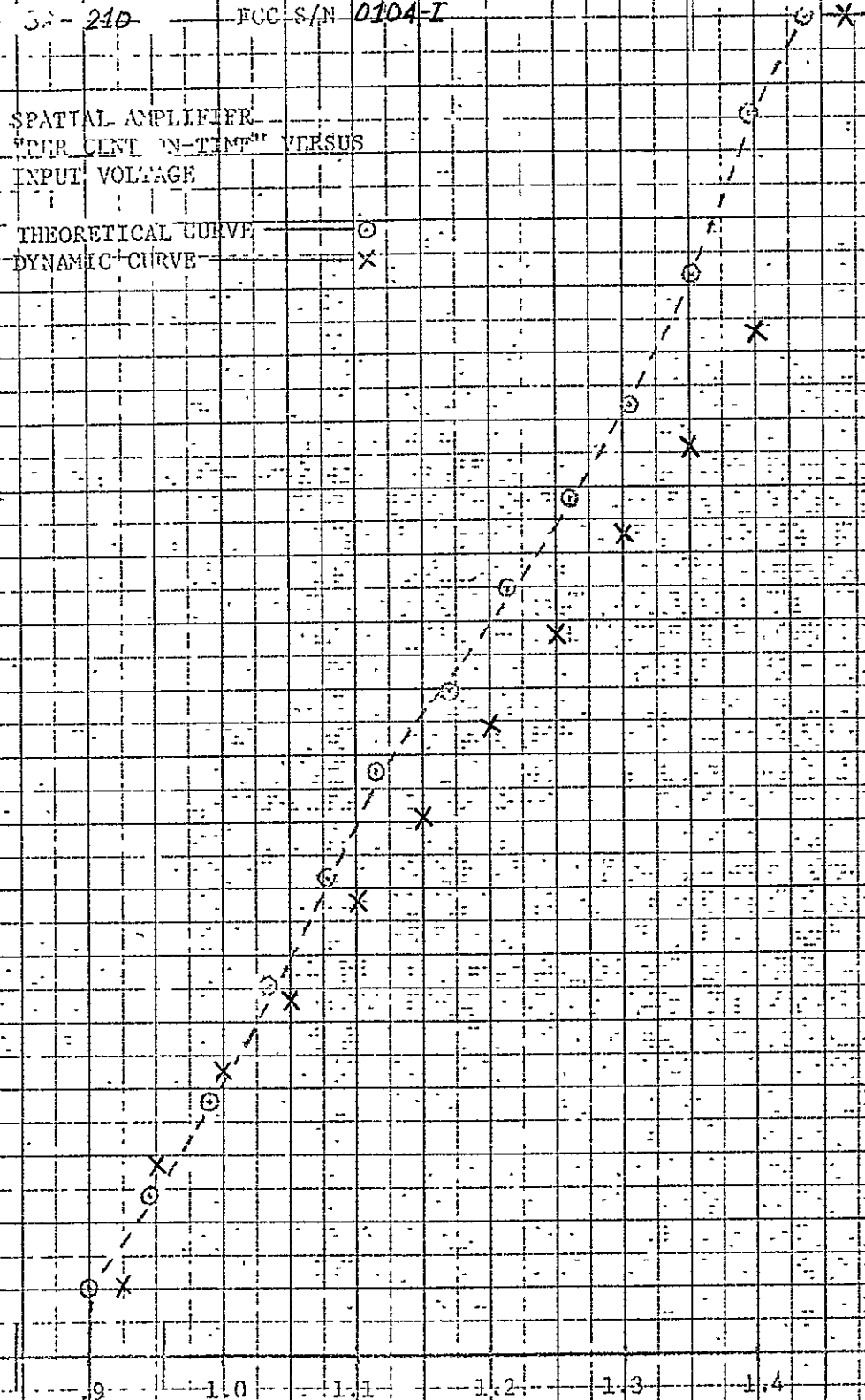
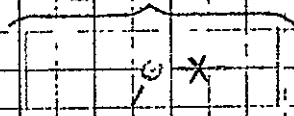

SPATIAL AMPLIFIER OUTPUT PULSE WIDTH  
VERSUS INPUT VOLTAGE

Theoretical Curve ———— ⊙  
Dynamic Curve ———— ×

MILLISECONDS - PULSE WIDTH

400

300

200

100

Tolerance  
at  
Threshold

9 1.0 1.1 1.2 1.3 1.4 1.5  
⊙ INPUT VOLTS

±5% Tol.

4-39

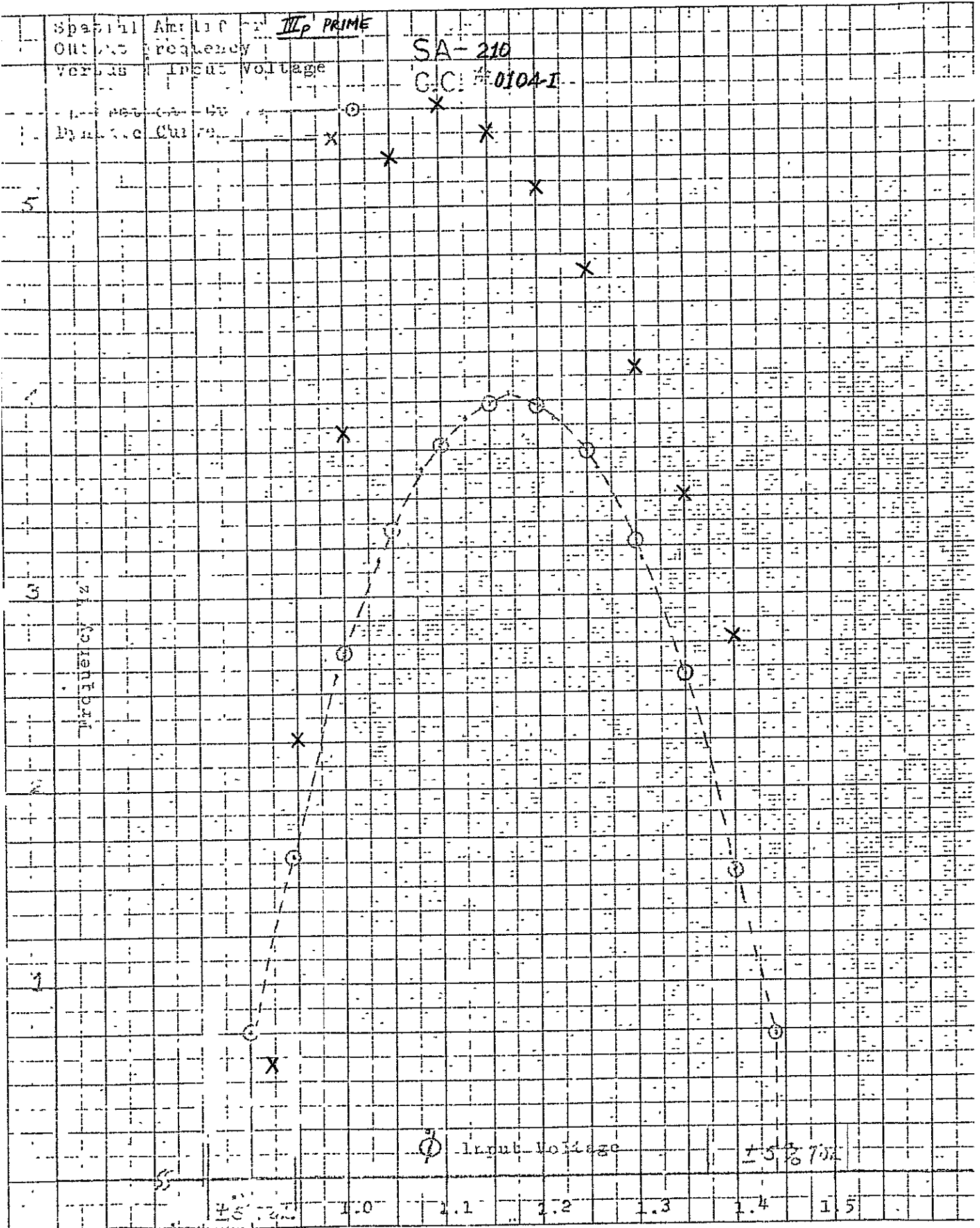

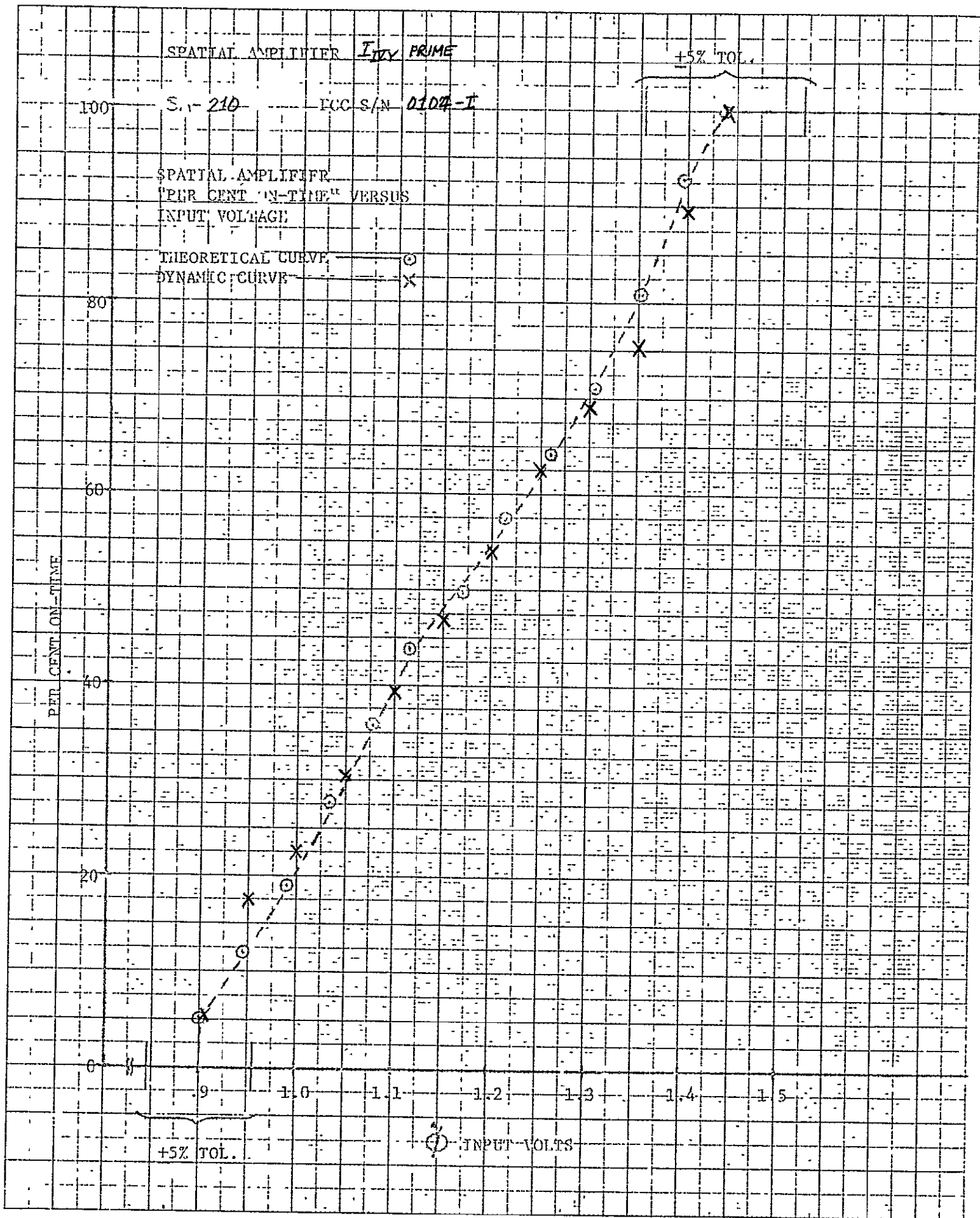

SPATIAL AMPLIFIER I<sub>BY</sub> PRIME

SA-210  
FCC # 0104-I

SPATIAL AMPLIFIER OUTPUT PULSE WIDTH  
VERSUS INPUT VOLTAGE

Theoretical Curve ———— ⊙  
Dynamic Curve ———— ×

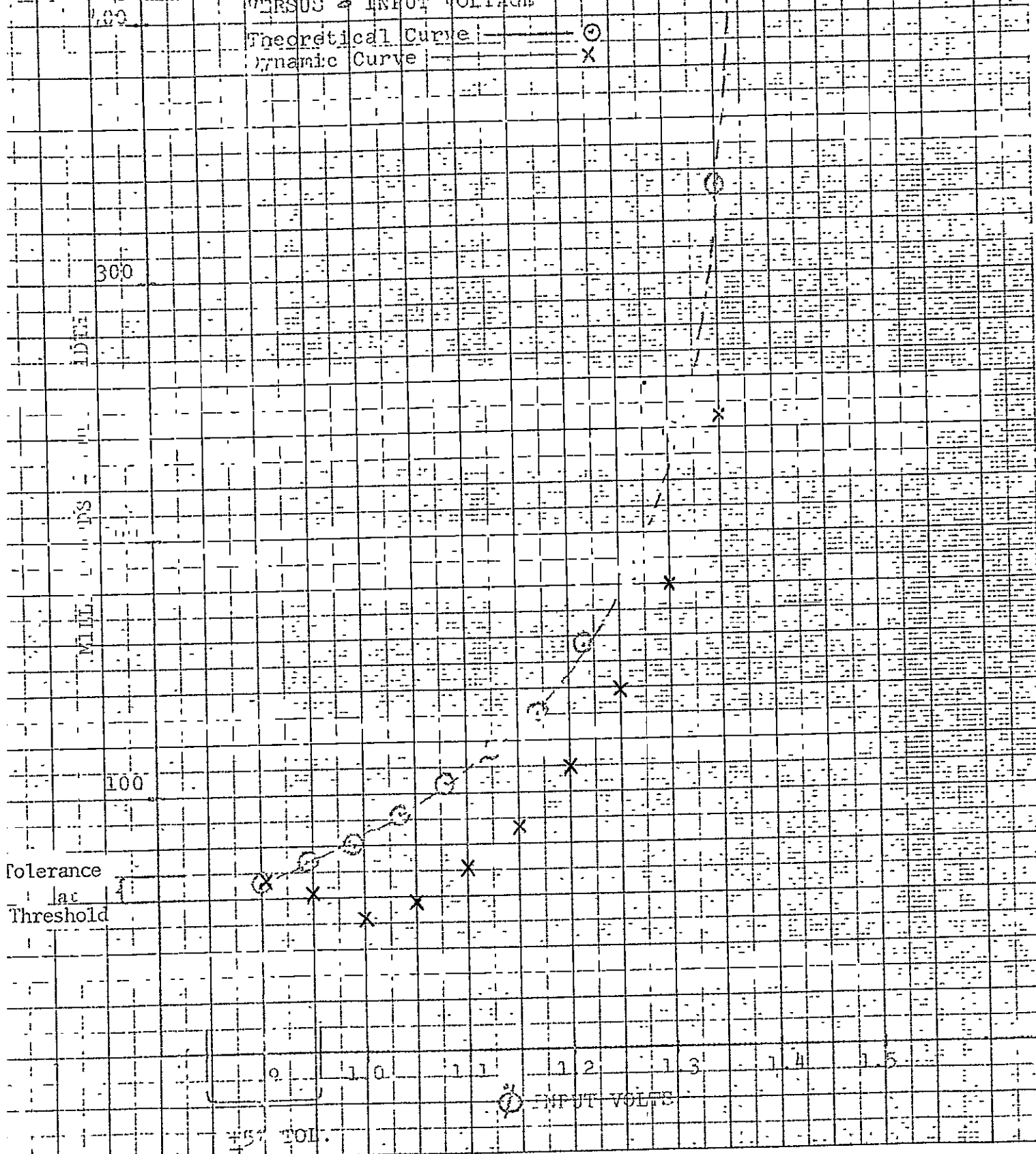

Spatial Amplifier *IVY PRIME*  
 Output Frequency  
 versus Input Voltage

SA-210  
 C.C. #0104-I

Report Co. Cr.  
 Dynamic Curve

5

4

3

2

1

Frequency Hz

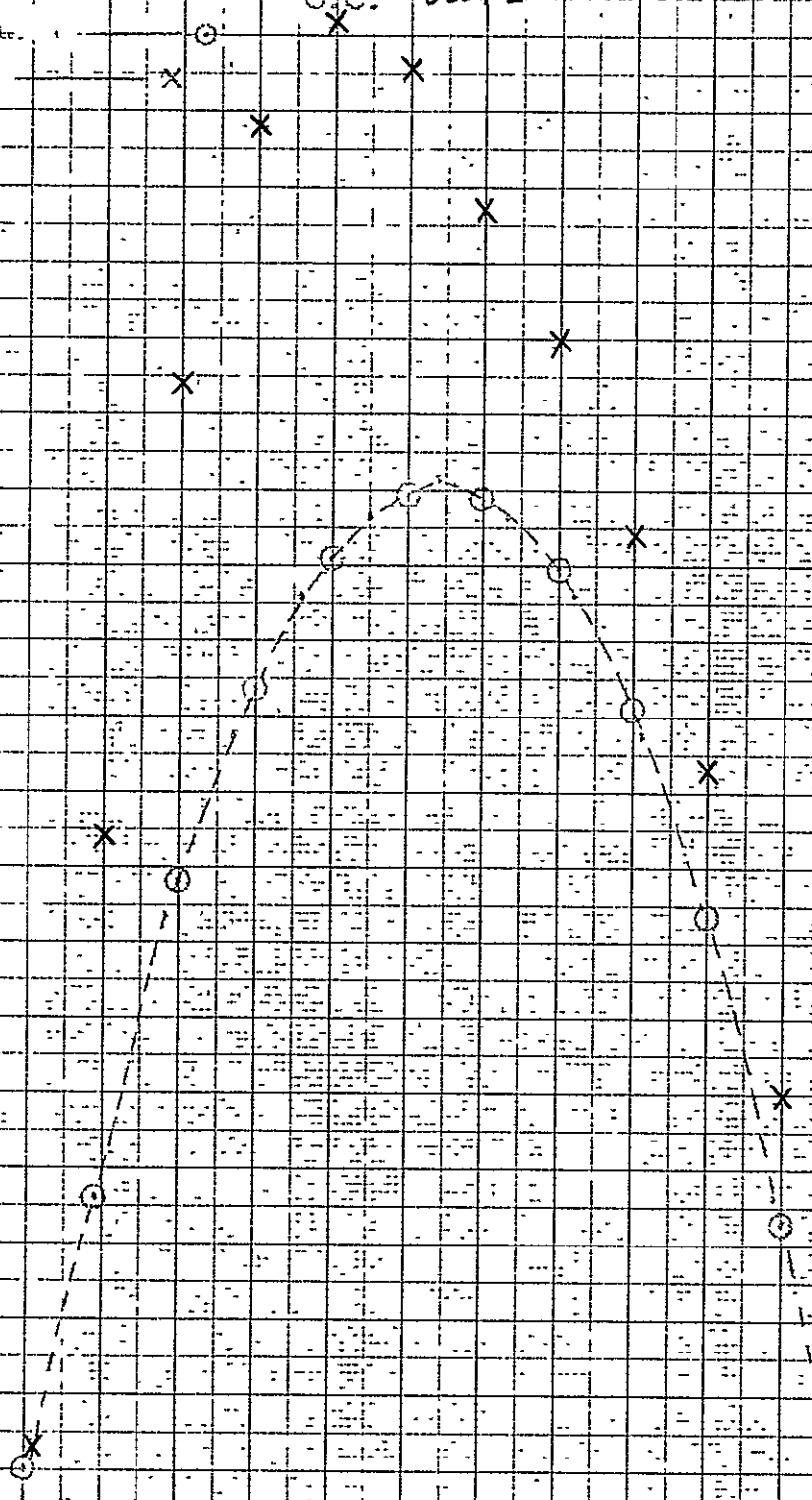

Input Voltage

1.5 1.0 1.5

1.0 1.1 1.2 1.3 1.4 1.5



SPATIAL AMPLIFIER *III PRIME*

3M-210 1CC S/N 0104-I

SPATIAL AMPLIFIER  
"PER CENT ON-TIME" VERSUS  
INPUT VOLTAGE

THEORETICAL CURVE — ○  
DYNAMIC CURVE — X

PER CENT ON-TIME

+5% TOL.

+5% TOL.

INPUT VOLTS

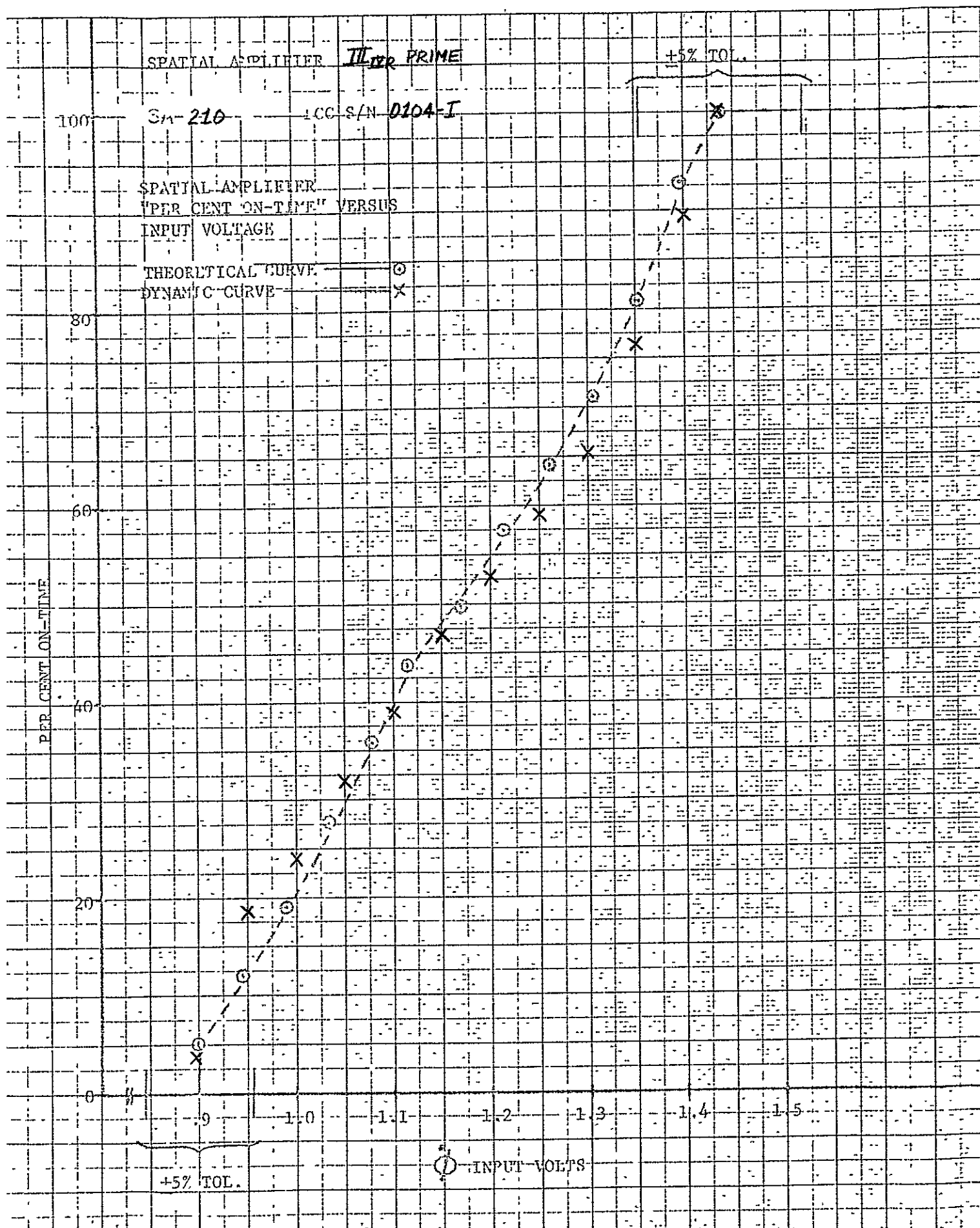

SPATIAL AMPLIFIER III PRIME

SA-210  
FCC #0104-I

SPATIAL AMPLIFIER OUTPUT PULSE WIDTH  
VERSUS INPUT VOLTAGE

400

Theoretical Curve ———— ⊙  
Dynamic Curve ———— X

MILLISECONDS - PULSE WIDTH

300

200

100

Tolerance  
at  
Threshold

0.9 1.0 1.1 1.2 1.3 1.4 1.5

⊙ INPUT VOLTS

±5% Tol.

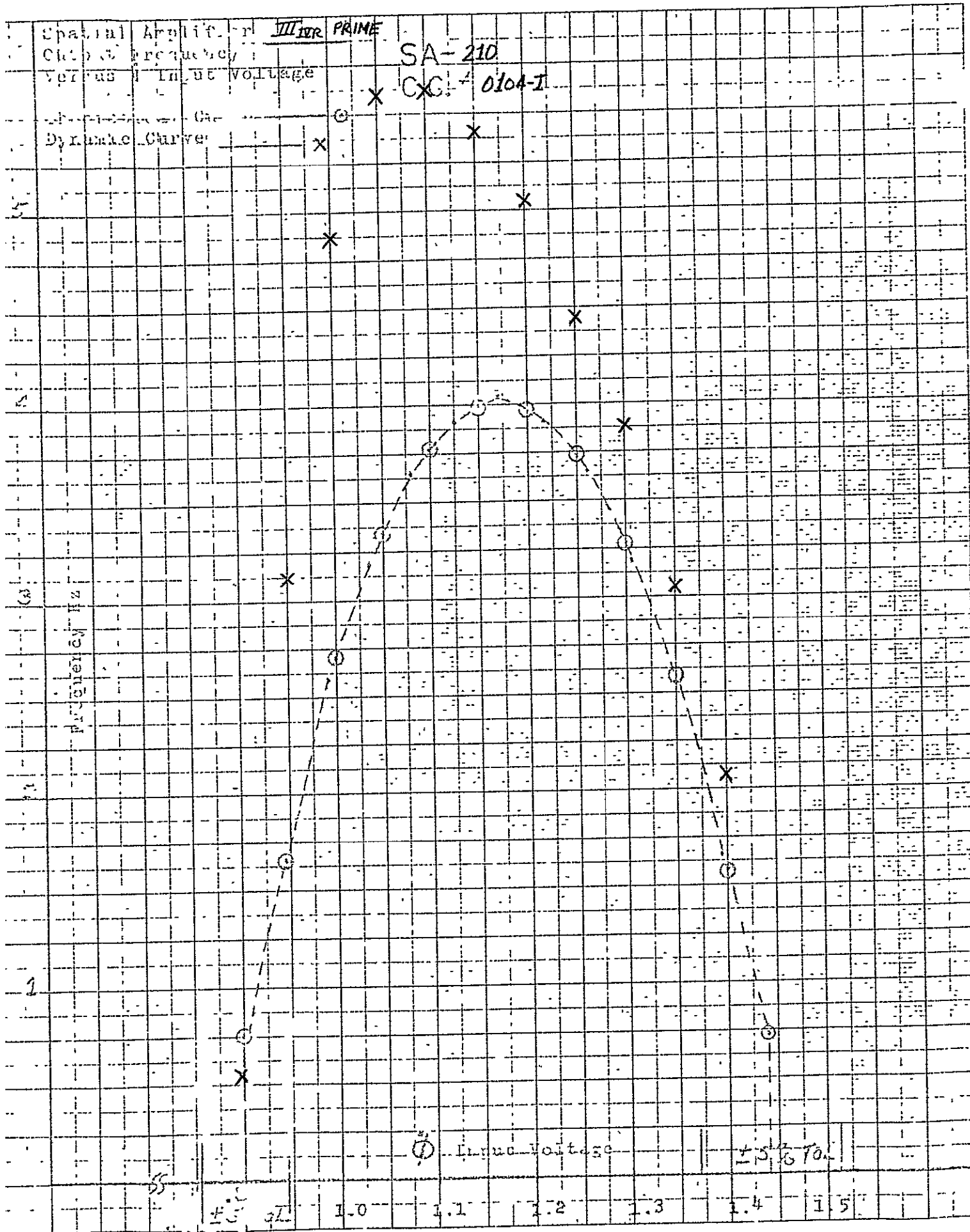

SPATIAL AMPLIFIER I<sub>p</sub> SPARE

SF-210

ECC S/N 0104-I

SPATIAL AMPLIFIER  
"PER CENT ON-TIME" VERSUS  
INPUT VOLTAGE

THEORETICAL CURVE ———— ⊙  
DYNAMIC CURVE ———— ×

PER CENT ON-TIME

100

80

60

40

20

0

+5% TOL.

⊙ INPUT VOLTS

+5% TO

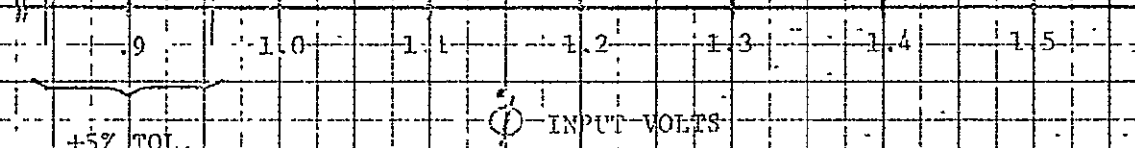

SPATIAL AMPLIFIER OUTPUT PULSE WIDTH  
VERSUS  $\phi$  INPUT VOLTAGE

Theoretical Curve ———— ⊙  
Dynamic Curve ———— ×

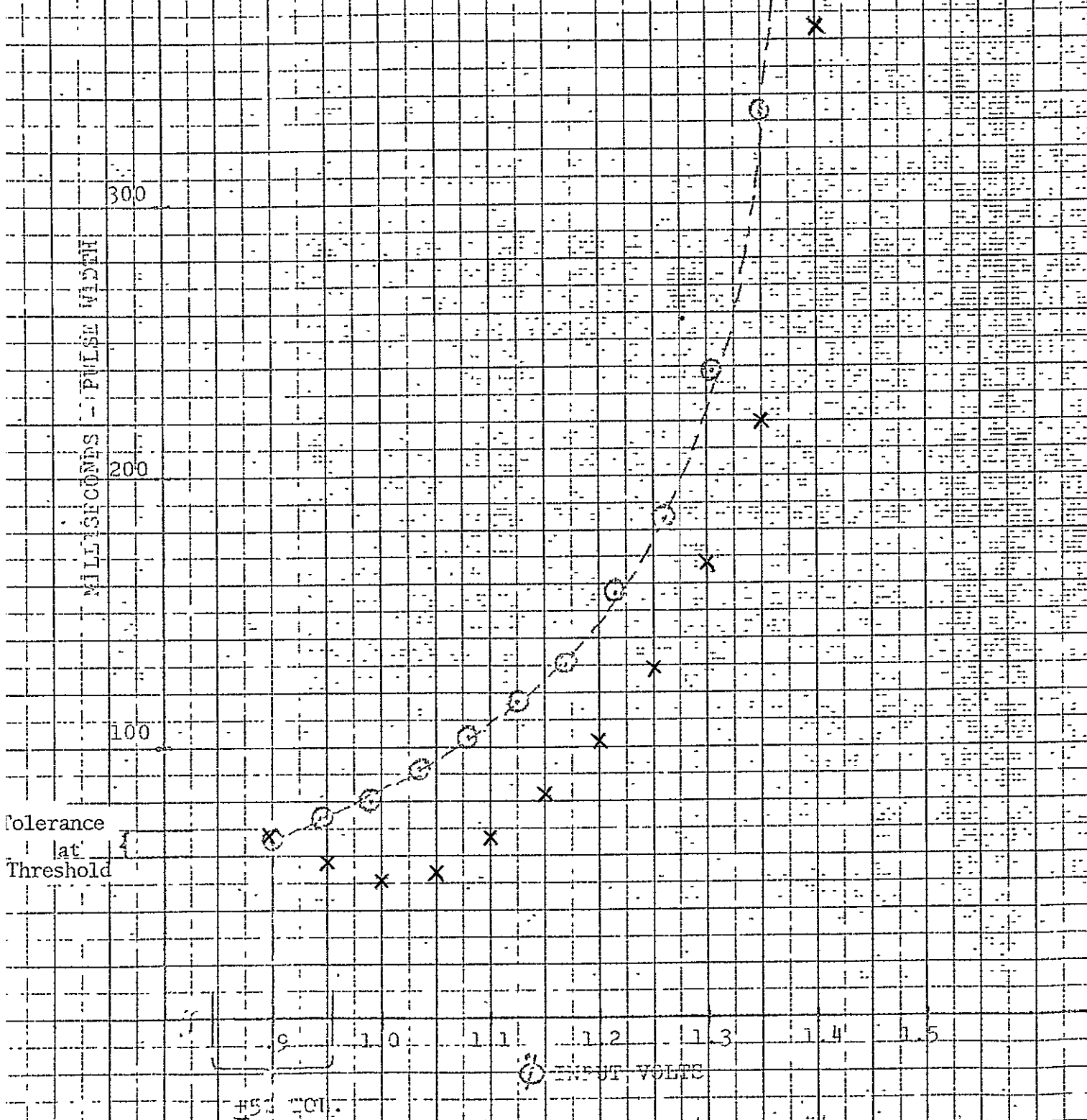

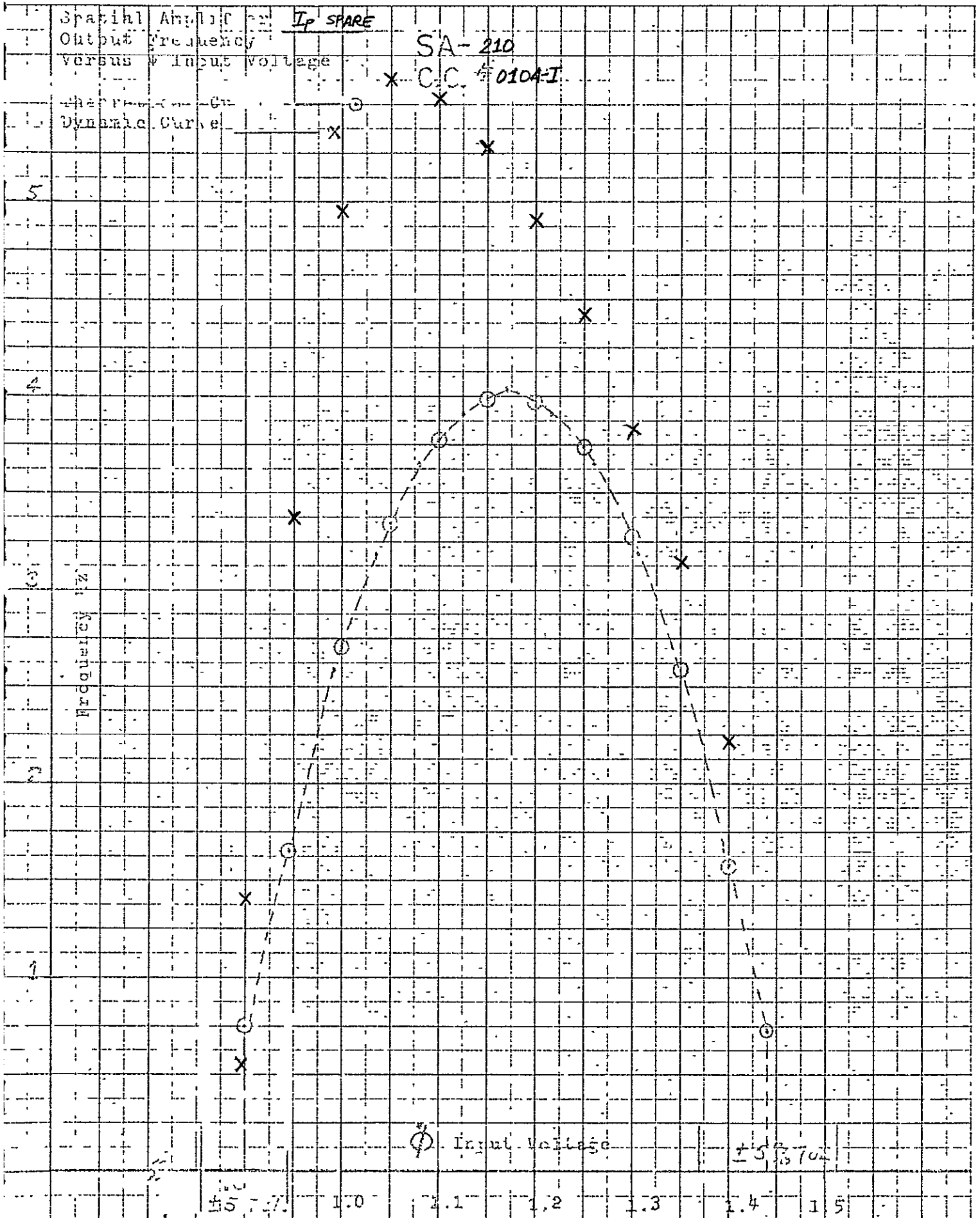

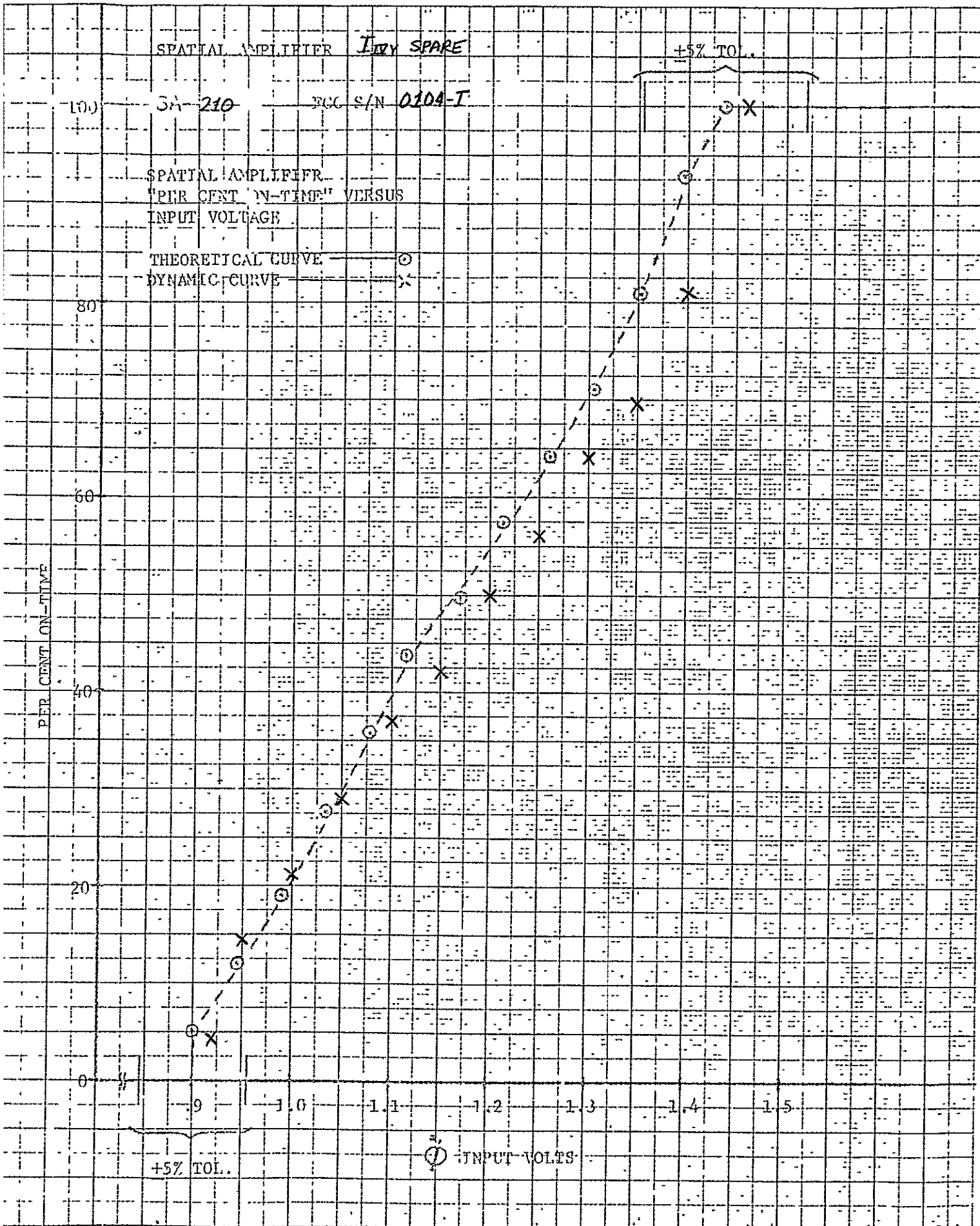

SPATIAL AMPLIFIER INDY. SPARE

SA-210  
FCC # 0104-I

SPATIAL AMPLIFIER OUTPUT PULSE WIDTH  
VERSUS INPUT VOLTAGE

Theoretical Curve ———— ⊙  
Dynamic Curve ———— ×

400

300

200

100

PULSE WIDTH

Tolerance  
as  
Threshold

0.9 1.0 1.1 1.2 1.3 1.4 1.5

+5% TOL. ⊙ INPUT VOLTS



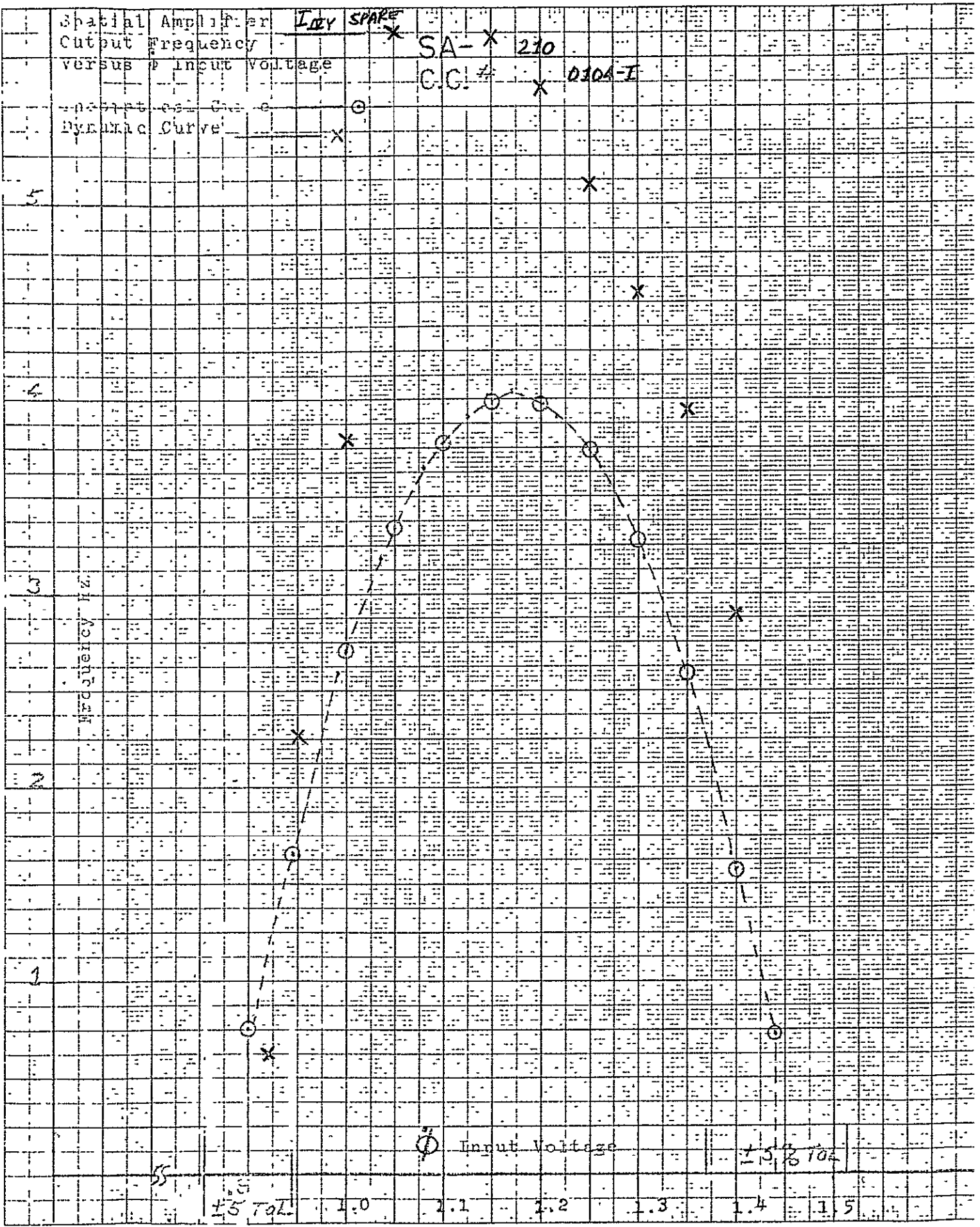

SPATIAL AMPLIFIER III<sup>RD</sup> SPARE

+5% TOL.

100

CA-210

ECC S/N 0104-T

SPATIAL AMPLIFIER  
"PER CENT ON-TIME" VERSUS  
INPUT VOLTAGE

THEORETICAL CURVE — ○ —  
DYNAMIC CURVE — X —

80

PER CENT ON-TIME

60

40

20

0

+5% TOL.

○ INPUT VOLTS

SPATIAL AMPLIFIER OUTPUT PULSE WIDTH  
VERSUS INPUT VOLTAGE

Theoretical Curve ———— ○  
Dynamic Curve ———— X

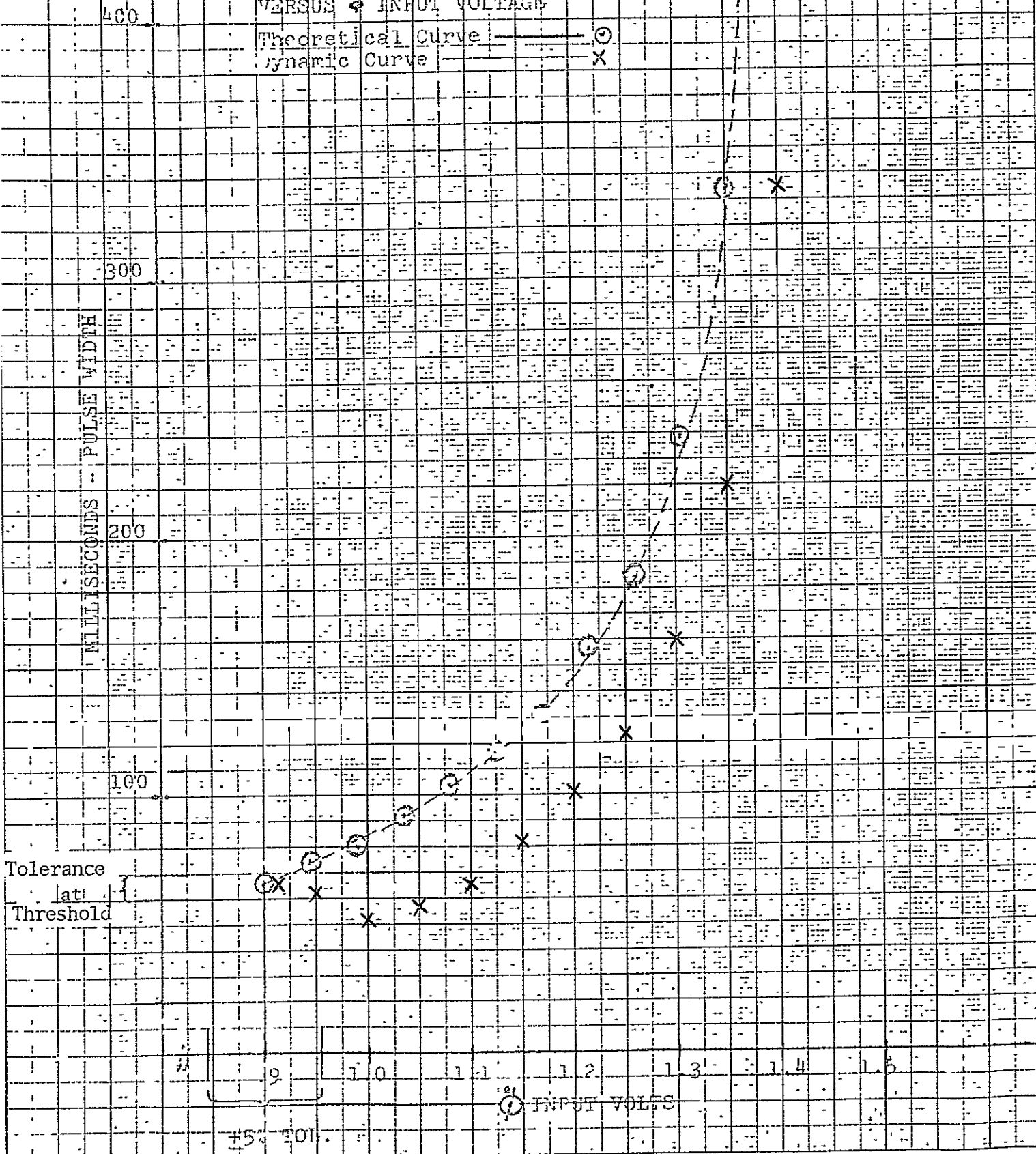

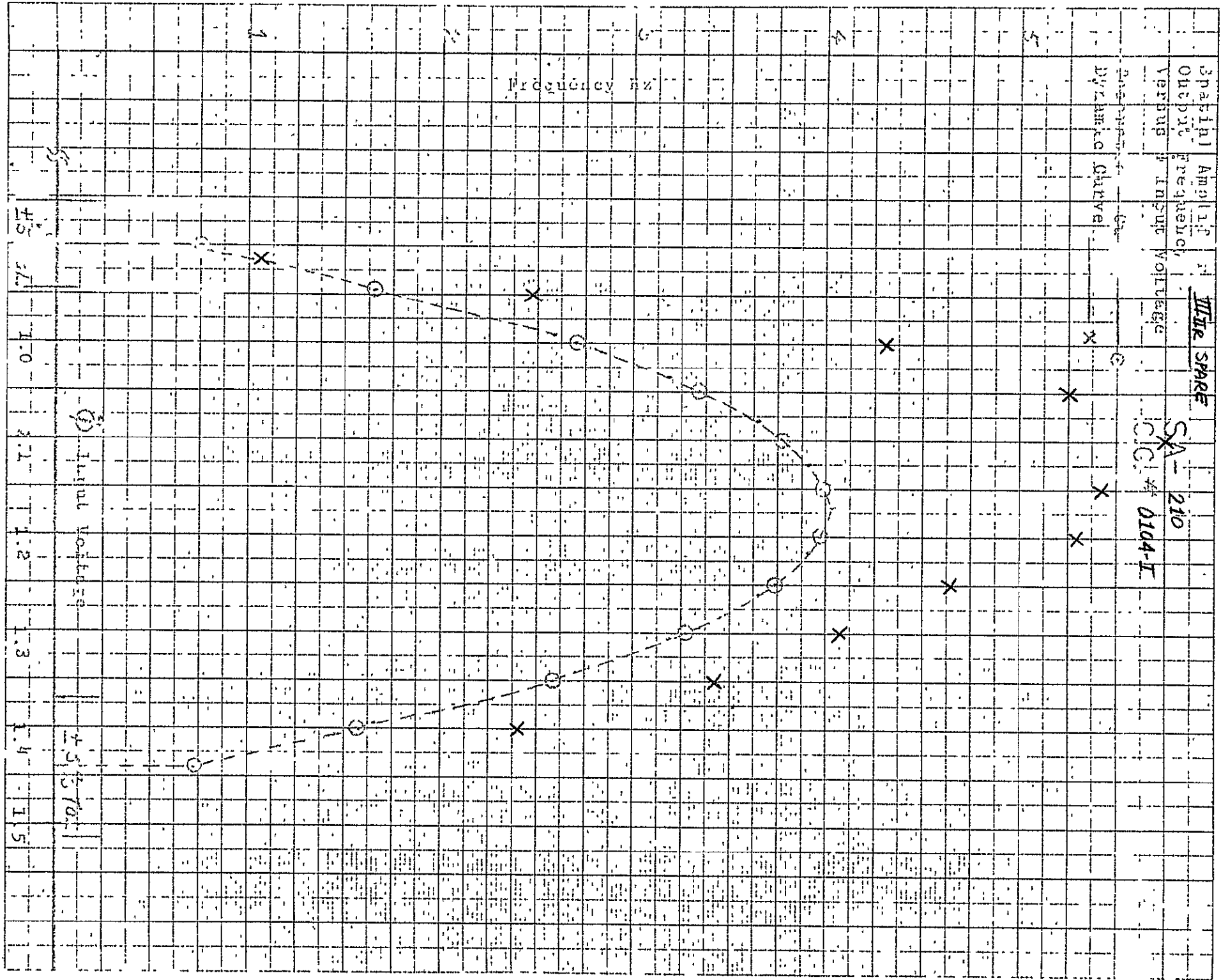

S-IVB STAGE COAST MODE

SPATIAL AMPLIFIER THRESHOLD AND FULL-ON FOR IU AND S/C CONTROL  
(SUMMARY OF OPERATIONAL CHARACTERISTICS DATA)

SPATIAL AMPLIFIER	$\psi$ INPUT OPERATION						Theo. Gain Change
	Threshold (volts)			Full-On (volts)			
	IU Control	S/C Control	Gain Change	IU Control	S/C Control	Gain Change	
I <sub>P</sub> Prime	0.797	0.310	2.571	1.275	0.496	2.570	P-Y 10/3.75 = 2.667 ( $\pm 10\%$ ) Roll 20/3.75 = 5.333 ( $\pm 10\%$ )
III <sub>II Y</sub> Prime	0.802	0.309	2.595	1.272	0.493	2.580	
I <sub>II R</sub> Prime	0.804	0.148	5.432	1.270	0.242	5.248	
III <sub>P</sub> Spare	0.800	0.315	2.552	1.276	0.503	2.532	
III <sub>IV Y</sub> Spare	0.806	0.314	2.567	1.284	0.503	2.553	
I <sub>IV R</sub> Spare	0.816	0.157	5.197	1.295	0.250	5.180	
$\phi$ INPUT OPERATION							
III <sub>P</sub> Prime	0.922	N/A		1.467	N/A		
I <sub>IV Y</sub> Prime	0.906			1.440			
III <sub>IV R</sub> Prime	0.897			1.434			
I <sub>P</sub> Spare	0.897			1.436			
I <sub>II Y</sub> Spare	0.920			1.460			
III <sub>II R</sub> Spare	0.913			1.445			

TEST REQUIREMENTS

- $\psi$  Channel Threshold = 0.800 volts ( $\pm 5\%$ ), 0.300 volts ( $\pm 5\%$ ) with S/C Control
- $\psi$  Channel Full-On = 1.280 volts ( $\pm 5\%$ ), 0.480 volts ( $\pm 5\%$ ) with S/C Control
- $\phi$  Channel Threshold = 0.900 volts ( $\pm 5\%$ )
- $\phi$  Channel Full-On = 1.440 volts ( $\pm 5\%$ )

CHANNEL TIME DELAY WHEN IN THE S-IVB COAST MODE

		Output Delay in MS. for input step of:			
Engine		+1.0V. $\psi$	-1.0V. $\psi$	+1.0V. $\dot{\phi}$	-1.0V. $\dot{\phi}$
PRIME	I <sub>P</sub>	54.0	<del>X</del>	256	<del>X</del>
	III <sub>P</sub>	<del>X</del>	53.2	<del>X</del>	247
	I <sub>II Y</sub>	46.6	<del>X</del>	254	<del>X</del>
	I <sub>IV Y</sub>	<del>X</del>	53.2	<del>X</del>	251
	III <sub>II Y</sub>	50.1	<del>X</del>	255	<del>X</del>
	III <sub>IV Y</sub>	<del>X</del>	50.9	<del>X</del>	257
	I <sub>II R</sub>	55.4	<del>X</del>	247	<del>X</del>
	I <sub>IV R</sub>	<del>X</del>	54.8	<del>X</del>	264
	III <sub>II R</sub>	<del>X</del>	55.9	<del>X</del>	253
	III <sub>IV R</sub>	52.5	<del>X</del>	247	<del>X</del>
SPARE	I <sub>P</sub>	49.0	<del>X</del>	252	<del>X</del>
	III <sub>P</sub>	<del>X</del>	47.7	<del>X</del>	256
	I <sub>II Y</sub>	49.5	<del>X</del>	248	<del>X</del>
	I <sub>IV Y</sub>	<del>X</del>	48.8	<del>X</del>	255
	III <sub>II Y</sub>	49.4	<del>X</del>	245	<del>X</del>
	III <sub>IV Y</sub>	<del>X</del>	49.1	<del>X</del>	255
	I <sub>II R</sub>	49.5	<del>X</del>	256	<del>X</del>
	I <sub>IV R</sub>	<del>X</del>	49.8	<del>X</del>	253
	III <sub>II R</sub>	<del>X</del>	48.9	<del>X</del>	255
	III <sub>IV R</sub>	51.8	<del>X</del>	268	<del>X</del>

TEST REQUIREMENTS:

- $\psi$  Channel = 40 to 70 msec delay
- $\dot{\phi}$  Channel = 240 to 270 msec delay

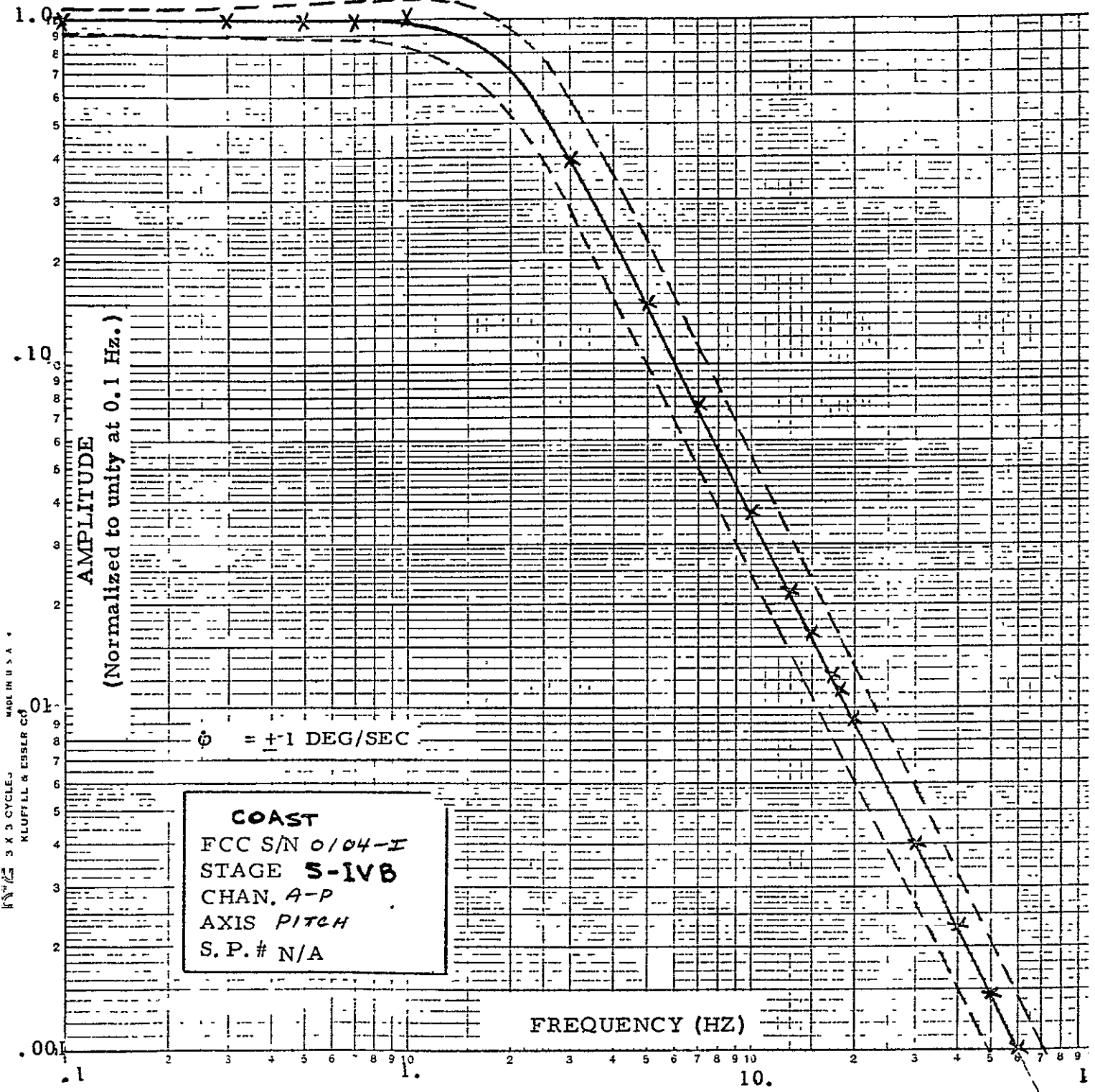

FREQUENCY RESPONSE REQUIREMENTS  
FOR THE 18 HZ. SPATIAL FILTER

ORIGINAL PAGE IS  
OF POOR QUALITY

### FREQUENCY RESPONSE REQUIREMENTS FOR THE 18 HZ. SPATIAL FILTER

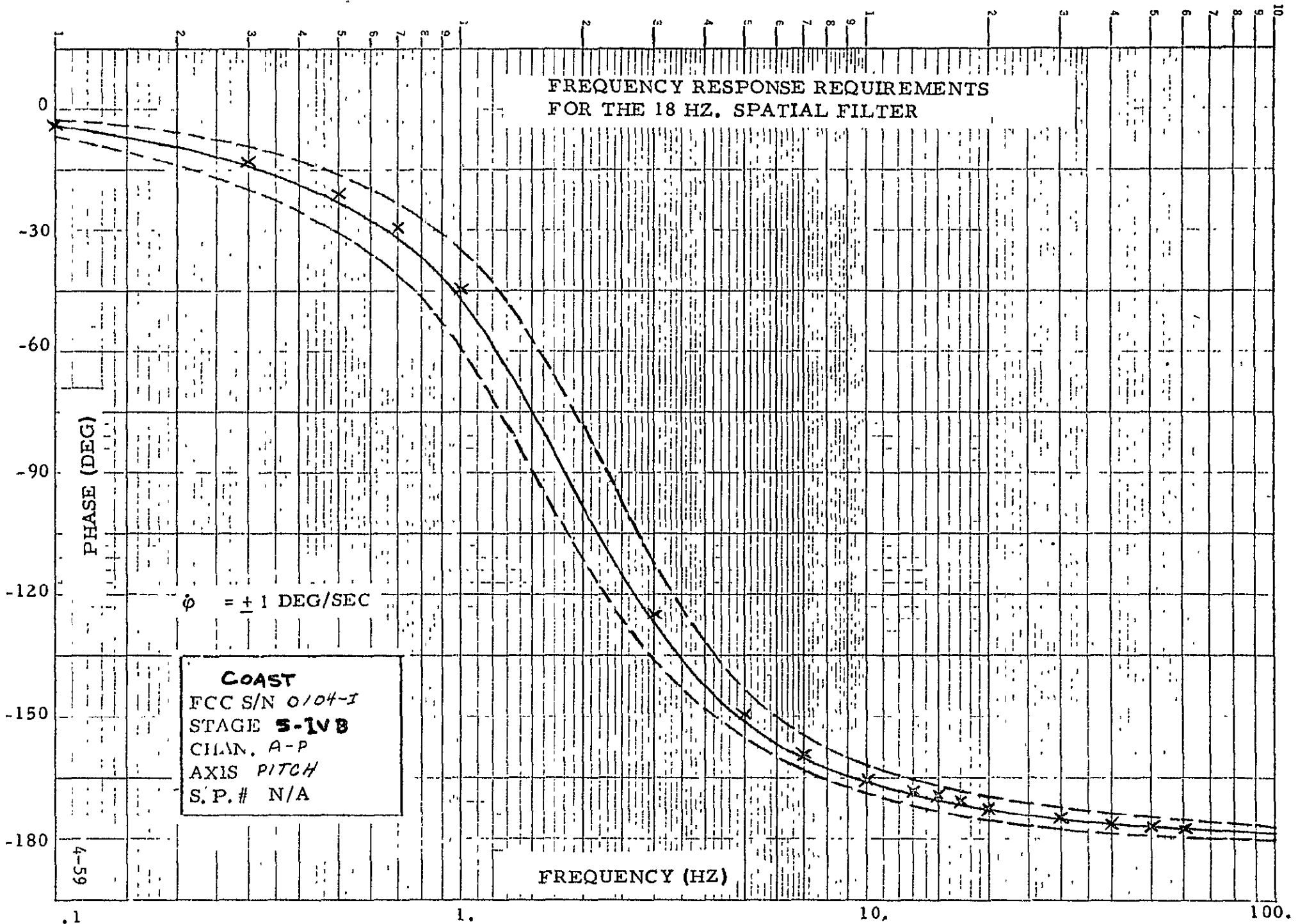



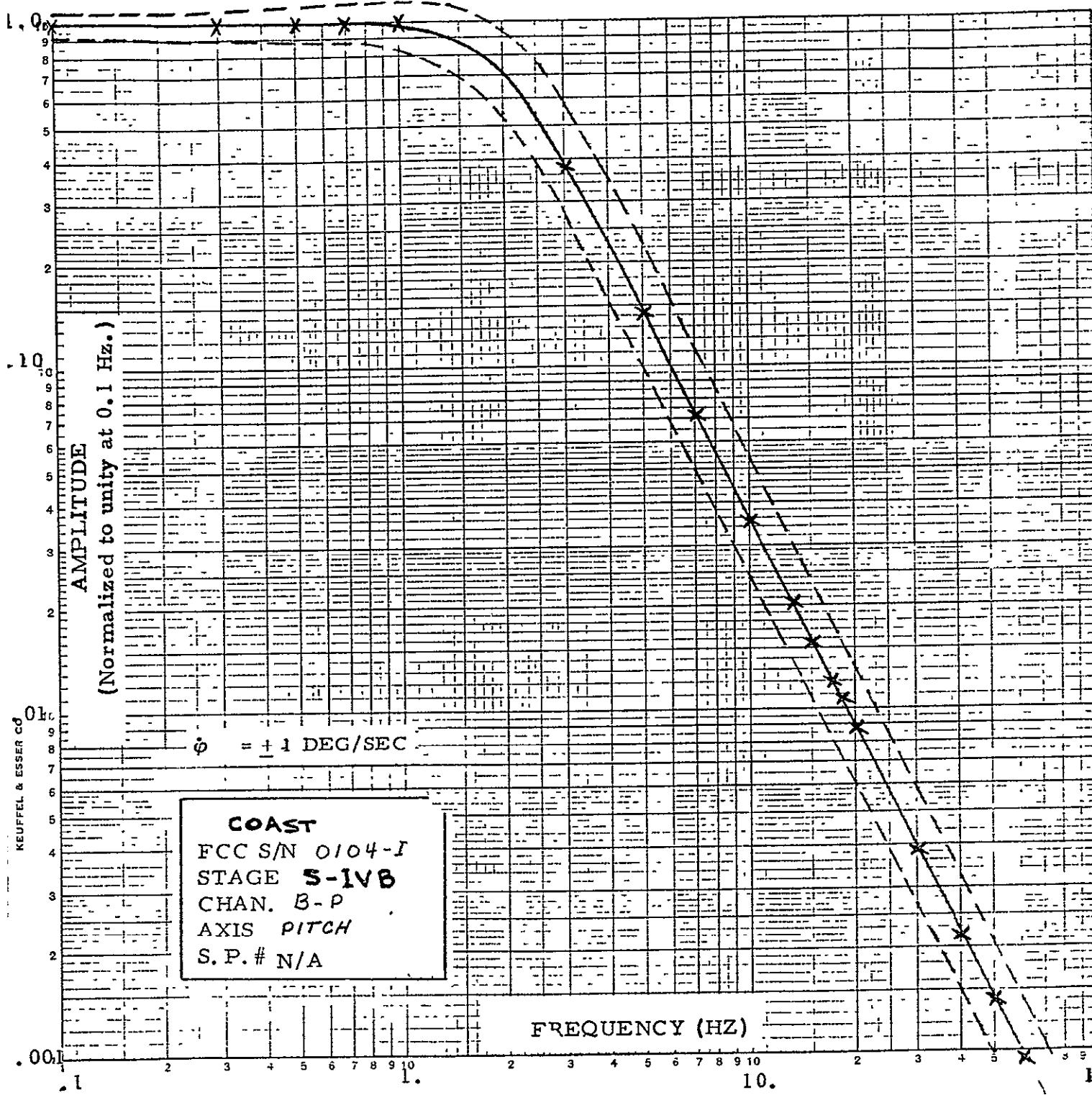

ORIGINAL PAGE IS  
OF POOR QUALITY

FREQUENCY RESPONSE REQUIREMENTS  
FOR THE 18 HZ. SPATIAL FILTER

### FREQUENCY RESPONSE REQUIREMENTS FOR THE 18 HZ. SPATIAL FILTER

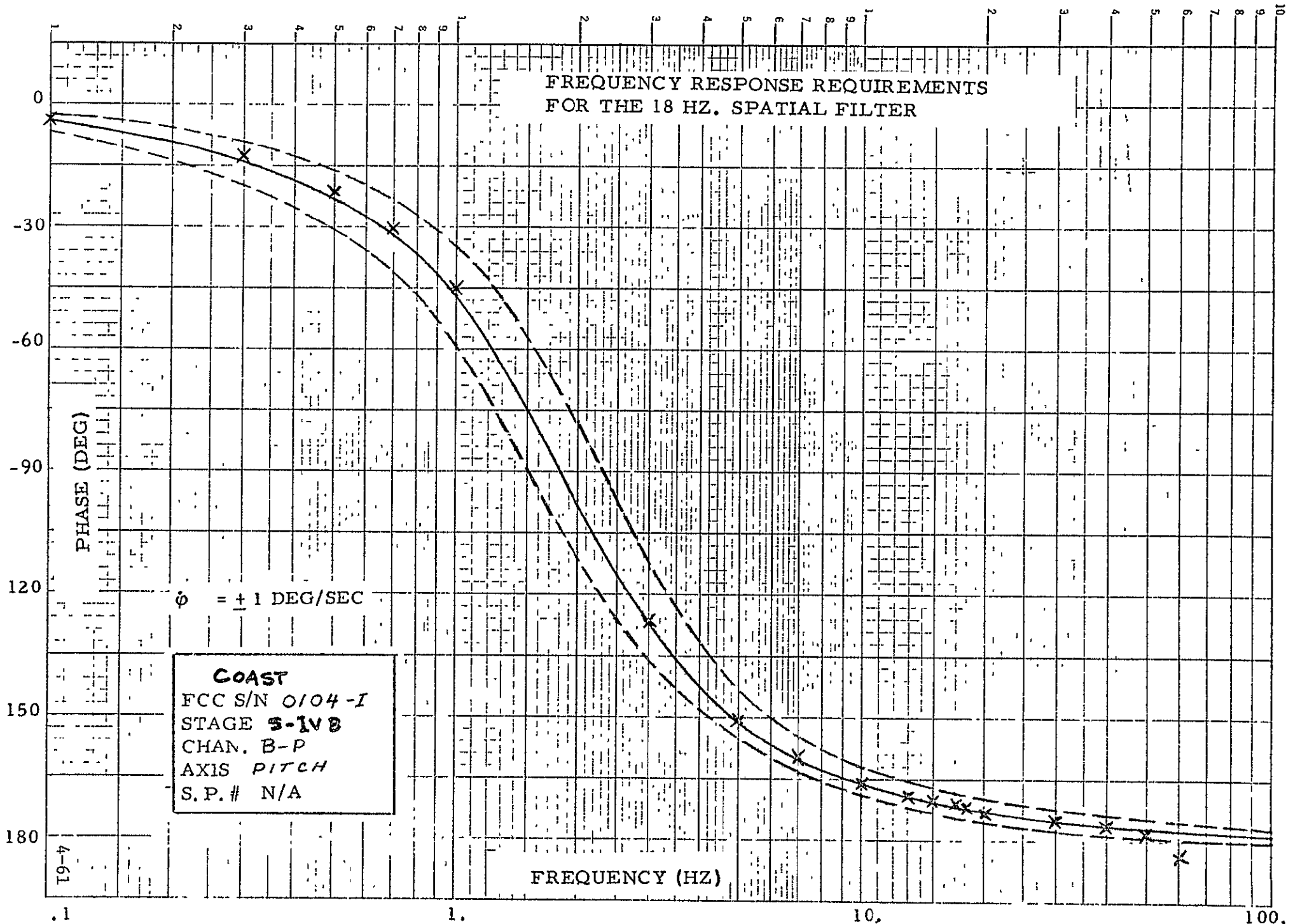

4-61

FREQUENCY (HZ)

.1 1 10 100

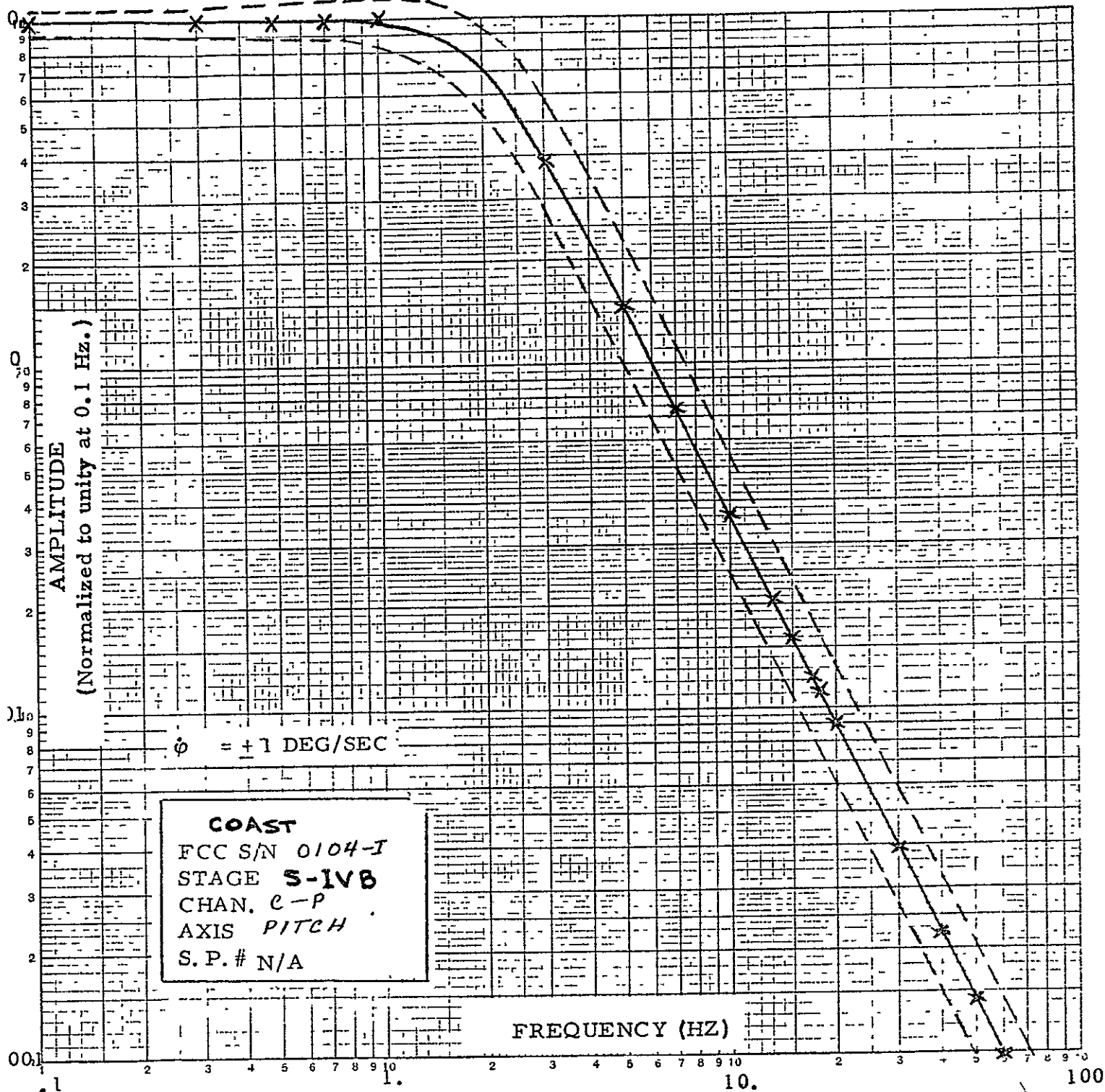

ORIGINAL PAGE IS  
OF POOR QUALITY

FREQUENCY RESPONSE REQUIREMENTS  
FOR THE 18 HZ. SPATIAL FILTER

### FREQUENCY RESPONSE REQUIREMENTS FOR THE 18 HZ. SPATIAL FILTER

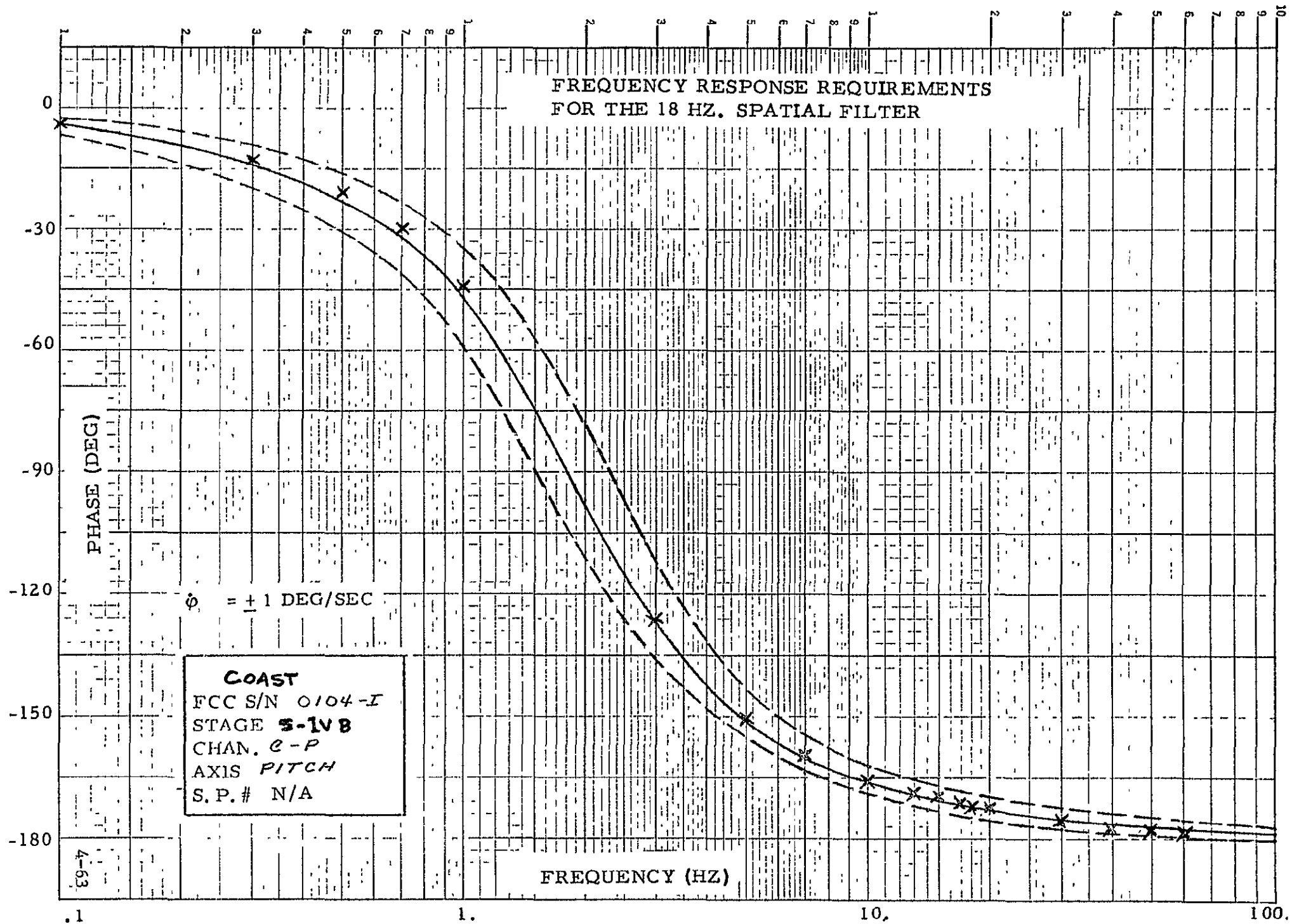

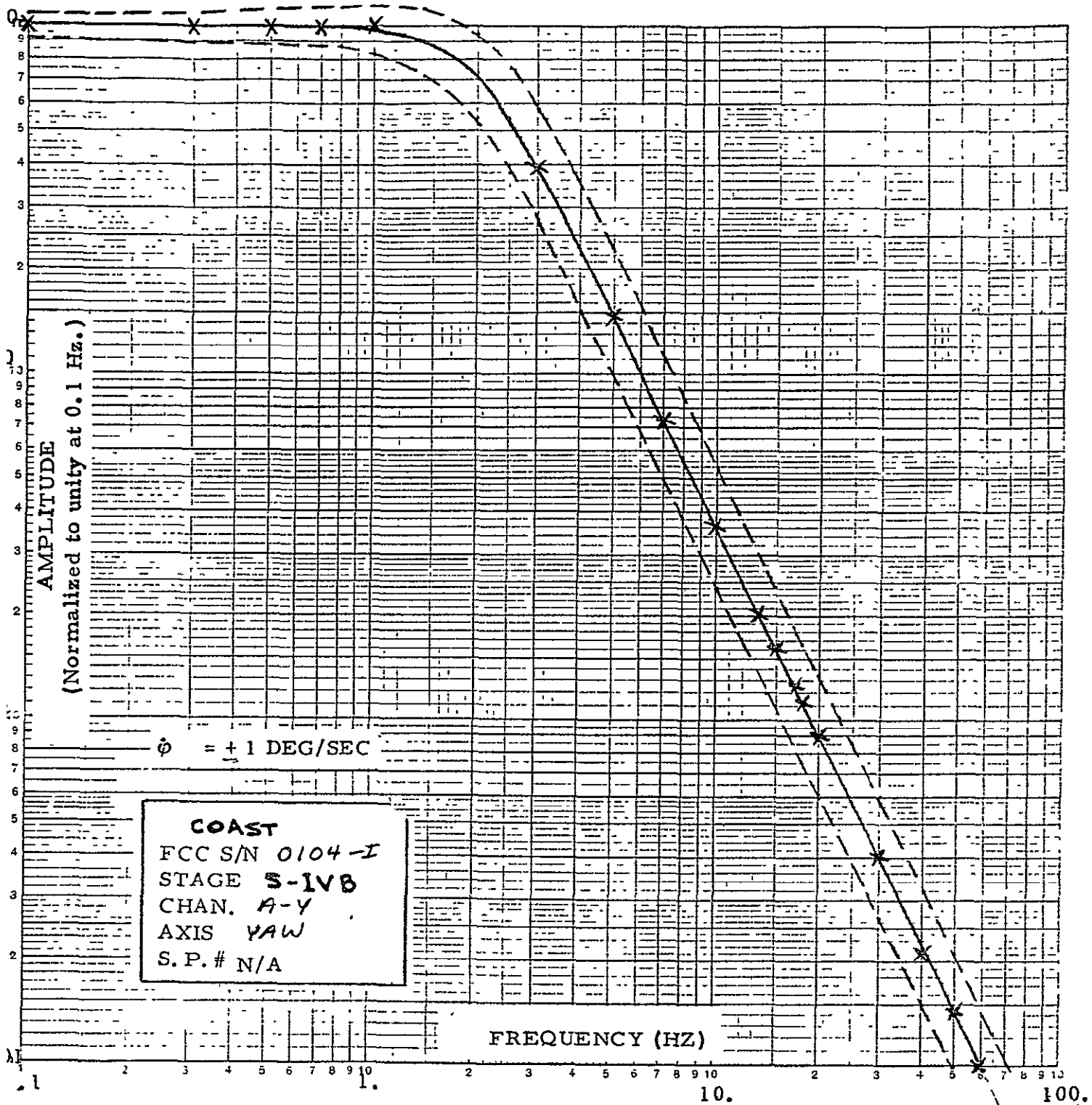

FREQUENCY RESPONSE REQUIREMENTS  
FOR THE 18 HZ. SPATIAL FILTER

ORIGINAL PAGE IS  
OF POOR QUALITY

### FREQUENCY RESPONSE REQUIREMENTS FOR THE 18 HZ. SPATIAL FILTER

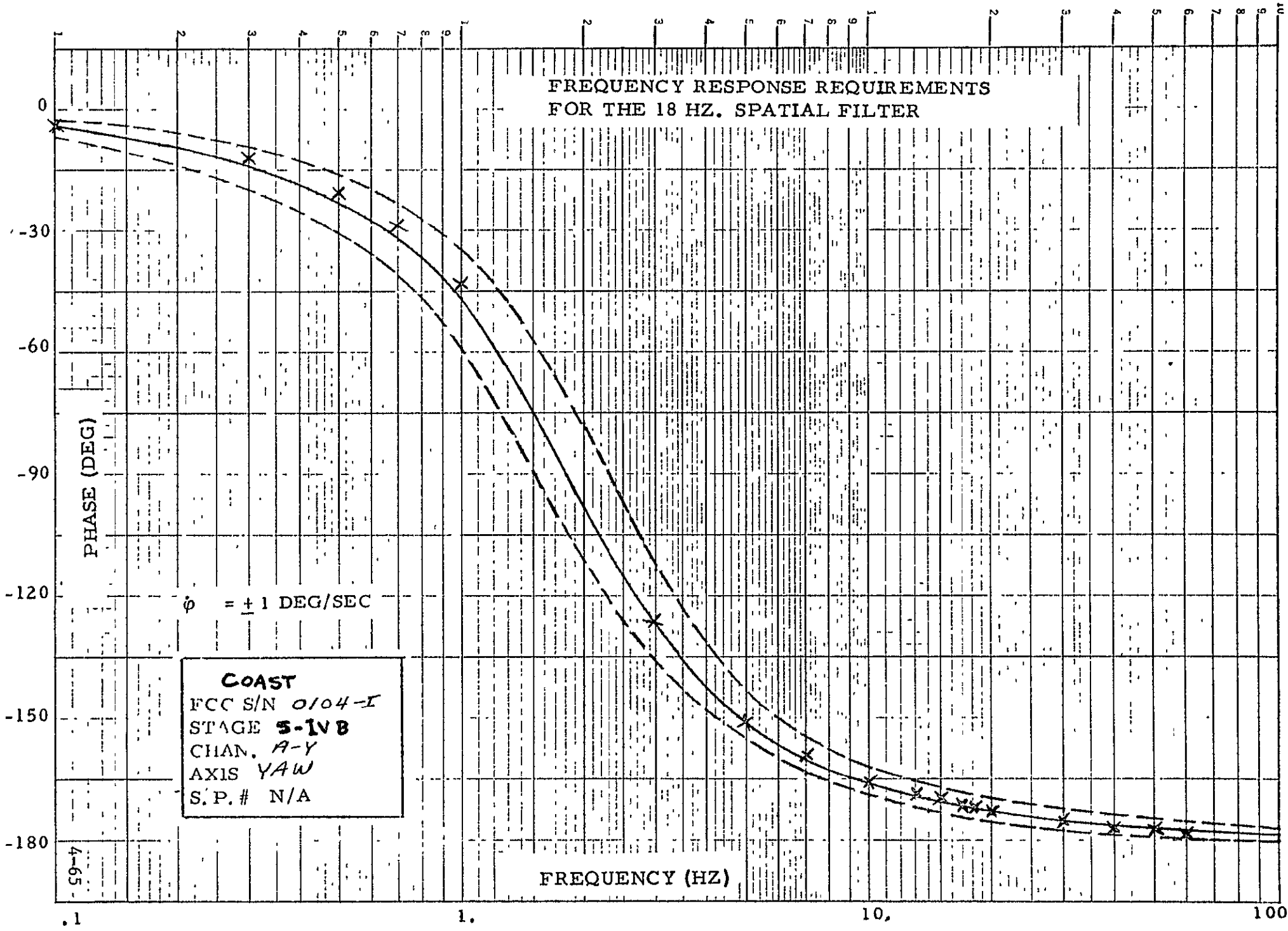

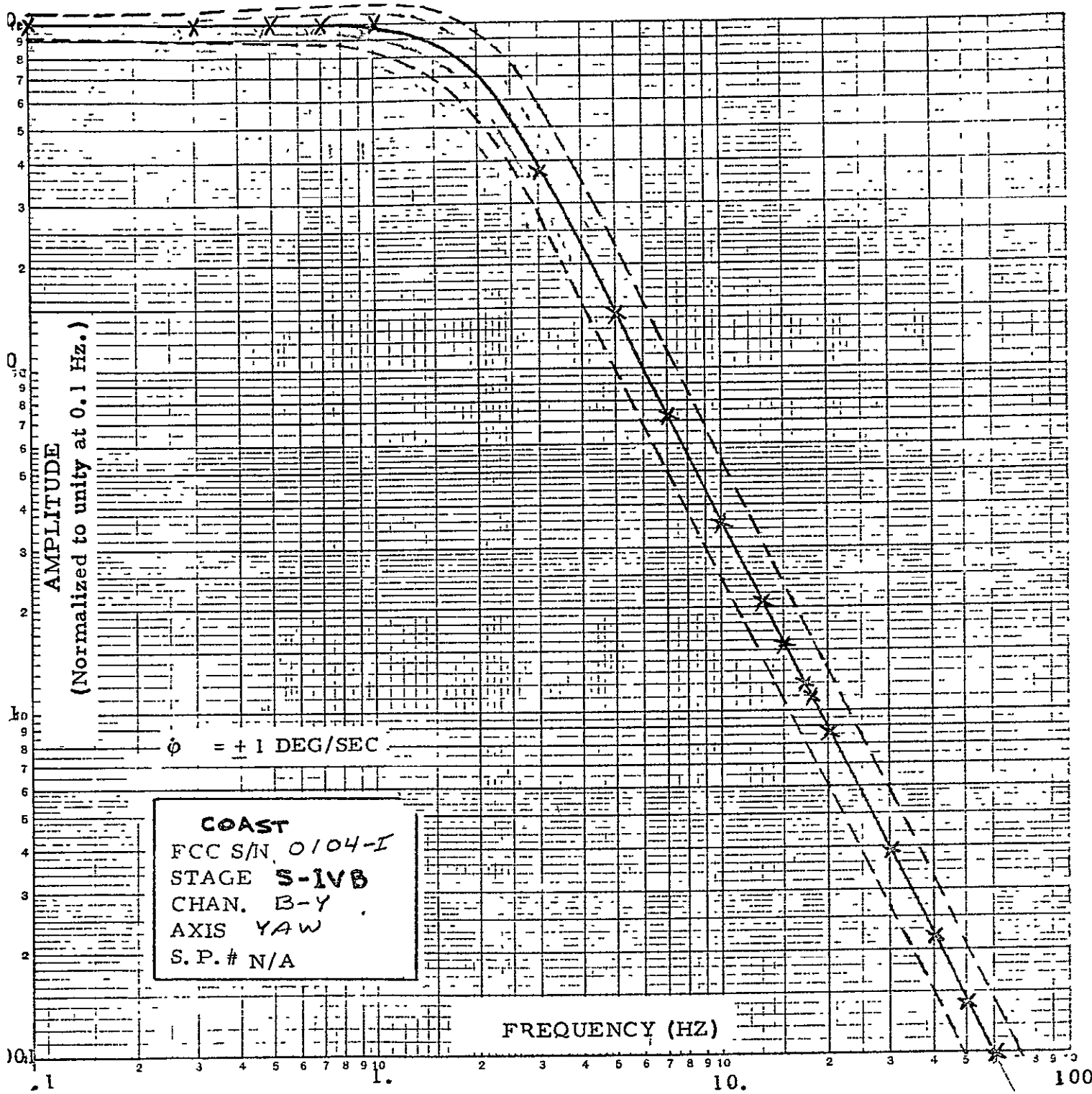

FREQUENCY RESPONSE REQUIREMENTS  
FOR THE 18 HZ. SPATIAL FILTER

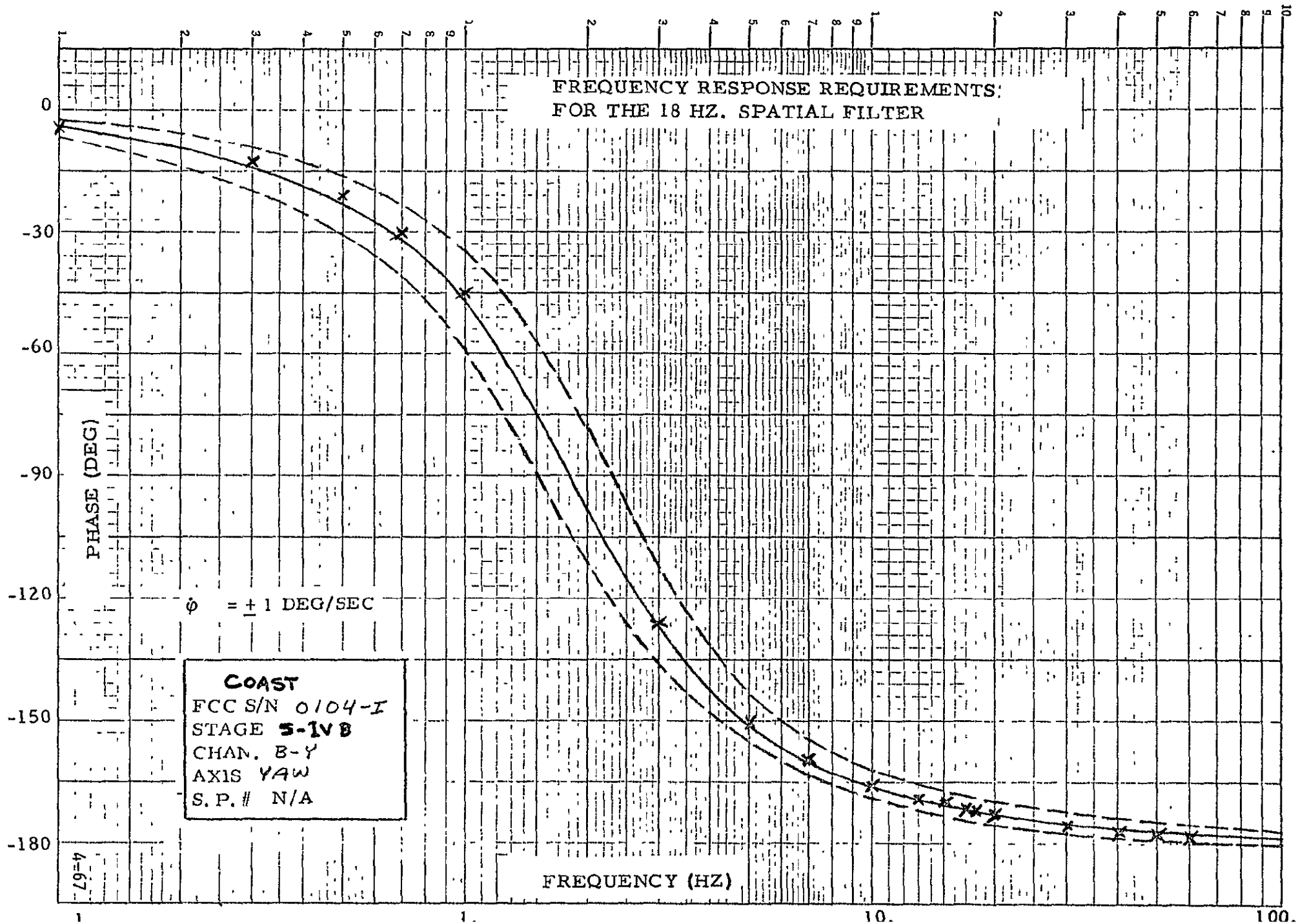



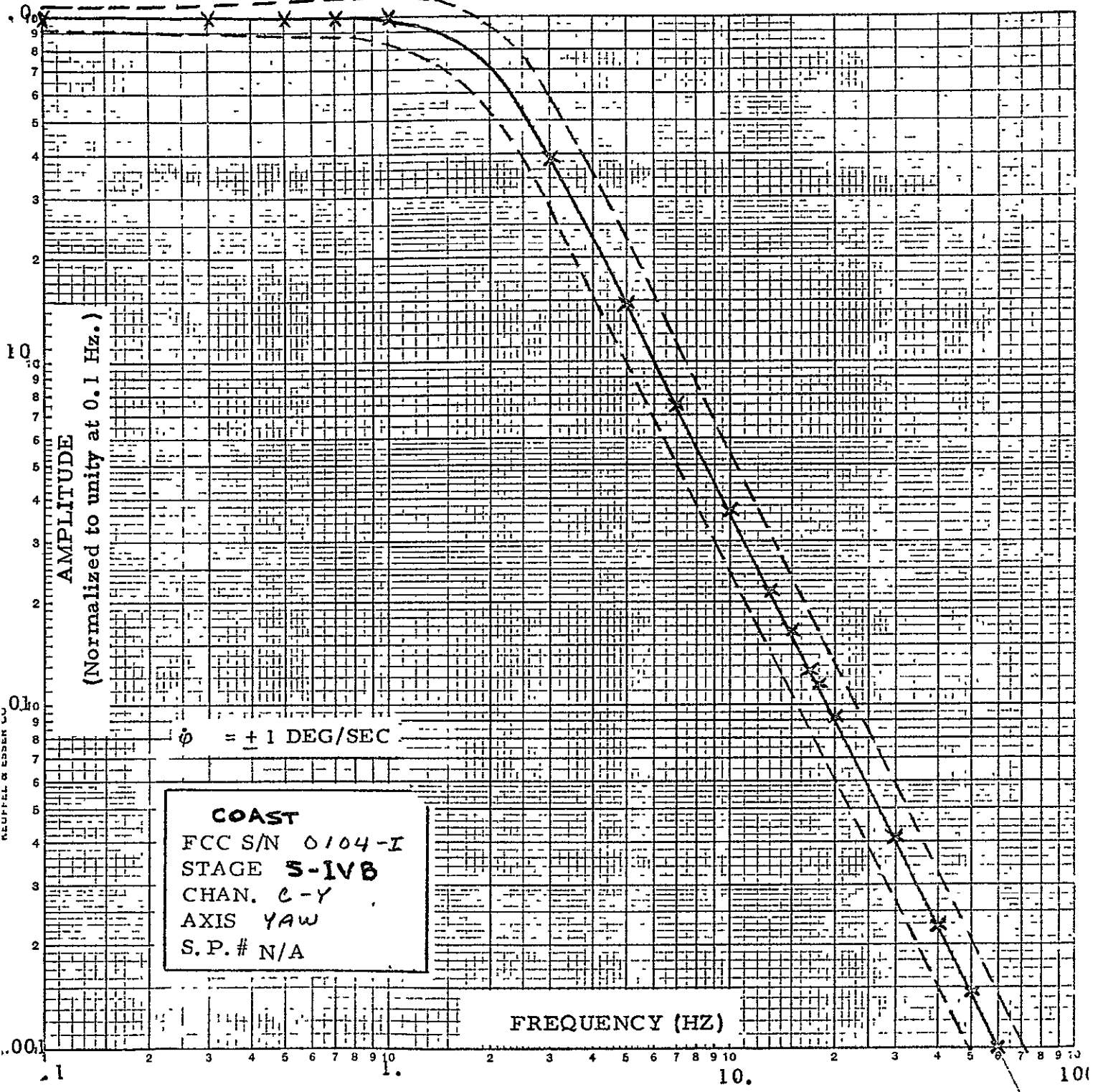

FREQUENCY RESPONSE REQUIREMENTS  
FOR THE 18 HZ. SPATIAL FILTER

### FREQUENCY RESPONSE REQUIREMENTS FOR THE 18 HZ. SPATIAL FILTER

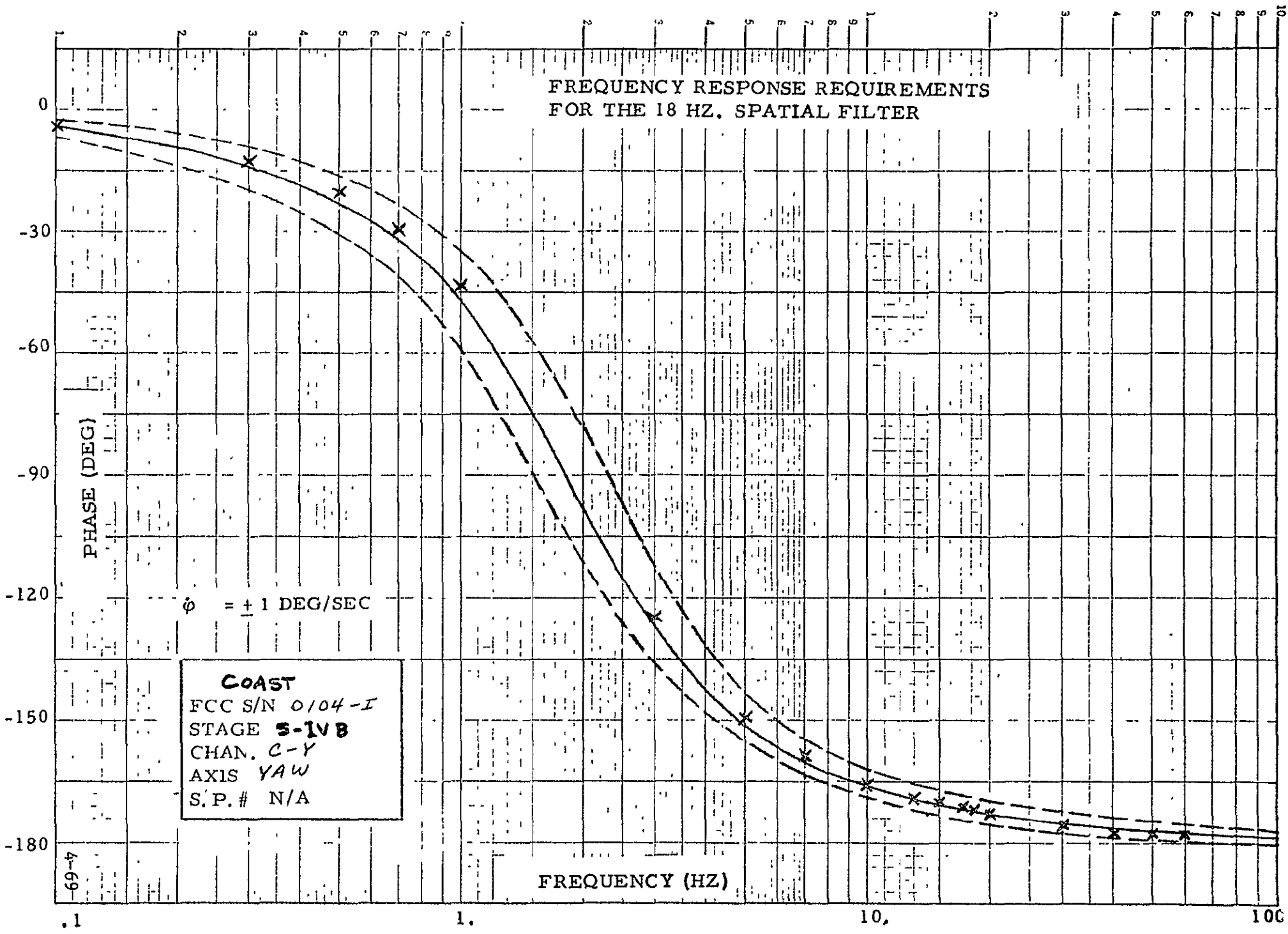

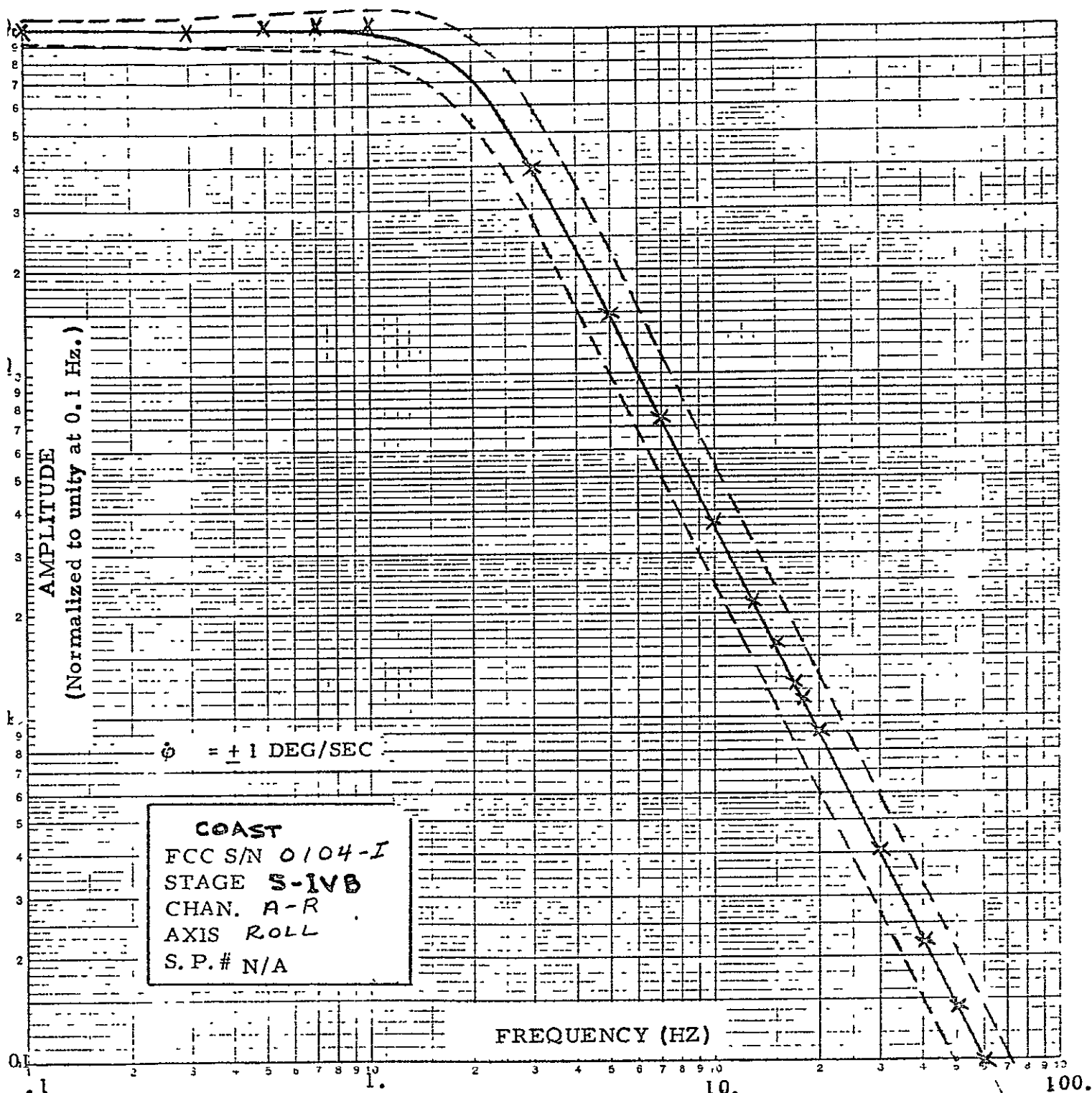

ORIGINAL PAGE IS  
OF POOR QUALITY

FREQUENCY RESPONSE REQUIREMENTS  
FOR THE 18 HZ. SPATIAL FILTER

### FREQUENCY RESPONSE REQUIREMENTS FOR THE 18 HZ. SPATIAL FILTER

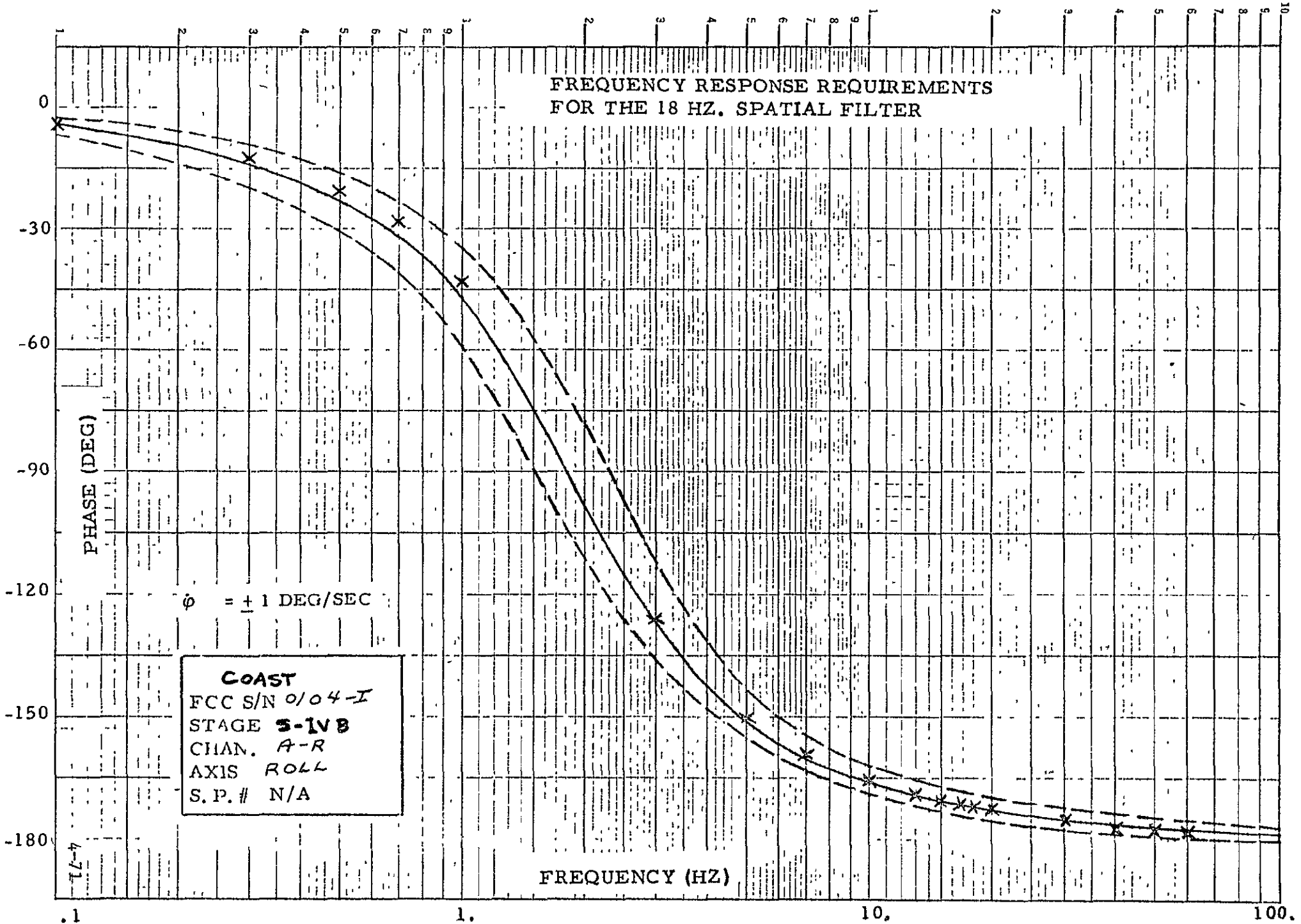

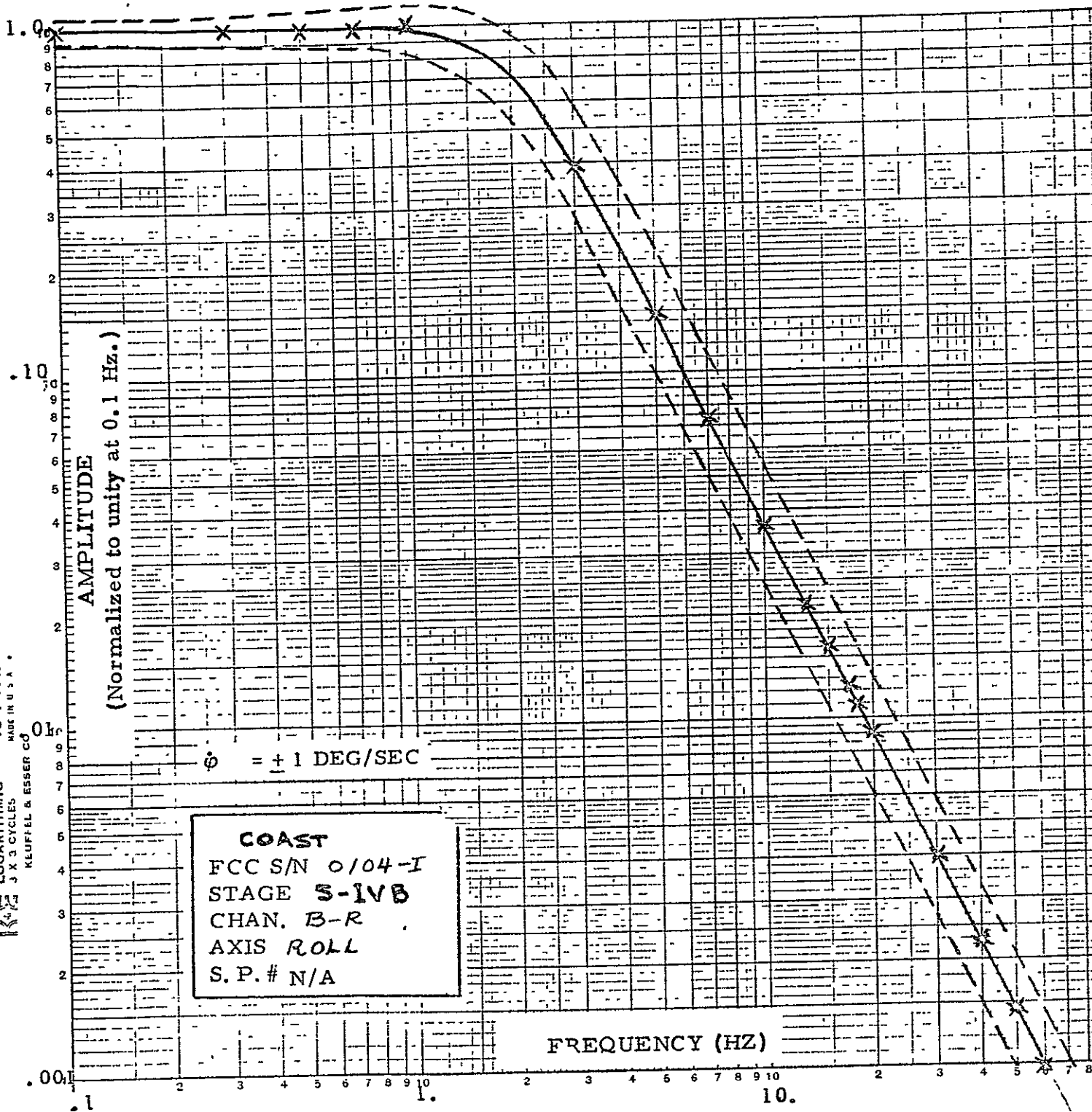

FREQUENCY RESPONSE REQUIREMENTS  
 FOR THE 18 HZ. SPATIAL FILTER

### FREQUENCY RESPONSE REQUIREMENTS FOR THE 18 HZ. SPATIAL FILTER

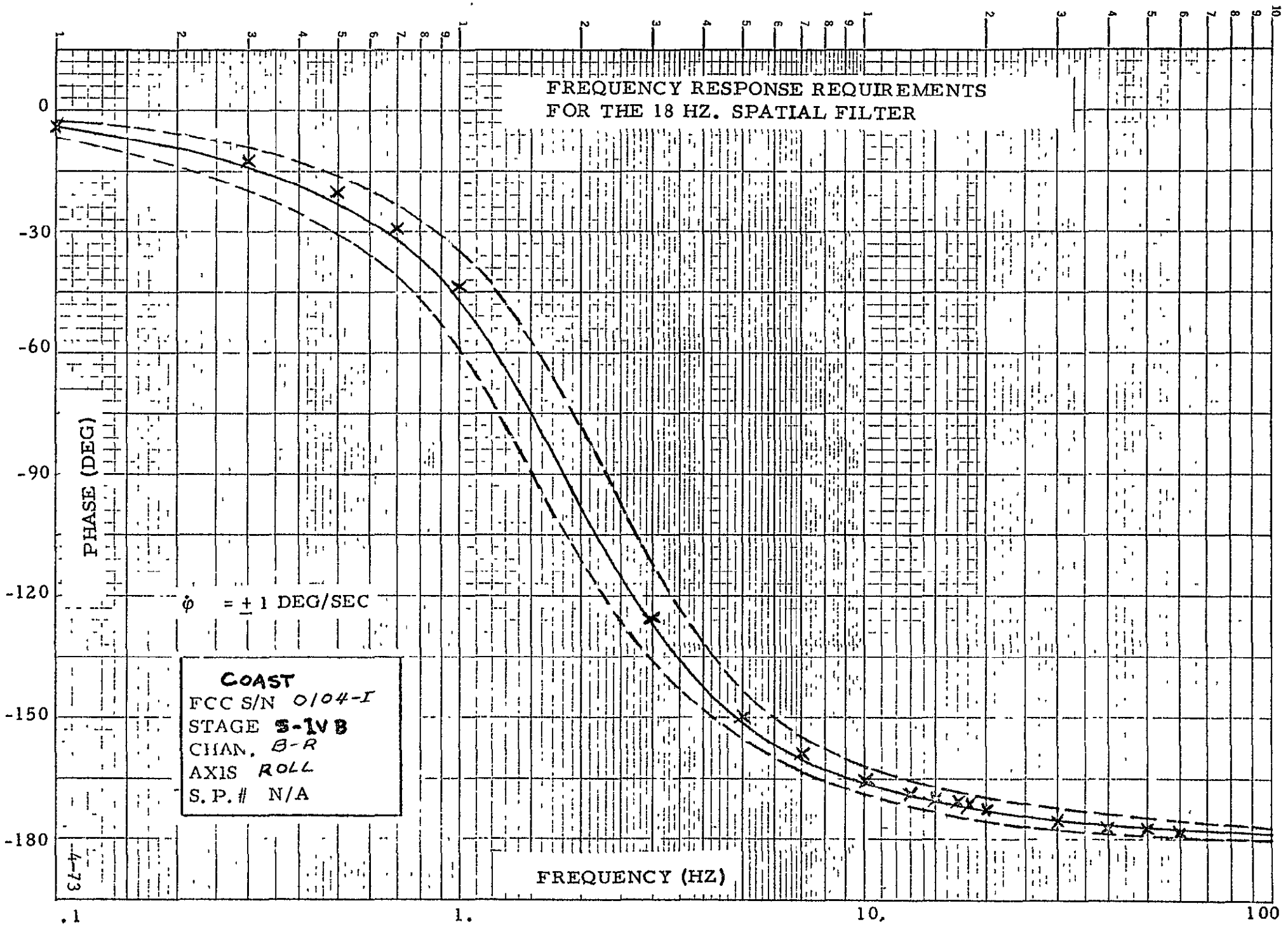

4-73

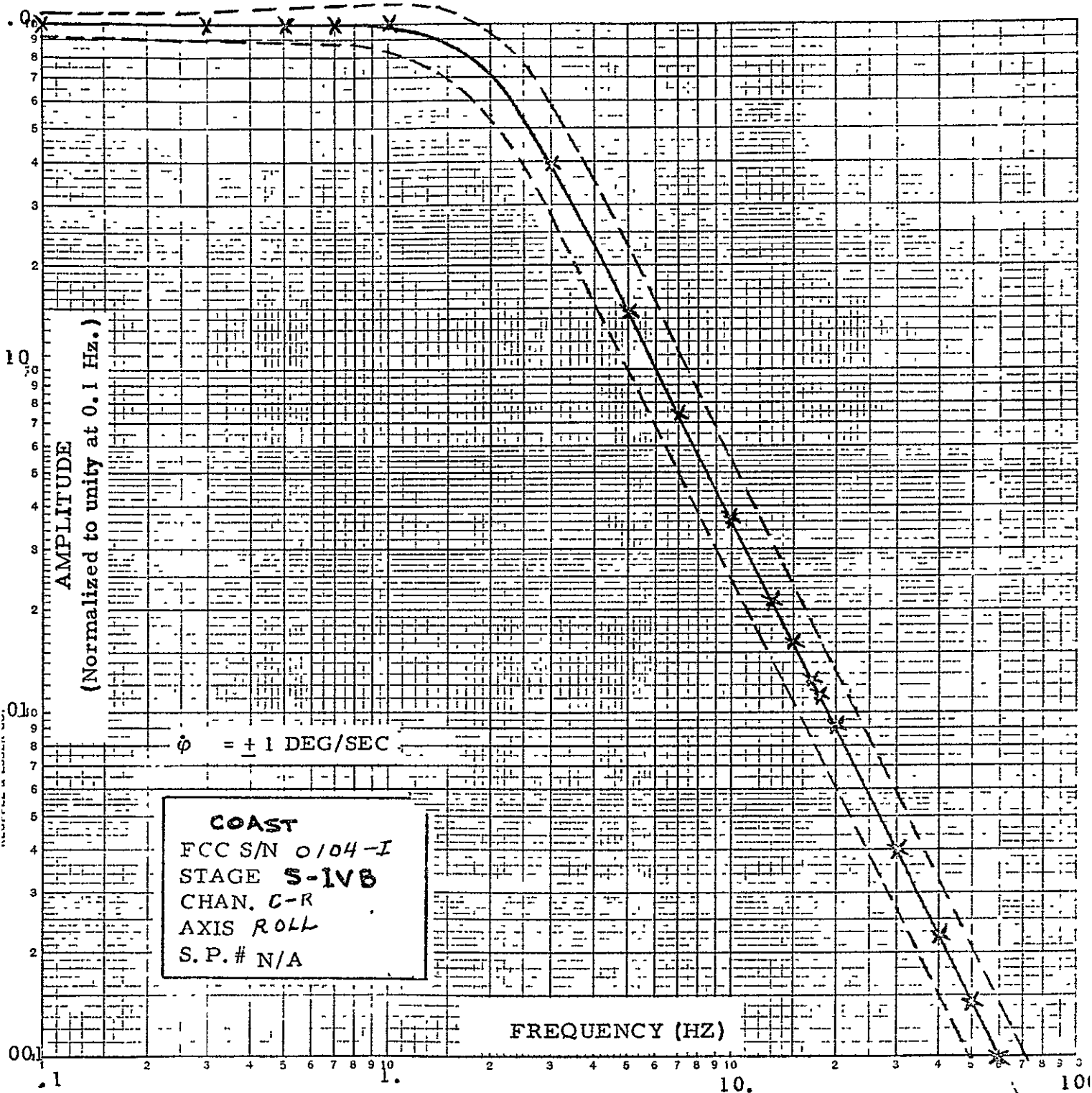

FREQUENCY RESPONSE REQUIREMENTS  
FOR THE 18 HZ. SPATIAL FILTER

ORIGINAL PAGE IS  
OF POOR QUALITY

FREQUENCY RESPONSE REQUIREMENTS  
FOR THE 18 HZ. SPATIAL FILTER

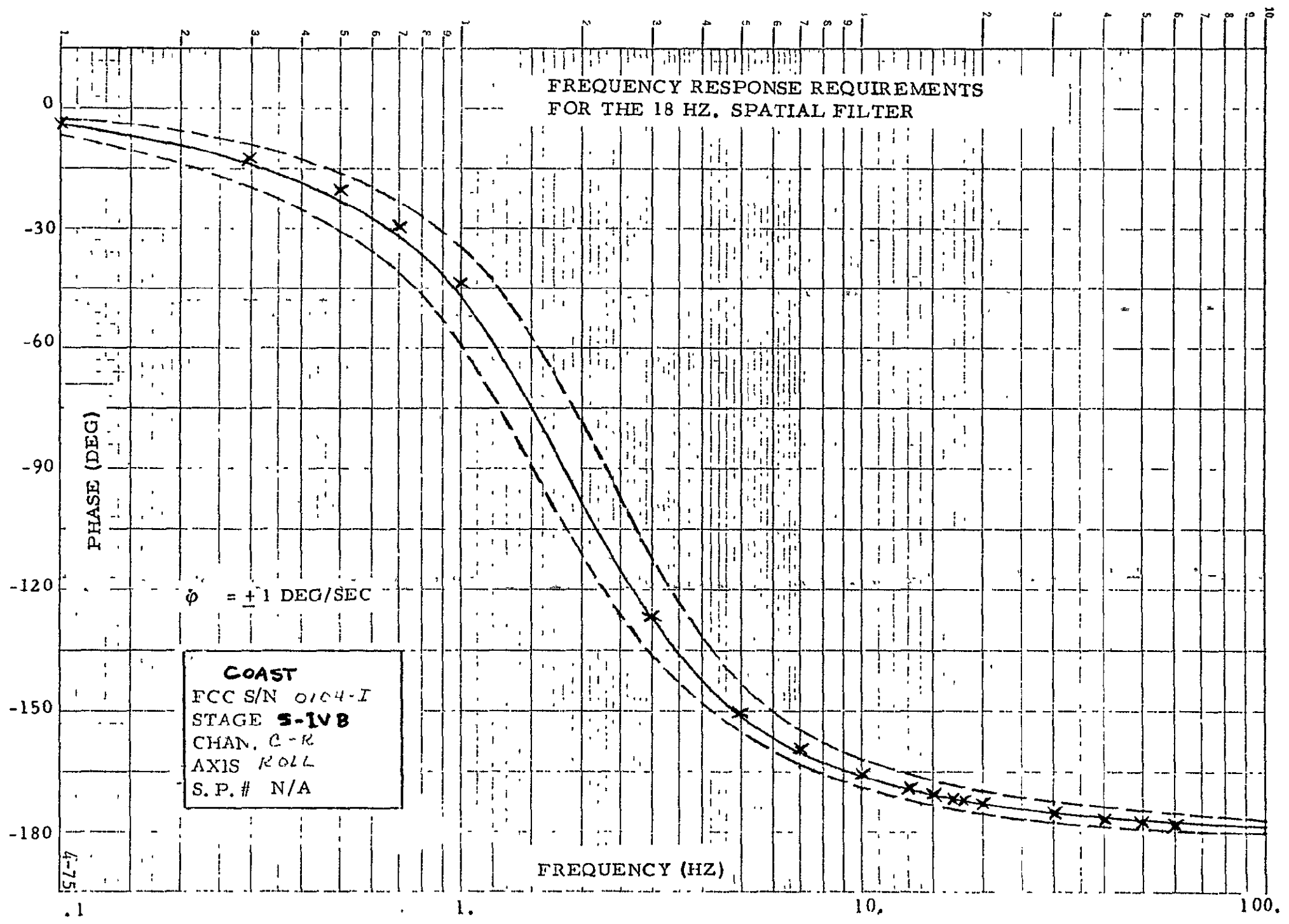



Appendix A

SWITCHPOINT UTILIZATION

## Appendix A

### SWITCHPOINT UTILIZATION

#### A.1 TEST PURPOSE

This test verifies that the proper attitude error and attitude rate channel control gains are activated at the proper switch point. In addition, it determines that each servo amplifier addresses an actuator with the correct relative polarity.

#### A.2 TEST RESULTS

This test is applicable to both stages, therefore, it is presented in the Appendix. All  $A_0$  channel outputs were obtained by applying 1 degree to the  $\psi$  input channels; similarly, all  $A_1$  channel outputs resulted from the application of 1 degree/second to the  $\phi$  input channels.

The control gain switching results are presented on page A-2. An analysis of these results can be summarized as follows:

- Control gain switching and vehicle staging were achieved as commanded.
- The static gain magnitudes are correct within allowable tolerances.
- Relative polarities of the respective servo amplifier outputs are correct.

TEST REQUIREMENTS				
Stage	Sw. Pt.	Axis	Outputs (divisions)	
			$\dot{\psi} = +1^\circ$	$\dot{\psi} = -1^\circ/\text{sec.}$
S-IB	0	P/Y	29.6	26.4
S-IB	2	P/Y	17.6	20.8
S-IB	3	P/Y	8.8	9.6
S-IB	0	ROLL	33.9	31.7
S-IB	2	ROLL	27.2	19.2
S-IB	3	ROLL	27.2	19.2
S-IVB	3	P/Y	32.9	19.9
S-IVB	4	P/Y	32.9	19.9
S-IVB	5	P/Y	32.9	15.3

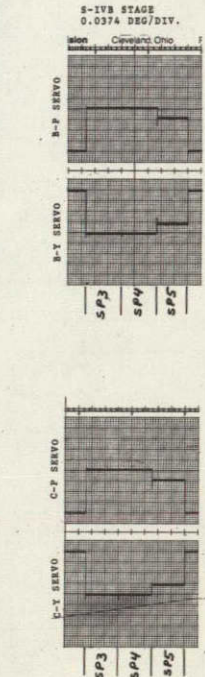
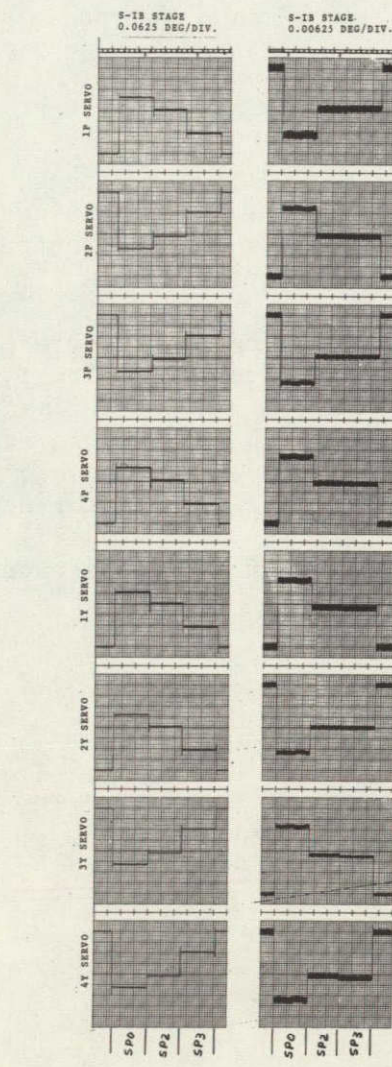
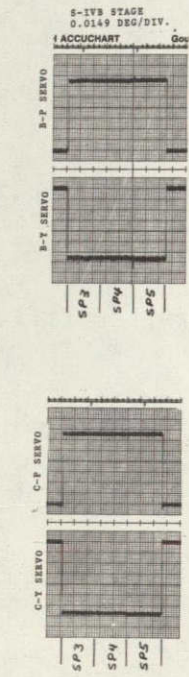
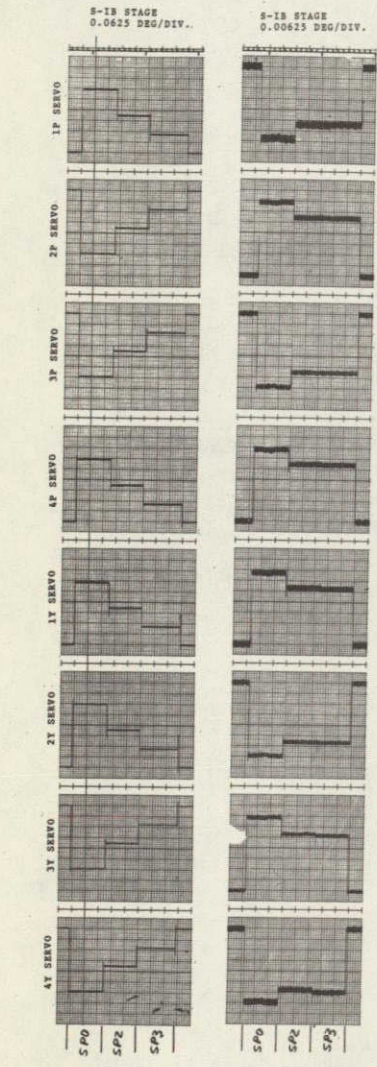

A<sub>0</sub> P-Y STATIC GAIN SWITCHING  
ψ = 0.8 V INPUT

A<sub>0</sub> ROLL STATIC GAIN SWITCHING  
ψ = 0.8 V INPUT

A<sub>1</sub> P-Y STATIC GAIN SWITCHING  
ψ = 4.5 V INPUT

A<sub>1</sub> ROLL STATIC GAIN SWITCHING  
ψ = 4.5 V INPUT

SWITCH POINT UTILIZATION FOR ONE UNIT OF INPUT

ORIGINAL PAGE IS  
OF POOR QUALITY

Appendix B

SPACECRAFT CONTROL

## Appendix B

### SPACECRAFT CONTROL

#### B.1 TEST PURPOSE

This test verifies that the FCC honors the spacecraft attitude error inputs with the proper gain increase when going from IU control to spacecraft (S/C) control.

#### B.2 TEST RESULTS

This test is applicable to both stages; therefore it is presented in the appendix. All  $A_0$  channel outputs were obtained by applying 1 degree to the  $\psi$  input channels.

The  $\psi$  channel gains resulting from energizing the S/C control relays are presented on page B-2. An analysis of these results can be summarized as follows:

- The FCC honors the spacecraft pitch and yaw attitude error inputs in the S-IB and S-IVB modes.
- The pitch and yaw attitude error channels have the correct increase in  $A_0$  channel gain (10/3.75) for S/C control.
- The FCC honors the spacecraft roll attitude error input, and the correct increase in the A channel gain (20/3.75) is achieved.

TEST REQUIREMENTS							
Stage	Sw.	Pt.	Azim (deg)	IU CONTROL		SC CONTROL	
				Y	Outputs (deg) ± 4%	Y	Outputs (deg) ± 4%
S-1B	0	P/Y	0.375	11.1	1.0	29.6	
S-1B	2	P/Y	0.375	6.6	1.0	17.6	
S-1B	3	P/Y	0.375	3.3	1.0	8.8	
S-1B	0	ROLL	0.375	6.4	2.0	33.9	
S-1B	2	ROLL	0.375	5.1	2.0	27.2	
S-1B	3	ROLL	0.375	5.1	2.0	27.2	
S-1VB	1	P/Y	0.375	12.1	2.667	32.2	
S-1VB	4	P/Y	1	13.1	2.667	35.0	
S-1VB	5	P/Y	1	13.1	2.667	35.0	

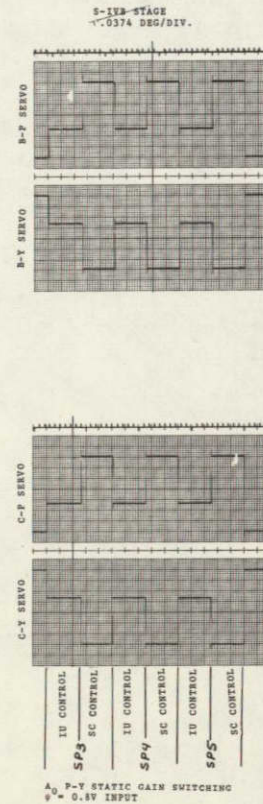
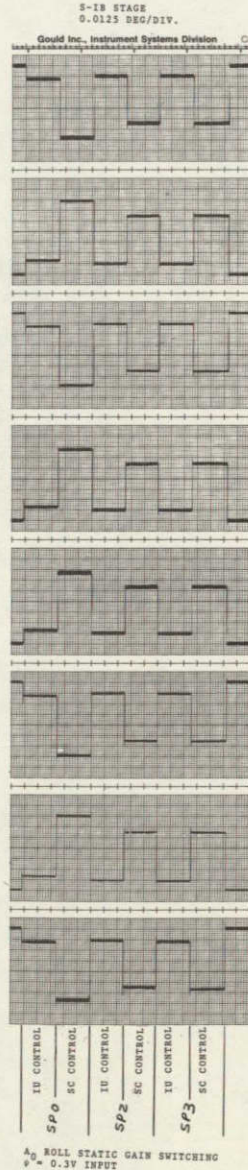
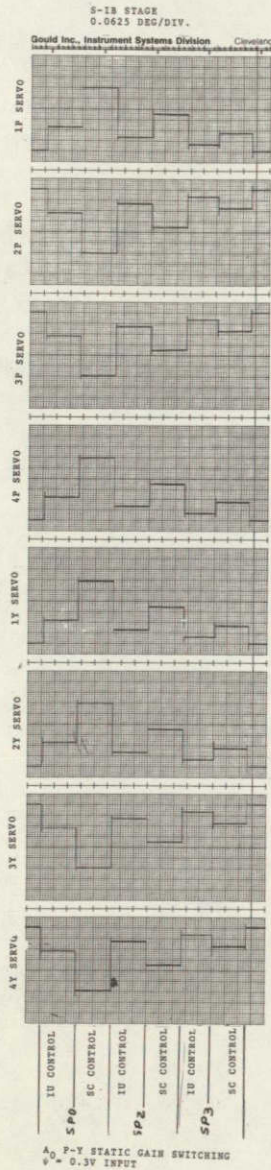

GAIN CHANGE IN THE ATTITUDE  
ERROR CHANNEL FOR SPACECRAFT CONTROL

ORIGINAL PAGE IS  
OF POOR QUALITY

## Appendix C

SERVO AMPLIFIER NOISE WITH 28-VOLT POWER SUPPLY VARIATION

## Appendix C

### SERVO AMPLIFIER NOISE WITH 28-VOLT POWER SUPPLY VARIATION

#### C.1 TEST PURPOSE

Since the 28-volt power supply varies throughout flight, there is concern for servo amplifier noise characteristics under these conditions. In particular, spurious oscillations can occur at a servo amplifier at other than the nominal 28-volt power supply setting.

#### C.2 TEST RESULTS

As a matter of convenience, this test data is presented in an appendix rather than on a per-stage basis. The worst case analysis is presented on page C-2.



SERVO AMPLIFIER NOISE AS POWER SUPPLY  
IS VARIED 24 VOLTS TO 32 VOLTS

Stage	SP	Servo	Maximum Noise Characteristics	Power Supply Setting/Range
S-IB Prime Inverter, C.A.T. @ 0 Seconds	0	1P	28 mvp-p (Random)	31.900 vdc
		2P	12 mvp-p (Random)	24-32 vdc
		3P	14 mvp-p (Random)	31.900 vdc
		4P	24 mvp-p (Random)	31.900 vdc
		1Y	38 mvp-p (0.7 Hz)	24.100 vdc
		2Y	26 mvp-p (0.7 Hz)	24.100 vdc
		3Y	19 mvp-p (0.7 Hz)	24.100 vdc
		4Y	36 mvp-p (0.7 Hz)	24.100 vdc
S-IB Prime Inverter, C.A.T. @ 70 Seconds	0	1P	34 mvp-p (Random)	24.550 vdc
		2P	14 mvp-p (Random)	24.550 vdc
		3P	16 mvp-p (Random)	24.550 vdc
		4P	28 mvp-p (Random)	24.550 vdc
		1Y	42 mvp-p (Random)	24.050 vdc
		2Y	28 mvp-p (Random)	24.050 vdc
		3Y	21 mvp-p (Random)	24.050 vdc
		4Y	42 mvp-p (Random)	24.050 vdc
S-IB Spare Inverter, C.A.T. @ 0 Seconds	0	1P	24 mvp-p (Random)	24.130 vdc
		2P	9 mvp-p (0.35 Hz)	29.250 vdc
		3P	12 mvp-p (Random)	24.130 vdc
		4P	19 mvp-p (Random)	24.130 vdc
		1Y	54 mvp-p (Random with Spikes)	24.000 vdc
		2Y	30 mvp-p (Random with Spikes)	24.000 vdc
		3Y	25 mvp-p (Random with Spikes)	24.000 vdc
		4Y	52 mvp-p (Random with Spikes)	24.000 vdc
S-IB Spare Inverter, C.A.T. @ 70 Seconds	0	1P	40 mvp-p (Random with 2.8 Hz Spikes)	24.200 vdc
		2P	13 mvp-p (Random with 2.8 Hz Spikes)	24.200 vdc
		3P	19 mvp-p (Random with 2.8 Hz Spikes)	24.200 vdc
		4P	30 mvp-p (Random with 2.8 Hz Spikes)	24.200 vdc
		1Y	58 mvp-p (Random with 2.8 Hz Spikes)	24.200 vdc
		2Y	29 mvp-p (Random with 2.8 Hz Spikes)	24.200 vdc
		3Y	27 mvp-p (Random with 2.8 Hz Spikes)	24.200 vdc
		4Y	54 mvp-p (Random with 2.8 Hz Spikes)	24.200 vdc

NOTES:

Data Recorded: 11/20/74

(1) Specification

- S-IB  $\leq$  60 mv p-p at  $\leq$  30 Hz. average per axis.
- S-IB  $\leq$  100mv p-p at  $\leq$  30 Hz. any servo.
- S-IVB  $\leq$  5 mv p-p at  $\leq$  30 Hz. any servo.

(2) All peripheral sensors powered off.

SERVO AMPLIFIER NOISE AS POWER SUPPLY  
IS VARIED 24 VOLTS TO 32 VOLTS

Stage	SP	Servo	Maximum Noise Characteristics	Power Supply Setting/Range
S-IVB	3	B-P B-Y C-P C-Y	No servo amplifier noise variations were observed.	24-32 vdc

NOTES:

Date Recorded: 11/20/74

- (1) Specification
  - S-IB  $\leq$  60 mv p-p at  $\leq$  30 Hz. average per axis.
  - S-IB  $\leq$  100mv p-p at  $\leq$  30 Hz. any servo.
  - S-IVB  $\leq$  5 mv p-p at  $\leq$  30 Hz. any servo.
- (2) All peripheral sensors powered off.

SERVO AMPLIFIER NOISE AS POWER SUPPLY  
IS VARIED 27 VOLTS TO 29 VOLTS

Stage	SP	Servo	Maximum Noise Characteristics	Power Supply Setting/Range
S-IB Prime Inverter, C.A.T. @ 0 Seconds	0	1Y	24 mvp-p (0.9 Hz)	27.280 vdc
		2Y	13 mvp-p (0.9 Hz)	27.280 vdc
		3Y	10 mvp-p (0.9 Hz)	27.280 vdc
		4Y	24 mvp-p (0.9 Hz)	27.280 vdc
S-IB Prime Inverter, C.A.T. @ 70 Seconds	0	1Y	28 mvp-p (0.8 Hz)	27.330 vdc
		2Y	17 mvp-p (0.8 Hz)	27.330 vdc
		3Y	14 mvp-p (0.8 Hz)	27.330 vdc
		4Y	30 mvp-p (0.8 Hz)	27.330 vdc
S-IB Spare Inverter, C.A.T. @ 0 Seconds	0	1Y	24 mvp-p (0.4 Hz)	27.350 vdc
		2Y	13 mvp-p (0.4 Hz)	27.350 vdc
		3Y	11 mvp-p (0.4 Hz)	27.350 vdc
		4Y	24 mvp-p (0.4 Hz)	27.350 vdc
S-IB Spare Inverter, C.A.T. @ 70 Seconds	0	1Y	22 mvp-p (0.3 Hz)	27.400 vdc
		2Y	18 mvp-p (0.3 Hz)	27.400 vdc
		3Y	15 mvp-p (0.3 Hz)	27.400 vdc
		4Y	30 mvp-p (0.3 Hz)	27.400 vdc

NOTES:

Date Recorded: 11/20/74

(1) Specification

- S-IB  $\leq$  60 mv p-p at  $\leq$  30 Hz. average per axis.
- S-IB  $\leq$  100mv p-p at  $\leq$  30 Hz. any servo.
- S-IVB  $\leq$  5 mv p-p at  $\leq$  30 Hz. any servo.

(2) All peripheral sensors powered off.

Appendix D

SERVO AMPLIFIER NULL AND NOISE CHARACTERISTICS

## Appendix D

### SERVO AMPLIFIER NULL AND NOISE CHARACTERISTICS

#### D.1 TEST PURPOSE

This test verifies that the servo amplifier null and noise characteristics with input signals absent are acceptable.

#### D.2 TEST RESULTS

Servo amplifier null and noise values for the S-IB and S-IVB stages are tabulated in the body of this report. The actual null and noise traces are included in this appendix to provide a graphical representation of the S-IB and S-IVB servo amplifier null and noise characteristics. Null and noise characteristics with FCC power on for 30 minutes and with power on for 210 minutes are contained on pages D-2 and D-3, respectively.



S-1B STAGE

PRIME INVERTER

SPARE INVERTER

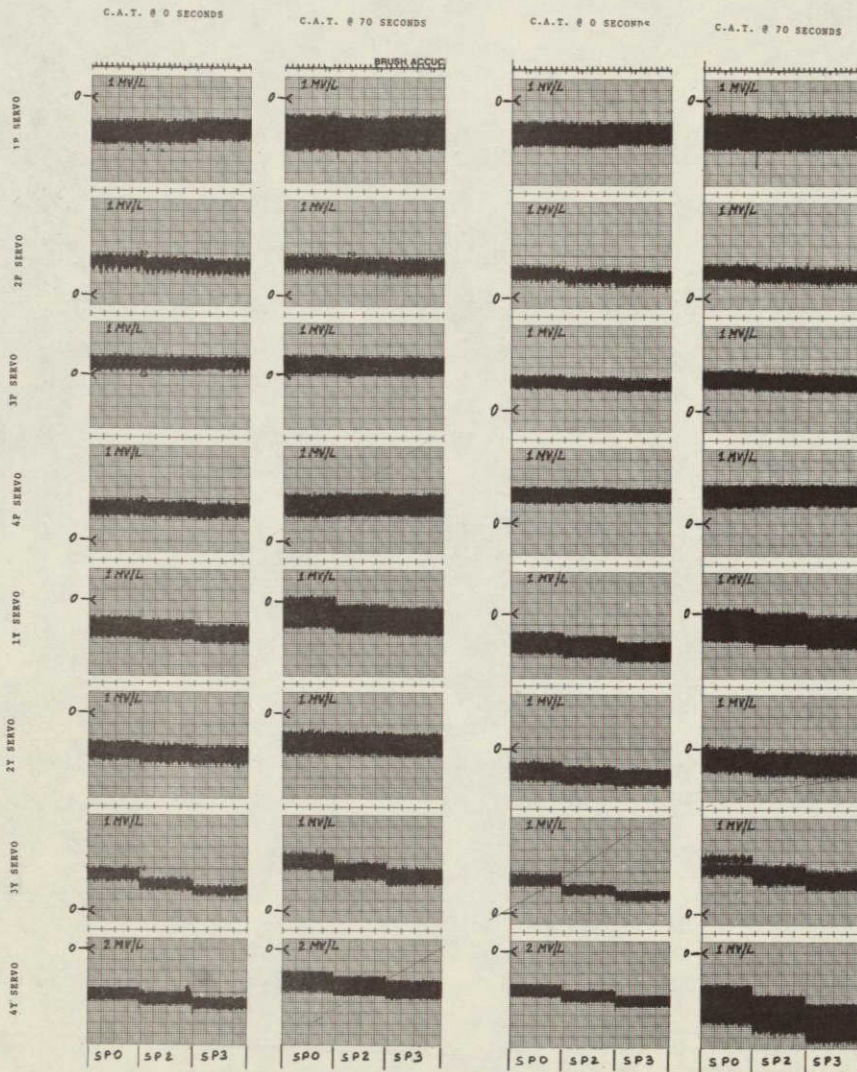

TIME SCALE: 2 MM/SEC

S-1VB STAGE

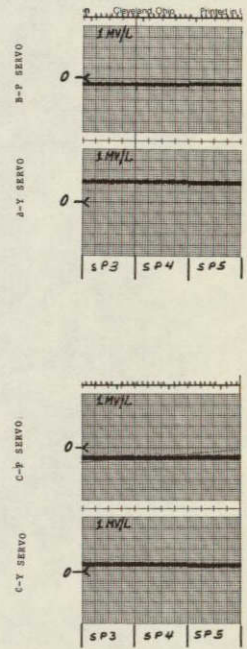

SERVO AMPLIFIER NULL & NOISE CHARACTERISTICS  
 FCC POWER ON FOR 110 MINUTES

ORIGINAL PAGE IS  
 OF POOR QUALITY

Appendix E

SIM LAB RG/CSP AND ACCELEROMETER FREQUENCY RESPONSES



## Appendix E

### SIM LAB RG/CSP AND ACCELEROMETER FREQUENCY RESPONSES

#### E.1 TEST PURPOSE

The signal sources, or sensors, for the FCC attitude rate and lateral acceleration channels are the Rate Gyro/Control Signal Processor (RG/CSP) subsystem and the Control Accelerometers, respectively. Frequency responses of these sensors can be of value in evaluating the open loop frequency responses of the FCC attitude rate and lateral acceleration channels. The RG/CSP frequency responses are also useful in analyzing the closed loop Nyquist responses.

#### E.2 TEST RESULTS

The RG/CSP subsystem and Control Accelerometer frequency response data, plotted on theoretical curves for comparative purposes, is presented on pages E-2 to E-29. Since the sensors are external to the FCC, this data is presented without comment as to its acceptability.



SATURN RATE GYRO/CSP OPEN LOOP  
 FREQUENCY RESPONSE REQUIREMENTS

CURVE	GYRO		CSP
	$f_n$ (Hz)	$\zeta$	$\theta$ (s)
①	20	.7	without
②	20	.7	with
③	17	.6	with
④	17	.9	with
⑤	23	.6	without
⑥	23	.9	without

  

$$\theta(s) = \frac{1 - .0011585s}{1 + .0011585s}$$

X =  $\pm 5$  p/sec

SA- SIMLAB CCC#1  
 RG S/N 119  
 CSP S/N 1004  
 CHAN PRIME  
 AXIS PITCH

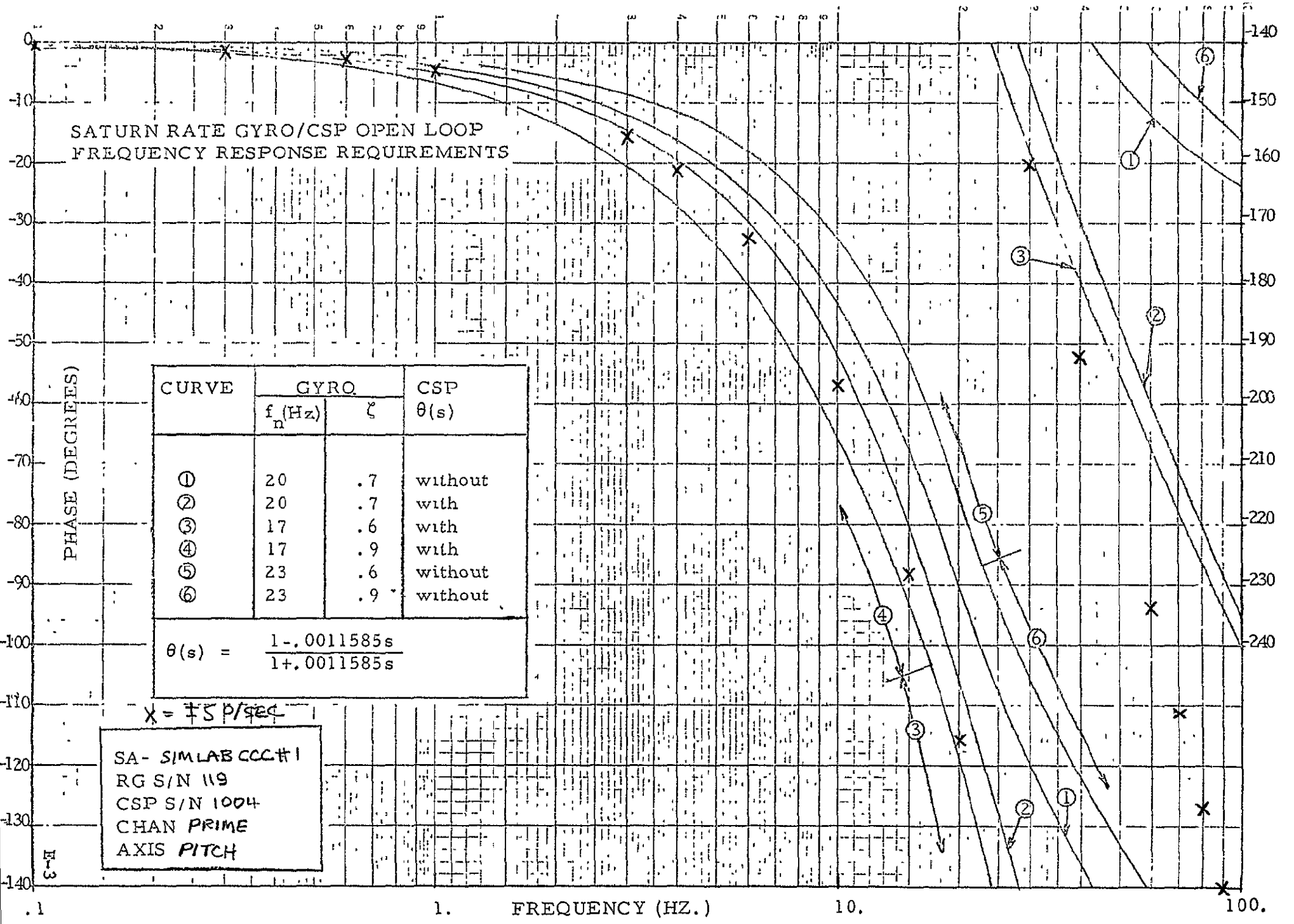

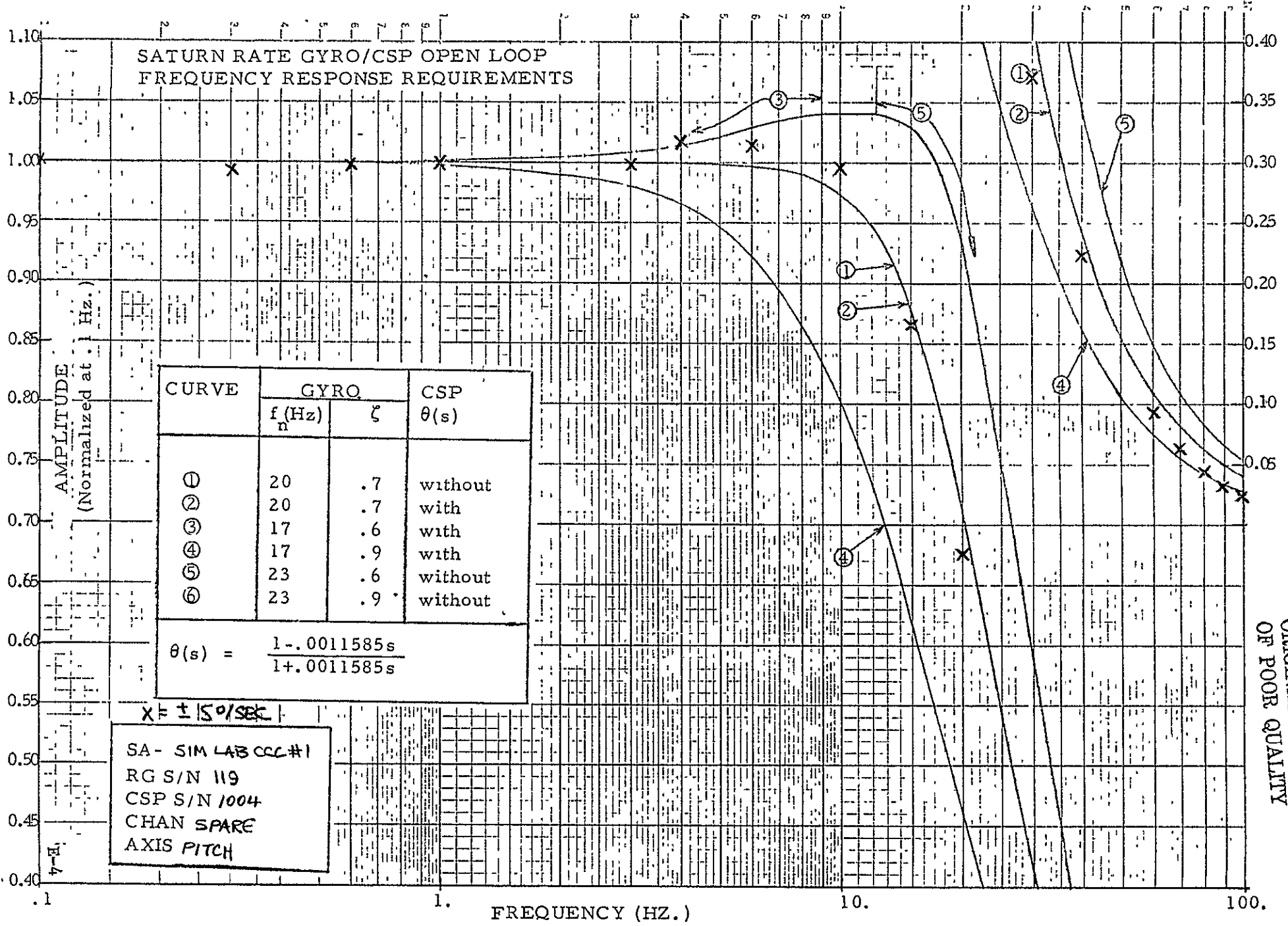

ORIGINAL PAGE IS  
 OF POOR QUALITY

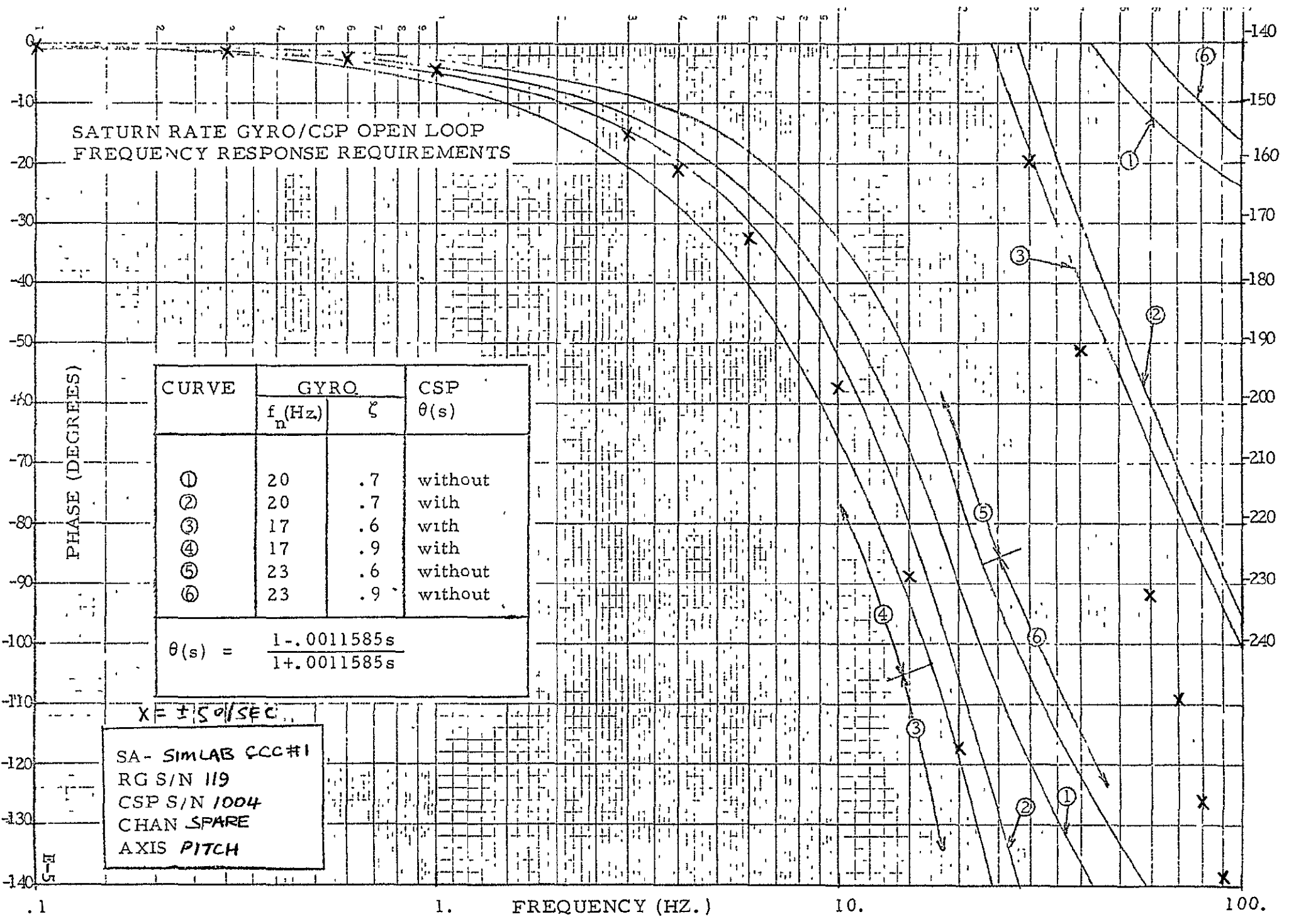

.1

1.

FREQUENCY (HZ.)

10.

100.

PHASE (DEGREES)

-10  
-20  
-30  
-40  
-50  
-60  
-70  
-80  
-90  
-100  
-110  
-120  
-130  
-140

-140  
-150  
-160  
-170  
-180  
-190  
-200  
-210  
-220  
-230  
-240

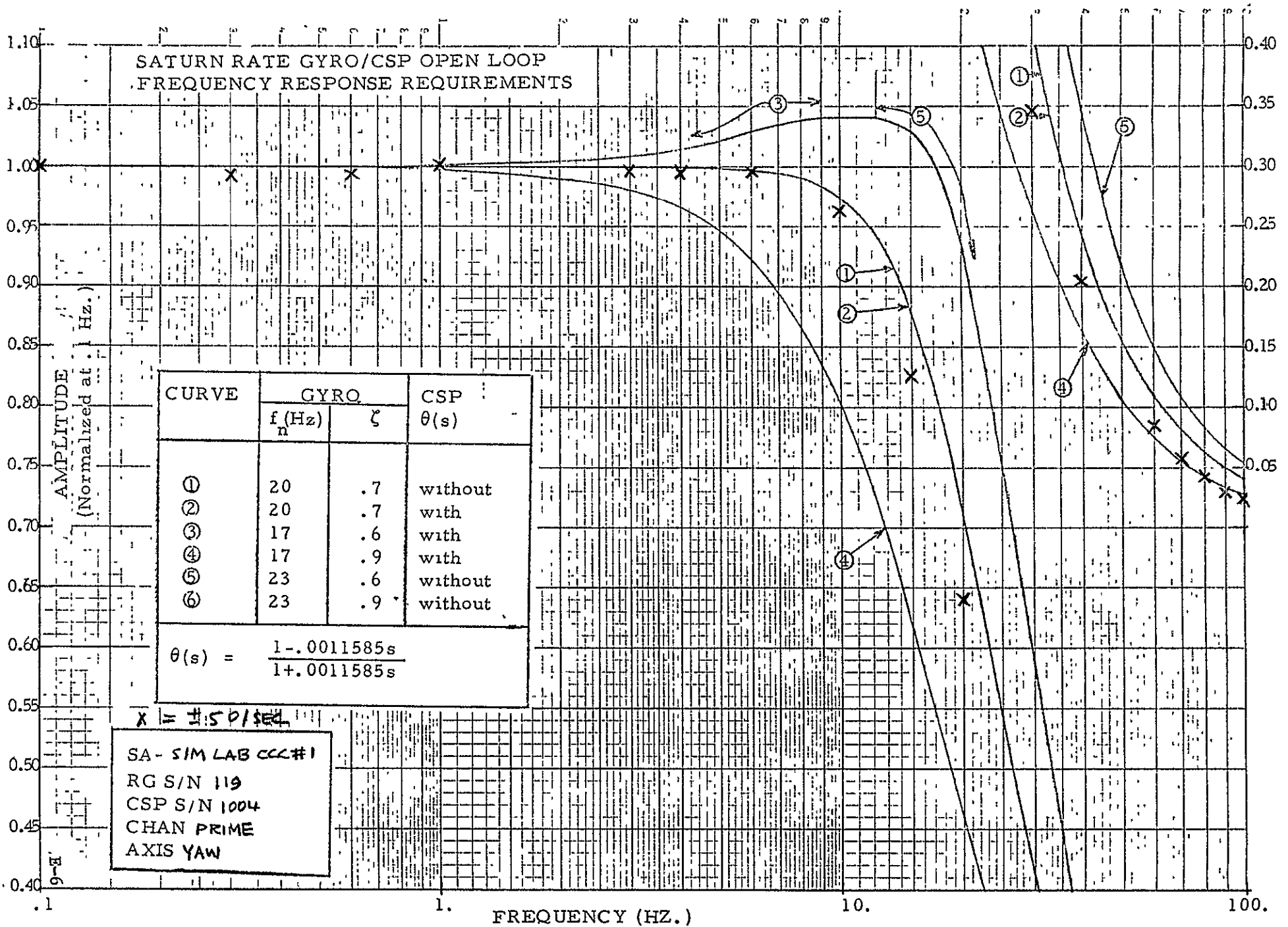

SATURN RATE GYRO/CSP OPEN LOOP  
 FREQUENCY RESPONSE REQUIREMENTS

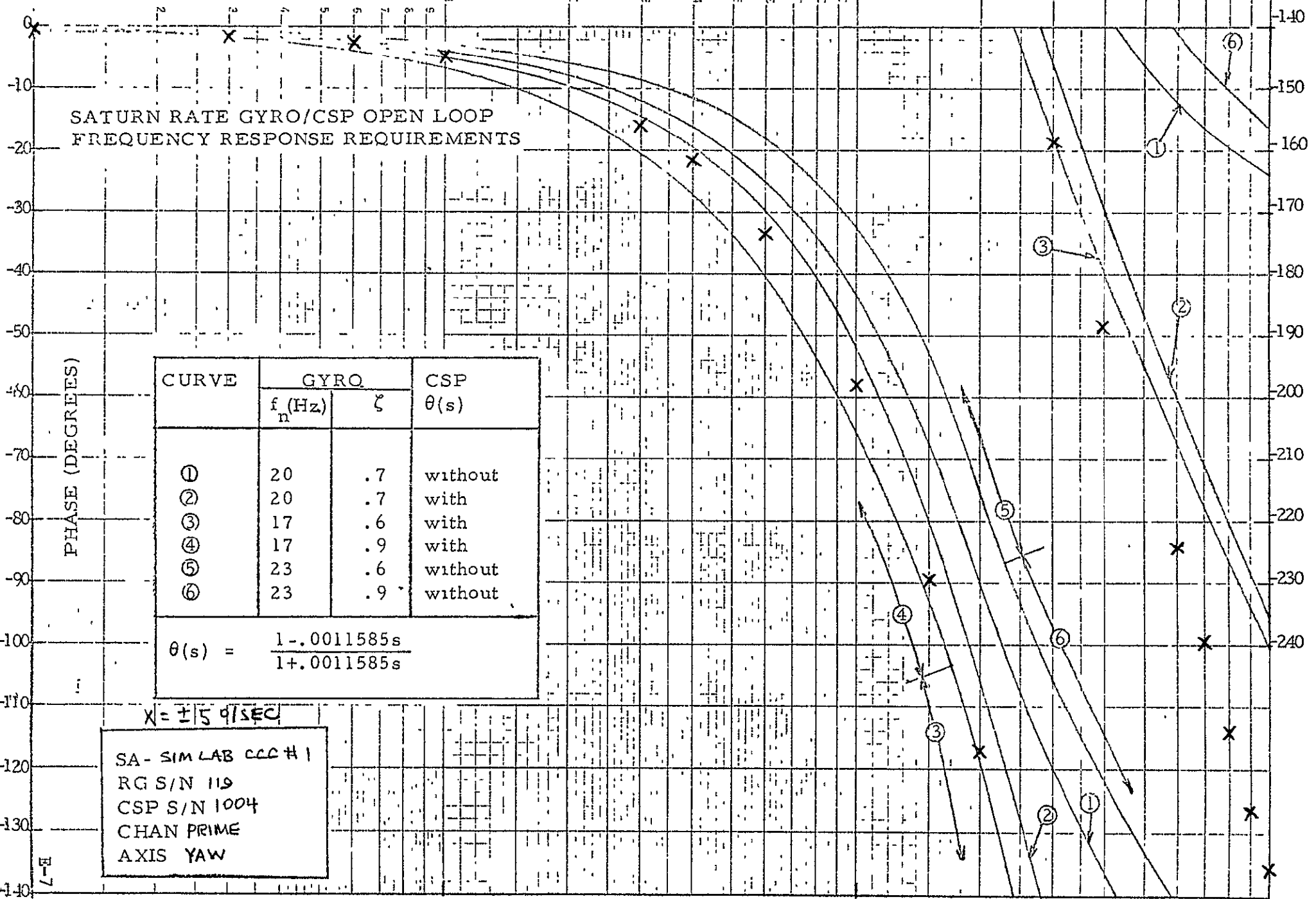

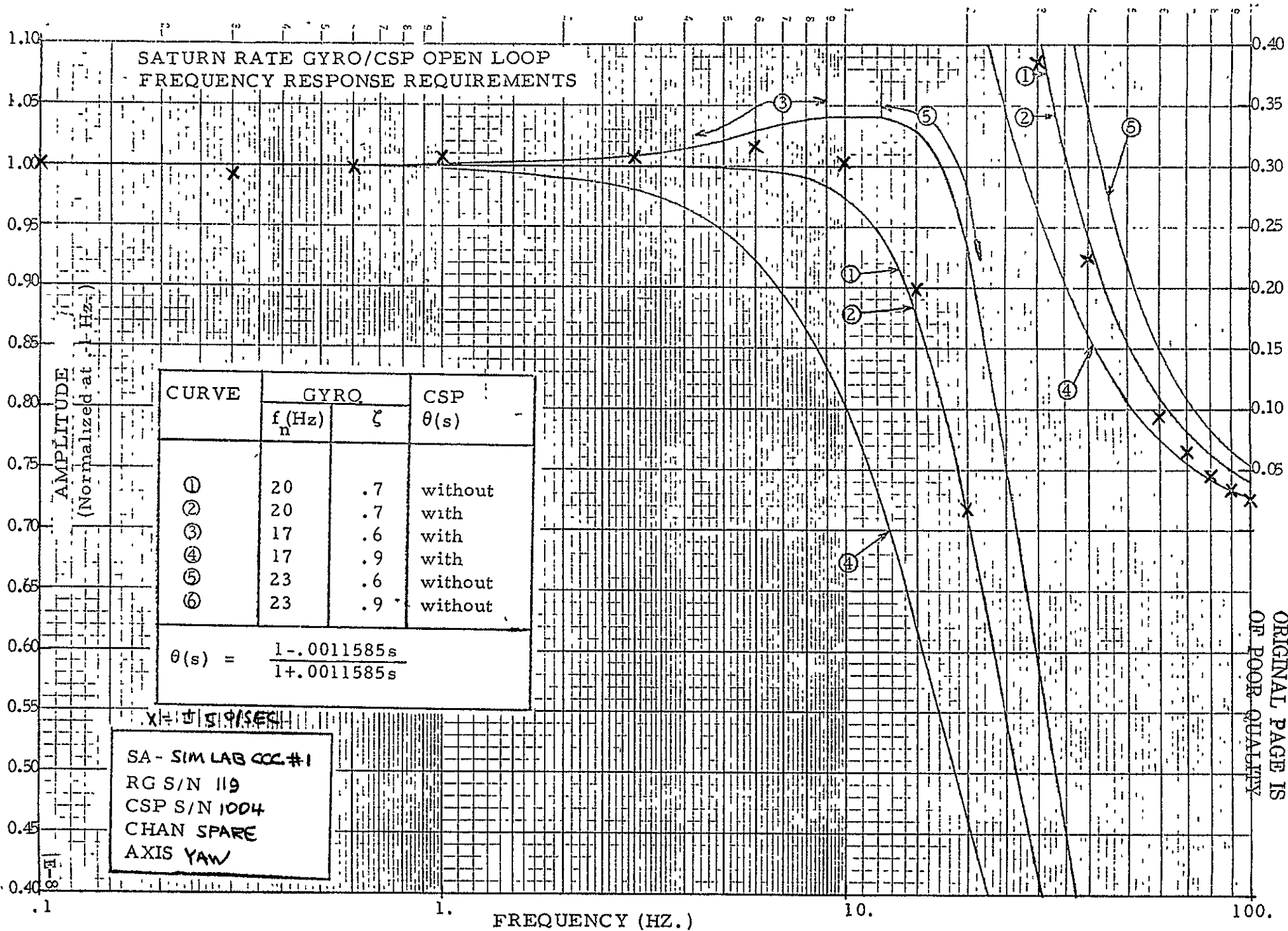

ORIGINAL PAGE IS  
 OF POOR QUALITY





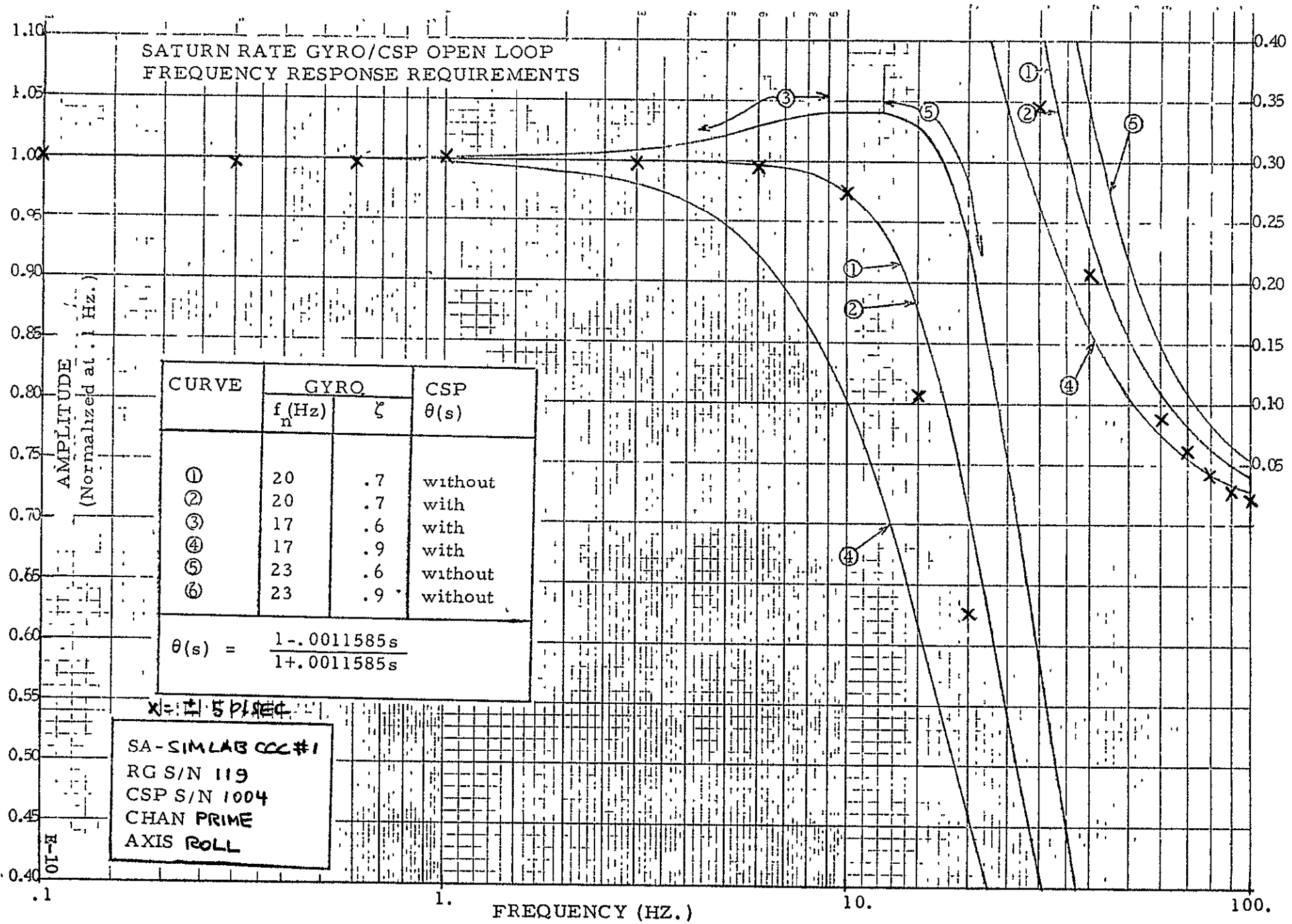

SATURN RATE GYRO/CSP OPEN LOOP  
 FREQUENCY RESPONSE REQUIREMENTS

CURVE	GYRO		CSP $\theta$ (s)
	$f_n$ (Hz)	$\zeta$	
①	20	.7	without
②	20	.7	with
③	17	.6	with
④	17	.9	with
⑤	23	.6	without
⑥	23	.9	without

$$\theta(s) = \frac{1 - .0011585s}{1 + .0011585s}$$

$X = F/50/SEC$

SA- SIM LAB CCC#1  
 RG S/N 119  
 CSP S/N 1004  
 CHAN PRIME  
 AXIS ROLL

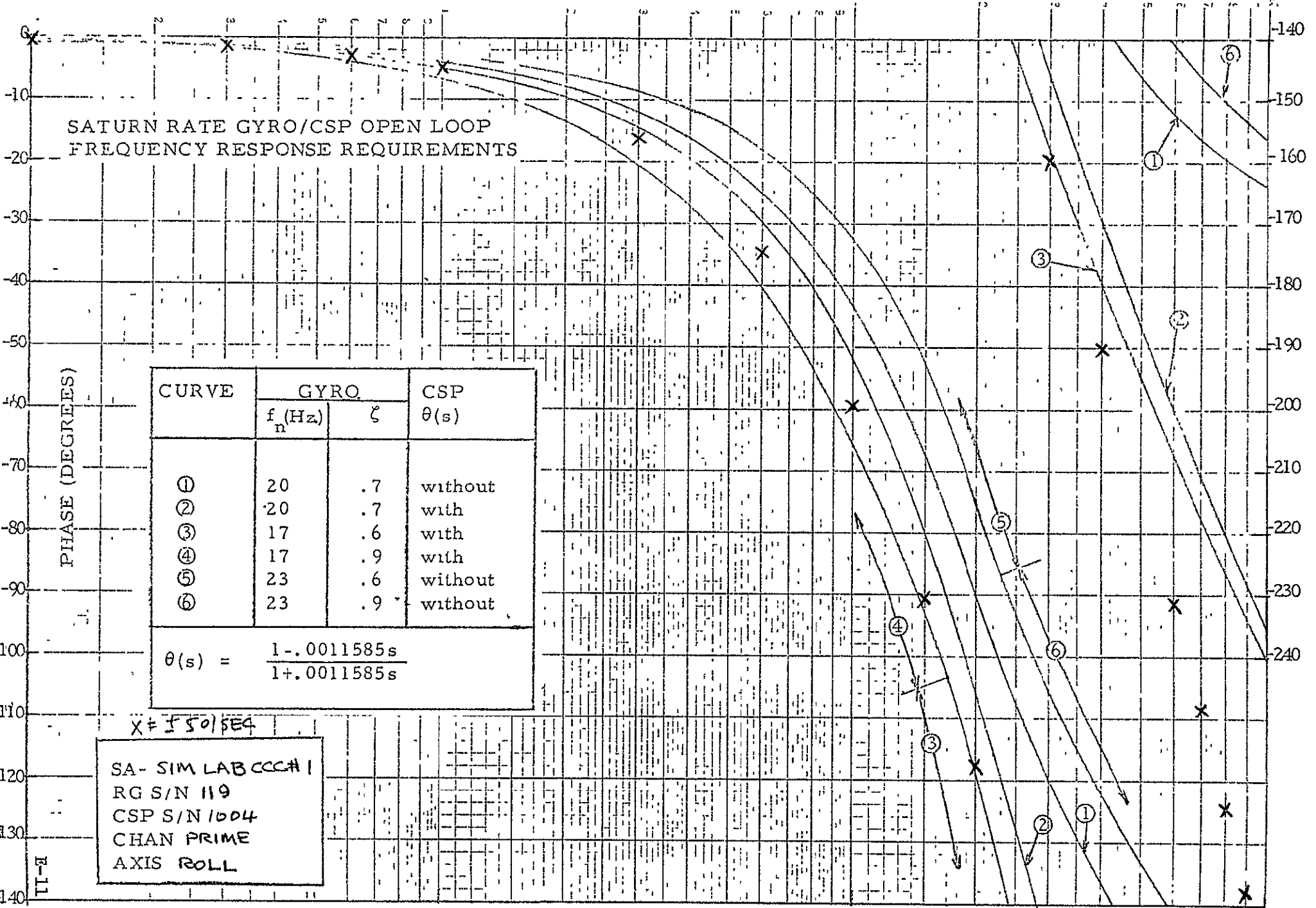

E-11

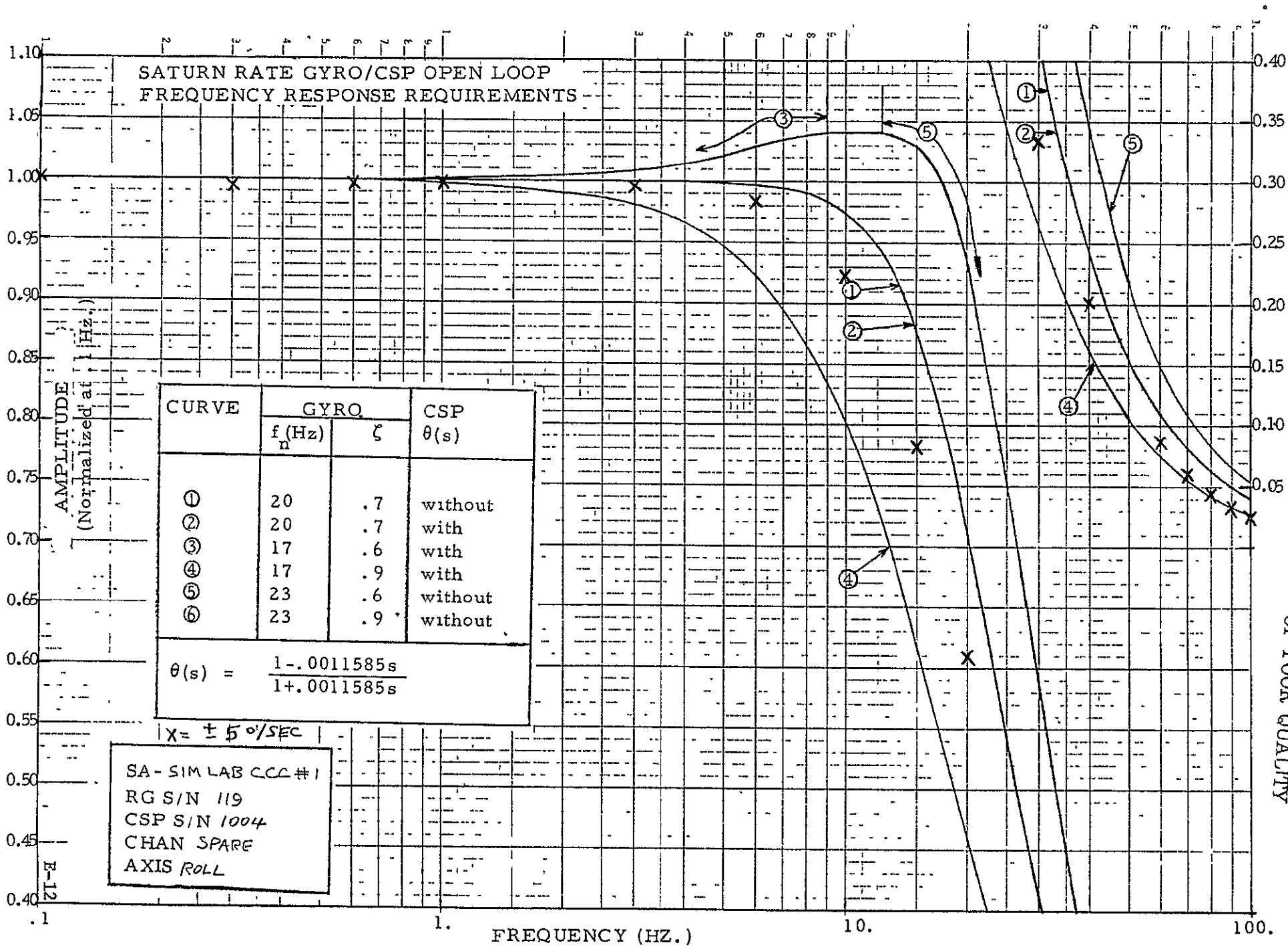

ORIGINAL PAGE IS  
OF POOR QUALITY

E-12

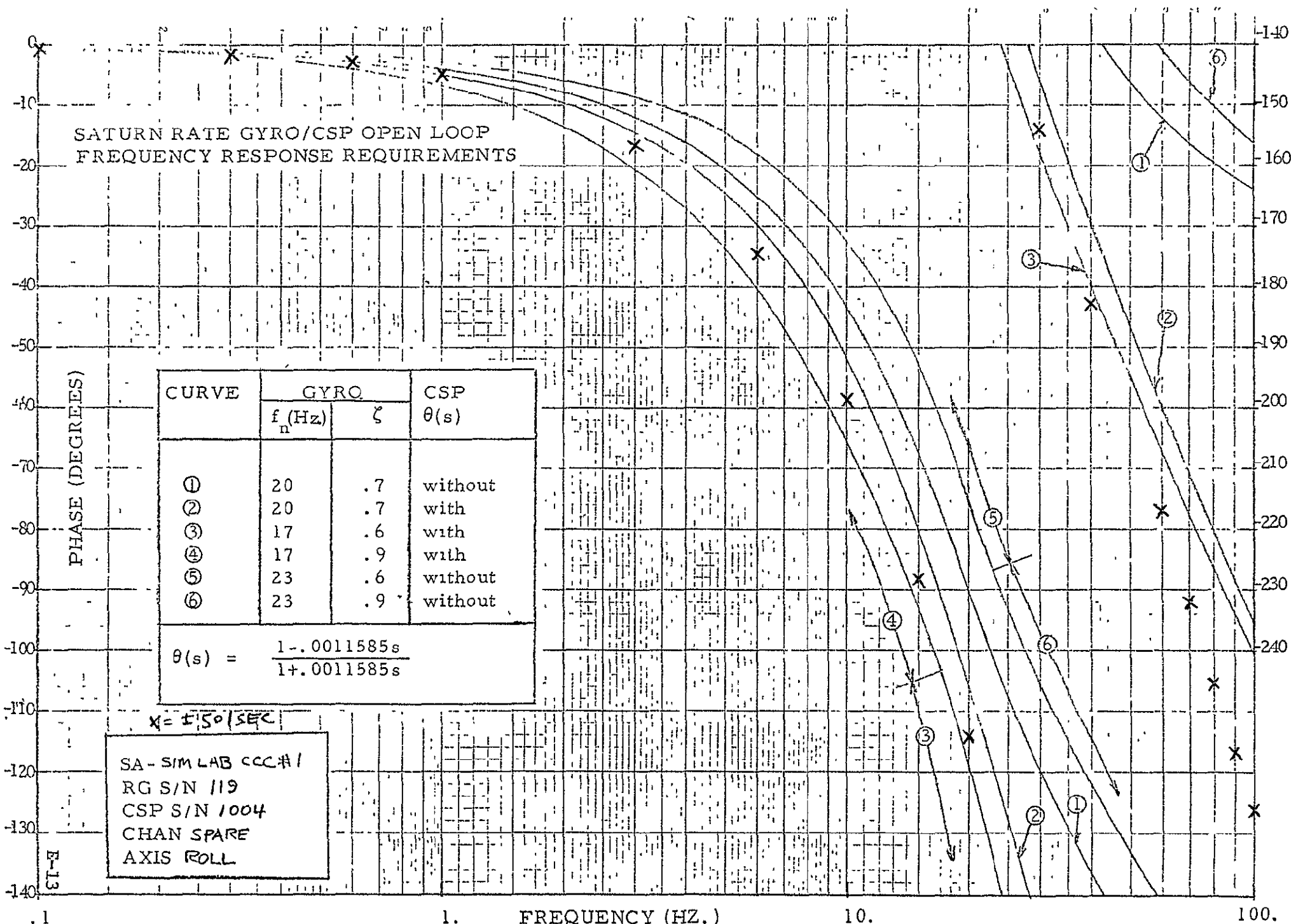

SATURN RATE GYRO/CSP OPEN LOOP  
FREQUENCY RESPONSE REQUIREMENTS

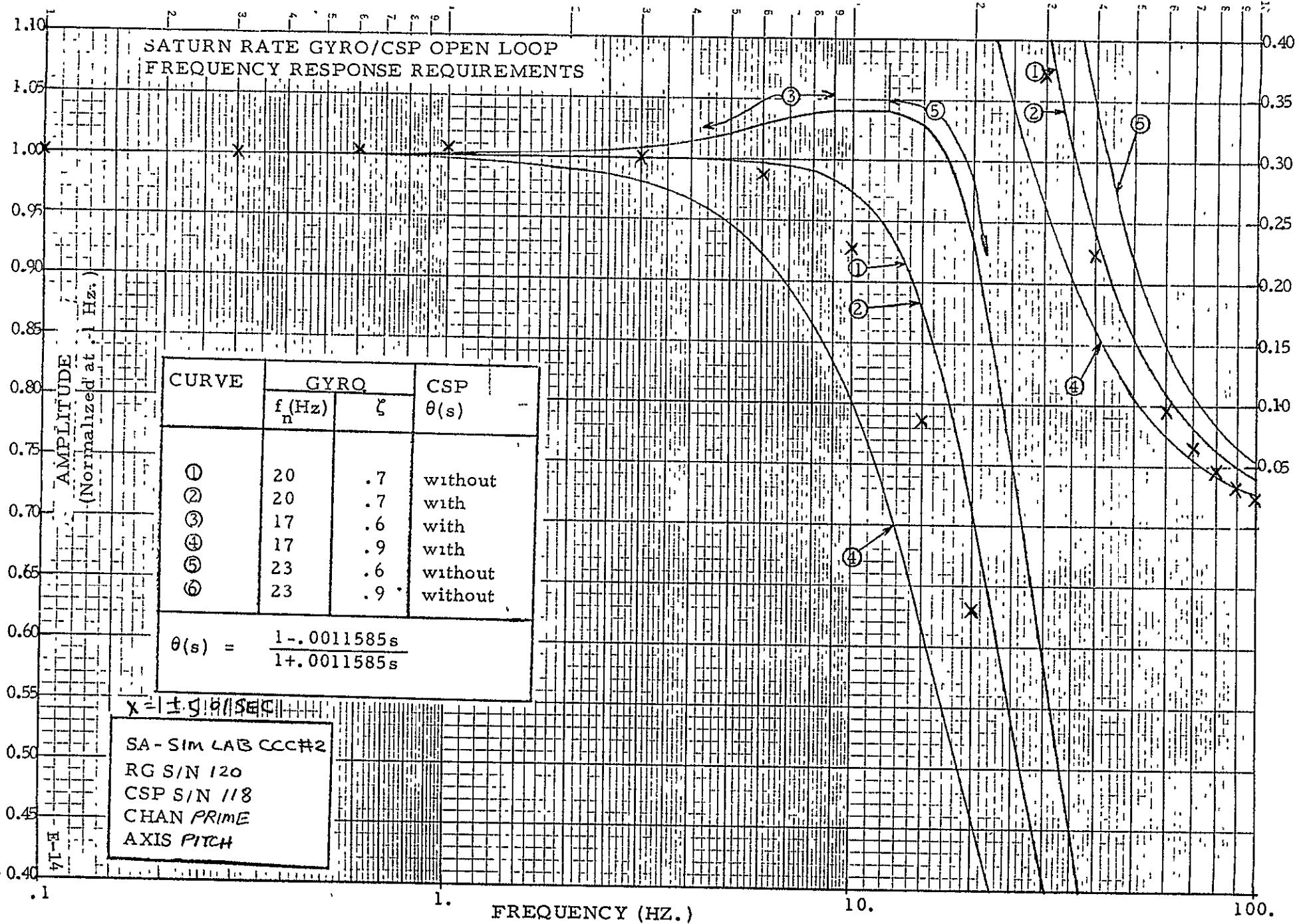

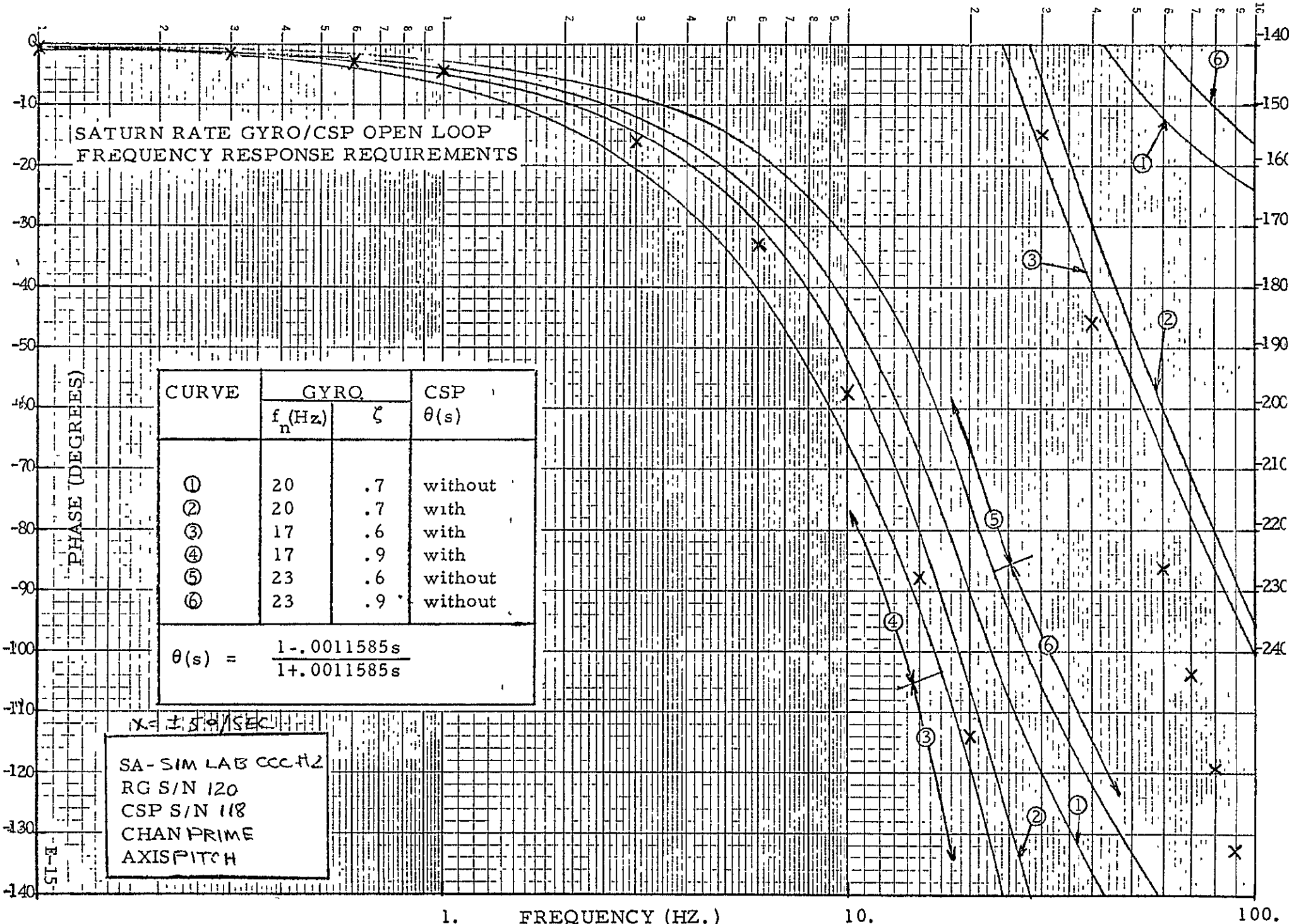

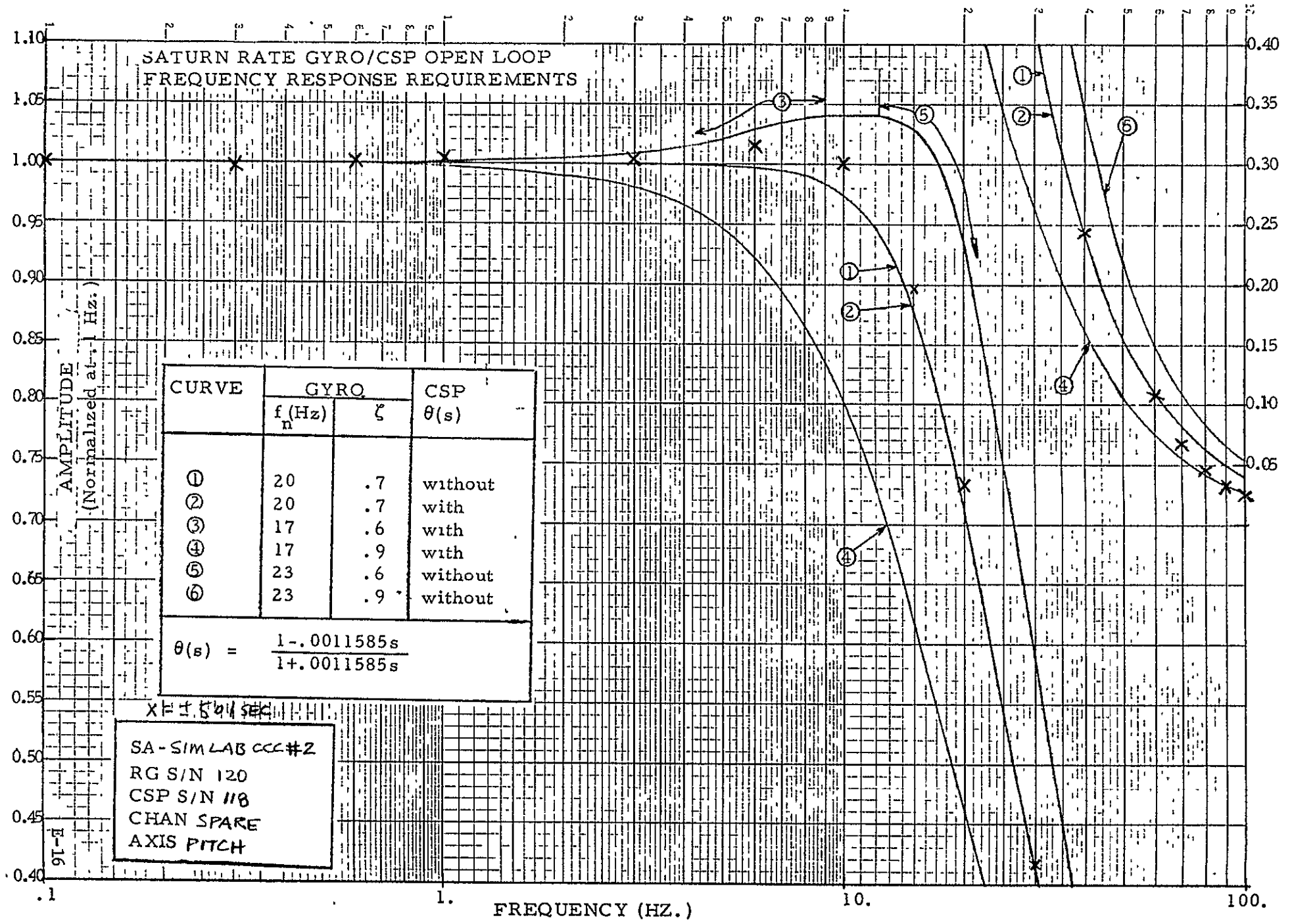



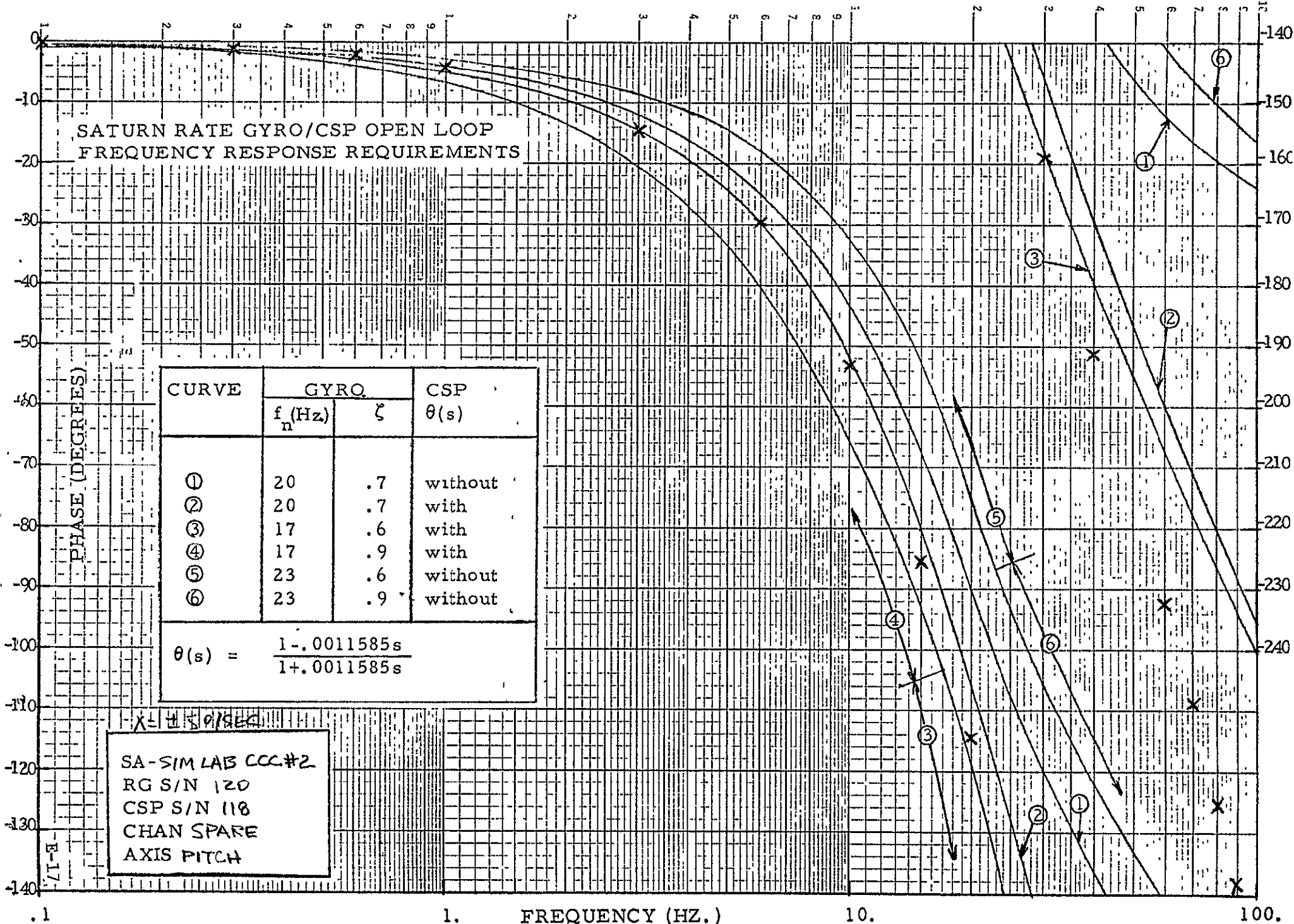

.1

1. FREQUENCY (HZ.)

10.

100.

SATURN RATE GYRO/CSP OPEN LOOP  
FREQUENCY RESPONSE REQUIREMENTS

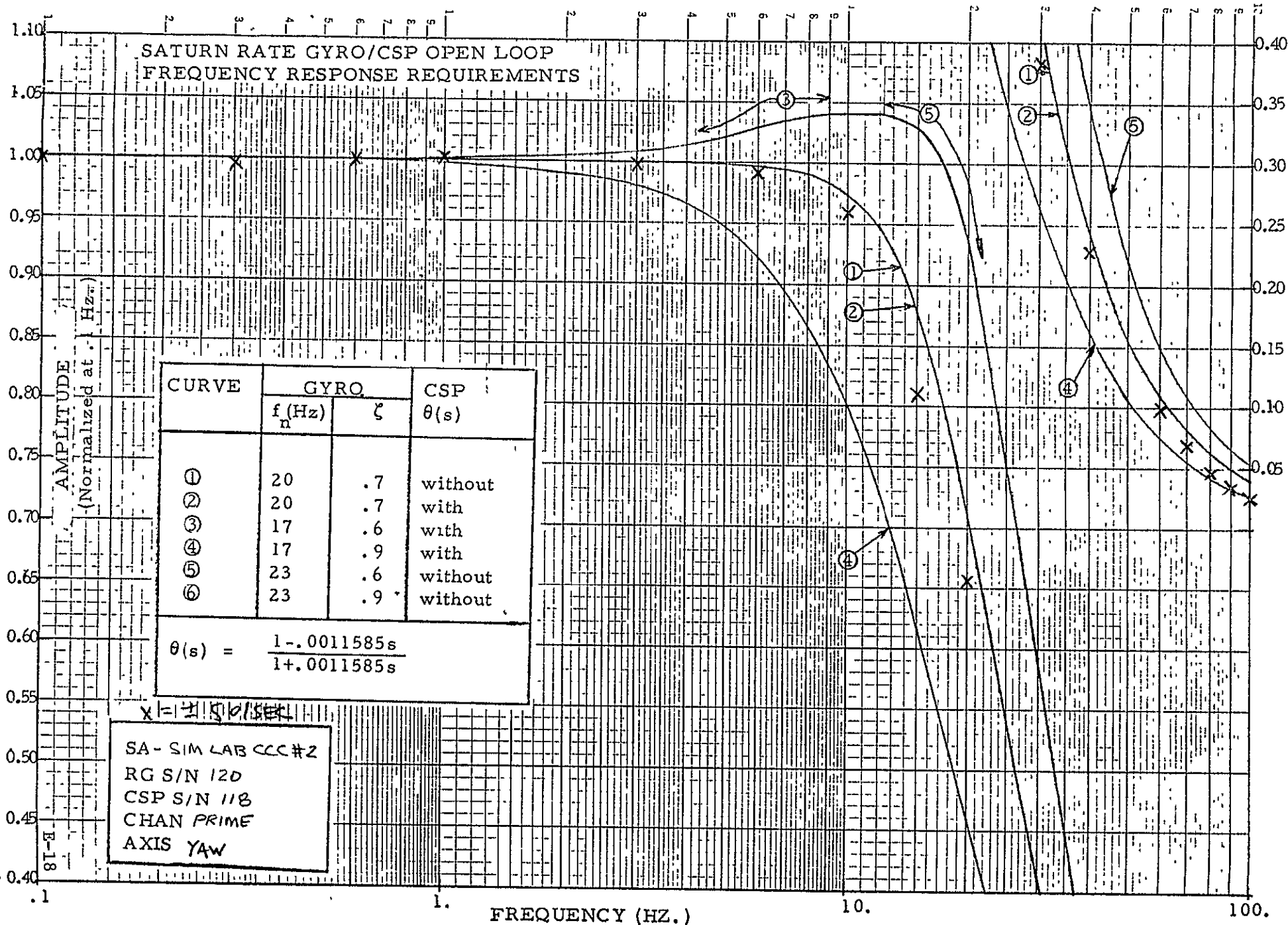

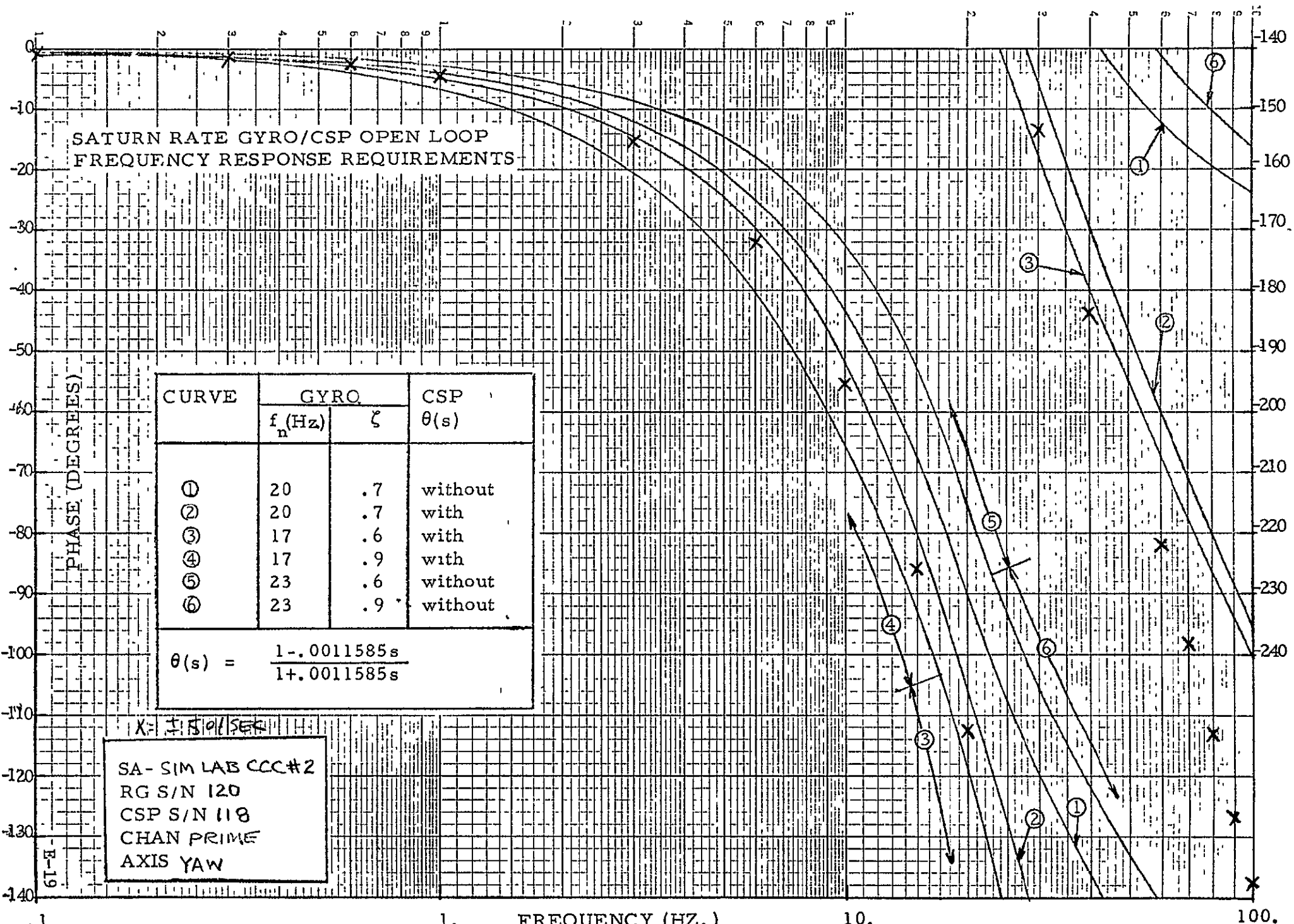

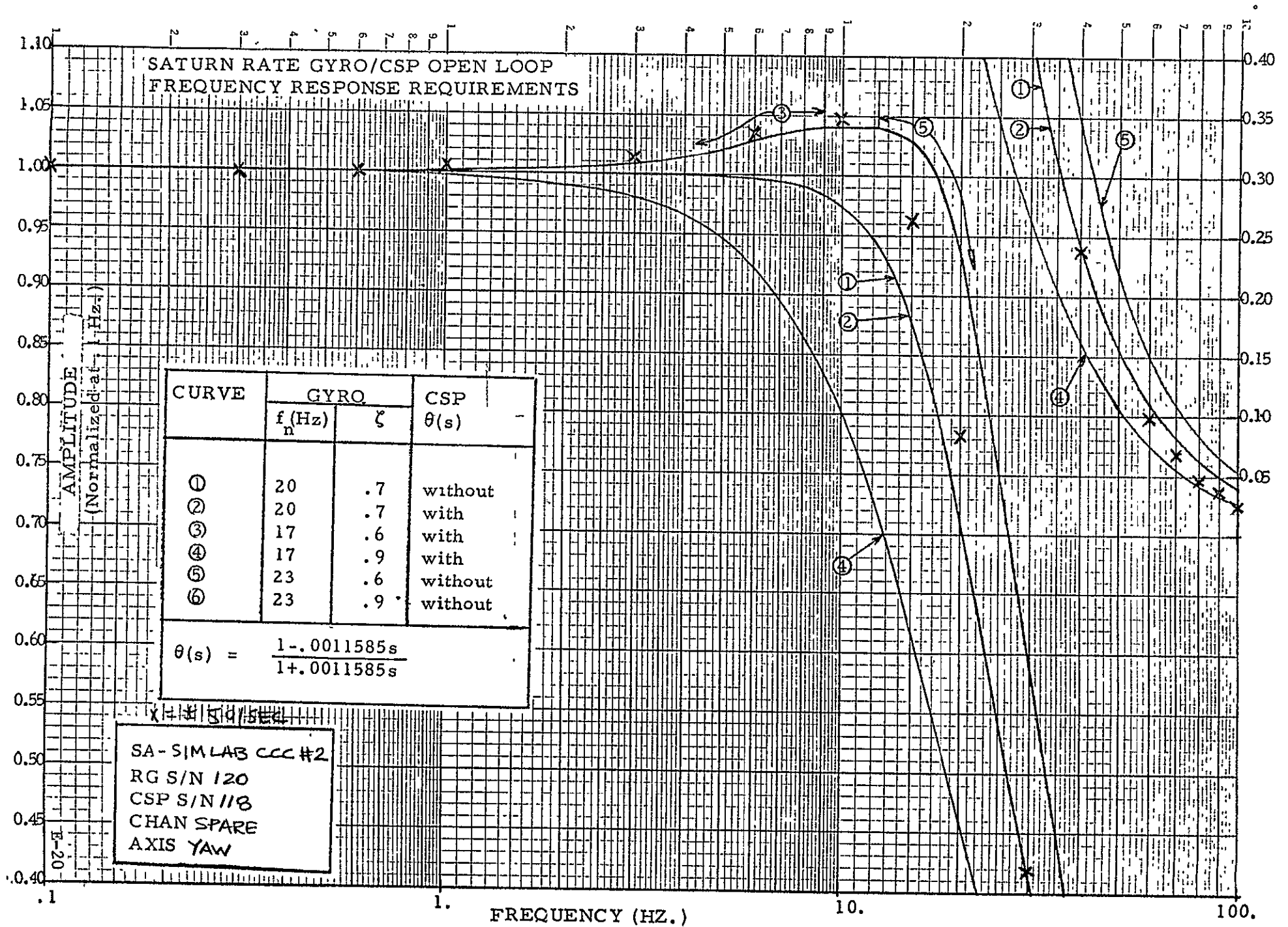

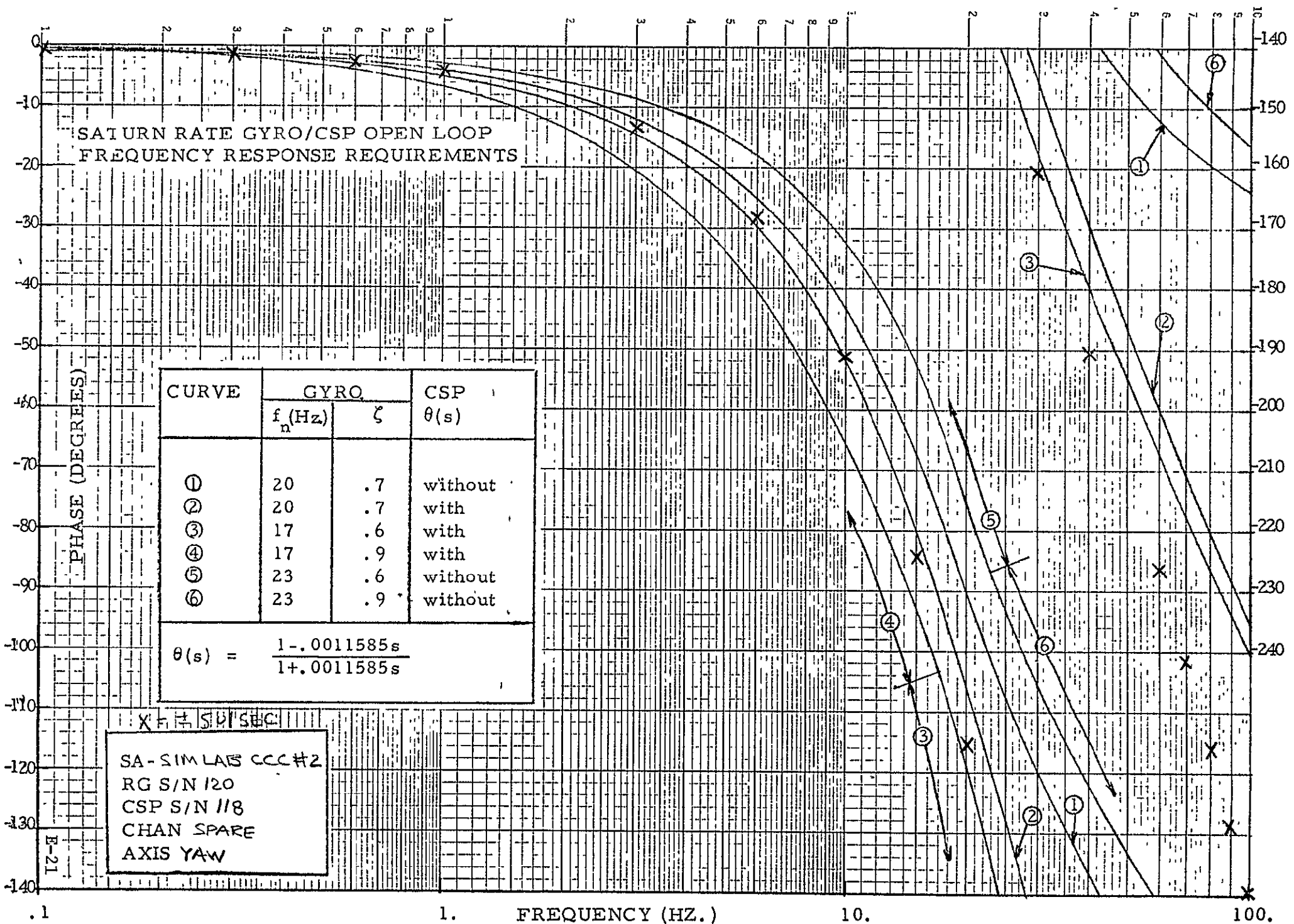

E-21

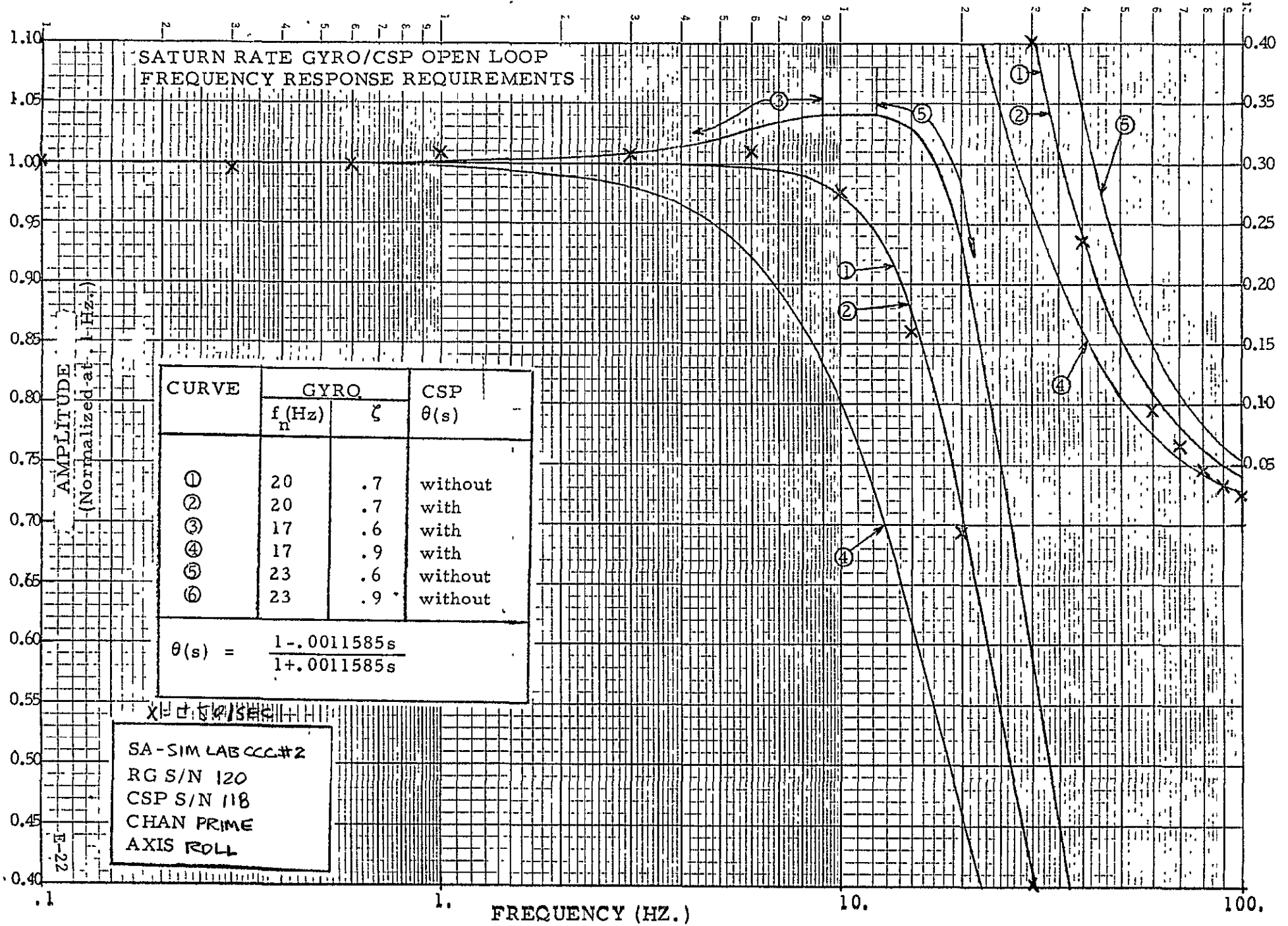

SATURN RATE GYRO/CSP OPEN LOOP  
 FREQUENCY RESPONSE REQUIREMENTS

CURVE	GYRO		CSP $\theta(s)$
	$f_n$ (Hz)	$\zeta$	
①	20	.7	without
②	20	.7	with
③	17	.6	with
④	17	.9	with
⑤	23	.6	without
⑥	23	.9	without

  

$$\theta(s) = \frac{1 - .0011585s}{1 + .0011585s}$$

$X = \pm 1 \text{ SP/SEC}$   
 SA-SIM LAB C00#2  
 RG S/N 120  
 CSP S/N 118  
 CHAN PRIME  
 AXIS ROLL

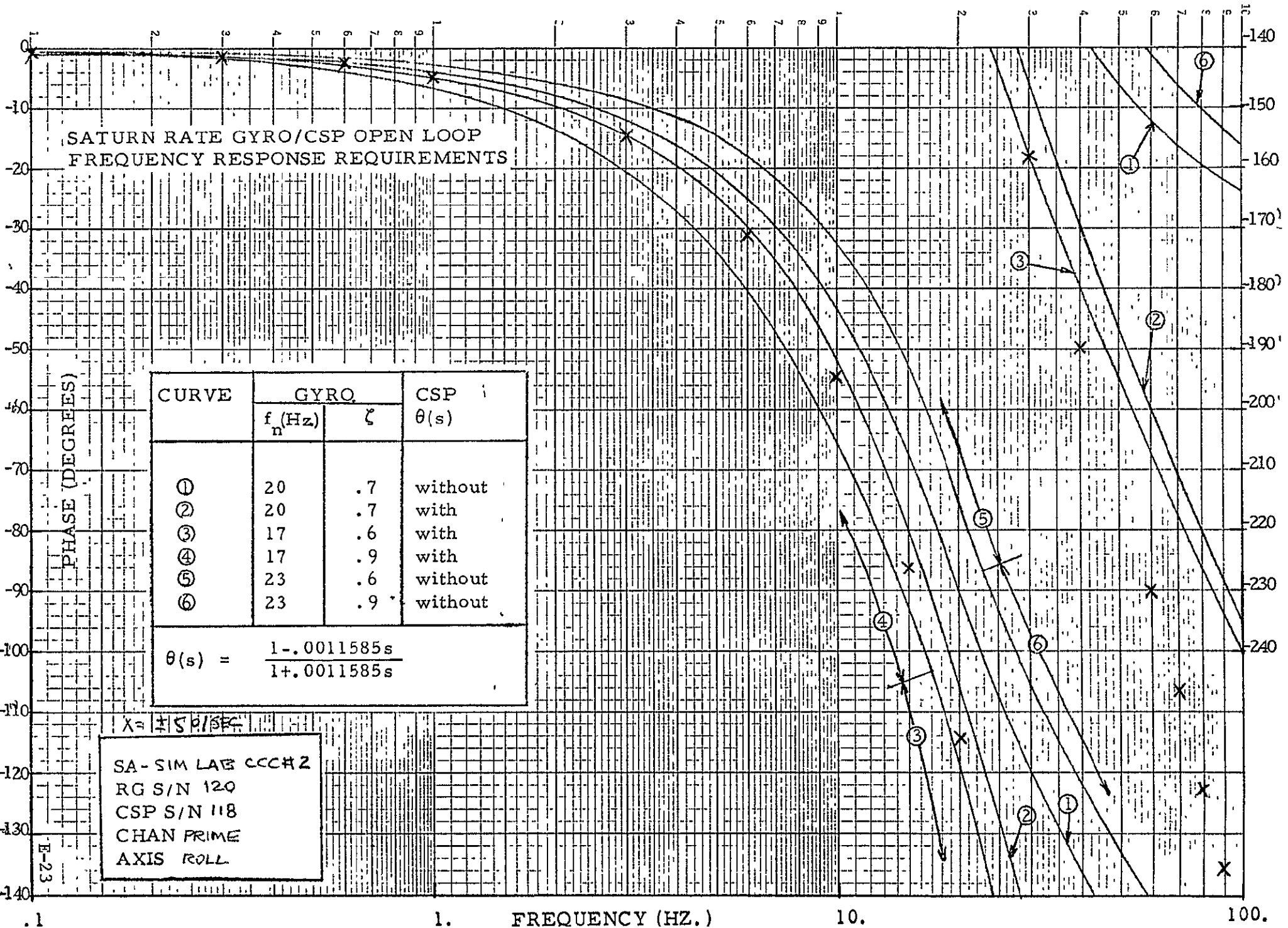

E-23

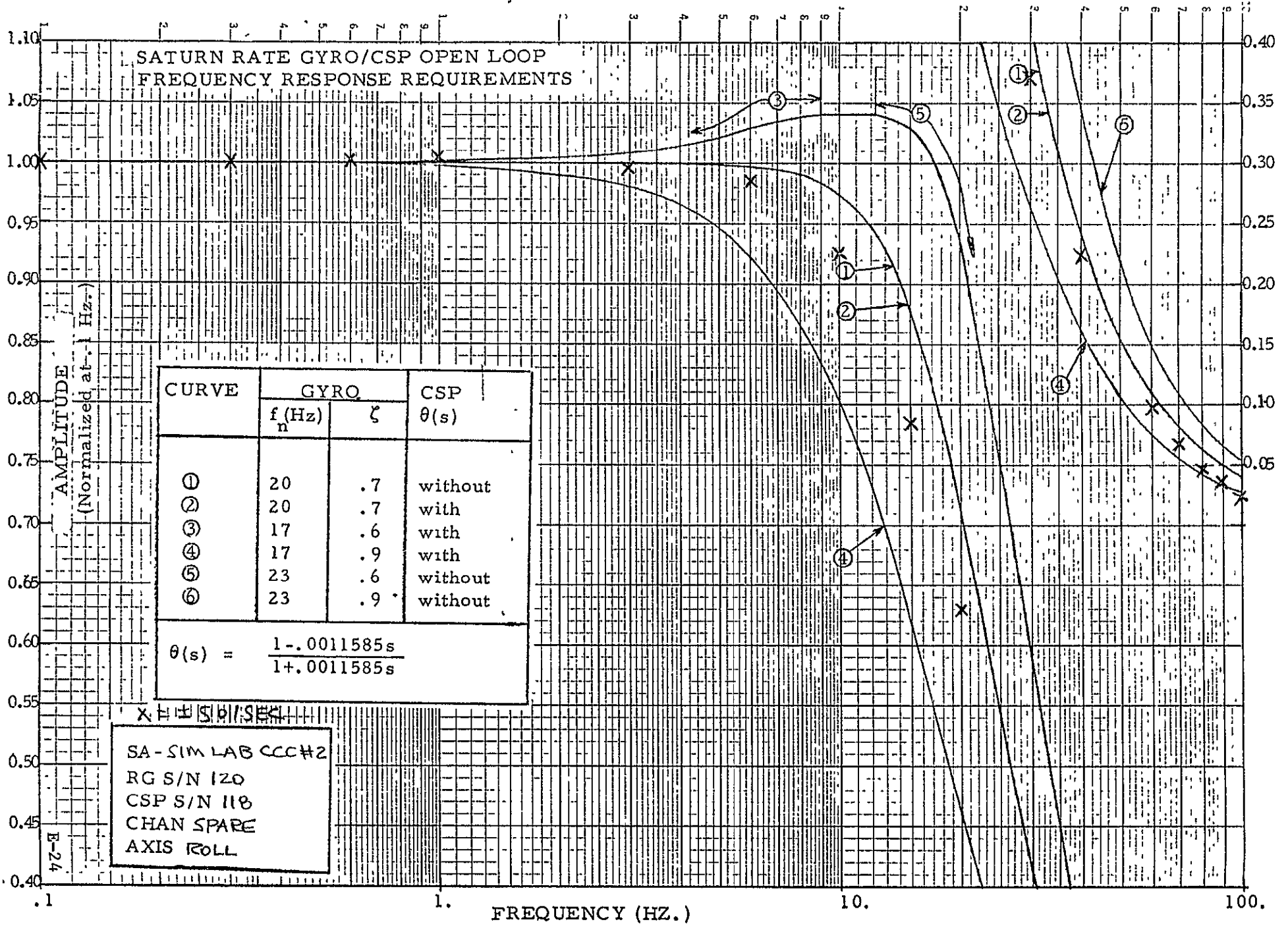



**SATURN RATE GYRO/CSP OPEN LOOP  
 FREQUENCY RESPONSE REQUIREMENTS**

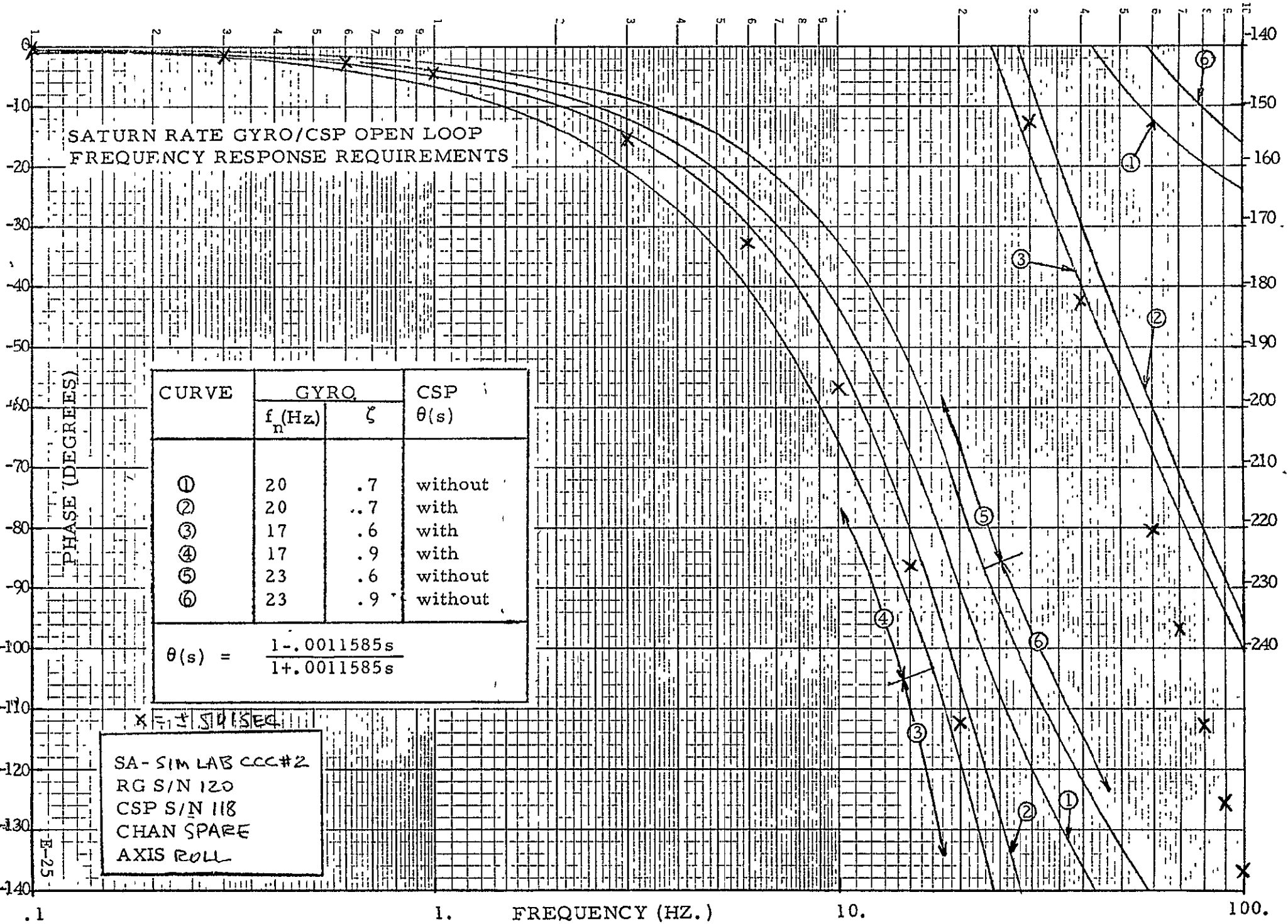

CURVE	GYRO		CSP $\theta(s)$
	$f_n$ (Hz)	$\zeta$	
①	20	.7	without
②	20	.7	with
③	17	.6	with
④	17	.9	with
⑤	23	.6	without
⑥	23	.9	without

$$\theta(s) = \frac{1 - .0011585s}{1 + .0011585s}$$

$x = \pm 5 \text{ SP/SEC}$

SA-SIM LAB CCC#2  
 RG S/N 120  
 CSP S/N 118  
 CHAN SPARE  
 AXIS ROLL

E-25

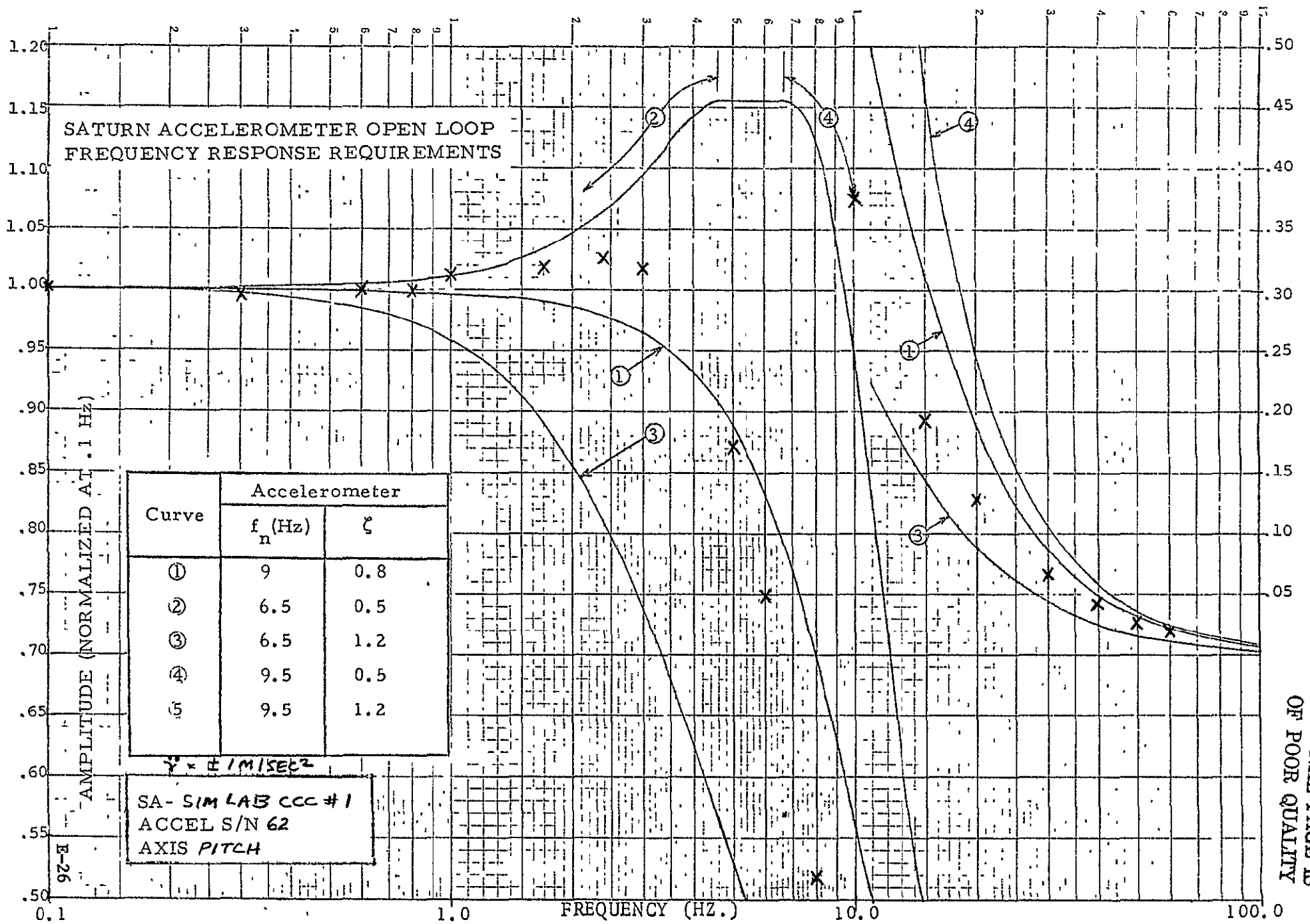

ORIGINAL PAGE IS  
OF POOR QUALITY

E-26

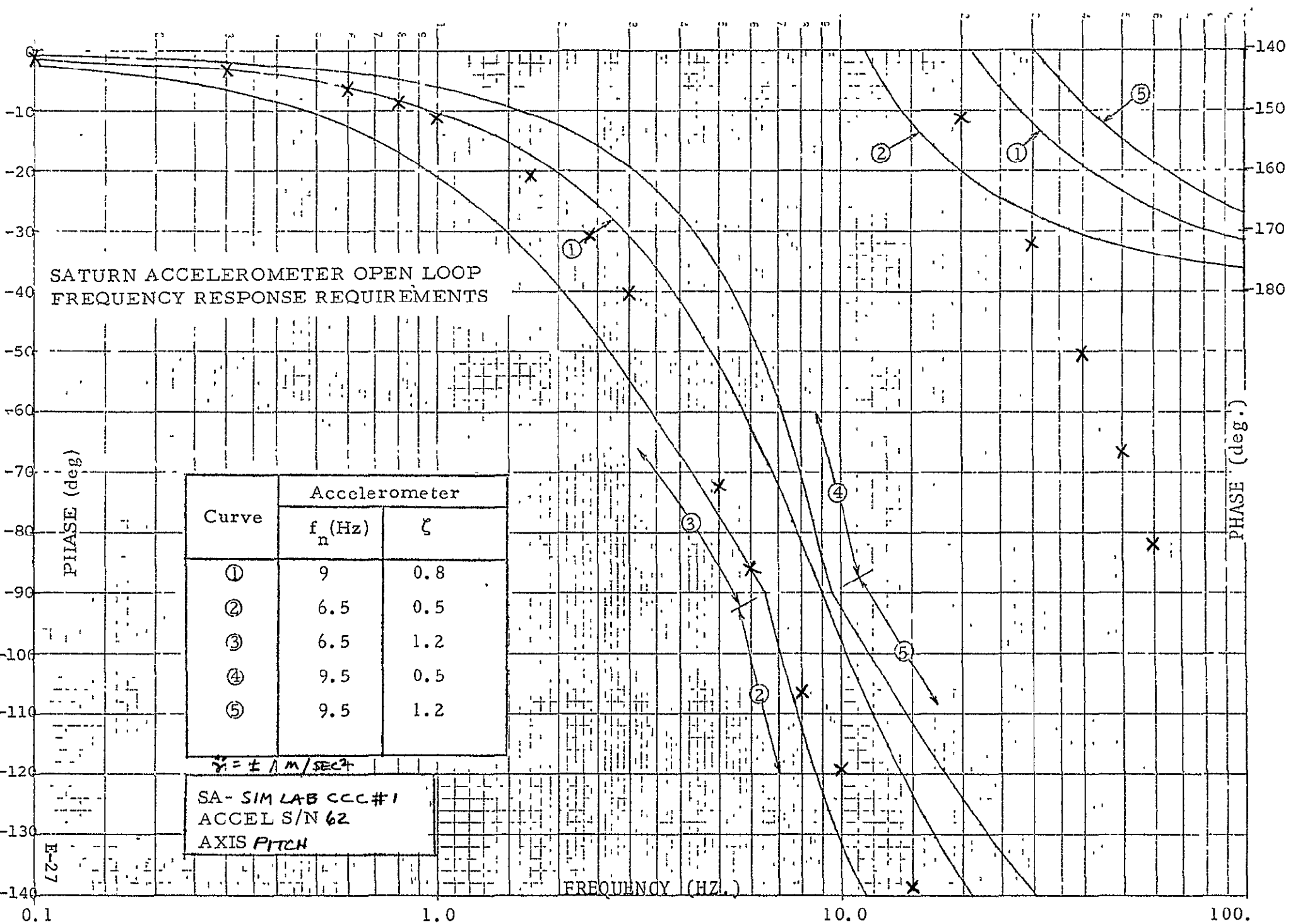

FREQUENCY (HZ.)

PHASE (deg.)

PHASE (deg)

0.1

1.0

10.0

100.

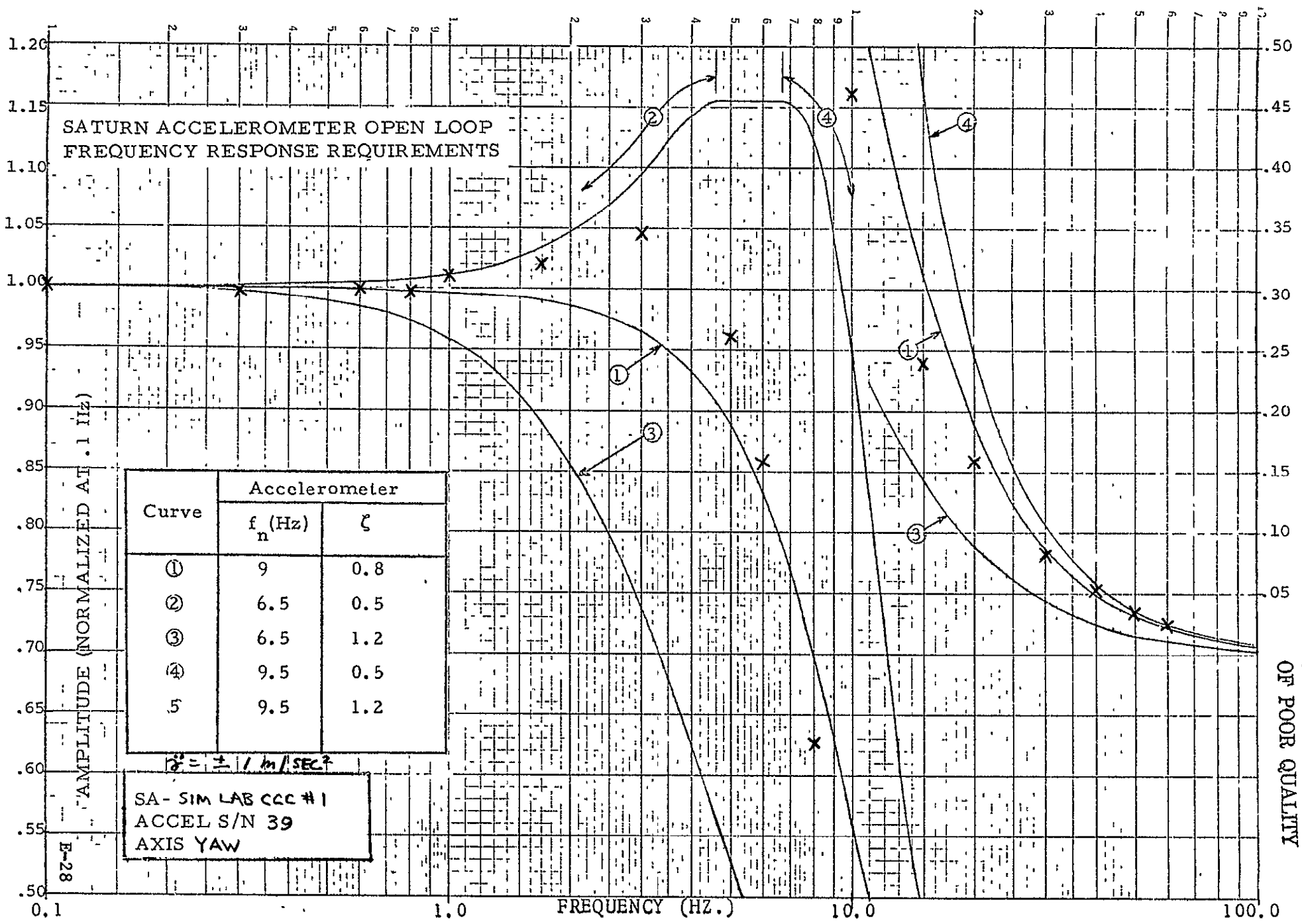

ORIGINAL PAGE IS  
OF POOR QUALITY

E-28

