

Chapter 3

PHYSICAL DESCRIPTION

3-1 SCOPE

This chapter describes PGNCS components. The purpose and capabilities of each component are discussed. Module locations and location and functions of operating controls are illustrated. Figure 3-1 shows the location of units in the PGNCS.

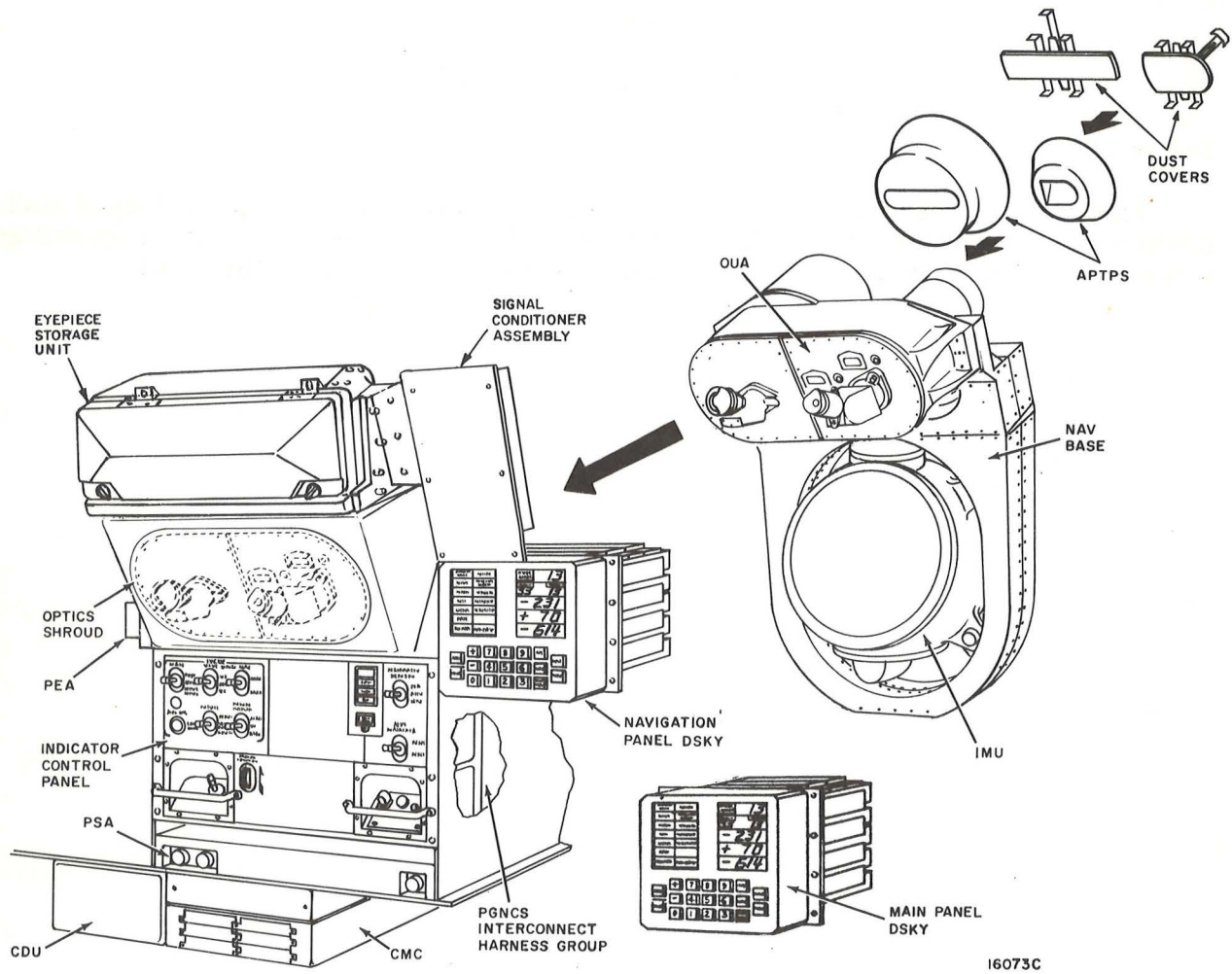

Figure 3-1. Primary Guidance, Navigation, and Control System

Table 3-I. APTPS Compatibility (Sheet 1 of 2)

COMPONENT PART NUMBER	DASH NUMBERS FOR PN 2015000																						
	SYSTEM SERIAL NUMBERS																						
	011 201	021 202	031 203	041 204	051 205	061 206	071 207	081 208	091 209	101 210	111 211	121 212	131 213	141 214	151 215	161 216	171 217	181 218	191 219	201 220	211 221	221 222	
1021373	051	NO		X	→		X															→	
	061	X		NO	→		NO															→	
		<p>X Required per print</p> <p>C Compatible: as good or better than print requirement. See ECP flow chart.</p> <p>T Not as good as print requirement, but can be used for testing. See ECP flow chart.</p> <p>NO CANNOT be used.</p>																					

Table 3-I. APTPS Compatibility (Sheet 2 of 2)

PGNCS	...
202	PN 1021373-061
204 thru 206, 208 thru 222	PN 1021373-051

Released with ECP 428 and 428R2

Table 3-1A. CDU Compatibility (Sheet 1 of 2)

COMPONENT PART NUMBER	DASH NUMBERS FOR PN 2015000																								
	SYSTEM SERIAL NUMBERS																								
	011 201	021 202	031 203	041 204	051 205	061 206	071 207	081 208	091 209	101 210	111 211	121 212	131 213	141 214	151 215	161 216	171 217	181 218	191 219	201 220	211 221	221 222			
2007222	031	X	T																				▶		
	051	C	T																					▶	
	071	C	T																					▶	
	091	C	T																					▶	
	101	C	T																					▶	
	111	C	T	T																				▶	
	161	C	T																					▶	
	181	C	T	C	▶	T	C						▶	T	C	▶	T		▶	C	▶	T		▶	
	191	C	T	X	X	T																			▶
	231	C	T	C	▶	T	X							▶	T	X	▶	T		▶	X	▶	T		▶
	271	C	T	C	▶	X	C							▶	X	C	▶	X	X	X	C	▶	X	X	▶
	281	C	T	C	▶	X	C							▶	X	C	▶	X	X	X	C	▶	X	X	▶
	311	C			▶	T	C							▶	T	C	T		▶	T	T	T	T	T	▶
	321	C			▶	X	C							▶	X	C	X	C		▶	X	X	X	X	▶
	331	C			▶	X	C							▶	X	C	X	C		▶	X	X	X	X	▶
2010744	051	C	T																					▶	
	091	C	X	T																				▶	
	X	Required per print																							
	C	Compatible: as good or better than print requirement. See ECP flow chart.																							
	T	Not as good as print requirement, but can be used for testing. See ECP flow chart.																							
	NO	CANNOT be used.																							

Table 3-1A. CDU Compatibility (Sheet 2 of 2)

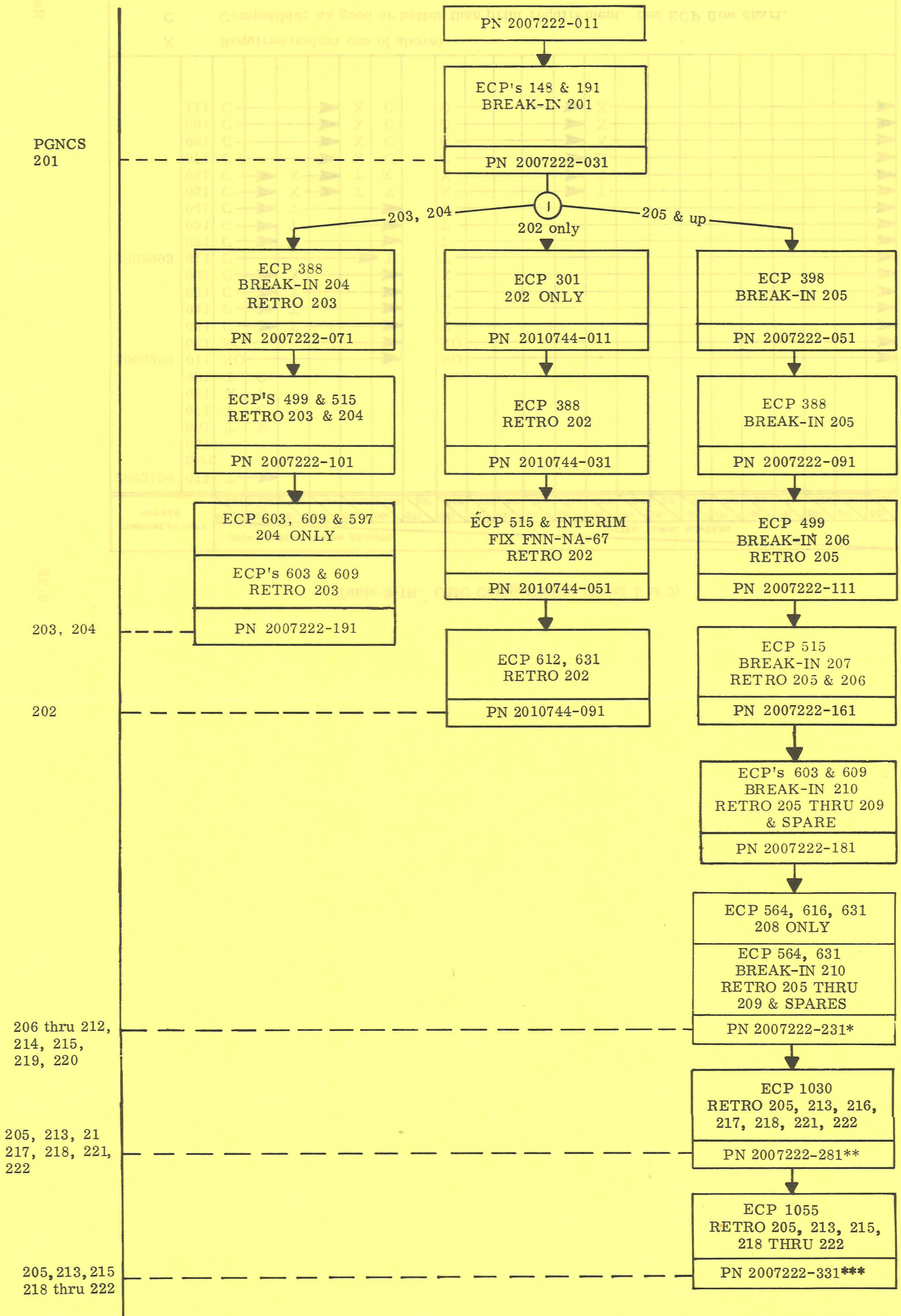

ECP	DESCRIPTIONS
148	ECDU transformer change BREAK-IN 201
191	CDU electronics module change BREAK-IN 201
301	Add thermal sensors 202 ONLY
388	Corrosion and outgassing protection

ECP	DESCRIPTIONS
603	Capacitor replacement in MSA and quadrature reject module BREAK-IN 210 RETROFIT 203 THRU 209
609	Elimination of ECDU DAC saturation during C/A BREAK-IN 210 RETROFIT 203 THRU 209
612	CSM-098

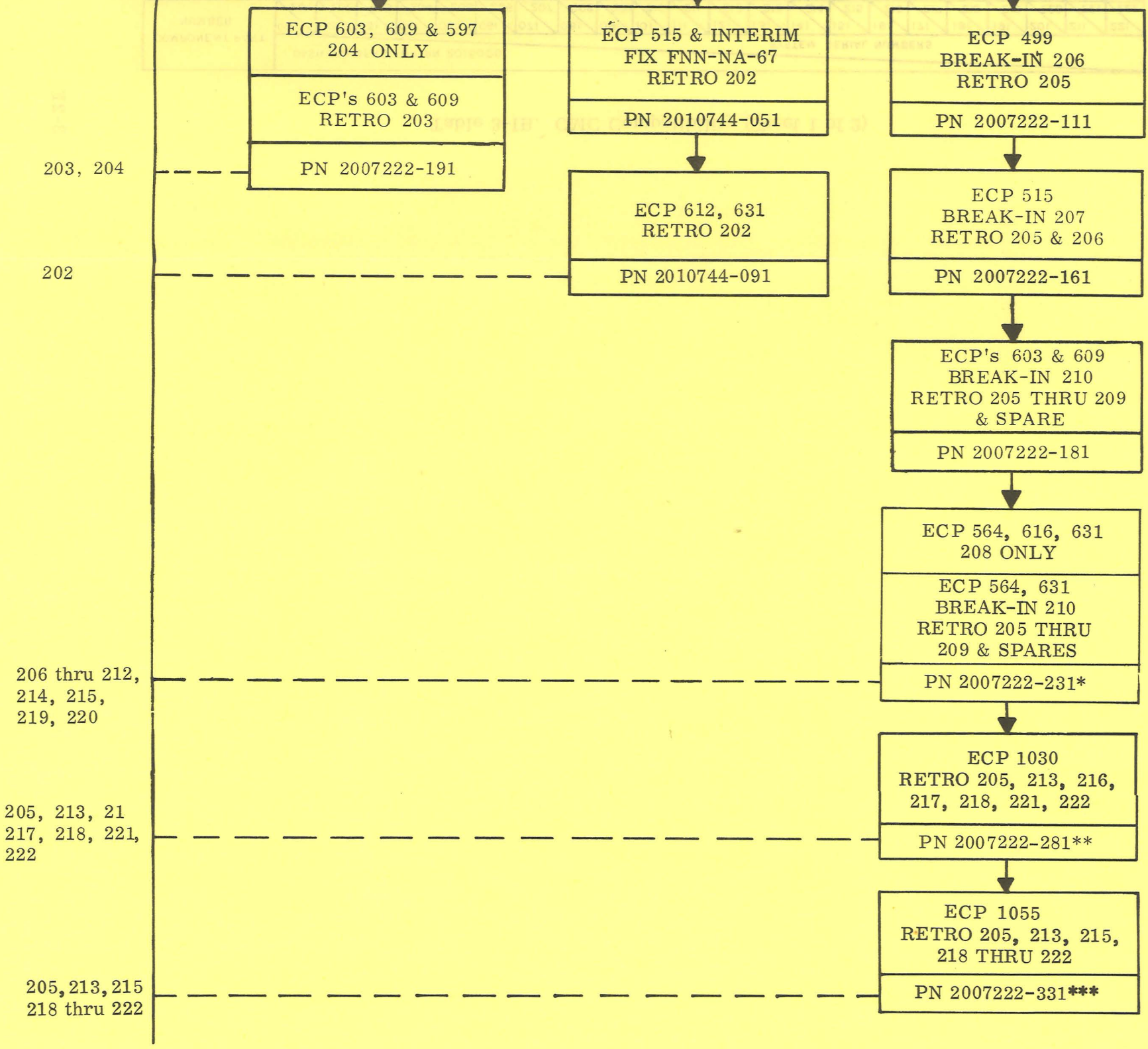

ECP	DESCRIPTIONS
148	ECDU transformer change BREAK-IN 201
191	CDU electronics module change BREAK-IN 201
301	Add thermal sensors 202 ONLY
388	Corrosion and outgassing protection BREAK-IN 204 & 205 RETROFIT 202 & 203 202 incorporated in part
398	Change potting material BREAK-IN 205
499	Addition of damper plate BREAK-IN 206 RETROFIT 203 THRU 205
515	Modify coarse system modules BREAK-IN 207 RETROFIT 202 THRU 206
564	Implementation of flat pack specifications ND 1002359A and ND 1002358B BREAK-IN 210 RETRO 205 THRU 209 & SPARES
597	CSM 101 204 ONLY

ECP	DESCRIPTIONS
603	Capacitor replacement in MSA and quadrature reject module BREAK-IN 210 RETROFIT 203 THRU 209
609	Elimination of ECDU DAC saturation during C/A BREAK-IN 210 RETROFIT 203 THRU 209
612	CSM-098 202 ONLY
616	CSM-103 208 ONLY
631	Replace RTV-102 with RTV-109. ECP 631 should be incorporated in PN 2007222-231. ECP 631 does not affect part number change. It may be included in lower part number assemblies.
1030	Replace ECDU modules containing 1010274 transformers to increase reliability RETROFIT 205, 213, 216, 217, 218, 221, and 222
1055	Modify mode module and D/A converters. RETROFIT 205, 213, 215, 218 THRU 222.

*PN 2007222-231 must have all three modules associated with ECP 564. Any combination less than three new modules is PN 2007222-181.

**PN 2007222-281 must have all three modules associated with ECP 564. Any combination less than three new modules is PN 2007222-271.

***PN 2007222-331 must have all three modules associated with ECP 564. Any combination less than three new modules is PN 2007222-321

Rev. AG

Table 3-IB. CMC Compatibility (Sheet 1 of 2)

COMPONENT PART NUMBER	DASH NUMBERS FOR PN 2015000																						SYSTEM SERIAL NUMBERS									
	011	021	031	041	051	061	071	081	091	101	111	121	131	141	151	161	171	181	191	201	211	221	201	211	221	201	211	221				
	201	202	203	204	205	206	207	208	209	210	211	212	213	214	215	216	217	218	219	220	221	222	201	211	221	201	211	221				
2003100	011	T	→																													
	thru																															
	051																															
	061	T	X																													
	071	T	C																													
2003200	081	X	T																													
	091	T	C																													
	011	NO																														
	021	NO																														
	031	C	→	T																												
2003993	041	C	→	T																												
	051	C	→	T																												
	061	C	→	X																												
	011	C																														
	021	C	→	T																												
	031	C	→	T																												
	041	C	→	T																												
	051	C	→	X	→		T																									
	061	C	→	X	→		T																									
	071	C			→		X																									
	081	C			→		X																									
091	C			→		X																										
111	C			→		X																										

X Required (select one of above)
 C Compatible: as good or better than print requirement. See ECP flow chart.
 T Not as good as print requirement, but can be used for testing. See ECP flow chart.
 NO CANNOT be used.

Table 3-IB. CMC Compatibility (Sheet 2 of 2)

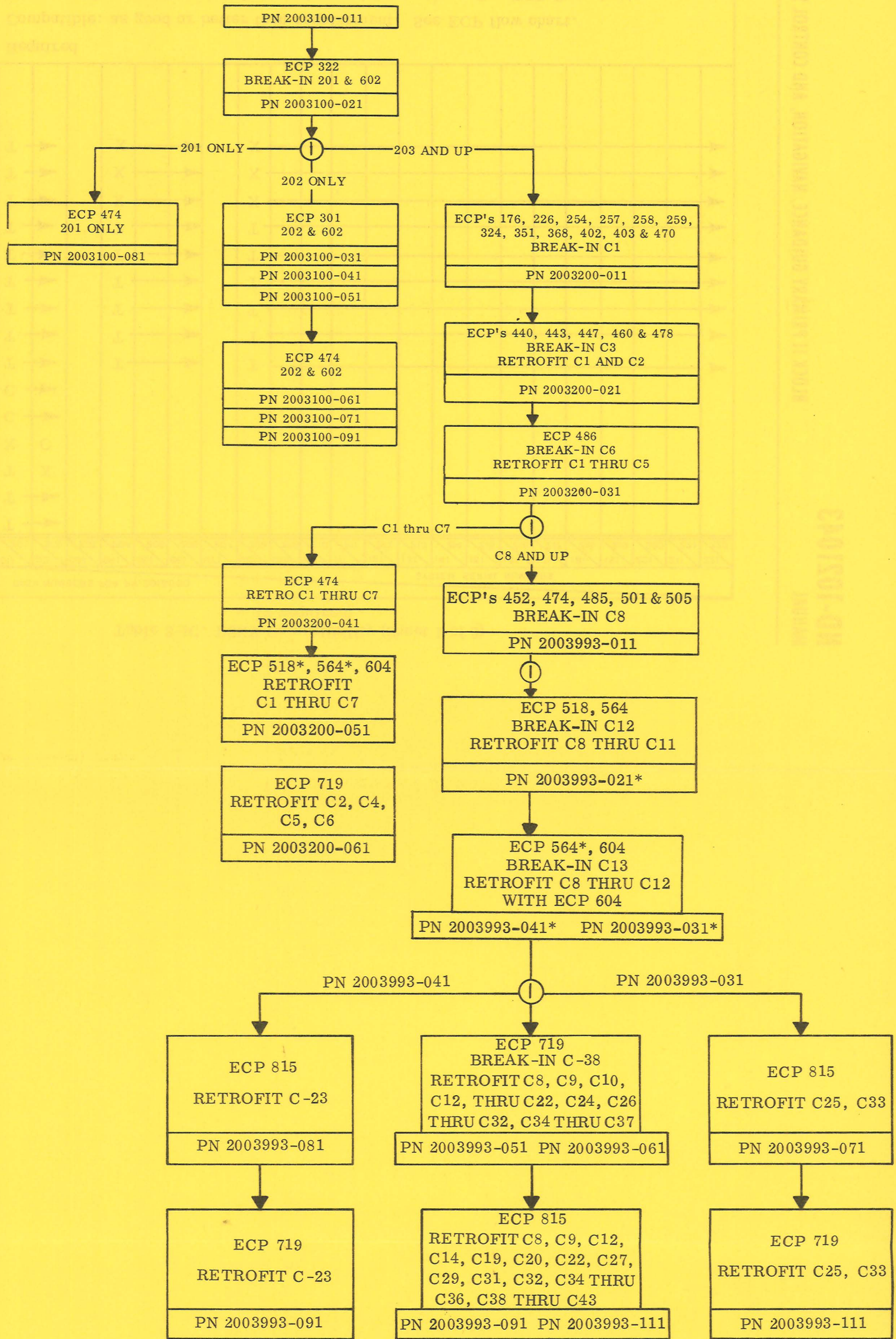

ECP	DESCRIPTION
176	In-process vibration and thermal cycle of AGC modules BREAK-IN C1
226	Aluminum to magnesium conversion of AGC trays BREAK-IN C1
254	Computer multilayer board layout (MLB) BREAK-IN C1
257	Redesign of rope & erasable drivers (Blk II) BREAK-IN C1

ECP	DESCRIPTION
478	Paint exposed surfaces on mid tray spacer BREAK-IN C3 RETROFIT C1 and C2
485	Redesign power supply to remove 28 vdc regulator BREAK-IN C8
486	Cut pins on AGC power supply to remove 28 vdc regulator BREAK-IN C6 RETROFIT C1 thru C5
501	Implementation of flight

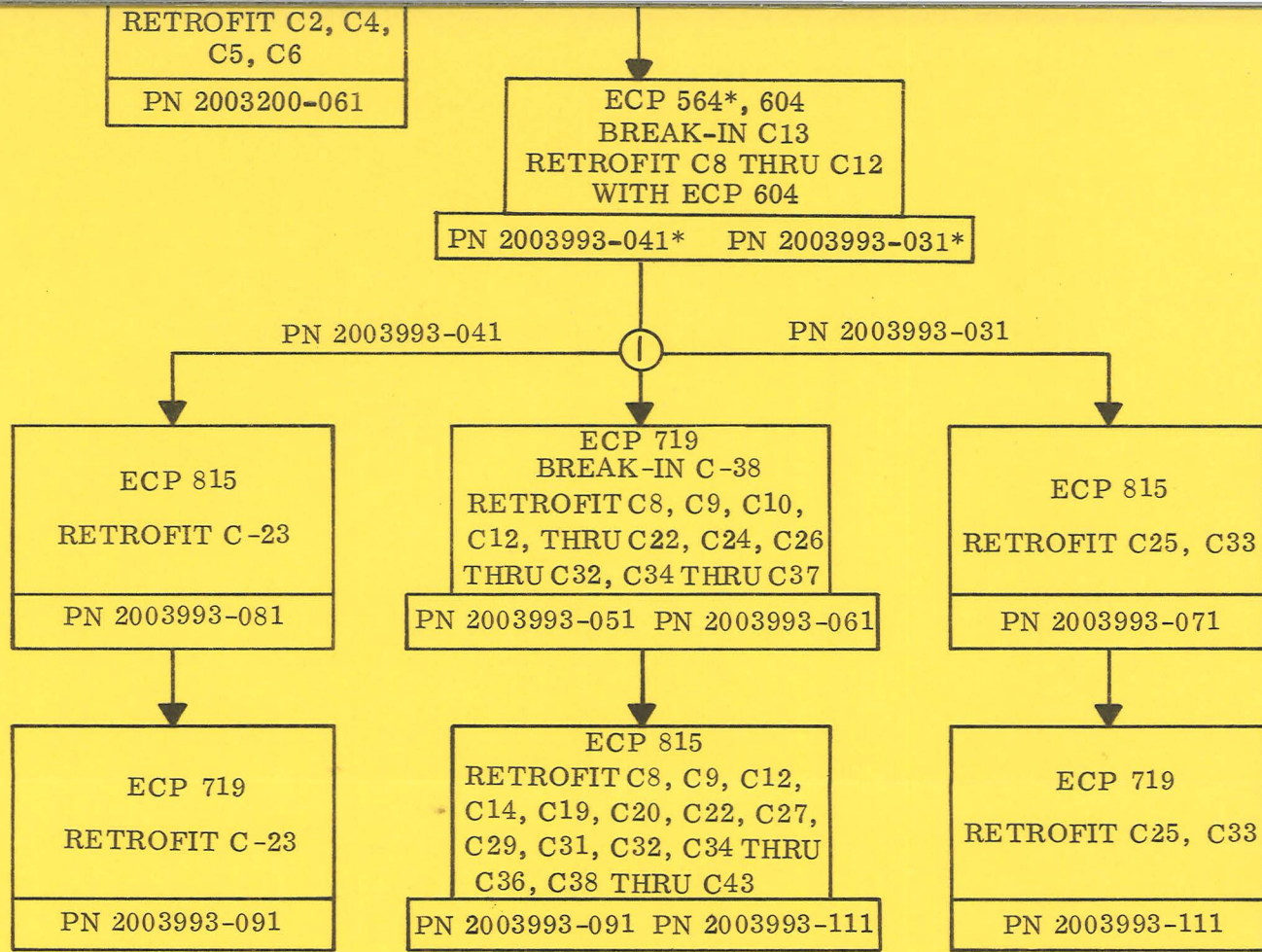

ECP	DESCRIPTION
176	In-process vibration and thermal cycle of AGC modules BREAK-IN C1
226	Aluminum to magnesium conversion of AGC trays BREAK-IN C1
254	Computer multilayer board layout (MLB) BREAK-IN C1
257	Redesign of rope & erasable drivers (Blk II) BREAK-IN C1
258	Redesign power supply module (Block II) BREAK-IN C1
259	Redesign of erasable memory (Blk II) BREAK-IN C1
301	Add thermal sensors 202 ONLY
322	Retrofit of AGC 601 BREAK-IN 201 and 602
324	Sense amplifier threshold voltage stability change BREAK-IN C1
351	Alarm module temperature stabilization of warning integrator and improved oscillator fail alarm BREAK-IN C1
368	Improved power supply module relays BREAK-IN C1
402	Clear circuit driver modification BREAK-IN C1
403	Strobe adjustment BREAK-IN C1
440	"Clear rope" driver circuit modification BREAK-IN C3 RETROFIT C1 and C2
443	Replacement of short screws BREAK-IN C3 RETROFIT C1 and C2
447	Incorporation of plastic pads under tray A&B covers BREAK-IN C3 RETROFIT C1 and C2
452	Wiring change to accommodate auxiliary memory unit BREAK-IN C8
460	Addition of jumper wires in tray A BREAK-IN C3 RETROFIT C1 and C2
470	Random workmanship vibration Blk II AGC and DSKY BREAK-IN C1
474	Manufacture test connector jumpers for Blk I-100, Blk II and LEM Computers to ground certain gate inputs BREAK-IN C8

ECP	DESCRIPTION
478	Paint exposed surfaces on mid tray spacer BREAK-IN C3 RETROFIT C1 and C2
485	Redesign power supply to remove 28 vdc regulator BREAK-IN C8
486	Cut pins on AGC power supply to remove 28 vdc regulator BREAK-IN C6 RETROFIT C1 thru C5
501	Implementation of flight processing spec ND 1002313 BREAK-IN C8
505	Implementation of flight processing spec ND 1002314 BREAK-IN C8
518	Standby change on computer* BREAK-IN C12 RETROFIT C1 thru C11
564	Implementation of flat pack specifications ND 1002359A and ND 1002358B*
604	Vibration dampening of E-memory module and design evaluation program BREAK-IN C13 and up RETROFIT C1 thru C12
719	Alarm module modification, V-fail detection BREAK-IN C38 RETROFIT C2, C4, C5, C6, C8, C9, C10, C12, C23, C24, C13 thru C22, C25 thru C37
815	Install Restart Monitor RETROFIT C8, C9, C12, C14, C19, C20, C22, C23, C25, C27, C29, C31 thru C36, C38 thru C43

*CMC Configuration for ECP 518 & 564

CMC	Logic Module	Power Supply	Tray A
2003200-051	2003121 or 2003888	2003892-011	2003092-041, 051, or -061
2003993-021 -041	2003121 or 2003888	2003892-011	2003092-041 or -061
2003993-031	2003888	2003892-011	2003092-041

Rev. AC

3-2G

BLOCK II PRIMARY GUIDANCE, NAVIGATION, AND CONTROL SYSTEM

ND-1021043
MANUAL

Table 3-IC. DSKY Compatibility (Sheet 1 of 2)
(2 required)

COMPONENT PART NUMBER	DASH NUMBERS FOR PN 2015000																					
	SYSTEM SERIAL NUMBERS																					
	011 201	021 202	031 203	041 204	051 205	061 206	071 207	081 208	091 209	101 210	111 211	121 212	131 213	141 214	151 215	161 216	171 217	181 218	191 219	201 220	211 221	221 222
2003985	021	T →																				
	031	T →																				
	041	T X																				
	051	X C																				
	061	C →																				
	081	C →																				
2003950 (SN 28, 30, 31 ONLY)	011	T →		T →				T →														▲
	031	T →		T →				T →														▲
	061	T →		T →				T →														▲
2003994	011	T →		T →				T →														▲
	021	T →		T →				T →														▲
	041	T →		T →				T →														▲
	051	T →		X →				X →														▲
	111	T →		X →				X →														▲
	121	T →		X →				X →														▲
X	Required																					
C	Compatible: as good or better than requirement. See ECP flow chart.																					
T	Not as good as requirement, but can be used for testing. See ECP flow chart.																					
NO	CANNOT be used.																					

Table 3-IC. DSKY Compatibility (Sheet 2 of 2) (2 required)

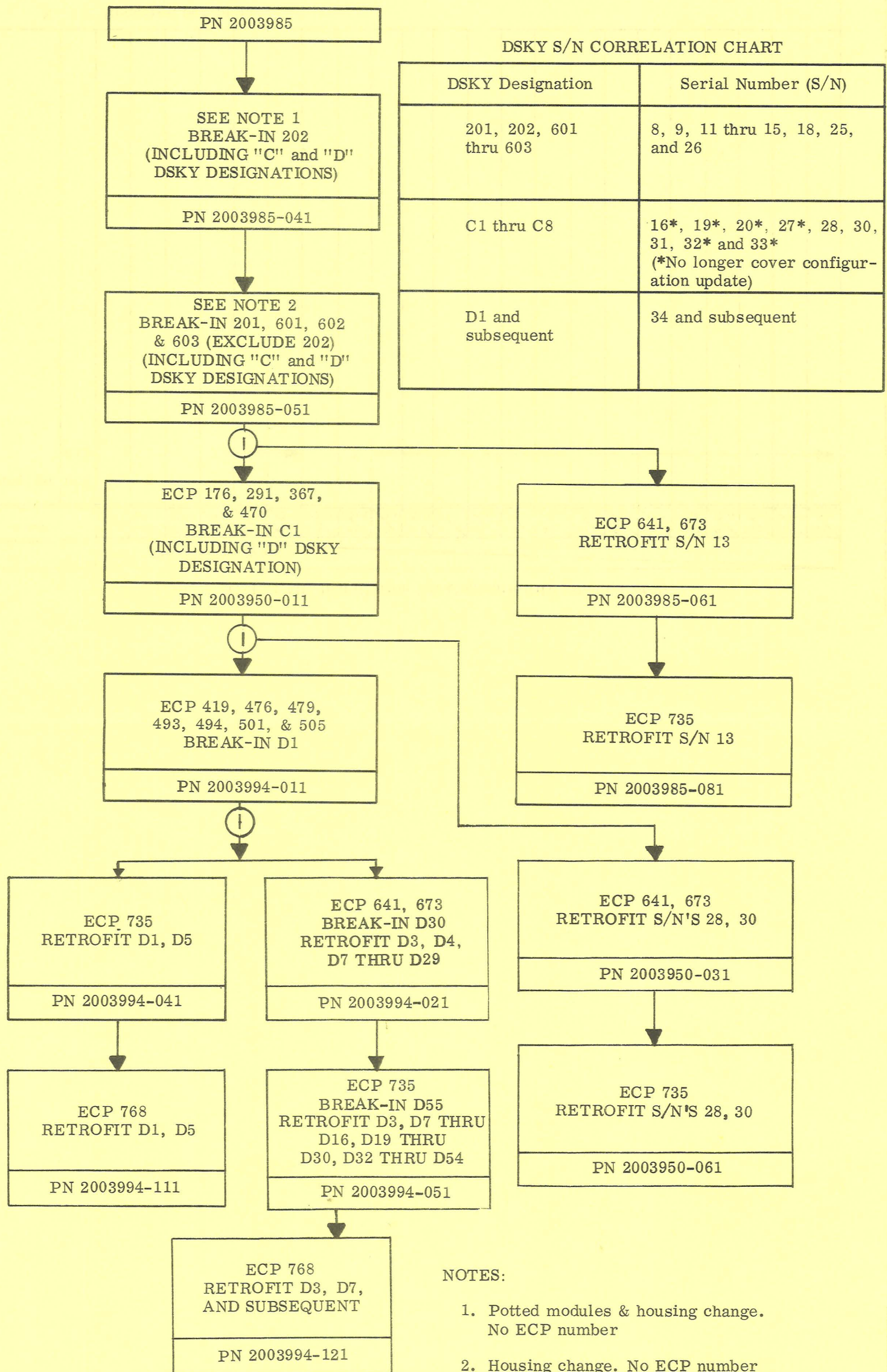

NOTES:

1. Potted modules & housing change. No ECP number
2. Housing change. No ECP number

ECP	DESCRIPTION
176	In-process vibration and thermal cycle of AGC modules BREAK-IN C1
291	Alarm lights BREAK-IN C1
367	Addition of light diffusing paint to DSKY BREAK-IN C1
419	IDM relay replacement in DSKY

ECP	DESCRIPTION
501	Implementation of flight processing spec BREAK-IN D1
505	Implementation of flight processing spec and new diode BREAK-IN D1
641	Non-metallic materials modification for DSKY BREAK-IN D30

BLOCK II PRIMARY GUIDANCE, NAVIGATION, AND CON

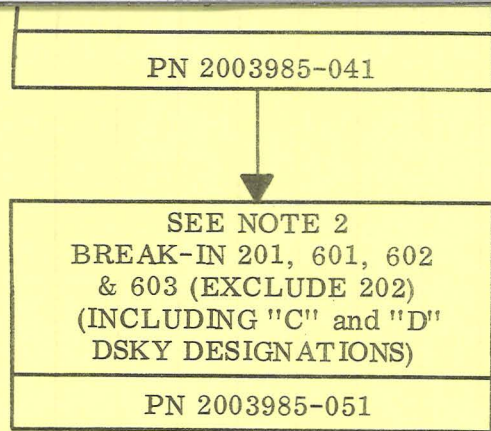

C1 thru C8	16*, 19*, 20*, 27*, 28, 30, 31, 32* and 33* (*No longer cover configur- ation update)
D1 and subsequent	34 and subsequent

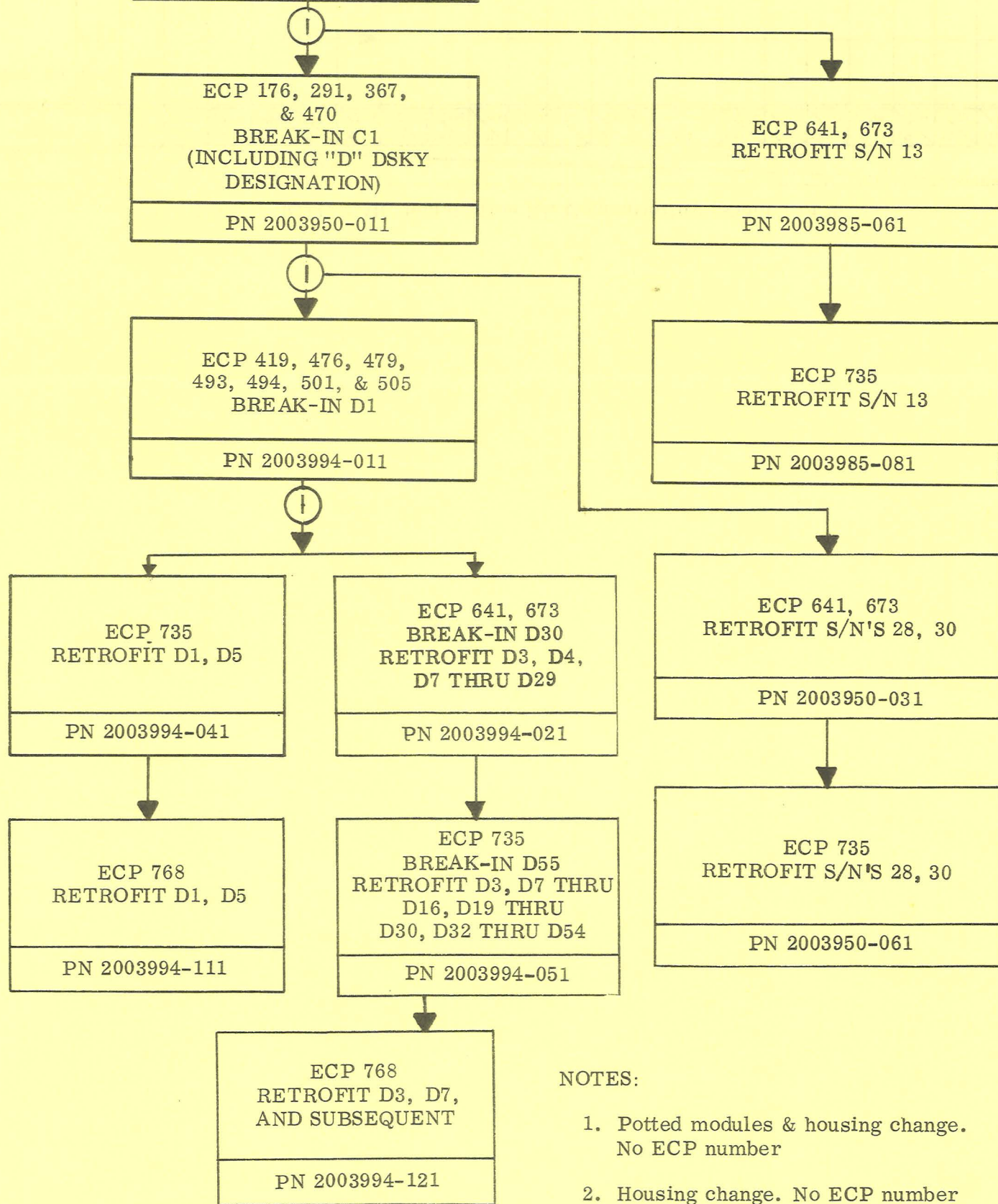

NOTES:

1. Potted modules & housing change. No ECP number
2. Housing change. No ECP number

ECP	DESCRIPTION
176	In-process vibration and thermal cycle of AGC modules BREAK-IN C1
291	Alarm lights BREAK-IN C1
367	Addition of light diffusing paint to DSKY BREAK-IN C1
419	IDM relay replacement in DSKY BREAK-IN D1
470	Random workmanship vibration Blk II AGC and DSKY BREAK-IN C1
476	Painting of alarm indicator face BREAK-IN D9 RETROFIT D1 thru D8
479	DSKY teflon coated pushbutton shaft BREAK-IN D1
493	Y-line feedback of base resistor BREAK-IN D1
494	DSKY wiring improvement BREAK-IN D1

ECP	DESCRIPTION
501	Implementation of flight processing spec BREAK-IN D1
505	Implementation of flight processing spec and new diode BREAK-IN D1
641	Non-metallic materials modification for DSKY BREAK-IN D30 RETROFIT D3, D4, D7 THRU D29, S/N's 13, 28, 30
673	DSKY pushbutton cap housing assembly leaf spring BREAK-IN D30 RETROFIT D3, D4, D7 THRU D29, S/N's 13, 28, 30
735	Addition of safety glass to cover DSKY EL and IL indicators BREAK-IN D55 RETROFIT D1, D3, D5, D7 thru D16, D19 thru D30, D32 thru D54, S/N's 13, 28, and 30
768	Thermal vaccum EL modification RETROFIT D1, D3, D5, D7, AND SUBSEQUENT

Table 3-IC-1. CMC Installation Kit Compatibility (Sheet 1 of 2)

COMPONENT PART NUMBER		DASH NUMBERS FOR PN 2015000																					
		SYSTEM SERIAL NUMBERS																					
		011 201	021 202	031 203	041 204	051 205	061 206	071 207	081 208	091 209	101 210	111 211	121 212	131 213	141 214	151 215	161 216	171 217	181 218	191 219	201 220	211 221	221 222
2004199	000	X	X																				
	011			X				X															

X Required per print
 C Compatible: as good or better than print requirement. See ECP flow chart.
 T Not as good as print requirement, but can be used for testing. See ECP flow chart.
 NO CANNOT be used.

3-2J

Rev. P

Table 3-IC-1. CMC Installation Kit Compatibility (Sheet 2 of 2)

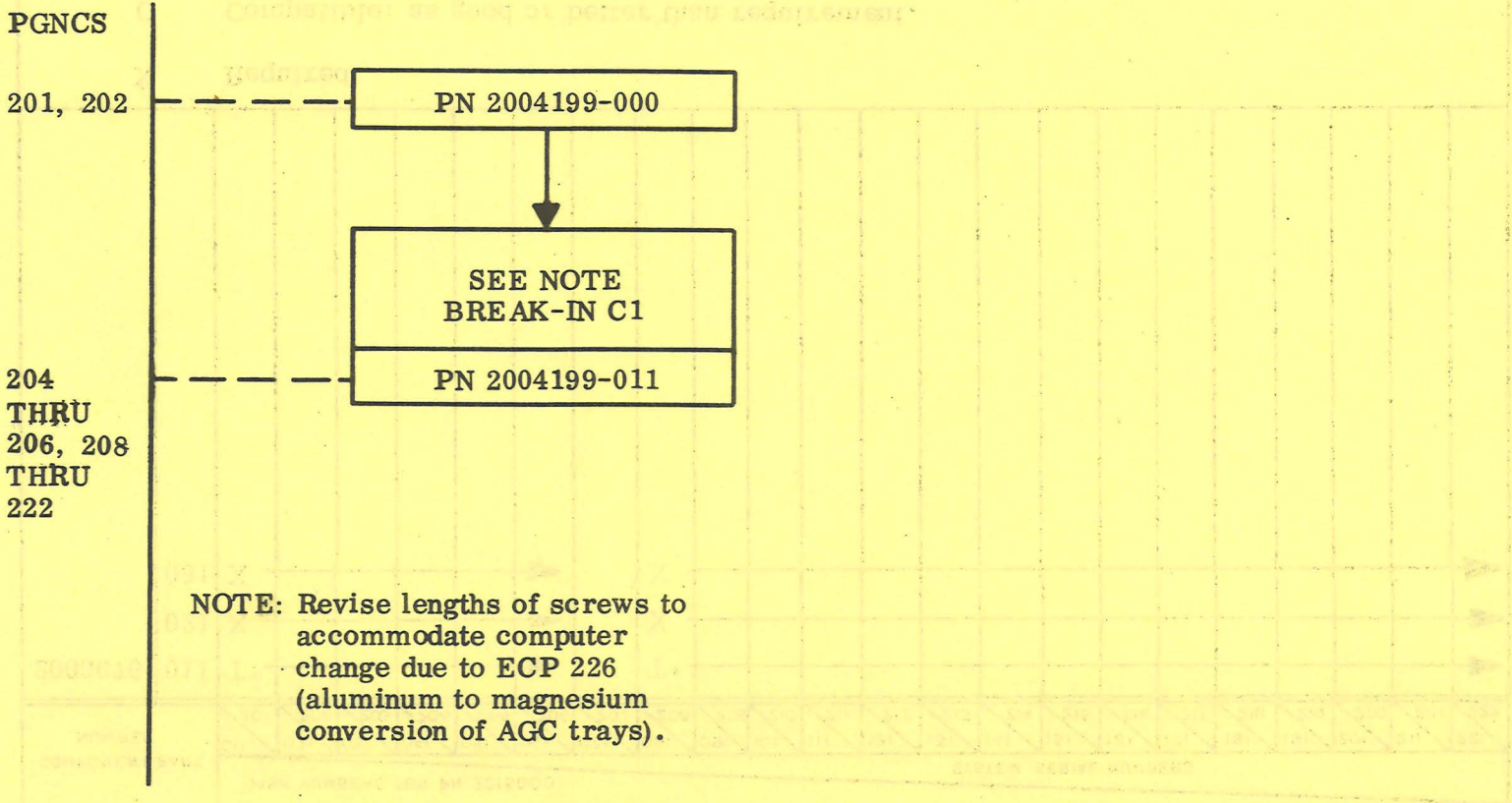

Table 3-IC-2. Jumper Module (Sundial 2021104) Compatibility

COMPONENT PART NUMBER	DASH NUMBERS FOR PN 2015000																					
	SYSTEM SERIAL NUMBERS																					
	011 201	021 202	031 203	041 204	051 205	061 206	071 207	081 208	091 209	101 210	111 211	121 212	131 213	141 214	151 215	161 216	171 217	181 218	191 219	201 220	211 221	221 222
2003076	011	T*				➔		T*														➔
	021	X				➔		X														➔
	031	X				➔		X														➔
<p>X Required</p> <p>C Compatible: as good or better than requirement.</p> <p>T Not as good as requirement, but can be used for testing.</p> <p>NO CANNOT be used.</p> <p>* Can be used in slots B4, B5, and B6 of "pre C" computers or in slot B4 of "C" computers.</p> <p>CAUTION: Do not use -011 module in slots B5 and B6 of "C" computers. Use of -011 module in these slots can damage the "C" computers.</p>																						

Table 3-IC-3. Rope Modules (Sundial) Compatibility

COMPONENT PART NUMBER	DASH NUMBERS FOR PN 2015000																					
	SYSTEM SERIAL NUMBERS																					
	011 201	021 202	031 203	041 204	051 205	061 206	071 207	081 208	091 209	101 210	111 211	121 212	131 213	141 214	151 215	161 216	171 217	181 218	191 219	201 220	211 221	221 222
2021104	011	T ^①				▶		T ^①														▶
	021	T ^②				▶		T ^②														▶
	031	T				▶		T														▶
	041	X				▶		X														▶
	051	X				▶		X														▶
	061	X				▶		X														▶

X Required
 C Compatible: as good or better than requirement.
 T Not as good as requirement, but can be used for testing.
 NO CANNOT be used.

COMPONENT PART NUMBER	MODULE PART NUMBER AND LOCATION									
	PN 2003053					PN 2003972				
	-121	-131	-141	-151	-161	-041	-071	-081	-211	
2021104	011	B1	B2 ^①	B3 ^①						
	021	B1			B2	B3 ^②				
	031					B1	B2	B3		
	041					B1	B2		B3	
	051	B1			B2				B3	
	051	B1					B2		B3	
	051				B2	B1			B3	
	061	B1	B2						B3	
	061		B2			B1			B3	

NOTE: -051 and -061 have several possible configurations
 ① Will NOT work with JDC 12217
 ② Contains gyro compassing error

Table 3-ID. Indicator Control Panel Compatibility (Sheet 1 of 2)

COMPONENT PART NUMBER	DASH NUMBERS FOR PN 2015000																							
	SYSTEM SERIAL NUMBERS																							
	011 201	021 202	031 203	041 204	051 205	061 206	071 207	081 208	091 209	101 210	111 211	121 212	131 213	141 214	151 215	161 216	171 217	181 218	191 219	201 220	211 221	221 222		
2014578	011 X	T																					→	
	021 C	T	X	T																				→
	031 C	T	C	T																				→
2021323 with waiver ACSK- E1185	011 C	X	T																					→
2021323	011 C				→ T																			→
	021 C		→ X	T																				→
2021290	011 C			→ T	T	X	T																	→
	021 C			→ T																				→
	041 C			→ T	X	C	X			→ T														→
	051 C			→ X	C					→ X														→
X		Required per print																						
C		Compatible: as good or better than print requirement. See ECP flow chart.																						
T		Not as good as print requirement, but can be used for testing. See ECP flow chart.																						
NO		CANNOT be used.																						
*Verify configuration of part number 2021323-011 before use. See ECP flow chart for clarification.																								

3-2J-4

* {

Rev. AC

Table 3-ID. Indicator Control Panel Compatibility (Sheet 2 of 2)

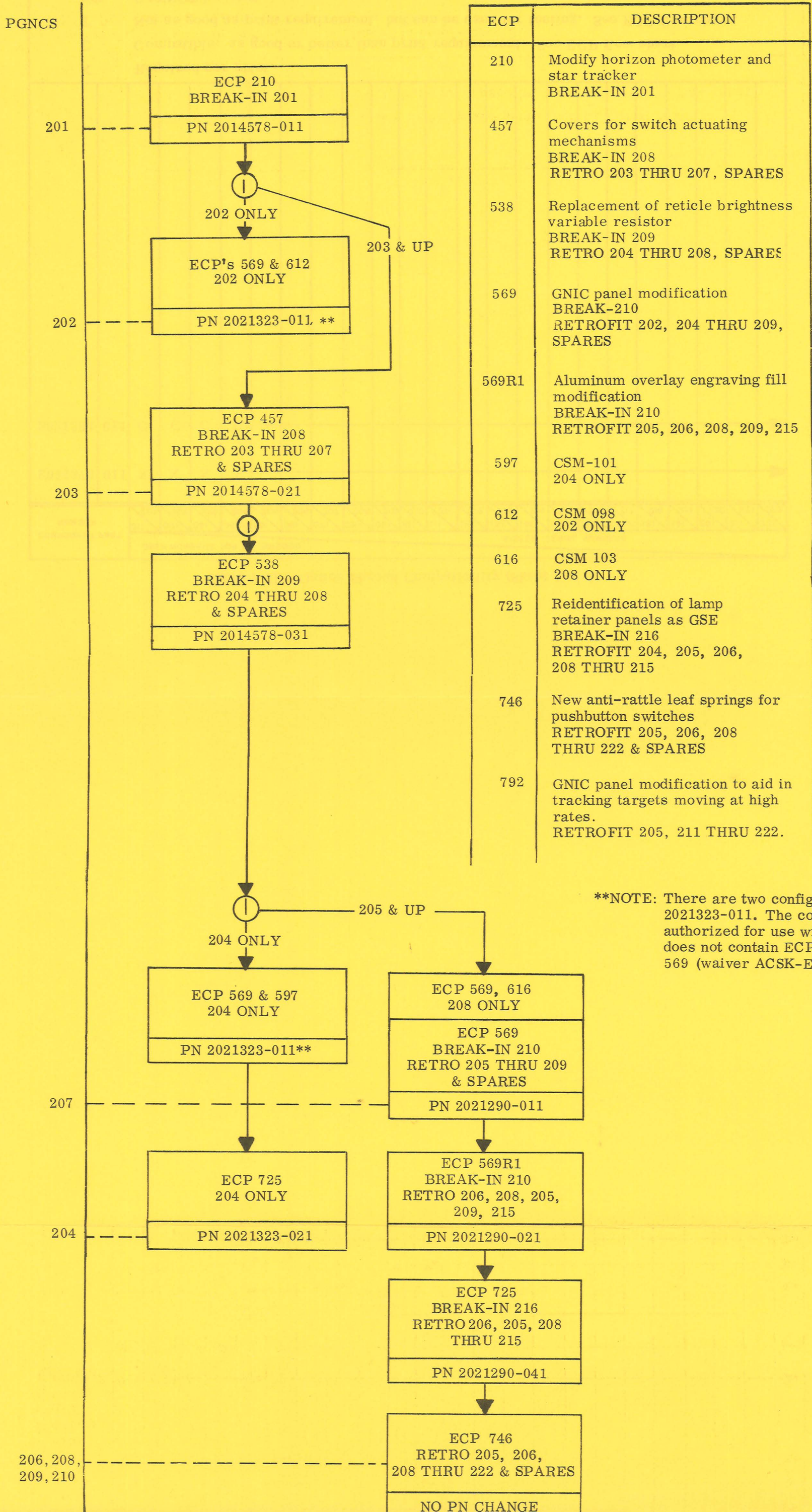

**NOTE: There are two configurations of PN 2021323-011. The configuration authorized for use with system 202 does not contain ECP 538 or all of 569 (waiver ACSK-E 1185).

Rev. AC

3-21

BLOCK II PRIMARY GUIDANCE, NAVIGATION, AND CONTROL SYSTEM

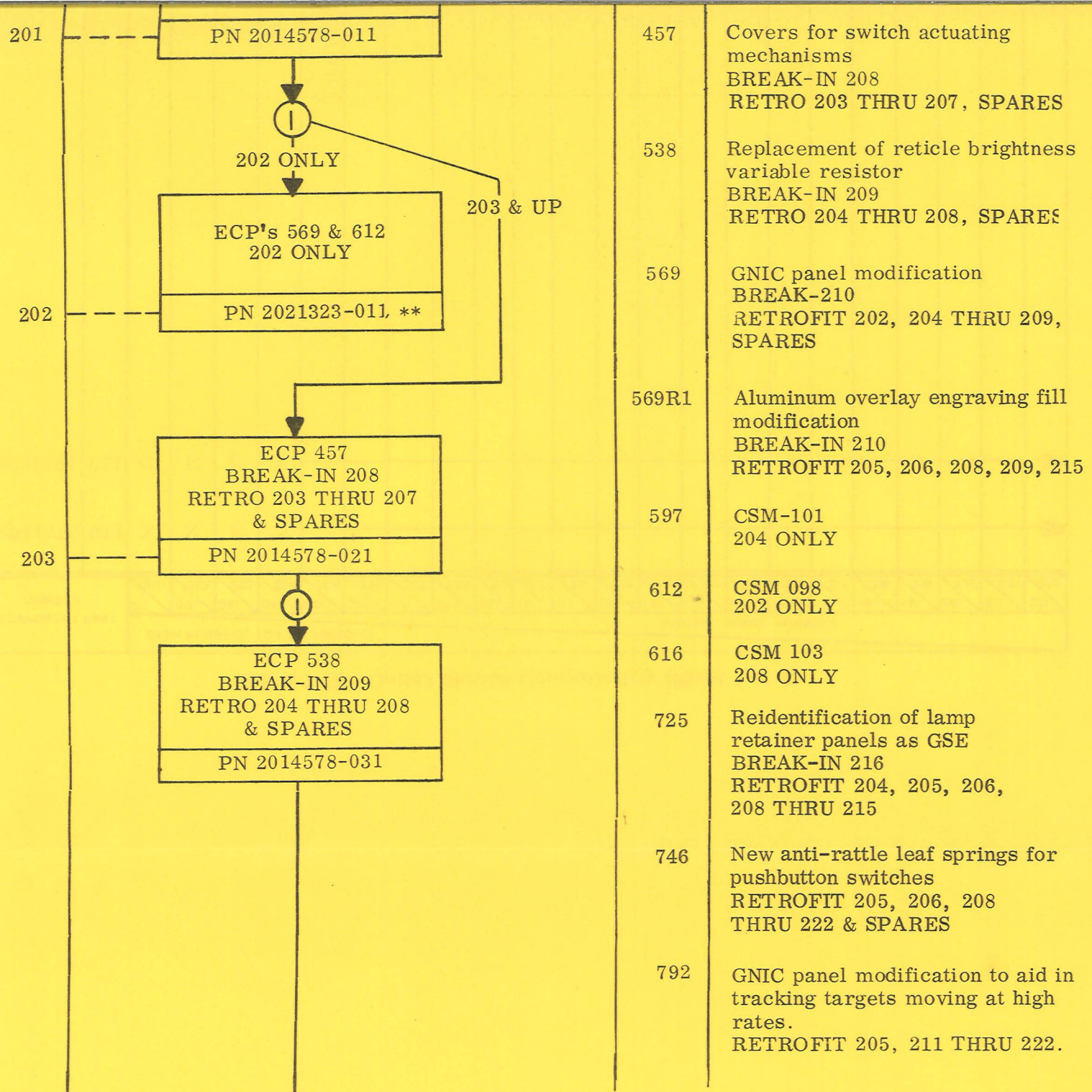

- 457 Covers for switch actuating mechanisms
BREAK-IN 208
RETRO 203 THRU 207, SPARES
- 538 Replacement of reticle brightness variable resistor
BREAK-IN 209
RETRO 204 THRU 208, SPARES
- 569 GNIC panel modification
BREAK-210
RETROFIT 202, 204 THRU 209, SPARES
- 569R1 Aluminum overlay engraving fill modification
BREAK-IN 210
RETROFIT 205, 206, 208, 209, 215
- 597 CSM-101
204 ONLY
- 612 CSM 098
202 ONLY
- 616 CSM 103
208 ONLY
- 725 Reidentification of lamp retainer panels as GSE
BREAK-IN 216
RETROFIT 204, 205, 206, 208 THRU 215
- 746 New anti-rattle leaf springs for pushbutton switches
RETROFIT 205, 206, 208 THRU 222 & SPARES
- 792 GNIC panel modification to aid in tracking targets moving at high rates.
RETROFIT 205, 211 THRU 222.

**NOTE: There are two configurations of PN 2021323-011. The configuration authorized for use with system 202 does not contain ECP 538 or all of 569 (waiver ACSK-E 1185).

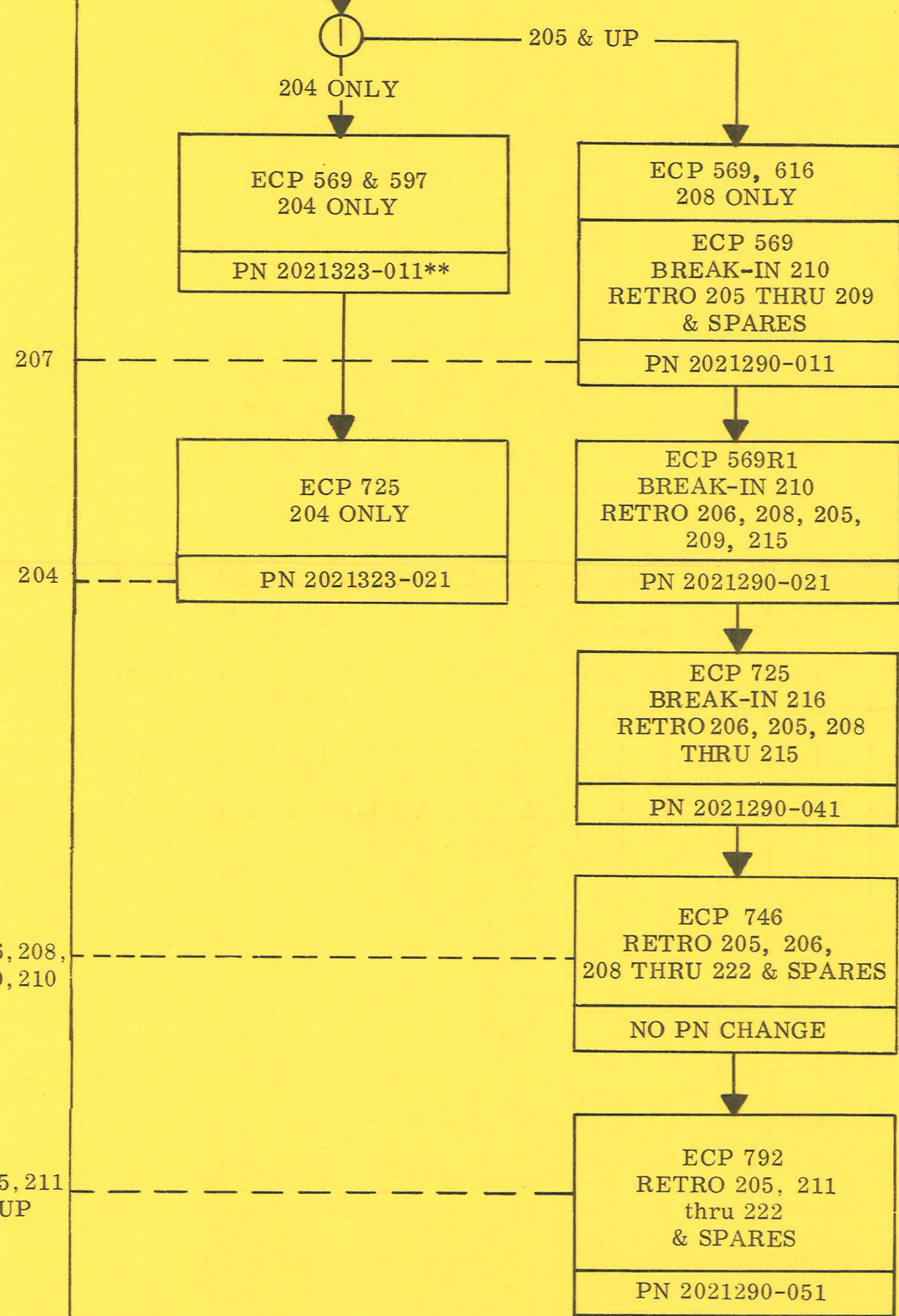

Rev. AC

3-2K

BLOCK II PRIMARY GUIDANCE, NAVIGATION, AND CONTROL SYSTEM

ND-1021043
MANUAL

Table 3-IE. Optics Shroud Compatibility (Sheet 1 of 2)

COMPONENT PART NUMBER	DASH NUMBERS FOR PN 2015000																						
	SYSTEM SERIAL NUMBERS																						
	011 201	021 202	031 203	041 204	051 205	061 206	071 207	081 208	091 209	101 210	111 211	121 212	131 213	141 214	151 215	161 216	171 217	181 218	191 219	201 220	211 221	221 222	
2014576	011	X	X	X	T																		▶
2021394	011	C	C	C	X																		▶
<p>X Required per print</p> <p>C Compatible: as good or better than print requirement. See ECP flow chart.</p> <p>T Not as good as print requirement, but can be used for testing. See ECP flow chart.</p> <p>NO CANNOT be used.</p>																							

Rev. Y

Table 3-1E. Optics Shroud Compatibility (Sheet 2 of 2)

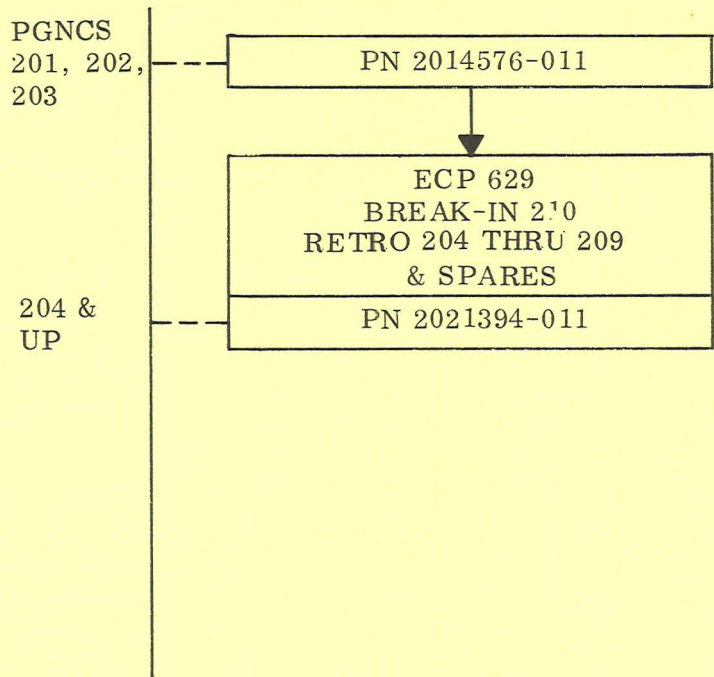

ECP	DESCRIPTIONS
629	Optics shroud redesign BREAK-IN 210 RETROFIT 204 THRU 209, SPARES

BLOCK II PRIMARY GUIDANCE, NAVIGATION, AND CONTROL SYSTEM

ND-1021043
MANUAL

Table 3-IF. Dust Cover, SCT Compatibility

COMPONENT PART NUMBER		DASH NUMBERS FOR PN 2015000																					
		SYSTEM SERIAL NUMBERS																					
		011 201	021 202	031 203	041 204	051 205	061 206	071 207	081 208	091 209	101 210	111 211	121 212	131 213	141 214	151 215	161 216	171 217	181 218	191 219	201 220	211 221	221 222
1021352	011	X		X	→		X																→
X		Required per print																					
C		Compatible: as good or better than print requirement.																					
T		Not as good as print requirement, but can be used for testing.																					
NO		CANNOT be used.																					

Table 3-IG. Dust Cover, SXT Compatibility

COMPONENT PART NUMBER		DASH NUMBERS FOR PN 2015000																						
		SYSTEM SERIAL NUMBERS																						
		011 201	021 202	031 203	041 204	051 205	061 206	071 207	081 208	091 209	101 210	111 211	121 212	131 213	141 214	151 215	161 216	171 217	181 218	191 219	201 220	211 221	221 222	
1021362	011		X		X	→			X	→														→
X		Required per print																						
C		Compatible: as good or better than print requirement.																						
T		Not as good as print requirement, but can be used for testing.																						
NO		CANNOT be used.																						

Table 3-IH. SCT Eyepiece Assembly (Adjustable Focus) Compatibility (Sheet 1 of 2)

COMPONENT PART NUMBER	DASH NUMBERS FOR PN 2015000																					
	SYSTEM SERIAL NUMBERS																					
	011 201	021 202	031 203	041 204	051 205	061 206	071 207	081 208	091 209	101 210	111 211	121 212	131 213	141 214	151 215	161 216	171 217	181 218	191 219	201 220	211 221	221 222
2012719 000		T		T																		▶
2012793 000		X		X	T	X			▶	T												▶
011		C		C	X	C			▶	X												▶
021		C		C	X	C									▶	X	C	X	C	C	X	X
X	Required per print																					
C	Compatible: as good or better than print requirement.																					
T	Not as good as print requirement, but can be used for testing.																					
NO	CANNOT be used.																					

Table 3-IH. SCT Eyepiece Assembly (Adjustable Focus) Compatibility (Sheet 2 of 2)

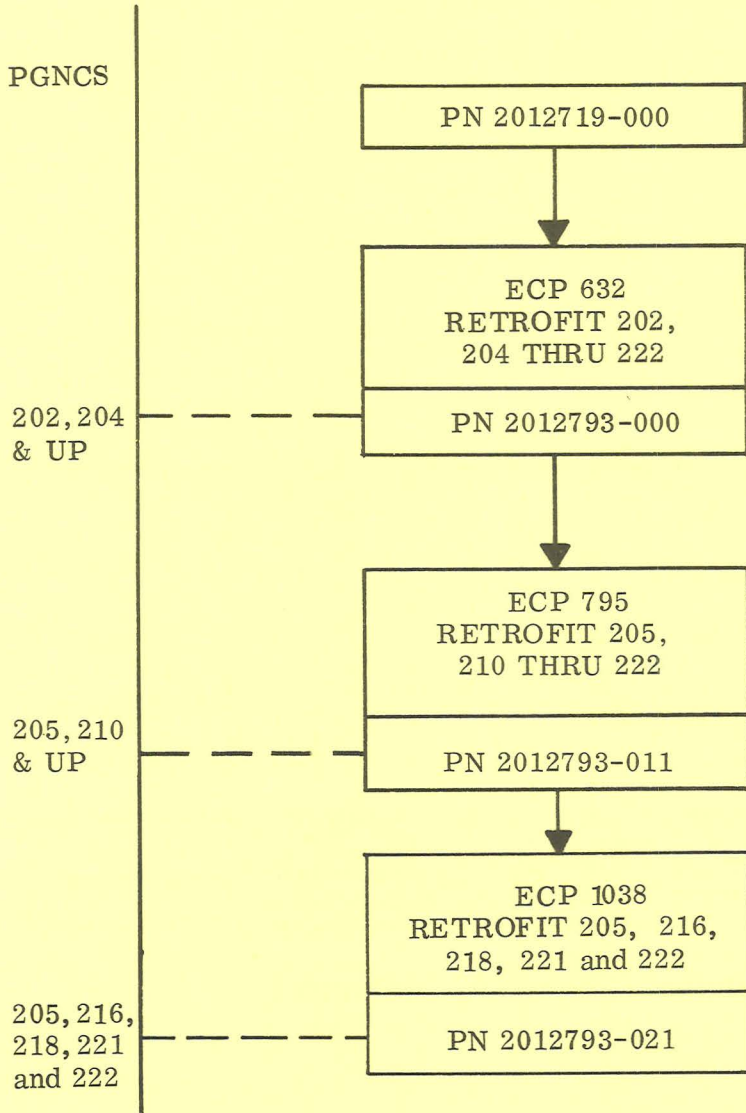

ECP	DESCRIPTION
632	CM OUA eyepiece assemblies flammability modifications RETROFIT 202, 204 THRU 222
795	Add teflon locking rings to fit on lens housing eyepiece assembly RETROFIT 205, 210 THRU 222
1038	Addition of heater to prevent eyepiece moisture during high humidity conditions.

Table 3-IJ. SCT Long Eye Relief Eyepiece Compatibility (Sheet 1 of 2)

COMPONENT PART NUMBER	DASH NUMBERS FOR PN 2015000																					
	SYSTEM SERIAL NUMBERS																					
	011 201	021 202	031 203	041 204	051 205	061 206	071 207	081 208	091 209	101 210	111 211	121 212	131 213	141 214	151 215	161 216	171 217	181 218	191 219	201 220	211 221	221 222
2012691 000		T		T																		▶
2012790 000		X		X																		▶
011					X																	▶

Table 3-IJ. SCT Long Eye Relief Eyepiece Compatibility (Sheet 2 of 2)

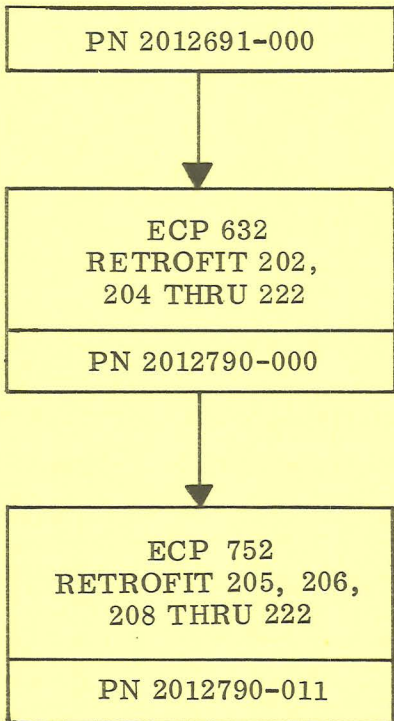

ECP	DESCRIPTION
632	CM OUA eyepiece assemblies flam- mability modifications RETROFIT 202, 204 THRU 222
752	Sunfilters for SCT eyepieces RETROFIT 205, 206, 208 THRU 222

Table 3-IK. SCT Prism Housing Assembly Compatibility (Sheet 1 of 2)

COMPONENT PART NUMBER	DASH NUMBERS FOR PN 2015000																					
	SYSTEM SERIAL NUMBERS																					
	011 201	021 202	031 203	041 204	051 205	061 206	071 207	081 208	091 209	101 210	111 211	121 212	131 213	141 214	151 215	161 216	171 217	181 218	191 219	201 220	211 221	221 222
2012667 000		T		T																		→
2012775 000		X		X																		→
	011	T		C	X	C									→	X	C	X	C	C	X	→
1013010 000		T		T																		→
1013016 000		C		C																		→
X	Required per print																					
C	Compatible: as good or better than print requirement.																					
T	Not as good as print requirement, but can be used for testing.																					
NO	CANNOT be used.																					

Table 3-IK. SCT Prism Housing Assembly Compatibility (Sheet 2 of 2)
(only one required)

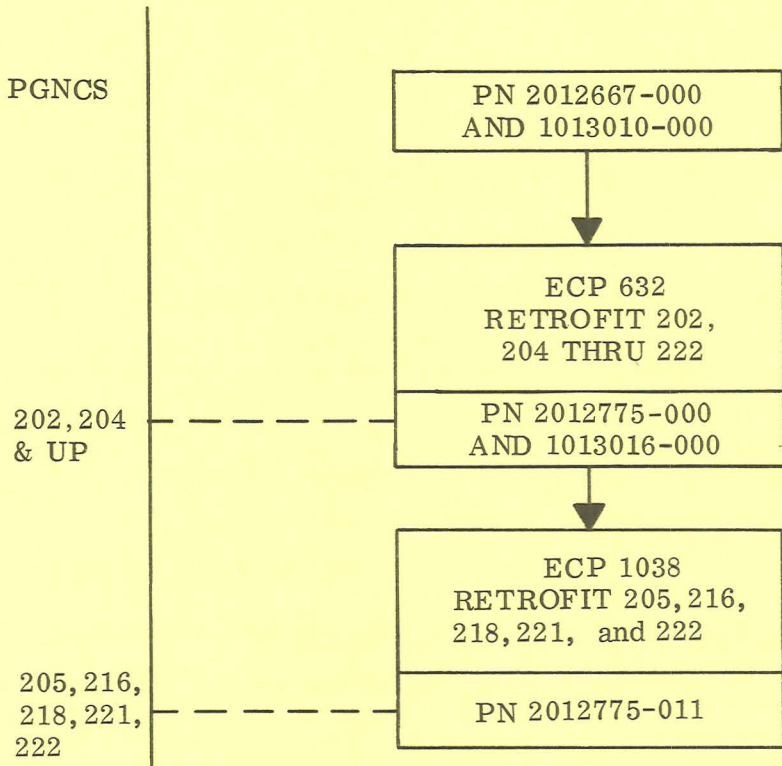

ECP	DESCRIPTION
632	CM OUA eyepiece assemblies flam- mability modifications RETROFIT 202, 204 THRU 222
1038	Addition of heater to prevent eye- piece moisture during high humidity conditions. RETROFIT 205, 216, 218, 221, and 222

Table 3-IL. SXT Eyepiece Assembly Compatibility (Sheet 1 of 2)

COMPONENT PART NUMBER		DASH NUMBERS FOR PN 2015000																						
		SYSTEM SERIAL NUMBERS																						
		011 201	021 202	031 203	041 204	051 205	061 206	071 207	081 208	091 209	101 210	111 211	121 212	131 213	141 214	151 215	161 216	171 217	181 218	191 219	201 220	211 221	221 222	
2012700	000	T	→		T																		→	
	011	X	→		X	T	X			→	T													→
	021	C	→		C	X	C			→	X													→
X		Required per print																						
C		Compatible: as good or better than print requirement. See ECP flow chart.																						
T		Not as good as print requirement, but can be used for testing. See ECP flow chart.																						
NO		CANNOT be used.																						

Table 3-IL. SXT Eyepiece Assembly Compatibility (Sheet 2 of 2)

PGNCS

PN 2012700-000

ECP 706
RETROFIT S/N's
018, 019, AND 2002
THRU 2023

PN 2012700-011

ECP 795
RETROFIT 205,
210 THRU 222

PN 2012700-021

205, 210
& UP

ECP	DESCRIPTION
706	Modification to prevent loosening of SXT eyepiece RETROFIT S/N's 018, 019, and 2002 THRU 2023
795	Add teflon locking ring to fit on the SXT eyeguard assembly to prevent loosening RETROFIT 205, 210 THRU 222

Table 3-IM. SXT Long Eye Relief Eyepiece Compatibility (Sheet 1 of 2)

COMPONENT PART NUMBER		DASH NUMBERS FOR PN 2015000																					
		SYSTEM SERIAL NUMBERS																					
		011 201	021 202	031 203	041 204	051 205	061 206	071 207	081 208	091 209	101 210	111 211	121 212	131 213	141 214	151 215	161 216	171 217	181 218	191 219	201 220	211 221	221 222
2012748	000	T →		T																			→
	011	X →		X																			→
X		Required per print																					
C		Compatible: as good or better than print requirement.																					
T		Not as good as print requirement, but can be used for testing.																					
NO		CANNOT be used.																					

Table 3-IM. SXT Long Eye Relief Eyepiece Compatibility (Sheet 2 of 2)

PGNCS

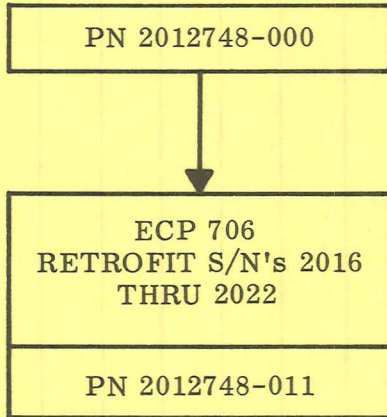

ECP	DESCRIPTION
706	Modification to prevent loosening of SXT long eye relief eyepiece RETROFIT S/N's 2016 THRU 2022.

Table 3-IN. SXT Mirror Housing and Eyepiece Assembly Compatibility (Sheet 1 of 2)

COMPONENT PART NUMBER	DASH NUMBERS FOR PN 2015000																					
	SYSTEM SERIAL NUMBERS																					
	011 201	021 202	031 203	041 204	051 205	061 206	071 207	081 208	091 209	101 210	111 211	121 212	131 213	141 214	151 215	161 216	171 217	181 218	191 219	201 220	211 221	221 222
2012699 000		T		T																		▲
2012791 000		X		X																		▲
011									X													▲
X	Required per print																					
C	Compatible: as good or better than print requirement. See ECP flow chart.																					
T	Not as good as print requirement, but can be used for testing. See ECP flow chart.																					
NO	CANNOT be used.																					

Table 3-IN. SXT Mirror Housing and Eyepiece Assembly Compatibility (Sheet 2 of 2)

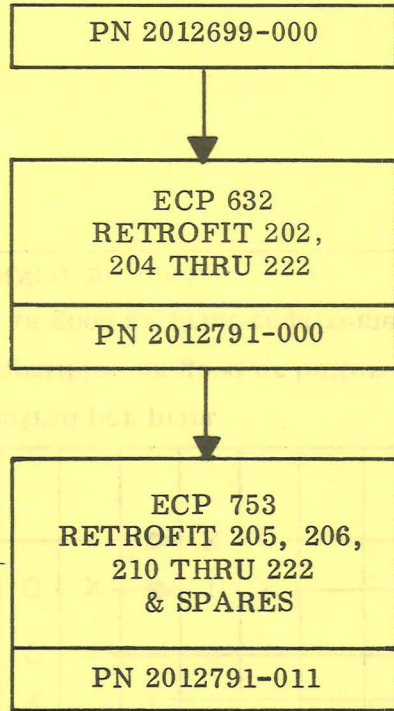

ECP	DESCRIPTION
632	CM OUA eyepiece assemblies flam- mability modifications RETROFIT 202, 204 THRU 222
753	Incorporate steel threaded inserts into the SXT Mirror Housings RETROFIT 205, 206, 210 THRU 222 & SPARES

Table 3-IP. Eyepiece Storage Unit Compatibility (Sheet 1 of 2)

COMPONENT PART NUMBER	DASH NUMBERS FOR PN 2015000																					
	SYSTEM SERIAL NUMBERS																					
	011	021	031	041	051	061	071	081	091	101	111	121	131	141	151	161	171	181	191	201	211	221
	201	202	203	204	205	206	207	208	209	210	211	212	213	214	215	216	217	218	219	220	221	222
2021255	011	X	X		T																	
2021382	011	C	C	T																		
	021	C	C	X →	T	X →									T →							
	031	C				X →		C →							X →							
		X	Required per print																			
		C	Compatible: as good or better than print requirement.																			
		T	Not as good as print requirement, but can be used for testing.																			
		NO	CANNOT be used.																			

Table 3-1P. Eyepiece Storage Unit Compatibility (Sheet 2 of 2)

PGNCS
201,
202

PN 2021255-011



ECP 628

PN 2021382-011



ECP 632
BREAK-IN 203
RETRO 205

203, 204
206
THRU
210

PN 2021382-021



ECP 790
RETRO 205,
211-222

205, 211
& UP

PN 2021382-031*

ECP	DESCRIPTIONS
628	ESU redesign as a result of flammability study
632	OUA eyepiece flammability fix BREAK-IN 203 RETROFIT 205
790	Addition of finger tab and replacement of SXT Eyepiece Retainer Bracket *211, 212 and 214 are to be retrofitted only if the eyepiece retainer fails.

Table 3-IQ. Flexible Hose Assembly (2 required) Compatibility (Sheet 1 of 2)

COMPONENT PART NUMBER	DASH NUMBERS FOR PN 2015000																					
	SYSTEM SERIAL NUMBERS																					
	011 201	021 202	031 203	041 204	051 205	061 206	071 207	081 208	091 209	101 210	111 211	121 212	131 213	141 214	151 215	161 216	171 217	181 218	191 219	201 220	211 221	221 222
2018821	011	X																				
	021		X																			

- X Required per print
- C Compatible: as good or better than print requirement. See ECP flow chart.
- T Not as good as print requirement, but can be used for testing. See ECP flow chart.
- NO CANNOT be used.

Table 3-IQ. Flexible Hose Assembly (2 required) Compatibility (Sheet 2 of 2)

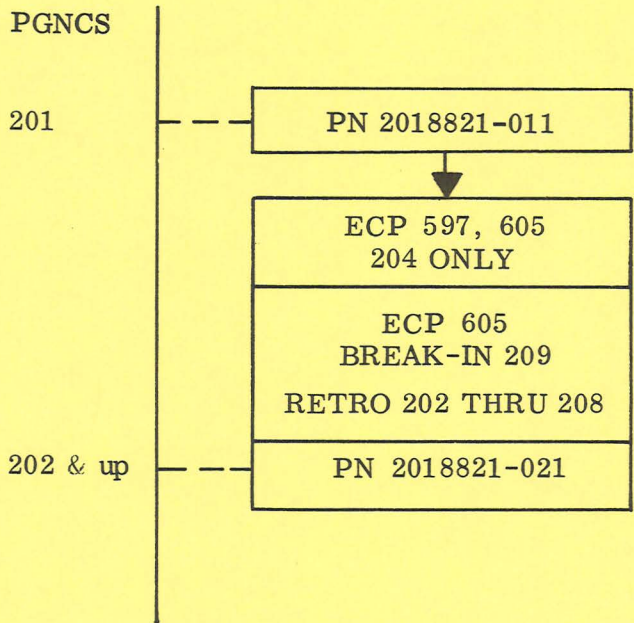

ECP	DESCRIPTION
597	CSM-101 204 ONLY
605	IMU blanket removal BREAK-IN 209 RETROFIT 202 THRU 208

Table 3-IR. Interconnect Harness J

COMPONENT PART NUMBER	DASH NUMBERS FOR PN 2015000																					
	SYSTEM SERIAL NUMBERS																					
	011 201	021 202	031 203	041 204	051 205	061 206	071 207	081 208	091 209	101 210	111 211	121 212	131 213	141 214	151 215	161 216	171 217	181 218	191 219	201 220	211 221	221 222
2010748		X																				
X	Required per print																					
C	Compatible: as good or better than print requirement.																					
T	Not as good as print requirement, but can be used for testing.																					
NO	CANNOT be used.																					

Table 3-IS. IMU and PEA Compatibility (Sheet 1 of 2)

COMPONENT PART NUMBER	DASH NUMBERS FOR PN 2015000																							
	011	021	031	041	051	061	071	081	091	101	111	121	131	141	151	161	171	181	191	201	211	221		
	201	202	203	204	205	206	207	208	209	210	211	212	213	214	215	216	217	218	219	220	221	222		
2007203	011	X	T		T																		▶▶	
	021	C	T		T																			▶▶
	thru 061																							
	071	C	T		T																			▶▶
	081	C	T		T																			▶▶
	091	C	T		T																			▶▶
	101	C	T		X*						▶ T													▶▶
	111	C	T		X	T	X						▶▶ T	X	X	T				▶ X	X	T		▶▶
121	C	T		C	X	C						▶▶ X	C	▶ X	X	X				▶ C	X		▶▶	
2010747	011	C	T		T																			▶▶
	041	C	T		T																			▶▶
	051	C	T		T																			▶▶
	071	C	X		T																			▶▶

X Required per print
 C Compatible: as good or better than print requirement. See ECP flow chart.
 T Not as good as print requirement, but can be used for testing. See ECP flow chart.
 NO CANNOT be used.

* See note 2 on sheet 2.

Table 3-IS. IMU and PEA Compatibility (Sheet 2 of 2)

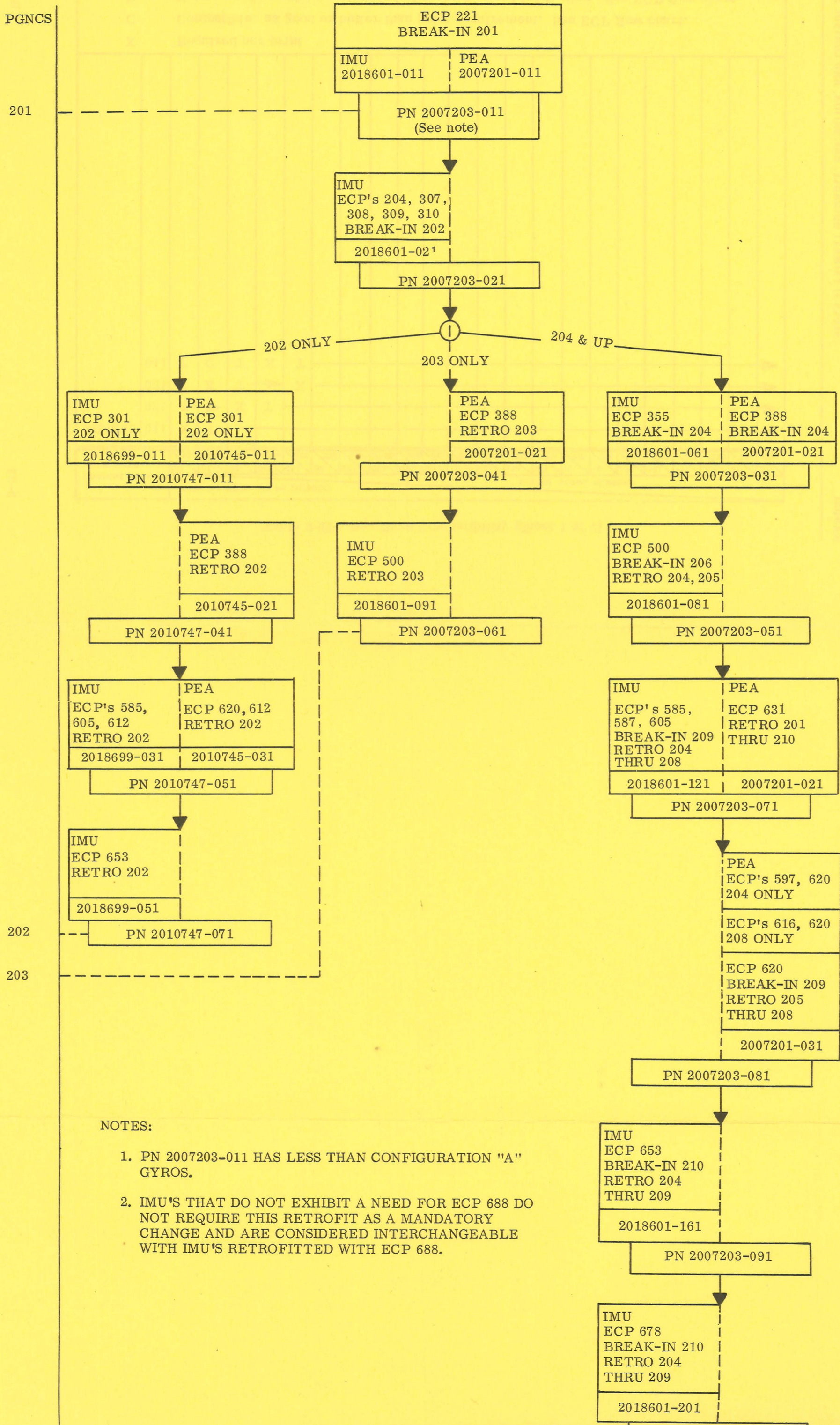

NOTES:

1. PN 2007203-011 HAS LESS THAN CONFIGURATION "A" GYROS.
2. IMU'S THAT DO NOT EXHIBIT A NEED FOR ECP 688 DO NOT REQUIRE THIS RETROFIT AS A MANDATORY CHANGE AND ARE CONSIDERED INTERCHANGEABLE WITH IMU'S RETROFITTED WITH ECP 688.

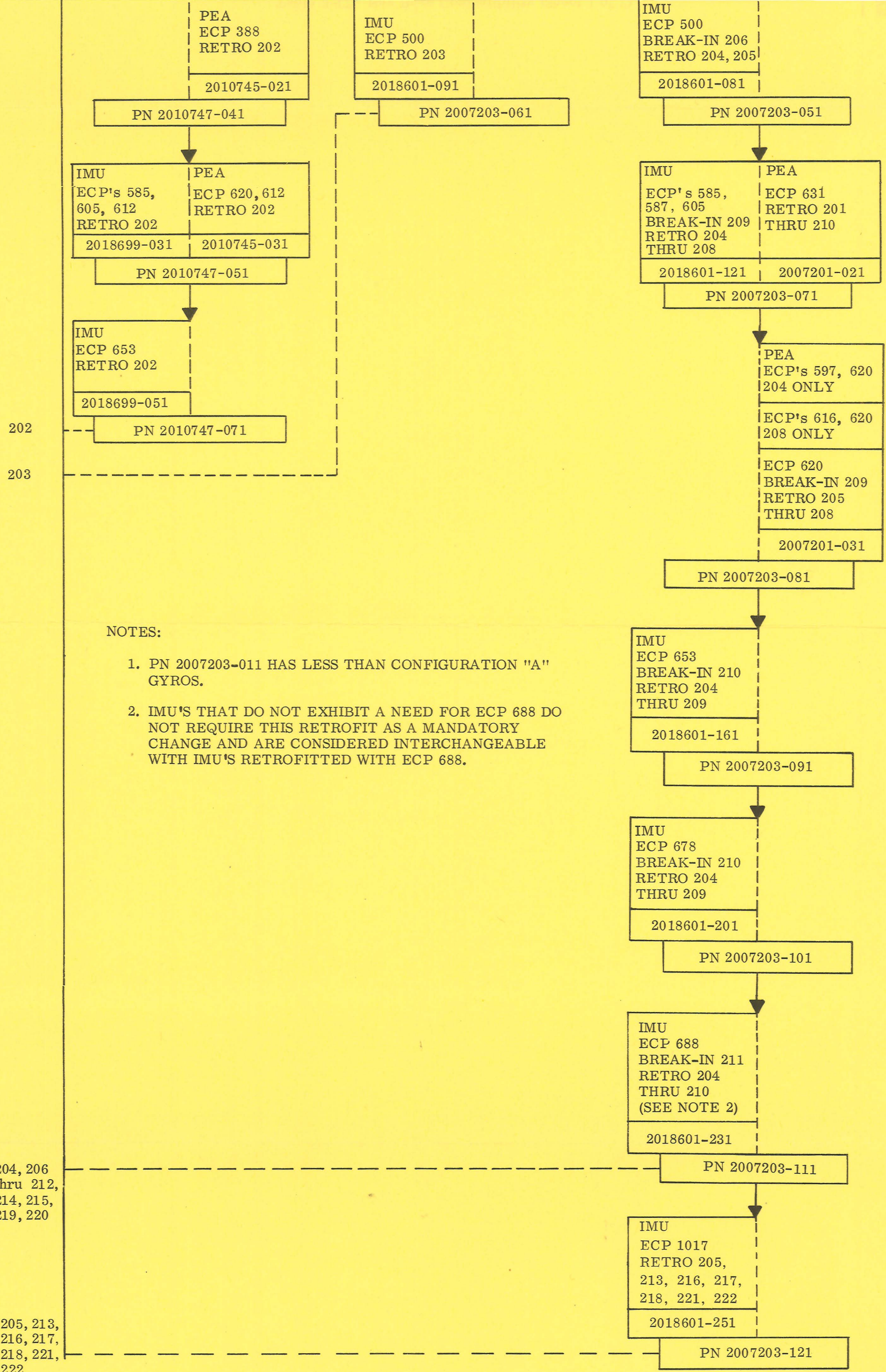

ECP	DESCRIPTIONS
204	Thermal control circuitry change BREAK-IN 202
221	Z axis IRIG rotation BREAK-IN 201
301	Add thermal sensors 202 ONLY
307	Middle axis assembly clamp changes BREAK-IN 202

ECP	DESCRIPTIONS
597	CSM-101 204 ONLY
605	IMU blanket removal BREAK-IN 209 RETROFIT 202 THRU 208
612	CSM-098 202 ONLY

BLOCK II PR

NOTES:

1. PN 2007203-011 HAS LESS THAN CONFIGURATION "A" GYROS.
2. IMU'S THAT DO NOT EXHIBIT A NEED FOR ECP 688 DO NOT REQUIRE THIS RETROFIT AS A MANDATORY CHANGE AND ARE CONSIDERED INTERCHANGEABLE WITH IMU'S RETROFITTED WITH ECP 688.

204, 206
thru 212,
214, 215,
219, 220

205, 213,
216, 217,
218, 221,
222

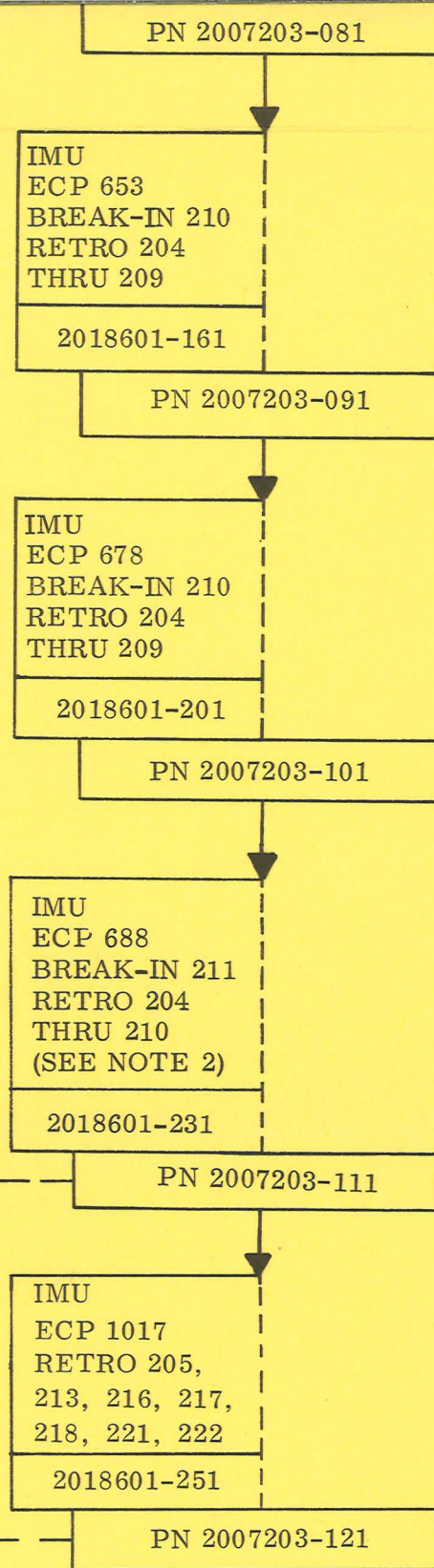

ECP	DESCRIPTIONS
204	Thermal control circuitry change BREAK-IN 202
221	Z axis IRIG rotation BREAK-IN 201
301	Add thermal sensors 202 ONLY
307	Middle axis assembly clamp changes BREAK-IN 202
308	Stable member heat transfer change BREAK-IN 202
309	PIP temp deviation reduction and temp alarm test BREAK-IN 202
310	IMU cross coupling change BREAK-IN 202
355	IRIG change BREAK-IN 204
388	Corrosion and outgassing protection BREAK-IN 204 RETROFIT 202, 203
500	PIP preamplifier change BREAK-IN 206 RETROFIT 203 THRU 205
585	PIP preamplifier capacitor replacement BREAK-IN 204 RETROFIT 202 THRU 208
587	ECP 587 should be incorporated in PN 2007203-071 and higher. 587 does not affect part number change. It may be included in lower part number assemblies.

ECP	DESCRIPTIONS
597	CSM-101 204 ONLY
605	IMU blanket removal BREAK-IN 209 RETROFIT 202 THRU 208
612	CSM-098 202 ONLY
616	CSM-103 208 ONLY
620	Flammability fix BREAK-IN 209 RETROFIT 202, 204 THRU 207
631	ECP 631 should be incorporated in PN 2007203-071 and higher. 631 does not affect part number change. It may be included in lower part number assemblies.
653	Modification of IMU wiring to reduce IRIG pre-amp oscillation BREAK-IN 210 RETROFIT 202 THRU 209, SPARES
678	End cap mounting hardware torque change to Apollo II IRIG BREAK-IN 210 RETROFIT 204 THRU 209
688	Add capacitor to IRIG end cap assembly BREAK-IN 211 RETROFIT 204 THRU 210
1017	Replace blower motor in IMU to increase reliability RETROFIT 205, 213, 216, 217, 218, 221, 222, and spares

Rev. AE

Table 3-IT. Nav Base Compatibility (Sheet 1 of 2)

COMPONENT PART NUMBER	DASH NUMBERS FOR PN 2015000																							
	SYSTEM SERIAL NUMBERS																							
	011 201	021 202	031 203	041 204	051 205	061 206	071 207	081 208	091 209	101 210	111 211	121 212	131 213	141 214	151 215	161 216	171 217	181 218	191 219	201 220	211 221	221 222		
2899982	011	X	T																				▲	
	021	T	→	X	T																			▲
	031	T	X	T	→	X																		▲
	041	T	C	T	X	T																		▲
	<p>X Required per print</p> <p>C Compatible: as good or better than print requirement. See ECP flow chart.</p> <p>T Not as good as print requirement, but can be used for testing. See ECP flow chart.</p> <p>NO CANNOT be used.</p>																							

Table 3-IT. Nav Base Compatibility (Sheet 2 of 2)

PGNCS
201

PN 2899982-011

203, 204 ONLY



203

ECP 362
203 AND 204 ONLY
PN 2899982-021

204

ECP 597, 630
204 ONLY
PN 2899982-041

ECP 612, 630
202 ONLY
ECP 616, 630
208 ONLY
ECP 630
BREAK-IN 210
RETRO 205 THRU 209
PN 2899982-031

ECP	DESCRIPTION
362	Vibration transducer mounting hardware 203 and 204 ONLY
597	CSM-101 204 ONLY
612	CSM 098 202 ONLY
616	CSM 103 208 ONLY
630	Flammability fix for Nav Base BREAK-IN 210 RETROFIT 202, 204 THRU 209

202,
205
& up

Table 3-IU. Nav Base, Optical Unit and Bellows Installation Kit Compatibility
(Sheet 1 of 2)

COMPONENT PART NUMBER	DASH NUMBERS FOR PN 2015000																					
	SYSTEM SERIAL NUMBERS																					
	011 201	021 202	031 203	041 204	051 205	061 206	071 207	081 208	091 209	101 210	111 211	121 212	131 213	141 214	151 215	161 216	171 217	181 218	191 219	201 220	211 221	221 222
2899950	011																					
	021	X		X																		
	031	X	X																			
<p>X Required per print</p> <p>C Compatible: as good or better than print requirement. See ECP flow chart.</p> <p>T Not as good as print requirement, but can be used for testing. See ECP flow chart.</p> <p>NO CANNOT be used.</p>																						

Table 3-IU. Nav Base, Optical Unit and Bellows Installation Kit Compatibility (Sheet 2 of 2)

PGNCS

201, 203

202, 204
THRU 222

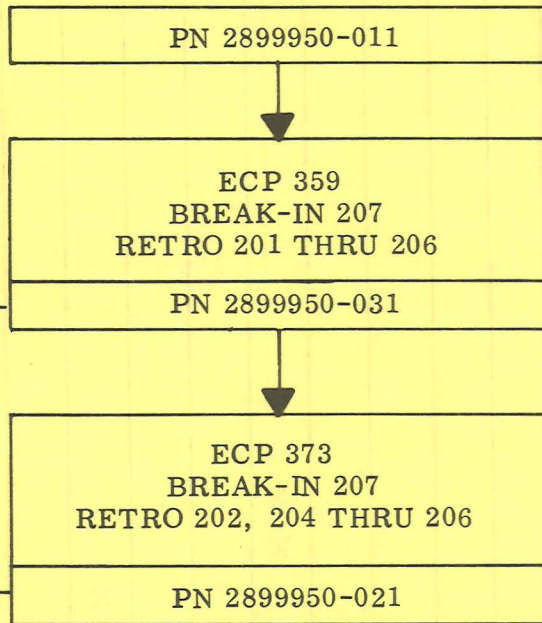

ECP	DESCRIPTION
359	Replacement of IMU mounting bolts BREAK-IN 207 RETROFIT 201 THRU 206
373	Fabrication of stainless steel bellows for Blk II G and N systems BREAK-IN 207 RETROFIT 202, 204 THRU 206

Table 3-IV. Optical Unit and Bellows Assembly Compatibility (Sheet 1 of 2)
 (Note: Changes are affected by OUA configuration see table 3-IW)

COMPONENT PART NUMBER	DASH NUMBERS FOR PN 2015000																					
	SYSTEM SERIAL NUMBERS																					
	011 201	021 202	031 203	041 204	051 205	061 206	071 207	081 208	091 209	101 210	111 211	121 212	131 213	141 214	151 215	161 216	171 217	181 218	191 219	201 220	211 221	221 222
2010790	121	X																				
	131			X	T	X	T	X	X	T												▶
	141			T																		▶
	181				T	C	X					▶	T	X	X	T	X	T	T	X	T	T
	171	X																				
	191				X								X			X		X	X		X	X
	201				X								X		X			C	X			▶
X	Required per print																					
C	Compatible: as good or better than print requirement. See ECP flow chart.																					
T	Not as good as print requirement, but can be used for testing. See ECP flow chart.																					
NO	CANNOT be used.																					

Table 3-IV. Optical Unit and Bellows Assembly Compatibility (Sheet 2 of 2)

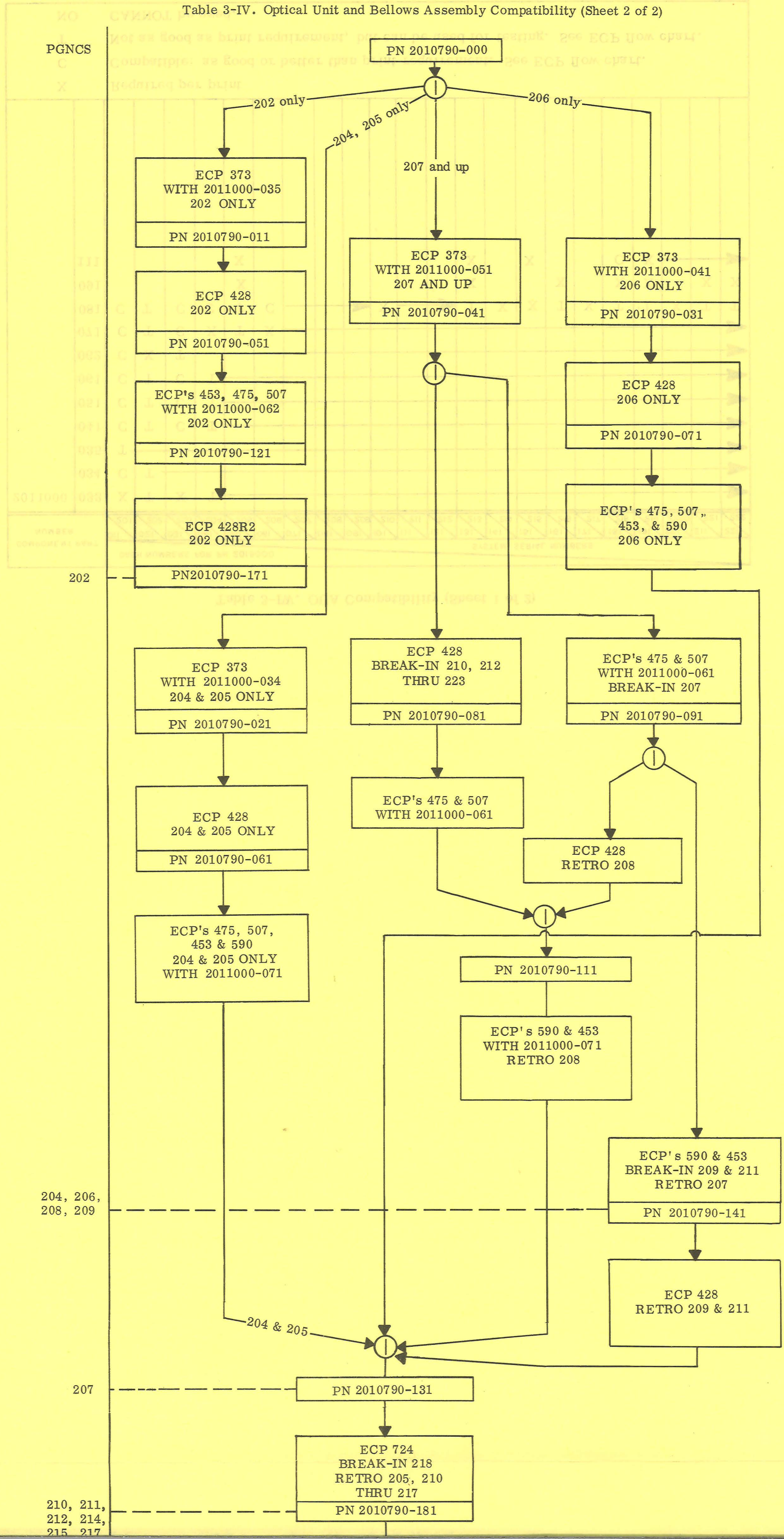

PGNCS

202

204, 206, 208, 209

207

210, 211, 212, 214, 215, 217

BLOCK II AIRWAY EQUIPMENT MAINTENANCE AND CONTROL 2121EW
 5010000
 3-52

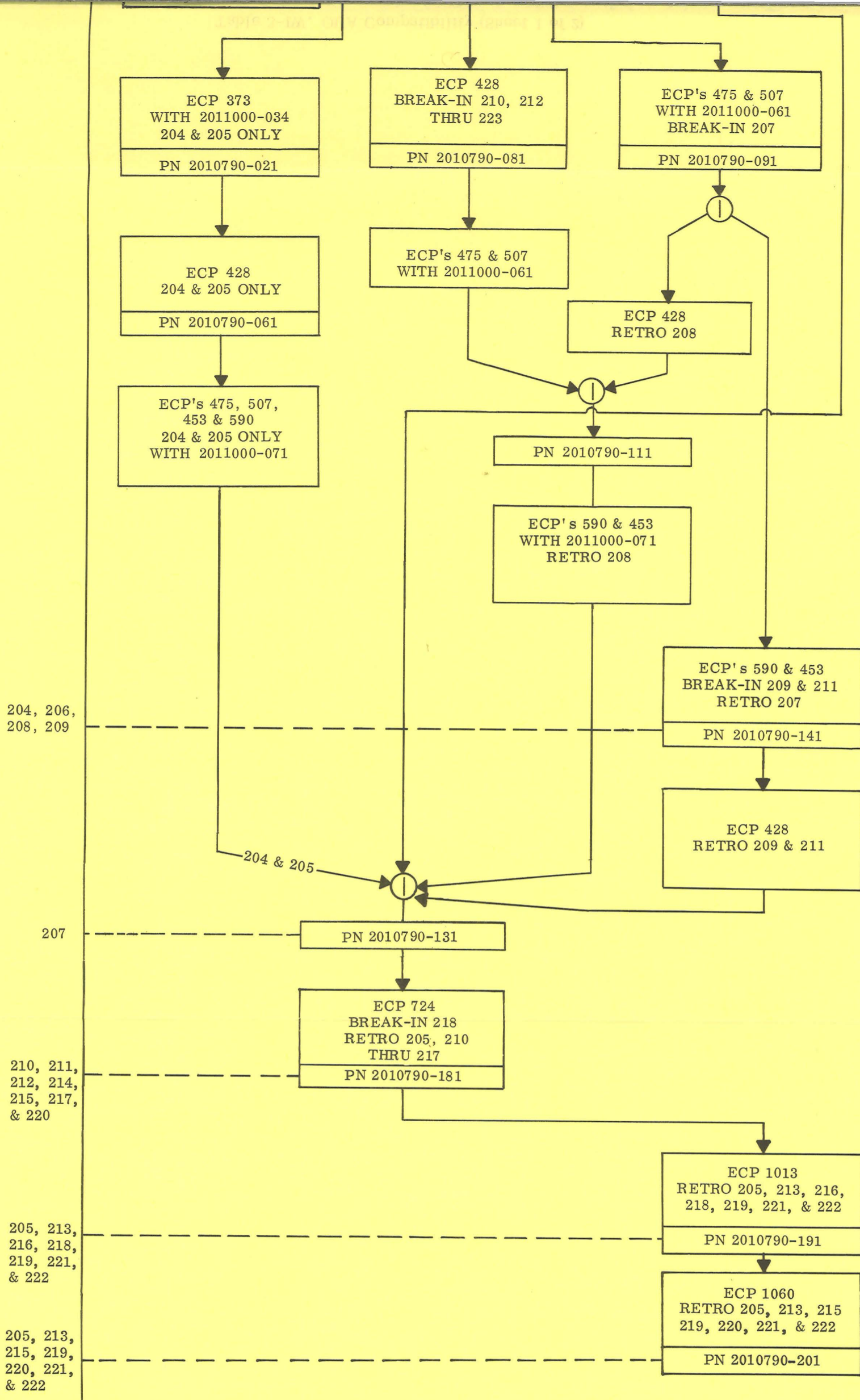

Rev. AG

3-2Y

ECP	DESCRIPTION
373	Fabrication of stainless steel bellows for Blk II G and N systems BREAK-IN 209 RETROFIT 202, 204 THRU 208
428	Astro sextant passive thermal protective system, Blk II BREAK-IN 210 RETROFIT 202, 204 THRU 206, 208, 209, & 211
453	Beryllium wedge fix to eliminate SXT head shift BREAK-IN 209 RETROFIT 202, 204 THRU 208
475	Chamfer of telescope manual adjust seal seat BREAK-IN 207 RETROFIT 202, 204 THRU 206
507	Modification of solvere motor-tach in OUA BREAK-IN 207 AND UP RETROFIT 202, 204 THRU 206

ECP	DESCRIPTION
590	Removal of anticreep protection BREAK-IN 209 RETROFIT 204 THRU 208
597	CSM 101 204 ONLY
724	OUA stop override BREAK-IN 218 RETROFIT 205, 210 THRU 217
1013	Refurbish OUA's by cleaning and relubricating the bearings and gears, adding new motor-tachs, and using new mounting techniques for SCT light rods. RETROFIT 205, 213, 216, 218, 219, 221, & 222
1060	Install new design OUA SXT and SCT base harness assemblies. RETROFIT 205, 213, 215, 219, 220, 221 & 222

BLOCK II PRIMARY GUIDANCE, NAVIGATION, AND CONTROL SYSTEM

ND-1021043
MANUAL

Table 3-IW. OUA Compatibility (Sheet 1 of 2)

COMPONENT PART NUMBER	DASH NUMBERS FOR PN 2015000																						
	SYSTEM SERIAL NUMBERS																						
	011 201	021 202	031 203	041 204	051 205	061 206	071 207	081 208	091 209	101 210	111 211	121 212	131 213	141 214	151 215	161 216	171 217	181 218	191 219	201 220	211 221	221 222	
2011000	033	X	T	X	T																		▲
	034	C	T																				▲
	035	T																					▲
	041	C	T	C	T																		▲
	051	C	T	C	T																		▲
	061	C	T	C	T																		▲
	062	C	X	T																			▲
	071	C	T	C	X	T	X																▲
	081	C	T	C	C	T	C		→	X		→	T	X	X	T	X	T	T	X	T	T	▲
	091					X							X			X		X	X		X	X	▲
	111					X							X		X			C	X				▲
	X	Required per print																					
	C	Compatible: as good or better than print requirement. See ECP flow chart.																					
	T	Not as good as print requirement, but can be used for testing. See ECP flow chart.																					
	NO	CANNOT be used.																					

Table 3-IW. OUA Compatibility (Sheet 2 of 2)

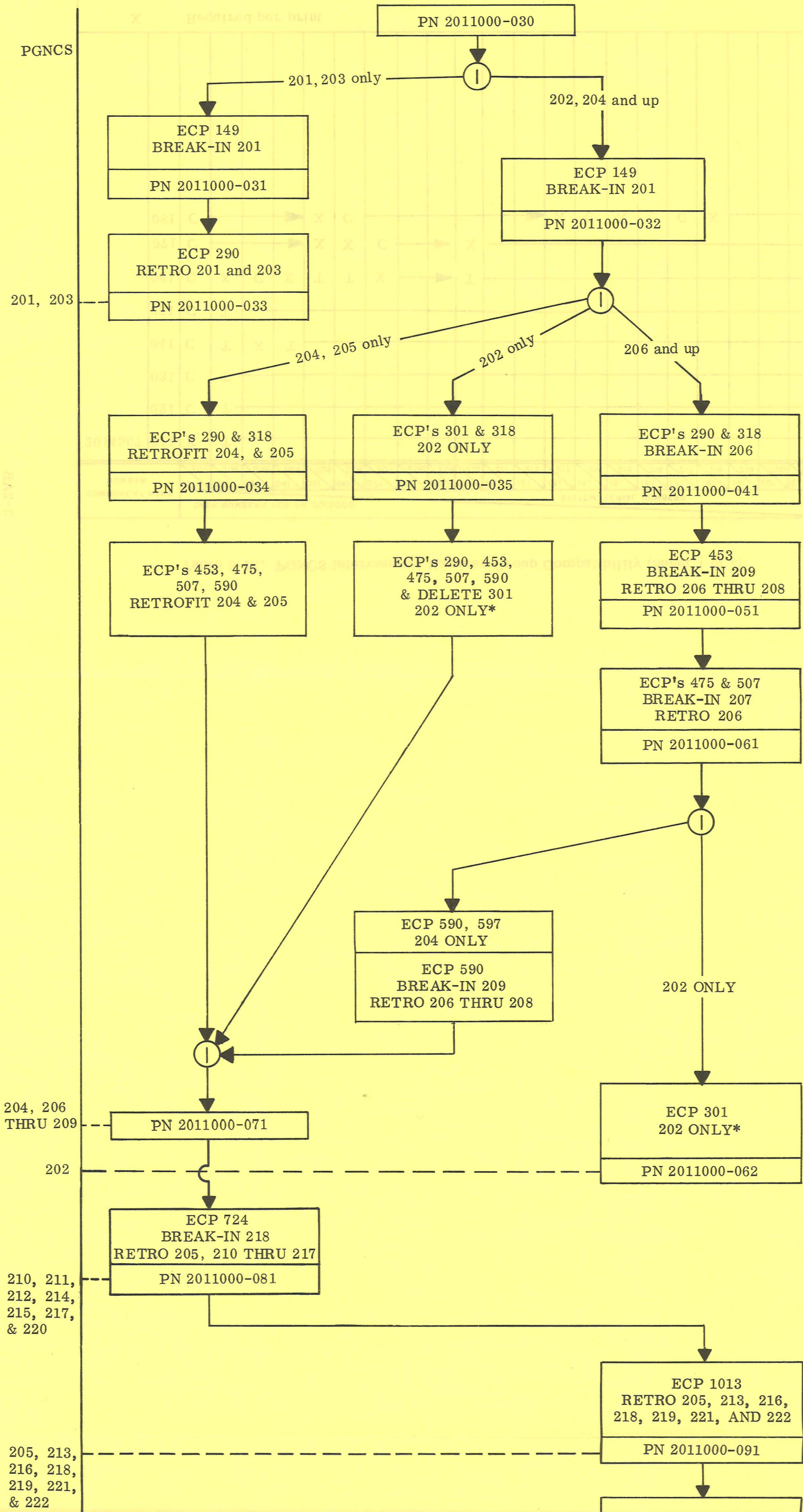

BLOCK II MINIMUM BRIDGE MAINTENANCE AND CONTROL SYSTEMS
 MD-1051043

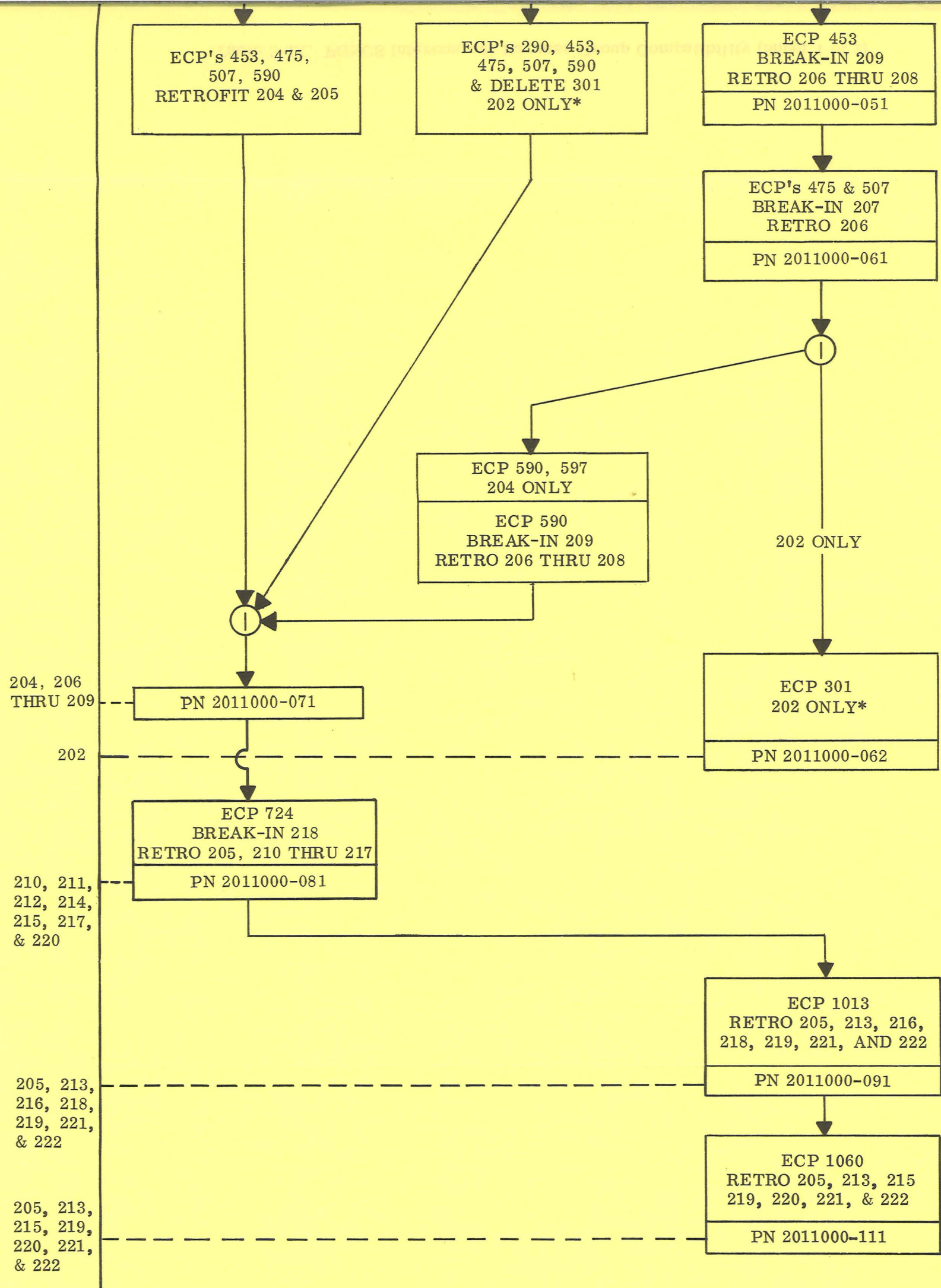

ECP	DESCRIPTION
149	Improve receptacle connector (resolver trim module) BREAK-IN 201
290	Quick disconnect OUA eyepiece BREAK-IN 206 RETROFIT 201 THRU 205
301	Add thermal sensors 202 ONLY
318	Corrosion protection of exposed beryllium on OUA and AOT BREAK-IN 204 RETROFIT 202, 203, 204
453	Beryllium wedge fix to eliminate SXT head shift BREAK-IN 209 RETROFIT 202, 204 THRU 208
475	Chamfer of telescope manual adjust seal seat BREAK-IN 207 RETROFIT 202, 204 THRU 206
507	Modification of solvere motor-tach in OUA BREAK-IN 207 RETROFIT 202, 204 THRU 206

ECP	DESCRIPTION
590	Removal of anticreep protection BREAK-IN 209 RETROFIT 204 THRU 208
597	CSM-101 204 ONLY
724	OUA stop override BREAK-IN 218 RETROFIT 205, 210 THRU 217
1013	Refurbish OUA's by cleaning and relubricating the bearings and gears, adding new motor-tachs, and using new mounting techniques for SCT light rods. RETROFIT 205, 213, 216, 218, 219, 221, & 222
1060	Install new design OUA SXT and SCT base harness assemblies. RETROFIT 205, 213, 215, 219, 220, 221 & 222

* OUA has been re-allocated

Rev. AG

3-2AA

BLOCK II PRIMARY GUIDANCE, NAVIGATION, AND CONTROL SYSTEM

ND-1021043
MANUAL

Table 3-IX. PGNCS Interconnect Harness Group Compatibility (Sheet 1 of 2)

COMPONENT PART NUMBER	DASH NUMBERS FOR PN 2015000																					
	SYSTEM SERIAL NUMBERS																					
	011 201	021 202	031 203	041 204	051 205	061 206	071 207	081 208	091 209	101 210	111 211	121 212	131 213	141 214	151 215	161 216	171 217	181 218	191 219	201 220	211 221	
2014567	011	X	T																			▶
	021	C	T																			▶
	031	C	T																			▶
	041	C	T	X	T																	▶
	051	C	T																			▶
	061	C	X	C	X	T	T	X	▶	T												▶
	071	C		▶	X	X	C	▶	X													▶
	081	C		▶	X	C						▶	X	C	X	C	C	X				▶
	X	Required per print																				
	C	Compatible: as good or better than print requirement. See ECP flow chart.																				
	T	Not as good as print requirement, but can be used for testing. See ECP flow chart.																				
	NO	CANNOT be used.																				

3-2AB

Rev. AG

Table 3-IX. PGNCS Interconnect Harness Group Compatibility (Sheet 2 of 2)

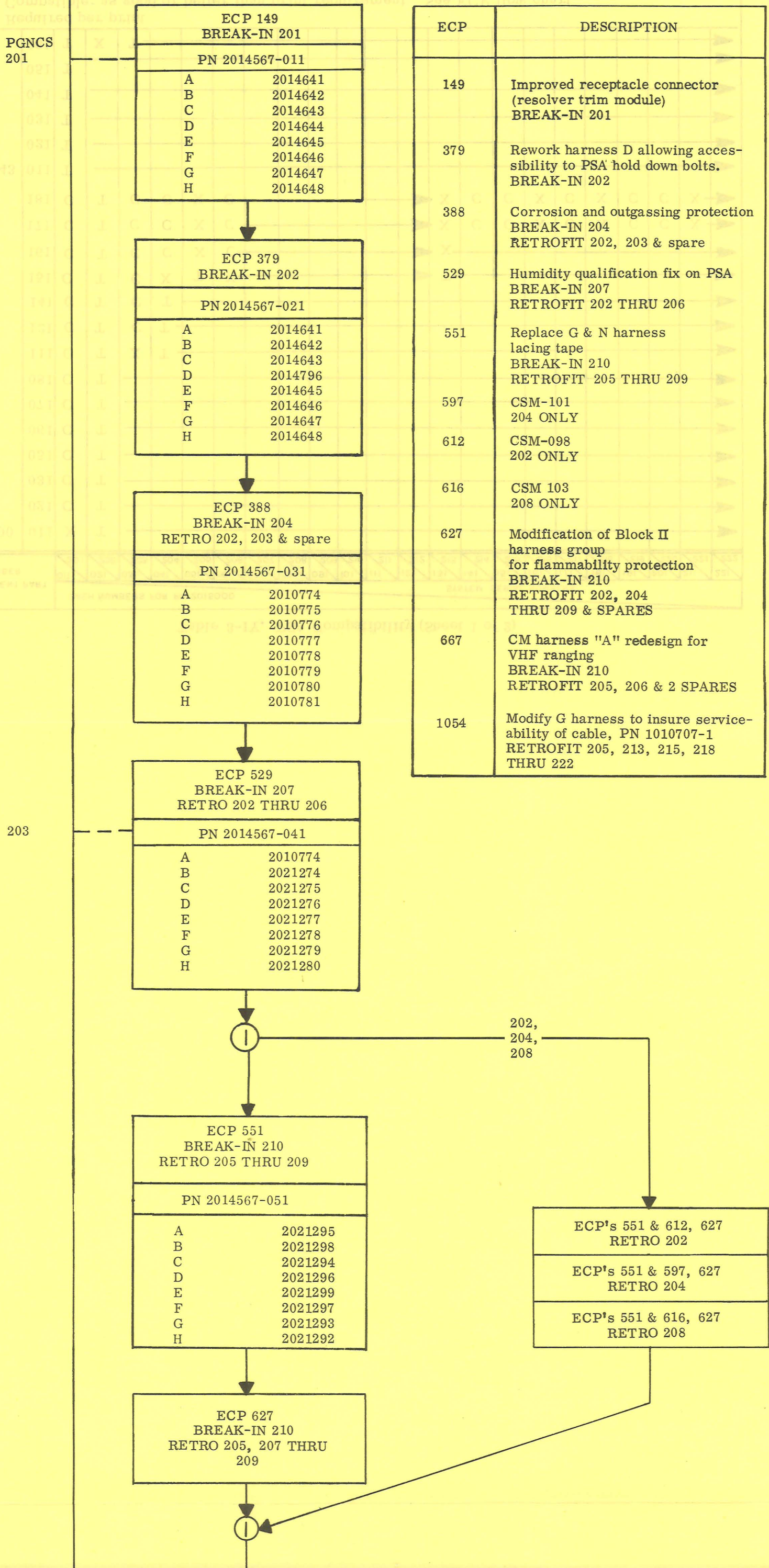

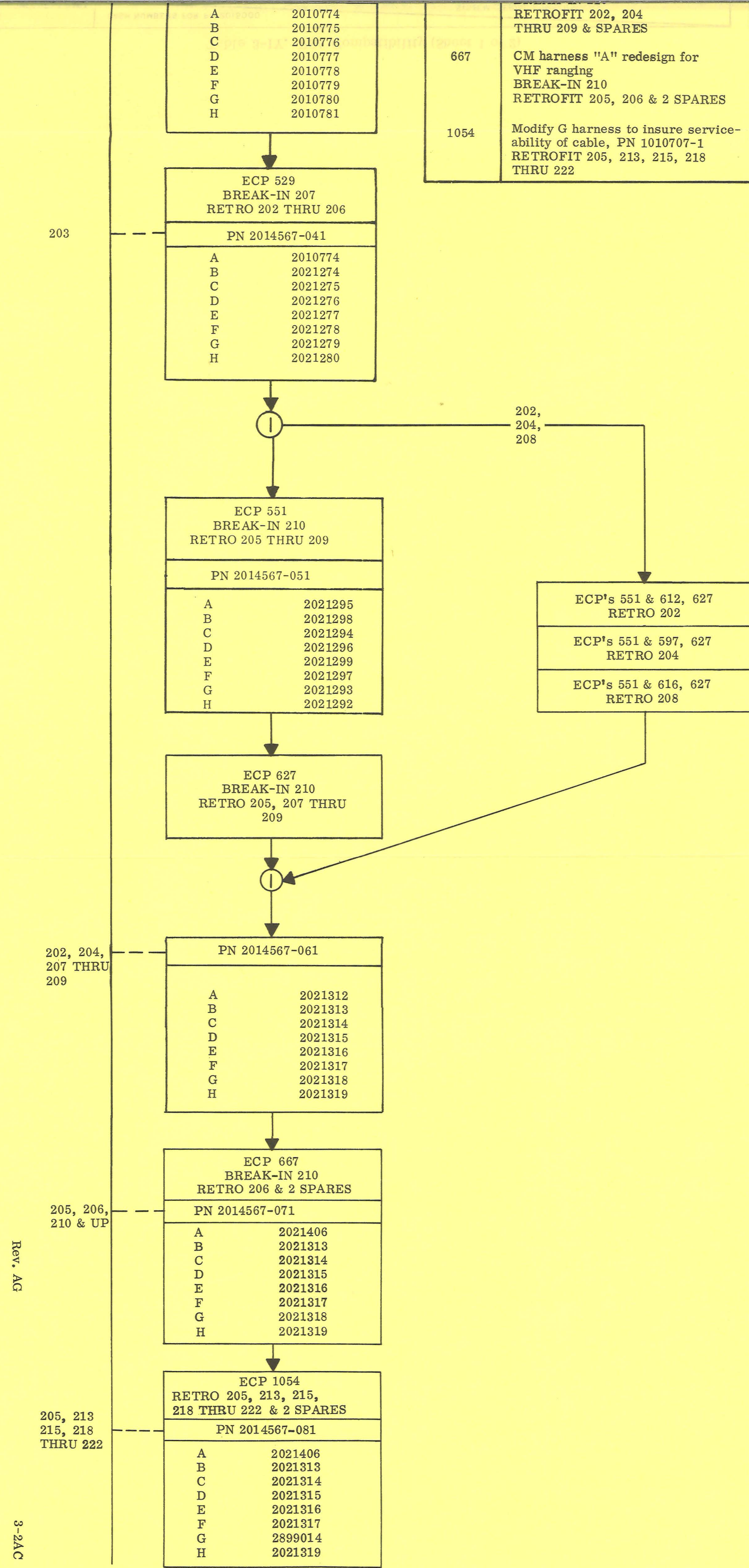

Rev. AG

3-2AC

Table 3-IY. PSA Compatibility (Sheet 1 of 2)

COMPONENT PART NUMBER	DASH NUMBERS FOR PN 2015000																								
	SYSTEM SERIAL NUMBERS																								
	011 201	021 202	031 203	041 204	051 205	061 206	071 207	081 208	091 209	101 210	111 211	121 212	131 213	141 214	151 215	161 216	171 217	181 218	191 219	201 220	211 221	221 222			
2007200	011	X	T																				▲		
	021	C	T																					▲	
	031	C	T																					▲	
	051	C	T																					▲	
	061	C	T																					▲	
	071	C	T																					▲	
	081	C	T																					▲	
	111	C	T	X	T																				▲
	121	C	T	C	T																				▲
	141	C	T	C	T																				▲
2010743	011	T																						▲	
	021	T																						▲	
	031	T																						▲	
	041	T																						▲	
	051	T																						▲	
	061	T	X	T																				▲	
	151	C	T	C	X	T	X					▲	T											▲	
161	C	T	C	C	X	C					▲	X											▲		
171	C	T	C	C	X	C					▲	X	C	C	X	C	X	C	C	X			▲		
181	C	T	C	C	X	C					▲	X	C	C	X	C	X	C	C	X			▲		

X Required per print
 C Compatible: as good or better than print requirement. See ECP flow chart.
 T Not as good as print requirement, but can be used for testing. See ECP flow chart.
 NO CANNOT be used.

3-2AD

Rev. AF

Table 3-IV. PSA Compatibility (Sheet 2 of 2)

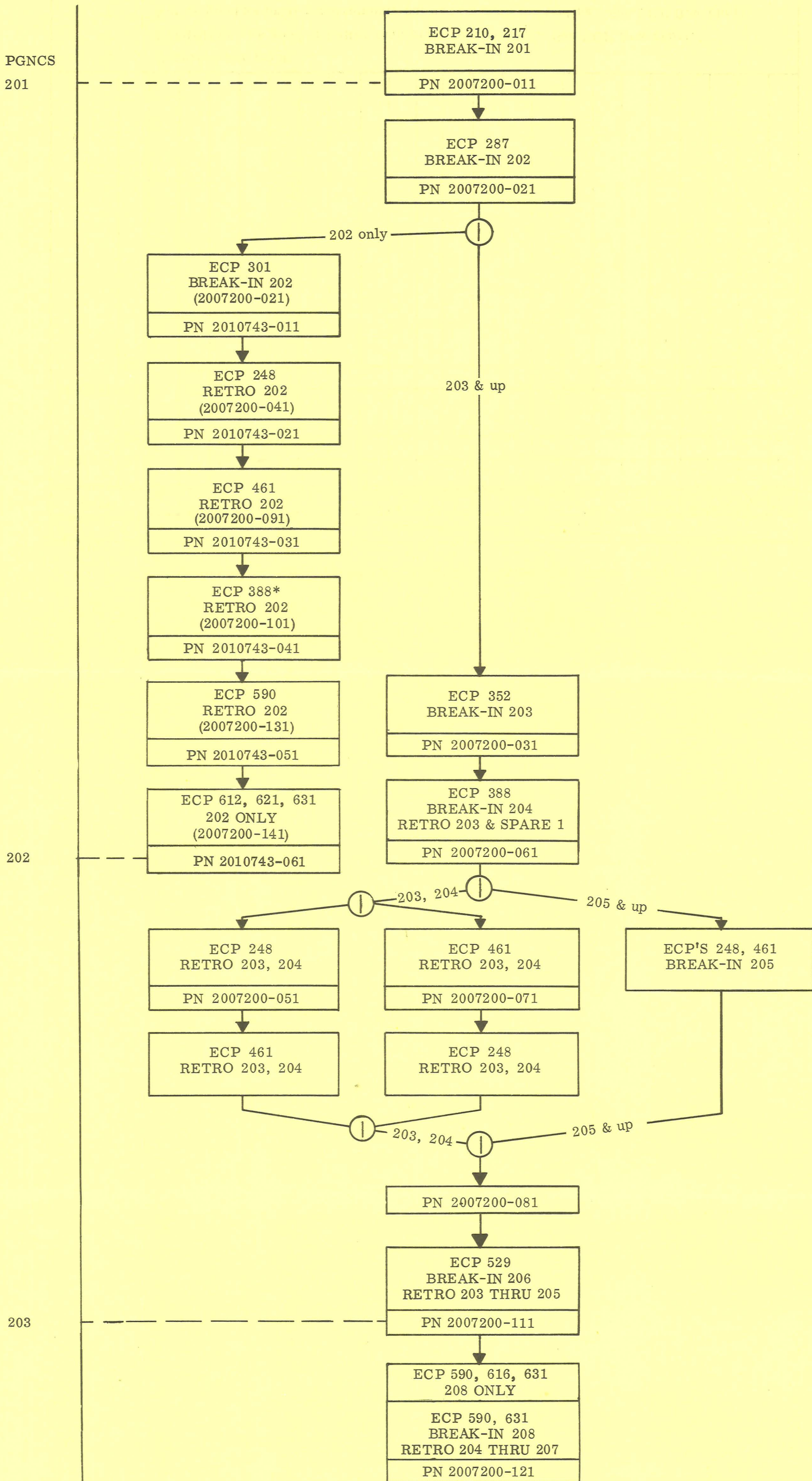

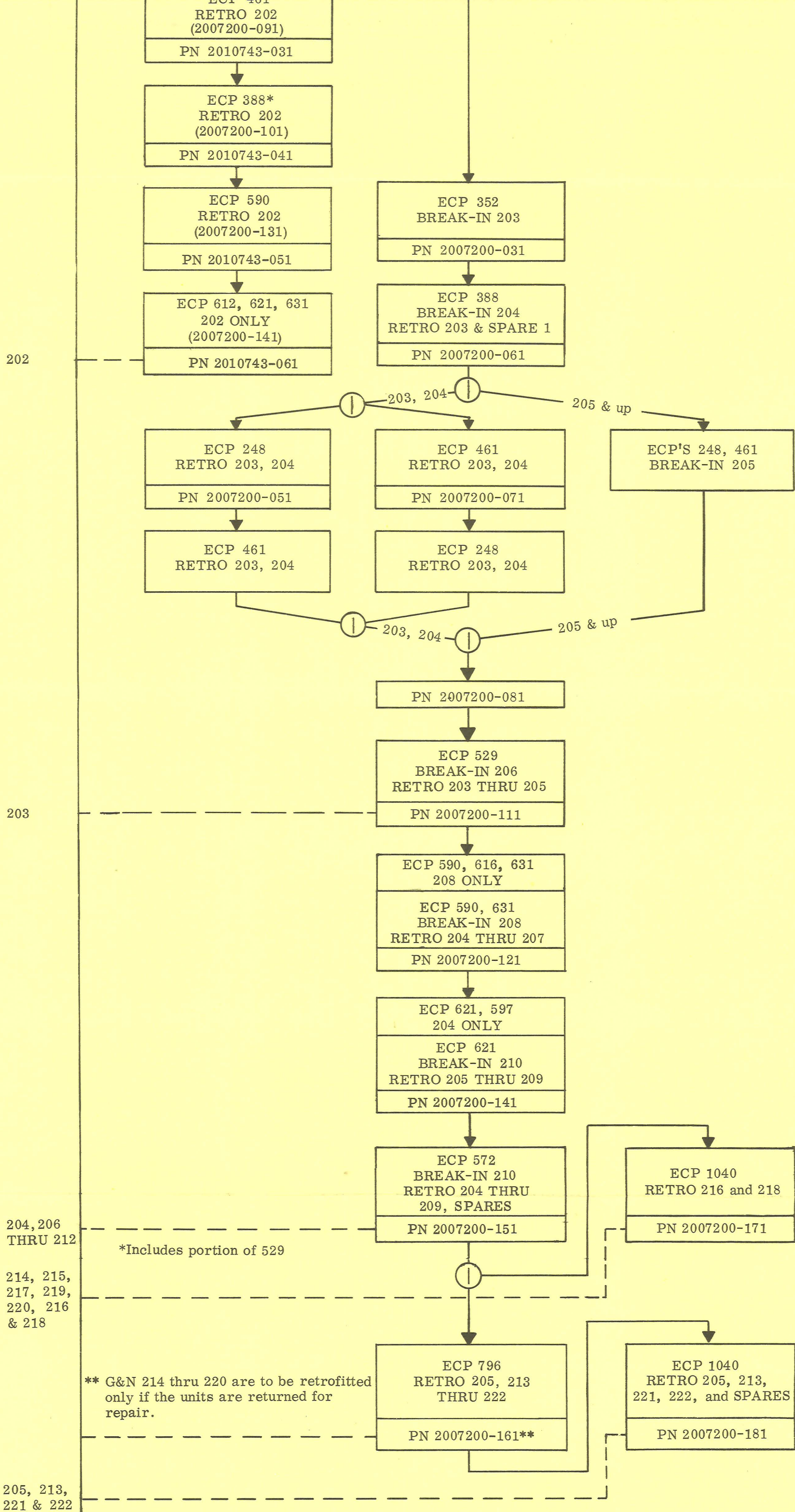

ECP	DESCRIPTION

ECP	DESCRIPTION

203, 204 205 & up

203

204, 206
THRU 212

214, 215,
217, 219,
220, 216
& 218

205, 213,
221 & 222

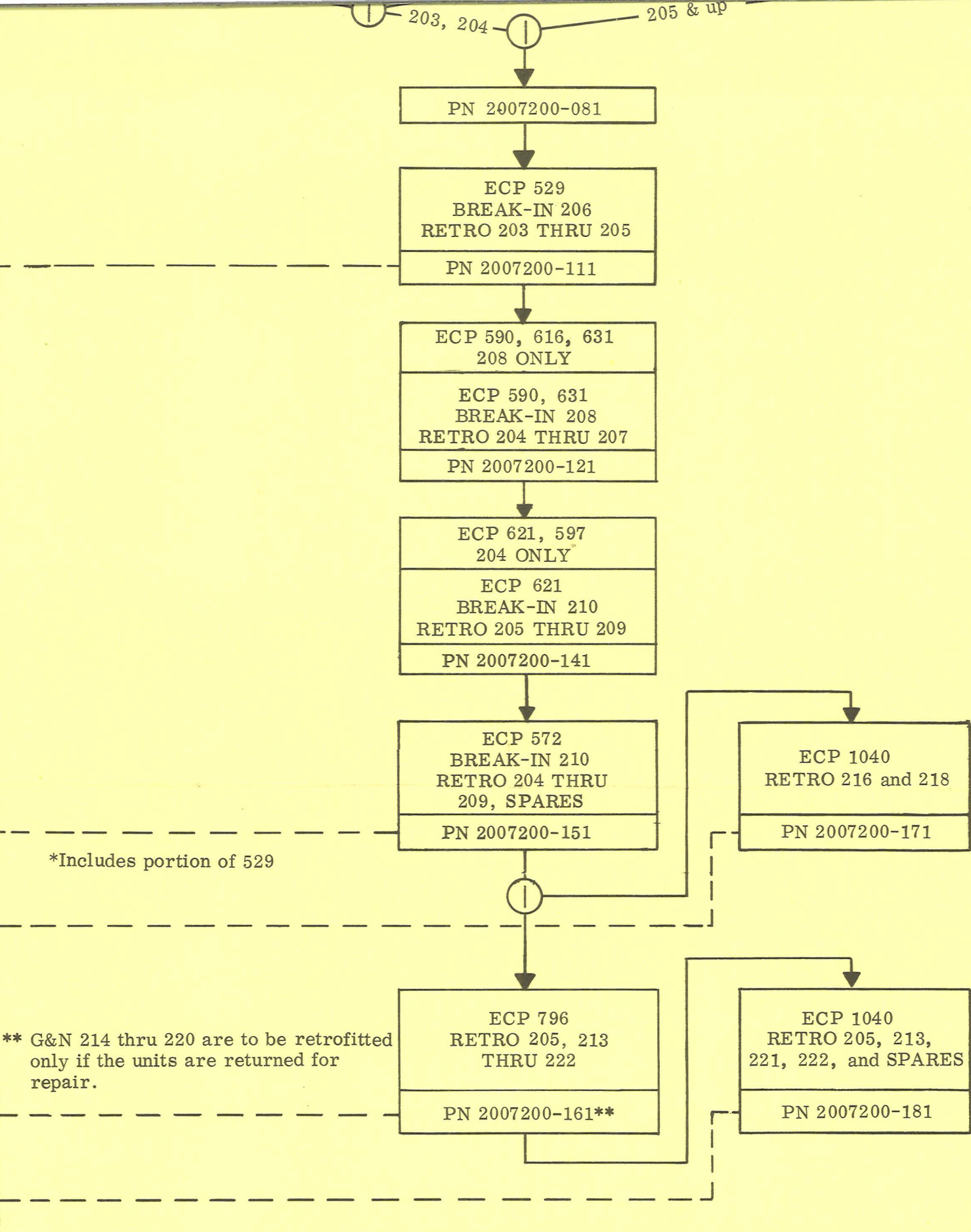

ECP	DESCRIPTION
210	Remove tracker/photometer PSA modules removed: 2007125-011 2007130-011 2007131-011 BREAK-IN 201
217	Delete signal conditioner power supply BREAK-IN 201
248	Pulse torque power supply redesign BREAK-IN 205 RETROFIT 202 THRU 204
287	Change header material from cast to wrought magnesium BREAK-IN 202
301	Add thermal sensors 202 ONLY
352	Change header wiring; change SXT motor drive amplifier BREAK-IN 203
388	Corrosion and outgassing protection BREAK-IN 204 RETROFIT 202, 203, AND SPARE-1
461	Change gimbal servo amplifier BREAK-IN 205 RETROFIT 202 THRU 204
529	Humidity qualification fix on PSA BREAK-IN 206 RETROFIT 203 THRU 205
572	PSA gasket replacement BREAK-IN 210 RETROFIT 204 THRU 209 SPARES

ECP	DESCRIPTION
590	Removal of anticreep protection BREAK-IN 208 RETRO 204 THRU 207
597	CSM-101 204 ONLY
612	CSM-098 202 ONLY
616	CSM-103 208 ONLY
621	Non-metallic materials modifica- tion for CM/PSA BREAK-IN 210 RETROFIT 202, 204 THRU 209
631	Replace RTV-102 with RTV-109. ECP 631 should be incorporated in PN 2007200-121. ECP 631 does not affect part number change. It may be included in lower part number assemblies.
796	Incorporate CM PSA Reverse Power Modification RETROFIT 205, 213 THRU 222
1040	Modification of 800 hz 5% amplifier in power and servo assembly to eliminate ampli- fier oscillation during system turn-on.

Rev. AF

3-2AE

BLOCK II PRIMARY GUIDANCE, NAVIGATION, AND CONTROL SYSTEM

ND-1021043
MANUAL

Table 3-IZ. Signal Conditioner Assembly Compatibility (Sheet 1 of 2)

ND-1021043
MANUAL

BLOCK II PRIMARY GUIDANCE, NAVIGATION, AND CONTROL SYSTEM

COMPONENT PART NUMBER	DASH NUMBERS FOR PN 2015000																					
	SYSTEM SERIAL NUMBERS																					
	011 201	021 202	031 203	041 204	051 205	061 206	071 207	081 208	091 209	101 210	111 211	121 212	131 213	141 214	151 215	161 216	171 217	181 218	191 219	201 220	211 221	221 222
2007234	011	T	NO	→ T																		→
	021	X	NO	→ X																		→
2007235	011	NO	X	T	NO																	→
	021	NO	C	X	NO																	→
X		Required per print																				
C		Compatible: as good or better than print requirement. See ECP flow chart.																				
T		Not as good as print requirement, but can be used for testing. See ECP flow chart.																				
NO		CANNOT be used.																				

3-2AF

REV. R

Rev. R

Table 3-IZ. Signal Conditioner Assembly Compatibility (Sheet 2 of 2)

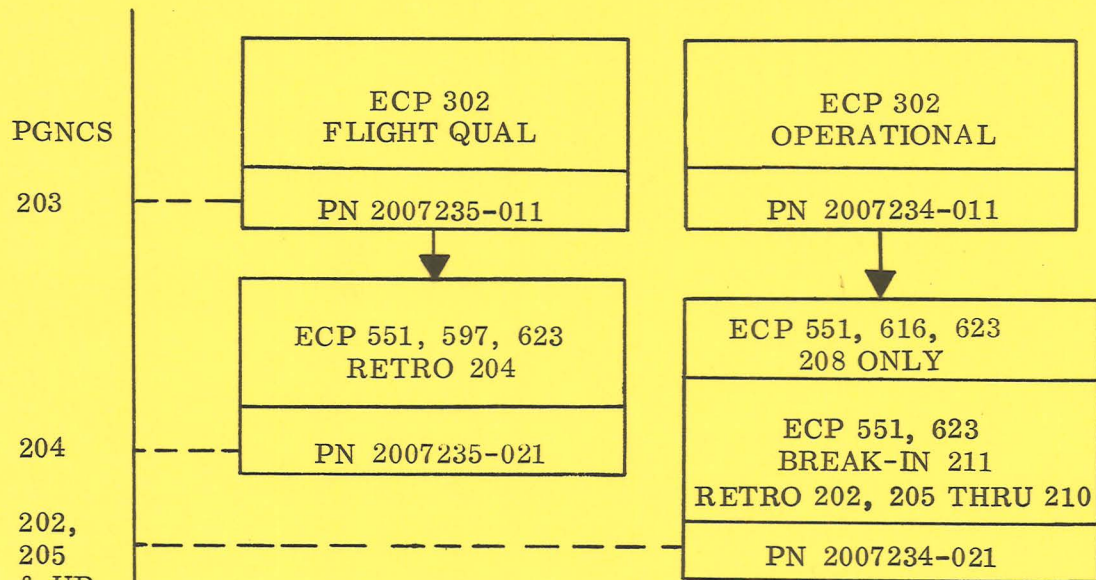

ECP	DESCRIPTION
551	Replace G & N harness lacing tape BREAK-IN 212 RETROFIT 204 THRU 211
302	Signal conditioner assemblies BREAK-IN 203
597	CSM-101 204 ONLY
623	Flammability fix for SCA (Block II) BREAK-IN 211 RETROFIT 202, 204 THRU 210
616	CSM 103 208 ONLY

3-2AG/3-2AH

BLOCK II PRIMARY GUIDANCE, NAVIGATION, AND CONTROL SYSTEM

ND-1021043
MANUAL

BLOCK II PRIMARY GUIDANCE, NAVIGATION, AND CONTROL SYSTEM

3-1B ASTROSEXTANT PASSIVE THERMAL PROTECTIVE SYSTEM (APTPS) ASSEMBLY

The APTPS consists of a SXT crown half and plug assembly and SCT crown half and plug assembly constructed of molded ablative materials. (See figure 3-1A.) The APTPS prevents damage to the optics and bellows during launch and entry and helps to maintain a normal spacecraft atmosphere.

Those systems which will have an APTPS have special cover and baffle assemblies on the OUA designed to accept the crown half and plug assemblies of the APTPS.

3-2 COUPLING DATA UNIT

The CDU (figure 3-2) consists of two tray assemblies containing a total of 32 modules. The two tray assemblies, tray X and tray S, are bolted together, module sides facing with a damper plate of corrugated stainless steel between the trays in the CDU's containing ECP 499 (see table 3-1A for effectivity). The damper plate has been added to reduce transmission of vibration to CDU modules. The unit is then mounted to a coldplate in the command module. The assembled unit, constructed mainly of magnesium, measures approximately 5.5 inches high, 11.3 inches wide, and 20 inches deep.

Tray X has a connector used only for component level testing, a connector, J53, used to connect to the PGNCS interconnect harness A, and a filler valve used to pressurize the CDU.

The modules in the CDU provide five separate channels to couple the CMC to the IMU and the OUA. In addition to the five separate channels, the CDU contains four modules which are shared by all channels. Basic CDU functions are as follows:

- (1) Interpret commands (digital) from the CMC and convert them to IMU gimbal positioning signals (analog).
- (2) Interpret gimbal positions (analog) and transmit the information to the CMC (digital).
- (3) Couple the IMU to the FDAI.
- (4) Interpret OUA shaft and trunnion angles (analog) and transmit the information to the CMC (digital).
- (5) Interpret commands (digital) from the CMC and convert them to OUA positioning signals (analog).

Module locations are illustrated in figure 3-3 and their functions are described in table 3-II.

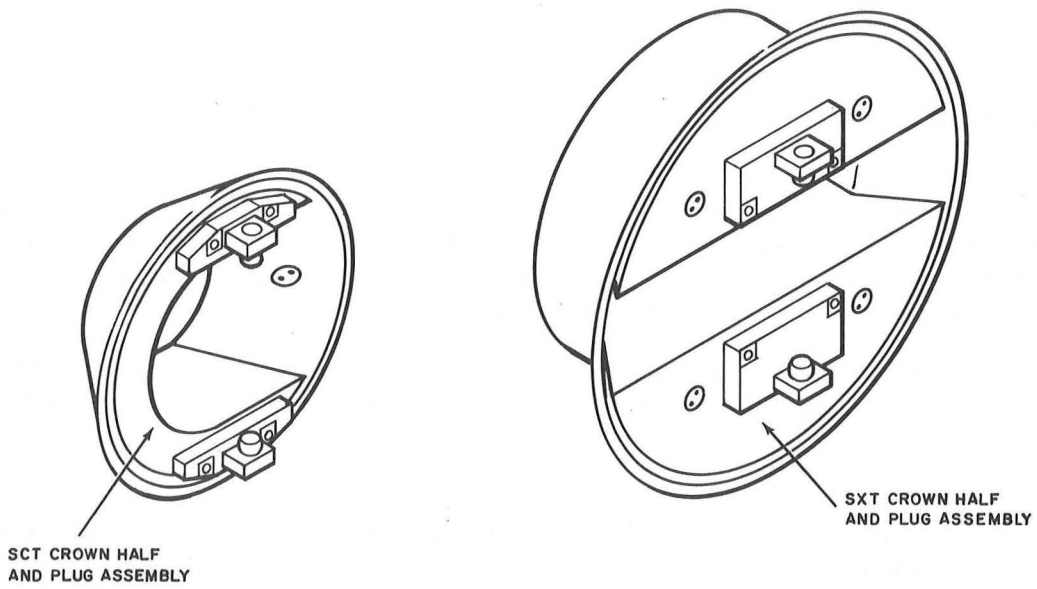

Figure 3-1A. Astro sextant Passive Thermal Protective System

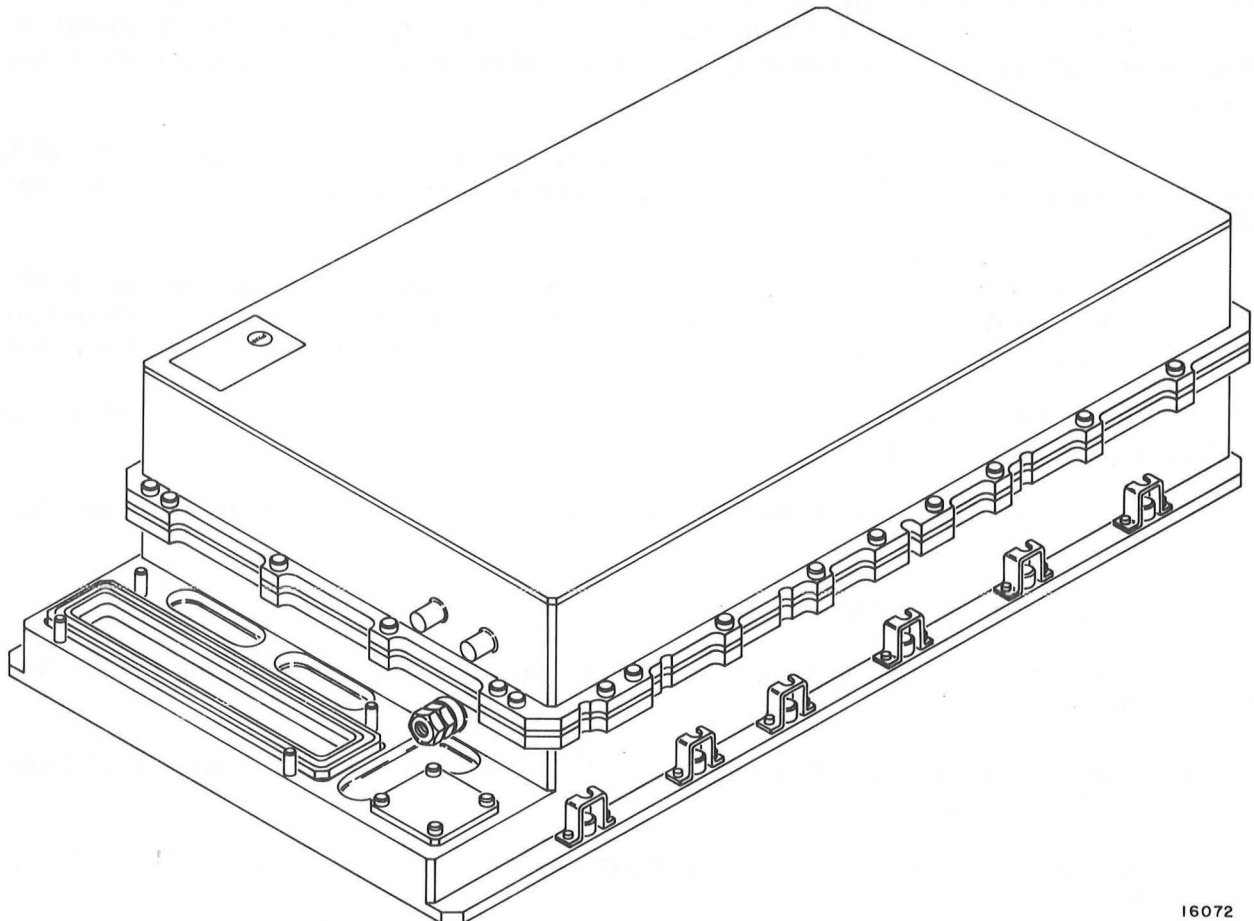

Figure 3-2. Coupling Data Unit

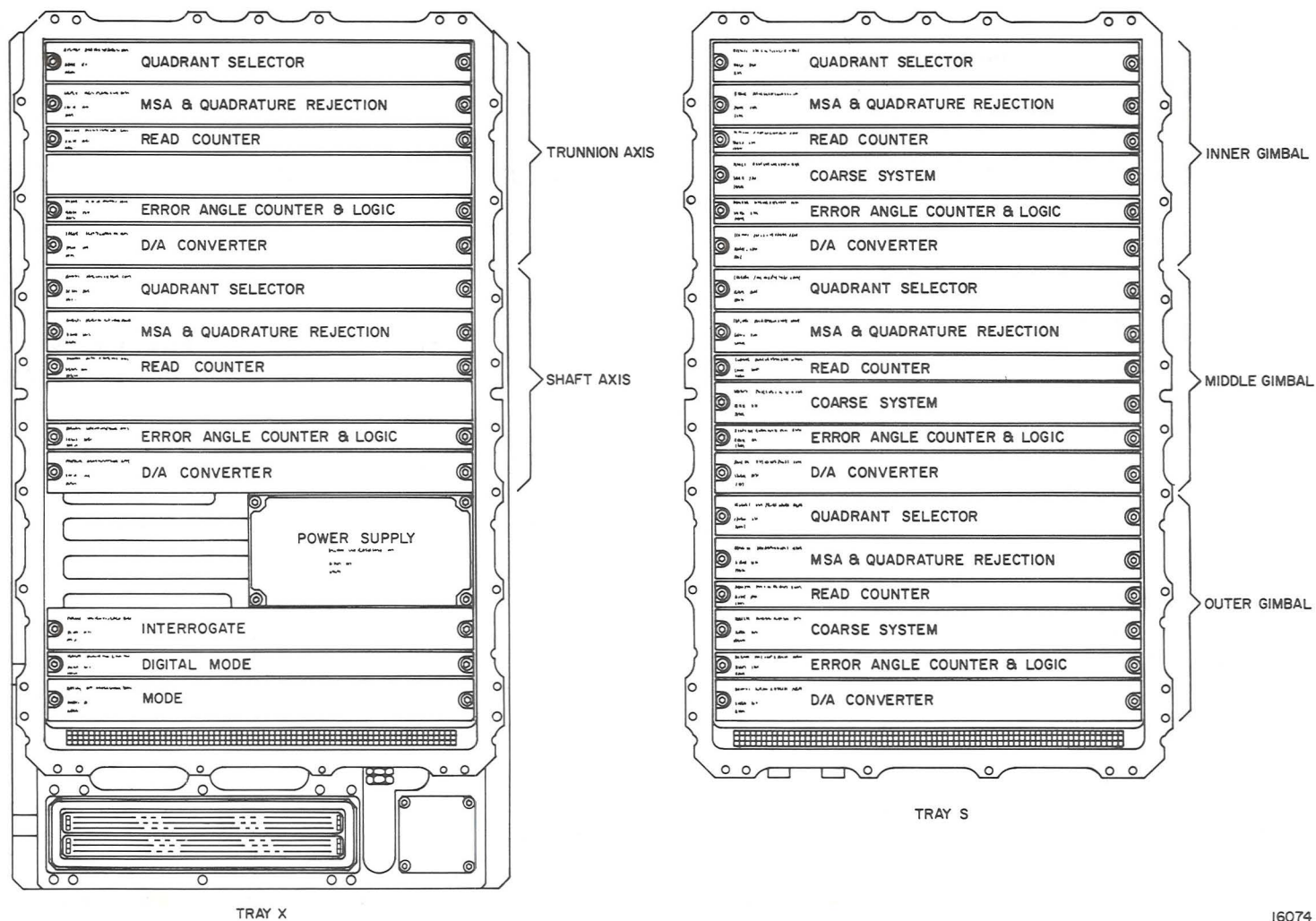

Figure 3-3. CDU Module Locations

16074

Table 3-II. Function of CDU Modules

Nomenclature	Part Number	Schematic Number	Logic Flow Diagram	Function
Coarse system (three)	2007236-011 -021 -031 with ECP 515*	2010030 2010792 2010030		Provides coarse switching and attenuation circuitry necessary to increment angles. (-011 and -021 module configurations are interchangeable.)
Digital mode	2007141-031 -041 with ECP 564*	2010095	2010053	Provides pulse commands which are used throughout CDU for synchronization, switching, and strobing. (-031 and -041 module configurations are interchangeable.)
D/A converter (five)	2007237-011 -021 -031	2010028 2010794 2899011		Converts digital information in error counter into dc analog signal and two ac analog signals.
Error angle counter & logic (five)	2007139-041 -051 with ECP 564*		2010093	Accumulates pulses representing angular error and provides logic circuitry to control operation of other CDU modules. (-041 and -051 module configurations are interchangeable.)
Interrogate	2007263-011	2010080		Generates a portion of the timing pulses required for CDU operation, produces 14 vdc power, and provides circuitry for data and pulse transmission.

*See table 3-IA for effectivity.

(Sheet 1 of 2)

Table 3-II. Function of CDU Modules

Nomenclature	Part Number	Schematic Number	Logic Flow Diagram	Function
MSA & quadrature rejection (five)	2007238-011	2010058		Provides fine switching and attenuation circuitry necessary to increment angles. (The -011 and -021 or -051, -061, -071, and -081 module configurations are interchangeable.)
	-021	2010793		
	-051	2021350		
	-061	2021351		
	-071	2021399		
	-081	2021400		
	With ECP's 603 and 609*			
Mode	2007254-011	2010084		Buffers signals and monitors CDU operations.
	-021	2899012		
	-031	2899013		
Power supply	2007142-011	2010062		Supplies 4 vdc logic power to digital logic portions of CDU.
Quadrant selector (five)	2007243-011	2010059		Converts sin and cos resolver signals to phase relationships required by main summing amplifier.
Read counter (five)	2007140-031 -041* with ECP 564	2010094	2010049	Accumulates pulses representing angles, and controls switching of coarse system module and main summing amplifier. (-031 and -041 module configurations are interchangeable.)

*See table 3-IA for effectivity.

BLOCK II PRIMARY GUIDANCE, NAVIGATION, AND CONTROL SYSTEM

3-3 COMMAND MODULE COMPUTER GROUP

3-3.1 COMMAND MODULE COMPUTER. The CMC (figure 3-4) consists of two flat tray assemblies bolted together, module side to module side. The tray assemblies, as a unit, measure approximately 6 inches high, 12.5 inches wide, and 24 inches deep. The unit is mounted on a coldplate which is a part of the spacecraft. Table 3-IIA gives the name and part number of the computer modules.

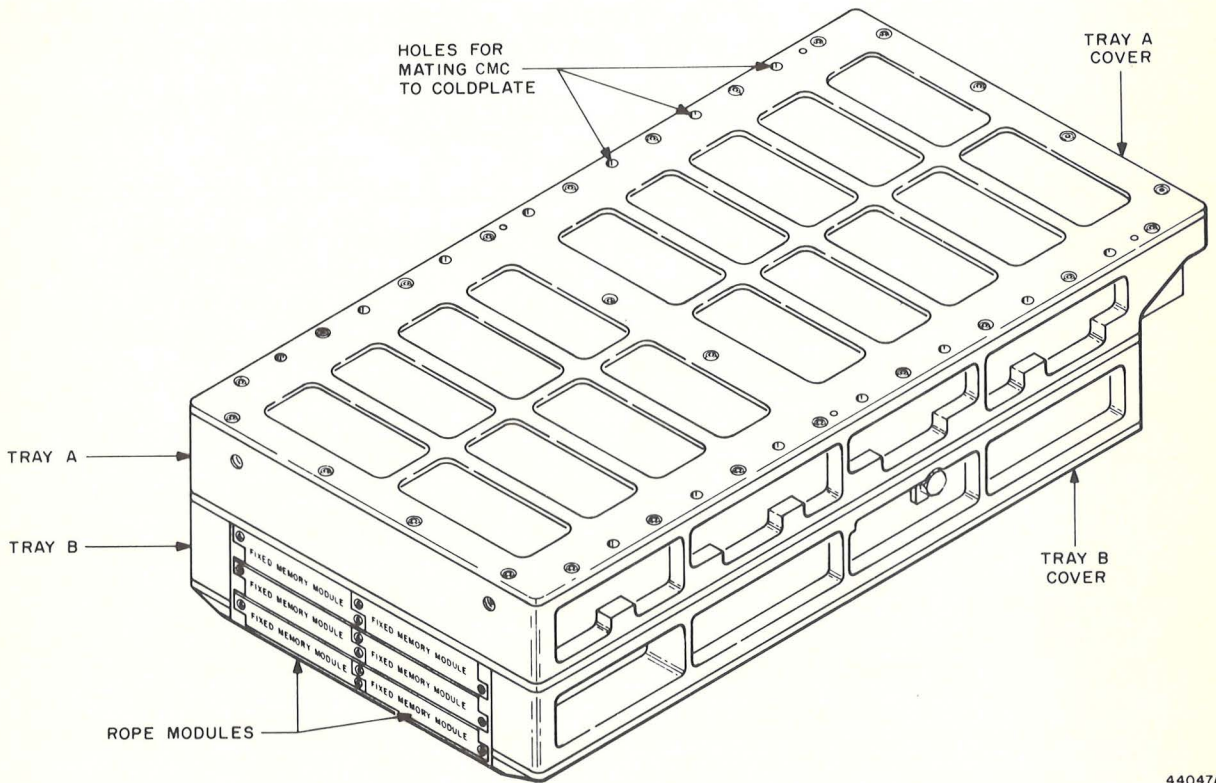

Figure 3-4. Command Module Computer, Part Numbers 2003200 and 2003993

3-3.1.1 Logic Tray A. Tray A assembly (figure 3-5) contains 31 modules: 24 logic modules, five interface modules, and two power supply modules. All modules are mounted on the tray and then potted with a silastic compound for CMC, part number 2003100, and with foam for CMC, part numbers 2003200 and 2003993.

Tray A has three intertray connectors: A61, A62, and A63; and two connectors on the rear. A 360 pin rear connector J1 connects the CMC through PGNCS interconnect harness A to the main power source of 28 vdc, to the DSKY's, to other parts of the PGNCS, and to other spacecraft systems. A 144 pin rear connector A52 provides interface with ground support equipment used in testing the CMC.

CMC's modified by ECP 518 and containing tray A, PN 2003092-041, have wires that were used to inhibit STRT1, STRT2, and ALGA removed. The capability to inhibit STRT1 and ALGA still exists in the GSE.

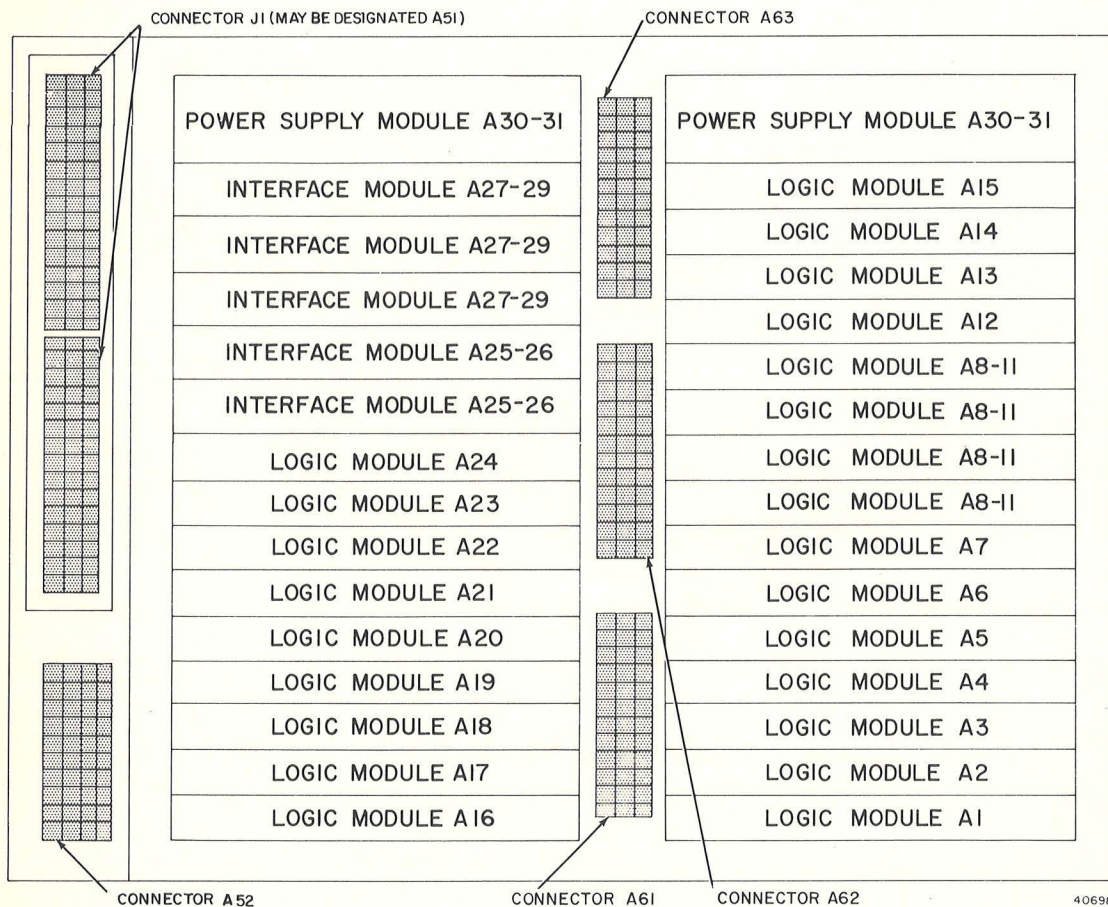
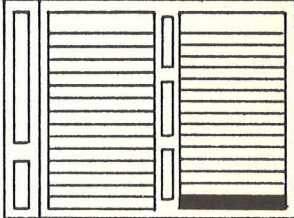
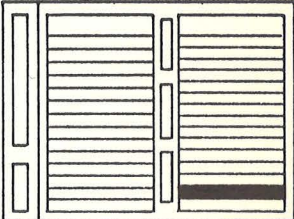
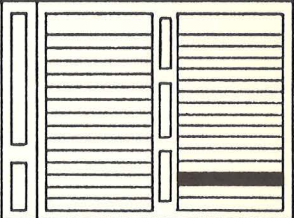

Figure 3-5. Tray A Module Side

BLOCK II PRIMARY GUIDANCE, NAVIGATION, AND CONTROL SYSTEM

Table 3-IIA. Computer Modules

Module Part Number		Module Assembly Name and Function	Location
CMC 2003200	CMC 2003993		
2003121-011	2003121-011	Logic Module A1 Contains scaler (functional part of timer) and provides signal outputs F2 thru F33, pulse outputs F2 thru F33, and real time word outputs CHAT 1 thru CHAT 14, CHBT01 thru CHBT14.	
2003888-011 with ECP 564*	2003888-011 with ECP 564*		
2003121-021	2003121-021	Logic Module A2 Contains clock divider logic (functional part of timer) and provides clear, write, and read control pulses, 1.024 mc gating pulses, 1.024 mc master clock to SC systems, inputs to oscillator alarm circuit, 102.4 kc gating pulses SB0, SB1, SB2, and SB4, 102.4 kc gating pulses P01 thru P05, and timing pulses T01 thru T12.	
2003888-021 with ECP 564*	2003888-021 with ECP 564*		
2003121-031	2003121-031	Logic Module A3 Contains register SQ control and associated control and decoder logic (functional part of order code processor). Order code content of register B is placed on write lines and into register SQ. Order code signals are converted to coded signals for command generator which produces instruction commands.	
2003888-031 with ECP 564*	2003888-031 with ECP 564*		

*See table 3-IB for effectivity.

Table 3-IIA. Computer Modules

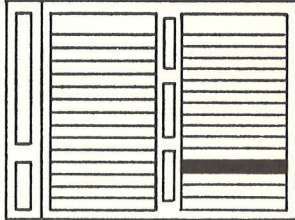
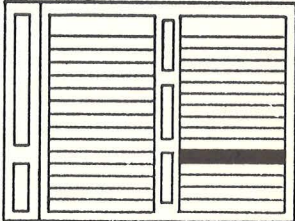
Module Part Number		Module Assembly Name and Function	Location
CMC 2003200	CMC 2003993		
2003121-041	2003121-041	<p>Logic Module A4 Contains stage counter and decoder (functional part of order code processor). Stage counter controls length of each instruction. Stage counter and decoder outputs are applied to the command generator to produce subinstruction and instruction commands. Module also contains branch logic which changes control pulse sequence.</p>	
2003888-041 with ECP 564*	2003888-041 with ECP 564*		
2003121-051	2003121-051	<p>Logic Module A5 Contains part of crosspoint generator number (functional part of control pulse generator) and receives instruction and subinstruction commands from command generator and branch commands from branch control. Crosspoint generator produces an action pulse when command signal and time pulse are ANDed. Action pulses are supplied to control pulse gates which convert them to specific control pulses for use in instruction execution.</p>	
2003888-051 with ECP 564*	2003888-051 with ECP 564*		

*See table 3-IB for effectivity.

BLOCK II PRIMARY GUIDANCE, NAVIGATION, AND CONTROL SYSTEM

Table 3-IIA. Computer Modules

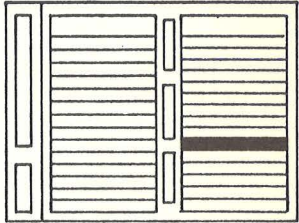
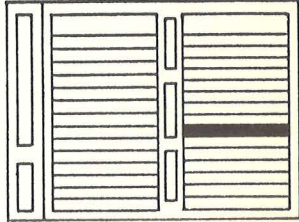
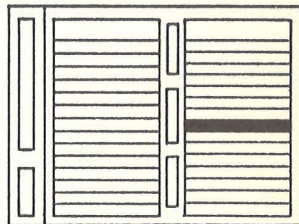
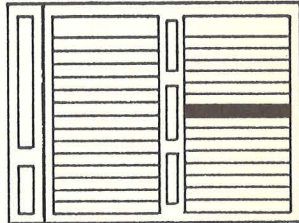
Module Part Number		Module Assembly Name and Function	Location
CMC 2003200	CMC 2003993		
2003121-061 2003888-061 with ECP 564*	2003121-061 2003888-061 with ECP 564*	Logic Module A6 Also part of crosspoint generator and functions in manner similar to logic module A5.	
2003121-071 2003888-071 with ECP 564*	2003121-071 2003888-071 with ECP 564*	Logic Module A7 Contains register service gates.	
2003121-081 2003888-081 with ECP 564*	2003121-081 2003888-081 with ECP 564*	Logic Module A8 Contains bits 1 through 4 of the central processor flip-flop registers.	
2003121-081 2003888-081 with ECP 564*	2003121-081 2003888-081 with ECP 564*	Logic Module A9 Contains bits 5 through 8 of the central processor flip-flop registers.	

*See table 3-IB for effectivity.

(Sheet 3 of 12)

Table 3-IIA. Computer Modules

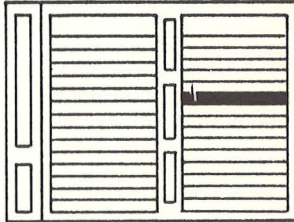
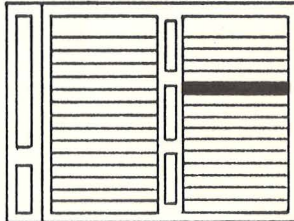
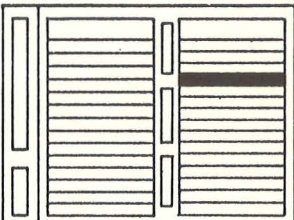
Module Part Number		Module Assembly Name and Function	Location
CMC 2003200	CMC 2003993		
2003121-081 2003888-081 with ECP 564*	2003121-081 2003888-081 with ECP 564*	Logic Module A10 Contains bits 9 through 12 of the central processor flip-flop registers.	
2003121-081 2003888-081 with ECP 564*	2003121-081 2003888-081 with ECP 564*	Logic Module A11 Contains bits 13 through 16 of the central processor flip-flop registers.	
2003121-091 2003888-091 with ECP 564*	2003121-091 2003888-091 with ECP 564*	Logic Module A12 Contains parity and S register logic. Parity logic insures that all words transferred from memory to central processor are read out correctly and generates a parity bit for all words written into erasable memory. S register logic is memory address logic which accepts 12 bit relevant address contained in an address word.	

*See table 3-IB for effectivity.

(Sheet 4 of 12)

BLOCK II PRIMARY GUIDANCE, NAVIGATION, AND CONTROL SYSTEM

Table 3-IIA. Computer Modules

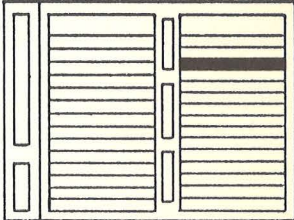
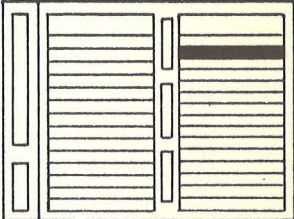
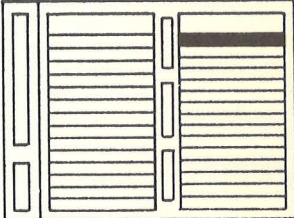
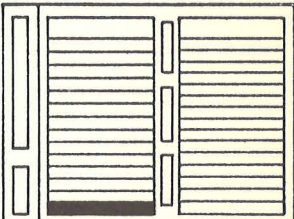
Module Part Number		Module Assembly Name and Function	Location
CMC 2003200	CMC 2003993		
2003121-111	2003121-111	Logic Module A13 Contains logic which constitutes alarm detection circuits to monitor power supply outputs, oscillator, scaler, and priority control. These circuits generate a restart, failure, caution, or warning signal if any output should fail.	
2003888-111 with ECP 564*	2003888-111 with ECP 564*		
2003121-121	2003121-121	Logic Module A14 Contains memory cycle timing logic.	
2003888-121 with ECP 564*	2003888-121 with ECP 564*		
2003121-131	2003121-131	Logic Module A15 Contains interrupt instruction control logic which accepts interrupt requests, generates an associated address, and causes program interrupt routine to be initiated.	
2003888-131 with ECP 564*	2003888-131 with ECP 564*		
2003121-141	2003121-141	Logic Module A16 Contains part of input-output logic, consisting of input-output channels to transfer information between computer and other SC subsystems. Logic module A16 contains bits 1 through 8 of channel 5, bits 1 through 8 of channel 6, bits 1 through 7 of channel 11, and bits 1 through 14 of channel 12.	
2003888-141 with ECP 564*	2003888-141 with ECP 564*		

*See table 3-IB for effectivity.

(Sheet 5 of 12)

Table 3-IIA. Computer Modules

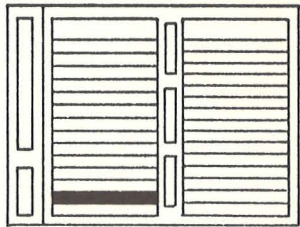
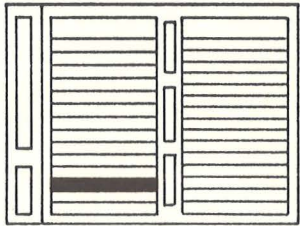
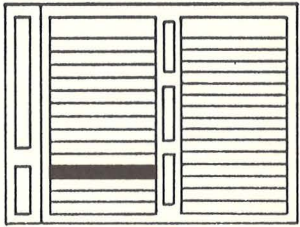
Module Part Number		Module Assembly Name and Function	Location
CMC 2003200	CMC 2003993		
2003121-151	2003121-151	Logic Module A17 Contains part of input-output logic, providing OR function for channel bits 1 through 14 (CHOR1-CHOR15) and CHOR16; service gates for channels 10, 11, 32, and 33; bits 13, 14, and 16 for channel 33; and the HNRDPT interrupt control logic.	
2003888-151 with ECP 564*	2003888-151 with ECP 564*		
2003121-161	2003121-161	Logic Module A18 Contains part of input-output logic consisting of interrupt logic bits 1 through 5 for channel 15, bits 1 through 4 and bit 11 for channel 13, bits 1 through 5 for channel 16, bit 12 for channel 33, and service gates for channels 11, 12, 13, 14, 15, and 16.	
2003888-161 with ECP 564*	2003888-161 with ECP 564*		
2003121-171	2003121-171	Logic Module A19 Contains part of input-output logic including UPLINK and CROSSLINK input logic, RHC input logic, BMAG input logic, CROSSLINK control logic, altitude meter control, EMS and THRUST drive control, and GYRO drive control.	
2003888-171 with ECP 564*	2003888-171 with ECP 564*		

*See table 3-IB for effectivity.

Table 3-IIA. Computer Modules

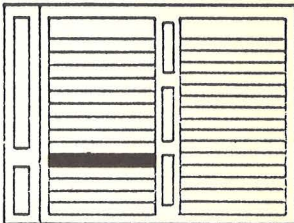
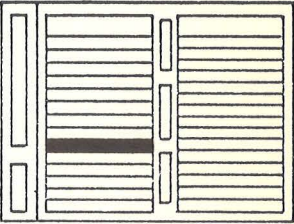
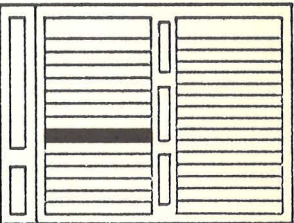
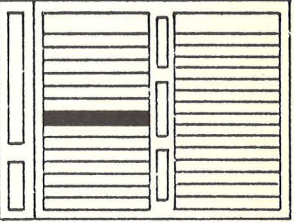
Module Part Number		Module Assembly Name and Function	Location
CMC 2003200	CMC 2003993		
2003121-181	2003121-181	Logic Module A20 Contains logic circuitry for priority cells 24 through 27, 30 through 37, 40, 41, and 50 through 55.	
2003888-181 with ECP 564*	2003888-181 with ECP 564*		
2003121-191	2003121-191	Logic Module A21 Contains logic for priority cells 42 through 47, 56, 57, 60; counter address generator; and counter and peripheral instruction control logic.	
2003888-191 with ECP 564*	2003888-191 with ECP 564*		
2003121-211	2003121-211	Logic Module A22 Contains part of input-output logic consisting of channel 13 service, channel 14 service, and includes downlink counter logic, word order logic, and downlink control logic.	
2003888-211 with ECP 564*	2003888-211 with ECP 564*		
2003121-221	2003121-221	Logic Module A23 Contains part of input-output logic consisting of PIPA precount logic channel 11 bits 8, 13, 14, and 16, alarm test and T6 RUPT enable logic, CDU drive control logic, channel 34 downlink control logic, channel 35 downlink control logic.	
2003888-221 with ECP 564*	2003888-221 with ECP 564*		

*See table 3-IB for effectivity.

Table 3-IIA. Computer Modules

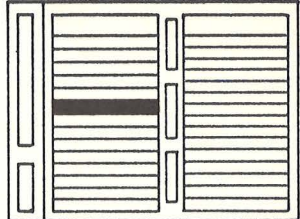
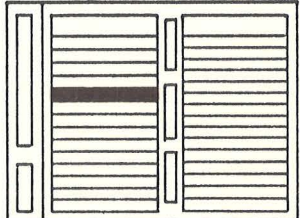
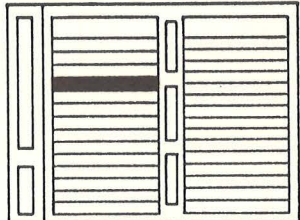
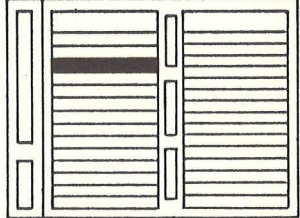
Module Part Number		Module Assembly Name and Function	Location
CMC 2003200	CMC 2003993		
2003121-231 2003888-231 with ECP 564*	2003121-231 2003888-231 with ECP 564*	Logic Module A24 Contains part of input-output logic consisting of input-output service for channels 1 through 14 and 16, WATCH instruction control logic, PIPA precount logic, channel 11 bits 10, 11, and 12, and counter decoder logic.	
2003070-021 2003070-031 with ECP's 501 & 505*	2003070-031	Interface Module A25 Provides interface for inputs from SC, ISS, nav DSKY, and OSS; and outputs from computer to RCS and DSKY.	
2003070-021 2003070-031 with ECP's 501 & 505*	2003070-031	Interface Module A26 Provides interface for inputs from main DSKY, and outputs from computer to ISS, PSA, SC, and RCS.	
2003067-031 2003067-041 with ECP's 501 & 505*	2003067-041	Interface Module A27 Provides interface for inputs from ISS and SC and outputs to ISS and OSS.	

*See table 3-IB for effectivity.

(Sheet 8 of 12)

BLOCK II PRIMARY GUIDANCE, NAVIGATION, AND CONTROL SYSTEM

Table 3-IIA. Computer Modules

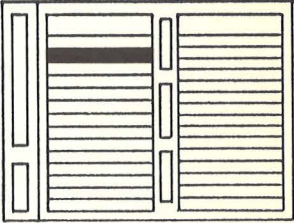
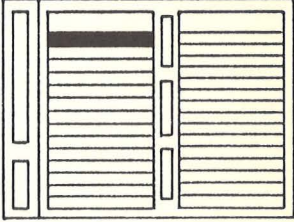
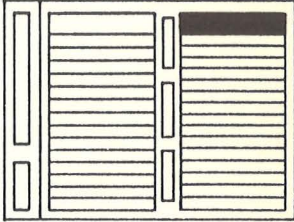
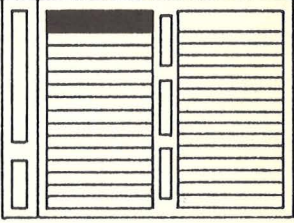
Module Part Number		Module Assembly Name and Function	Location
CMC 2003200	CMC 2003993		
2003067-031 2003067-041 with ECP's 501 & 505*	2003067-041	Interface Module A28 Provides interface for in-puts from SC and ISS, and outputs to SC and ISS.	
2003067-031 2003067-041 with ECP's 501 & 505*	2003067-041	Interface Module A29 Provides interface for in-puts from SC, and outputs to SC and OSS.	
2003953-011 2003953-021 with ECP 486* 2003892-011 with ECP 518	2003887-011 2003892-011 with ECP 518	Module A30 Supplies outputs of +4 vdc and +4 SW.	
2003953-011 2003953-021 with ECP 486* 2003892-011 with ECP 518	2003887-011 2003892-011 with ECP 518	Module A31 Supplies B plus (+14 volts) and BPLSSW.	

*See table 3-IB for effectivity.

(Sheet 9 of 12)

Table 3-IIA. Computer Modules

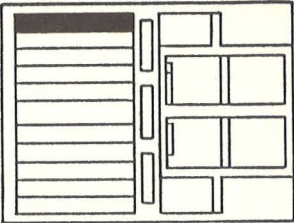
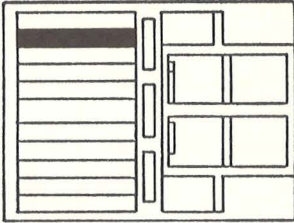
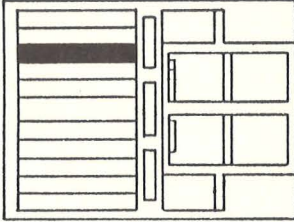
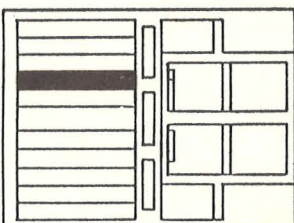
Module Part Number		Module Assembly Name and Function	Location
CMC 2003200	CMC 2003993		
2003036-021 2003036-031 with ECP's 501 & 505*	2003036-031	Oscillator Module B7 Contains oscillator which generates master clock frequency of 2.048 mc.	
2003983-011 2003983-021 with ECP's 501 & 505*	2003983-021	Alarm Module B8 Contains alarm detection circuits which monitor outputs of power supply, oscillator, scaler, and priority control.	
2003114-011 2003114-021 with ECP's 501 & 505*	2003114-021	Erasable Driver Module B9 Contains switching circuits which allow selection of memory cores.	
2003114-011 2003114-021 with ECP's 501 & 505*	2003114-021	Erasable Driver Module B10 Contains sixteen inhibit line drivers which prevent setting an erasable memory core when ZERO is to be written into bit location.	

*See table 3-IB for effectivity.

(Sheet 10 of 12)

BLOCK II PRIMARY GUIDANCE, NAVIGATION, AND CONTROL SYSTEM

Table 3-IIA. Computer Modules

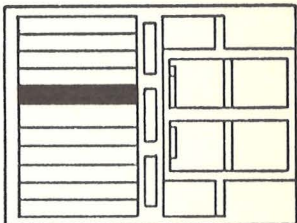
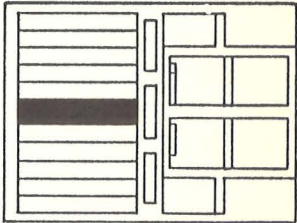
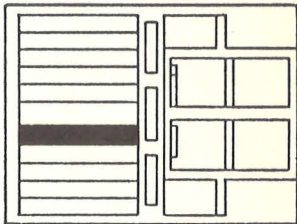
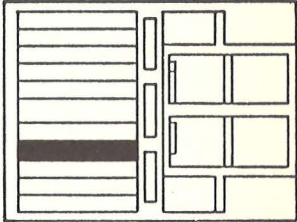
Module Part Number		Module Assembly Name and Function	Location
CMC 2003200	CMC 2003993		
2003026-021 2003026-031 with ECP's 501 & 505*	2003026-031	Current Switch Module B11 Contains read and write current circuits for X and Y top and bottom select switches.	
2003111-011 2003111-021 with ECP 505*	2003111-021 2003111-031 with ECP 692*	Erasable Memory Module B12 Contains storage capacity of 2048 words. The memory is random access, destructive readout storage device with density of one word per 16 cores. It can be altered or updated.	
2003982-011 2003982-021 with ECP's 501 & 505*	2003982-021 2003982-031 with ECP 483*	Sense Amplifier Module Erasable Memory B13 Contains sixteen sense amplifiers, which accept bipolar signals from core array sense lines to produce an output of eight bits to register G.	
2003982-031 with ECP 483*			
2003981-011 2003981-021 with ECP's 501 & 505*	2003981-021 2003981-031 with ECP 483	Sense Amplifier Module Fixed Memory B14 Contains sixteen sense amplifiers which operate similar to those in erasable memory to produce eight bits to register G.	
2003981-031 with ECP 483			

*See table 3-IB for effectivity.

(Sheet 11 of 12)

Table 3-IIA. Computer Modules

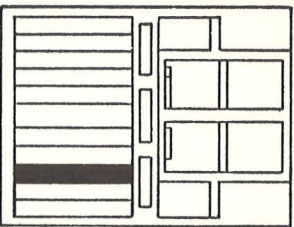
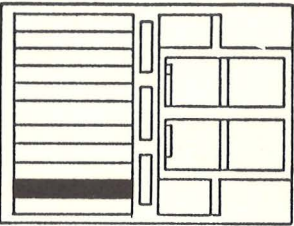
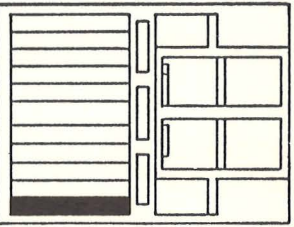
Module Part Number		Module Assembly Name and Function	Location
CMC 2003200	CMC 2003993		
2003027-021 2003027-031 with ECP's 501 & 505*	2003027-031	Strand Select Module B15 Contains three identical strand selector circuits each with four gates, and two identical module selector circuits each with three gates. Strand selectors provide 3 X 4 combination to select proper strand among 12 possibilities, and module selectors provide 2 X 3 combination to select proper module from 6 possibilities. This 6 X 12 combination selects proper strand from 72 possibilities that make up fixed memory.	
2003140-011 2003140-021 with ECP 440* 2003140-031 with ECP's 501 & 505*	2003140-031	Rope Driver Module B16 Contains three separate rope return circuits comprised of 16 inhibit drivers, 2 set drivers, and four reset drivers (to set or reset the cores).	
2003140-011 2003140-021 with ECP 440* 2003140-031 with ECP's 501 & 505*	2003140-031	Rope Driver Module B17 Contains driver circuits with three clear lines; each line threads all cores of both modules to clear the memory when required.	

*See table 3-IB for effectivity.

(Sheet 12 of 12)

BLOCK II PRIMARY GUIDANCE, NAVIGATION, AND CONTROL SYSTEM

3-3.1.2 Tray B. Tray B assembly (figure 3-6) contains 17 modules, including 6 rope modules. All modules are potted into the tray except the rope modules which are plugged into the front of the CMC. Tray B has three intertray connectors: B61, B62, and B63.

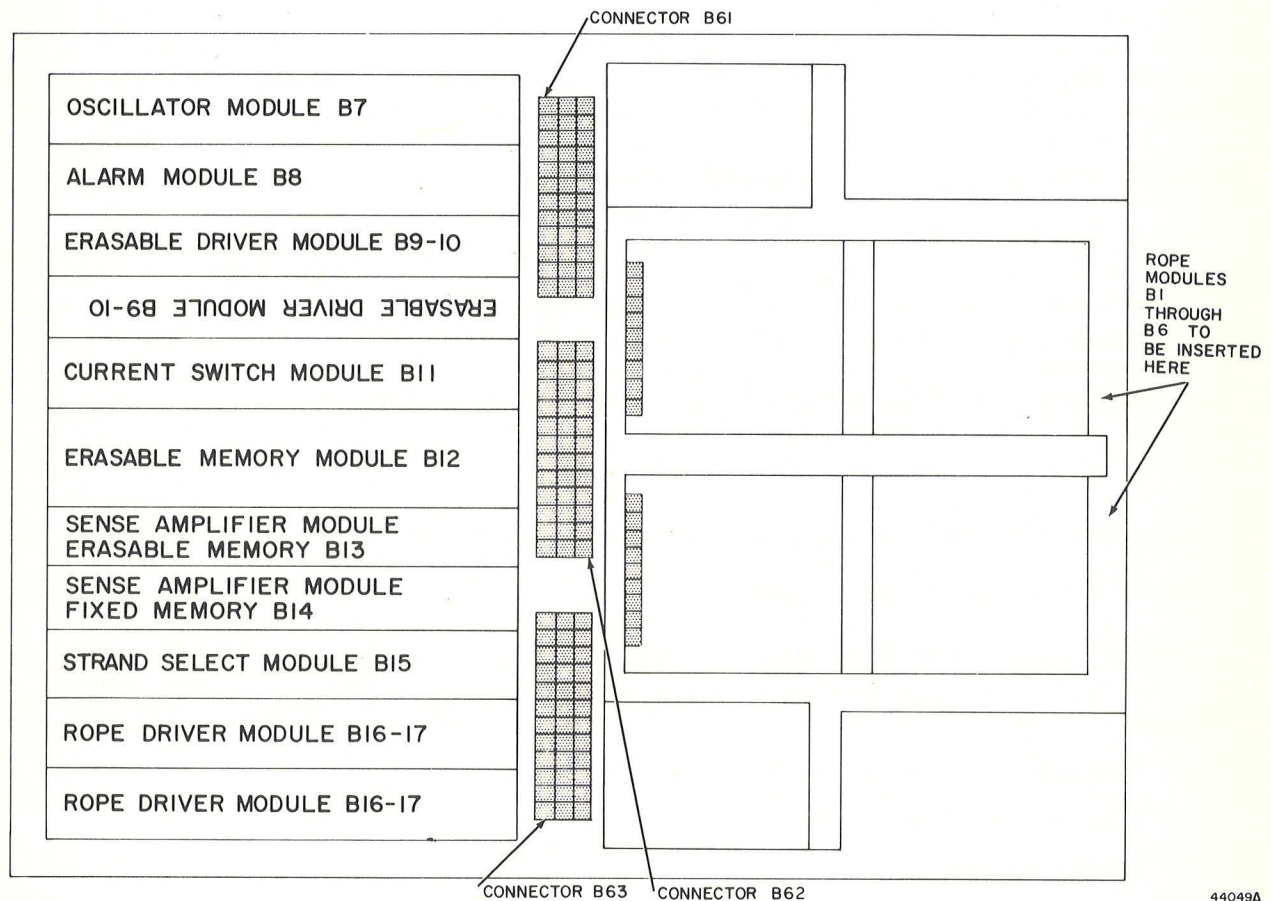

44049A

Figure 3-6. Tray B Module Side (CMC, Part Numbers 2003200 and 2003993)

3-3.2 DISPLAY AND KEYBOARD (DSKY). There are two identical and interchangeable DSKY's associated with the CMC, the main panel DSKY and the navigation panel DSKY (figure 3-7). Each DSKY measures approximately 8 inches high, 8 inches wide, and 7 inches deep. Table 3-IIB gives the name and part number of the DSKY modules.

Each DSKY is divided into two sections: one section for displays and one section for the keyboard. The display section contains 14 caution and alarm indicators for DSKY, part number 2003985, 10 caution and alarm indicators for DSKY, part numbers 2003950 and 2003994, a computer activity display, 6 operation display indicators, and 18 data display indicators. The words PROG, VERB, and NOUN associated with the operation display indicators, and the lines separating the three groups of data display indicators, are always illuminated. Six interchangeable indicator driver modules are mounted at the rear of the display section. The keyboard section contains 19 keys. The word, sign, or number of a key is always illuminated.

An 85 pin connector, a filler valve, and a power supply are also mounted on the rear of each DSKY. The connector (J9) connects the DSKY to the CMC, PGNCS, and other spacecraft systems. Connections are through PGNCS interconnect harness A for the main panel DSKY and through PGNCS interconnect harness H for the navigation panel DSKY. The filler valve is used for pressurizing the DSKY to .7 to 1.5 psig. The power supply module supplies the voltage required to light the display indicators.

The operating controls and indicators, and their functions, are listed in table 3-III.

3-4 DISPLAY AND CONTROL GROUP

3-4.1 INDICATOR CONTROL PANEL. The indicator control panel (figure 3-8) provides displays and controls, equipped with electroluminescent lamps, for the following functions:

- (1) Manual spacecraft maneuvering.
- (2) Manual optics positioning.
- (3) Optics mode control.
- (4) Warning, caution, and status lamps.

The indicator control panel is approximately 12.6 inches high, 23.5 inches wide, and 4.1 inches deep. An electrical connector (J1) provides connections between the indicator control panel and the PSA through PGNCS interconnect harness E. All flight indicator control panels have protective covers over the exposed portions of the switch mechanisms.

BLOCK II PRIMARY GUIDANCE, NAVIGATION, AND CONTROL SYSTEM

Table 3-IIB. DSKY Modules

Nomenclature	Part Number	
	DSKY 2003950	DSKY 2003994
Indicator driver module D1 thru D6	2003952-021	2003952-031
Power supply module D7	2003901-021	2003901-031
Keyboard module D8	2003909-021	2003909-031

With the incorporation of ECP 725, the indicator control panel has been modified to identify the two blank lamp retainer panels as GSE panels. (See table 3-ID for effectivity.) The GSE lamp retainer panels are used on the indicator control panel until two airborne panels which contain star list data and verb-noun data peculiar for each mission are available. When available, the two airborne lamp retainer panels are installed on the indicator control panel in accordance with JDC 17109.

3-4.2 OPTICS SHROUD. The optics shroud is manufactured from laminated fiberglass cloth and is used as protection and as a cover for the OUA. The optics shroud is aluminum with incorporation of ECP 629. (See table 3-IE for effectivity.) The optics shroud is approximately 12.75 inches high, 23.5 inches wide, and 6 inches deep.

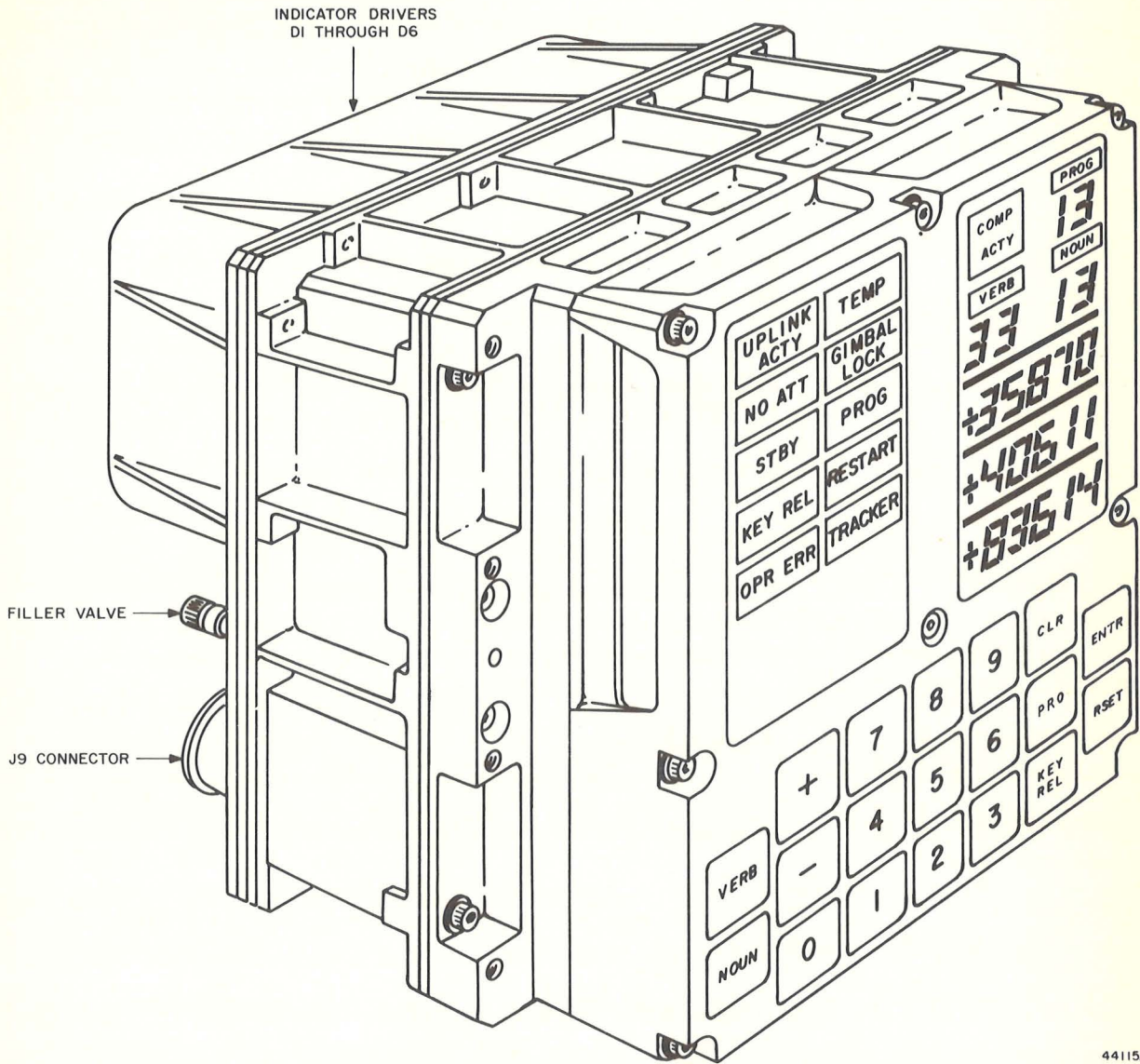

44115A

Figure 3-7. Main Panel and Navigation Panel DSKY,
Part Numbers 2003950 and 2003994

Table 3-III. DSKY Operating Controls and Indicators

Controls and Indicators	Function
Caution and Alarm Indicators	
UPLINK ACTY	Indicates information is being received via UPLINK.
STBY	Indicates CMC is in restart condition (low power mode).
KEY REL	Indicates that program information wishes to be displayed.
RESTART (DSKY, part number 2003950)	Indicates occurrence of any one or more of the following: PARITY FAIL, RUPT LOCK, TC TRAP, NIGHT WATCHMAN, VOLTAGE FAIL, ALARM TEST.
RESTART (DSKY, part number 2003985)	Indicates CMC is in restart condition.
OPR ERR	Indicates illegal keyboard operation.
AUTO (DSKY, part number 2003985)	Not used.
HOLD (DSKY, part number 2003985)	Not used.
FREE (DSKY, part number 2003985)	Not used.
NO ATT	Indicates that ISS is not suitable for use as attitude reference.
TEMP	Indicates overheat or underheat condition of IMU stable member.
GIMBAL LOCK	Indicates middle gimbal angle in excess of 75 degrees.
PROG	Indicates that program check has failed. This indicator is controlled by CMC program.
TRACKER	Not used.

(Sheet 1 of 3)

Table 3-III. DSKY Operating Controls and Indicators

Controls and Indicators	Function
Caution and Alarm Indicators	
SPARE (DSKY, part number 2003985)	Spare.
Operation Display Indicators	
COMP ACTY	Indicates that CMC is in operation.
PROG	Indicates function or functions of program being executed in CMC.
VERB	Indicates verb code entered at keyboard.
NOUN	Indicates noun code entered at keyboard.
Data Display Indicators	
Data display indications	A plus or minus sign signifies data displayed is decimal; no sign signifies data is octal.
Keyboard Keys	
<p>KEY REL</p> <p>PRO (DSKY, part numbers 2003950-031 and 2003994-021 and up</p> <p>STBY (DSKY, part numbers 2003950-011, -021 and 2003994-011</p> <p>RSET</p> <p>CLR</p>	<p>Releases control of keyboard so that information supplied by program action may be displayed.</p> <p>Puts CMC into low power mode (standby) and returns CMC to normal operation. Key can be used to proceed without data.</p> <p>Puts CMC into low power mode and returns CMC to normal operation.</p> <p>Clears caution indicators and OPR ERR indicator.</p> <p>Clears data contained in data register currently in use. Successive depressings clear the other two data displays.</p>

(Sheet 2 of 3)

Table 3-11. DART Operating Controls and Indicators

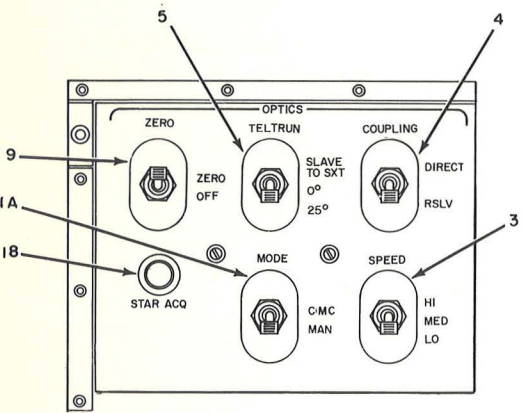

Configuration with ECP569 incorporated, see table 3-ID for effectivity.

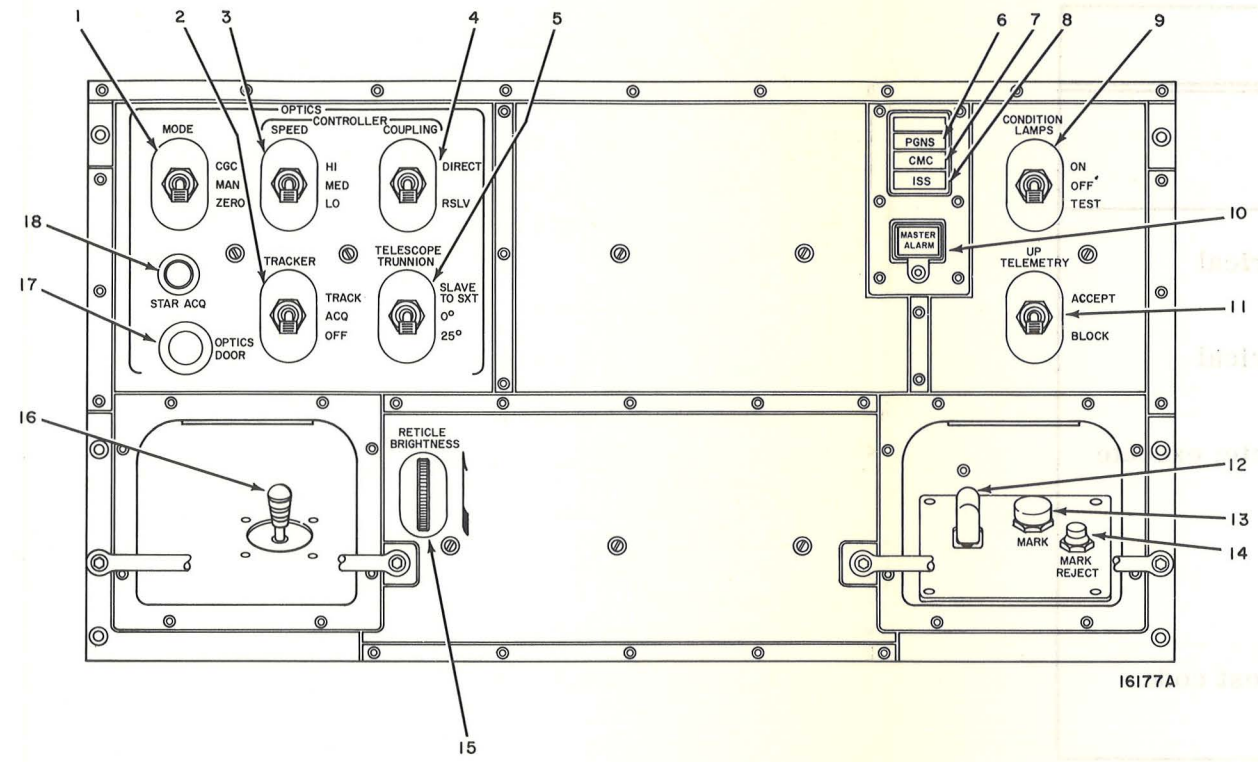

Index Number	Control or Indicator	Function
1	OPTICS MODE	Selects circuitry for either zeroing optics, manual control of optics, or CMC control of optics.
1A	OPTICS MODE	Selects circuitry for manual or CMC control of optics.
2	OPTICS TRACKER selector	Not used.
3	OPTICS SPEED CONTROLLER	Varies voltage for optics hand controller use.
4	OPTICS COUPLING CONTROLLER	Selects either direct or resolved positioning of optics.
5	OPTICS TRACKER selector	Not used.
6	TRACKER	Not used.
7	OPTICS DOOR	Not used.
8	RETICLE BRIGHTNESS	Adjusts reticle brightness.
9	TRACK ACQ OFF	Not used.
10	SLAVE TO SXT 0° 25°	Not used.
11	TELESCOPE TRUNNION	Not used.
12	DIRECT RSLV	Not used.
13	HI MED LO	Not used.
14	OPTICS CONTROLLER SPEED	Not used.
15	CGC MAN ZERO	Not used.
16	MODE	Not used.
17	STAR ACQ	Not used.
18	OPTICS DOOR	Not used.
19	MASTER ALARM	Not used.
20	PGNS	Not used.
21	CMC	Not used.
22	ISS	Not used.
23	UP TELEMETRY	Not used.
24	CONDITION LAMPS ON OFF TEST	Not used.
25	ACCEPT	Not used.
26	BLOCK	Not used.
27	MARK	Not used.
28	MARK REJECT	Not used.

Figure 3-8. Indicator Control Panel (Sheet 1 of 2)

Table 3-III. DSKY Operating Controls and Indicators

Controls and Indicators	Function
Keyboard Keys (cont)	
VERB	Conditions CMC to interpret next two numerical characters as action request.
NOUN	Conditions CMC to interpret next two numerical characters as address code.
ENTR	Informs CMC that assembled data is complete; execute requested function.
+key	Enters positive sign for decimal data.
-key	Enters negative sign for decimal data.
0 through 9	Enters data, address code, and action request code into CMC.

(Sheet 3 of 3)

BLOCK II PRIMARY GUIDANCE, NAVIGATION, AND CONTROL SYSTEM

Index Number	Control or Indicator	Function
5	OPTICS TELESCOPE TRUNNION selector	Slaves SCT to SXT S _t LOS or SXT LLOS, or off-sets SCT 25° in trunnion angle from SXT LLOS.
6	PGNS condition lamp	Indicates malfunctions in PGNCS equipment.
7	CMC condition lamp	Indicates malfunctions in CMC equipment.
8	ISS condition lamp	Indicates malfunctions in ISS equipment.
9	CONDITION LAMPS selector	Enables condition lamp circuitry or lights condition lamps for test.
10	MASTER ALARM lamp and pushbutton	Indicates failure in PGNCS and allows resetting of alarm circuitry.
11	UP TELEMETRY switch	Allows or blocks telemetry data from ground stations to be entered into CMC.
12	Attitude impulse hand control	Supplies signals to reaction control system to position the spacecraft in attitude.
13	MARK pushbutton	When pressed, sends signals to CMC to record time and optics and gimbal angles.
14	MARK REJECT pushbutton	Cancels input initiated by MARK pushbutton.
15	RETICLE BRIGHTNESS control	Varies voltage to change reticle lamp brightness.
16	Optics hand controller	Supplies signal to drive optics about shaft axis and/or trunnion axis in manual mode.
17	OPTICS DOOR	Opening through which tool can be inserted to manually open optics door in case of mechanical failure. (Removed with ECP 569*)
18	STAR ACQ lamp	Not used.
19	OPTICS ZERO selector	Selects circuitry for zero optics.

Figure 3-8. Indicator Control Panel (Sheet 2 of 2)

3-4A DUST COVERS

The SXT and SCT dust covers (figure 3-8A) are constructed of reinforced pyrolyzed plastic and are used to protect the optics from damage or contamination during launch and during ejection of the launch escape system. The dust covers are mounted on the SXT and SCT crown half and plug assemblies when the optics shaft axis is at $0^\circ \pm 15^\circ$. Rotation of the optics about the shaft axis causes ejection of the dust covers.

3-5 FLEXIBLE HOSE ASSEMBLY

The flexible hose assemblies connect the IMU to the spacecraft environmental control system which provides the necessary coolant solution. The flexible hose assemblies are approximately 9.75 inches long and are equipped with quick disconnects. The connections to the environmental control system are welded.

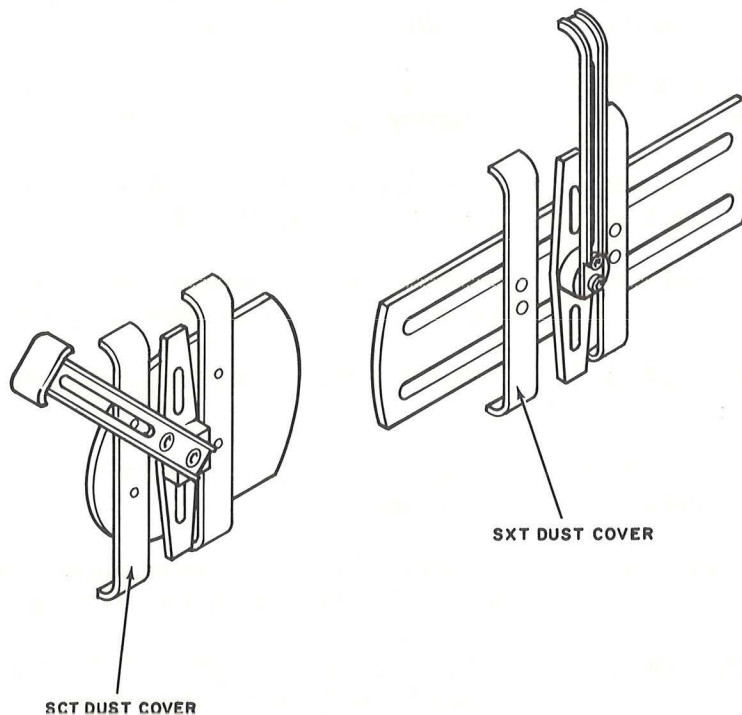

18784

Figure 3-8A. Dust Covers

BLOCK II PRIMARY GUIDANCE, NAVIGATION, AND CONTROL SYSTEM

3-5A. EYEPIECE STORAGE UNIT. The eyepiece storage unit (figure 3-8B) houses and protects the optics regular eyepieces, prism and mirror housings, and long eye relief eyepieces when not installed on the OUA. The eyepiece storage unit is manufactured from ABS plastic sheet and is approximately 6.31 inches high, 21.4 inches wide, and 9.12 inches deep. Three harness plugs mounted to the eyepiece storage unit connector bracket provide eyepiece heater current. Notches for the eyepiece heater cables are above the connector bracket and allow the eyepieces to be securely installed in the storage unit with cover closed while heater current is applied. The eyepiece storage unit is located directly above the optics shroud.

The eyepiece storage unit is manufactured from aluminum with incorporation of ECP 628. (See table 3-IP for effectivity.)

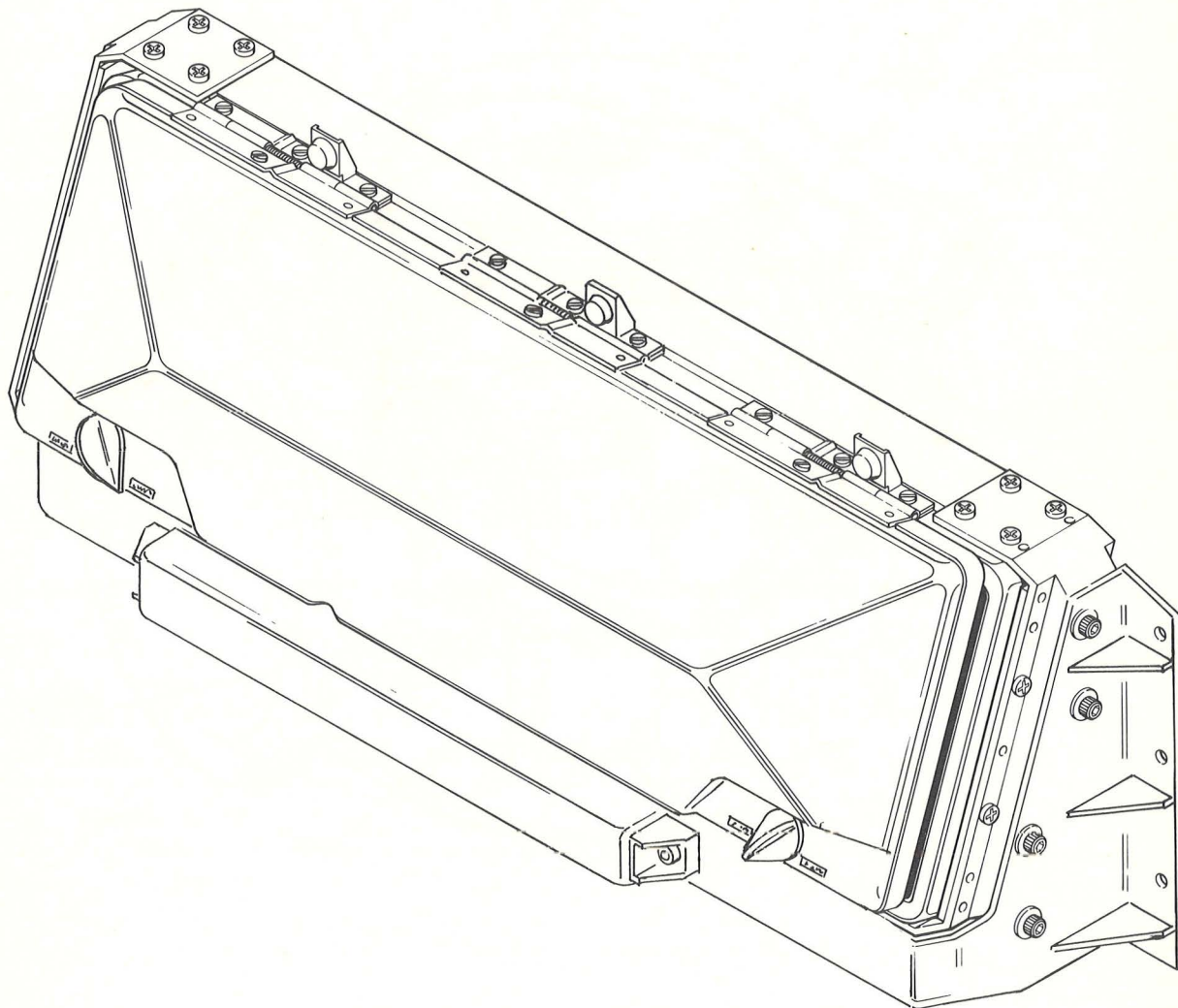

16462

Figure 3-8B. Eyepiece Storage Unit

3-6 INERTIAL MEASURING UNIT AND PIP ELECTRONICS ASSEMBLY

3-6.1 INERTIAL MEASURING UNIT. The IMU (figure 3-9) is a three-gimbal system. The command module has unrestricted movement about all axes of the gyro-stabilized inner gimbal (stable member). During normal operation, the middle gimbal angle is not allowed to exceed ± 70 degrees. The inner gimbal is held stable by three Apollo II IRIG's. Accelerations along any component of the three orthogonal axes of the stable member are sensed by one or more of the three 16 PIP accelerometers. Intergimbal assemblies physically support the gimbals and pass electrical signals between them. The temperature of the IMU is maintained at the desired level by a system of heaters, blowers, thermostats, and coolant passages. The IMU is sealed to maintain one atmosphere pressure as an aid in convection cooling when the IMU is subjected to pressures of less than one atmosphere.

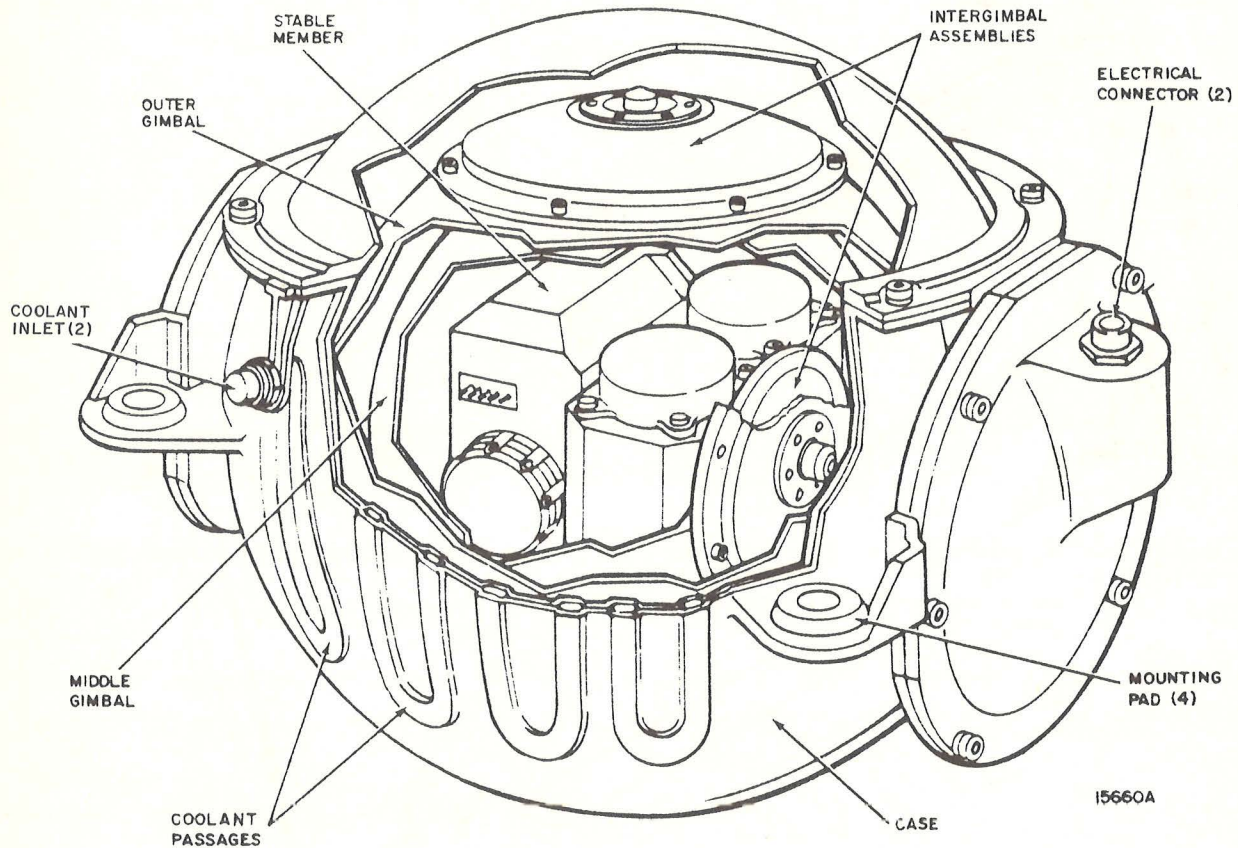

Figure 3-9. Inertial Measuring Unit

BLOCK II PRIMARY GUIDANCE, NAVIGATION, AND CONTROL SYSTEM

3-6.1.1 Stable Member. The stable member is suspended by two intergimbal assemblies inside the middle gimbal. It is free to rotate without restriction about the inner gimbal (IG) axis. The stable member is machined from a solid block of beryllium 6.5 x 5.9 x 5.2 inches. Holes are machined to receive the three Apollo II IRIG's and the three PIP's. Accelerometer preamplifiers, stable member heaters, temperature control circuitry and thermostats, a ducosyn transformer, and two safety thermostats are attached to the stable member.

3-6.1.1.1 Gyroscopes. Three Apollo II IRIG's are mounted on the stable member (figure 3-10).

Ducosyns are used for magnetic suspension of the gyro rotor and for signal and torque generation. The signal generator ducosyn is located at the positive output axis end of the float; the torque generator ducosyn is located at the negative output axis end.

The gyro wheel assembly operates as a hysteresis synchronous motor. The hub of the wheel is made of beryllium and the rim is made of heavy steel. This method of construction concentrates the weight at the rim giving the wheel a high inertial moment.

3-6.1.1.2 Accelerometers. The Block II IMU uses three 16 PIP accelerometers for sensing acceleration. Figure 3-10 shows the orthogonal placement of the 16 PIP's on the stable member. The 16 PIP is basically a cylindrical float with a pendulous mass unbalance and is pivoted with respect to a case. Ducosyns are located at each end of the float for magnetic suspension and signal and torque generation.

3-6.1.1.3 Stable Member Mounted Electronics. Table 3-IV gives the location and functions of electronics modules which are mounted on the stable member.

3-6.1.2 Middle Gimbal. The middle gimbal is suspended by two intergimbal assemblies inside the outer gimbal. It, in turn, supports the stable member. Slip ring assemblies in the intergimbal assemblies provide a means of carrying electrical signals between the outer gimbal and the stable member. The middle gimbal is approximately 9.5 inches in diameter.

3-6.1.3 Outer Gimbal. The outer gimbal is similar in configuration to the middle gimbal, being suspended inside the supporting gimbal by two intergimbal assemblies. The outer gimbal has two thermostatically controlled axial-flow blowers mounted in its walls to force air from the vicinity of the middle gimbal to the walls of the case, where heat is transferred to a water-glycol coolant solution circulating through passages in the case. The outer gimbal is approximately 10.6 inches in diameter.

3-6.1.4 Supporting Gimbal. The supporting gimbal (case) is a spherical enclosure which supports the three gimbals described in the preceding paragraphs. The outer gimbal is suspended inside the case by two intergimbal assemblies which allow complete freedom of rotation. The walls of the case contain coolant passages through which a water-glycol solution is circulated to dissipate heat generated by inertial components and electrical modules. Two quick disconnect fittings connect the coolant passages to the Block II command module coolant supply. The case is surrounded by insulating material to prevent condensation on the coolant passages. The case is approximately 12.6 inches in diameter.

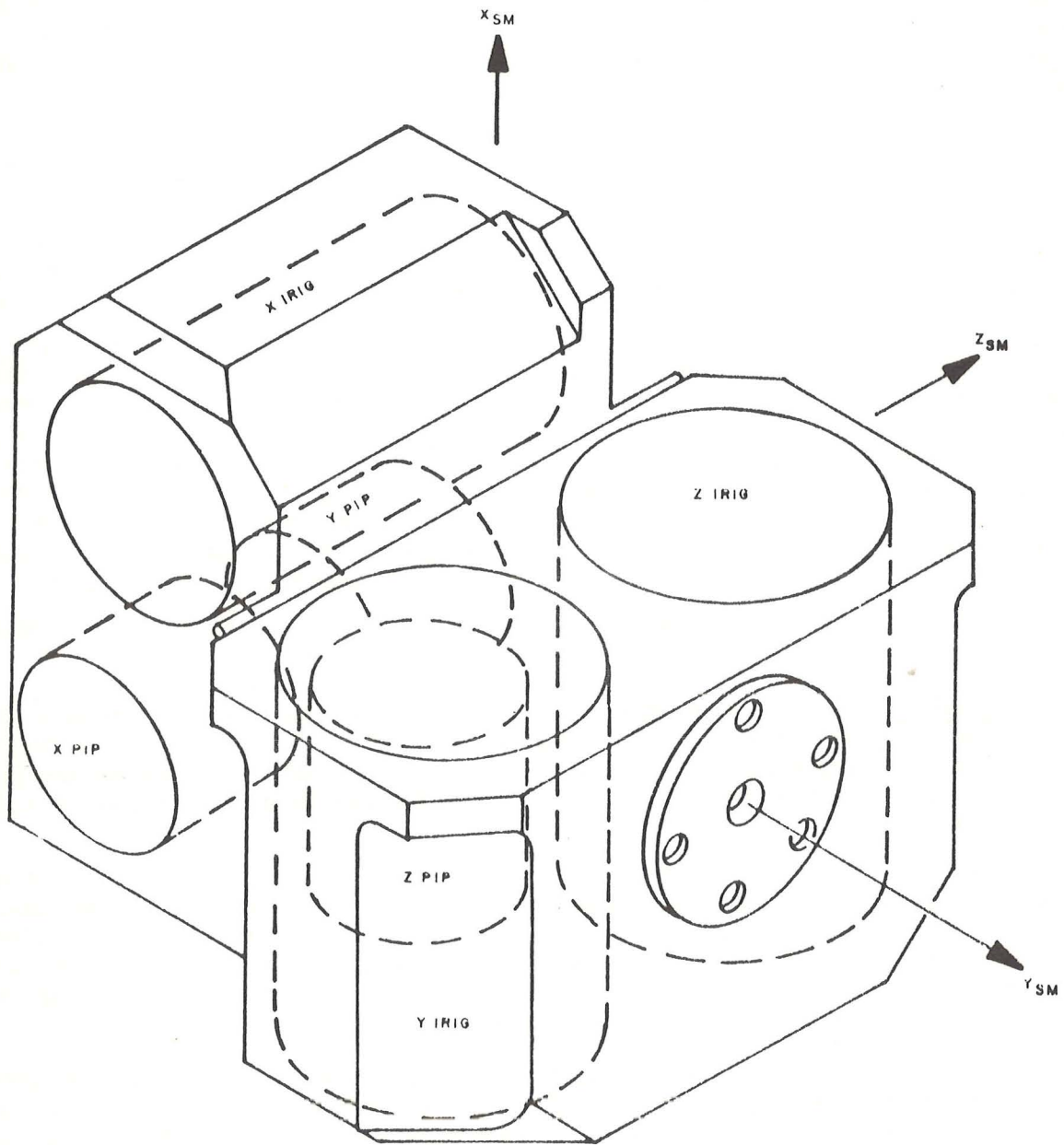

16136

Figure 3-10. Stable Member

Table 3-IV. Location and Functions of IMU Electronics

Nomenclature	Part Number	Location and Function
Blower control module assembly	2007171-011, 2007172-011 with ECP 204*	Stable member (SM): Removes power from blower control relay in response to request from blower control thermostat and heater assembly.
Blower control relay	1010353-10, 1010353-13 with ECP 204*	Outer gimbal resolver intergimbal assembly: Removes power from blower motors at request of blower control module assembly.
Blower control thermostat and heater assembly	2018635, 2018825-011 with ECP 204*	SM: Controls on-off action of blower motors on outer gimbal.
Ducosyn transformer assembly	2007019-011	SM: Reduces 28 volts ac to 2 volts and 4 volts for signal generator excitation of PIP and IRIG ducosyns, respectively.
PIP preamplifier assembly	2007060-011, 2007060-021 or 2021269-011 with ECP 500*	SM: Amplifies signals generated by PIP signal generator to prevent loss in slip ring assemblies. Also provides 45 degree phase shift from reference voltage.
Precision resolver alignment assembly	2007204-011	Outer gimbal resolver intergimbal assembly: Compensates for design anomalies in intergimbal assembly resolvers.
Safety thermostat (2)	1001485	SM: Disables all IMU heaters if extreme overheat condition exists.
Stable member heater assembly (2)	2018641	SM: Supplements and stabilizes heat generated by inertial component heaters.

*See table 3-IS for effectivity.

(Sheet 1 of 2)

Table 3-IV. Location and Functions of IMU Electronics

Nomenclature	Part Number	Location and Function
Temperature alarm module assembly	2007170-011	SM: Signals CMC that overheat or underheat condition exists.
Temperature alarm thermostat assembly	2018636 before ECP 204*	SM: Controls operation of temperature alarm module assembly.
Temperature alarm thermostat and heater assembly (high)	2018823-011 with ECP 204*	SM: Controls operation of temperature alarm module assembly during overheat conditions.
Temperature alarm thermostat and heater assembly (low)	2018824-011 with ECP 204*	SM: Controls operation of temperature alarm module assembly during underheat conditions.
Temperature control module assembly	2007064-011	SM: Applies power to heaters in IRIG's, PIP's, and on SM, in response to request from temperature control thermostat and heater assembly.
Temperature control thermostat and heater assembly	2018637, 2018826-011 with ECP 204*	SM: Controls operation of temperature control module to maintain proper heat in inertial components.

*See table 3-IS for effectivity.

(Sheet 2 of 2)

Electrical interface between the IMU and the remainder of the PGNCS is accomplished by two electrical connectors (J1 and J2) on the case. A precision resolver alignment assembly module and a blower control relay are mounted on the resolver intergimbal assembly of the outer gimbal. The resolver alignment assembly is accessible from outside the case.

3-6.1.5 Intergimbal Assembly. The intergimbal assemblies serve four basic purposes: the duplex ball bearings support the gimbal with a minimum of friction, the torque motor drives the gimbal in response to an error signal, the multispeed resolver furnishes signals which represent the angular position of the gimbal, and the gyro error resolver (inner gimbal only) transforms gyro error signals into gimbal angle error signals. Slip rings are also mounted in each intergimbal assembly providing a means of transferring electrical signals from the stable member and intergimbal assemblies and allowing 360 degrees of freedom for each gimbal.

3-6.2 PIP ELECTRONICS ASSEMBLY. The PEA (figure 3-11) consists of a group of modular electronic assemblies whose functions are related to inertial components in the IMU. The PEA is mounted close to the IMU to avoid line loss in low-level signals. Table 3-V identifies and lists the functions of the PEA modules. The PEA has two connectors: an 85 pin connector (J14) used to connect the PEA to the IMU and PSA, and a 44 pin connector (J15) used as a PIPA test connector. Table 3-VA lists the signals, by pin number, available at jack J15. The PEA measures approximately 9.1 inches high, 10 inches wide, and 2.6 inches deep. A filler valve is used to pressurize the PEA.

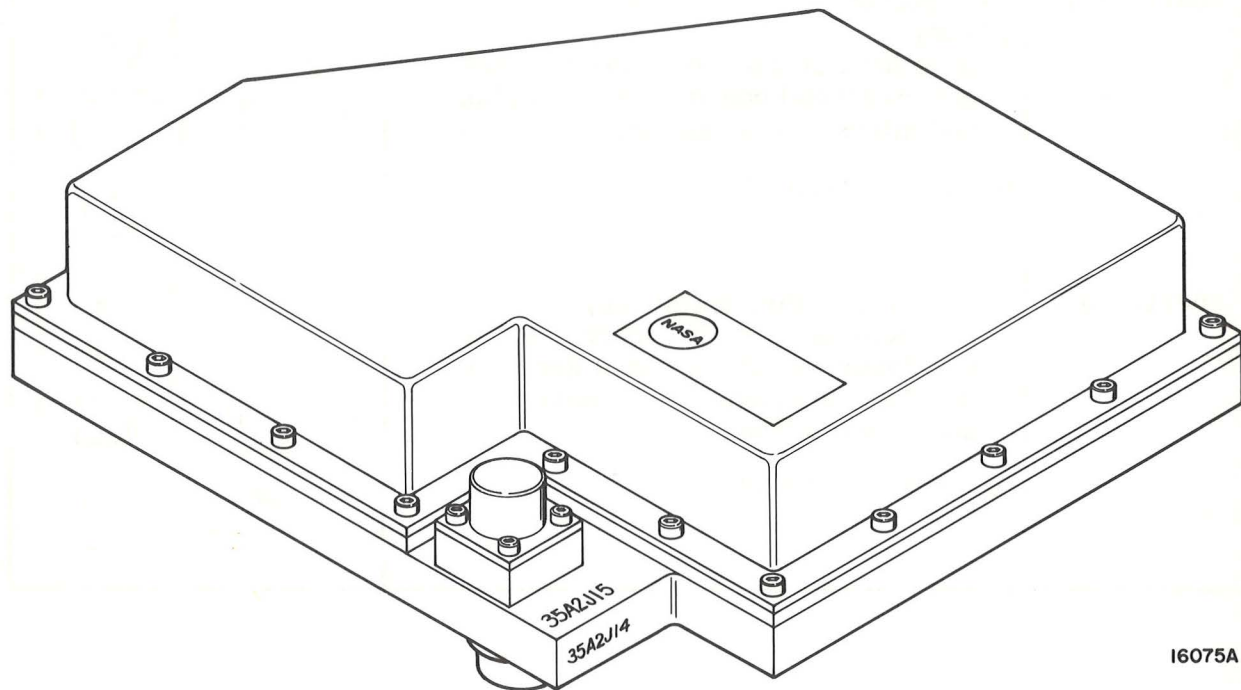

16075A

Figure 3-11. PIP Electronics Assembly

Table 3-V. Location and Functions of PIP Electronics Assembly Modules

Module Part Number	Module Assembly Name and Function	Location
2007101-011	<p>DC differential amplifier and PVR (three) Regulates torquing current supplied through binary current switches.</p> <p>Schematic 2010029</p>	
2007103-011	<p>Binary current switch (three) Switches constant current pulses between PIPA torque generators to null PIPA loops. Supplies pulses to CMC forward backward counter to indicate velocity change.</p> <p>Schematic 2010017</p>	
2007104-011	<p>AC differential amplifier and interrogator (three) Amplifies signals from PIPA signal generator and converts them to plus and minus torque pulses.</p> <p>Schematic 2010018</p>	
2007105-011	<p>C/M PIPA calibration (three) Compensates for differences in inductive loading of PIPA signal generator windings and regulates balance of plus and minus torques.</p> <p>Schematic 2010016</p>	 <p style="text-align: right; font-size: small;">16071</p>

Table 3-VA. PEA Test Points

Pin Number	Signal Description	Pin Number	Signal Description
1	Z PIPA current monitor (low)	26	0 vdc IMU Y PIPA error monitor (low)
4	X PIPA error monitor (high)	28	X PIPA N pulses
6	Z PIPA current monitor (high)	29	X PIPA P pulses
8	Y PIPA PVR (low)	32	X PIPA current monitor (high)
9	Z PIPA error monitor (high)	34	Y PIPA current monitor (high)
11	Y PIPA error monitor (high)	36	Y PIPA PVR (low)
14	0 vdc IMU X PIPA error monitor (low)	37	X PIPA PVR (high)
15	X PIPA current monitor (low)	38	Z PIPA PVR (high)
17	Y PIPA current monitor (low)	39	Z PIPA PVR (low)
20	Y PIPA PVR (high)	40	Z PIPA N pulses
23	0 vdc IMU Z PIPA error monitor (low)	41	Z PIPA P pulses
		43	Y PIPA N pulses
		44	Y PIPA P pulses

3-7 NAVIGATION BASE

The nav base (figure 3-12) provides a mounting surface for the IMU and OUA.

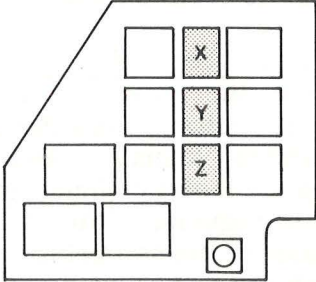
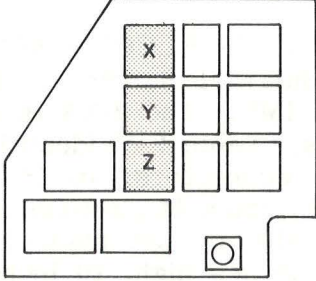
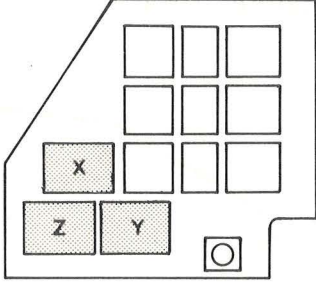
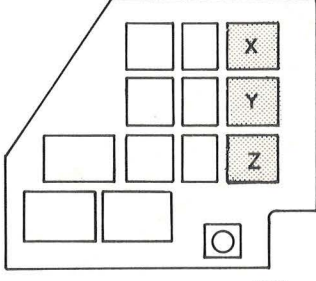
The outer shell is constructed by riveting and bonding anodized preformed sheet aluminum alloy panels together. The shell is filled with polyurethane foam.

Precisely machined mounting surfaces insure that the plane formed by the IMU mounts is $32^{\circ} 32' 23''$ from the plane formed by the OUA mounts. The nav base is positioned behind the indicator control panel with the OUA along the conical surface of the command module.

The nav base is constructed with a 20° offset and is approximately 27 inches long, 22 inches wide, and 4.5 inches high.

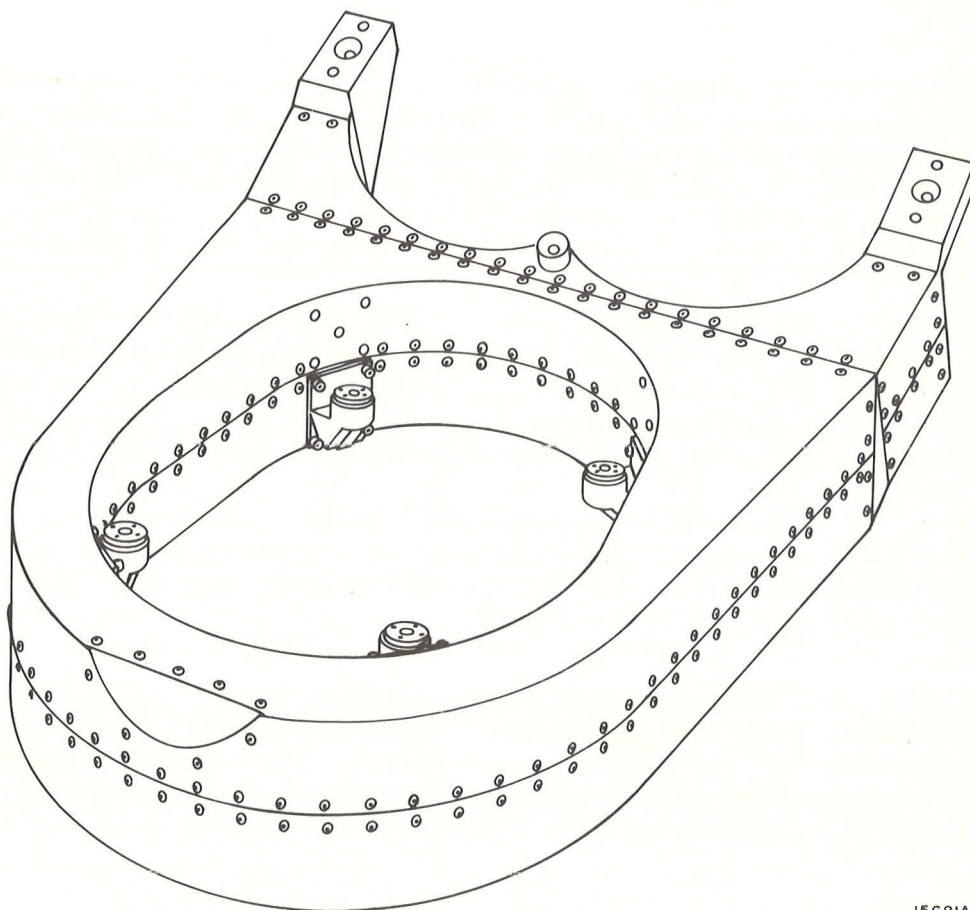

15681A

Figure 3-12. Navigation Base

3-8 NAVIGATION BASE, OPTICAL UNIT ASSEMBLY, AND BELLOWS INSTALLATION KIT

The nav base, OUA, and bellows installation kit consist of nav base mounting assemblies (fixed, line, and plane) for shock mounting the nav base to the spacecraft; OUA to spacecraft seal assemblies to provide seals between the inner shell of the spacecraft and the housings of the SXT and SCT; and hardware for mounting the OUA and IMU to the nav base.

3-9 OPTICAL UNIT ASSEMBLY (PGNCS PART NUMBER 2015000-011)

The OUA consists of two optical instruments, a SXT and a SCT, mounted on a common optical base. (See figure 3-13.) The base is rigidly mounted on the nav base above the IMU. Three precision ball mounts on the optical base provide for mounting the OUA on the nav base. Two bellows function as flexible seals between the inner shell of the spacecraft and the housings of the SXT and SCT.

3-9A OPTICAL UNIT AND BELLOWS ASSEMBLY. (PGNCS PART NUMBER 2015000-021 AND ABOVE.)

The optical unit and bellows assembly is identical to the optical unit assembly described in paragraph 3-9 except that the two bellows which function as seals between the inner shell of the spacecraft and the housings of the SXT and SCT are manufactured from stainless steel. Aluminum alloy cover and baffle assemblies are provided for the OUA's that will receive an APTPS. The cover and baffle assemblies replace the covers furnished with the OUA and provide mounts for the APTPS crown half and plug assemblies.

3-9.1 OPTICAL BASE. The optical base, a precisely machined beryllium casting, provides a mount for the SCT and SXT and houses the shaft axis drive and control components of the SXT and SCT. Internal components of the base are sealed by the SXT and SCT panels (figure 3-13), which provide mountings for the SXT and SCT eyepiece assemblies. SCT shaft and trunnion mechanical angle counters are located in the SCT panel assembly. The SCT panel is equipped with adapters to allow manual positioning of the SCT trunnion and shaft axes in the event of servo positioning loop failure. (NOTE: Do not exercise the manual drives in a laboratory configuration.) All beryllium surfaces that will be directly exposed to spacecraft cabin atmosphere are painted and/or anodized to prevent oxidation.

3-9.2 SEXTANT. The SXT assemblies are contained in a cylindrical housing which protrudes outward from the optical base. (See figure 3-14.) The housing contains optical components and trunnion drive assemblies. The SXT head assembly is protected by an aluminum alloy head cover. An elongated aperture extending to the periphery of the cover permits unobstructed lines-of-sight for the SXT through its entire operating range.

3-9.3 SCANNING TELESCOPE. The SCT assemblies are mounted in a cylindrical housing which protrudes outward from the optical base. (See figure 3-14.) The housing contains optical components and trunnion drive assemblies. The SCT head assembly is protected by a counterweight and cover assembly. This assembly has an aperture which allows an unobstructed line-of-sight through the entire SCT operating range.

BLOCK II PRIMARY GUIDANCE, NAVIGATION, AND CONTROL SYSTEM

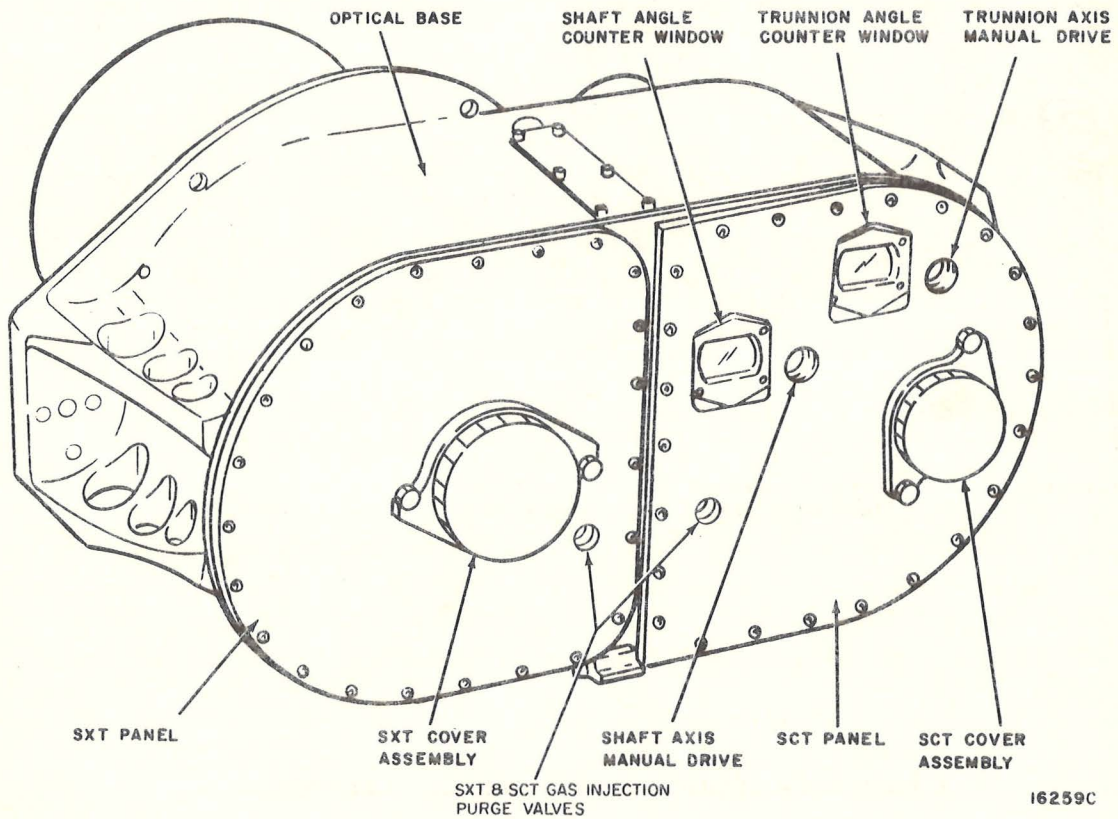
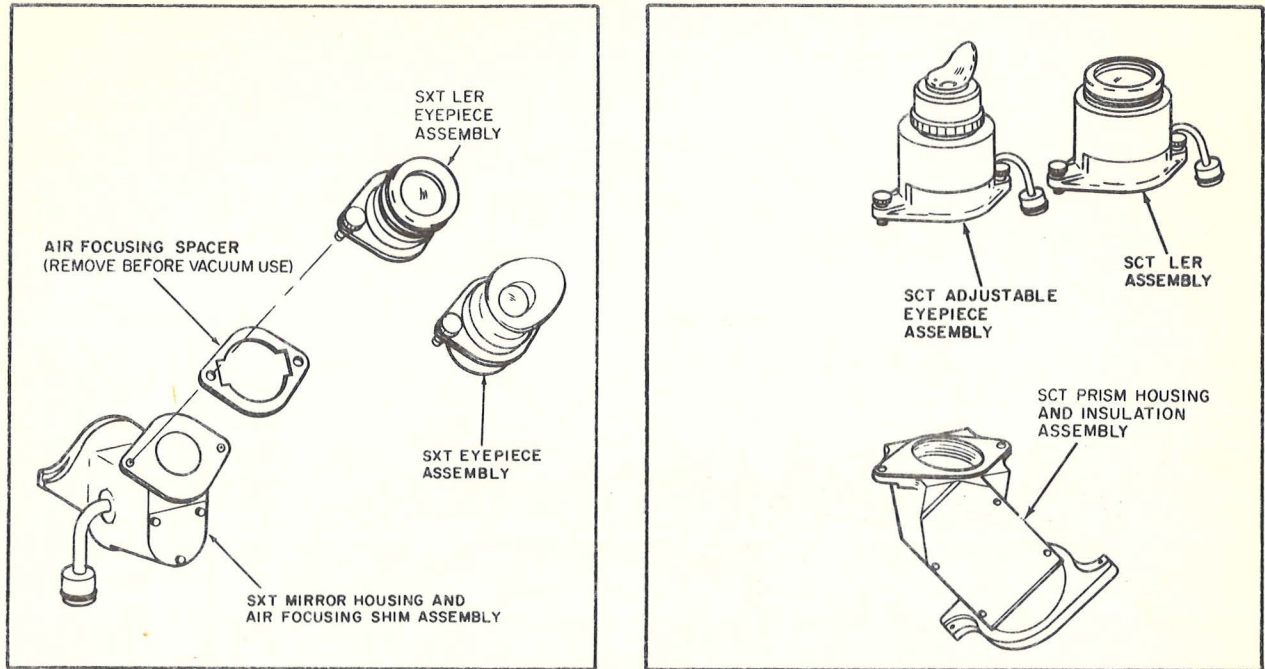

Figure 3-13. Optical Unit Assembly, Front View

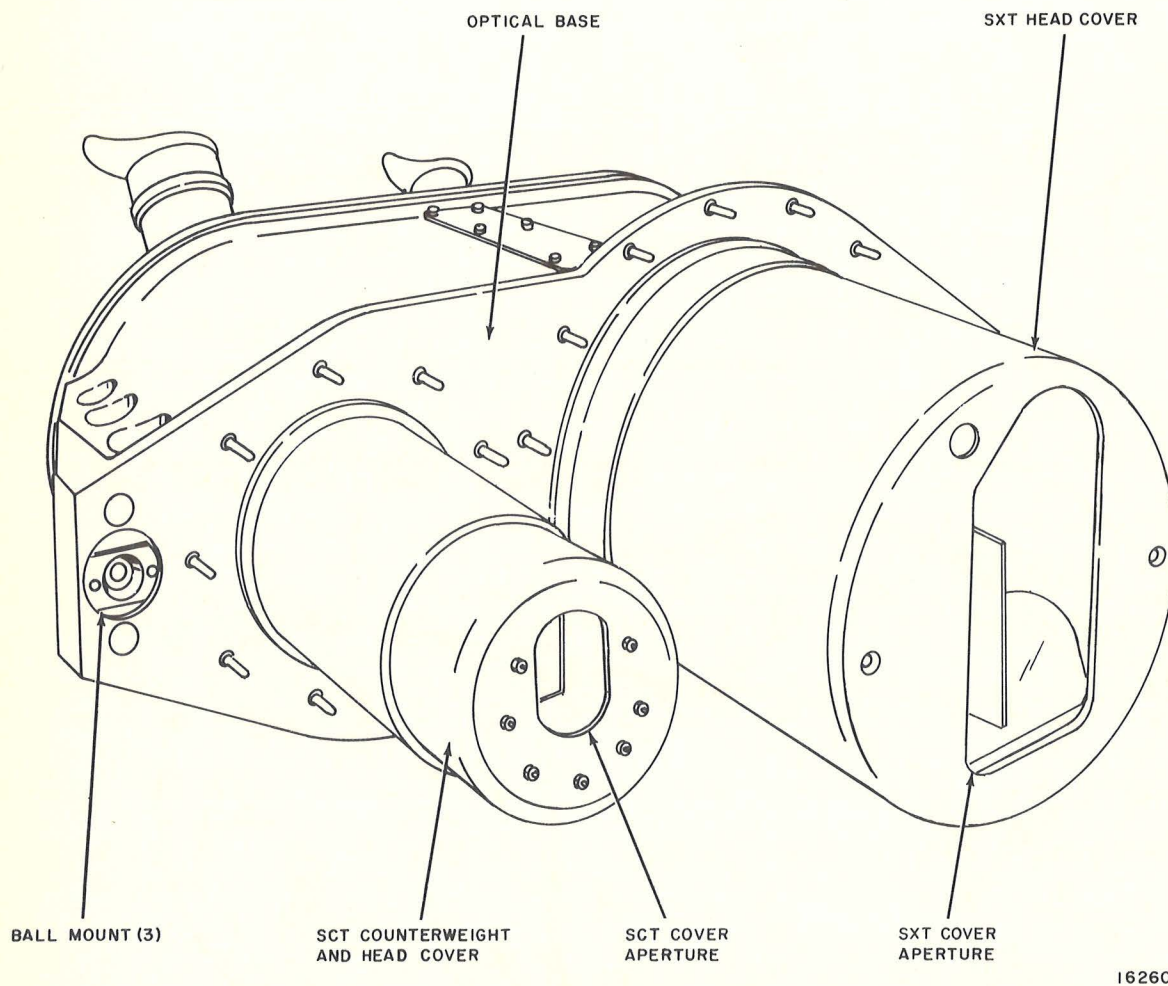

Figure 3-14. Optical Unit Assembly, Rear View

BLOCK II PRIMARY GUIDANCE, NAVIGATION, AND CONTROL SYSTEM

3-10 PGNCS INTERCONNECT HARNESS GROUP

The PGNCS interconnect harness group (figure 3-14A) connects the PGNCS to the spacecraft power supplies and electrically interconnects PGNCS components. These connections are made through eight wiring harnesses. Component interconnections are listed in table 3-VI.

3-11 POWER AND SERVO ASSEMBLY

The PSA (figure 3-15) contains encapsulated electronic circuitry for the inertial and optical subsystems of the PGNCS. The PSA contains 37 modules (36 modules with ECP 590) mounted on a common frame which in turn is mounted on a coldplate. The coldplate dissipates heat generated by the electronic components. Table 3-VII gives the location and functions of the PSA modules.

The PSA has 10 connectors: two 61 pin connectors (J1 and J3) which are used for test and monitor; one 19 pin connector (J2) used to connect the portable temperature controller to the PSA for GSE control of IMU temperature; one 323 pin connector (J4) which connects the PSA to the CMC, CDU, and main panel DSKY through PGNCS interconnect harness D, and also used for test and monitor; one 116 pin connector (J5) which connects the SXT to the PSA through PGNCS interconnect harness B; one 193 pin connector (J6) which connects the IMU and PEA to the PSA through PGNCS interconnect harness C; one 114 pin connector (J7) which connects the indicator control panel to the PSA through PGNCS interconnect harness E; one 68 pin connector (J8) which connects the nav panel DSKY to the PSA through PGNCS interconnect harness H, and also used for test and monitor; one 66 pin connector (J9) which connects the SCT to the PSA through PGNCS interconnect harness F; and one 192 pin connector (J10) which connects the signal conditioner assembly to the PSA through PGNCS interconnect harness G, and also used for test and monitor. A filler valve is used to pressurize the PSA. Tables 3-VIII and 3-IX list the signals, by pin number, available at jacks J1 and J3.

The PSA is approximately 2.75 inches high, 23.1 inches wide, and 22.6 inches deep.

Table 3-VI. PGNCS Interconnect Harness Group Connections

PGNCS Interconnect Harness		Connects to	
Number	Plug	Jack	Component
A	56P1	56J1	PGNCS interconnect harness D
	56P2	56J2	PGNCS interconnect harness D
	56P3	56J3	PGNCS interconnect harness D
	56P4	56J4	PGNCS interconnect harness D
	56P5	56J5	PGNCS interconnect harness H
	56P6	J336	Interface, CMC signals
	56P7	J337	Interface, ISS signals
	56P8	J335	Interface, main panel DSKY signals
	56P9	40J53	CDU
	56P10	05A1J1*	CMC
B	56P13	65A1J1	SXT
	56P14	65A1J2	SXT
	56P18	45J5	PSA
C	56P12	35A2J14	PEA
	56P15	35A1J2	IMU
	56P16	35A1J1	IMU
	56P19	45J6	PSA
D	56J1	56P1	PGNCS interconnect harness A
	56J2	56P2	PGNCS interconnect harness A
	56J3	56P3	PGNCS interconnect harness A
	56J4	56P4	PGNCS interconnect harness A
	56P17	45J4	PSA
E	56P24	50J1	Indicator control panel
	56P26	45J7	PSA
F	56P23	65A2J1	SCT
	56P28	45J9	PSA
G	56J6	65A1P1	OUA eyepiece heaters
	56J7	65A2P2	OUA eyepiece heaters
	56J8	65A2P3	OUA eyepiece heaters
	56P20	30A1J1	Signal conditioning module
	56P21	30A1J2	Signal conditioning module
	56P22	30A1J3	Signal conditioning module
	56P29	45J10	PSA
	56P32	J347	Interface, PCM signals
H	56J5	56P5	PGNCS interconnect harness A
	56P25	05A2J9	Navigation panel DSKY
	56P27	45J8	PSA
	56P30	J345	Power bus A
	56P31	J346	Power bus B

* May be designated A51

BLOCK II PRIMARY GUIDANCE, NAVIGATION, AND CONTROL SYSTEM

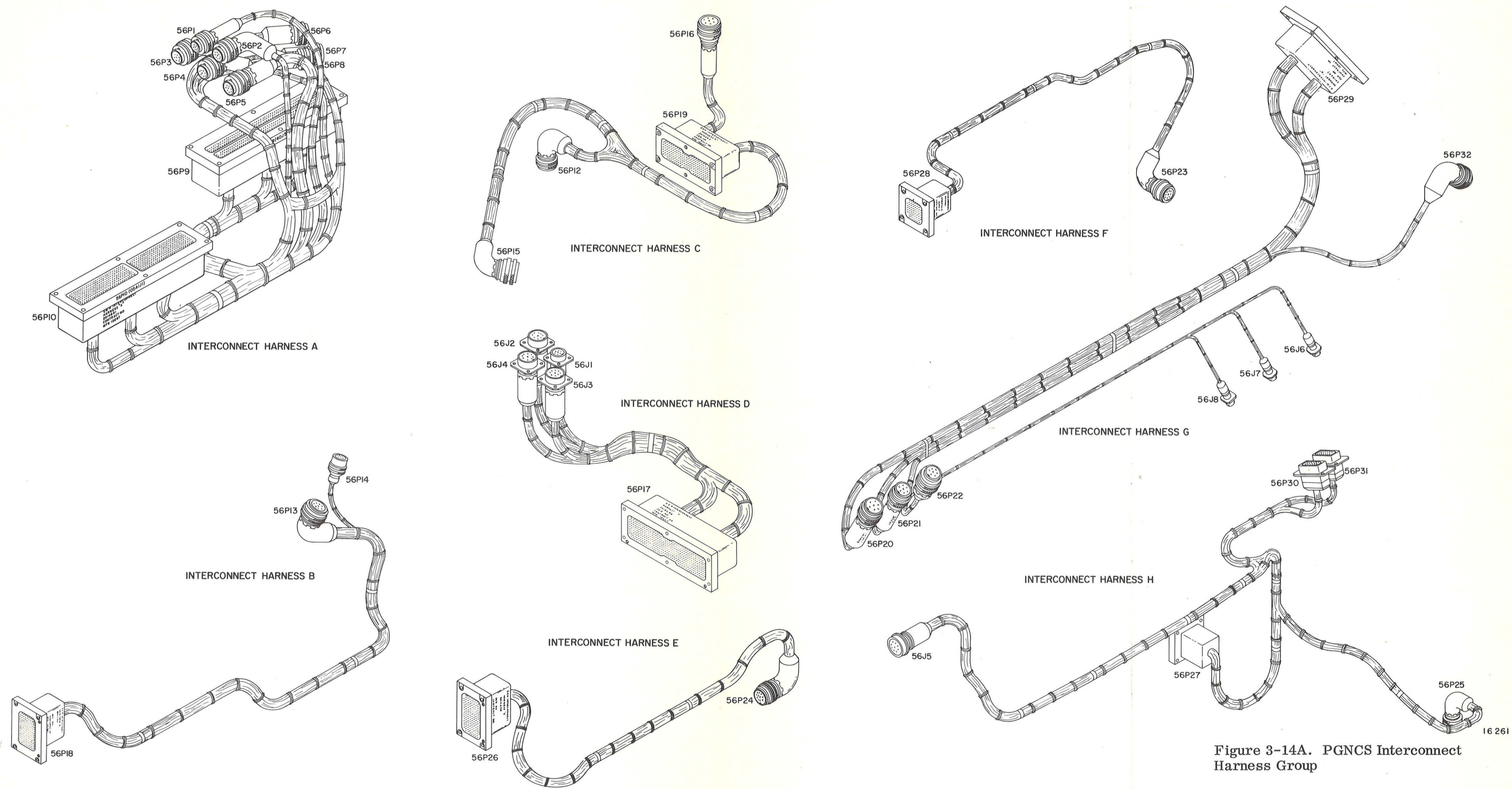
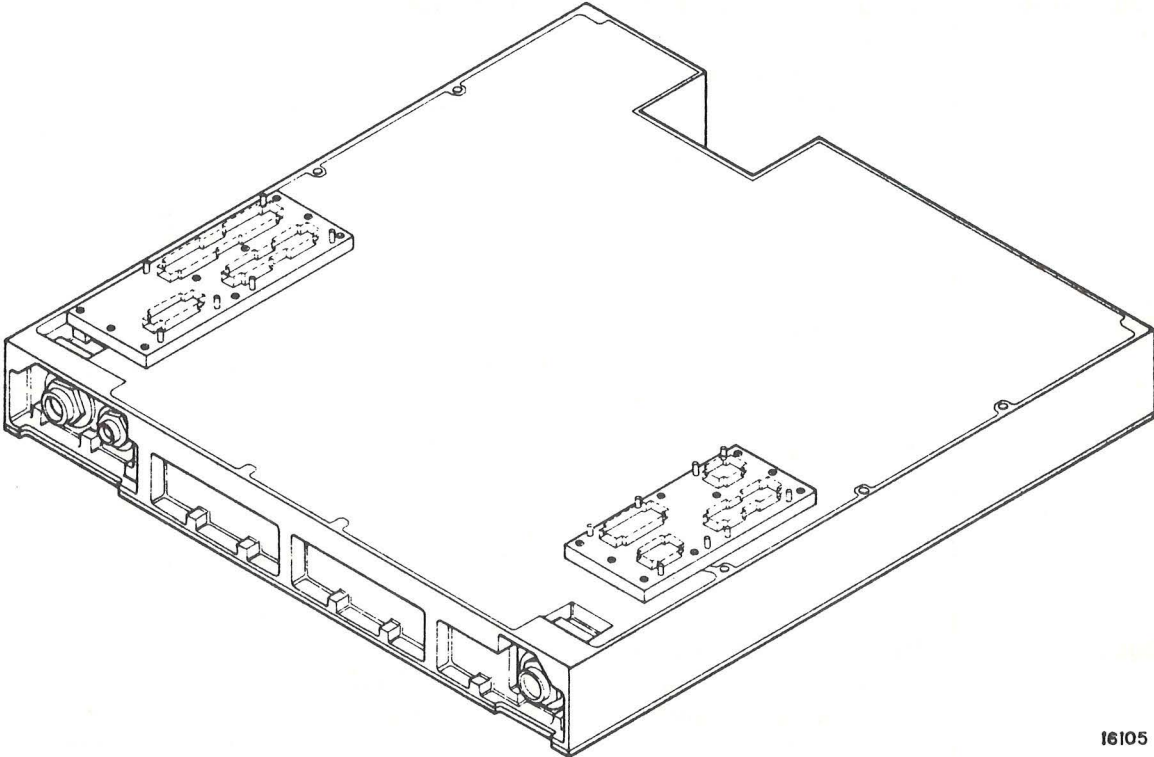

Figure 3-14A. PGNCs Interconnect Harness Group



16105

Figure 3-15. Power and Servo Assembly

Table 3-VII. Location and Functions of PSA Modules

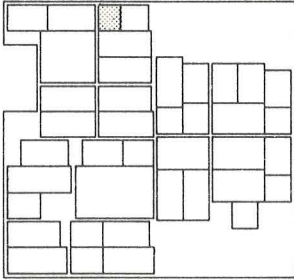
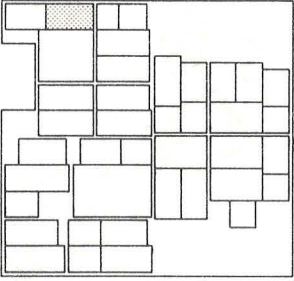
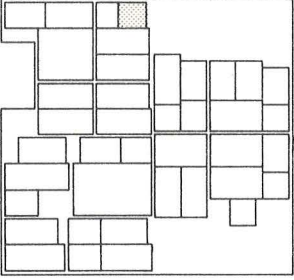
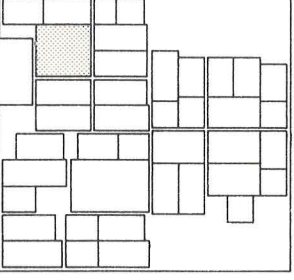
Module Part Number	Module Assembly Name and Function	Location
2007101-011	<p>DC differential amplifier and precision voltage reference Supplies precision reference voltage for IRIG pulse torquing current control.</p> <p>Schematic 2010029</p>	
2007102-011	<p>Gyro calibration Applies plus or minus torque pulses to IRIG's as directed by CMC.</p> <p>Schematic 2010020</p>	
2007103-011	<p>Binary current switch Switches current pulses to one of IRIG torque generators to control gimbal position.</p> <p>Schematic 2010017</p>	
2007106-011 (2007166-011 with ECP 248*)	<p>Pulse torque power supply Supplies +120 vdc to PIPA loops and to fine align electronics. Also supplies +28, +20, and -20 vdc to PIPA loops.</p> <p>Schematic 2010015 (2010087 with ECP 248*)</p>	

(Sheet 1 of 9)

*See table 3-IV for effectivity.

Table 3-VII. Location and Functions of PSA Modules

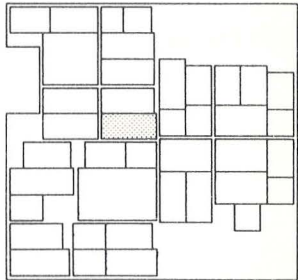
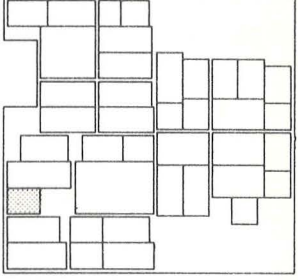
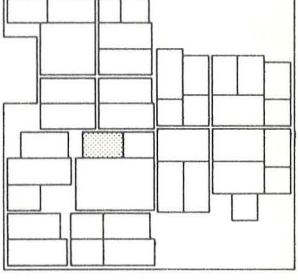
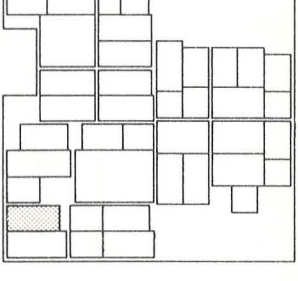
Module Part Number	Module Assembly Name and Function	Location
2007107-021	<p>-28 volts dc power supply Supplies power to three gimbal servo amplifiers in stabilization loop and to pulse torque power supply to generate -20 vdc for accelerometer loops.</p> <p>Schematic 6010682</p>	
2007108-011	<p>3,200 cps 1% amplifier Supplies 3,200 cps ducosyn excitation and magnetic suspension voltage. Also used as reference for gimbal servo amplifier demodulator in all modes of operation except coarse align mode.</p> <p>Schematic 2010006</p>	
2007109-011	<p>3,200 cps AAC, filter and multivibrator Regulates operation of 3,200 cps 1% amplifier.</p> <p>Schematic 2010081</p>	
2007110-011	<p>800 cps 1% amplifier Provides IMU resolver excitation and reference for 800 cps 5% amplifier.</p> <p>Schematic 2010008</p>	

(Sheet 2 of 9)

Table 3-VII. Location and Functions of PSA Modules

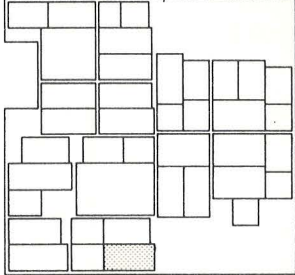
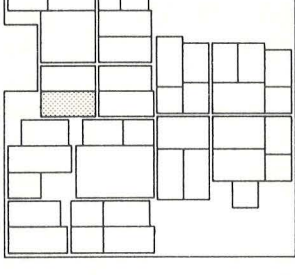
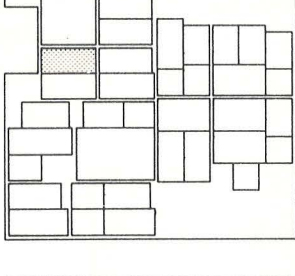
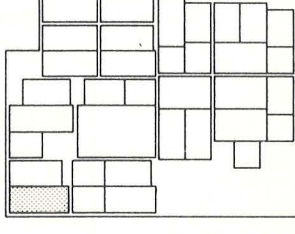
Module Part Number	Module Assembly Name and Function	Location
2007110-011	<p>800 cps 1% amplifier Provides resolver and tachometer excitation for OSS, and reference for 800 cps 5% amplifier.</p> <p>Schematic 2010008</p>	
2007111-021	<p>800 cps 5% amplifier Supplies 28 volts 800 cps for IMU blowers and PIP heaters and 28 volts 800 cps phase A IRIG wheel power.</p> <p>Schematic 2899010</p>	
2007111-021	<p>800 cps 5% amplifier Supplies 28 volts 800 cps for IMU blowers and PIP heaters and 28 volts 800 cps phase B IRIG wheel power.</p> <p>Schematic 2899010</p>	
2007111-021	<p>800 cps 5% amplifier Supplies excitation for trunnion and shaft motors in SXT and SCT.</p> <p>Schematic 2899010</p>	

(Sheet 3 of 9)

Table 3-VII. Location and Functions of PSA Modules

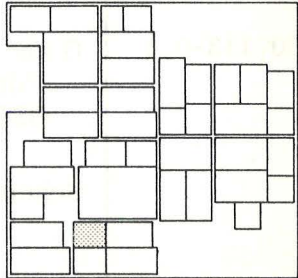
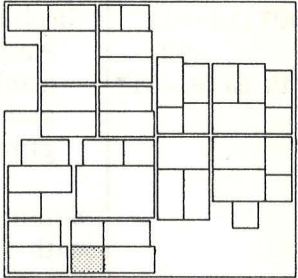
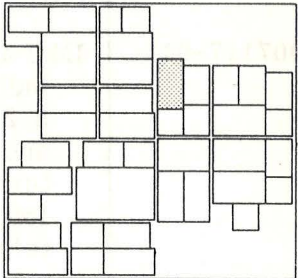
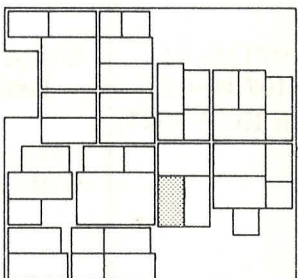
Module Part Number	Module Assembly Name and Function	Location
2007112-011	800 cps AAC, filter and multivibrator Supplies and regulates 800 cps voltage to IMU 1% power amplifier. Schematic 2010009	
2007112-011	800 cps AAC, filter and multivibrator Supplies and regulates 800 cps voltage to optics 1% power amplifier. Schematic 2010009	
2007113-011	G and N subsystem supply filter Filters 0 and 28 vdc power for ISS standby power. Schematic 2010078	
2007113-011	G and N subsystem supply filter Filters 0 and 28 vdc power for ISS operate power. Schematic 2010078	

(Sheet 4 of 9)

Table 3-VII. Location and Functions of PSA Modules

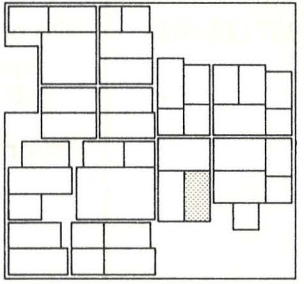
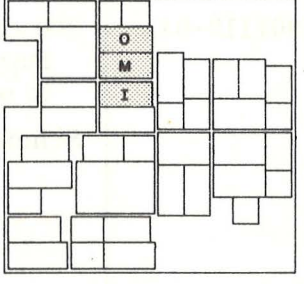
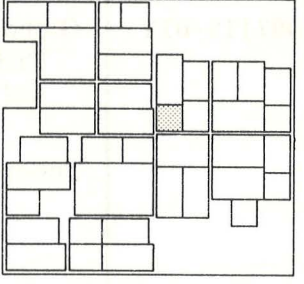
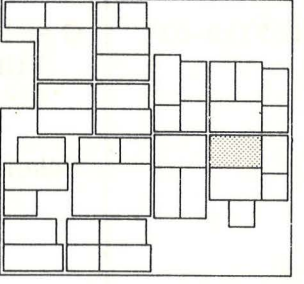
Module Part Number	Module Assembly Name and Function	Location
2007113-011	<p>G and N subsystem supply filter Filters 0 and 28 vdc power for OSS operate power.</p> <p>Schematic 2010078</p>	
2007114-011 -021 with ECP 461*	<p>Gimbal servo amplifier (three) Amplifies outer gimbal (O), middle gimbal (M), and inner gimbal (I) error and supplies correction signals to gimbal torque motors.</p> <p>Schematic 2010004 (2010791 with ECP 461*)</p>	
2007117-011	<p>IMU auxiliary Indicates out of tolerance conditions on 3,200 cps 28 v rms, 800 cps 28 v rms, and gimbal error signals provides IMU turn-on moding discrete; and indicates IMU temperature out of tolerance to telemetry.</p> <p>Schematic 2010082</p>	
2007118-011 (2010734-011 with ECP 352*)	<p>Motor drive amplifier Drives SXT trunnion motor.</p> <p>Schematic 2010021 (2010733 with ECP 352*)</p>	

*See table 3-IY for effectivity.

(Sheet 5 of 9)

Table 3-VII. Location and Functions of PSA Modules

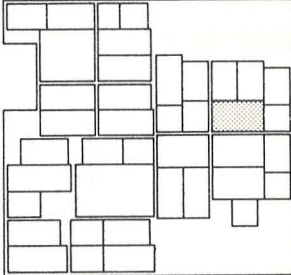
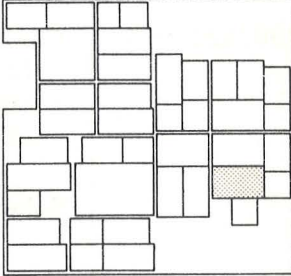
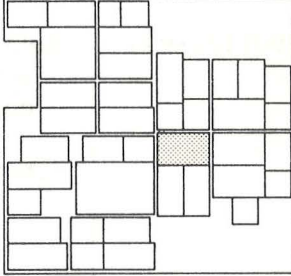
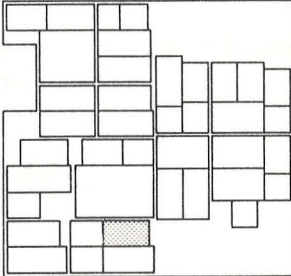
Module Part Number	Module Assembly Name and Function	Location
2007118-011 (2010734-011 with ECP 352*)	Motor drive amplifier Drives SXT shaft motor. Schematic 2010021 (2010733 with ECP 352*)	
2007118-011	Motor drive amplifier Drives SCT trunnion motor. Schematic 2010021	
2007118-011	Motor drive amplifier Drives SCT shaft motor. Schematic 2010021	
2007120-011	Optics load compensation Provides power factor correction for 800 cps 1% and 5% power supplies. Schematic 2010001	

*See table 3-IV for effectivity.

(Sheet 6 of 9)

Table 3-VII. Location and Functions of PSA Modules

Module Part Number	Module Assembly Name and Function	Location
2007121-011	<p>Two speed switch Provides signal selection for switching null seeking servo loops from coarse to fine resolver error detection.</p> <p>Schematic 2010023</p>	
2007122-011	<p>Cosecant generator Maintains image trace of optics at constant rate regardless of trunnion angle in resolved mode.</p> <p>Schematic 2010068</p>	
2007123-011	<p>Relay (three) Provides relay switching for optics control.</p> <p>Schematic 2010025</p>	
2007123-011	<p>Relay Provides relay switching for IMU control.</p> <p>Schematic 2010025</p>	

Table 3-VII. Location and Functions of PSA Modules

Module Part Number	Module Assembly Name and Function	Location
2007124-011 (removed by ECP 590*)	<p>Anti-creep electronics Removes B+ from motor drive amplifiers when optics hand controller output drops below certain limits and thus prevents optics from drifting.</p> <p>Schematic 2010014</p>	
2007126-011	<p>Optics automatic operate relay Provides signals to STAR PRESENCE and STAR ACQ lamps and contains relays for computer control of optics.</p> <p>Schematic 2010026</p>	
2007128-011	<p>SCT moding Provides fixed input to SCT 1X resolver corresponding to 25° offset in SCT and provides optics moding capability.</p> <p>Schematic 2010027</p>	
2007132-011	<p>IMU load compensation Provides power factor correction for 800 cps 1% and 5% power supplies.</p> <p>Schematic 2010076</p>	

*See table 3-IY for effectivity.

(Sheet 8 of 9)

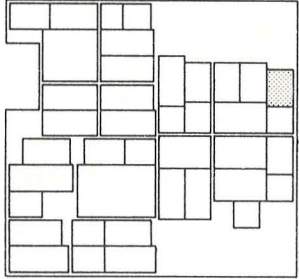
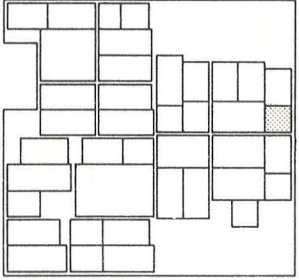
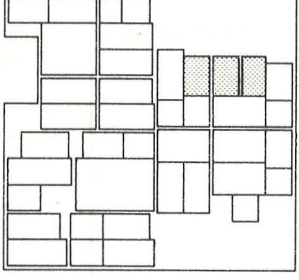
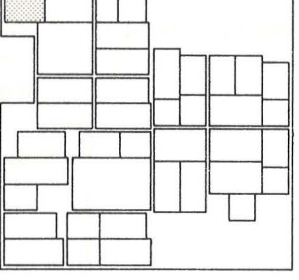
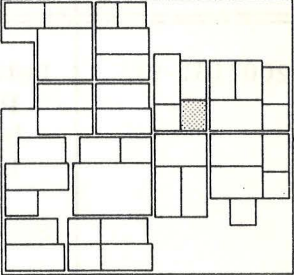
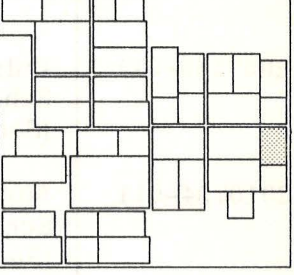
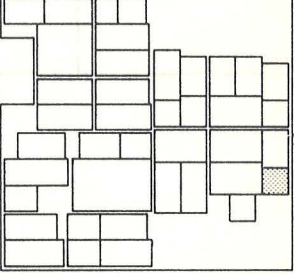
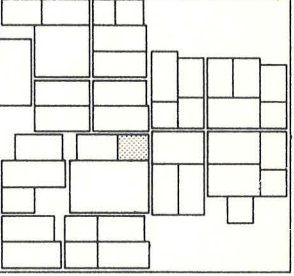
Table 3-VII. Location and Functions of PSA Modules

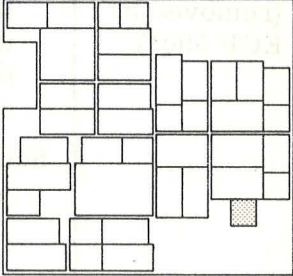
Module Part Number	Module Assembly Name and Function	Location
2007161-011	Reticle light dimmer Provides circuitry for controlling brightness of SXT and SCT reticle lamps. Schematic 2010074	
2007166-011	Pulse torque power supply Schematic 2010087 (See part number 2007106-011.)	
2010734-011	Motor drive amplifier Schematic 2010733 (See part number 2007118-011.)	

(Sheet 9 of 9)

BLOCK II PRIMARY GUIDANCE, NAVIGATION, AND CONTROL SYSTEM

Table 3-VIII. PSA Test Points for Jack 45J1

Pin Number	Signal Description	Pin Number	Signal Description
1	MG coarse error (high)	17	MG TM current (high)
2	CMC temperature monitor (low)	18	IG servo amplifier test input
3	IG coarse error (high)	19	Y PIPA error monitor (high)
4	OG coarse error (high)	20	X PIPA error monitor (high)
5	MG fine error (high)	21	CNTRL 2 ACE
6	MG servo amplifier test input	22	CMC +14.5 vdc
7	OG servo amplifier test input	23	OG AC D/A error to FDAI (high)
8	CMC temperature monitor (high)	24	IG AC D/A error to FDAI (low)
9	CMC + 4 vdc	26	CDU +4 vdc supply
10	MG AC D/A error to FDAI (low)	27	CDU common
11	MG AC D/A error to FDAI (high)	31	+20 vdc
12	Shaft fine error (high)	32	PIPA Calibration Module Temperature (high)
13	Trunnion fine error (high)	33	-28 vdc
14	IG fine error (high)	34	OG TM current
15	OG fine error (high)	35	IG TM current
16	IMU 0 vdc	37	Y PIPA error monitor (low)
		38	X PIPA error monitor (high)
		39	Inhibit computer power fail

(Sheet 1 of 2)

Table 3-VIII. PSA Test Points for Jack 45J1

Pin Number	Signal Description	Pin Number	Signal Description
40	CNTRL 1 ACE	53	20 vdc return
41	+28 vdc computer	54	PIPA calibration module temperature (low)
42	CMC 0 vdc	55	PSA temperature monitor (low)
43	OG AC D/A error to FDAI (low)	56	PSA temperature monitor (high)
44	IG AC D/A error to FDAI (high)	60	Z PIPA error monitor (high)
47	+120 vdc PIPA (Buff)	61	Z PIPA error monitor (low)
48	+120 vdc PIPA (Ret)		
52	-20 vdc		

(Sheet 2 of 2)

Table 3-IX. PSA Test Points for Jack 45J3

Pin Number	Signal Description	Pin Number	Signal Description
4	SCT trunnion MDA output monitor phase 1 (high)	13	IRIG current monitor (low)
5	+28 vdc IMU standby	15	+28 vdc IMU operate
6	+28 vdc optics	16	0 vdc optics
7	800 cps common	17	800 cps 28 V 5% phase A (high)
8	IRIG temperature (high)	18	IMU 28 V, 2.5% 800 cps phase B (high)
9	IRIG temperature (low)		

(Sheet 1 of 2)

BLOCK II PRIMARY GUIDANCE, NAVIGATION, AND CONTROL SYSTEM

Table 3-IX. PSA Test Points for Jack 45J3

Pin Number	Signal Description	Pin Number	Signal Description
19	Control heater duty cycle	46	SCT trunnion tach feedback (low)
27	IRIG current monitor (high)	47	SCT trunnion tach feedback (high)
29	SCT shaft MDA input (high)	48	IRIG PVR (low)
30	SXT shaft MDA input	49	IRIG PVR (high)
31	SXT shaft MDA output monitor phase 1 (high)	50	SCT trunnion MDA input (high)
32	OG servo amplifier input	51	SXT trunnion MDA input
33	IG servo amplifier input	52	SXT trunnion MDA output monitor phase 1 (high)
34	800 cps 28 V 1% optics monitor (low)	53	SCT shaft MDA output monitor phase 1 (high)
35	Optics 28 V, 5%, 800 cps monitor (high)	54	MG servo amplifier input (high)
36	Blower operation	55	0 vdc IMU operate
38	SXT trunnion tach feedback (low)	56	3200 cps 28 V 1% suspension power (high)
39	SXT shaft tach feedback (high)	57	3200 cps 28 V 1% suspension power (low)
40	SXT shaft tach feedback (low)	58	800 cps 28 V 1% optics monitor (high)
44	SCT shaft tach feedback (high)	59	IMU 800 cps 28 V 1% monitor (high)
45	SCT shaft tack feedback (low)	60	IMU 800 cps 1% (low)
		61	SXT trunnion tach feedback (high)

(Sheet 2 of 2)

3-12 SIGNAL CONDITIONER ASSEMBLY

The signal conditioner assembly (SCA) contains encapsulated electronic circuitry to condition PGNCS signals so that they are acceptable to the spacecraft telemetry system. Two SCA's are supplied to the field: operational (figure 3-16) and flight qualification (figure 3-17). The operational SCA contains four modules mounted on a common frame, and the flight qualification SCA contains six modules on a common frame. Tables 3-X and 3-XI give the location and function of the SCA modules. The operational or flight qualification SCA is located to the right of the eyepiece storage unit and the OUA.

The operational SCA has three connectors (J1 through J3): one 85 pin connector (J1) used to connect the SCA to the PSA through PGNCS interconnect harness G; one 61 pin connector (J2) used to connect the SCA to the PSA through harness G; and one 85 pin connector (J3) used to connect the SCA outputs to the spacecraft telemetry system.

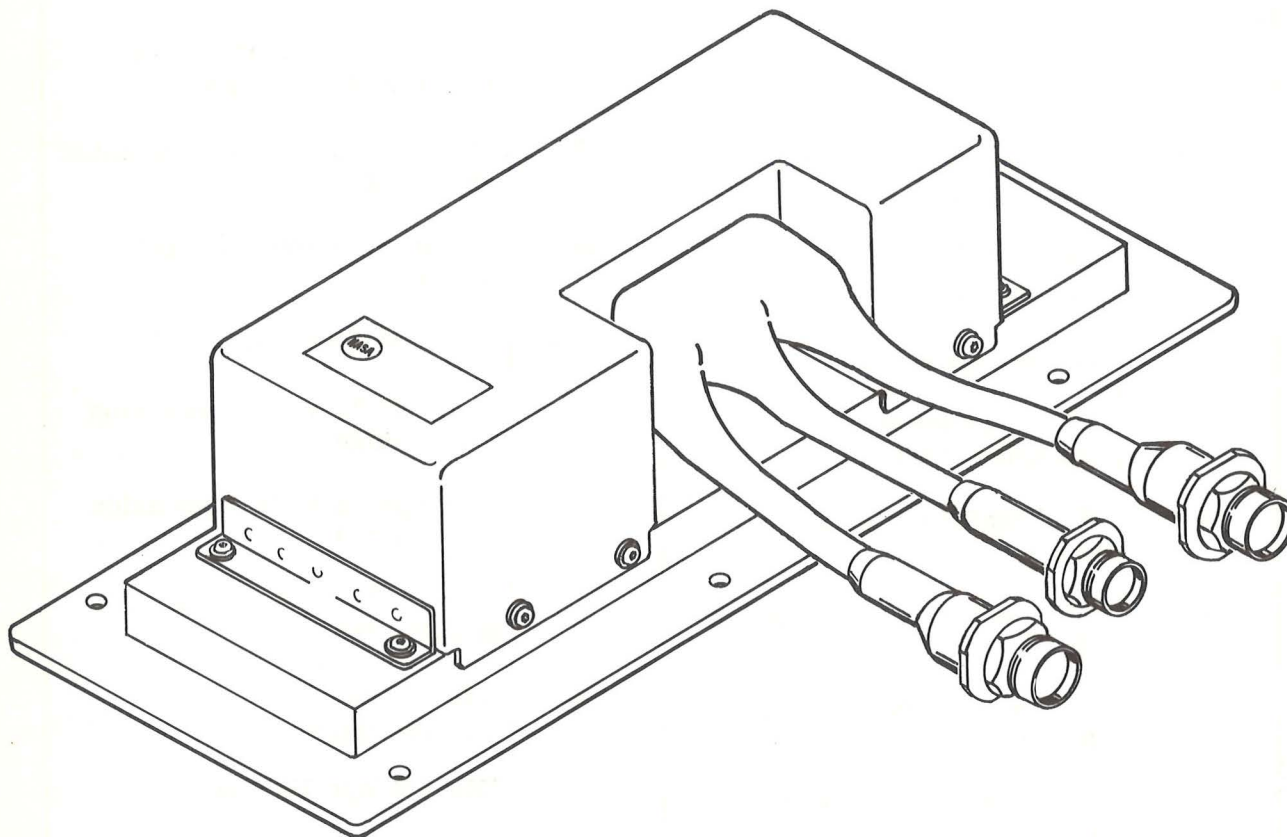

18908

Figure 3-16. Operational Signal Conditioner Assembly

The flight qualification SCA has four connectors: J1 through J3, and J10. Connectors J1 through J3 are identical to the operational SCA connectors. Connector J10 is a 19 pin connector used to connect the SCA to nav base vibration sensors, which are installed only in system 204.

The operational SCA is approximately 3 inches high, 5.7 inches wide, and 14.3 inches deep. The flight qualification SCA is approximately 3 inches high, 5.7 inches wide, and 15.4 inches deep.

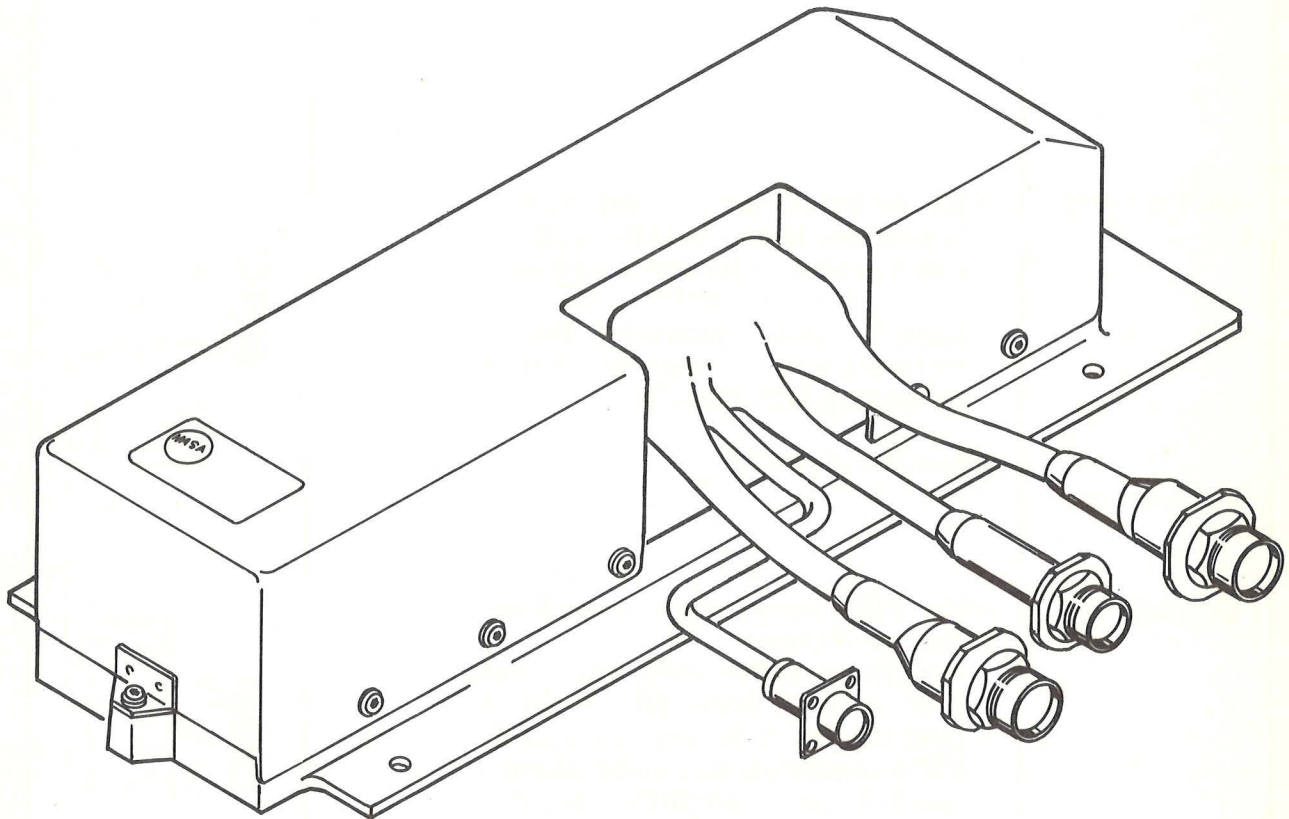

18907

Figure 3-17. Flight Qualification Signal Conditioner Assembly

Table 3-X. Location and Functions of Operational SCA Modules

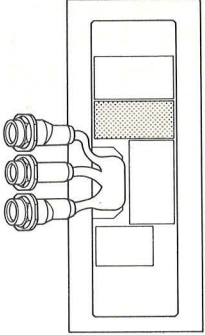
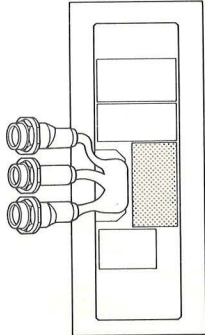
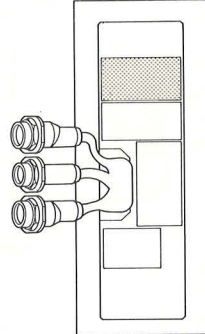
Module Part Number	Module Assembly Name and Function	Location
2007230-011	<p>Gimbal resolver signal conditioner Conditions inner, middle and outer gimbal resolver sine and cosine signals.</p> <p>Schematic 2010120</p>	
2007231-011	<p>IRIG and PIPA signal conditioner Conditions inner, middle, and outer gimbal IRIG error signals, and X, Y, and Z PIPA error signals. Also generates 3,200 cps square wave reference required to operate SCA circuits.</p> <p>Schematic 2010122</p>	
2007233-011	<p>DAC, PIPA temp, and 2.5 vdc bias signal conditioner Conditions optics shaft and trunnion DAC outputs, pitch attitude error DAC output, CGC warning signal, PIPA temperature sensor signal, and 800 cps 1% amplifier output. Also supplies 2.5 volt dc bias required to operate SCA circuits.</p> <p>Schematic 2010124</p>	

(Sheet 1 of 2)

Table 3-X. Location and Functions of Operational SCA Modules

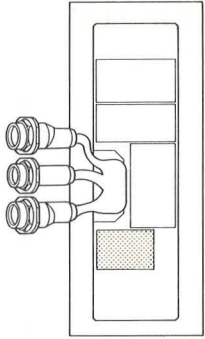
Module Part Number	Module Assembly Name and Function	Location
2007244-011	120 v PIPA supply signal conditioner Conditions 120 volt output of pulse torque power supply. Also supplies 800 cps square wave reference required to operate SCA demodulators. Schematic 2010128	

(Sheet 2 of 2)

Table 3-XI. Location and Functions of Flight Qualification SCA Modules

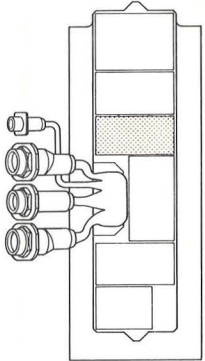
Module Part Number	Module Assembly Name and Function	Location
2007230-011	Gimbal resolver signal conditioner Conditions inner, middle, and outer gimbal resolver sine and cosine signals. Schematic 2010120	

(Sheet 1 of 3)

Table 3-XI. Location and Functions of Flight Qualification SCA Modules

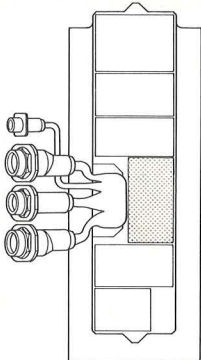
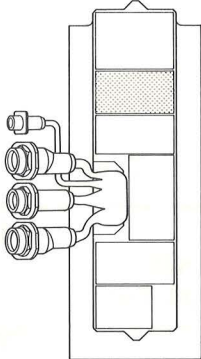
Module Part Number	Module Assembly Name and Function	Location
2007231-011	<p>IRIG and PIPA signal conditioner Conditions inner, middle, and outer gimbal IRIG error signals, and X, Y, and Z PIPA error signals. Also generates 3,200 cps square wave reference required to operate SCA circuits.</p> <p>Schematic 2010122</p>	
2007233-011	<p>DAC, PIPA temp, and 2.5 vdc bias signal conditioner Conditions optics shaft and trunnion DAC outputs, pitch attitude error DAC output, CGC warning signal, PIPA temperature sensor signal, and 800 cps 1% amplifier output. Also supplies 2.5 volt dc bias required to operate SCA circuits.</p> <p>Schematic 2010124</p>	

(Sheet 2 of 3)

BLOCK II PRIMARY GUIDANCE, NAVIGATION, AND CONTROL SYSTEM

Table 3-XI. Location and Functions of Flight Qualification SCA Modules

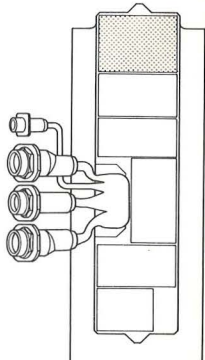
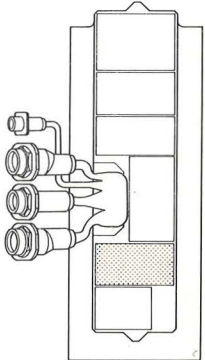
Module Part Number	Module Assembly Name and Function	Location
2007239-011	<p>Torque motor and 1X sine gimbal resolver signal conditioner Conditions inner, middle, and outer gimbal resolver and torque motor signals, IMU heater and blower current signals, and optics shaft and trunnion fine error signals. Also supplies 2.5 volt dc bias required to operate SCA circuits.</p> <p>Schematic 2010125</p>	
2007240-011	<p>Optics and attitude error signal conditioner Conditions SCT and SXT shaft and trunnion DAC outputs, roll and yaw attitude error DAC outputs, and optics 800 cps 1% amplifier output. Also supplies 2.5 volt dc bias required to operate SCA circuits.</p> <p>Schematic 2010123</p>	
2007241-011	<p>120 v PIPA supply and IRIG temp signal conditioner Conditions 120 volt output of pulse torque power supply and IRIG temperature sensor signal. Also supplies 800 cps square wave reference required to operate SCA demodulators.</p> <p>Schematic 2010126</p>	