



XIII.1

R-ASTR-S-85-66
June 14, 1966



HUNTSVILLE, ALABAMA

SATURN HISTORY DOCUMENT
University of Alabama Research Institute
History of Science & Technology Group
Date ----- Doc. No. -----

AS-203

TECHNICAL INFORMATION

SUMMARY

Prepared by:

- R-AERO-P
- R-ASTR-S
- R-P&VE-VA

National Aeronautics and Space Administration



TECHNICAL INFORMATION

SUMMARY

This report outlines, through a series of sketches with accompanying text, the general features of the SA-203 Launch Vehicle and information on launch preparation, the launch facility and mission peculiar experiments.

1. Mission Purpose:

The basic purpose of the Apollo-Saturn 203 Mission is to insert a modified S-IVB/IU/Nose Cone into a 100 n.m. circular orbit with maximum liquid hydrogen on board to evaluate the hydrogen vent and engine restart systems in an orbital environment.

2. Primary Mission Objectives:

- a. Evaluate the S-IVB LH₂ continuous venting system.
- b. Evaluate J-2 engine LH₂ chilldown and recirculation system, and ullage requirements for simulated engine restart.
- c. Determine cryogenic liquid/vapor interface configuration and fluid dynamics in near zero - g environment.
- d. Determine the heat transfer into liquid through a tank wall and obtain data required for a propellant thermodynamic model.
- e. Evaluate S-IVB/IU checkout in earth orbit.
- f. Demonstrate the mission support facilities required for launch and mission orbital operations.
- g. Demonstrate orbital operation of the launch vehicle attitude control and thermal control systems.
- h. Demonstrate the launch vehicle guidance system operation.
- i. Demonstrate the structural integrity of the launch vehicle and confirm the structural loads and dynamic characteristics.

3. Secondary Mission Objectives:

- a. Evaluate launch vehicle powered flight external environment.
- b. Evaluate launch vehicle sequencing system operation.
- c. Evaluate performance of the Emergency Detection System (EDS) in open-loop configuration.

- d. Evaluate separation of the S-IVB/IU/Nose Cone from the S-IB.
 - e. Evaluate the launch vehicle propulsion system's operation.
 - f. Evaluate the MSC subcritical cryogenic experiment.
4. Principal Differences Between AS-203 and AS-201:
- a. S-IB Stage:
 - (1) Weight reduced by redesign of: propellant container, barrel assembly, outriggers, and by removal of outboard engine skirts.
 - (2) GOX interconnect and vent system redesigned.
 - b. S-IVB Stage:
 - (1) Heavier forward and aft skirts due to revised loading conditions.
 - (2) Forward skirt modified to include nozzles and fairings for the LH₂ tank continuous venting system.
 - (3) Special LH₂ tank manhole cover supporting two T.V. cameras and lights for viewing LH₂ behavior.
 - (4) Hydrogen tank vent system modified to simulate Saturn V/S-IVB configuration.
 - (5) Additional baffle ring in the LOX tank due to off loading of LOX.
 - (6) LH₂ experiment instrumentation in the LH₂ tank consisting of an additional probe for temperature, pressure and liquid vapor sensors.
 - (7) LH₂ tank baffle to prevent propellant sloshing following S-IVB cutoff and during LH₂ experiment.
 - (8) Additional LOX tank vent system to simulate Saturn V/S-IVB APS ullage engine thrust.
 - (9) Ambient helium sphere added for partial LH₂ tank repressurization for simulated restart.
 - c. Instrument Unit
 - (1) Control accelerometers relocated from skin to coldplates.
 - (2) Television antennas, control units, exciters and related equipment added.

d. Nose Cone:

(1) Apollo spacecraft replaced by a double angle aerodynamic enclosure bolted to IU (not separated), and housing the MSC subcritical cryogenic (LN₂) experiment.

5. Mission Profile:

(a) Launch Phase:

The AS-203 vehicle will be launched from Launch Complex 37B at Cape Kennedy on a 90° E of N launch azimuth and rolled to a 72° flight azimuth. Staging occurs .8 seconds after S-IB outboard engine cutoff. The S-IVB stage is ignited approximately 2 seconds after S-IB outboard engine cutoff at 143 seconds. Approximately 12 seconds after S-IVB ignition, active adaptive guidance is initiated, and the vehicle is guided into a 100 nautical mile circular orbit by the Iterative Guidance Mode (IGM). Due to the short burn time of the S-IVB Stage, the LH₂ tank will be about 50% full at S-IVB cutoff (436 sec).

(b) Orbital Phase:

The orbital phase for this mission is defined in two parts:

(1) The active vehicle orbital phase, which occurs from S-IVB cutoff through the LH₂ experiment and orbital checkout tests (approximately 6 hours after lift-off). During this phase, the simulated engine restart capability will be evaluated, behavior of liquid hydrogen will be observed, and the S-IVB/IU systems' state of readiness and ability to perform within design tolerances while in an orbital environment will be evaluated.

(2) The inactive vehicle orbital phase which covers the remaining vehicle orbital lifetime from the cessation of all orbital tests to the time of reentry.

(c) Recovery Phase:

Two camera capsules ejected from the S-IB stage will be recovered. No recovery of the orbited hardware is anticipated.

DISTRIBUTION

DIR	Dr. von Braun
DIR-T	Dr. Rees
	Mr. Neubert
I-DIR	Gen. O'Connor
	Dr. Mrazek
	Dr. Farish (50)
I-IB-MGR	Mr. James
	Col. Teir
I-IB-B	Mr. Vreuls (2)
I-IB-G	Mr. Dunlap (3)
I-IB-T	Mr. Fikes (3)
I-IB-S-IB	Mr. Thompson (3)
I-IB-U	Mr. Simmons (3)
I-K	Mr. Montgomery (10)
I-E-A	Mrs. Watson (25)
I-MO-MGR	Dr. Speer (10)
I-MO-F	Mr. Casey (10)
I-MICH-D	Mr. Quinton (25)
R-DIR	Mr. Weidner (2)
R-OM	Mr. Fellows (5)
R-TO	Mr. Richard
R-RP-DIR	Dr. Stuhlinger
R-AERO-P	Mr. Teague (60)
R-P&VE	E (All Supervisors)
R-ASTR	E (All Supervisors)
R-COMP-RP	Mr. Cochran (6)
R-ME-DIR	Mr. Kuers (10)
R-QUAL-J	Mr. Klauss (10)
R-TEST-S	Mr. Driscoll (5)
PA	Mr. Jones
KSC	Mr. Williams (250)
MSFC/DAC through	
R-ASTR-BV/DAC	Mr. French (20)
DAC/H	Mr. Peterson (5)
IBM-H	Mr. Martin (20)
IBM-H	Mr. Robin (10)
CCSD/M	Mr. Juengling (5)

Additional copies of this report may be obtained from the following personnel:

R-AERO-P	R. Teague, 876-4443	Bldg 4200/408
R-ASTR-S	E. Noel, 876-1860	Bldg 4487/AA211
R-P&VE-VA	O. E. Moon, 876-1277	Bldg 4610/1091

Intentionally Left Blank

LIST OF FIGURES

<u>Figure</u>	<u>Title</u>	<u>Page</u>
<u>GENERAL</u>		
1	AS-203 Space Vehicle	8
2	Launch Complex - 37	9
3	LC-37B Integrated Launch ESE Block Diagram	10
4	LC-37B Propellant and Pressurization Subsystems	11
5	LC-37 (Pad B) Configuration	12
6	Launch Countdown	13
<u>SPACE/LAUNCH VEHICLE</u>		
7	Secure Range Safety Command System	15
8	Emergency Detection System (EDS)	17
9	S-IB Stage Flight Sequencing	18
10	S-IVB Stage Flight Sequencing	19
11	Trajectory Information	20
12	Guidance and Control System Block Diagram	23
13	Guidance and Control System Information	24
14	Vehicle Control System Information	25
15	Vehicle Tracking and Television Systems	27
16	Example of Orbital Station Coverage	29
17	Space Vehicle Weight vs Flight Time	31
<u>S-IB STAGE</u>		
18	S-IB Stage Configuration	33
19	H-I Operational Sequence	34
20	H-I Engine System	35
21	S-IB Stage Propellant System	37
22	S-IB Stage Thrust Vector Control System	39

LIST OF FIGURES

<u>Figure</u>	<u>Title</u>	<u>Page</u>
	<u>S-IB STAGE (Continued)</u>	
23	S-IB Stage Measuring System	40
24	S-IB Stage Telemetry System	41
25	S-IB Stage Electrical Power and Distribution System . . .	42
	<u>S-IVB STAGE</u>	
26	S-IVB Stage Configuration	45
27	J-2 Engine System	47
28	S-IVB Stage Propellant System	49
29	S-IVB Stage Propellant Utilization System	50
30	S-IVB Stage Thrust Vector Control System	53
31	Auxiliary Propulsion System	55
32	S-IVB Stage Measuring System	56
33	S-IVB Stage Telemetry System	57
34	S-IVB Stage Electrical Power and Distribution System . . .	58
	<u>INSTRUMENT UNIT</u>	
35	Instrument Unit Configuration	61
36	Instrument Unit Measuring System	62
37	Instrument Unit Telemetry System	63
38	Instrument Unit Electrical Power and Distribution System .	64
39	IU/S-IVB Environmental Control System	67
	<u>NOSE CONE</u>	
40	Nose Cone Configuration	68

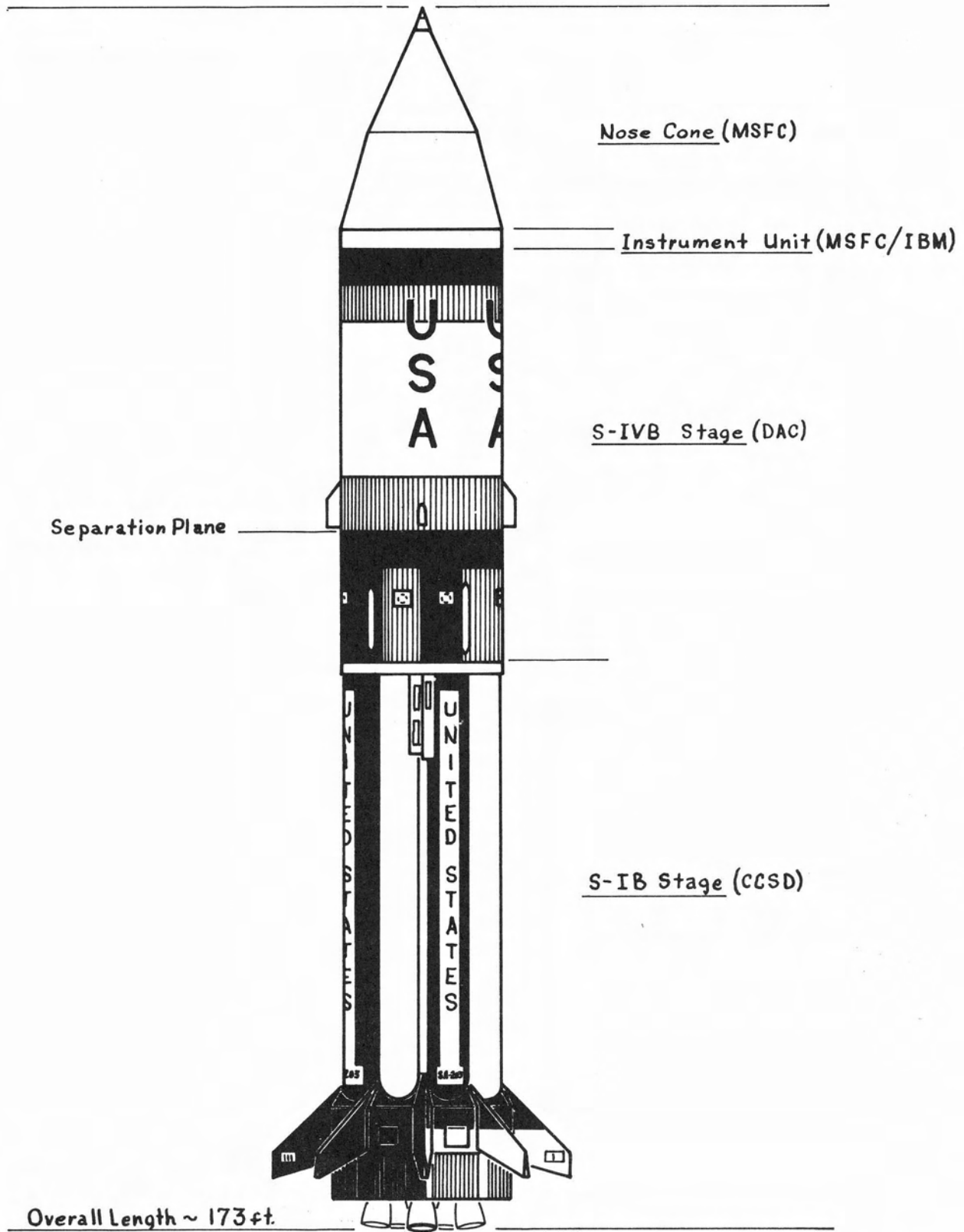

Figure 1

AS-203 Space Vehicle

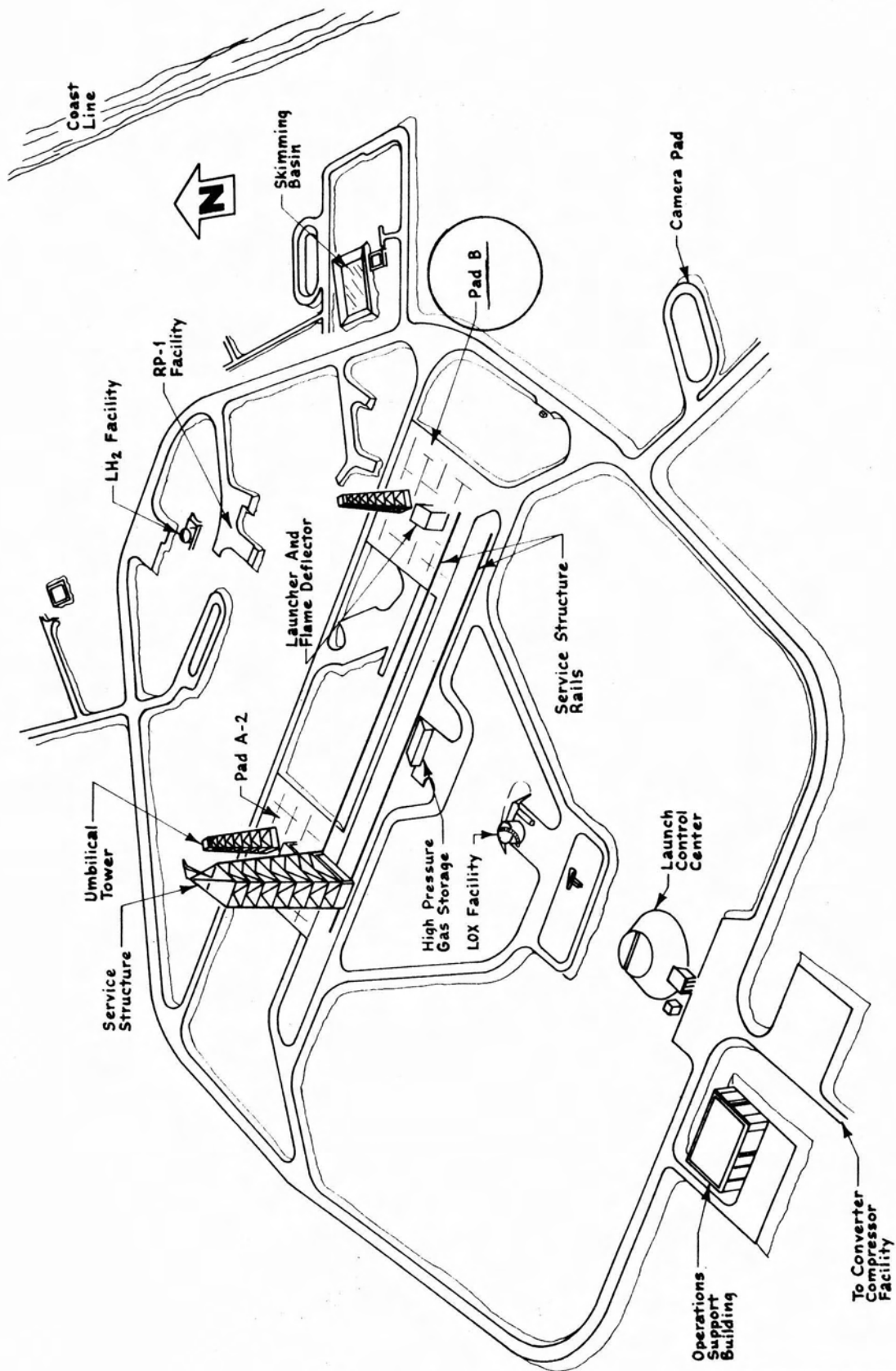

Figure 2

Launch Complex 37

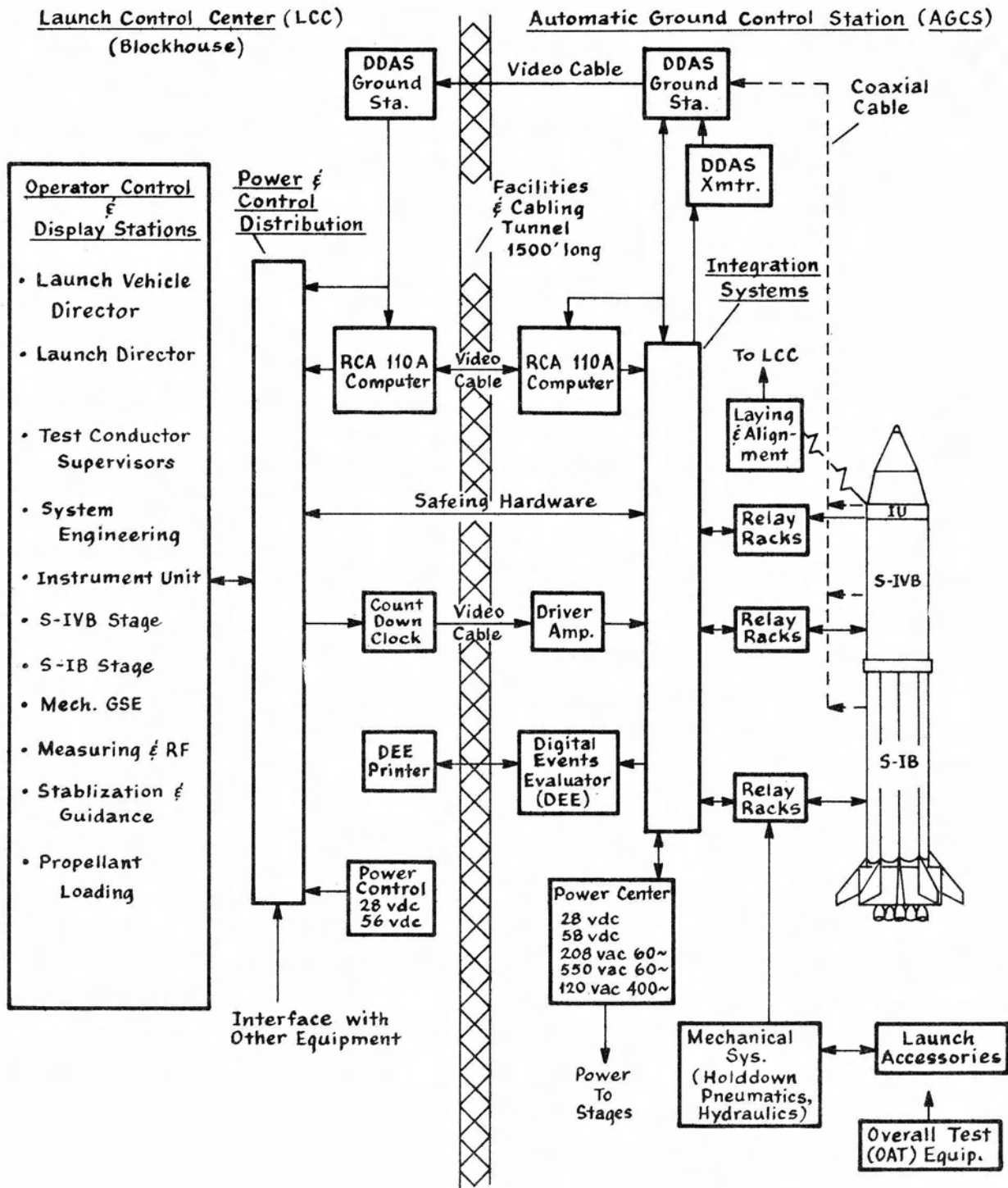
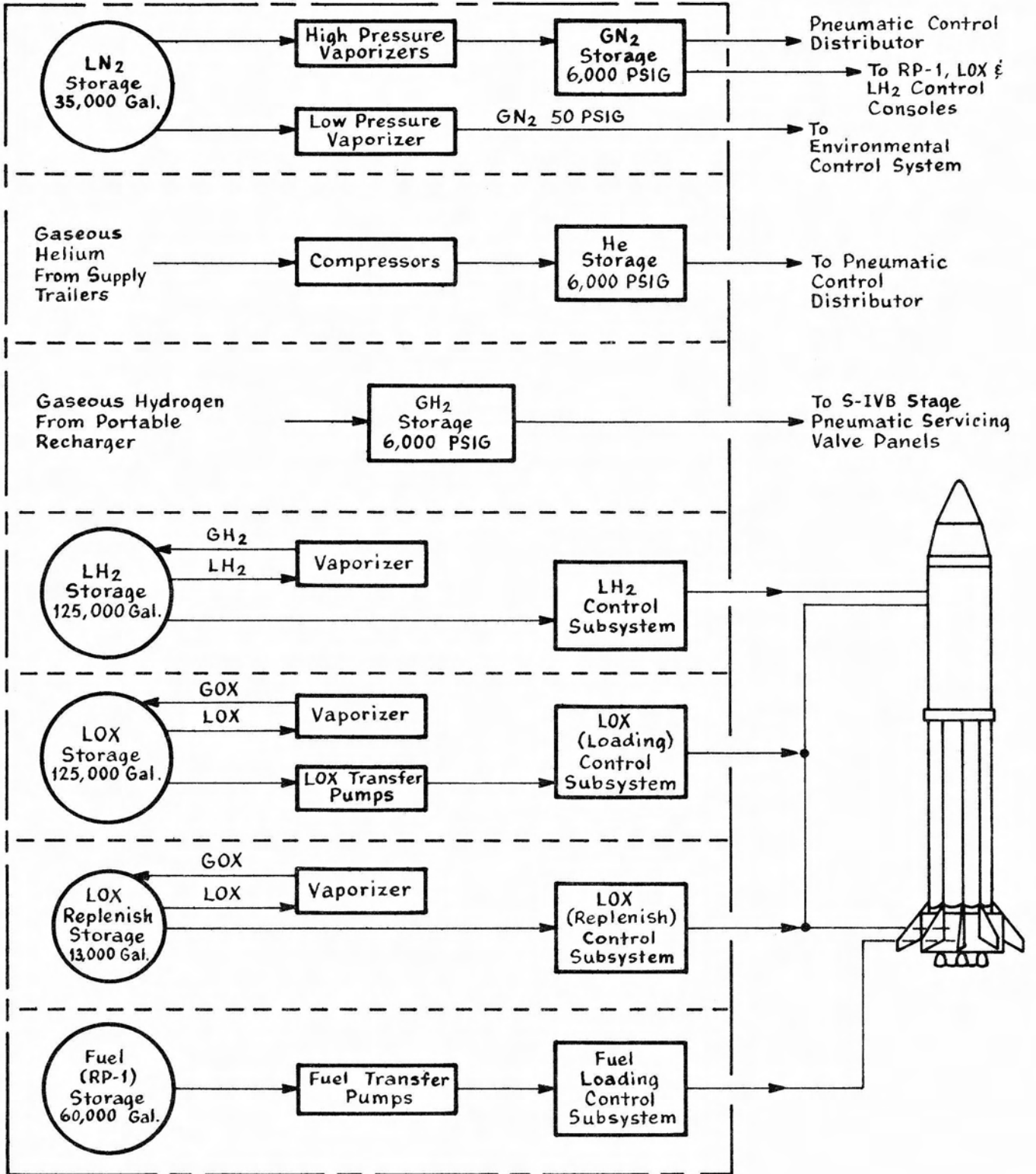

Figure 3

LC-37B Integrated Launch ESE Block Diagram

MSE FACILITY

PROPELLANT & PRESSURIZATION SUBSYSTEMS



MSE... Mechanical Support Equipment

Figure 4

LC-37B Propellant & Pressurization Subsystems

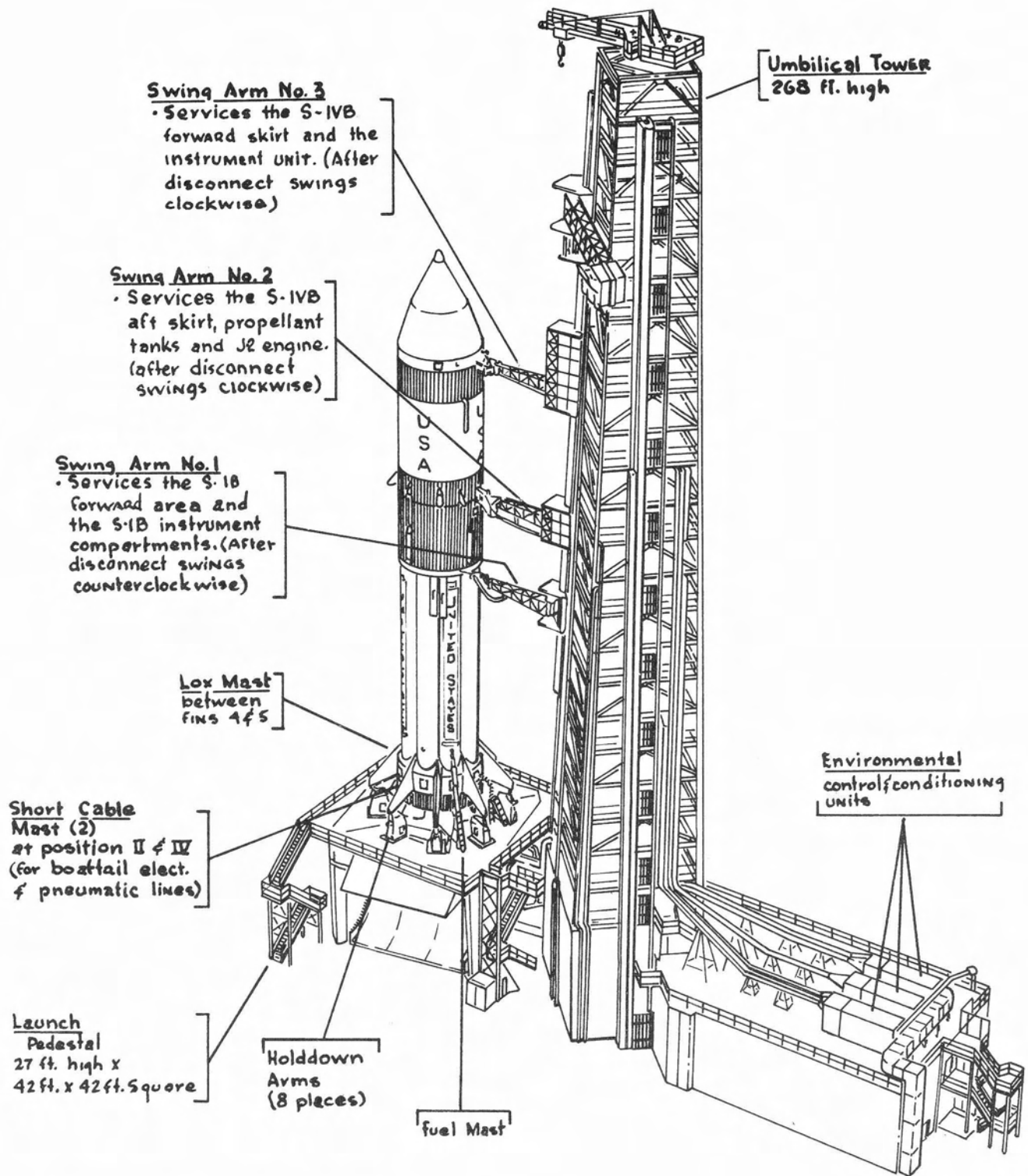

Note: Paint pattern intentionally omitted.

Figure 5

LC-37 (pad B) Configuration

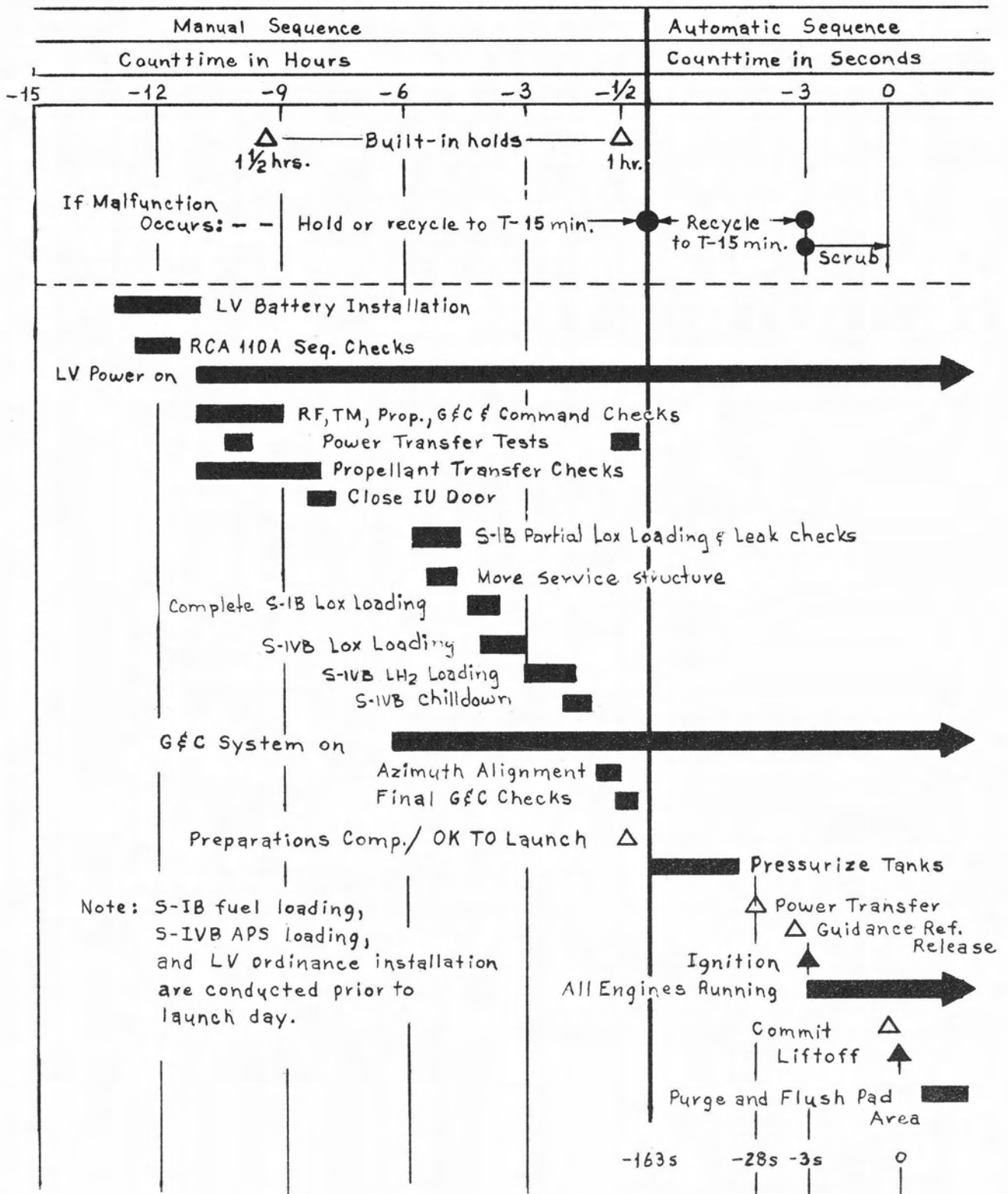

Figure 6

Launch Countdown

LAUNCH VEHICLE SECURE RANGE SAFETY COMMAND SYSTEMS

The secure range safety command systems on the S-IB and S-IVB stages provide a communications link to transmit commands from ground stations to the vehicle during powered flight, and a positive means of terminating the flight of an erratic vehicle by initiating emergency engine cutoff and, if necessary, propellant dispersion.

Each powered stage contains two UHF radio receivers. Both command receivers on each of the two stages respond to the same command signal, each providing a backup system for the other.

The safety and arming device located on each stage is armed by a signal from the blockhouse before vehicle ignition. Following orbital insertion the S-IVB range safety system is "safed" by a command from Range Safety Control to preclude accidental destruct.

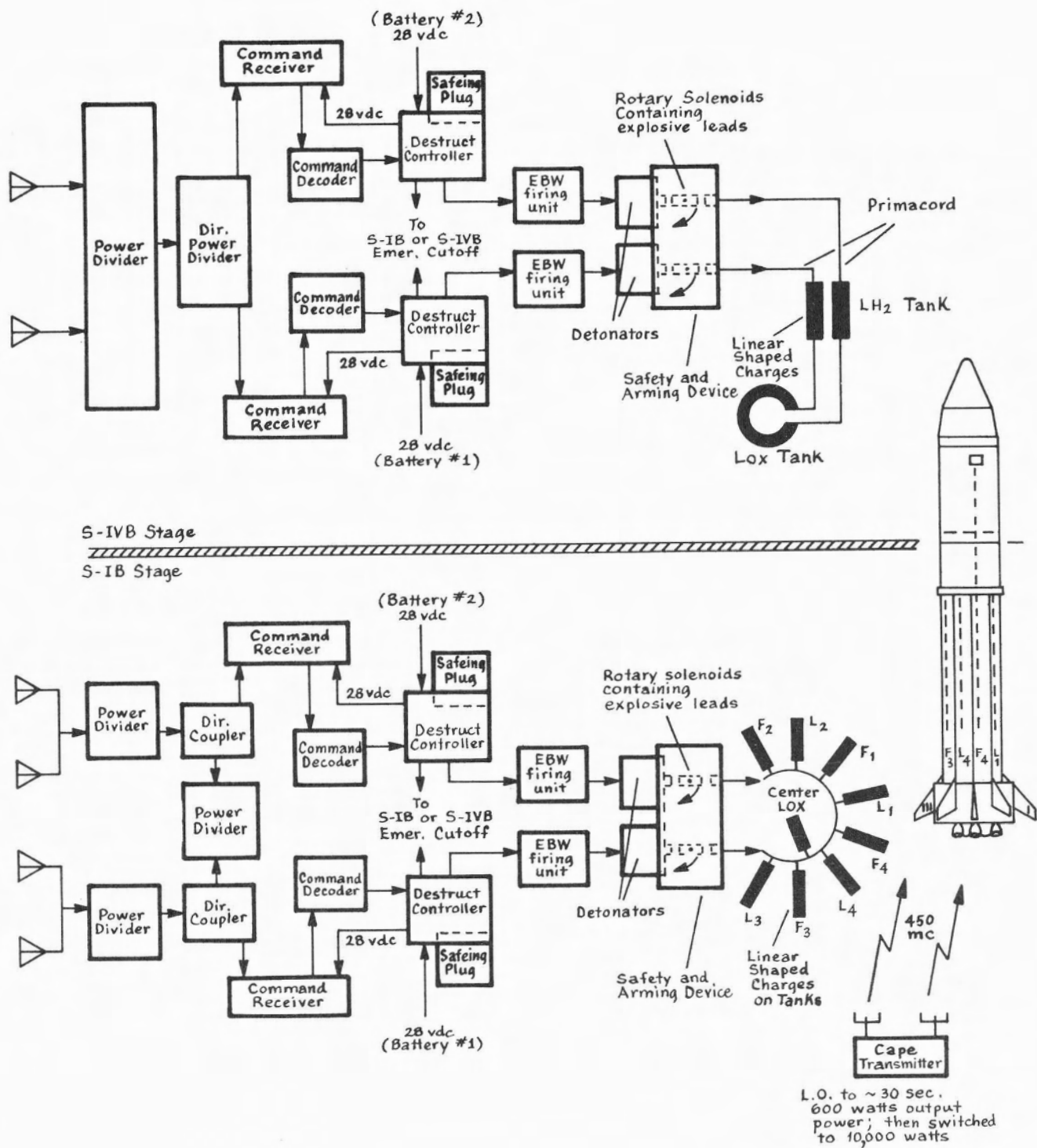

Figure 7

EMERGENCY DETECTION SYSTEM

Mission AS-203 does not carry an Apollo Spacecraft and therefore does not have a complete EDS. The EDS cannot initiate an auto abort. All EDS abort parameters are telemetered for monitoring by the Launch Director.

Launch Vehicle rate abort limits are:

Pitch and Yaw	5.0 ±0.6 deg/sec.
Roll	20.0 ±0.5 deg/sec.

An overrate condition must be indicated by two of the three gyros in any one axis to activate the abort bus. All EDS rates are filtered to eliminate low frequency noise due to vibration and acoustics.

Two of the three thrust OK switches on two H-1 engines must indicate loss of thrust before the abort bus is activated.

There is a redundant Q-Ball on the Nose Cone.

On AS-203 the EDS CANNOT activate an abort (flown in "open loop" configuration)

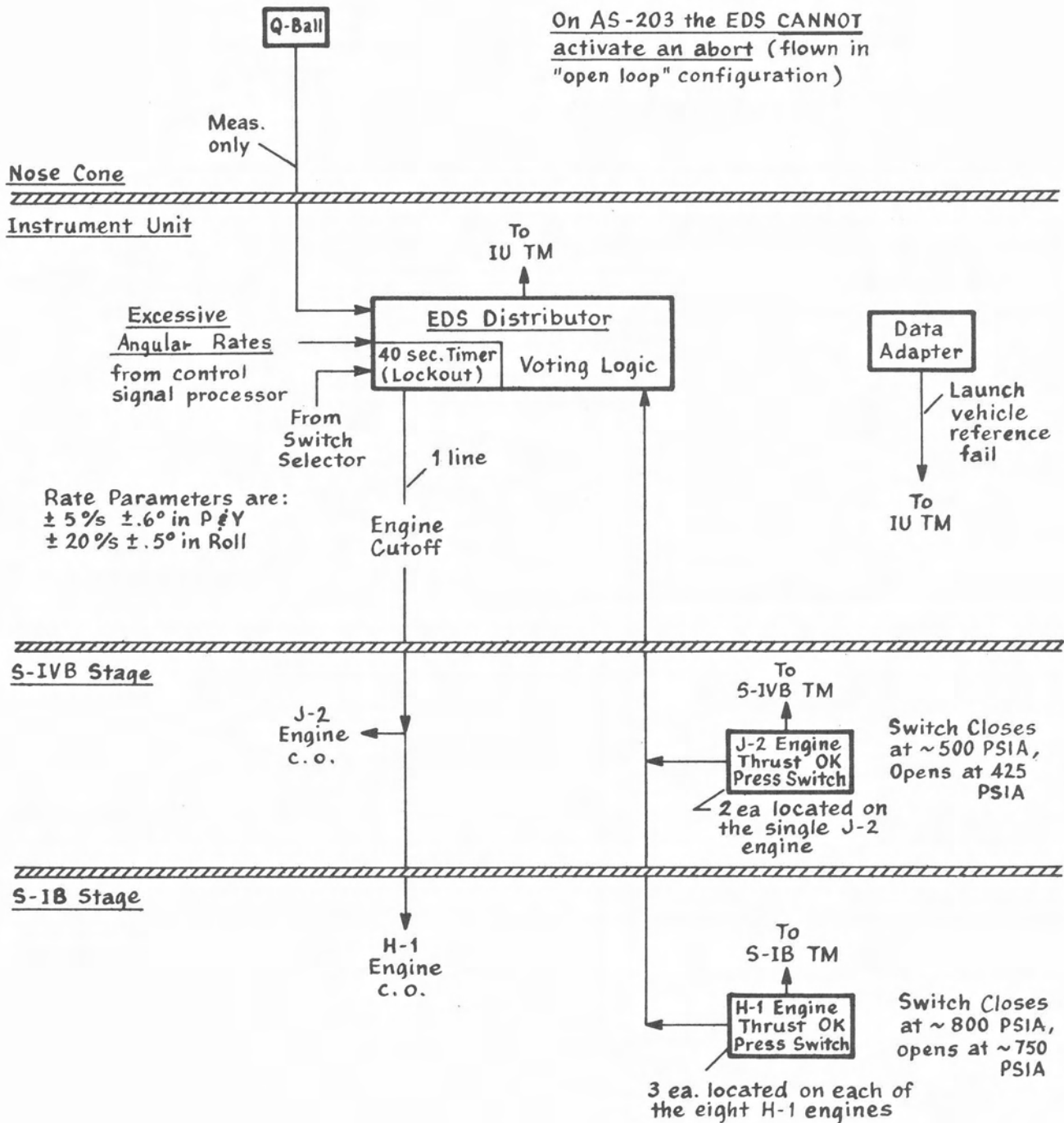

Figure 8

Emergency Detection System (EDS)

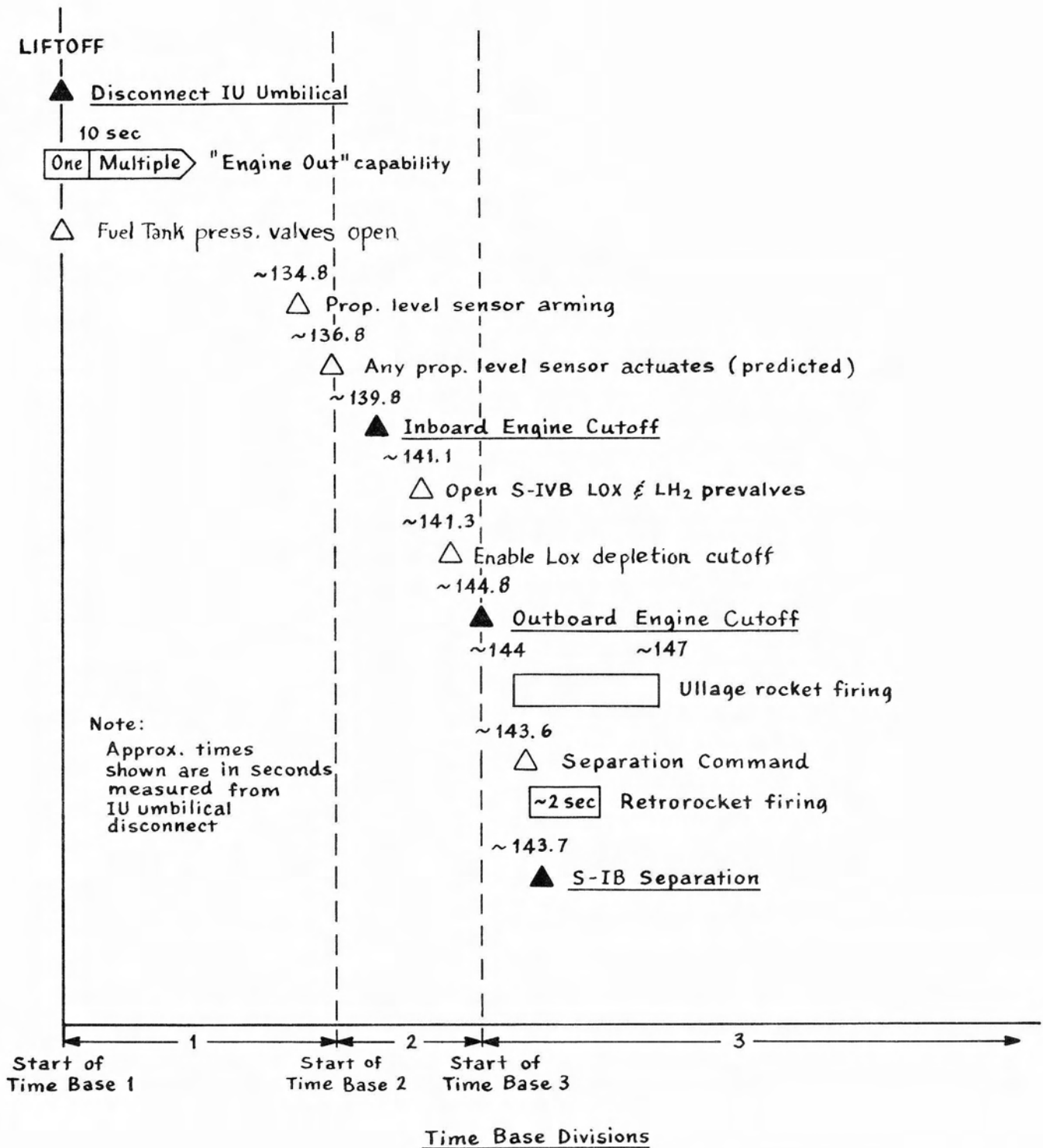
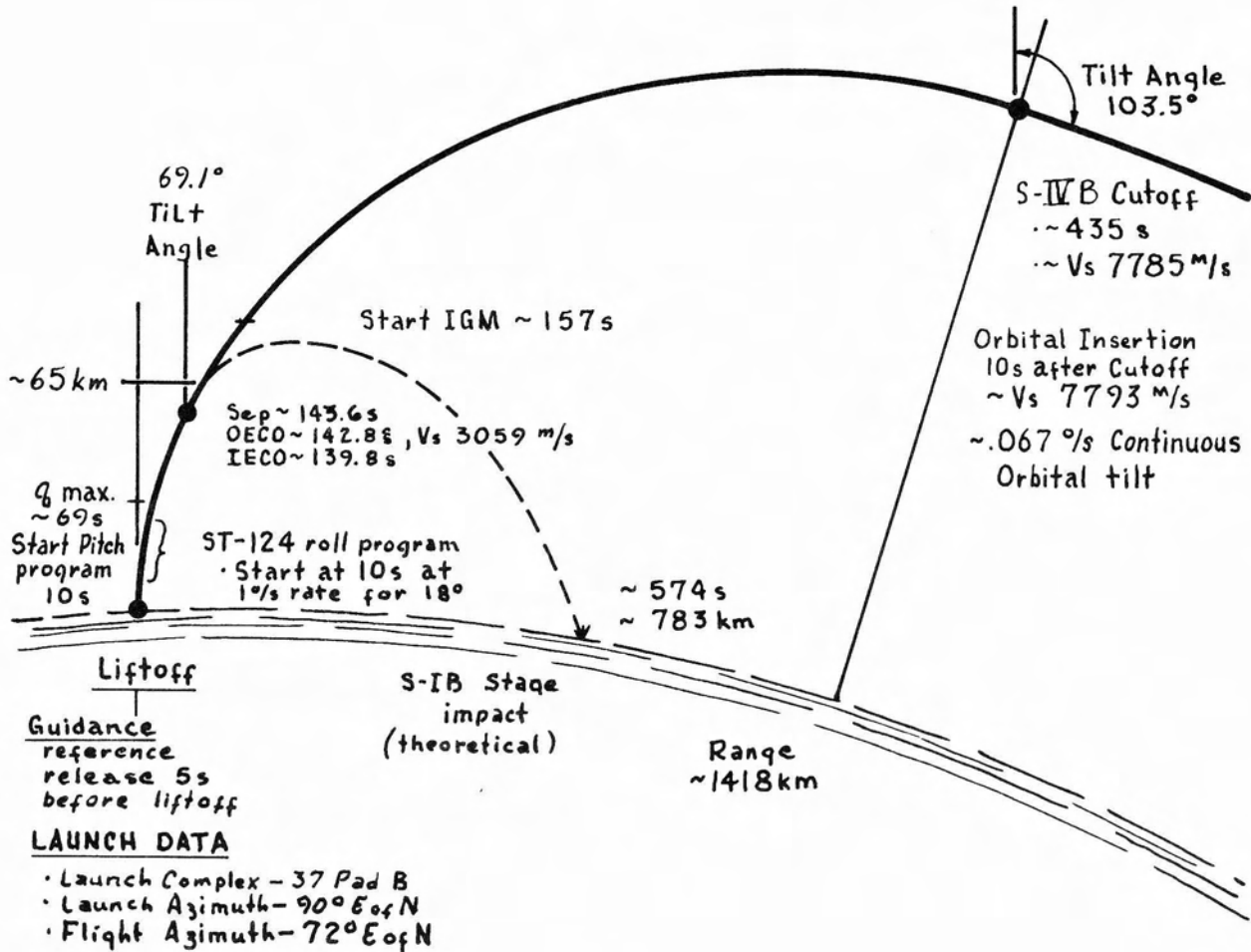

Figure 9

S-IB Stage
Flight Sequencing

IECO - Inboard Engine Cutoff
 OECO - Outboard Engine Cutoff
 IGM - Iterative Guidance Mode
 s - Seconds from Liftoff

Apogee	184 km
Perigee	182 km
Inclination	31.98°
Lifetime	3 days



LAUNCH DATA

- Launch Complex - 37 Pad B
- Launch Azimuth - 90° E of N
- Flight Azimuth - 72° E of N

Cutoff Arming

- S-IB
 - IECO -- 134.8s ; propellant level sensors armed.
 - OECO -- Level sensing + 4.5s enable LoX depletion cutoff. (fuel depletion cutoff enabled 1 sec. later)
- S-IVB
 - OECO -- + 277.7s ; propellant level sensors placed in cutoff mode.

Figure 11

Trajectory Information

GUIDANCE AND CONTROL SYSTEM

Function and Description

The G&C system provides these basic functions during flight: (1) stable positioning of the vehicle to the command position with a minimum amount of sloshing and bending, (2) a first stage tilt program which gives near zero lift trajectory through the atmosphere and produces reasonable end conditions at Outboard Engine Cutoff (OECO), (3) reduction of wind loads during the high dynamic pressure region, (4) steering commands during S-IVB burn which guide the vehicle to a predetermined set of end conditions while maintaining a minimum propellant trajectory, (5) final cutoff and sequencing signals, (6) attitude signals for the sensing, computing, and actuation elements of the G&C system. A block diagram of the hardware used to implement these functions is shown in Figure 12.

The stabilized platform (ST-124M) is a three gimbal configuration with gas bearing gyros and accelerometers mounted on the stable element. Vehicle accelerations and rotations are sensed relative to this stable element. Gimbal angles are measured by redundant resolvers and inertial velocity is obtained from accelerometer head rotation in the form of encoder outputs (also redundant).

The launch vehicle data adapter (LVDA) is an input-output device for the LVDC. These two components are digital devices which operate in conjunction to carry out the flight program. This program performs the following functions: (1) Processes the inputs from the ST-124M, (2) performs navigation calculations, (3) provides first stage tilt program, (See Figure 14), (4) calculates IGM steering commands, (5) resolves gimbal angles and steering commands into the vehicle system for attitude error commands, (6) issues cut-off and sequencing signals.

The control accelerometers supply signals to the control computer during S-IB burn which are proportional to the aerodynamic lift forces acting on the vehicle. They are spring-mass devices which are mounted on IU coldplates.

The Control/EDS rate gyro package contains 9 gyros (triplex redundant in 3 axes). Their outputs go to the control signal processor (CSP) where they are voted and sent to the control computer for damping angular motion. These outputs are also processed in the CSP for use as an abort parameter.

The control computer sends commands to the S-IB and S-IVB engine actuators and to the control relay package based on signals from the LVDA, control accelerometers, and rate gyros. These signals are filtered and scaled (See Figure 13), then summed in magnetic amplifiers. This computer provides redundant operation during S-IVB burn and coast only.

The control relay packages accept computer commands and relay these commands to operate propellant valves in the Auxiliary Propulsion System (APS). All relays and valves are redundant. The APS has 6 nozzles (three in each module) which operate spontaneously when fuel and oxidizer are mixed.

The 8 hydraulic actuators of the S-IB stage are used to gimbal the outboard engines and provide control in all axes. The two hydraulic actuators of the S-IVB stage are used to gimbal the J-2 engine and provide control in pitch and yaw axes. These two actuators use mechanical feedback.

The switch selectors are used to relay discrete commands from the LVDA to other locations in the vehicle. The cutoff signal and time based events are issued through the switch selectors.

Operation

The vehicle is erected on the launch pad with position I at a 90° E of N azimuth. The stabil-ized platform is aligned to 72° azimuth during countdown and held in an earth fixed position, perpendicular to the gravity vector. A roll presetting of 18° is used to eliminate the attitude error which would result from this difference in azimuth. The LVDC operates in ground routines prior to GRR and attitude error signals are set to null. At the instant of GRR, the platform becomes space fixed to establish the guidance coordiante system and the LVDC enters the flight mode. In this mode accelerometer processing, steering, navigation, telemetry, and other functions are performed exactly as they are after liftoff.

Liftoff signal (IU umbilical disconnect) initiates time base 1. Ten seconds later, the pitch program starts and the initial roll presetting is reset to zero. The vehicle rolls into alignment with the platform at 1°/second. There is no active path guidance during S-IB burn. Control is maintained by gimbaling the four outboard engines on command from the control computer. Sequencing signals are issued to the various switch selectors to perform time dependent functions.

Propellant level sensing signal and OEEO are interrupts to the LVDC which start time bases 2 and 3. Path guidance (IGM) begins about 14 seconds after OEEO. S-IVB engine cutoff is issued based on total space fixed velocity and starts time base 4.

The APS is used for control in all axes during S-IVB coast. A pitch over maneuver starts at 5 seconds after S-IVB engine cutoff and continues at about .067°/s for the duration of the mission.

The digital command system carried in the IU is a phase shift keyed/frequency modulated (PSK/FM) system. The LVDC will be programmed to receive two types of commands from the IU Command Decoder: Mode Commands and Data Commands. Mode Commands will be decoded to determine what routine or sub-routine is to be executed by the LVDC. Data Commands will be used to satisfy the data requirements of the commanded routine. The principal functions of the IU Command System are: to initiate alternate LH₂ experiment sequences, to update the time sequence, to command single switch selector functions, to control the TV systems, and to initiate other system functions on a test basis (navigation update, systems checkout).

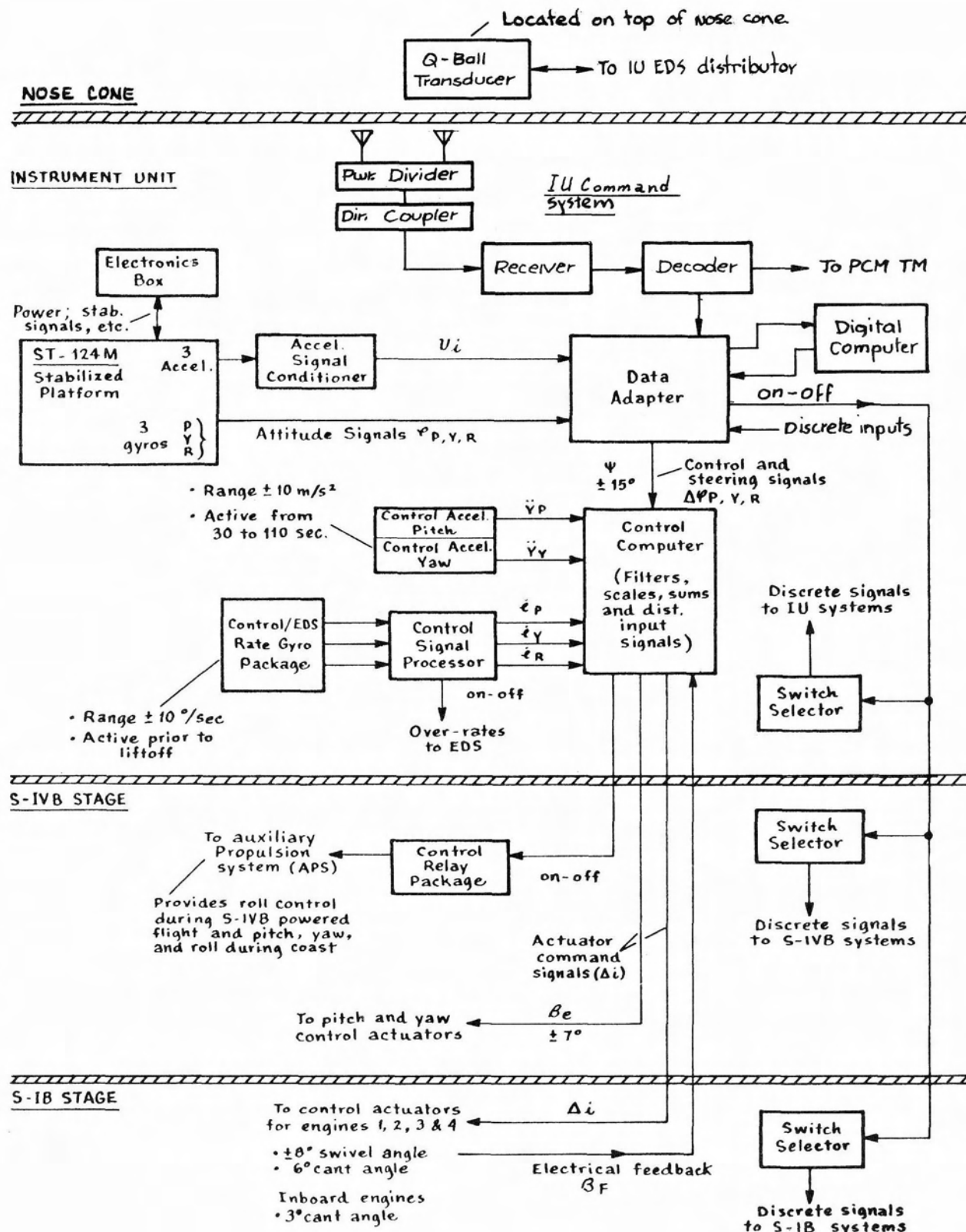
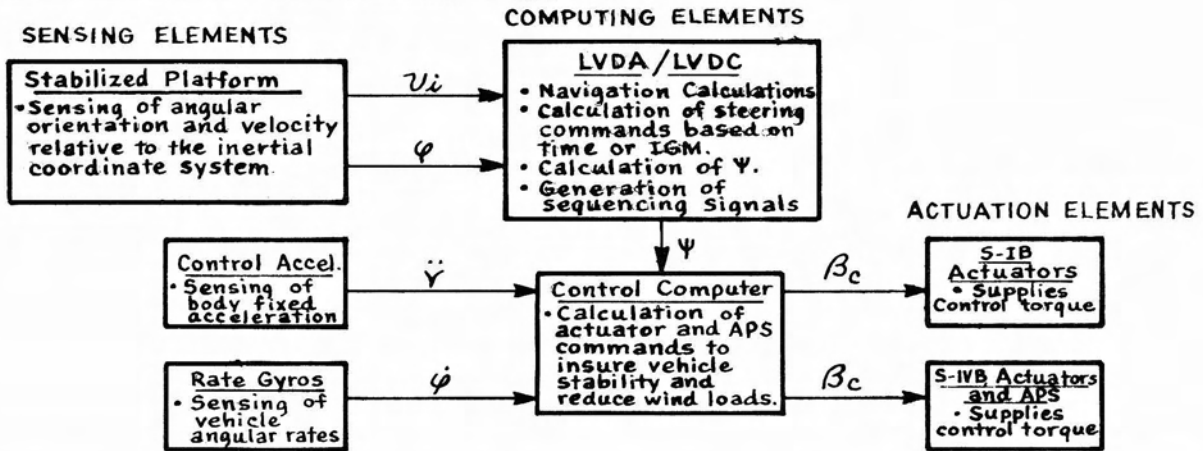

Figure 12

Guidance & Control System Block Diagram

Functional Diagram of G & C Systems



SA-203 CONTROL SYSTEM DESIGN OBJECTIVES

The design objectives used in determining the control gains and shaping networks during both S-IB and S-IVB Stage burn are to provide adequate vehicle response and stability margins throughout flight. Passive shaping networks are used in the attitude error and attitude rate channels. Active shaping is used in the accelerometer channels. The networks are tuned to provide minimum phase lag at slosh frequencies consistent with gain stabilizing all bending modes except the first bending mode during S-IB Stage burn. The first bending mode during S-IB Stage burn is phase stabilized.

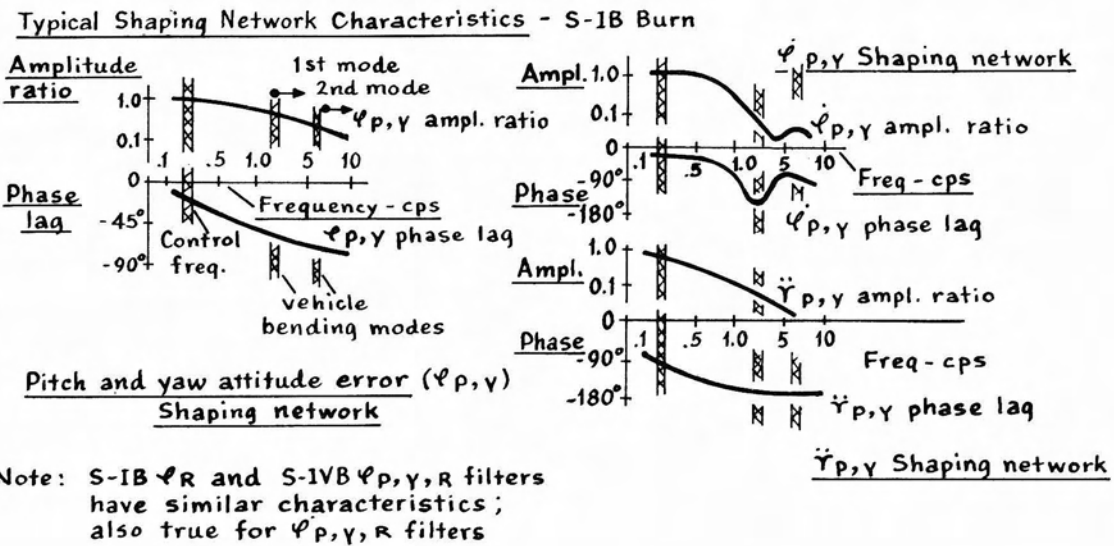
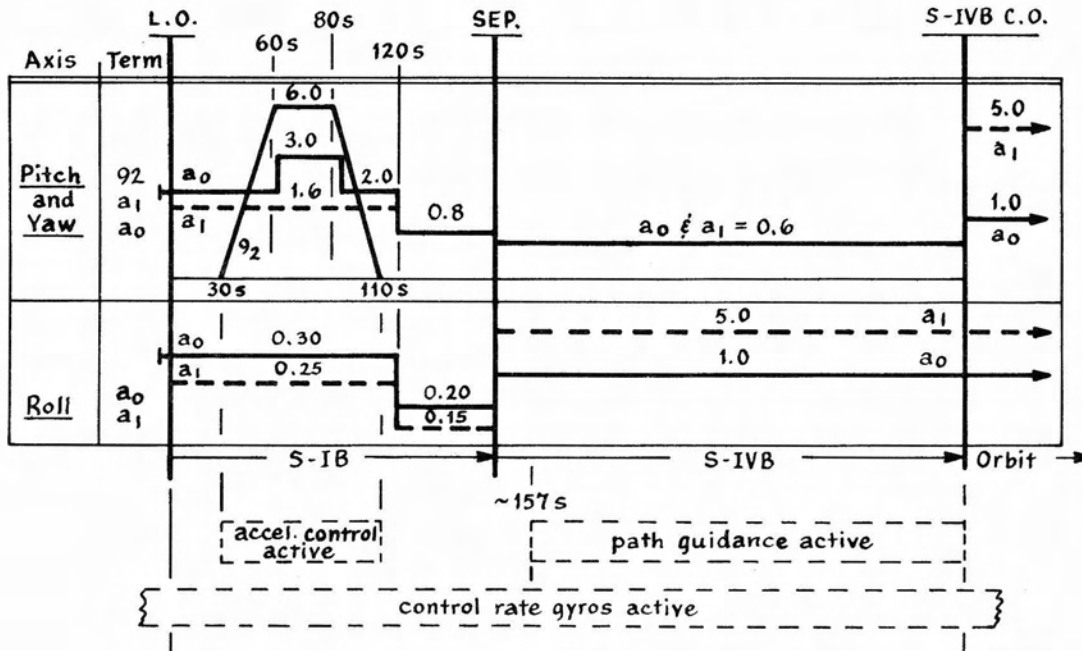

Figure 13

Guidance and Control System Information

Control System Gain Factors

$a_0 = \text{deg/deg}$ (Attitude rate)
 $a_1 = \text{deg/deg/s}$ (Attitude error)
 $q_2 = \text{deg/m/s}^2$ (Acceleration)



Vehicle Pitch Program

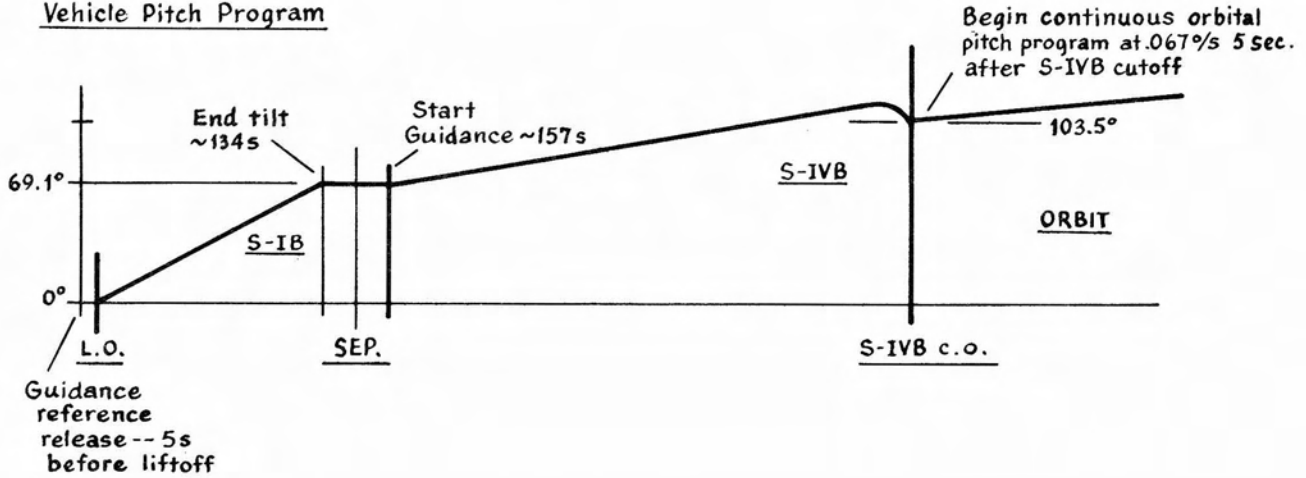

Figure 14

Vehicle Control System Information

VEHICLE TRACKING SYSTEMS

1. Azusa and C-Band Radar Systems.

The Azusa ground station determines successive trajectory positions of the vehicle by continuous phase comparison between the signals transmitted to the receiver from the onboard transponder. The C-Band Radar Transponder onboard the vehicle provides (upon interrogation from the ground) a single pulse reply to ground radar system. This signal is fed to the ground computer complex to obtain position, velocity, and acceleration information. Trajectory data from the launch vehicle Azusa and C-Band are presented on plotting boards for the range safety officer to use in determining "real time" vehicle trajectory parameters. In addition, the launch vehicle Azusa and C-Band are used for the post flight determination of the vehicle trajectory.

2. ODOP System

The vehicle's ODOP transponder transmits a continuous wave signal (at 70 mc above the received frequency) to the ground receiving stations where the doppler shift (due to the radial velocity of the vehicle) is used to provide trajectory data for the post flight evaluation of vehicle performance.

Nose cone None

Instrument Unit

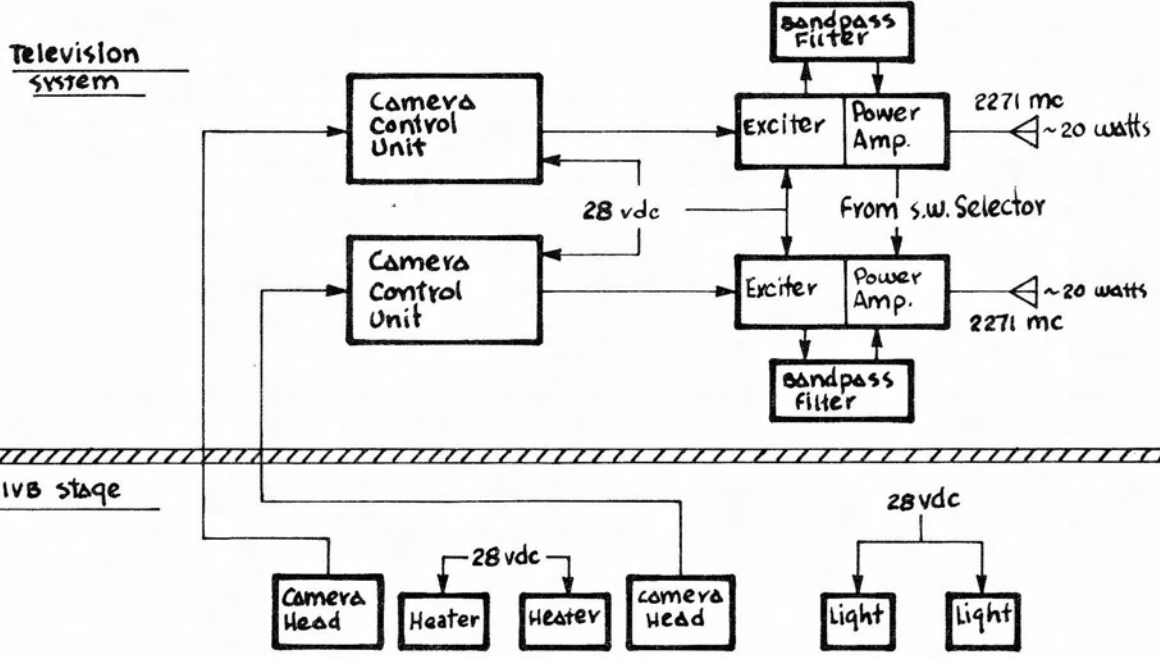
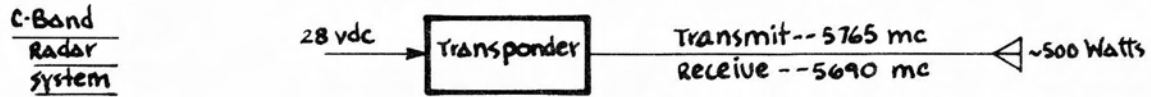
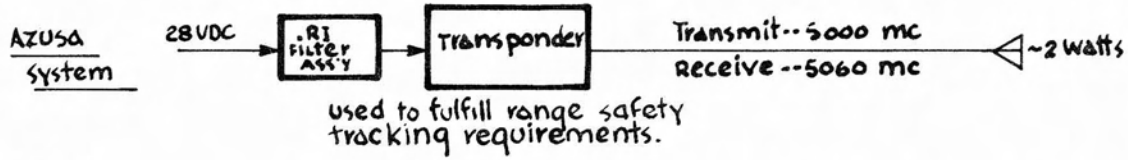

5-1B stage

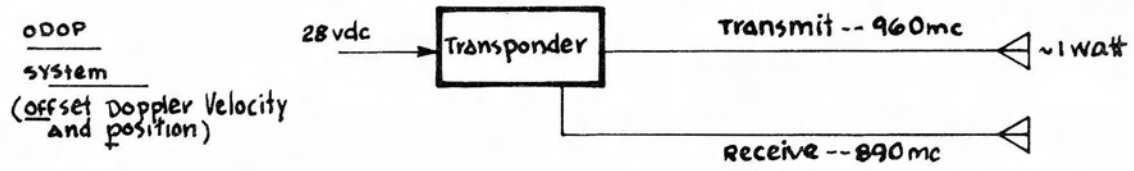
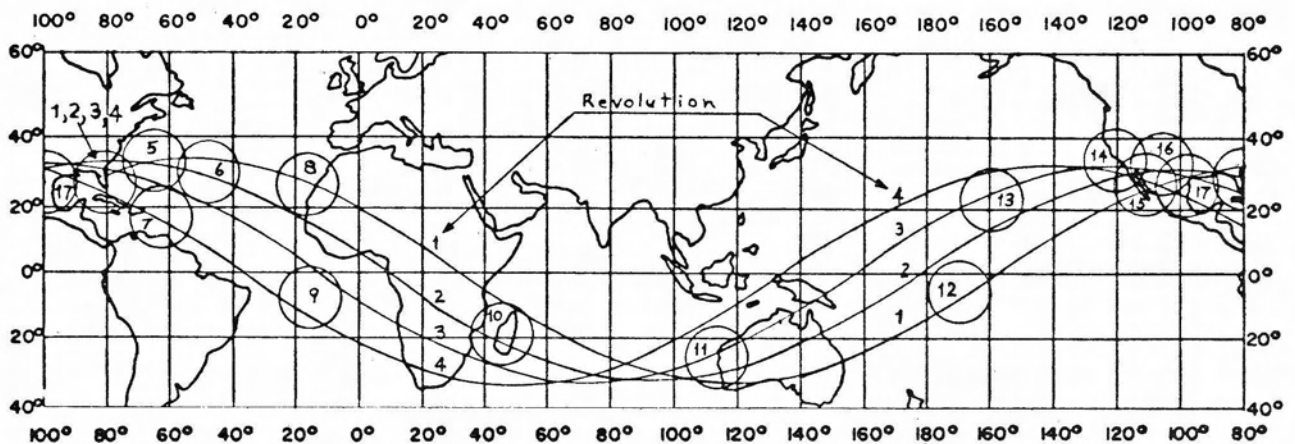

Figure 15

Vehicle Tracking and Television Systems

STATION COVERAGE SUMMARY

	<u>STATION</u>	<u>TRACKING</u>	<u>RANGE SAFETY</u>	<u>TV</u>	<u>TM</u>	<u>IU COMMAND</u>	
1.	Cape Kennedy Area	X	X	X	X	X	
2.	Atlantic Field	X					
3.	Eleuthera	X					
4.	Grand Bahama	X			X		
5.	Bermuda	X	X	X	X	X	
6.	Insertion Ship				X		
7.	Antigua	X			X		
8.	Canary Island	X			X		
9.	Ascension	X			X		
10.	Tananarive, Madagascar				X		
11.	Carnarvon, Australia	X		X	X	X	
12.	Canton Island				X		
13.	Hawaii	X			X		
14.	Point Arguello	X					
15.	Guaymas, Mexico				X		
16.	White Sands	X					
17.	Corpus Christi			X	X	X	
18.	Houston (MCC-H)	Direct command capability thru facilities at KSC, Corpus Christi and Bermuda.					X



Example:
Pass no.3, Carnarvon, Australia

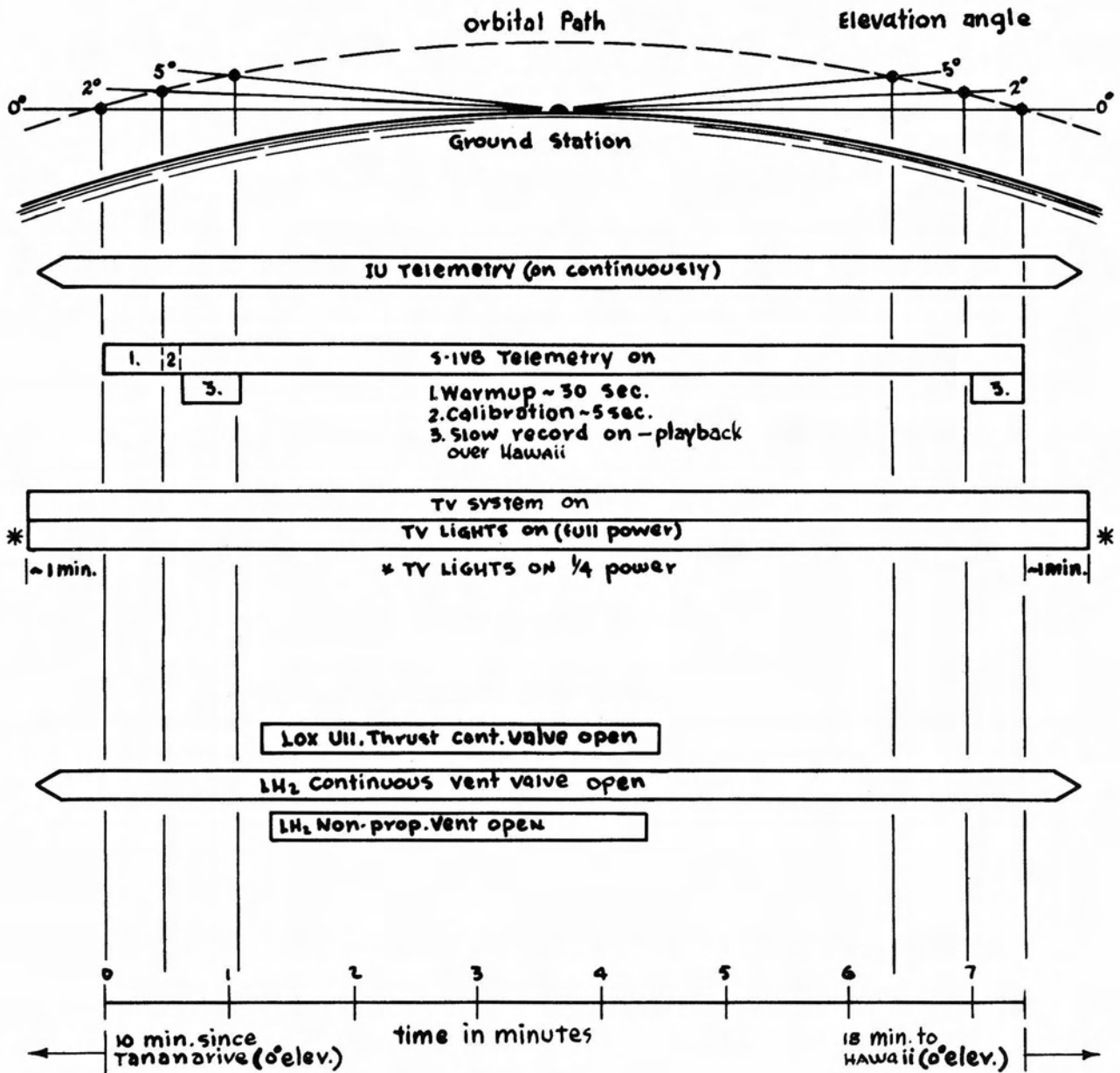

Figure 16

Example of Orbital
Station Coverage

GROUND TRACKING

Optical

1. CZR Cameras and Theodolites -- Primarily used up to ~ 500 meters altitude. Targets for tracking are vehicle paint patterns.
2. Long Range Cameras -- To track vehicle during flight until loss of view.

Other

1. Skin Tracking -- The S-IB stage after separation will be skin tracked by radars located at the Cape. The S-IVB/IU will be skin tracked during the remainder of the trajectory by Cape and downrange radars.
2. GLOTRAC -- Downrange stations will use the Azusa transponder after ~ 140 seconds.

SPACE VEHICLE WEIGHT VS. FLIGHT TIME

The total flight time from liftoff to orbital insertion of the S-IVB stage is ~ 7.3 minutes. Propellant consumption during S-IB stage flight (~ 144 seconds) is ~ 885,500 pounds and during S-IVB stage flight at 90% thrust (~ 298.4 seconds) is ~ 136,000 pounds.

In case one engine of the S-IB Stage malfunctions and is cut off during flight, the remaining engine will consume the propellant intended for the "dead" engine. Burning time of the stage would increase, and the overall vehicle performance loss would be minimized.

<u>Vehicle weight Data (Approximate)</u>	<u>Pounds</u>
Total at S-IB ignition	1,201,000
Total at liftoff	1,187,000
Total S-IB O.E.C.O	300,700
Total at S-IVB ignition	195,000
Total at S-IVB cutoff	58,700

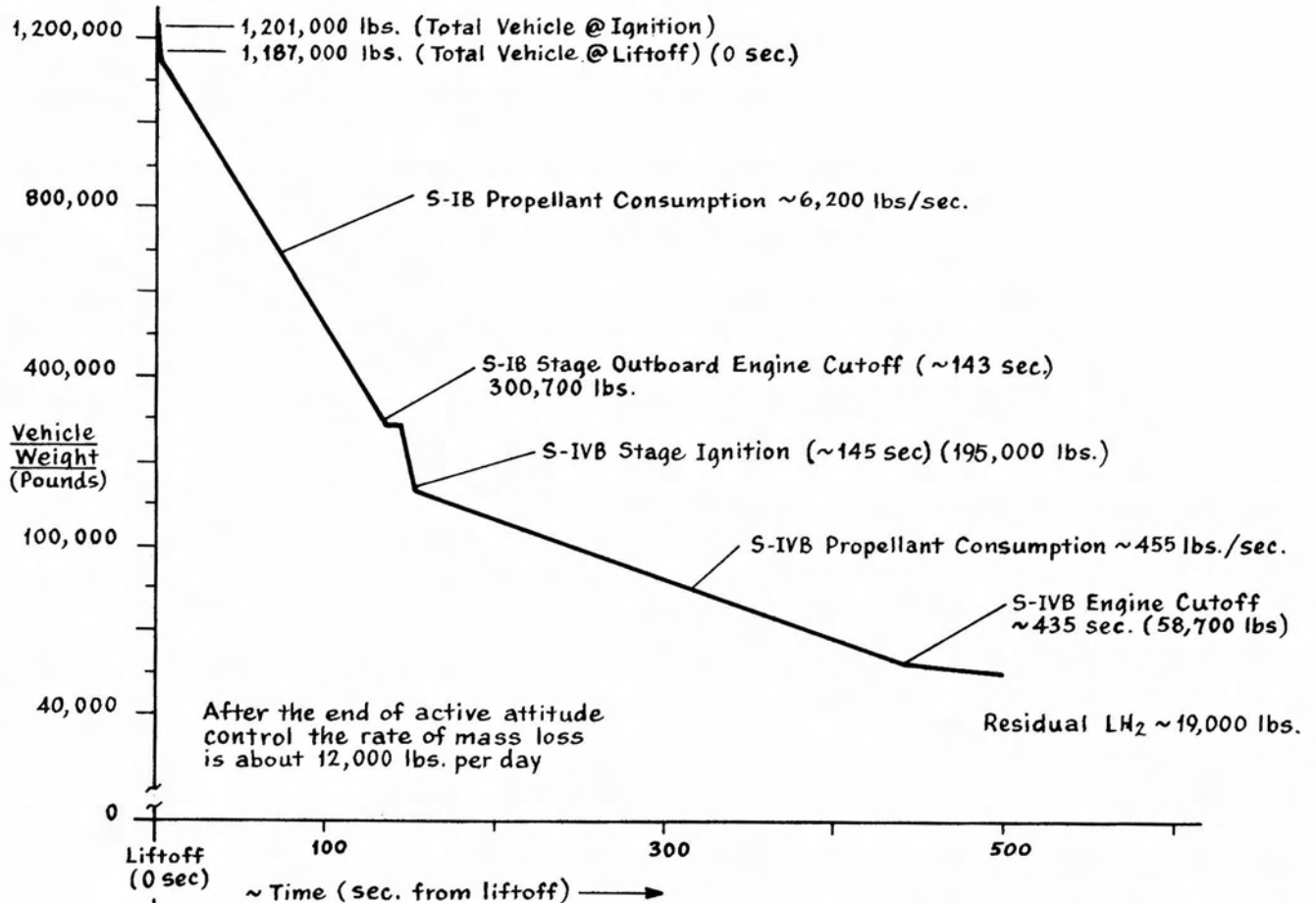

Figure 17

Space Vehicle Weight vs Flight Time

S-IB STAGE STRUCTURE

The S-IB stage consists of four 70-inch diameter fuel containers mounted alternately with four 70-inch diameter LOX containers around a 105-inch diameter LOX container. The containers are supported at the base by a thrust structure assembly to which are affixed the eight H-1 engines. The spider beam assembly provides the support structure at the forward end of the containers and serves as an adapter for the S-IVB interstage. Eight fins are mounted at the base of the S-IB stage to improve aerodynamic stability, pre-flight support, and holddown of the vehicle.

PROPULSION SYSTEM

The first stage of the launch vehicle is powered by a cluster of eight Rocketdyne H-1 engines developing a total sea level thrust of 1,600,000 pounds. Four engines are mounted outboard and four inboard; the four outboard engines are gimballed for vehicle control. The propellants are LOX and RP-1.

EJECTABLE CAMERA CAPSULES

Two ejectable cameras are to be carried onboard the S-IB stage for the purpose of viewing S-IB/S-IVB stage separation and other phenomena associated with performance of the vehicle during separation. The camera ejection system consists of a high-pressure storage sphere, two solenoid control valves, two camera ejection mechanisms, and the necessary valves, tubing, and associated hardware.

The camera capsules are mounted in the seal plate at the top of the S-IB stage and will be ejected twenty-five seconds after S-IB/S-IVB separation. The capsules will follow a ballistic path to an altitude of approximately 14,000 feet. At this point, parachutes will be deployed to decelerate the capsules. A floatation bag (approximately 20 inches in diameter with alternate colored panels of international orange and silver) will keep the capsules afloat after impact.

For recovery, the capsules are equipped with SARAH transmitters that operate on a frequency of 242 mc, and have a battery life of approximately 30 hours. The effective range of the transmitters is approximately twenty-five miles. In addition, a dye marker is also released to aid in aerial sighting.

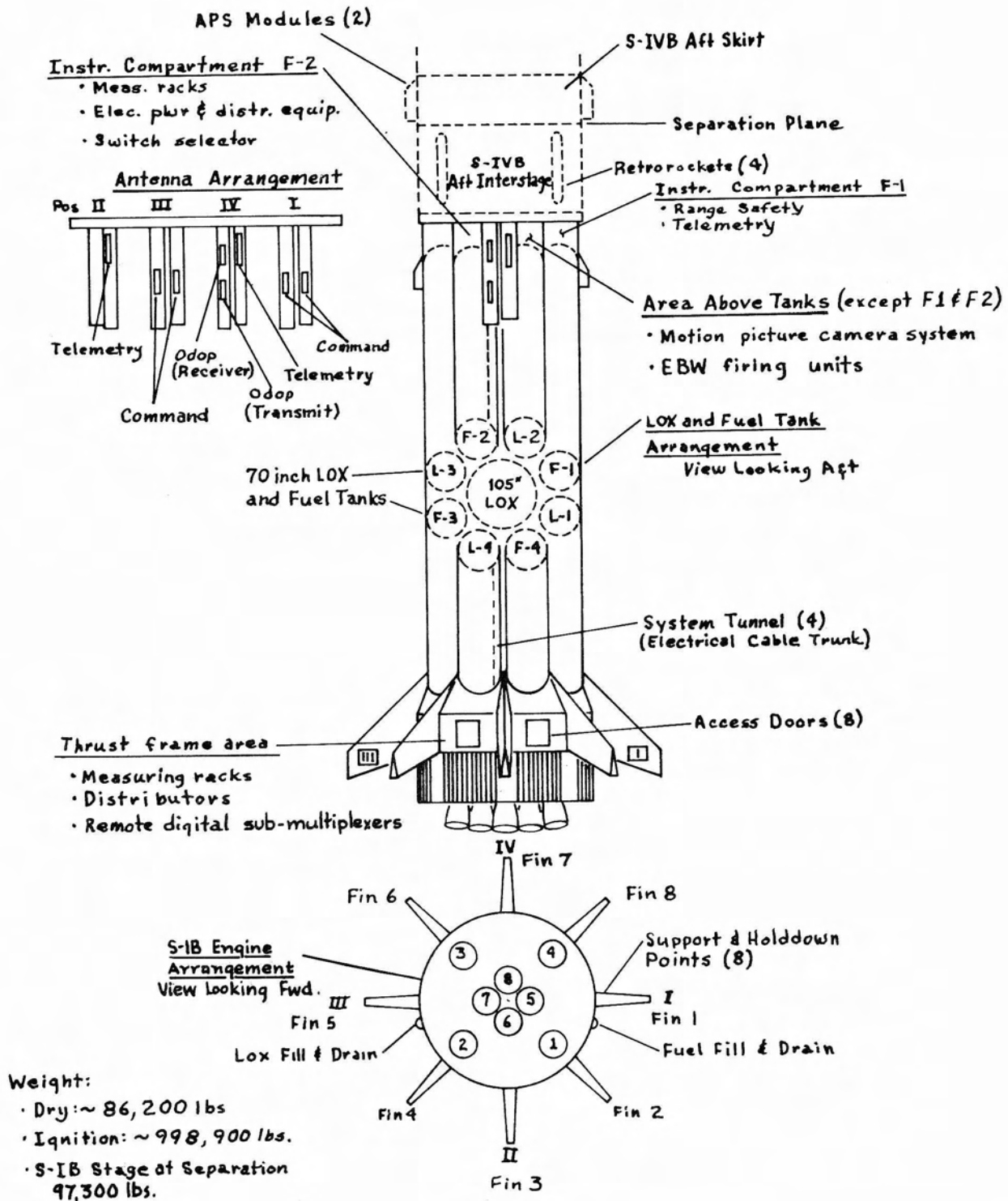

Figure 18

S-IB Stage Configuration

H-1 ENGINE OPERATION

A start signal ignites the solid propellant gas generator (SPGG) which accelerates the LOX and RP-1 pumps. Increasing fuel pressure opens the main LOX valve which, in turn, opens the sequence valve permitting fuel pressure to rupture the hypergolic cartridge. Primary ignition occurs when the RP-1 and hypergolic fluid contact LOX in the thrust chamber. The injector fuel pressure opens the main RP-1 valve and provides propellant flow to the liquid propellant gas generator (LPGG) which sustains turbine operation.

The digital computer initiates inboard engine cutoff 3.0 seconds after the propellant level sensor actuation. Outboard engine cutoff is initiated by either the thrust OK switches, the backup timer (from the computer), or the fuel depletion probes. Both cutoff signals are routed through the S-IB stage switch selector. The cutoff signal opens the explosively actuated Conax valve equalizing the RP-1 pressure at the main LOX valve. The valve closes to interrupt fuel flow and terminate engine operation.

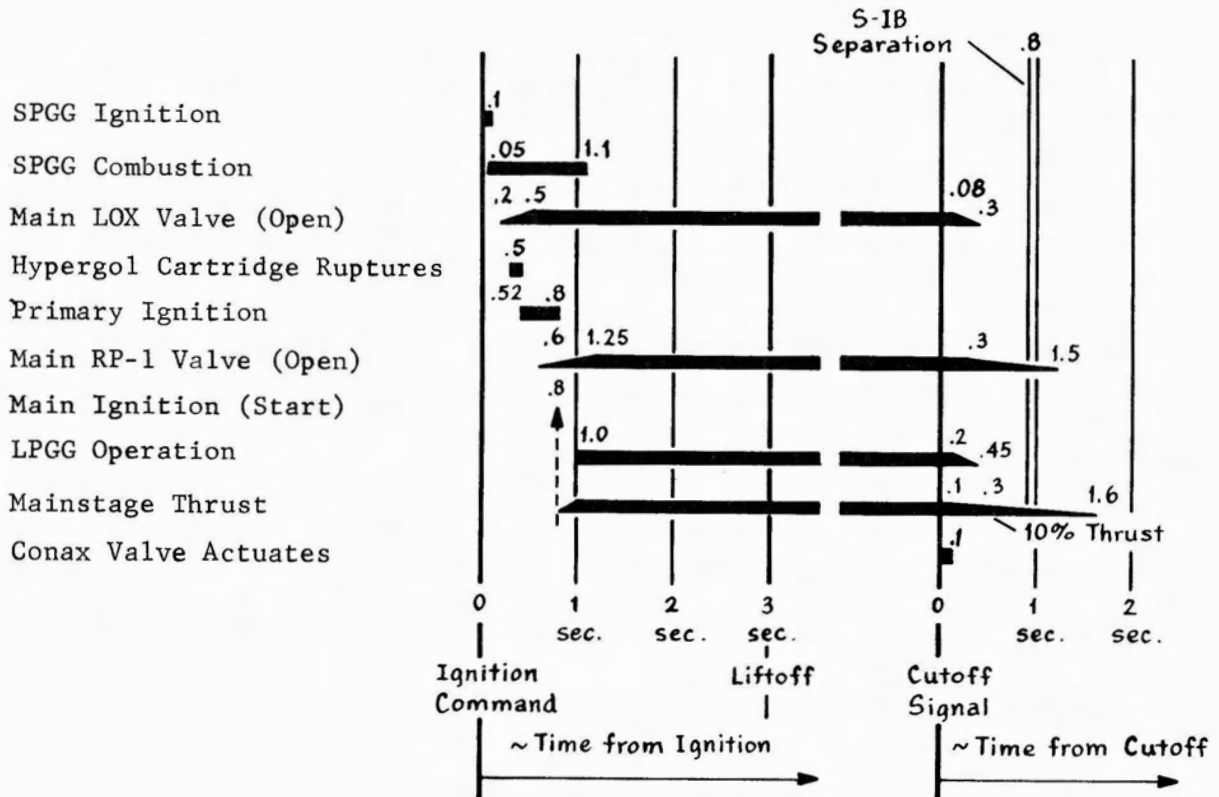

Figure 19

H-1 Operational Sequence

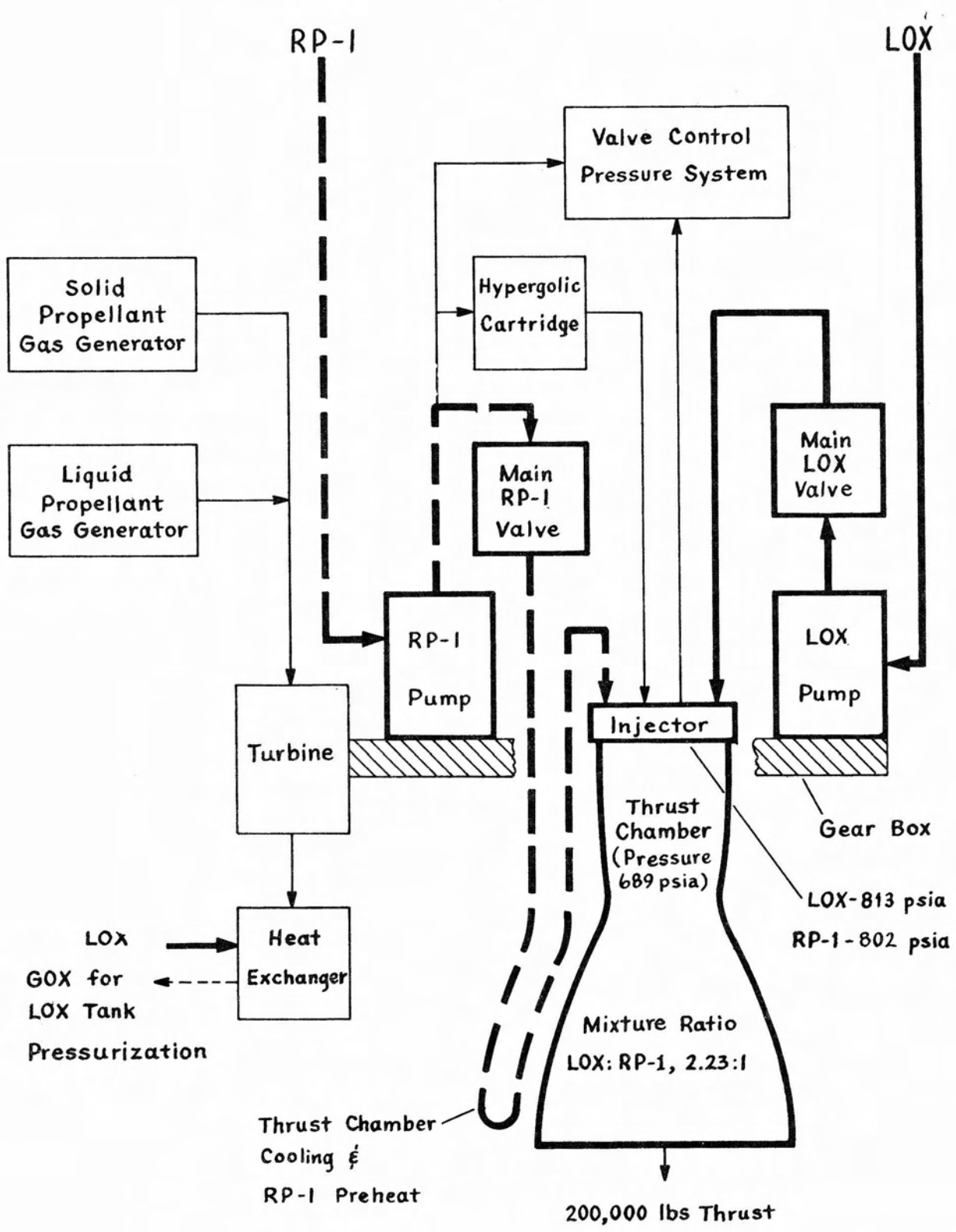
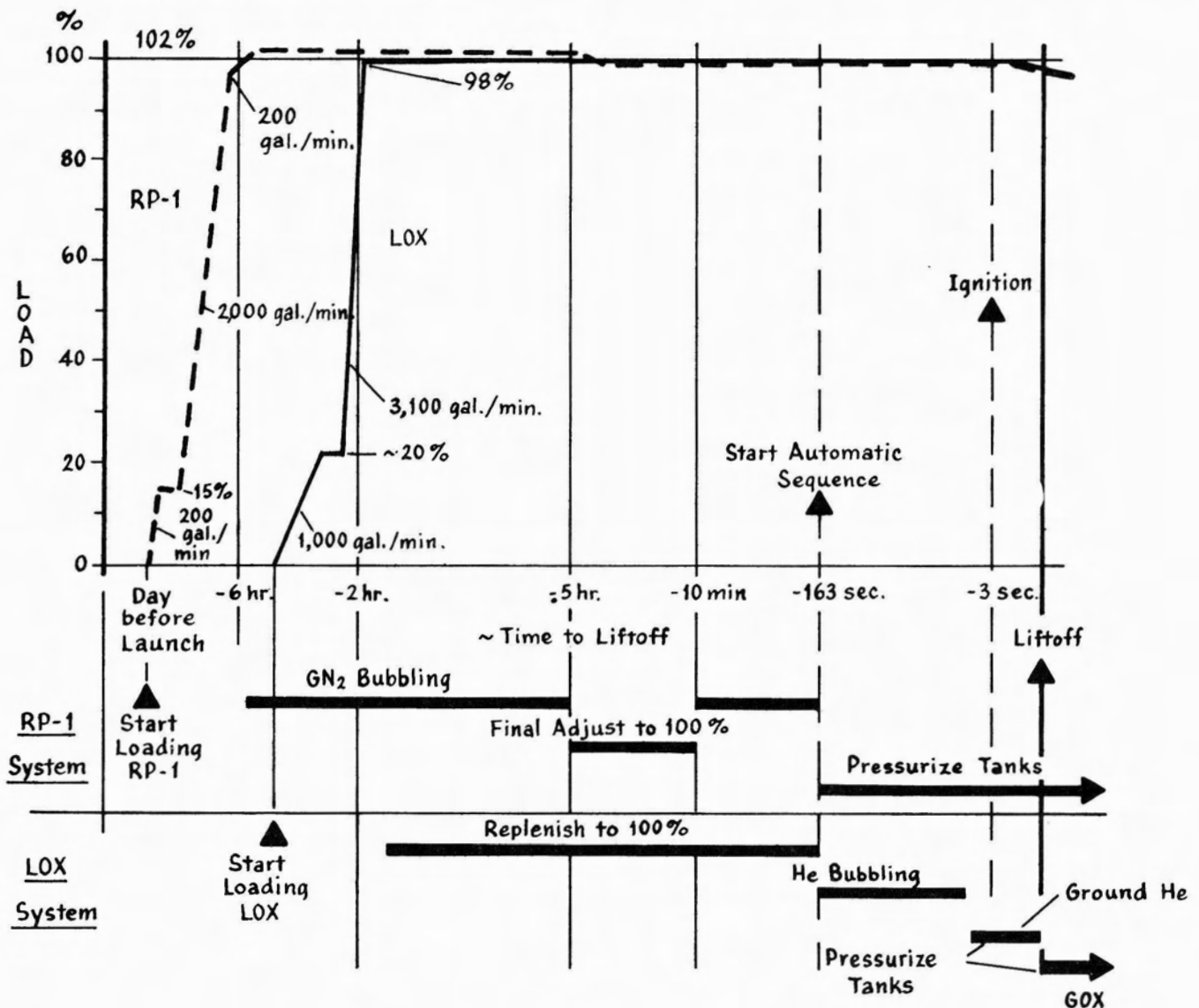

Figure 20

H-1 Engine System

S-IB STAGE PROPELLANT SYSTEM

The S-IB Stage propellant system is composed of five LOX tanks, four RP-1 tanks, propellant lines, control valves, vents, and pressurization subsystems. The sumps of each group of tanks are interconnected to provide uniform propellant levels and pressures. Loading of LOX and RP-1 tanks is controlled by ground computers. After the RP-1 has been loaded and just before the start of LOX loading, ground source GN₂ is bubbled through the RP-1 suction lines to prevent temperature stratification. At the start of the automatic sequence the RP-1 tanks are pressurized with ground source GN₂. During S-IB burn, fuel tank pressurization is maintained by GHe from two 20 cubic foot spheres located above two of the fuel tanks. Ground source helium is bubbled through the LOX lines and tanks at the start of the automatic sequence to prevent temperature stratification in the engine LOX suction lines. Prior to engine ignition the bubbling is discontinued and the LOX tanks are pressurized with helium from a ground source. After liftoff, the LOX tank pressurization is maintained with GOX converted from LOX in the heat exchanger.



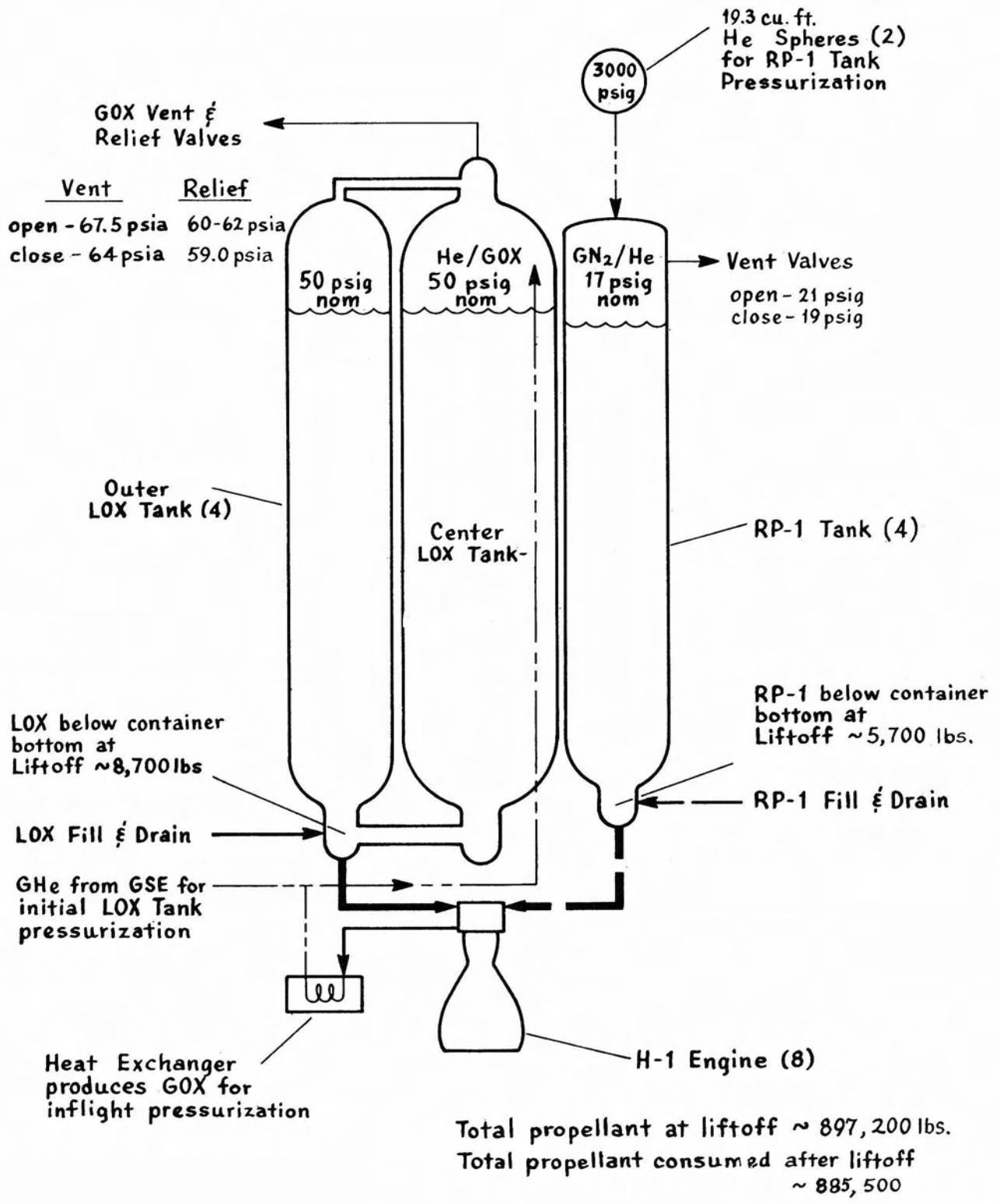

Figure 21

S-IB Stage Propellant System

S-IB STAGE THRUST VECTOR CONTROL SYSTEM

Each of the four outboard H-1 engines is gimbal mounted on the stage thrust structure to provide engine thrust vectoring for vehicle attitude control and steering. Two hydraulic actuators are utilized to gimbal each engine in response to signals from the Flight Control Computer located in the Instrument Unit.

The actuators are part of an independent hydraulic system on each gimballed engine. Hydraulic fluid flows to the actuators from the high pressure accumulator and returns to the low pressure reservoir. The electric motor driven auxiliary pump operates only during prelaunch check-out of the thrust vector control system.

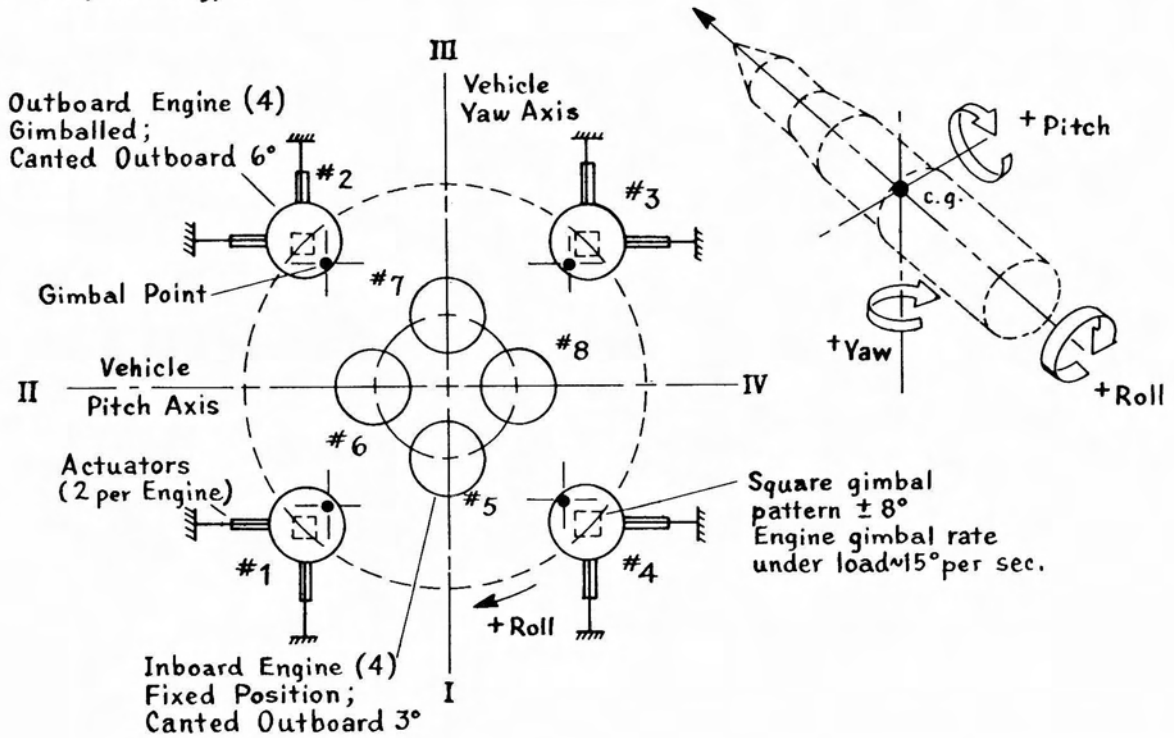
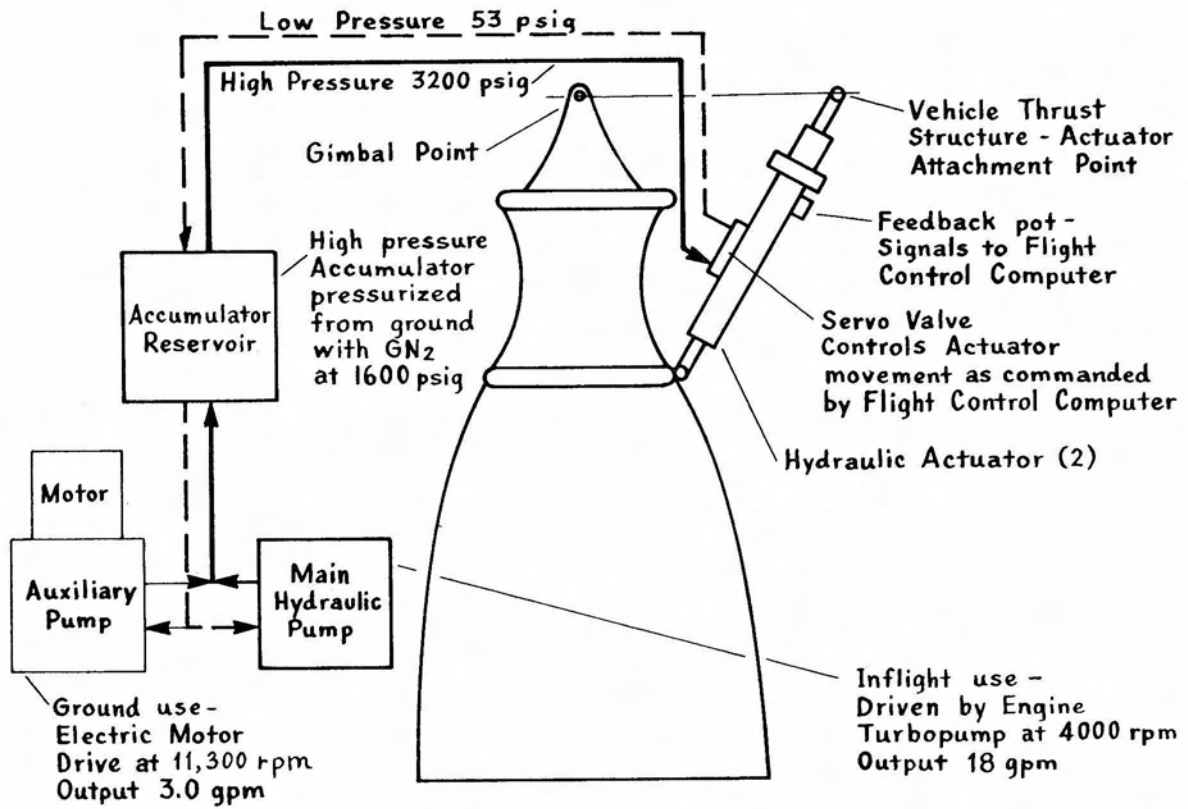

Figure 22

S-IB Stage Thrust Vector Control System

* ~122 blockhouse mea. are also inflight mea.

Note: There were ~498 inflight and ~176 LCC measurement on S-IB-1

Summary of Measurements	
Inflight	S-IB-3
1. Lig. Level	18
2. Temperature	90
3. Pressure	102
4. Strain	124
5. Vibration	62
6. Signals	62
7. Voltage, Current, Freq.	25
8. Miscellaneous	20
Total	~503
LCC (Blockhouse)	~167*

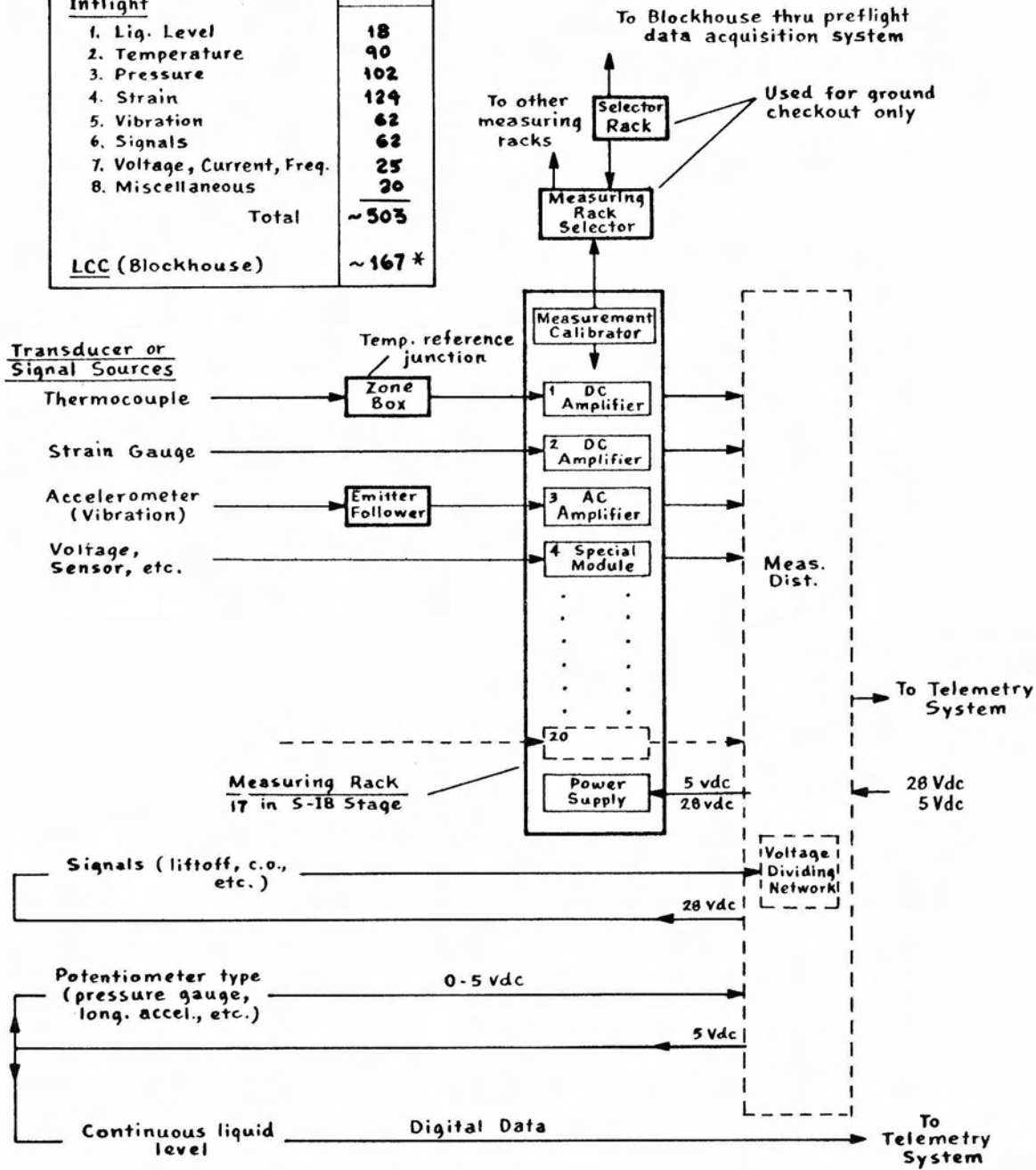

Figure 23

S-IB Stage Measuring System

SS - Single Sideband
 FM - Frequency Modulation
 DDAS - Digital Data Acquisition System
 PAM - Pulse Amplitude Modulation
 PCM - Pulse Code Modulation
 TM - Telemetry
 RF - Radio Frequency

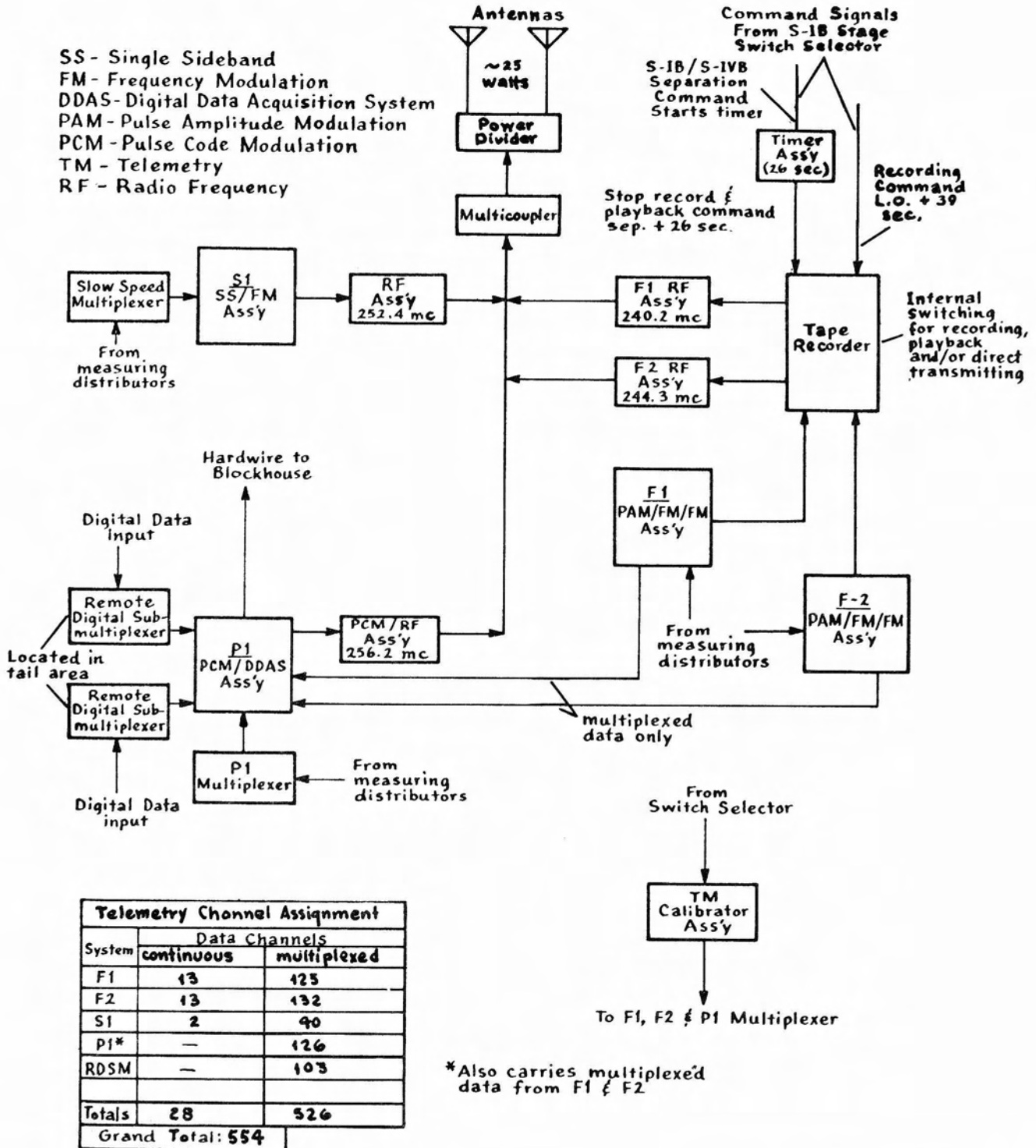

Figure 24

S-1B Stage Telemetry System

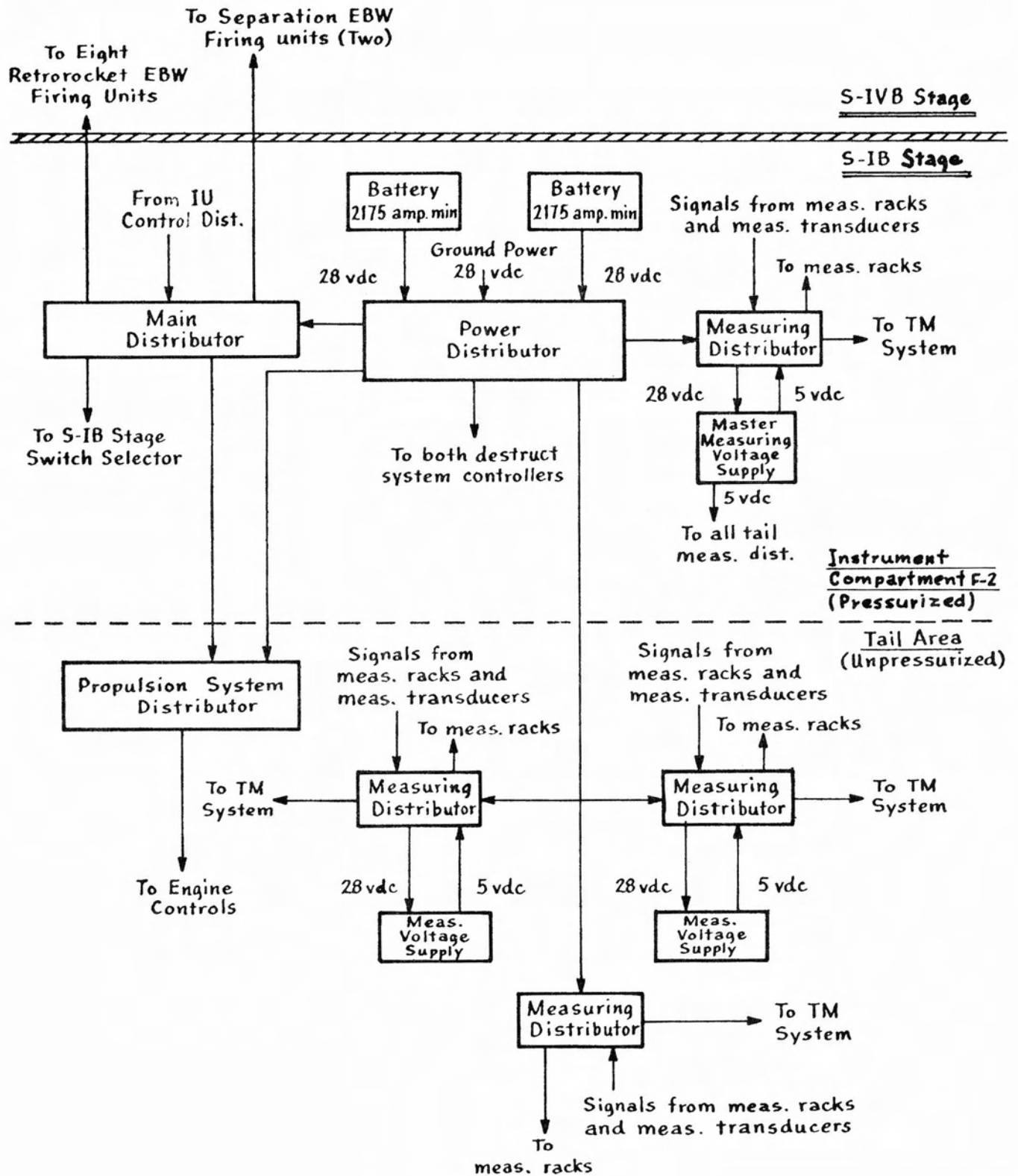

Figure 25

S-IB Stage Electrical Power and Distribution System

Intentionally Left Blank

S-IVB STAGE STRUCTURE

The S-IVB Stage is a 260-inch diameter semimonocoque structure consisting of a cylindrical propellant container with hemispherical ends, a thrust structure assembly, a forward skirt, an aft skirt, and a S-IB/S-IVB interstage.

The propellant tanks are separated by a common hemispherical bulkhead. The liquid oxygen tank is located aft of the liquid hydrogen tank. A single J-2 engine is attached to the stage by a conical thrust structure assembly.

PROPULSION SYSTEM

A single Rocketdyne J-2 engine mounted on the vehicle centerline powers the second stage. Using LOX and LH₂ as propellants, the engine develops a thrust of 200,000 pounds. During powered flight, vehicle pitch and yaw control moments are attained by gimbaling the engine. The Auxiliary Propulsion System provides roll control during powered flight and provides control in all axis during orbital coast.

LH₂ EXPERIMENT PECULIAR EQUIPMENT

1. LH₂ Tank Venting Systems

The LH₂ tank can be vented by two systems. The non-propulsive vent system rapidly reduces the LH₂ tank pressure. The smaller propulsive vent system is enabled shortly after insertion into orbit and produces a minimum vehicle axial acceleration of 2×10^{-5} G to bottom the propellant.

2. TV System

Two TV cameras and two 300-watt lamps, mounted on a modified LH₂ dome manhole cover view the interior of the LH₂ tank. Electrical heaters will be operated continuously during the experiment to keep the camera temperatures from falling below the camera operating limits.

3. Instrumentation

Instrumentation has been added to the basic S-IVB/IU for the experiment. These instruments consist of numerous temperature and liquid/vapor sensors within the LH₂ tank of the S-IVB for the purpose of locating the liquid and studying the convective patterns within the LH₂. Also, a quality meter has been added to the hydrogen continuous venting system to measure the liquid-vapor ratio in the vented gas. Other appropriate temperature and pressure measurements are included in the hydrogen vent systems, and the ullage thrust system to permit calculation of flowrates, thrust, and thrust unbalance. Temperature and pressure of the ambient helium bottle are measured to determine tank repressurization requirements. The hydrogen recirculation system and engine bell are instrumented with appropriate temperature and pressure sensors to provide for detailed assessment of engine chilldown for engine restart.

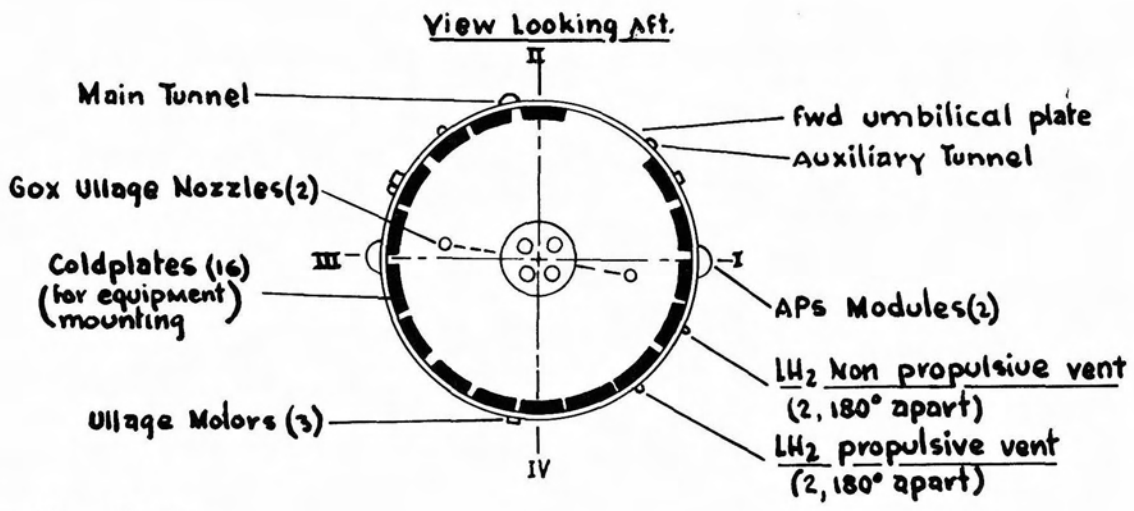

Stage Length: ~ 59 ft.

Including 8 in. protrusion
of LH₂ tank beyond S-IVB/IV
mating surface

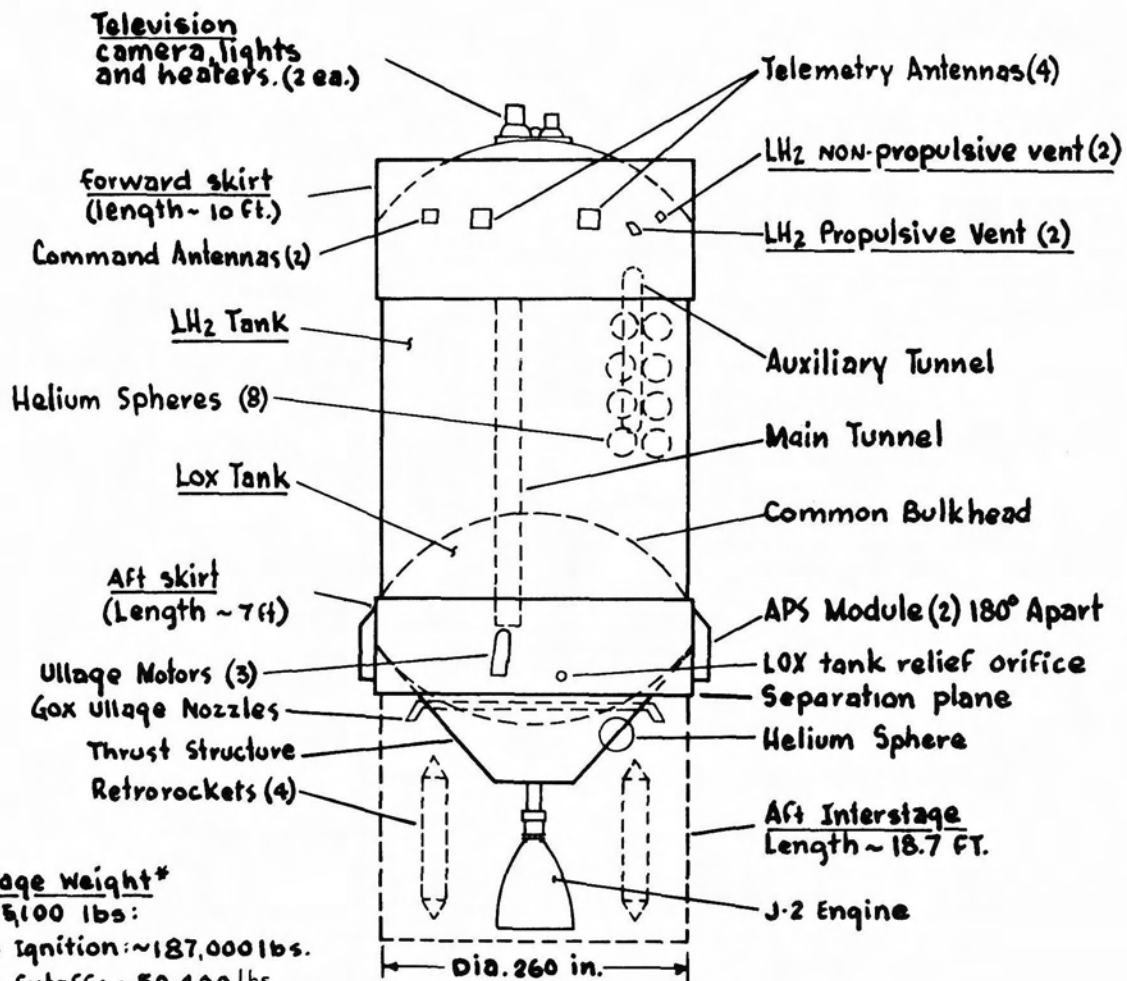

S-IVB stage weight*

- Dry: ~ 25,100 lbs.
- At S-IVB Ignition: ~ 187,000 lbs.
- At S-IVB Cutoff: ~ 50,400 lbs.

* Excludes wt. of retro-rockets & aft interstage

Figure 26

S-IVB Stage Configuration

J-2 ENGINE OPERATION

The normal operating cycle of the J-2 Engine consists of prestart, start, steady-state operation, and cutoff sequences. During prestart, LOX and LH₂ flow through the engine to temperature-condition the engine components, and to assure the presence of propellant in the turbopumps for starting. After a timed cooldown period, the start signal is received by the sequence controller which energizes various control solenoid valves to open the propellant valves in the proper sequence. The sequence controller also energizes spark plugs in the gas generator and thrust chamber to ignite the propellant. In addition, the sequence controller releases GH₂ from the start tank. The GH₂ provides the initial drive for the turbopumps that deliver propellant to the gas generator and the engine. The propellant ignites, gas generator output accelerates the turbopumps, and engine thrust increases to main stage operation. At this time, the spark plugs are de-energized and the engine is in steady-state operation.

Steady-state operation is maintained until a cutoff signal is received by the sequence controller. The sequence controller de-energizes the solenoid valves which in turn close the engine propellant valves in the proper sequence. As a result, engine thrust decays and the cutoff sequence is complete.

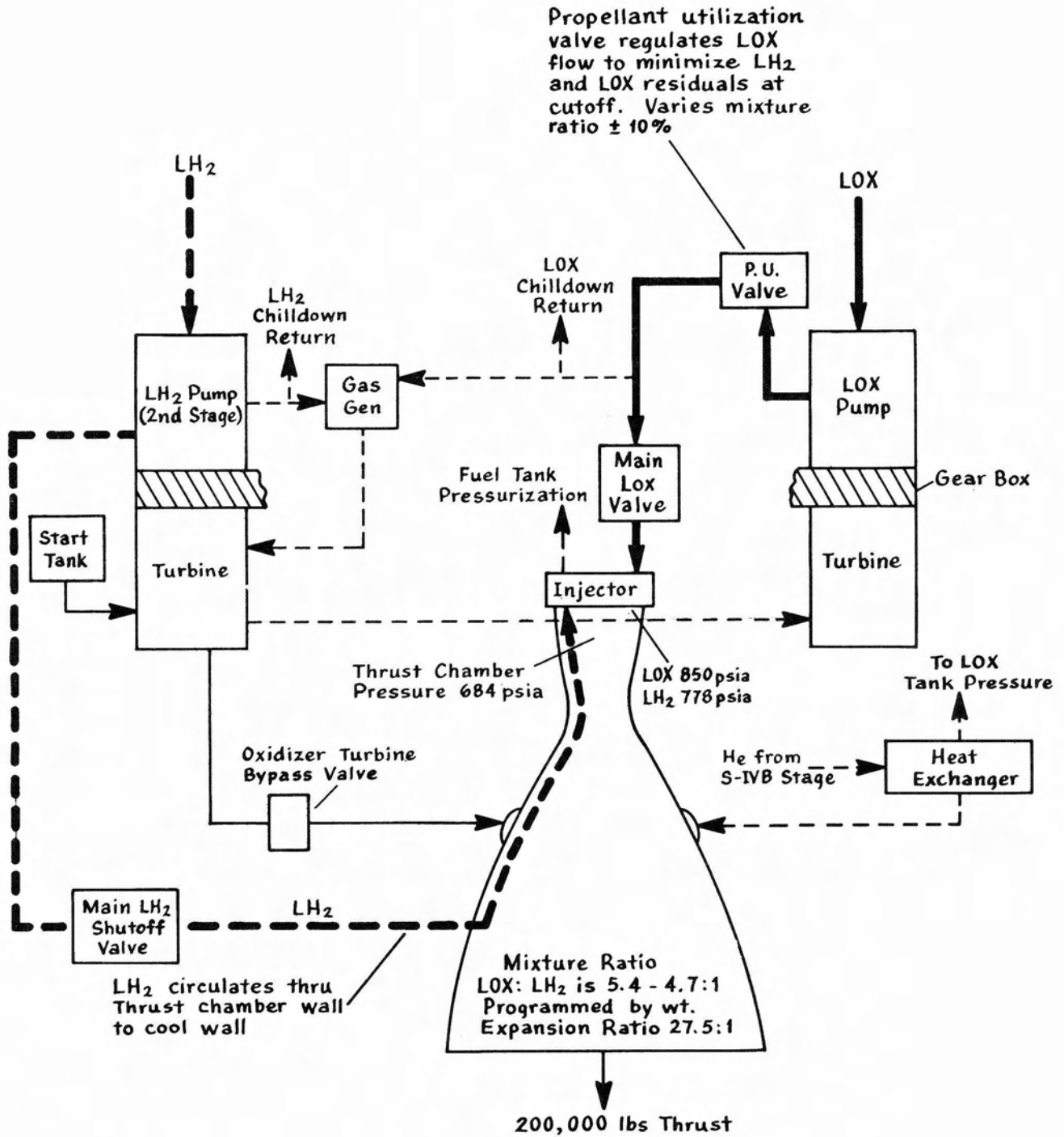

Figure 27

J-2 Engine System

S-IVB STAGE PROPELLANT SYSTEM

The S-IVB propellant system is composed of integral LOX/LH₂ tanks, propellant lines, control valves, vents, and pressurization subsystems. Loading of the propellant tanks and flow of propellants is controlled by the propellant utilization system. Both propellant tanks are initially pressurized by ground source cold helium. LOX tank pressurization during S-IVB Stage burn is maintained by helium supplied from spheres in the LH₂ tank, which is expanded by passing through the helium heater, to maintain positive pressure across the common tank bulkhead and to satisfy net positive suction head. The LH₂ pressurization strengthens the stage in addition to satisfying net positive suction head requirements. After engine ignition the pressure is maintained by GH₂ tapped from the engine supply.

S-IVB PROPELLANT LOAD AND OPERATIONAL SEQUENCE

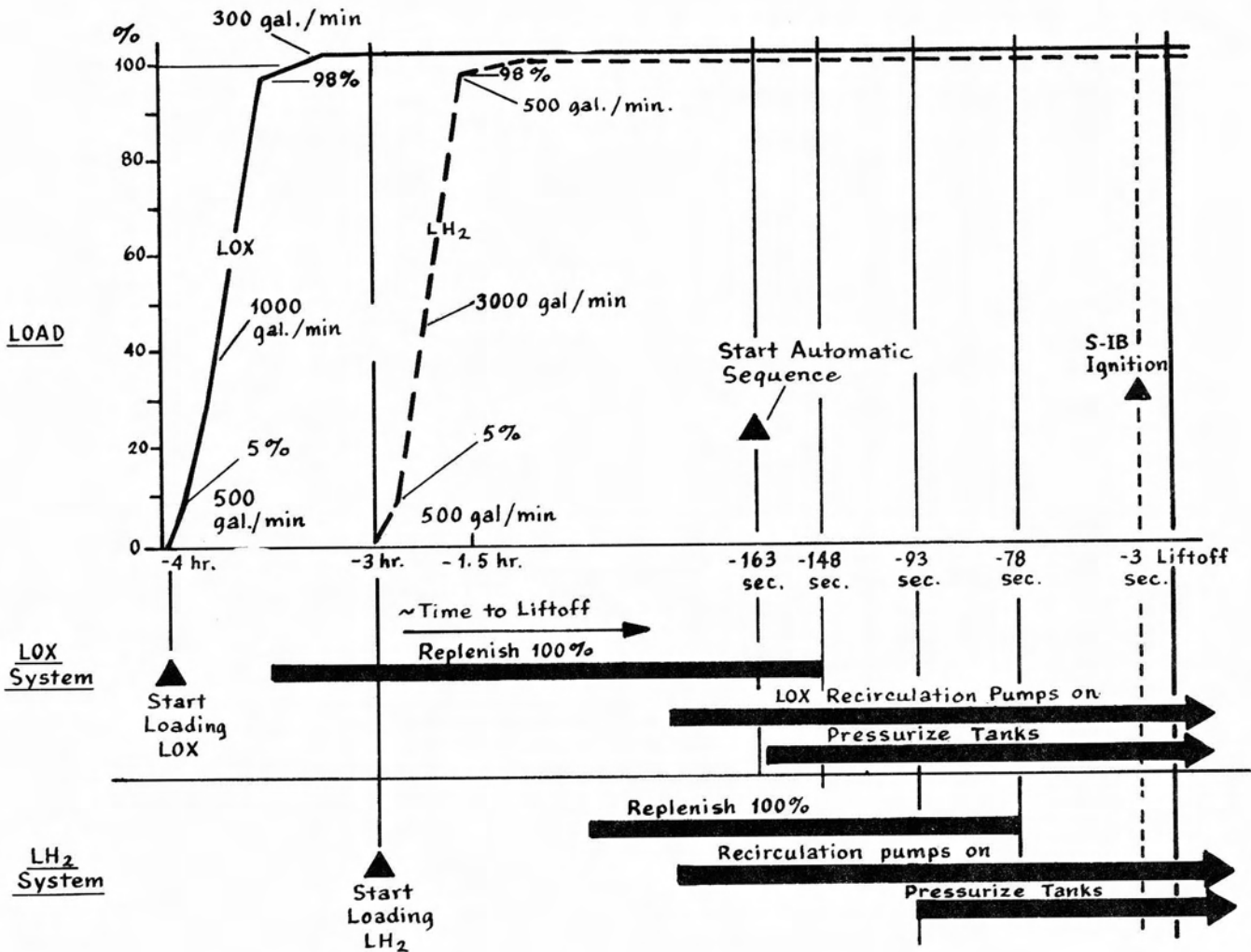

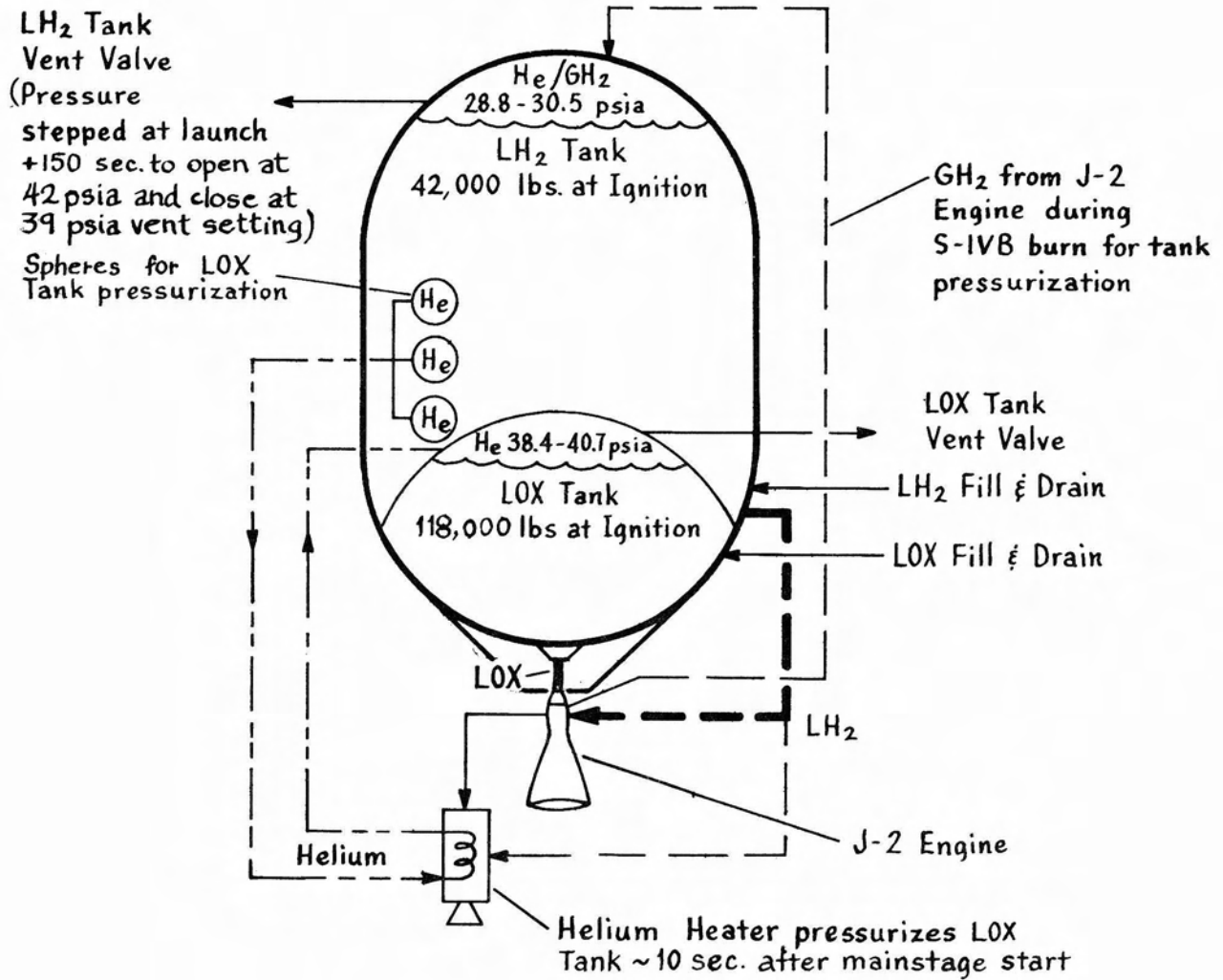

LH₂ tank is about 50% full at J-2 engine cutoff
 LOX remaining at J-2 engine cutoff is ~4800 lbs.

Figure 28

S-IVB Stage Propellant System

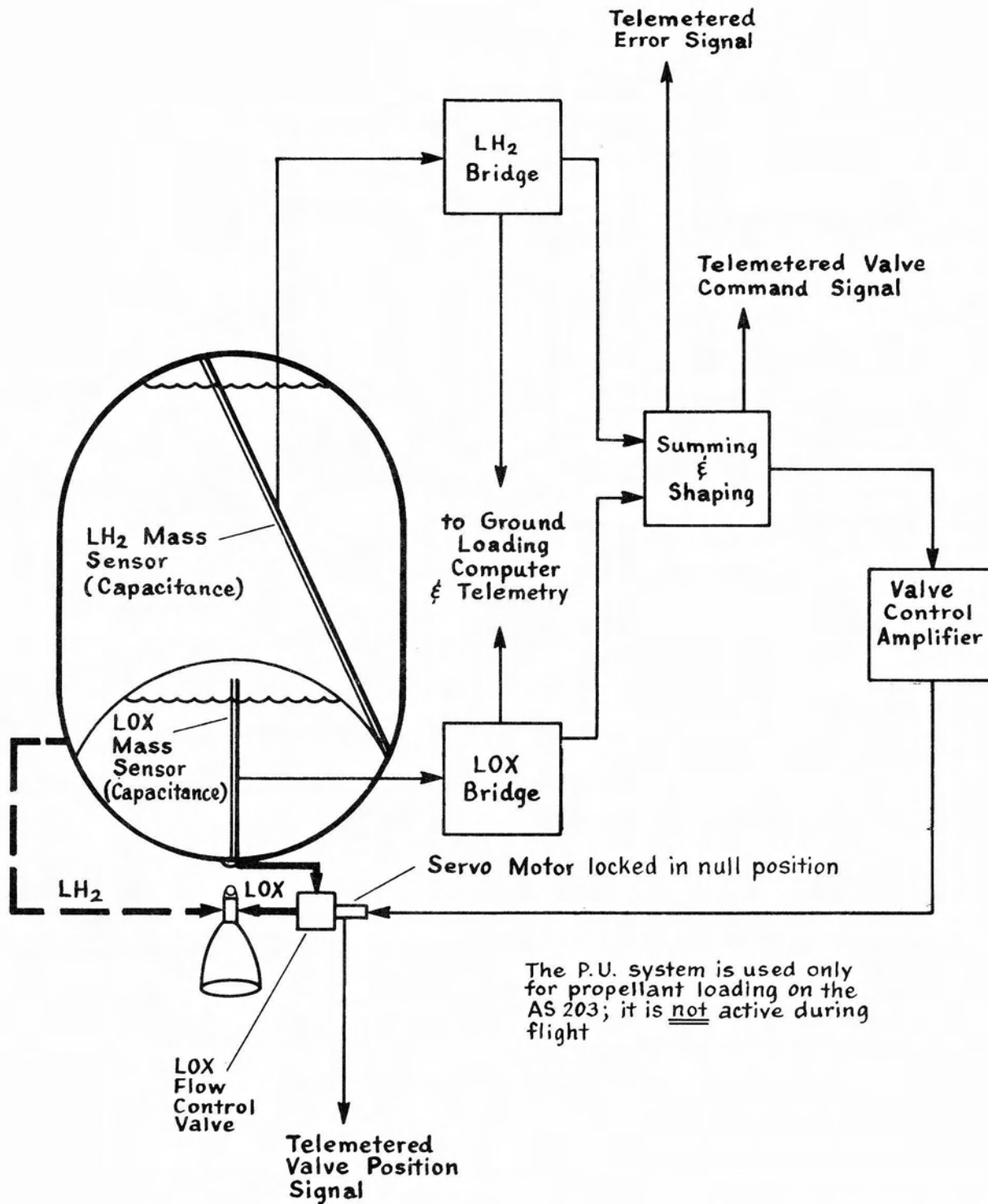

Figure 29

S-IVB Stage Propellant Utilization System

Intentionally Left Blank

S-IVB STAGE THRUST VECTOR CONTROL SYSTEM

The single J-2 engine is gimbal mounted on the longitudinal axis of the S-IVB Stage. Power for gimbaling is supplied by a hydraulic control system mounted on the engine.

Pitch and yaw control, during powered flight, is maintained by actuator control of the engine thrust vector. Roll control of the stage is maintained by properly sequencing the pulse-fired hypergolic propellant thrust motors in the APS. When the stage enters the coast mode, the APS thrust motors control the stage in all three axes.

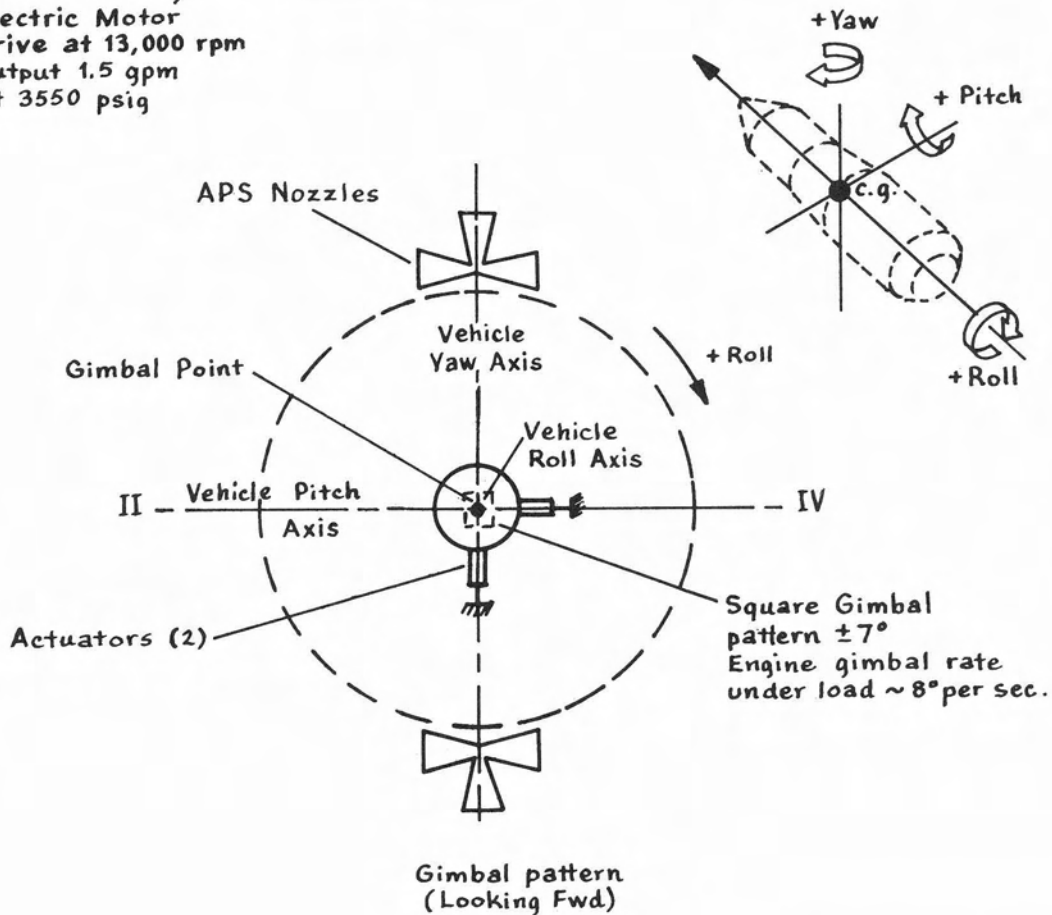
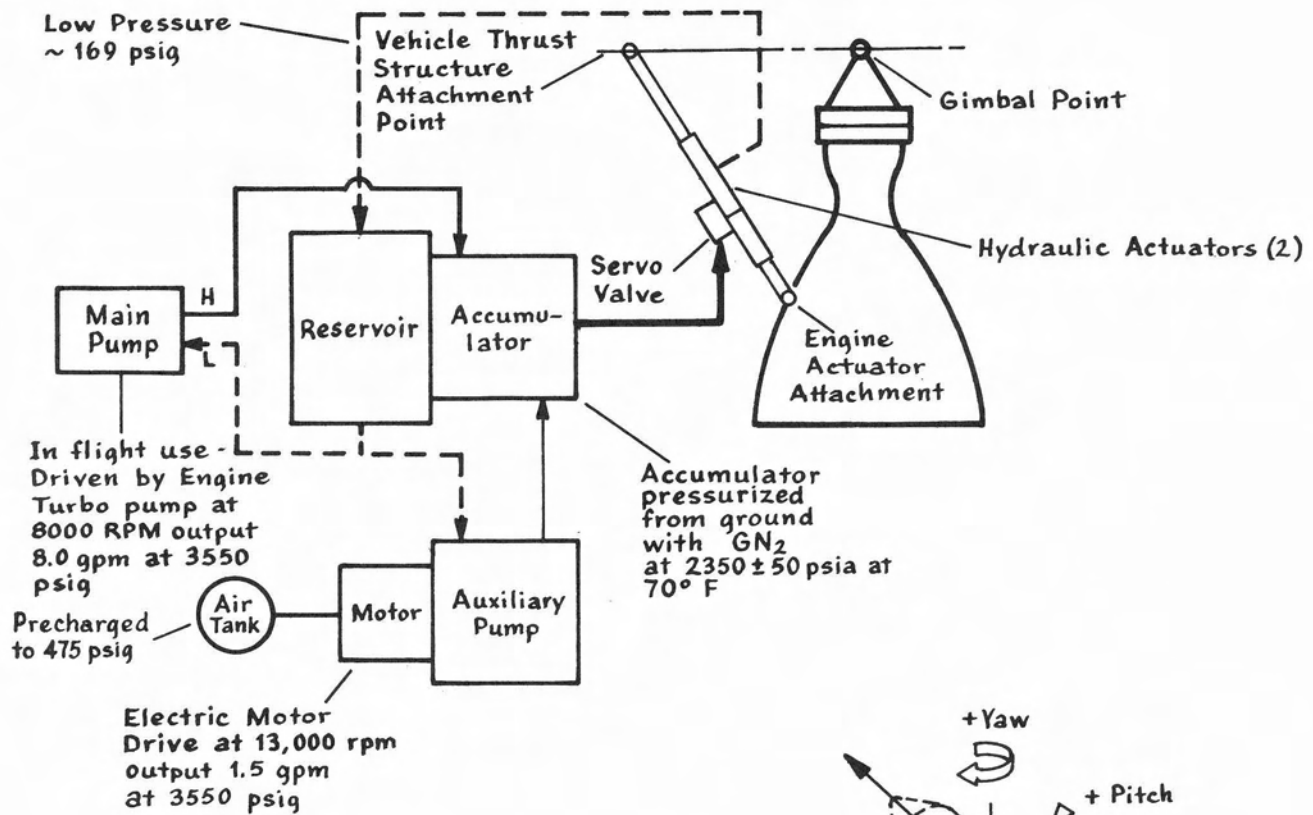
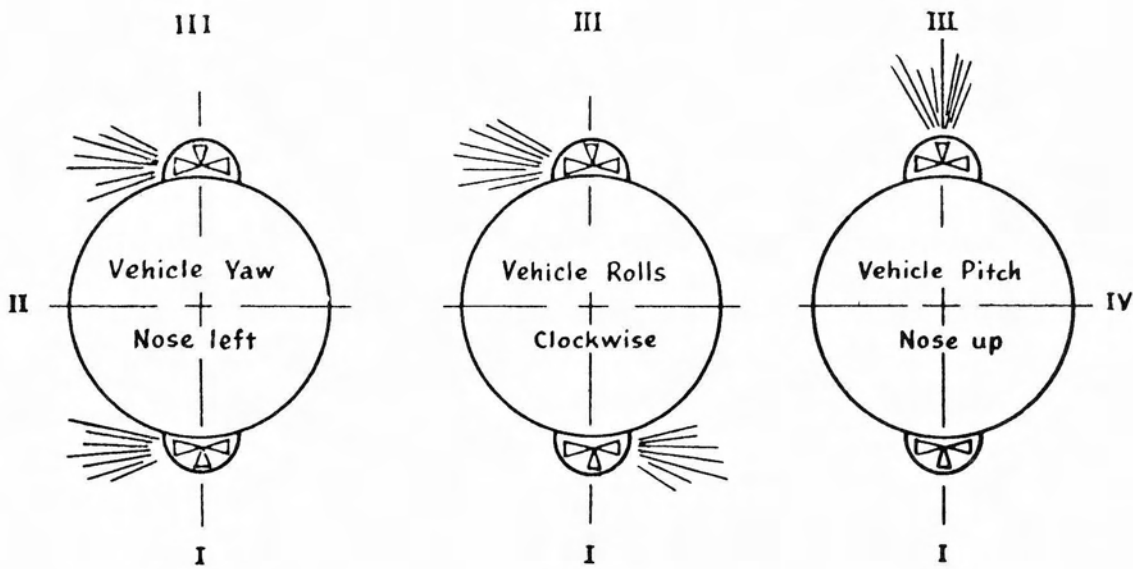
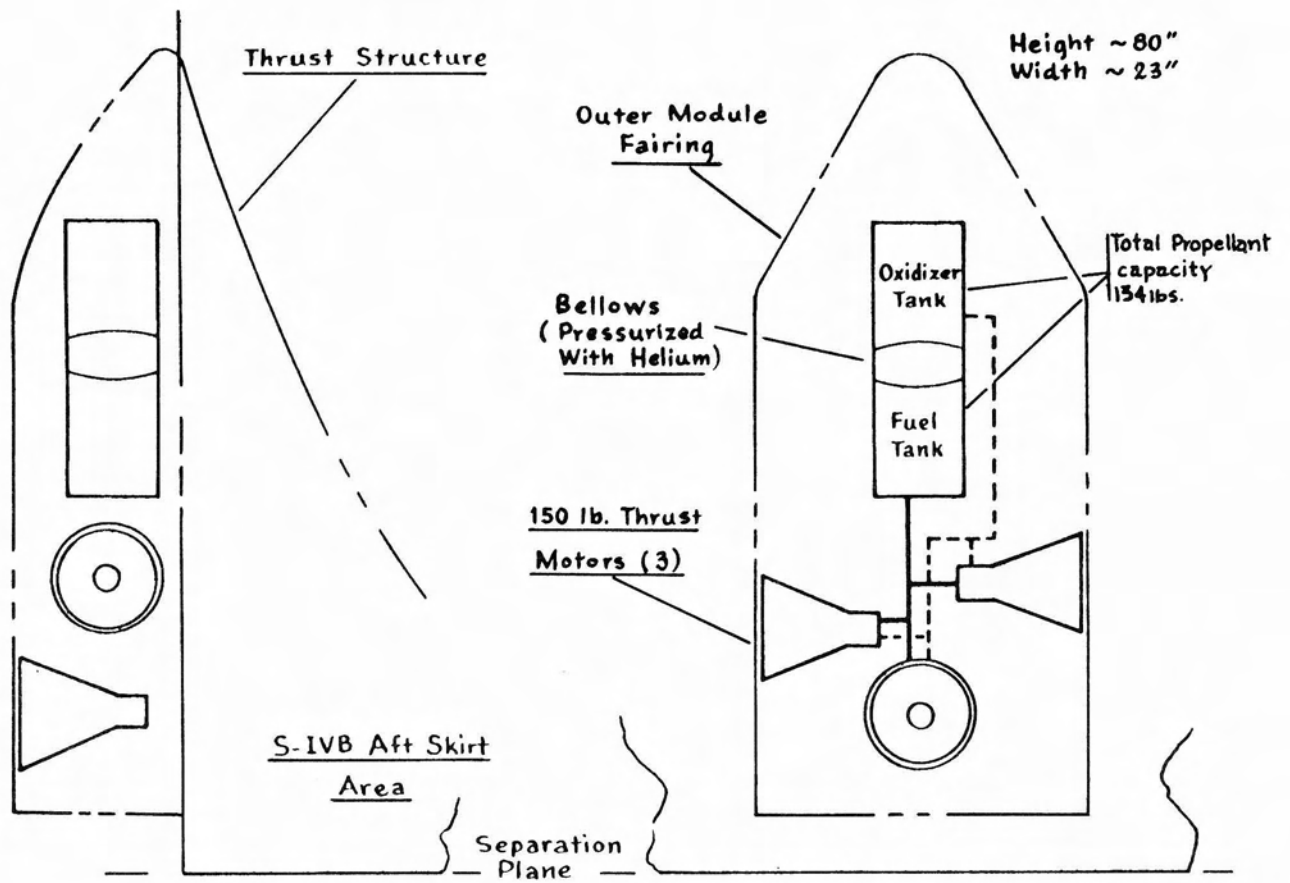

Figure 30

S-IVB Stage Thrust Vector Control System

AUXILIARY PROPULSION SYSTEM

The APS consists of two self-contained attitude control modules mounted 180 degrees apart on the aft skirt of the S-IVB stage. Each attitude control module contains three thrust motors which use hypergolic propellant (nitrogen tetroxide (N_2O_4) and monomethylhydrazine (MMH)). The thrust motors are pulse-fired and no ignition system is required. The thrust motors provide pitch, yaw and roll control during the S-IVB coast mode of operation, and roll control during powered flights.



View from aft
looking forward or
downrange

Figure 31

Auxiliary Propulsion System

Summary of Measurements	
Inflight	S-IVB-3
1. Liquid Level	6
2. Temperature	208
3. Pressure	138
4. Strain	12
5. Vibration	40
6. Signals	81
7. Voltage & Current	46
8. Miscellaneous	59
Total	~590
LCC (Blockhouse)	~151 *

Note: There were ~468 inflight and ~128 LCC measurements on S-IVB-1.

*121 LCC measurements are also used as inflight measurements.

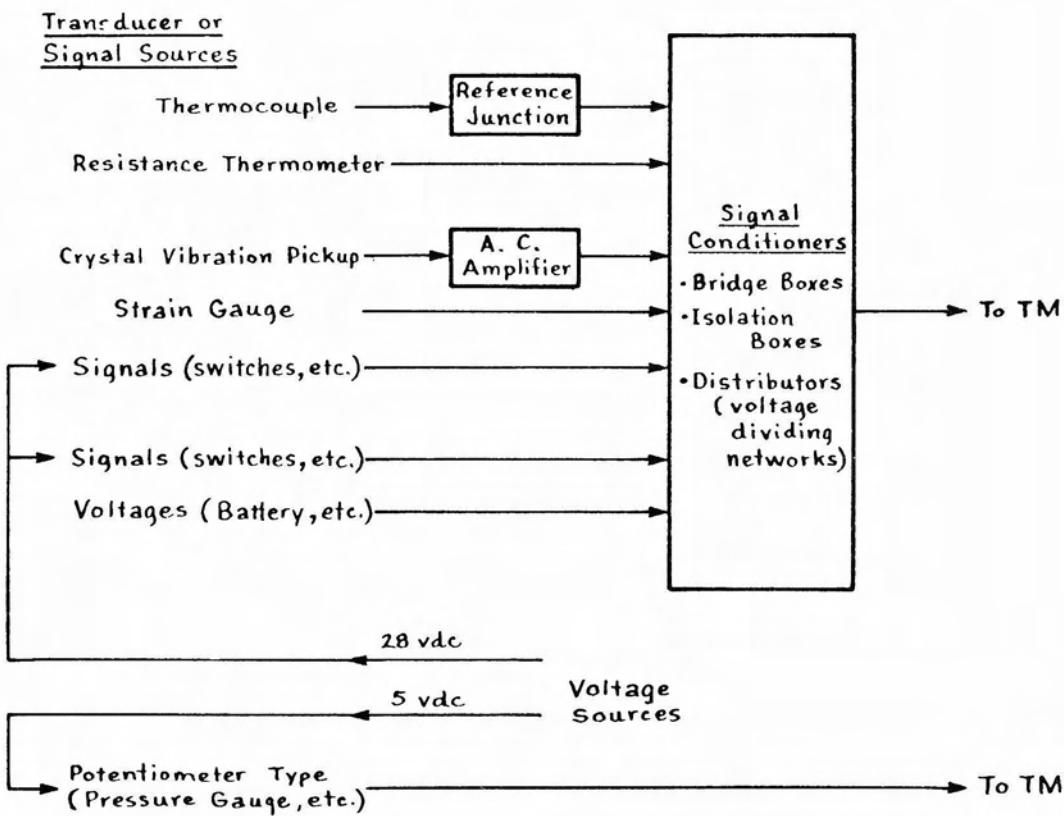

Figure 32

S-IVB Stage Measuring System

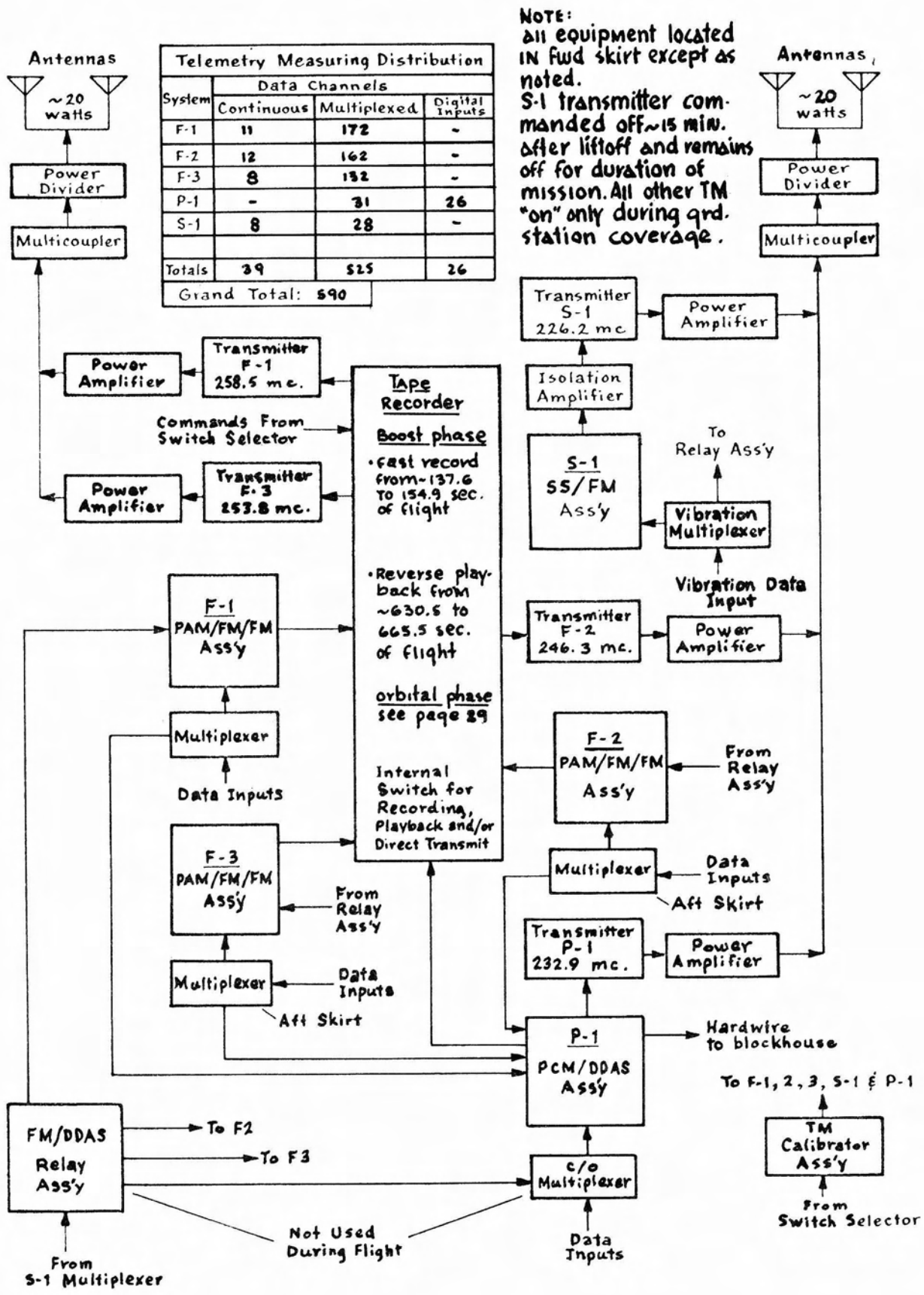

Figure 33

S-IVB Stage telemetry System

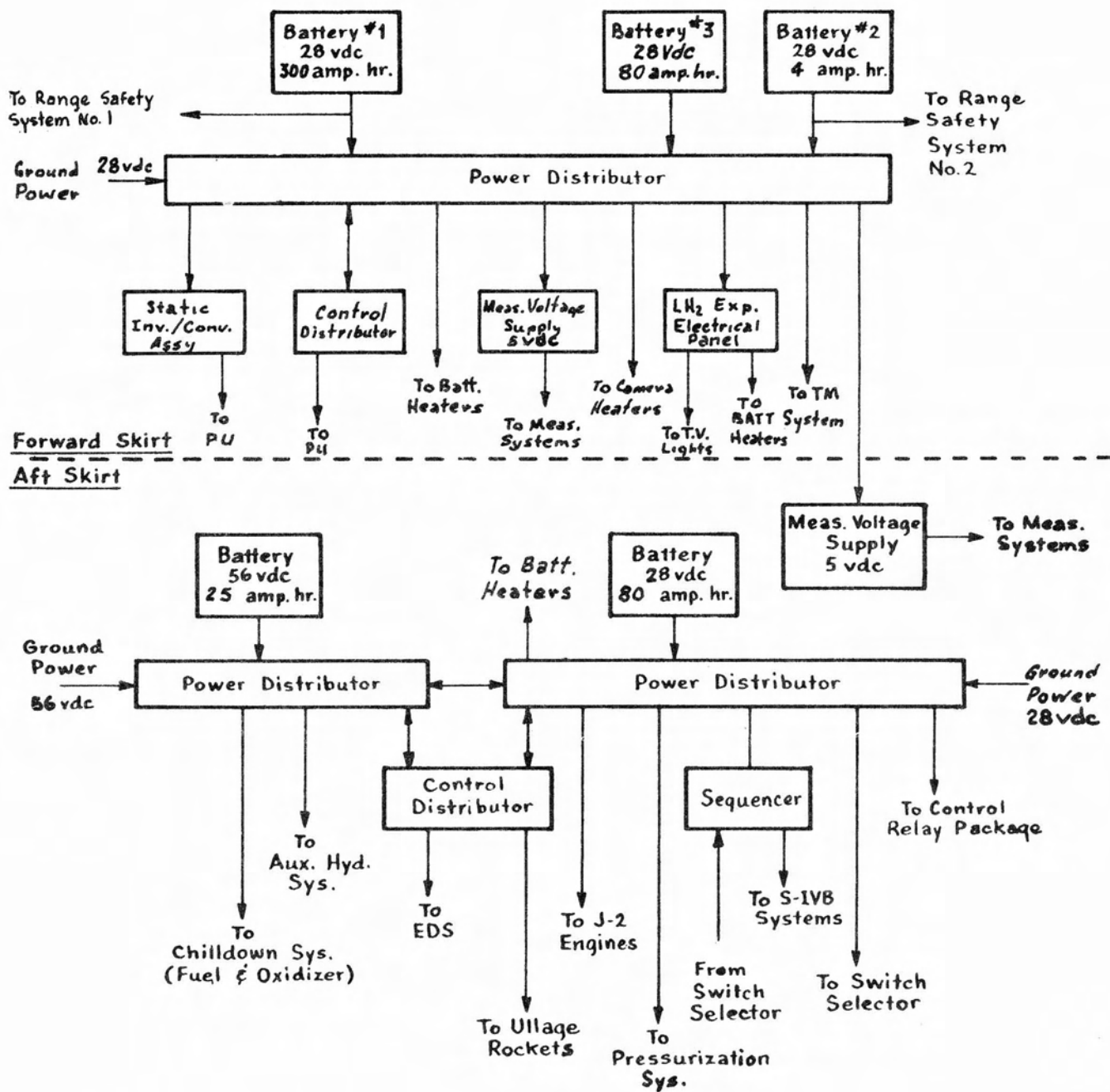

Figure 34

S-IV B Stage Electrical Power and Distribution System

Intentionally Left Blank

INSTRUMENT UNIT

The S-IU-203 Instrument Unit (IU) structure consists of three arc segments (numbered 601, 602, and 603) of sandwiched honeycomb. The three arc segments are joined with splice plates bolted to the skin and the channel ring segments, thus forming a single unit of honeycomb construction. This construction forms an assembly 260 inches in diameter and 36 inches high. Brackets are bonded to the inner skin to provide mounting surfaces for 16 cold plates, which are 30 inches square. A coolant fluid is circulated through the cold plates to dissipate heat generated by the electrical components mounted on them. This arrangement provides clearance for the landing gear of the Lunar Module to be included in later missions, and for the forward bulkhead of the S-IVB hydrogen tank which extends into the IU. A honeycomb-constructed access door in segment 601 provides access to components within the IU after the IU is assembled as part of the vehicle.

Prior to vehicle launch, a temperature controlled atmosphere is forced into the IU and S-IVB forward skirt from a ground source to maintain a temperature of 60 to 80 degrees Fahrenheit. Compressed air is used as a purging medium up to thirty minutes before the S-IVB stage is loaded with propellant, then the air purge is replaced with a nitrogen purge. The compartment purge will be disconnected at vehicle liftoff by retraction of the IU umbilical service arm.

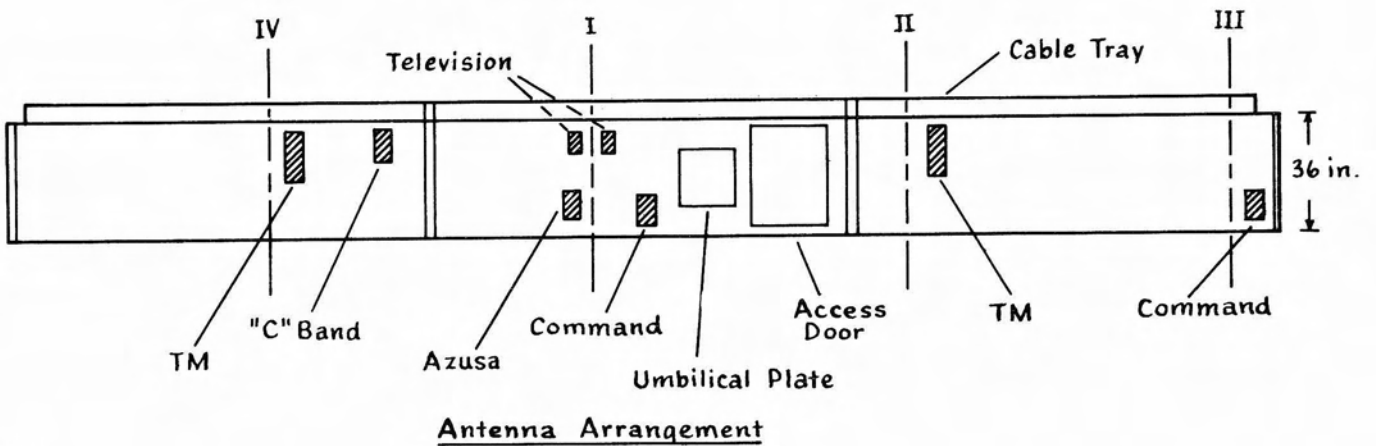
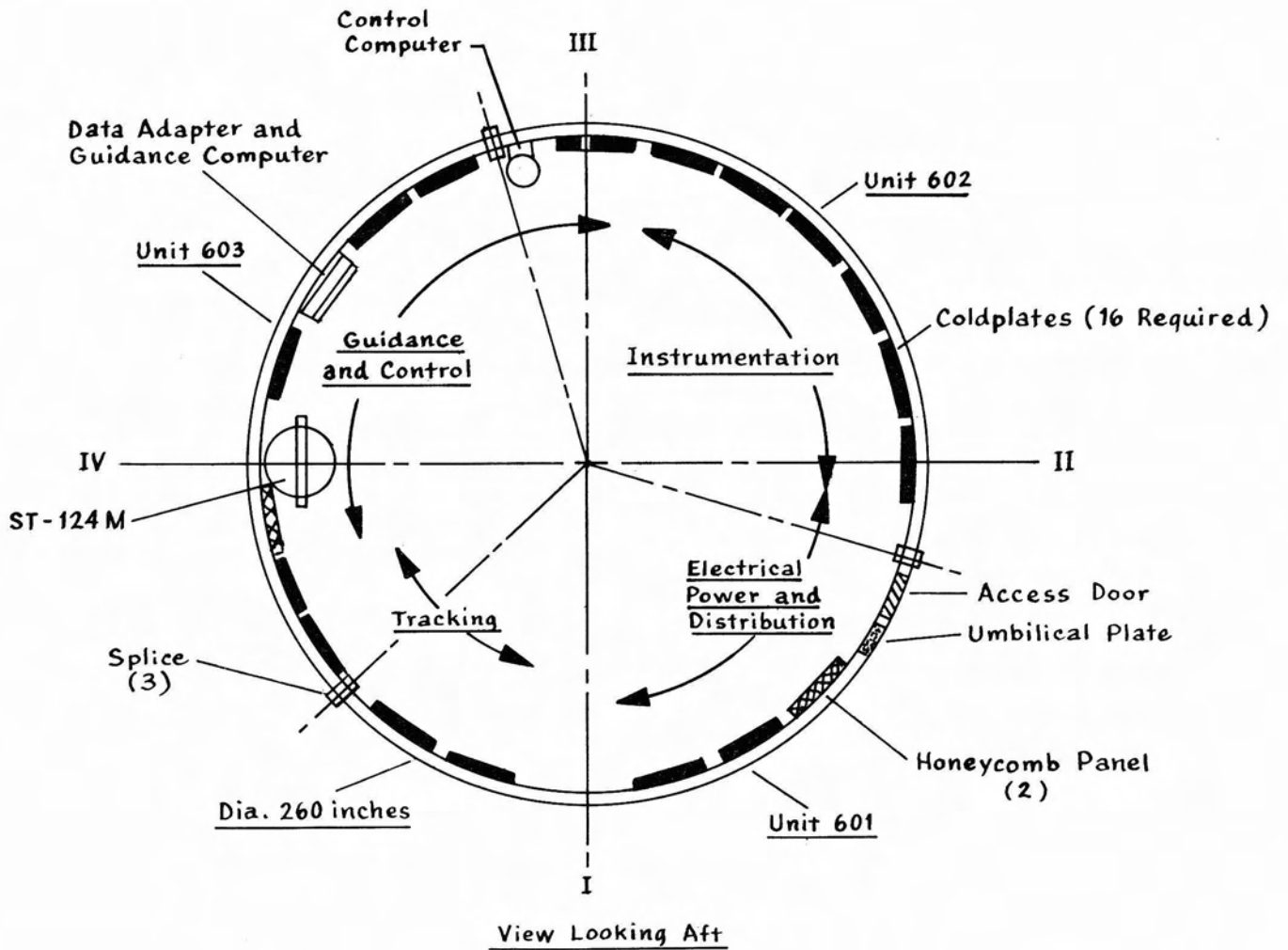

Weight:

- Dry: ~ 4250 lbs.
- At S-IVB ignition: ~ 4560 lbs.
- At S-IVB cutoff: ~ 4560 lbs.

Figure 35

Instrument Unit Configuration

** All blockhouse meas. are also used as inflight meas.

** There were ~303 inflight and ~172 LCC measurements on S-IU-201.

* Includes MSC Experiment measurements.

Summary of Measurements	
	S-IU-203
<u>Inflight</u>	
Voltage, Current & Freq.	27
Pos. & Angular Velocity	45
Temperature	64
Pressure & Flow Rate	33
Vibration	26
Guidance & Control	46
Discrete Signals	87
Miscellaneous	34
	<u>~362*</u>
<u>LCC (Blockhouse)</u>	<u>~224**</u>

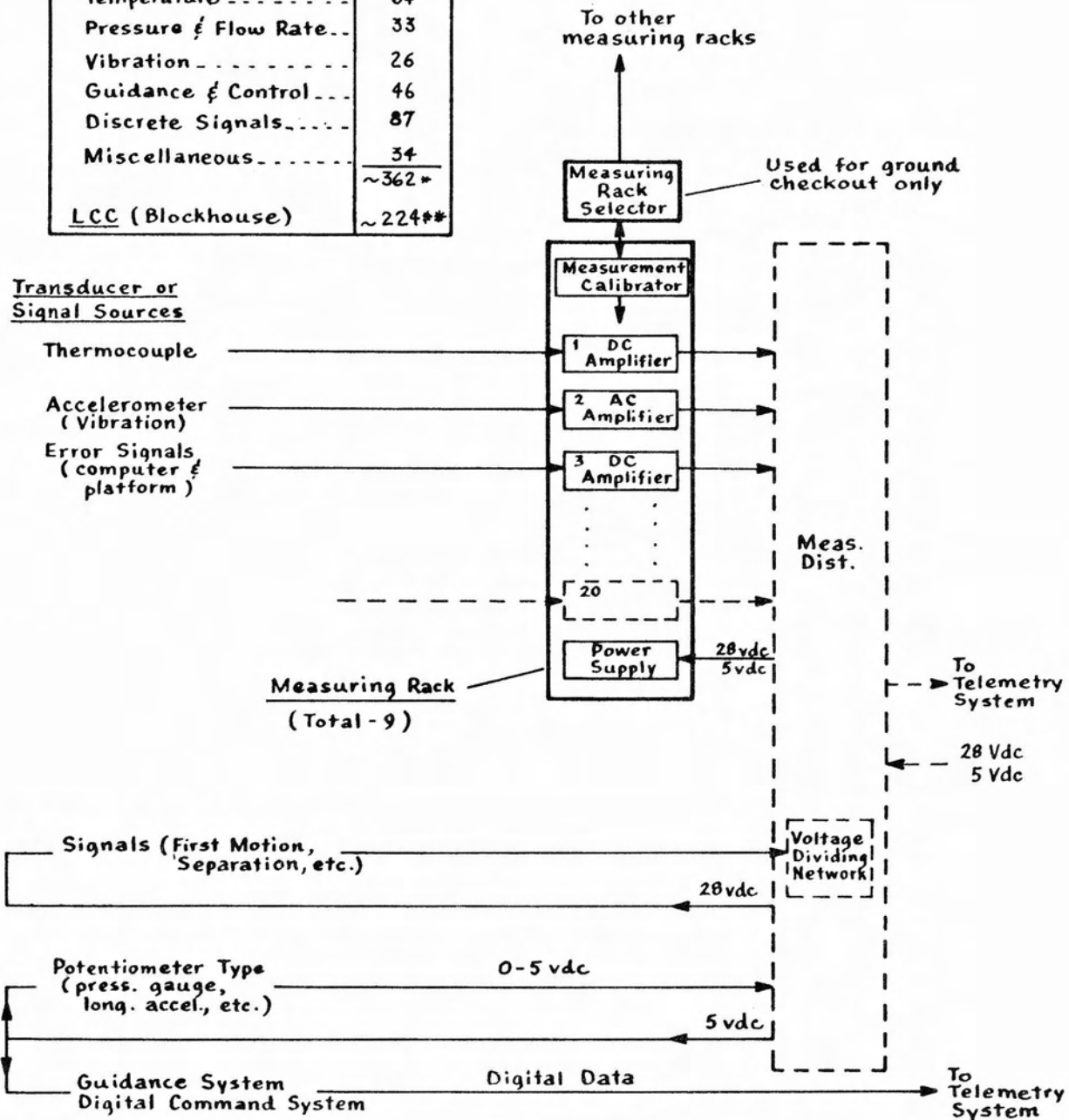

Figure 36

Instrument Unit
Measuring System

Telemetry Channel Assignment		
System	Data Channels	
	Continuous	Multiplexed
F-1	22	1
F-2	15	128
P-1	-	317
S-1	1	29
Total	38	481
Grand Total: 519		

Note: The IU telemetry system remains on continuously during flight.

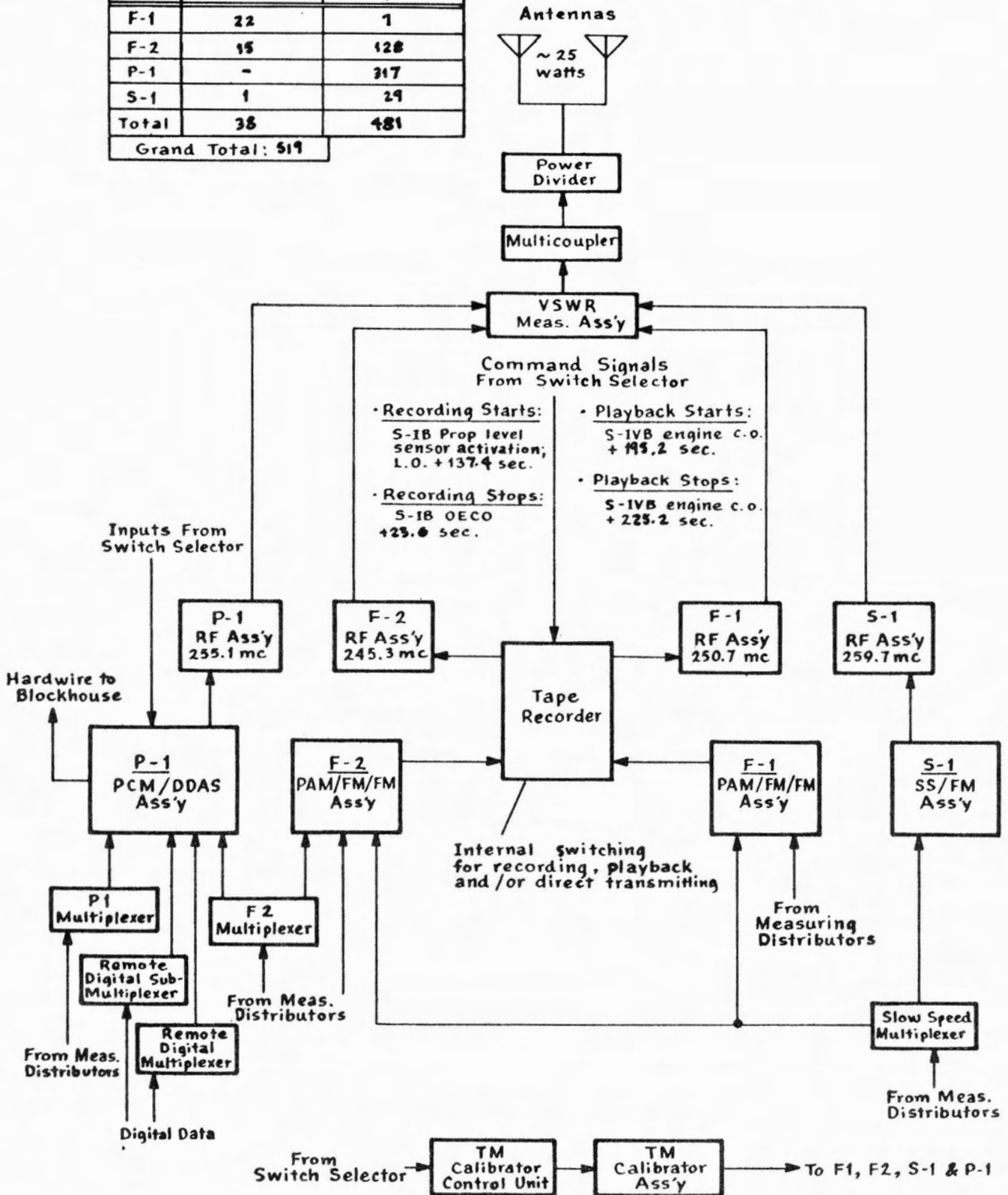

Figure 37

Instrument Unit
Telemetry System

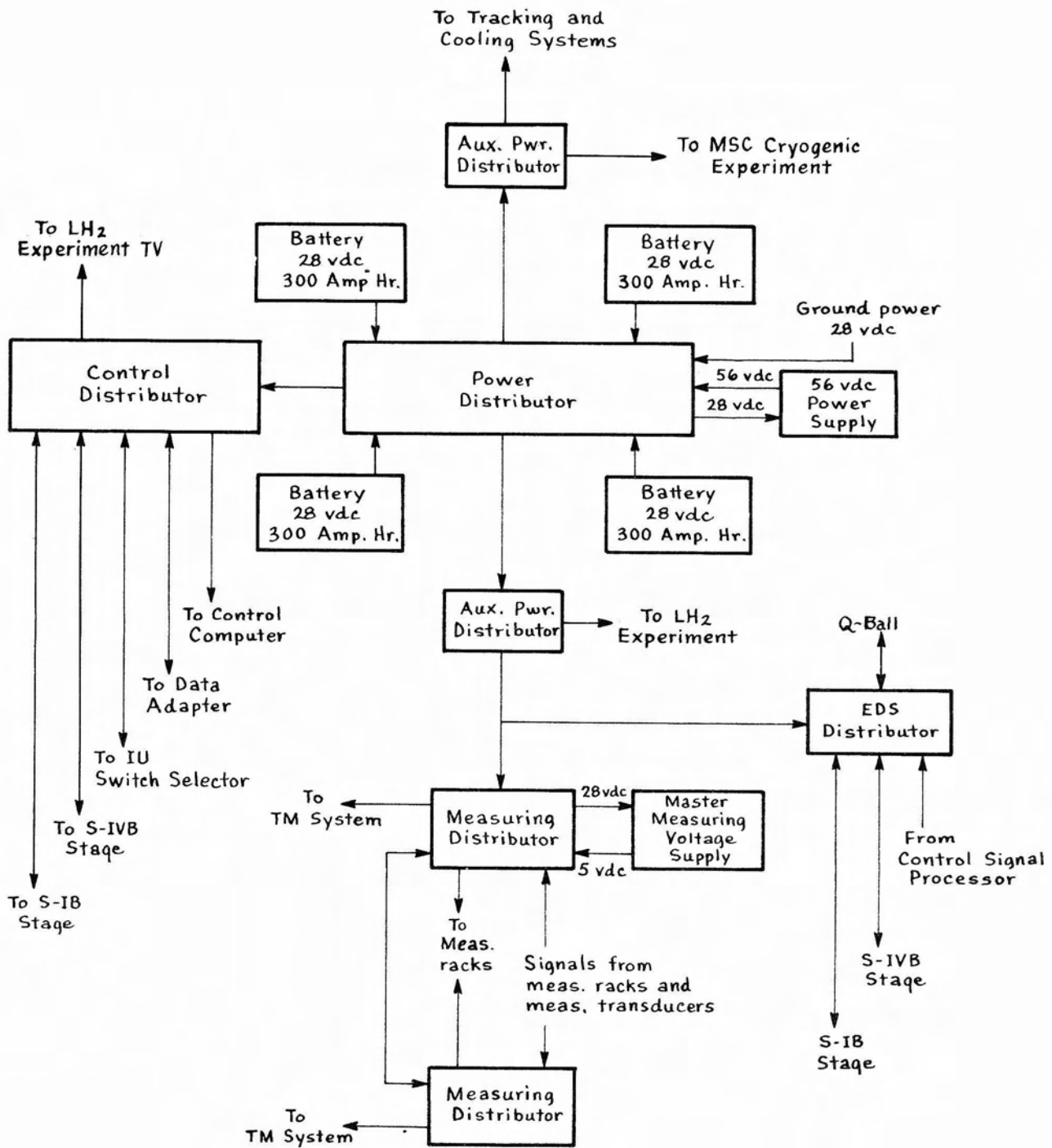

Figure 38

Instrument Unit Electrical Power and Distribution System

Intentionally Left Blank

ENVIRONMENTAL CONTROL SYSTEM (ECS)

Heat generated by the electronic equipment located in the S-IVB forward skirt and the IU is dissipated by circulating a methanol-water solution through the coldplate network.

Prior to liftoff, a methanol-water solution is supplied and circulated through the coldplates from the GSE. After liftoff the ECS is a self-contained unit which begins operation 3 minutes after liftoff when the sublimater is activated.

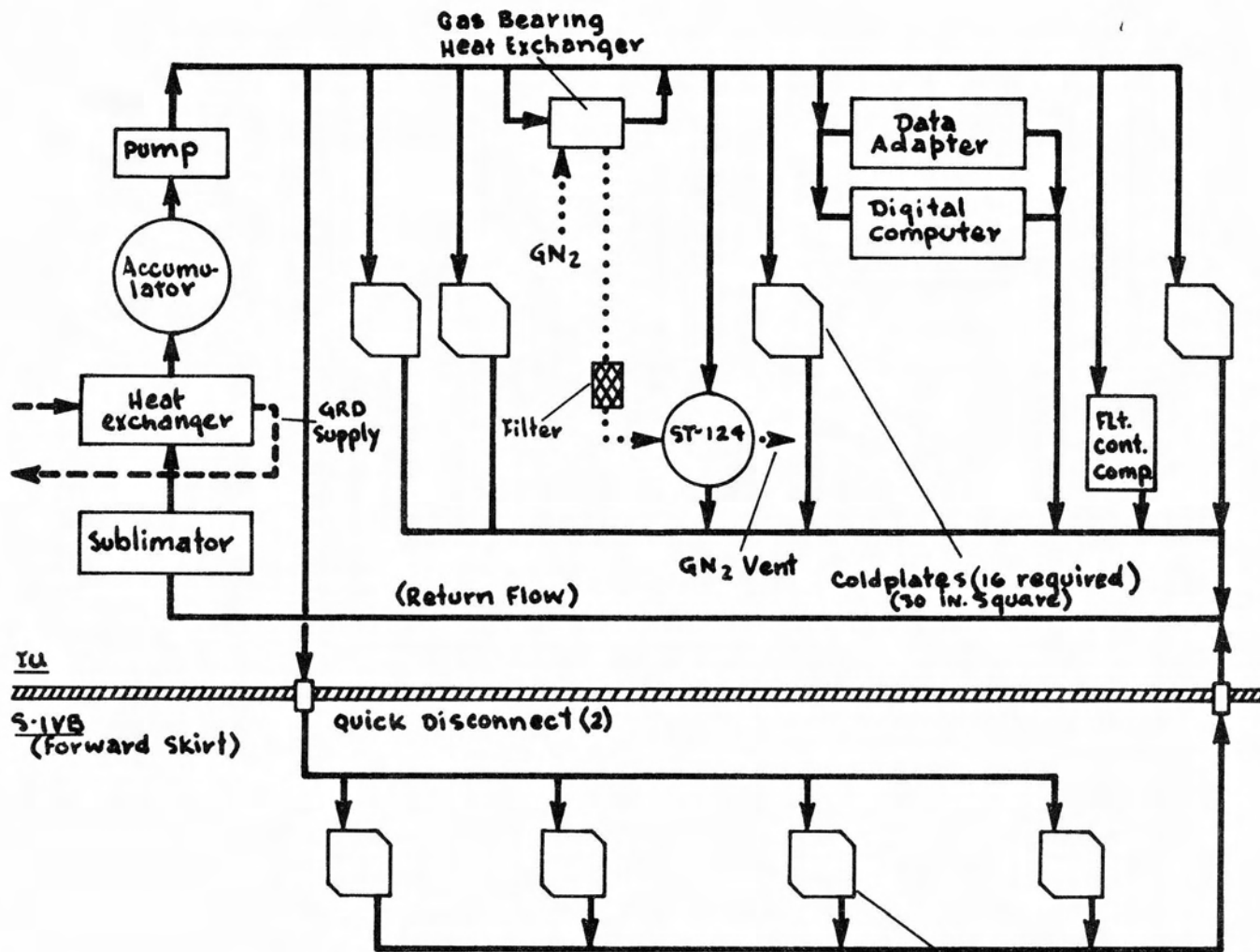

————— Methanol-Water (closed system)
 - - - - - Methanol-Water (GSE Supplied)
 GN₂

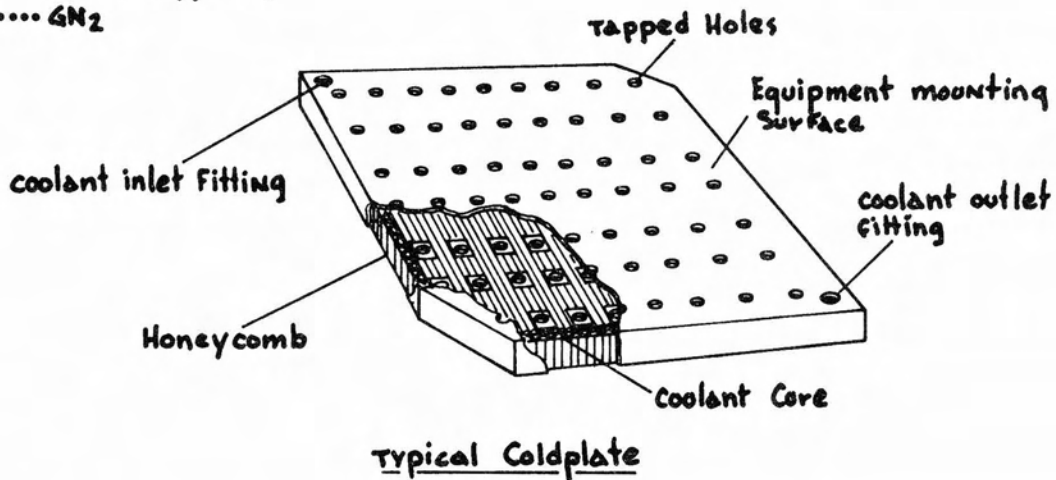

Figure 39

IU/S-IVB Environmental Control System

MSC EXPERIMENT PACKAGE

The MSC experiment is a subcritical cryogenic storage system orbital test. The purpose of the experiment is to demonstrate operation of the system in a weightless condition. The cryogenic fluid will be liquid nitrogen, which was chosen to simulate liquid oxygen to eliminate the possibility of hazard to the booster and to eliminate the need for purging.

The experiment will attempt to verify the stratification of the liquid phase, quantity measurement of the two-phase fluid, and uniform delivery of gas in the weightless environment.

The experiment hardware consists of a spherical tank and signal conditioner plate. Sensor equipment is located on the vessel, and the sensor output is conditioned at the equipment mounted on the plate. The parameters to be measured will be transmitted by the IU telemetry system.

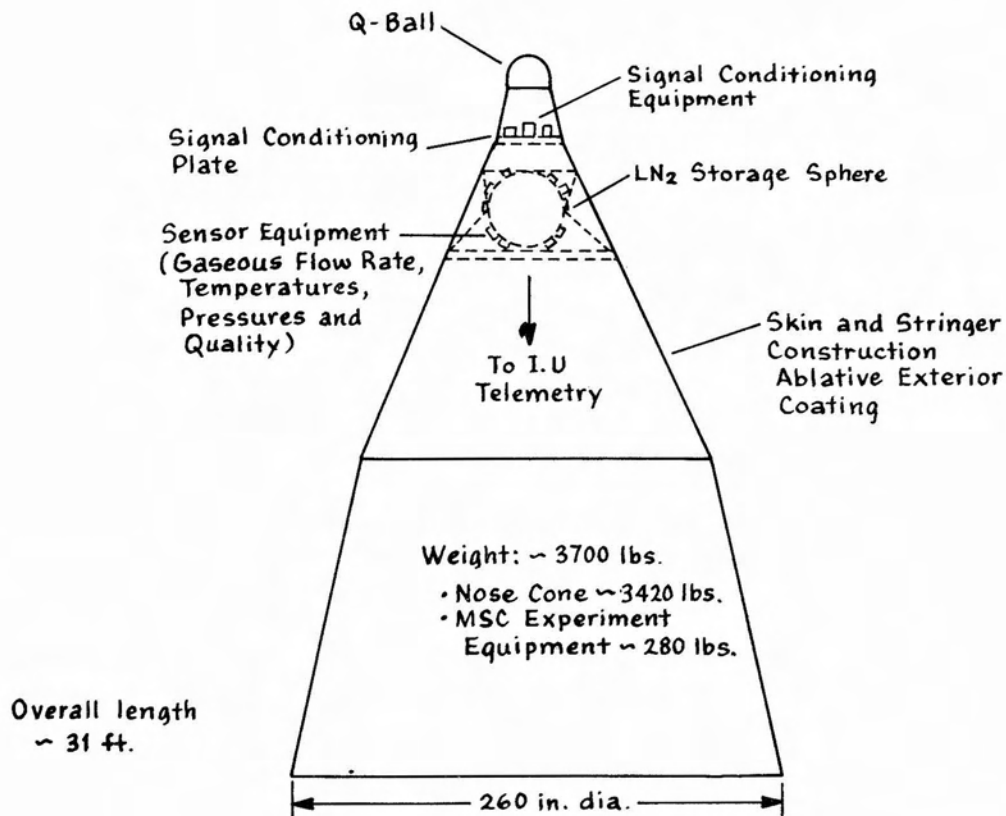

Figure 40

Nose Cone Configuration