

28 April 1965

TO: Distribution

FROM: Mr. R. Farmer

SUBJECT: THE COARSE ALIGN LOOP USING THE ELECTRONIC COUPLING DATA UNIT (CDU)
(Paper X)

I. Introduction

The purpose of this memo is to analyze the performance of the coarse align loop for the Block II Command Module and LEM Systems.

An integral component of the loop is the Electronic Coupling Data Unit. Familiarity with the operation of this device is assumed. (Ref. 1-8)

II. Conclusion

The present coarse align loop mechanization has adequate stability. The rate limiting necessary for protection of the gyro's can be achieved by providing additional counting speeds for the gimbal angle counter.

1. Block Diagram

The coarse align loop is shown in block diagram form in Figure 1. The normal coarse align mode is obtained when the computer sends to the CDU the coarse align and the enable error counter signals. The coarse align signal causes the $\Delta\theta_c$ pulses from the Read Counter to be fed back to the error counter. In addition, the coarse align relays in the PSA are energized.

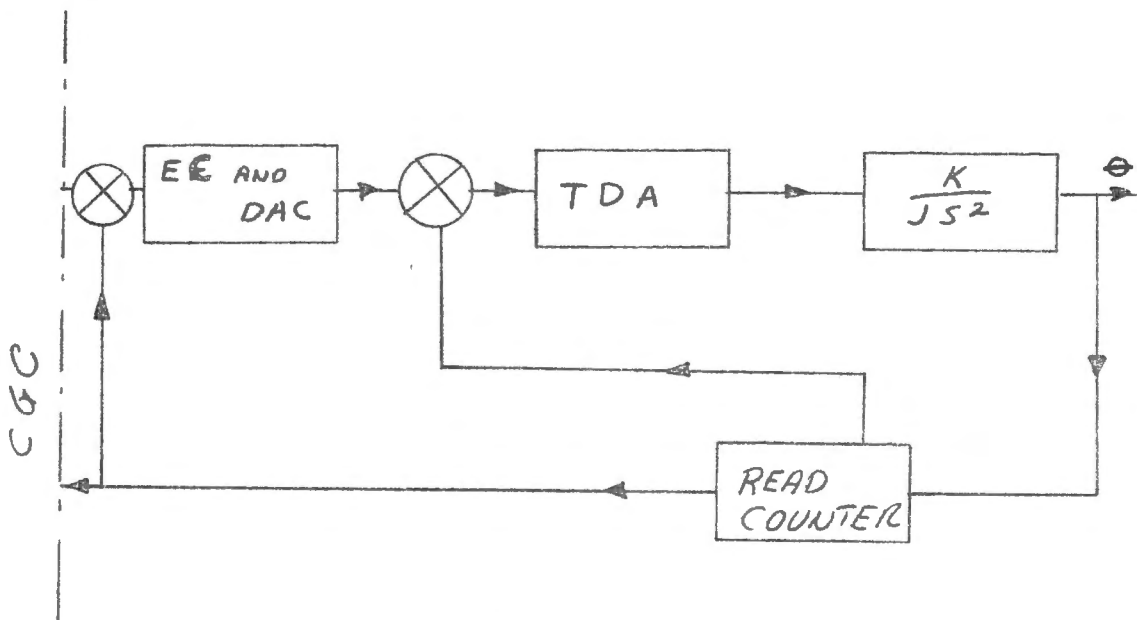

FIGURE 1
COARSE ALIGN LOOP

2. Torque Drive Amplifier

Energizing the coarse align relays in the PSA switches the reference voltage of the demodulator from 3200 cps to 800 cps. The input is switched from the output of the gyro preamp to the output of the Digital to Analog Converter.

To insure stability when the gain is reduced (1500 MV/MR to 17.5 MV/MR) when entering coarse align, the compensation of the torque drive amplifier is changed by switching in additional capacitance. The open loop Bode plot of this loop (neglecting CDU and CGC) is shown in Figure 2.

The gain of the torque drive amplifier is adjusted for each gimbal so that the open loop frequency plot is the same for all three loops. This assures adequate gain and phase margin in all three loops even though the closed loop characteristics are different for each gimbal. (θ vs Torque dist)

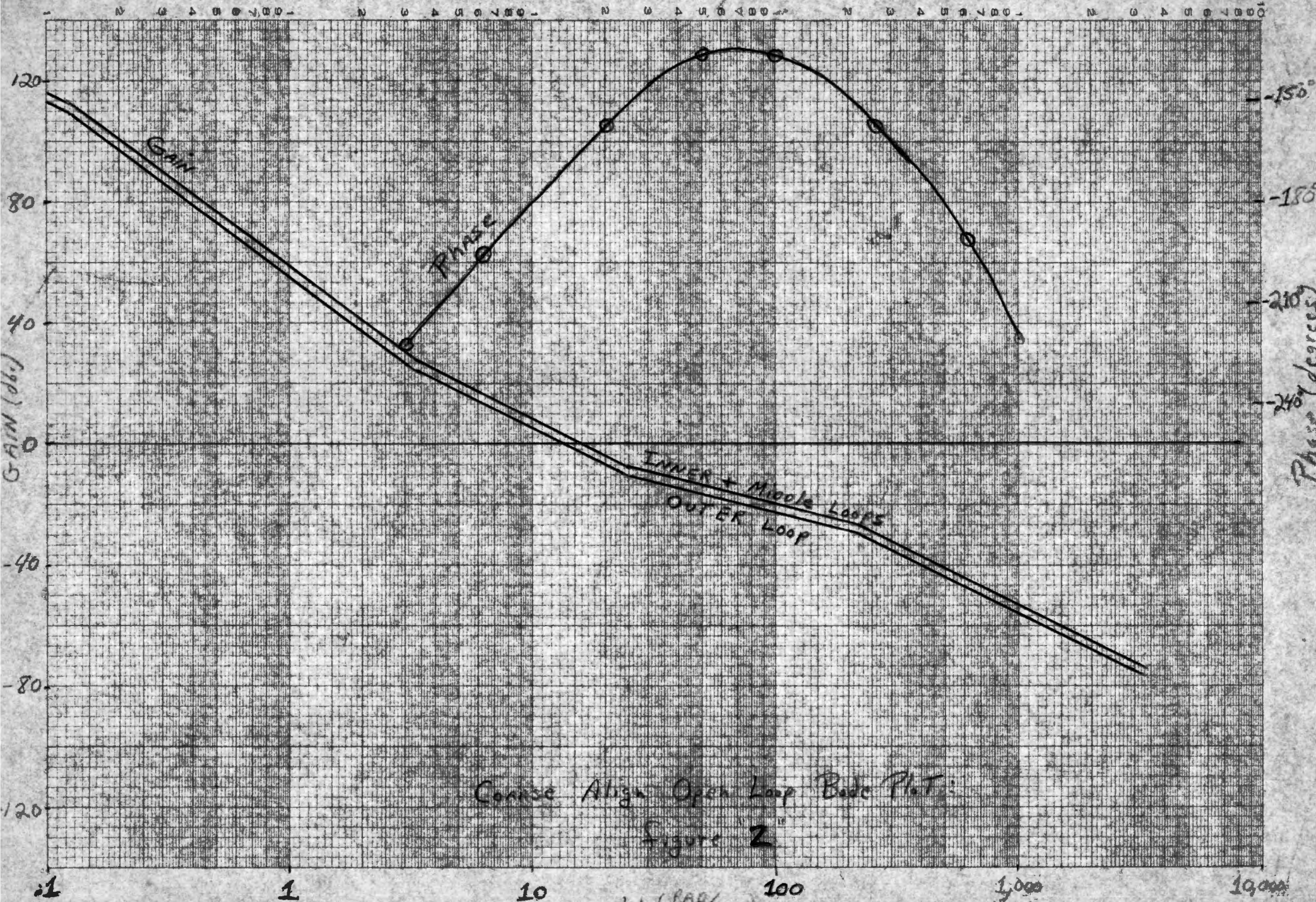

Concise Align Open Loop Bode Plot:
Figure 2

3. The Coupling Data Unit

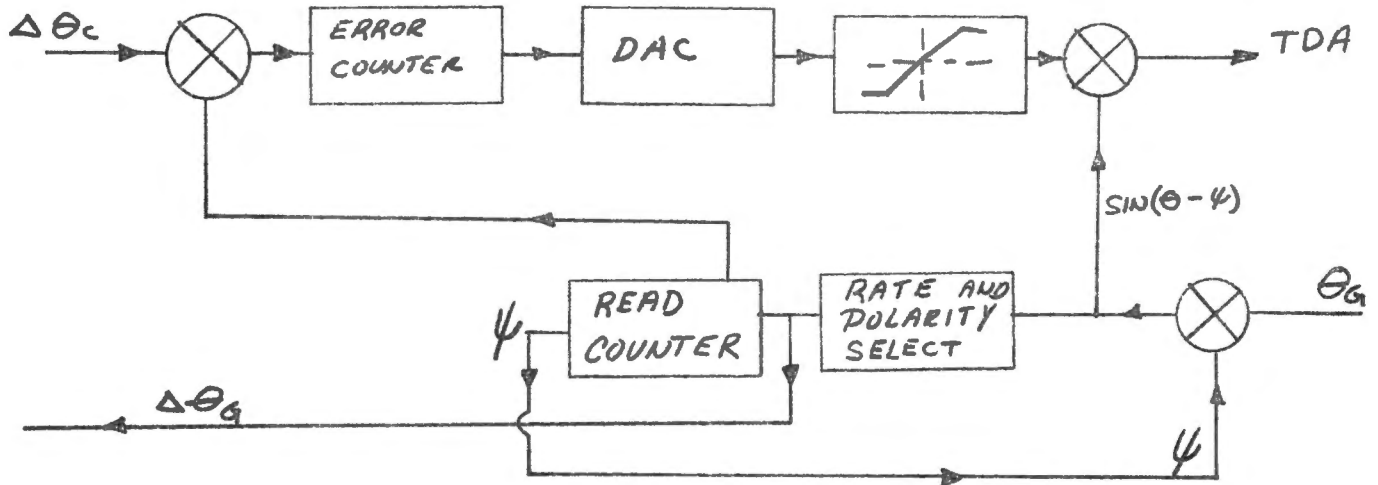

In the coarse align mode, the computer calculates a desired change in gimbal angle and converts this angle into a number of $\Delta\theta_c$ pulses to be sent to the error counter. These pulses are sent to the error counter at a rate of 3200 pps in 80 millisecond bursts. These bursts can be repeated every 240 milliseconds. Each pulse has a weight of 160 sec.

The contents of the error counter is converted to an 800 cps amplitude modulated analog voltage by the digital to analog converter. This voltage has a scale factor of 0.3 volts (rms)/degree. This voltage is limited and sent to the torque drive amplifier to move the gimbals. As the gimbals move, $\Delta\theta_G$ pulses are generated. These pulses are fed back to the error counter. The error counter reaches a null when the gimbal angle has moved an amount equal to the ^{voltage} pulses sent by the computer to the error counter.

The rate at which the gimbals move must be limited to prevent damage to the gyro's. The rate is limited by feeding back the coarse and fine error signals. These signals, depending on the relative gain, will limit the gimbals to either the high or the low counting speed of the read counter. This action is explained below.

4. Rate Limiting

The rate limiting of the coarse align loop can be studied by considering the block diagram below:

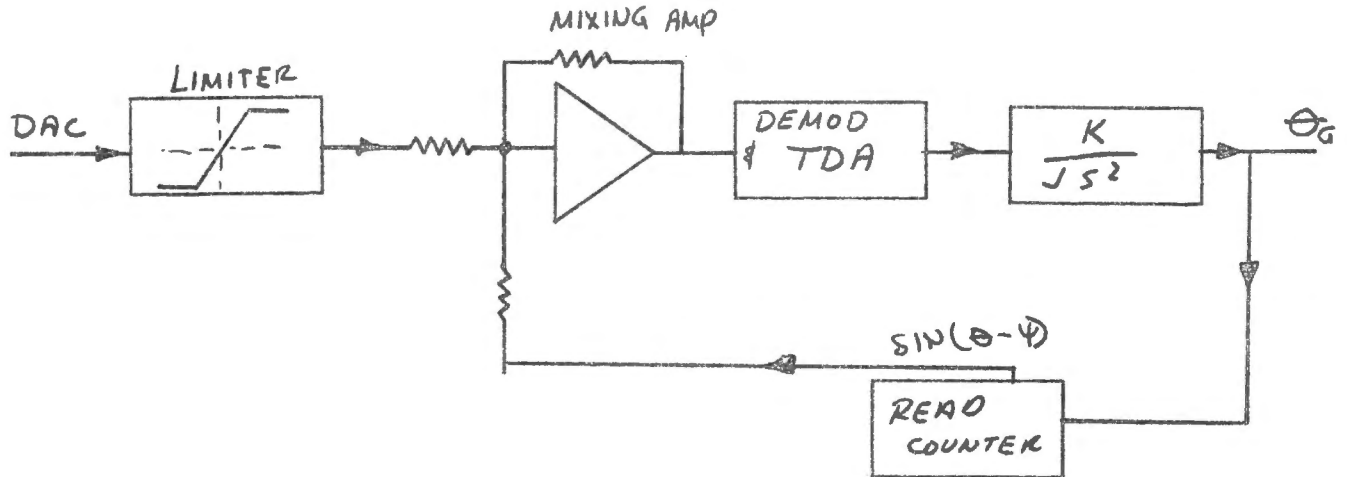

The steady state action of the gimbals can be deduced by determining the conditions under which the output of the mixing amplifier is nulled.

The output of the mixing amplifier will be a null (except for small output to overcome friction) when the input from the DAC (after limiting) is exactly cancelled by the error signal from the CDU. Since limiting of the DAC voltage occurs at a small angle (≈ 1.6 degrees), it is a reasonable assumption that the rate limiting must function with a constant voltage out of the limiter. A null at the mixing amplifier is obtained when this voltage equals the error signal:

$$V_{DAC} = K \sin(\theta - \psi) \approx K(\theta - \psi)$$

The CDU error signal will be a constant only when the gimbal and the CDU are going at the same rate with the gimbal leading the CDU angle.

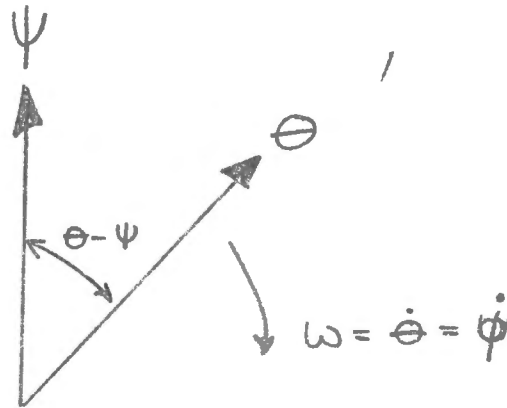

Since the CDU is constrained to counting at one of two speeds, the gimbals will be constrained to a rate equal to one of these two speeds depending on the relative gain of the fine and coarse error signals.

If the gimbals are moving faster than the CDU is counting, the signal, $\text{SIN}(\theta - \psi)$ will increase causing a retarding torque to be generated by the TDA. If the gimbals are moving slower than the rate at which the CDU is counting $\text{SIN}(\theta - \psi)$ will decrease and the TDA will cause an accelerating torque to be applied to the gimbals.

An analogy may be drawn here between this and the action of the synchronous motor in that the rotor pole lags some spatial angle behind the stator pole. This spatial angle is referred to as the torque angle. The important feature being that the rotor and stator rotate at the same speed.

Therefore, by adjusting the gain of the coarse or fine error signal into the mixing amplifier, the gimbal rate can be limited to either 70° per second (12.8 Kpps counting rate) or 4.5° per second (800 Kpps counting rate). Limiting to any other speed rate can be easily accomplished by using different counting speeds.

5. High - Low Counting Speeds

When the gimbal is being driven at a rate which is in excess of the slow counting speed but less than the high counting speed, the error signal (both coarse and fine) is a constant. The high ternary signal is present and causes high speed counting whenever the fine error signal is in excess of 0.1° (1X). When the error is less than 0.1° , low speed counting will result. For any gimbal rate between 4.5 degrees per second and 70 degrees per second, the error signal will remain constant (except for switching hysteresis): the amount of time spent in fast counting will be directly proportional to the gimbal rate in excess of 4.5 degrees per second.

6. Switching Hysteresis

Because the gimbal angle counter can switch counting speeds only when an interrogate pulse occurs, the waveform of the error signal is not as simple as implied above. The various wave shapes of this error are shown for several gimbal rates. While these waveforms show some change in average value with gimbal rate, the difficulty in filtering to obtain a usable signal is appreciable. Studies are presently underway to attempt this.

7. Conclusion

The coarse align loop has been analyzed. It is recommended that the necessary rate limiting be obtained by using gimbal angle counting speed equivalent to the desired 15 degrees per second.

Written by:

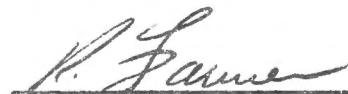

R. Farmer
Inertial Subsystem Group
Apollo Engineering

Approved by:

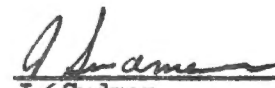

J. Sudman
Inertial Subsystem Group
Apollo Engineering

/np

ERROR VS TIME FOR VARIOUS GIMBAL RATES

$$\epsilon \triangleq \sin(\theta - \psi)$$

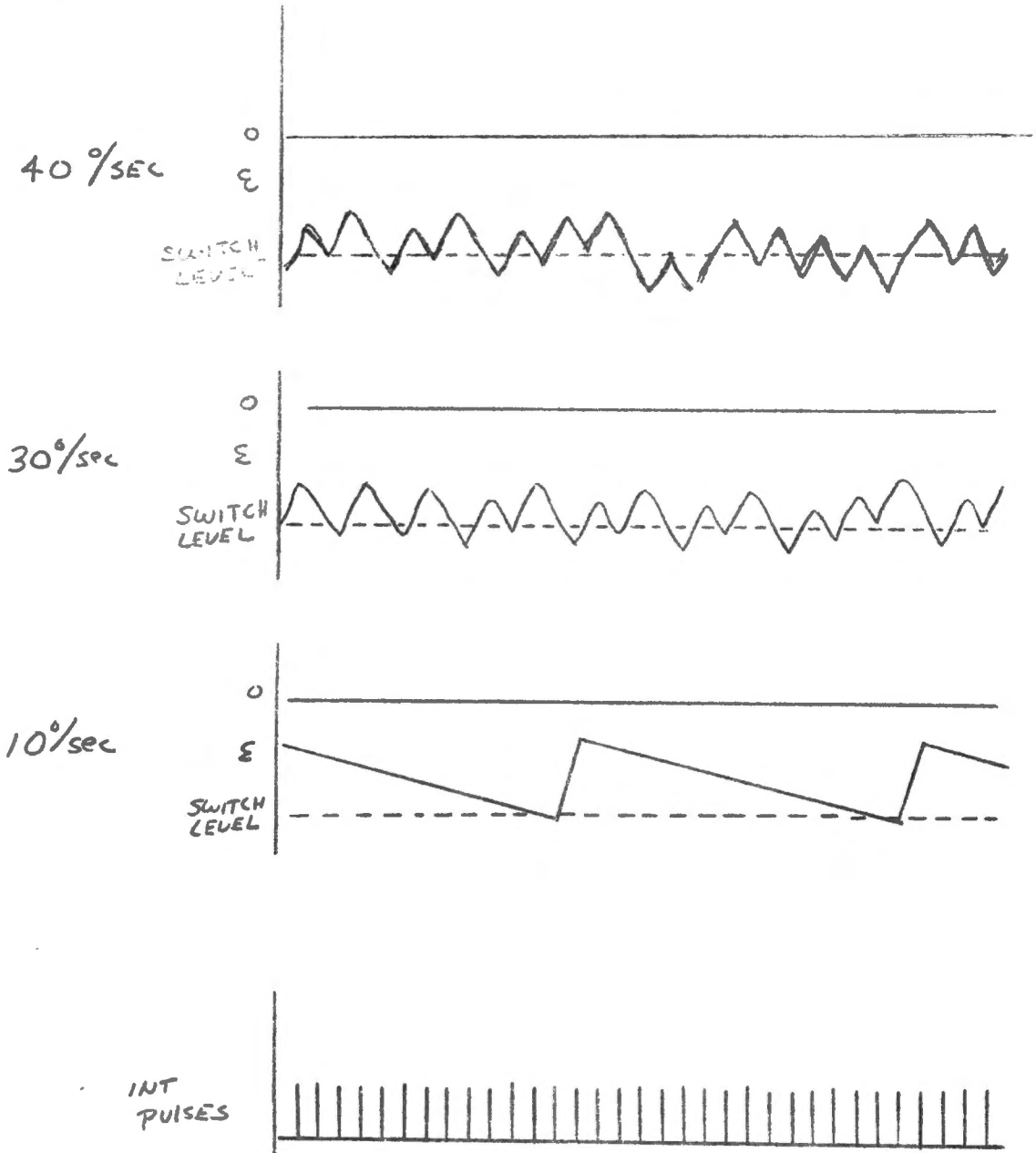

REFERENCES

1. Apollo Engineering Memorandum #4481, by Mr. P. Grant
Subject: An Introduction to the Electronic Coupling Data Unit (ECDU)
(Paper I)
2. Apollo Engineering Memorandum #4544, by Mr. P. Grant
Subject: The Coarse System of the Electronic Coupling Data Unit (ECDU)
(Paper II)
3. Apollo Engineering Memorandum #4636, by Mr. P. Grant
Subject: The Power Supply and Common Circuits of the Electronic Coupling
Data Unit
(Paper III)
4. Apollo Engineering Memorandum #4850, by Mr. P. Grant
Subject: The Fine System of the Electronic Coupling Data Unit (ECDU)
Part I (Paper IV)
5. Apollo Engineering Memorandum #4927, by Mr. P. Grant
Subject: The Fine System of the Electronic Coupling Data Unit (ECDU)
Part II (Paper V)
6. Apollo Engineering Memorandum #5009, by Mr. P. Grant
Subject: The Quadrature Rejection Network of the Electronic Coupling
Data Unit (ECDU)
(Paper VI)
7. Apollo Engineering Memorandum #5041, by Mr. B. Hobbs
Subject: The Digital to Analog Converter of the Electronic Coupling
Data Unit
(Paper VII)
8. Apollo Engineering Memorandum #5792, by Mr. P. Grant
Subject: The Digital System of the Electronic Coupling Data Unit
(Paper VIII)

DISTRIBUTION LIST

(ACSP)

Digital Systems Group
Don Gothard
Mark Mastandrea
Don Grassell
Gordon Hinricks
Dick Streufert
Joe Calabretta
Ed Herbert
Don French
Jim Temmel
George Hoffman
Jim Whiteman
Jerry Wachholz
John Albert
Lloyd Mosier
Les Garhardt
John Prange (38-03)

(NAA)

Jim Corrigan

(RAYTHEON)

Fritz Reichert
Paul Grant

(MIT/IL)

Glenn Cushman (7)
Mark Birnbaum
Bob Kowalski
Bob Lee
Marv Smith
John Barker
Ted Rogers

Steve Glatch (7)
Bob Erickson
John Weber
Ken Kido
Marty Sack
Gerry McWeeney
Keith Cherne

Rom Gilbert (9)
R. Lones
Dick McKern
Jerry Gilmore
Bob Therrien
George Slaver
Harry McQuat
Bob Karm
Salvi Laquidara

Harlan Neuville (3)
Dick Drozewski
Alex Koso