

NOTICE - WHEN GOVERNMENT DRAWINGS, SPECIFICATIONS, OR OTHER DATA ARE USED FOR ANY PURPOSE OTHER THAN IN CONNECTION WITH A DEFINITELY RELATED GOVERNMENT PROCUREMENT OPERATION, THE UNITED STATES GOVERNMENT THEREBY INCURS NO RESPONSIBILITY FOR ANY OBLIGATION WHATSOEVER, AND THE FACT THAT THE GOVERNMENT MAY HAVE FORMULATED, FURNISHED, OR IN ANY WAY SUPPLIED THE SAID DRAWINGS, SPECIFICATIONS OR OTHER DATA IS NOT TO BE REGARDED BY IMPLICATION OR OTHERWISE AS IN ANY MANNER LICENSING THE HOLDER OR ANY OTHER PERSON OR CORPORATION, OR CONVEYING ANY RIGHTS OR PERMISSION TO MANUFACTURE, USE, OR SELL ANY PATENTED INVENTION THAT MAY IN ANY WAY BE RELATED THERETO.

1006321

REVISIONS			
SYM	DESCRIPTION	DATE	APPROVAL
-	INITIAL RELEASE CLASS A PER TDOR	15729	1/2/65 WK

NOTES:

- GENERAL REQUIREMENTS:
 - UNIT SHALL BE IN ACCORDANCE WITH MIL-S-19500 IN ADDITION TO THE REQUIREMENTS HEREIN.
 - ABSOLUTE MAXIMUM RATINGS AT 25°C AMBIENT:
 - VOLTAGE TO PIN 10: PLUS 10.0 VOLTS WITH RESPECT TO PIN 5
 - VOLTAGE APPLIED TO ANY INPUT PIN PLUS OR MINUS 4 VOLTS WITH RESPECT TO GND PIN
 - THERMAL RESISTANCE, JUNCTION-CASE. (θ_{JC}): 200°C/WATT.
 - THERMAL RESISTANCE, JUNCTION-AMBIENT. (θ_{JA}): 500°C/WATT.
 - TEMPERATURE:
 - TEMPERATURE RANGE, JUNCTION, OPERATING: -55°C TO +125°C.
 - TEMPERATURE RANGE, JUNCTION, STORAGE: -65°C TO +150°C
 - TEMPERATURE, SOLDERING LEADS: +250°C (1 MINUTE MAX.).
 - MARKING: UNITS SHALL BE MARKED IN ACCORDANCE WITH ND-1002019 WITH THE MANUFACTURER'S IDENTIFICATION, DATE CODE, KEYING STRIPE AND THE NUMBER 321. THE NASA DRAWING NUMBER AND REVISION LETTER SHALL BE MARKED ON EACH INTERIOR AND EXTERIOR SHIPPING CONTAINER AS WELL AS ON A TAG TO BE INCLUDED IN EACH SHIPPING CONTAINER. NO BODY PAINT.
- CONSTRUCTION REQUIREMENTS:
 - SEMICONDUCTOR: SILICON. NPN.
 - ENCLOSURE: SEE FIGURE, HERMETICALLY SEALED AND ELECTRICALLY ISOLATED FROM POWER OR GROUND.
 - LEADS: LEAD MATERIAL SHALL BE IN ACCORDANCE WITH NASA DOCUMENT PS 1015402 EXCEPT THAT THE GOLD PLATE SHALL BE A MINIMUM OF 100 AND A MAXIMUM OF 200 MICRO INCHES THICK AND EXCEPT PAR. 3.4. CERTIFICATE OF COMPLIANCE FOR LEAD MATERIAL SHALL ACCOMPANY EACH LOT SHIPPED.
- QUALITY ASSURANCE REQUIREMENTS:
 - LOT: A LOT IS DEFINED AS A GROUP OF PARTS IN A SINGLE PROCUREMENT SELECTED FROM A SINGLE CONTINUOUS PRODUCTION RUN USING LIKE MATERIALS WHICH ARE CONTROLLED USING A PROCESS WHICH IS THE SAME FROM THE BEGINNING TO THE END OF THE RUN. MAXIMUM SHIPPED NUMBER OF UNITS IN ANY LOT SHALL BE 5000 UNITS.
 - INSPECTION CONDITIONS: UNLESS OTHERWISE SPECIFIED HEREIN ALL ELECTRICAL TESTS MUST BE REFERENCE TO AN AMBIENT TEMPERATURE OF PLUS 25 PLUS OR MINUS 1/2 DEGREE CENTIGRADE.
 - ACCEPTANCE INSPECTION: PER TESTS IN TABLES I, II AND III AS INDICATED BELOW
 - THE PRE-ELECTRICAL TEST PROCESSING DEFINED IN TABLE I SHALL BE DELETED IN THE SEQUENCE INDICATED.
 - UNITS USED IN QUALITY DEMONSTRATION TESTS OF TABLE III WILL NOT BE SHIPPED AS PART OF THE DELIVERY SCHEDULE BUT WILL BE FORWARDED ALONG WITH TEST DATA UNDER SEPARATE COVER, TO THE PURCHASER, ATTENTION: PURCHASING AGENT
 - UNITS USED IN TABLE III, SUBGROUPS 1 AND 5 MAY BE ELECTRICAL REJECTS FROM THE SAME LOT.
 - ACCEPTABLE UNITS USED IN TESTING SUBGROUP 2 OF TABLE II SHALL BE USED IN SUBGROUPS 2, 3, AND 4 OF TABLE III. IN TABLE III ACCEPTABLE UNITS FROM SUBGROUP 2 MAY BE USED IN SUBGROUP 5.
 - AFTER COMPLETION OF TESTS, UNITS USED IN SUBGROUP 3 OF TABLE III SHALL BE USED IN SUBGROUPS 6 AND 7 OF TABLE III.
 - THE UNITS USED IN THE QUALITY DEMONSTRATION TESTS SHALL BE RANDOMLY SELECTED FROM THE ENTIRE GROUP OF UNITS WHICH CONSTITUTE A LOT.
 - A LOT MAY BE RESUBMITTED FOR THE QUALITY DEMONSTRATION TEST ONCE. THE REQUIREMENT OF MIL-S-1900C FOR LOT RESUBMITTAL WILL APPLY WITH THE TIGHTENED INSPECTION FOR THE CHARACTERISTICS WHICH FAILED.
 - UNITS SHALL BE DATE CODED INDICATING THE WEEK SEALING OPERATION THAT WAS PERFORMED.

LOGIC SYMBOL

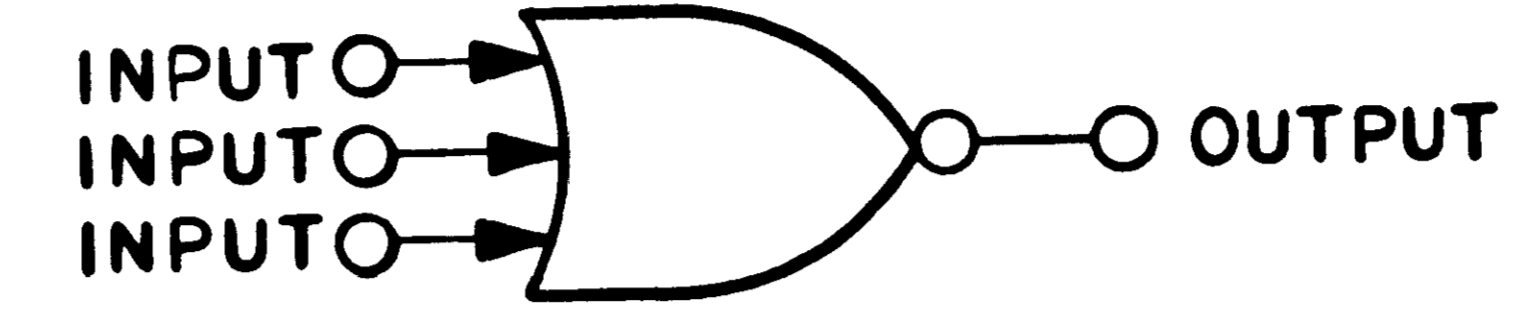

ON SPEC BODY DIMENSIONS MAX INCLUDE ALL GLASS CLIMB. BODY DIM. TO BE SYMMETRICAL ABOUT ϕ WITHIN .010 AND ϕ OF LEADS TO BE SYMMETRICAL WITHIN .005

LEAD DIMENSIONS TYP BOTH SIDES

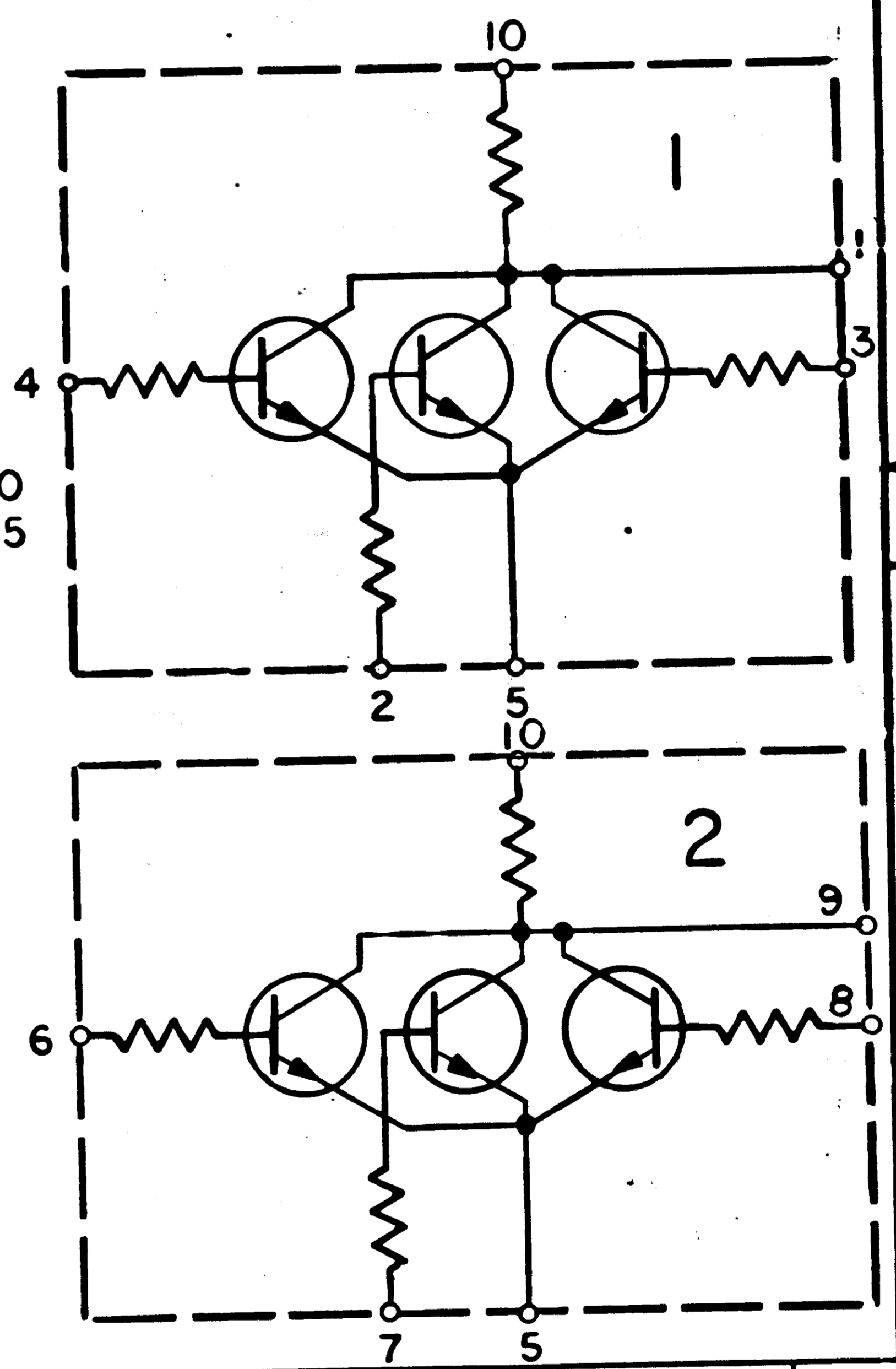
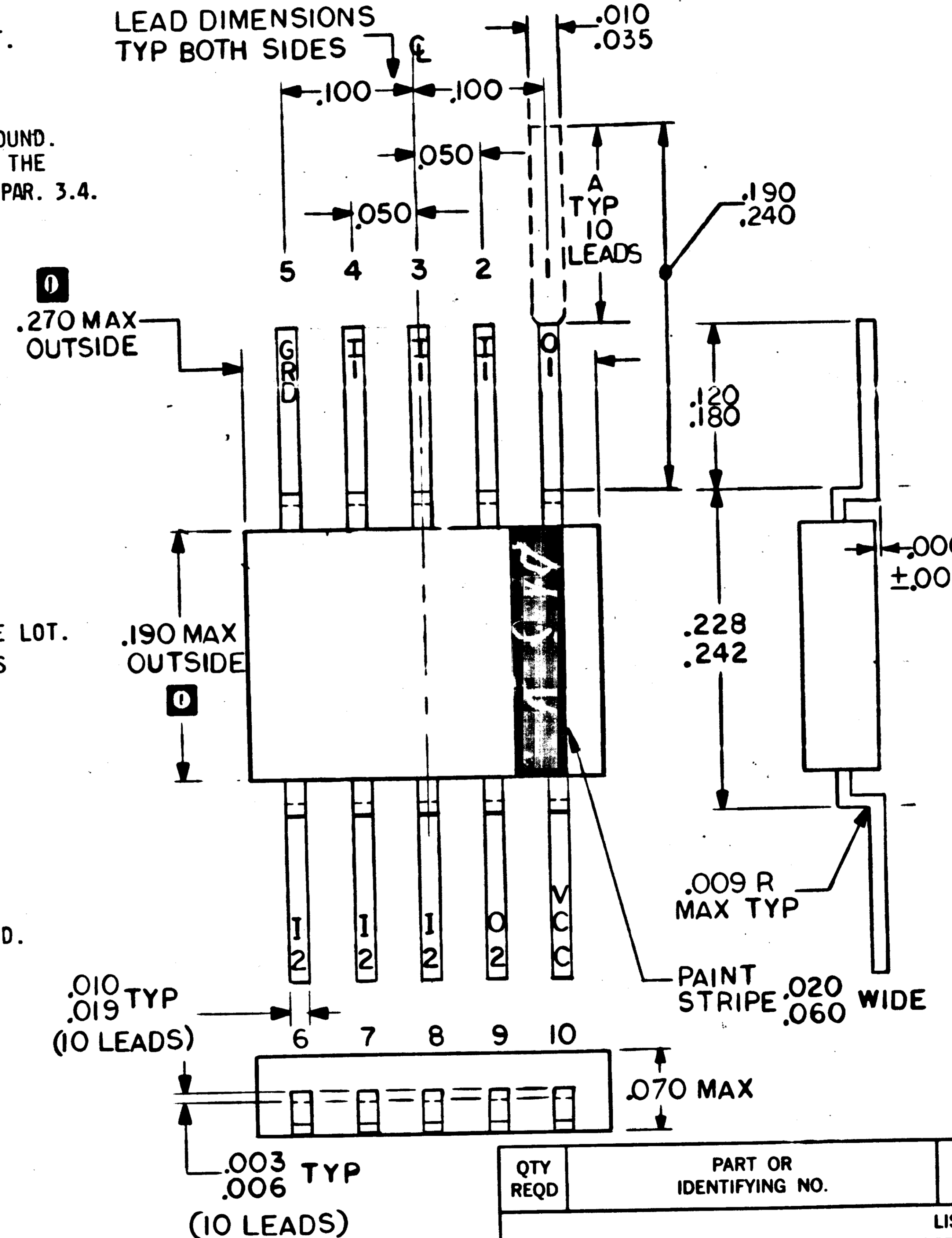

QTY REQD	PART OR IDENTIFYING NO.	NOMENCLATURE OR DESCRIPTION	FIND NO.
LIST OF MATERIALS			
MIT INSTRUMENTATION LAB CAMBRIDGE, MASS.		MANNED SPACECRAFT CENTER HOUSTON, TEXAS	
DRAWN <i>A. Adair Jr</i> DATE 23 DEC 64		DUAL NOR GATE (FLAT PACK) SPECIFICATION CONTROL DRAWING NASA DRAWING NO. 1006321	
CHECKED <i>L. A. Hanley</i>			
APPROVAL <i>L. A. Hanley</i>		CODE IDENT NO.	SIZE
APPROVAL <i>Edna C. Smith</i>			C
NASA APPROVAL <i>A. C. [Signature]</i>		SCALE NONE	WT
MIT APPROVAL <i>W. [Signature]</i>			SHEET 1 OF 5

UNLESS OTHERWISE SPECIFIED DIMENSIONS ARE IN INCHES
TOLERANCES ON FRACTIONS DECIMALS ANGLES
± ± ±
DO NOT SCALE THIS DRAWING
MATERIAL
HEAT TREATMENT
FINAL FINISH
NEXT ASSY USED ON APPLICATION

NOTICE - WHEN GOVERNMENT DRAWINGS, SPECIFICATIONS, OR OTHER DATA ARE USED FOR ANY PURPOSE OTHER THAN IN CONNECTION WITH A DEFINITELY RELATED GOVERNMENT PROCUREMENT OPERATION, THE UNITED STATES GOVERNMENT THEREBY INCURS NO RESPONSIBILITY FOR ANY OMISSION, MISTAKE, OR AND THE FACT THAT THE GOVERNMENT MAY HAVE FORMULATED, FURNISHED, OR IN ANY WAY SUPPLIED THE SAID DRAWINGS, SPECIFICATIONS OR OTHER DATA IS NOT TO BE REGARDED BY IMPLICATION OR OTHERWISE AS IN ANY MANNER LICENSING THE HOLDER OR ANY OTHER PERSON OR CORPORATION, OR CONFIRMING ANY RIGHTS OR PERMISSION TO MANUFACTURE, USE, OR SELL ANY PATENTED INVENTION THAT MAY IN ANY WAY BE RELATED THERETO.

1006321

REVISIONS			
SYM	DESCRIPTION	DATE	APPROVAL
-	INITIAL RELEASE CLASS PER TDRR	1/26/65	WLR

NOTES (CONTINUED)

3. D. TEST METHODS: (REF. MIL-STD-750 WITH EXCEPTIONS NOTED BELOW).
- (1) LEAD FATIGUE: LEADS SHALL BE CAPABLE OF WITHSTANDING THE FOLLOWING LEAD BEND TEST. THE UNIT SHALL BE HELD IN A VERTICAL POSITION WITH A 2 OUNCE WEIGHT SUSPENDED FROM THE LEAD TO BE TESTED. TWO CYCLES OF BENDING SHALL BE PERFORMED. A CYCLE CONSISTING OF MOVING THE BODY OF THE UNIT, 45 DEGREES FROM THE VERTICAL IN ONE DIRECTION, AND BACK 45 DEGREES TO THE ORIGINAL POSITION. NO MECHANICAL DAMAGE SHALL BE EVIDENCED AFTER THE TEST.
 - (2) LEAD TENSION: EACH LEAD SHALL BE CAPABLE OF WITHSTANDING AN AXIAL PULL OF 1 POUND MINIMUM FOR 30 SECONDS. NO MECHANICAL DAMAGE SHALL BE EVIDENCED AFTER THE TEST.
 - (3) SEAL TEST: THE UNITS SHALL BE SUBJECTED TO A HELIUM OR RADIFLO LEAK DETECTION TEST WITH A SENSITIVITY OF AT LEAST 1×10^{-8} CC/ATM/SEC. THE UNITS MUST ALSO BE SUBJECTED TO THE GROSS LEAK TEST AS SPECIFIED IN ND1002246. A LEAKAGE RATE OF 5×10^{-8} CC/ATM/SEC OR GREATER SHALL CONSTITUTE A FAILURE.
 - (4) AVERAGE PROPAGATION DELAY (T_p): MEASUREMENTS SHALL BE PERFORMED ON EACH INPUT USING TEST CIRCUIT SPECIFIED IN FIGURE 1 MADE UP OF ACCEPTABLE UNITS WHERE $T_p = (T_1 + T_2)/2$. VOLTAGE $4V \pm 10\%$. DURING TEST ALL UNUSED BASES SHALL BE GROUNDED.
 - (5) OPERATION LIFE: AN ODD NUMBER OF UNITS (GATES) SHALL BE CONNECTED IN SERIES WITH THE OUTPUT OF THE LAST UNIT SUPPLYING THE INPUT TO THE FIRST UNIT, THUS FORMING A "RING" AS SHOWN IN FIGURE 2. WITH $8V \pm 5\%$ DC APPLIED TO THE POWER TERMINALS OF ALL UNITS IN THE CIRCUIT ("RING") OSCILLATION MUST OCCUR AT THE INITIATION OF THE TEST.
 - (6) VISUAL AND MECHANICAL EXTERNAL EXAMINATION UNDER 10X AND 80X MAGNIFICATION: MARKINGS SHALL BE LEGIBLE. THE CASE FINISH SHALL HAVE NO FLAKING, SPATTERING, CHIPPING OR HOLES. THE GLASS OR CERAMIC SHALL HAVE NO SEAL IMPAIRING CRACKS. RE-ENTRANCE AT THE GLASS, CERAMIC OR SOLDER SEAL SHALL NOT EXTEND TO OVER 50% OF THE SEAL WIDTH. NO FOREIGN MATTER SHALL BE IN OR ON THE SEAL INTERFACE. LEADS SHALL BE FREE FROM KINKS AND NICKS AND SHALL MAINTAIN A UNIFORM THICKNESS WITHIN LEAD SPECIFICATIONS. THE UNITS SHALL COMPLY WITH THE SPECIFIED LEAD MATERIAL REQUIREMENT. LEAD SECTION A MAY BE CUT FROM THE LEAD PREFORM AND SHALL NOT BE SUBJECTED TO PHYSICAL EXAMINATION.
 - (7) THE UNITS SHALL BE OPENED AND EXAMINED UNDER 10X AND 80X MAGNIFICATION FOR DEFECTS IN THE METALIZED INTERCONNECTION PATTERNS WHICH ARE OR COULD BE DUE TO MECHANICAL ABRASION OR CHEMICAL REACTION WITH CONTAMINATE SUBSTANCES. DEFECTS IN THE METALIZATION WILL BE CAUSE FOR REJECTION. TEST METHOD ND1002239.
 - (8) EMITTER-BASE BACK BIAS TEST: ALL BASE INPUTS SHALL HAVE MINUS 4 VOLTS WITH RESPECT TO THE COMMON EMITTER CONNECTION. A BETA TEST SHALL BE PERFORMED BEFORE AND AFTER THE EMITTER-BASE BACK BIAS TEST WITH A MAXIMUM TOLERABLE CHANGE IN BETA OF $\pm 10\%$.
- E. THE SUPPLIER SHALL CONFORM TO THE QUALITY ASSURANCE PROVISIONS SPECIFIED IN ND 1015404. CLASS 2.

QTY REQD	PART OR IDENTIFYING NO.	NOMENCLATURE OR DESCRIPTION	FIND NO.
LIST OF MATERIALS			
MIT INSTRUMENTATION LAB CAMBRIDGE, MASS.		MANNED SPACECRAFT CENTER HOUSTON, TEXAS	
UNLESS OTHERWISE SPECIFIED DIMENSIONS ARE IN INCHES TOLERANCES ON FRACTIONS DECIMALS ANGLES ± ± ±		DUAL NOR GATE (FLAT PACK)	
DO NOT SCALE THIS DRAWING MATERIAL _____ HEAT TREATMENT _____ FINAL FINISH _____		SPECIFICATION CONTROL DRAWING CODE IDENT NO. _____ SIZE C NASA DRAWING NO. 1006321	
NEXT ASSY	USED ON	MIT APPROVAL <i>W. J. R. 1/22-29-65</i>	SHEET 2 OF 5
APPLICATION		SCALE _____ WT _____	

NOTICE - WHEN GOVERNMENT DRAWINGS, SPECIFICATIONS, OR OTHER DATA ARE USED FOR ANY PURPOSE OTHER THAN IN CONNECTION WITH A DEFINITELY RELATED GOVERNMENT PROCUREMENT OPERATION, THE UNITED STATES GOVERNMENT THEREBY INCURS NO RESPONSIBILITY FOR ANY OBLIGATION WHATSOEVER, AND THE FACT THAT THE GOVERNMENT MAY HAVE FORMULATED, FURNISHED, OR IN ANY WAY SUPPLIED THE SAID DRAWINGS, SPECIFICATIONS OR OTHER DATA IS NOT TO BE REGARDED BY IMPLICATION OR OTHERWISE AS IN ANY MANNER LICENSING THE HOLDER OR ANY OTHER PERSON OR CORPORATION, OR CONFERRING THE ANY RIGHTS OR PERMISSION TO MANUFACTURE, USE, OR SELL ANY PATENTED INVENTION THAT MAY IN ANY WAY BE RELATED THEREBY.

1006321

REVISIONS			
SYM	DESCRIPTION	DATE	APPROVAL
-	INITIAL RELEASE CLASS A PER TDR	15729	12/6/65 WK

TABLE II

*** ACCEPTANCE INSPECTION **												
TEST	SYMBOL	TEST CONDITIONS						LIMITS		UNITS	LOT	
								MIN	MAX			
SUBGROUP 1 VISUAL AND MECHANICAL EXAMINATION	-	METHOD 2071 SEE NOTE 3 D (6)						-	-		*LTPD = 10 MAX. ACC. NO. = 3	
SUBGROUP 2		PIN 2,6	PIN 3,7	PIN 5	PIN 4,8	PIN 1,9	PIN 10				*LPTD = 1.0 MAX. ACC. NO. 2 (COMBINED)	
BASE CURRENT	I _B	+870±2mV	+1800±10mV	0V	+1800±10mV		+4±.01V	152	152	uA		
BASE CURRENT	I _B	+1800±10mV	+870±2mV	0V	+1800±10mV		+4±.01V	152	152	uA		
BASE CURRENT	I _B	+1800±10mV	+1800±10mV	0V	+870±2mV		+4±.01V					
OUTPUT VOLT. PIN 1,9	V _O	+770±2mV	OPEN	0V	OPEN		+4±.01V	300	300	mV		
OUTPUT VOLT. PIN 1,9	V _O	OPEN	+770±2mV	0V	OPEN		+4±.01V	300	300	mV		
OUTPUT VOLT. PIN 1,9	V _O	OPEN	OPEN	0V	+770±2mV		+4±.01V					
SAT. VOLT. PIN 1,9	V _S	+870±2mV	OPEN	0V	OPEN		+4±.01V	220	220	mV	*LTPD = 5 (COMBINED) MAX. ACC. NO. = 3	
SAT. VOLT. PIN 1,9	V _S	OPEN	+870±2mV	0V	OPEN		+4±.01V	220	220	mV		
SAT. VOLT. PIN 1,9	V _S	OPEN	OPEN	0V	+870±2mV		+4±.01V					
OUTPUT CURRENT PIN 1,9 COLLECTOR-EMITTER THRESHOLD CURRENT	I _O I _{CEX}	+500±2mV +500±2mV	+500±2mV +500±2mV	0V 0V	+500±2mV +500±2mV	+870±2mV +1,00±.01V	+4±.01V OPEN	760	15	uA uA		
COLLECT. CUTOFF CURRENT	I _{CEO}	OPEN	OPEN	0V	OPEN	+5±.1V	OPEN	100	100	uA		
EMITTER CUTOFF CURRENT	I _{EBO}	0V	0V	+4±.1V	0V	OPEN	OPEN	100	100	uA		
COLLECT. CUTOFF CURRENT	I _{CBO}	0V	0V	OPEN	0V	+8±.1V	OPEN	100	100	uA		
INTERFACE TEST	B ₁	870±2mV	OPEN	0V	OPEN	5KΩ TO +10V	OPEN	400		mV		
INTERFACE TEST	B ₂	OPEN	870±2mV	0V	OPEN	5KΩ TO +10V	OPEN	400		mV		
INTERFACE TEST	B ₃	OPEN	OPEN	0V	870±2mV	5KΩ TO +10V	OPEN	400		mV		
COLLECTOR EMITTER SUSTAINING VOLTAGE	V _{CEO} SUST.	I _C = 5mA (PULSED) PINS 1,9 AND 5						5			VOLTS	
AVERAGE PROPAGATION DELAY	T _p	SEE NOTE 3D (4) AND FIGURE 1							24		nsec	*LTPD = 7 MAX. ACC. NO. = 1
COLLECTOR RESISTANCE	R _L	BETWEEN PINS 10 AND 1,9 MEASUREMENT CURRENT = 1mA						2.7	4.15		Kohms	*LTPD = 10 MAX. ACC. NO. = 3
D.C. CURRENT GAIN	h _{FE}	I _C = 1mA, V _{CE} = 0.5V ALL TRANSISTORS						30	200			*LTPD = 7 MAX. ACC. NO. = 1

- * LTPD PER MIL-S-19500C, TABLE IV
- ** SAMPLE SIZE USED BY THE BUYER AND VENDOR SHALL BE THE SAME AND SHALL CORRESPOND TO THE MAX ACC NUMBER SPECIFIED IN MIL-S-19500C, TABLE IV
- *** MEASUREMENTS TO BE MADE ON GATE 1 AND GATE 2.
- **** TEKTRONIX SAMPLING PROBE P6032 WITH 50X ATTENUATOR
- ***** TEST TO BE PERFORMED IN SEQUENCE INDICATED

QTY REQD	PART OR IDENTIFYING NO.	NOMENCLATURE OR DESCRIPTION	FIND NO.
LIST OF MATERIALS			
MIT INSTRUMENTATION LAB CAMBRIDGE, MASS.		MANNED SPACECRAFT CENTER HOUSTON, TEXAS	
DRAWN <i>A. Adams</i> DATE 22 DEC 64		<h2 style="margin: 0;">DUAL NOR GATE (FLAT PACK)</h2> <p style="margin: 0;">SPECIFICATION CONTROL DRAWING</p>	
CHECKED <i>R. D. Hanley</i>			
APPROVAL <i>R. D. Hanley</i>		NASA APPROVAL <i>W. J. P. Jones</i>	CODE IDENT NO. SIZE
APPROVAL <i>Eden Chast</i>		MIT APPROVAL <i>W. J. P. Jones</i>	C 1006321
HEAT TREATMENT		SCALE	WT
FINAL FINISH		SHEET 3 OF 5	
NEXT ASSY	USED ON		
APPLICATION			

1006321

NOTICE - WHEN GOVERNMENT DRAWINGS, SPECIFICATIONS, OR OTHER DATA ARE USED FOR ANY PURPOSE OTHER THAN IN CONNECTION WITH A DEFINITELY RELATED GOVERNMENT PROCUREMENT OPERATION, THE UNITED STATES GOVERNMENT THEREBY INCURS NO RESPONSIBILITY NOR ANY OBLIGATION WHATSOEVER, IN ANY WAY SUPPLIES THE SAID DRAWINGS, SPECIFICATIONS OR OTHER DATA IS NOT TO BE REGARDED BY IMPLICATION OR OTHERWISE AS IN ANY MANNER LICENSING THE HOLDER OR ANY OTHER PERSON OR CORPORATION, OR CONVEYING ANY RIGHTS OR PERMISSION TO MANUFACTURE, USE, OR SELL ANY PATENTED INVENTION THAT MAY IN ANY WAY BE RELATED THERETO.

1006321

REVISIONS			
SYM	DESCRIPTION	DATE	APPROVAL
-	INITIAL RELEASE CLASS A PER TDRR	15729	1/24/65 WR

TABLE III
QUALITY DEMONSTRATION TESTS**

TEST	TEST CONDITION	LOT
SUBGROUP 1 PHYSICAL DIMENSION	SEE NOTE 3 C (3) METHOD 2066	LTPD* = 20 MAX. ACC. NO. = 1
SUBGROUP 2***** THERMAL SHOCK SEAL TEST	SEE NOTE 3 C (4) METHOD 1056, CONDITION B (150°C TO -65°C, 5 CYCLES) SEE NOTE 3 D (3)	LTPD* = 7 (COMBINED) MAX. ACC. NO. = 1
SUBGROUP 3***** STORAGE LIFE SHOCK VIBRATION VARIABLE FREQUENCY CONSTANT ACCELERATION	SEE NOTE 3 C (4) METHOD 1031 tstg = 150 ± 5°C, 1000 HOURS METHOD 2016, 1500 G, 0.5 MSEC 5 BLOWS EACH IN ALL AXIS DIRECTIONS 30 BLOWS TOTAL METHOD 2056, 30 G FROM 5 TO 2000 CPS LIMITED TO 0.12 DOUBLE AMPLITUDE, 3 CYCLES, 15 MINUTES PER CYCLE MINIMUM METHOD 2006, (20,000 G) Y1 & Y2 AXIS ONLY	LTPD* = 5 (COMBINED) MAX. ACC. NO. = 1
SUBGROUP 4 OPERATION LIFE	SEE NOTE 3 C (4) METHOD 1026 SEE NOTE 3 D (5) AND FIGURE 2 T _A = +22°C MIN IN FREE AMBIENT AIR t = 1000 HOURS	λ* = 3 MAX. ACC. NO. = 0
SUBGROUP 5***** LEAD TENSION LEAD FATIGUE	SEE NOTE 3 C (3) SEE NOTE 3 D (2) SEE NOTE 3 D (1)	LTPD* = 20 (COMBINED) MAX. ACC. NO. = 1
SUBGROUP 6***** VISUAL INTERNAL INSPECTION	SEE NOTE 3 C (5) AND NOTE 3 D (7)	LTPD* = 15 MAX. ACC. NO. = 1
SUBGROUP 7***** EMITTER-BASE BACK BIAS	SEE NOTE 3 D (8) AND NOTE 3 C (5) t = 72 HOURS T _A = 100 ± 5°C	LTPD* = 10 MAX. ACC. NO. = 1

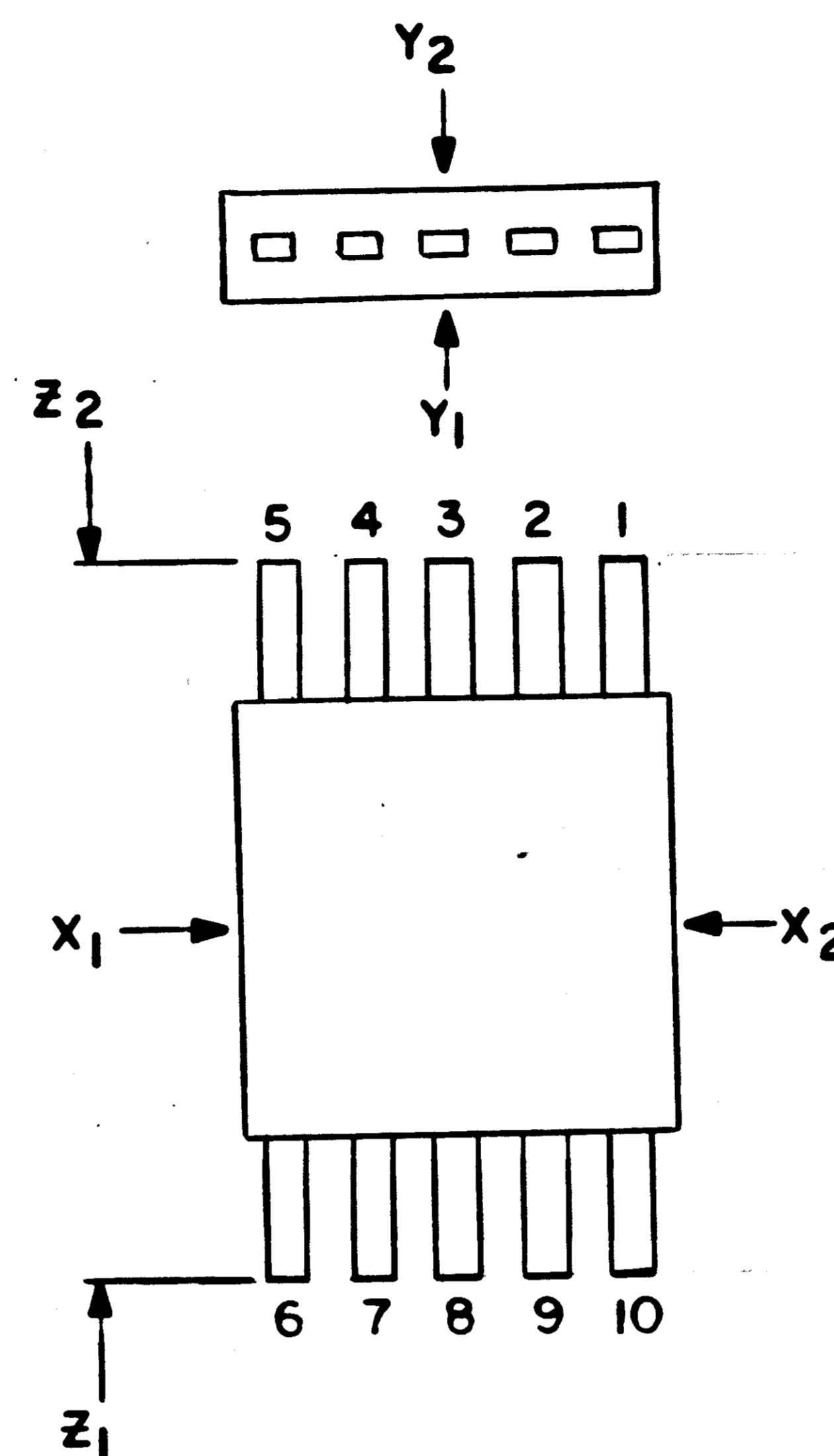

VIEW SHOWN FOR AXIS REFERENCE ONLY

TABLE III (CONTINUED)

TEST	SYMBOL	TEST CONDITIONS	LIMIT		UNITS
			MIN	MAX	
END POINTS FOR SUBGROUPS 2, 3, AND 4					
OUTPUT VOLTAGE, PIN 1, 9	V _O	SAME AS SPECIFIED IN TABLE II	-	300	mV
OUTPUT VOL. AGE, PIN 1, 9	V _O		-	300	mV
OUTPUT VOLTAGE, PIN 1, 9	V _O		-	300	mV
OUTPUT CURRENT, PIN 1, 9	I _O		.760	-	mA
COLLECTOR EMITTER THRESHOLD CURRENT	I _{CEX}		-	20	uA
BASE CURRENT, I 2.6	I _B		-	152	uA
BASE CURRENT, I 3.7	I _B		-	152	uA
BASE CURRENT, I 4.8	I _B		-	152	uA

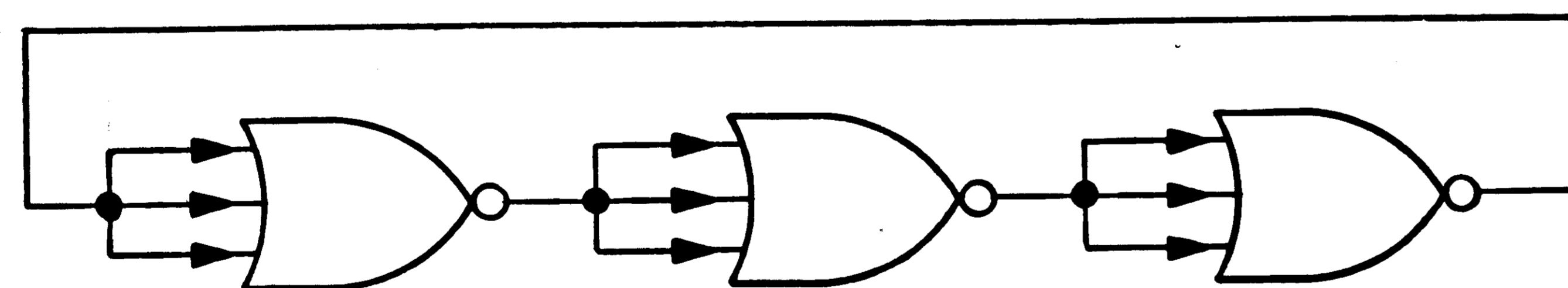

FIGURE 2
TEST CIRCUIT - POWER BURN IN

UNLESS OTHERWISE SPECIFIED DIMENSIONS ARE IN INCHES
TOLERANCES ON FRACTIONS DECIMALS ANGLES
± — ± — ± —
DO NOT SCALE THIS DRAWING
MATERIAL
HEAT TREATMENT
FINAL FINISH
NEXT ASSY USED ON
APPLICATION

QTY REQD	PART OR IDENTIFYING NO.	NOMENCLATURE OR DESCRIPTION	FIND NO.
LIST OF MATERIALS			
MIT INSTRUMENTATION LAB CAMBRIDGE, MASS.		MANNED SPACECRAFT CENTER HOUSTON, TEXAS	
DRAWN <i>A. Adonis Jr.</i> DATE 24 DEC 64		DUAL NOR GATE (FLAT PACK) SPECIFICATION CONTROL DRAWING NASA DRAWING NO. 1006321	
CHECKED <i>L. D. Hanley</i>			
APPROVAL <i>L. D. Hanley</i>			
APPROVAL <i>Elden C. Hall Sr. Deaky</i>		CODE IDENT NO.	SIZE
NASA APPROVAL <i>W. J. Rhee</i> 12-28-64			C
MIT APPROVAL <i>W. J. Rhee</i> 1/24/65		SCALE NONE	WT
			SHEET 4 OF 5

NOTICE - WHEN GOVERNMENT DRAWINGS, SPECIFICATIONS, OR OTHER DATA ARE USED FOR ANY PURPOSE OTHER THAN IN CONNECTION WITH A DEFINITELY RELATED GOVERNMENT PROCUREMENT OPERATION, THE UNITED STATES GOVERNMENT THEREBY INCURS NO RESPONSIBILITY NOR ANY OBLIGATION WHATSOEVER, AND THE FACT THAT THE GOVERNMENT MAY HAVE FORMULATED, FURNISHED, OR IN ANY WAY SUPPLIED THE SAID DRAWINGS, SPECIFICATIONS OR OTHER DATA IS NOT TO BE REGARDED BY IMPLICATION OR OTHERWISE AS IN ANY MANNER LICENSING THE HOLDER OR ANY OTHER PERSON OR CORPORATION, OR CONVERTING ANY RIGHTS OR PERMISSION TO MANUFACTURE, USE, OR SELL ANY PATENTED INVENTION THAT MAY IN ANY WAY BE RELATED THERETO.

- 1006321		REVISIONS	
SYM	DESCRIPTION	DATE	APPROVAL
-	INITIAL RELEASE CLASS A PER TDRR	15729	1/26/65 WK

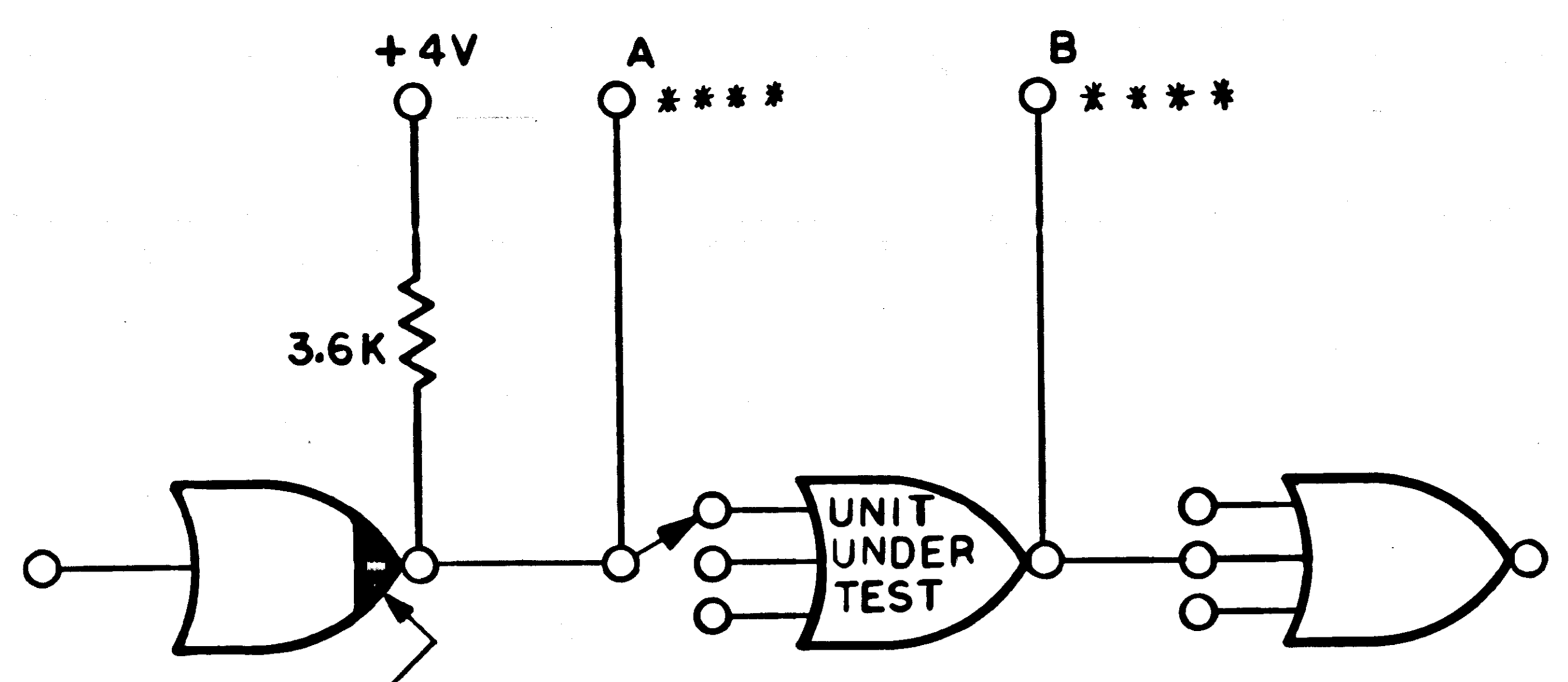
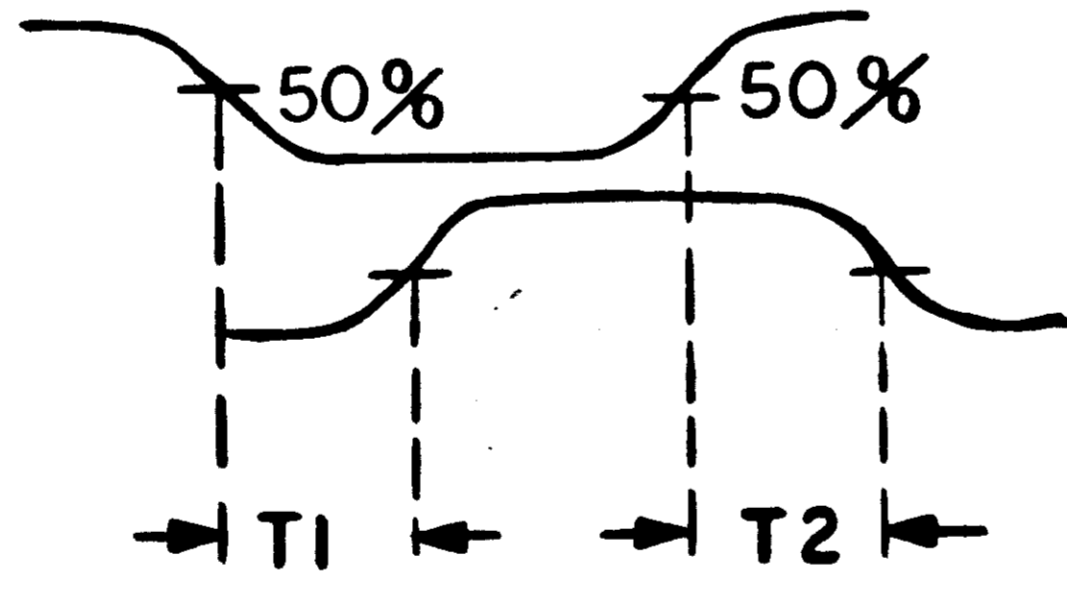
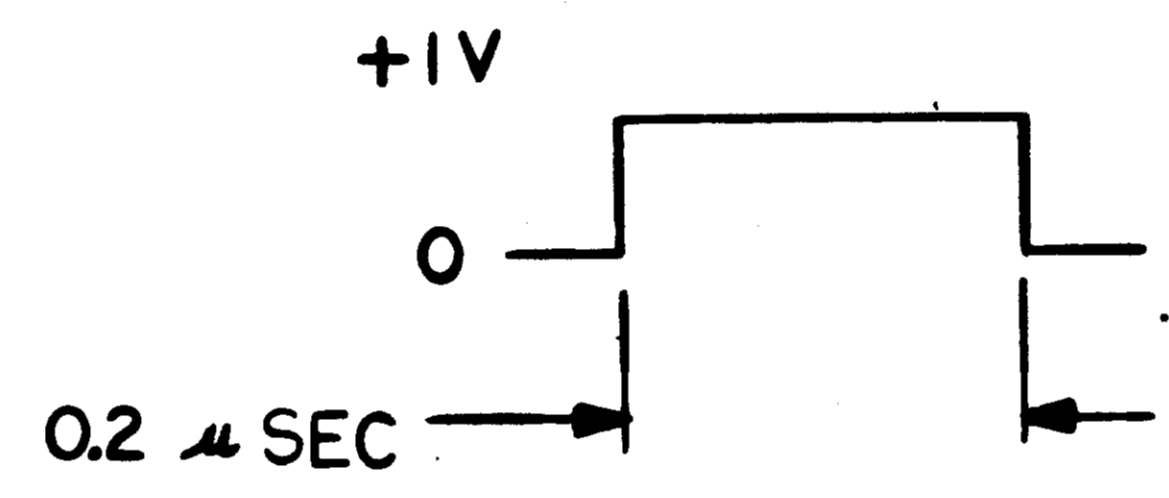

FIGURE I
AVERAGE PROPAGATION DELAY



QTY REQD	PART OR IDENTIFYING NO.	NOMENCLATURE OR DESCRIPTION	FIND NO.
LIST OF MATERIALS			
MIT INSTRUMENTATION LAB CAMBRIDGE, MASS.		MANNED SPACECRAFT CENTER HOUSTON, TEXAS	
DRAWN <i>A. Adamez</i> DATE 22 DEC 64		DUAL NOR GATE (FLAT PACK) SPECIFICATION CONTROL DRAWING	
CHECKED <i>R. W. Hanley</i>			
APPROVAL <i>R. W. Hanley</i>		CODE IDENT NO.	NASA DRAWING NO.
HEAT TREATMENT		SIZE	1006321
NEXT ASSY	USED ON	MIT APPROVAL <i>W. J. P. [Signature]</i> 1/26/65	SCALE
APPLICATION	FINAL FINISH	WT	SHEET 5 OF 5

4 3 2 1

4 3 2 1