

From the point of view of command, the air signal communications forces were organized so that the signals consultants at all of the higher level agencies were simultaneously the officers in charge of carrying out all of the missions in this field. Success of these forces depended upon the tactical and technical ability of the officers and the technical achievements of the engineers, civil officials, and specialized non-commissioned officers. Extreme care in the selection of officers, intensified training of all personnel at the Signal Communications School in Halle, a thorough orientation in the requirements of serving flying units, and the frequent assignment of signal communications personnel to Luftwaffe schools for orientation training, all helped to contribute toward the realization of the goals of signals units.

The Luftwaffe's signal communications forces grew rapidly from modest beginnings in 1935 into a very strong organization.* On 1 October of the following year five signal communications battalions and one signal personnel replacement battalion were established, and by the end of 1936 four additional signal personnel replacement battalions were being formed. In 1937 the Luftwaffe organized one signal training battalion, one signal training and experimental regiment, three signals schools, one advanced technical school (in Halle), one air traffic-control company, one replacement company in each Air Service Area, and an Air District Signal Communications Company in each Air District. The Luftwaffe also established a Main Airfield Signal Communications Company (Leitthorstaechrichtenkompanie) for each airfield area.

Following the reorganization of the Luftwaffe General Staff and the Reichs Aviation Ministry (2 June 1937), Martini and the air signal forces were organized under the General Staff of the Luftwaffe as Branch 7, Air Signal Communications Branch.† Martini thereafter commanded this organization, the signal communications branch in the office of the Commander in Chief of the Luftwaffe, and the Cryptographic Section (Chiffrierstelle) of the Reichs Aviation Ministry. From this post he saw to it

* On 26 February Hitler announced the creation of a new branch of service, the Luftwaffe, whose activation became effective 1 March 1935.

† See Chart No. 11.

that all important agencies of the Luftwaffe had officers from the Air Signal Communications Branch.

From 1937 on the inevitable and necessary cooperation between the technical agencies of the Reichs Aviation Ministry and industry suffered somewhat because of the friction developing between General Martini and State Secretary Milch.* This, however, did not affect procurement in any way.

The Luftwaffe Signal Communications Forces were assigned the following missions:

(a) To carry out signal communications services, the establishment of facilities between Luftwaffe command posts and all subordinate agencies in the field of communications, and to provide communications channels from Luftwaffe command headquarters to motorized Luftwaffe and flak artillery units on the march.

(b) To control air traffic by promptly establishing reliable lines of communications between weather observation stations, airfields, airfield commands, emergency fields, etc., in order to insure flying safety in peacetime and in time of war, and by establishing a reliable network of direction-finding beacons and other ground navigational aids, and in war to provide ground-to-air direction of bomber units.

(c) To maintain precise air surveillance over the important areas in order to detect the appearance of both friendly and enemy aircraft, and to report promptly to the headquarters responsible for military and civil air defense operations.

(d) To continue the expansion and operation of a radio

* Part of the difficulty stemmed from the fact that Martini was subject only to the wishes (or nearly so) of State Secretary Milch, since the Air Signal Communications Branch (7) was after 2 June 1937 an integral part of the Luftwaffe General Staff.

† After 1938, apart from the Navy's aircraft reporting units along the coast, the Luftwaffe Signal Communications Branch assumed full responsibility for aircraft reporting for the entire Wehrmacht.

intercept network which even in peacetime would be capable of closely monitoring the radio communications of the air forces of neighboring countries, and which in time of war would be capable of keeping all enemy radio communications under surveillance (if necessary, with the aid of additional, reliable, special communications lines). Later on this mission was expanded to include ground control of fighter and dive-bomber units, radio-frequency warfare such as radio deception, jamming, and the protection of German communications against interference or jamming.

According to the organizational plan of 1938-39,* the Chief of the Air Signal Communications Branch (Branch 7 of the Luftwaffe General Staff) had command after October of 1938 over the Cryptographic Section (known after 1 January 1937 as the Central Interpretation Section), over the Air Signal Communications Battalion of the Commander in Chief of the Luftwaffe in Potsdam-Eiche, the 6th Radio Intercept Company (Motorized), and over the Senior Commander of Air Signal Communications Schools. The air signal replacement battalions were organized on 1 April 1938 into Air District Signal Communication Battalions.

Signal commanders assigned to the First, Second, and Third Air Fleets were in command of the 1st, 2nd, and 3rd Air Signal Regiments (Motorized), while those assigned to the Luftwaffe Command Vienna and Luftwaffe Command East Prussia commanded the 4th and 6th Air Signal Communications Battalions respectively. Besides these organizations, the 88th Signal Communications Battalion, serving with the Legion Condor in Spain, provided a useful body of practical experience for all of the signals units of the Luftwaffe.

On 1 October 1937 the mobile radio intercept service was expanded, and by 1939 there were seven platoons of this sort, two of them assigned to each of the three signal communications regiments and one to the 4th Air Signal Communications Battalion. In addition, there were the three radio intercept and radio direction-finding companies of the signal communications battalion under the Commander in Chief of the Luftwaffe, the Air Signal Communications Training Battalion, and the Air Signal Communications Training and Experimental Regiment at Koethen. Thus,

* See Chart Nos. 12 and 13.



Figure 20

Arado Ar-68 E, which, with the Heinkel He-51, became a mainstay of the German fighter arm until after 1936.



Figure 21

The Luftwaffe's long-range Fighter, the Me-110.

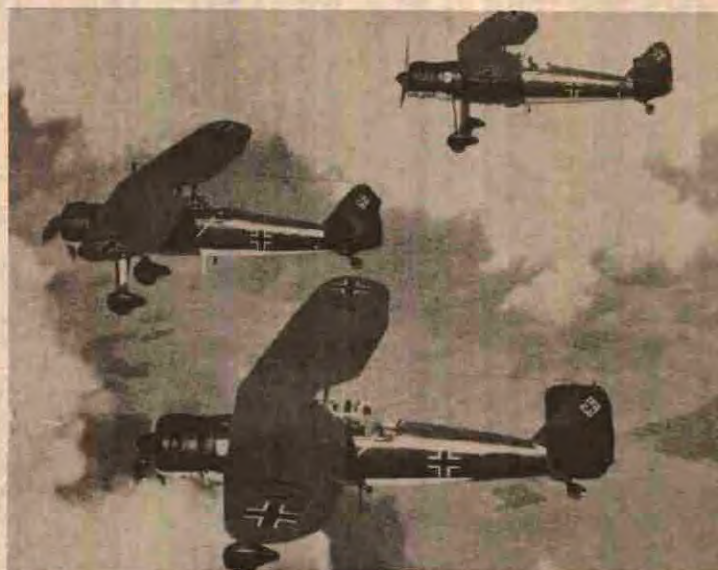

Figure 22

A formation of Henschel Hs-126
Reconnaissance Aircraft.

by the outbreak of war, the Luftwaffe had four radio monitoring command posts with nine radio intercept (monitoring) stations, plus the main radio direction-finding station at Glindow, which was a sort of supervisory agency for all Luftwaffe radio communications. This expanded radio monitoring network, supplemented by the Army and Navy networks, was able to cover all of the radio communications transmitted by Germany's neighbors, including Great Britain, French North Africa, the Balkans, and the southern part of the Soviet Union. The ten Air District Signal Communications Battalions, one for each Air District and for the Luftwaffe Command East Prussia, were subordinate to the signal communications commanders attached to the Air Districts. The broad scope of activities of the Air Districts made the missions of the signal battalions quite diversified. They were also in charge of the main airfield signal companies.

There were 44 main airfields, 13 assigned to the First Air Fleet, 12 to the Second Air Fleet, 13 to the Third Air Fleet, 4 to the Fourth Air Fleet, and 2 to Luftwaffe Command East Prussia. The commanding officers of the main airfield signal companies were also the signal commanders of their respective airfield areas, and were subordinate to the airfield commander.

Flak Artillery Units

Until the end of March 1935 the Reichs Aviation Ministry issued all orders to the Air Defense Branch and its subordinate Flak Artillery Inspectorate, which was the headquarters of all antiaircraft artillery forces.* One of the leading figures who played a pioneer role in the development and employment of flak artillery was Col. Guenther Ruedel, Chief of the Air Defense Branch.† As early as 6 December 1932 he established a development program within the Reichswehr, which was so comprehensive in scope that it was years before any modifications were required. The program was guided toward realization in close cooperation with the Army Ordnance Office and its subsidiary agencies, Ammunition and Ballistics, Heavy Flak Artillery, and Range Meters and Fire Control Equipment.

The transfer in March of 1935 of the Air Defense Branch to the Reichs Aviation Ministry as the Inspectorate for Flak Artillery and Air Defense did not necessitate any substantial changes

* Up to this time all flak units belonged to the Army.

† See figure 23.

in the mission of flak artillery forces, except that the new inspectorate assumed the responsibility for civil air defense.*

Meantime, the Navy was working on a similar flak artillery program, although the requirements for its antiaircraft development were very different. The Navy needed ship-based flak as well as fixed flak installations, the latter to be located primarily along the coast and at regular naval stations. Despite the inherent disadvantages in parallel development projects, the constant exchange of views and experiences with Army and Aviation Ministry leaders proved to be of great value to the entire air defense program.

Air defense for troop units was initially a matter for the Inspectorate of Infantry and the troops themselves, since military leaders thought that massed small-arms fire would provide ample protection against enemy air attacks. However, by 1932, development was begun on light and medium flak pieces designed especially for troop air defense. The Air Defense Department of Inspectorate 4 of the Army Command supervised the development of these weapons. In the project initiated on 6 December 1932, the goal of the flak artillery was described as "the destruction of enemy aircraft." There was no mention of flak units participating in ground fighting, a method of employment which grew out of dire necessity during World War II.† The tasks assigned to flak forces were always too numerous for the number of batteries available.

In the development of flak artillery the guiding spirit was Training Staff 3 (Army), which had its own staff of instructors at the drill area in Berlin-Doeberitz. Air defense problems were handled by the Reichs Aviation Ministry (B-Office), although most of the practical work was done by a volunteer organization,

* See Col. (Ret.) K. G. Jacob, "Der deutsche Luftschutz" ("The German Air Defense"), an unpublished study prepared for the USAF Historical Division, Karlsruhe Document Collection.

† ~~Editor's Note~~: There is evidence that some of the German forces in Spain (1936-1939) were the first to discover the effectiveness of the 8.8 cm. gun in direct fire against enemy armor. See documents pertaining to the flak artillery forces, F/VI/1, Karlsruhe Document Collection.

the Reichs Air Defense Association (Reichsluftschutzverband). The tangible results achieved in this area were rather inconspicuous, but the organization proved to be useful by creating public interest in this vital field, thereby preparing the way for more intensive development activities to come.

The weapons selected for development were chosen on the basis of the mission to be fulfilled. Those required for use against low-flying aircraft were 15-20 mm. antiaircraft machine-guns having an effective range of up to 6,560 feet and a 3.7 cm. medium flak gun having a firing range of about 9,840 feet. The latter weapon was to be extremely mobile, suitable for use by platoon sized units, and to be equipped with a central fire control and teletransmission.

For use against enemy aircraft the most indispensable gun was the 8.8 cm., which had an effective firing range of 22,960 to 26,240 feet. Each of these pieces weighed about nine tons and was equipped with a fire control set capable of automatically activating and turning off all of the firing elements of the gun. These guns were also coupled with the search-light units and sound locators, the latter having a range of seven and a half miles. The problem of beam direction-finding without optical aids was outlined as a future field for developmental work.*

Priority for development and production was given to the 2 cm., the 3.7 cm., and the 8.8 cm. guns and auxiliary equipment, with the development of barrage balloons second, and remote controlled apparatus taking third place. Efforts were also made to perfect the motorized flak forces.

At the end of March 1935 the flak artillery forces were officially transferred to the Luftwaffe, a move which assured close cooperation with Germany's combat air forces. Flak units also were able to gain a much closer familiarity with both indigenous and foreign air forces, with offensive air combat methods, with the principles and potentialities of aircraft employment,

* Supplemental instruments of defense were planned, which included barrage balloons and kites for altitudes up to 16,400 feet, barrage artillery rockets for altitudes up to 22,960 feet, and parachute rockets with attached barrage cables.

the operation of the aircraft reporting services, and the interaction of command and reconnaissance agencies of the flak artillery, the flying units, and the signal communications forces.* Antiaircraft defenses had to remain a single, closely-integrated entity. The only flak units not affected by the transfer were the stationary installations along the coast (whose mission included firing against naval targets) and ship-based antiaircraft artillery, which naturally remained under naval command.

In the beginning, it was the home air defense program which required the lion's share of the flak artillery. The demand for antiaircraft protection of Army forces from high-altitude bombing attacks did not come to the foreground until 1936. Nevertheless, flak artillery units (the number of which was never fully adequate for the demands) had to be left under Luftwaffe command in order to make it possible to establish a point of main effort if the need should arise.

It was more practical for the flak artillery to be under the Luftwaffe than under the Army, because the Luftwaffe was able to secure greater sums of money for testing and procurement than was true of the Army. The Commander in Chief of the Luftwaffe ordered all matters concerning procurement and development of flak equipment to be assigned to the flak artillery offices (now in the Luftwaffe) which had been handling these matters all along. It was a decided disadvantage, of course, that the German Air Force did not permit the Army to exert more influence upon these activities, and that it did not make the staffs of antiaircraft units more readily available to the Army. No attempt was made to inform the Army of the number of staffs and units activated during each year of the mobilization program, nor were flak forces encouraged to cooperate with the Army. Had these matters been more fairly handled it might have softened the Army's attitude toward the idea of a united flak artillery force under the command of the Luftwaffe.

By the autumn of 1935, the Senior Flak Artillery Commanders

* The ultimate consolidation of both air units and flak artillery in the Reichs Aviation Ministry also helped to make tow aircraft and other special equipment readily available for antiaircraft units.



Figure 23

Germany's top Flak Artillery officers, L.
to R : General der Flakartillerie Guenther
Ruedel and General der Flakartillerie
Walther von Axthelm.



Figure 24

An 8.8 cm. (heavy) antiaircraft
gun and crew in firing position
during the 1936 war games.

(assigned to the five Air Service Commands then in existence) had at their disposal fifteen heavy and three light flak artillery battalions, all motorized. The Flak Artillery School at Rerik was under the command of the Flak Artillery Inspectorate. In 1937 the training battalion at this school was redesignated the Flak Artillery Training and Experimental Battalion. On 1 April 1937 one flak regiment, consisting of one heavy and one light flak artillery battalions and one searchlight battalion, was assigned to the Luftwaffe Training Division (Luftwaffe-Lehrdivision).

The number of flak artillery battalions nearly doubled between 1935 and 1936, with the battalion remaining for the time being as the tactical unit.* There were 29 mixed and 8 light flak battalions, with 87 heavy† and 53 light and medium batteries and 29 searchlight batteries.†† Flak battalions had one heavy and one light personnel replacement battery each, which was to permit a doubling of units in case of mobilization or an acceleration of peacetime activation.

The third phase of activation began in October of 1937, and established one senior flak command (air), five regimental staffs, six mixed battalions, and nine light battalions, so that the total was 6 senior flak commanders, 11 regimental staffs, 1 flak commander (sea), 35 mixed battalions, 17 light battalions, and 1 searchlight battalion, altogether 115 heavy batteries, 14 permanent cadre batteries, 69 light and medium batteries, and 37 searchlight batteries.

It is significant to note that in 1937 a flak training regiment was assigned to the Luftwaffe Training Division, for the coordinated training of both flying and flak artillery forces. This made it possible to set up additional light flak artillery

* There were also five senior flak artillery commanders and six regimental commanders, whose duties were at this time primarily concerned with training and administration.

† See figure 24.

†† The stations of the mixed battalions were usually selected in accordance with the targets to be defended. The Office of the Flak Artillery Commander (Sea), in Kiel, existed in addition to and outside of the Air Service Command organization.

battalions for the protection of Army units, especially the mobile troop units. Each such battalion had a staff (headquarters) battery, a 3.7 cm. battery, and two 2 cm. batteries to convert most of the second battalions of the flak artillery regiments to mixed battalions like the first ones, and to set up additional heavy stationary batteries, most of which were permanently assigned to protect specific military targets. The Hermann Goering Regiment was assigned in 1937 to the flak forces.

In October 1938 the Luftwaffe initiated the fourth phase of activation of flak forces in conjunction with the establishment of additional top-level Luftwaffe staffs, creating positions in the ten Air District Commands for flak officers of the rank of Colonel or Generalmajor. These officers were made fully responsible for air defense activities within their respective areas. Within the framework of the fourth phase air defense forces increased in strength from 25 to 50 percent. In so doing, 9 new regimental staffs (counting the two flak artillery reconnaissance staffs), 10 mixed battalions (three light battalions had been deactivated), 5 fortress flak battalions, and 15 searchlight battalions were set up.

In order to facilitate the conduct of air defense operations in areas which had a number of high priority targets (such as armament plants), Air Defense Commands were established at Stettin and Berlin in the III Air District, at Leipzig in the IV Air District, at Duesseldorf in the VI Air District, and at Hamburg in the XI Air District. The flak artillery units stationed in the Air Defense Commands were subordinate to the Air District Commands via the regimental staffs. This step constituted an establishment of points of main effort in particularly threatened areas.

In addition, the Command Headquarters, Western Air Defense Zone (under the Senior Commander, III Fortress Flak Artillery) was established, which included 2 flak reconnaissance staffs, one in the Eifel and one in the Black Forest, and 5 fortress flak battalions. This new command was a part of the defense system for the West Wall.

The Western Air Defense Zone was designed to form a tightly-knit line of flak artillery defenses along the entire western border of the Reich, a line which enemy aircraft would have to cross before they came into the range of the flak units guarding

the specific military objectives. The Luftwaffe planned to restrict the enemy's ability to operate against Germany, to limit enemy air activity over areas occupied by the German Army, and, with the diversified weapons at its disposal, to provide a kind of "reception line" for the front. Flak forces were also responsible for protecting the bridges over the Rhine, the autobahns, and nearby industrial installations.

Luftwaffe Meteorological Service

During World War I an air meteorological service existed for the Army and Navy. It survived the end of the war in a considerably reduced form, becoming no more than a rudimentary artillery weather service. Although it was not until the development of civil aviation during the twenties that an air weather service was established under the auspices of the Reichs Traffic Ministry, by 1931 the service had already outgrown the assistance which could be provided by that Ministry. As a result, the Central Air Traffic Control Station was called into being and assumed supervision over the weather observation and reporting services. The state meteorological stations controlled only the day to day routine activities.

In 1933, the Reichs Meteorological Service, together with the air traffic control and air traffic supervisory units and all civil aviation agencies of this sort, also came under the authority of the Reichs Aviation Commission and, later, of the Reichs Aviation Ministry. The Meteorological Service became Branch III of the General Air Office,* and served as a base for the establishment of air weather services at Luftwaffe flying schools and airfields.

The organization of meteorological services began in earnest in 1935. Luftwaffe meteorological services were then separated from the civilian meteorological services by establishment of the post of Air Fleet Meteorologist, an office which entailed a close coordination with the staffs of the Air Fleets. The

* The General Air Office had five branches: Branch I (air traffic), Branch II (air defense), Branch III (meteorological services), Branch IV (aerial photography), and Branch V (ground organization and air traffic control).

meteorological services were also given a definite legal status in the Reichs Weather Service Law of 1935. During the same year the Luftwaffe abolished the Central Air Traffic Control Station and made its Signal Communications and Illumination Branch a part of Branch III of the General Air Office. The Air Weather Service Branch (Abteilung Flugwetterdienst) as well as the missions of the state meteorological stations were taken over by the newly created Reichs Office for Meteorological Services (Reichsamt fuer Wetterdienst), which was augmented by the Scientific Senate for Reichs Meteorological Services, made up of the directors of the state meteorological stations and a number of university professors. This made it possible to assign qualified meteorologists to all agencies down to wing staff, a step which had long been urgently necessary. From this time on, the meteorologists were present at every orientation session, every conference in which combat orders were issued, and at every situation briefing, and their tactical weather maps rested on the planning tables beside the strategic situation maps. All of this was supplemented by practice sessions for predicting weather conditions three to six or even twelve to fifteen hours in advance.

From 1935 on, the recruitment of meteorologists and weather service technical personnel presented certain difficulties. An attempt to relieve the situation was made by recruiting in the various German states candidates who were slated for instructional posts in allied fields, by offering courses in the newly created Reichs Meteorological Service School, and by providing on-the-job training at the various meteorological stations.

After the establishment on 1 August 1936 of the Luftwaffe General Staff the cooperation between this organization and Branch III of the General Air Office was exemplary. Flying personnel and meteorologists became an inseparable team, the meteorologists providing what information they could and the flying personnel keeping them informed of experiences gained during their missions.

The Meteorological Information Network (Wetterrundschreibnetz), established jointly by the Signal Communications Inspectorate and the Reichs Meteorological Service, united all meteorological stations by means of its own teletype network. In accordance with precise schedules, the district meteorological centers (the main meteorological stations in each state) forwarded their reports to this new agency. Whenever necessary, the basic network could

be supplemented by the special networks maintained by the various air fleets. The civil air weather services retained their former reporting network.

In the event of mobilization, the coding of weather reports, which had to be simple and foolproof, was to be handled as prescribed with appropriate mobilization symbols by a coding machine operated by the Signal Communications Forces. The weather services also worked out a coding method for use by weather reconnaissance aircraft in flight.

Luftwaffe leaders realized that, with the outbreak of war, many weather reports emanating from enemy territory or territory under enemy surveillance would not be received. This problem was partially solved by the establishment of a Central Meteorological Service Group (Zentral Wetterdienstgruppe), organized to prepare short-range, medium-range, and long range weather forecasts on the basis of incomplete reports received. This Group, made up of the most experienced meteorologists, and all of the meteorological stations, had to learn to work on the basis of partial or incomplete information. Neutral weather stations were assigned to check on the accuracy of the Group's forecasts, while radio sounding stations contributed to the more accurate construction and interpretation of high-altitude weather maps pertaining to conditions over enemy territory.

Experimental operations showed that the Central Meteorological Service Group had to be made as effective as possible, that high-altitude weather maps (500 millibars) and absolute and relative topographical maps, substantiated by the most accurate measurements possible, ought to be issued twice a day, and that special weather reconnaissance units with experienced meteorologists were an absolute necessity.

The Central Meteorological Service Group prepared air climatologies and air weather studies for all European countries in coordination with Branch 7 of the General Staff, collated scientific materials for use in medium and long-range weather predictions, promoted the development of meteorological equipment and supply channels for such equipment, including also radio sounding equipment, airborne meteorological equipment, mobile weather stations, and unmanned reporting stations, and provided material for use in meteorological courses in Luftwaffe schools.

The expansion of Luftwaffe meteorology services also helped to simplify the weather services of the Navy, the Army artillery, and the flak forces, for it was no longer necessary for batteries to take constant temperature readings, since air density and wind conditions could be ascertained for any given area and time from the aerological network readings issued twice a day by means of space and time interpolation. This method was passed on to countless meteorologists in the official training courses.¹¹

The Development of the Luftwaffe Ground Organization

The Luftwaffe Administration Office in the Reichs Aviation Ministry was the agency responsible for issuing the orders pertaining to the development of the ground organization. Within the Luftwaffe Administration Office this responsibility was exercised by Branch III (Billeting, Physical Installations, Construction). Execution of these orders was the responsibility of agencies within Air District Commands. These agencies, in turn, worked closely with the airfield commands (later airfield area commands [Flughafenbereichskommandos]).

The airfield area commands, which at the same time were main airfield commands (Leithorstkommandanturen), were the higher headquarters for all of the peacetime airfields, emergency airfields, field landing areas, combat landing fields, and dummy airfields located within these respective areas. They were responsible for keeping these installations supplied with all necessary items and for supervising the activity of the ground organizations there. The number and size of the airfield area commands were determined by the tactical significance of the areas concerned.¹²

Apart from the commercial airports, there were until 1933 only those few airfields established and supported by the Reichs Traffic Ministry that were used by the Commercial Flying School, Severa. Although these fields were capable of meeting only the most primitive requirements in terms of size, quality of runways, billeting facilities, and repair services, they were taken over by the Luftwaffe in 1933 and enlarged and improved for extended operations. The fields at Warnemuende, Wilhelmshaven, Norderney, and Borkum were taken over for naval units, while those at Stettin, Staaken, Braunschweig, Wuerzburg, Schleissheim, and Boeblingen were for land aircraft units.

The Air Command Office supervised the establishment of requirements for airfields needed by the Luftwaffe, taking into consideration especially the aspects of training, operations, and organization at such bases. It then issued appropriate instructions to the Luftwaffe Administrative Office. Because of the required size of the landing fields the latter agency soon had differences of opinion with the Luftwaffe Technical Office, which immediately necessitated cooperative work with other command agencies in the Reichs Aviation Ministry, such as the Signal Communications Branch, the General Air Office, and associated meteorological agencies.

After all elements of the problem had been examined, the Air Command Office sent a summary of its findings to the Luftwaffe Administrative Office, which then took the necessary steps to purchase the selected territory. Later, in conformity to instructions from the Air Command Office, the Air Service and Air District Commands sought out the proper locations for the new fields themselves. The Air Command Office then passed these recommendations on to the Luftwaffe Administrative Office for investigation and comment. The requirements were so extensive that all of the available engineers and skilled and unskilled workers, and all of the raw materials provided by the German iron-processing industry, were fully utilized.

In selecting locations for new airfields one had to give heavy consideration to their purpose, their future integration into existing Air Service Commands, the suitability of the selected areas from the point of view of the pilots and from the standpoint of construction, as well as to the economy of choosing a particular site.*

The peacetime development of airfields was generally completed by the end of 1937, although not all of the buildings were then ready for occupancy. Individual installations scheduled for completion in 1942 were added later as the need for them arose. By 1 September 1939 Germany possessed airfields for

* Cover and deception actually required that airfields be established in sparsely populated areas affording good ground cover, preferably in wilderness areas. Such construction was then carried out in coordination with the Reichs Labor Service (RAD).

schools, flying units, and supply units, for land and sea air forces, as well as commercial airports and fields operated by industry.

Despite all efforts at deception and camouflage, it was logical to assume that the size and location of German airfields, and the number of troops assigned to them, had not remained a secret. This, combined with the fact that the uniform distribution of units along the borders of the Reich created the danger of airfield congestion if operations became limited to a single sector of the frontier, and that fighter units would require unoccupied airfields as alternate landing fields in the border zones, led to the establishment of field airports (E-Haeften). Maneuvers carried out in the autumn of 1936 in the Welzow area (a poorly organized and equipped area from the point of view of aviation) inspired the field airport system. This idea was perfected during the latter part of that year and in 1937 as an instrument for the mobile conduct of air operations, and was exploited with spectacular success by the Air Service Command concerned during the Sudeten crisis of 1938.

The network of field airports increased in density in the eastern part of Germany. By 1 March 1938 the Luftwaffe had 84 of these fields completed or in some major stage of construction, while 14 others were scheduled for preparation, and on 1 September 1939 the Luftwaffe could boast of a total of 89 first and second class field airports ready for action.* Of the fields ready at the opening of World War II, 24 were in the zone of the First Air Fleet, 9 were in that of the Second Air Fleet, 40 in the Third Air Fleet area, and 16 were in the zone of the Fourth Air Fleet.

* Directives issued 28 April 1939 prescribed the preparation of 180 airfields by 1 April 1941, 92 in the first category and 89 in the second class, while 25 were to be used as Luftwaffe command posts. By the outbreak of war, 55 of the 59 first class fields, and 25 of the 30 second class fields (of the total of 89 completed fields), were situated in the East. The other first class fields were near the coast, primarily for naval use. This indicates to some extent the German High Command's primary emphasis upon possible troubles in the East rather than in the West.

Field airports had to be so well camouflaged that they could not be recognized from the air or on the ground. For this reason, broad, sweeping lawn areas had to be avoided as taxiing areas in order to create the impression of small cultivated fields of a typical agrarian district. Feeder roads and railway spur lines, hangars, and other structures had to be meticulously concealed.

All operations at field airports had to comply strictly with prearranged schedules, and all facilities at these sites had to be ready for possible use within a few hours' notice. The most significant defect in the system was the lack of workshops and repair depots, which meant that the main fields, the air parks, and supply and procurement offices had to help fill the void. This shortcoming proved to be more troublesome as the war progressed.

Measures by the Ground Organization to Insure Mobility of Bomber Units

The High Command of the Luftwaffe insisted that bomber units be capable of transferring from one base to another, if necessary over long distances, under their own power in order to be able to establish points of main effort at crucial times. This was to be accomplished at regular flying speeds so that these units would be available and ready for immediate commitment upon arrival at the new station. This required a separation of the air units from their less mobile ground organization. In order to solve the problem, the required ground service personnel (apart from a few specialists who invariably accompanied the flying units) were organized into motorized airfield service companies, two of which were assigned to every flying unit. In this way it was possible to send the companies that were not needed for current operations to other sectors of the front or even to other theaters of operation. Thus, when the flying units landed at their new bases they found the necessary ground service personnel already there and ready to go to work. This arrangement became known as the "hotel system."

In case of emergency, of course, ground service personnel could also be temporarily flown in by transports to other stations to help in making provisional repairs.

CHAPTER 4

THE AIR ARMAMENT INDUSTRY IN GERMANY

An air force of world significance presupposes an air armament industry that is quantitatively and qualitatively superior to that of most other nations. The mutual interdependence upon tactics and technology bears more heavily upon the air armament industry than upon other branches of the service. Air leaders have to recognize this as those in Germany did prior to the announcement of the new service law in 1935.*

In early 1933 the top-level command of the Luftwaffe was still fairly amorphous. The air armament industry consisted of eight aircraft factories and five aircraft engine works, and by 1 April of that year there were seven more firms in the process of being developed. The Siebel Company (Halle), the Miag Company (Braunschweig), and the Chassis Works in Gotha were to build the He-46, the Gotha Chassis Works the He-45, the Ago Company (Aschersleben) and the Erla Company (Leipzig) the Ar-65, and the Dornier Company (Weimar) the Do-11.

At this time the airframe industry had a serious shortage of skilled workers, and engineer personnel were at a premium. This was probably a result of the restrictions on military designing and development in the aircraft field because of the Versailles Treaty, which effectively kept younger men from becoming interested in aviation engineering. Thus, as long as this shortage persisted, the few officers with advanced technical training were tied down in jobs with urgently practical applications.

In 1933 there were no large-scale production facilities available in Germany. Most of the aircraft factories had to struggle along with inadequate purchase and contract orders, so that they normally manufactured individual aircraft rather than an entire series. These plants, served by only two metallic construction firms, became known as "blacksmith shops." The remainder of the companies functioned as small-scale manufacturers of diversified products. Engine and equipment firms were no more

* This section is based largely on studies prepared by Generalingenieurs Hertel, Huebner, Haase-Berton, and Bauer, and by General der Flakartillerie (Ret.) Otto von Renz.

than subsidiaries of the aircraft factories. Despite these handicaps, however, the German aircraft industry produced a great many more aircraft in 1933 than it had in the previous years, even if these models were admittedly inferior to those of many other nations at the time.

One cannot overestimate the value of the experiences gained during this period with respect to construction, the economical execution of series production orders, the development of production aids (standardization of equipment, blueprints, cast-metal models), and sub-contracting procedures. Raw materials research had brought results which enabled the Reich, poor as it was in terms of many of these goods, to make a start in the direction of mass production. Furthermore, the firm Production Ltd. and the Junkers Company had introduced a production method which was to prove of decisive significance to the Reich.

With the establishment of the Reichs Aviation Ministry, all of the technical agencies were consolidated under the Technical Office. Its first Chief was Col. Wilhelm Wimmer, who was in charge of the consolidation operation. The Office was organized in accordance with the horizontal pattern which meant that research and development (under the leadership of Lt. Col. Wolfram Freiherr von Richthofen) was kept separate from procurement (under Major Fritz Loeb), each department being independent of the other. The Office Chief was in direct command of all testing, while the approval of new equipment for release to the troops was the responsibility of construction supervision specialists.*

The immediate task of the air armament industry was to provide the necessary equipment for initial issue to the schools and flying units and to begin stockpiling the replacement equipment to make up losses due to wear and tear, obsolescence, and enemy activity in the event of war.

* Construction supervision specialists (Bau-Aufsichten), from 1933 to 1938 subordinate to the Construction Supervision Chief, were outside the province of officers involved with testing and procurement. The business and financial aspects, including checking and approving of prices, was handled by the Economic Group (Wirtschaftsgruppe) of the Administration Office.

The requirements set up by the General Staff were elaborated by the Planning Group of the Technical Office under the direction of Engineer Guenther Tschersich. This Group was concerned with a number of categories of activity, including those related to the designing and construction of airframes, propellers, airfields, gunnery ranges, engines, aircraft engines, airborne instruments and safety equipment such as parachutes, flares, pneumatic rafts, etc., armaments and bomb sights, and all sorts of ground service equipment.

Available facilities had to be considerably expanded or new plants established. Fortunately--this was largely due to Goering's influence upon Hitler, which was then extremely great--money was not a problem in the first stage of Luftwaffe development. The location and construction of new plants were determined by a number of factors. Only in exceptional cases were factories permitted to be in the vicinity of the border, and even then the firms concerned had to construct alternate establishments in less endangered areas. In order to satisfy the best interests of air defense the Luftwaffe High Command attempted to place industrial plants in areas that were not vulnerable to attack, and, especially to avoid congested areas. This was not easy to accomplish in many cases, since it often contradicted the best interests of economy. Once it was established, the Central Office for Construction Planning (under Minister Hans Kehrl) proved to be a big boon to the Luftwaffe's air armament industry.

Industrial plant elements had to be dispersed whenever possible -- no building could be larger than 64,560 square feet, and each had to be separated from the next by a distance equivalent to two buildings of this size -- and had to be adapted to the characteristics of the terrain. Air raid shelters had to be provided.

Other important factors in the development of the German air armament industry were the availability of a requisite force of skilled and unskilled workers, adequate transportation facilities for both workers and materials, and sufficient amounts of electrical power, coal, gas, and water. Because time was of the essence, production was begun even before the construction of the industrial plants had been completed.

Industrial facilities were to be planned in such a way that they took as little land and as few workers as possible away from

agriculture and the food-processing industries, and a sharp lookout was to be maintained to see that Communist or pro-Communist infiltration was kept to a minimum at such plants. Because of this principle, important aircraft parts sometimes had to be manufactured in three different plants, each located far from the others. By 1939 Germany had at her disposal a fairly broad foundation of air armament production facilities, organized from the mother plants on a trust pattern.

Raw Material Problems

In connection with its rearmament effort, the German Reich was confronted with a bottleneck as far as copper, molybdenum, tungsten, manganese, zinc, tin, rubber, fuel, and some other raw materials were concerned. This was also true to a lesser degree with the production of aluminum, which was restricted by a shortage of bauxite, even though in 1937 Germany led the world in the production of aluminum.

Germany had no restrictive regulations which could have been helpful in avoiding poor planning and a dissipation of her resources by utilizing them for purposes other than the armament industry. Moreover, her critical foreign exchange situation did not allow any considerable increase in the amounts of raw materials which she could acquire. The Military Economics Planning Staff, which should have taken over this job, was reduced in its effectiveness by the German officer corps' total lack of understanding of economic problems. Thus, the Staff operated primarily as a statistical office rather than as a fundamental guiding agency. Reichs War Minister Werner von Blomberg lacked the talent and resolution to make an issue of the matter and to bring it up at Cabinet level, while Generalmajor Georg Thomas, Chief of the Military Economics Planning Staff, possessed neither the status nor the personality (and perhaps not the ability) to stand up to the united front presented by the Wehrmacht, the Ministry of Economics (Wehrwirtschaftministerium), and German industry.*

* Editor's Note: Thomas apparently did not enjoy the confidence of the High Command, with the exception of Goering. Field Marshal Wilhelm Keitel described him in early 1941 as a person who was generally "trusted by the Reichsmarschall, but in his other activities and assignments was unbearable." Keitel also mentioned that he "tends toward pessimistic judgments." See biographical section in the rear of this study.

Goering, in whose field of activity the entire matter fell, was one of the parties most concerned by virtue of his position as head of the Luftwaffe, but he was hardly the man to devote himself to the routine work so necessary for the achievement of results. In this situation it was precisely unrelenting routine work that was required.

Germany finally succeeded in building up a small reserve of the most vital materials. In the long run, however, these stocks were ridiculously inadequate, especially in the event of a war. Hitler had not informed his military leaders of a possible date when war might be expected, and, in complete disregard of the revolutionary and explosive character of his political moves, in spite of the surprises he had brought about thus far, and in spite of the indications laid down in his Mein Kampf, German military leaders were convinced in 1938 that there would be no war until 1943 at the earliest.¹ To be more accurate, military leaders were reluctant to come to grips with the problems which confronted them and with the frightening potentialities of these problems, to consider the sudden dangers in Hitler's policies and to think them through to the logical conclusion. If Germany's leaders had faced the possibility of war coming as early as 1940, then presumably raw materials would have been better husbanded and used more discriminatingly for projects of military importance rather than for splendid Party or Wehrmacht offices, art museums, and theaters.* The Four Year Plan would surely have begun prior to 1936, and its administrators would have taken a much firmer position toward the frequently recalcitrant German industry and would have compelled it to take more adequate air security measures. In this connection the phrase "too late" hits the nail squarely on the head.

The Four Year Plan came into existence on 16 October 1936. It was designed to make the German economy, particularly the agrarian economy, able to withstand any possible crisis, and to help Germany to become as self-sufficient as possible in case of war and blockades. It also envisioned a considerable increase in coal production, the exploitation of ore deposits which had hitherto been regarded as inaccessible or were not economical

*Editor's Note: Some of the barracks (Kasernen), especially air base installations, were constructed in particularly beautiful and elaborate styles. These became the envy of some of the ground forces. See figures 25 and 26.

to mine (such as those at the Hermann Goering Works at Salzgitter), and the acceleration of construction schedules for hydrogenation plants, aluminum production facilities, and plastics factories. The Four Year Plan did not have a chance to take effect prior to the outbreak of the war.

The raw material shortage began to make itself felt in the beginning of 1937, when, on 4 January, a plan for the peacetime mobilization of industry was finally drawn up. Supplies of aluminum were entirely inadequate for the requirements of the project, and iron and steel allotments were cut by 60 percent. By 1937 the backlog of iron and steel orders amounted to 117,000 tons. Aircraft production (Me-109, Me-110, Do-17-F, He-111, Ju-86, Ju-87, Fw-56, Fw-58, Do-18, and W-34) which scheduled the completion of 9,800 aircraft by 1 April 1938, actually produced only 4,800, 2,000 of which really belonged to the previous delivery goal. In order to maintain the scheduled strength of the units already in existence, manufacturers had no choice but to delay the mass production of the Ju-88.* The conversion to new models, scheduled for 1 April 1938, had to be postponed for a full year.

The rational functioning of the various factories was seriously jeopardized by the constant modifications requested from above and by the Technical Office, and by the necessity of helping each other out with raw materials during acute shortages. As a result of the curtailment of materials in 1933, the Miag, Heinkel, Dornier plant in Wismar, and other firms were forced to discharge large numbers of employees, including skilled workmen.²

The planned expansion of the air armament industry gradually bogged down. Important installations such as altitude test chambers were first postponed and then given up altogether. The same applied to certain airfields and billets. As a result, the Quartermaster General of the Luftwaffe found it necessary on 4 June 1937 to make the following report of curtailments to the Chief of the Luftwaffe General Staff:

The annual allocation of iron had to be reduced from 290,000 to 180,000 tons, 48,000 of which had

* The plants producing the Ju-87 and Do-17 were also not working up to full capacity.

been earmarked for the expansion of production facilities. The allotment of 63,000 tons per year for artillery pieces was reduced to 30,000 tons, resulting in a bottleneck in the vital conversion from machine-guns to 2 cm. flak artillery pieces. Instead of 80,000 tons per year, only 41,000 could be spared for flak artillery ammunition, and, instead of 18,000 tons for bombs per year, only 2,000 was allocated. . . . The allotment for motor vehicle production was curtailed from 47,000 tons per annum to 22,000 tons, thereby reducing the flak artillery batteries to a state of immobility. Twenty three medium aircraft fuel columns had to be disbanded, a dangerous omen with respect to the refueling of airfields not equipped with railway spurs or underground tanks.³

As early as 30 October 1937 Milch was forced to report to Goering that the production goal of 21,800 aircraft by 1942 could be met only as far as 75 percent, and that only 25 percent of the flak artillery production goals could be met. For the civil air defense program there was simply no more iron available. All of these problems were to have been mitigated by the Four Year Plan, which began a year earlier.

In 1937, Goering, acting in his capacity as Chief of the Four Year Plan, delegated fairly comprehensive authority to General Udet, Chief of the Technical Office, to initiate measures independent of existing regulations and restrictions in a number of fields. He was thus empowered to issue instructions to the Ministry of Labor (Arbeitsministerium) requiring the labor force still available in the Reich and (later) in Austria to be primarily assigned to the air armament industry. In conjunction with the Ministry of Economics he could temporarily restrict the export of machine tools, ball bearings, and other essential products, and could accept far-reaching financial commitments, even those above and beyond the established budget for 1938-39.

Besides all of this, Udet was empowered to order the Ministry of Economics and its subordinate supervisory agencies to provide raw materials and semi-finished materials in accordance with the demands of the Military Economics Planning Staff, if necessary by temporarily restricting exportation and by curtailing the allotment of civilian projects.

Despite a number of difficulties, so much had been accomplished in the air armament industry by the outbreak of war that General Georg Thomas, Chief of the Military Economics Planning Staff, was able to state in a report before the Foreign Office representatives on 24 May 1939:

. . . out of the few factories permitted by the Versailles Treaty has grown the mightiest air armament industry which exists in the world today. It has risen to achievements that not only compare with Germany's accomplishments during the war, but which, in many cases, even surpass them. Germany's production of crude steel, after that of America, is today the greatest in the world, her aluminum production far exceeds that of America and of the rest of the world. The output of our rifle, machine gun, and artillery arms factories is at present larger than that of any other nation.⁴

Unfortunately for the Wehrmacht, this record performance of peacetime could not be maintained during the war.

Aviation Fuel*

Since Germany's own oil production was negligible, the petroleum supplies required for air units had to be imported. The hydrogenation of bituminous coal was unknown in 1934, although the Leuna Works (an ammonia plant) in Merseburg produced approximately 200,000 tons of fuel per year by the hydrogenation of soft coal (lignite).

As far as aircraft engines were concerned, German aviation leaders had to be content with unleaded gasoline (without the addition of lead tetra-ethyl). The problem of the construction of production centers for synthetic aircraft fuels -- this was a long-range project at best -- remained in the future until 1935. Satisfactory lubricating oils for aircraft engines were developed only after long and painstaking cooperative efforts between the Technical Office and the various private firms.

Importation became increasingly the only acceptable method

* From April 1934 on, aircraft fuels were handled by special groups within the Technical Office (Groups II and III).

of meeting current needs and establishing reserve stocks. This, in turn, required the availability of considerable storage and transport capacity. The construction of the necessary facilities began in September 1934. In the middle of May 1935, a beginning could be made in building storage plants at Derben, Nienburg, and Stassfurt.* By 1942 large storage tanks with a capacity for approximately 26,248,000 cubic feet of aviation gasoline and 3,884,100 cubic feet of lubricants had been built. These were exemplary in every respect, were well concealed, and were easily accessible and simple in operation. Fuel storage tanks with a capacity of 390,000 gallons of leaded aviation gasoline were also erected at the airfields themselves. The chemical inspection of these tanks and the fuels contained in them was the responsibility of the Aircraft Fuels Group (Flugbetriebsstoff-Gruppe) in the Technical Office.

In 1938 the Reichs Aviation Ministry found it necessary to withdraw responsibility for the expansion of home production from the Four Year Plan administration, which had failed to achieve any noticeable progress. The project was then placed under the direct command of the State Secretary. Petroleum exploration, despite test drilling down to depths between 9,840 and 13,120 feet, had failed to produce results. This made the hydrogenation of both bituminous and soft coal an absolute necessity.

In order to supplement the facilities of the Leuna (Hydrogenation) Works the Reichs Aviation Ministry persuaded the I. G. Farben concern to open two subsidiary plants, one in Boehlen near Leipzig, and the other in the vicinity of Magdeburg, each having an annual production of 80,000 to 100,000 tons. The plant near Ruhland (Lausitz) produced only automotive gasoline, which was too low in octane for aviation use. By 1940, these gasoline plants had been augmented by two bituminous coal hydrogenation plants, Hibernia near Scholven, and the Gasoline Works at Gelsenberg north of Essen, by a soft coal hydrogenation plant at Zeitz near Gera, and by a plant in Poelitz north of Stettin, where synthetic petroleum was produced.

* The original capacity of these tanks amounted to 2,648,250 cubic feet, which was later increased to 3,531,000 cubic feet. Those tanks for lubricants were originally 35,310 cubic feet and later 61,558 cubic feet.

Imported lead tetra-ethyl fluid was insufficient for the requirements of mobilization. After long and complicated negotiations, the American Ethyl Gas Corporation agreed to build a plant in Doeberitz. This installation, which was ready during the winter of 1936-37, was a beginning at least, and even though its production was adequate to provide lead for only 40 percent of Germany's gasoline, it helped to meet the needs of mobilization. A second large ethyl plant was constructed at Nachterstedt near Oschersleben, but only after many difficulties caused by the Farben people had been mastered. This plant started to produce in 1939.

Despite the fact that the allotment of lead remained a serious problem until the end of the war, there was never any shortage of lead tetra-ethyl fluid. Ethylene dibromide (produced by the I. G. Farben Works in Oppau near the eastern border) made up some 45 percent of the total product. Plans were made to transfer the plant to Skoppau in the event of hostilities. Chromium, another very important material, was provided by the German Potash Syndicate (Kali-Syndikat) at the request of the Reichs Aviation Ministry.

In 1939 the German Luftwaffe had a reserve of 400,000 tons of aviation gasoline, augmented by 20,000 tons per month from German production facilities, 9,000 tons per month imported from Rumania, and in 1940 by the capture of a cache of 200,000 tons of enemy aviation gasoline. From 1942 on, thanks to the increased output of the hydrogenation plants, Germany's production climbed to 120,000 tons per month.*⁵

Aircraft Design and Procurement

Until World War II it had been recognized that four years were required from the time an original design was drawn up and

* General der Flieger (Ret.) von Seidel, Quartermaster General of the Luftwaffe, commented during a lecture in 1949, "Our demands that a reserve supply of aviation gasoline adequate for six months (approximately 600,000 tons) be set up...were ridiculed as 'exaggerated.'" See p. 29 of von Seidel's lecture, Karlsruhe Document Collection.

submitted until it was approved for mass production. Aircraft engines in Germany required even longer, sometimes as much as seven years. One year was required for the design and construction of the sample aircraft, one year for testing, one year for the preliminary production series, and one year for mass production, preparations for which had to have been made in the preceding two years. Under pressure of the supposedly necessary rearmament pace, German air leaders had no choice but to arbitrarily shorten the developmental period in order to speed up the production of the aircraft concerned. An effort was made to save a year by starting production before the results of the tests had been evaluated. This saving of a year was a serious mistake, for the mass-produced planes from this accelerated program proved to be unready for introduction at troop level. Correcting the many defects required the expenditure of more time and labor than would have been the case had the original plan been maintained.

Besides this, the speeded up program resulted in a bogging down of the entire production process and led to endless friction between designers, producers, and the Reichs Aviation Ministry, so that the year saved was really a year lost. This is precisely what occurred in the case of the Ju-88 and the Ju-86, and with most aircraft brought out during the war. Even more serious was the fact that some models had to be temporarily withdrawn from service or dropped completely shortly before or shortly after their first test flight because of irreparable defects. This wasted millions of development work hours which could have been profitably expended upon such worthwhile projects as diving performances, pressurized cabins, remote-controlled weapons and weapon systems -- all matters of great technological complexity. In some cases faulty design and the need for subsequent modifications were due to the inaccurate statement of military requirements, often the result of a tendency on the part of the engineers to overrate the potentialities of technology. Nevertheless, the Luftwaffe General Staff has been often accused of neglecting its responsibilities after 1939 with respect to the formulation of tactical and technological requirements.⁶

The fact that individual aircraft firms (often acting upon their own initiative) worked on too many different aircraft models at the same time served to dissipate the industry's resources and to overburden production facilities. The Heinkel firm, which is a perfect illustration of this sort of thing,

developed or tested between 1933 and 1939 the He-74, He-111, He-112, He-115 (250 of which were finally produced), He-116 (the model used by Lufthansa), He-118, He-119, He-176 (the world's first rocket powered aircraft, 1939), He-178 (with the world's first jet engine, August 1939), and the He-100.*

In establishing deadline schedules German aviation leaders often forgot that frequently a larger number of engineering work hours was needed for initial production, including the correction of defects revealed in the first test flights, and for further development, which included the modification of equipment to comply with the latest technological advances, than for bringing equipment to the initial testing stage. Examples of this are the development of the Me-109 and the He-111.

That so many defects and fiascos were possible in spite of the devoted work by all concerned was surely due to the lack of experience of the Luftwaffe General Staff and the Inspectorates, which were in the process of organization and did not have experienced planning staffs. It was also due to the excessively heavy work load of the Technical Office. With the change in chiefs in 1936, General Wimmer was replaced as Chief of the Technical Office by Generaloberst Ernst Udet, and the officers in charge of the individual branches were replaced by engineers. It is possible that the latter may not have been fully qualified for their jobs or that Udet could not supervise them properly. In any case, the results were unsatisfactory.

The Luftwaffe did not make a start in developmental planning until 1940, and the statistical material and information regarding the operational capacity of the individual development firms (so necessary for effective preliminary planning) were not made available until 1941. In order to collect and examine these materials it was necessary to utilize engineer personnel from the firms themselves.

It was unfortunate, but true, that the industry was more

* The He-100 achieved a record speed of 393 miles per hour over a 62 mile flight on 5 June 1938, and of 463 miles per hour over the same distance in March of 1939.

powerfully motivated by the ideas of competition and personal gain than by that of cooperation. The practices of reporting higher capacities than actually existed, of promising early deadlines for test model aircraft, and of promising to begin initial and mass production at unrealistically early dates, were not in keeping with the better traditions and ethics of the business world.

Flight testing was early augmented by the work of Lufthansa. The State Secretary, who had come to the Luftwaffe from Lufthansa, then acted as a middleman between the civil aviation enterprises and the Luftwaffe. The technical supervision of Lufthansa rested with Generalmajor Karl-August Freiherr von Gablenz, while its business interests were represented by Director Ernst Lutz.

After 1933, the testing stations, such as that at Rechlin, became more and more important. Rechlin, for example, with its greatly enlarged physical plant and its increases in personnel and equipment, gradually assumed the proportions of a county rather than a community. It had two airfields, extensive bombing and gunnery ranges, engine test beds, etc. For the naval air units, Tarnowitz and Travemuende (the former with an island base projecting into the sea and ideal gunnery ranges) remained the most important test centers. Peenemuende, originally built by the Luftwaffe, was utilized for the building and testing of the V-weapons.* Diepensee was the site of a tactical experimental station.

In the beginning these stations were directly subordinate to the Technical Office, but in 1941, in order to avoid duplication at the various establishments, the office of Commander of Testing Stations (Kommandeur der Erprobungsstellen) was set up under Col. Edgar Petersen. The question of whether testing stations ought to be commanded by officers or by engineers was largely one of personality. The chiefs had been able to stand up for their views to the Technical Office, to parallel agencies (industry), and to subordinate agencies (engineer and pilot personnel assigned to the stations). They needed not only an intuitive understanding of the most complicated technological processes, but also the highly developed technical instincts of the experienced pilot. If they were engineers, they had to be familiar with the potentials of aircraft and with the prevailing conditions in all anticipated areas of operation, and if they

* The development of the V-1 was a Luftwaffe project, but a part of the Peenemuende station was under the command of the German Army Ordnance Office.

were officers, they had to possess a fundamental knowledge of technology and have a marked talent for organization. Sometimes the Commander of Testing Sections set up special testing sections for specific projects.* The entire testing program was hampered during the war, however, when the Luftwaffe Training Division was committed at the front, removing a number of the most experienced personnel from the testing activity.

Agencies concerned with basic and specialized research[†] forwarded their findings to industry and to the Reichs Aviation Ministry. The industry was then responsible for development, construction of test models, and preliminary testing, depending upon the desires of the industrial firm concerned. The testing stations intervened either at this point, working with industrial representatives to iron out any defects as quickly as possible, or after the initial production had begun. All equipment declared ready for introduction by the testing stations and authorized by the Reichs Aviation Ministry was released for testing at the troop level. Aircraft from initial production, the manufacture of which had begun during the testing stage, were also assigned to the front, and any defects revealed there were reported to the Technical Office as were the subsequent corrections of those defects.

* This included the Experimental Section, Office of the Commander in Chief of the Luftwaffe (Versuchskommando ObdL), with its 1st, 2nd, and 3rd Squadrons, the 26th Testing Station (Erprobungskommando 26) an antitank testing squadron, the testing section at Karlshagen, the 41st Testing Section (forest protection), the balloon squadron at Werneuchen, used also to test Luftwaffe experimental weapons at Adlershof, the Experimental Unit for Transport Operations, the 4th Testing Section (fighters), the Kolb Testing Section (machine guns) at Fuerstenfeldbruck, the Nebel Special Duty Section at Offingen, and the Testing Center at Laupheim.

[†] Independent development firms such as Horten, Focke, Ackgelis, Walter-Kassel, etc.

Aeronautical Research in Germany*

The aftermath of World War I and the terrible inflationary period of the twenties would have meant the death-knell for German scientific research activity if industry had not stepped in with generous contributions through the auspices of the Emergency Organization for German Science, which was founded in 1920.† The projects supported by this organization were all the more in need of assistance since the German government was unable to provide adequate financial aid for its 2,600 university and college research institutes, for the extensive Reichs Institutes of Applied Physics and Applied Chemistry, or for the Kaiser-Wilhelm Institute with its thirty-seven subdivisions.

In the field of aviation there were the German Experimental Institute for Aviation in Berlin and the Experimental Institute of Aeronautics in Goettingen, but the German aviation industry believed that these two were insufficient to meet the needs of the time. Industry therefore took the initiative and established a research institute of its own, but, in so doing it made the mistake of failing to allot it sufficient funds. The result was a duplication of efforts in research and a lack of clearly delineated programs.

The Reichs Aviation Ministry was well aware of the inadequacies of this system and in 1933 authorized the founding of the Association for Aviation Research, an organization which was redesignated on 25 June 1936 as the Lilienthal Society for Aviation Research. Its objectives, apart from the establishment of aviation research goals, the promotion of specialized research projects, and the advancement of the exchange of scientific information, lay primarily in the area of applied technology. In addition, the Society endeavored to establish and maintain contact with the aviation industry, with commercial air agencies, and with the authorities concerned with the administration of civilian aviation activities, to disseminate information on the latest technological advances in aviation,

* In the original manuscript this section was immediately preceded by a treatise on the development of flak artillery within the Army Ordnance Office.

† This was later renamed the German Research Association (Deutsche Forschungsgemeinschaft).

and to promote the education of a new generation of flying enthusiasts. More ambitious research undertakings were handled by the German Academy of Aviation Research, a group which maintained contact with aviation and allied scientific agencies.

In 1937 the German Experimental Institute for Aviation and the Experimental Institute of Aeronautics were consolidated in the German Experimental Institute of Aviation, whose branch organizations spread rapidly from Adellershof-Goettingen to Braunschweig. This became the central research institute for aviation, and entailed the following research fields: aerodynamics, stability of construction aircraft mechanics, naval aviation activities, construction materials research, engine research, manual procedures and thermodynamics, power plant mechanics, fuel research, airborne equipment and navigation, and electro-physics.

Goering backed the Institute with the full authority of his office, and it was financed to a large extent by the Reichs Aviation Ministry. Once established, the aviation industry made no further attempt to set up research centers of its own, although a good many of the industrial research centers were, in any case, closely allied through their directors with the official research agencies.

The Institute was handicapped by a shortage of qualified engineers (mainly because industry offered much higher salaries), as well as by the fact that Generaloberst Udet, Chief of Supply and Procurement, seemed to lack contacts among the leading personalities in the field of aviation research.* At the same time the aviation industry did not possess the required technical equipment for many undertakings, and it was not until 1941, for example, that the first large-scale wind tunnels became available.

The Office of Luftwaffe Supply and Procurement

The Luftwaffe established the Office of Supply and Procurement

* As shown by the behavior of Udet's Chief of Staff, Generalmajor (diploma engineer) August Ploch (not to be confused with General Hermann Plocher), toward designers and inventors visiting the Office of Supply and Procurement. Udet himself was inclined to be shy and suspicious.

on 1 November 1934 as a subsidiary agency of the Reichs Aviation Ministry and charged it with the responsibility for all supply activity. This office was directly subordinate to the State Secretary and remained in existence until 1936, when it was made a part of the newly established Luftwaffe Supply Office.

In 1936 and 1937 the Luftwaffe Supply Office was subordinate to the State Secretary, in 1938 it was transferred to the command of the Chief of Air Defense, and in 1939, together with the Technical Office and Department of Industry and Economics, to the Office of the Chief of Luftwaffe Supply and Procurement. This move gave the latter office exclusive control over the Luftwaffe technical field.*

The need for secrecy required the creation of an office for Luftwaffe supply and procurement outside the framework of the Ministry itself. The name Luftzeugmeister (Air Ordnance Chief), was coined from the Army's counterpart, the Feldzeugmeister (Field Ordnance Chief). This office was in charge of all supply and procurement.

Despite its subordinate status to the State Secretary, the Supply and Procurement Office received orders and instructions pertaining to the type and sequence of issue of troop supplies and the stockpiling of supplies for mobilization from the Quartermaster Group, Operations Branch, of the Air Command Office. Working closely with the Operations Branch, the Quartermaster Group was provided with the plans for unit activations, equipment, and station locations (together with geographical data) as well as the material it needed to prepare preliminary calculations regarding the initial issue of equipment, requirements to meet current needs and to establish adequate supply stocks. These calculations, used in drafting the tables of organization and equipment, served as a basis for the work of the Supply and Procurement Office. Close cooperation between these agencies was of the essence.

* In 1938 and 1939 the Office of the Chief of Luftwaffe Supply and Procurement was divided into Branch 1 (organization of supply), Branch 2 (aircraft and air equipment), Branch 3 (motor vehicles, etc.), and Branch 4 (flak).

In 1934 the Luftwaffe Administrative Office supervised the construction of the most diversified kinds of supply installations: supply and procurement offices, depots, aircraft parks, and ammunition depots. The following year, when Germany regained her military sovereignty and the Luftwaffe established its six Air Service Area Commands -- a supply and procurement group was established in each of these areas under a commander who acted simultaneously as quartermaster officer for the Air Service Area concerned -- the lower echelon organization came into being. Between 1934 and 1936, as long as there were only schools to be supplied, the work of the Supply and Procurement Office remained within reasonable bounds, but there was soon too much work to be done, so that some of the burden had to be delegated to subordinate units. These agencies, whose commanders were of high rank and great authority, were able to assume responsible control over the supply system. This, however, left the Supply and Procurement Office somewhat separated from its lower echelon operations. Since it was not deemed advisable to set up a special board for the supervision of these operations, it was decided at the highest level in the Luftwaffe to establish another office, the Office of Supply. The responsibilities and authority of the Chief of Supply and Procurement were distributed between the new Office of Supply and the Office of the Senior Quartermaster (Oberquartiermeister), which had developed out of the Quartermaster Group of the Air Command Office. The Chief of the Quartermaster Group had become Senior Quartermaster and therefore was directly subordinate to the Chief of the General Staff.

With its comprehensive activities in equipping the Luftwaffe and with its assumption of responsibility for supplying the flak artillery units, the Luftwaffe Supply Office soon developed into a miniature ministry, and by 1 February 1938 had reached its final state of development and was ready for integration into the newly established Office of the Chief of Luftwaffe Supply and Procurement. At this time the Senior Quartermaster was redesignated the Quartermaster General.

Until 1 April 1937 the organizational plans of the Luftwaffe called for the assignment of a quartermaster officer to each Air Service Area. The creation of Air Districts left this system unchanged. These quartermaster officers, who were in charge of the supply and procurement groups in their respective areas, came under the command of the airfield area commanders, and administered the supply functions in accordance with orders and

requests submitted to them from units in the area.

The commanders of the airfield areas were responsible for all of the supply activity within their commands, with the exception of that of the ordnance administrative offices. In case of war, the units working in cooperation with the Army or Navy, or temporarily subordinate to them, were to be guided by special procedures.

At the outbreak of war in 1939, the Luftwaffe had 12 supply and procurement groups, 7 supply and procurement offices, 1 signal communications supply office, 14 aircraft parks (for land aircraft), 3 aircraft parks (for seaplanes), 3 flak parks, 2 Luftwaffe equipment turn-in stations, 48 ammunition depots, 14 fuel depots, and 1 gas processing plant. Besides these, and in addition to the regular supply columns which would have to be organized, there were to be 10 aircraft equipment issue stations (motorized) and 13 aircraft equipment issue stations (rail) available in the event of mobilization.

During the period of secrecy, the Chief of the Supply and Procurement Office was the superior officer for all supply installations. In conformity to orders issued by the Air Command Office and the Quartermaster Group, he arranged all supply activity in connection with Luftwaffe schools. Between 1 April 1935 and 1 February 1938 the Quartermaster General was responsible for maintaining a high state of operational readiness in the Luftwaffe, from the standpoint of personnel as well as materiel. This also applied to those Luftwaffe elements which were temporarily or permanently assigned to the Army or the Navy. His office was in charge of effecting a proper distribution of supplies among front units, schools, personnel replacement units, and newly activated organizations. It supervised ground organization installations and the expansion of those ground units. The Quartermaster General also had authority to order into action the rear area units of the Reichs Aviation Ministry and of the Commander in Chief of the Luftwaffe.

The Chief of Air Defense and his successor, the Chief of Luftwaffe Supply and Procurement, functioned as the superior headquarters of the Luftwaffe Supply Office in connection with equipping all Luftwaffe agencies, as well as with the matter of building up the required stocks of supplies. The Luftwaffe Supply Office, as the central clearing house for the Reichs Aviation Minister and the Commander in Chief of the Luftwaffe, presented

its requests for aircraft, weapons, ammunition, fuel, and equipment to the Technical Office and distributed these items to the various subordinate units for issue.

The Luftwaffe Administration Office (subordinate to the Chief of Air Defense) had charge of supply in the field of clothing and food, and worked through the Air Service Area Food Supply Officers with the Air District Food Supply Officers (Luftgauintendanten). The latter, under the command of the Commanders in Chief and their staff chiefs, were responsible for administering all procurement and distribution of food within the Air Districts.

The Luftwaffe Personnel Office (also subordinate to the Chief of Air Defense) was responsible for organizing and assigning personnel replacements in accord with the Luftwaffe Administration Office. Its channel of operation was through the Organization Branch (Officer and Enlisted Personnel) and the Quartermaster Branch of the particular Air Fleet to the Air District Command.

Air Districts functioned as centralized intermediate levels of command. They were authorized to issue orders to local administrative agencies as well as to those local agencies concerned with technical matters.

Logistical services for Luftwaffe units attached to the Army and the Navy were handled by the Logistics Staff Officer (Sachbearbeiter fuer Versorgung) on the staff of the Luftwaffe General with the Office of the Commander in Chief of the Army and by the Senior Quartermaster on the staff of the Luftwaffe General with the Office of the Commander in Chief of the Navy, respectively.

Luftwaffe commanders assigned to the High Command of the Army were responsible for the logistical services for Luftwaffe units assigned permanently or temporarily to Army operational areas. In coordination with the appropriate Air District Commands (Quartermaster and Food Supply Branches) they supervised the issue of supplies, including food and clothing as well as equipment, to flak artillery and motor vehicle units. The issue of all other supplies was coordinated with the quartermaster officers of the individual Armies.

The Senior Quartermaster, who was able to draw on the Supply and Procurement Office (Naval Air Forces) and on the aircraft parks, administered the logistical support of Luftwaffe units which were either permanently or temporarily assigned to the Navy.

Production and maintenance firms delivered equipment (exclusive of such items as clothing, ammunition, fuel, and oxygen) to the Supply and Procurement Offices, which, in turn, distributed these items to the aircraft and flak artillery parks. Only in special instances did production firms make direct deliveries to the parks. Shipments by industry served to supplement and to increase the supply stocks at the ammunition depots. The main ammunition depots assembled flak ammunition (which was all delivered unassembled except for 2. cm. ammunition) and issued it ready for use to subordinate depots.

Aircraft fuel tank depots, fuel supply depots, and vehicle fuel supply depots were supplied either from large established depots or from the particular production firms.

The number and type of supply installations assigned to each Air District depended upon the size of the District, the number of units assigned, and the relative vulnerability of the site (nearness to the border, etc.) to enemy action. In keeping with the local situation supply and equipment points were set up at the intermediate level between the schools and the field units.⁷

Army Medical Supply Depots issued medical supplies to the Luftwaffe Medical Supply Branch Depots, and these, in turn, issued the requested items to the higher level medical using agencies.

The Supply of Field Units

In general the Quartermaster General or the Senior Quartermaster administered the supply of troop units. Aircraft were either ferried by the producing industry to the Supply and Procurement Offices or picked up by aircrews from those Offices. The Supply and Procurement Offices had the responsibility of preparing the aircraft for combat use by installing radio equipment, weapons, etc. Crews of these Offices flew all aircraft to the receiving units except in the case of extremely urgent requests. In an effort to keep to a minimum the special procedure

of having using units pick up their own aircraft the Luftwaffe assigned in 1939 Aircraft Ferry Groups (Flugzeug-Ueberfuehrungsgruppen) to the Supply and Procurement Groups. In 1942 an Aircraft Ferry Wing was distributed among the Supply and Procurement Groups located near the front areas, and proved to be able to master all difficulties which arose.

After the outbreak of war in September 1939, it also proved to be necessary to establish aircraft test areas behind the front lines in order to permit the testing of planes before release to line units. These areas were also used for the final assembling of aircraft. In the South, for example, lightweight aircraft were transported over the Alps by rail during periods of inclement weather, and were then assembled and tested under the supervision of the Air Fleet Chief Engineer at fields conveniently located south of the Alps. Partially or completely damaged aircraft were picked up by salvage columns working under the direction of the Air Fleet Chief Engineers. The evacuation of unused and unserviceable weapons and equipment and other materiel was carried out in accordance with procedures that were uniform for all areas.

Normal supply transport facilities were supplemented by motorized transport columns, motorized fuel columns, and horse-drawn transport columns, all consolidated under the special Transport Column Staffs in each area. In compliance with the mobilization plan a total of 12 of these staffs and 117 motorized Luftwaffe supply columns had been set up by late 1939.

The Selection of Aircraft in the Luftwaffe*

Luftwaffe leaders regarded the selection and production of

* Material contained in this section is based upon a brief study by General der Flieger (Ret.) Paul Deichmann, on a study by Generalingenieur (Ret.) Gerbert Huebner, "Der tatsaechliche Ablauf der Aufgabenstellung (Planung und Auswahl der Flugzeuge fuer die deutsche Luftwaffe)," (The Actual Course of the Mission: Planning and Selection of Aircraft for the German Air Force), and upon a study by General der Flieger (Ret.) Hellmuth Felmy, entitled "Kurze Angaben ueber die Geschichte des 4-mot. Bombers" (Brief Remarks on the History of the Four-Engine Bomber), and a second study by Felmy, "Wie Kam der Gedanke eines Schnellbombers auf?" (How did the Idea of a Fast Bomber come about?), Karlsruhe Document Collection.

various types of aircraft for the fighting forces as one of their major responsibilities. Consequently, it was imperative that the technical and tactical agencies of the Luftwaffe High Command should work closely together. In some cases it was even necessary to ascertain the political intentions and opinions of the heads of state in order to make decisions on aircraft. Obviously, the entire program could succeed only if all of the agencies concerned--military, government, and industry--accomplished their tasks with skill and conscientiousness, and no link in the chain could be allowed to fail if crucial mistakes were to be avoided.

Tactical and Technical Requirements of the General Staff

The General Staff, and particularly the Tactical and Technical Requirements Group (IT Group) within this organization, was responsible for determining the aircraft types required on the basis of the plans for the conduct of operations in the event of war. This was naturally dependent upon Germany's knowledge of the enemy and the resources available to him.

For determining the tactical and technical requirements of aircraft the General Staff could call upon the individual Inspectorates under its command.* Each of these was called in for consultation with respect to the aircraft type under its supervision, the 1st Inspectorate for reconnaissance aircraft, the 2nd for bombers (and after 1 February 1939 for dive-bombers as well), and the 3rd for fighters and dive-bombers (and after 1 February 1939 for fighters, ground-attack aircraft, and "destroyers"). As expert bodies directly concerned with the inspection of the flying units, these Inspectorates served as a link between the General Staff and the units in the field. In compliance with orders from the General Staff, they were responsible for recommending the tactical requirements necessary to enable the aircrews to accomplish their missions. The views of the Inspectorates on tactical and technical requirements were also important from the standpoint of training. These requirements could be extremely varied, and included items such as the number of crew members required for different types of missions, the supplementary equipment needed to make aircraft suitable for the assigned tasks, and the modifications necessitated by unusual

* See p. 63.

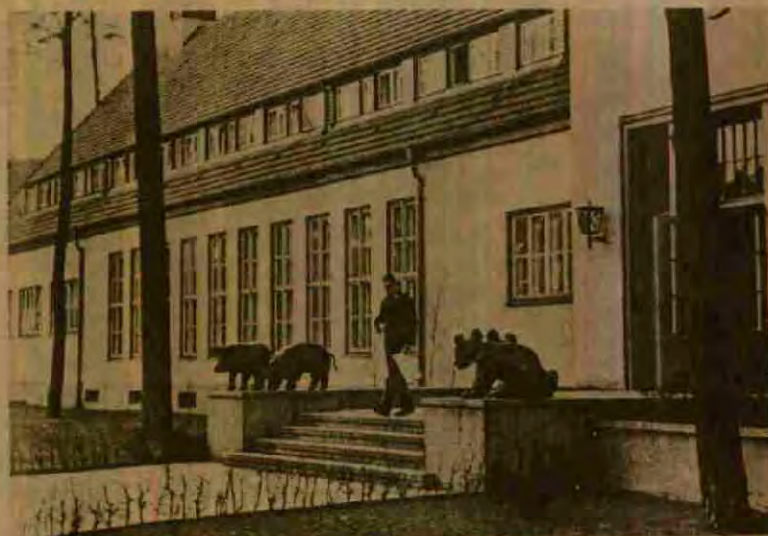

Figure 25

A typical modern barracks at a Luftwaffe base.



Figure 26

Luftwaffe personnel relaxing on the patio of a mess hall after luncheon.



Figure 27

An early transport plane and Luftwaffe bomber, the Ju-86, which, with proper power plant modifications, might have been useful in World War II. As it was, it was obsolete by 1939.

conditions. All of these things had to be taken into account in the earliest stages of design.

Inspectorates had to maintain very close contact with the Technical Office and had to participate in the inspection of the various mock-up and model aircraft. This was not accomplished, however, without difficulty. Frequent personnel changes in key positions, the lack, at least in the early period, of qualified personnel in the field of bomber aircraft, and the tendency of the Commander in Chief of the Luftwaffe (who seemed to think that youth could do no wrong) to appoint excessively young officers without the necessary experience to important posts in the development program all hampered the work of the Inspectorates.

The Chief of the General Staff was kept constantly informed of developments in this field and was responsible for making the final determinations of tactical and technical requirements. Once approved by Goering -- this sometimes also involved the concurrence of the State Secretary -- they finally became effective and the plans could be put into action. Unpredictable changes in the political situation, however, including spur-of-the-moment decisions by either Hitler or Goering, often upset the plans.

The General Staff has been accused, partly from its inception⁸ and partly from the period since 1939,⁹ of having failed to provide effective guidelines or purposeful requirements for developmental activity, and it was precisely sensible guidelines which were most needed to meet the threat of war and to assure a smooth continuation of these programs in the course of a war.

The fourth Chief of the General Staff, Hans Jeschonnek, whose own knowledge in the technical field was obviously quite limited, had a technically well-versed consultant to assist him until the beginning of the war in the person of Capt. (GSC) Helmut Pohle. But, when Pohle, who had already been taken away from his job with the General Staff by his assignment as chief of the Ju-88 testing program at Rechlin, was shot down during an attack by his Ju-88 group on enemy naval targets at the mouth of the Tyne River on 16 October 1939, and was then taken prisoner by the British, the highly important IT Group fell into the hands of a group of youthful, inordinantly ambitious officers who were both inexperienced and inadequately controlled by Jeschonnek. The results were chaotic. According to General-richter (Ret.) Dr. Manfred Roeder:

. . . since 1939 neither the General Staff nor the IT Group bothered to submit concrete requirements for the technical performance of aircraft. Instead, they contented themselves with commonplaces, and Storp, the Chief of the IT Group, during his visits to the factories to inspect mock-ups of new aircraft models, paid a great deal more attention to external features such as crew comfort than to the technical data of the particular aircraft. It was Storp who ordered a minor change in the airframe of the mock-up of the JU-188* which delayed series production for several months.

Interrogation of the General Staff members revealed the incredible fact that there were no performance requirements for future aircraft models on file and that the Office of the Chief of Luftwaffe Supply and Procurement had not been provided with any data which could be used by the technical agencies to develop the technological requirements likely to be demanded of the aircraft then in the process of development for use by strategic Luftwaffe units in air operations.

The IT Group had furnished the Chief of Luftwaffe Supply and Procurement with only a single fundamental principle to work from, namely that the ideal to be striven for was the unification of all types of aircraft performance (fighter, bomber, and dive-bomber) in a single model, in order to reduce the total number of individual aircraft types. This requirement, surely unique in the history of technological development, was patently so unrealistic that Generalfeldmarschall von Richthofen, during the course of the investigation, felt constrained to declare, "Utter nonsense! Nature can't be deceived!"¹⁰

Soon after General Wever's death it became apparent that the Luftwaffe General Staff was neglecting to adjust its technological requirements to the anticipated operations of a potential war. In part this may have been due to the fact that the Wehrmacht High Command and the Army High Command consistently

* Editor's Note: An advanced design drawn from the Ju-88. This model did not get into series production until 1942.

refused to make any prognosis regarding the possible course of a war and advocated the view that in any case air armament would be able to adjust itself quickly to wartime conditions. It was by no means common knowledge, even among those who ought to have known, that the development of an aircraft from the planning stage to production took a minimum of two years.¹¹

The conditions described may be attributed in part to the deterioration of relationships between the leading personalities of the Luftwaffe which began to make itself felt soon after Wever's death on 3 June 1936, and which became more marked after General Wimmer's resignation from the Technical Office on 15 June 1936. Worst of all was the enmity which existed between Jeschonnek and State Secretary Milch.¹² Nor was Jeschonnek on a particularly amiable footing with the sensitive and suspicious Udet, Chief of the Luftwaffe Supply and Procurement Office.¹³ Milch had been extremely cool toward the Luftwaffe General Staff Chief since 1937, when the General Staff succeeded in changing its status so that it was no longer subordinate to Milch in his capacity as permanent deputy to the Commander in Chief of the Luftwaffe.¹⁴ At the same time his relationship with Udet, who was also directly subordinate to Goering, began to worsen. Goering, whose office placed him above all three of these men, seemed to be incapable of smoothing over the situation. Therefore, the urgently needed cooperation and integration of top-level agencies, a sine qua non for the achievement of the air armament program's goals, no longer existed.

Far graver than this, however, was the sin of omission on the part of the Luftwaffe General Staff which can best be explained by the provisional character of Germany's foreign policy at the time, a policy which declined to furnish top-level Wehrmacht agencies with specific (insofar as was possible) information concerning the government's plans and intentions for the future. Instead, the government tried to steer a course characterized by excessive optimism and a complete disregard of risks which should have been clearly apparent as it moved along the thin line between peace and war, seemingly as if the Wehrmacht was fully prepared to go into action immediately in case of the outbreak of hostilities.¹⁵ -

The Technical Office

The missions and duties of the Chief of the Technical Office were laid down in an order issued on 18 January 1938. This order

stipulated:

- 1) The Chief of the Technical Office is directly subordinate to the Reichs Aviation Minister and the Commander in Chief of the Luftwaffe.
- 2) In compliance with instructions issued by the Reichs Aviation Minister and the Commander in Chief of the Luftwaffe, the Chief of the Technical Office supervises the procurement of equipment and the industrial activity incidental to the armament program of the Luftwaffe.
- 3) In concurrence with research agencies, industry, and the Army Ordnance Office, the Chief of the Technical Office is in charge of research and development, particularly of aircraft and aircraft equipment and of testing.
- 4) On the basis of requirements reported to him, the Chief of the Technical Office procures the stocks of equipment and ammunition needed to take care of initial issue, current supply, and the establishment of a reserve for use in the event of war.

On the basis of requirements pertaining to supply during wartime, he supervises the expansion and the production capacity of the companies engaged in armament production for the Luftwaffe and, in coordination with the Military Economics Staff of the Wehrmacht, takes steps to insure the availability of personnel and raw materials required by industry in the event of war. He represents the interests of the Luftwaffe in connection with the allotment of materials and industrial facilities during conferences with other Wehrmacht agencies.

- 5) In accordance with instructions issued by the Reichs Aviation Minister and the Commander in Chief of the Luftwaffe, the Chief of the Technical Office supervises the production of Luftwaffe equipment by industry.¹⁶

The Technical Office was organized horizontally in that the

Development Branch and the Production Branch were on the same level. This form of organization was retained with very few modifications until 1938. Clearly separate areas of activity were in the hands of well-organized, expert staffs. Frequent discussions and exchanges of opinion could be had without the necessity of going through long and complicated channels. Those areas of activity which required constant coordination, such as fuselage and engine development, were combined under a single chief, who then established the necessary contacts between the sections dealing with testing and procurement.

The horizontal structure of the organization was abandoned on 1 February 1939 in favor of a vertical arrangement in which development and procurement were combined in the various major branches dealing with the different aircraft types. Under this new system one individual was responsible for each sort of equipment from development to mass production. This, of course, helped to relieve the burdens of the Chief of the Technical Office. The main disadvantage lay in the fact that the Chief now had to deal with thirteen separate, but mutually interdependent, groups instead of the four branches or groups under the old system. As a result it was no longer possible for him to maintain close contact with all aspects of operations of his office.

The procurement agencies (which were supposed to work with considerable independence and in accord with sound business principles) were organized into seven separate groups. There was no uniform direction of these groups, and the Economic Group in the Luftwaffe Administrative Office was not large enough to compensate for the disadvantages which this entailed. Thus, under the new system of organization it was quite possible that there might be no one in the Technical Office who was fully acquainted with all aspects of the work being done on a particular aircraft, such as, for example, the He-177.

Neither Udet, his Chief of Staff, Generalmajor August Ploch, nor his Chief Engineer, Generalingenieur Roluf Lucht, was capable of holding such an amorphous office together. Yet, the Technical Office was enlarged even more when the Office of Supply and Procurement was established on 1 February 1939. Research, development, testing, procurement, and business supervision were all placed under a single authority. This was an appealingly neat form of organization, but one which Udet, with his artistic temperament and lack of talent for routine work, was not equipped to handle. To make matters worse, his Chief

of Staff, Generalmajor Ploch, was even less fitted to command such an organization.

The old Technical Office, still under Udet's direct command, the new special groups, testing stations, and other organizations making up twenty two agencies, all fell within the jurisdiction of the Chief of Luftwaffe Supply and Procurement. This organization had nine more technical groups than it had before 1939. The disadvantages of the vertical form of organization were scarcely mitigated by the annexation of the Industry and Economics Department. When war came these disadvantages had not yet become apparent, and the initial victorious campaigns in Poland, Norway, and France gave the impression that everything was in reasonable order, but during the Battle of Britain they began to make themselves painfully felt. The repercussions of this played a significant role in Udet's subsequent suicide.

The Role Played by the Technical Office

Once the tactical and technological requirements for new equipment had been determined, the Technical Office took over and worked out the technological aspects of the largely tactical demands of the General Staff. For example, it might be necessary to disapprove the use of a recommended material or to order the use of another or to specify the aircraft engine models to be used. This preliminary work was followed by calling for bids on projects and awarding contracts to one or more production firms. Experience had shown that it was advisable to have at least two companies working on the development of each piece of equipment.

Germany's aircraft development program was seriously handicapped by the fact that she was far behind other nations in the development of aircraft engines. Prior to 1933 Germany had no choice but to get by as best it could with the few foreign engines (Napier "Lion," Bristol "Jupiter," and Pratt and Whitney "Hornet") she was able to import. The engine development program launched in 1930* had not yet reached the production stage. Both 30 liter and 20 liter engines, as well as two Diesel models, were in the process of development in 1933 and 1934, and two test models were constructed of each (30 liter engine - DB 600-601 and Junkers Jumo 211, and 20 liter engine - BMW 116 and Junkers Jumo 210). There were still a number of difficulties to be overcome before Germany could begin the licensed production of the

*See p. 23.

air-cooled "Hornet" as the BMW-123 and the Bristol "Jupiter" as the SA-22. This caused a great delay in the introduction of the air-cooled radial engine.

Because of this situation, the aircraft had to be designed so that obsolete engines could be later replaced by more modern ones, whose extra power would make it possible to achieve the performance standards which were originally specified. Sometimes aircraft had to be built on the basis of already existing models, provided that these came close to meeting the required performances.

Aircraft Production

Once the designs had been approved production firms constructed full-size wooden or cardboard mock-ups of the aircraft to allow checks on space layout, visibility conditions, and the accessibility of vital equipment. Representatives from all agencies concerned, as well as experienced pilots from the front, took part in these inspections.

After this had been done and the inspections evaluated, the Technical Office requested test models to be made of the particular aircraft. These were then tested by the firms which built them and, later, by the Reichs Aviation Ministry. When this had been completed a testing phase followed in Luftwaffe units, usually those of the Training Division. This final test determined whether the model ought to be introduced to front line units. Ordinarily this decision was made by the Commander in Chief of the Luftwaffe, after he had heard the views of the Technical Office and the General Staff and had seen demonstrations of the model in question. The same procedures were followed for aircraft engines and other equipment.

Both design and construction were under constant pressure to produce "as much as possible as quickly as possible." In these circumstances it was clear that the procurement of spare parts was sooner or later bound to lag behind. In vain did Luftwaffe leaders recommend that these parts be procured at the rate of 20 to 30 percent of the completed aircraft.

Unfortunately for the Luftwaffe, production was never rationalized nor was the operation of awarding of contracts to the various firms or the exchanging of experiences and opinions

between the several firms. Company managers displayed unusual skill in acquiring contracts from the Reichs Aviation Ministry, a skill they continued to utilize to the fullest, even when their firms had no more production capacity available. The Heinkel and Messerschmitt companies, for example, were active in greatly diversified fields, and were "over-extended" in the scope of their operations. By the end of the war Messerschmitt was building not only the single-engine fighters Me-109, Me-163, and Me-262, but also the twin-engine fighters Me-110, Me-210, and Me-410, as well as large capacity cargo gliders, the Me-321, the Me-323 (converted for use as a transport), and the Me-264 long range reconnaissance and bomber aircraft. Focke-Wulf, to mention a third firm of this sort, was building a night fighter, the Fw-154, the Fw-200 long-range bomber, the Fw-189 reconnaissance aircraft, the Fw-44 training plane, as well as the various versions of the Fw-190. The rest of the aircraft firms had much the same situation.

Three aircraft engine firms were carrying out parallel development work on three engines of equal power (DB-603, BMW-801, and the Jumo-213). How much better it would have been from the standpoint of increasing production and saving material and labor to have combined them! This would have simplified the supply, storage, and maintenance problems and would have allowed the assignment of all of the designers to a single project.

The frequent changes in the tactical and technological requirements made it impossible for the air armament industry to exploit its capabilities to the fullest extent. Equally unfavorable in its effect was the failure to discontinue work without delay on any item that had clearly failed to meet the specifications demanded of it. Instead, projects were allowed to go on, even though the results were bound to be patchwork at best. The Ju-288 for example, although obviously sub-standard, was not dropped from the program for four more years, during which time a large staff of designers and skilled technicians wasted vast supplies of valuable materials in the vain hope of improving it.

Aerial Torpedoes

It was shocking to think that after ten years of existence the Luftwaffe had no suitable aerial torpedo. Instead of assigning the development of this weapon to industry, the Reichs Aviation Ministry had turned this task over to the Experimental

Torpedo Institute (Torpedo-Versuchsanstalt) operated by the German Navy in Eckernfoerde. The Norwegian campaign brought to light the gross inadequacy in this field. The Institute had managed to seal itself off from the outside world so effectively that not even the Luftwaffe officials directly concerned with torpedo development were permitted to be present during the testing of German-made and foreign-made torpedoes. The Norwegian "Horten" torpedo (LTF 5b), a few of which had been delivered as early as 1934 and 1935 but which were not tested until 1938 (in Travemuende), turned out to be a complete dud. Better results were obtained with Italian torpedos (LTF 5w, manufactured under license and based on the Whitehead torpedo, and the S.I. torpedo built by Silurificio Italiano), which were tested at a flight altitude of 328 feet and a speed of 210 miles per hour.

In order to keep its inefficiency and blundering from becoming public, the Experimental Torpedo Institute established greatly exaggerated security measures, even with respect to sister branches of the Wehrmacht. Neither the commanders of naval air units, Generals Joachim Coeler and Martin Harlinghausen, nor Generalingenieur Ernst Marquardt had been able to elicit any information of significance.

The Experimental Barrage Command, on the other hand, achieved highly satisfactory results in the development of aerial mines. The work on this weapon was handled on the same basis as the development of the submarine mines.

Introducing Aircraft at Troop Level

The introduction of aircraft at the troop level was hardly handled in a manner conducive to serving the best interests of the Luftwaffe. From the beginning any decisions in this area made by Luftwaffe leaders were powerfully influenced by political factors. Fear of Allied interference in the German rearmament program made it impossible to establish a truly comprehensive training program for flying personnel from the outset and to accomplish the painstaking and time-consuming developmental work needed for aircraft to meet high performance standards. All of this would have taken more time than German government leaders (working under the pressure of an anticipated Allied intervention) were willing to grant. What they wanted was the rapid activation of units which, to the outside world, would appear to be capable of striking a powerful and telling blow. It seemed to be irrelevant to them that these units had to get by with obsolete equipment.

The main thing was to make it clear to any potential enemy as soon as possible that he would be taking a grave risk to tangle with Germany.

It lay in the nature of the situation that these units could only be activated by utilizing the military aircraft which were already available or by adapting commercial aircraft for use as bombers. This was a stopgap measure, and it meant that the greater part of the initial aircraft issued to the newly-formed units were already obsolete and would presumably have to be scrapped within the very near future. During the summer of 1935 Goering openly and cynically admitted to some of his friends that he would have no objections if the entire production of 1933, 1934, and 1935 were simply consigned to the trash heap after Germany announced its military sovereignty. The main thing from his point of view was that enough aircraft should be produced to force industry to expand its capacity and -- this was no less important -- "to impress Hitler and to enable Hitler, in turn, to impress the world."¹⁷

During the first phase of events (1934 to 1936) the Luftwaffe's units were activated in rapid succession and equipped with military aircraft previously developed by the Reichs War Ministry or with commercial aircraft outfitted with makeshift weapons. Developments made during the period of secrecy prior to 1933, which were tested in Lipetsk, were available, but these were advanced very little beyond the 1918 types and were of little combat value.

The second phase (1936 to 1938) was dominated by the objective of equipping the new air force with aircraft models which could be expected to be a match for those of any potential enemies. The developmental work on most of these models had either begun within the framework of military or civilian programs, or could be initiated without delay with the help of other nations. It was during this period that the medium bombers, the Do-17, the He-111, and the Ju-86 came out.* The Ju-86 (the first all-metal aircraft made with non-corrugated metal) had excellent flight characteristics, but was equipped with an engine (Ju-205 Diesel) that caused endless troubles. Because of inadequate testing of these engines, the aircraft had to be withdrawn from line units in 1937, and left the Junkers firm no choice but to scrap the pre-cut parts already on hand, enough for 1,000 aircraft. It might have been retained as a training aircraft, but, instead, the Ju-52 (an all-aluminum aircraft) was

* See figure 27.

used for this purpose. Aluminum was even then critically scarce and the Ju-52's three engines consumed more fuel than the Ju-86 would have if outfitted with moderate-sized gasoline engines.

The Luftwaffe provided in its Rhineland Program of 1935 that bomber units should be equipped with the Do-17, the Ju-86, and the He-111. Prior to this plans had been made in the Technical Office to replace the first two of these by the He-111.

It was also during the second phase of air armament that the Ju-87 "Stuka," which became so famous as a dive-bomber, was introduced. This was inspired by Udet's visit to the United States and his favorable impression of the Curtiss "Hawk's" low-altitude dive-bombing performance. After purchasing two of these planes and demonstrating them before a number of military observers, the Luftwaffe accepted the dive-bombing idea and selected the Curtiss aircraft as the model for this type of plane. The first aircraft of this sort developed in Germany was the He-123, followed soon thereafter by the Junkers Ju-87,* a two-place, low wing aircraft with a 30 liter engine. This was first introduced in 1937 (141 aircraft) and maintained its place throughout World War II with very few modifications. /

Among German fighters, the predominant aircraft before 1936 was the He-51, a biplane which was employed in Spain as a fighter and, later in the war, as a bomber. Its speed was only 185 miles an hour, not appreciably more than that of the Arado-68. During the second phase of the air armament program the Me-(Bf) 109, the classic fighter of the Luftwaffe, made its appearance. It was selected by Udet over its closest competitor, the He-112, because of its speed, climbing ability, and general performance.

* Both the Arado and Heinkel firms had been asked to submit plans for a dive-bomber, but neither the Ar-81 nor the He-118 was able to meet the specified standards. Only the Junkers Ju-87 proved to have the necessary diving capability. See figure 28.

/ Editor's Note: Between 1939 and the end of 1944, 4,881 Ju-87's were produced. Nevertheless, except in the East, this aircraft could scarcely carry out its mission without fighter escort after 1940. The Battle of Britain indicated how obsolete it was when used against a competent air force.

Fighter pilots of World War I (with the exception of Udet) were dead set against it from the beginning because of its unusually high wing loading and poor banking capabilities. It became the main fighter of the German Air Force in World War II and was used for bomber and reconnaissance work as well.*

The Me-110, selected for development in 1935, was designed as a top performance twin-engine fighter and long-range fighter.† It was equipped, however, with two Junkers Jumo-210-G engines, barely adequate to meet the requirements of a 1,200 mile flying radius, and its speed was thus a severe disappointment. The Me-110, whose top speed was 270 miles per hour, was obsolete as soon as it was produced.

The Do-17 was the only long-range reconnaissance aircraft of any importance. As far as tactical reconnaissance planes were concerned, there was the Hs-122 and the Hs-126 produced by the Henschel Company. The Hs-126 was an all-metal aircraft with a speed and flying range considerably in excess of that of the He-46. At the end of 1936 new tactical and technological requirements established by the General Staff opened the way for the development of the Fw-189.††

As previously mentioned, the development of the long range bomber requested by Major Wimmer (Chief of the Wa Pr 8 Office) as early as October or November 1932 (approved by General Wever, Chief of the Air Command Office, in the autumn of 1933) and again later by Wimmer when he became Chief of the Luftwaffe Technical Office, ended in a catastrophically wrong decision.** Four-Engine bombers were being developed by the Dornier Company (the Do-19) and the Junkers Works (Ju-89). The former was a cantilever design, high-wing aircraft, while the Ju-89 was the same

* A total of 30,573 Me-109's were produced, a greater number than that of any other fighter on either the Axis or Allied side.

† See figure 21.

†† Between 1939 and the end of 1940 a total of 846 of these were produced, some of them in the S.N.C.A. de Sud-Ouest plants in occupied France. See figure 29.

** See p.55. See also Richard Suchenwirth, Historical Turning Points in the German Air Force War Effort, USAF Historical Studies No. 189, Maxwell Air Force Base, Alabama: USAF Historical Division, ASI, June 1959, pp. 40-44.

type, but with retractable landing gear. In the beginning both were equipped with Bramo 322 engines, with a take-off horsepower of 715. The Luftwaffe planned to replace these with more powerful engines in time, since the flying radius was only 925 miles and the cruising speed was only 177 miles per hour with those power plants.

Wever included this four-engine bomber in his plans for strategic air operations, and gave it the name of "Ural Bomber," indicating the possible use for which it was intended. With more powerful engines it would no doubt have fulfilled its mission, and it could have been ready by the outbreak of war, two and a half years later. However, a group of engineers in the Technical Office managed to win over the State Secretary (and presumably Udet as well) to their way of thinking and secured a ban on its further development. The Chief of the General Staff did not object, and, in fact, is said to have suggested to Goering on 24 April 1937 that such development ought to be stopped.¹⁸ It is possible that the attitude of the Commander of the Training Wing, Lt. Col. Jeschonnek, may have had an influence upon the Chief of the General Staff. In any case, the efforts of the Chief of Branch 1 of the General Staff, Lt. Col. Paul Deichmann (who appealed directly to Goering to allow further development) were in vain.* The five sample aircraft already built were scrapped.

The difficulties encountered in obtaining raw material during the construction of the four-engine bomber could presumably have been resolved within the framework of the German economy. In the meantime, however, a new premise had been accepted, the idea of numbers rather than effectiveness in aircraft produced.¹⁹

The two aircraft firms entrusted with the development of the four-engine bomber were reluctant to drop the project. According to Generalingenieur (Ret.) Gottfried Reidenbach, the State Secretary himself ordered the scrapping of the sample Do-19's on the occasion of an inspection visit to the Dornier plant in Friedrichshafen.²⁰ The abandonment of this project had a

* See p. 55.

† See p. 56.

†† As reported to General der Flieger (Ret.) Paul Deichmann.

disastrous effect upon the Luftwaffe.

In the third phase of Luftwaffe air armament (1938-42) it was the objective of German leaders to provide aircraft which would be superior to those of its potential enemies. Two bomber models, the fast bomber which had been ordered by the General Staff in 1935 and the new long-range bomber,* as well as a dive-bomber with an increased radius of action were important developments during this period. Major Wolfram Freiherr von Richthofen, Chief of Branch II of the Technical Office under the Air Command Office since the spring of 1934, was an ardent champion of the superspeed bomber.²¹ Industrial firms too, particularly Junkers, were enthusiastic about it. This aircraft was supposed to have a speed of 300 miles per hour, a range of 1,500 miles, and to be able to carry a bomb load of 1,102.5 pounds. It was to have only one machine gun (for moral support) in its armament.

Models developed by the Bavarian Aircraft Works, / Messerschmitt, Henschel, and Dornier were dropped in December of 1937 in favor of the aircraft produced by the Junker Works, the Ju-88. In the meantime the General Staff requested that a new superspeed bomber be developed which could carry 4,410 pounds of bombs. The record flight of the Ju-88 in the spring of 1938 over a 1,200 mile course from Dessau to the Zugspitze and back showed a speed of 315 miles per hour, a speed which was later considerably reduced by a 30 percent increase in weight from the installation of a machine gun position, the dive brakes, and the storage racks for additional bombs.

Jeschonnek, disappointed by the horizontal high-level and low-level bombing demonstrations he had seen at Greifswald, determined to develop the Ju-88 as a dive-bomber so that it could

* We have no definitive answer to the question of whether this long-range bomber was requested by the General Staff or developed by the Technical Office on its own initiative. Likewise, the question of when this development was requested requires further clarification. It is possible that it was submitted in late autumn of 1937, subsequent to Jeschonnek's assumption of office. See Ernst Heinkel, Sturmische Leben (Stormy Life), Stuttgart: Mundus Verlag, 1953, p. 407.

/ Editor's Note: Redesignated September 1938 as Messerschmitt A. G.

strike targets such as power plants with 100 percent accuracy, making it possible for the Luftwaffe to eliminate an enemy's sources of strength. In May and June of 1939 Capt. Pohle and a special testing group achieved good results with Ju-88's in an 80 degree dive at Rechlin-Roggenthien.²² Yet, the Ju-88 did not come up to expectations in every respect. Heinrich Koppenberg, General Director of the Junkers Works, was ordered on 3 September 1938 to begin series production of the Ju-88. The Sudeten crisis necessitated immediate action. Soon, however, a number of modifications had to be made, which slowed the speed of the aircraft and made it impossible for the Junkers firm to meet production schedules. By the outbreak of war there were far fewer Ju-88's than had been anticipated, and only 119 were produced in 1939.

The long-range bomber was to have a cruising speed of 310 miles per hour, an operational range of 3,000 miles, and a bomb load capacity of 2,205 pounds. Over distances of 1,200 miles it was supposed to carry 4,410 pounds of bombs. Originally, this was to have been a four-engine aircraft, but this was soon changed to a plan for a twin-engine bomber for which the Heinkel Company offered its He-119 as a possible solution, and the Junkers firm submitted the Ju-85. After inspecting the mock-ups of these two aircraft, Jeschonnek and Udet decided on the four-engine bomber after all and assigned the task to Heinkel. In the summer of 1938 Heinkel also received orders to construct a second model, with a double power plant, to be constructed in as modern a form as possible. On 29 November of that year the Technical Office sent instructions that all aircrafts were to have double power plants and diving capability.^{23*} The decision to construct an He-177 with double power plant and diving capability was to become one of the most fatal decisions ever made by Luftwaffe leaders. This aircraft cost the lives of thirty crews just during its trial runs, and never took its place at the front.²⁴

The further development of the Me-110, whose range was completely inadequate, to the Me-210 (intended by the General Staff

* Capt. Pohle states that the General Staff was merely interested in determining whether it was theoretically possible to construct a four-engine bomber with dive-bombing capability, but that series production should not have been held up because of this requirement.

to be a super-speed, long distance dive-bomber) could not be completed by the beginning of the war, and its subsequent development proved to be one of the great disappointments of the German Luftwaffe.

In the meantime there arose the promising idea that the traditional airscrews, which permitted a top speed of about 500 miles per hour, might be replaced by rockets, or by turbine or jet engines. The Heinkel firm was the source of both of these ideas and, with the support of the Development Branch, Dr. Wernher von Braun began the experiments which led to the He-176. This first German aircraft with rocket propulsion was tested in the air on 20 June 1939. It was then demonstrated before Hitler at Rechlin on 3 July of that year. Yet, despite the uniqueness of this craft, those who observed this demonstration were not fully aware of its monumental significance.²⁵

The Brandenburg Engine Works (Bramo) developed a jet engine (the He-S-3) for aircraft, and it was on the basis of this engine that the Heinkel firm built its He-178. Because of the favorable demonstration of this latter aircraft on 1 November 1939 before Milch, Udet, Lucht, and others, the Technical Office decided to take direct action in producing jet aircraft.²⁶

At the outbreak of World War II, the Luftwaffe had three types of bombers, He-111's (of which 787 had been produced), Do-217's (331), and Ju-88's (18), one dive-bomber, the Ju-87, of which 366 had been produced; one ground attack aircraft, the Hs-123 (40), two fighter types, Me-109 (1056) and Ar-68 (28), a single transport model, Ju-52's (552), three tactical reconnaissance aircraft, Hs-126's (275), He-46's (67), and He-45's (14), and only one long-range reconnaissance plane, the Do-17, of which 257 had been built for that purpose. The Luftwaffe also had 167 various types of naval aircraft.

The Luftwaffe Administration Office

As an independent branch of the Wehrmacht the Luftwaffe was entitled to have its own administrative apparatus. This organization only evolved gradually. In the beginning of the Luftwaffe organization the Reichs Aviation Ministry worked directly with local agencies or even utilized its own personnel in administrative functions.

From the Army and Navy administrative establishments the

Luftwaffe borrowed whatever principles were clearly in keeping with the characteristics of its own organization, and acquired several outstanding officers and civilians from both of these service arms. These people were well versed in administrative procedures and organization. The Luftwaffe Administration Office was organized into four major branches: LD-I (Budget Branch), LD-II (Personnel Branch), LD-III (Billeting and Construction Branch), and LD-IV (Food and Clothing Branch). Until 1945 there was only one major change in this structure. On 1 February 1939 the Economic Group was taken from the Budget Branch and transferred to the Office of the Chief of Luftwaffe Supply and Procurement. From 1933 until 1 February 1938 the Administration Office was directly subordinate to the State Secretary, but after this time to the General Staff.

At the territorial (or local) echelon the organization of administrative services was as follows:

1) All command headquarters and troupe units down to group (battalion) level had their special branches (IV a-Abteilungen) to deal with pay, personnel assignment, food, clothing, and billeting. The chief of the branch (the ranking civilian official in each case) was immediately subordinate to the commander. The branch accompanied the headquarters or unit on maneuvers or to the front. The branch chief also served as paymaster unless the entity concerned was serviced by a local base finance office.

2) In the Senior Air Offices (1 April 1934 - 1 April 1935) the Food Supply Officers (known as IVa officials) functioned as intermediaries between the Ministry and the local agencies. In the Air Service Commands (1 April 1935 to 1 April 1938) this function was fulfilled by the Air Service Command Food Supply Officers, in the Luftwaffe Groups and Commands as of 1 April 1938 by the respective food supply officers, and in the Air Fleet Commands, after the redesignation of the Luftwaffe Group Commands on 1 April 1939, by the Air Fleet Food Supply Officers. They were responsible for activities listed under section 1 (above), and took care of personnel matters (except for officer personnel), the physical plant, and finances.

3) The Air District Commands created on 1 April 1936 were also assigned food supply officers, who were made subordinate to their counter parts in the Air Service Commands (Luftwaffe Group Commands, Luftwaffe Commands, and Air Fleets).

4) The assignment of qualified administrative officials to the airfield areas was a further step in the decentralization of administrative activity which was particularly welcome in the areas of physical plant maintenance and utilities and billeting.

As early as 30 January 1933 an increased emergency budget (Special Plan XI) was approved in the aviation branch of the Reichs Aviation Ministry to take care of the increased needs in the field of personnel recruiting. Preliminary work on the first formal budget of the Reichs Aviation Ministry was begun on 1 October 1933, and this budget for fiscal year 1933-34 (1 April 1933 to 31 March 1934) was introduced into the public (white) budget as Special Plan XVI. This called for the expenditure of approximately 78,350,000 Reichsmarks, and was augmented by an additional 30 or 40 million from the Army and Navy budgets, since both of these service branches contributed to the expenditures anticipated under Special Plan XVI. Most of these expenditures were classified Secret.

During the period of secrecy, which, from the financial viewpoint, extended until the outbreak of war, there were two separate budgets for the Luftwaffe. The "white" Special Plan XVI, which amounted to 210,200,000 Reichsmarks for the fiscal year 1934-35 and 340,000,000 annually after 1936, and the "black" Special Plan XVI, which amounted to approximately 3,000,000,000 Reichsmarks per year after 1935, was mostly covered by Mefe bills.* Although the "black" Special Plan appeared neither in

* Editor's Note: Hjalmar Schacht, President of the Reichsbank, in an effort to support the rearmament and construction problems in Germany and to assist in the work creation programs, considered some means to use the great industrial complexes and their stockpiles in the process. He feared inflation on the home scene and lack of confidence in the Reichsmark abroad if these government projects were supported by inflationary financial measures. As a result, considering Germany's materials and industry as a form of dormant capital, he encouraged the formation (by four financiers after whom the organization was named) of a corporation which could supply short-term (90 days up to five years), interest-bearing notes to support the government in its armament and industrial projects. The German government assumed direct liability for these notes. Mefe bills were thus a type of money, closely resembling a true interest-bearing

the Reichs Budget nor in any other public budget, there was a careful accounting of all expenditures made under its authority.

Allotments from the two budgets were made in careful coordination with the allotments from the Army and Navy budgets.

The Personnel Branch of the Luftwaffe Administration Office was entrusted with the personnel build-up of the Luftwaffe (civilian officials and employees). This Branch represented the interests of the Luftwaffe in negotiations with the various organizations, with the trustee agencies of the Luftwaffe, and, most of all, with the Reichs Finance Ministry. Since it handled questions pertaining to payrolls and disputes over salaries, it affected every member of the Luftwaffe.

To put it more succinctly, the Personnel Branch was responsible for securing a sufficient number of properly qualified employees for the Luftwaffe. These employees were recruited for more than a hundred different categories of work from technological research to administration, but, in view of the sudden expansion in all departments it was difficult for the Personnel Branch to find applicants capable of meeting the requirements established by the individual technical branches. Training courses and schools had to be utilized in order to compensate for these deficiencies. Applicants for top-level positions were required to demonstrate their familiarity with and an understanding of the problems of field level units.

The Personnel Branch of the Luftwaffe Administration Office

note, which were issued by a government-instigated corporation. Since the amount was always limited -- in 1937 the Reichsbank purchased 12,000,000,000 Reichsmarks in Mefo bills -- the measure was not inflationary and proved to be a clever expedient. See Hjalmar Schacht, My First Seventy Six Years: Autobiography of Hjalmar Schacht (Translated from the German by Diane Pyke), London: Wingate, 1955, and Edward N. Peterson, Schacht: For and Against Hitler: A Political Economic Study of Germany, 1923-1945, Boston: Christopher Publishing House, 1954.

was also in charge of examining the budgetary expenditures of the Reichs Aviation Ministry. It supervised the operation of the Luftwaffe finance offices and took care of the necessary accounting with the Reichs Finance Office. At the close of each fiscal year the Reichs Finance Office submitted a Reichs Budget Account to the Budget Branch of the Luftwaffe Administration Office for justification of expenditures which either exceeded, or failed to come up to, the amounts allotted. This was then reviewed and passed on to the Reichs Audit Office and to the legislative bodies of the government.

Once the budget was approved, the agencies concerned were responsible for assuring through their subordinate organizations that the allotted funds were expended in accordance with regulations and that justifications for expenditures were forwarded to higher headquarters. Nearly all of the amounts authorized by each year's budget could be carried over into the following year without a penalizing decrease in allotment for the following year. Expense account funds and representation funds required no detailed accounting, and their allotment was the responsibility of the commander concerned.

The Billeting and Construction Branch of the Luftwaffe Administration Office was responsible for the construction of billets and other buildings and establishments, which included the selection of plans and sites, the purchase, lease, or rent of property, etc. Only in special cases was it entrusted with the inspection of industrial plant facilities.

The Luftwaffe has often been reproached for the large amounts spent on construction, but it should be pointed out that most of these Luftwaffe installations were located far from any larger settlements, on islands, or in generally isolated areas. It was clear that a certain degree of comfort and recreation (pleasant clubrooms, lounges, messes, gymnasiums, swimming pools, theaters, apartments for married personnel, commissaries, etc.) had to be provided for the thousands of young men assigned to these installations.

The Luftwaffe deliberately abandoned the monotonous style used by the Army and Navy in their construction projects, and, without any increase in construction costs, managed to build installations which were nicely adapted to the terrain in which they were located.*

* See figures 25, 30, 31.



Figure 28

The standard Luftwaffe dive-bomber,
the Junkers Ju-86, "Stuka."



Figure 29

The Focke-Wulf Fw-189 Tactical Recon-
naissance and Multi-Purpose Aircraft.



Figure 30

An attractive mess hall at a modern
Luftwaffe base, 1938.

The most expensive items in Luftwaffe construction were caused by the need to prepare the terrain for construction (preliminary ground work, laying light and water lines, streets and railway lines) and by the need for air raid shelters. The exigencies of air defense and civil defense made it necessary to disperse billets and living quarters, to dispense with high buildings and large blocks of houses, to camouflage vital installations, to take appropriate steps to counter the effects of incendiary bombs, and to provide shelter for personnel as well as ammunition and fuel.

The continual need to enlarge and improve airfields and the need to equip them with technically complex installations also resulted in an increase in construction and maintenance costs, and the need to accomplish so much in a relatively short span of time inevitably resulted in higher costs.

The Administration Office's Food and Clothing Branch worked closely with its counterparts in the Army and Navy. The Luftwaffe uniform was similar to that worn by the air forces of some other nations, and a special procurement section working in collaboration with the Army Clothing Branch purchased the uniforms for the entire Luftwaffe. Clothing offices were set up to handle the distribution of this clothing, and a Sales Branch served as the intermediary between the producing firms and the final consumers (officers, civilian officials, and officer candidates).

As far as food procurement was concerned, a certain amount of independence had to be granted to remotely located units and headquarters. Furthermore, special arrangements had to be made for flying units, which received special allotments consisting of the standard flying ration, emergency rations, and special rations for personnel (such as paratroops) engaged in special missions.

No serious difficulties were ever encountered in the recruitment of enlisted personnel and non-commissioned officer personnel for the Luftwaffe. Those who volunteered -- there were always enough of these -- represented the idealistic youth of the nation. There was also no difficulty in recruiting enough qualified technical personnel from among the flying enthusiasts of the Reich.

All personnel recruited for flying training were required

to pass certain preliminary examinations designed to test their aptitude for such training. Those unable to pass these tests satisfactorily were assigned to the flak artillery or signal communications forces. These services, particularly flak artillery forces, were seldom able to recruit the necessary qualified personnel. Flak forces established the so-called E-batteries (replacement batteries), which provided four-week training courses for men thirty to forty years old for assignment to the home units being established.

Luftwaffe Groups (which later became Air Fleets) were responsible for personnel replacement throughout their respective areas of jurisdiction. Personnel needs which could not be met by recruiting of volunteers were reported to the Reichs War Ministry. After completing preliminary training, replacement personnel were assigned to the Air District Commands for further assignment to specific units. The Air District Commands also took care of the assignment of replacement personnel to the signal communications and flak artillery forces.

The Luftwaffe Officer Corps

The establishment of a numerically adequate and highly qualified officer corps for the Luftwaffe was a much more difficult task than the procurement of enlisted personnel. The cadre of experienced officers which could be taken over from the 100,000 Man Army was limited to the 220 names contained on the aircraft pilot roster. The Luftwaffe thus had no alternative but to borrow personnel from the Army, a procedure which has been previously mentioned.

Among the many highly competent officers acquired from the Army in this manner were Wever and Kesselring, and the future Luftwaffe Personnel Chief, Col. Stumpff. Until June of 1937 it was Col. Stumpff who was in charge of building up the Luftwaffe's commissioned and non-commissioned officer cadre and of insuring that the officer corps was not dominated by exclusively political tenets. The National Socialist Party, the SA, and even the SS, sought to gain a foothold in the Luftwaffe. Stumpff naturally had to accept the fact that Goering was determined to bring many of his old comrades into the organization, among whom were many who had long since become unaccustomed to the rigors of military life or of the devotion to duty expected of a soldier. Most of

these came into the German Air Force with very high ranks.* Even Stumpff himself, not to mention State Secretary Milch, had advanced from captain to general with unprecedented rapidity. It must be counted in Goering's favor that he proved to be a reliable support for his Personnel Chief in controversies with the Nazi Party.

In order to recruit the necessary number of officers, Stumpff had no choice but to resort to measures such as the re-activation of retired personnel, the assignment of replacement officers, and an expanded training of new officer candidates.†

Engineer Officers

During the Reichswehr period many officers had been granted special arrangements so that they might earn their diplomas in engineering at one of the German Technical Colleges (Technische Hochschulen). In most cases these men did not get the subsequent experience which is normally a part of the professional life in this field. Some of these officers, however, did take advanced work or continued on to the doctorate in the field of engineering. One of the later Air Fleet Commanders, Freiherr von Richthofen, was one of these.††

It was no easy matter for the Luftwaffe to build up a competent and adequate corps of engineers. Once the decision had been made to accept engineer personnel as officers of equivalent rank (being retained as civilian officials), most of the engineers employed by the Wa Prüf 8 Office were immediately appointed to

* Examples of officers who owed much of their rank and prestige to this policy were Bruno Loerzer, Ernst Udet, Alfred Keller, and Robert Ritter von Greim.

† Officer candidates were trained at four Air Academies (Luftkriegsschulen), Dresden, Berlin-Gatow, Wildpark-Werder, and Fuerstenfeldbruck. These were associated with the flying schools of the A/B category. The Advanced Luftwaffe School (Hoehere Luftwaffenschule) in Berlin-Gatow trained candidates for the academies, after weeding out those who were unpromising.

†† In Germany the diploma in engineering (Diplomingenieur) was granted upon the successful completion of the four year course. It was thus equivalent to the American B.S. degree in engineering.



Figure 31

The Mathematics Institute at the Luftwaffe
Technical Academy, Berlin-Gatow.



Figure 32

Inspection of a new class by the Commandant at
the Luftwaffe's Air War College.

high-ranking positions. At that time most of the engineers came to the Ordnance Office directly after graduation, and thus had no experience with industry or in the field in other capacities.

In an engineer corps established on the basis of civilian officials the licensed engineers in higher-ranking positions and top-level agencies and the non-academic practical engineers could scarcely establish a common meeting ground. The Chief Engineers (Chefingenieure) of the Technical Office -- this was Professor Bock prior to Udet's term of office, and Generalstabsingenieur Lucht from autumn of 1936 until Udet's suicide on 17 November 1941 -- seemed to be incapable of welding these two camps into an effective whole. All personnel in the engineer forces came under the personnel administration agency of the Luftwaffe Administration Office until the establishment of the Office of the Chief of Luftwaffe Supply and Procurement.²⁷

The Luftwaffe General Staff

On 1 August 1936, after some resistance on the part of Goering and Milch and some degree of reluctance on the part of General Wever had been overcome, the General Staff of the Luftwaffe was established. There was already a small experienced cadre of officers on hand, since about forty General Staff officers had transferred to the Luftwaffe at the time the Reichs Aviation Ministry was set up.* Some of these were officers who had served on the General Staff during World War I, while others had received their General Staff training with the Reichswehr. Only a small percentage came from the Navy.

During 1936 and 1937 a good many officers who completed their General Staff training at the Army War Academy (Kriegsakademie) transferred to the Luftwaffe. Most of them still had to complete their flying training before they could be accepted. The first graduates of the Air War Academy (Luftkriegsakademie), which was established on 1 November 1935, became available for assignment

* See Generalleutnant (Ret.) Andreas Nielsen, The German Air Force General Staff, USAF Historical Study No. 173, Maxwell AFB, Alabama: USAF Historical Division, RSI, June 1959.

in 1938.* By the time the war began, the Luftwaffe General Staff had a sufficient number of officers. Like the Army General Staff officers, Luftwaffe General Staff officers were entitled to wear the General Staff insignia (the crimson and gold lapel insignia and the double crimson stripes on the trousers).

Besides the Air War Academy, the Luftwaffe High Command opened on 1 November 1935 the Luftwaffe Technical Academy, an institution which was established with the intention of training ten officers a year in the intricacies of advanced aircraft technology. This project, which involved the expenditure of a considerable sum of money, was abandoned after a short time.

* See figure 32.

CHAPTER 5

LUFTWAFFE PREPARATIONS FOR THE WAR*

Basic Thinking on the Strategic and Tactical
Employment of the Luftwaffe

The basis for the thinking of Luftwaffe leaders with respect to the strategic and tactical employment of the German Air Force during World War II was laid down in 1936 in Luftwaffe Service Manual 16,¹ a handbook based upon preliminary drafts going back to the period prior to 1933. Most of it was the work of General Helmut Wilberg, who was killed in an air crash in November 1941,² but a good part of it is also attributed to General der Flieger Walther Wever, the first Chief of the Luftwaffe General Staff.

This guide was based upon the premise that the Luftwaffe was an independent branch of the Wehrmacht, but not an end in itself, and, in accordance with Paragraph 10 of the Manual, was to be concerned with the task of "subduing the enemy's armed forces."²

Luftwaffe Service Manual 16 clearly recognized the necessity of a centralized command. According to Article 24:

The agency in charge of military operations must ... have a clear picture of the potential effectiveness of its own air forces as well as of the potential effects of enemy air action on its own territory, and from this it must be in a position to draw the proper conclusions with respect to the most effective conduct of aerial warfare, to the organization of the air force, and to the air defense of the nation.³

* The material contained in this chapter and section is based on a study concerning Luftwaffe Service Manual 16 by Generalmajor (Ret.) Hans-Detlef Herhudt von Rohden, written in 1946.

² See the biographical section in the back of this study.

The agency in charge of military operations was designated as the supreme authority, responsible for coordinating the operations of the Army, Navy, and Luftwaffe, and for achieving the highest possible degree of effectiveness by shifting the point of main concentration within the individual branches of the Wehrmacht.⁴ The Manual stated further that:

When operations threaten to come to a standstill, it may well be that the Luftwaffe is the only instrument capable of preventing the decimation of the ground forces and of forcing a decision. The prerequisite for success in this case is the complete shift of the point of main effort to aerial warfare, even at the expense of other instruments of war. Inevitably, such a shift takes time. It must thus be carefully prepared in advance.⁵

In view of the outcome of World War II, it can be asked whether or not Luftwaffe Service Manual 16 actually provided a clear definition of "decision" or, in other words, whether it made clear the strategic significance inherent in the "employment of Luftwaffe forces." The Manual listed three primary missions of the Luftwaffe: combating of enemy air forces, intervening in ground or naval actions, and combating the sources of the enemy's strength and disrupting logistical lines to the front. Only within the framework of the overall situation could one decide which of these was the most significant.⁶ It seems clear that the authors of the Manual were not irrevocably committed to strategic air warfare, inasmuch as they spoke of a "battle," rather than of "destruction" or "the attempt to destroy" as would have been true had they been guided exclusively by Douhet's principles. Paragraphs 10 and 11 of the Manual reflect a certain caution and reserve.

Although combating the enemy's sources of military strength was viewed as essentially decisive, the Manual stated that such action might not always be immediately effective since it might not exert an influence upon Army and Navy operations until too late. Moreover, this use of airpower ordinarily ties down a substantial force for a long time. Therefore, unless the destruction of these targets could be expected to have an immediate effect upon the course of operations, the disruption of logistical lines to the front and the combating of the enemy's sources of strength could only be recommended in instances in which ground or naval operations represented either the preliminary step of a critical engagement in which decisive operations

were nearing a conclusion, or in which there was reason to expect that the war could be ended almost solely through the destruction of the enemy's sources of strength.⁷

In the interest of conserving forces, Manual 16 prescribed dispensing with the concept of "destruction" if the desired effect could be achieved by harassment or containment. In this connection it should be noted that nineteen paragraphs of this directive were devoted to operations against enemy rail and highway facilities, while only two subparagraphs of Paragraph 161 were related to operations against enemy ground installations, and these mentioned "disrupting the enemy's materiel supply" by means of damaging the ground organization or "by interdicting certain areas (seaports, production centers, inland harbors) from the enemy hinterland, and of weakening the enemy by disrupting his logistical activity."⁸

Generally speaking, there was a noticeable lack of conviction concerning the vital importance of strategic operations, especially since there was no mention of the necessity of integrating them into a positive contribution toward the ultimate objective of defeating the enemy, as would naturally have been true of any logical continuation of procedures based upon Douhet's principles.

The pervading confidence of the Luftwaffe High Command in both the speed of its bombers and in their ability to defend themselves was reflected by the fact that the Manual failed to provide for fighter escorts. Paragraph 229 was a reflection of the optimistic views which were then popular in the highest Luftwaffe command circles:

. . . bombers attacked by enemy fighter forces are to carry out the necessary defensive measures independently, without losing sight of the need to complete their original missions if at all possible. Those bombers not bothered by enemy fighters are to continue on their course, without permitting themselves to become involved in aerial combat.⁹

German air doctrine interpreted combating of the enemy to mean operations carried out against the enemy air force (including its supply and production facilities), but the concept of air supremacy was conspicuously lacking. Thus, for all practical purposes, this phase of activity mainly involved the direct

support of Army operations by reconnaissance and air defense units under the Army's command, with the stipulation that, if the ground situation or overall military situation should require it, "fighter aircraft as well" could be assigned to augment these forces.¹⁰ According to Paragraph 122, large Luftwaffe elements could also be employed "in decision-seeking ground battles," in which case the Wehrmacht High Command would be responsible for determining the scope of the air support required. Paragraph 135 specified that the Navy would also be accorded direct air support by the reconnaissance and bomber units regularly assigned to it, and that larger Luftwaffe forces could be placed at its disposal in order to provide indirect air support through attacks on enemy naval and air bases as well as through operations to counter enemy landing efforts.

The entire Manual reflected high ethical standards, especially in Paragraph 186, which rejected in principle the concept of "terror raids upon cities." However, the Manual expressly reserved for the Luftwaffe the right to carry out "retaliatory raids" when justified, stipulating that "the attack in question must be handled in such a way that its retaliatory character is clear."¹¹

Paragraph 24 of the Manual singled out the concept of attack as the principle which had to be "dominant over all others." This principle crystallized Germany's thinking in terms of the conduct of aerial warfare, and may well be connected with the ethical concept that air defense operations should be restricted to protecting the victims of attack, and that the part of air defense operations entrusted solely to fighters and flak artillery should be regarded as an offensive defense against enemy invaders. At that time, however, very little thought had been given to the possibility of air battles for the protection of the Reich itself, and Paragraph 16 dispassionately pointed out that the dangers to the Wehrmacht and to Germany from enemy air attack could never be adequately met by defensive measures over the home territory alone.* The Luftwaffe leadership believed that, at the outset of hostilities, air forces ought to be used offensively against the enemy air forces over the enemy's territory. Although Service Manual 16 reflects a fundamentally conservative concept of aerial warfare, certain aspects of the more

* Hitler's ideal at this time was the abolition of bombing by all air forces.

revolutionary thinking of Douhet show through. There are occasional indications of Douhet's thought, but it is also clear that at no point was it wholeheartedly accepted.

This directive was not intended to proclaim unalterable dogmas, and its authors were by no means irrevocably committed to the principles outlined in it. It was the task of Luftwaffe leaders to supplement the Manual if necessary, to revise it uniformly and completely in the light of subsequent developments in weapons and equipment, from the experiences gained during the Spanish Civil War, and from new advances in staff thinking (at home and abroad) in the field of aerial warfare.¹²

But 1936 was not 1939! The section on air transportation, for example, which was inserted as section VI as an afterthought between section V and the previous section VI, could well have been revised on the basis of the air transport experiences of Ju-52 units in Spain during 1936. This would have expanded the prevailing thought on aerial warfare and would have pointed to a promising field for future development. Furthermore, it would have spurred the organizational experts on to think in terms of establishing a really firm structure for the employment of this new air arm. Unfortunately for the Luftwaffe, this Manual was never revised before the outbreak of war.

The Training of Top-Level Luftwaffe Leaders

Top-level Luftwaffe leaders were well aware of the importance of adequate training for higher commanders so that they could fulfill their assignments in the future commitment of the German Air Force. During the pre-war period this training took the form of war games, staff journeys, and maneuvers.*

War Games and Staff Journeys

During war games and staff journeys a military operation

* Material in this section is based on a study by General der Flieger (Ret.) Paul Deichmann, "Operative und taktische Schulung der Hoheren Fuehrung der deutschen Luftwaffe" (Strategic and Tactical Training of the Higher-Ranking Commanders in the German Air Force"), Karlsruhe Document Collection.

was followed through in theory with the help of maps, while in the maneuvers troop units also participated. The operations for this sort of study were usually actual aspects of the military situation which the Luftwaffe might expect to confront in case of war. They thus provided an opportunity for testing the theoretical battle instructions.

The first large-scale war game carried out by the Luftwaffe took place at the end of 1934 under the direction of General Wever, Chief of the Air Command Office, in the old building of the Reichs Aviation Ministry in Behrens Street, Berlin. The participants included all of the branch chiefs of the Ministry and those high-level commanders and their deputies whose units were scheduled for immediate deployment in the event of war. The subject was the commitment of the Luftwaffe in case of a French attack on Germany for the purpose of interfering with the Reich's armament program. The conditions under which the war game was carried out simulated those which were anticipated in terms of the presumed development of the overall military situation. It was assumed that the German Army, still relatively weak at the time, was retreating, but still fighting, in the mountainous regions of the Weserberg, the Vogelsberg, and the Rhoen.* The war game included the deployment and commitment of air forces at the beginning of operations. Neither the battle plan of the Army nor the relatively small size of the Luftwaffe permitted more than a defensive employment of the available air units. Nevertheless, this did not reflect fundamentally defensive thinking on Wever's part as Rieckhoff¹³ and Walter Goerlitz¹⁴ would have us believe.

Even at that time General Wever regarded the conduct of strategic air operations to be paramount. General der Flieger (Ret.) Paul Deichmann, who was at that time a Staff Consultant in the Operations Branch and a deputy to Wever, reports:

During the course of the war game, the bomber units were employed deep in the heart of enemy territory. At that time most of these units were equipped with provisionally armed Ju-52's,

* Located in Upper Hessen.

which were completely inferior to the French fighters. Officers in charge of the maneuver suggested to General Wever that he assume a loss of 80 percent for the bomber force, but Wever refused brusquely with the words, "That would deprive me of my confidence in strategic air operations!" Although the maneuver leaders pointed out that the percentage of losses would presumably be that high only in this particular instance, i.e., until the German Luftwaffe had more modern bombers at its disposal, Wever insisted upon a lower percentage.¹⁵

Political factors naturally played a part in the conduct of war games, and a maneuver prepared and scheduled for the winter of 1935-36 was cancelled for being "out of date," since it dealt with a theoretical war against Poland. At that time Czechoslovakia was in the limelight, and Hitler was thinking of having his Wehrmacht settle that issue first.

During the staff journeys* higher commanders had the opportunity to try out tactical problems. One example was the General Staff journey to Salzbrunn from Schleissheim in the spring of 1936 under Wever's guidance. Besides a number of officers from the Operations and Organization Branches of the Luftwaffe General Staff, quite a few inexperienced top commanders took part in that phase of operations devoted to the commitment of fighters, a matter which was examined in some detail. Goering

* Editor's Note: These journeys were designed to enable participating officers to become familiar with special problems involving operations from Germany's borders, such as those planned for possible use against Czechoslovakia. Those in the winter seldom lasted longer than ten days, while the summer trips could be as long as four weeks. These journeys were made by automobile or other appropriate vehicles to allow the officers to get an "on the spot" feeling for the terrain, the conditions, etc. Sometimes the area was scanned by the group from aircraft. Various aspects of tactics and strategy were studied during this time, and very brief war games (carried out in the most realistic manner possible under the conditions) were staged to provide practical exercises in command and leadership. Such days were called "game days." The summer journeys became the capstone of the General Staff courses.

was on hand for this exercise, and the Commanders in Chief of the Army and Navy attended the final discussion session. The maneuver, based on the premise of a war with Czechoslovakia, clearly reflected the views of the High Command of the Luftwaffe with respect to the commitment of air forces. Only a small number of bombers were assigned to support the Army in its effort to break through the Czech border fortifications. The preponderance of Germany's air power was utilized in relentless blows designed to destroy the Czech Air Force, and, by purely strategic operations, to break the enemy's resistance in the shortest possible time. This maneuver was the first demonstration of the Luftwaffe as an independent factor capable of deciding the outcome of a war.

In the autumn of 1936 the Senior Quartermaster of the Luftwaffe directed a quartermaster exercise in Wuerzburg, which was intended to train the officers who had been selected for careers in the quartermaster field and to test Luftwaffe divisions. The final discussion session was attended by State Secretary Milch, by the new Chief of the General Staff, General-leutnant Albert Kesselring, and by the Chief of the Luftwaffe Operations Branch, Col. Wilhelm Mayer. The exercise gave ample evidence that the General Staff Chief clearly recognized the importance of logistics in air operations. Furthermore, the experience gained contributed a great deal to the preparation of the Luftwaffe Service Manual 90/2, "The Supply of the Luftwaffe in Wartime."

The staff and command post exercise of 1937 was designed to determine how quickly the Luftwaffe could be deployed in the event of a conflict with a neighboring state. Since the geographical situation was so favorable for this exercise, the deployment was carried out along the Czech border. Each staff down to group level set up a small air staff which was moved by transport aircraft. Each flak artillery unit down to battery level (including reserve units in the process of activation) was expected to provide an operations staff. Signal communications forces (without reserves) were committed in their entirety.

In accordance with instructions, the exercise staffs were to report to the military combat headquarters and to the operational airfields selected for the simulated war against Czechoslovakia. Flak artillery reconnaissance troops were assigned

to firing positions scattered throughout all of Germany.

In order to keep the purpose of the exercise from leaking out to other nations, maps were used on which all place names had been altered. In addition, a second (dummy) radio network was set up and placed in operation in northern Germany, so that foreign military observers would conclude that the exercise was between northern and southern Germany. This exercise proved conclusively that the German signal communications were inadequate for the demands of wartime, and that many new radio cables had to be laid. Numerous modifications had to be made in the Mobilization Plan and in the deployment and battle instructions by command headquarters at all levels.

Maneuvers

Luftwaffe units as well as Army and Navy forces took part in the Wehrmacht maneuvers of 19 to 24 September 1937, in which it became apparent for the first time that the geographical framework of operations, while sufficiently extensive for ground operations, was hardly adequate for Luftwaffe operations. Western Pomerania and eastern Mecklenburg had been selected as the Army maneuver area, with the Navy stationed in the middle and western Baltic. The Luftwaffe area, on the other hand, extended all over Germany, including East Prussia. The course of the maneuver substantiated the fundamental German concept of a strategic air commitment.

A careful evaluation of this particular maneuver, which entailed sizeable strategic commitments of airpower, could have taught foreign military observers a great deal about Germany's views on the conduct of aerial warfare in accordance with the concepts of Douhet, the establishment of air supremacy, the provision of air support for the Army and Navy, and air defense doctrine. This could, therefore, have provided valuable indications of the Luftwaffe's probable methods of commitment in case of war.^{16*}

The Last Staff Training before the War

At the turn of the year 1937-38, when the danger of a war

* The exercise was openly discussed in the German press.

with Britain began to emerge, Goering instructed the Commander in Chief of Luftwaffe Group 2* (Felmy) in Braunschweig, who would presumably be in charge of operations in case of such a development, to carry out a map exercise on this basis. In early 1939 the Luftwaffe accomplished an exercise of this sort, which resulted in far-reaching conclusions concerning organization and command. The bombers then available to the Luftwaffe turned out to be grossly inadequate in range, requiring the establishment of new airfields along the German coast. This, in turn, involved certain aspects of international law. The policy of air attacks upon open cities had been firmly rejected.¹⁷

The Commander in Chief of the Luftwaffe established in May of 1939 a special staff under Generalleutnant Hans Geissler to study the questions of preparing and conducting a Luftwaffe attack on and over the sea as well as along the coast, and of establishing the requirements to be met in the areas of command, organization, training, and equipment.

On 14 June 1938, Hitler inspected the Luftwaffe instruction units. There were combat maneuvers off the Pomeranian coast, attended by the Commanders in Chief of the three Wehrmacht branches, Goering (Luftwaffe), General Walther von Brauchitsch (Army), and Admiral Dr. h.c. Erich Raeder (Navy). The Luftwaffe carried out a practice attack against an airfield defended by the Training Wing and by flak artillery.

In June of 1939 the General Staff made a trip to the Rhine, the last one held before the war began and the first and last one conducted by the young General Staff Chief, Hans Jeschonnek. During the final meeting, which was well attended by higher commanders of the Luftwaffe, Jeschonnek discussed the prospects of and the probable requirements for an air operation in Poland, stressing the importance of air operations against the enemy air force and in support of the Army during the first few days of war. In Jeschonnek's words:

The largest possible force, including the squadron reserves, must be committed in the first, sudden attack. The fact that the enemy anti-aircraft defenses

* This was later redesignated as the Second Air Fleet.

† Editor's Note: In Germany recipients of only an honorary doctorate are invariably entitled "Dr. h.c." or (doctor-honoris causa).

have not yet acquired an effective operating routine must be exploited to the utmost and the assigned area bombarded as intensely as possible.¹⁸

The General Staff was apparently convinced that Germany would only have to cope with a single (and relatively weak) enemy, Poland. He emphasized, however, the need for increased mastery and further development in the field of tactics.

A dive-bomber exercise, carried out shortly before the Polish campaign to train aircrews in operations against enemy troops,* ended in tragedy. The exercise was organized by General Freiherr von Richthofen, a past master in dive-bombing operations and Commander of the VIII Air Corps. By disregarding an unfavorable weather report, a group of aircraft from the 77th Dive-Bomber Wing started diving through a heavy cloud cover which, over the target, extended nearly to the ground. As a result, most of the aircraft could not pull out in time and crashed with a loss of more than twenty planes and crews. Since the losses were so high the accident had to be reported to Hitler, who interpreted the disaster as an unfavorable omen for the coming war.¹⁹

The Compilation of Operational Data

Even during peacetime it was relatively easy to gather data on air targets which would presumably be attacked during the initial phase of a war.† As early as 1935 a Target Preparation Group (Gruppe Zielbearbeitung) was attached to the Operations

* Until 1939, dive-bombers had only received training at home for strategic air operations.

† This section is drawn largely from the studies prepared by General der Flieger (Ret.) Paul Deichmann.

‡ Editor's Note: In his first volume on the war against Russia, Generalleutnant (Ret.) Hermann Plocher emphasizes the difficulty which was experienced in trying to collect intelligence data about the Soviet Union, which, even prior to World War II, was a closely guarded area. See The German Air Force versus Russia, 1941, USAF Historical Studies No. 153, Maxwell AFB, Alabama: USAF Historical Division, ASI, July 1965, pp. 16-20.

Branch of the Air Command Office, and on 1 January 1938 was made a part of the Foreign Air Forces Branch in order to consolidate the operations of gathering and evaluating target data.

A folder containing all important and pertinent data was prepared for each individual target. This included maps for use during the approach flight (scale 1:250,000) and a map of the target area (1:5,000) indicating any unusual features as well as the position and presumed strength of anti-aircraft defenses and shelters. Whenever possible, these were supplemented by exact situation plans or sketches showing the target in detail. Questionnaires were included, containing notations relative to the importance of the target to the enemy, key points on the target, most favorable timing for an attack, and parts of the target vulnerable to fire or explosion.

Production schedules for enemy factories or industrial plants were calculated, and individual targets were classified into target groups. This served to provide a basis for an overall evaluation of the various sectors of the enemy's economy.

The large number of target groups and sub-groups and the extensive number of targets contained in each group made it necessary to evaluate the relative priority of the individual groups and targets. This was fairly simple in the case of small-scale targets, where it was possible to determine their relative importance by comparison with others of approximately equal size. It was more difficult, however, in the case of larger-scale targets, which included diversified fields of the enemy's war effort. Examples of small-scale targets were mobilization centers, important government and military headquarters, armed forces supply storage depots, and harbors, while war production facilities, light and power systems, import activity, food supply, and rail and highway networks were classified as large-scale targets.

Completed target data had to be constantly reexamined and evaluated and kept current for instant combat utilization. The results of this data and the studies made from it were then kept on file in the Luftwaffe High Command to serve as a basis for strategic decisions and as an aid in the training of higher level command staffs. Studies made from the collected data could be regarded as being in the nature of recipes, which could be selected as the occasion warranted.

Because of this system of target data compilation and evaluation it was possible to set up a plan of attack for the Luftwaffe for the very first phase of each new campaign, such as was the case with Planstudie BLAU (Planning Study Blue) in preparation for the campaign against Britain.

The Air Defense File

The air defense file was more or less the counterpart of the target file, and was handled by a section of the Operations Branch of the Luftwaffe High Command. The purpose of this file was to list all installations in Germany which might possibly present attractive targets for an enemy air force and to assign air defense priority ratings to each. This work, which was carried out in close coordination with appropriate military and civilian agencies, resulted in the accumulation of highly valuable information concerning the weaknesses of a nation facing possible enemy air attack.

Flak defenses were then established in accordance with the importance of each installation and its vulnerability to aerial attack.

Deployment and Battle Instructions

The deployment and battle instructions issued in the spring of each year by Branch I (Operations) of the Luftwaffe General Staff were based on the premise that there would be war, and ordered the completion of the required preliminary preparations so that, in the event of a conflict, only a few brief code words would be needed to assure implementation of the plan. The first deployment and battle instructions were issued in 1936 under General Wever.* It was prophetic that these first orders, after they were completed and ready for distribution, had to be supplemented at Goering's command to include the possibility of a war

* Editor's Note: This would be the second if one considers the instructions for the Luftwaffe issued by the Reichswehr Ministry on 25 October 1933, outlining the action to be taken in case the League of Nations decided to take sanctions against Germany for withdrawing from the League. See folio G/a, Karlsruhe Document Collection.

with Russia, the realization of which would depend upon the attitude of Poland.²⁰

Preliminary preparations required by the 1936 orders included not only an exact determination of peacetime stations for the flak artillery, but also, whenever possible, the improvement and enlargement of these bases. Operational airfields were to be kept continually supplied with fuel, bombs, and ammunition, and the necessary railroads were to be prepared in detail.

The Luftwaffe General Staff issued its deployment and battle instructions for 1939 (under the code name "Planning Study 1939") on 7 February of that year. Under Section 3 of this document appears the leading statement:

Unless special projects have been assigned for completion, all operational measures are to be prepared with a view toward being ready to meet the worst possible development, namely, that war should break out without previous warning, leaving no time for adequate preparations or for systematic mobilization activity.²¹

These instructions were established to cover the possibilities of a war in the West, a war in the East, or a simultaneous outbreak of war in both the East and the West.

The Order for Operations against the East (Weisung fuer den Einsatz gegen Osten), issued in May of 1939, included an evaluation of enemy forces, instructions for the offensive forces, air defense forces, signal communications forces, the forces concerned with navigational aids and radio monitoring and intercept services, for those elements of the Luftwaffe attached to the Army and the Navy, general instructions concerning preparations for a war in the East, a glossary of passwords (in code), and a table with the probable timings of individual actions.

The Luftwaffe Mobilization Plan*

* Material in this sub-section is based on the study by Col. (Ret.) Adolph Hering, "Mobilmachungsplan der Luftwaffe" (Mobilization Plan of the Luftwaffe), and the study by Generalmajor (Ret.) Conrad Seibt, "Mob. Plan, LDv 151" (Mobilization Plan, 151st Air Division), Karlsruhe Document Collection.

The measures to be taken in mobilizing the Luftwaffe were worked out by Branch II (Organization) of the Luftwaffe General Staff, which, on 1 February 1939, was redesignated Branch II (Planning and Mobilization). All plans connected with this mobilization were classified Top Secret Command Matters.

The Luftwaffe coordinated the Plan with the Army and the Navy in order to avoid duplication in the personnel groups to be called up and to make certain that enough equipment would be available for the units scheduled for activation. The Mobilization Plan was drawn up in such a way that it could be integrated into a general Wehrmacht mobilization or into orders for a single branch of the service.

This document, which also dealt with the legal aspects of transition from peacetime conditions to the exigencies of wartime, covered questions such as the procurement of required personnel,* of motor vehicles (emphasis being placed on acquiring large numbers of vehicles of the same model), of basic equipment, of clothing, food, supplies, payroll funds, the provision of billets, the scheduling of rail transportation and field post offices, and even the timely delivery of personnel identification tags.

Amendments in the directions referred to special measures which might become necessary in connection with mobilization, such as special regulations referring to the combat readiness of the Luftwaffe or of individual Luftwaffe elements, and guidelines thereto. Amendment V considered the steps which might be taken to prepare the Luftwaffe, or at least a part of it, for action in case a rather lengthy period of tension should precede the outbreak of war.† By means of predetermined "tension

* The necessary personnel had to be available in the vicinity of the activation center, since operational readiness generally had to be assured within four hours of the receipt of the original order.

† Hering and Seibt's information does not correspond with the text with respect to Amendment V (above). According to them, Amendment V is supposed to deal with the aircraft reporting service. This is obviously an error in numeration.

priorities" the Luftwaffe High Command could carry out exercises designed to test the performance of certain Air Service or Air District Commands under wartime conditions, without awakening the public to the fact that a general mobilization was taking place. By the time Priority II was ordered, however, the entire Luftwaffe was supposed to be ready for immediate commitment. The primary and ultimate aim of the "immediate measures" specified by the instructions was to achieve absolute combat readiness prior to the outbreak of war.

The Air District Commands* were responsible for the accomplishment of the preparatory work needed for the mobilization operations. From the standpoint of replacement personnel, the Air District Commands worked closely with the agencies in charge of military replacement personnel (Wehrersatzdienststellen), and from the standpoint of equipment (replacement vehicles) with the military replacement inspectorates (Wehrersatzinspektionen). Because unit activation had been carried on during peacetime, there was practically nothing left for the Luftwaffe to do when mobilization came. In the long run, however, the Luftwaffe never actually achieved the authorized strength it expected to have in the event of war.

From 1939 on, the Luftwaffe's flying forces and other personnel proved to be sufficient for the establishment of combat readiness. This was not true of the flak artillery and signal communications forces, which required additional personnel to come up to this status.

Landing fields were to be made ready for use as soon as possible by equipping them with the necessary signal facilities and by insuring their adequate supply. Schools, however, presented a special problem. While mobilization schools had to be established to train the unschooled people who would surely be called up during mobilization, † part of the equipment and aircraft

* See Chart No. 14.

† Civilian flying training schools were to be taken over by the Chief of Training, and, in addition, special schools were to be set up for training in specific types of aircraft.

assigned to the schools had to be taken from them to assure a proper supply of combat units. This was naturally a serious blow to the schools.*

Bomber, dive-bomber, fighter, and strategic reconnaissance units were considered to be operational even during peacetime, while the tactical reconnaissance units -- their number was to be immediately doubled in case of war -- were weakened by the withdrawal of their cadres. They were later restored to war-time strength by replacements from the reserves.

In accordance with the instructions, each wing and group was entitled to a staff with a flight of three aircraft. Groups consisted of three squadrons of nine aircraft each, plus a wing reserve force of three aircraft for each of the squadrons.

Air transport units were to be set up within twenty-four to forty-eight hours, the crews and aircraft to be drawn from Lufthansa and from the schools. The latter were also responsible for setting up the airfield service companies.

Courier squadrons attached to the High Command of the Wehrmacht, the Army, Navy, and Luftwaffe High Commands, and weather reconnaissance and emergency medical squadrons, were formed from personnel and equipment of the appropriate training schools.

The Luftwaffe increased the number of its ground personnel staff, and arranged for the release of cadres for this purpose from peacetime airfield commands. These cadres were augmented by replacement personnel drawn whenever possible from the vicinity of the newly established bases. For those base areas not yet scheduled for improvement, progress schedules were set up to reflect the personnel and equipment requirements.

All of the flak units were motorized and therefore capable of cross-country mobility and immediate commitment. The motorized flak units released cadre personnel to the new units, which were then brought up to full strength by replacements from units in the vicinity. Flak units assigned to home defense missions were set up from cadres detached from the original batteries. Cadres for barrage balloon battalions were already available, and anti-aircraft machine-gun units had existed even during peacetime when they were stationed near top priority defense installations.

* See p. 187.

Even during peacetime the motorized signal communications units assigned to the Commander in Chief of the Luftwaffe, to the Air Fleets, and the Luftwaffe signal communications regiments, were ready for action. Units assigned to the Luftwaffe ground organization -- some of these were motorized -- were forced to give up many of their troops for replacement units.

The supply and procurement offices, aircraft parks, equipment issuing offices, ammunition depots, and fuel dumps of the Signal Communications Forces were ready for action during peacetime, but, in those areas where no peacetime ammunition depots were available, they had to be formed from cadres detached from existing installations. These were then brought up to strength by replacements.

Air replacement groups (Flieger-Ergaenzungsgruppen) with both pilot and technical personnel were organized by drawing upon the schools and replacements, and were attached to the supply and procurement offices.

In case of mobilization, supply units were to be made up from the ranks of replacement personnel, from Luftwaffe construction units, and the Reichs Labor Service (Reichsarbeitsdienst or RAD). However, it had to be taken into account that part of the labor force was liable for military conscription, so that permanent replacements had to be secured by the fourteenth day of mobilization. Luftwaffe construction equipment platoons were set up using replacement personnel and vehicles.

Paratroop units were fully combat ready even during peacetime, were at a high state of training, and drew from the Parachute Schools for personnel and equipment.

The Ministry of the Interior (Innenministerium) organized the civil defense forces. This was a completely new organization, composed of elements from the Police, the Fire Brigade, the Red Cross, and the Technical Emergency Service.

The Western Air Defense Zone*

* This section is based upon a study by General der Flakartillerie (Ret.) Walther von Axthelm, "Die Luftverteidigungszone West" (The Air Defense Zone West), Karlsruhe Document Collection.

The High Command of the Luftwaffe established the Western Air Defense Zone along the western fortification line (West Wall). This zone extended for about 375 miles along the rear of the West Wall, from the Dutch border (at a point about as far north as Meunster) to Mannheim, from there to Lake Constance, and thence along the right back of the Rhine bordering on Switzerland. The depth of the line was about twelve and a half miles in the northern area, from twenty five to twenty eight miles between Wesel and Cologne, and about sixty two miles south and southeast of Koblenz (including the flak artillery defenses around Mainz, Mannheim, and Stuttgart).

In addition to providing extra protection for the Rhine-Westphalian industrial district and for the chemical and heavy industries along the middle and upper Rhine, the air defense line was designed to form as unbroken a fire barrage front as possible, while, at the same time, presenting an advance belt of operations for the areas and targets situated further to the east. The Muenster-Dortmund-Duesseldorf-Cologne and Mainz-Mannheim-Stuttgart areas were to be the points of concentration for the flak forces. Enemy aircraft, weakened by continuous losses while flying over the Zone were to be forced to climb to their maximum altitude (and into areas of poor visibility) in order to escape the range of German defensive fire. On the other hand, German planes returning from missions over enemy territory were to find protection against pursuing enemy planes once they had entered the area of defense. Furthermore, the Zone was to furnish air protection for German divisions being deployed in the West, for their assembly areas, and for their unloading centers.

Because of the all-out effort, flak artillery had 245 new reinforced concrete positions by the time the war began, and a continuous belt of searchlights behind and between these positions. Of the 245 positions, 197 were constructed for heavy units and the remainder for light and medium batteries. The erection of these positions required 3,000 carloads of materials, and cost 400,000,000 Reichsmarks. German leaders hoped that these positions, when fully manned by 250 batteries with 788 pieces of heavy flak artillery (8.8 and larger) and 576 pieces of light flak artillery, would provide a three-fold overlapping field of fire cover at an altitude of 23,000 feet. Considering the flying speeds at that time, this meant that every enemy aircraft would be exposed to five minutes of continuous fire by

three batteries at a time, assuring a concentration of about 600 rounds of ammunition on each individual target.

The administration of the Western Air Defense Zone was the responsibility of a Senior Commander of the Fortification Flak Artillery, appointed in 1938, with headquarters in Frankfurt am Main. On 15 November 1938 he assumed command of five fortification flak artillery battalions and of the Eifel and Black Forest Reconnaissance Staffs.

Measures in the Field of Training*

There were not enough flying training schools available in Germany to meet the demands brought about by the losses of flying personnel in training and by the activation of new units. In such circumstances it was impossible even to think of establishing a reserve of flying personnel. At the beginning of 1939, when the office of the Chief of Training of the Luftwaffe was first established, the Chief of Training had submitted a statistical report on the personnel situation to the General Staff, along with a request for permission to establish additional schools. This was disapproved on the ground that all available resources in the technical field were needed for the activation of combat units.

The Chief of Training therefore had no alternative but to act upon his own initiative. As a provisional measure he ordered each Luftwaffe group to accept twenty five men for training. These men were trained in single-engine aircraft and then assigned to advanced schools for specialized training. The Chief of Training also took steps to relieve the Luftwaffe of responsibility for providing initial aviation training to beginners. This pre-military aviation training was turned over to the National Socialist Flying Corps which established the necessary schools.†

* This section is based largely upon material prepared by General der Flieger (Ret.) Paul Deichmann in his study, "Die Ausbildung der deutschen Luftwaffe bis Kriegsbeginn" (Training in the German Air Force until the Beginning of the War), Karlsruhe Document Collection.

† The reader is also referred to the study by General der Flieger (Ret.) Werner Kreipe, Col. (Ret.) Rudolf Koester, and Capt. (Ret.) Karl Gundelach entitled "Die Ausbildung in der deutschen Luftwaffe" (The Training in the German Air Force), Karlsruhe Document Collection.

These measures did not have a chance to become effective before the war, but they did result in making available to the Luftwaffe about 1,000 pilots with twin-engine training, who were ready for assignment to more specialized schools. Many of the Luftwaffe units which were activated shortly before the war had not achieved an advanced level of training by the time combat operations began. Most of the younger pilots in these units lacked experience in night flying and flying in inclement weather, were deficient in bombing training, and in air-to-air and air-to-ground firing. But the standards of training in the older units also left something to be desired, chiefly because they so often had to give up their well-trained cadres to form the nuclei for new organizations.

According to statistics of the Office of the Quartermaster General, as of 2 September 1939 the Luftwaffe was short 61 tactical reconnaissance aircrews, 11 strategic reconnaissance aircrews, 139 single-engine fighter pilots, 54 twin-engine fighter crews, 36 dive-bomber crews, and 111 regular bomber crews.²² To make matters worse, there were also no reserve crews available from which to make up the losses which began to occur in the early part of the war. However, flak and signal units were able to fulfill their training missions and to keep pace with the activation of new units without too much trouble.

As was previously mentioned, the Luftwaffe carried out no systematic preparation for armament activity prior to the war, and took no preliminary steps to permit the immediate conversion of the German aircraft industry from a peacetime basis to a war production footing, to make sure that plant capacities would be exploited fully,* or to provide an adequate labor reserve against the day when a large part of the male labor force was bound to be conscripted.

* See the commentary of Diplom-Ingenieur Eberhardt Schmidt, former Technical Director of the Messerschmitt Company, in his article, "Grundlage und Wandlungen in der deutschen Flugzeugindustrie in den Jahren 1933-45," Flugwehr und Technik ("Fundamental Basis and Changes in the German Aircraft Industry during the Years from 1933 to 1945," Military Aviation and Technology), Vol. 2, Zuerich: February 1947.

The Military and Political Roles of the
Luftwaffe Before the War

The Luftwaffe as an Instrument of Political Policy

In 1933, Germany's political situation was highly unstable and clearly uncertain. Europe viewed Germany with a good deal of distrust, and it was imperative that Hitler acquire as soon as possible a reliable weapon which was capable of inspiring respect abroad and which would embody a warning to any foreign power that might be inclined to interfere with the Reich.* Because of the length of time required for the Army and the Navy to rearm adequately, these branches of service could not satisfy the need, but the Luftwaffe (assisted, to be sure, by a certain amount of deception) presented a distinct possibility. The fact that its build-up had to start almost from scratch soon gave Germany an advantage over her neighbors, for the new Luftwaffe would have up-to-date aircraft at its disposal, while a great part of the ample, but rapidly aging, equipment of the rest of Europe's air forces would be of little worth.

Soon after the announcement of the existence of the Luftwaffe as an independent branch of the Wehrmacht -- which naturally ended the secrecy which had shrouded its build-up -- one of the first steps taken by German air leaders was to represent the German Air Force as a considerably larger and more powerful body than it actually was at the time. In this way the Reich successfully frustrated an agreement which had been suggested during an Anglo-French conference in London on 3 February 1935, stipulating that the German air forces should be restricted to one-third as many aircraft as the British Royal Air Force had.

During the rather critical weeks following Germany's rearmament announcement it was a great help to Hitler to be able to inform the British negotiators, Sir John Simon and Lord Privy Seal Anthony Eden (whom Hitler met in Berlin on 26 March 1935) that the German Luftwaffe had already reached the strength of the Royal Air Force.† There was no longer any danger of Germany being ordered to cut down on air armament.

* The risk (Risiko) Luftwaffe. See p.78.

† The German figures included the aircraft assigned to flying units, schools, and supply and procurement offices.

The tendency to exaggerate the strength of the Luftwaffe was also given impetus by the personality of its Commander in Chief, Hermann Goering. As Commander in Chief, Goering managed to create an impression of trustworthiness and disarming honesty. He spoke continually of the fact that the German people were becoming a nation of "flying enthusiasts." Again and again Goering and his deputy, State Secretary Milch, pointed to the prowess of the Luftwaffe in greatly magnified terms. In order to make this prowess seem plausible abroad, flying schools, Luftwaffe branch schools, and the supply and procurement offices were all given uniform designations as Luftwaffe Groups and their locations announced openly. The branch school designations contained the symbol "S" and the supply and procurement offices the symbol "Z." Thus, the Air Group (Z) Jueterbog meant the supply and procurement office at Jueterbog and the Air Group (S) Tutow, the Bomber School at Tutow. No changes were made in the tasks assigned to the newly designated agencies.

When Goering made his famous speech of 10 March 1935 revealing the existence of the Luftwaffe, he informed the British journalist Ward Price that he was unable to quote precise figures, but that the strength of the German air forces in comparison with the strength of the air forces of other European nations had been based on the fact that Germany, by virtue of its position in the middle of Europe, was presumably in greater danger of air attack than other nations.

The fact was, that at that time the strength of the new Luftwaffe amounted to no more than five reconnaissance squadrons, one and one third fighter groups, and two bomber groups. The Luftwaffe was then in the process of activating seven reconnaissance squadrons, one and one third fighter groups, four bomber groups, and a number of naval air squadrons.

After June 1936 the Luftwaffe openly utilized the formerly secret three-digit numbering designations of the units, and flying schools and supply and procurement offices were also publicly acknowledged in this way. Quite apart from this numbering system, which clearly made a significant impression abroad, the subsequent transfers of units and divisions of units for the purpose of new activations created such a furor of activity that foreign observers were bound to conclude that the new German air arm was growing by leaps and bounds. As General Heinz J. Rieckhoff says:

It is no wonder, in view of the methods employed, that foreign military observers gradually came to the conclusion that a tremendously powerful air force was coming into existence in Germany.²³

This was augmented by the powerful impression which the new German Luftwaffe's installations were bound to make upon foreign military attachés and other official visitors, for no attempt had been made to economize in this respect. On the contrary, a great deal of money and materiel had been and was being expended in the construction of modern, well-designed airfields. And, if the external appurtenances were so impressive, the visitor was bound to reason that the force itself must be even more impressive. The time when German military leaders had anticipated inspection visits by Allied officers with some foreboding was long since past. Now, the more visitors the better, and the higher the rank or the more brilliant the reputation of the visitor the more eagerly he was welcomed! Men like the American Col. Charles A. Lindbergh or the Chief of the French Air Force General Staff, General Joseph Vuillemin, were extremely welcome and led to believe that a good deal more advanced aviation equipment and aircraft existed in Germany than was actually the case.*

* Generalleutnant Heinz J. Rieckhoff commented, "Naturally we were aware of the fact that these officers were expected to furnish their espionage chiefs with reports, which were forwarded through diplomatic channels without being censored by German authorities, and . . . would, . . . ultimately reach the top government circles of all the major powers. On the other hand, these foreign officers were presumably unaware of the fact that their German hosts deliberately kept them from seeing Germany's top achievements. . . . In addition to the systematic bluff organized at top level, there was also the willing self-deception of the foreign air observers, who simply refused to believe what their eyes saw and insisted on assuming that there was still more hidden behind it. They had no way of knowing that many of the gigantic hangars they were shown were either completely empty or filled with ancient, dust-covered aircraft. . . ." See Trumpf oder Bluff? 12 Jahre Deutsche Luftwaffe (Trump or Bluff? 12 Years of German Air Force), Geneva: Verlag Inter-Avia, 1945, p. 157.

By this time, however, the Luftwaffe had really become a factor to be reckoned with. After Col. Lindbergh departed from Germany he became a warm friend of the Reich, and even during the early part of the war did his best to influence public opinion in the United States in favor of continued peaceful relations with Germany.* But Vuillemin, the sharp critic whose attitude toward Germany was anything but friendly, reacted differently.²⁴ He was undoubtedly impressed during his visit to the Heinkel Works in Oranienburg on 26 August 1938, during which time the He-100 fighter was demonstrated to him. This aircraft had been made up in three test models, but never reached the mass production stage. When this speedy plane landed, it rolled to a stop near the group of visiting French officers accompanied by Milch and Udet. One of the French officers suddenly cried out in pain as he stood too close to the He-100 and burned his hand by touching the still hot metal of the fuselage of the He-100. Milch then asked the pre-arranged cue question concerning

* Editor's Note: Prof. Ernst Heinkel, among others who were close to Lindbergh during his visit to Germany, disagrees with the view presented by the author. Heinkel writes, "How little feeling there was between Goering and Lindbergh was clear to me on the next day, . . . Goering was naturally invited to the reception. He arrived late without offering an excuse. He unceremoniously handed Lindbergh a decoration, in passing so to speak, . . . Goering thrust the little case forward and said with the bluntness characteristic of him, 'From the Fuehrer,' and then turned to the American Ambassador and to the American Military Attaché, Truman Smith. Lindbergh looked strangely at Goering, shook his head, and shoved the decoration into his trousers pocket like a handkerchief, without casting a glance around." Sturmische Leben (Stormy Life), Stuttgart: Mundus Verlag, 1953, pp. 351-352. To this day Lindbergh remains a controversial figure because he advocated non-involvement and absolute neutrality concerning the European war, because of his association with the "America-First" movement, and because of his frank appraisals of Allied air strength vis-a-vis the Luftwaffe. Those hostile to Lindbergh claimed he had received a German military war decoration (Iron Cross), that he favored Nazi policies in general and anti-Semitism in particular, and was a dangerous security risk. None of these charges were established, and Lindbergh later rendered conspicuous service in the Pacific during World War II, flying 50 missions and even (although unofficially) shooting down two Japanese "Zeros." See The Airman, Vol. VII. No. 2, February 1963, Washington: U.S. Government Printing Office, p.12.

what the situation was with respect to the mass production of the He-100. Udet thereupon replied that the second assembly line run had already been started and that the third run would begin within the next two weeks. Vuillemin was deeply impressed. Even before this, during an inspection visit to a number of aircraft hangars, when every attempt had been made to show him Germany's war preparations in detail, he had exclaimed, "I am amazed!"²⁵ A report by the French Ambassador to Germany, André Francois-Poncet, concerning this inspection visit mentioned that Vuillemin had been invited to visit Germany by Goering in the month of August 1938. He described Vuillemin's visit as follows:

He was given a hearty welcome. He was shown the newest models, the troop drill areas, the workshops and factories, and the air raid shelters. No attempt was made to hide anything from him, and he was able to confirm that the reports which I had been sending him for months were entirely accurate. After a farewell breakfast at Karinhall, Goering asked him a question pertaining to the future, "What would France do in the case of a war between Germany and Czechoslovakia?" The General answered, "France will keep the promise which she has given!" But, in the automobile which subsequently took us back to Berlin, he confided to me, "If war breaks out at the end of September, as you think it will, there won't be a single French aircraft left after fourteen days!"²⁶

The Role of the Luftwaffe in the Pre-War Crises

It is understandable that the emerging Luftwaffe played no role at all in the deliberations of the general staffs of Europe during the crises of the mid-1930's. This was true of the German reoccupation of the Rhineland in March of 1936, although Luftwaffe strength had by then increased so that the few air forces utilized in this operation represented only a fraction of the actual available German air power. During this tension-filled movement, as well as in the subsequent action in Spain (1936-39), the general staffs of only two Western powers took any notice of the German Luftwaffe, and even these viewed it as

* See figure 33.



Figure 33

French Officers visiting Fighter Wing
"Richthofen" in Doeberitz, 1938: L. to
R.: (standing) General Joseph Vuellemin,
Chief of Staff of the French Air Force;
the German State Secretary of Aviation,
Erhard Milch; and General of the French
Air Force, D'Astier.

a force whose strength could not be accurately assessed and must, therefore, be overrated. Nevertheless, it would not be far wrong to accept the cautious evaluation of General Maurice Gamelin, Chief of the French General Staff, who believed that Luftwaffe strength, even at that time, was not unduly influenced by the general tendency toward exaggeration.

The effect of these inflated reports was even greater in the case of smaller nations, as evidenced by the situation in Austria. It was not a mere accident, nor could it be attributed to the martial expression of General der Flieger Hugo Sperrle, that Hitler kept the latter near him during the luncheon given on 12 February 1938 on the Obersalzburg to commemorate the visit of the Austrian Chancellor, Dr. Kurt Schuschnigg. For Sperrle, in reality a good-hearted man despite the brutality and harshness of his features, represented the German Luftwaffe, a force which was already a tangible factor in military planning and was capable of inspiring respect and fear. Shortly after Schuschnigg's visit the German Army and Luftwaffe gave demonstrations along the Bavarian-Austrian border to underline the importance of the agreements reached at Berchtesgaden.* During the critical days following Schuschnigg's announcement in Innsbruck that a plebiscite would be held and until his final resignation on 11 March 1938 (and even in the hours immediately following) these demonstrations were repeated.

Doubtless the annexation of Austria was greatly facilitated by the Luftwaffe, which was by this time fairly strong and appeared to be even more powerful than it was. Of course, large numbers of impressionable Austrians were enthusiastic about the Luftwaffe, which they viewed as a symbol of Germany's strength. At this juncture, and to an even greater degree than was true elsewhere, France finally realized that the Luftwaffe had become a factor with which to be reckoned. France had been the leading nation in Europe since the Versailles Treaty, but Vuillemin,

* The Austrian government was not deceived by these demonstrations. See Ludwig Eichstaedt, Von Dollfuss zu Hitler (From Dollfuss to Hitler), Mainz: 1955, p. 209. The agreements mentioned above effectively removed the last organized opposition to Hitler in Austria. In the plebiscite held on 10 April 1938, 99.75 percent voted to become Germans.

who on 26 August 1938 had been so impressed by his inspection trip to German air installations, submitted a report to his government stating that the German Luftwaffe is "so vastly superior to the French Air Force that, for this reason alone, the French Army must reckon with a defeat. The German Reich produces between 500 and 600 aircraft per month, while France produces only seventy."²⁷ According to the writer Fritz Hesse, this report was the main reason why France refrained from intervening in the Czechoslovakian crisis.

As a last example of the political effectiveness which the Luftwaffe managed to exercise without going into action, one should consider Goering's threat to the Czech President, Dr. Emil Hacha. During the night of 14 March 1939, Dr. Hacha was faced with the German ultimatum to approve the secession of Slovakia and the incorporation of Bohemia and Moravia into the Reich as a German protectorate. Although Hacha had long refused to accede to German demands, Goering forced him to agree by declaring that, in the case Czech resistance was offered to the planned German occupation, the Luftwaffe would bomb the city of Prague.*²⁸

On the whole this intimidation was the last successful effort to use the Luftwaffe as an instrument of political policy. In Europe events were rapidly coming to a head. Great Britain had forged ahead in the field of air armaments and felt strong enough to influence France to follow suit, although the latter continued to hesitate. The spectre of German strength had made a deep impression upon the French mentality. On 10 September 1939, after both Britain and France had become embroiled in the conflict,[†] Chamberlain noted in his diary, "The efforts of France to postpone an official declaration of war as long as possible

* Editor's Note: President Hacha had been summoned to Berlin by Hitler, where he was subjected to the most incredible type of verbal abuse and pressures. Hitler actually threatened far more than the bombing of Prague. See Alan Bullock, Hitler, A Study in Tyranny, rev. ed., New York: Harper and Brothers, 1961, pp. 429-431.

† Editor's Note: Great Britain and France declared war on Germany on 3 September 1939.

until the French women and children could be evacuated played an important role in the final, time-consuming agonies preceding the declaration of war."²⁹ This was a clear indication of the general fear which prevailed in France with respect to the striking power of the Luftwaffe.

Year after year the German Air Force had provided valuable assistance in helping Germany to achieve its political goals, first of all because its very existence discouraged desires to interfere with German activities in foreign countries, and secondly, because the highly exaggerated ideas concerning the actual strength of the Luftwaffe facilitated peaceful settlements of the 1938 crises. But, at the same time, its largely propagandistic role in the events of the time were not without grave dangers. A military leader who consistently and arrogantly magnifies the strength of his forces -- Goering once bragged that the skies over London would "grow dark" when the Luftwaffe began its attacks -- runs the risk of gradually coming to believe his own propaganda. As the war was to reveal, this is precisely what happened to Hermann Goering, and which was to lead to the defeat of the Luftwaffe.

FOOTNOTES

Chapter 1

1. Germany, Auswaertigen Amt, Der Friedensvertrag zwischen Deutschland und den Alliierten und Assoziierten Meechten nebst dem Schlussprotokoll und der Vereinbarung betreffend die militaerische Besetzung der Rheinlaende (The Peace Treaty between Germany and the Allies and their Associates, together with the Final Protocol and the Agreement Concerning the Military Occupation of the Rhineland, prepared under the auspices of the German Foreign Office), Berlin-Charlottenburg: 1919. Cited hereafter as Versailles Treaty.
2. Ibid., Articles 201-202.
3. Ibid., Article 202.
4. General der Kavallerie Ernst von Hoepfner, Deutschlands Krieg in der Luft. Ein Rueckblick auf die Entwicklung und die Leistungen unserer Heeres-Luftstreitkraefte im Weltkriege (Germany's War in the Air. A Retrospective View of the Development and the Accomplishments of our Army-Air Combat Forces in the World War), Leipzig: Koehler & Amelang Verlag, 1921, p. 175.
5. Ibid., pp. 174-175.
6. Ibid., p. 179.
7. Interview of General der Flieger (Ret.) Paul Deichmann by the author, 7 March 1954. Cited hereafter as Deichmann Interview, 7 March 1954.
8. Generalleutnant Heinz J. Rieckhoff, Trumpf oder Bluff? 12 Jahre Deutsche Luftwaffe (Trump or Bluff? Twelve Years of the German Air Force), Geneva: Verlag Inter-Avia, 1945, p. 27. Cited hereafter as Rieckhoff, Trump or Bluff?
9. Ibid., pp. 27-28.

10. General a.D. Friedrich von Rabenau, ed., Seeckt: Aus seinem Leben (Seeckt: From his Life [Memoirs of Generaloberst Hans von Seeckt, Vol. II]), Leipzig: Hase und Koehler Verlag, 1940, p. 528. Cited hereafter as Rabenau, Seeckt Memoirs.
11. Ibid., p. 529.
12. Ibid., pp. 529-530.
13. General der Flieger a.D. Hellmuth Felmy, "Luftfahrt Ausbildung in der Reichswehr," Teil I (Aviation Training in the German Defense Department, Part I), p.5, B/I/1b, Karlsruhe Document Collection. Cited hereafter as Felmy, Aviation Training. See also Generalleutnant a.D. Bruno Maass, "Organisation der Fliegerstellen im RWM 1920-1933" (Organization in the Aviation Positions in the Reichs Defense Ministry from 1920 to 1933), A/I/2, Karlsruhe Document Collection. Cited hereafter as Maass, Air Organization in the Reichswehr.
14. General der Flieger a.D. Wilhelm Wimmer, "Stellungnahme zu Luftfahrt-Ausbildung in der Reichswehr von Hellmuth Felmy, Teil I" (Commentary on Hellmuth Felmy's "Aviation Training in the Reichswehr, Part I"), B/III/1a, Karlsruhe Document Collection. Cited hereafter as Wimmer, Commentary on Aviation Training.
15. Ibid., p. 3.
16. Ibid., p.4.
17. Ibid., p. 51.
18. Felmy, Aviation Training, Part I, p.4.
19. Ibid., pp. 4-5. See also Wimmer, Commentary on Aviation Training, p. 4.
20. Maass, Air Organization in the Reichswehr, p. 8.
21. Ibid., p. 1. See also Versailles Treaty, Article 202.

22. Versailles Treaty, Articles 198-202.
23. Ernst Heinkel, Stuermisches Leben (Stormy Life), Stuttgart: Mundus Verlag, 1953, p. 118. Cited hereafter as Heinkel, Stormy Life.
24. Versailles Treaty, Article 314.
25. Heinkel, Stormy Life, pp. 119-126.
26. Ibid., pp. 135-137.
27. Rabenau, Seeckt Memoirs, p. 529.
28. Interview of Ministerial Director and Confidential Advisor (Geheimrat), Ret., Wilhelm Fisch by the author, 20 December 1957. See also Heinkel, Stormy Life, pp. 144-145.
29. Maass, Air Organization in the Reichswehr, p. 9.
30. Hauptm. (Res.) Karl Gundelach, Oberst a.D. Rudolf Koester, General der Flieger a.D. Werner Kreipe, "Ausbildung in der Fliegertruppe" (Capt. [Res.] Karl Gundelach, Col. [Ret.] Rudolf Koester, and General der Flieger [Ret.] Werner Kreipe, Training in the Flying Forces), B/III/lb, Karlsruhe Document Collection. Cited hereafter as Gundelach, et al.
31. Rabenau, Seeckt Memoirs, p. 308.
32. Letter from Generaloberst Hans von Seeckt to Generalleutnant Johann Hasse, dated 17 May 1922.
33. Memorandum from Generaloberst Hans von Seeckt to the new Reichs Chancellor, Dr. Wilhelm Cuno, dated 23 November 1922.
34. Generalingenieur a.D. Thomsen, "Junkers Flugzeugwerke Fili in der Naeh von Moskau 1924-1927" (Junkers Aircraft Works at Fili in the Vicinity of Moskow, 1924-1927), C/III/1, Karlsruhe Document Collection. Cited hereafter as Thomsen, Junkers Factory at Fili.
35. Felmy, Aviation Training, Part I, p. 9.

36. Written reply, dated 7 September 1954, by Ministerial Director (Ret.) Wilhelm Fisch to a query by the author.
37. Interview of Generalingenieur (Ret.) Fritz Siebel by the author, concerning the Paris Air Agreement, (dated 15 August 1954. See also Dr. H. Orlovius, Schwert am Himmel; Fuenf Jahre deutsche Luftwaffe (Sword on the Heavens; Five Years of the German Air Force), Berlin: Scherl Verlag, 1940, pp. 11-12. Cited hereafter as Orlovius, Five Years of the Luftwaffe.
38. Generalleutnant a.D. Andreas Nielsen, The German Air Force General Staff, USAF Historical Study No. 173, Maxwell AFB, Alabama: USAF Historical Division, RSI, June 1959, pp. 62-65. Cited hereafter as Nielsen, Luftwaffe General Staff. See also Maass, Air Organization in the Reichswehr, pp. 8-12.
39. Nielsen, Luftwaffe General Staff, p. 62.
40. Germany, Reichswehrministerium, Nr. 42/25 T 2 III (L) pers. vom 22. 1. 1925 (Defense Ministry, No. 42 of 1925, Branch T 2 III [L], Personal, of 22 January 1925). See also G.Z. (fruehere TA Stab) Nr. 65 (Central Unit of the Army General Staff [formerly TA Staff] No. 65).
41. H.Wa.A. Nr. 2840/28, geh.Kommandosache "Z" Wa B6 (Army Ordnance Office, No. 2840 of 1928, Top Secret Command Matter, Branch Office Wa B 6).
42. OKM, Dvs. 15, 1937, "Der Kampf der Marine gegen Versailles 1919-1935: Aufbau der Luftwaffe im Rahme der Kriegsmarine nach dem 1. Weltkrieg," bearbeitet von Kapt. z. See Schuessler (High Command of the Navy, Service Regulation 15, 1937, "The Battle of the Navy against Versailles 1919-1935: Buildup of the Air Force within the Framework of the Navy after the First World War," compiled and written by Capt. [Navy] Schuessler), A/V, Karlsruhe Document Collection.
43. Heinkel, Stormy Life, pp. 410-415.

44. Georg W. Feuchter, Geschichte des Luftkriegs. Entwicklung und Zukunft (History of Air Wars. Development and Future), Bonn: Athenaeum Verlag, 1954, p. 104. Cited hereafter as Feuchter, History of Air War.
45. H.Wa.A., Karte, "Luftwaffentechnik 1929 bis 1933; Organisation" (Army Ordnance Office, Map "Air Force Technology 1929 to 1933, Organization"), Anlage 3 (Appendix 3), A/II/1a, Karlsruhe Document Collection. See also Thomsen, Junkers Factory at Fifi.
46. Interview of General der Flieger (Ret.) Hellmuth Felmy by the author, 16 February 1954. Cited hereafter as Felmy Interview, 16 February 1954.
47. Gundelach, et al., p. 31 (Commentary of Col. Rudolf Koester).
48. General der Flieger a.D. Wilhelm Speidel, "Reichswehr und Rote Armee," Vierteljahrshefte fuer Zeitgeschichte (German Ministry of Defense and the Red Army, Quarterly for Contemporary History), Vol. 1, January 1953, Stuttgart: Deutsche Verlags-Anstalt, pp. 24-30. Cited hereafter as Speidel, Reichswehr and Red Army.
49. Ibid., pp. 36-40. See also Felmy, Aviation Training, Part I, p. 38. See also Gundelach, et al. (Commentary of Col. Koester), p. 31.
50. Speidel, Reichswehr and Red Army, p. 41.
51. Ibid., p. 42.
52. Col. Friedrich Greffrath, "Der Aufbau der deutschen Luftwaffe 1919-1939" (The Buildup of the German Air Force 1919-1939), A/II/2a, Karlsruhe Document Collection.
53. Aktennotiz des Reichswehrministers Groener vom 3.12.1930 (Memorandum of Defense Minister Groener of 3 December 1930).
54. Germany, Reichswehrministerium, Aktennotiz vom 14.11.1932 (Defense Ministry, Memorandum of 14 November 1932).
55. Ibid., See also Speidel, Reichswehr and Red Army, pp. 18-26.

56. General der Flieger a.D. Hans Siburg, "Vorbereitende Massnahmen der Marine-leitung auf dem Gebiete des Seeflugwesens in den Jahren 1920-1933" (Preparatory Measures taken by the Navy Command in the Area of Naval Aviation in the Years 1920-1933), A/V/1, Karlsruhe Document Collection.
57. Ibid. See also Felmy Interview, 16 February 1954.
58. Generalingenieur a.D. Walter Hertel, "Die Beschaffung in der deutschen Luftwaffe" (Procurement in the German Air Force), C/IV/6b, Karlsruhe Document Collection. Cited hereafter as Hertel, Luftwaffe Procurement.
59. Germany, Reichswehrministerium, Nr. 549/32, geh. Kommando-sache, In 1 (L) vom 15.7.1932 (Defense Ministry, No. 549 of 1932, Top Secret Command Matter, Branch In 1 [L], Aviation Branch, of 15 July 1932).
60. Felmy Interview, 16 February 1954. See also Speidel, Reichswehr and Red Army, pp. 40-45.
61. Germany, Reichswehrministerium, Nr. 401/33, geh.Kdos. In 1 (L) vom 21.3.1933 (Defense Ministry, No. 401 of 1933, Top Secret Command Matter, Branch In 1 L of 21 March 1933). See also Nr. 150/33, geh. Kommandosache, T 2 III B/In 1 (L) V vom 21.2.1933 (No. 150 of 1933, Top Secret Command Matter, Branch T 2 III B/In 1 [L] V of 21 February 1933).

Chapter 2

1. Versailles Treaty, Articles 198-202.
2. Maass, Air Organization in the Reichswehr, pp. 1-8.
3. Rabenau, Seeckt Memoirs, p. 529.
4. Interview of Generalstabsrichter Dr. Alexander Kraell by the author, 24 June 1955. Cited hereafter as Kraell Interview, 24 June 1955. See also Heinz Conradis, Nerven, Herz, und Rechenschieber: Kurt Tank, Flieger, Forscher, Konstrukteur (Nerves, Heart, and Slide Rule: Kurt Tank, Flyer, Researcher, Builder), Goettingen: Musterschmidt Verlag, 1955. Cited hereafter as Conradis, Nerves, Heart, and Slide Rule. See also Rabenau, Seeckt Memoirs, p. 529, (Commentaries of von Below).

5. General der Flieger a.D. Josef Kamhuber, "Planung fuer den weiteren Ausbau der Luftwaffe" (Planning for the further Expansion of the Air Force), A/I/2, Karlsruhe Document Collection. Cited hereafter as Kamhuber, Expansion of the Air Force. See also Richard Suchenwirth, "Hans Jeschonnek, der vierte Generalstabschef der deutschen Luftwaffe" (Hans Jeschonnek, the fourth Chief of the General Staff of the German Air Force), p. 39, Karlsruhe Document Collection. Cited hereafter as Suchenwirth, Jeschonnek Study.
6. Germany, Reichs Chancellory, "Niederschrift ueber die Besprechung in der Reichskanzlei am 5.11.37 von 16.15 bis 20.30 Uhr, Berlin, den 10. November 1937," Der Prozess gegen die Hauptkriegsverbrecher vor dem Internationalen Militaergerichtshof Nuernberg (Notes on the Conference in the Reichs Chancellory on 5 November 1937 from 1615 to 2030 hours, Berlin, the 10th of November 1937, The Trial of the Major War Criminals before the International Military Tribunal, Nuremberg), Vol. II, Nuremberg: International Military Tribunal, 1947-49, pp. 296-308. Cited hereafter as Hossbach Minutes. See also General der Infanterie a.D. Friedrich Hossbach, "Eidesstattliche Erklaerung von Friedrich Hossbach, ehemalige General der Infanterie vom 18. Juni 1946," Der Prozess gegen die Hauptkriegsverbrecher vor dem Internationalen Militaergerichtshof Nuernberg (Sworn Declaration of Friedrich Hossbach, formerly General of the Infantry of 18 June 1946, The Trial of the Major War Criminals before the International Military Tribunal, Nuremberg), Vol. XXXII, Nuremberg: International Military Tribunal, 1947-1949, pp. 228-230.
7. Richard Suchenwirth, "Hermann Goering, der Oberbefehlshaber der deutschen Luftwaffe. Ein Versuch" (Hermann Goering, the Commander in Chief of the German Air Force. An Essay), 1957, pp. 15-21, Karlsruhe Document Collection. Cited hereafter as Suchenwirth, Hermann Goering.
8. Ibid., p. 48.

9. OKL, Chef des Generalstabes der Luftwaffe, 8. (kriegswissenschaftliche) Abt., "Die Lehre Douhets und der Luftkrieg der Gegenwart," ein Studie vom 22.11.1944 (High Command of the Air Force, Chief of Staff of the Air Force, 8th [Military Science] Branch, "The Lessons of Douhet and Air Warfare of the Present," a Study dated 22 November 1944), F/I/2, Karlsruhe Document Collection.
10. Suchenwirth, Hermann Goering, p. 26.
11. Ibid., pp. 17-21.
12. Heinkel, Stormy Life, p. 411.
13. Letter from Landsberg from Field Marshal (Ret.) Erhard Milch to General der Flieger (Ret.) Paul Deichmann, 21 February 1954. Cited hereafter as Milch Letter, 21 February 1954.
14. General der Flieger a.D. Karl Koller, Der letzte Monat: Die Tagebuchaufzeichnungen des letzten Generalstabschef der deutschen Luftwaffe vom 14.4 - 27.5.1945 (The Last Month: The Diary Notations of the Last Chief of the German Air Force General Staff from 14 April to 27 May 1945), Mannheim: Norbert Wohlgemuth Verlag, 1949, p.61. Cited hereinafter as Koller, The Koller Diary.
15. Nielsen, Luftwaffe General Staff, pp. 20-21. See also Maass, Air Organization in the Reichswehr, pp. 14-16.
16. Maass, Air Organization in the Reichswehr, p. 7.
17. Tbid., p. 9.
18. Richard Suchenwirth, "Erhard Milch. Ein Versuch" (Erhard Milch. An Essay), 1957, pp.2-9, Karlsruhe Document Collection. Cited hereafter as Suchenwirth, Milch Study.
19. Generalfeldmarschall a.D. Albert Kesselring, Soldat bis zum letzten Tag (Soldier to the Last Day [This work appears in the English edition as A Soldier's Record]), Bonn: Athenaeum Verlag, 1953, p. 32. Cited hereafter as Kesselring, Soldier to the last Day.

20. Maass, Command Organization in the Luftwaffe to 1939, pp. 6, 21-27, 31-33, 58-63.
21. Ibid., pp. 58-63.
22. Felmy Interview, 16 February 1954, Deichmann Interview, 7 March 1954, Suchenwirth, Milch Study, p. 18. See also Richard Suchenwirth, "Walther Wever, der erste Generalstabschef der deutschen Luftwaffe" (Walther Wever, the first Chief of the General Staff of the German Air Force), 1956, pp. 5-6. Cited hereafter as Suchenwirth, Walther Wever Study.
23. Deichmann Interview, 7 March 1954. See also Maass, Command Organization in the Luftwaffe to 1939, pp. 83-84.
24. "Unterredung Goerings mit dem Sonderberichterstatter der DAILY MAIL, WARD PRICE, vom 10.3.1935" (Interview of Reichsmarschall Hermann W. Goering by Mr. Ward Price, Special Reporter of the London Daily Mail, 10 March 1935), A/I/2, Karlsruhe Document Collection.
25. Suchenwirth, Milch Study, p. 14. See also Maass, Command Organization in the Luftwaffe to 1939, pp. 83-88.
26. Maass, Command Organization in the Luftwaffe to 1939, pp. 83-95.
27. Ibid., pp. 83-84, 96-97.
28. Reichsminister der Luftfahrt und Oberbefehlshaber der Luftwaffe, Generalstab, 2. Abt., geh. vom 23.11.1937 (Reichs Minister of Aviation and Commander in Chief of the Air Force, General Staff, 2nd [Organization] Branch, Secret, of 23 November 1937), Number not given. A memorandum prepared for the Chief of the Luftwaffe General Staff, Karlsruhe Document Collection.
29. Reichsminister der Luftfahrt und Oberbefehlshaber der Luftwaffe, Generalstab, 2. Abt., Nr. 200/38, geh. Kommandosache (I) vom 18.1.38 (Reichs Minister of Aviation and Commander in Chief of the Air Force, General Staff, Operations Branch, No. 200 of 1938, Top Secret Command Matter of 18 January 1938), Karlsruhe Document Collection.

30. Ibid. See also Maass, Command Organization in the Luftwaffe to 1939, pp. 103-104.
31. Maass, Command Organization in the Luftwaffe to 1939, pp. 103-107.
32. Ibid., pp. 169-170. See also Suchenwirth, Jeschonnek Study, pp. 3-4.
33. Reichsminister der Luftfahrt und Oberbefehlshaber der Luftwaffe, Min. A.A.I. Nr. 50/39 vom 23.1.1939 (Reichs Minister of Aviation and Commander in Chief of the Air Force, Training Branch Inspectorate, No. 50 of 1939 of 23 January 1939), Karlsruhe Document Collection.
34. _____, "Dienstanweisung fuer das Mob.-Jahr 1938/39 (Aus Besondere Anlage 1 zum Mob. Plan [Luftwaffe]), Kriegspitzengliederung der Luftwaffe und Gliederung der hoeheren Kommandobehoerden der Luftwaffe in Kriege Mob. Jahr 1938/39," Ausgabe vom 1.8.1938, Pruef Nr. 113 (Service Instructions for Mobilization Year 1938-39 [From the Special Appendix 1 to the Mobilization Plan (Air Force)]), War Command Organization of the Air Force and Organization of the Higher Command Positions of the Air Force for the War Mobilization Year 1938-39, Copy No. 113), A/II/1, Karlsruhe Document Collection. See also Maass, Command Organization in the Luftwaffe to 1939, p. 185.
35. Maass, Command Organization in the Luftwaffe to 1939, p. 128.
36. Ibid., pp. 114, 157, 159.
37. Ibid., pp. 130-131.
38. Suchenwirth, Jeschonnek Study, pp. 119-120.

39. _____, Map, "Territorialorganisation der Luftwaffe 1937" (Territorial Organization of the Air Force 1937). A Map derived from official Luftwaffe sources), A/I/1a, Karlsruhe Document Collection. See also Reichsminister der Luftfahrt und Oberbefehlshaber der Luftwaffe, Chef des Generalstabes der Luftwaffe, 2. Abt. Nr. 1600/37, geheim, vom 2.6.37, "Spitzengliederung der Luftwaffe" (Reichs Minister of Aviation and Commander in Chief of the Air Force, Chief of the Air Force General Staff, Operations Branch, No. 1600 of 1937, secret, of 2 June 1937, "Command Organization of the Air Force").
40. _____, Map, "Bereiche der Luftkreise, Luftgaue und Luftamtsbezirke, Stand: 1.4.36-31.10.37" (Areas of the Air Administration Areas, Air Service Command Areas, and Air Office Districts, from 1 April 1936 to 31 October 1937). A Map drawn from official Luftwaffe documents, A/III/1, Karlsruhe Document Collection. See also _____, Chart, "Gliederung der Luftwaffe 1.4.34-31.3.35" (Organization of the Air Force from 1 April 1934 to 31 March 1935). A chart taken from official Luftwaffe records, A/III/1, Karlsruhe Document Collection.
41. Nielsen, Luftwaffe General Staff, pp. 72-75.
42. _____, Chart, "Unterstellungs-und Befehlsverhaeltnisse im Luftkreis I-V, 1.4.1935-31.3.1936" (Subordination and Chain of Command Relationships in Air Administration Areas I to V, from 1 April 1935 to 31 March 1936). A chart with explanation taken from official Luftwaffe records, A/III/1, Karlsruhe Document Collection.
43. Maass, Command Organization in the Luftwaffe to 1939, pp. 76, 99.
44. _____, Chart, "Gliederung eines Luftkreiskommandos ab 1.4.35" (Organization of an Air Administrative Area Command as of 1 April 1935), A Chart drawn from official Luftwaffe documents, A/III/1, Karlsruhe Document Collection.

45. _____, Chart, "Gliederung eines Luftwaffengruppenkommandos 1.7.1938 bzw. Luftflottenkommandos ab 1.2.1939" (Organization of an Air Force Group Command as of 1 July 1938 and of an Air Fleet Command as of 1 February 1939). Chart taken from official Luftwaffe documents, A/III/1, Karlsruhe Document Collection.
46. Maass, Command Organization in the Luftwaffe to 1939, pp. 100-105.
47. _____, Chart, "Gliederung der Luftwaffe 1.7.1938-31.1.1939" (Organization of the Air Force 1 July 1938 to 31 January 1939). A Chart taken from official Luftwaffe sources, A/III/lc, Karlsruhe Document Collection.
48. _____, Chart, "Gliederung der Luftwaffe ab 1.2.1939" (Organization of the Air Force as of 1 February 1939). A Chart taken from official Luftwaffe sources, A/III/lc, Karlsruhe Document Collection.
49. _____, Chart, "Gliederung eines Luftgaukommandos ab 1.7.1938" (Organization of an Air Administrative Area Command as of 1 July 1938). A Chart taken from official Luftwaffe records, A/III/lc, Karlsruhe Document Collection.
50. _____, Chart, "Gliederung der Stab einer Fliegerdivision" (Organization of the Staff of an Air Division). A chart probably taken from official Luftwaffe sources, A/III/lc, Karlsruhe Document Collection.
51. _____, "Organisation, Unterstellung und Zusammenarbeit Marine und Luftwaffe bei Kriegsbeginn" (Organization, Subordination and Cooperation between Navy and Air Force at the beginning of the War), Karlsruhe Document Collection.

Chapter 3

1. Adolph Hitler, Mein Kampf (My Battle), Munich: Franz Ehr Verlag, 1925.
2. Heinkel, Stormy Life, p. 411.
3. Ibid., pp. 411-412.
4. Hans Frank, Im Angesicht des Galgens. Deutung Hitler und seiner Zeit auf Grund eigener Erlebnisse (In the Shadow of the Gallows. The Interpretation of Hitler and his Time on the Basis of personal Experiences), Munich: Verlag F. A. Beck, 1953. See also Ernst von Weizsaecker, Erinnerungen (Memoirs), Freiburg: List Verlag, 1950, p. 132.
5. OKL, Generalstab, Ruestungsstab, "Uebersicht ueber den Eisen- und Stahlverbrauch der Wehrmacht Ende 1938 - Anfang 1939," Der Prozess gegen die Hauptkriegsverbrecher vor dem Internationalen Militaergerichtshof Nuernberg (High Command of the Air Force, General Staff, Armament Staff, "Overview of the Iron and Steel Requirements of the Armed Forces from the end of 1938 to the beginning of 1939," The Trial of the Major War Criminals Before the International Military Tribunal, Nuremberg), Vol. XXVII, Document 1301-PS, pp. 165-166. See also Oberst a.D. Kurt Wittekind, "Aus 20 Jahren deutscher Wehrwirtschaft - 1925 - 1945" (From 20 Years of Military Economics 1925-1945), C/I/1, Karlsruhe Document Collection. See also Hermann Goering, Ministerpraesident Generaloberst Goering Beauftragter fuer den Vierjahresplan St. M. Dev. 1007, Berlin, den 26. November 1936, Auszug aus den Nuernberger Dokumenten, Akten Nr. 243-EC (Minister President Generaloberst Goering, Commissioner of the Four-Year Plan, Staff M, Foreign Exchange, 1007, Berlin, 26 November 1936, Excerpt from the Nuremberg Trials Documents, Document No. 243-EC), pp. 233-237, C/I/1, Karlsruhe Document Collection.

6. General der Flieger a.D. Paul Deichmann, "Aeusserung des Generalstabschefs Jeschonnek waehrend einer Stabsreise zur Rhein, Juni 1939" (Expressions of the Chief of the General Staff Jeschonnek during a Staff Journey to the Rhine, June 1939), Statements attributed to Generaloberst Hans Jeschonnek by General der Flieger Paul Deichmann, A/I/2, Karlsruhe Document Collection. See also Generalleutnant a.D. Hermann Plocher, "Zur Organisation der Luftwaffe. Gegensaetzliche Auffassungen des Generals Jeschonnek zur 2. (Org.) Abt." (Concerning the Organization of the Luftwaffe. Opposing Views of General Jeschonnek regarding the 2nd [Organization] Branch of the Luftwaffe), A/I/2, Karlsruhe Document Collection.
7. _____, "Gliederung und Befehlsverhaeltnisse der Seeluftstretkraefte" (Organization and Command Relationships of the Naval Air Forces), A/V/, Karlsruhe Document Collection. See also OKL, Generalstab, 2. Abt., "Aufbau der Luftwaffe im Rahmen der Kriegsmarine nach dem 1. Weltkrieg," Auszug aus Dienstvorschrift Nr. 15, "Der Kampf gegen Versailles" (High Command of the Luftwaffe, General Staff, 2nd Organization Branch, "Buildup of the Air Force within the Framework of the Navy after the First World War," Excerpt from the Service Manuel No. 15, "The Battle against Versailles"), A/V/, Karlsruhe Document Collection. See also Heinz Bongartz, "Organisation: Luftmacht Deutschland, 1939" (Organization: German Air Power, 1939), A/I/2, Karlsruhe Document Collection. See also Maass, Organization in the Luftwaffe to 1939, Generalleutnant a.D. Bruno Maass, "Aufbau der Fliegertruppe: 1.4.1934 - 1.9.1939" (Buildup of Flying Forces: 1 April 1934 to 1 September 1939), A/VI/1, Karlsruhe Document Collection, and Kesselring, Soldier to the Last Day, pp. 36-41.
8. Interview of Ministerial Director and Confidential Advisor (Ret.) Wilhelm Fisch of the Reichs Air Ministry by the author, 20 December 1957. See also Reichsminister der Luftfahrt und Oberbefehlshaber der Luftwaffe, Generalstab, Gen.Qu., 2. Abt. Az. 11616, 14 Nr. 2769/39, g.Kdos., Berlin, den 21.9.39, "Aufstellung der Kampfgruppe 88" (Reichs Minister of Aviation and Commander in Chief of the Air Force, General Staff, Quartermaster General, 2. Organization Branch, Document Symbol 11616,14, No. 2769 of 1939, Top Secret Command Matter,

Berlin, the 21st of September 1939, "The Establishment of Bomber Group 88"), A/VI/1, Karlsruhe Document Collection. See also Richard Suchenwirth, Historical Turning Points in the German Air Force War Effort, USAF Historical Studies No. 189, Maxwell AFB, Alabama: USAF Historical Division, RSI, June 1959, pp. 40-44. Cited hereafter as Suchenwirth, Historical Turning Points.

9. Eberhard Spetzler, "Der Weg zur Luftschlacht um England im kriegsrechtlicher Bedeutung," Wehrwissenschaftliche Rundschau (The Battle of Britain and its Significance in Terms of International Law, Military Science Review), Vol. 6, No. 8, August 1956, p. 442.
10. General der Luftnachrichtentruppe a.D. Wolfgang Martini, "Die Geschichte der Luftnachrichten-Truppe" (The History of the Air Signal Forces), A/VI/3, Karlsruhe Document Collection. See also Reichsminister der Luftfahrt und Oberbefehlshaber der Luftwaffe, Generalstab, Gen.Qu., 2. Abt., Az 11B20, M Nr. 7144/39, g.Kdos., vom 5.9.39, "Neuaufstellung von Luftnachrichten-Einheiten" (Reichs Minister of Aviation and Commander in Chief of the Air Force, General Staff, Quartermaster General, 2. [Organization] Branch, Document Symbol 11b20, m, No. 7144 of 1939, Top Secret Command Matter, of 5 September 1939, "New Formation of Air Signal Units"), A/VI/3, Karlsruhe Document Collection. See also Reichsminister der Luftfahrt und Oberbefehlshaber der Luftwaffe, Generalstab, Gen. Qu., 2. Abt. (Reichs Minister of Aviation and Commander in Chief of the Air Force, General Staff, Quartermaster General, 2nd [Organization] Branch): Nr. 900/39, g.Kdos. vom 24.6.1939, "Aufstellung der Fliegerverbaende (Land) zum 1.11.1939" (No. 900 of 1939, Top Secret Command Matter of 24 June 1939, Establishment of Flying Units Land to 1 November 1939); Nr. 860/39, g.Kdos., vom 10.9.39, "Aufstellung von Fliegenden Verbaenden" (No. 860 of 1939, Top Secret Command Matter of 10 September 1939, "Establishment of Flying Units"); and Nr. 2730/39, g.Kdos., vom 8.9.39, "Aufstellung von Jagdverbaenden" (No. 2730 of 1939, Top Secret Command Matter of 8 September 1939, "Establishment of Fighter Units").

11. General der Flieger a.D. Paul Deichmann, "Organisation des Wetterdienstes" (Organization of the Weather Service), 1956, A/VI/5, Karlsruhe Document Collection. See also Ernst Thost, "Der Wetterdienst im Bereich des Gen. d. Luftwaffe beim Oberbefehlshaber des Heeres, 1939-1942" (The Weather Service within the area of the General of the Luftwaffe attached to the Commander in Chief of the Army, 1939-1942), A/VI/5, Karlsruhe Document Collection. See also Ministerialdirigent a.D. Dr. Rudolf Benkendorff, Chef Meteorologe der Luftwaffe, "Organisation des Wetterdienstes" (Chief Meteorologist of the Air Force, "Organization of the Weather Service"), A/VI/5, and "Anordnungen fuer den Wetterdienst. Auszug aus der Planstudie 1939, Heft I, Aufmarsch-und Kampfanweisung der Luftwaffe" (Administrative Details in Combat Orders for the Weather Service. Excerpt from the Plan Study 1939, Vol. 1, Deployment and Combat Directions for the Air Force), pp. 26-27, A/VI/5, Karlsruhe Document Collection.
12. Rieckhoff, Trump or Bluff? pp. 51-54. See also Kesselring, Soldier to the Last Day, pp. 33-35. See also Reichsminister der Luftfahrt und Oberbefehlshaber der Luftwaffe, Generalstab, Gen. Qu., 2. Abt., vom 25.5.1939, "Organisation der Flieger-Bodenorganisation" (Reichs Minister of Aviation and Commander in Chief of the Air Force, General Staff, Quartermaster General, 2nd [Organization] Branch, of 25 May 1939, "Organization of Aviation Ground Organizations"). See also Reichsminister der Luftfahrt und Oberbefehlshaber der Luftwaffe, Generalstab, Gen. Qu. 2. Abt. vom 2.10.1937, "Ausbau der E-Haefen 1937" (Reichs Minister of Aviation and Commander in Chief of the Air Force, General Staff, Quartermaster General, 2nd [Organization] Branch, of 2 October 1937, "Construction of E-Bases in 1937"); R.d.L. und Ob.d.L., Generalstab, Gen. Qu., 2. Abt., vom 1.3.1938, "Stand der Bodenorganisation am 1.3.1938" (Reichs Minister of Aviation and Commander in Chief of the Luftwaffe, General Staff, Quartermaster General, 2nd [Organization] Branch, of 1 March 1938, "Condition of the Ground Organization on 1 March 1938"); R.d.L. und Ob.d.L., Generalstab, Gen. Qu., 2. Abt., vom 28.4.1939, "Festlegung der E-Haefen (April 1939)" (Reichs Minister of Aviation and Commander in Chief of the Air Force, General Staff, Quartermaster General, 2nd [Organization] Branch, of 28 April 1939, "Designation of E-Bases (April 1939)"); and "Aufgaben des Generals der Fliegerbodenorganisation" (Tasks of the Commanding General of the Air Force Ground Organization), a document drawn from official Luftwaffe records, A/VII/, Karlsruhe Document Collection.

Chapter 4

1. Hossbach Minutes, pp. 296-300.
2. Reichsminister der Luftfahrt und Oberbefehlshaber der Luftwaffe, Generalstab, LC III 1, vom 3.6.1937 (Reichs Minister of Aviation and Commander in Chief of the Air Force, General Staff, Technical Office, Branch III 1, Directive of 3 June 1937).
3. Reichsluftministerium, L.A., O.Qu., Nr. 1077/37, geh. Kommandosache (Reichs Air Ministry, Planning Office, Senior Quartermaster, No. 1077 of 1937, Top Secret Command Matter), date not given, A/I/1a, Karlsruhe Document Collection.
4. International Military Tribunal, Der Prozess gegen die Hauptkriegsverbrecher vor dem Internationalen Militaergerichtshof Nuernberg (The Trial of the Major War Criminals before the International Military Tribunal, Nuremberg), Vol. XXXVI, Nuremberg: International Military Tribunal, 1947-49, pp. 113-132.
5. General der Flieger a.D. Hans-Georg von Seidel, "Vortrag des General der Flieger a.d. von Seidel bezueglich Flugbetriebstoff in der Luftwaffe" (Speech of General der Flieger (Ret.) von Seidel concerning aviation fuel in the Air Force), p. 29, A/I/1, Karlsruhe Document Collection.
6. Kraell Interview, 24 June 1955. See also Letter from Generalrichter Dr. Manfred Roeder to the author, dated 23 June 1955. Cited hereafter as Roeder Letter, 23 June 1955.
7. Reichsluftministerium, L.Dv. Nr. 90, geheim, Ziffern 99-111 (Reichs Air Ministry, Air Service Manual No. 90, Secret, Ciphers 99-111), B/III/lb, Karlsruhe Document Collection.
8. Walter Goerlitz, Der Zweite Weltkrieg 1939-1945 (The Second World War 1939-1945), Vol. I, Stuttgart: Steingrueben Verlag, 1951, pp. 420-426. Cited hereafter as Goerlitz, Second World War, V. I.
9. Ibid., pp. 418-423. See also Deichmann Interview, 7 March 1954.

10. Generalrichter a.D. Dr. Manfred Roeder, "Abschlussbericht ueber die Voruntersuchung gegen Ploch-Tschersich-Reidenbach" (Final Report on the Investigation against Ploch-Tschersich-Reidenbach), C/III/1, Karlsruhe Document Collection.
11. Roeder Letter, 23 June 1955.
12. Suchenwirth, Jeschonnek Study, pp. 119, 164.
13. Ibid., pp. 120-121.
14. Deichmann Interview, 7 March 1954.
15. Kammhuber, Expansion of the Air Force. See also Suchenwirth, Hermann Goering, pp. 26-28.
16. Reichsminister der Luftfahrt und Oberbefehlshaber der Luftwaffe, Generalstab, "Dienstanzweisung fuer den Chef des Technischen Amtes 1938, vom 18.1.38." (Reichs Minister of Aviation and Commander in Chief of the Luftwaffe, General Staff, "Service Directive for the Chief of the Technical Office, 1938, of 18 January 1938"), A/II/1a, Karlsruhe Document Collection.
17. Suchenwirth, Hermann Goering, pp. 20-25, 61-65.
18. Generalfeldmarschall a.D. Erhard Milch, "Vorlesung aus seinem Tagebuch," Der Prozess gegen die Hauptkriegsverbrecher vor dem Internationalen Militaergerichtshof Nuernberg (The Trial of the Major War Criminals before the International Military Tribunal, Nuremberg), Vol. IV, Nuremberg: International Military Tribunal, 1947-49, p. 73.
19. Milch Letter, 21 February 1954.
20. Ibid. See also Hertel, Luftwaffe Procurement.
21. Heinkel, Stormy Life, p. 407.
22. Interview of Captain Helmut Pohle by the author, dated 19 April 1956.

23. Heinkel, Stormy Life, p. 408. See also Generalingenieur a.D. Ernst Marquardt, "Die Stuka-Idee hat der deutschen Luftwaffe den Untergang gebracht" (The Stuka Idea caused the Downfall of the German Air Force), C/IV/4, Karlsruhe Document Collection. Cited hereafter as Marquardt, The Stuka Idea. See also Suchenwirth, Jeschonnek Study, p. 27.
24. Marquardt, The Stuka Idea.
25. Heinkel, Stormy Life, pp. 466-472.
26. Ibid., pp. 479-482.
27. Germany, Reichskriegsministerium, Reichsgesetzblatt I, "Gesetz ueber das Ingenieur-Korps der Luftwaffe," vom 18.10. 1935 (Reichs War Ministry, Reichs Legal Proclamation No. I, "Law concerning the Engineer Corps of the Air Force," of 18 October 1935).

Chapter 5

1. Reichsminister der Luftfahrt und Oberbefehlshaber der Luftwaffe, Generalstab, L.Dv. Nr. 16, 1936 (Reichs Minister of Aviation and Commander in Chief of the Air Force, General Staff, Air Service Manual No. 16 of 1936), reprinted in Berlin, 1940, pp. 1-12. Cited hereafter as Service Manual 16.
2. Ibid., par. 10.
3. Ibid., par. 24.
4. Ibid., par. 10.
5. Ibid., pars. 10, 30.
6. Ibid., par. 24.
7. Ibid., pars. 10, 11.
8. Ibid., pars. 143-185.
9. Ibid., par. 219.
10. Ibid., pars. 10, 16-19, 103-119, 121, 135.

11. Ibid., par. 186.
12. Ibid., pars. 24, 32.
13. Rieckhoff, Trump or Bluff?, p. 85.
14. Goerlitz, Second World War, V. I., p. 422. See also Suchenwirth, Walther Wever Study, pp. 9-11, 22-25.
15. Commentary of General der Flieger (Ret.) Paul Deichmann to the author concerning General Wever and the 1935 War Games.
16. Col. (GSC) Walter Schwabedissen, "Die Luftwaffe in Wehrmachtmanoever," Jahrbuch der deutschen Luftwaffe 1939 ("The Air Force in Armed Forces Maneuvers," Year Book of the German Air Force 1939), Leipzig: Breitkopf & Haertel, 1938, pp. 98-106.
17. Service Manual 16., par. 186.
18. OKL, Luftflottenkommando 3., Fuehrungsabteilung, Nr. 2778/39 (High Command of the Air Force, Third Air Fleet Command, Operations Branch, No. 2778 of 1939), undated, A/III/1, Karlsruhe Document Collection.
19. Joint interview of General (Ret.) Karl Wilke and Col. (Ret.) Wilhelm Knust by the author at Hanover, 20 November 1955.
20. Deichmann Interview, 7 March 1954.
21. Reichsminister der Luftfahrt und Oberbefehlshaber der Luftwaffe, Generalstab, I. Abt., Nr. 5015/39, g.Kdos, Chef-Sache, vom 7.2.1939, "Plan-studie 1939, Heft I., "Aufmarsch und Kampfanweisungen der Luftwaffe 1939" (Reichs Minister of Aviation and Commander in Chief of the Air Force, General Staff, Branch I, No. 5015 of 1939, Top Secret Command Matter, Branch Chief's Matter, of 7 February 1939, "Planning Study 1939, Vol. I., Deployment and Combat Instructions for the Air Force 1939"), F/I/1a, Karlsruhe Document Collection.

22. Feuchter, History of Air War, pp. 65-75. See also Wimmer, Commentary on Aviation Training. See also Deichmann. Interview, 7 March 1954. See also Gundelach, et al.
23. Rieckhoff, Trump or Bluff?, p. 60. See also Letter from Generalleutnant (Ret.) Bruno Maass to the author, 19 April 1958.
24. Rieckhoff, Trump or Bluff?, p. 157. See also Koller, The Koller Diary.
25. Heinkel, Stormy Life, pp. 381-383.
26. André François-Poncet, Als Botschafter in Berlin 1931-1938 (As Ambassador in Berlin 1931-1938), (Translated from the French by Erna Struebel. Mainz: Kupferberg Verlag, 1947, p. 331.
27. Fritz Hesse, Deutsche Politik von Bruening bis Adenauer: Geschichte des Anschlusses Oesterreichs, 1933-1938 (German Policy from Bruening to Adenauer: History of the Anschluss with Austria, 1933-1938), Munich: Isar Verlag, 1953, p. 133. See also Ludwig Eichstaedt, Von Dollfuss zu Hitler (From Dollfuss to Hitler), Mainz: Institut fuer europaeische Geschichte, 1953, p. 209.
28. Reichsmarschall Hermann W. Goering, "Aussage des Reichsmarschall Goerings vor dem Internationalen Nuernberger Militaertribunal," Der Prozess gegen die Hauptkriegsverbrecher vor dem Internationalen Militaergerichtshof Nuernberg (The Trial of the Major War Criminals Before the International Military Tribunal, Nuremberg), Vol. IX, Nuremberg: International Military Tribunal, 1947-49, p.341.
29. Joachim von Ribbentrop, Zwischen London und Moskau: Erinnerungen und letzte Aufzeichnungen (Between London and Moscow: Memoirs and Last Notations), Leoni am Starnberger See: Druffel Verlag, 1953, p. 201. See also Keith Feiling, The Life of Neville Chamberlain, London: Macmillan & Co., Ltd., 1946. See also Suchenwirth, Historical Turning Points, pp. 16-19. See also Orlovius, Five Years of the Luftwaffe, pp. 22-29.

APPENDIX I

BIOGRAPHICAL SECTION

(Soviet) General Yakov Ivanovich Alksnis

Born in 1897 in Livonia; Ensign in Russian Imperial Army; joined Bolshevist Party 1916; served on Soldiers' Committee on Western Front (German-Russian) in World War I. In 1919 joined command staff of Red Army and fought in civil war as a Military Commissar; completed Soviet Military Academy in 1924 and the School of Military Aviation, 1931. Commander in Chief of Red Air Force, 1931-38. Close associate of Tukhachevsky; arrested 1937; disappeared. Said to have died in 1940.

General der Flakartillerie Walter von Artheim

Born 1893 in Bavaria; served in the field artillery in World War I; transferred to antiaircraft artillery arm after the war; by 1931 was a General Staff officer in the Reichswehr Ministry in Berlin. Became member of the Luftwaffe and Inspector of Flak Artillery in the Air Ministry, 1 April 1935. During World War II became the most prominent flak artillery officer in the Luftwaffe. Promotion dates of significance: Colonel, 1 February 1939; Generalmajor, 28 May 1940; Generalleutnant, 1 October 1942; General der Flakartillerie, 1 April 1944.

Generalmajor Gerhard Bassenge

Born 1897; entered the Army in 1914; served in Field Flying Forces in World War I. Later served in Army Ordnance Office, with special duty with Dornier firm. Transferred in 1934 to Luftwaffe and served with Reichs Air Ministry as Group Chief in the Technical Office. Later commanded Flying Group Stendal, and by 1938 was Inspector of Paratroops. Chief of Staff of Air Administrative Area XVII (1 June 1939); of the Fifth Air Fleet (July 1940); of Luftwaffe Mission Rumania (October 1940); and in October 1942 became Liaison Officer of the Fourth Air Fleet for the Royal Rumanian Air Force. He later commanded the Second Air Fleet, and on 22 February 1943 took charge of Bizerte-Tunis Defense Forces until captured, 10 May 1943.

Lt. Colonel Werner Baumbach

Entered the Luftwaffe, 1936; commissioned, 1938; served with 30th Bomber Wing in Poland and France; Commander of Bomber Wing, June 1942; in August 1942 became only German bomber pilot to receive the Oak Leaf and Swords to the Knight's Cross of the Iron Cross. Later worked with remote-controlled bombs in collaboration with Dr. Speer. After the war published a book on the Luftwaffe entitled Zu Spaet? (Too Late?).

Colonel Nicolaus von Below

Born in 1907; commissioned in German Infantry, 1 October 1932; transferred to the Luftwaffe, 1 October 1933. Underwent pilot training, 1933-36; Squadron Commander in Fighter Wing "Richthofen," 12 March 1936 to 15 June 1937; then served as Luftwaffe Adjutant to Hitler from 16 June 1937 to 29 April 1945, attaining rank of Colonel, 1 March 1944. Left the Fuehrer's bunker in Berlin 29-30 April 1945 and remained at large until found in January 1946.

Captain Dr. Ing. e.h. Ernst Brandenburg

One of central figures in German aviation, with a brilliant record as a bomber pilot and air commander in World War I; won Pour le Mérite. After the war remained active in air activities as far as possible within limits of Versailles Treaty; Ministerial Director of Aviation Branch, Reichs Traffic Ministry (1920-1933), where his great organizational ability, energy, and foresight helped to lay the groundwork for German military and commercial aviation. Assumed direction of the Motor Transport and Highways Branch, Reichs Traffic Ministry (1933), and a seat on the Board of Directors of Lufthansa. Awarded an honorary doctorate from the Technical College of Berlin for his aviation achievements.

Reichs War Minister, Field Marshal Werner von Blomberg

Graduate of the War Academy, 1907; served on Great General Staff in World War I; won Pour le Mérite; commanded 5th Division (1921-25); Chief of Branch III, Reichswehr Ministry (1925-27); Chief of Troop Office (1927-35); War Minister (1935-38); promoted to Field Marshal, 1936. The British said of him, "towers physically and mentally above most German generals. A leader of men, with great personal charm of character and manner. . . .but can be a stern critic and drives home his point well. . . . Much broader and more objective than most German officers, and a better

soldier even than von Hammerstein, having far more energy, quickness, and decision. . . . He is generally regarded as the most able soldier in Germany." Dismissed from the Army at Hitler's behest on 4 February 1938; arrested by the Allies in 1945; died in Allied custody, 14 March 1946.

General der Flieger Paul Deichmann

Infantry officer and aerial observer in World War I; later Reichswehr officer; transferred to Reichs Air Ministry as technical advisor, 1934. In World War II served as Chief of Staff, II Air Corps, in the West and later in Russia; as Chief of Staff of Wehrmacht Command South under Field Marshal Kesselring, (June 1942 - August 1942); subsequently held other important Luftwaffe posts, including command of IV Air Administrative Command (Austria). A Knight's Cross winner, Deichmann lent invaluable assistance to the USAF Historical Division's GAF Monograph Project in Karlsruhe as well as to the Fuehrungsakademie of the Bundeswehr. In 1964 he became the first foreigner to be awarded the USAF Air University Award.

Generalleutnant Kurt von Doering

Born in 1889 in Pomerania; served in Fighter Squadron 10 of the famous "Richthofen" Wing; later served in the Reichswehr. During World War II held the following positions: Commander of Fighter Command 2 of the Second Air Fleet (1939-40); Inspector of Fighter & Ground Attack Aircraft (1940); Commander of the Night Fighter Division (1941); Commander of 1st Fighter Division (1942); Office Chief of Central Division, Reichs Air Ministry (1944-45). Von Doering was promoted to Generalleutnant, 1 October 1941.

Professor Dr. e.H. Claude Dornier

German aircraft designer and manufacturer of international repute. Graduated from Munich Institute of Technology (1907); became associated with work of Count von Zeppelin; in 1910 became designer of lighter-than-air craft for Zeppelin Airship Co., Ltd. During World War I worked with Hirth firm building airships; was first to incorporate light metal alloys into steel frameworks. In 1922 formed his own company, Dornier Works, Ltd.; designed the Dornier "Whale" and "Super-Whale," and many other seaplanes and flying boats. His firm also made the Do-17, 217 bombers and developed the Do-335, the fastest piston-engine aircraft made during

World War II (but which never became operational). Moved to Switzerland (1947), headed up a number of firms in various countries, such as Oficinas Tecnicas Dornier in Madrid.

General der Flieger Karl Drum

Entered military service July 1913; served in World War I as company infantry officer and as a reconnaissance flyer; between wars was trained as a General Staff Officer. Held a number of technical and advisory posts, last of which was Chief of the Inspectorate of Air Reconnaissance Forces and Operations, Reichs Air Ministry. As a specialist in Army-Luftwaffe cooperation, began World War II as Chief of Staff to the Luftwaffe General with Commander in Chief, Army, and was Chief, Air Support Command, Army Group South (Russian Front), 1941-42. Thereafter served as Commander of Wehrmacht Forces in Holland; Commanding Officer, 11th Luftwaffe Field Division; and as head of several administrative commands, the last being Commanding General of Luftwaffe Administrative Area Western France. After the war, Drum contributed substantially to the GAF Monograph Project in Karlsruhe.

General der Flieger Hellmuth Felmy

One of Germany's "old eagles," Felmy was a flyer in 1912; commanded air units in World War I; played a leading role in the development of the new Luftwaffe and held important command posts. Worked in various clandestine aviation staffs within the Reichswehr (1920-33); commanded the aviation schools in Berlin (1933-35); in Munich (1935-36); served with VII Air Service Area Command; and from 1937-39 was with Second Air Fleet, Braunschweig. Retired, January 1940, he was recalled to active duty in May 1941 as Military Commander in Greece. Later served as Commanding General LXVIII Corps (1942-45), participating in events in Kalmyk Steppes, the Mius area, Greece, and Yugoslavia. After his release from prison in 1951, Felmy made valuable contributions to the USAF Historical Division's GAF Monograph Project.

General der Flieger Veit Fischer

Fischer was a veteran of World War I, having served in the Army. He was active in the development of the new Luftwaffe in the early 1930's and was promoted to Colonel, 20 April 1936. Prior to World War II he had attained the rank of Generalmajor,

and was promoted to Generalleutnant, 1 December 1940. Commanded the Staff for Special Duties in Air Administrative Commands I and II, respectively, (1941-42); also Headquarters, Air Administrative Command Moscow; Air Administrative Commands XXVII and VIII. Fischer was promoted to General der Flieger, 1 June 1942.

Reichsmarschall Hermann Wilhelm Goering

Credited with 20 aerial victories in World War I, Goering was the last commander of the famous "Richthofen" Fighter Wing No. 1. After the war he promoted aviation ventures in Germany and Sweden, avidly supporting the Nazi Party. He fled to Sweden after being wounded in Hitler's abortive "Putsch" in Munich in 1923; soon returned to Germany and became a leading political figure; became Minister President of Prussia, and later President of the Reichstag. Commander in Chief of the Luftwaffe and Reichs Minister of Aviation, he was promoted to Field Marshal (1938), and became Germany's only Reichsmarschall (19 July 1940). Removed from his post by Hitler, 23 April 1945, he only escaped a worse fate by the intervention of loyal Luftwaffe ground troops. Tried and sentenced to death in the main trials at Nuremberg, he took his own life by poison, 15 October 1946.

Field Marshal Robert Ritter von Greim

World War I flyer with 28 aerial victories; won Pour le Mérite and a hereditary title from the King of Bavaria; helped organize Chiang Kai-Shek's Chinese Air Force in the 1920's; one of main organizers of German Commercial Flying School, Wuerzburg. Reentered German Air Force as Commander, Fighter Wing No. 1 (1934); became Commander of Air Division 5 (1939). During World War II he commanded V Air Corps (1940-43); Luftwaffe Command East (later redesignated Sixth Air Fleet), July 1943. Promoted to Field Marshal (25 April 1945), he was given Goering's post as Commander in Chief of the (then almost non-existent) Luftwaffe. A Knight's Cross winner; committed suicide in 1945, shortly after capture by American forces.

Generalleutnant Johann Hesse

Born 1878; German infantry general; had outstanding World War I record, winning Pour le Mérite with Oak Leaf, Bavarian Max-Josefs Order, etc.; active in the Reichswehr after 1918; influential in assisting the formation of the Aviation Branch

of the Reichswehr Ministry. Promoted to Generalleutnant 1 February 1926, he commanded the 3rd Division, and Military Service Area Command III.

Professor Dr. Ing. Ernst Heinkel

Born 1888; educated Stuttgart Institute of Technology; designer of aircraft (1910-11); chief constructor and engineer for Albatros firm (1913); chief construction engineer, technical director with Hansa and Brandenburg Aircraft (1914); built 30 different types of aircraft for Austrian Army, Navy during World War I. Founded Ernst Heinkel Aircraft Works, Warnemuende (1922), and later firms at Rostock and Oranienburg. Designed and built 100 aircraft types by May 1945. His aircraft held numerous speed and distance records, and his firm built world's first rocket-powered aircraft (1938), and first jet aircraft (1939). Following World War II (1950) established the Ernst Heinkel Co. for manufacture of trucks, scooters, etc. at Stuttgart-Zuffenhausen. Winner of National Prize for Art and Science.

Reichs President, Field Marshal Paul von Hindenburg und Beneckendorff

Born in Posen in 1847; entered Prussian Cadet School (1858); fought in Danish War (1864); Austro-Prussian War (1866); and Franco-Prussian War (1870-71); retired in 1911. Recalled to active duty 22 August 1914, commanded forces in East Prussia in victorious Battle of Tannenberg (September 3-4, 1914); promoted to Field Marshal. Later commanded forces on the Eastern Front and then all forces on the Western Front. Emerged as leading military figure in Germany after World War I; elected Reichs President (1925), he allowed the Republican government to continue without much interference, although he was a devoted Monarchist at heart. Initially reluctant to name Hitler Chancellor -- he called him the "Bohemian Corporal" -- he was persuaded in his senility to do so in January 1933. His death, 2 August 1934, opened the way for Hitler's assumption of absolute control in Germany.

General der Kavallerie Ernst von Hoeppner

Born in 1860; educated in the Main Cadet School; began active service in the 6th Dragoon Regiment at Stendal. He attended the War Academy in Berlin and then served as Squadron Commander, 14th Dragoons in Colmar (1893-1901); on the Great General Staff (1902-05); as Commander, 13th Hussars in Diedenhofen (1906-7); Chief of Staff, VII Corps (1908-12); and from 1912 to 1914 as Commander, 14th Cavalry Brigade, Bromberg. In World War I he was Chief of Staff, Third Army (1914-15); Commander, 14th Reserve Division (1915); Chief of Staff, Second Army and Commander, 75th Reserve Division (Eastern Front) in late 1915 and early 1916; and was appointed in 1916 as Germany's first Commanding General of Air Forces. He was raised to the nobility in 1913, and awarded the Pour le Mérite for his outstanding work as an air force commander. His book, Germany's War in the Air (Deutschlands Krieg in der Luft) is one of the great aviation stories of World War I. Hoeppner died 25 September 1922.

Generalleutnant Hans Jeschonnek

Served in World War I and in the Reichswehr between the wars, promoting all aviation groups. Transferred to the Luftwaffe as a Captain (1933); by 1939, was Chief of the Luftwaffe General Staff. Although a protégé of General Wever, Jeschonnek remained basically an opponent of strategic air power; differed at times with Goering, and sometimes even with Hitler, whom he considered to be a genius; his appointment as Chief of the General Staff of the Luftwaffe represents the first clear break with the older traditions of the Reichswehr. The circumstances surrounding his suicide (19 August 1943) provide an interesting insight into command and policy problems in the Luftwaffe and the personality of Jeschonnek himself.

Professor Dr. Hugo Junkers

World famous aircraft designer and manufacturer and a pioneer in all-metal construction and in commercial aviation. By 1910 Junkers had registered many patents, and in 1914 built one of the first wind tunnels to test model aircraft. During World War I worked on armored aircraft. At his Dessau plant he produced the F-13 (1919), the first true commercial transport aircraft and forerunner of the Ju-52. A pacifist by nature, he was urged into constructing a plant at Fili, near Moscow, in 1923, on the

ground that his aircraft were vital to Germany's "defenses." About 1930 the Nazis began a program of intimidation and blackmail against Junkers which did not abate until his death. Forced to the brink of financial ruin (largely the work of Goering and Milch), he was systematically deprived of his airline, his fortune, his firm, and his patents. Although seriously ill, Junkers continued to defy the Nazi regime, and only escaped the false charge of treason by his death, 3 February 1935. A controversial figure, Junkers' character and motives now appear to have been above question.

Field Marshal Wilhelm Keitel

Served before and during World War I, mostly in the artillery; remained in service in the Reichswehr, holding a number of command and staff posts, notable among which was that of Branch Chief of T 2 in the Reichswehr Ministry (1929-33) and Chief of the Army Ordnance Office (1935-39). Served as Chief of the High Command of the Wehrmacht (September 1939-May 1945). Hitler found him useful in that he could rely upon him to follow "his master's bidding" in keeping the old Reichswehr officers in line. A "yes man," he was not held in high esteem by the professional officer corps. Tried and convicted at Nuremberg and executed 16 October 1946.

Field Marshal Albert Kesselring

Doubtless the best known Luftwaffe combat commander to Americans, he served in World War I and in the Reichswehr after the war. Transferred to the Luftwaffe (October 1933); promoted to general (1934); Generalleutnant (1 April 1936); Chief of the General Staff of the Luftwaffe (1936-37); Commander, Air Service Area III, Dresden (1937); Commander, Luftwaffe Group 1, Berlin (1938); Commander, First Air Fleet (1938-39); Commander, Second Air Fleet (1940-43); Commander of Army Group "C" and German Forces in Italy, as well as Defensive Forces in the West and South (July 1943-10 March 1945). Kesselring rendered great assistance to the USAF Historical Division's GAF Monograph Project in Karlsruhe. Died 16 July 1960.

(1919-1936). Commanded 3rd Group, Bomber Wing "General Wever" (1936-37); served as Chief of Staff Air Administrative Command III, Chief of Staff, Air Administrative Command VII (1938-summer of 1944); thereafter with Luftwaffe Mission Rumania and the Office of the Commander in Chief of the Luftwaffe. Hospitalized late in 1944 and saw no further action or service. Maass wrote a number of essays and historical papers for the GAF Monograph Project in Karlsruhe.

General der Luftnachrichtentruppe Wolfgang Martini

Served in the First World War in the Army Signal Forces; a key signals officer in the Reichswehr after the war; saw action on Germany's eastern border against Polish incursions (1919); established himself as the Army's top signals officer (1920's). Transferred to the Luftwaffe and headed the Air Signals Branch (1934); trained as pilot and observer; Generalmajor (1938); Generalleutnant (1940); he became one of the Luftwaffe's most valuable chiefs. Promoted in 1941 to General der Luftnachrichtentruppe, commanding all Luftwaffe Signals Forces, and in 1944 to the post of Inspector of Air Inspectorate 7, Luftwaffe High Command. Winner of Knight's Cross of the War Service Cross with Swords.

Professor Dr. e.H. Willy Messerschmitt

Born in 1898; educated at the Munich Institute of Technology; associated with glider development (1912-23); development of high performance sport and transport aircraft (1923-27); chief designer and co-owner of Bavarian Aircraft Works, which later became known as Messerschmitt AG, Augsburg (1927-45). One of Germany's top military aircraft designers, he designed the Me-109, which held the land plane speed record (1937) and world absolute speed record (1939); designed the jet fighter Me-262 and others. A favorite of the German Air Ministry and High Command, Messerschmitt reestablished his commercial enterprises between 1945 and 1954, traveled extensively, and has remained active in technical developments in a number of fields. Holder of Knight's Cross of the War Service Cross and German National Prize for Art and Science.

(Soviet) Colonel S. A. Mezheninov

Fought in the civil war against the "White Army" at the close of World War I; was active member of the Communist Party and the Soldiers' Councils; became a specialist in aviation, particularly air operations. Chief of Operations, Red Air Force (1928-33 or possibly longer); wrote a book entitled, Air Forces in War and Operations, published in 1927. Mezheninov was one of the leading Soviet officers who dealt with Reichswehr air officers during the time when German airmen were secretly training in the Soviet Union.

Field Marshal Erhard Milch

Milch served during World War I as a member of Fighter Group 6. After the war he left the service and entered private aviation business, becoming associated with Lufthansa (German airlines). Appointed State Secretary of Aviation with the rank of Colonel in the Luftwaffe (February 1933), he was not looked upon with pleasure by older professionals who had worked their way up and remained in service. Promoted to Field Marshal, 19 July 1940. A competent technical officer with great talents in this field, a man of boundless energy, who also had the ability to make bitter enemies. Milch was the number two man in German aviation and in the Luftwaffe until his dismissal by Hitler over the use of jet aircraft. He now lives in retirement in southern Germany.

Generalleutnant Hilmar Ritter von Mittelberger

Born 1878 in Bavaria; served in World War I in the infantry; knighted by the King of Bavaria, received other high decorations. After the war served in the Reichswehr; Colonel (1 February 1927); Generalmajor (1930); Chief of the Aviation Branch of the Reichswehr in the late 1920's and early 30's; Generalleutnant (1 January 1932). Retired prior to World War II; may have served briefly in the early part of World War II. A leader of considerable ability.

Generalleutnant Professor Dr. Oscar Ritter von Niedermayer

A Bavarian, born in 1885; speaking ability in 8 languages. Entered the Army Artillery (15 July 1905); served as General Staff officer in World War I; knighted for his service, served

General der Flieger Karl Kitzinger

Served on both Eastern and Western Fronts in the infantry, World War I; after the war served in Reichswehr; Major (1 March 1927) and staff officer in 5th Division (1928-30); took flying training and transferred to the Luftwaffe (1 January 1934) with rank of colonel. Promoted to Generalmajor (1 April 1936); Supreme Commander of Air Defense (1938-40); Commander of Luftwaffe Forces in Norway (1940-41); Commander in Chief of Forces in the Ukraine (1941-43); Commander in Chief France and the West Wall (1944-45). Promoted to General der Flieger, 1 October 1939.

Generalmajor Fritz Loeb

Born in Berlin, 1895; entered the service in 1913; served in World War I as junior officer in Army Engineers. After the war served in the Reichswehr; Rittmeister (1 February 1926); in 9th (Prussian) Cavalry Regiment in late 1920's while taking an active part in German military aviation activities. Transferred to the Luftwaffe (1934); Colonel (1 December 1936); Generalmajor (1 February 1938); Loeb was Chief of the Luftwaffe Administration Office (1939); Commander of Luftwaffe Administrative Area Belgium (1940); and was killed in an aircraft collision while landing at Brussels-Evere, 22 June 1940.

Generalstabsingenieur Rolf Lueht

Entered the German Navy, 1924, after graduation from the Berlin Technical College in engineering; took pilot training (1926) and flew in Navy air forces until 1934, when he transferred to the Luftwaffe. Just prior to World War II was promoted to Fliegerchefingenieur and appointed Chief Engineer, Department of Director General of Luftwaffe Equipment. On 1 August 1940 he was promoted to Generalstabsingenieur. Involved in investigation of Technical Office. Retired with pension, 1 January 1943. Thereafter worked as Manager of Messerschmitt Works at Regensburg. Killed in action in Germany, 1945.

Generalleutnant Bruno Maass

Began his military career with 2nd Hussars in 1911; served in flying forces in World War I; and served in Reichswehr after 1918. Served in the 9th Cavalry Regiment, Military Service Area Command III, and in aviation activities in the Reichswehr Ministry

in Epp's Freikorps (1919). Then served in Motor Bn 23 (1919-20); Reichswehr Ministry (1920-21); transferred to the Reserves (1921). From 1921-32 worked in various positions in connection with the Reichswehr. Returned to active duty as an (E) officer (1 May 1932); became inactive (31 January 1933); then again returned to active duty (1 November 1935). He became Director of the Institute for General Military Knowledge (October 1938); Director of General Language Knowledge, University of Berlin (1 September 1939); and later commanded the Infantry and Armored Schools; the 162nd Infantry Division; and in May 1944 East Troops No. 703 for Special Duties with the High Command, West. More of a scholar and a thinker than an aggressive commander or a natural leader, he was released from duty late in the war.

Generalleutnant Theodor Osterkamp

Flyer in German Imperial Navy, World War I, with 32 aerial victories winning Pour le Mérite; commander of a reconnaissance squadron with 1st Guards Division (Kurland) (1918-19); worked with naval agency on anti-aircraft aiming techniques. Joined Luftwaffe (1933) as squadron leader, Fighter Wing "Richthofen"; later commanded group in Fighter Wing "Horst Wessel"; also directed 1st Fighter School, Werneuchen. In World War II, commanded 51st Fighter Wing in France; 2nd Fighter Command in Battle of Britain; and division in Second Air Fleet in 1941. Commander, Luftwaffe Administrative Command Africa (2 August 1941-1 August 1942); Generalleutnant and Chief of Luftwaffe Inspectorate for France (1 August 1942). Released from duty because of injuries sustained 31 December 1944. Knight's Cross winner.

Franz von Papen

Avowed Monarchist; service in Army before 1900; General Staff Officer and Military Attache to U. S. (1914-15); persona non grata (1915), returned to Germany. World War I service, Chief of Staff, 4th Turkish Army (Palestine). After war held seat in Prussian Landtag until 1932 as conservative member of (Catholic) Center Party; appointed Chancellor (1 June 1932) by Hindenburg; could not hold hostile elements of coalition together, largely because of Nazi pressures. Resigned (November 1932); taken into Hitler's government as Vice-Chancellor (January 1933); believed he could restrain Hitler and Nazis. Fell from favor, became Ambassador to Austria prior to Anschluss; became Ambassador to Turkey until August 1944 when Turkey broke off relations with

Germany. Acquitted at Nuremberg, he was sentenced by German denazification court. This decision not upheld, and he was freed (1949). A clever, smooth, but often ineffectual political figure, and an extremely controversial one.

Colonel Edgar Petersen

Born in Strassburg, 1904; trained as technician and businessman in motor and machine industry. Began flying (1924); took further courses at Kassel, Schleissheim, Staaken; became flying instructor in Russia (1929-30); began military service in German infantry (1934). Soon transferred to aviation arm; became flying instructor 1935-37; officially transferred to Luftwaffe (1938); served in World War II with 10th Air Division (1939); Commander, 40th Bomber Wing (1940); won Knight's Cross (1940). Transferred to Luftwaffe Operations Staff (15 April 1941); Commander, Experimental Station at Rechlin (Mecklenburg), (1 October 1941 until war's end).

Generalmajor Diplom Ing. August Pfoch

Born 1894; aerial observer in World War I; served in Reichswehr after war; also studied engineering. Held various assignments in 1920's: battery commander of an artillery regiment (Potsdam), specialist for aviation in Army Ordnance Office under Wilhelm Wimmer. Served in Lipetsk; fluent in Russian language; transferred 1933 to Reichs Air Ministry as group commander; became wing commander; later succeeded Fritz Loeb, and was finally Chief of Staff to Ernst Udet, Chief of the Technical Office. Worked on the Armistice Commission in the demobilization of French Army (1941). Close friend of Udet, he was relieved of his office after some difficulty with State Secretary Milch (1 October 1941), sent to Air Administrative Command II. Retired after further trouble with Milch and investigation, 30 November 1942. Capable, and quite young for permanent retirement.

Generalleutnant Hermann Pfocher

Born in 1901; served in Infantry Regiment 126 in World War I; served in 13th (Wuerttemberg) Infantry Regiment between wars; took flying training in late 1920's; went to Russia for training (1928-29); remained active in Reichswehr. He graduated from the

War Academy (1935); transferred that year to the Luftwaffe General Staff (Organization Branch); went to Spain (1936); Chief of Staff, "Legion Condor" (1937-38); Chief of Plans and Mobilization, Luftwaffe General Staff (1939); Chief of General Staff, V Air Corps (5 May 1940-March 1941). He served as Chief of Staff, Luftwaffe Command East (1 April 1942-Autumn 1942), with command over 1st Air Division; was Commander, 19th Luftwaffe Field Division (France-Netherlands) from 1 February 1943 to July 1943; Chief of Staff, Third Air Fleet (1 July 1943); Commander, 6th Parachute Division (1 October 1944 to capitulation). Plocher was Assistant Control Officer of the USAF Historical Division's GAF Monograph Project in Karlsruhe (1953-57); returned to service as Deputy Inspector of the West German Air Force and Chief of the Luftwaffe Operations Staff (1 March 1957), and retired 31 December 1961.

Field Marshal-Dr. Ing. Wolfram Freiherr von Richthofen

Cousin of the famous Baron Manfred von Richthofen, he also served in the famous Fighter Wing No. 1 in World War I, achieving 8 aerial victories. After the war served in the Reichswehr; during 1920's was one of the few officers to earn a doctorate in engineering; served in Spain with "Legion Condor," which he commanded (1938-39). During World War II he served in the Polish and French campaigns; became Commander of the VIII (Close Support) Air Corps (June 1941); assumed command of the Fourth Air Fleet (July 1942); promoted to Field Marshal (February 1943); took over the Second Air Fleet (1943). A Knight's Cross winner, he was once an enemy of dive-bombing, but later became one of its staunchest adherents, and carried out operations of this sort with great effectiveness in southern Russia. Died of a lingering illness in Austria, July 1945.

Generaloberst Guenther Ruedel

Entered the German Army, 1902; served as artillery officer in World War I; served after the war as artillery and anti-aircraft artillery specialist in Reichswehr; Member of Troop Office (October 1928-1930); Inspector of Motorized Batteries and Commander of Artillery Training Staff (1930-33); Inspector of Air Defense Units (1 September 1933) concurrently with post of Chief of Air Defense Branch, Army Ordnance Office. A general in 1934, he was integrated, along with all flak forces, into the Reichs Air Ministry (1 April 1935); became Inspector of Flak Artillery

and Air Defense Units. Ruedel was made Chief of German Air Defense (1 February 1938); promoted to Generaloberst (1 November 1942). A Knight's Cross winner, he was one of Germany's leading flak specialists.

Reichs Chancellor, Generalmajor Kurt von Schleicher

Born 1882 in Brandenburg; entered 3rd Regiment of Foot Guards at Potsdam (1900); Captain (1913); served as General Staff officer in World War I; Assistant to General Groener, Quartermaster General (1918); in similar capacity in Reichswehr after the war. During crises of 1923-24 Aide to Generaloberst von Seeckt; appointed Chief of Armed Forces Branch, Reichswehr Ministry (1926); Colonel (1 March 1926); Generalmajor (1929). Continually at odds with Hitler; had frequent arguments with Bruening and Hindenburg. Helped to bring about the fall of Bruening and the appointment of von Papen as Chancellor in 1932. Schleicher, a master intriguer, became Reichswehr Minister, and, after the resignation of Papen (1 December 1932), Reichs Chancellor. In the final years of the Weimar Republic, v. Schleicher was the leading opposition figure to the Nazis. He sought to control the Nazi movement by controlling the Reichswehr as his own instrument. Seen by Hitler as the number one enemy of National Socialism, Schleicher and his wife were murdered in the night of the "long knives," 30 June 1934.

Generaloberst Hans von Seeckt

One of the most brilliant, energetic, and imaginative of the old school of German General Staff officers; responsible more than any other person for maintaining the quality of the Army after 1918 and in building the Reichswehr. Born in 1866; began his service with Kaiser Alexander Guards Grenadier Regiment; by 1897 was General Staff officer, Chief of Staff, III (Baden) Corps (1913). During World War I achieved reputation as Chief of Staff to Field Marshal August von Mackensen in the Southeastern Front. As Chief of the Troop Office after 1918, (a cover name for the General Staff), he organized the new Army, admonishing officers to remain "apolitical" and aloof from the State. This rule, prudent as it was in a time of great political turmoil, later had serious consequences. Seeckt died before Hitler had begun to undo his handiwork.

General der Flieger Hans-Georg von-Seidel

World War I veteran with General Staff experience; left the Army in 1920 as Captain of Cavalry. Returned to active duty in 1st (Prussian) Cavalry Regiment (1934); began aviation training and secured position on the Luftwaffe General Staff (1935); Generalmajor (1 September 1939). Promoted to General-leutnant (20 July 1940). At the opening of the Russo-German war was Quartermaster of the Luftwaffe and General der Flieger; was the foremost figure in the establishment of the Quartermaster Service of the Luftwaffe, a branch which bore the imprint of his capable leadership. His final assignment was as Commander, Tenth Air Fleet. After the war he contributed a number of first-rate papers and essays to the GAF Monograph Project in Karlsruhe.

Colonel (Director) Friedrich Wilhelm (Fritz) Siebel

Born in 1891; served during World War I as aircraft pilot and observer; opened his own aircraft construction firm in 1919. In 1922, following the signing of the Treaty of Rapallo, went to the Soviet Union as a representative of the German Foreign Office to arrange for the establishment of German aircraft factories in Russia. One of the founders of Klemm Light Aviation Construction Co., Ltd., he became well known both in Germany and on the war fronts as a specialist in Luftwaffe engineering projects during World War II. A tireless worker, Siebel designed the well-known "Siebel Ferries," which were so extensively used in the Kuban bridgehead area and elsewhere in the East. After World War II he reestablished his firm in Oberpfaffenhofen near Munich, and died in 1955.

General der Flieger Hans Siburg

Born 1893 in Saarburg, Alsace, Siburg joined the German Navy in 1912, served as a naval flyer, 1915-18 (a Russian POW, 1916-17, but escaped via Sweden), and served in the Navy after the war. Assigned to duty in the Technical Office, Reichs Air Ministry (1934); Commander of Naval Flying Training Schools (1934-36); studied flying training in the U.S.A. in 1934; transferred to the Luftwaffe as a wing commander (1936); served in Air Administrative Command VII (1937-38); in Polish campaign (1939); assigned to Inspectorate for Aerial Navigation, Reichs Air Ministry (1940); Commander of Air Administrative Area Command Holland

(1940-43); promoted to General der Flieger, 1 April 1942; and served finally in Berlin as Chief of the Luftwaffe Administrative Office (1943-45). Siburg was assigned to the Fuehrer Reserve, 1 April 1945.

Colonel Wilhelm Siegert

Born in Erfurt in 1872, Siegert was a pioneer German aviator and air leader. Entering the Army a decade before the turn of the century, he flew in 1910, and by 1914 had established several German air records. Before World War I he was in charge of the airfields at Metz, Strassburg, and Darmstadt, and in August 1914, was in command of the Air Battalion at Strassburg. He served ably during World War I, becoming Adjutant to General Headquarters XIV, while taking part in bombing operations; became Chief of Staff to the Commander of Field Flying Forces, Colonel Hermann von der Lieth-Thomsen; and finally served as Chief of Staff to General von Hoepfner, Commander of German Air Forces. Siegert, who understood the significance and use of air power, was one of the most highly respected of German aviation leaders. He remained active in this field until his death on 26 January 1929.

General der Flieger Wilhelm Speidel

Born in 1895; served from 1914 to 1929 in various capacities as a German infantry officer. In 1929 went to Washington to the German Embassy as forerunner to the Air Attaché. He became a specialist in organization of air forces, 1930-33, transferred to the Reichs Air Ministry in 1933, and until 1935 served in the Operations Branch. He then became a group commander in the 53rd Bomber Wing, in 1936 was Chief of Staff of Luftwaffe Administrative Area Command III, Dresden, and in 1938, Chief of Staff, First Air Fleet. In 1939 he became Chief of Staff, Second Air Fleet, and in October 1940, Chief of Luftwaffe Mission Rumania (which in 1941 included Bulgaria). Speidel was Military Commander of Southern Greece, 1942, Military Commander of Greece, 1943, Commander of the Liaison Staff for the Southeast of the Luftwaffe High Command, and in 1945 headed the Third Special Field Police. A brother of the well-known Dr. Hans Speidel, this officer played a key role in the development of Luftwaffe organization.

Field Marshal Hugo Sperrle

Born in 1885; joined Infantry Regt. 126 in 1903; aerial observer and commander of air units in World War I. In Freikorps Luettwitz (1919), Organization Branch (Air) in the Reichswehr Ministry (1925-28), and commanded an infantry battalion (1929-33). Commander, 8th Infantry Regiment (1933), he transferred in 1934 to the Luftwaffe as Commander of Flying Units in Air Service Area II, and was Commander, Air Service Area V (1935). In November 1936 he went to Spain as Commander of "Legion Condor," a post he held until 30 October 1937, when he returned to Germany. During World War II he commanded the Third Air Fleet and Luftwaffe Command West (1939-23 August 1944), when he was transferred to the reserves. Awarded the Knight's Cross, he was promoted to Field Marshal 19 July 1940. Tried and acquitted at Nuremberg, he died 2 April 1953.

Generaleoberst Kurt Student

Entered the Army in 1910 and served as an aviator in World War I. Served after the war in the Air Technical Branch of the Army Ordnance Office (120-28), as an infantry commander (1928-31), visiting the Lipetsk (U.S.S.R.) airfield every year from 1924-28. He then served in the Air Defense Branch of the Reichswehr Ministry (1931-33), transferring in 1934 to the Luftwaffe as Commander of Air Armament Schools. Student commanded the Luftwaffe Experimental Station Rechlin (1935), was Chief of Staff of the Flying School Command (1936), Inspector of Flying Schools in Air Service Area IV (1937), and Commander of Paratroops and the 7th Air Division in 1938. During World War II he commanded the 7th Air Division in the West (1940), the XI Air Corps in Crete (May-June 1941), the Parachute Army at home and in the West (1942-October 1944), Army Group Student, redesignated 7 November 1944 Army Group "H", from October 1944 to 30 January 1945, Parachute Army West (16-28 April 1945), and Army Group Vistula until the capitulation. A Knight's Cross winner, he was promoted to Generaleoberst 13 July 1944. Student is one of the pioneers of paratroop and airborne operations, in which areas he distinguished himself.

Generaloberst Hans-Juergen Stumpff

Generaloberst Stumpff entered the military service before World War I, saw much war service during that conflict, and became a General Staff officer in the Reichswehr after the war. In 1933 he was transferred to the Luftwaffe as an administrative specialist, and became Chief of the Personnel Office, Reichs Air Ministry. From 1 June 1937 to 31 January 1939 he was Chief of the General Staff of the Luftwaffe. During the first part of 1940 he commanded the First Air Fleet. With his promotion to Generaloberst, 11 May 1940, he took command of the Fifth Air Fleet (Norway and Finland) a post he held until 5 November 1943. He later commanded defense units of the Reich until the capitulation. He was primarily an Army man and an administrative expert, but was highly decorated in both wars for combat activities.

General der Infanterie Georg Thomas

Thomas began his service in 1908, served during World War I, and later in the "100,000 Man Army." By 1 September 1939 he had become Chief of the Economic and War Armaments Office of the High Command of the Wehrmacht. At the end of 1942 he was relieved of those duties pertaining specifically to the War Armaments Office, but continued as Chief of the War Economy Office. On 16 January 1943 he was also appointed General for Special Duties with the Chief of the High Command of the Wehrmacht (Keitel). On 15 August 1944 he was relieved of all active assignments by Field Marshal Keitel, who thought Thomas painted too pessimistic a picture of Germany's potential and the future course of the war. He remained in the reserves until the end of the war. He took ill and died in 1946 while in American custody.

General der Flieger Hermann von der Lieth-Thomsen

Born in 1867; entered the service in 1887, and was a flyer before World War I. From 1901-03 and from 1905-14 served as an officer in the Great General Staff. In early 1914 he was with the Inspectorate of Air and Motor Transport Services. Thomsen served in the Battle of Tannenberg, at Ypres, and most of the critical areas of the war. On 8 October 1916 he was made Chief of Staff to the Commanding General of Air Forces (Hoeppner), and later was Chief of Field Flying Forces. He was generally acknowledged as one of the most able leaders and organizers of German air forces. Winner of the Pour le Mérite. Left the

service after demobilization in 1919 and engaged in aviation activities in behalf of the German government at home and abroad. Although nearly blinded by a serious eye ailment from 1928-1933, he was appointed Generalmajor in the new Luftwaffe in 1935 and rose to become General der Flieger. His principal duty was that of an advisor at the High Command level.

Generaloberst Ernst Udet

An internationally famous stunt pilot and aviator, and one of Germany's top aces in World War I. As a flyer in Fighter Wing No. 1 under Baron Manfred von Richthofen he achieved 62 aerial victories, second only to the "Red Knight" himself. A Pour le Mérite winner, Udet then became a commercial and stunt flyer, traveling to Africa, Greenland, the United States, and other countries. In 1936 he was back in service as Chief of the Technical Office of the Luftwaffe, and a year later was Generalmajor. In 1938 he became Chief of the Office for Special Supply and Procurement, a position he held until his death. He did not understand the intricacies of political maneuvering and pressures, nor was he particularly talented in the field of development and production planning. His suicide on 17 November 1941 was obscured from the public as an "accident which occurred while testing a new type of aircraft."

Generalleutnant Walther Wever

Wever was in many respects the "Father of the Luftwaffe." A highly gifted organizer, temperamentally well suited to high command, he demonstrated his talents in World War I and in the Troop Office (a cover name for the General Staff) of the Reichswehr. Wever was the first Chief of the General Staff of the Luftwaffe, and held this position until his untimely death in 1936. Of a completely different mold than Goering, he saw clearly the future of air power, especially strategic air power, was keenly aware of the work of Douhet, but also remembered problems of defense which he considered in relation to future air warfare. He was able to inspire confidence, stifle discord, and promote harmony in his organization. No Luftwaffe commander who followed him could equal his performance in these areas. His favorite idea was the creation of a four-engine bomber force capable of flying beyond the Urals and back. This plane he called the "Ural Bomber." Some progress was made in this direction, but all plans were jettisoned after his death in an air accident, 3 June 1936. Had he lived, the Luftwaffe might have been a much more formidable organization.

Generalleutnant Helmut Wilberg

Born in 1880 in Berlin, Wilberg was a flyer before World War I, and served as commander of air units for the First and Fourth Armies during the war. He then served as Chief of the special air group (T-2) in the Reichswehr Ministry (1920-27); promoted to Lt. Colonel, 1 February 1926; Colonel, 1 October 1929; in 18th (Prussian) Inf. Regt. (1929-31); Commandant of Breslau (1932); retired 30 November 1932. Wilberg held the position of Inspector of Arms Schools, Reichswehr Ministry (1933), as well as that of one of the guiding forces behind the German Commercial Flying Schools. In 1934 he returned to active duty with the Reichs Air Ministry. Wilberg was Commander of the War College, 1 October 1935; Chief of Special Staff "W" (direction of German forces in Spain) in 1936; and Commander of the Luftwaffe Cadet School in Gatow (1936-38). Conceded by many to have been the "natural commander of the Luftwaffe," Wilberg's Jewish background is thought to have prevented him from attaining a higher post and to have led to his retirement (in the rank of General der Flieger) on 31 March 1938. This highly competent officer was killed on 20 November 1941 in an air accident.

General der Flieger Wilhelm Wimmer

Wimmer's military service began in 1909. He was a pilot during World War I, and left the Army in 1920. Reentering the service in 1921, he became active in aviation activities in the Reichswehr Ministry from 1921-1932. Transferred to the Reichs Air Ministry in the LC Office (technical matters), 1 September 1933, he was promoted to Generalmajor on 1 April 1936 and given command of air units in Air Service Area III. During World War II he commanded the 12th Air Division and Luftwaffe Forces East Prussia (1939), Air Administrative Area I and the First Air Fleet (1 February-23 August 1940), took command on 25 June 1940 of Air Administrative Area Command Belgium-Northern France (redesignated 15 June 1944 as Air Administrative Area Command XIV), and was transferred to the reserves 21 September 1944 after reputedly withdrawing in France without proper authority. Later served in the Paratroop Command. Wimmer, one of the leading German personalities in aviation organization before the war, was not given an operational command during the war. His role in the development of the GAF was nevertheless considerable.

Reichs Chancellor Karl Joseph Wirth

Member of the Center Party, Wirth was educated at Freiburg, and in 1918 became a Professor of National Science in the Technical College at Freiburg. Elected to a seat in the Baden Diet in 1913, and to a seat in the Reichstag in 1914, he became Minister of Finance for Baden, 1919, and Reichs Minister of Finance in 1920. In 1921 he became Reichs Chancellor, heading a coalition government. He favored a policy of fulfillment with respect to reparations, but lost support for this idea after the League of Nations acted in favor of Poland in partitioning Upper Silesia. Unable to build a successful coalition government he resigned in November 1922. He resigned from the Center Party in 1925, re-joined it in 1926, and died shortly thereafter.

APPENDIX II

LIST OF GAF MONOGRAPH PROJECT STUDIES

I. Published

<u>Study No.</u>	<u>Title</u>
153	The German Air Force versus Russia, 1941
154	The German Air Force versus Russia, 1942
155	The German Air Force versus Russia, 1943
160	Development of the German Air Force, 1919-1939
163	German Air Force Operations in Support of the Army
167	German Air Force Airlift Operations
173	The German Air Force General Staff
175	The Russian Air Force in the Eyes of German Commanders
176	Russian Reactions to German Airpower in World War II
177	Airpower and Russian Partisan Warfare
189	Historical Turning Points in the German Air Force War Effort

II. To Be Published (in approximately the following order)

174	Command and Leadership in the German Air Force (Goering, Milch, Jeschonnek, Udet, Wever)
161	The German Air Force versus the Allies in the Mediterranean

<u>Study No.</u>	<u>Title</u>
158	The German Air Force versus the Allies in the West (1)
159	The German Air Force versus the Allies in the West (2)
178	Problems of Fighting a Three-Front Air War
164	German Air Force Air Defense Operations
185	Effects of Allied Air Attacks on German Bases and Installations
III. Not To Be Published but Will Be Made Available to Researchers in the Historical Division Archives	
150	The German Air Force in the Spanish War
151	The German Air Force in Poland
152	The German Air Force in France and the Low Countries
157	Operation Sea Lion
162	The Battle of Crete
165	German Air Force Air Interdiction Operations
166	German Air Force Counter Air Operations
168	German Air Force Air-Sea Rescue Operations
169	Training in the German Air Force
170	Procurement in the German Air Force
171	Intelligence in the German Air Force
172	German Air Force Medicine

<u>Study No.</u>	<u>Title</u>
179	Problems of Waging a Day and Night Defensive Air War
181	The Problem of Air Superiority in the Battle with Allied Strategic Air Forces
182	Fighter-Bomber Operations in Situations of Air Inferiority
183	Analysis of Specialized Anglo-American Techniques
184	Effects of Allied Air Attacks on German Divisional and Army Organizations on the Battle Fronts
186	The German Air Force System of Target Analysis
187	The German Air Force System of Weapons Selection
188	German Civil Air Defense
190	The Organization of the German Air Force High Command and Higher Echelon Headquarters Within the German Air Force
194	Development of German Antiaircraft Weapons and Equipment up to 1945
Extra Study	The Radio Intercept Service of the German Air Force

LIST OF CHARTS

1. Offices within the Army Troop Office dealing with Air Matters, 1 March 1920 - 31 March 1927.
2. Offices within the Army Troop Office dealing with Air Matters, 1 April 1927 - 30 September 1929.
3. Offices within the Army Troop Office dealing with Air Matters, 1 October 1929 - 31 March 1933.
4. Air Technical Activities within the Army Ordnance Office, 1 October 1929 - 31 March 1933.
5. The Air Defense Office in the Reichswehr Ministry, 1 April 1933.
6. The Reichs Aviation Ministry (RLM), 1 September 1933.
7. The Reichs Aviation Ministry (RLM), 1933 - 1937.
8. Organization of the Reichs Aviation Ministry, 1 April 1934.
9. Organization of the Reichs Aviation Ministry after the Implementation of the new Service Law and Open Rearmament, 16 March 1935.
10. Organization of the Reichs Aviation Ministry, 1936.
11. Organization of the Luftwaffe General Staff after 1 June 1937.
12. Organization of the Luftwaffe General Staff after 1 February 1938.
13. Organization of the Luftwaffe Signal Communications Service after 1 July 1938.
14. The Top Command Positions in the Luftwaffe, 28 August 1939.

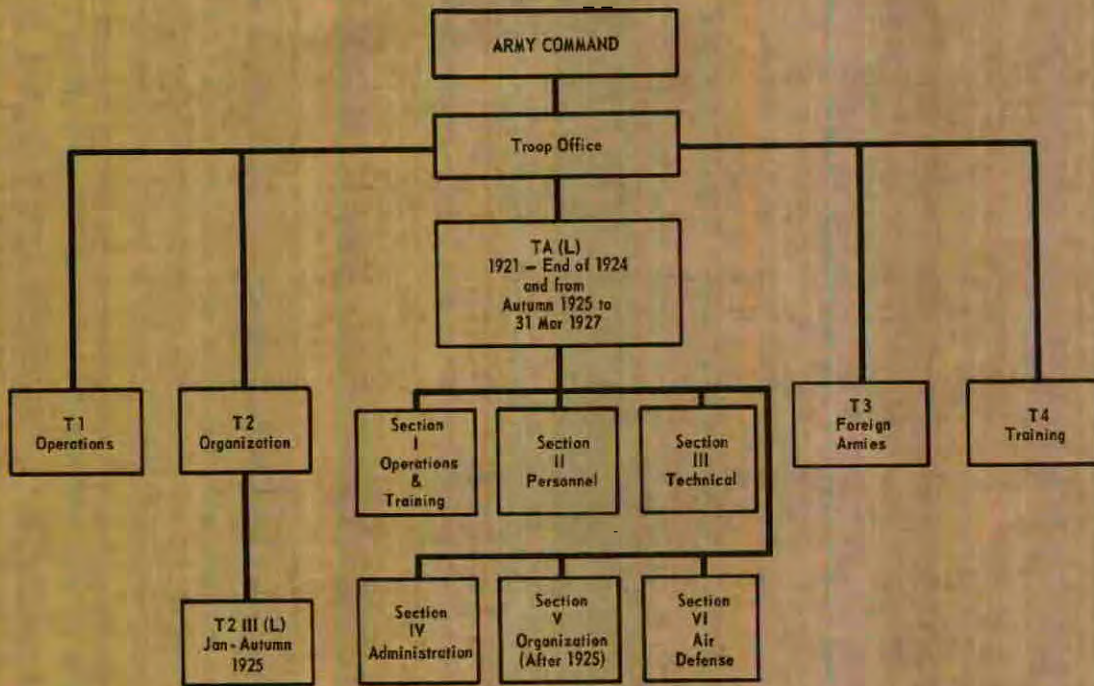

Chart 1

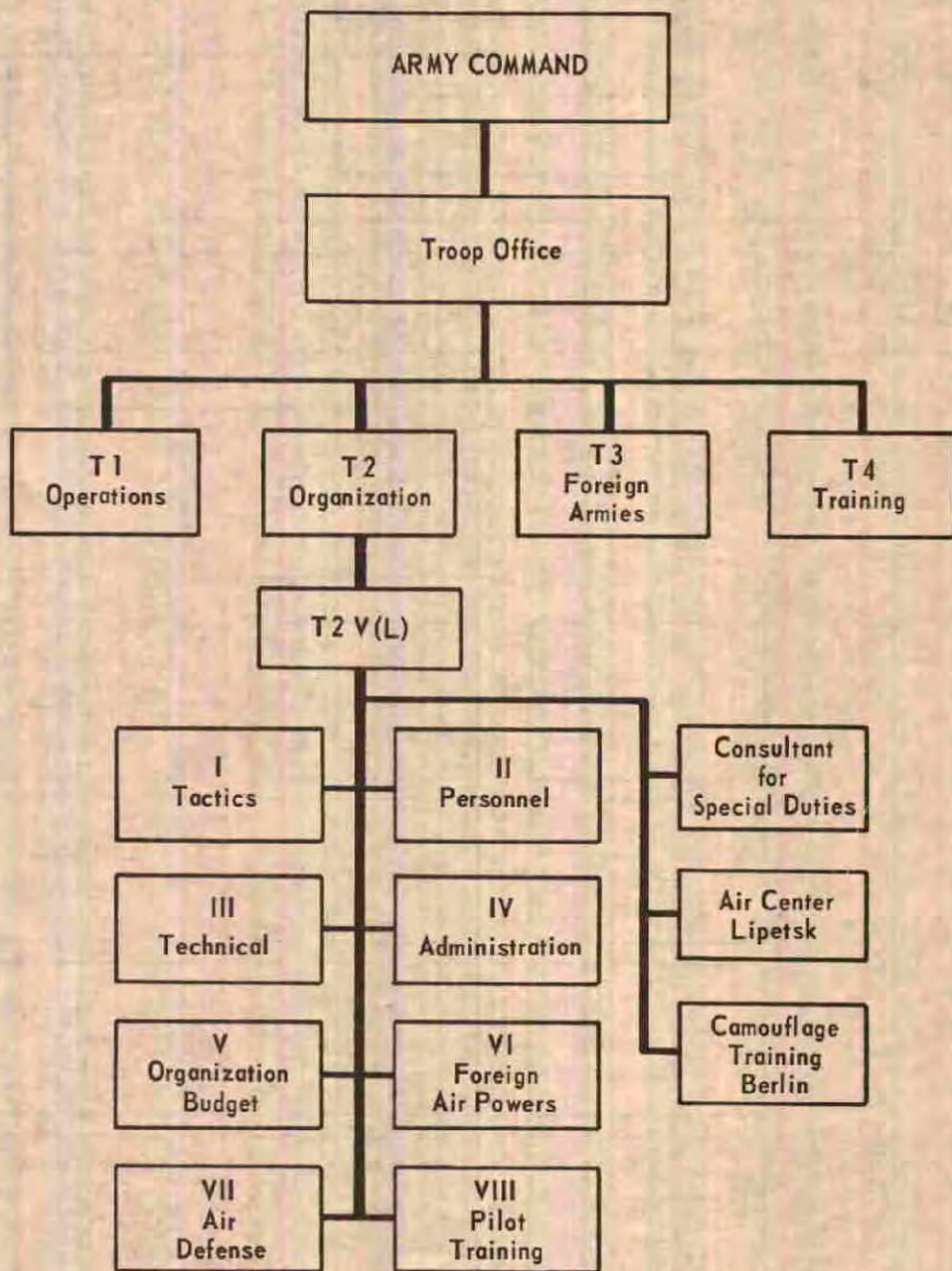

Chart 2

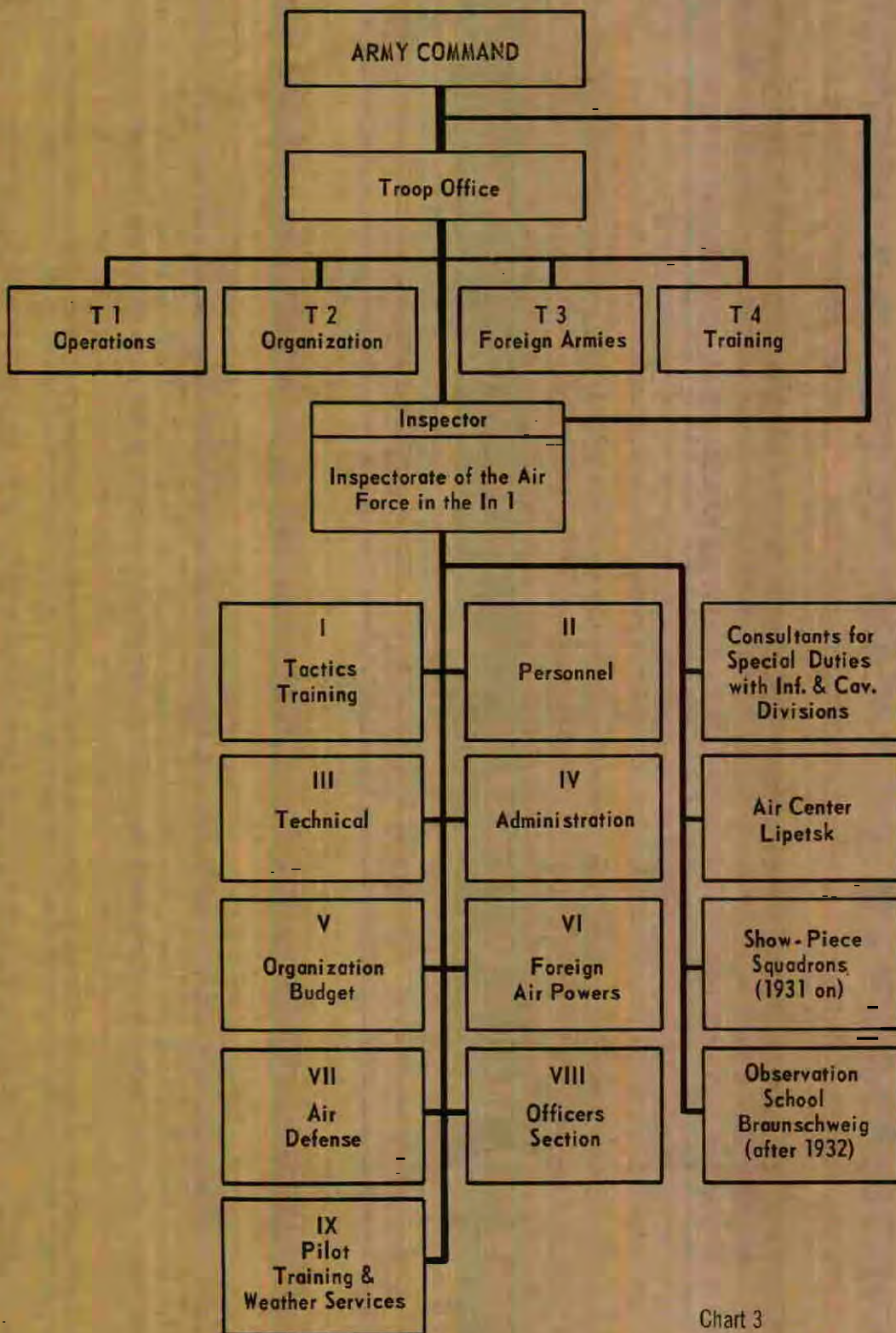

Chart 3

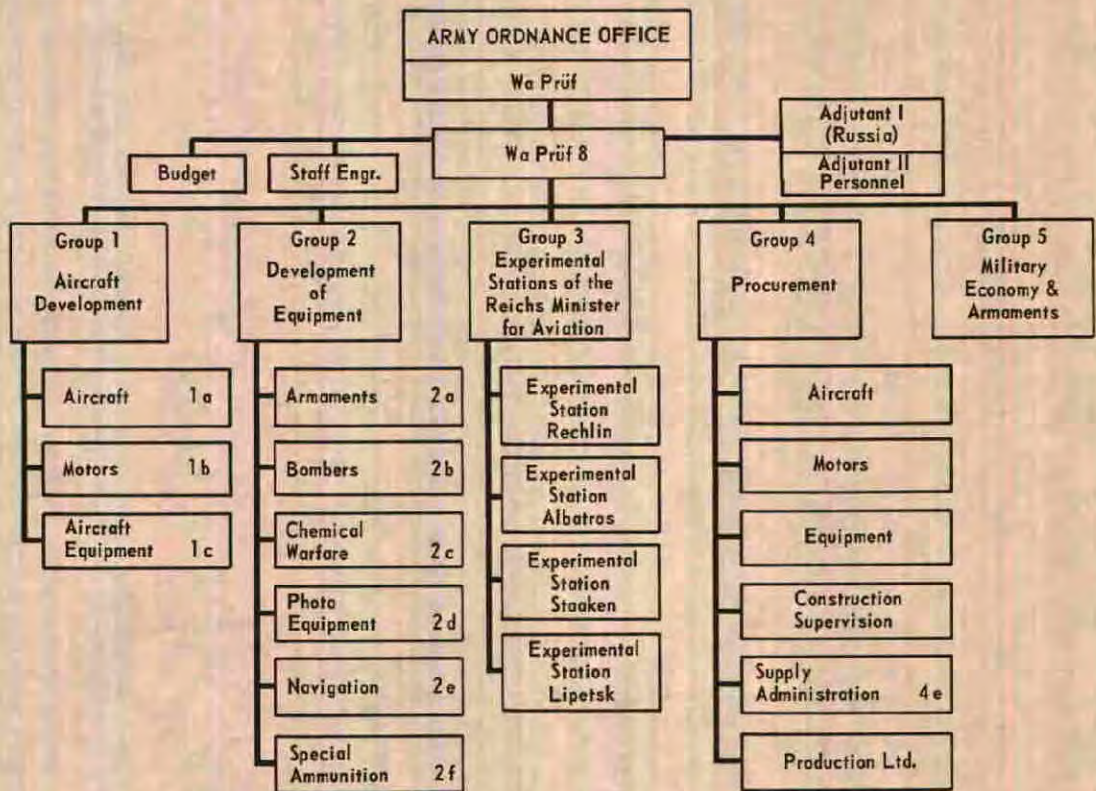

Chart 4

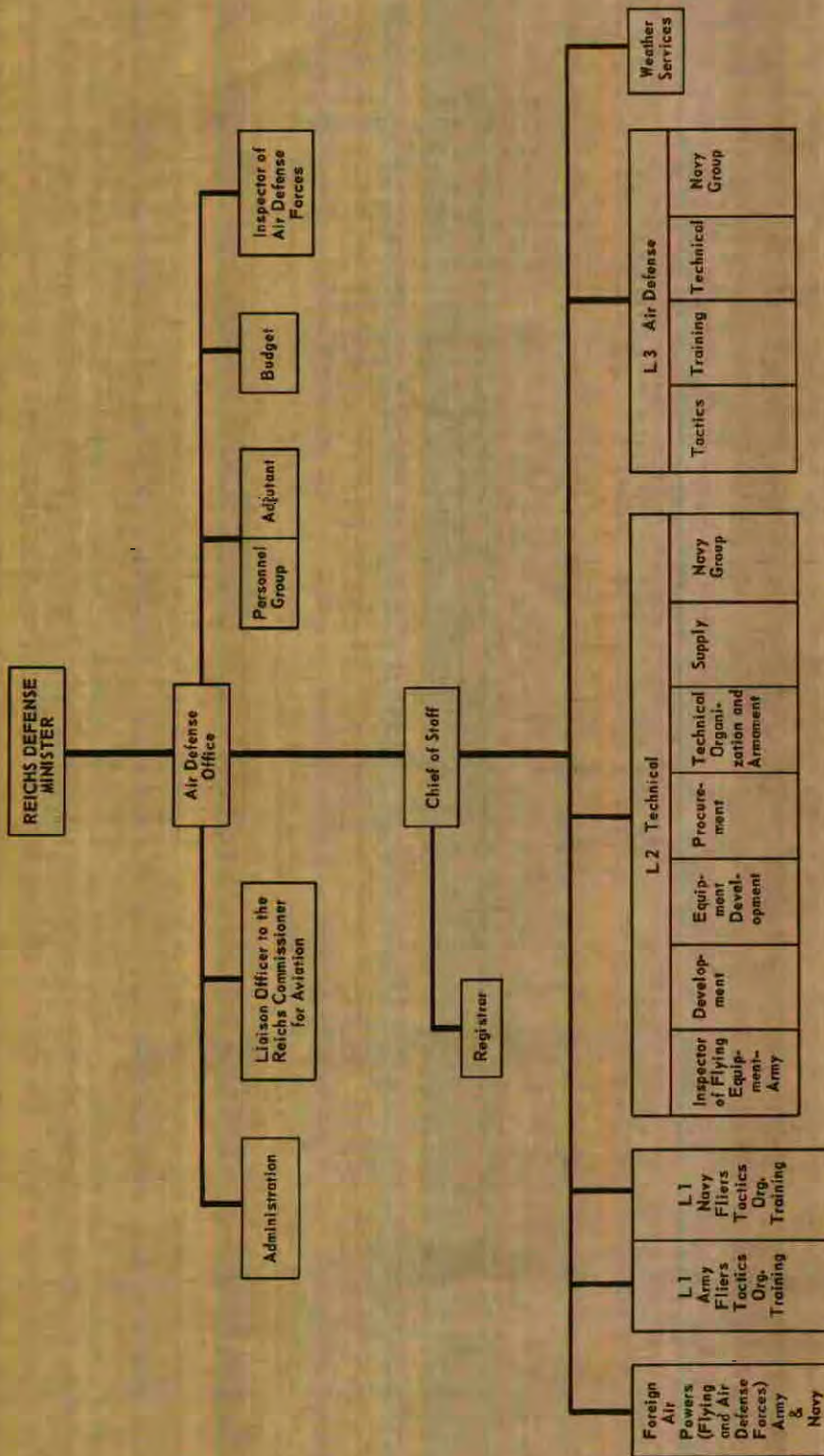

Chart 5

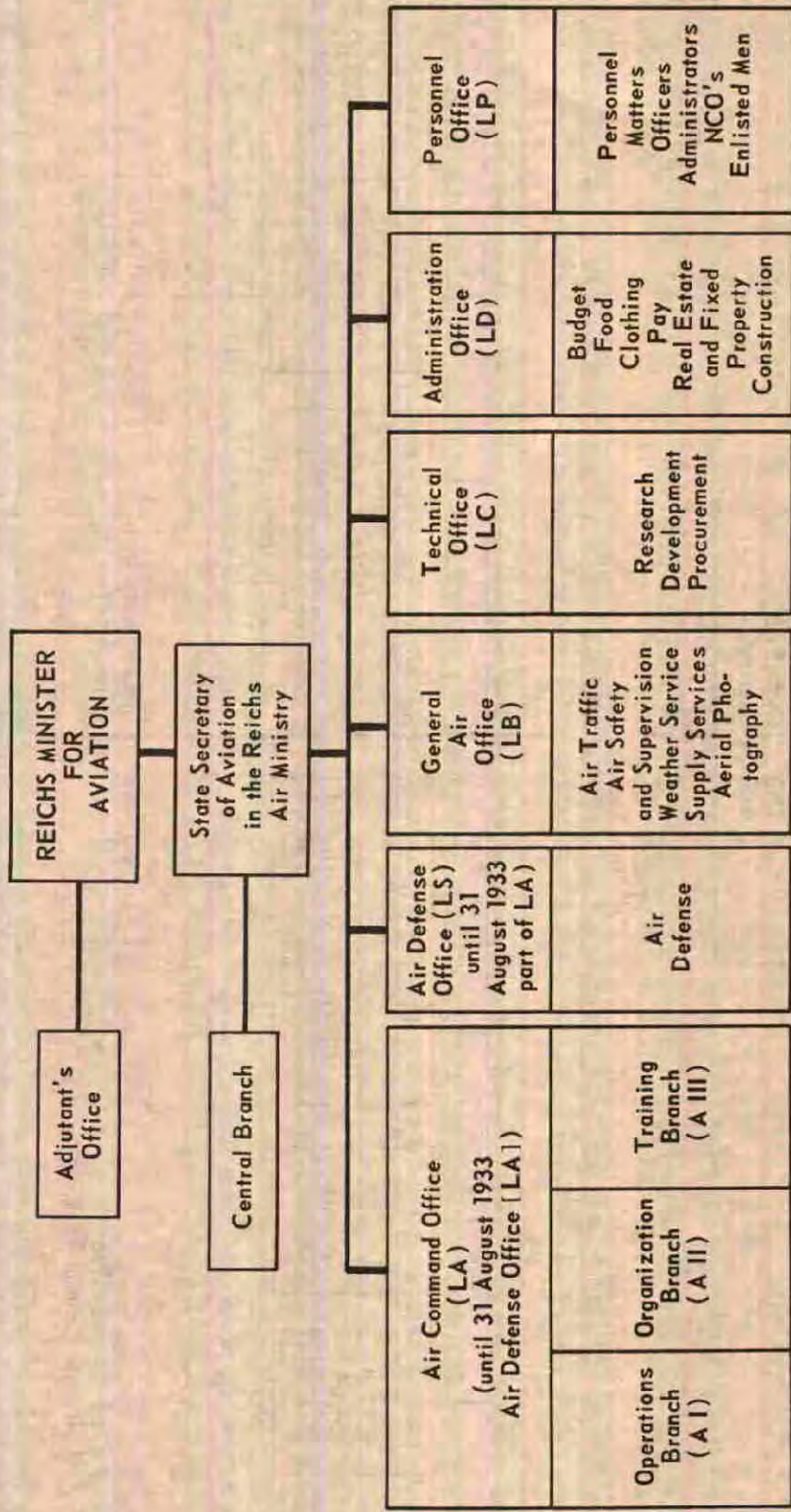

Chart 6

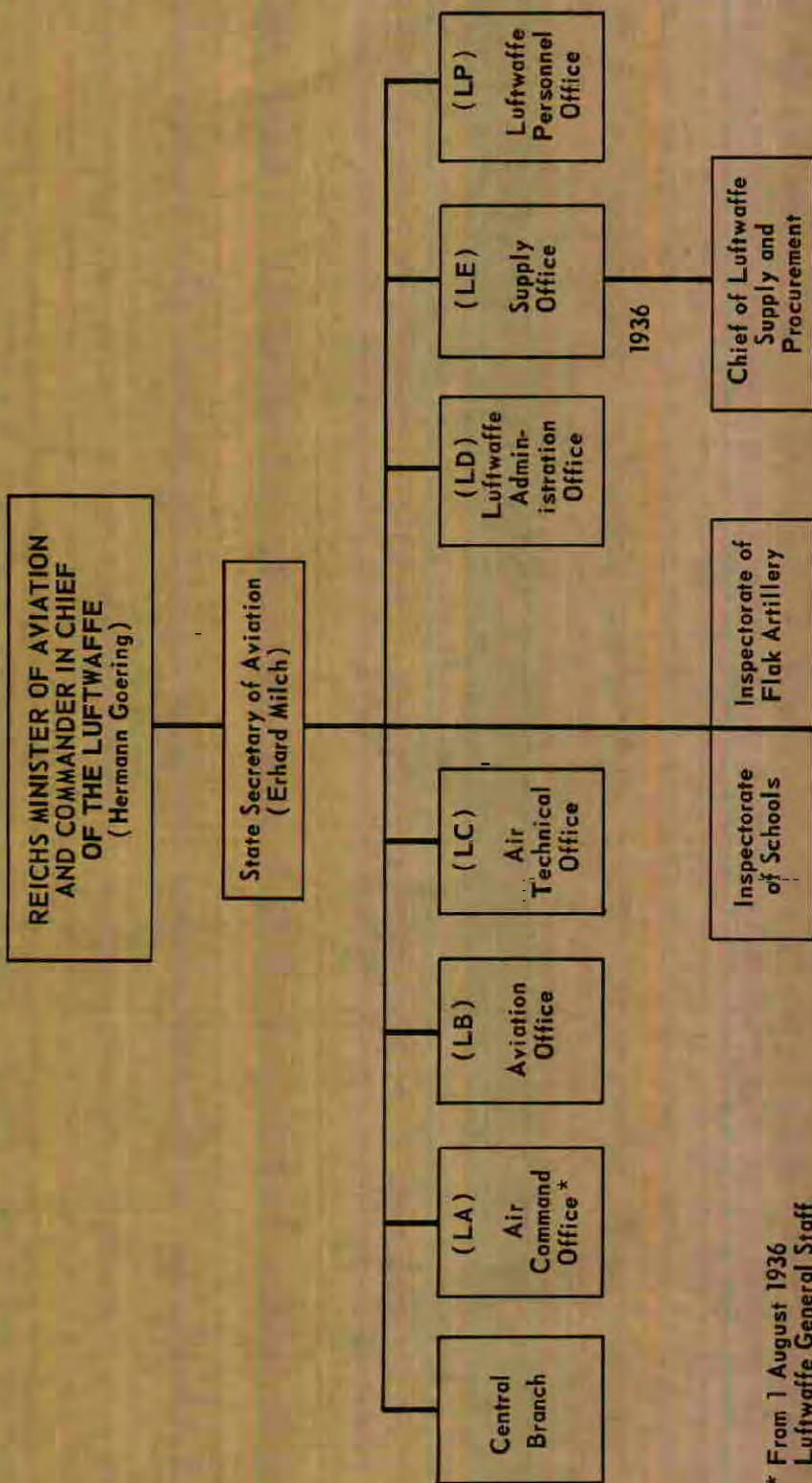
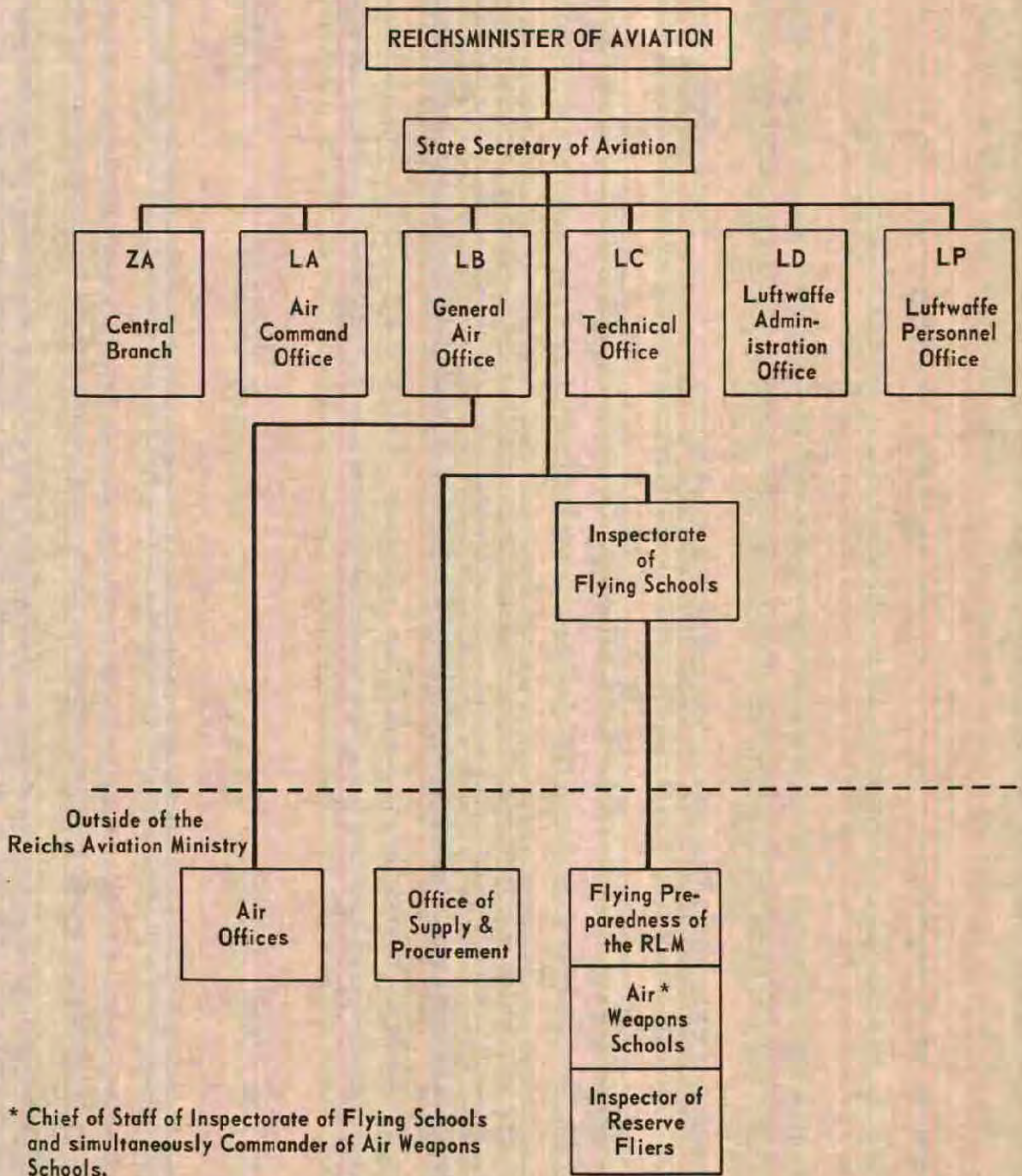

Chart 7

* From 1 August 1936
Luftwaffe General Staff



* Chief of Staff of Inspectorate of Flying Schools and simultaneously Commander of Air Weapons Schools.

Chart 8

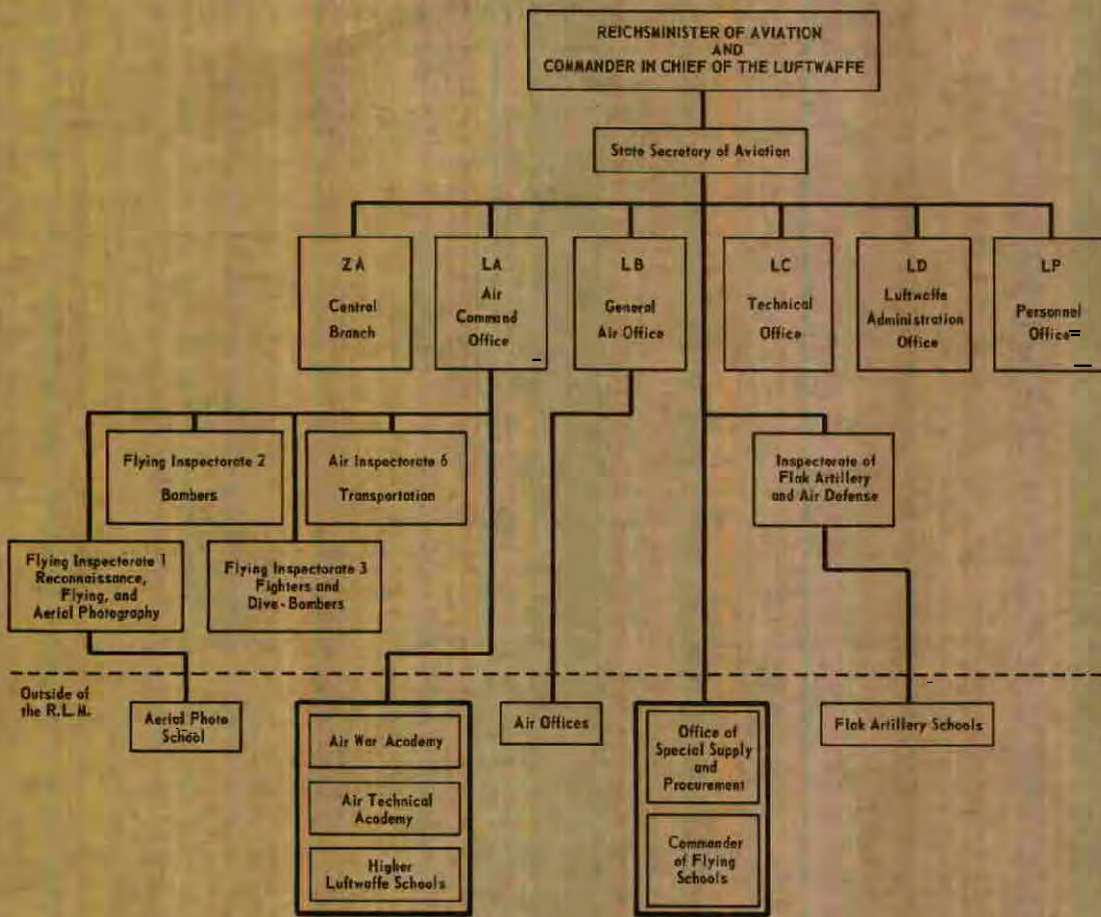

1.11.35

Chart 9

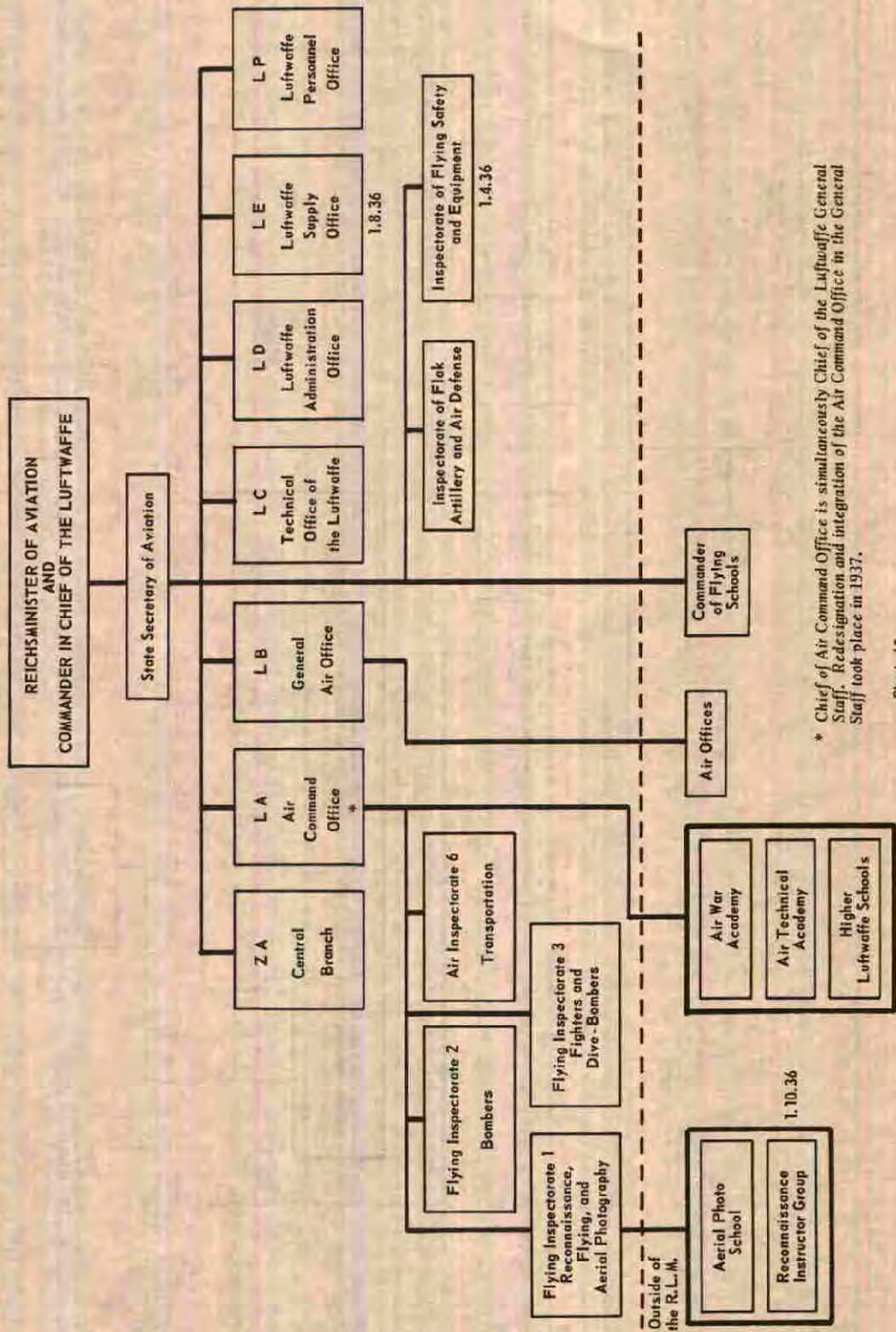

* Chief of Air Command Office is simultaneously Chief of the Luftwaffe General Staff. Redesignation and integration of the Air Command Office in the General Staff took place in 1937.

Chart 10

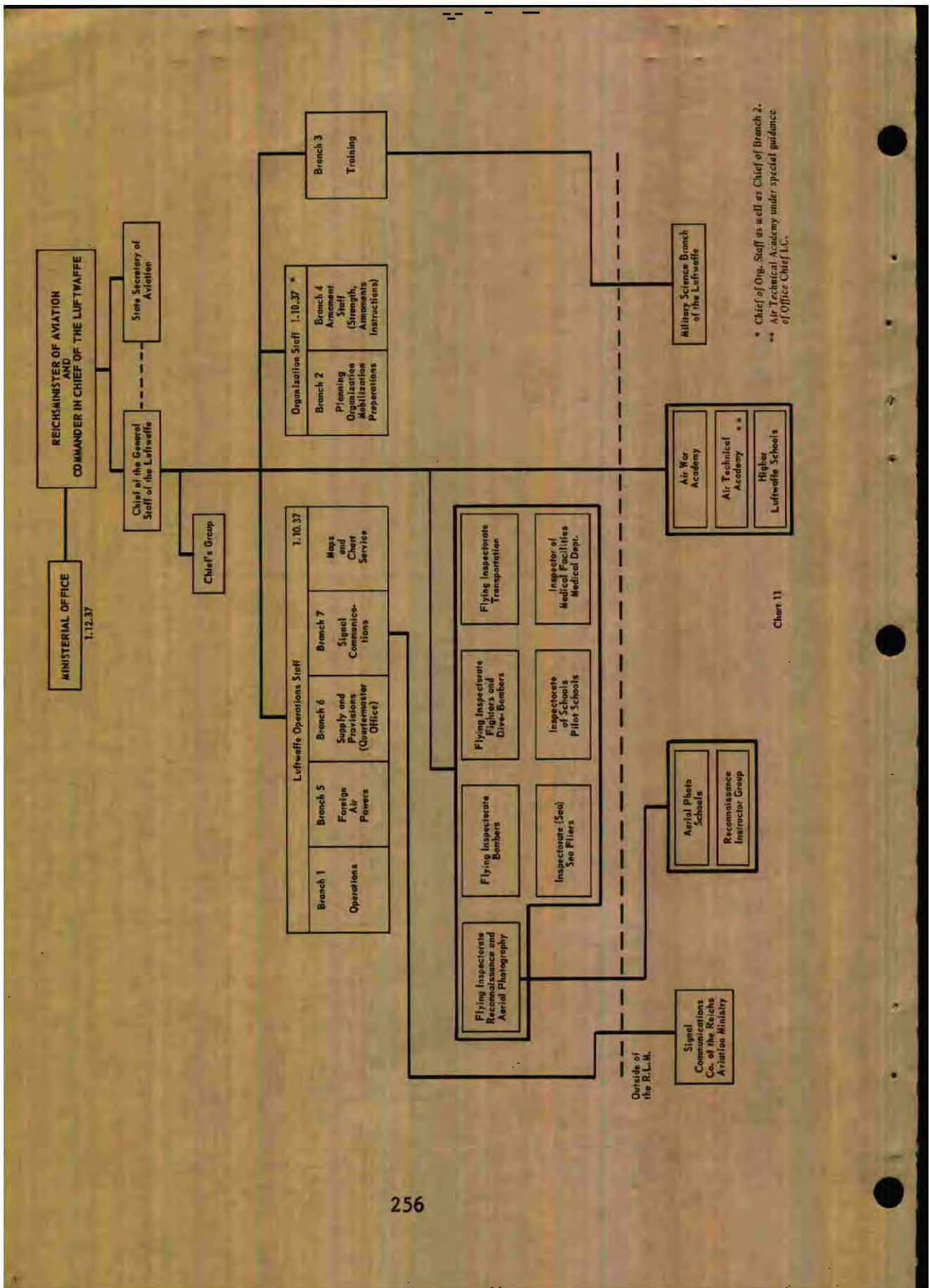

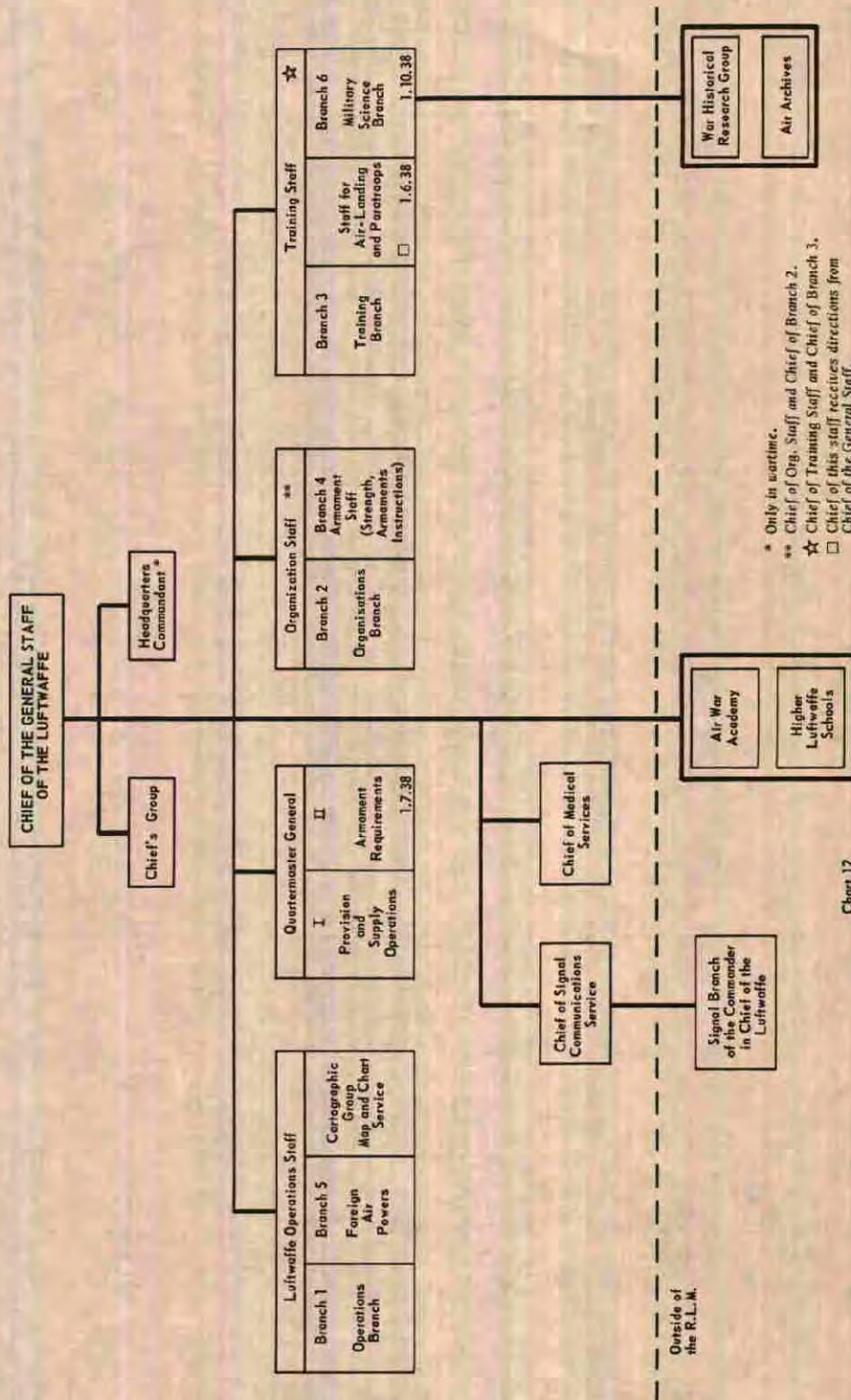

* Only in wartime.
 ** Chief of Org. Staff and Chief of Branch 2.
 ☆ Chief of Training Staff and Chief of Branch 3.
 □ Chief of this staff receives directions from Chief of the General Staff.

Chart 12

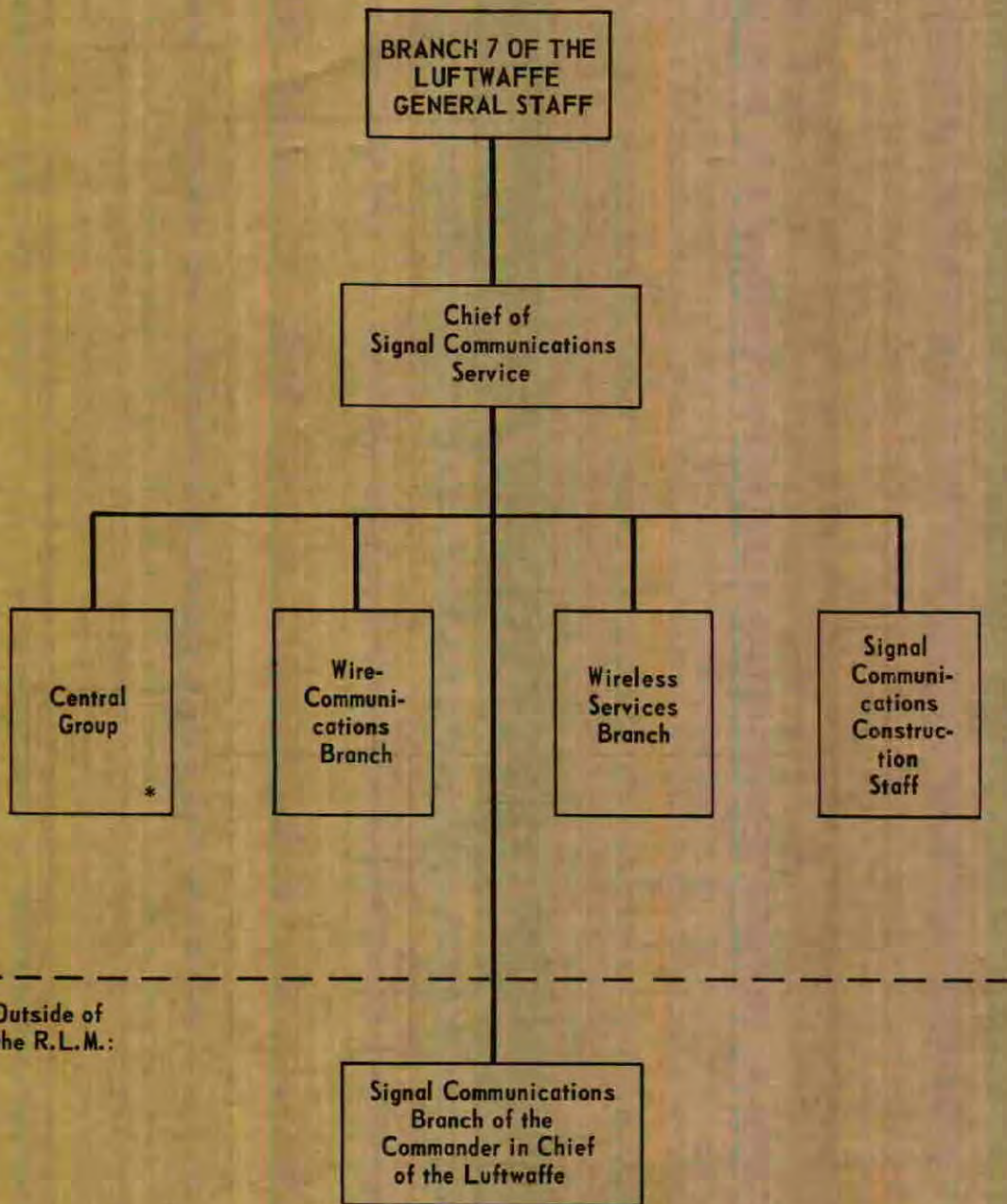

* 1 Consultant of the Central Group with Branch 1 of the Luftwaffe General Staff.

Chart 13

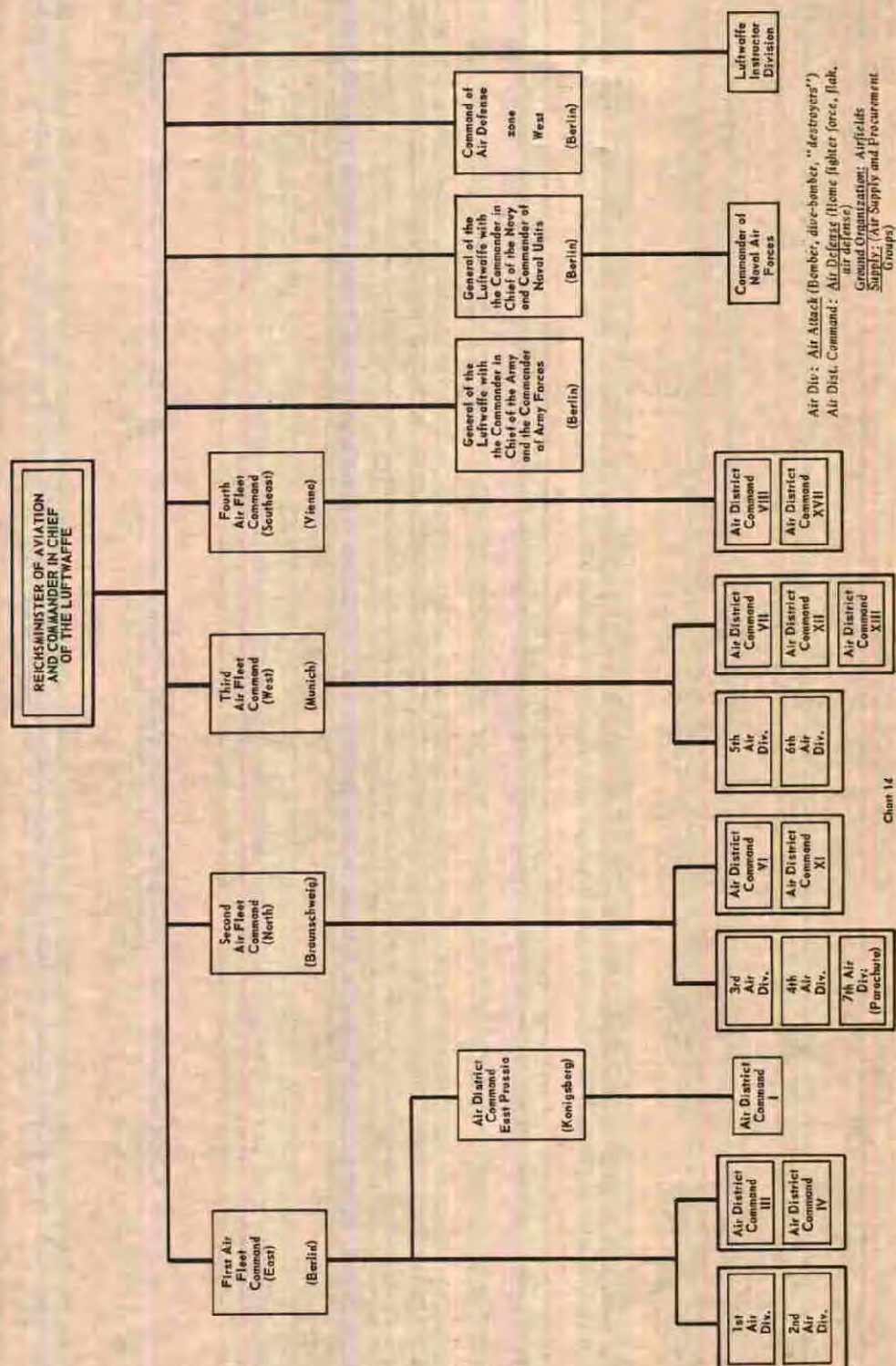

Chart 14