

MHI
Copy 3

FM 10-10

WAR DEPARTMENT

**QUARTERMASTER
FIELD MANUAL**



**QUARTERMASTER SERVICE
IN
THEATER OF OPERATIONS**

March 2, 1942

PROPERTY OF
QUARTERMASTER
TECHNICAL LIBRARY
FORT LEE, VA.

QUARTERMASTER FIELD MANUAL

QUARTERMASTER SERVICE IN THEATER OF OPERATIONS

CHANGES }
No. 1 }

WAR DEPARTMENT,
WASHINGTON, October 8, 1942.

FM 10-10, March 2, 1942, is changed as follows:

■ 66 (Superseded.) **QUARTERMASTER GASOLINE SUPPLY UNITS.—**

a. The gasoline supply battalion consists of a headquarters and headquarters detachment and four companies (see T/O 10-75 and T/O 10-76). The gasoline supply company consists of a company headquarters and two platoons of two sections each (see T/O 10-77). Each section is equipped with a gasoline driven dispensing unit, eight hundred 5-gallon cans, five trucks, and five trailers.

b. The gasoline supply battalion will not normally be employed as a unit. Each company is capable of operating two gasoline and oil railheads for army troops, corps troops, or divisions other than armored divisions. For armored divisions one company per division will be required.

c. The gasoline supply company has a gasoline container and transporting capacity of 16,000 gallons of gasoline and oil. It is not, however, a transport company. This container capacity, consisting of gasoline in 5-gallon cans, is used to establish an initial stockage at the railhead or gasoline refilling point and to provide prompt supply of full containers for exchange for empty containers. Full containers are transported by the gasoline supply unit from the old railhead or gasoline refilling point to a new railhead or gasoline refilling point and from a railhead or gasoline refilling point to form distributing points established for one or two divisions, corps, or army. The gasoline supply company operates the distributing points. Distributing points should be pushed as far forward for divisions as the tactical situation permits. This location is influenced also by

*These changes supersede section I, Training Circular No. 48, War Department, 1942.

the round trip distance and the amount of gasoline required by the unit served. Units will not be permitted to come to the railhead or gasoline refilling point to exchange empty containers for full ones, and every precaution will be taken to reduce and conceal activity at this point. A gasoline distributing point will be established even though only a short distance from the railhead or gasoline refilling point.

d. The gasoline supply company reduces bulk deliveries of gasoline to 5-gallon cans at the railhead or refilling point, loads these filled cans on trucks for movement to distributing point, and unloads them at distributing point. Units drawing fuel and lubricants at gasoline distributing points are charged with the loading and unloading of their unit vehicles.

e. Additional truck transportation, gasoline containers, and labor may be attached to supplement gasoline supply companies when required due to length of lines of communication and gasoline requirements.

[A. G. 062.11 (8-22-42).] (C. 1, Oct. 8, 1942.)

■ 130. GRAVES REGISTRATION.—See TM 10-630.

[A. G. 062.11 (7-28-42).] (C 2, Oct. 8, 1942.)

CHAPTER 3

CAVALRY AND ARMORED DIVISIONS

* * * * *

SECTION II

ARMORED DIVISION (SUPERSEDED)

■ 151. GENERAL.—Quartermaster service in the armored division is provided by the quartermaster section of the rear echelon of division headquarters, and by the division quartermaster platoon and the service platoon of headquarters company of the supply battalion (T/O 10-35). The division quartermaster is a staff officer on the division commander's special staff. He has no troop command.

■ 152. ORGANIZATION OF THE DIVISION QUARTERMASTER OFFICE.—In general, the organization of the division quartermaster's office is similar to the organization of that office in infantry and cavalry divisions. The organizational chart of this office follows:

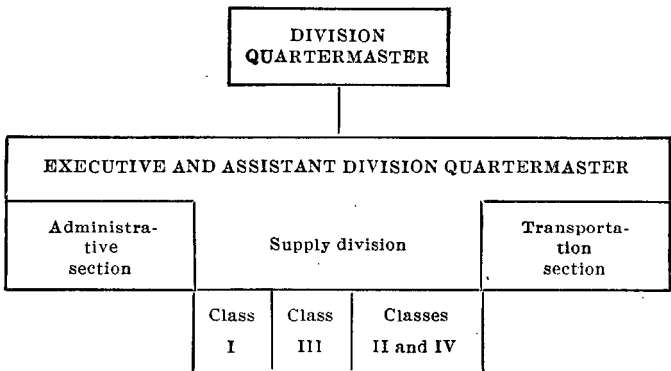

■ 153. SPECIAL CONSIDERATION.—*a.* The armored division is organized to provide the maximum flexibility of combat groupings. The combat commands are formed by grouping various combat and supply elements of the division to meet the tactical requirements in each situation. The supply system of the division must be equally flexible.

b. The normal load of the supply battalion consists of ammunition. No rolling reserves of other classes of supply are carried in the division train. If the trucks of the supply battalion are to be used for other classes of supply, the ammunition load must first be distributed or dumped. Because of the volume of ammunition expended by the armored division, use of trucks of the supply battalion for other loads than ammunition will be exceptional.

c. A "day of operation" is considered as 100 miles of movement for all vehicles. Two "days of operation" of fuel, including that carried in vehicle tanks, are available within the regiments and separate units.

d. The division train and the unit trains are frequently grouped together for control and protection. When so grouped they are controlled tactically by the division train commander. The latter is not responsible for the technical operations of the services.

■ 154. CLASS I SUPPLY.—Railhead or other army supply point distribution is normal. There is no truck transportation available to the division quartermaster for making unit distribution. Regrouping of unit trains to conform to the particular grouping of the combat commands is accomplished by the division train commander in the train bivouac prior to dispatching trains to the railhead. The service platoon of the headquarters and headquarters company, supply battalion, is used for making the breakdown of the ration, by unit, at the railhead and for manhandling the organic ammunition load of the truck companies. Units are responsible for the loading of their rations at the railheads. Each unit in the combat command will be furnished fuel and lubricant trucks and ration trucks, for its resupply, by its parent organization of the armored division. One of the unit supply officers (normally of the armored regiment or armored infantry regiment) will act as S-4 for the combat command. The grouping and proper utilization of the supply vehicles and procurement of supplies will be coordinated by this S-4 in conformity with orders of the combat command commander.

■ 155. CLASS III SUPPLY.—A system similar to that described in paragraph 154 is required for the distribution of fuel and lubricants. There is no transportation available to the division quartermaster for making unit distribution. However, it is the division quartermaster's responsibility that timely requests are made to the army, corps, or other higher echelons to place the required amounts and kinds of class III supplies as close to the unit trains as transportation and the tactical situation permits. The service includes filling of 5-gallon cans with fuel and when practicable, assisting in unloading empty cans from unit vehicles and loading the vehicles with full cans.

■ 156. CLASS II AND IV SUPPLY.—See paragraph 118*n*, FM 10-5. The supply of these classes is normally accomplished during lulls in operations.

■ 157. INDEPENDENT ARMORED DIVISION.—When the armored division is acting alone on a detached or independent mission, it will be necessary to have attached army or GHQ supply units to accomplish those parts of the supply mission which are normally required of the higher echelon. Two truck companies;

SERVICE IN THEATER OF OPERATIONS

two railhead detachments; one gasoline supply company; one quartermaster company (service); and one quartermaster company, HM, mobile, or a detachment therefrom, can be considered normal attachments, except when distances, terrain, or weather make additional reinforcements necessary.

[A. G. 062.11 (6-11-42).] (C 1, Oct. 8, 1942.)

BY ORDER OF THE SECRETARY OF WAR:

G. C. MARSHALL,
Chief of Staff.

OFFICIAL:

J. A. ULIO,
Major General,
The Adjutant General.

FM 10-10

QUARTERMASTER FIELD MANUAL



**QUARTERMASTER SERVICE
IN
THEATER OF OPERATIONS**

**Prepared under direction of
The Quartermaster General**



**UNITED STATES
GOVERNMENT PRINTING OFFICE
WASHINGTON : 1942**

WAR DEPARTMENT,
WASHINGTON, March 2, 1942.

FM 10-10, Quartermaster Field Manual, Quartermaster Service in Theater of Operations, is published for the information and guidance of all concerned.

[A. G. 062.11 (9-24-41).]

BY ORDER OF THE SECRETARY OF WAR:

G. C. MARSHALL,
Chief of Staff.

OFFICIAL:

J. A. ULIO,
Major General,
The Adjutant General.

DISTRIBUTION:

D (6); B 1, 2, 4, 6, 7, 17 (3); R (2), 10 (5); Bn 10 (5);
IBn (3); C 10 (3); IC 3 (4).

(For explanation of symbols see FM 21-6.)

TABLE OF CONTENTS

	Paragraphs	Page
PART I. Communications zone.		
CHAPTER 1. Organization and functions of theater of operations.		
Section I. General-----	1-5	1
II. Terminology-----	6-23	7
CHAPTER 2. Organization and operation of quartermaster service in communications zone.		
Section I. Office of quartermaster, communications zone-----	24-29	11
II. Operation of quartermaster service in communications zone-----	30-32	23
III. Depots-----	33-39	28
IV. Regulating stations-----	40-50	38
V. Railheads-----	51-56	18
CHAPTER 3. Supply installations.		
Section I. Salvage and related activities	57-62	44
II. Subsistence-----	63-65	50
III. Gasoline and oil supply-----	66-67	54
IV. Remount depot-----	68-70	55
V. Personnel replacement-----	71-80	56
CHAPTER 4. Transportation.		
Section I. Water-----	81	60
II. Motor-----	82-85	60
III. Rail-----	86-90	68
IV. Air-----	91	68
PART II. Combat zone.		
CHAPTER 1. General.		
Section I. Responsibility and functions	92-94	72
II. Definitions-----	95-116	74
CHAPTER 2. Division quartermaster units.		
Section I. Quartermaster regiment-----	117-119	77
II. Division quartermaster's office (square division)-----	120-121	82
III. Operations-----	122-132	86
IV. Quartermaster battalion, Infantry division (triangular)	133-139	109
CHAPTER 3. Cavalry and armored divisions.		
Section I. Cavalry division (horse)-----	140-150	114
II. Armored division-----	151-158	121
CHAPTER 4. Army corps.		
Section I. Corps as part of army-----	159-172	125
II. Independent corps-----	173-176	134
CHAPTER 5. Army.		
CHAPTER 6. Quartermaster service.		
Section I. Air Force-----	186-188	146
II. GHQ-----	189-192	152

TABLE OF CONTENTS

Part II. Combat zone—Continued.	Paragraphs	Page
CHAPTER 7. Troop movements.		
Section I. Assigned motor transport.....	193-194	153
II. Shuttling-----	195-200	155
III. Railway -----	201	160
CHAPTER 8. Plans, orders, estimate of situation, and reports-----	202-207	161
CHAPTER 9. Protection of food supplies against poisonous gas-----	208-213	169
APPENDIX, Routing of requisitions, calls, and supplies -----	1-11	171
INDEX -----		174

QUARTERMASTER FIELD MANUAL

QUARTERMASTER SERVICE IN THEATER OF OPERATIONS

PART I

COMMUNICATIONS ZONE

CHAPTER 1

ORGANIZATION AND FUNCTIONS OF THEATER OF OPERATIONS

	Paragraphs
SECTION I. General.....	1-5
II. Terminology	6-23

SECTION I

GENERAL

■ 1. THEATER OF WAR.—The theater of war comprises those areas of land and sea which are or may become directly involved in the operations of war. That part of the theater of war within the control of each belligerent is usually divided into a zone of interior and one or more theaters of operations.

■ 2. ZONE OF THE INTERIOR.—*a.* The zone of the interior is that part of the national territory not included in the theater of operations. The mission of the supply system of the zone of interior is to accumulate supplies for the military forces and to issue these supplies to the troops as required. This mission is continuous during both peace and war and embraces all supply activities. It is accomplished by the determination of requirements, the mobilization of industries and resources to produce these requirements, and the procurement, storage, transportation, and issue of supplies.

b. In general, the functions of the several agencies of the zone of the interior, in time of war, are to supply the commander of the field forces with the means necessary for the accomplishment of his mission. These functions are carried out by the chiefs of the supply services of the zone of the interior, their respective operations being directed and controlled by the Secretary of War. (See FM 100-10.)

■ 3. THEATER OF OPERATIONS.—*a.* (1) A theater of operations covers the land and sea areas it is desired to invade or defend.

including what is necessary for administrative establishments and agencies pertaining to the forces in the theater. Each theater of operations is divided, for the purposes of combat and for decentralization of administration, into a communications zone and a combat zone. (See FM 100-10.)

(2) Initially, in a campaign, the theater of operations may include only a combat zone; installations and facilities of the zone of the interior being utilized for the service of the combatant troops. However, as soon as the advance is such that all of the territory gained is not required for combat operations, a communications zone should be organized.

b. The commander of a theater of operations, in addition to the direction of combat operations, is responsible for the provision and distribution of supplies and replacements, hospitalization and evacuation, necessary control over the civil population in friendly territory, administration of military government in hostile territory, and control of all means of transportation within the theater of operations. He organizes the system of supply in the manner best suited to the performance of its proper functions. The organization of the system of supply is controlled by the consideration that it must be capable of adapting itself to the constant, and often rapidly, changing conditions of military operations. Figure 1 shows a method of decentralizing the administrative control by the theater commander.

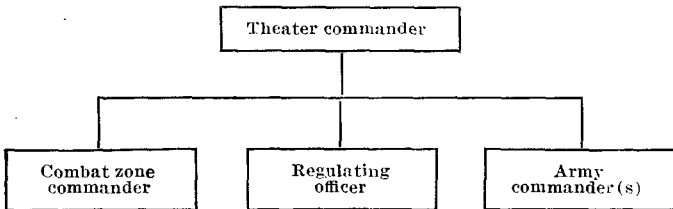

FIGURE 1.—Method of decentralizing administrative control by theater commander.

c. When there is more than one theater of operations under a single commander, the functions of general headquarters with regard to supply and evacuation consist, in general, in the apportionment of available resources and facilities, and in the establishment of priorities among the several theaters.

d. The supply section of the general staff of a theater of operations prepares and issues the orders and directions nec-

essary to secure compliance with the commander's basic policies, decisions, and plans, and also follows up their execution.

e. Chiefs of supply services, at headquarters of a theater of operations, exercise general technical direction of their services as a whole. They are responsible to their commander for—

(1) The preparation of a complete project for building up the organization of their respective services, and its expansion in conformity with the general organization project and with approved priorities.

(2) The efficient operation of their service as a whole.

(3) The establishment and maintenance of simplified and uniform methods of administration, operation, and procedure for all activities of their service in the theater of operations.

(4) Cooperation with their service representatives in subordinate commands.

(5) Development of new, improved, or special types of service supplies to meet the particular requirements of the theater of operations.

(6) Command of all service troops, and installations, not assigned to or attached to subordinate units. (See FM 100-10.)

■ **4. COMMUNICATIONS ZONE.**—*a. Definition.*—The communications zone comprises that portion of the theater of operations containing the principal establishments of supply and evacuation, lines of communication, and other agencies required for the immediate support and maintenance of the forces in the theater of operations. It includes all the territory between the rear boundary of the theater of operations and the rear boundary of the combat zone. (See FM 100-10.)

b. Boundaries.—Laterally, the area of the communications zone is usually coextensive with that of the theater of operations. The rear boundary of the communications zone is the rear boundary of the theater of operations and is fixed from time to time by the War Department. The rear boundary of the combat zone is fixed by the commander of the theater of operations. It is determined by the idea that the combat zone should embrace only the territory necessary for the combat forces opposed to the enemy. In an advance the rear boundary of the combat zone is stepped forward in order to

relieve commanders of the combat zone from the responsibility of administration of as much territory as possible.

c. Subdivisions.—(1) The depth and organization of the communications zone will vary between wide limits, in accordance with each situation. The primary consideration is that it be so organized as to fit in with the plan of military operations and relieve the combat forces of every consideration except that of defeating the enemy.

(2) When the situation is favorable for effecting much of the supply and evacuation direct between zone of interior establishments and the combat zone, the communications zone may be very limited in depth.

(3) In some cases the communications zone may be or may become so extended in depth as to make it desirable to divide the zone into a base section and an advance section in order to secure centralized control and decentralized operation.

(4) In exceptional cases, such as an oversea operation, it may become desirable to divide the communications zone into three sections, designated in order from rear to front: base, intermediate, and advance. Conditions may require a subdivision of the sections into subsections.

d. Supply functions.—(1) *Base of operations.*—The communications zone is the base of operations of the supply system in the theater of operations. It is the function of the communications zone to provide for the necessary flexibility of supply by an adequate echelonment of supply establishments, both laterally and in depth. The forward establishments contain balanced stocks maintained at a level determined from time to time by the theater commander as necessary to meet promptly the immediate needs of the troops in the combat zone. In the rear establishments are received the supplies arriving from the zone of the interior or obtained by local procurement. In the communications zone, also, will be found the main repair, replacement, and evacuation establishments.

(2) *Establishment of communications zone.*—Conditions may arise which will permit operation, in the initial phase of a campaign, directly between the zone of the interior and the combat zone without an intervening communications zone. However, the early establishment of a communications zone, even though it be of slight depth, is desirable. The first installations to be established are those of the advance section,

followed later by those of the base and intermediate sections in the order named. When only the advance section is established, depots of the zone of interior function as base depots.

(3) *Communications zone depots.*—Depots are the backbone of the system of supply, and are the means through which the flexibility of supply operations is assured. Communications zone depots contain the reserves. The number, location, and character of these depots, together with the base reserves to be stocked and maintained, are determined by the commander of the communications zone in accordance with the instructions and policies of the theater commander. The communications zone commander allots depot space to the services and determines the location of repair establishments and other installations pertaining to each service. (See also FM 100-10 and 10-5.)

(4) *General depots.*—General depots are organized into sections corresponding to the several supply services represented. Each section is designated by the name of the supply service to which it pertains, for example, Ordnance Section, Quartermaster Section, etc. Each general depot is commanded by an officer designated by, and who operates under, the communications zone commander. In general, the commander of a general depot coordinates the activities of the general depot supply officers while leaving to them the internal management of their respective sections. Specifically, the duties of a depot commander include—

(a) Coordination of the activities pertaining to transportation, finance, and utilities.

(b) Assignment of space and other facilities to the various sections of the depot.

(c) Control of a common labor pool and of its allotment to the various supply sections in accordance with their needs.

(d) Facilitating the hauling of incoming and outgoing shipments, and the loading and unloading of cars and other means of transportation.

(e) Supervision and control of methods of storage so far as safety and proper utilization of allotted space is concerned.

(f) Cooperation in every way with the chiefs of the supply services. (See also FM 10-5 and 100-10.)

(5) Each depot quartermaster supply officer at a general depot is responsible for the proper storage, care, maintenance, and issue of all supplies pertaining to his service; the

operating control of the personnel assigned to his section; the supply records pertaining to his service; the supervision of the loading and unloading of his supplies; the proper marking of all shipments; the necessary arrangements with the transportation agencies of the depot for shipments; and the timely transmission, through prescribed channels, of information with respect to shipments.

(6) The organization and administration of branch depots are direct responsibilities of the chiefs of the supply services. Commanders of branch depots are assigned by the commander of the communications zone on the recommendations of the chief of service concerned. Supplies are stored in branch depots in such amounts as may be prescribed by the communications zone commander. The commander of a branch depot has the same responsibilities as those given for the depot supply officer and, in addition, the duties of a commanding officer of a station.

(7) The chief of the quartermaster supply service is directly responsible to the commander of the communications zone for the supply operations of his branch depots and for the operations of his repair shops or other establishments. He is charged with the following responsibilities:

(a) The provision, proper storage, and issue of all supplies pertaining to the quartermaster service.

(b) The maintenance of depot stocks at prescribed levels.

(c) The supply of technically trained quartermaster personnel necessary for the efficient functioning of quartermaster depots and of quartermaster sections of general depots.

(d) The keeping of records in such form that prompt report can be made whenever directed as to kind, quantity, location, and condition of supplies available for distribution.

(e) The issue of such technical instructions to his subordinates as will insure the efficient functioning of the quartermaster service.

(f) The taking of such measures as may be necessary for equalization of stocks between depots.

(g) The prompt report, with appropriate recommendations, to the commander of the communications zone, of all items of supply which require special attention.

(8) In the forward movement of troops and supplies to the combat zone the responsibility of the communications zone ends with delivery to the control of the regulating officer.

(9) The issue of supplies to organizations in the communications zone is made from the most convenient depots.

(10) In addition to the procurement and distribution of supplies and material of all kinds for the theater of operations, the communications zone provides the following:

(a) Facilities for evacuation and hospitalization of men and animals.

(b) Transportation for men and supplies.

(c) Depots for replacements and casualties.

(d) Rest camps, leave and quartering areas, and training centers.

(e) Facilities for the reception and care of salvage. (See FM 100-10.)

■ 5. COMBAT ZONE.—*a.* The combat zone comprises that part of the theater of operations required for the active operations of the combatant forces. Its depth is dependent upon size of the forces assigned, nature of the operations contemplated, character of the lines of communication, important terrain features, and enemy capabilities. The combat zone is divided into army, corps, and division areas, each comprising the zone of operations of the unit to which it pertains.

b. The army service area is the territory between the corps rear boundary and the combat zone rear boundary. The mass of army administrative establishments and army service troops is usually located in this area.

c. In an advance the rear boundary of the combat zone is stepped forward in order to relieve commanders within the combat zone from responsibility of administration of as much territory as possible. (See FM 100-10 and 100-5.)

SECTION II

TERMINOLOGY

■ 6. SUPPLIES.—In a military sense the term "supplies" covers all items necessary to the equipment, maintenance, and operation of a military command. It includes food, clothing, equipment, arms, ammunition, fuel, forage, construction materials, and machinery of all kinds. For simplicity and convenience of administration, supplies required by troops in the field are divided into five classes as follows—(see also FM 100-10):

a. Class I.—Those articles which are consumed at an approximately uniform daily rate irrespective of combat oper-

ations or terrain and which do not necessitate special adaptation to meet individual requirements, such as rations and forage.

b. Class II.—Those authorized articles for which allowances are established by Tables of Basic Allowances and Tables of Allowances, such as clothing, gas masks, arms, trucks, radio sets, tools, and instruments.

c. Class III.—Engine fuels and lubricants, including gasoline for all vehicles and aircraft, Diesel oil, fuel oil, and coal.

d. Class IV.—Those articles of supply which are not covered in Tables of Basic Allowances and demands for which are directly related to operations contemplated or in progress (except for articles in classes III and V), such as fortification materials, construction materials, and machinery.

e. Class V.—Ammunition, pyrotechnics, antitank mines, and chemicals. (See also FM 10-5.)

■ 7. REQUISITION.—Request for supplies, usually on a form furnished for the purpose. The word is also used to signify the purchase by demand of supplies in hostile occupied territory.

■ 8. CREDIT.—Allocation of a definite quantity of supplies which is placed at the disposal of the commander of an organization for a prescribed period of time.

■ 9. CALL.—Demand for delivery of supplies covered by credits.

■ 10. PRIORITIES.—Priorities are definite rulings which establish, in order of time, the precedence of shipments and movements of rail, road, water, or air transport.

■ 11. RESERVES.—Supplies accumulated in excess of immediate needs for the purpose of insuring continuity of adequate supply. Also designated as reserve supplies.

a. Battle reserves are supplies accumulated by the army, detached corps, or detached division in the vicinity of the battlefield in addition to unit and individual reserves.

b. Individual reserves are those carried on the soldier, animal or vehicle for his or its individual use in emergency.

c. Unit reserves are prescribed quantities or supplies carried as a reserve by a unit.

■ 12. BALANCED STOCKS.—Accumulation of supplies of all classes and in quantities determined as necessary to meet requirements for a fixed period of time. (See also FM 100-10.)

■ 13. UNITS OF MEASURE.—*a.* The term “day of supply” is the estimated average expenditure of the various items of supply per day in campaign, expressed in quantities of specific items or in pounds per man per day. It is a yardstick used by the higher echelons of the staff for determining levels, credits, transportation requirements, etc. The quantities of the various items which, taken collectively, represent a day of supply are determined on the recommendations of the respective supply services and of the using arms. These recommendations are based on experience tables, the size and composition of the forces involved, the character of the operations, the nature of the enemy, and the climatic conditions of the theater of operations.

b. A “unit of fire” for a designated organization or weapon is the quantity in rounds or tons of ammunition, bombs, grenades, and pyrotechnics which it may be expected to expend on the average in 1 day of combat.

■ 14. REQUIREMENTS.—Requirements are the computed needs for a military force, embracing all supplies necessary for its equipment, maintenance, and operation for a given period, and classified as individual, organizational, initial, maintenance, and reserve.

a. Individual requirements are those supplies necessary to enable the individual to function as a soldier.

b. Organizational requirements are those supplies necessary for the organization to function as a unit.

c. Initial requirements are those supplies required to meet the original demands incident to field operations.

d. Maintenance requirements are those supplies required to replace expenditures.

e. Reserve requirements are those supplies necessary to meet emergency situations incident to campaign.

■ 15. AUTOMATIC SUPPLY.—The term “automatic supply” signifies a process of supply under which deliveries of specific kinds and quantities of supplies are moved in accordance with a predetermined schedule. Daily automatic supply means that certain supplies are dispatched daily to an organization or installation.

■ 16. DAILY TELEGRAM.—Telegram or other message dispatched daily by divisions and larger units giving the unit's situation relative to supplies. A strength report is included.

The telegram is the basis on which class I and other supplies to be forwarded are computed.

■ 17. **DEPOT.**—Organized locality for the reception, classification, storage, issue, or salvage of supplies, or for the reception, classification, and forwarding of replacements. Arm or service depots pertain to a single arm or service and general depots pertain to two or more supply arms or services; for example, First Army Ammunition Depot No. 1 or Communications Zone General Depot No. 3. (See also FM 100-10 and 10-5.)

■ 18. **SUPPLY POINTS.**—The generic term used to include depots, railheads, distributing points, and dumps.

■ 19. **DISTRIBUTING POINT.**—Place other than a depot or railhead where supplies are issued to regiments and smaller units. Distributing points are designated by the class of supplies therein and by the identity of the unit establishing them; for example, Class I Distributing Point, 1st Division, or Ammunition Distributing Point, 1st Infantry.

■ 20. **LINES OF COMMUNICATION.**—*a.* This includes the network of railways, waterways, and roads which lead into the combat zone from the supply and evacuation establishments located in the communications zone and the zone of the interior.

b. Railroads are the main arteries of supply and evacuation in the theater of operations. They are also the main connecting links in the chain of supply and evacuation between the theater of operations and the zone of the interior, except in the case of oversea expeditions. Roads, inland waterways, and, at times, narrow-gage railways form important adjuncts to the standard-gage railways.

■ 21. **REGULATING STATION.**—This is a traffic-control agency established on lines of communication and through which movements are directed and controlled by the commander of the theater of operations.

■ 22. **RAILHEAD (TRUCKHEAD, NAVIGATION HEAD).**—A supply point where loads are transferred from particular type of transportation being employed; for example, Class I Railhead, 1st Division; Gasoline and Oil Railhead; Ammunition Railheads, 1st and 2d Divisions.

■ 23. **DAILY TRAIN.**—Train arriving daily at railhead with supplies for troops which the railhead serves. (See FM 100-10.)

CHAPTER 2

ORGANIZATION AND OPERATION OF QUARTERMASTER SERVICE IN COMMUNICATIONS ZONE

	Paragraphs
SECTION I. Office of quartermaster, communications zone----	24-29
II. Operation of quartermaster service in communications zone-----	30-32
III. Depots-----	33-39
IV. Regulating stations-----	40-50
V. Railheads-----	51-56

SECTION I

OFFICE OF QUARTERMASTER, COMMUNICATIONS ZONE

■ 24. GENERAL.—General headquarters (GHQ) is the designation given the headquarters of the commander of the field forces. The commander of the field forces exercises command over all of the theaters of operation, specifying, regulating, and coordinating the operations therein in accordance with the general policies prescribed by the President and under the general direction of the Secretary of War. He is assisted, as in all other large commands, in the performance of his duties by a general and special staff. One member of the special staff is designated the quartermaster, general headquarters. Similarly, on the staff of a commander of the theater of operations and the communications zone, there is a special staff officer designated as the quartermaster, theater of operations, and the quartermaster, communications zone, respectively. (See also FM 10-5.)

■ 25. DUTIES OF THE QUARTERMASTER CORPS.—The Quartermaster Corps in the communications zone, under the supervision of the quartermaster of the communications zone, is charged with the efficient conduct of the entire quartermaster system of supply and transportation to the theater of operations, either directly or indirectly. This service includes—

a. The administration of all Quartermaster Corps activities in the communications zone.

b. Procurement from the zone of the interior or from sources of supply in the theater of operations of all quartermaster supplies.

c. Storage of quartermaster supplies in quartermaster branch depots and quartermaster sections of general depots in the communications zone.

d. Distribution of quartermaster supplies to troops in the combat zone, based upon predetermined requirements or credits approved by the commanding general, theater of operations, and distribution to troops within the communications zone based upon approved requisitions.

e. Operation of salvage plants and concentration of material at salvage depots where repair, reclamation, and, at times, manufacture are conducted on an extensive scale. In this connection the service includes the supervision and operation of laundries and sterilization plants within the communications zone.

f. Procurement, conditioning, care, and distribution of remounts.

g. Operation of the graves registration service, which acquires, maintains, and controls cemeteries; identifies the dead; registers burials; locates single graves and disposes of all personal effects of deceased personnel.

h. Transportation service for personnel, animals, material, and supplies via rail, motor, animal, water, and air. (See also FM 101-5.)

■ 26. QUARTERMASTER, COMMUNICATIONS ZONE.—a. *General duties.*—The quartermaster, communications zone, is responsible for the quartermaster service in the communications zone, and his duties, in general, are—

(1) *Staff.*—(a) Adviser to the commander and staff on matters concerning quartermaster activities.

(b) Planning, including estimates of requirements in supplies, equipment, personnel, and establishments.

(c) Technical supervision and inspection, within the limits prescribed by his commander, of quartermaster activities in the communications zone.

(2) *Command.*—(a) Command of the quartermaster service within the communications zone.

(b) The efficient operation of his service in accordance with the policies, plans, and basic decisions of his commander.

(3) This dual function has many advantages in facilitating the proper discharge of both staff and command duties. However, although vested in the same individual, one duty must not be confused with the other or permitted to interfere one with the other. The quartermaster, communications zone, should possess excellent leadership, executive ability, and a thorough understanding of strategical concentrations, tactical maneuvers, capabilities of combatant forces, and a detailed knowledge of the functions, and training and personnel problems, of all quartermaster units.

b. Specific duties.—The specific duties of the quartermaster, communications zone, are—

(1) The administration and operation of all Quartermaster Corps branch depots, repair shops, or other establishments of the communications zone.

(2) The operation of the quartermaster sections at general depots of the communications zone.

(3) Provision, proper storage, and distribution of all supplies of standard manufacture and of all supplies common to two or more arms and services, including motor- and animal-drawn transport, except special or technical items to be used or issued exclusively by other supply services.

(4) Shipment and reception of troops and supplies transported by common carrier, including railways and inland waterways operated by the engineer service; transportation of troops and supplies, except such as may be allocated to another service; and the operation of motor transport establishments, motor transport pools, army transport establishments, docks, and stevedore services.

(5) Operation of bakeries, cold storage and ice plants, gardens, laundries, baths, shoe repair shops, salvage plants, paint shops, blacksmith shops, motor repair shops, fire protection stations, baggage collection depots, cemeteries, and other quartermaster utilities.

(6) Provision and operation of the labor service pool.

(7) Provision and distribution of animal replacements.

(8) Operation and maintenance of all quartermaster troops, trains, installations, establishments, utilities, and activities.

(9) The maintenance of depot stocks at prescribed levels.

(10) The keeping of records in such form that prompt report can be made whenever directed as to kind, quantity, location, and condition of supplies available for distribution.

■ 27. ORGANIZATION OF QUARTERMASTER'S OFFICE.—The office of the quartermaster normally is organized into three main divisions—administrative, supply, and transportation. (See fig. 2.)

a. Administrative division.—The administrative division may be divided into the following branches:

- (1) Administrative branch.
- (2) Personnel branch.
- (3) Graves registration branch.

b. Supply division.—The supply division may, if the work requires, be subdivided into branches. If the volume of work does not require it, some of these may be combined. The branches shown are—

- (1) Administrative branch.
- (2) Planning branch.
- (3) Procurement branch.
- (4) Salvage branch.
- (5) Subsistence (class I supplies) branch.
- (6) Clothing and equipage (class II supplies) branch.
- (7) Remount branch.
- (8) Miscellaneous branch.
- (9) Gasoline and oil branch.

c. Transportation division.—The transportation division may be divided into the following branches, whenever the volume of work requires:

- (1) Administrative branch.
- (2) Planning branch.
- (3) Rail transport branch.
- (4) Motor transport branch.
- (5) Animal transport branch.
- (6) Water (and air) branch.
- (7) Traffic branch.

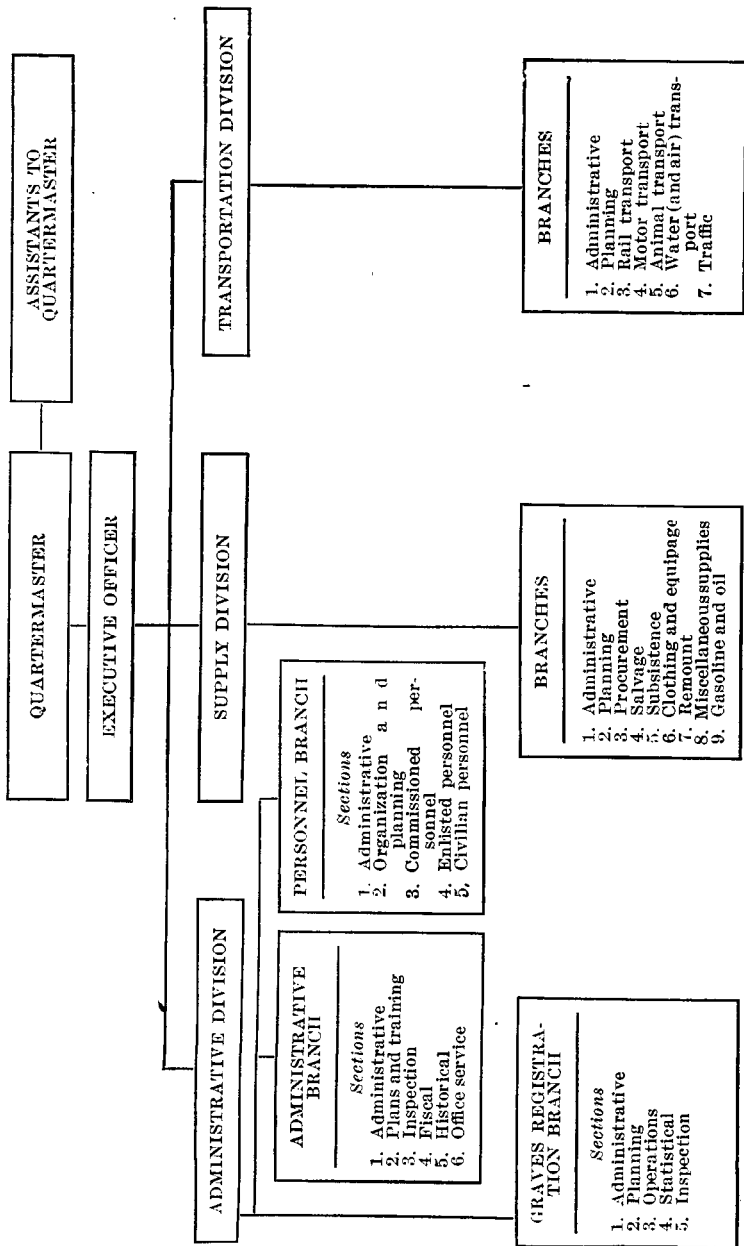

FIGURE 2.—Suggested organization chart for office of quartermaster of communications zone.

d. This organization may be expanded into more than three divisions in time of war and some of the branches may become divisions, and some of the sections may become branches.

e. *Functions of the administrative division.*—(1) *Administrative branch.*—This branch handles all records, mail, telegrams, cablegrams, and messenger service; prepares plans for training Quartermaster Corps personnel; handles all matters pertaining to inspection of quartermaster activities; prepares estimates of funds; and maintains historical data.

(2) *Personnel branch.*—This branch procures quartermaster replacements from the zone of the interior and makes assignments and distribution of the replacements upon their arrival in the communications zone. The personnel branch exercises no control over personnel destined for the combat zone after it has reached the regulating station.

(3) *Graves registration branch.*—This branch acquires, maintains, and controls cemeteries; identifies the dead; registers burials; locates graves; and disposes of all the personal effects of the deceased.

f. *Functions of the supply division.*—The functions of the supply division are the procuring, storage, distribution, and salvage of quartermaster supplies. The various branches, for example, subsistence, clothing and equipage, gasoline and oil, salvage and miscellaneous, perform the functions as indicated by their classifications.

g. *Functions of the transportation division.*—The functions of the transportation division are to handle traffic matters; furnish, operate, and maintain all motor and animal transport required; and provide for movement of troops and supplies by all means of transportation.

(1) *Maintenance.*—The maintenance of motor and truck transportation is the responsibility of the Quartermaster Corps under the supervision of the commander of the communications zone.

(2) *Motor transport.*—The motor transport pool is operated under the supervision of a motor transport service officer on the staff of the chief quartermaster, communications zone. Animal transportation may supplement motor transportation.

(3) *Air transport.*—Air transport includes all means of transportation by airships or airplanes. In the theater of

operations its use, as far as the Quartermaster Corps is concerned, is ordinarily limited to emergency transport, where time is extremely important, of mail, ammunition, commander's staff officers, couriers, urgent supplies, and possibly detachments.

■ 28. INSTALLATIONS.—Within the communications zone the following quartermaster installations or establishments may be operated, either in their entirety or in part:

a. Supply.—(1) Quartermaster depots.

(2) Quartermaster section of general depots.

(3) Salvage depots.

(4) General sales stores.

(5) Gasoline and oil depots.

(6) Filling stations.

(7) Bakeries.

(8) Cold storage and refrigerator plants.

(9) Shoe and textile repair shops.

b. Transportation.—(1) Army Transport Service.

(2) Motor transport service.

(3) Commercial traffic service.

(4) Animal transportation units.

c. Personnel.—(1) Quartermaster replacement depots.

(2) Provide training cadres at quartermaster replacement depots, in event replacements received require additional training.

d. Remount.—(1) Remount depots.

(2) Advance remount replacement depots.

■ 29. UNITS.—The following quartermaster units may operate within the communications zone:

a. Supply.—The following units may operate the various supply installations and establishments within the communications zone:

(1) Quartermaster service battalions and companies.

(2) Bakery battalions or companies.

(3) Depot (supply) companies.

(4) Gasoline supply battalions or companies.

(5) Graves registration companies.

(6) Laundry battalions or companies.

(7) Refrigeration companies.

(8) Sales commissary companies.

(9) Salvage depot and collecting companies.

- (10) Shoe and textile repair (mobile) companies.
- (11) Sterilization and bath battalions or companies.
- (12) Truck regiments, battalions, and companies.
- (13) Railhead companies.

b. Transportation.—(1) Motor transport operating units.

- (2) Motor transport maintenance units.
- (3) Quartermaster service, GHQ Air Force.
- (4) Port of embarkation (debarkation).
- (5) Port battalions and companies.

c. Personnel.—Replacement depot units.

d. Remount.—Remount squadrons or troops.

e. Animal transport.—(1) Wagon battalions and companies.

- (2) Pack troops.

SECTION II

OPERATION OF QUARTERMASTER SERVICE IN COMMUNICATIONS ZONE

■ 30. PERSONNEL.—*a. Requirements.*—The study of requirements for quartermaster units and miscellaneous personnel, commissioned, enlisted, or civilian, is made in a series of phases in which the ratio of personnel pertaining to the different administrative services and to combat divisions en route from the zone of the interior is determined by headquarters, theater of operations, and the details for those relating to the quartermaster service are worked out by the personnel section, quartermaster, communications zone. These studies are sent to the zone of the interior where the units and miscellaneous personnel are organized, trained, and prepared for service in the theater of operations.

b. Procurement.—(1) Procurement of personnel from the zone of the interior is handled by means of the requirements program and special calls.

(2) Procurement of personnel from local sources is confined to transfers of officers and enlisted men from other branches of the Army and the hire of civilian employees. Civilian employees are hired by the quartermaster depots and stations according to local needs, as authorized by the quartermaster, communications zone (personnel section). Civilians employed in the office of the communications zone quartermaster, principally stenographers, typists, and clerks, are

hired by the personnel section which keeps the records pertaining to them. This class of employees is procured from the zone of the interior, or, when operations are conducted in friendly territory, in part from the local inhabitants.

(3) *Replacement depots.*—Upon arrival of units in the communications zone, they are given assignments by the personnel section and they then proceed to their destinations. Units for which no special assignment is immediately available, and all commissioned and enlisted personnel not assigned to units are routed to replacement depots. Upon arrival at these depots, casual officers and men are classified according to individual qualifications. Their qualification cards are then forwarded to the personnel section, office of the quartermaster, communications zone, and form a basis for future assignments.

c. Distribution.—(1) All requisitions for quartermaster personnel, including replacements, are received by the office of the quartermaster, communications zone. They are filled from the pool at the replacement depot or by the transfer of personnel from other assignments, according to the qualifications required. It will be necessary for the personnel section to exercise close supervision over all assigned personnel within the communications zone so as to determine from which points it can best be spared to meet urgent calls.

(2) The personnel section exercises no control over personnel destined for the combat zone after it has reached the regulating station. Records are maintained, however, as to the assignments of every officer and enlisted man both in the combat zone (by unit) and in the communications zone (by unit and station). As occasion demands, personnel in the communications zone is redistributed by the quartermaster, communications zone, with the approval of G-1, communications zone.

■ 31. SUPPLY.—*a. Requirements.*—The determination of supply requirements under the policies established by headquarters, theater of operations, is made by the supply division of the quartermaster's office, in coordination with G-4, communications zone.

b. Procurement.—(1) Most of the supplies are secured from the zone of the interior and are based on requirements and special requisitions.

(2) Some supplies are procured from sources in the theater of operations, either by purchase or by requisition.

c. Storage.—The supply division supervises the operations of all quartermaster branch depots, and quartermaster sections of general depots in the communications zone. These depots are exempted from the control of section commanders except for discipline, fire protection, and other matters pertaining to routine administration.

d. Distribution.—(1) *Within communications zone.*—Requisitions for quartermaster supplies prepared by organizations stationed in the communications zone are submitted through local quartermasters to section quartermasters of the communications zone and in the event credits have not been established, transmitted by the latter to the communications zone quartermaster's office (supply division) for approval. After approval they are transmitted to the proper depots for filling. In the event credits have been established for units or sections, the using agency procures the supplies by means of a call or draft from the proper depot.

(2) *Class I supplies.*—The requisition for class I supplies, when on an automatic basis, is known as the daily telegram. The army receives daily telegrams which give the strength of its divisions and corps troops. These telegrams are consolidated by the army quartermaster who adds to these figures the strength of the army troops. He then forwards this consolidated daily telegram to the regulating officer. The regulating officer then calls upon the designated depots of the communications zone for the necessary supplies. These depots in turn ship in bulk the required supplies to the regulating officer who sorts them into division and similar unit lots and forwards them by the daily train to the proper railhead. (For details see ch. 2, pt. II.)

(3) *Class III supplies.*—(a) Gasoline and oil supply depots are established at convenient locations throughout the communications zone. They should be located at points where there are adequate rail and highway facilities. These depots ship gasoline and oil to the regulating station in either tank cars, tank trucks, or 10-gallon containers, upon call from the regulating officer. The regulating officer, based upon requests submitted through the medium of the daily telegram, will forward this gasoline and oil to designated gasoline and oil railheads or truckheads. He may also attach gasoline and

oil cars to the unit section of the daily train, but this should be done only under exceptional circumstances, because of the danger of fire which might destroy the entire train.

(b) *Filling stations.*—Gasoline and oil filling stations will be established at all depots and other supply points throughout the communications zone and at such other locations along the main highways to provide an adequate number of gasoline and oil supply points throughout the entire communications zone. Gasoline and oil supply units should make frequent deliveries of gasoline and oil to these filling stations.

(c) *Gasoline and oil supply units.*—Sufficient gasoline and oil supply companies or battalions must be assigned to the communications zone to provide adequate supply of gasoline and oil to all supply points in the communications zone. These units, and such additional units from GHQ as may be required, may be used to supplement the gasoline and oil deliveries to the combat zone whenever the situation requires it.

(4) *Class II and class IV supplies.*—(a) Credits may be established in the communications zone depots by the theater commander for designated units. When such credits have been established, the army or other units may draw supplies by submitting a draft or call, either upon the regulating officer, or upon the designated depot. In the event the call is made through the regulating officer, he ships the supplies by rail to a designated railhead or truckhead. If the call is made direct on a depot the supplies may be transported by trucks furnished by the unit making the call. In the event the call is made through the regulating officer, and the rail lines are interrupted, he must arrange with the motor transport service to forward the supplies by truck.

(b) In the event credits have not been established, or have become exhausted, the army will submit requisitions, approved by the army commander, to the regulating officer or to the quartermaster, communications zone. If the supplies are available, they will be forwarded either by rail or truck to the designated supply point. If the supplies are not available in the designated depot, the unfilled items will be extracted to the quartermaster, communications zone, who will designate other depots where the supplies are available.

(c) The demand for class IV supplies varies between wide limits, and as the supplies in the theater are usually limited,

credits should be established only when the situation clearly demands it. Owing to the limited quantities available, supplies of this class will normally be procured through requisitions approved by the theater commander.

e. Salvage.—The quartermaster, communications zone, operates all salvage plants and depots within the communications zone. The collection of salvage within the combat zone is an army function. All unserviceable quartermaster and miscellaneous material is concentrated at salvage depots where repairs are conducted on an extensive scale and where some manufacturing is done. In connection with these activities the quartermaster supervises the operation of laundries and sterilization and bath units.

■ 32. TRANSPORTATION.—*a. Rail shipments.*—The operation of military railways is a function of the Corps of Engineers. The quartermaster is charged, however, with arranging with the operating agency in the theater of operations for the shipment of all troops and supplies by rail.

b. Water transportation.—The quartermaster service operates such water transportation of the Army Transport Service and the harbor boat service of the Quartermaster Corps as may be assigned to the theater of operations.

c. Motor transportation.—The motor transport activities of the quartermaster service consist of—

(1) The operation of motor transport of the quartermaster service.

(2) The third and fourth echelon maintenance of the motor transport of the quartermaster service and of units of the combat arms and other services equipped with motor vehicles supplied by the Quartermaster Corps.

(3) The operation of motor transport centers and sub-centers.

(4) Procurement and distribution of motor vehicles, unit assemblies, spare parts, and automotive operating and maintenance supplies. (See pars. 82 to 85, incl., of this manual and FM 100-10 and 10-5.)

SECTION III

DEPOTS

■ 33. GENERAL.—Field Service Regulations define an army depot as a supply point designated as such by the army commander and located in the army area where the temporary storage of supplies that the situation demands is maintained nearer at hand than is possible in the advance section of the communications zone and for the storage of supplies requisitioned in the combat zone. Supplies maintained in the army area are ordinarily limited in character to those essential to maintain combat efficiency and in quantity to that required to meet the needs of the army for a period not exceeding a few days. Therefore, an army depot should not be established unless the situation clearly demands it, and the army should always look to the communications zone for replenishment of supplies. (See also FM 100-10.)

■ 34. DEPOTS.—Depots within the communications zone may be classified under three heads. *Advanced depots* are always organized, even though the communications zone may be shallow in depth. *Base depots* are established when the communications zone is of considerable depth, and *intermediate depots* may be established when the communications zone is of great depth. The order of these depots from front to rear is advanced, intermediate, and base. Figure 3 shows a schematic diagram of depots and regulating stations within the theater of operations. All depots designated within the combat zone are army depots. The smaller circles within the communications zone indicate the advanced depots, the next larger circles the intermediate depots, and the largest circles the base depots. Depots within a communications zone may be either general or branch. General depots are organized so as to provide a supply section for each of the services. The branch depots, however, are organized so as to house only one service. Depots within the communications zone are numbered serially, a separate series of numbers being assigned to the general depots and a separate series for the branch depots for each of the services, for example, Communications Zone General Depot No. 3, or Communications Zone Quartermaster Depot No. 1.

■ 35. LOCATION OF DEPOTS.—Advance depots should be located as far forward in the communications zone as the situation permits. All depots should be located along the lines of communication, preferably along railroad lines. These should also be located so as to provide a good highway net to the combat zone. In addition, if possible, either standard or narrow gage railways should be available to transport supplies to the combat zone. (See FM 100-10.)

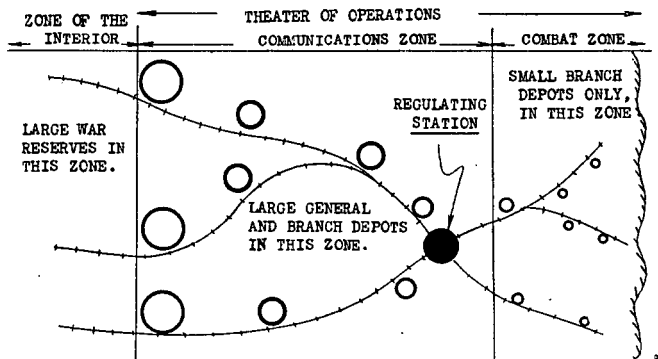

FIGURE 3.—Distribution of general and branch depots in theater of operations.

■ 36. ORGANIZATION OF COMMUNICATIONS ZONE.—*a. General depots.*—General depots in the communications zone are organized so as to provide a supply section for each of the services. Each section is designated by the name of the supply service to which it pertains, for example, ordnance section, quartermaster section, etc. The general depot is commanded by an officer designated by the commander of the communications zone and operates directly under the communications zone commander. The internal management of the respective supply sections is left to the chief of that section, under the chief of that service, but the activities of the depot are generally coordinated by the depot commander.

b. Quartermaster depots.—A commanding officer of the depot is designated by the commander of the communications zone. The office should be divided into three divisions—ad-

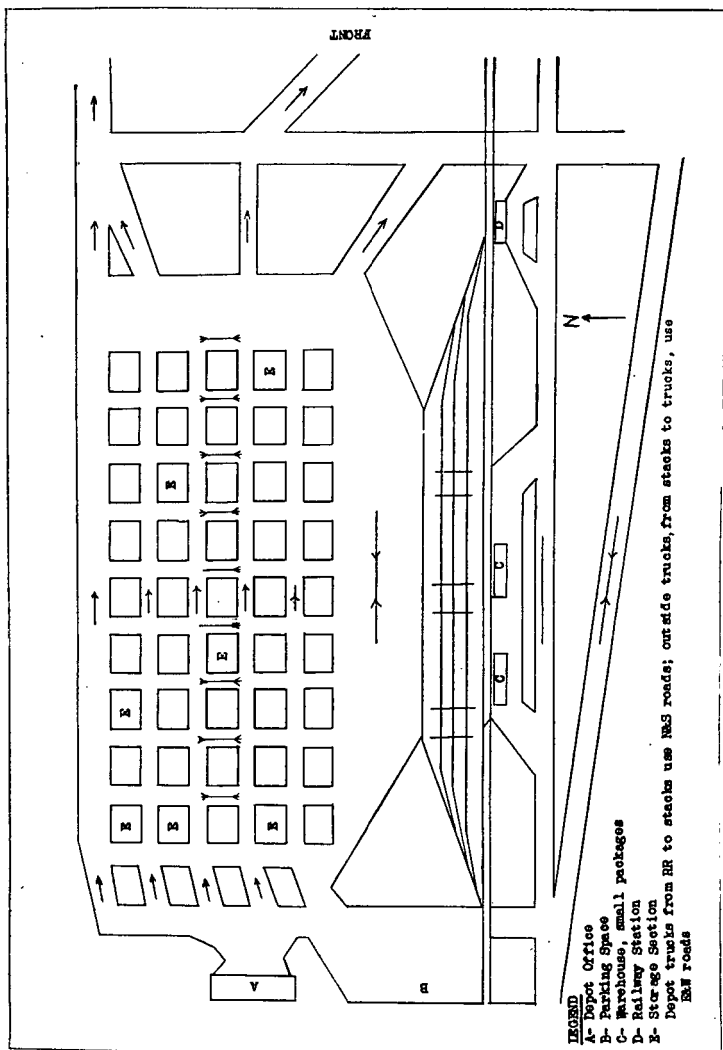

FIGURE 4.—Layout for quartermaster (supply) depot.

ministration, supply, and depot quartermaster. The depot quartermaster division operates the local depot supply and motor transportation, and provides for the upkeep of the depot, including the maintenance of roads. The supply division provides the necessary personnel to operate the receipt, storage, and issue of quartermaster supplies. The administration division, operating under the executive officer, provides the personnel for administering to the needs of the depot. A typical layout for a quartermaster supply depot is given in figure 4. Any layout for a depot should provide space for an office, warehousing of small packages which should be under cover, a railway station, and ample parking space for vehicles. There should also be ample space for open storage. The open storage piles should permit the passing of vehicles between each pile in all directions. The piles should not be too high nor spread over too much ground. Railroad facilities should be available for the movement of supplies to and from the depot. There should be ample turn-around facilities for vehicles around the tracks and enclosed warehouses.

■ 37. OPERATIONS.—*a.* As the supply system must be flexible to meet the constantly changing situations, so must the organization and operation of the quartermaster depots be flexible and assure that troops in the combat zone can secure the required supplies promptly and on short notice. In order to accomplish this, requisitions must be reduced to a minimum and the method of issue so simplified that any essential article can be issued without delay.

b. Quartermaster depots may be required to operate under either of the following systems:

(1) Credits may be set up in the depot upon the order of the theater commander. These credits may be allotted for either the army as a whole or for the various divisions or corps and army troops of the army. These credits may be set up in terms of days of supply of the various items and will be available to the limit of established credits. Upon call by the unit to which the credits have been allocated, the depots must be prepared to ship by rail to the appointed supply point any supplies called for under the terms of the credit, or to issue at the depot to vehicles of the unit concerned any supplies desired.

(2) When credits have not been established, all supplies are secured through the medium of requisitions and must bear the approval of the army quartermaster and the quartermaster, communications zone. As soon as the supplies have been made available within the various depots, the requisitioning agency may send organic transportation to the depot to draw the supplies, or may request that the supplies be shipped by rail to a designated railhead or by motor convoy to a designated truckhead.

c. When supplies are not available within the depot, the depot commander should extract the unfilled requisitions

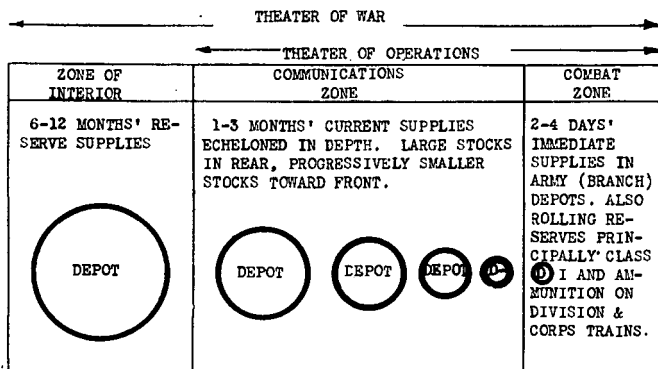

FIGURE 5.—Echelonment of supplies in theater of war.

to the communications zone quartermaster, who will designate other depots to fill them, or call on the zone of interior for the supplies.

■ 38. STOCKAGES.—Normally there will be from 1 to 3 months of current supplies echeloned in depth from the largest stocks in the rearmost depot to the smaller stocks toward the front. In addition to the supplies maintained in the communications zone, a few days of immediate supplies are usually held available in army depots. Figure 5 shows the echelonment of supplies stocked in the various depots.

■ 39. QUARTERMASTER COMPANY DEPOT (SUPPLY).—a. This is the administrative and technical unit for operating a quartermaster supply depot other than motor transport and remount.

It has the capacity to supply all classes of quartermaster supply, except animals and motor transports, to maintain 60,000 men under war conditions. Two or more companies can be combined to supply personnel to the larger depots in the communications zone. The company is divided into a company headquarters, a depot headquarters platoon, and a storage platoon. The company is commanded by a captain who supervises the administrative and record work of the depot.

b. The company headquarters provides the personnel for the interior economy of the company, including messing, supplies, and clerical work.

c. The depot headquarters platoon furnishes the personnel required to handle the clerical work of the depot and to maintain the depot utilities. Sufficient office personnel is provided so as to permit organization of the depot along commodity lines, one section for subsistence, one for clothing and equipage, and one for general supplies.

d. The storage platoon furnishes the personnel necessary for the receipt, storage, warehousing, and issue of supplies in the depot. (See T/O 10-227.)

SECTION IV

REGULATING STATIONS

■ 40. GENERAL.—Regulating stations are traffic control agencies designed to maintain regularity in supply and evacuation movements to, within, and from the combat zone, communications zone, and, when necessary, from the zone of the interior to the theater of operations.

a. Regulating stations are established on the lines of communication. They are provided usually at the rate of one for each army or similar command. Each of the regulating stations serves a definite area of the combat zone delimited on the basis of the available lines of communication, the strength of the forces involved, and the capacity of the station. If conditions permit, each area should be coincident with an army area in the combat zone.

b. Regulating officers operate under the orders of the theater commanders as traffic control agencies.

c. Owing to the dangers of interruption of railway transportation by hostile aircraft, it is necessary to supplement

the railway transportation service. Motor transportation is ideally suited for this, and a representative of the motor transport service should be on the staff of all regulating officers. Detailed plans should be prepared for the prompt substitution of motor service when railroad transportation is disrupted. In such a contingency the regulating officer will also have authority under general control of the theater headquarters to control all road traffic between the communications zone and the army service area.

d. Even though all lines are functioning normally, less than carload lots of supplies may often be shipped from the communications zone depot to army depots by motor rather than by rail. The coordination of this type of shipments will be handled by the motor transport officer on the staff of the regulating officer. (See FM 100-10.)

■ 41. RELATIONSHIP BETWEEN REGULATING OFFICER, THEATER COMMANDER, AND COMMANDERS OF COMMUNICATIONS ZONE AND ARMY.—The regulating officer is the direct representative of the commander of the theater of operations, and operates under his orders.

a. The communications zone commander is responsible for the maintenance of stocks in the depots supplying the combat zone and for the operation of the military railway service. Under policies formulated by theater headquarters, he designates the depots in which the army is given credits, the locations to which salvage is to be evacuated, and the number of trains and other railway equipment to be made available to the regulating officer.

b. The principal job of the regulating officer is to meet the needs of the army for supply and evacuation within the limitations of the facilities at his disposition. He must be kept informed of pending operations and contemplated changes in locations of army depots and railheads.

c. The regulating station must be in direct communication with theater headquarters. It must be in close touch at all times with communications zone headquarters and installations. Between the regulating station and army headquarters and depots there should be a continued interchange of information and advice. The regulating station system provides the elasticity, mobility, safety, and secrecy essential to large scale operations in modern warfare, and provides the

commander of the theater of operations the desired degree of control over movements of troops, supplies, and evacuation.

d. Figure 6 shows the relationship between the regulating officer, the commanding general of the theater of operations, the army commander, and the commanding general of the communications zone. Command is exercised by the commanding general, theater of operations, through the commanding general of the communications zone, the regulating officer, and the army commander. The regulating officer's primary function is the coordination of supplies between the communications zone and the army. (See also FM 100-10.)

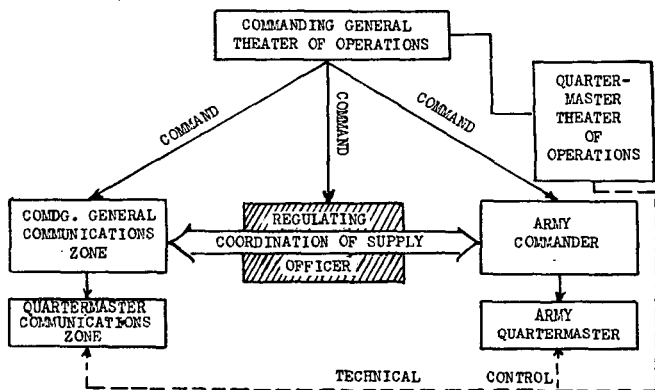

FIGURE 6.—Regulating officer's relationship to theater of operations commanders and quartermasters.

■ 42. KINDS OF REGULATING STATIONS.—a. There are two kinds of regulating stations, primary and secondary.

(1) Secondary stations are temporary in character, consisting essentially of sufficient tracks to allow trains, made up for divisions at the communications zone depots, to be switched as necessary and routed to their railheads.

(2) Primary regulating stations, on the other hand, are of a more permanent character and have yard and switching facilities, when possible, at the junction point of several routes leading from the various depots and installations in the rear from which supplies and replacements are drawn.

b. Secondary regulating stations represent the first effort of the military forces operating in a theater of operations to

relieve congestion at the depots by establishing the place for regulation of trains at least several miles from the depots and at points convenient to the front. They may also be used in the rapid advance of mobile warfare. Since this type of station has no facilities normally for the make-up of trains, the daily trains are made up, as far as possible, at the depots, cars being added, as necessary, with class II, III, and IV supplies when such supplies are shipped to railheads. (See also TM 5-400.)

■ 43. LOCATION.—Flexibility and mobility in the use of the communications net are obtained by establishing regulating stations in the communications zone at or near the rear boundary of the combat zone and, when necessary, at or near the rear boundary of the theater of operations. When the situation permits, a regulating station should be established at a location where the necessary facilities exist or can be quickly provided. Preferably, it should be located at a junction of two or more routes leading from the supply and evacuation establishments in rear of the combat zone. It is also desirable that two or more separate routes lead to the area served by the station. It should be linked with other regulating stations so that traffic may be maneuvered laterally as well as to and from the combat zone. The regulating station should be located near enough to the combat zone to enable trains departing about dark, to arrive at their destination before daylight. It must also be far enough to the rear to be reasonably safe from enemy activities. (See FM 100-10.)

■ 44. ORGANIZATION.—An outline of a regulating station organization is shown in FM 100-10. A tentative functional diagram of a regulating station organization is shown in figure 7; however, this figure is merely to indicate a type set-up to be modified as required.

a. The regulating officer commands the station. He is the direct representative of the commander of the theater of operations and responsible only to him. He is provided with the necessary operating personnel and suitable staff assistants. He is responsible for the systematic and orderly movement of supplies and reinforcements from the regulating station to the front and for the movement by rail of the sick and wounded men and animals, prisoners of war, and matériel to the rear.

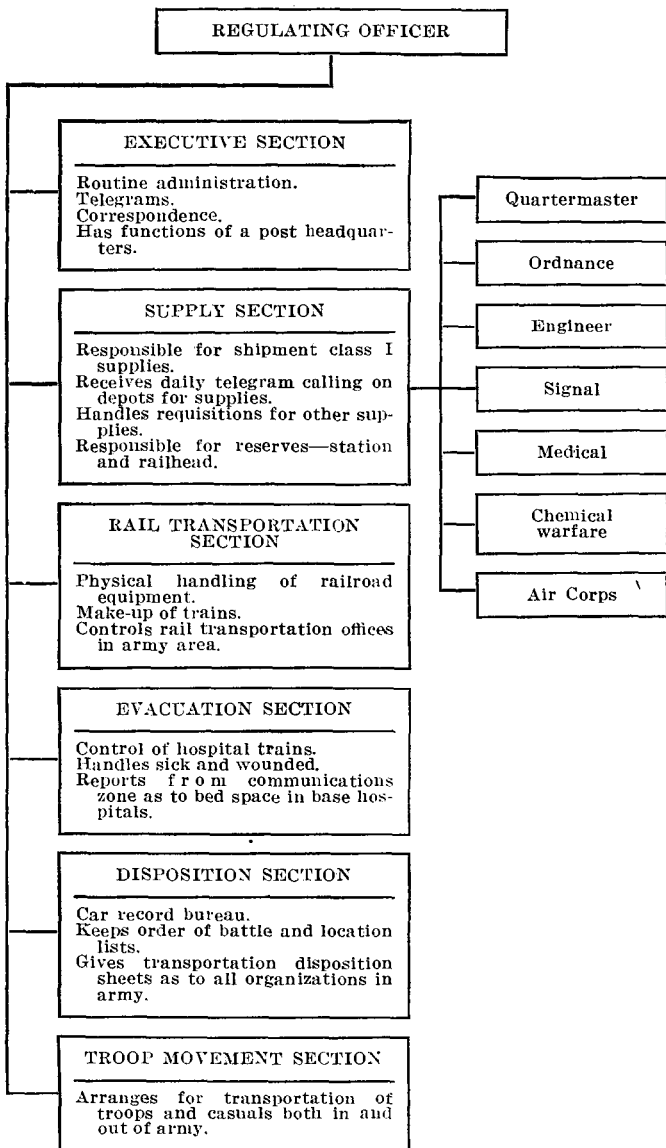

FIGURE 7.—Functional diagram of a primary regulating station organization.

b. A superintendent of the military railway service is assigned to the staff of the regulating officer. He is directly responsible for the movement of all trains in accordance with the instructions and priorities received from the regulating officer.

c. The quartermaster transportation section should have a troop movement branch and supply movement branch. This section receives the requests for rail movements, assembles the requirements for railway transport, arranges with the superintendent, military railways, for the necessary movements, and insures that movements to the combat zone are in accordance with priorities established by the regulating officer.

d. The medical evacuation section, under a medical officer, is charged with effecting the necessary arrangements for the movement of sick and wounded men and animals from army evacuation hospitals to general hospitals in the communications zone. The evacuation of men is accomplished by the use of specially equipped hospital trains placed at the disposition of the regulating officer. This section maintains a record of the credits in beds in the communications zone hospitals. The evacuation of animals is usually made in stock trains.

e. Each supply section is in charge of a representative of the particular chief of supply service concerned. Each has, in general, the functions of any supply office. It receives requests from the army, transmits the tonnage, car, or train requirements to the quartermaster transportation section, follows up the arrangements made for shipping, and notifies the army when shipments may be expected.

f. The adjutant's section is responsible for making arrangements, through the quartermaster transportation section, for the movement of personnel replacements, adjutant's department supplies, and mail. It follows up these shipments and advises the army when they may be expected to arrive. Normally the chief of this section will have charge of the postal regulating station which handles the reception and sorting of mail dispatched to or from the combat zone.

■ 45. INSTALLATIONS.—For a regulating station serving an army, when possible, there should be provided approximately four receiving tracks, eight classification tracks, eight de-

parture tracks, four storage tracks for reserve supplies, two extra tracks for emergencies, and two tracks for bad order cars. Each of these tracks should be able to accommodate a full standard train length. In addition, there should be provided about 2 miles of track for engine overhaul facilities and about 2 miles of track for switching facilities for the services having stocks of emergency supplies at the regulating station. (See FM 100-10.)

a. In addition to the necessary trackage and switching facilities, a regulating station will require storage space for the supply of the personnel of the station; a warehouse or freight shed for handling mail, baggage, express, and less than carload shipments; another for handling small components of the ration, if these are not received from the depots packed in unit sections; and facilities for handling casualties and prisoners of war.

b. Since a regulating station is primarily a traffic control agency, large depots should not be located near it. The transloading of supplies for storage and issue is not a normal function of the regulating station, and will cause such a congestion as to defeat the object of the regulating station.

■ 46. OPERATION.—Class I supplies are received at the regulating station in several ways:

a. In unit sections of the daily train, each section loaded with 1 day of supply for the specific organization to which assigned. This method is preferred when the situation permits, as the unit sections, as soon as checked, can be shifted to the departure tracks where cars containing mail, casualties, or other supplies are added. This method greatly simplifies the operations of the regulating station.

b. In unit sections of the daily train, each section loaded with 1 day of supply for units approximating the strength of a division. This simplifies the operations at the communications zone depot, and gives greater flexibility in the use of the unit sections by the regulating station.

c. In bulk train shipments, each train being loaded with carloads of but one kind of supply, such as bread, meat, other ration items, hay, grain, gasoline, or oil.

d. A combination of *a* or *b* and *c*, daily train sections being limited to 1 day of supply of designated ration items, other items being received in bulk train shipments.

e. Figure 8 shows the schematic method of operating the

regulating station with reference to class I supplies. The various train loads of rations and other components of class I and III supplies are received at the regulating station where they are broken down and sorted into unit lots for the daily train.

f. When trains are received at the regulating station under *c* or *d* method, they are taken at once to the receiving tracks of a regulating station. There the cars are checked by numbers and by contents; when the checking operation is completed the train is broken up. Cars, the contents of which have to be rehandled before attachment to the daily supply trains, are switched on the sidings which serve the mobile storage installations of the Quartermaster Corps or other supply services, or they are placed on the siding where less than carload (LCL) shipments are handled.

g. Loaded cars which do not have to be rehandled before entering into the composition of a daily train are shunted to the classification tracks marked "F" on the diagram. The tracks in this yard are specialized by commodities. In other words, one track will have on it only cars of oats, another track, cars of hay, another, cars of bread, etc.

h. The unit sections of a daily train are made up in the classification yard "F" by taking the proper number of cars from each track. To these cars are added those containing mail, other supplies, casualties, or less than carload shipments. When such sections are made up they are switched to the departure yard "A" where they remain until their departure for the railheads. Only at the last moment are cars containing personnel, animals, or mail attached to the waiting supply trains. These daily trains are run on regular schedules, and should be so timed as to arrive at the railhead preferably not later than midnight. Immediately upon the departure of each daily train from the regulating station the railhead officer concerned is given information of the departure of the train and is advised as to the car numbers and the contents of each car. It is desirable that all locomotives be used to their full capacity, and for this reason when the rail net serves more than one division, a daily supply train usually is made up of two or three unit sections.

i. Upon the return of the supply trains to the regulating station, inverse operations to those described in the preceding paragraphs are not generally the case. Only cars bringing

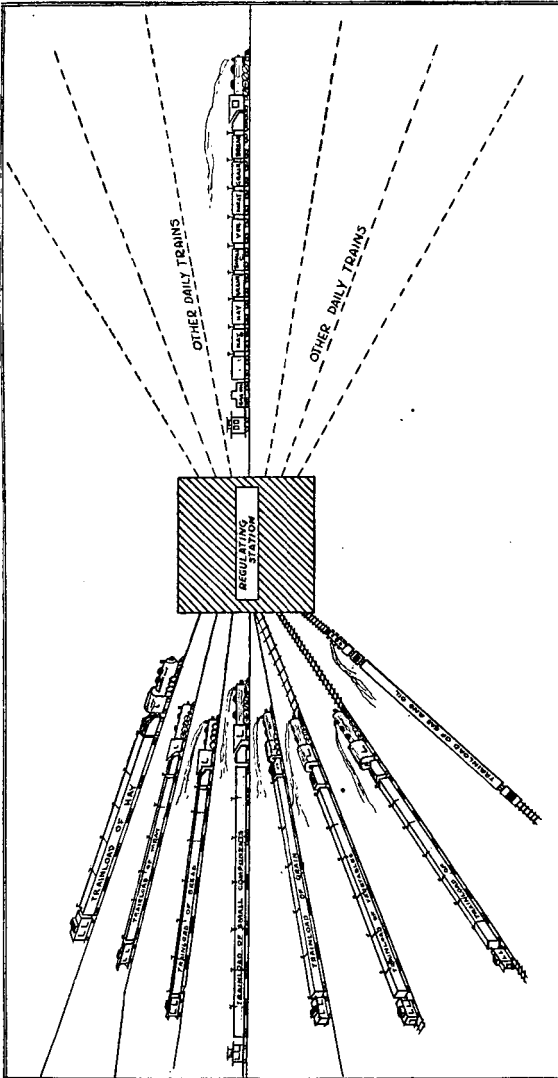

FIGURE 8.—Receipt and reshipment of class I supplies at regulating station.

back supplies or materials which are to be held temporarily at the regulating station are allowed to remain there. All empty cars remain at the regulating station as short a time as possible and are sent to large railway centers in the communications zone.

■ 47. **AMMUNITION AND BULK SUPPLIES.**—Shipments of ammunition, engineer supplies, such as road-building material, and other bulk supplies, are handled, as far as possible, by complete train shipments. Depots in the communications zone load complete trainloads of ammunition and other bulk supplies, and those trains are moved without delay direct through the regulating station, or preferably around it, to the proper supply points. Under no circumstances are ammunition trains stored in the regulating stations. When mobile reserves of ammunition and gasoline are required to be temporarily stored in the vicinity of the regulating station, they should be stored a few miles away from the station itself.

■ 48. **EVACUATION.**—The evacuation of sick and wounded is handled by the employment of specially equipped hospital trains which are assigned to and controlled by the regulating station. These trains are routed forward to army evacuation hospitals and from there back to general hospitals in the communications zone or zone of the interior, through the regulating station. When casualties have been heavy the regulating officer may have to use any empty rolling stock which is in his yards to make up special trains for evacuation. The medical officer on the staff of the regulating officer is given credits by the surgeon, communications zone, under policies formulated by theater headquarters, in numbers of beds in various hospitals in the communications zone or the zone of the interior. He receives information from the army of the cases to be evacuated from the various hospitals and he then arranges with the superintendent, military railway service, for the dispatch of hospital trains which are held on sidings at strategical points near the regulating station. The evacuation of sick and wounded animals is handled in a similar manner, using stock trains specially fitted up for the purpose.

■ 49. **PERSONNEL.**—Replacements should not be sent in as individuals. They should be formed into detachments at the replacement depots, under an officer or noncommissioned

officer for particular units. Much confusion and congestion would be caused at regulating stations by detraining casualties and replacements and sorting them out for dispatch to their proper organizations. Large troop movements are handled by the regulating officer just as any other movement into or from the combat zone. If possible, however, it is desirable to route these trains around the regulating station.

■ 50. MOTOR OR ANIMAL TRANSPORTATION.—The fundamental factors governing the organization and establishment of regulating stations on the rail net are applicable to organized roadways when it is necessary to employ motor or animal-drawn transport columns to supplement the railways between the communications zone and the combat zone. In order to meet the conditions so imposed, motor or animal-drawn transport columns are organized in the communications zone and dispatched through regulating stations established at points best located to meet the needs of the combat troops. Under these conditions, regulating stations are pushed as far forward as safety permits.

SECTION V

RAILHEADS

■ 51. GENERAL.—A railhead is a point on a railroad designated as such which provides rail accommodations for the unit it is designated to serve. Railheads are agencies of the regulating station and are operated by quartermaster railhead companies under the supervision of the regulating officer. The responsibility of the regulating officer for supplies begins when the supplies have been turned over to him by the communications zone. The regulating officer's responsibility ceases when he has delivered the supplies to the troops at the proper railhead. A railhead may serve one or two divisions or similar units. (See also FM 100-10.)

■ 52. CHARACTERISTICS.—Any railway station that is to be used as a railhead for a considerable length of time should possess the following characteristics:

- a. Located as conveniently as possible to the units to be served but beyond the effective range of hostile artillery.
- b. Storage facilities, both open and closed, sufficient to care for the supplies to be maintained.

c. Receiving, switching, and spare sidings. A siding capacity of eleven 36-foot cars is ample for the unit section of a daily train for one division. Greater siding capacity, therefore, may permit two such trains to be at the railhead at the same time. This will permit the class I supply of more than one division, or an additional train with other than class I supplies.

d. Unloading platforms for supplies, personnel, and animals.

e. Good highway facilities.

f. Space in and around the station sufficient for trucks to keep off the main highway while at the railhead, and also for the necessary maneuver of vehicles during the operation of loading. (See fig. 9.)

■ 53. OPERATION.—*a. Personnel.*—Railheads and railhead personnel are exempted from the control of commanders of tactical units in whose territorial jurisdiction they may be located, except in matters of police, traffic control, and measures for the enforcement of sanitation and safety. In emergencies, when railhead or service troops are insufficient to meet the requirements in labor, the railhead officer may call upon the nearest military commander for assistance.

b. Railhead officer.—Each railhead is commanded by a railhead officer who is responsible for the efficient operation of his installation. He commands by virtue of authority delegated to him by the commander of the theater of operations, through the regulating officer. He receives his instructions from the latter, and is assisted by suitable personnel from the services interested (See also FM 100-10.) His duties are the following:

(1) He is charged with the reception, unloading, custody, and delivery of all supplies received at his station. He is warned by his railway transportation officer of the probable hour of arrival of trains and must make arrangements to unload all cars with utmost dispatch. These cars should be released without delay.

(2) He is responsible for the sanitation and appearance of his yards and all grounds adjacent thereto.

(3) Whenever a railhead is located at a commercial station, a station not devoted entirely to military purposes, he must exercise particular care not to encroach upon portions of the yard reserved for commercial purposes. He

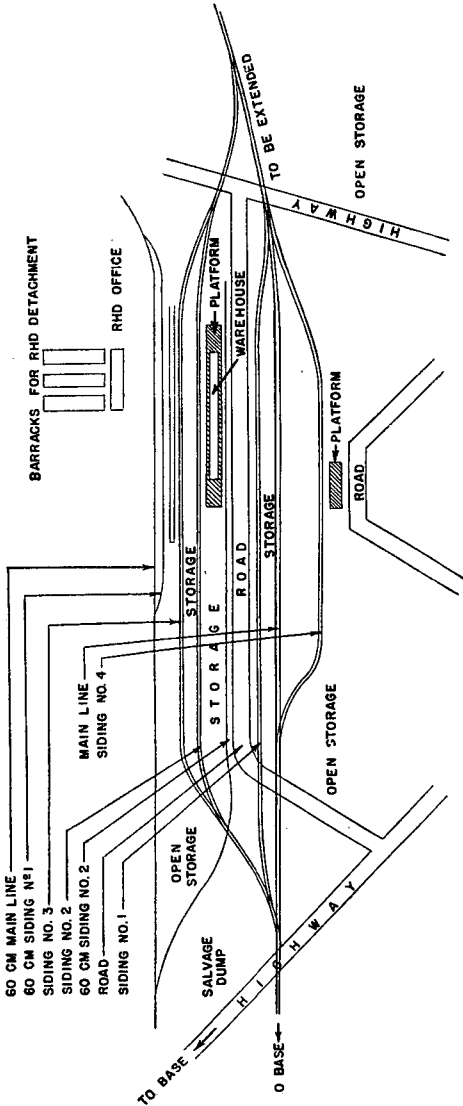

FIGURE 9.—Plan showing layout of model railroad.

should establish friendly relations with the station agent and the commercial railway personnel on duty thereat.

(4) He should take special precautions to keep the loading platforms and the ground near the tracks clear.

(5) He distributes to the division quartermaster, or other supply officer, the daily class I supplies of rations and forage based upon the actual strength of the organization in men and animals, and all other items of class I supplies on actual requirements. Other supplies are distributed in accordance with the original demand for them.

(6) Records are kept showing the receipts, issue, and disposition of all supplies received.

(7) Under such regulations as may be prescribed by the regulating officer, he receives and ships all salvage and surplus property delivered to him.

(8) By means of a daily report of the actual issues and stock on hand of the main items of class I supply, he keeps the regulating officer informed as to conditions at the railhead, which enables the regulating officer to adjust the loads of the daily trains to meet actual requirements of the troops and to assure the proper level of railhead reserves.

(9) He, or a commissioned assistant, inspects the contents of each car and verifies its quantity and condition.

c. Railway transportation officer.—The railhead officer has associated with him as his subordinate a railway transportation officer to cooperate in matters of railway operation. The railway transportation officer is a representative of the rail transport service and, in all matters of railway operation, reports to and receives his orders from his division superintendent. Actually he is a military station agent. In cooperation with the railhead officer he should, by all means in his power, expedite the movement, release, and return of all railway rolling stock and free the railhead as rapidly as possible of railway equipment. He keeps a car record showing the car number, date of arrival and departure, and contents.

■ 54. RAILHEAD COMPANY.—*a.* A quartermaster railhead company (T/O 10-197) is organized for the purpose of operating the railhead. This company is organized into a company headquarters and three platoons, and has a capacity to receive, issue, and evacuate all class I, II, III, and IV supplies (except ammunition and animals) required to maintain

25,000 men. The company headquarters supervises the operations and is responsible for all administrative duties pertaining to the company.

b. The platoon is the basic operating unit. It is divided into two sections for convenience in staggering working hours, or for the purpose of handling specific commodity classes of supplies. (See also FM 100-10.)

■ 55. DAILY TRAIN.—*a.* A daily train is usually accompanied by a noncommissioned officer from the regulating station who turns over to the railhead officer the invoice of the shipment. This invoice is used either by the lieutenant in charge of records or the lieutenant in charge of operations in inspecting the contents of each car. The inspection is facilitated by the loading slip, duly verified, which is tacked in a conspicuous place in each car near the door. In open cars, the slips are tacked in places protected from the weather. The loading slips show the car number, contents, weights or quantities, and the consignee.

b. As the railhead officer (or his representative) inspects each car, unloading details with checkers are present to begin unloading the supplies, either placing them in the storehouses and open storage, or issuing them direct to vehicles. Where the loading slip and the checker's list do not agree, a report is made to the regulating officer setting forth the discrepancies in detail. Hay and grain are placed in open storage on dunnage and under paulins, while rations are stored under cover. Fuel and gasoline are placed in open storage. (See also FM 100-10.)

■ 56. RAILHEAD RESERVES.—*a.* A railhead reserve consists of such items as may be prescribed by the division or higher commander. A class I supply railhead will normally stock reserves to an amount prescribed by the division or higher commander in all stabilized situations. In mobile situations the tactical situation, type of combat, facilities available, the terrain, and the danger of hostile interruption of lines of communication will all influence the commander's decision as to the type and quantity of reserves. In general, it can be said that 1 day of class I supplies normally will be carried at each railhead. If, however, a river must be crossed in supplying the troops, and there is danger of interruption by hostile air attack, additional days of supply should be concentrated in the railheads in the amount decided upon by

the commanders. In some instances the advance or withdrawal may be so rapid as to preclude the maintenance of a railhead reserve. (See also FM 100-10 and 10-5.)

b. Between the submission of the daily telegram and the receipt of the supplies by the division quartermaster there will be a lapsed period of several days. This is known as the "time lag." The length of this time lag may vary from 1 to 5 days. During this period, changes in the strength of the organizations both in men and animals may take place. To compensate for these fluctuations a small railhead reserve becomes automatically established to compensate for these differences. For example, daily telegrams submitted on each of the following days show the strength of the division:

<u>Jan. 10</u>	<u>Jan. 11</u>	<u>Jan. 12</u>	<u>Jan. 13</u>	<u>Jan. 14</u>
11,298	11,201	10,200	9,703	12,772

The time lag from date of submission of the daily telegram until supplies are received by the division quartermaster is assumed to be 3 days. Therefore, the supplies ordered January 10th will be received night January 13-14, and supplies ordered January 11th, will be received night January 14-15. However, the telegram of January 10th called for supplies for 11,298 men, but when received night January 13-14 the division has only 9,703 men. The quantity of supplies for the difference of 1,595 men is placed in the railhead reserve. On January 11th, the telegram called for supplies for 11,201 men, but when the supplies are received night January 14-15, the division has 12,772 men and there will be a shortage of 1,571 rations. On night January 13-14, however, 1,595 rations were placed in the railhead reserve and these are now available to the railhead officer to make up the shortage. As only 1,571 rations are required, there will still be a railhead reserve of 24 rations available for future issues.

c. In cases where the quantity of rations received at the railhead is less than that required by the division and there is no railhead reserve, special provisions will have to be improvised by the command until this shortage has been adjusted.

d. Shortages may also be made up from such railhead reserves as may be prescribed by the commander, for in those instances 1 or more days of supply are maintained for the entire division. This reserve, however, will also fluctuate, based upon the time lag.

CHAPTER 3

SUPPLY INSTALLATIONS

SECTION		Paragraphs
I.	Salvage and related activities.....	57-62
II.	Subsistence.....	63-65
III.	Gasoline and oil supply.....	66-67
IV.	Remount depot.....	68-70
V.	Personnel replacement.....	71-80

SECTION I

SALVAGE AND RELATED ACTIVITIES

■ 57. GENERAL.—*a.* The prompt salvage of equipment and material which are partially worn out or abandoned on the battlefield and in camps and bivouacs, together with the exploitation of captured material, makes available considerable quantities of supplies for issue to the troops and lightens the burden on the lines of communication incident to the transportation of supplies from the rear. (See also FM 10-5.)

b. A salvage service is organized in the theater of operations for the purpose of collecting and sorting all abandoned and unserviceable property. Fundamentally, salvage operations in the combat zone are organized and executed under the direction of army headquarters. During periods of stabilization, corps and division commanders may be made responsible for salvage operations within their commands.

c. Salvage property is collected at points so located as to permit its transportation by empty vehicles moving to the rear. Articles which cannot be placed in serviceable condition for reissue to troops by facilities at the disposition of the army are evacuated to railheads.

d. Arms and equipment of the sick and wounded are collected at hospitalization establishments and turned over to the salvage services.

e. In order to insure the proper sorting of salvage property, it is essential that the several services be represented by competent personnel at points where salvage is collected.

f. Salvage property not required in the army is evacuated as rapidly as conditions permit to designated depots of the communications zone or zone of the interior.

g. In war, two agencies cooperate in the recovery of salvage materials. Organizations collect and return to dumps or railheads all unserviceable and excess supplies, and quartermaster salvage collecting companies collect, sort, and classify all salvage and waste material.

h. Salvage materials collected in the combat zone are taken to salvage dumps or collecting stations which are established at convenient points along railways, roads, or other avenues of communication. At salvage dumps the materials are carefully inspected by quartermaster salvage collecting companies and separated into two classes:

- (1) That which is new or fit for immediate reissue.
- (2) That which is to be sent back to salvage depots.

i. Salvaged optical instruments should be rolled in burlap bags, tied, and labeled in letters not less than 1 inch high, **OPTICAL INSTRUMENTS—HANDLE WITH CARE.** Optical instruments are never allowed to accumulate, but are shipped at once to the nearest ordnance shop or depot.

j. Rifles should be dipped in an oil bath and securely tied in bundles of three, two with butts down, with a rope or piece of canvas between them to prevent marring.

k. Before beginning the collection on a battlefield an officer should make a preliminary survey for the following purposes:

- (1) To locate the places containing the largest quantity of material.
- (2) To determine the amount of labor necessary.
- (3) To determine the best arrangement for evacuation.

l. Salvage officers should keep a general receipt and expended or issue account of all articles handled by them.

m. The corps or army quartermaster will normally have as his assistants the necessary quartermaster officers to supervise salvage activities pertaining to his command. (See FM 100-10 and 10-5.)

■ 58. **SALVAGE COLLECTING COMPANY.**—This unit is designed for the receipt, collection, sorting, and basic classification of all classes of salvage at salvage collecting points, salvage dumps, and at railheads and to evacuate it to salvage depots in the communications zone. It is organized into three platoons of two sections each, the sections having two squads. It has ordnance, chemical, and signal personnel attached. (See T/O 10-187 and FM 10-5.)

■ 59. HEADQUARTERS, QUARTERMASTER SALVAGE DEPOT.—The organization for the headquarters of a quartermaster salvage depot has been designed to repair and reclaim damaged, un-serviceable, and abandoned quartermaster property and materials recovered from the battlefield and after repair to dispose of it by returning it to quartermaster depots for re-issue. This unit provides for the officers and enlisted men required to operate and maintain the depot and its repair equipment and to supervise the personnel and repair work of the installation. The actual repair work is performed by civilians or enlisted men who are specialists in the manufacture or repair of the various classes of equipment and supplies that will probably have to be handled. The salvage depot repairs only articles of quartermaster issue and reships to salvage depots of other supply services the reparable items and reclaimable materials pertaining to the respective service which have been received at the quartermaster salvage depot. The headquarters, quartermaster salvage depot, is organized as shown in T/O 10-250. (See FM 10-5.)

a. Administrative division.—The administrative division is subdivided into two branches, the administrative and the service branch. The administrative branch of this division maintains the records and performs the military and technical paper work incident to the operation of the depot and its personnel. The service branch is subdivided into supply, utilities, and maintenance sections. The supply section of the service branch handles all classes of supply for the depot, including clothing and rations for the personnel employed and all of the machinery, tools, and technical operating supplies required in the repair shops. The utilities section maintains the building, grounds, and machinery, including the operation of the power and heating plant. The maintenance section provides watchman service, operates a general mess, and provides the transportation required about the depot.

b. Salvage division.—This division is divided into administrative, classification, disposal, and storage branches. The administrative branch of this division supervises the activities of the division in general, including the assignment of personnel and the maintenance of salvage records. The classification branch supervises the receipt of salvage sent to the depot, its classification, and distributes the various

classes and items to the proper shops of the repair division and/or the storage branch. The disposal branch is charged with the disposal of waste materials and nonreclaimable and nonreparable property. The storage branch is charged with the storage and disposition by issue or shipment to depots of the various supply arms and services, of the serviceable and repaired property.

c. Repair division.—The repair division is subdivided into six branches. This division repairs only items of common issue to all branches of the service. It does not repair motor vehicles, weapons, aircraft, radios, or other technical Signal Corps, Medical Department, or Chemical Warfare Service equipment; such material is repaired in shops especially designed for this class of work and operated by the respective supply services. The administrative branch supervises the activities of the division in general, including the assignment of personnel and the maintenance of the repair records. The clothing and textile branch is charged with the repair of clothing, fabric headwear, bedding, blankets, and other supplies of a textile nature. The shoe and leather goods branch is charged with the repair of shoes, harness, saddlery, and other articles fabricated from leather. The canvas and webbing branch is charged with the repair of tentage, paulins, web equipment, upholstery, and other articles made of canvas or web materials. The machinery and metal goods branch is charged with the repair of mechanical equipment, animal-drawn transportation, tools, laundry and bakery equipment, and other supplies fabricated from metal. The miscellaneous branch is charged with the operation of several miscellaneous shops for the repair of band instruments, typewriters, rubber goods, and other supplies not falling definitely into the classes repaired by other branches of the repair division.

■ 60. STERILIZATION AND BATH.—*a. Battalion sterilization and bath.*—(1) The quartermaster sterilization and bath battalion or company has the mission of divesting personnel and clothing of lice and similar parasites. This mission is accomplished by providing hot water shower baths, medical examinations, and a change of clothing for personnel. Clothing removed from infested personnel is sterilized and that which needs no repair is laundered by a quartermaster laundry company and made available for reissue immediately. Clothing which needs

repair is sent back to the salvage depot for repair and then placed in stock.

(2) The battalion headquarters and headquarters detachment supervises the administration, supply, and technical operations of the battalion as a whole. The battalion headquarters personnel is attached to one of the companies for rations and quarters.

b. Company sterilization and bath.—The company is composed of a company headquarters, a supply platoon, and a sterilization and bath platoon. (See T/O 10-177.)

(1) The company headquarters administers, supplies, messes, and supervises the technical operations of the company as a whole. It consists of the company commander and 22 enlisted men. To process, that is, to bathe, physically examine, and reclothe the number of troops listed as the daily capacity of the company (2,500) in 10 hours, all of the platoons, sections, and squads are required.

(2) The supply platoon fits and issues clean clothing to the troops and disposes of the soiled clothing, after it has been sterilized, by sending it to a quartermaster laundry company for further renovation, or to salvage if not reissuable.

(3) The sterilization and bath platoon operates the steam sterilizers and provides the bathing service.

(4) It takes about 45 minutes for a soldier to pass through the plant, this time being divided about as follows:

	<i>Minutes</i>	
Undressing -----	5	}
Bathing -----	15	
Medical examination -----	5	
Drawing clean clothing -----	10	
Dressing -----	10	

Includes time of passing from one "station" to another.

(5) The steam sterilizers and the shower baths are installed on the 5-ton sterilization and bath semitrailers, one to each of the four sections of the sterilization and bath platoons; a 5-ton tractor truck is provided for each of these semitrailers. Each of the four issue squads in the supply section of the supply platoon has a 2½-ton cargo truck with 1-ton trailer. The clean articles of clothing which are issued to the soldier consist of one each of undershirt, underdrawers, socks (pair), shirt, trousers, coat, overcoat and mittens (pair) (if cold weather), cap or hat, waist belt, handkerchief, leggings (pair),

and shoes (pair) if required. The clothing issue, fitting, and exchange are handled by the squads of the supply section, and the salvage by the salvage section, of the supply platoon. The processing of the men through the unit is administered by the supply platoon headquarters.

(6) Buildings or tentage may be used for undressing, medical examination, dressing, and salvage operations. Steam and hot water for the sterilization of the clothing and for the baths are generated on the semitrailer. An ample supply of water must be available.

■ 61. LAUNDRY.—*a. Quartermaster laundry battalion.*—The quartermaster laundry battalion is composed of a battalion headquarters and headquarters detachment and four laundry companies. The quartermaster laundry battalion has sufficient personnel and equipment to serve a force of 144,000 men weekly and is organized in accordance with T/O 10-165.

b. Quartermaster laundry company.—The quartermaster laundry company is a mobile unit and can provide weekly laundry service to a force of 36,000 men by washing 36,000 each of shirts, socks (pairs), towels, trousers, undershirts, and underdrawers. These operations do not include ironing, dry-cleaning, or degassing. This weekly capacity is based on two 6-hour operating shifts per day. The company is organized in accordance with T/O 10-167.

(1) The company headquarters performs the usual administrative and technical supervisory functions for the company as a whole.

(2) The platoon is the basic operating unit and is self-contained. It can provide weekly laundry service to a force of 9,000 men by washing 9,000 each of shirts, socks (pairs), towels, trousers, undershirts, and underdrawers. The distribution and number of personnel permits working two 6-hour shifts per day which can be lengthened, if necessary.

(3) The laundry company is mobile, all of its operating equipment being mounted on laundry semitrailer vans. Tractor trucks are provided to move the unit from one location to another.

(4) Each platoon has four semitrailer vans, laundry, 5-ton, on which are mounted electric motor-driven washing machines, extractors, and tumblers; also, equipment for furnishing steam and hot water. One 1½-ton cargo truck and a 1-ton trailer are provided to each platoon for local hauling needs.

■ 62. SHOE, CLOTHING, AND TEXTILE REPAIR.—The quartermaster mobile shoe and textile repair company is a unit provided for the purpose of accomplishing shoe, clothing, and textile repairs with or in close proximity to the troops in order to reduce excessive movements along the line of communications and to be able to reissue the shoes, clothing, and textile equipment in less time than that involved where shoes, clothing, and textile equipment must be shipped long distances to the rear for repair.

a. The company has a strength of 3 officers and 199 enlisted men, and is organized into a company headquarters and two 2-section platoons. (See T/O 10-237.)

b. The section is the basic repair unit, with its own foreman, operators, and equipment. The platoon is merely a combination of two sections, with the addition of a shoe machine mechanic and a sewing machine mechanic. It has six semi-trailer vans, two for shoe repair, two for clothing repair, and two for textile equipment repair; it is equipped with shoe and sewing machines and other necessary equipment. It also has six tractor-trucks, 4- to 5-ton, as organic transportation for the shop vans.

SECTION II

SUBSISTENCE

■ 63. COMMISSARY COMPANY.—a. The sales commissary company has a strength of 4 officers and 201 enlisted men. It is composed of a company headquarters and three platoons of four sections each. It is equipped with three trailers per section, one for sales, one for administration, and one for stock. (See T/O 10-157.) The company headquarters performs the usual administrative and "housekeeping" functions for the company as a whole, and supervises the sales activities and the property and money accounts of the operating platoons and sections.

b. The sales commissary company operates the general sales stores in the communications zone. It is the largest unit of its type and is capable of serving about 120,000 troops. Although its primary function is to provide this service for troops in the combat zone, the organization is such that a mobile unit operated by a section capable of serving 10,000 troops may be set up at any desirable point in the communi-

cations zone as well as the combat zone. Likewise, larger stores operated by a platoon of four sections or any combination of sections, each section serving about 10,000 troops, may be operated as the necessity arises.

c. Items to be sold will be designated by proper authority. These items will be procured from depots operating within the communications zone or from other sources as directed.

d. Authorized individuals, organizations, and messes as designated by proper authority may purchase at the general sales store. Records, accounts, etc., will be maintained as directed for the operation of sales commissaries in existing regulations or current orders. (See FM 10-5.)

■ 64. BAKERY BATTALION.—a. The quartermaster bakery battalion has a strength of 23 officers and 645 enlisted men, and is organized into a battalion headquarters and headquarters detachment and four companies. The bakery battalion has a daily capacity to bake sufficient fresh bread to supply approximately 160,000 men. (See T/O 10-145.)

b. The quartermaster bakery company, 5 officers and 158 enlisted men, has a baking capacity per day capable of serving 40,000 troops. It is organized into a company headquarters and four platoons. (See T/O 10-147.)

c. The bakery platoon, with 1 officer and 35 enlisted men, is the basic operating unit and is organized into a platoon headquarters and four baking sections. Each section operates one oven and can bake about 980 pounds of bread in seven "runs" per 24 hours; this results in the platoon's baking normally about 3,920 pounds and the company 15,680 pounds of bread per 24 hours. If necessary, ten "runs" per day can be turned out, thus making the maximum output per 24 hour day about 1,400 pounds per section, 5,600 pounds per platoon, and 22,400 pounds per company. Thus, the normal capacity of the bakery company will provide for a force of 40,000 men.

d. Fresh bread is usually supplied from field bakeries operated in the communications zone by the bakery battalions or company. The field bakery is set up at or near advance quartermaster class I supply depots which serve troops in the combat zone. Other field bakeries are set up to serve the troops within the communications zone. In exceptional cases field bakeries may be operated by an army in the combat zone. When operating in this manner they function directly under

the army quartermaster service, and are usually attached to the army or independent corps.

■ 65. COLD STORAGE AND REFRIGERATION.—*a. Refrigeration company.*—The refrigeration company consists of 4 officers and 224 enlisted men. It is made up of a headquarters platoon, butchery platoon, refrigeration platoon, and a cold storage platoon. (See T/O 10-217.)

(1) *Headquarters platoon.*—The headquarters platoon is organized into a company and platoon headquarters, an administrative section, and a plant service section.

(a) *Company and platoon headquarters.*—The company and platoon headquarters performs the military, administrative, supply, and training functions for the company and the plant as a whole.

(b) *Administrative section.*—The administrative section handles the technical administration of the several operating platoons.

(c) *Plant service section.*—The plant service section, or utilities group, maintains the machinery and technical equipment and tools used to operate the plant. As this installation preferably operates in permanent buildings, and must so operate where ice is to be manufactured, a considerable amount of machinery and an ammonia piping system must be kept in repair. While the company can operate from the roadside, for example, at a regulating station or railhead, by using refrigerator cars in which to store the perishable subsistence, it is preferable to provide for a permanent installation in the communications zone, and to forward the perishables to the front in refrigerator cars or trucks, when available.

(2) *Butchery platoon.*—The butchery platoon does the meat cutting in order to forward to railheads the "retail" cuts rather than the "wholesale" market cuts. In addition, this platoon can slaughter, dress, and perform abattoir functions to a limited degree if it becomes necessary to procure live animals in the theater of operations. The platoon is not equipped to conduct continued or large scale slaughterhouse activities, but it can perform these functions when the necessity arises. Should such activities become necessary the additional labor required must be secured from quartermaster service units.

(3) *Refrigeration platoon.*—The refrigeration platoon operates the refrigeration and ice-making machinery and equipment of the plant, and personnel for this purpose is provided in sufficient numbers to be able to operate in three 8-hour shifts.

(4) *Cold storage platoon.*—The cold storage platoon receives and stores the frozen and chilled meats, meat food, dairy, and other perishable products, and loads them into cars for forwarding to the railheads on the daily train or to trucks which may be sent out from the plant.

(5) *Transportation.*—Transportation is furnished to the company to provide only the local needs of the plant and the supervisory and operating personnel.

(6) *Medical personnel.*—As this company and its installations will normally be found in the communications zone where medical service is available, attached medical personnel has not been provided.

(7) *Inspection.*—Two officers and eight enlisted men of the Veterinary Corps attached to the company are for the purpose of inspecting the meats and other perishables upon receipt and prior to shipment, to act in an advisory capacity as concerns the sanitation of the plant, and to render such other technical assistance as may be required.

(8) *Existing facilities.*—Whenever possible, existing cold storage and refrigeration facilities should be used. This is particularly so in the case of loading and unloading facilities at ports of debarkation.

b. Functions.—The refrigeration company is organized for use in war in the communications zone. It has two major functions—namely, the storage and issue of fresh meats, poultry and eggs, dairy products, fresh fruits and vegetables, and medical department perishables, and the manufacture of the ice required by hospitals and other installations in the theater of operations. In addition it is equipped to quarter beef (cattle), to produce “retail” meat cuts from “wholesale” cuts, and to perform such boning work as may be required. The company is designed for a capacity to serve 120,000 troops, provide a 30-day stockage of 2,500 tons of meat, a 30-day stockage of 1,500 tons of other perishable food products, and to manufacture 200 tons of ice in a 24-hour day. (See FM 10-5.)

SECTION III

GASOLINE AND OIL SUPPLY

■ 66. QUARTERMASTER GASOLINE SUPPLY UNITS.—*a.* (1) The mission of the gasoline supply battalion is to distribute gasoline and oil to general headquarters and army and corps troops, to augment distribution to divisions when required, particularly in event of disruption of the railroads, augment or supplant deliveries from the zone of the interior or communications zone to the combat zone, and to operate filling stations at various points in the theater of operations.

(2) The method under which this battalion is employed will depend on the situation. It is contemplated that, except under unusual circumstances, the battalion will not operate as a unit in one locality. The company is the normal operating unit.

(3) The battalion has a capacity of 62,800 gallons of gasoline and 1,200 gallons of oil, sufficient to serve 4,800 vehicles, all classes, based on one trip per day. The battalion and each of its companies is equipped with 2½-ton cargo trucks and 1-ton trailers for delivery of gasoline and oil in 10-gallon unit containers.

(4) The battalion is organized into a headquarters and headquarters detachment and four companies, with a total strength of 10 officers and 480 enlisted men. (See T/O 10-75.)

b. (1) The gasoline supply company has a capacity of 15,700 gallons of gasoline and 300 gallons of oil, sufficient to serve 1,200 vehicles, all classes, based on one trip per day. (May also carry small amounts of gear lubricants and greases.) The company is organized with a company headquarters, a truck platoon, and a service platoon, as per T/O 10-77.

(2) While the company is the normal operating unit, it may, if conditions warrant, have sections or squads attached to tactical units. The company may also set up and operate service stations and supply points at convenient points along the highway, and may operate civilian installations and make deliveries direct to train bivouacs or distributing points.

(3) The truck platoon is practically a standard platoon, organized, equipped, and with a strength almost exactly like a platoon of a truck company. (See T/O 10-57.)

(4) The service platoon is organized similar to, and with the strength of, a section of a quartermaster service company. (See T/O 10-67.) This platoon functions at railhead or filling stations to fill cans from tank cars, tank trucks, or drums, to load and unload trucks, and issue gasoline and oil. Normally, 20 of the 40 gasoline handlers are attendants on trucks (usually one to a truck) to unload and issue filled cans and to unload empty containers.

■ 67. GASOLINE AND OIL FILLING STATION.—The army quartermaster will establish gasoline and oil supply points at all railheads and depots or at convenient locations, such as civilian gasoline filling stations, on the main supply routes. This is to permit motor vehicles sent to the rear for any purpose to be filled with gasoline and oil on the same trip. (See FM 100-10.)

SECTION IV

REMOUNT DEPOT

■ 68. REMOUNT SQUADRON.—*a.* The function of the remount squadron is to operate a field remount depot with a capacity of 1,600 animals. The squadron is organized into a squadron headquarters and headquarters detachment and four remount troops. It has a strength of 19 officers and 674 enlisted men, plus attached medical of 8 officers and 44 enlisted men, mostly veterinary technicians. (See T/O 10-95.)

b. The squadron headquarters and headquarters detachment performs the administrative, supply, and general supervisory functions for the squadron as a whole.

■ 69. REMOUNT TROOP.—The personnel of the remount troop is sufficient to receive, handle, condition, and supply 400 animals. It is organized into a troop headquarters and a depot group. The personnel consists of 4 officers and 165 enlisted men, plus attached veterinary of 1 officer and 7 enlisted men. (See T/O 10-97.)

a. The troop headquarters administers, supplies, and messes the personnel of the troop and performs the record and paper work incident to the operation of the depot.

b. The depot group is the operating unit of the company.

■ 70. OPERATIONS.—*a.* The animals to haul wagons should be taken from those being conditioned at the depot. In good

weather, where pasturing is available, a comparatively small quantity of grain and long forage will have to be fed, but during inclement weather or where pasturing is not available, hay, straw, oats, and bran must be provided daily.

b. Normally, a field remount depot is operated by a remount squadron and will be found at or near a veterinary hospital. The plan of coordinated and cooperative work by and between the personnel of those two installations is that when replacement animals are delivered to troop units, usually by marching, the remount personnel will be charged with the delivery and will be assisted by the veterinary corps personnel attached to the remount squadron or by personnel from the adjacent veterinary hospital. The accompanying veterinary personnel is especially required when shipments or deliveries are to be made by water, rail, or truck during which many cases of travel sickness and injuries are found. When the delivery of the replacement animals has been made to the troop units, the sick and wounded animals from the combat area are evacuated to the veterinary hospital, this movement being in charge of the veterinary personnel and assisted by the remount depot personnel. (See FM 100-10 and 10-5.)

c. In providing nonsupervisory operating personnel to the depot group, a further basis has been accepted as satisfactory in most cases: 1 horseshoer per 100 animals, 1 saddler per 100 animals, and 1 horsetrainer and 1 stableman per 8 animals. (See FM 10-5.)

SECTION V

PERSONNEL REPLACEMENT

■ **71. REPLACEMENT PLAN.**—A plan for the organization, training, and forwarding of personnel in sufficient numbers to maintain all troops in the theater of operations at full strength at all times is a basic necessity in preparation of any plan of operation. (See FM 100-10.)

■ **72. PREPARATION OF PLAN.**—The preparation of the replacement plan, including the number of replacements estimated as necessary, is a function of the zone of the interior. However, the commander of the theater of operations is materially concerned and must make representations as to his requirements when necessary.

■ 73. TYPES OF REPLACEMENT.—Replacements of personnel are divided into two classes: filler replacements and loss replacements. Filler replacements are those required initially to raise units to prescribed strength. Loss replacements are those needed to replace losses. All replacements should be thoroughly trained, clothed, equipped, and properly armed before being forwarded to a theater of operations.

■ 74. REPLACEMENT SYSTEM.—*a.* The replacement system in the theater of operations must be sufficiently flexible to meet the local needs and to insure an unfailing and timely arrival of replacements where needed.

b. Replacements, like supplies, are echeloned in depth. The number of echelons depends mainly on the depth of the theater of operations. Base and advance replacement depots may be established in the communications zone if necessary. (See FM 100-10.)

■ 75. SOURCES OF REPLACEMENT.—Sources of replacements comprise the zone of the interior; evacuees in the theater of operations who, as a rule, are automatically returned to their former organizations; the personnel returned to an assignment status from absence without leave; prisoners upon completion of sentence; officers upon reclassification; and others who for any reason become available for assignment. (See FM 100-10.)

■ 76. FORWARDING REPLACEMENTS.—*a.* Replacements are forwarded upon requisition. A company requisitions on the regiment, the regiment, on the division. A division fills the requisitions in whole or in part from replacements available to the division and makes requisition on the army for the part or parts of requisitions which it is unable to fill. Corps requisition directly on the army. The army fills in whole or in part the requisitions which it receives from replacements available in the army replacement battalions; it draws on the communications zone for the part or parts of the requisition which it is unable to fill. Credits may be established for the theater of operations by the War Department in depots in the zone of the interior upon request of the commander of the theater of operations.

b. (1) Replacements are forwarded to their organizations in the theater of operations by the most convenient means

available—by rail, motor, or water transportation, or by marching. Forward movements beyond railheads are normally executed by marching or by motor.

(2) Replacements may be forwarded directly from the zone of the interior to divisions in the theater of operations, to the army replacement battalions, or to the base or advance replacement depots. A replacement depot is an agency located in the theater of operations for the reception and distribution of replacements. They may be forwarded from the latter to the army replacement battalions or to divisions; or from the army replacement battalions to divisions. Replacements for corps and army troops are forwarded in a similar manner. The method selected is that which is the most convenient and practicable, depending on the situation and the character of the operations.

c. (1) Priority in the forwarding of replacements to the army is established by army headquarters. Where two or more armies are served by a common communications zone, the next higher headquarters under which the armies operate establishes priority.

(2) In the forwarding of replacements by railroad, regulating stations function in the same manner as in the shipment of supplies for the commands which they serve. Priority of movement to the army is determined and coordinated by the regulating station under instructions from the army. (See FM 100-10.)

■ 77. SYSTEM OF REQUISITIONING AND FORWARDING OF REPLACEMENTS.—The system of requisitioning and forwarding of replacements is shown diagrammatically in FM 100-10.

■ 78. REPLACEMENT OF QUARTERMASTER PERSONNEL.—In general, the replacement of quartermaster personnel will follow the system outlined above. (See FM 100-10.)

■ 79. ADDITIONAL SOURCES OF REPLACEMENTS.—In addition to the zone of the interior as a source from which replacements are obtained, men discharged from hospitals, both in the zone of the interior and theaters of operations, will be available. These sources increase in importance as hostilities continue. (See FM 100-10.)

■ 80. RETURN OF PERSONNEL TO UNITS.—a. Effort should be made to return individuals as replacements to the units from

which they were evacuated. Where the military situation makes this too difficult, or when appropriate vacancies do not exist in these units, such action may be impracticable. For example, when a vacancy occurs in a noncommissioned grade in a quartermaster unit, it will ordinarily be filled under first priority by a noncommissioned officer from the same unit who is returning as a replacement. If there is no such returning noncommissioned officer, the vacancy may be filled by promotion. A temporary excess of total noncommissioned grades in a company or similar unit or headquarters organization is authorized for the sole purpose of permitting a noncommissioned officer replacement to return to his old organization. Such excess, however, will be limited and must be absorbed by the first permanent vacancies that occur in the organization concerned.

b. Wherever practicable, quartermaster officers discharged from hospitals in the theater will be included among the replacements returned to the divisions or other units in which they formerly served.

CHAPTER 4

TRANSPORTATION

	Paragraphs
SECTION I. Water	81
II. Motor	82-85
III. Rail	86-90
IV. Air	91

SECTION I

WATER

■ 81. PORTS OF EMBARKATION (DEBARKATION).—See FM 10-5 and T/O 10-260-1.

a. Port headquarters company.—The port headquarters company is organized for the purpose of performing the normal “housekeeping” and local quartermaster administrative functions at the port. The company headquarters has 3 officers and 114 enlisted men. All enlisted men of the port headquarters sections are assigned to the headquarters company for administration, supply, and messing. (See FM 10-5.)

b. Quartermaster battalion, port.—The common labor at a port is performed by personnel of the quartermaster battalion, port. This battalion consists of a headquarters and headquarters detachment and four companies of three platoons each. (See T/O 10-265.) Each company has a loading or unloading capacity of 1,500 ship tons and 150 animals per day. The size and capacity of the port will decide the number of port companies or battalions to be attached. Additional labor that may be required may be provided by attaching quartermaster service units.

SECTION II

MOTOR

■ 82. GENERAL.—*a. Importance.*—Motor transport is an important component of the transportation service available to the commander of the communications zone. It is the normal means of supplementing the available rail and inland

waterway transport. It is extensively used in troop movements, in administration of depots and other establishments, and in the movement of less than carload lots between depots and the combat zone. In order to provide for the efficient operation of motor transport, it is essential that an adequate number of motor transport supply depots and repair shops be established throughout the communications zone. (See FM 10-5.)

b. Organization.—The units of the motor transport service attached to the communications zone function under the direction of the communications zone quartermaster in accordance with the policies established by the commander of the communications zone. The organization, training, maintenance, and operation of this service is a function of the Quartermaster Corps. This transport service includes a headquarters and such administrative, passenger, cargo, supply, and maintenance units as are necessary for its efficient operation. It is responsible for the procurement of all motor transport operating in the theater of operations for which the quartermaster is charged, motor replacement parts, gasoline supply, and trucks and component parts. Units of the motor transport service are attached to armies and corps when the situation demands and within the communications zone to ports, depots, hospitals, and other establishments in accordance with their needs. Whenever motor pools are established within the communications zone, transportation units of all classes of transport may be assigned to the pool. (See FM 10-5 and 100-10.)

c. Operations.—Movement of troops and supplies to, and evacuation from, the combat zone by motor transport are controlled by the regulating officer in the same manner as for rail traffic. The regulating officer keeps informed as to traffic conditions and the availability of motor transportation, arranges for shipments by motor transport as desired, and coordinates such movements and the traffic control agencies between the communications zone and the armies. (See par. 32 and FM 10-5.)

■ 83. MOTOR TRANSPORTATION UNITS.—*a.* In order to effect the pooling of all motor transportation, provide for efficient maintenance within the communications zone, and reduce the quartermaster motor supply and transportation responsibili-

ties of the theater commander, all motor transportation may be organized into a motor transport service. To provide for the control of such a service, a motor transport service headquarters and a motor transport service headquarters company is provided, which will supervise the procurement, operation, and maintenance of all motor transport operating within the theater of operations with which the Quartermaster Corps is charged. This headquarters is divided into three divisions—an administrative division, an operations division, and a maintenance division. The headquarters company provides the clerical force and other personnel required to operate the headquarters and to perform the military and housekeeping duties for the headquarters personnel. Other units that are normally available for assignment to the motor transportation service are car companies, light maintenance battalions, heavy maintenance regiments, truck regiments, and gasoline supply battalions. (See T/O 10-500-1 and 10-500-2.)

b. Car company.—The car company is organized to furnish passenger transportation and messenger service for various headquarters and the motor transportation service. This unit establishes and operates the headquarters garage and such subgarages as may be required for headquarters of units larger than a division. This company has sufficient capacity to care for the needs of an army headquarters, while one of the four platoons is sufficient to provide the requirements of an army corps. The platoons are so organized that one or more of them may be detached from the company and still be capable of establishing a headquarters garage and messenger service. This company is divided into a company headquarters and four operating platoons. The company headquarters performs the normal administrative duties common to all units. (See T/O 10-87.)

c. Quartermaster truck regiment.—(1) The quartermaster truck regiment is designed to provide the transportation unit for the hauling of cargo and for the movement of personnel by motor transport. This regiment is equipped with six-wheeled vehicles which may be of 2½-ton, 4-ton, or 6-ton capacity and equipped with either cargo bodies or tank bodies; they may also have 2½-ton, 6 x 6, truck tractors and semitrailers. The type depends on the necessity for a particular design or type vehicle. Subordinate units and personnel of these regiments will have the same organization

regardless of the type or design of the truck assigned to that unit. These regiments are all supplied with some 620 trucks and 505 trailers, but only 576 of the trucks and 480 of the trailers are normally considered available for cargo-carrying purposes. The remainder of the vehicles are required for administrative and housekeeping purposes within the regiment.

(2) The regiment consists of a regimental headquarters and headquarters detachment, three operating battalions, and attached medical and chaplain personnel. The regimental headquarters and headquarters detachment provide the necessary personnel for administering the needs of the regiment. It consists of 4 officers and 25 enlisted men. (See T/O 10-51.)

(3) Each battalion is organized into a battalion headquarters and four companies. The headquarters and headquarters detachment perform the general administrative functions of the battalion. Each battalion has one-third of the cargo- and troop-carrying capacity of the regiment. A major commands the battalion and has as his assistant a captain who is adjutant and traffic officer, and who is the commander of the headquarters detachment. The adjutant, as the chief of the traffic section, is responsible for the road reconnaissance and road control of the battalion. The headquarters and headquarters detachment is normally attached to one of the companies of the battalion for messing. (See T/O 10-55.)

(4) The quartermaster truck company or troop is the basic operating unit of the regiment and consists of a company headquarters and two platoons, each platoon being divided into two sections. The company headquarters performs the normal duties of company administration. It is provided with a 2½-ton cargo truck equipped for second echelon maintenance, a wrecker truck, and the usual kitchen truck and company equipment truck. Each of the two platoons is divided into two sections of two squads each. (See T/O 10-57.)

■ 84. MOTOR VEHICLE MAINTENANCE.—See FM 25-10 and 10-5.

■ 85. MOTOR VEHICLE MAINTENANCE UNITS.—*a.* The light maintenance battalion and the heavy maintenance regiment provide the necessary units for the operation of repair and maintenance establishments within the communications zone and the combat zone.

b. Light maintenance battalion.—(1) The light maintenance battalion is designed to furnish third echelon motor maintenance, which includes the supplying of second echelon repair parts for operating motorized units. The battalion may be operated as one unit in some central location or it may be distributed by companies throughout the communications and combat zone area, establishing its shops near the units which it is intended to serve. This battalion is organized so as to provide for the detachment of subordinate units for this purpose. It is also designed to provide for attachments to heavy maintenance regiments when assisting in the operation of base shops. This battalion or its companies may be attached to army, corps, and divisions, and can be used to handle the overflow from the triangular divisions. (See T/O 10-25.)

(2) The battalion is organized into a headquarters and headquarters detachment and four companies. The headquarters and headquarters detachment provide the normal administration for the battalion. The light maintenance company readily adapts itself to act as a light maintenance troop when assigned to a mechanized cavalry brigade by substituting motorcycle mechanics for half of the automobile and truck mechanics that are normally assigned to the company.

(3) The company is divided into a company or troop headquarters, a supply platoon, and two light maintenance platoons. The company headquarters provides for the administrative overhead of the company, while the supply platoon is responsible for providing first and second echelon repair parts for motor vehicles assigned to the company and the third echelon repair parts to the maintenance platoons. Each maintenance platoon is divided into a platoon headquarters performing the normal duties of such headquarters, a wrecker section, and a maintenance section. The wrecker section is responsible for picking up and removing to the motor repair shop all wrecked vehicles abandoned on the road and evacuating to fourth echelon repair shops all vehicles not readily repairable in the third echelon shops. The maintenance section is responsible for the actual repair of motor vehicles sent to the shops for the repair within the limits prescribed for third echelon maintenance. (See T/O 10-27.)

(4) The light maintenance company is capable of performing third echelon maintenance for units employing 1,500 vehi-

cles of all classes. Normally, three light maintenance battalions will be attached to each field army and one company to each corps.

c. *Quartermaster heavy maintenance regiment.*—(1) *General.*—The quartermaster heavy maintenance regiment is designed to provide fourth echelon motor maintenance and to store and issue in bulk all motor transport supplies required to serve vehicles of all classes. This regiment operates immobile overhaul and reconstruction establishments and motor transport depots. It is organized into a headquarters and headquarters detachment and three battalions. The headquarters and headquarters detachment for the regiment perform the duties necessary for the supply and normal administration of the regiment. (See T/O 10-41.)

(2) *Heavy maintenance battalion.*—The heavy maintenance battalion is the basic heavy operating unit. It not only performs the fourth echelon repair work, but stocks, issues, and ships all classes of motor transport supplies and repair parts, unit assemblies, tires, batteries, etc., and performs motor salvage and reclamation work. This battalion is, therefore, a combined motor transport supply depot and fourth echelon maintenance shop. It stocks supplies and is equipped to perform fourth echelon work and motor vehicle salvage to serve vehicles of all classes. It is organized into a headquarters and headquarters detachment, one depot company (motor transport), and three heavy maintenance companies. (See T/O 10-45.)

(3) *Headquarters.*—The headquarters and headquarters detachment of the battalion provides for the administrative overhead of the battalion.

(4) *Depot company (motor transport).*—The first companies in the battalions, that is, A, E, and I, are the depot companies. These companies are responsible for the storage and issue in bulk or wholesale of motor transport supplies to units throughout the theater of operations and to the battalion shop. It also furnishes transportation, maintenance, police, fire, and guard details for the battalion shop and its grounds. This company is organized into a company headquarters which performs the normal company duties, a supply platoon, a salvage platoon, a service platoon, and a transportation platoon.

(a) The supply platoon, as a whole, is responsible for the storage and issue of all supplies required by the regiment, and is capable of supplying the needs of 3,000 vehicles of all classes. It is divided into a depot headquarters section, which performs the clerical work in connection with procurement, receipt, and issue of supplies; and a storage section, which is responsible for the receipt, storage, and issue of all supplies stored in the depot.

(b) The salvage platoon is divided into a salvage section, power plant section, chassis and heavy units section, and a body, tire, and battery section. This platoon is responsible for the receipt, cleaning, inspection, assembling, tear-down of evacuated vehicles and unit assemblies, and the disposition of nonreclaimable motor transport equipment and supplies. The salvage section is responsible for such salvage operations as are not specifically assigned to other sections of the platoon. The power plant section is responsible for all operations in connection with salvage of automobile power plants. The chassis and heavy unit section is responsible for the salvage of all chassis and heavy units. The body, tire, and battery section is responsible for the salvage of bodies, tires, and batteries of vehicles entering the shop.

(c) The service platoon is divided into a depot maintenance section, fire and guard section, and police and labor section. The depot maintenance section is responsible for the maintenance of the shops, machinery, and equipment. The fire and guard section is responsible for furnishing the fire and police protection for the battalion shops, buildings, and areas. The police and labor section is responsible for the maintenance and police of the grounds and the operation of the labor pool.

(d) The transportation platoon is responsible for the operation of the organic transportation and furnishes motor transport service for the battalion. (See T/O 10-48.)

(5) *Heavy maintenance company.*—(a) The remaining three companies of the heavy maintenance battalion are heavy maintenance units. This company is organized along departmental organization lines and provides mechanics in the proper proportions for each major division of work and in such numbers as to round out a well-balanced shop organization. While the depot company of the battalion stocks and issues supplies in bulk or wholesale, each heavy maintenance company must maintain repair records for the com-

pany and provide one-third of the personnel employed in the battalion shop, stock, and tool room.

(b) This company is organized into a company headquarters, shop headquarters and supply platoon, a power plant platoon, allied trades platoon, a vehicle assembly platoon, and a heavy units platoon. The company headquarters provides the administrative overhead for the company; but, in addition to this, the officers of the company headquarters perform various duties in the battalion shops. Shop headquarters and supply platoon provide the personnel required for supervisory and clerical positions in the shop headquarters and in the shop, stock, and tool room. The vehicle assembly platoon is charged with the reassembling of complete vehicles. These assemblies may be made from new, rebuilt, or reconditioned parts and unit assemblies. The heavy units platoon is responsible for the reassembling of new or reconditioned parts of heavy unit assemblies, as, for example, transmissions and differentials. The power plant platoon is charged with the reassembling of all power units. The allied trades platoon is responsible for a variety of labor activities, as, for example, upholstering, painting, sheet metal work, welding, etc. (See T/O 10-47.)

(c) The heavy maintenance company is a self-contained unit for its own housekeeping and shop work; but, if operating alone, it has no personnel attached to perform transportation, police, fire, guard, and depot duties. It is probable that the smallest fourth echelon shop in the theater of operations will normally consist of at least one heavy maintenance battalion.

(6) *Variation in operations.*—In addition to the extent and difference of repair operations performed by the light and heavy maintenance units, there is one other important variation in their methods of operations. The limit of repair operations prescribed for a light maintenance unit is such that, under normal conditions, vehicles sent to third echelon shops will be out of service for only a relatively short time. An exception to this might be when a thorough inspection reveals that the vehicle is in need of a major overhaul. Upon completion of the repairs at the light maintenance battalion, the vehicles are then returned to the unit to which assigned. On the other hand, vehicles requiring fourth echelon maintenance must be evacuated to the communications zone and the period of repair may be quite lengthy. Vehicles repaired

by the fourth echelon, therefore, pass into a vehicle pool until they are called for by requisition to replace vehicles anywhere in the theater of operations.

d. Gasoline and oil supply.—See paragraphs 66 and 67 and FM 10-5.

SECTION III

RAIL

- 86. GENERAL.—See FM 10-5 and 100-10.
- 87. RAIL TRANSPORTATION OF INDIVIDUALS.—See FM 10-5 and TM 10-370.
- 88. RAIL TRANSPORTATION OF TROOPS.—See FM 10-5 and TM 10-370.
- 89. RAIL TRANSPORTATION OF SUPPLIES.—*a. General.*—See FM 10-5 and TM 10-370.
b. Daily trains.—Shipment of supplies to forward areas will ordinarily be made on military railways by means of daily trains or on special trains in the case of ammunition and special supply requirements. Daily trains normally carry class I supplies to fulfill daily requirements and their movement is controlled by the regulating officer.
- 90. REFERENCE.—For details of troop movements by rail and other matters concerning rail transportation, see paragraph 203 and TM 10-375.

SECTION IV

AIR

- 91. QUARTERMASTER SERVICE IN THE AIR FORCE.—See paragraphs 189 and 190 for general fundamentals, mission, and duties.
a. Within each air base area designated by the air force commander, quartermaster personnel already assigned to the air base augmented by the mobile field sections assigned to other air base services, and truck, maintenance, and labor units as determined by the air force commander operate the quartermaster facilities at the following air base establishments:
 - Air base airdrome (air force depot).
 - Sub-air base airdromes.

Quartermaster class I supplies supply point.

Supply points aviation gasoline and oil.

Supply points chemicals and ammunition.

Supply points engineer materials.

Distributing points for all classes of supplies.

(1) An air base airdrome is an Air Corps establishment assigned to the air force and contains the flying field and all installations and facilities for operations, maintenance, and supply of troops and their equipment. It is normally a one-group or two-group station and is under the command of an air base commander with his headquarters thereat. When time and space are factors in the distribution of supplies from the zone of interior or communications zone depots, an air force depot is established at the air base airdrome under the command of the air base commander. It is a general depot and contains a quartermaster section which is operated by the air base quartermaster with personnel from the separate quartermaster company (air base). The air force commander will designate the level at which stocks of Quartermaster Corps supplies will be maintained.

(2) In an air base area where transportation facilities are limited or distances too great for proper distribution by quartermaster truck units, one or more sub-air base airdromes are established by the air base commander for the distribution of class I supplies and certain designated items of other classes of quartermaster supplies when air transports from the air base are inoperative. Quartermaster personnel from the mobile field unit of the quartermaster (air base) truck and labor units are placed thereat for the handling and issue of these supplies to combat units at designated distributing points. It is commanded by a representative of the air base commander and functions as a small air force depot.

(3) Where aviation gasoline and lubricants for airplanes cannot be handled through the established regulating stations for the ground forces, one or more gasoline and oil reconsignment points are established on the railroads in the air theater of operations for the distribution of aviation gasoline and oil to supply points for the air force. At the reconsignment point the reserve supply is established for troops being supplied therefrom. The establishment of at least one gasoline and oil reconsignment point is normal.

A small detail of officers and men from the Air Corps and quartermaster air base services to include a rail transportation officer from the air base concerned is placed thereat for reconsignment of supplies and the handling of the reserve.

(4) Where quartermaster class I supplies cannot be obtained direct from convenient quartermaster or commercial distributing agencies, a quartermaster class I supplies reconsignment point is established on a railroad where these supplies are made up daily for distribution to air force troops at designated distributing points either by rail or by quartermaster truck units assigned to the air force. A representative from the air base commander and a representative from the air base rail transportation office with necessary personnel for the handling and distribution of supplies is placed thereat.

(5) Supply points for aviation gasoline and oil, ordnance ammunition and bombs, chemical supplies to include decontamination equipment, and engineer materials are established in the air base area as needed and operated by their respective services under the air base commander concerned. The number and type will depend on the particular requirements of the troops served, terrain, transportation facilities available, and the location of communications zone depots. Quartermaster personnel to include truck and labor units of the air force assigned to the air base by the air force commander are conveniently placed for the proper handling and transportation of these supplies from the supply points to distributing points for issue to combat troops.

(6) Distributing points are established by the air base commander for requisition and issue of all classes of supplies to air force troops. One distributing point is normally established per auxiliary airdrome within the air base area. One squadron is normally assigned to an airdrome. The distributing point is operated by a representative of the air base commander with a detail of service troops from the air base. Quartermaster personnel consisting of two or three enlisted men from the mobile field section of the air base service unit are assigned to this detail. Supplies are drawn from the distributing point by the squadron concerned.

b. The distribution of all classes of quartermaster supplies is made from the air force depot whenever possible and preferably by air. In situations where quartermaster dis-

tributing agencies, other than those under air force command, and commercial distributing agencies are conveniently located for supply, the air force commander arranges with the responsible parties concerned for distribution and issue through these agencies. The detailed arrangements are consummated by the air base quartermaster.

c. Quartermaster class I supplies are issued on a daily automatic basis. Two days' supplies are stocked at each distributing point for troops served thereat. The rations consist of one field and one reserve.

d. Other classes of quartermaster supplies are procured by the air base commander by requisition, either formal or informal, from the zone of the interior or the theater of operations depots. The air base quartermaster arranges for distribution of these supplies to troops from stocks in the air force depot, withdrawals against credits, or by requisition on depots not under air force command. In the case of class IV supplies, the requisition must receive the final approval of the air force commander. No stocks of these supplies are placed at distributing points.

e. *Advantages and disadvantages.*—See FM 10-5.

f. *Employment.*—See FM 10-5.

g. Airplanes may be employed for the transport and dropping of ammunition, gasoline and oil, medical supplies, medical personnel, and evacuation of wounded. Such employment will be limited to exceptional cases such as detachments of troops that have been cut off, tank and mechanized units which have broken through, or reconnaissance detachments. (See FM 10-5 and 100-10.)

PART II
COMBAT ZONE
CHAPTER I
GENERAL

SECTION I. Responsibility and functions.....	Paragraphs 92-94
II. Definitions	95-116

SECTION I

RESPONSIBILITY AND FUNCTIONS

■ 92. SERVICES.—*a.* In the combat zone the function of the Quartermaster Corps is to furnish the quartermaster services essential to the well-being of the unit concerned. These services consist of the following:

- (1) Procurement, storage, and distribution of quartermaster supplies, including animals, and means of transportation.
- (2) Procurement and operation of quartermaster utilities, including storage, maintenance, and repair facilities.
- (3) Establishment and operation of the graves registration service.
- (4) Establishment and operation of salvage activities in the combat zone.
- (5) Transportation of troops and supplies by land and water except such as may be allocated to another service.
- (6) Regulations for operation, maintenance, and inspection of motor and animal transportation.
- (7) Establishment and operation of a labor and motor pool.
- (8) Procurement of quartermaster units and personnel for the combat zone and their distribution among subordinate commands.

b. It is a fundamental of quartermaster organization that within each command all quartermaster personnel, units,

establishments, or other activities not assigned or attached to a subordinate unit constitute a single, self-contained, workable quartermaster service, functioning as such under the command of the senior officer of the Quartermaster Corps on duty therewith.

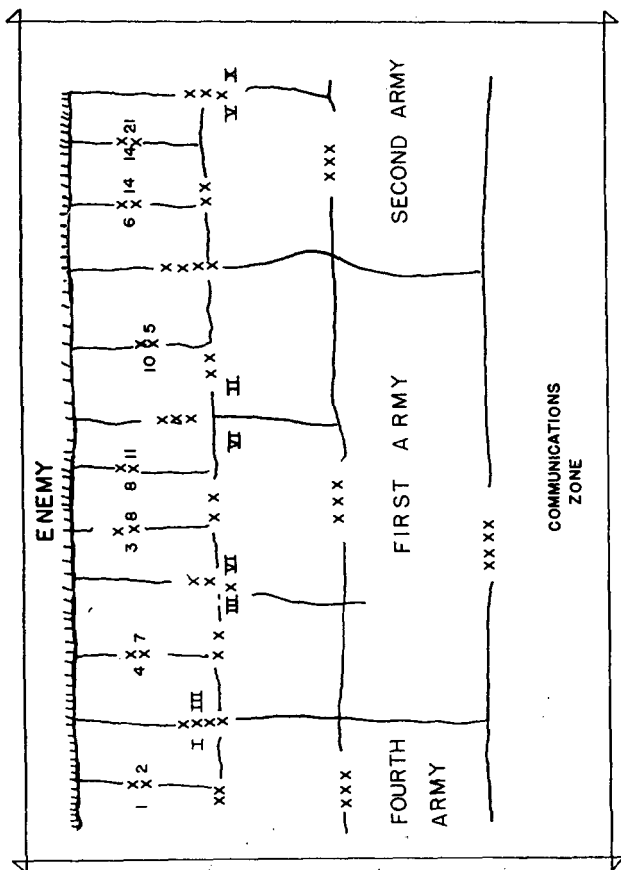

FIGURE 10.—Combat zone.

c. The strength and composition of the quartermaster service within the combat zone and each subordinate command depends on the organization of the combat zone and

the functions and movements of each subordinate command. Deficiencies in any subordinate unit are met by the assignment of quartermaster personnel or units from higher headquarters.

■ 93. **RESPONSIBILITY.**—Supplies of all classes are shipped by the regulating officer from the communications zone to supply points within the combat zone. These supply points may be depots, railheads, air bases, or dumps. Upon receipt of the supplies at any of these supply points, their storage and distribution becomes the responsibility of the quartermaster charged with the operation of such establishment.

■ 94. **DIVISION OF THE COMBAT ZONE.**—See paragraph 5 and figure 10. (See also FM 100-10, 100-5, and 10-5.)

SECTION II

DEFINITIONS

■ 95. **CLASSES OF SUPPLIES.**—For simplicity and convenience of administration, supplies required by troops in the field are divided into five classes as shown in FM 10-5.

■ 96. **DEPOT.**—See paragraph 17.

■ 97. **RAILHEAD (TRUCKHEAD, NAVIGATION HEAD).**—See paragraph 22.

■ 98. **DUMP.**—Temporary stock of supplies established by a corps, division, or smaller unit. When supplies are ordered issued from dumps, the latter become distributing points. Dumps are designated by the identity of the unit establishing them and by the class of supplies therein, such as 1st Infantry Ammunition Dump or 1st Division Class I Supply Dump. (See FM 100-10.)

■ 99. **SUPPLY POINT.**—See paragraph 18.

■ 100. **DISTRIBUTING POINT.**—See paragraph 19.

■ 101. **CONTROL POINT.**—An agency established by a unit at a convenient point on the route of its trains where information and instructions are given and received in order to facilitate and regulate supply or traffic, for example, "Class I Control Point." (See FM 100-10.)

■ 102. CLEARING STATION.—Corps or division medical installation where sick and wounded are assembled from collecting and aid stations, sorted, treated if necessary, and turned over to the army for further evacuation. (Formerly called hospital station.) (See FM 100-10.)

■ 103. TRAIN.—*a.* The train of a unit is that portion of the unit's transportation, including personnel, operating under the immediate orders of the unit commander primarily for supply, evacuation, and maintenance. It is designated by the name of the unit, such as 1st Infantry Train. (See FM 100-10.)

b. A train may be subdivided according to the service in which it is engaged, for example, "Ammunition Train, 1st Infantry," "Kitchen Train, 1st Battalion, 2d Infantry," or "Medical Train, 1st Battalion, 1st Field Artillery."

c. For divisions and larger units, the term train is seldom used, as it will be found more convenient to refer to the particular service unit concerned, for example, "1st Quartermaster Regiment" instead of "1st Quartermaster Train."

■ 104. TROOP MOVEMENTS.—*a.* Troop movements are said to be "by marching" when the foot troops move as such and other units move by the organic transport.

b. Troop movements are said to be by rail, water, or motor when the foot troops and all other elements move simultaneously by rail, water, or truck, respectively.

c. Troop movements are said to be "by shuttling" when all or a portion of the trucks make successive trips in moving both cargoes and troops.

■ 105. MOTOR TRANSPORT SERVICE.—This embraces all general cargo and personnel transportation, except such elements as are assigned organically to troop units, together with the necessary operating personnel and maintenance facilities. (See T/O 10-500-1 and ch. 1, FM 25-10.)

■ 106. MILITARY RAILWAY SERVICE.—It is responsible not only for the rail transportation of personnel and supplies, but also for maintenance of ways and structures.

■ 107. CREDIT.—See paragraph 8.

■ 108. CALL.—See paragraph 9.

■ 109. RESERVES.—See paragraph 11.

- 110. **BALANCED STOCKS.**—See paragraph 12.
- 111. **DAY OF SUPPLY.**—See paragraph 13*a*.
- 112. **UNIT OF FIRE.**—See paragraph 13*b*.
- 113. **DAILY TELEGRAM.**—See paragraph 16.
- 114. **AUTOMATIC SUPPLY.**—See paragraph 15.
- 115. **GASOLINE AND OIL ALLOWANCES.**—Gasoline and oil allowances are prescribed from time to time by the commander of the field force. Owing to many indeterminable factors, a daily allowance of gasoline and oil ordinarily cannot be fixed.
- 116. **RATIONS.**—*a.* A ration is the allowance of food for the subsistence of one person for one day. For field rations A, B, C, and D see FM 100-10 and AR 30-2210.
b. The grain ration is the amount of grain for one animal for one day. It varies from 9 to 14 pounds, depending on the weight of the animal.

CHAPTER 2

DIVISION QUARTERMASTER UNITS

	Paragraphs
SECTION I. Quartermaster regiment.....	117-119
II. Division quartermaster's office (square division) ..	120-121
III. Operations.....	122-132
IV. Quartermaster battalion, Infantry division (triangular)	133-139

SECTION I

QUARTERMASTER REGIMENT

■ 117. **GENERAL.**—Certain services have been assigned to the infantry division (square) to relieve the fighting troops of the responsibility of administrative details. The quartermaster regiment is one of the units providing such service and is organized so as to accomplish the quartermaster service necessary to an infantry division. This regiment furnishes for this purpose the necessary personnel and units trained in the technique of quartermaster administration, supply, transportation, and other assigned activities.

■ 118. **DUTIES.**—*a.* The duties required of the quartermaster regiment may be grouped under four general headings—administration, supply, transportation, and utility services.

b. Under administration the regiment is charged with—

(1) Procuring and disposing of all real estate necessary for division operations, and the handling of all claims arising from the occupancy of real estate.

(2) The operation of the division labor pool.

(3) Maintaining the graves registration service and the handling of all mortuary matters.

c. Under supply, the regiment is charged with the distribution of all classes of supply and the maintenance and operation of the salvage service.

d. Transportation duties consist of transporting troops and supplies by all means of travel. Truck transportation for troops and supplies is of particular importance.

e. Under utility services the duties consist of maintaining and operating the activities of the following units when attached to the division:

- (1) Sales commissary units.
- (2) Sterilization and bath units.
- (3) Laundry units.
- (4) Bakery units.
- (5) Salvage units.
- (6) Other units which may be attached.

■ 119. ORGANIZATION OF QUARTERMASTER REGIMENT.—a. In order to perform all these services the quartermaster regiment has been organized into a regimental headquarters and headquarters company, a service company (less one platoon), two truck battalions, and one light maintenance and car battalion. This regiment (including attached medical and chaplain) consists of 40 officers, 1 warrant officer, and 885 enlisted men.

b. The regimental headquarters consists of a colonel, commanding, and six other officers, who form the nucleus for both the regimental and division quartermaster staffs. The commander of the regiment acts in the dual capacity of commander of his regiment and member of the division commander's special staff. As a commander he performs the normal duties of a commanding officer and is responsible for the efficient operation of the quartermaster regiment and such troops that might be attached to his regiment, in accordance with policies, plans, and decisions of the division commander. As a special staff officer he supervises all quartermaster activities throughout the division and is responsible for the efficient operation of quartermaster units assigned or attached. The prescribed duties and responsibilities as a special staff officer and commander include—

- (1) Commander of the organic quartermaster units and any attached quartermaster troops.
- (2) Adviser to the commander and his general and special staff on quartermaster corps matters, including recommendations for quartermaster activities.
- (3) Supply of quartermaster equipment and supplies, including animals and motor transport supplies.

(4) Procurement and operation of quartermaster utilities and storage, maintenance, and repair facilities.

(5) Installation and operation of salvage service.

(6) Operation of graves registration service.

(7) Transportation of troops and supplies except such as may be allocated to another service.

(8) Maintenance and operation of labor and motor pools.

(9) Technical inspection of motor and animal transportation and supervision within limits prescribed by the division commander of all quartermaster activities within subordinate units. (See FM 101-5 and 100-5.)

c. Cooperation within the special staff is necessary to proper staff team play. The division quartermaster must, through the very nature of his mission, work in close harmony not only with the other members of the special staff, but all sections of the general staff and commanders of all subordinate units. A quartermaster's relations with the commanders of subordinate units are those of a special staff officer of a higher unit commander. He, in no sense whatever, exercises his command functions in such dealings.

d. The designation of the six officers in regimental headquarters is as follows:

(1) Lieutenant colonel—executive and assistant division quartermaster.

(2) Captain—quartermaster supply officer.

(3) Captain—intelligence and plans and training officer.

(4) Captain—transportation officer.

(5) Captain—adjutant.

(6) Captain—regimental supply officer.

e. Regimental headquarters is normally organized into three principal sections. The first section (S-1), under the regimental adjutant, a captain, handles all administrative and personnel details. The second section combines the duties of an intelligence (S-2) and plans and training (S-3), under a captain (S-2 and S-3). The third section, also under a captain, takes care of all regimental supply details (S-4).

f. The headquarters company is divided into a company headquarters and a gasoline supply platoon. (See T/O 10-272.)

(1) The company headquarters performs the normal duties of housekeeping for the regimental headquarters and the

company. These duties include the clerical work, supply, and messing necessary for the proper operation of the company.

(2) A division quartermaster section furnishes all the enlisted personnel necessary to operate the office of the division quartermaster.

(3) A regimental headquarters section provides the personnel incident to the operation of the regimental command post.

(4) The gasoline supply platoon furnishes the transportation and personnel required to distribute gasoline and oil to the kitchens and to the motor vehicles of the division. Any prescribed reserve of gasoline and oil normally is transported in this platoon. This platoon does not supply the quartermaster regiment with its gasoline and oil, for trucks are available in each of the three battalions for this purpose. The platoon normally is bivouacked near the class I supply railhead or near the bivouac of the truck battalions.

g. The service company, designated company "S", consists of a company headquarters to administer to the company, and two platoons. However, the quartermaster regiment has only the company headquarters and one platoon of the service company. Each platoon is subdivided into two sections of four squads each. The function of the company is to load and unload supplies at various divisional supply points and to provide such other labor that might be assigned it by competent authority. The company forms the nucleus for any labor pool that might be organized within the division. It usually moves with the truck battalions and bivouacs in the vicinity of the class I supply railhead. It is estimated that labor troops of this company can move an average of approximately two-fifths (0.42) of a ton per man per hour for a period of 12 hours. (See T/O 10-67.)

h. (1) The two truck battalions are numbered the 1st and 2d battalions. Each consists of two companies and a battalion headquarters. A and B companies compose the 1st battalion, and C and D companies compose the 2d battalion. In each battalion, the battalion headquarters directs the operations and performs the usual administrative duties of a battalion headquarters.

(2) The truck battalions transport supplies and troops as needed, such division reserves that may be prescribed by

higher headquarters, and forms the nucleus of a motor pool, when prescribed. (See T/O 10-285.)

(3) Each company consists of a company headquarters and two platoons, each platoon is further divided into a platoon headquarters and two sections. The company headquarters furnishing the personnel and equipment for company house-keeping is divided into two groups, one the operations group, and the other the administration group. The operations group, under the supervision of the company commander, composed of the first sergeant (truckmaster) and such other enlisted personnel as is necessary, directs and controls the operations of the company. The administrative group, under the company commander, includes the supply and mess sergeant, company clerk, cooks, and mechanics and drivers of headquarters vehicles; it performs the administrative and supply duties for the company. The two platoons furnish the transportation. Each platoon is commanded by a lieutenant, assisted by a staff sergeant, as assistant truckmaster. Each vehicle carries one extra 10-gallon can of gasoline in addition to the gasoline in the vehicle tank as a reserve. Each company can provide forty-eight 2½-ton trucks for division transport purposes. The remaining trucks are available for company administration and replacements. In addition, 40 cargo trailers, ¾- to 1-ton, 2-wheeled, are provided. (See T/O 10-57.) These battalions normally bivouac in the vicinity of the class I supply railhead or ammunition railhead.

i. (1) The third battalion is known as the light maintenance and car battalion. It consists of a battalion headquarters, one light maintenance company, and one car company. (See T/O 10-275.)

(2) The battalion headquarters performs the normal duties of a battalion headquarters.

(3) (a) Company E is also known as the light maintenance company. It consists of a company headquarters for proper direction and control of the company and three platoons—one supply and two maintenance. (See T/O 10-137.) Each platoon is capable of operating a third echelon repair shop. The company bivouacs in the vicinity of the shop or shops.

(b) It provides personnel trained in replacement of unit assemblies, minor repairs to automotive equipment, and technique of motor transport supply and is prepared to set up and operate two repair shops. It also receives, stores, and

distributes motor transport supplies and equipment normally furnished by the Quartermaster Corps. It furnishes technical advice on motor repair and maintenance to the division and subordinate units and performs inspection service throughout the division.

(c) Each repair shop requires about 10,000 square feet of operating floor space and about 30,000 square feet of parking space.

(4) (a) Company F is the car company. It consists of a company headquarters, a car platoon, and a motorcycle platoon. (See T/O 10-277.)

(b) The company headquarters performs the normal duties of a headquarters. The car platoon furnishes the necessary passenger cars for the division commander and his staff officers. This company usually bivouacs in the vicinity of the rear echelon of division headquarters.

(c) The motorcycle platoon provides the message center with motorcycles and drivers. These act as messengers for division headquarters, and, because of the nature of the duties performed, the messengers should be kept on this work permanently.

j. Completing the organization of the regiment are the attached medical and chaplain personnel whose normal duties consist of looking after the health and welfare of the regimental personnel. (See T/O 10-271.)

k. All quartermaster units, when attached to the division, operate under the division quartermaster and are normally attached to the quartermaster regiment of the division. (See FM 10-5.)

SECTION II

DIVISION QUARTERMASTER'S OFFICE (SQUARE DIVISION)

■ 120. ORGANIZATION OF OFFICE OF DIVISION QUARTERMASTER.—There is no prescribed organization of a division quartermaster's office and any organization that adequately serves the needs of the regiment and division will be satisfactory. It should be borne in mind that the personal characteristics of the quartermaster, state of training of the unit, and type and organization of both the general and special staffs will greatly influence the quartermaster in organizing his office. The

Commanding officer, quartermaster regiment, and division quartermaster Colonel, Quartermaster Corps.

Regimental headquarters, second in command and executive officer Lieutenant Colonel (S-Ex).

Office of division quartermaster		Regimental staff
Administrative division	Supply division	Transportation division
Chief (or assistant)—War-rant officer. Chief clerk—Staff sergeant. Clerk, general—Sergeant. Headquarters clerks—2 privates, first class, or privates. Stenographer—Private, first class, or private. Chauffeurs—3 privates, first class, or privates.	Quartermaster supply officer—Captain. Personnel clerk—Master sergeant. Clerk, supply—Sergeant.	Regimental adjutant—Captain (S-1). Intelligence planning and training officer—Captain (S-2 and 3) ^a . Sergeant major—Master sergeant. Clerk, mail and record—Corporal. Clerk, chaplain's—Corporal. Chauffeurs—2 privates, first class, or privates. Motorcyclist—Private, first class, or private. Orderlies—3 privates, first class, or privates. Basic—Private.

	Classes I and III supply	Classes II and IV supply	Salvage	Operations branch	Maintenance branch		Supply section
<p>The intelligence, planning, and training officer might, in addition, head Administrative division.</p> <p>(Traves registration officer—(Officer detailed from service company.)</p> <p>Functions:</p> <p>Plans and orders quartermaster service.</p> <p>Maintenance of records.</p> <p>Estimates and allotments of funds.</p> <p>Quartermaster accounts.</p> <p>Control of labor pool.</p>	<p>Chief—1st lieutenant (commanding officer, gasoline supply platoon, headquarters company).</p> <p>Class I—sergeant.</p> <p>Class III—sergeant (from gaso-line supply platoon, headquarters company).</p>	<p>Chief—1st lieutenant (from company headquarters, headquarters company).</p>	<p>Chief—Sergeant (supply sergeant from headquarters company).</p>	<p>Division motor officer—(Senior truck battalion commander.)</p> <p>Transportation clerk—Sergeant.</p>	<p>Division maintenance officer—(Commanding officer, light maintenance and car battalion.)</p> <p>Motor and chief mechanic—Sergeant (from company headquarters, headquarters company.)</p>	<p>Personnel section</p>	<p>Regimental supply officer—Captain (S-4).</p> <p>Supply sergeant.</p> <p>Master sergeant.</p> <p>Clerk, sergeant.</p>

NOTE.—Designated set-up, especially below dotted line, is merely a suggested arrangement, and only in outline form, from available personnel per headquarters Table of Organization. Variations from or additions to the above organization may be made by the division quartermaster.

FIGURE 11.—Suggested type of organization for office of division quartermaster and headquarters, quartermaster regiment, Infantry division, square. (See T/O 10-272.)

workable organization outlined herein is adequate to provide the administration for a unit of any size and, with modification deemed necessary by each individual, should provide a suitable organization. This organization facilitates the direction and administration of all quartermaster activities within the division.

■ **121. DUTIES AND FUNCTIONS.**—Generally all the duties and functions of the quartermaster can be grouped under three main headings: administration, supply, and transportation. See figure 11 for a suggested type organization. (See FM 10-5.)

a. The warrant officer assigned to the regiment may act as the chief of the administrative division, or the division may operate directly under the regimental intelligence, plans, and training officer, who would thus combine this duty with his responsibilities as a regimental staff officer. A subdivision of this division is the graves registration section, which is supervised by an officer detailed from the service company for this specific purpose. The administrative division performs the essential functions as enumerated in FM 10-5.

b. The supply division operates under the division quartermaster supply officer. This division may be divided into three sections, the first section, operating under the first lieutenant commanding the gasoline and oil supply platoon of headquarters company, handles class I and class III supplies. The second section, operating under the lieutenant from company headquarters of headquarters company, handles class II and class IV supplies. The third section, operating under a sergeant from headquarters company, handles all duties pertaining to salvage. The principal duties of the supply division are as indicated in FM 10-5.

c. A captain from the regimental headquarters is assigned to the transportation division as transportation officer, whose primary duties are those of a transportation officer in any quartermaster office. He deals principally with rail, water, and motor shipments; he may be assisted by a division motor officer and a division maintenance officer. This division may operate under the senior battalion commander of the truck battalions, who may be designated the division motor officer. One of his assistants may be the commander of the third battalion, who acts as the division maintenance

officer. In that case, the captain would be a second assistant, in charge of normal quartermaster transportation duties. The general duties of this division are listed in FM 10-5.

d. The relationship existing between the heads of the three divisions and the division quartermaster is that of a staff officer to his commanding officer. In most cases all of the recommendations made by the division quartermaster to the division commander have been previously received by the quartermaster from the heads of the three divisions. These officers make the detailed study and reconnaissances necessary, and submit their recommendations to the quartermaster. He in turn makes such reconnaissance as may be necessary, studies the recommendations of his assistants, questioning them where necessary, and then, after making such changes as he deems advisable, submits his recommendations to the commander.

e. Location of division quartermaster's office.—Because of the nature of the quartermaster's work, his office should be located near the rear echelon of division headquarters. The rear echelon contains those special staff officers whose primary mission is supply, evacuation, administration, and welfare and usually an assistant from the fourth section of the general staff. Wherever possible, the division quartermaster's office should be housed in the same building with the rear echelon of division headquarters.

f. Location of command post.—Because of the dual position of the quartermaster, the regimental command post should be located near the division quartermaster's office. If the situation permits, the command post should be in the same building with the division quartermaster's office, preferably adjoining it. (See FM 100-10.)

SECTION III

OPERATIONS

■ 122. FUNDAMENTALS OF SUPPLY.—*a. Basis of supply.*—When the trains of a division are motorized, supply operations for all classes of supply are conducted by either regimental or divisional transportation from army supply points to the using troops. Supplies are not normally transferred to other trucks or placed in dumps from the time they are received at army supply points until they are delivered to the using troops.

b. Fundamentals.—Troops should not be burdened with a greater quantity of supplies than is necessary for their well-being, nor should their attention be unnecessarily diverted by supply details. The supply system should permit continuity, flexibility, elasticity, and provide maximum mobility with the greatest degree of simplicity.

c. Responsibility.—The division commander is responsible for the supply of his unit and he must insure that the requirements placed on subordinate units for the utilization of their transportation in effecting supply are not excessive. He determines the degree of responsibility that will be placed upon subordinate commanders for effecting resupply with their organic transportation. This decision can be determined only by a study of the supply and evacuation situation and must be based upon a consideration of many factors. In order to determine the responsibility to be placed upon subordinate commanders, the commander must evaluate the tactical situation, the reserves to be carried, the probable expenditure rate, the distances involved, the routes available, and the restrictions imposed by higher authority, and the terrain.

d. Prescribed load.—The quantity and type of rations to be carried by individuals and on unit trains as a prescribed load is announced from time to time by the division commander. The factors that influence this decision are the probability of combat, distance to army supply points, defiles, amount of transportation available, character and condition of road net, danger of hostile air and mechanized attack, and the probable relative urgency of class I supply versus other supplies. (See FM 10-5 and FM 100-10.)

■ 123. CLASS I SUPPLY.—See FM 10-5.

a. Daily telegram.—See FM 10-5 and figure 12.

b. Daily train.—The supplies are normally shipped to the regulating officer in bulk from one or more depots. For example, one depot might ship meat for the entire army, another might ship bread, another the remainder of the ration, and still another might ship the illuminants, etc., or one depot might ship everything bulk loaded. The regulating officer has these supplies broken down into divisional and similar unit lots, each lot being consolidated on a section of a train known as the unit section. One, two, or three of these unit sections

make up the daily train. As the daily train passes each railhead, the unit section for the division supplied at that railhead is left for unloading. It is normal to supply only one division from each railhead, but if the situation warrants it two divisions or similar units may be supplied. If two divisions are supplied at the same railhead, corps or army must prescribe the hours each will draw supplies. Additional cars carrying other supplies, such as gasoline, oil, engineer supplies, ammunition, etc., may be added to the unit section of the daily train. If all classes of supplies are received at the same railhead, the division G-4 must coordinate the drawing of the various classes. (See FM 10-5.)

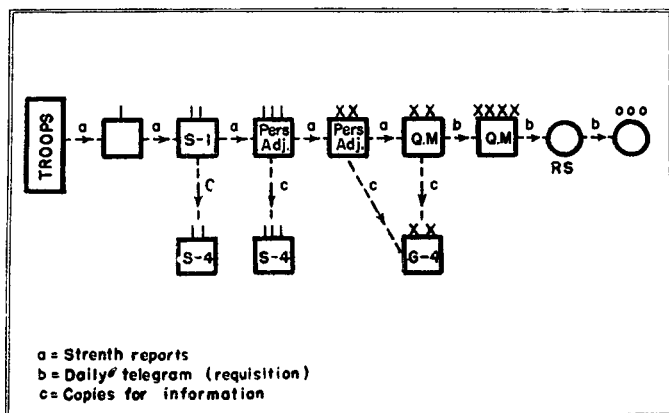

FIGURE 12.—Class I supply requisition and daily telegram.

c. *Railhead*.—See FM 100-10 and 10-5 and figure 9.

d. *Railhead reserves*.—See paragraph 56.

e. *Rations*.—(1) Paragraph 116 defines the various types of rations for field use.

(2) The “A” ration will, except under exceptional circumstances, be issued daily from army class I railheads to all divisions and other units not actively engaged with the enemy.

(3) In battle, the “B” or “C” ration will normally be issued. The “D” ration will, when the situation warrants the issue of an individual reserve ration, be issued to units or

individuals. However, whenever possible, the "B" or "C" ration should be issued daily to all of the troops.

(4) The quantity and type of rations to be carried by individuals and on unit trains as a prescribed load are announced from time to time by the division or higher commander.

f. Issue at class I supply railhead.—(1) Prior to the arrival of the daily train each day, the division quartermaster supply officer submits to the railhead officer a strength report of the units as of that day and the method of distribution to be used. From that report and the information as to the number of rations due in on the daily train, the railhead officer knows whether he must draw from his reserve or whether he has an excess of rations. From this information he can also plan the sorting and loading for that particular issue.

(2) Upon the arrival of the daily train, the railhead officer directs the unloading of the train, the sorting of supplies, and their loading on the divisional vehicles. He and his platoon are assisted in this work by additional labor furnished by the service company of the quartermaster regiment. As soon as all the supplies are loaded on the divisional transportation, the quartermaster supply officer gives a receipt to the railhead officer for all the supplies drawn.

(3) (a) When the field forces are operating in the presence of the enemy, distribution of class I supplies will most likely be conducted during hours of darkness. This provides some measure of defense for supply operations and helps prevent the enemy from gaining information relative to the locations of trains and supply establishments. The time required to effect distribution, therefore, becomes an important factor.

(b) The distance from railhead to distributing points, the condition of roads and the volume of traffic moving over them, the time required to unload supplies at distributing points, and the time required to sort and load supplies at the railhead are all variable factors. Only the time required to sort and load supplies at the railhead are discussed in this manual.

(c) The time required at the railhead to sort and load rations, grain, and hay for unit distribution varies widely with conditions existing at a railhead. If ample platform space,

labor, and mechanical aids such as warehouse trucks, etc., are available for handling the supplies from railroad car to platform, thence to motor truck, it is possible to complete truckloading in approximately the same time it requires to unload a car of miscellaneous supplies into a warehouse, possibly as short a time as 2½ to 3 hours. On the other hand, if supplies must be handled directly from car to truck, loading time must necessarily be longer, owing to the smaller number of trucks which can be loaded simultaneously and the difficulty of sorting supplies in the cramped space of a loaded box car. This difficulty is of little importance if the car contains only a few different commodities; but sorting in the car is impracticable when the car contains from 15 to 18 or more varied commodities. The latter will usually be the case in a car containing the smaller components of the ration, hence the desirability, as a timesaving expedient, of loading the smaller components of the ration from the railhead reserve. For a rough estimate, 2 hours should be allowed for unloading the train and sorting the supplies. For unit distribution employing quartermaster trucks, add to this 2 more hours. When railhead distribution is to be made, allow 4 hours for loading the trucks in addition to the 2 hours for unloading the train and sorting at the railhead. If the supplies are to be bulk loaded on quartermaster trucks, allow 2 hours. In actual operations, this time can probably be reduced, for as the personnel becomes more familiar with the work it will naturally become more efficient in the handling of supplies. Every effort should be made, however, to complete not only the loading of the trucks, but also the entire distribution under cover of darkness.

(d) Ample roadway for circulation of vehicles through the railhead and for maneuvering vehicles at loading points, and road space at or in the immediate vicinity of the railroad, where empty vehicles can be held awaiting their turn to load and where loaded vehicles can be assembled into suitable groups for movement to distributing points, simplify the traffic problem at the railhead and affect loading time.

(e) Whatever the conditions at the railhead, loading operations can proceed in an orderly and expeditious manner only if they follow a carefully devised plan. Such a plan should contain specific details regarding—

1. Organization of the transport into truck groups (one group for each regiment or similar unit).

2. The load, by commodity and amount, for each truck of a group.
 3. Allotment of labor at each loading point at the railhead and to accompany each truck group to division distributing points or dumps.
- (f) 1. The loading schedule may be based on either of the following methods of operation:
- (a) Require that all trucks of a group complete loading before any truck of the following group begins loading.
 - (b) Require trucks of a group to begin loading at any loading point just as soon as loading operations at that point have been completed by the preceding group.
2. The first method is the simpler of the two, so offers less chance for error or confusion. Its principal disadvantage is the possible loss of time. A truck loading with certain commodities, such as vegetables, will complete loading in much less time than one loading with the smaller components, so operations at some loading points may be suspended for varying periods of time. The second method is timesaving in that it provides for uninterrupted operations at each loading point. However, because trucks of different groups are intermingled during loading operations, this method requires much closer supervision and offers more chance for error and confusion.
3. In some situations it may be advantageous to plan distribution of hay, or hay and grain, as a separate operation, in which case the truck groups so employed operate independently of the groups employed in distribution of rations and wood.
4. In general, the simplest method which meets the needs of a particular situation is the one most likely to work successfully.
- (4) If an "A" ration is delivered, special care must be exercised in handling the perishables. Paulins should be spread to receive the ice and fresh meats, and other paulins used to cover them until they are loaded in the trucks.

Fresh bread should be shipped in sacks, but if not so shipped, care should be exercised in its handling; if sacks can be secured by quartermaster supply officer, the bread should be issued in them.

(5) In distributing supplies, the railhead officer should issue whole packages to the division. One method of handling small components is to receive and issue them for a period of 5, 10, or 15 days. The situation, however, may not permit this, and it may become necessary to resort to a day-to-day issue. In order to make an issue of a week or 10 days' supply of small components, such as pepper, spices, etc., it will be necessary for the quartermaster supply officer and the railhead officer to make special arrangements with the regulating officer.

(6) In some instances wood and hay may not be shipped to the railhead. The division quartermaster is then charged with the procurement of these supplies from local sources whenever needed. (See FM 10-5.)

g. Distribution by division quartermaster.—(1) The method of distribution of class I supplies will be determined by the division commander. The division quartermaster, in making his estimate of the situation, carefully considers the methods to be employed. He recommends to G-4 the methods he believes best suited to the situation and G-4 approves or disapproves these recommendations. In some instances, the division commander may not delegate the authority to G-4, in which case his recommendations must be submitted to the commander. The method of distribution normally is determined during the G-1-G-4 special staff conference. However, the quartermaster may recommend changes in the method of distribution whenever the supply situation or availability of trucks alter the situation.

(2) There are several methods and combinations of methods of distributing class I supplies. Unit distribution and railhead distribution are the principal methods. A rarely used method is through division distributing points or dumps. Combinations of these methods are possible. Figure 13 diagrammatically shows three methods of distribution.

(3) *Unit distribution.*—(a) Unit distribution is made by the quartermaster, utilizing trucks from the quartermaster regiment. Delivery of the supplies is made to the kitchens, bivouacked by battalions or regiments. It is not necessary

for the kitchen trucks to be actually in the bivouac at the time delivery is made. A representative of the unit should be there in order to receive the supplies, and they may be dumped on the ground preparatory to issue to the kitchens. Unit distribution is used whenever ample quartermaster transport is available and time and space permit, or where regimental transportation is not available. Inasmuch as the function of the quartermaster regiment is the supply of troops in the field, this method might be considered normal in a square division and the division quartermaster should always endeavor to utilize it whenever possible. (See fig. 14.)

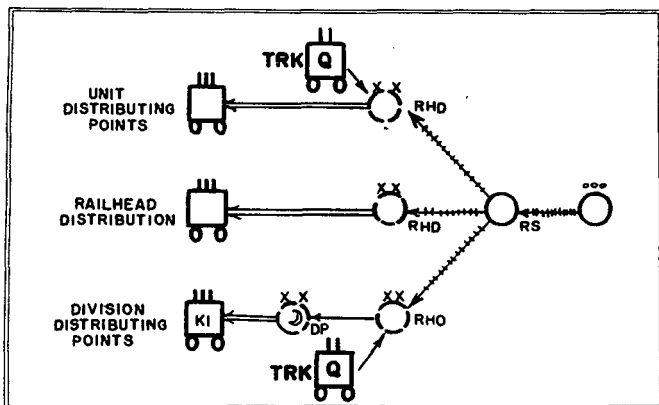

FIGURE 13.—Three methods of class I supply distribution.

(b) The estimate of truck requirements for unit distribution is based upon the weight and the items of the ration to be delivered. In order to facilitate loading at the railhead it will frequently be desirable to have a greater number of trucks for each unit group than that actually required in terms of truck tons. If this is done, trucks loading less than a ton of meat would make only one stop at the railhead even though they had less than a full load. Every effort should be made to limit the number of stops at the railhead for each truck to not more than two, for example, one truck might take a partial load of meat and complete the load with small components. The quartermaster trucks assemble at the rail-

head in groups, each group to have the required number of trucks necessary to transport the supplies for one kitchen group. As these kitchen groups vary in size, so will the number of trucks vary within each group. For example, a regiment of truck-drawn 75-mm field artillery may require about three trucks, an infantry regiment four trucks, and the medical regiment only two. These groups are loaded at the railhead and are then consolidated into a convoy. The convoy follows a prescribed route and the truck groups are dropped off at the various unit distributing points. If pro-

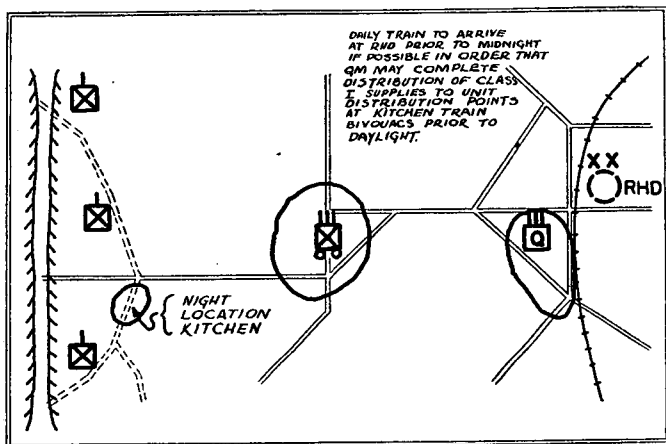

FIGURE 14.—Unit distribution of class I supplies.

tection is not essential, truck groups might proceed separately to the bivouacs of the kitchens they supply.

(c) Whenever unit distribution is employed, class I supply control stations should be employed. These stations are located at prominent terrain features along the route followed by the quartermaster trucks. Each station has a representative of the units being served. As the convoy reaches this point, it is broken up and the representatives of the various units guide each truck group to the proper kitchen bivouac. The use of these control stations greatly facilitates the delivery of supplies and prevents truck groups from getting lost. Because it expedites delivery this system

should be used even during daylight distribution, unless the quartermaster personnel is thoroughly familiar with the location of all units.

(d) Information as to the method of distribution and location of the class I supply control station should be given to the troops either in fragmentary orders or in the administrative order whenever issued. (See FM 10-5.)

(4) *Railhead distribution.*—(a) In railhead distribution, regimental or kitchen trucks of the various units, operating under the supervision of a quartermaster supply officer, draw class I supplies at the railhead. In many situations it will be found that this method of distribution is the only one that can be utilized.

(b) The kitchen or regimental trucks are grouped under the supervision of the unit supply officer, and report to the railhead at a time specified by division headquarters. Upon arrival at the railhead, the railhead officer, assisted by the quartermaster supply officer, issues the supplies for each organization. The unit supply officer receipts to the quartermaster supply officer for the supplies received and the quartermaster supply officer, in turn, receipts to the railhead officer for all the supplies issued to the division. The only time that the unit trucks are under the direct supervision of the quartermaster supply officer is during the period that they are at the railhead. Upon completion of the issue to any one unit, that unit is released and proceeds to its bivouac, where the supplies are broken into kitchen lots. The number of trucks required by each unit will be similar to that given in subparagraph (3) (b) above.

(c) In order to coordinate the issue of the supplies at the railhead, the method of distribution and time that each unit will draw supplies must be incorporated in either fragmentary orders or the administrative order of the division.

(d) Railhead distribution may be partial or complete, that is, some units may draw supplies at the railhead, utilizing their own transportation, and some units may have unit distribution. The selection of the units for railhead distribution and unit distribution will depend on the situation. In some instances, those units that are most distant from the railhead might have unit distribution, while those that are bivouacked near the railhead might have railhead distribution. Railhead distribution is complete when all units of the division draw their supplies at the railhead.

(e) Railhead distribution normally is used when quartermaster transportation is not available and when there is sufficient transportation available within the regiment and similar units. It should be used, however, only when this method of distribution can be completed under cover of darkness and when no other division or similar unit is being served at that railhead. It might also be used in rest areas where time and secrecy are not major considerations.

(f) In view of the fact that the transportation facilities within the regiments of the division are limited, it may frequently be necessary for the units to use their kitchen trucks in order to accomplish railhead distribution. This can be done by having the kitchen trucks carry the kitchens or prepared meals to the front line, and there unload the kitchens or prepared meals, so that the men may be fed during the night. From there the trucks can proceed to the railhead to draw supplies, these supplies to be delivered at the unit bivouacs by these trucks. Then the same trucks can proceed to the front lines, pick up the kitchens or such equipment left there, and return to their unit bivouacs. (See FM 10-5.)

(5) *Division distributing points.*—(a) The division quartermaster may deliver class I supplies to division distributing points or dumps.

(b) In making distribution to division distributing points the quartermaster supply officer has the supplies at the railhead bulk-loaded for all those units being served at each division distributing point. The regimental units send their trucks to the division distributing point. The quartermaster breaks down the supplies into regimental or similar unit lots and turns them over to the units. The quartermaster vehicles then return to their bivouac or proceed on any other mission ordered. The unit vehicles return to their bivouacs and complete the distribution in the same manner as in other methods of distribution.

(c) The location of these division distributing points and the time that the various units will draw their supplies must be incorporated either in fragmentary orders or in the administrative order of the division. Usually two or three distributing points for the division, supplying units of approximately the size of the brigade, are necessary.

(d) This method is not normal and will rarely be used. However, there are certain situations where it will be found advantageous, for example, in retrograde movements, where it is advisable to dump class I supplies at distributing points, so that the unit kitchens may pick them up while moving toward the rear. It can also be used when the distance or time involved is too great for either the quartermaster regiment to make unit distribution or the regimental units to draw supplies at the railhead during the specified time. As the time to sort and load the supplies at the railhead is considerably less than for other methods of distribution, this method might be used when, owing to the danger of hostile air attack, rapid dispersion of supplies becomes imperative. Where class I supply dumps have been established by the division, the units may draw their supplies from these dumps in a manner similar to that in railhead distribution, in which case unit trucks proceed to the dump, draw supplies for their regiment, and then return to their bivouac. (See FM 10-5.)

(6) Labor for handling supplies at the division distributing points, railhead, or at the division dumps is furnished by the service company of the quartermaster regiment. Labor at unit distributing points is furnished by the units receiving the supplies.

(7) *Special methods.*—Owing to circumstances beyond the control of the quartermaster, it may be necessary for him to devise special combinations and methods of distribution; for example, it might, under certain conditions, be necessary for him to make unit distribution to some units, railhead distribution to others, and establish a division distributing point for others. These special methods of distribution, however, should be kept at a minimum. (See FM 10-5.)

h. Division reserve.—Each kitchen can usually carry one ration and the unconsumed portion of another. This means that a kitchen may have as a maximum one and two-thirds rations. The ration cycle may begin with any meal and consists of that meal and the next two consecutive meals and continues daily until changed by competent authority. Breakfast, dinner, and supper each day provide one complete cycle. When supplies are delivered during the night, the most convenient meal to begin the cycle with is the evening meal, or supper. When the cycle begins with supper

and the rations are delivered at night, the ration delivered one night will be for consumption beginning with supper of the following night. In rest camps and under other favorable circumstances the cycle may begin with breakfast. When this is done the ration will usually be delivered during the day. If reserve rations are ordered carried in the quartermaster regiment, they remain intact until such time as it becomes necessary to issue them. They may, however, be issued prior to the arrival of the daily train, provided the supplies arriving on the daily train are of the same type as those carried in the quartermaster regiment. If this is done, the ration must be replaced in the quartermaster service train as soon as practical after it has arrived at the railhead. The issue of any reserve ration carried in the quartermaster train should never be made unless it has the prior approval of the division commander. (See FM 10-5.)

i. Rations.—If an "A" ration is to arrive on the daily train, every effort should be made to distribute as soon as possible and distribution of the reserve ration carried in the quartermaster train should be avoided.

j. Distribution of class I supplies in varying situations.—
(1) *On the march.*—(a) The supply of troops on the march is not difficult. Although railhead distribution might be considered normal for supply on the march, any of the methods of distribution mentioned may be utilized. Supplies may be secured by the regimental kitchens either before the march begins or after the march ends. When combat is imminent, it is more desirable to have the supplies issued to the kitchens prior to the initiation of the march, as it provides a full complement of rolling reserves with the marching of columns. However, this may only be done if the kitchens have sufficient capacity to carry a full day's supply of class I supplies. In other situations, where the kitchen trucks lack carrying capacity, it may be necessary for the kitchens to secure their supplies in the new bivouacs. The method of distribution will depend upon the situation, the same general fundamentals applying as have been enunciated in subparagraph *g* above.

(b) If distribution is to be made in the new bivouac area it may be possible to advance the railhead during the march. This can, however, only be done when friendly troops are protecting the new bivouac. If the distance between the

using troops and the railhead is too great for the kitchens or quartermaster trucks to make the return trip during the prescribed period, distributing points may be set up between the new bivouac and the railhead.

(2) *Attack*.—(a) In the attack, the railhead and other quartermaster installations can be located relatively close to the combat area. However, this does not mean that they should be located so close as to endanger the installations.

(b) In a wide envelopment, special attention must be given to the supply of the enveloping force. If the envelopment is very wide and the distance too great, it may be necessary to attach to the enveloping force extra transportation from the quartermaster regiment. The supply of the holding force will provide no special problem of supply.

(3) *Pursuit*.—In the pursuit, special attention must be given to the encircling force. In many instances it may be found necessary to attach additional quartermaster trucks to units of the encircling force in order to insure adequate supply. It must be borne in mind that in some situations the encircling force will be out of touch with the supply system for several days. The direct pressure force will provide no special supply problem. Supply installations can be pushed well forward in the pursuit.

(4) *Defense*.—In the defense, the railhead and quartermaster installations will probably be located well to the rear. Reserves of class I supplies may be kept either at the railhead or at division dumps.

(5) *Navigation head and truckhead*.—The same methods of distribution as outlined for supplies received at a railhead apply to truckheads and navigation heads. (See FM 10-5.)

■ 124. GASOLINE AND OIL SUPPLY.—*a. General*.—The army quartermaster establishes gasoline and oil supply points at all railheads and depots, and at other convenient locations on the main supply routes leading thereto. Some of these installations may be civilian gasoline filling stations taken over by the army quartermaster. In addition, it will be necessary for gasoline and oil to be delivered to the division quartermaster in order to supply those vehicles, such as weapon carriers, prime movers, etc., that are in the forward area of the division. Each vehicle carries, in addition to the gasoline

in tanks on the vehicle and the oil in the crankcase, a 10-gallon can of gasoline.

b. Supply vehicles.—Those vehicles which are traveling between the division area and army supply points should be supplied with gasoline and oil, either at the supply point or at some convenient filling station en route. The drivers of these vehicles should make every effort to arrive in the division area with the maximum amount of gasoline and oil and should, therefore, refill at the last possible supply point prior to entry into the division area.

c. Supply by division quartermaster.—A reserve of gasoline and oil, in containers, is carried in each unit within the division. As far as practicable, initial distribution of this reserve will be made to each motor vehicle. This constitutes the entire division reserve. The supply of those vehicles in the forward area will be by the division quartermaster, who will transport the gasoline in 10-gallon containers to division gasoline and oil distributing points, where the units will exchange their empty containers for full ones. If facilities are available in the forward area, the division quartermaster might establish filling stations, utilizing any workable commercial facilities available.

d. Requirements of method of distribution.—Receipts for any gasoline and oil issued by the division quartermaster should be secured from the units receiving these supplies. These receipts serve not only as a receipt for the gasoline and oil drawn, but also form a basis for the requirements of the daily telegram.

e. Special gasoline.—Special gasoline may be required for use in cooking ranges and gasoline lanterns. This gasoline will probably be issued with the class I supplies. If not available at that time, it will be distributed separately.

f. Transportation.—If the division or higher commander prescribes that the reserve of gasoline and oil be carried in the quartermaster regiment, it will normally be carried in the vehicles of the gasoline and oil supply platoon of the headquarters company. (See FM 10-5.)

■ 125. CLASS II AND CLASS IV SUPPLIES.—*a. Class II and class IV supplies (less animals).*—See FM 10-5.

b. Animal replacements.—See FM 10-5.

■ 126. WATER SUPPLY.—See FM 10-5.

■ 127. EMPLOYMENT OF TRANSPORT.—*a.* The transportation of the division quartermaster unit constitutes the division reserve, which is seldom adequate to meet in full the requirements for resupply of the division during a protracted period. It is, therefore, essential that the use of this transportation be planned in advance and that all activities involved in its use be coordinated by the division motor officer. Whenever trucks are sent out on missions that do not involve their entire capacity, the division motor officer should contact other services and see if they can use the extra available capacity. This transportation is available to the division commander for the purpose of transporting supplies and troops and of such other work as he may deem necessary. Some of the more important duties performed by the quartermaster truck battalions are the transportation of class I supplies, the transportation of both small arms and field artillery ammunition, assisting in the movement of engineer supplies, and, wherever practicable, transporting class II and class IV supplies for the division. It may, in some instances, be necessary to utilize some of this transportation for the delivery of gasoline and oil. However, except under the most abnormal conditions, the gasoline and oil supply platoon can handle this work. Troop and supply movements by motor transport are covered in detail in FM 100-10 and 25-10.

b. Work sheet.—In order to facilitate the allocation of transportation to the various duties to be performed, some method of advance planning must be utilized. In some cases, the use of a control board, showing the various duties on which each truck is engaged, may be satisfactory. In long range planning, however, a work sheet similar to that shown in figure 15 may be used. This work sheet should simplify transport planning. Column 1 is for the mission of the truck or group of trucks. Column 2 is for the designation of the company furnishing the trucks. Column 3 is for the number of trucks and trailers required. Column 4, under the first step, is for the place that the trucks originate their mission and the time that they depart; for example, the trucks might originate their mission at the truck battalion bivouac. Column 5, under second step, is for the first stopping point, for example the class I supply railhead, together with its time of arrival and time of departure. The time of departure will be the time of arrival plus the time required

1	2	3	4		5		6		7		8							
			Truck	Trail- ers	1st step	2d step	3d step	4th step	5th step	Place	Depart	Place	Arrive	Depart	Place	Arrive	Depart	
Task	Truck com- pany	Number of trucks and trailers																

FIGURE 15.—Work sheet.

to load or unload the truck or group of trucks, or the time the truck or group of trucks is required to wait at that point. The next column, under the third step, is for the next stopping place, for example the 1st Infantry kitchen bivouac, together with its time of arrival and departure. The method of computing the time of departure is the same in each case as for the second step. Columns 7 and 8 are repetitions. Each task should be listed separately and careful consideration should be given not only to the total number of trucks used during the period for which the work sheet is prepared, but also to the times of arrival and departure so that there will be no overlapping by the same truck or group of trucks. (See FM 25-10.)

c. Wherever possible, each truck or group of trucks, after having completed one mission, should, if the distance is not too great, return to its bivouac before starting another task. This will provide better control by the quartermaster over his transportation and will prevent straggling. In some instances, however, it may be possible for the same truck or group of trucks to perform two or more tasks in sequence without returning to its bivouac.

d. In solving any problems that might arise with reference to the disposition of the trucks in performing their missions for any given period, the following procedure may be followed:

(1) List all of the tasks to be performed by the quartermaster regiment involving trucks during the period under consideration.

(2) List all of the restrictions imposed by higher headquarters that will affect the use of the trucks; for example, prohibition against use of lights, time of opening or closing of installations, use of certain roads, etc.

(3) Next, make a table showing, in terms of miles and time, with and without lights, all distances over which the trucks must travel.

(4) Next, list all of the means that are available, together with their present loads.

(5) Finally, through the use of the work sheet, list the means, together with their missions in the order of performance, the number of trucks required, time of departure from bivouac, time of arrival and departure at various supply points or other destinations, and times of return at quartermaster regimental bivouacs.

■ 128. PROTECTION.—*a.* The protection of the quartermaster train is a responsibility of the quartermaster as regimental commander. The regiment itself is equipped with rifles but, if the situation warrants, the division quartermaster should supplement this with a request for additional protection from line troops. When the latter is done, the quartermaster regiment will travel as a convoy. The best protection that the quartermaster regiment has is in the speed of its trucks. Additional protection can be furnished in concealment and dispersion and the establishment of road blocks which should be maintained by effective fire support.

b. In bivouac.—Owing to the danger of hostile air attacks, it is necessary that close attention be given to the protection of the quartermaster regiment when in bivouac. Truck units should be bivouacked so as to conceal their vehicles from air observation. This concealment can be secured by placing the trucks in garages of the cities and towns in which the regiment is bivouacked or along those streets in a city that have a considerable number of shade trees, or along roads in the country, placing the vehicles under trees. Trucks should be concealed wherever possible, not only from overhead air observation, but from oblique observation as well.

c. Additional protection can be secured by the proper use of camouflage and concealment by artificial covers, such as nets, branches of trees, and brush, by changing the pattern to resemble other objects compatible with the surroundings. (See FM 10-5.)

■ 129. CAMOUFLAGE.—*a.* In general, camouflage work is executed by the troops of the activity or area being camouflaged. Major camouflage projects are executed by general engineer troops.

b. Use of camouflage.—(1) Natural cover should be supplemented by camouflage, which, when successful, not only conceals the camouflaged objects, but also disguises the fact that camouflage has been used. Insofar as practicable, the enemy must be kept in ignorance of any change in conditions, and work must be conducted so that it will not register in aerial photographs or be detected by ground observers from within the enemy lines. Photographs frequently disclose things not visible to an observer's unaided eye. Or-

ganization commanders should, therefore, familiarize themselves with the fundamentals of camouflage, prevent the making of trails, tracks, or other betraying marks in the vicinity of any work, and instruct their personnel in the use of natural and artificial cover.

(2) Natural cover or camouflage prepared from natural material is usually more effective and economical than cover prepared from artificial material. Full advantage should always be taken of such cover. When natural materials, such as leaves or branches, are used for camouflage, care should be taken to see that the wilting process does not destroy their effectiveness.

(3) In general, it is useless to attempt to camouflage a position where work has already begun and where the enemy has had an opportunity to observe and register the site.

(4) Even though it may be impossible to camouflage completely a military structure, its visibility should be reduced by disguising its outline and eliminating highlights and reflecting surfaces.

(5) Subsidiary military works or auxiliary structures, such as temporary kitchens or latrines, must be located and camouflaged carefully.

(6) There should be close cooperation among the intelligence sections, air corps, and camouflage officers, in order that camouflage work may be properly executed. Whenever practicable, the counter-intelligence plan should provide for aerial photographs of our own positions to insure the proper surveillance of the camouflaged effort. Camouflage officers should study these photographs with a view to correcting defective work.

(7) In order that they may perform their camouflage duties properly, responsible officers must acquire an intimate knowledge of the area in which they are to operate. They must learn the photographic values, textures, and character of the materials required, as well as the best means of adapting their work to the terrain. For detailed instructions concerning the use of camouflage see FM 5-15. (See also FM 10-5.)

c. Camouflage discipline.—The proper concealment of troops from hostile aviation depends, in large measure, on the understanding by all military personnel of what aerial photographs reveal and on the degree of camouflage discipline prevailing within the command. Trained troops utilize to the maximum

existing roads, trails, and paths before making new ones, and avoid making any that are unnecessary.

d. All identification marks, such as divisional, regimental, or lower organizational designations, or insignia, on all classes of individual or organizational equipment should be effectively obliterated on orders of higher authority prior to entry into the combat zone.

e. Use of cover.—Troops should make maximum use of the concealment afforded by terrain features, such as woods, covered routes, and villages. Whenever possible this should be supplemented by artificial concealment prepared from various materials such as grass, leaves, or burlap. For detailed instructions concerning individual use of concealment, see FM 21-45.

f. Use of darkness.—(1) *Night marches.*—In general, troop movements in the combat zone should be made under cover of darkness and with restrictions on the use of lights. The different degrees of restrictions on the use of lights will be defined in orders by the theater commander. In some instances lights will not be permitted in the division area. In other instances lights will be permitted only in the area forward of the light line. This line will be the line forward of which lights will be prohibited. When troops are being concentrated by night marches, daybreak should find them either in position or under cover in woods or villages.

(2) *Blackout.*—If the enemy possesses a powerful air force, a blackout system must be employed in the theater of operations, the necessary instructions for which will be issued by the theater commander.

■ 130. GRAVES REGISTRATION.—See FM 10-5.

■ 131. SALVAGE.—See FM 10-5.

■ 132. TRAFFIC AND TRAFFIC CONTROL.—*a. General.*—The personnel of the quartermaster regiment should thoroughly understand traffic control and the rules and regulations affecting the flow of traffic.

b. Circulation.—Circulation is the movement of traffic over routes in accordance with circulation plans which determine the direction of traffic and classes of traffic permitted over the various routes.

(1) Within each division area a circulation map will be prepared by the G-4 section in collaboration with the division engineer. This circulation map will show the direction of traffic on principal routes within the division area, together with the location of any traffic control stations that might be established. All personnel of the quartermaster truck units should be thoroughly familiar with the circulation of traffic within the division area and the area in which its trucks operate. As the quartermaster supply trucks operate between the army supply points and the division area, all personnel should be familiar with the circulation map of the army and corps as well as of the division. The circulation plan must be based upon the tactical situation, plan of supply and evacuation, and upon the road net within the area.

(2) The backbone of the circulation map is the main supply road. This road may be a single road, operating two-way traffic from the rear to the front, or it may be two single roads, one as a road carrying inbound traffic and the other road carrying outbound traffic. The best road in the area should be devoted to the inbound traffic for the trucks traveling this road will normally be loaded. It is preferable to have an inbound and outbound road rather than a two-way road. The two-way road is objectionable because it permits cross traffic over the main supply road when making left hand turns. The direction of traffic over lateral routes, that is, roads generally paralleling the front, should be alternated and, if practicable, the lateral routes should be limited to one-way traffic. Division supply points, clearing stations, collecting points, etc., should be located on roads or spurs, preferably off the main supply route. Turn-arounds should be provided over a one-way road, and passing points should be designated or traffic controlled by a block system, the vehicles operating in one direction being permitted to pass over a section of the road under control of military police.

c. Traffic control.—Traffic control means the control of the movement of persons, animals, and vehicles. Its object is to facilitate and expedite travel by preventing accidents, interference, and congestion. This can best be accomplished by enforcing traffic regulations as to speed, direction of travel, the prohibition of double banking, and the use of reserved or specially assigned routes.

(1) Travel may be expedited by the proper issuance of instructions and information to transportation personnel by the military police.

(2) Traffic control is necessary because of the heavy and continuous traffic to which the roads in the theater of operations are subjected. The movement of motor transport, horse-drawn vehicles, and foot troops must be coordinated in order to secure the best advantage of the available road capacity. As a corollary to this, the fewer the roads, the closer the supervision. The requirements for the combat troops should dominate the traffic control.

(3) The principal measures for control are as follows:

(a) Reserving certain routes for use of a particular type of transportation, such as for the exclusive use of animal-drawn transportation.

(b) The allotment of specific hours to combat units or supplies, as for example, allotting the hours prior to midnight for use of combat troops and the hours subsequent to midnight for the transportation of supplies.

(c) Rigid enforcement of traffic rules and regulations by the military police.

(d) The proper enforcement of march discipline.

(e) The elimination of cross traffic.

(4) There are two methods of traffic control:

(a) *Block system.*—This system may be employed during the movement of small bodies of troops or convoys not in the presence of the enemy and on routes that are not in constant use. The military police proceed in advance along the route to be followed by the troops and convoys. At crossings, detours, and other places, they take station far enough ahead to insure the march being made without interference by other traffic. When the head of the column passes the traffic control station thus established, the military police proceed to the next unposted point, clearing the road as they go. This procedure is carried out until the troops have reached their destination.

(b) *Point system.*—The point system consists of one or more men stationed at important points to regulate traffic in much the same manner as civilian traffic policemen. Traffic controls consist of men mounted on horse, bicycle, or motorcycle, and are used to patrol constantly the roads between traffic control posts. This system may be used

on roads that are in constant use during movement of large bodies of troops. (See FM 10-5, 100-10, 25-10, and 29-5.)

SECTION IV

QUARTERMASTER BATTALION, INFANTRY DIVISION (TRIANGULAR)

■ 133. GENERAL.—The quartermaster battalion (triangular division) is the unit assigned to provide quartermaster service for the infantry division (triangular). The battalion is organized to provide personnel and units trained in the technique of quartermaster administration, supply, and transportation.

■ 134. DUTIES.—The duties required of the quartermaster battalion are identical with the duties prescribed in paragraph 118.

■ 135. ORGANIZATION OF QUARTERMASTER BATTALION.—*a.* In order to perform the quartermaster service incident to the infantry division, triangular, the battalion has been organized into a battalion headquarters and headquarters company, and one truck company. The battalion consists of 18 officers and 302 enlisted men. (See T/O 10-15.)

b. Battalion headquarters consists of a lieutenant colonel commanding, and seven other officers who form the nucleus for both the battalion headquarters and the office of the division quartermaster. The battalion commander acts in a dual capacity; he commands the battalion and is a member of the division special staff. Prescribed duties and responsibilities of the battalion commander are identical with those listed in paragraph 119*b* and *c*.

c. The designation of the seven other officers in the battalion headquarters is as follows:

- (1) One major, executive, second in command and assistant division quartermaster.
- (2) One captain, division supply officer.
- (3) One captain, division transportation officer.
- (4) One first lieutenant, adjutant.
- (5) One lieutenant, assistant to the division supply officer.
- (6) One lieutenant, assistant transportation and gasoline supply.

(7) One second lieutenant, battalion supply officer.

d. The headquarters company is divided into a company headquarters, a car platoon, a service platoon, and a maintenance platoon.

(1) The company headquarters performs the normal duties of housekeeping for the battalion headquarters and for the company. These duties include clerical work, supply, and messing for the company.

(2) The car platoon furnishes the passenger transportation for division headquarters. It operates five 5-passenger automobiles, and eight ½-ton command and reconnaissance trucks.

(3) The service platoon, consisting of two sections, furnishes labor for the division and is the nucleus for any labor pool that may be organized within the division. Its function is to load and unload supplies at various divisional supply points and to perform such other labor as might be assigned to it by competent authority. It acts in a manner similar to the service company, quartermaster regiment, infantry division, square. The platoon is commanded by a second lieutenant.

(4) The maintenance platoon is divided into a platoon headquarters, two repair sections, one wrecker section, and one supply section.

(a) Platoon headquarters, consisting of one officer, and four enlisted men, performs the normal duties of a platoon headquarters.

(b) The repair sections maintain and operate a mobile maintenance shop.

(c) The wrecker section provides the equipment and personnel to provide wrecker service for the division. It is normally located with the maintenance shop.

(d) The supply section, under the supervision of a second lieutenant, provides the personnel for operating the motor transport supply service. This can best be operated in conjunction with the maintenance shop.

(e) The platoon should be bivouacked in the vicinity of the third echelon maintenance shop.

e. The truck company consists of a company headquarters and two platoons; under the command of a captain.

(1) The company headquarters provides personnel and equipment for company housekeeping, including clerical work, supply, and messing.

(2) The platoons furnish the truck and trailer transportation for the division. The company provides either forty 2½-ton cargo trucks or forty ¾- to 1-ton 2-wheeled cargo trailers for general cargo and troop-hauling purposes within the division. (See FM 10-5.)

■ 136. ORGANIZATION OF OFFICE OF DIVISION QUARTERMASTER.—

a. A suggested type organization of the office of the division quartermaster and headquarters, quartermaster regiment, square division, is given in figure 11. The same doctrine, duties, and fundamentals are applicable to the operation of the division quartermaster's office, triangular division, as outlined in paragraphs 120 and 121 for the square division. The main difference in the organization of the two offices is in the rank, numbers, and detailed assignment of personnel. It should be noted that this is only a guide, and that T/O 10-16 essentially governs. (See FM 10-5.)

(1) The administrative division may be headed by the battalion adjutant.

(2) The supply division is headed by a captain who is designated as the quartermaster supply officer. A first lieutenant assists him in operating the supply division. One of the lieutenants in the transportation division also assists the quartermaster supply officer in matters pertaining to class III supplies.

(3) The transportation division is headed by a captain, who is designated as the transportation officer. He is assisted by a first lieutenant of the battalion headquarters, by the lieutenant commanding the maintenance platoon of the headquarters company, who performs the duties of the division maintenance officer, and, if necessary or desirable, by the commander of the truck company, who may be the division motor officer.

(4) Two officers are assigned to the battalion headquarters. One is the adjutant, who also performs the duties of S-2 and S-3; the other is the battalion supply officer, S-4.

b. The assignment of personnel to various duties in the office of the division quartermaster is dependent on the personnel available in the battalion, the idiosyncrasies of the

division quartermaster, and on the organization of the division general and special staff. The allocation of enlisted personnel to battalion headquarters and office of the division quartermaster is based upon the organization adopted by the division quartermaster.

■ 137. DISTRIBUTION OF SUPPLY.—*a. Class I supply.*—In general, all the methods outlined in section III for the procurement and distribution of class I supply can be applied to the triangular division. The triangular division may find it necessary to resort to railhead distribution more frequently than the square division. This is due in part to the limited amount of transportation available within the quartermaster battalion. Nevertheless, the primary function of the division quartermaster is still that of procurement and distribution of supplies, and recommendations and supervision by the quartermaster service are still necessary. A reserve of class I supply is carried by the truck company of the quartermaster battalion whenever the division or higher commander prescribes. If the situation precludes the establishment of a reserve within the division, a railhead reserve of at least 1 day's class I supply should be prescribed. (See FM 100-10.)

b. Class III supply.—The methods for procuring and distributing gasoline and oil in the triangular division are similar to those laid down in paragraph 124. Whenever gasoline and oil are distributed by the quartermaster service in the triangular division the distribution will be effected under the supervision of the first lieutenant, assistant to the transportation officer, using labor secured from the service platoon of the headquarters and headquarters company, and transportation secured from the truck company. (See FM 100-10.)

c. Class II and class IV supply.—Class II and class IV supply are handled in the triangular division in the same manner as that laid down in paragraph 125. (See FM 100-10.)

■ 138. TRANSPORT.—Owing to the limited amount of transportation available in the quartermaster battalion and the limited amount of other truck transport available within the division, all transportation in the division, except prime movers and weapon carriers, should be utilized as a pool in order to obtain the maximum flexibility and hauling capacity. Motor vehicles from the quartermaster battalion or division

pool are frequently attached to units for specific periods when the task exceeds the capacity of organic unit transportation. (See FM 100-10 and 25-10.)

■ 139. MOTOR MAINTENANCE.—*a.* The third echelon maintenance shop operated by the repair section of the maintenance platoon, headquarters company, should be located on the main supply route between the division railheads and the forward area of the division. Towns with existing repair shops furnish excellent locations for third echelon maintenance shops. If such locations are not available, the field shop should be set up in a convenient location.

b. Units perform all first and second echelon maintenance and the maximum amount possible of third echelon maintenance. Spare parts are obtained from the supply section of the maintenance platoon of headquarters company, quartermaster battalion.

c. Vehicles which cannot be repaired promptly by the unit are turned over to the division quartermaster service or are collected by the wrecker section of the maintenance platoon. Pending repair by the third echelon shop, or replacement from army, replacement of vehicles needed by units may be temporarily supplied from the truck company, quartermaster battalion. (See FM 10-5 and 25-10.)

CHAPTER 3

CAVALRY AND ARMORED DIVISIONS

	Paragraphs
SECTION I. Cavalry division (horse)-----	140-150
II. Armored division-----	151-158

SECTION I

CAVALRY DIVISION (HORSE)

- 140. GENERAL.—See FM 10-5.
- 141. ORGANIZATION OF QUARTERMASTER SQUADRON.—See T/O 10-115 and 10-116.
- 142. ORGANIZATION OF DIVISION QUARTERMASTER'S OFFICE.—The organization of the division quartermaster's office is similar to that outlined for the infantry division, square, given in paragraph 120. The only difference is the grade of the officers assigned to the various divisions.
- 143. CLASS I SUPPLIES.—*a.* The fundamentals governing quartermaster operations in the Infantry division, square, given in section III, chapter 6, are applicable to the Cavalry division and are to be employed whenever practicable. However, modifications are frequently necessary. The wide fronts over which Cavalry may operate, its probable distance from suitable rail facilities, and the difficulty of dispatching and guarding convoys may necessitate intermittent supply at 2- or 3-day intervals, in which case Cavalry subsists on its reserve supplies or resorts to local procurement. When intermittent supply is necessary, arrangement is to be made for the replenishment of the supplies consumed during the interval missed. Railheads often are far to the rear, and usually unit distribution of class I supplies is found more suitable. In many instances, it is found feasible for the quartermaster to issue class I supplies, from such reserve as may be carried in the quartermaster squadron, prior to the arrival of the daily train. The supplies issued from the reserve are to be replaced as soon as practicable after the arrival of the daily train. (See FM 10-5 and 100-10.)

b. In many situations Cavalry may find itself operating where rail facilities are not available. Under such circumstances it is necessary for the army to forward supplies by motor transport to truckheads, which can serve the Cavalry division. An alternative method is to attach trucks to the division from the motor transport service in order to provide a reserve of class I supplies in addition to those normally carried by the division. The amount of transportation to be attached will depend on the number of days of supply prescribed by the division commander or higher headquarters. These trucks may, in some instances, dump their initial loads at class I supply dumps, the dumps so established becoming supply points of various classes for the division or regiment. The motor transport trucks then haul between the motor supply points and the dump. (See FM 10-5 and 100-10.)

c. In some rare situations, it may be necessary for the division to secure its supplies through the medium of air transportation; that is, when certain cavalry units are an extreme distance from the base or where the presence of hostile troops prevents the use of rail or motor transport. (See FM 10-5 and 100-10.)

d. Under certain conditions it may be necessary for the division to resort to local procurement for all types of supplies. The responsibility for local procurement rests upon the division quartermaster. He must take steps to accomplish the collection and distribution of supplies without interfering with or delaying the tactical mission of the combat troops. Before entering a territory where the command may have to live off the country, the division quartermaster should obtain all available information concerning its resources. Upon entering the territory, systematic inspections of all parts of the locality should be made in order to verify previous reports and to gain additional information. Plans and preparations are made for the collection and distribution of supplies to be purchased or requisitioned. Organizations, unless specifically authorized to do so, are not permitted to seize supplies for their own use. When practicable, all supplies are collected at specific points where they are taken over by the quartermaster and issued to the command in the usual manner. The guiding factor is that collection of supplies should cause the minimum of interference with the

tactical mission of the command. To simplify the exploitation of the resources of a territory, advantage should be taken of assistance from local authorities. These authorities ordinarily know the amount of supplies available within their communities and the quantities that can be procured. In friendly territory local transportation and labor may be hired or impressed. In either case, local transportation and labor are more difficult to handle than military and are to be employed only when necessary. Their most frequent use is in the collection of supplies to convenient points where such supplies can be picked up by organic transport. (See FM 10-5.)

e. A Cavalry command authorized and required to subsist itself upon supplies obtained through local sources must have a carefully considered plan of supply. This plan should include decisions on the following points:

(1) System of getting information on the resources of the country.

(2) Whether supplies are to be levied, requisitioned, or purchased.

(3) Whether supplies are to be collected by details from the division or delivered at central locations by the inhabitants.

(4) Best method of using the trains.

(5) Whether or not to use impressed transportation.

(6) Whether to have the area passed through divided into sectors for supply of separate units, or to have the whole command supplied from one area.

In making initial supply plans, it is necessary to consider the attitude of the inhabitants of the occupied area. If the inhabitants are passively disposed, the task of procuring the local supplies is made easier. If the inhabitants are hostile, the work of collecting supplies is most difficult. In the latter case, attempts may be made to carry off, conceal, or destroy the resources so as to prevent the troops from deriving benefit therefrom. Cash payments generally bring about the best results in local procurement.

f. Probably the most efficient method of obtaining first-hand information concerning the resources of an area immediately available for use by troops is to send out, with advance guards and reconnaissance detachments, agents of the supply services. These agents are assigned certain

areas to cover and they make their reports direct to the headquarters of the force. These reports, together with those of organization supply officers, patrols, and reconnaissance troops, give the location, quantity, and nature of supplies found, information of the roads, local transportation available, feasibility of securing supplies locally, and the availability of local labor. Every officer in charge of a reconnaissance detachment or patrol is, temporarily, a supply agent for his commanding officer insofar as obtaining this information is concerned.

g. Supplies obtained in friendly territory are ordinarily paid for by cash. A finance officer or his agent accompanies the troops to make the necessary payments.

h. In hostile territory, there are two methods of collecting supplies—

(1) *Direct purchase or requisition by subordinate units.*—This system permits each unit to obtain locally all available supplies for its own use. It is most often used by smaller units. Requisitions are to be resorted to only when authorized by the commander of the theater of operations. They are enforced by detachments commanded by commissioned officers.

(2) *Systematic collection under division control.*—(a) By this method, which is the more efficient system for a large force, supplies are located, obtained, collected, and thereafter distributed and issued through the regular supply channels.

(b) The plan for the collection of supplies is influenced by the following factors:

1. Reconnaissance missions of troops accompanied by supply agents.
2. Reports of supply agents received at the headquarters of the unit.
3. Sectors to be assigned subordinate units, based on reported locations of supplies.
4. Organic and impressed transportation to be used.
5. Time supplies are to be delivered to collection points.

(c) The actual collection of supplies is, as far as possible, accomplished by service troops. Sometimes, however, a show of force is necessary, and combat troops may be detailed for

this purpose. Collection may be made by the combat organizations themselves.

(d) If local transport is to be employed, it is organized and placed under an officer of appropriate rank and experience. A small detachment of combat troops may be assigned to insure order in the train column.

(e) Probably the best method of handling this difficult supply problem is to put the burden of actually serving the Cavalry upon the civil population. Full resort to officials is to be made by agents collecting information of supplies. Local authorities ordinarily know the quantity of supplies in the locality and the amount that can be spared with least hardship to the inhabitants. Working through local authorities, it may be possible to have supplies collected and delivered at specified points by civilian inhabitants. This method has the disadvantage of usually taking more time than the collection of supplies by agencies of the command.

i. Gasoline and oil requirements for the Cavalry division are more difficult to supply than those of an Infantry division, because the distance traveled by a Cavalry division and the distance the division must travel to its supply points are usually much greater. All of this tends to increase the difficulty of supplying a Cavalry division with sufficient gasoline and oil.

j. Under normal conditions the army establishes gasoline filling stations on routes between the army supply points and the area in which the division is operating in addition to those stations operated at the supply points. Many of the vehicles, however, do not return to supply points, but continue to operate in the forward area. Special provisions for gasoline and oil for the vehicles operating in the forward area must be made. This can be accomplished when delivering gasoline and oil at gasoline and oil railheads or by forwarding gasoline and oil by motor transport. Distribution to the using troops may then be made by establishing mobile filling stations or gasoline and oil distribution points. (See FM 10-5.)

k. Whenever possible, local resources are to be exploited for gasoline and oil. Gasoline and oil requirements increase the difficulty of completely supplying a Cavalry division from local resources, especially in hostile territory. These commodities are easily destroyed. Except by surprise action,

procurement in hostile territory generally is impossible. In friendly territory, procurement in sufficient quantity is dependent upon the locality.

■ 144. **FORAGE.**—A full supply of forage is even more important to Cavalry than a full supply of rations. Horses quickly become unserviceable if deprived of adequate forage. There is insufficient transportation in the Cavalry division to carry hay in addition to other loads. If hay is not otherwise available, the division quartermaster must be constantly on the lookout for some suitable substitute. Other grasses and nearly all growing crops may help to take the place of hay. Frequently the division quartermaster must also find substitutes for oats, such as corn, barley, wheat, rye, peas, beans, rice, or similar grains. Grain, however, due to its concentrated food value, may be carried in such division reserve as may be prescribed. If hay cannot be shipped in by the daily train or by a truck column operating to the rear, local procurement may be resorted to. The corollary to this is that, wherever possible, local procurement is made in order to avoid the transportation of such bulky supplies over long distances. (See FM 10-5.)

■ 145. **WATER.**—Water is another important item of supply for the Cavalry, because of the large requirements for its men, animals, and motors. Animals, in particular, need not only large quantities of water, but they must have it at frequent intervals in order to maintain their efficiency. In some theaters these large requirements cannot always be obtained locally, in which event water must be transported to the area by rail, motor, or pipe line and distribution made to the units at water-distributing points. Water for the men and kitchens can usually be distributed in 5- or 10-gallon containers. This method of distribution is identical with that employed in the Infantry division. (See FM 10-5 and 100-10.)

■ 146. **CLASS II AND CLASS IV SUPPLIES, INCLUDING REMOUNTS.**—In a rapidly moving situation there is little opportunity to secure quartermaster class II and class IV supplies and remounts from the rear. In such cases, when the replenishment of these supplies or the replacement of remounts is imperative, the division quartermaster must make every effort to secure the supplies from the army supply points or resort

to local procurement. Where class I supplies are being shipped to the Cavalry division through a railhead, it may be practicable periodically to attach additional cars of other quartermaster supplies, such as horseshoes, clothing, saddle equipment, motor parts, and other urgently needed replacement, to the daily train. The transportation available for the handling of these supplies is limited and the requisitioning of such is to be restricted. Ammunition, ordnance, and engineer supplies also may be shipped to the Cavalry division railhead when conditions permit and when the Cavalry division is operating at considerable distance from the army depots. The method of procuring these supplies follows that outlined in paragraph 118, FM 10-5.

■ 147. MISCELLANEOUS.—Graves registration and mortuary matters are handled in a manner similar to that given in paragraph 118, FM 10-5. The major difference between a Cavalry division and an Infantry division is that Cavalry frequently operates over wide fronts and in rapidly moving situations and, therefore, may require a greater number of cemeteries. Every effort is made by the quartermaster to restrict the number of cemeteries and individual graves, and special attention is given to their recording.

■ 148. SALVAGE.—The collection of salvage is conducted in a manner similar to that given in paragraph 118, FM 10-5. The division quartermaster, however, will find collecting salvage for the Cavalry division more difficult than collecting it for the Infantry division, owing to the rapidity with which Cavalry moves.

■ 149. QUARTERING.—Quartering is handled in a manner similar to that given in paragraph 118, FM 10-5.

■ 150. PROTECTION.—*a.* The fundamentals of protection and the method employed are given in paragraph 128. In many situations, however, it is necessary for the quartermaster regiment to travel under convoy. This is particularly true when operating in hostile territory and where there is constant danger of attack by hostile Cavalry or mechanized forces. Constant reconnaissance, observation, and other security measures are to be adopted whenever the quartermaster regiment is operating between the Cavalry area and its supply points.

b. Owing to the distance over which Cavalry may operate, it is frequently necessary for the attachment of additional quartermaster units. The types and number of these units that are to be attached is dependent upon the circumstances. This involves the width of the front, the distance the division is operating from supply points, availability of supplies, availability of good motor roads, the danger of mechanized motor and air attacks, and the availability of quartermaster mechanized units.

c. In all other respects, the division quartermaster and the quartermaster units of the Cavalry division operate and perform their duties in a manner similar to that outlined in paragraphs 122 to 132 inclusive. (See FM 100-10 and 10-5.)

SECTION II

ARMORED DIVISION

■ 151. QUARTERMASTER SERVICE.—*a.* Quartermaster service in the armored division is provided by a quartermaster battalion (T/O 10-35). An armored force is a combined force comprising reconnaissance, assault, and supporting troops of more than one arm or service, transported in wheeled or tracklaying type motor vehicles, the bulk of which are provided either with partial or complete armor.

b. Operations of the quartermaster service in the armored division are analogous to those in the Cavalry division and the Infantry division (triangular) with such modifications as are necessary to meet the needs peculiar to mechanized and motorized units. The distances that an armored division is capable of covering, the speed of its operations, and the consequent wear on transportation aggravating the supply of repair parts and supplies, and the absolute dependence of the division on an adequate supply of motor fuels and lubricants will develop special difficulties which the division quartermaster must be prepared to overcome. (See FM 100-10.)

■ 152. QUARTERMASTER BATTALION — ORGANIZATION.—*a.* The quartermaster battalion, armored division, consists of a battalion headquarters and headquarters company, a light maintenance company, and a truck company.

b. Battalion headquarters furnishes the officer and enlisted personnel for the operation of battalion headquarters and the office of the division quartermaster.

c. The headquarters company is organized with a company headquarters, a service platoon, a communication platoon and a division supply section.

(1) The company headquarters performs the normal duties of a company headquarters.

(2) The service platoon provides labor for handling supplies and forms the nucleus of the division labor pool.

(3) The division supply section embraces the purchasing and contracting officer, the class I supply officer, an ammunition-handling officer, and a transportation officer.

d. The truck company, organized according to T/O 10-57 is equipped with 48 trucks, 2½-ton, and 40 trailers, 1-ton (160 truck tons) available for general cargo transportation including the transportation of such reserves as may be prescribed.

e. The light maintenance company, organized according to T/O 10-27 provides third echelon motor maintenance for the division transportation whose maintenance is a responsibility of the Quartermaster Corps. (See AR 850-15.)

■ 153. OFFICE OF DIVISION QUARTERMASTER.—No definite office organization is prescribed. An organization similar to that recommended for the quartermaster battalion, triangular Infantry division (par. 137, and fig. 11), modified to conform to the personnel available, will meet requirements from a functional standpoint. (See also T/O 10-36, and chart on p. 121, FM 10-5.)

■ 154. RESERVE SUPPLIES.—a. Supply of the armored division is based on the fundamental that each major unit has sufficient capacity to enable the unit to be self-sufficient for short periods. Normally each company will carry one type A or B ration in the unit kitchen, each vehicle will carry two type C rations for each individual assigned to the vehicle, and the quartermaster will transport one type B ration for all troops of the division. In all, four rations are available.

b. Reserves of gasoline and oil are prescribed for each unit so as to give the division freedom of action within a 300-mile radius. Each vehicle will carry in its tanks and in containers sufficient fuel for 150 miles of operation; each unit will carry

on its transportation sufficient fuel for an additional 150 miles of operation for all vehicles. (See FM 100-10.)

c. In actual operations a reserve of ammunition is carried both in the combat units and in the division trains. Normally 1 day of fire of small arms ammunition is carried on the person or the vehicle and another day of fire on the regimental or unit transportation; artillery ammunition is available on the basis of 1 day of fire for each weapon carried in transportation of the unit. Within the limits of the capacity of transportation available in the quartermaster battalion a reserve of ammunition may be carried by that battalion. When the mission assigned requires the division to carry within the division a reserve of ammunition in excess of the transportation available, additional transportation must be assigned by higher authority. (See also par. 159.)

■ 155. CLASS I AND CLASS III SUPPLY.—The conventional methods of supply will be employed whenever the tactical and supply situation makes such methods practicable. During periods where continuous supply is not possible, procurement from local resources must be resorted to and such resources exploited to the utmost. Foresight and timely preparations incorporated into a flexible plan will enable an alert division quartermaster to adapt expedients to meet all conceivable contingencies. (See also par. 159.)

■ 156. CLASS II AND CLASS IV SUPPLY.—See paragraph 118, FM 10-5.

■ 157. TRANSPORTATION.—a. Transportation available within the quartermaster battalion is limited; therefore, distribution of supplies to divisional units will normally be accomplished by transportation of the unit.

b. When elements of the division are detached on independent missions, sufficient transportation should be attached to such elements to insure continuity of supplies for the execution of the mission. The limitations to the distance of strategical operation of supply are based on the following considerations:

(1) The cargo capacity of company and regimental vehicles.

(2) The mobility of supply trains or similar attached vehicles, which is governed by the capabilities of vehicles

and personnel. These capabilities cannot be exceeded for any considerable period of time with impunity.

(3) The location of railheads, truckheads, or other similar establishments where replenishment of supplies is received. These establishments should be located so that trains, in maintaining the continuous flow of supplies, will not be required to exceed a normal marching distance each day. At times this may necessitate a daily forward displacement of such establishments equal to the daily advance of the combat elements of the division. (See FM 100-10 and 10-5.)

■ 158. LOGISTICAL CONSIDERATIONS.—*a.* Where prolonged operations of armored divisions and corps of GHQ tank units are contemplated, adequate arrangements must be made by the higher headquarters to insure timely replenishment of supplies required by the armored units. Where the armored units are required to operate at great distances from their base of supplies, when continuity of supply is interrupted by enemy action, and in other emergency situations delivery of urgent supplies may be made by air.

b. As a general guide to the logistical capabilities of armored divisions, the following, expressed in terms of days of supply, are the maximum supplies carried organically:

(1) Class I: 3 days (including one "D" ration) in units, plus 1 day in quartermaster battalion.

(2) Ammunition: 2 days' supply of small arms, 37-mm, 60-mm mortar; 1 day's supply 81-mm mortar, 105-mm howitzer, and 75-mm antitank guns.

(3) Gasoline and oil: 2 days' supply.

In addition, the quartermaster battalion of the armored division can carry 120 tons of ammunition or gasoline and oil (over and above the normal division reserve of 1 day's supply of class I—40 tons).

c. The following are the approximate tonnages of 1 day's supply of the indicated items for an armored division:

	<i>Tons</i>
Ammunition, all classes.....	600
Gasoline and oil (assumed <i>average</i> operating distance, 100 miles).....	220
Class I.....	40

CHAPTER 4

ARMY CORPS

	Paragraphs
SECTION I. Corps as part of army.....	159-172
II. Independent corps.....	173-176

SECTION I

CORPS AS PART OF ARMY

■ 159. GENERAL.—*a.* The normal chain of supply, evacuation, and maintenance is direct between this independent corps and the divisions. The corps, as part of an army, has few administrative responsibilities except for corps troops. The corps is ordinarily concerned with the supply of the divisions only to the extent of the assurance that administrative arrangements are functioning satisfactorily.

b. The corps is responsible for the allocation to divisions as well as to corps troops of such quartermaster supplies and credits as may be allocated to it by higher authority. The corps quartermaster is responsible for the supply of corps troops and the command and supervision of all corps quartermaster activities. The corps, therefore, is not a link in the chain of supply when acting as part of an army. The corps is concerned with the supply of the divisions only to the extent of being assured that the supply is satisfactory. The trains of the corps quartermaster normally carry no reserve supplies for its divisions, but may carry reserve supplies for corps troops. The quantity of reserves carried must of necessity be decided upon by the corps commander or higher authority. (See FM 10-5 and 100-10.)

■ 160. COMPOSITION.—*a.* The corps quartermaster service consists of the quartermaster section, headquarters army corps and such attachments as may be ordered from general headquarters. The quartermaster section, headquarters, army corps, is composed of five officers and nine enlisted men and furnishes the nucleus for operating the corps quartermaster service. The normal attachments of the quartermaster units consist of two truck companies, one light maintenance com-

pany, one quartermaster gasoline supply company, and one quartermaster service company (a total of 15 officers and 746 enlisted men). If the situation demands, additional quartermaster units may be attached to the corps. These units provide supply, labor, and transportation service to the corps troops and are available for reattachments to the combat divisions of the corps. (See FM 10-5.)

b. Heading the corps quartermaster service is the corps quartermaster, who is a member of the corps special staff, and commands the corps quartermaster service. As a special staff officer, he makes such technical inspections as may be directed by the corps commander. He may call on division quartermasters and supply officers of corps troop units for such technical reports as may be necessary in supervising quartermaster activities with which corps headquarters is charged. As commander of the corps quartermaster service, he commands all quartermaster units assigned or attached to the corps.

■ 161. HEADQUARTERS CORPS QUARTERMASTER SERVICE.—a. The nucleus of the corps quartermaster service is provided by the quartermaster section, headquarters army corps, which consists of five officers and nine enlisted men. (See T/O 100-1.) Other officers and men are detailed from attached quartermaster units as are required.

b. The office of the corps quartermaster is the headquarters for the corps quartermaster service and is located at the rear echelon corps headquarters. The office of the corps quartermaster supervises and directs all quartermaster activities pertaining to the corps. The executive officer assists the quartermaster in the performance of his special staff functions and is second in command and executive of the corps quartermaster service.

c. The organization of the corps quartermaster's office may follow the same general lines as laid down in paragraph 120 and performs the same duties as outlined in paragraph 121. The administrative section is headed by a first lieutenant, who also acts as adjutant for the corps quartermaster service. The executive officer may head the supply division with one captain as assistant. The transportation division may be headed by a major, probably assisted by a captain or lieutenant detailed from an attached quartermaster unit.

■ 162. CORPS QUARTERMASTER SERVICE.—*a. Truck companies.*—The two truck companies provide motor transportation for hauling supplies, including such reserves as may be prescribed by the corps commander, for the movement of troops, and a nucleus for the motor pool.

b. Quartermaster light maintenance company.—(1) The quartermaster light maintenance company provides personnel for the transportation of the corps quartermaster's office, motor inspection for corps troops and divisions, motor supplies (except gasoline and oil) for corps troops, and third echelon motor maintenance for quartermaster motor vehicles for corps troops.

(2) The commander of the light maintenance company is corps motor maintenance officer and assistant to the corps motor officer. He is adviser to the corps quartermaster on matters pertaining to motor maintenance for corps troops and is responsible to him for the efficient functioning of motor supply, administration, inspection, and third echelon motor maintenance of all quartermaster motor vehicles of the corps troops.

(3) This unit is capable of operating two mobile repair shops, each shop being capable of providing third echelon motor maintenance for 750 vehicles, all classes. The organization of the company into two platoons, each operating one mobile repair shop, permits echelonment of shops. This permits the company to keep abreast of repair work in case of forward, lateral, or retrograde movement of troops being served. (See T/O 10-27.)

c. Gasoline supply company.—A gasoline supply company provides the facilities for supplying gasoline and oil for corps troops. The company has a trip-day capacity of 15,700 gallons of gasoline and 300 gallons of oil, in 10-gallon cans, plus small amounts of gear lubricants and grease. The company is equipped with 26 cargo trucks, 2½-ton, and 22 trailers, 1-ton. (See T/O 10-77.)

d. Service company.—The service company consists of a company headquarters and two platoons. This company furnishes the nucleus for the corps general labor pool, providing men for the operation of quartermaster utilities, handling of such corps reserves as may be loaded on the truck battalion, and the handling of quartermaster supplies and

ammunition as directed. It normally moves on the trucks of the truck battalion (companies).

(1) The company headquarters administers the mess and supplies, and supervises the labor activities of the company as a whole.

(2) The two platoons each consist of a lieutenant and 101 enlisted men, of whom 80 are laborers. (See T/O 10-67.)

e. Car platoon.—While not specified as a normal part of the corps quartermaster service, a platoon of the car company (with 6 passenger cars and 7 motorcycles, T/O 10-87) may be attached to provide transportation for corps headquarters and motorcycle messenger service for the corps message center. In such case this platoon probably will also operate the headquarters garage.

■ 163. GENERAL EMPLOYMENT OF CORPS QUARTERMASTER SERVICE.—*a.* Elements of the corps quartermaster service are employed as directed by the corps commander.

b. Specific missions of the corps quartermaster service in a given situation are set forth in the corps administrative plan, approved by the corps commander. These missions are carried out pursuant to administrative instructions issued through G-4. Service operations involved are prescribed by the corps quartermaster.

c. The corps quartermaster service is designed primarily to take care of corps troops and in this respect functions similarly to the quartermaster regiment of an Infantry division.

■ 164. SUPPLY.—*A. Class I supplies.*—(1) The corps quartermaster prepares and dispatches the daily telegram for class I supplies for corps troops to the army quartermaster. As in the case of a division, the basis of this message is the strength report of corps troop units received from the corps adjutant general. A copy of the daily telegram is sent to corps G-4 immediately upon its dispatch.

(2) Supplies are received and distributed by the corps quartermaster in a manner similar to that employed by the division quartermaster for the infantry regiment (square). On arrival at the class I supply railhead, the corps quartermaster supply officer receives the day's requirements from the railhead officer, loads, usually by unit, on vehicles of the truck battalion, and makes delivery to unit distributing

points of corps troop units. When this is impracticable, railhead distribution may be resorted to.

b. Gasoline and oil supply.—The requirements for gasoline and oil supply may be incorporated in the daily telegram. The quantities requisitioned are based upon daily reports submitted by unit supply officers of corps troops. All vehicles drawing supplies at army establishments should secure the gasoline and oil at these points in order that they may return to the area with their vehicles nearly filled. The army will have established other gasoline supply points throughout the area. These may be used by vehicles passing between the army area and the front lines for resupply of gasoline. In addition to this, the corps quartermaster is to provide gasoline and oil in a manner similar to that given in paragraph 124. There is available for this purpose the gasoline supply company. When the situation demands it, sections of this company may be attached to subordinate divisions in order to supplement their supply facilities. For example, when one division of the corps is making a wide envelopment and the distance between supply points and the using troops is great, it may be necessary to attach one or more sections of the gasoline supply platoon to that division. Special equipment should be provided by the railhead officer to facilitate unloading of tank cars. Distribution of gasoline and oil is a continuous process and tank trucks and containers of the gasoline supply company are to be kept filled at all times. The corps commander prescribes the quantities of gasoline and oil to be carried as a reserve for the corps. Mobile filling stations are habitually established at both echelons of corps headquarters, at the bivouac of the truck battalions, and at other convenient points for the service of separate vehicles.

c. Other quartermaster supplies.—After approval by their commanders, supply officers of corps troop units submit requisitions for other quartermaster supplies direct to the corps quartermaster. If the corps has a credit in the army depot, the corps quartermaster draws against this credit and arranges for issue to requiring units of corps troops. If the corps has no credit, the quartermaster prepares a consolidated requisition, secures approval of the corps commander, and presents it to the army quartermaster for the necessary ad-

ministrative action. Supplies are drawn at the time and place designated by the army quartermaster and issued to corps troop units as arranged by the corps quartermaster with supply officers concerned. Owing to the length of time required for the preparation and filling of requisitions, delivery of supplies other than class I through railheads usually is not satisfactory. The safest and most certain method is delivery through army depots. Corps motor transportation can usually draw these supplies at the proper depot. (See FM 10-5.)

■ 165. TRANSPORTATION.—Motor transport operations are prescribed by the corps quartermaster, based upon standing operating procedure for that corps and such orders as may be issued by the commander, and executed by the corps motor officer who commands the truck battalion.

a. Motor transportation pool.—(1) The basis of all operations of the motor transport of the corps quartermaster service is the motor transport pool under the corps motor officer. Motor vehicles of other corps troop units and their operating personnel, when not required exclusively for the service of their own units, may be attached to this pool for operation in the general passenger and supply movements of the corps. All or a portion of the quartermaster vehicles of the divisions may also be assigned to the corps pool.

(2) When all the quartermaster vehicles of a division are assigned to the pool, the division commander may not use those vehicles without securing the approval of the corps. If only a portion of the division quartermaster vehicles are assigned to the pool, the division commander may use the vehicles of his division not so assigned but must secure approval of the corps if the vehicles assigned to the pool are needed by the division.

(3) The pool may be operated as a physical pool in which all the vehicles assigned to the pool are bivouacked in one locality. Another more usual method of operating the pool is to leave the vehicles assigned to the pool in their bivouacs, but remaining available to the corps motor officer for assignment to such missions as are required. Those vehicles assigned to the pool and remaining in their own bivouacs may not be used by their organizations without prior approval from the corps motor officer.

(4) The corps motor officer should maintain a chart or other ready method of ascertaining the status of the vehicles of the pool, together with their location. A suitable chart for maintaining such a record can be made with graph paper, the vertical scale representing trucks or groups of trucks, the horizontal scale representing a given period of time. Horizontal lines may then be drawn opposite the trucks for the period that they are in use.

b. Headquarters garage.—Passenger car and motorcycle service for corps headquarters, including the message center, is provided by the headquarters garage. Except for vehicles assigned to the corps commander and his principal staff officers, passenger cars and motorcycles of headquarters garage are operated on a pool basis. The garage is located in the vicinity of the rear echelon of corps headquarters. In some situations it may be necessary to locate a subgarage in the vicinity of the corps headquarters forward echelon. The garage should be located in an existing building, if possible, in order to secure protection from hostile observation and air attack.

c. Prescribed loads.—During combat, when transport is required for battle service, any prescribed loads in the corps truck companies may either be dumped at train bivouacs or placed at the disposal of the proper corps supply service chief. Quartermaster vehicles engaged in artillery ammunition supply usually operate on a job assignment basis, the quartermaster remaining responsible for the operation and maintenance of such transport.

d. Bivouac.—Bivouacs should have a good water supply and afford sufficient hard standings for parking purposes. Truck companies may bivouac separately. In some instances the truck companies are bivouacked in the vicinity of the corps class I supply railhead or railheads. If a truck battalion (less 2 companies) is provided, the companies may bivouac as a battalion, provided parking facilities are available and the situation so requires.

e. Movement.—Coordination of movement of corps quartermaster transport employed in the service of supply is exercised by the corps commander through the assistant chief of staff G-4. Troop movements and marches are coordinated through the assistant chief of staff G-3 and directed in field orders or troop movement orders.

■ 166. MOTOR MAINTENANCE.—*a.* The corps quartermaster service is responsible for the operation of third echelon of motor maintenance for corps troops. This includes unit replacement, motor supply, and motor salvage. Motor maintenance is in the direct charge of the corps motor maintenance officer. Unit replacement, motor salvage operations, and distribution of motor equipment and supplies are performed by the light maintenance battalion.

b. Unit replacement shops are established by the light maintenance company separately or in groups. Shops are to be located convenient to the bivouac or bivouacs of the truck battalion. When unit replacement shops serving the truck battalion are not located so as to facilitate prompt service of other corps troop units, particularly the corps artillery, separate shops are to be established in order to serve such units. In combat situations, a platoon of a light maintenance company may be attached temporarily to the corps artillery brigade.

■ 167. LABOR.—The service company furnishes the personnel for the operation of quartermaster utilities and the handling of loads carried on the truck companies and is the nucleus of the corps labor pool. Normally this company moves with the truck companies and bivouacs convenient to it. When available, service platoons may be attached to divisions to reinforce the division labor pool and to perform the labor necessary in connection with burial.

■ 168. MARCHERS.—When on the march, vehicles and units of the corps quartermaster service are assigned to columns in accordance with their normal rate of march. The truck companies and light maintenance company and the gasoline supply company may be marched as one organization or by separate units. The car platoon moves with the corps headquarters. The service company usually moves with the truck battalion.

■ 169. UTILITY SERVICES.—*a.* Utility services of the corps quartermaster service may be briefly classified as follows:

Salvage.

Transportation.

General.

b. Salvage utility service includes mobile and portable establishments set up by attached supply units, such as laundry, sterilization and bath, salvage collecting, and shoe and textile repair companies. They operate under an assistant to the supply officer, designated as the salvage officer. Transportation utility service includes all motor maintenance units. The general utility service includes all other quartermaster units performing utility work and not otherwise classified.

■ 170. GRAVES REGISTRATION.—*a.* The graves registration officer is detailed from available officers of the corps quartermaster service and serves as such under the general supervision of the chief of the administrative division. The graves registration officer is charged with all graves registration and mortuary matters pertaining to corps troops.

b. Personnel required for registration and other administrative work is provided by the administrative division. The labor required for burial duty is furnished from combat troops or from the quartermaster service company, while the necessary transportation is detailed from the truck battalion.

c. In situations where the administrative personnel of the corps quartermaster service is inadequate to perform the registration work required, a graves registration unit may be attached by the army, the size of which is determined by the requirements.

d. In battle, a graves registration and burial detachment is stationed at the clearing station for corps troops. Another detachment operates from the corps troops cemetery. Collections are made at unit aid stations and from burial collecting stations established during the search of the battlefield. One additional service company is required to handle the average burial requirements of corps troops during battle where burial is performed by the quartermaster service.

■ 171. SALVAGE.—*a.* Field salvage is a function of the supply division, performed under the supervision of an officer of the quartermaster service detailed as salvage officer.

b. The salvage officer arranges for the systematic routine collection of salvage at unit distributing points for class I supplies or other collecting points, and its evacuation to the railhead for corps troops or to a sorting station. Salvage

which can be used by the corps may be retained for issue. All other salvaged material is evacuated to communications zone depots for reclamation.

c. Salvage operations of the corps quartermaster service are performed by detachments of the service battalion especially assigned to such work. Special salvage units may be attached for duty under the corps quartermaster. These units include detachments of salvage collecting companies, laundry companies, and sterilization and bath companies.

d. No reclamation facilities are established in the corps.

■ 172. MOVEMENTS BY RAIL.—*a.* The corps quartermaster is concerned with the movement by rail of corps troops or of units thereof. When such a movement is ordered, the corps quartermaster arranges through the designated shipping quartermaster or, if none is designated, direct with the agent of the military railway service for the transportation requirements of corps troops and for detailed information with reference to entraining points and train schedules. (See FM 10-5.)

b. The corps quartermaster is responsible for arranging for the provision of ramps and permanent loading details at entraining and detraining points to assist corps troops in loading heavy mobile equipment.

c. The corps quartermaster usually assists G-3 in the preparation of the entraining table for corps troops, which is issued as an annex to the field order. (See FM 10-5 and 100-10.)

SECTION II

INDEPENDENT CORPS

■ 173. COMPOSITION.—*a.* The independent corps differs from the corps as part of an army only in that it is responsible for the administration, supply, and evacuation of all troops in the corps, and functions in this respect the same as an army, while in the corps as part of an army the corps is responsible, in general, for the administration, supply, and evacuation of corps troops only. To permit the independent corps to perform its additional functions of administration, supply, and evacuation, it is necessary to reinforce its organic corps troops with service troops from higher echelons.

b. The quartermaster service of the independent corps consists of the organic quartermaster service of the corps and such reinforcing quartermaster personnel and units as are necessary to furnish a quartermaster service for the corps as a whole.

c. In general, it might be said that reinforcing quartermaster personnel detachments and units which may be required to operate the quartermaster service of the independent corps include the units similar to those attached to the army. (See FM 10-5 and 100-10.)

■ 174. QUARTERMASTER OF INDEPENDENT CORPS.—*a.* The quartermaster of the independent corps has the following functions to perform:

- (1) Special staff duties.
- (2) The quartermaster service for corps troops.
- (3) A quartermaster service for the corps as a whole.
- (4) Command of all corps organic and attached quartermaster troops.

b. The quartermaster of an independent corps functions the same as the quartermaster of an army. (See FM 10-5.)

■ 175. HEADQUARTERS CORPS QUARTERMASTER SERVICE.—*a.* The office of the corps quartermaster is charged with the supervision and direction of all quartermaster activities pertaining to the corps as a whole. The corps quartermaster's office is located at the rear echelon of corps headquarters.

b. The executive officer assists the corps quartermaster in the performance of his special staff duties and is second in command of the corps quartermaster service.

c. (1) The office of the corps quartermaster is divided into three main divisions as follows: administrative, supply, and transportation.

(2) The administrative division, under its chief, is responsible for the preparation of the plans and orders of the corps quartermaster. It administers personnel, graves registration and burial activities, and the quartermaster general labor pool. It also maintains the office of record for the corps quartermaster.

(3) The supply division, under the quartermaster supply officer, is charged with the provision and distribution of all quartermaster supplies (except motor transport supplies and equipment), animal replacements, and the control of at-

tached supply units. Supply depots, under the corps quartermaster, operate under the direct control of this division.

(4) The transportation division operates under the quartermaster transportation officer and administers all transportation activities of the corps quartermaster service. These include the shipment of troops and supplies by rail, water, or motor transport, the employment of the corps motor pool, the inspection and third echelon maintenance of quartermaster motor vehicles of corps troops, and motor maintenance and supply for the corps as a whole.

■ 176. OPERATIONS.—When an army corps is detached from an army for both operation and administration, it becomes in effect a small army and, therefore, is responsible for its own supply and evacuation. Quartermaster supply installations, similar in character to those prescribed for the army, are operated by the corps. In most situations it is not necessary to establish more than one quartermaster depot for class II and class IV supplies. Two depots may be required for class III supplies. Class I supplies are handled in a manner similar to that outlined for the army in chapter 9. The same general types of supply installations, railheads, depots, and distributing points are used in supplying the independent corps. (See FM 100-10 and 10-5.)

CHAPTER 5

THE ARMY

■ 177. ORGANIZATION OF QUARTERMASTER SERVICE.—*a.* In order to provide a nucleus for the performance of quartermaster services to the army, a quartermaster section is provided for in the army headquarters. This section is organized as follows:

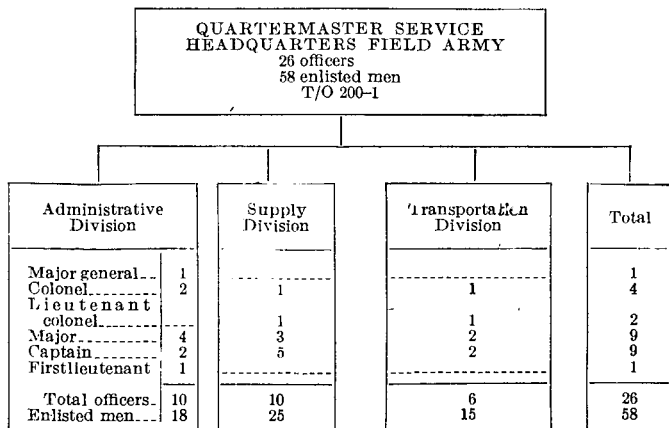

The enlisted men of the office of the army quartermaster's office perform clerical duties and are attached to the army headquarters company for the purpose of military administration and messing.

b. The normal attachments of quartermaster units from GHQ to a field army constitute the army quartermaster service, as follows:

- One regiment, truck, T/O 10-51.
- Three battalions, light maintenance, T/O 10-25.
- One battalion, gasoline supply, T/O 10-75.
- One company, car, T/O 10-87.
- One company, depot (motor transport), T/O 10-48.
- One company, depot (supply), T/O 10-227.
- One battalion, sterilization and bath, T/O 10-175.
- Six battalions, service (labor), T/O 10-65.

These units provide supply and transportation service to the army troops and are available for reattachment to the corps and/or divisions of the army. (See FM 10-5.)

c. In some situations it may be necessary to attach additional quartermaster troops to the army.

d. The duties and functions of the army quartermaster service are similar to those outlined for the division and corps in paragraphs 118, 119, and 162. (See FM 10-5.)

■ 178. ORGANIZATION OF ARMY QUARTERMASTER'S OFFICE.—The army quartermaster's office may be organized in a manner similar to that for the division and corps as respectively outlined in paragraphs 121 and 162. The army quartermaster heads the quartermaster section of the field army headquarters. Each of the three divisions of this office is headed by a colonel, and sufficient personnel is provided to handle the administrative details. If, in any situation, the volume of work becomes too great to be handled by one division, it may be necessary to create additional divisions, such as a utility division, which will supervise the operations of all quartermaster utilities within the army.

■ 179. OPERATIONS.—a. *Class I and class III supplies.*—Class I and class III supplies are usually provided on an automatic daily basis. Calls for class I and class III supplies are made by means of the daily telegram. Division and corps quartermasters prepare and send to the army quartermaster the daily telegram pertaining to their respective units. The army quartermaster prepares a consolidated daily telegram, including provisions for the army troops, and dispatches it to the regulating officer. This officer, through his quartermaster supply officer, notifies the designated depot of the communications zone (or zone of the interior) to forward the required supplies. These depots make up the shipments as required and dispatch them to the regulating station where the supplies are sorted and prepared for shipment to the various division, corps, and army railheads. The distribution of supplies from army railheads is identical to that outlined for the division in chapter 6.

b. *Class II and class IV supplies.*—(1) Class II and class IV supplies are usually made available to the army in the form of credits at designated communications zone depots. When

credits are established for an army in communications zone depots, calls are made as necessary by the army quartermaster service directly upon the proper communications zone depot or through the quartermaster supply officer at the regulating station. If sent directly to the communications zone depot, a copy is sent to the regulating officer for his information. Shipments are made at the depots and dispatched through the regulating station to the proper army quartermaster supply establishment. The army may send motor transportation to the depot to draw the supplies whenever the situation warrants such action. The army may further reallocate to the division and corps troops such credits of these classes as may have been set up for the army. When credits are so established, division and corps troops may make calls as required direct to the proper communications zone depot through the division or corps quartermaster service. In addition, the army may establish credits for the division and corps troops in army depots. Calls may be made by division and corps quartermaster services in the same manner as outlined above for communications zone credits. In either instance, division and corps transportation may be sent direct to the depot for the desired supplies, in which case they do not pass through the regulating station.

(2) If credits have not been established, supply is on a requisition basis. Under these circumstances supply officers for division and corps troops submit requisitions approved by their unit commanders direct to the army quartermaster where the requisitions are filled either from available stocks in army quartermaster depots or extracted to the communications zone depots.

c. Class V supplies.—Class V supplies are normally made available in the form of credits at designated supply points for a stated period or operation. The quartermaster is concerned with Class V supplies only because the quartermaster service may frequently be called upon to furnish transportation for movement of ammunition.

d. Salvage.—The initial collection of salvage rests with the various units within the army area and it is then collected by the division, corps, or army quartermasters at railheads or other salvage collecting points. The salvage at these points is sorted and prepared for shipment to salvage depots in the communications zone. Those articles that may be repaired

locally are retained in the area and the repairs accomplished as soon as possible. In order to provide for the reception, sorting, and shipment of salvage, it may be necessary to attach to the army one or more salvage collecting companies.

e. Gasoline and oil.—See FM 10-5.

■ 180. STOCKAGE.—The level of supplies of the several classes to be established and maintained in the army service will be determined by the army commander based on many considerations, such as status of credits, length, vulnerability, and capacity of lines of communication, tactical (strategical) lines of action under consideration, and status of supply within subordinate units. The minimum stockage will consist of 1 day of class I supply and sufficient motor fuel and lubricants to resupply all vehicles for 1 day's maximum activity (class III). Items of essential combat supplies of classes II and IV usually will be stocked in quantities sufficient to replace expenditures for 1 or 2 days of operations. (See also FM 100-10 and 10-5.)

■ 181. SERVICE AT ARMY SUPPLY POINTS.—The army quartermaster service furnishes a commander, staff, and the technically trained personnel required for the operation of each quartermaster supply point stocked with supplies for the procurement and distribution of which it is responsible. Labor and trucks are detailed from the army pool as required. Service personnel operating with the army not only stock supply points but also load trucks dispatched for refilling from divisions and from army and corps troops. (See FM 100-10 and 10-5.)

■ 182. LOCATION OF DEPOTS.—As the bulk of supplies shipped into army installations usually arrives by rail, the unloading point for depots must be at points on the rail net affording the necessary siding facilities. In the interest of safety against hostile air bombardment, supplies should be dispersed as rapidly as possible. This may be accomplished either by utilizing many railroad sidings or by unloading railroad cars promptly and dispersing supplies in small groups accessible to roads throughout a large area. The latter method not only furnishes protection but may also facilitate issues to the troops. If the railroad unloading point for any depot is too far to the rear to support adequately the combat troops,

the depot should be advanced from the unloading point far enough to be within reach of the unit trains. To provide protection, the operations described above will frequently have to be carried out during periods of low visibility, or at night without lights. (See FM 10-5 and 100-10.)

■ 183. ARMY DEPOTS.—*a.* Army depots should not be established unless the situation clearly demands such establishments, for the army should normally look to the communications zone for replenishment of supplies through railheads or other supply points.

b. Army depots are wasteful of labor and matériel; labor, because it operates under adverse conditions without labor saving devices and where abnormal storage conditions will usually be found; matériel, because in the rehandling of supplies there is bound to be deterioration or breaking of packages.

c. Any army depot should, except in particularly long stabilized situations, be considered as merely a transfer point for the transportation, rehandling, and sorting facilities sufficient for the prompt and orderly transfer of supplies to the trains of the combat units. Reserve stocks should be held to a minimum. However, it will probably be normal to maintain from 2 to 4 days of reserve stocks in an army area, of which there will be from 1 to 3 days available in the army depot.

d. In the early stages of campaign, before a communications zone is organized, army depots may be established as the first echelon of supply to fill the current needs of the troops. These depots then become, in effect, advance depots.

e. Organization.—An army depot, being a branch depot, should be organized in a manner similar to that of any other branch depot. See figure 16 showing the possible set-up of an army quartermaster supply depot. The administrative division provides the necessary personnel to administer to the needs of the depot. The supply division provides trained personnel for receiving, storing, and issuing supplies. The depot division provides trained personnel for the entire house-keeping of the depot, including messing, operation of motor transport, maintenance, and repair, including roads of the depot proper.

f. Personnel for operating army quartermaster depots is provided by a depot (supply) company, that is normally attached to the army. This organization provides the clerical and administrative personnel incident to operating the depot, while the labor required at the depot is supplied by the quartermaster service regiments that are attached to the army.

g. Field remount depots.—If the military situation demands a large number of animals with an army, it will be necessary to have attachments of field remount squadrons in order to operate the necessary field remount depots that may be established. The supply of animals through these depots may be either through the medium of credits or by requisition. In either case the using unit will send detachments to remount depots to draw the animals when ready for issue and transport them to their respective organizations. In some situations animals may be shipped by rail. The attachment of any quartermaster units will be dependent upon the situation. (See FM 100-10 and 10-5.)

■ 184. ESTABLISHMENTS.—See FM 10-5.

■ 185. FUNDAMENTALS GOVERNING LAY-OUTS.—*a.* In laying out a depot the fundamental of dispersion should be given paramount consideration. Figure 17 shows a schematic lay-out for a depot. This takes full advantage of the road net, use of rail unloading facilities, storage in buildings, and dispersion of open storage facilities. Trains deliver to Point A, where supplies are transferred to motor or animal transportation and taken to the proper storage point, such as items of clothing to Point B. Units drawing supplies send their vehicles to the parking space "C", and the vehicles are concealed there while the unit train commander proceeds to the office, Point D. As soon as he has submitted his requisition and received his instructions as to where the supplies will be drawn, he proceeds to the parking area, directs his vehicles to the proper loading point, B, if he is to draw clothing, loads, and after loading, returns via out-bound route to his organization area.

b. It must be borne in mind that the fundamentals in the operation of any army depot are "speed" and "simplicity." The following are some of the important matters that should

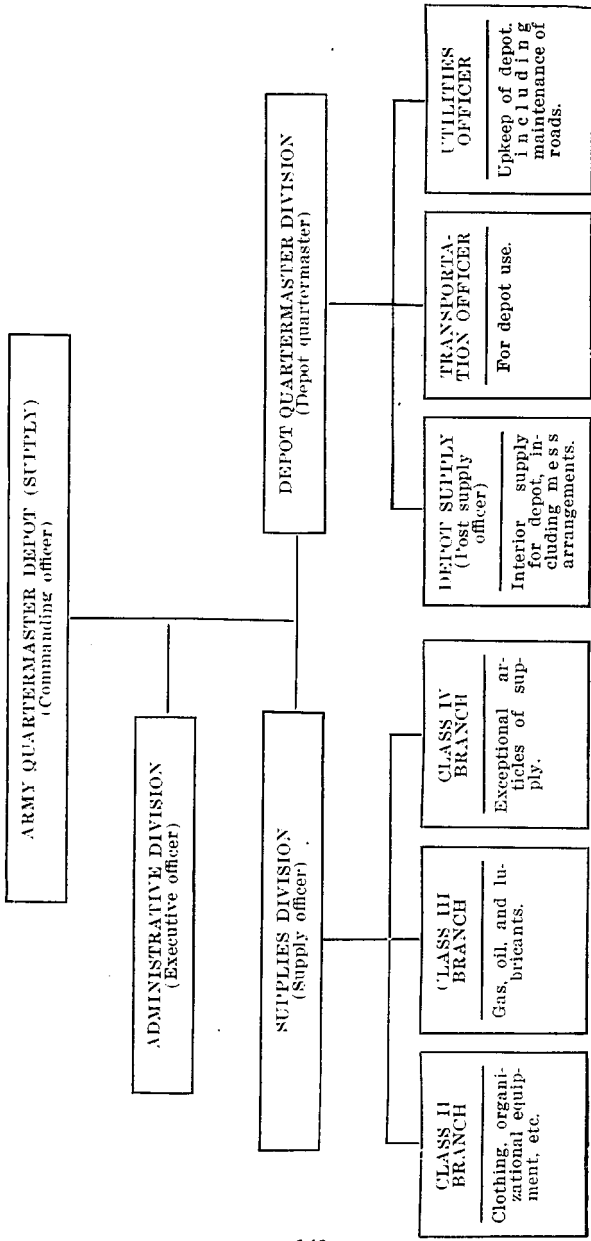

FIGURE 16—Possible set-up of an army quartermaster supply depot.

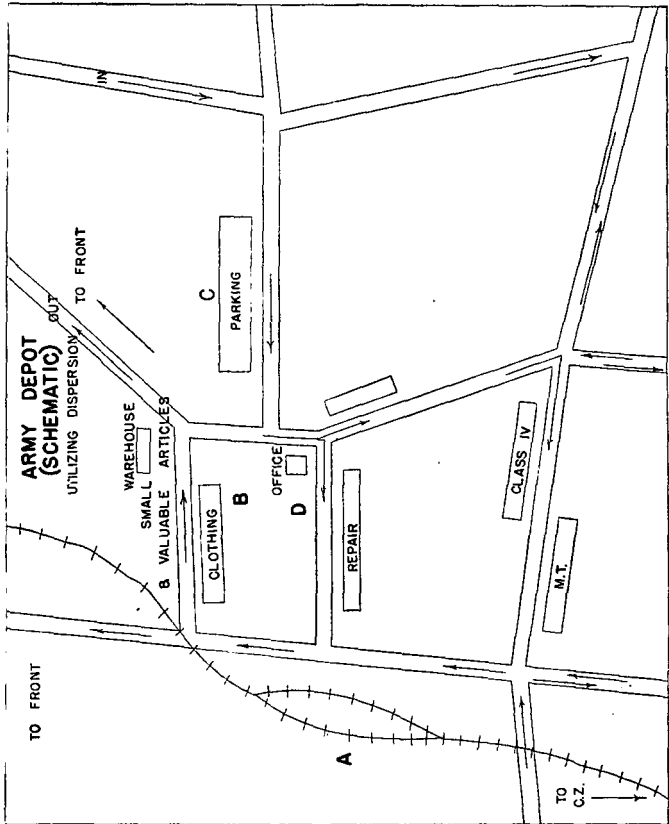

FIGURE 17.—Schematic lay-out for an army depot.

be considered in laying out an army quartermaster supply depot:

- (1) Lay-out should be so arranged as to effect maximum speed in delivery.
- (2) It should have sufficient trackage for incoming trains.
- (3) Keep main railway lines clear at all times.
- (4) Trackage to be for transit only. Do not attempt to store on or near tracks.
- (5) Have one or two buildings for storage of small and valuable articles.

(6) Plots used for storage to be raised from 6 to 12 inches.

(7) Store on dunnage and cover with camouflaged tarpaulins.

(8) Keep area well drained.

(9) Do not store over 6 feet in height. Higher storage will throw shadows visible in air photographs.

(10) Storage of goods should be staggered to avoid loss of entire stock of any one article in case of enemy bombing. (See also FM 10-5 and 100-10.)

CHAPTER 6

QUARTERMASTER SERVICE

	Paragraphs
SECTION I. Air Force.....	186-188
II. GHQ.....	189-192

SECTION I

AIR FORCE

■ 186. GENERAL.—For mission and general duties in an air base depot, see FM 10-5.

■ 187. QUARTERMASTER TROOPS WITH AIR FORCE.—*a.* The quartermaster corps troops assigned to an air force are organized into a quartermaster service consisting of a special staff section at each of the headquarters of the command, such as air base, wing, and air force; a separate quartermaster company (air base) for each air base established; and certain truck, light maintenance, and service units. The units are organized into companies, battalions, and regiments for command control and operations, depending on the location, composition, and strength of the air force to be served. (See fig. 18 and FM 100-10.)

b. The special staff or quartermaster section at each headquarters is organized and operates similar to the quartermaster section of a division, corps, or army headquarters. The officer who commands the quartermaster section of an air base headquarters is called the air base quartermaster; that of a wing, the wing quartermaster; and that of an air force, the air force quartermaster.

c. The quartermaster company, separate (air base), T/O 10-357, provides the necessary personnel for the operation of all the quartermaster corps facilities at an air base and a mobile unit for the establishment and operation of such field facilities as are required. It augments the quartermaster personnel at other established air bases when needed, and furnishes the necessary distributing point details within the air base areas occupied. The company is composed of a company headquarters and four platoons. Its organization and duties are—

(1) *Company headquarters.*—Performs the usual company administrative duties.

(2) *Headquarters platoon.*—Provides the necessary personnel for the operation of the air base quartermaster's

office for the administration of all quartermaster corps facilities of the air base. It performs such administrative duties as personnel, fiscal, mail, records, cemeterial, real estate including leasing, quartering of troops, purchase, and contract.

(3) *Supply platoon*.—Provides personnel for the procurement, warehousing, and issue of quartermaster corps supplies and equipment to include fuel, gasoline and lubricants for motor vehicles, general supplies, clothing and equipage, subsistence and ice, and salvage.

(4) *Transportation platoon*.—Provides personnel for the operation and maintenance of the air base (base airdrome) motor, rail, animal, and water transportation including technical inspection and excepting third echelon of motor maintenance for motor vehicles. It establishes and operates the base airdrome motor transport pool.

d. The quartermaster company, supply aviation (T/O 10-367), is composed of the usual company headquarters, a depot platoon, a refilling point platoon, and a distributing point platoon. The total strength of the company depends upon the strength of the depot platoon, refilling point platoon, and distributing point platoon. The total strength indicated includes 3 depot sections, 4 refilling point sections, and 50 distributing point sections. The depot platoon is organized to handle 3 depot sections which may be widely separated. For training purposes, detachments of the company are assigned by air force commanders to air bases. These detachments augment the air base quartermaster sections of the corps area service command.

(1) *Company headquarters*.—Performs the normal company administrative duties.

(2) *Depot platoon*.—Provides personnel for the operation of the quartermaster section of the air force air base, a quartermaster class I supply depot, and a quartermaster class III supply depot. If one or more of these sections is not required, the strength of the platoon will be reduced accordingly.

(3) *Refilling point platoon*.—Provides personnel for the establishment, operation, and maintenance of refilling points for class I and class III supplies in each air base area as required, and its strength may vary accordingly.

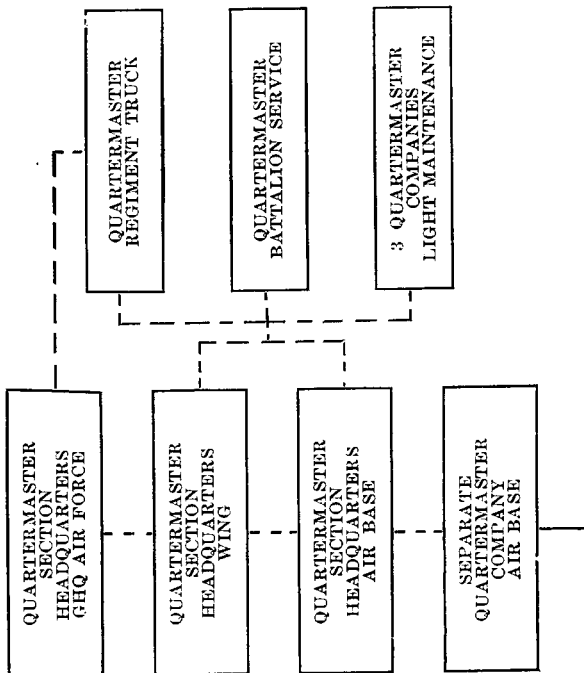

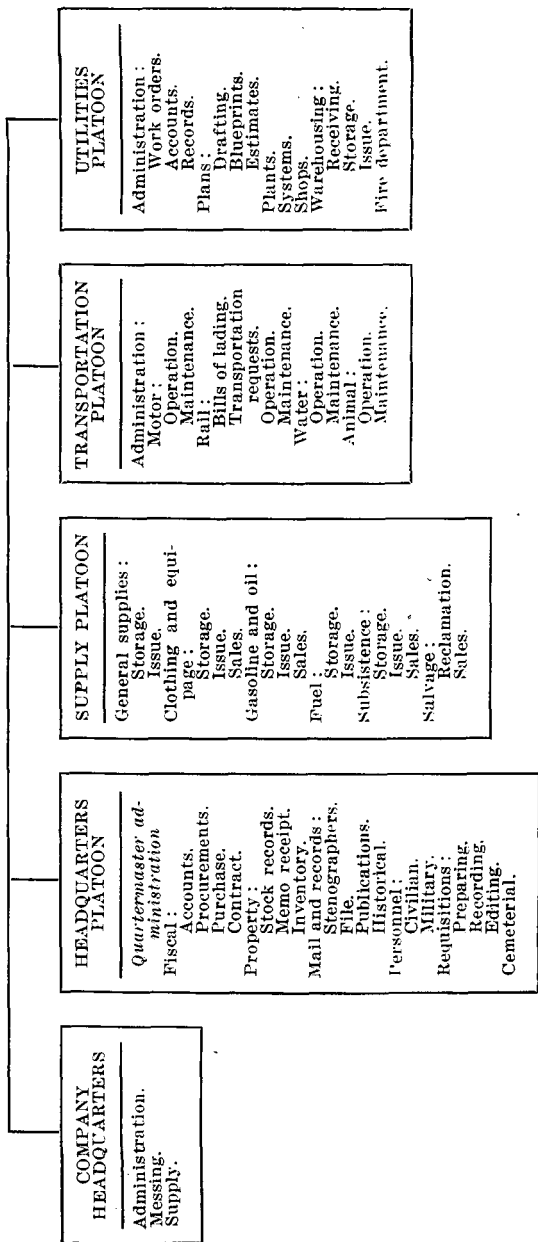

FIGURE 18.—Quartermaster service, GHQ Air Force.

(4) *Distributing point platoon.*—Provides personnel for two-man distributing point sections for each combat and headquarters squadron. The strength of the platoon varies with the number of distributing sections required. One section is required for each combat and headquarters squadron in the air force. The normal strength for purpose of planning is 100.

e. Truck companies.—Quartermaster truck battalions are normally assigned at the rate of one per wing. If more than one battalion is assigned they will be organized into a regiment of two or more battalions, depending on the number. The number of truck companies assigned to a battalion is determined by the number of combat groups assigned to a wing on the basis of one truck company per combat group assigned. The truck companies are charged with the general movement of supplies and troops between refilling and distributing points, especially the transportation of aviation gasoline and lubricants and ammunition. They augment the motor vehicles assigned to tactical organizations of the air force in the transportation of troops, baggage, and field equipment by convoy during cross-country operations.

f. Light maintenance companies.—These are assigned normally one per wing and are charged with the operation of motor repair shops, both air base and mobile field, for the third echelon of motor maintenance of all motor vehicles assigned to organizations of the air force. It makes the necessary technical inspections of motor vehicles.

g. Service companies.—Quartermaster service companies (labor) are normally assigned at the rate of one per wing. Two or more companies are organized into a service battalion which provides the necessary labor personnel for the handling of all classes of supplies within the air base areas, and the operation of labor pools.

■ 188. OPERATIONS.—*a. Operation of quartermaster facilities.*—Within each air base area designated by the air force commander, quartermaster personnel already assigned to the air base is available, augmented by the mobile field units from the separate quartermaster companies (air base) assigned to other air bases; truck, maintenance, and labor units as determined by the air force commander operate the quartermaster facilities at air base establishments.

(1) *Air base airdrome.*—This is an Air Corps establishment assigned to the air force and contains the flying field and all installations and facilities for operations, maintenance, and supply of troops and their equipment. It is normally a one-group or two-group station and is under the command of an air base commander with his headquarters thereat. When time and space are factors in the distribution of supplies from the zone of the interior or communications zone depots, an air force depot is established at the air base airdrome under the command of the air base commander. It is a general depot and contains a quartermaster section which is operated by the air base quartermaster with personnel from the separate quartermaster company (air base). The air force commander designates the level at which stocks of quartermaster corps supplies will be maintained. (See also FM 100-10.)

(2) *Sub-air base airdromes.*—In an air base area where transportation facilities are limited or distances too great for proper distribution by quartermaster truck units, one or more sub-base airdromes are established by the air base commander for the distribution of quartermaster class I supplies and certain designated items of classes II, III, and IV supplies when air transports from the air base are inoperative. Quartermaster personnel from the mobile field unit of the separate quartermaster company (air base), and truck and labor units are placed thereat for the handling and issue of these supplies to combat units at designated distributing points. It is commanded by a representative of the air base commander and functions as a small air force depot. (See FM 100-5.)

(3) *Quartermaster class I holding and reconsignment point.*—Where quartermaster class I supplies cannot be obtained direct from convenient quartermaster distributing agencies of the zone of the interior and communications zone or commercial distributing agencies, a quartermaster class I supplies rail holding and reconsignment point is established on a railroad where these supplies are made up daily for distribution to troops at designated distributing points either by rail or by quartermaster truck units assigned to the air force. A representative from the air base commander and a representative from the air base transportation office with necessary personnel for the handling and distribution of supplies is placed thereat. (See also FM 100-10.)

(4) *Supply points.*—Supply points for aviation gasoline and oil, ordnance ammunition and bombs, chemical supplies to include decontamination equipment, and engineer materials are established in the air base area as needed and operated by their respective services under the air base commander concerned. The number and type will depend on the particular requirements of the troops served, terrain, transportation facilities available, and the location of the zone of the interior or communications zone depots. Quartermaster personnel to include truck and labor units of the air force assigned to the air base by the air force commander are conveniently placed for the proper handling and transporting of these supplies from the supply points to distributing or other points for issue to combat troops.

(5) *Distributing points.*—See FM 10-5 and 100-10.

b. *Distribution of quartermaster supplies.*—See FM 10-5.

SECTION II

GHQ

- 189. GENERAL FUNCTIONS.—See FM 10-5.
- 190. QUARTERMASTER, GHQ.—See FM 101-5 and 10-5 and T/O 300-1.
- 191. ORGANIZATION.—See FM 10-5.
- 192. ESTABLISHMENT.—See FM 10-5.

CHAPTER 7

TROOP MOVEMENTS

	Paragraphs
SECTION I. Assigned motor transport.....	193-194
II. Shuttling.....	195-200
III. Railway.....	201

SECTION I

ASSIGNED MOTOR TRANSPORT

■ 193. **GENERAL.**—Details covering motor movements are found in FM 100-10, 101-10, 25-10, and 10-5.

■ 194. **DISCUSSION.**—*a. Regulating point.*—A regulating point is a point where an incoming motor transport column is separated into detachments for entrucking groups. It should be an easily recognizable terrain feature where the selected routes through the entrucking or detrucking areas diverge. It should be at or near the road intersection nearest the entrucking area so that the truck groups will arrive at the entrucking point from the direction desired. The distances truck groups must travel under decentralized control should be reduced to a minimum.

b. Initial point.—An initial point is a point where two or more motor groups are brought under the control of the column commander. It should be an easily recognized terrain feature on the route the column is to follow and at a point on this route at which truck groups converge to form a column.

c. Entrucking points.—Entrucking points are the points where the head of a truck column halts for the entrucking of troops and matériel. They should be easily recognized terrain features on the selected routes through the entrucking area. They should be at or near the bivouac or assembly area of the troops to be transported, preferably on the side of the area toward the initial points. They should be so selected that the distances necessary for troops to march for entrucking is reduced to a minimum.

d. Entrucking groups.—Entrucking groups consist of troops, matériel, and supplies entrucked at one entrucking point. (See also FM 25-10.)

e. Routes.—The routes followed through any area will be the shortest routes available and will require the minimum of marching by the troops.

f. Work sheet.—In preparing a work sheet, the entrucking groups should be numbered serially in the order they will leave the area.

(1) These groups should be entered in column 1 on the work sheet.

(2) Column 2 gives the number of trucks assigned to each group.

(3) Column 3 indicates the length of the motor transport columns in minutes.

(4) The time the head of each truck group passes the regulating point is entered in column 4.

(5) The time distances from the regulating point to the entrucking point are entered in column 5. This computation is derived by measuring the distance between the two points and converting it into minutes based upon the rate of march.

(6) Column 6 shows the hour the head of each group arrives at the entrucking point and is computed by adding column 5 to column 4.

(7) Column 7 shows the time distances from the entrucking point to the initial point in terms of minutes.

(8) The earliest that the head of the column can pass the initial point is equal to the time of the arrival, plus the total delay of all groups at the regulating point, plus the time of the longest route through the area, plus 30 minutes for inspection and entrucking. This time as computed should be entered in column 8 for the first group. The time each succeeding group passes the initial point is equal to the time the first group passes, plus the time length of each preceding group.

(9) The hour the head of each group leaves the entrucking point (column 9) is determined by subtracting column 7 from column 8.

(10) Column 10 gives the hour the entrucking should begin, and is found by subtracting 15 minutes from the times entered in column 9. (See also FM 25-10.)

g. Entrucking table.—The data from the work sheet may be entered under its proper column in the entrucking table. As this is an annex to the field order, care should be exercised in placing the number of the annex and field order in the

table and that it is signed or authenticated by the proper staff officers. (See FM 101-5.)

SECTION II

SHUTTLING

■ 195. GENERAL.—A shuttle movement is a movement of a partially motorized unit in which all or part of the trucks are required to make successive trips to complete the movement of the armament, equipment, and personnel of the unit. Its purpose is to utilize the available transportation to the greatest practicable extent in order to make movements in minimum time. It also conserves the energy of troops and makes possible the moving of units greater distances.

a. The pooling of all means of transport within subordinate units to the extent required is necessary in shuttling operations. Sufficient trucks should be pooled, when available, to complete the movement in three trips or less.

b. Shuttling movements are of two general types. One, in which the foot elements are transported the entire distance in motors, and the other in which the foot elements march part of the distance and are transported the remaining distance. Movements of the first type are, in effect, a series of movements by motor transportation, the unit being divided into serials to conform to the accommodations which are available in the trucks. (See FM 25-10.)

■ 196. PLANNING AND PREPARATION.—a. Preparation for shuttle movements includes timely issue of warning orders, reconnaissance, determination of the formation for the movement, and field orders as in other methods of marching. Additional preparation in shuttling requires allotment of vehicles and designation of assembly points therefor. The allotment of vehicles requires shifting the means of transport from one unit to another. A determination of which units of the command should furnish trucks for the movement of other units is made by reference to tables of transportation on hand in the several components of the command. The commander designates a part of all specific classes of vehicles as available for pooling after an estimate of the tactical and supply requirements of the situation in conjunction with the following considerations:

(1) Vehicles required in the maintenance of mobility, such as gasoline and oil supply vehicles, motor maintenance vehicles, road building vehicles, and the requirements of motorized security detachments.

(2) Vehicles required in the exercise of command, such as radio trucks and other cargo trucks used for communication.

(3) Vehicles required for combat purposes, such as anti-aircraft trucks, trucks of antimechanized units and weapon and ammunition carriers of units not a component of advance or flank security detachments.

(4) Vehicles required for supply purposes, such as ammunition, kitchen, medical aid station, and general cargo trucks.

(5) Vehicles that may be attached from a higher unit and the time and place they are to be released.

b. Shuttling movements follow the procedure for troop movements by assigned motor transport as outlined in FM 100-10 and 101-10. Certain factors outlined below, however, must be considered in planning shuttling movements. Some or all of the motors must make at least two round trips, necessitating turn-arounds, that is, reversing the direction of movement of the motor column. Therefore, a preliminary road reconnaissance is essential in order that suitable road circuits for this purpose may be selected. It may be necessary for the motor column to leave the prescribed route of march for short distances for the purpose of turning around. In this case, the added distance traveled by the trucks must be considered in computing the time distance for the trip.

c. If foot troops are to be picked up en route, the movements of the motors and foot elements must be so timed as to bring them to the entrucking point at approximately the same time.

d. It may be necessary to drop the normal loads of certain, or all, of the trucks in order to make the shuttling movement. Time must be allowed for this in planning. (See also FM 25-10.)

■ 197. COMPOSITION OF SERIALS.—*a.* In situations in which the tactical requirements are paramount, the composition of serials should be such as best meet these requirements while the convenience of the troops receives secondary consideration. As in other marches, the serials are composed of ele-

ments which move at the same normal rates of speed. In a shuttling movement it may be necessary to have several serials of the same type but moving independently of each other. Thus, in the movement of the regiment there may be several serials of foot elements. It would be illogical to march all of these elements in one serial to the entrucking point en route when only a portion of them can be accommodated at one time in the motor transportation available. The arrangement of the serials involves a consideration of the commander's general plan for the movement, the length of the march, the road net, the cargo and troops to be moved by motor, and the number and capacity of the vehicles available. These factors having been considered, the order or priority of movement is then fixed so as to insure the most expeditious movement.

b. Because of their limited capacity and because they are normally needed for the control and service of the movement, the use of the command and maintenance vehicles for the transportation of the dismounted elements is not warranted. Owing to their limited capacity and lack of seats the $\frac{3}{4}$ -ton trailers will ordinarily not be used for the transportation of personnel, although they may be so used in emergency.

c. Certain of the vehicles of regiments have assigned loads. These loads constitute the cargo to be moved. They consist of one or several of the following categories:

- (1) Weapons.
- (2) Ammunition.
- (3) Personnel.
- (4) Supplies.
- (5) Equipment.

Whether to transport these loads to the march destination before or after transporting the dismounted elements will usually depend upon the conditions peculiar to the particular movement.

■ 198. MOVEMENT OF SERIALS.—*a.* It may be possible to arrange the order, or priority, of movement of the serials to suit the convenience of the unit, or it may be necessary to have them move in a specific order because of conditions beyond the control of the commander. When practicable, the serials should be so arranged that—

(1) The maximum use is made of the motor transportation available.

(2) The foot elements are required to march the minimum distance on foot and without excessively long halts en route awaiting transportation.

b. In the usual case, the problem of the priority of movement resolves itself into a consideration of the desirability or necessity of moving the normal loads before or after the foot elements are transported. In the absence of any conditions which might render one method more desirable than the other, one of the following general methods may be followed:

(1) The prescribed loads are initially left at the old bivouac, and those foot elements which can be accommodated in the motors available are transported to a prescribed point en route, whence they continue the march on foot to the march destination. The trucks then return to a designated entrucking point en route, to which the remaining foot elements, in the meantime, have marched. These are then transported to the march destination, the trucks returning to the old bivouac where the normal loads are picked up and transported to the march destination.

(2) The trucks carrying the normal loads proceed to the march destination, where the loads are dropped. In the meantime a serial of foot elements which can be transported in one trip by the motors marches a prescribed distance on foot. The trucks return to the entrucking point, pick up the marching foot elements at that point, and transport them to the destination. The trucks again return to the entrucking point, pick up the remaining foot elements which have marched to the prescribed point, and transport them to the destination.

(3) Clear sufficient transport of prescribed loads in the old area to completely motorize a well-balanced force, move the force to its destination and return the necessary number of empty vehicles to move the remaining troops and cargo to the new area. This method is applicable to tactical situations wherein combat is expected prior to the completion of the movement of the unit.

■ 199. NECESSITY FOR CALCULATIONS.—*a. General.*—In order that the serials may move in accordance with a logical time schedule, certain preliminary calculations are necessary. The S-3 of the unit is normally charged with the preparation of the orders for the movement, and, hence, with making

the preliminary calculations. Based upon information gained on reconnaissance or from a map study he selects the initial point, suitable entrucking or detrucking points, and turn-arounds for the motors. He makes a tentative arrangement of serials and computes their time lengths. Then using the speedometer readings made on reconnaissance or by measuring the distances on the map, he determines the time distances of the serials to their destinations. In determining the time distances, he allows adequate time for entrucking, detrucking, collection or discharge of normal loads, and for turn-arounds of motor serials and closing-in time. A reasonable safety factor determined on the basis of local conditions should be injected to cover unforeseen contingencies. With this information, he is prepared to fix tentatively the order in which the serials are to move and time of departure of the various serials from the first initial point, from entrucking or detrucking points en route, or for the return trip of the trucks from the march destination. Should the route be blocked by cross traffic or be denied the unit for any period of time, he must so fix the time of departure of the serials as to avoid interference with crossing or parallel columns and also to avoid excessively long halts by troops or transportation en route. When a satisfactory arrangement of serials has been determined and approved by the commander, the order for the movement is prepared. In order that the commander may assure himself that the march, as ordered, is capable of execution, the recommendations of the S-3 may be presented to him in the form of a march graph.

b. For planning purposes an approximation of the time required may be obtained by application of the formula—

$$\text{Hours required} = \frac{\text{Number of shuttles} \times \text{distance in miles}}{\text{Speed in miles per hour}} = T$$

T is a variable representing the time consumed in loading, unloading, turn-arounds, and closing-in time of the column in the area of destination, and varies between wide limits. A reasonably safe value to adopt for T , under average conditions, is 3 hours.

c. In computations of time and space consideration must be given to the variance in density of vehicles per mile of

highway in daylight and night movements. Daylight movements should be conducted at an approximate density of 12 vehicles per mile as a passive means of protection against hostile air operations. Night movements are normally conducted at a density based on a safe driving distance between vehicles. For night operations at this density computation should be based on 750 vehicles passing a given point in 1 hour, regardless of the speed employed.

d. Coordination of shuttle movements requires the designation of initial points on the routes of march assigned, time each march unit should pass the initial point, the designation of an assembly area at destination, and the density and speed of the movement. As in movements by assigned transport, control points on the routes of march should be established as required. Depending upon the time available for preparation and planning, coordination may be exercised through centralized control or decentralized to subordinate route commanders.

e. The turn-around of transport in shuttling movements may be effected on a road circuit, by a loop turn-around in a field, or by successive or individual turn-arounds. Choice of the type of turn-around is dependent upon the tactical situation, the road net, the type of road, weather, control, and the state of training of vehicle operators.

■ 200. SHUTTLE OF LARGE FORCES.—In forces larger than a regiment the organic motors of several of the component units may be combined to transport the foot elements. For example, in an Infantry division the organic motors of two of the Infantry regiments may be used to transport, in turn, the foot elements of the regiments the entire distance. These motors can transport all of the foot elements of one regiment in one trip. While for the unit being moved, this would be a movement by motor transport, for the force as a whole it would be a shuttling movement. (See FM 25-10, 100-5, 100-10, and 101-10.)

SECTION III

RAILWAY

■ 201. TYPICAL RAIL MOVEMENT.—For information and data see TM 10-375 and FM 101-10.

CHAPTER 8

PLANS, ORDERS, ESTIMATE OF SITUATION, AND
REPORTS

■ 202. GENERAL.—The entire operation of the quartermaster services in any unit is put into effect through the medium of quartermaster field orders. To provide an understandable order that covers all the details, a plan, known as the quartermaster plan, should be announced by the senior quartermaster of the unit. This plan is to be based upon an estimate of the supply situation as affecting the quartermaster services. In every situation, therefore, first, there should be an estimate of the situation; second, a plan; and third, a field order. These may be mental, oral, or written, depending on circumstances. (See FM 10-5.)

■ 203. ESTIMATE OF SUPPLY SITUATION.—Every quartermaster given a mission should make an estimate. In war and in the field this is known as the quartermaster estimate of the supply situation. Such an estimate is a thorough study of all factors, tangible and intangible, that affect the plan, and it should take into consideration all possible intentions of the enemy and such contingencies that might affect the plan of the commander. The estimate of the supply situation is usually a continuous mental process which leads to a decision. Where special staff officers are concerned, as, for example, a quartermaster, the decisions arrived at are often presented to the commander or his general staff in the form of recommendations. When these recommendations are approved, they become the basis for the quartermaster plan. (See FM 101-5.)

■ 204. FORM FOR ESTIMATE OF QUARTERMASTER SUPPLY AND EVACUATION SITUATION (See Form 3, FM 101-5).—*a.* Every written estimate is to show in the upper right-hand corner the issuing unit, place, date, and hour of the estimate. This is followed by a list of those maps that are needed for an understanding of the estimate. Paragraph 1 should discuss in detail the tactical considerations of our own force and of the enemy. Subparagraph *a* should consider the present dispositions of the major elements of the command. This usually

can best be shown on the map. Next, the tactical line of action that is under consideration; for example, whether the unit will attack, defend, withdraw, etc. Under this tactical line of action should be considered the probable tactical developments, for example, in the attack, whether the method to be employed is an envelopment of the right or left flank, a penetration, etc. Consideration should be given, also, to the period these operations are expected to cover, the anticipated location of the major elements of the command at stated intervals during this period, and the probable nature of the combat during these same intervals. In subparagraph *b*, the present dispositions of the major elements of the enemy command should be discussed, preferably supplemented by a study of the map. All the major capabilities of the enemy should be taken into account, with special attention given to the action of the main force as a whole, for example, whether the enemy can attack, defend, withdraw, etc., and if so, where, under the attack, and whether he is capable of enveloping our right or left flank or of making a penetration. Minor capabilities, such as sabotage, air or ground raids, etc., likely to affect supply and evacuation, should be studied.

b. In estimating the supply situation the quartermaster, in paragraph 2, should consider all of the logistical and other factors, which information can be secured primarily from other staff officers and G-4. The quartermaster must consider all other supply and evacuation installations in making his estimate, as they may affect the locations of quartermaster installations. Therefore, the present location of all supply and evacuation installations should be shown on the map and studied. Estimated expenditures of losses during the period contemplated, quantities of supplies and animal replacements on hand, en route, and available from local resources, and such credits as may have been established should be thoroughly studied. An estimate should be made of the evacuation of surplus supplies, salvaged and captured matériel, and prisoners of war. A complete study of all lines of communication should be made to include the location, capacity, condition, critical points, availability, and siding and terminal facilities of all railways within the unit area. Likewise, the road net, considering the all-weather roads, secondary roads and their capacity, condition, critical points, and availability should be taken into account. Under waterways,

their location, critical points, dockage, and storage facilities should be carefully considered. All airway terminals, together with their location and capacity should be included. Careful thought should be given to the requirements of each type, quantities of all types, locations, cargo capacity, and rates of speed of all available transport. The requirements and quantity of labor available should be included in this estimate. Under terrain, a careful study should be made as to its effect upon location of establishments, security of lines of communication, and operation of transport. Weather is an important factor in all military operations and the past, present, and future weather should be considered. The quartermaster should endeavor to secure from the other services and from G-3 an estimate of the requirements of all transport required by the units.

c. Under paragraph 3 should be listed the several elements that appear to be feasible and such alternatives that can be used. A complete discussion of the relative advantages and disadvantages of each of these elements must be made. This is usually done conveniently by expressing these elements under the following headings: Lines of communication, installations, trains, supplies, transportation, evacuation, labor, and protection.

d. In paragraph 4 there should be stated the essential elements of the quartermaster plan of supply as recommended to the general staff or the commander. Also, there should be indicated herein whether or not the plan recommended will adequately support the tactical plan under consideration, together with such unavoidable supply deficiencies as may exist. A further statement, showing the effect of possible major adverse conditions of the plan and the alternative measures necessary to overcome them or the unavoidable deficiencies that will arise, should be made.

e. If the estimate is submitted in writing to G-4 or the commander, it is to be signed by the unit quartermaster.

f. A separate estimate is usually prepared for each proposed line of action, but most of the data will be applicable to all lines of action. A separate conclusion, however, will be required. It will seldom be necessary to reduce the entire estimate to written form. Usually paragraph 4 is all that the unit quartermaster will submit to the commander or his general staff for consideration and decision.

■ 205. QUARTERMASTER PLAN.—*a. Preparation.*—Based upon the estimate of the quartermaster supply, the unit quartermaster prepares the quartermaster plan, a form of which is shown in *b* below. In considering this plan, all phases of the quartermaster service are to be given attention. However, in many instances there may be few, if any; changes under each of the headings. In such cases, the plan will include only those points that require changes and for which orders must be issued.

(1) The location of the railhead and other quartermaster establishments, such as bakeries, depots, attached units, bathing units, etc., incinerators, and location of division baggage applicable, should be incorporated in the plan, together with the employment of all quartermaster units.

(2) Paragraph 4 should embrace the plan of supply arrangements for all classes of supply, including motor maintenance and animal replacement. Under this heading there should be indicated the type of ration to be received, the period for which it is intended, the source of these supplies, the method of distribution, the units attached for such supply, and the location of class I control points.

(3) Paragraph 5 should cover any changes that may be required in motor maintenance, together with the location of shops, salvage of vehicles in the unit, evacuation of the vehicles, and such arrangements as may be made with the quartermaster of the higher unit with reference to the vehicles. (See FM 10-5.)

(4) Paragraph 6 should cover the location of the headquarters garage and such subgarages as may be selected.

(5) Paragraph 7 should show the method by which units may secure animal replacements and the location of field remount depots. The assignment and distribution of animals to units should also be covered in this paragraph.

(6) Under paragraph 8, the question of quartering, together with such special arrangements, if any, for quartermaster troops, headquarters of quartermaster units, and equipment and supplies, should be included, together with the disposition of all claims arising from the occupancy of real estate.

(7) Paragraph 9 should cover all instructions for collection and delivery of salvage to collecting points and its disposition.

(8) Paragraph 10 should cover all the details of labor for collection and burial of the dead, and the location of cemeteries.

(9) Paragraph 11 should include the recommendations of the quartermaster for the location of all trains for which he is called upon to make recommendation and such special instructions concerning their locations as may be necessary.

(10) Paragraph 12 should cover the location, headquarters, and bivouacs of all units of the quartermaster services including such units as may be attached. There should also be incorporated in this paragraph the employment of all units of the quartermaster service. (See FM 101-5.)

b. Suggested form for quartermaster plan.

1. RAILHEAD.—Location recommended.
2. LOCATION QUARTERMASTER ESTABLISHMENTS.—Bakeries, depots, bathing units, incinerators, etc., if operating for the division. Location of division baggage if applicable.
3. EMPLOYMENT OF QUARTERMASTER UNITS.—General assignment of all units including attached.
4. QUARTERMASTER SUPPLY ARRANGEMENTS.
 - a. *Class I supply.*
 - (1) Kind: A, B, C, or D ration. What period for each. Include or exclude hay.
 - (2) Source: Daily train; division reserve; railhead reserve.
 - (3) Distribution: When, where, how to be delivered to units.
 - (4) Enumerate units attached for class I supply.
 - (5) Location of class I control points.
 - b. *Other quartermaster supply, except motor transport and animal replacements.*—Indicate method by which units may procure.
 - c. *Third echelon motor maintenance supply.*—Indicate where supplies, spare parts, and unit assemblies may be procured.
5. MOTOR MAINTENANCE.—Location of shops; salvage of vehicles of the division; evacuation of vehicles; arrangements with army quartermaster concerning vehicles. Issue of spare parts and automotive supplies.
6. HEADQUARTERS GARAGE.—Location, and any subgarages to be selected.
7. ANIMAL REPLACEMENTS.—Method by which units may procure, and location of field remount depot. Assignment and distribution.
8. QUARTERING.—Special arrangements, if any, for quartermaster troops, headquarters of quartermaster units, equipment, and supplies. Disposition of claims.
9. SALVAGE.—Instructions for collection of and delivery to collecting points and disposition.
10. BURIAL.
 - a. Location of cemeteries.
 - b. Method of burial with necessary details.

11. BIVOUACS OF UNIT TRAINS, INFANTRY, ARTILLERY, AND ATTACHED CAVALRY.—Recommendation by regiment and such special instructions as may be desired.

12. QUARTERMASTER REGIMENT.

a. Locations, headquarters, and bivouacs.

- (1) Regimental headquarters and company.
- (2) Each battalion, truck.
- (3) Battalion, light maintenance and car.
- (4) Service company.
- (5) Attached units.

b. Employment of units.

- (1) Battalions, truck.
- (2) Battalion, light maintenance and car.
- (3) Service company.
- (4) Attached units.

206. QUARTERMASTER FIELD ORDER.—a. General.—From the quartermaster plan the staff of the unit quartermaster issues the orders necessary to put the plan into effect. Many of these instructions may be issued in fragmentary form, either orally or in writing; in other instances, it may be possible to issue a complete written field order. If the latter is not possible, a complete written field order covering all oral and written fragmentary orders should be published confirming all previous instructions.

b. Form for quartermaster field order.

Title
Place
Date and hour

FO _____

Maps: (Including administrative map, if issued, showing it to be a numbered annex.)

1. INFORMATION:

a. *Enemy*.—Location; strength; dispositions; etc.

b. *Own forces*.

- (1) Tactical plan of whole command as contained in paragraph 2 of the division field order and such other information as the quartermaster regiment will require to perform its mission.
- (2) Extracts from the division administrative plan or order which affect the quartermaster activities, in sequence, and to include only those which have been changed, such as—
 - Class I railhead and time of opening.
 - Time of arrival of daily train.
 - Supply points and distributing points that may affect the quartermaster regiment.
 - Division cemetery and burial.
 - Traffic restrictions or control.
 - Rear boundary of the division.
 - Bivouacs of service troops and trains, except the quartermaster regiment.
 - Rear echelon division headquarters.

2. Mission and general plan of operation of the quartermaster regiment, including general instructions, such as movement to bivouac areas, time and order of march, route, general bivouac areas, etc.
3.
 - a. Instructions in a separate lettered subparagraph for each unit and attached units.
 - b. Instructions for two or more units or the regiment as a whole, to be placed in paragraph x.
4. Administrative details pertaining to the interior administrative operations of the regiment such as—
 - a. Rations, time, place, and method of issue.
 - b. Bivouacs for each unit.
5.
 - a. Command posts of quartermaster regiment, battalions, service company, and attached units.
 - b. Location of division quartermaster's office.

Authentication

Signature

Annexes

Distribution

NOTE.—Refer to administrative map and annexes whenever possible in preparation of the field order.
(See FM 101-5.)

c. Annexes to accompany field orders.

Annex No. ——— Labor

To accompany Quartermaster Field Order No. —, Date —

Organization	Number and grade	Report to	At	Time	Transportation required	Duty

Authentication

Signature

Annex No. ——— Transport

To accompany Quartermaster Field Order No.—, Date —

Class I supplies

Number of		Company	Tons				For unit	Report to railhead		Remarks
Trucks	Trailers		Rations	Grain	Hay	Fuel		Location	Time	

Ammunition, troop movements, and miscellaneous transport

Number of		Company	Mission	Report to—	Time		Remarks
Trucks	Trailers				Departure	Return	

Authentication

Signature

■ 207. REPORTS.—The quartermaster of each unit renders reports, as directed by the headquarters to which he is attached, covering all quartermaster operations or activities. Such reports are usually rendered daily, but may cover longer periods. Among the reports submitted will be a complete report, including information concerning the strength of the quartermaster regiment, casualties, and stragglers; the location of the various units of the regiment; location of installations such as quartermaster distributing points, collecting points, and division cemeteries; and a statement of the status of quartermaster supply, transportation, salvage, evacuation of salvage, burials, and other quartermaster activities. The form of the quartermaster report is similar to the G-4 periodic report (Form 18) shown in FM 101-5.

CHAPTER 9

PROTECTION OF FOOD SUPPLIES AGAINST
POISONOUS GAS

■ 208. GENERAL.—For defense and protection against chemical attack see FM 21-40.

■ 209. PACKAGES.—*a.* Foodstuffs are packaged in various ways, such as in hermetically sealed glass bottles and tins, which afford maximum protection against gas, and in sacks (which are normally used for sugar, flour, etc.), which afford a minimum amount of protection. Procurement of foodstuffs should be made of items packaged in a material which gives the maximum protection against chemicals. As an example, waxed and grease-proof papers are superior to ordinary papers.

b. Complete protection against all forms of chemicals is afforded by airtight bottles and sealed tins. Complete protection against vapor and small amounts of liquid is afforded by sealed wooden barrels, such as those used for the storage of vinegar, pickles, etc. Good protection against vapor and liquid is afforded to foodstuffs packaged in oilskin, waxed cartons, and greaseproof paper. Limited protection only is afforded against vapor and no protection is afforded against liquid for foodstuffs packaged in thin cardboard and ordinary papers. No protection is afforded to foodstuffs packaged in ordinary sacks.

■ 210. STORAGE.—Gasproof shelters should be used for the storage of food supplies in the field. The degree of protection against gas of a warehouse or other place where foodstuffs are stored is dependent upon the type of foodstuff which is stored and the container in which it is packaged. Warehouses which cannot be adjusted to afford good protection against gas should be used for the storage of the better-packaged foodstuffs. Cold storage plants of up-to-date construction are extremely satisfactory and should need no further gasproofing construction, owing to the fact that they are provided with tightly fitting doors and other means of excluding the air. Warehouses of ordinary construction must

efully examined. Exits and entrances should be reduced to a minimum. The ones being kept in use should be provided with air locks and the remainder should be sealed. Where a large warehouse containing several rooms or sections is used, each room or section should be shut off from the other. This decreases the chance of gas entering all of the rooms. Poor protection against gas is afforded by open sheds. Foodstuffs stored therein should be covered by impervious oil-dressed tarpaulins. Ordinary waterproof covers of the canvas type are easily penetrated by gas, but must be used if none other are available. The tarpaulins should be supported on a framework so that they do not come in actual contact with the foodstuffs to be protected.

■ 211. TRANSPORTATION.—Foodstuffs packaged in containers readily susceptible to chemical contamination, when being transported on a road or railway, should be transported in a closed type of vehicle. If trucks or barges are used, tarpaulins should be used to cover the items.

■ 212. RATIONS.—When cooked rations are delivered to troops, they should be kept in closely covered containers until used. Ration carts should be covered with tarpaulins for protection against chemical spray. Field kitchens should be provided with tent flies or other overhead covers. Canned goods sprayed with chemicals should be decontaminated by boiling before being opened.

■ 213. WATER.—Water which has been contaminated with mustard gas should be avoided. In an emergency, such water may be rendered safe for use by settling, chlorination, and boiling. Water so treated should not be used until it has been tested by a medical officer. Water contaminated by arsenical agents such as lewisite and adamsite, or by white phosphorus, cannot be purified by boiling.

APPENDIX

ROUTING OF REQUISITIONS, CALLS, AND SUPPLIES

- 1. Figure 19 is a diagrammatic representation of a theater of operations. The communications zone is divided from front to rear into a base section and an advance section. Certain establishments are indicated by rectangles which bear their designations. Routings of requisitions, calls, and supplies are indicated by various lines.
- 2. One of the communications zone headquarters is shown as the headquarters base section and the other as a headquarters advance section.
- 3. The general base depot (a) is a general depot stocking quartermaster, medical, and engineer supplies. The quartermaster base depot (b) stocks only quartermaster supplies.
- 4. The 1st Division requires certain class IV quartermaster supplies for which credits have not been established. These supplies may be secured only from the quartermaster base depot (b). The routing of the requisition is shown by the line IV.
- 5. The 1st Division requires certain class II quartermaster supplies for which credits have not been established and which must be shipped from general base depot (a). The routing of the requisition is shown by the line II.
- 6. The 1st Division requires certain class III quartermaster supplies which must be shipped from the gasoline and oil depot. A credit to the First Army has been set up in this depot. Line III shows the routing of the requisition for these supplies.
- 7. The 9th Division is in need of animal replacements. These replacements may be partly supplied from sources in the Second Army, the remainder from the remount depot in the communications zone. Credits have not been established

Second Army. Line AR shows the routing of the requisition in order to secure these animal replacements.

■ 8. A class I supply depot in the communications zone is designated to fill calls for class I supplies from the Second Army. Class I supplies are on an automatic daily basis. Unit sections of the daily train are made up at the class I supply depot. Daily telegrams are forwarded from the headquarters, 9th Division. The solid line I shows all establishments through which the detailed information given in the daily telegram will pass. The broken line I shows the establishments through which these supplies will move to the 9th Division.

■ 9. Credits have not been established for Camp X, and the camp is in need of certain supplies which must be drawn from the quartermaster base depot (b). Line S shows the routing of the requisition for the procurement of these supplies.

■ 10. The 1st Division needs some class IV quartermaster supplies for which the army has established credits. These credits have not been exhausted. Line IVa indicates the establishments through which the call and the supplies will pass.

■ 11. The 6th Division is in need of ammunition. The army has established a 10-day credit for the I corps which has not yet been exhausted. Line A shows the establishments through which the call and the supplies will pass.

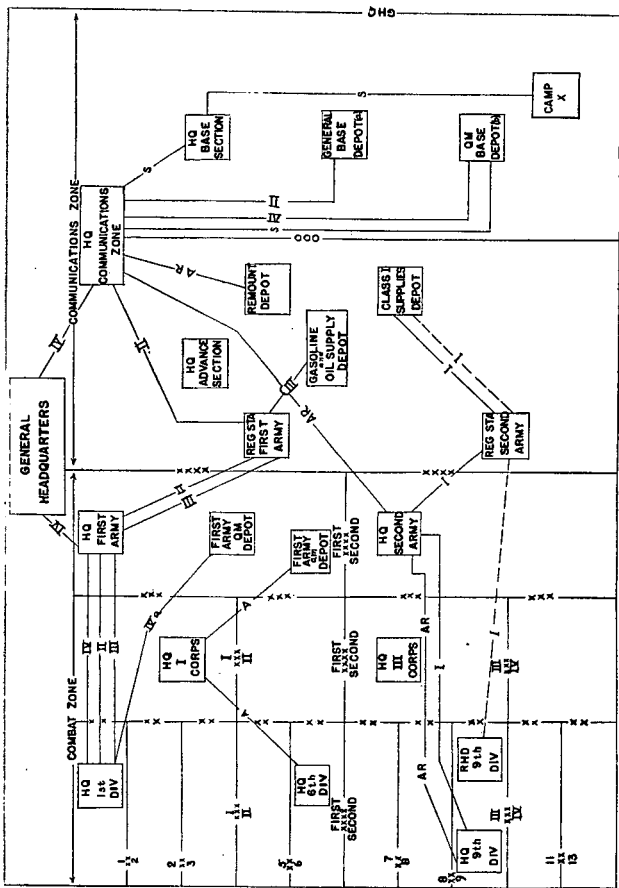

FIGURE 19.—Routing chart for quartermaster supplies.

INDEX

	Paragraph	Page
Air Force:		
Mission and general duties.....	186	146
Operations.....	188	150
Quartermaster troops.....	187	146
Air transportation.....	91	68
Ammunition, at regulating station.....	47	37
Animal transportation, regulating stations.....	50	38
Animals, rations.....	116	76
Armored division:		
Battalion, organization.....	152	121
Class I and class III supply.....	155	123
Class II and class IV supply.....	156	123
Logistical considerations.....	158	124
Office, division quartermaster.....	153	122
Operations.....	151	121
Quartermaster service.....	151	121
Army:		
Depots:		
Establishment.....	183	141
Lay-outs.....	185	142
Location.....	182	140
Office, army quartermaster.....	178	138
Operations.....	179	138
Organization, quartermaster service.....	177	137
Service at army supply points.....	181	140
Stockage.....	180	140
Army corps. (See Corps.)		
Automatic supply, definition.....	15	9
Bakery battalion.....	64	51
Balanced stocks.....	12	8
Bathing.....	60	47
Bulk supplies, regulating station.....	47	37
Call:		
Definition.....	9	8
Routing.....	App.	171
Camouflage.....	129	104
Cavalry division (horse):		
Class I supplies.....	143	114
Class II and class IV supplies.....	146	119
Forage.....	144	119
Graves registration.....	147	120
Office, division quartermaster.....	142	114
Protection.....	150	120
Quartering.....	149	120
Remounts.....	146	119
Salvage.....	148	120
Squadron, organization.....	141	114
Water.....	145	119
Civilian personnel.....	30	18
Clearing station.....	102	75

INDEX

	Paragraph	Page
Clothing:		
Repair	62	50
Sterilization and reissue	60	47
Cold storage	65	52
Combat zone:		
Definition	5	7
Responsibility and functions	92-94	72
Commissary company	63	50
Communications zone, definition	4	3
Contamination, protection of food supplies from	208-213	169
Control point	101	74
Corps:		
As part of army:		
Composition	160	125
Employment	163	128
Graves registration	170	133
Headquarters corps, quartermaster service	161	126
Labor	167	132
Marches	168	132
Motor maintenance	166	132
Movements by rail	172	134
Quartermaster service	162	127
Responsibilities	159	125
Salvage	171	133
Transportation	165	130
Utility service	169	132
Independent:		
Composition	174	135
Headquarters, quartermaster service	175	135
Operation	176	136
Credit, definition	5	7
Daily telegram	16	9
Daily train	23, 55	10, 42
Day of supply	13	9
Definitions:		
Combat zone	5, 95-116	7, 74
"Communications zone"	4	3
Terminology	6-23	7
"Theater of operations"	3	1
"Theater of war"	1	1
"Zone of the interior"	2	1
Depots:		
Army	182-185	140
Communications zone:		
Designation	34	23
Location	35	24
Operations	37	26
Organization	36	24
Quartermaster company depot (supply)	39	27
Stockages	38	27
Definition	17	10
Purpose	33	23
Remount	68-70	55
Salvage	59	46
Distribution, division supplies	123, 137	87, 112
Division quartermaster units:		
Armored. (See Armored division.)		

INDEX

Division quartermaster units—Continued.	Paragraph	Page
Battalion, triangular division:		
Distribution of supply-----	137	112
Duties-----	134	109
Motor maintenance-----	139	113
Organization-----	135, 136	109, 111
Purpose-----	133	109
Transport-----	138	112
Cavalry. (See Cavalry Division.)		
Office, division quartermaster:		
Square division-----	120, 121	82, 85
Triangular division-----	136	111
Operations:		
Camouflage-----	129	104
Class I supply-----	123	87
Class II and class IV-----	125	100
Employment of transport-----	127	101
Fundamentals of supply-----	122	86
Gasoline and oil supply-----	124	99
Graves registration-----	130	106
Protection-----	128	104
Salvage-----	131	106
Traffic and traffic control-----	132	106
Water-----	126	100
Regiment-----	117-119	77
Dump-----	98	74
Estimate of situation-----	203, 204	161
Evacuation, sick and wounded-----	48	37
Field order-----	206	166
Filling station-----	67	55
Forage-----	144	119
Gasoline and oil:		
Allowances-----	115	76
Corps supply-----	162	127
Division supply-----	124	99
Filling station-----	67	55
Supply units-----	66	54
General headquarters:		
General-----	24	11
Quartermaster service-----	189-192	152
Graves registration-----	130, 170	106, 133
Hospitals, source of replacement-----	79	58
Independent corps. (See Corps.)		
Infantry division. (See Division quartermaster units.)		
Installations:		
Communications zone-----	28	17
Regulating station-----	45	33
Interior, zone, definition-----	2	1
Labor, corps-----	167	132
Laundry-----	61	49
Lines of communication-----	20	10
Logistical considerations, armored division-----	158	124
Marches, corps units-----	168	132

INDEX

	Paragraph	Page
Military railway service.....	106	75
Motor maintenance, corps.....	166	132
Motor transport service.....	105	75
Motor transportation:		
Corps.....	165	130
Employment.....	127	101
Importance.....	82	60
Maintenance.....	84, 85, 139	63, 113
Operation.....	82	60
Organization.....	82	60
Pool.....	138	112
Regulating station.....	50	38
Movements by rail.....	172	134
Armored division.....	153	122
Cavalry division.....	142	114
Communications zone:		
Duties of quartermaster.....	26	12
Installations.....	28	17
Organization.....	27	14
Quartermaster corps, duties.....	25	11
Units.....	29	17
Division (square).....	120	82
Division (triangular).....	136	111
Independent corps.....	175	135
Order, field.....	206	166
Packages, protection from chemicals.....	209	169
Personnel:		
Procurement and distribution, communications zone.....	30	18
Regulating station.....	49	37
Replacement. (See Replacement.)		
Plan.....	202, 205	161, 164
Poisonous gas, protection of food supplies from.....	208-213	169
Priorities, definition.....	10	8
Promotion, noncommissioned officers.....	80	58
Protection.....	128, 150	104, 120
Quartering.....	149	120
Quartermaster:		
Communications zone:		
Duties.....	26	12
General.....	24	11
Office.....	24-29	11
Division:		
Duties and functions.....	121	85
Office organization.....	120	82
General headquarters.....	24	11
Independent corps.....	174	135
Theater of operations.....	24	11
Quartermaster battalion:		
Distribution of supply.....	137	112
Duties.....	134	109
Organization.....	135	109
Purpose.....	133	109
Transport.....	138	112
Quartermaster corps; duties in communications zone.....	25	11

INDEX

	Paragraph	Page
Quartermaster regiment:		
Duties.....	118	77
Organization.....	119	78
Purpose.....	117	77
Rail movement.....	201	160
Rail transportation.....	86-90	68
Railhead:		
Characteristics.....	52	38
Company.....	54	41
Daily train.....	55	42
Definition.....	22	10
Operation.....	53	39
Purpose.....	51	38
Reserves.....	56	42
Rations:		
Definition.....	116	76
Protection from contamination.....	212	170
Refrigeration.....	65	52
Regiment.....	117-119	77
Regulating station:		
Ammunition.....	47	37
Animal transportation.....	50	38
Bulk supplies.....	47	37
Definition.....	21	10
Evacuation.....	48	37
Installations.....	45	33
Kinds.....	42	30
Location.....	43	31
Motor transportation.....	50	38
Operation.....	46	34
Personnel.....	49	37
Purpose.....	40	28
Regulating officer.....	41	29
Remount depot:		
Operations.....	70	55
Squadron.....	68	55
Troop.....	69	55
Replacement:		
Forwarding.....	76, 77	57, 58
Hospitals as source.....	79	58
Plan.....	71, 72	56
Quartermaster personnel.....	78	58
Requisitioning.....	77	58
Return to original units.....	80	58
Sources.....	75, 79	57, 58
System.....	74	57
Types.....	73	57
Reports.....	207	168
Requirements, definition.....	14	9
Requisition:		
Definition.....	7	8
Routing.....	App.	171
Reserves:		
Armored division.....	154	122
Definition.....	11	8
Railhead.....	56	42

INDEX

	Paragraph	Page
Sajvage:		
Cavalry division.....	148	120
Collecting company.....	58	45
Corps quartermaster service.....	171	133
Headquarters quartermaster salvage depot.....	59	46
Laundry.....	61	49
Procedure.....	57	44
Purpose.....	57	44
Shoe, clothing, and textile repair.....	62	50
Sterilization and bath.....	60	47
Services, combat zone.....	92	72
Shoe repair.....	62	50
Shuttling:		
Calculations, necessity for.....	199	158
Large forces.....	200	160
Planning.....	196	155
Pooling.....	195	155
Preparation.....	196	155
Purpose.....	195	155
Serials:		
Composition.....	197	156
Movement.....	198	157
Types.....	195	155
Sterilization and bath.....	60	47
Stockages.....	38, 180	27, 140
Storage, protection against chemicals.....	210	169
Subsistence:		
Bakery battalion.....	64	51
Cold storage and refrigeration.....	65	52
Commissary company.....	63	50
Supplies:		
Classes.....	95	74
Definition.....	6	7
Routing.....	App.	171
Supply:		
Communications zone.....	31	19
Gasoline and oil. (See Gasoline and oil.)		
Installations.....	57-80	44
Points:		
Combat zone.....	93	74
Definition.....	18	10
Terminology.....	6-23	7
Theater of operations, definition.....	3	1
Theater of war, definition.....	1	1
Traffic and traffic control.....	132	106
Train, definition.....	103	75
Transportation:		
Air.....	91	68
Armored division.....	157	123
Communications zone.....	32	22
Food, protection against contamination.....	211	170
Motor.....	82-85	60
Rail.....	86-90	68
Water.....	81	60
Troop movements:		
Assigned motor transport.....	193, 194	153
Definition.....	104	75
Railway.....	201	160
Shuttling. (See Shuttling.)		

INDEX

	Paragraph	Page
Units, communications zone.....	29	17
Units of fire.....	13	9
Units of measure.....	13	9
Utility services, corps quartermaster service.....	169	132
Water:		
Protection from contamination.....	213	170
Supply.....	126, 145	100, 119
Zone of the interior, definition.....	2	1