

ETO

RA-10119

201-05
3.3-05

JUN 16 1945

1-5

TECHNICAL INTELLIGENCE BRANCH
File No. 201-1-48-3300
Copy No. 0

REPORT

WAR DEPARTMENT
OFFICE OF CHIEF OF ENGINEERS
MILITARY ENGINEERING DIVISION
TECHNICAL INTELLIGENCE BRANCH

RESTRICTED

OF

RHINE RIVER CROSSINGS

FIRST UNITED STATES ARMY

RESTRICTED
UNCLASSIFIED
REGRADED
25 Jun 51
ORDER SEC ARMY
BY TAG PER
AT 99

RA-10119



LUDENDORF RAILROAD BRIDGE
REMGAN, GERMANY

Structure Reading
crossing
Smith Aug 45
Shaplan
OFFICE OF THE ENGINEER
FIRST UNITED STATES ARMY
MAY 1945



- TECH. INT. BR.
O.C.E.
Distribution
- Loan
 - Retention
 - Lt. Col. Fanner
 - E. & D. Div.
 - W. P. Div.
 - Engr. School
 - Engr. Board
 - C & G.S. School
 - ASPTC - Belvoir
 - ASPTC - Lewis
 - ASPTC - Wood
 - Strategic Int.
 - Air Engineer
 - AGF Engineer
 - AGF Int. Div.

6/21/45

ADD MICROFILM
ITEM NO: 3657

RESTRICTED

8 JUL 1945

PO Box # 1402384

RESTRICTED

HEADQUARTERS
FIRST UNITED STATES ARMY
Office of the Engineer
Command Echelon
APO 230

RHINE RIVER CROSSINGS

INTRODUCTION

This report has been compiled to furnish technical information concerning all phases of the Rhine River Crossings in the First United States Army Sector of advance.

Subject matter for the preparation of this report has been freely borrowed from personnel and units engaged in the various phases of the crossing.

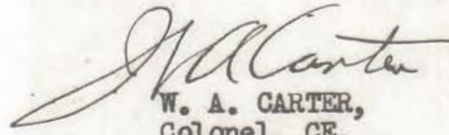
W. A. CARTER,
Colonel, CE,
Engineer.

May 1945.



RESTRICTED

INDEX

Section I

PAGE

Capture of LUDENDORF Railroad Bridge

- A. General Situation..... 1 - 2

Section II

III Corps Crossings

- A. General Situation..... 3
B. Heavy Ponton Ferries..... 4 - 7
C. DUKW and LCVP Ferries..... 8 - 9
D. REMAGEN M-2 Steel Treadway Bridge..... 10 - 11
E. KRIPP Reinforced Heavy Ponton Bridge..... 12 - 13
F. REMAGEN Floating Bailey Bridge..... 14 - 15

Section III

VII Corps Crossings

- A. General Situation..... 16 - 17
B. Heavy Ponton Ferries..... 18
C. ROLANDSECK M-2 Steel Treadway Bridge..... 19
D. KONIGSWINTER Heavy Ponton Bridge..... 20
E. BONN M-2 Steel Treadway Bridge..... 21

Section IV

V Corps Crossings

- A. General Situation..... 22
B. HONNINGEN M-2 Steel Treadway Bridge..... 23

Section V

Army Crossing

- A. Dual Carriageway Bailey Bridge on Barges..... 24 - 27

Section VI

Miscellaneous

- A. Protective River Booms..... 28 - 32
B. Collapse of LUDENDORF Railroad Bridge..... 33 - 35
C. Security Precautions..... 36 - 42
D. Bridge Equipage Supply..... 43 - 45
E. Personalities..... 46 - 48

ANNEX 1 - Comparative Bridge Chart.

ANNEX 2 - Map of Rhine River Crossing Locations.

SECTION I.

CAPTURE OF LUDENDORF RAILWAY BRIDGE.

A. General Situation.....Pages 1 & 2

SECTION I.

CAPTURE OF LUDENDORF RAILWAY BRIDGE

A. General Situation.

On 6 March 1945, First U.S. Army was advancing northeast to the Rhine River with three Corps abreast as shown in Plate 1.

Divisional troop list on this date was as follows:

	<u>VII Corps</u>	<u>III Corps</u>	<u>V Corps</u>
1.	3 Armd Div	9 Armd Div	7 Armd Div
2.	8 Inf Div	1 Inf Div	2 Inf Div
3.	99 Inf Div	9 Inf Div	28 Inf Div
4.	104 Inf Div	78 Inf Div	69 Inf Div
			106 Inf Div

The missions of the 9th Armored Division, (III Corps) for 8 March 1945, were to seize REMAGEN, Germany and establish crossings over the AHR River. In order to accomplish these missions, CCA and CCB, 9 Armored Division, were given orders as follows:

CCA - To seize crossings at BAD NEUENAHN and HEIMERSHEIM.

CCB - To take REMAGEN, KRIPP and seize crossings over the AHR at SINZIG and BODENDORF.

CCB attacked in two columns, one in the direction of each of its objectives against light opposition. At 071515A March 1945 a recently captured Pw stated that the Railway Bridge at REMAGEN was to be blown at 071600A March 1945. This intelligence was immediately transmitted by CG, CCB, 9th Armored Division, to the CO, 14th Tank Battalion, with orders to seize the bridge if possible. Instructions also specified the use of WP and smoke around the bridge, covering the advance with tank and MG fire, and the employment of engineers to cut the demolition wires and neutralize fuzes. CO, 14th Tank Battalion, immediately ordered one platoon of Company 'B', 9th Armored Engineer Battalion, to reconnoiter the Railway Bridge and report on its serviceability for infantry traffic.

The 2nd Platoon, Company B, arrived at the west approach to the Railway Bridge at 071530A March 1945. Five minutes later (at 1535A) as the Platoon Commander, Platoon Sergeant, one Squad Sergeant started across the bridge, an explosion occurred approximately 2/3 of the way over, damaging some of the decking. As the party proceeded, they cut all wires in sight, to make certain that all charges were disconnected. In the center of the bridge four (4) 20 to 30 pound charges were tied to the I beams underneath the bridge decking; demolition wires to these charges were cut. At the west end of the bridge on the downstream tower, heavy wires leading into a master switchbox were cut by rifle fire. An unexploded 500 to 600 pound charge was found in a well of the West Pier with fuse cap blown. The failure of this charge to detonate is unexplained, however, it is believed that the TNT was defective. This charge was neutralized by cutting the lead wires. Further hasty examination was made to completely neutralize all charges on the bridge by cutting demolition wires. Although the bridge, when captured, was damaged throughout its length, the major severed parts were:

- a. Several hangers.
- b. Several floor members.
- c. Stringers adjacent to south abutment.
- d. Lower chord of upstream arch truss adjacent to the north abutment.

While the charges on the bridge were being neutralized by the engineer reconnaissance party, troops of the 27th Armored Infantry Regiment crossed on foot to clear and establish a bridgehead. Artillery laid smoke continually on the west shore in an effort to conceal the operations on the bridge, however, the wind limited its effectiveness. The bridge was under constant small arms, sniper and artillery fire. As rapidly as more engineer troops became available, they were employed in the repair of the bridge approaches and mine clearance of roads on the east bank.

At 072400A March 1945, hasty repairs on the bridge were completed and vehicular and tank traffic proceeded to the bridgehead area.

On 080400A March, Company C, 9th Armored Engineer Battalion, relieved Company B of bridge maintenance. This company removed a total of 1400 lbs of explosives from wells in the bridge piers. Approaches were maintained, roads swept clear of mines, and guard-rails were erected.

On 100800A March 1945, the 276th Engineer Combat Battalion, relieved Company C of the maintenance of the bridge.

During the period that the 9th Armored Engineer Battalion maintained the bridge, continuous artillery fire and air bombing were directed at the railway bridge.

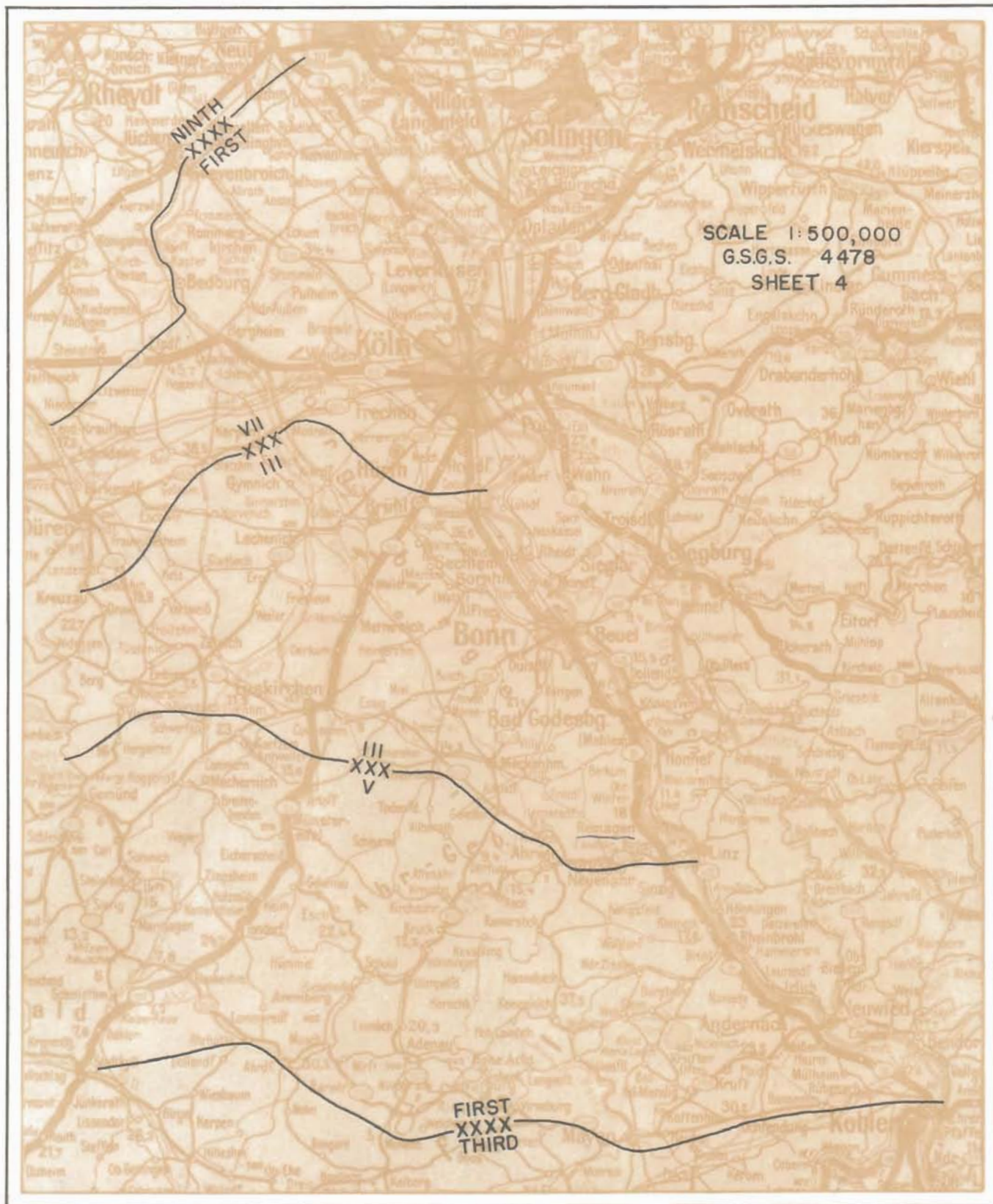

CORPS BOUNDARIES

7 MARCH 1945

PLATE I

SECTION II.

III CORPS CROSSINGS.

A.	General Situation.....	Page 3
B.	Heavy Ponton Ferries.....	4 - 7
C.	DUKW and LCVP Ferries.....	8 - 9
D.	REMAGEN M-2 Steel Treadway Bridge.....	10 - 11
E.	KRIPP Reinforced Heavy Ponton Bridge..	12 - 13
F.	REMAGEN Floating Bailey Bridge.....	14 - 15

SECTION II.

III CORPS CROSSINGS.

A. General Situation.

After the capture of the LUDENDORF Railway Bridge, reinforcement of the bridgehead became an immediate problem. The West bank of the Rhine River had not yet been completely cleared of enemy. The troops necessary for the reinforcement of the bridgehead had to be disengaged in their zones of action and sent over the railway bridge. Engineer troops and bridging equipment were necessary to construct additional crossings. Traffic circulation and signal communication became critical problems.

As rapidly as troops could be disengaged from combat on the West bank of the Rhine, they were crossed to the far shore to expand the bridgehead. Because of the heavy constant artillery shelling, traffic was closely controlled and signal communications required constant maintenance.

An engineer plan for further crossings was immediately put into effect; this plan called for three ferry crossings, one treadway bridge, one reinforced heavy ponton bridge and protective mine booms for the bridges.

The following units were alerted and given instructions to assemble in the vicinity of SINZIG to accomplish missions as indicated:

51st Engineer Combat Bn	- Construct Reinf. Hvy Pon Bridge vic. KRIPP.
164th Engineer Combat Bn	- Construct Protective Booms at Bridge Sites.
276th Engineer Combat Bn	- Maintain LUDENDORF RR Bridge, REMAGEN.
291st Engineer Combat Bn	- Construct M-2 Steel Treadway Bridge vic. REMAGEN.
86th Engineer Hvy Pon Bn	- Construct & operate Hvy Pon Ferries.
181st Engineer Hvy Pon Bn	- Construct Reinf. Hvy Pon Bridge.
552nd Engineer Hvy Pon Bn	- Construct Reinf. Hvy Pon Bridge.
998th Engineer Treadway Bridge Co	- Construct Treadway Bridge
'th Engineer Treadway Bridge Co	- Construct Treadway Bridge
WP Unit No. 1	- Operate Ferries & Work Boats.

The detailed operations to accomplish these missions are given below.

B. Heavy Ponton Ferries.

1. Troops: 86th Engineer Heavy Ponton Bn.
Platoon, 299th Engineer Combat Bn.

2. General.

On 072000A March 1945, the 86th Engineer Heavy Ponton Bn. was instructed to move to the vicinity of SINZIG and passed from operational control of the 1160th Engineer Combat Group (Army) to 1111th Engineer Combat Group (III Corps). The battalion closed at SINZIG after a considerable number of traffic delays, at 082100A March 1945.

On 8 March 1945 the 86th Engineer Heavy Ponton Bn. was given the following missions:

a. Construct and operate a vehicular and tank ferry 1000 yards downstream of the LUDENDORF RR Bridge at REMAGEN.

b. Prepare to construct and operate a vehicular and tank ferry at KRIPP.

c. Two platoons of combat engineers were to be attached to assist in the construction and operation of the ferries.

3. Battalion Plan.

a. Co. 'A' was to construct and operate three 5 boat reinforced rafts at REMAGEN and prepare the west ferry approaches.

b. Co. 'B' was to place the cable, construct the east shore approach and be prepared to construct and operate a ferry at KRIPP.

4. Supply.

All T/E equipment, except one Quickway Crane was on hand. Transportation was immediately sent to pick up 6000 ft. 3/4" cable, 96 cable clips and 10 floating travellers. These supplies arrived at the ferry site at about 091200A March 1945.

5. Ferry Site.

The ferry site was selected during the early morning of 9 March 1945 and was located at F 647203, REMAGEN, Germany. It was never used as a ferry, but later became the site of the first treadway crossing. The approaches to this site were completed before it was turned over to the treadway construction crews. A new ferry site was selected approximately 600 yards downstream of the first ferry site at F 642205 as shown in Plate 2. Both banks were 45 degree revetments approximately 8 ft. high. The water at each approach was deep enough to preclude the use of a trestle pier.

6. Approach Work.

Approach work was simple. An R-4 Bulldozer was used on each side to form approach roads 20 ft. wide and sloping about 25 degrees. Rubble from nearby demolished buildings was used as a road surface. Each approach road averaged 40 to 50 yards in length and connected the ferry with the existing road net in the town. Work on the approaches was started at 100800A March 1945 and was completed at 101030A March 1945.

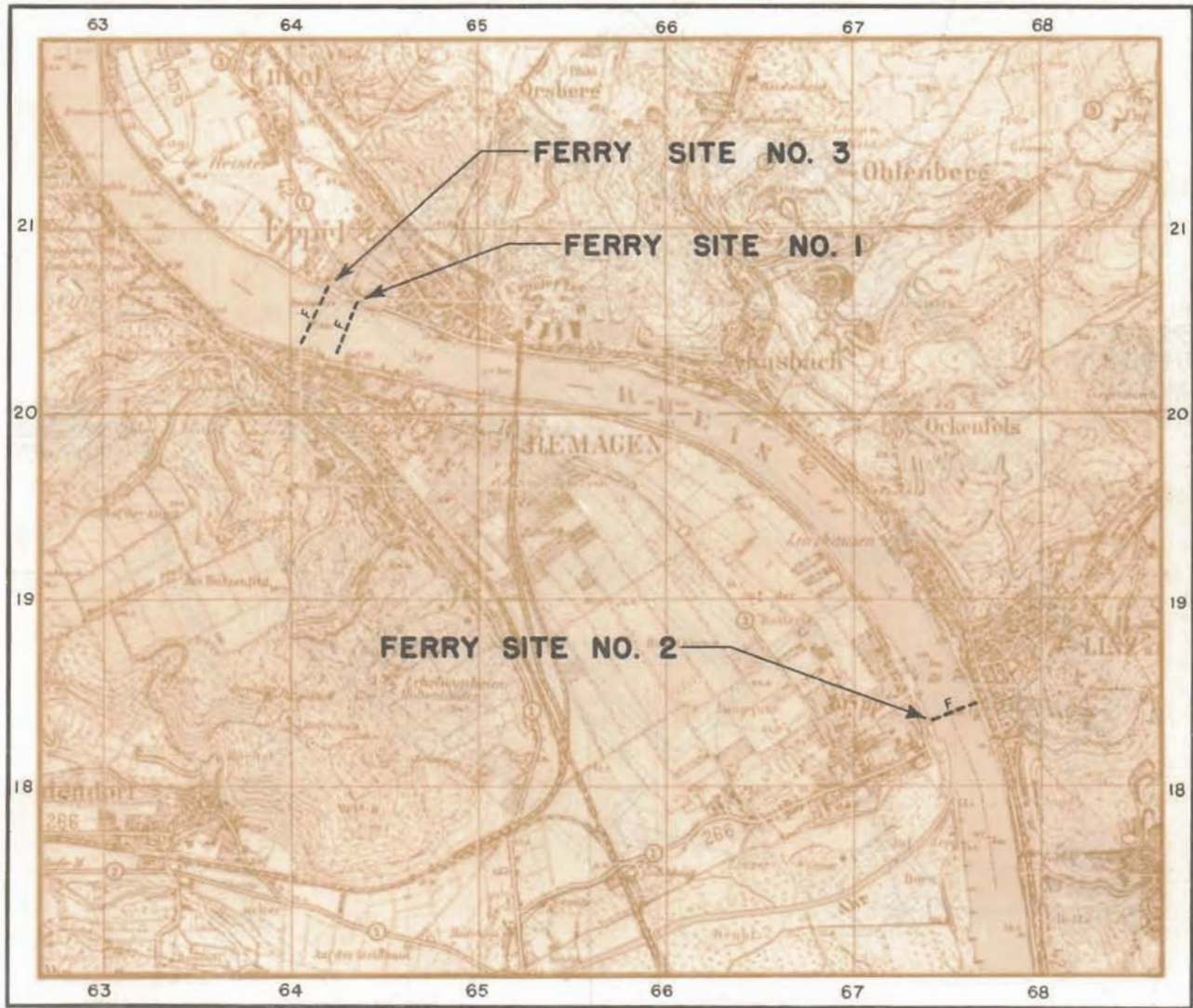

FERRY SITE LOCATIONS - III CORPS

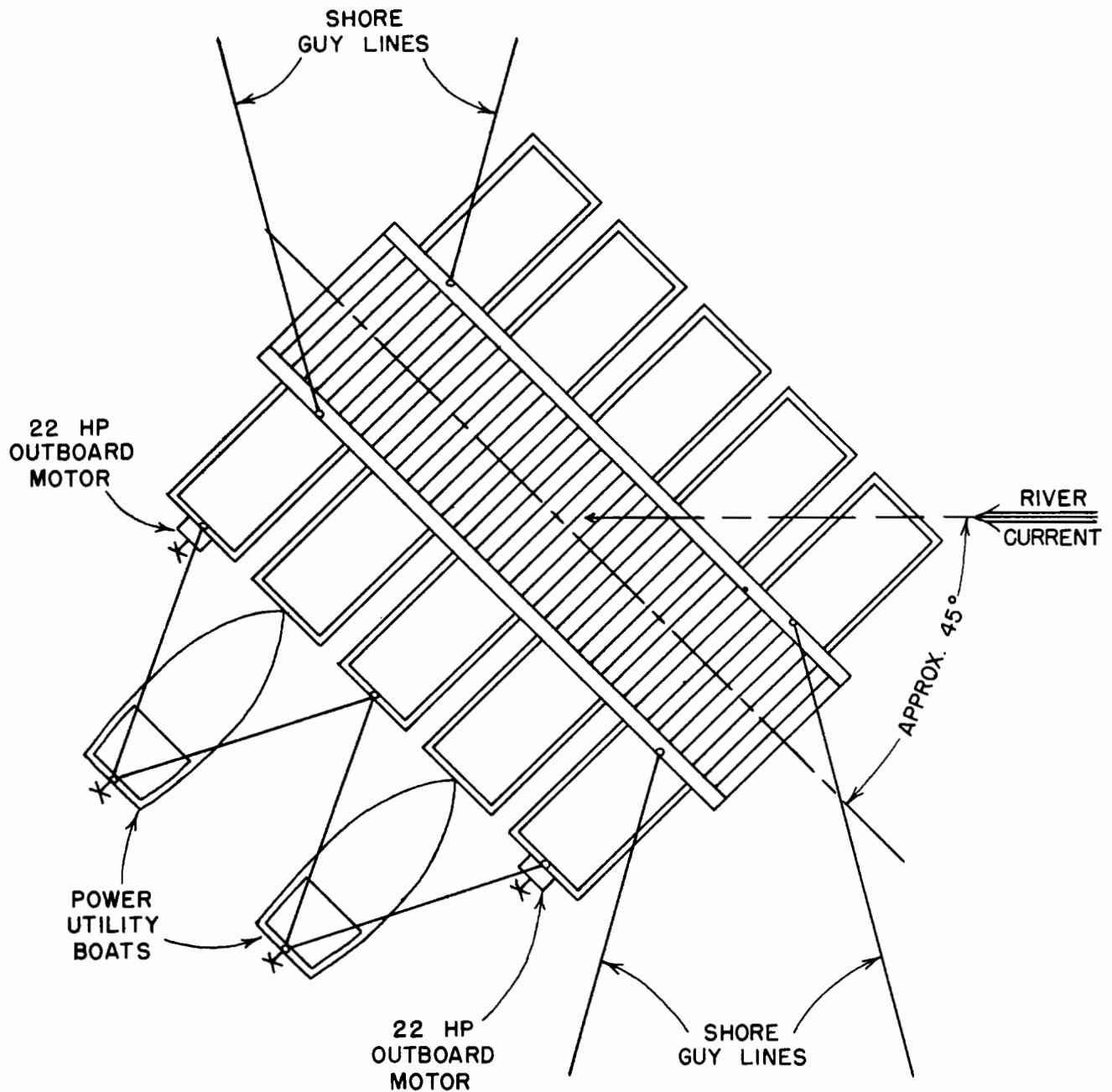

CREW

- 1 - NCO, RAFT COMMANDER
- 2 - OPERATORS, POWER UTILITY BOATS
- 2 - ASST. OPERATORS
- 2 - OPERATORS, OUTBOARD MOTORS
- 8 - SHORE GUY LINE HANDLERS

PLAN VIEW
REINFORCED 5 PONTON RAFT

Heavy Ponton Ferries (Cont'd).

7. Ferry Construction.

Fifteen loads of Heavy Ponton Equipment and one Quickway crane were dispatched from SINZIG at 090015A March and arrived at the ferry site in REMAGEN at 090300A March. This represents a distance of approximately 2½ miles in 3 hours. The excessive time was caused by darkness, unfamiliar streets and roads, artillery shelling and exceedingly heavy traffic. Construction sites were downstream of the approaches on the west bank and approximately 90 yards apart. As soon as the equipment was unloaded the trucks and semi-trailers were dispersed in defiladed areas in the town. Actual raft construction started at 090400A March and at 090730A March, two 5 boat reinforced rafts were completed; by 091030A March a third raft was complete. Intermittent artillery fire delayed ferry construction.

Five ponton rafts, with bow adapters, were constructed as outlined in War Department Technical Bulletin, Engineer, No. 46, dated 24 October 1944. Two 22 HP outboard motors and two power utility boats were used as propulsion units. A plan view of the ferry is shown in Plate 3.

8. Cable Laying.

Cable laying which was delayed awaiting the arrival of 3/4" cable, was started at 091300A March and completed at 091715A March. The cable reel was blocked up on the west shore, the free end fastened to two power utility boats and towed to the east shore where it was anchored to deadmen. After anchoring the west end of the cable, it was ready for operation.

9. Ferry Operation.

Each reinforced ponton raft required a crew of 15 EM, whose duties are shown below:

1 NCO	-	Raft Commander.
2 EM	-	Power Utility Boat Operators.
2 EM	-	Asst. Power Utility Boat Operators.
2 EM	-	Outboard Motor Operators.
8 EM	-	Guy line and cable crew.

The above crew was the minimum necessary to satisfactorily man one raft operating free of the cable.

This ferry was opened to traffic on 091100A March 1945. During the period of its operation, power utility boats were frequently sent upstream to the M-2 Treadway Bridge Site as replacements. This necessitated ferry operation with only outboard motors or at times with one power utility boat and two outboard motors. The following time-table represents the average for ferry operations in the Rhine (Current 4 to 5½ ft per sec).

<u>Serial</u>	<u>Propulsion Units</u>	<u>Loading, Ferrying & Unloading</u>
1	2 Power Utility Boats 2 Outboard Motors	7 minutes
2	1 Power Utility Boat 2 Outboard Motors	15 minutes
3	3 Outboard Motors	15 minutes
4	4 Outboard Motors	12 minutes

After approximately 36 hours operation, one reinforced raft was converted to a normal 5 ponton raft and operated on the submerged cable. The

Heavy Ponton Ferries (Cont'd).

conversion was made to permit the ferrying of a larger number of vehicles. The cable operated ferry raft was powered by two outboard motors as a trail ferry. Ferry operations are photographically showed in Plates 4, 5 and 6.

10. Ferry Loads and Traffic.

Traffic on 9 and 10 March was very light. On 11 and 12 March maximum use was made of ferries especially for the delivery of ammunition and gasoline to the bridgehead and the evacuation of wounded from the bridgehead. On 10 March 1945 an ammunition truck received a direct artillery hit while crossing the REMAGEN Railway Bridge. After this accident all gasoline and ammunition was ferried to the west shore until additional tactical bridges were constructed. Infantry, ammunition and gasoline were ferried to the west bank and battle casualties (walking wounded, and stretcher cases) were ferried to ambulances parked on the east bank. Considerable communications wire and submarine cable were laid by ferries to the east bank. Total ferry traffic is tabulated below:

Tank, M-26	-	4
Tank, Medium	-	31
Vehicles, 2½ ton	-	533
Infantry (to bridgehead)	-	1200 (approximate)
Casualties (to west bank)	-	479

One standard 5 ponton raft carried 110 Infantry, 2- 2½ ton Cargo trucks, and 2- 57 mm AT guns. M-26 tanks were easily ferried on the reinforced 5 ponton raft.

11. Other Ferry Sites.

Two additional ferry sites were constructed and operated to relieve the traffic over the REMAGEN Railway Bridge. These sites were at KRIPP, F 641205 and UNKEL, F 676183, as shown in Plate 2:

One platoon, 299th Engineer Combat Bn. assisted in their construction, especially the approaches. Construction, cable laying and operation were similar to those outlined above. The same types of loads were ferried.

12. Enemy Action. All ferries were constructed and operated under intermittent light and heavy artillery fire. MG fire was encountered at the KRIPP ferry, small arms fire was very sporadic and air bombing was infrequent and inaccurate. One raft received a direct bomb hit, wounding 2 EM, damaged some chess and one heavy ponton. Most of the casualties resulted from artillery action.

Total losses of equipment from enemy action were:

- 1 Heavy Ponton
- 1 Power Utility Boat
- 1 Quickway Crane
- 1 Prime Mover, 4 ton.
- 5 Chess.

On 12 March three 1000 ton river barges, observed drifting down the river, severed several phone lines and cables. To prevent further destruction holes were blasted in the hulls until the barges sank.



6 PONTON FERRY RAFT

Unloading ambulances on West bank of RHINE
River at KRIPP, GERMANY on 12 March 1945.



REINFORCED 5 PONTON FERRY RAFT

Loading M-26 tank on West bank of RHINE
River at REMAGEN, GERMANY on 12 March 1945.



REINFORCED 5 PONTON FERRY RAFT

Loading M-26 tank on West bank of RHINE River at REMAGEN, GERMANY on 12 March 1945. Note 4 22 HP outboard motors and landing deck.

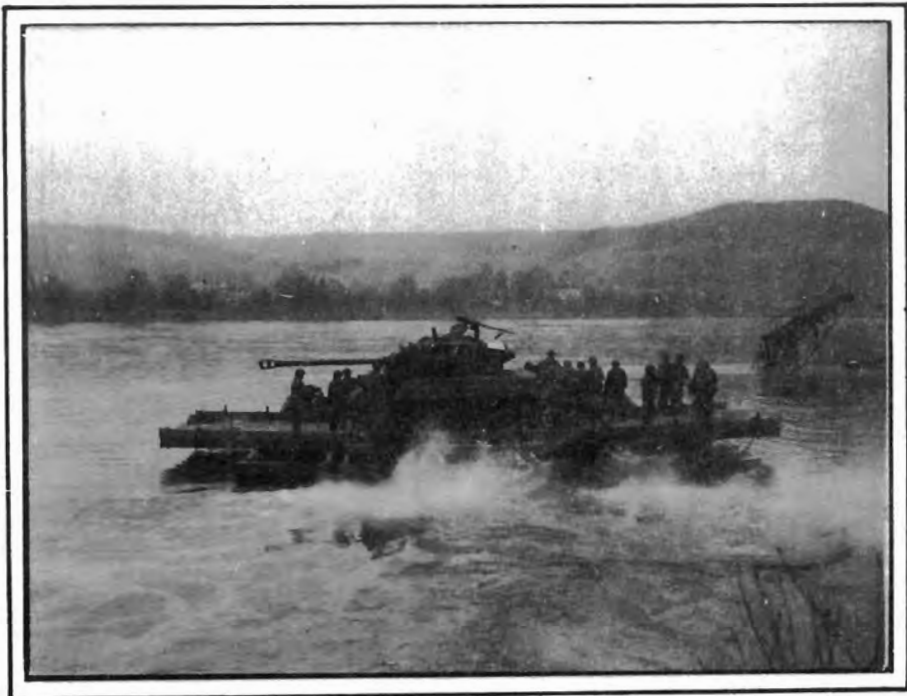

REINFORCED 5 PONTON FERRY RAFT

Ferrying M-26 tank to East bank of RHINE River at REMAGEN, GERMANY on 12 March 1945. Note 4 outboard motors and draft of pontoons.

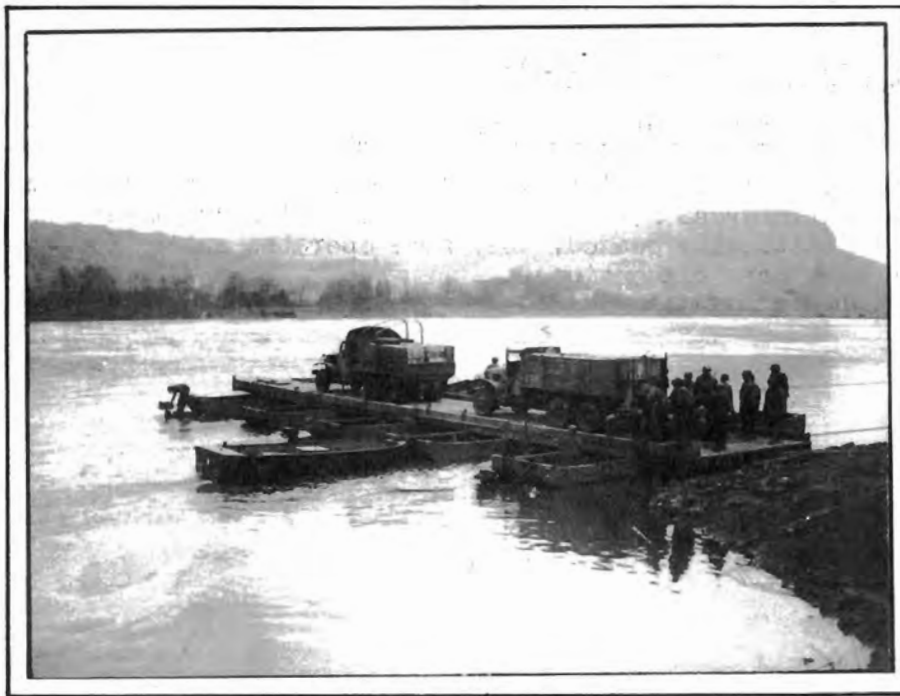

5 PONTON FERRY RAFT

Loading 2½-ton ammunition trucks to East bank of
RHINE River at REMAGEN, Germany on 12 March 1945.

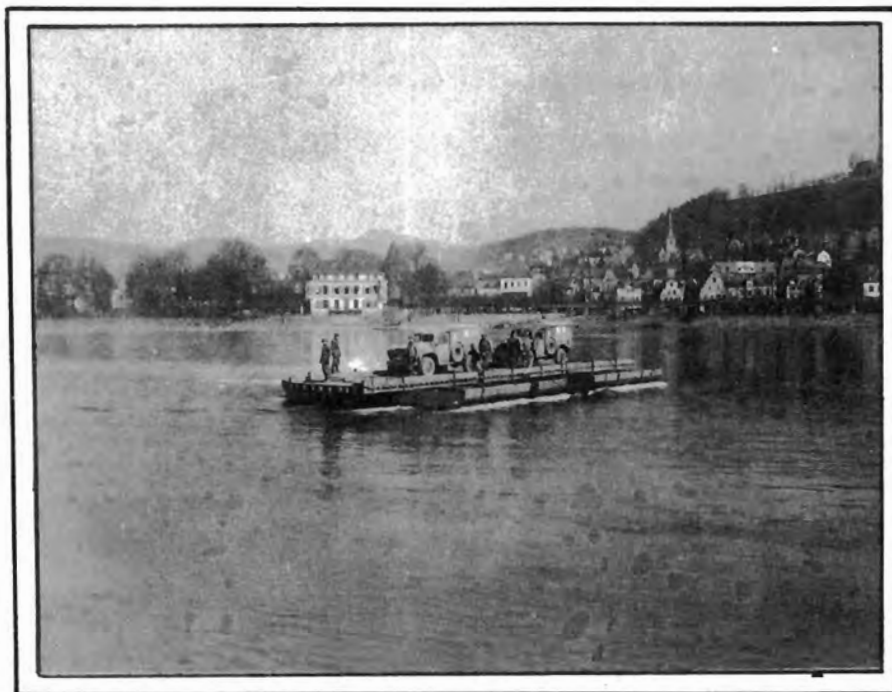

6 PONTON FERRY RAFT

Ferrying ambulances to West bank of RHINE
River at KRIPP, GERMANY on 12 March 1945.

Heavy Ponton Ferries (Cont'd).

13. Discontinuance of Ferry Operations.

On 13 March 1945 virtually all traffic was crossing the M-2 Steel Treadway and Reinforced Heavy Ponton Bridge. Although traffic over the ferries had practically ceased, they were operated until 26 March 1945 on which date they were discontinued.

C. DUKW and LCVP Ferries.

1. DUKW'S.

DUKW Ferries were limited to approximately two or three loaded DUKW's which crossed East. All other DUKW's used during the operation crossed on tactical bridges.

2. LCVP'S.

Troops - LCVP Unit No. 1, U.S. Navy.

3. General.

LCVP's were used in all the Rhine River operations, as ferries and work-boats. Their performance, except for the towing of heavy mine nets and heavy loads through the swift current, was excellent. The unit was attached successively to III Corps, VII Corps and V Corps to assist in the river crossing operations.

4. Use as Ferries.

In all ferry operations the loads carried were casualties, infantry, and light vehicles (1/4 ton to 3/4 ton). The following are totals of all loads carried during period 12 to 28 March 1945.

Casualties	-	500 (Approx.).
Infantry	-	13,143
Vehicles (1/4 ton to 3/4 ton, incl ambulances)	-	286.

A few bulk loads were carried such as TNT, Buoys and Mine Nets. The loaded LCVP encountered no difficulties in crossing if the bow was headed slightly upstream.

5. Use as Work Boats.

The following work was successfully performed by the LCVP.

a. Assisted in construction of Reinforced Heavy Ponton Bridges by towing rafts, and holding the offshore ends of the bridge in position before the bridge was joined.

b. Laid wire rope work cables and telephone cables.

c. Towed buoys, logs, and protective boom materials, however, it was not powerful enough to tow or hold anti mine nets against the current.

d. River security patrol upstream of the bridge sites and protective boom sites.

e. The dropping of demolition charges upstream to discourage enemy swimmers making attempts to demolish the bridges.

f. Supported treadway bridge as debris floated downstream and threatened the bridge.

g. Searched river for casualties and personnel who fell into the river when the LUDENDORF Railway bridge collapsed.

DUKW and LGVP Ferries (Cont'd).

- h. Towed damaged and mechanically defective workboats.
- i. Laid **smoke** screens by patrolling river and burning smoke pots.
- j. Powered heavy ponton ferries.

D. M-2 Steel Treadway Bridge.

1. Troops.

291st Engineer Combat Battalion
998th Engineer Treadway Bridge Company
988th Engineer Treadway Bridge Company

2. General.

On 092030A March 1945, the 291st Engineer Combat Battalion (1111th Engineer Combat Group) received instructions to construct an M-2 Steel Treadway Bridge at REMAGEN, Germany, with equipment supplied by the 998th and 988th Engineer Treadway Bridge Companies. The 291st Engineer Combat Battalion was engaged in routine engineer missions in support of the III Corps attack in the vicinity of RHEINBACH, when the order was received. At 092330A March, the battalion moved to the proposed bridge site at REMAGEN and arrived at 100430A March. The 998th Engineer Treadway Bridge Company arrived at the proposed bridge site at 100830A March. As in the case of 86th Engineer Heavy Ponton Battalion, movement was very slow because of the traffic congestion, artillery shelling and darkness.

3. Battalion Plan.

A battalion plan was orally issued to the company commanders and staff at 092130A March. Company missions were as follows:

Company A - Construct and assemble treadway rafts.
Company B - Construct and assemble treadway rafts.
Company C - Prepare approaches, guy lines and cables.

The bridge was to be constructed only from the near shore, although one platoon of Company C was given the mission of preparing the east bank approach.

4. Bridge Site.

Upon arrival at REMAGEN, the best treadway site was being prepared for a heavy ponton ferry. As the treadway was more important than a ferry, it was decided to move the ferry site downstream and construct the bridge at this site. This site was located at REMAGEN, F 647203, and its map location is illustrated in Plate 7. Both banks were revetted with cobblestones, sloped approximately 45 degrees and about 12 feet high. The only work required on the approaches was cutting with a D-7 Bulldozer to make the approaches slope approximately 20 degrees and resurfacing with rubble and gravel. Most of this work had been performed by the 86th Engineer Heavy Ponton Battalion before the site had been turned over to the treadway construction crews.

5. Bridge Construction.

M-2 Steel Treadway equipage was dispersed downstream of the bridge site at 75 yard intervals. Construction started on 100830A March 1945. Bridge floats were constructed and launched in accordance with Field Manual procedures. When the bridge was complete, the bridle cable was laid over the bridge, and rolled on to 4 supplementary floats which were then towed upstream to their final position about 75 yards upstream of the treadway bridge. Bridge photographs are shown in Plates 8 and 9.

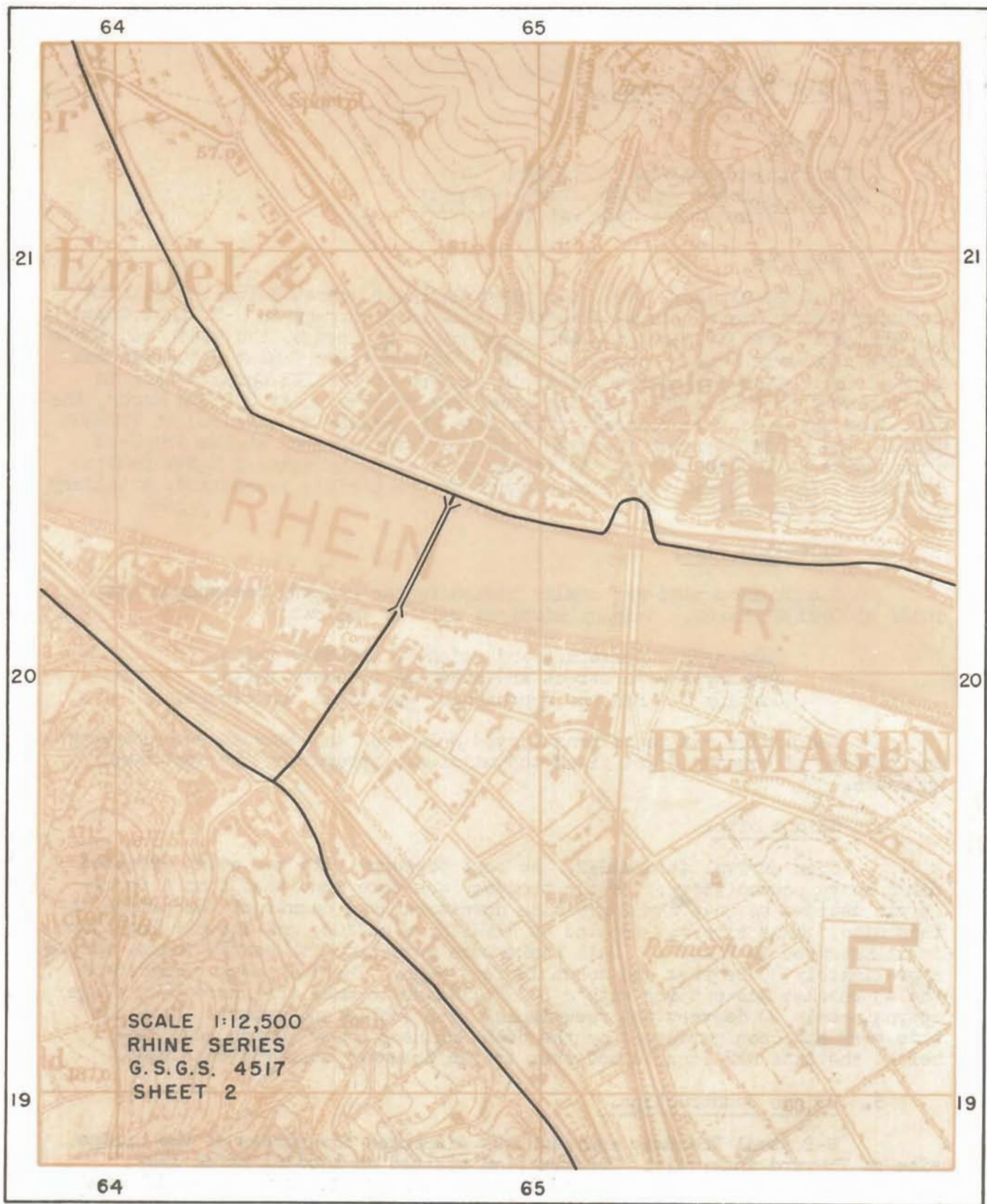

M-2 STEEL TREADWAY BRIDGE

REMAGEN, GERMANY

PLATE 7



BRIDGE SITE, M-2 TREADWAY BRIDGE

Looking EAST prior to construction, location,
REMAGEN, Germany.



ASSEMBLY SITES, M-2 TREADWAY BRIDGE

Downstream on WEST bank. Note dispersion of all
equipment. Smoke is coming from a burning BROCK-
WAY truck which had been hit by artillery fire.



M-2 STEEL TREADWAY BRIDGE

Looking EAST from REMAGEN, Germany.
Photo shows 5 damaged floats.

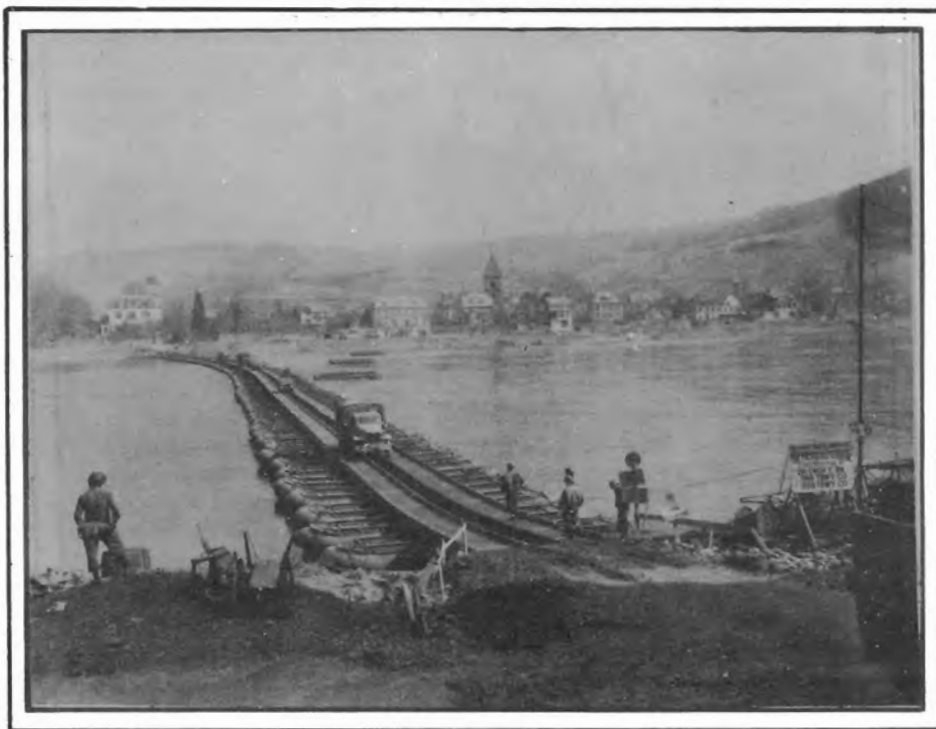

M-2 STEEL TREADWAY BRIDGE

Looking EAST from REMAGEN, Germany. Note:
Definite upstream bow, pneumatic floats
supporting bridle cable.

M-2 Steel Treadway Bridge (Cont'd).

The bridge was constructed with a definite upstream bow which provided:

- a. Compression in the bridge rather than tension.
- b. A reduced pull on the anchors.

The current was approximately 5 feet per second during the construction period.

The main difficulties encountered during bridge construction were:

- a. The flow of debris from the protective boom sites upstream.
- b. Heavy enemy artillery fire.

Debris floated against the bridge for approximately two hours. During this period, power utility boats, personnel stationed on the bridge floats and a Quickway crane were used to pass the debris over or under the treadway bridge.

The bridge was completed and opened to traffic on 111700A March 1945.

6. Enemy Action.

Artillery fire, sniper fire, and air bombing which were particularly heavy caused an estimated working time loss of 12 hours. On 10 March 1945 and during the night of 10-11 March 1945, observed artillery fire was directed against the bridge construction crews. Total casualties from enemy action during the bridge construction period were 35.

Air bombing directed at the LUDENDORF Railway Bridge, which was in the vicinity of the treadway crossing, delayed bridge construction considerably.

The following equipment was damaged by enemy action: 3 Quickway Cranes, 2 treadway trucks, 2 air compressors, 3 - 2½ ton dump trucks, 32 floats.

7. Bridge Maintenance.

Very little maintenance was needed on the completed bridge, other than that necessary to replace floats damaged by artillery fire. Four (4) partially inflated floats were kept in the water on the west bank as reserve at all times. Floats were partially inflated in order to permit their placement under the treadways of the constructed bridge.

8. Bridge Chart.

Annex 1, comparative bridge chart, shows all essential construction data, times, lengths, etc.

E. Reinforced Heavy Ponton Bridge.

1. Troops:

51st Engineer Combat Battalion
181st Engineer Heavy Ponton Battalion
552nd Engineer Heavy Ponton Battalion

2. General.

Instructions to construct a Reinforced Heavy Ponton Bridge were issued simultaneously with the orders to construct the Steel Treadway Bridge. The 51st Engineer Combat Battalion (1111th Engineer Combat Group) was given this mission. The 181st and 552nd Engineer Heavy Ponton Battalions were attached for bridge supply and technical supervision. Prior to this time all three units were engaged in other missions; the 51st Engrs with road and bridge maintenance and the 181st & 552nd Engrs in transportation of engineer supplies to forward depots and dumps.

3. Bridge Site.

Selection of the bridge site was simple. The bridge was to be constructed from KRIPP to LINZ making best use of the existing road net in the towns. Reconnaissance showed an existing civilian ferry with a cobblestone road on the west bank leading down into the water. On the east bank, construction of 50 yards of approach road was necessary. The east bank was about 12 ft. high and sloped 45 degrees. This bank was sloped with a D-7 Bulldozer and resurfaced with rubble and crushed rock. Plate 10 shows the map location of the reinforced heavy ponton bridge.

4. Bridge Construction.

Bridge construction started on 101630A March 1945. The bridge was constructed by parts, using 4 boat, 3 bay rafts reinforced with pneumatic floats. One major difficulty was encountered during construction; this was the failure of the 150 pound kedge anchors to "dig" into the gravel bed of the main channel. A temporary expedient of lashing two anchors together to form a grapnel was used for a short period until larger anchors could be obtained. Large barge anchors averaging 500 and 750 pounds were eventually used in the main channel and were satisfactory but did not completely solve the difficulty. It was finally solved by the use of 1" wire rope guy lines from the bridge quarter points to the shore deadmen and the use of a 1" wire rope upstream of the bridge to which 1/2" wire rope bridle lines were attached to every fourth bridge ponton. This 1" wire rope was supported by 4 ponton boats upstream. The bridge was completed on 112200A March 1945. Photographs of the bridge are shown in Plates 11, 12 and 13.

The following list of remarks are the results of the experiences of the constructing units:

a. Skillful experienced personnel are required to maneuver rafts into position in the bridge. The method, using two power utility boats, as prescribed in Technical Bulletin, Engineer, No. 31, War Dept., dated 30 June 1944 was used and found to be satisfactory.

b. It is unsafe to cast anchors from power utility boats in a swift current. The boat is unwieldy and difficult to control in the process of casting.

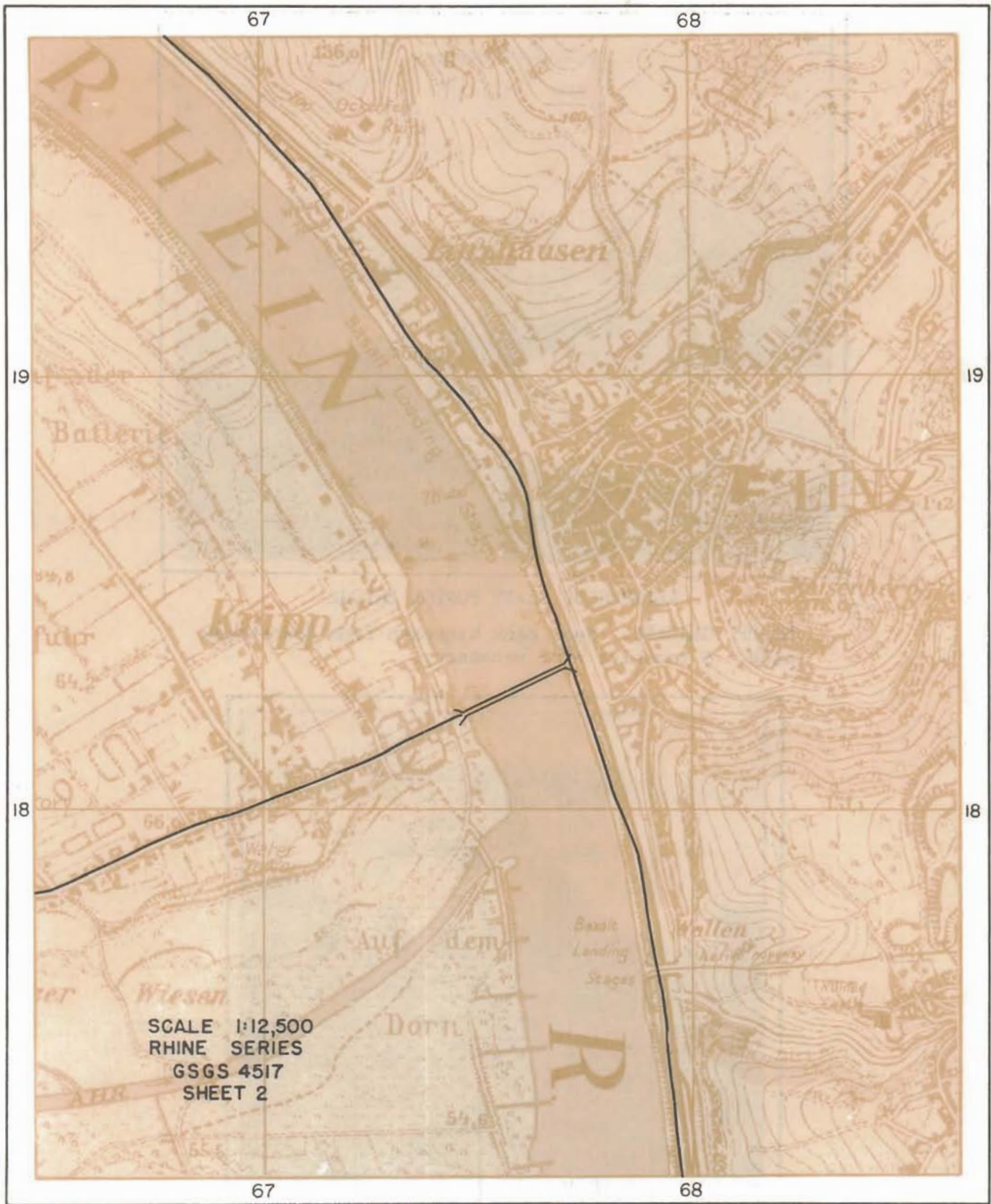

REINFORCED HEAVY PONTON BRIDGE

KRIPP, GERMANY

PLATE 10

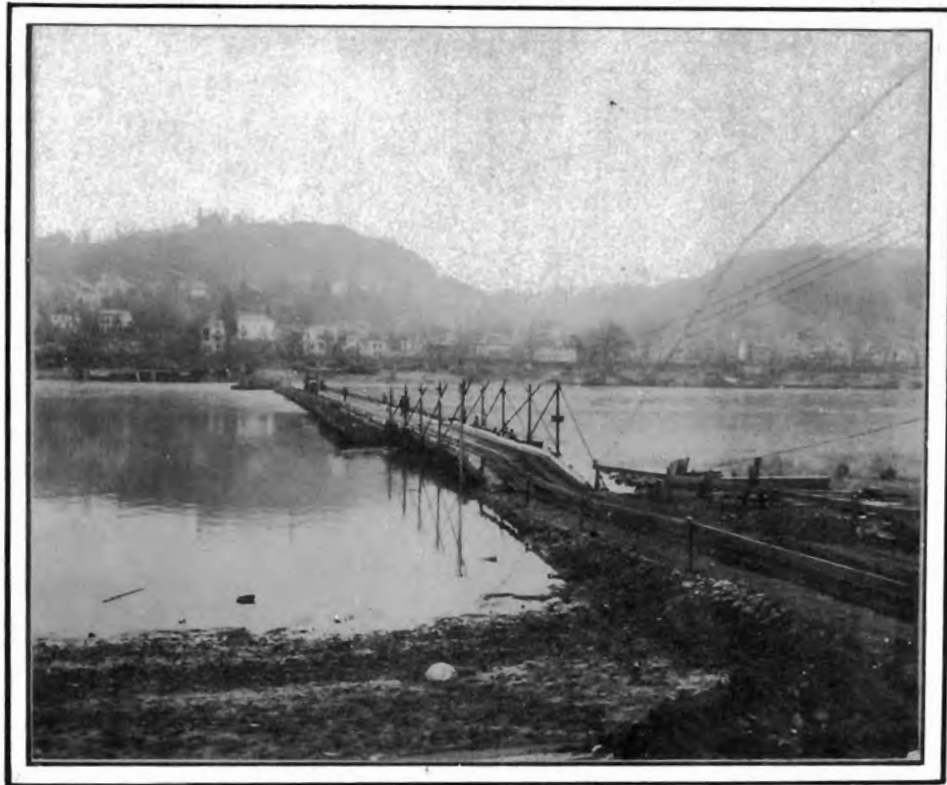

REINFORCED HEAVY PONTON BRIDGE

KRIPP, GERMANY. West bank approach from downstream side. 5 trestles were necessary.

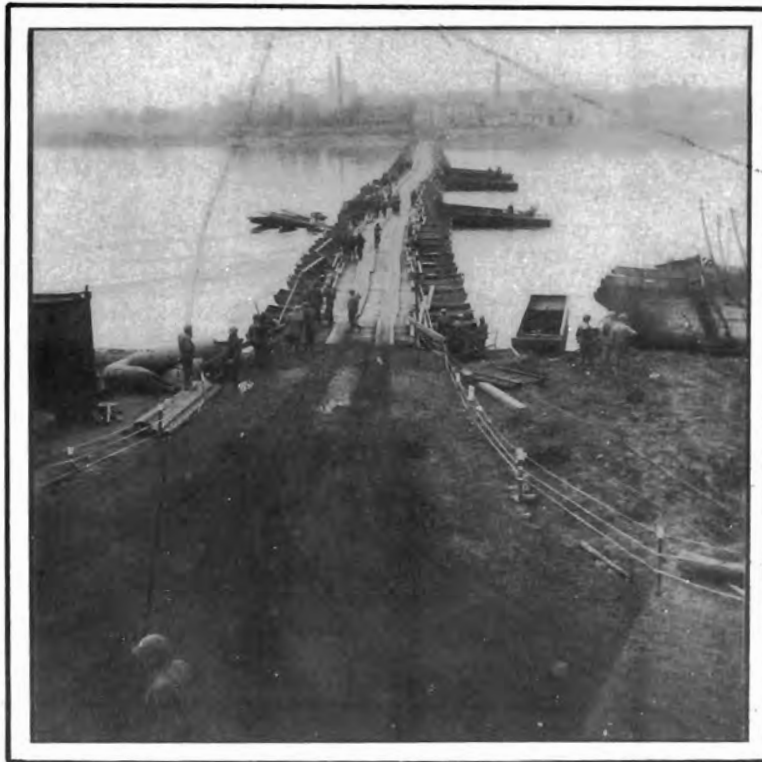

REINFORCED HEAVY PONTON BRIDGE

KRIPP, GERMANY. East bank approach. Three LCVP are removing the downstream bow from the bridge by pushing upstream.

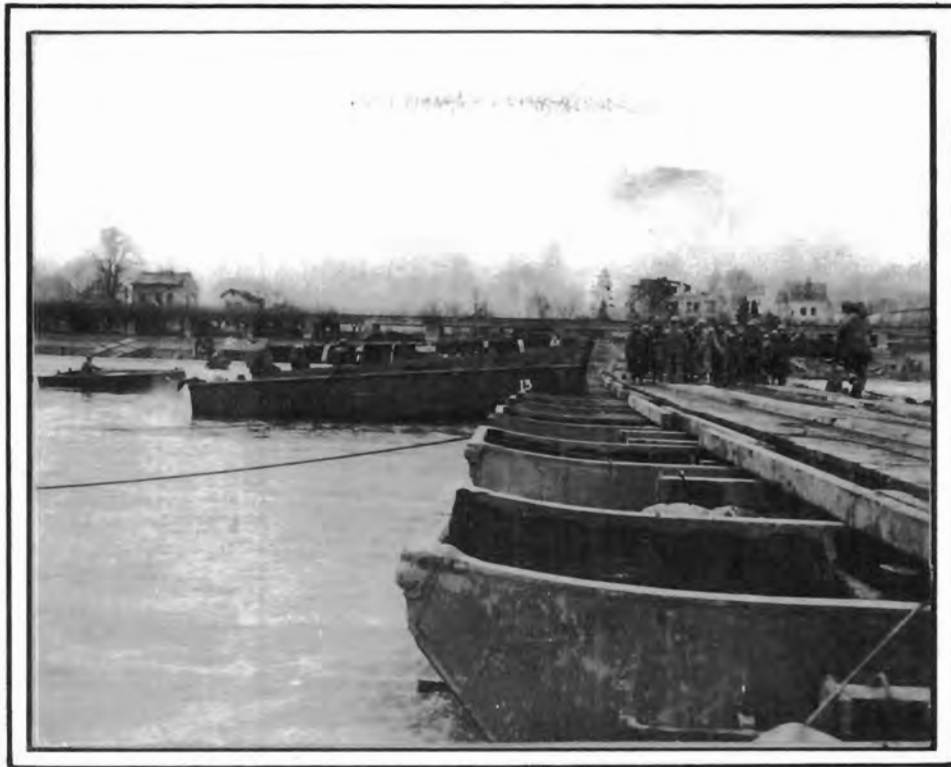

REINFORCED HEAVY PONTON BRIDGE

KRIPP, GERMANY. LCVP reducing the downstream bow in the bridge. LCVP were excellent work boats for Heavy Ponton Bridge operations.



REINFORCED HEAVY PONTON BRIDGE
KRIPP, GERMANY, Completed view of bridge
from upstream bank of west shore.



REINFORCED HEAVY PONTON BRIDGE

KRIPP, GERMANY. Assembly and raft construction site on downstream side of west bank.

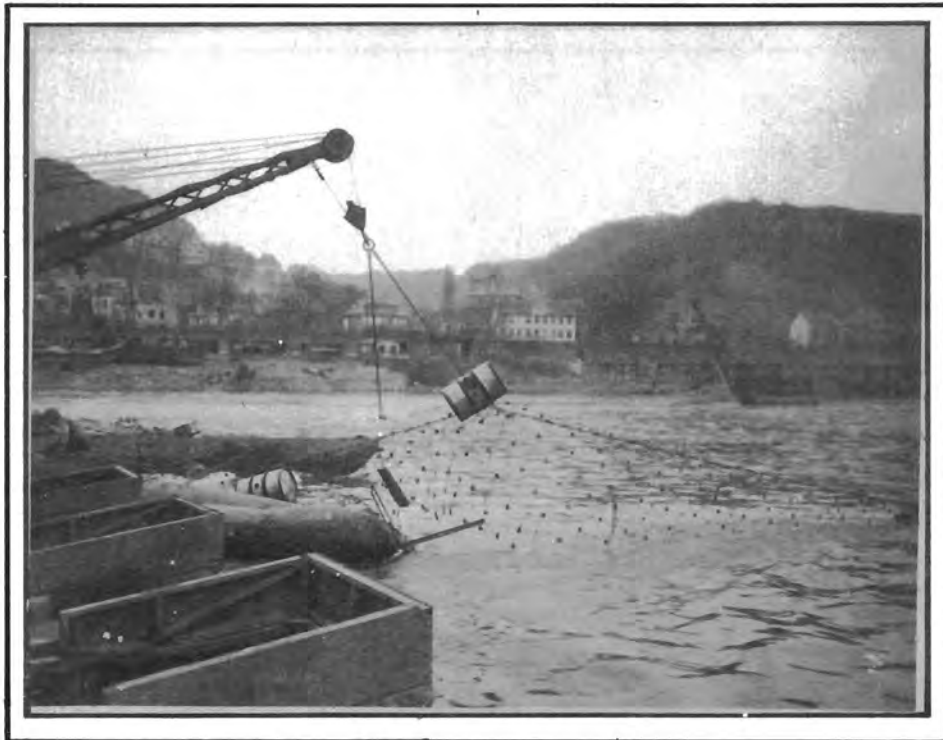

REINFORCED HEAVY PONTON BRIDGE

KRIPP, GERMANY. Quickway crane pulling anti-mine net from upstream side. This net broke loose upstream, floated down the swift current to threaten the security of the bridge. Plate 13

Reinforced Heavy Ponton Bridge (Cont'd).

c. Inflation of pneumatic floats prior to arrival at the bridge site reduces construction time and prevents congestion at the construction sites.

d. A 100% reserve of power utility boats is needed to replace boats that fail mechanically or are lost during construction.

e. Sunken river barges upstream of the bridge are excellent deadmen for bridge guy lines.

5. Enemy Action.

Enemy action at this site was occasional unobserved artillery fire and sporadic air bombing. When this bridge was constructed, the bridgehead area had been considerably expanded thus reducing the effectiveness of enemy artillery fire.

6. Bridge Maintenance.

Maintenance of the bridge required the following crew continuously:

1. Anchor crew	2 NCO's	15 EM
2. Balk fastener and side rail clamp crew	1 NCO	8 EM
3. Ponton and float inflation & replacement detail	1 NCO	6 EM
4. Tag lines, trestle bracing, flooring and treadway	1 NCO	4 EM
5. Supervision	2 Officers	

A reserve detail of 60 EM was in an alert status to assist when needed.

7. Bridge Chart.

ANNEX 1, comparative bridge chart, shows all essential construction data, times, man hours, lengths, etc.

F. Floating Bailey Bridge.

1. Troops.

148th Engineer Combat Battalion
One Co., 291st Engineer Combat Battalion
LCVP Unit No. 1, U.S. Navy.

2. General.

Orders to construct a Standard Class 40 Floating Bailey Bridge at REMAGEN, were received by the 148th Engineer Combat Battalion on 171800A March 1945, 10 days after the capture of the LUDENDORF Railway Bridge and on the same day this bridge collapsed.

3. Battalion Plan.

Immediately a plan was made and equipment needed was ordered. At 172400A March, the plan and orders were issued to the Company Commanders as follows:

a. Company A:

- (1) Installation of guy lines.
- (2) Clearing and signing roads from main road to construction sites.
- (3) Placing bridge hub-guards.
- (4) Anchoring the bridge.

b. Company B:

- (1) Construction of floating bays.

c. Company C:

- (1) Landing bays, landing bay piers and end floating bays.
- (2) Maintenance crew for the bridge.
- (3) Ponton repair crew of 4 EM.
- (4) Placing treads on the bridge..

d. Bn Hq & Hq Co

- (1) Bridge loading.
- (2) Delivery of bridge to construction sites.
- (3) Supply.
- (4) Communications.
- (5) Control and coordination.
- (6) Vehicular maintenance crews.

e. One Co. of the 291st Engineer Combat Battalion was assigned the mission of unloading Bailey Bridge equipment at the construction sites and construction of approach roads.

4. Bridge Site.

The bridge was constructed at a heavy ponton ferry site in REMAGEN, as shown on the map in Plate 14. 75 feet of near shore approach and 300 feet of far shore approach roads were necessary to link the bridge with the existing

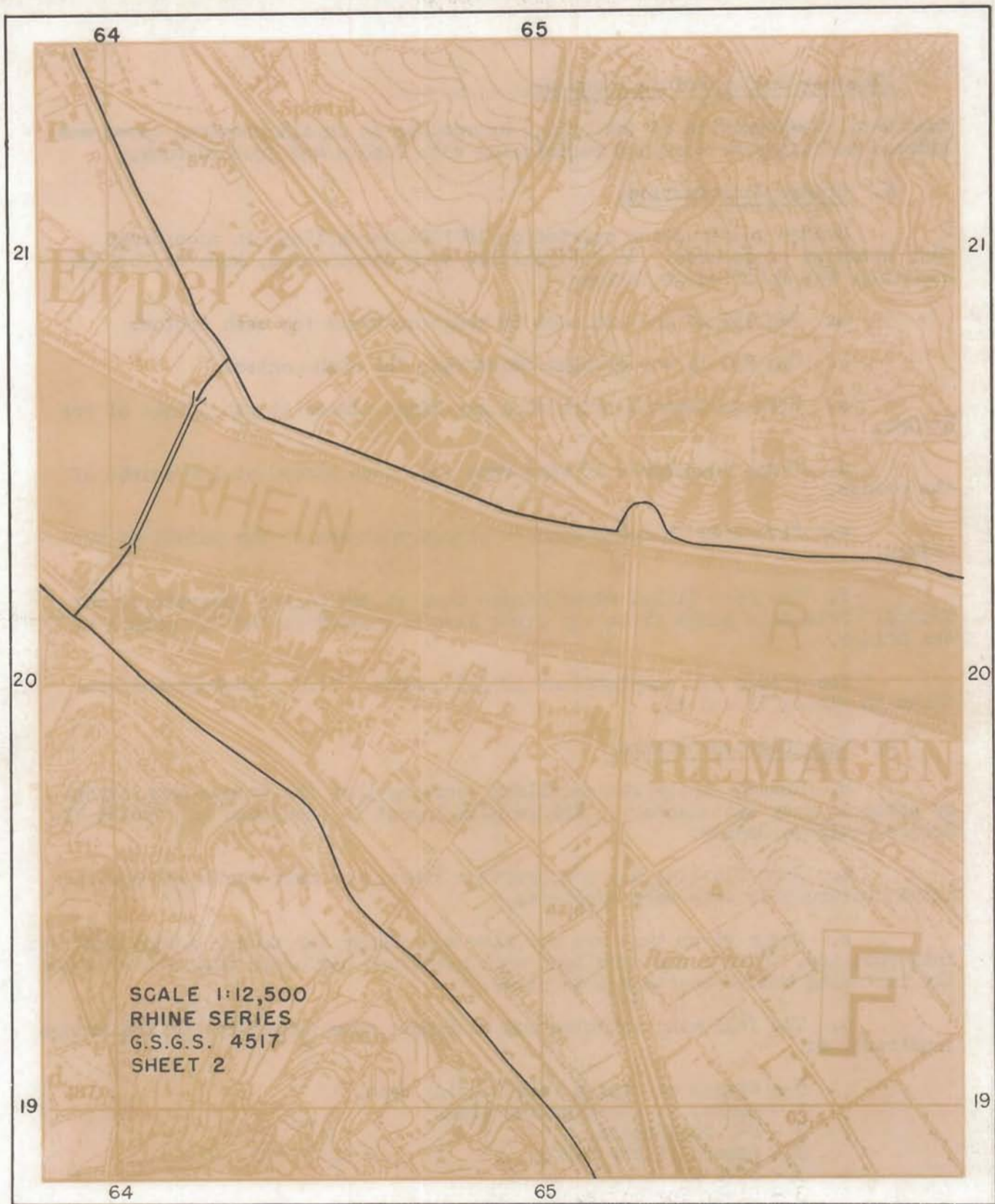

CLASS 40 FLOATING BAILEY BRIDGE
REMAGEN, GERMANY

Floating Bailey Bridge (Cont'd).

road net. Construction of the bridge approaches as in all previous cases was limited to bulldozer work and resurfacing with rubble and crushed rock.

5. Bridge Construction.

Bridge construction started on 180730A March 1945, in accordance with standard procedures. No difficulties were encountered, however, bridge anchorage was modified as follows:

- a. Two 150 lb anchors used in kedge upstream for each ponton.
- b. One 150 lb anchor used downstream for each ponton.
- c. Five upstream 1" wire rope guy lines placed at 6th points of the bridge.
- d. Three downstream 1" wire rope guy lines placed at 1/4 points of the bridge.
- e. Five 1500 lb kedge anchors placed upstream at 6th points of the bridge.
- f. Two rock filled river barges sunk at 3rd points upstream of the bridge. From each barge three guy lines were connected to the 7th points of the bridge.

The bridge was completed at 200715A March. Bridge photographs are shown in Plates 15 and 16.

6. Construction Remarks.

- a. Bridge supply was excellent, proving that the bridge park layout by parts is very satisfactory. Bridge park layout is described in Section VI, Bridge Equipage Supply.
- b. Four floating bay construction sites, one near shore and one far shore construction site were adequate.
- c. Large river tugs are too slow and clumsy for towing bridge sections into position. LCVP's are excellent work boats and performed very satisfactorily in towing bridge sections into place.
- d. The following vehicles and equipment were necessary for the bridge construction:
 - 5 - Cranes at Bridge Park loading site.
 - 5 - Cranes at construction site.
 - 3 - D-7 Bulldozers .
 - 3 - Power Utility Boats.
 - 3 - LCVP's.
 - 3 - River Tug boats.
 - 90 - 2½ ton trucks (Bn trucks plus attached trucks).

8. Bridge Chart.

Annex 1, comparative bridge chart, shows all essential construction data, times, lengths, etc.



CLASS 40 BAILEY BRIDGE

RETAGEN, Germany. Completed bridge showing WEST bank approach. NOTE hub guards on panels and absence of standard ribbands.



CLASS 40 BAILEY BRIDGE

RETAGEN, Germany. Completed bridge showing WEST bank approach road. NOTE slight upstream bow of bridge.



CLASS 40 BAILEY BRIDGE

REMAGEN, Germany. Unloading and assembly points
downstream on WEST bank.



CLASS 40 BAILEY BRIDGE

REMAGEN, Germany. LVP preparing to tow 30 ft.
floating section into position. LVP were ex-
cellent work boats in the swift current.

SECTION III.

VII CORPS CROSSINGS.

A.	General Situation.....	Page 16 - 17
B.	Heavy Ponton Ferries.....	18
C.	ROLANDSECK M-2 Steel Treadway Bridge..	19
D.	KONIGSWINTER Heavy Ponton Bridge.....	20
E.	BONN M-2 Steel Treadway Bridge.....	21

A. General Situation.

1. Tactical Situation.

On 12 March 1945 the Rhine River bridgehead was firmly established by III Corps. The decision was made to cross VII Corps on the left (north) of III Corps and seize the line of the SIEG River to secure a broader bridgehead and a more advantageous road net for future operations. The 78th Infantry Division, attached to VII Corps was to drive north from its positions in the bridgehead area and seize the line of the SIEG River. The 1st Infantry Division, passing through the 78th Infantry Division to the east was to expand the bridgehead in depth and secure the east flank of 78th Infantry Division. One Combat Command of 3rd Armored Division was to be used between the two divisions. The general tactical plan provided for crossing units on existing bridges to the south, and the construction of additional bridges as rapidly as the desirable sites were cleared of enemy small arms and machine gun fire.

2. Bridge Equipage.

Bridge equipage was available for the construction of two M-2 Steel Treadway Bridges and one Reinforced Heavy Ponton Bridge. It was decided to construct first a Steel Treadway, second a reinforced Heavy Ponton and third a Steel Treadway as rapidly as suitable sites were uncovered by the 78th Infantry Division in its advance from south to north on the East bank.

3. Road Net.

Generally, the road net through BONN from the north and northwest was excellent. The road net to the south in the III Corps zone was poor. From BONN southward to COBLENZ, the Rhine is paralleled by excellent roads on each bank within 1/2 miles of the river, and approximately 5 miles east of the Rhine, the COLOGNE - FRANKFURT Reichsautobahn roughly parallels the river. Technically, the road net favored construction of bridges in the vicinity of BONN, however, tactically, it was necessary to construct bridges in the south portion of the VII Corps zone as rapidly as possible to support VII Corps.

4. River Characteristics.

In the VII Corps zone the river varied in width between 1000 and 1500 ft. Velocities varied from 4 ft. per second near the bank to 6 ft. per second in the main channel. The river banks, along most of its length are revetted on a 45 degree slope for a height of 5 to 10 ft. above water level. Behind the revetment a broad firm shelf approximately 50 yards wide rises to 30 ft. or more above mean water level. Several commercial ferry sites are located throughout the area. High hills with a commanding view of the river on either side afford excellent observation to concealed observers.

5. Security during Construction.

The construction of bridges and operation of ferries in the III Corps Zone had been harassed by snipers, accurately adjusted artillery fire, and air bombing. For this reason special security precautions to expedite construction and to prevent loss of critical bridge equipage were indicated.

General Situation (Continued)

a. One battalion of 155 Howitzers was placed in direct support of the engineer battalion at each bridge site. This support included two forward observers and an air OP over the site during the hours of daylight. This support had been successfully used during the ROER River Crossings.

b. One battery of AA AW was provided at each end of each bridge. All weapons were emplaced prior to the start of construction. 90 mm AA guns covered the entire area. Depressed beam searchlights were used to provide "artificial moonlight" during the hours of darkness and greatly improved visibility.

c. Special precautions were taken for close-in ground and river defense upstream and downstream against swimmers and floating objects. Protective booms were constructed below each bridge and two LCVP's, each mounting .50 cal. MG's, patrolled the area downstream of the bridges during the hours of darkness. The destroyed bridge at BONN provided additional downstream protection at the BONN bridge site. Canal Defense Lights, tank mounted, provided illumination upstream and downstream of the bridge sites. Detachments of Engineers patrolled the areas having ground observation of the bridge on each bank. German civilians along the river were required to remain indoors and free circulation of civilians during the construction periods was prevented.

d. Two chemical smoke generating companies, which were attached to the engineer battalion in charge of construction, provided covering smoke along each bank in a zone approximately 4000 yards long. This smoke was thickened, when necessary, by smoke generators mounted in boats.

60

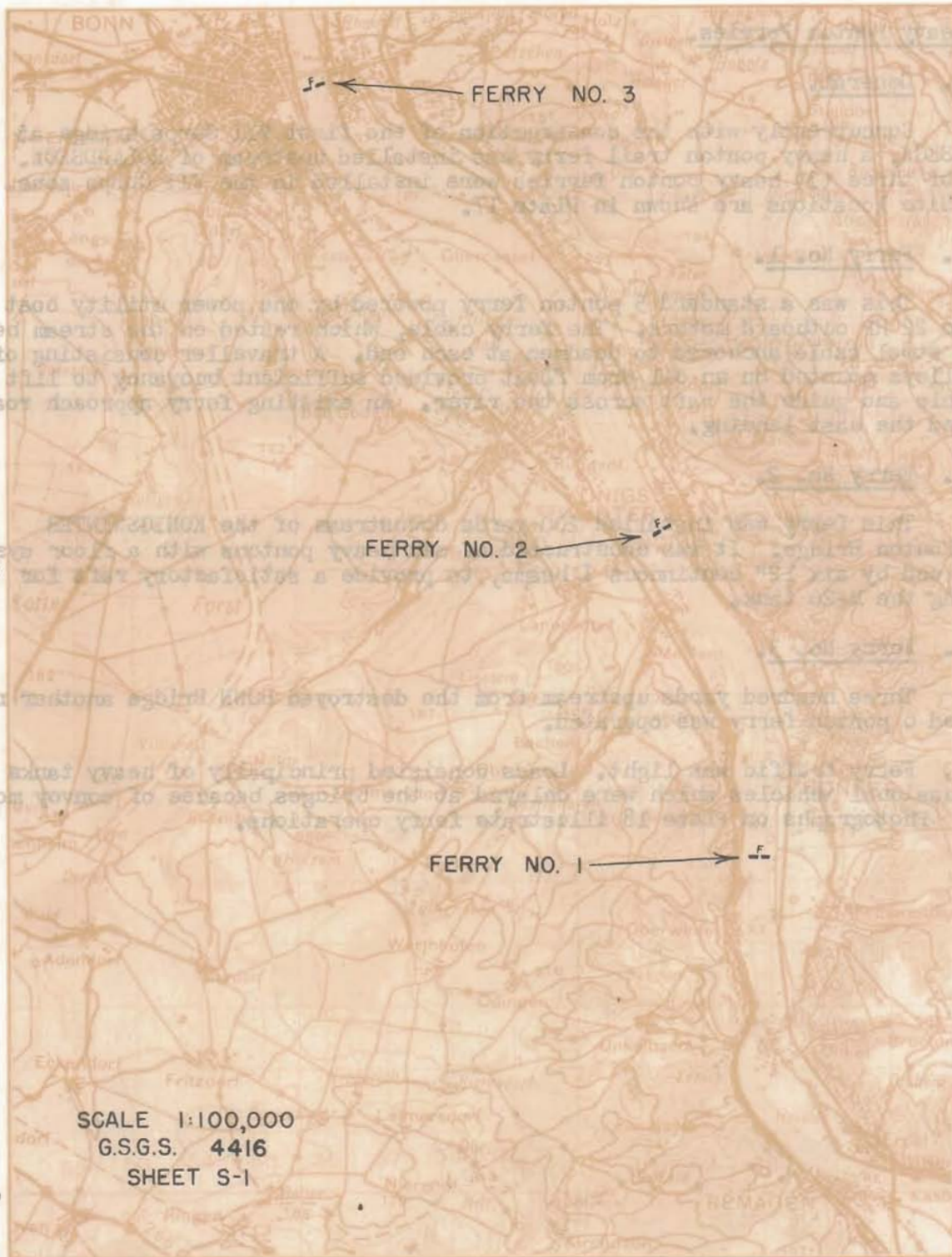

SCALE 1:100,000
 G.S.G.S. 4416
 SHEET S-1

20

20

60

VII CORPS
 HEAVY PONTON FERRY LOCATIONS

B. Heavy Ponton Ferries.

1. General.

Concurrently with the construction of the first VII Corps bridge at ROLANDSECK, a heavy ponton trail ferry was installed upstream of ROLANDSECK. A total of three (3) heavy ponton ferries were installed in the VII Corps zone. Ferry Site locations are shown in Plate 17.

2. Ferry No. 1.

This was a standard 5 ponton ferry powered by one power utility boat and two 22 HP outboard motors. The ferry cable, which rested on the stream bed was $1\frac{1}{4}$ steel cable anchored to deadmen at each end. A traveller consisting of two pulleys mounted on an oil drum float provided sufficient buoyancy to lift the cable and guide the raft across the river. An existing ferry approach road provided the east landing.

3. Ferry No. 2.

This ferry was installed 200 yards downstream of the KONIGSWINTER Heavy Ponton Bridge. It was constructed of six heavy pontoons with a floor system reinforced by six 12" continuous I beams, to provide a satisfactory raft for crossing the M-26 tank.

4. Ferry No. 3.

Three hundred yards upstream from the destroyed BONN Bridge another reinforced 6 ponton ferry was operated.

5. Ferry traffic was light. Loads consisted principally of heavy tanks and occasional vehicles which were delayed at the bridges because of convoy movements. Photographs on Plate 18 illustrate ferry operations.



REINFORCED 6 PONTON RAFT

Ferrying M-26 tank. Ferry is propelled by one LCVP.



REINFORCED 6 PONTON RAFT

Ferrying M-26 tank. Ferry is propelled by one LCVP.

C. ROLANDSECK M-2 Steel Treadway Bridge.

1. Bridge Site.

This bridge was constructed at the location of an existing civilian ferry. (See Plate 19 for map location). On the west bank, a small amount of work was necessary on a 50 yard approach road which ran down to the waters edge. The east bank, which was gravel and loam having a 1 to 10 slope, required some dozing to connect the bridge with the ferry exit road.

2. Assembly Sites.

The banks downstream from the site had a 45 degree revetted slope about 10 ft. above water level, hence it became necessary to locate the two west bank assembly sites about 700 yards upstream where a meadow gave easy access to the river. The east bank assembly site was also located upstream because of the number of sunken barges downstream of the site.

3. Anchorage.

Initial anchorage was provided by one standard 100 lb. anchor per section on a 300 ft. anchor rope. Every fourth section was anchored downstream. Guy lines to points both upstream and downstream were added. Later a 1 inch steel cable, supported on seven heavy pontoons, which were anchored with two 300 lb. anchors per ponton, was placed upstream. Bridle lines were run from the bridge to the cable.

4. Bridge Construction.

Construction of the bridge had been ordered for darkness 17 March 1945. At 161400A March 1945, orders were received to start construction at dark on 16 March 1945. The bridge was constructed from both banks by placing the single float rafts with power utility boats. The bridge was completed in 36 hours, 30 minutes. Two difficulties were encountered during the construction:

a. Bridge material and construction equipment were in the bridge park about 10 miles from the site. Traffic and blackout driving difficulties delayed the delivery of bridge equipage to the east bank until 170800A March 1945.

b. The Engineer Battalion S-3, in charge of construction, was wounded during the night of 16 March and evacuated. Other than these two events, no unusual difficulties were experienced. Bridge photographs are shown on Plates 20 and 21.

5. Bridge Chart.

Annex 1, Comparative Bridge Chart shows all essential construction data, times, lengths, etc.



REINFORCED 6 PONTON RAFT

Ferrying M-26 tank. Ferry is propelled by one LCVP.



REINFORCED 6 PONTON RAFT

Ferrying M-26 tank. Ferry is propelled by one LCVP.

C. ROLANDSECK M-2 Steel Treadway Bridge.

1. Bridge Site.

This bridge was constructed at the location of an existing civilian ferry. (See Plate 19 for map location). On the west bank, a small amount of work was necessary on a 50 yard approach road which ran down to the waters edge. The east bank, which was gravel and loam having a 1 to 10 slope, required some dozing to connect the bridge with the ferry exit road.

2. Assembly Sites.

The banks downstream from the site had a 45 degree revetted slope about 10 ft. above water level, hence it became necessary to locate the two west bank assembly sites about 700 yards upstream where a meadow gave easy access to the river. The east bank assembly site was also located upstream because of the number of sunken barges downstream of the site.

3. Anchorage.

Initial anchorage was provided by one standard 100 lb. anchor per section on a 300 ft. anchor rope. Every fourth section was anchored downstream. Guy lines to points both upstream and downstream were added. Later a 1 inch steel cable, supported on seven heavy pontoons, which were anchored with two 300 lb. anchors per ponton, was placed upstream. Bridle lines were run from the bridge to the cable.

4. Bridge Construction.

Construction of the bridge had been ordered for darkness 17 March 1945. At 161400A March 1945, orders were received to start construction at dark on 16 March 1945. The bridge was constructed from both banks by placing the single float rafts with power utility boats. The bridge was completed in 36 hours, 30 minutes. Two difficulties were encountered during the construction:

a. Bridge material and construction equipment were in the bridge park about 10 miles from the site. Traffic and blackout driving difficulties delayed the delivery of bridge equipage to the east bank until 170800A March 1945.

b. The Engineer Battalion S-3, in charge of construction, was wounded during the night of 16 March and evacuated. Other than these two events, no unusual difficulties were experienced. Bridge photographs are shown on Plates 20 and 21.

5. Bridge Chart.

Annex 1, Comparative Bridge Chart shows all essential construction data, times, lengths, etc.

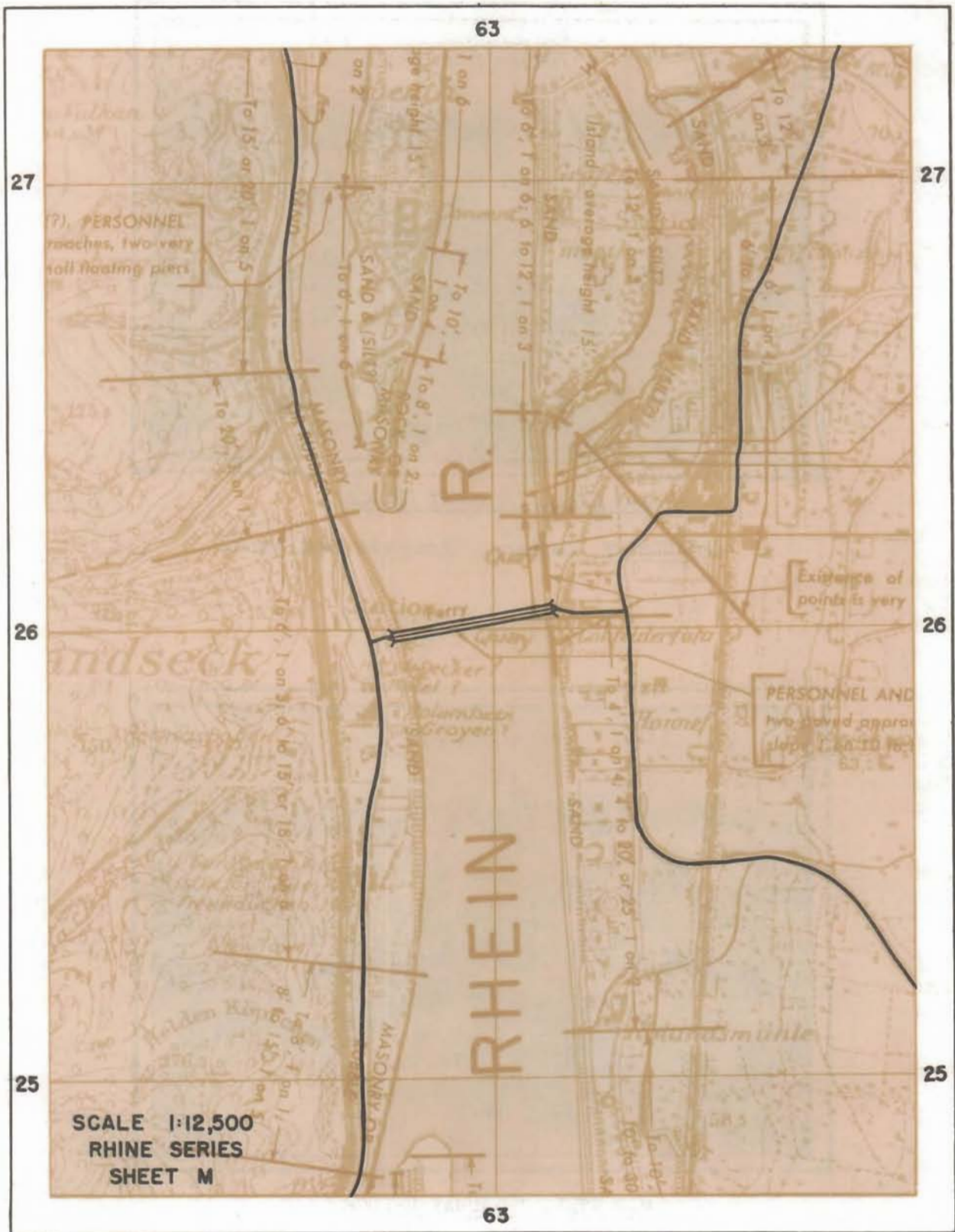

M-2 STEEL TREADWAY BRIDGE

ROLANDSECK, GERMANY

PLATE 19

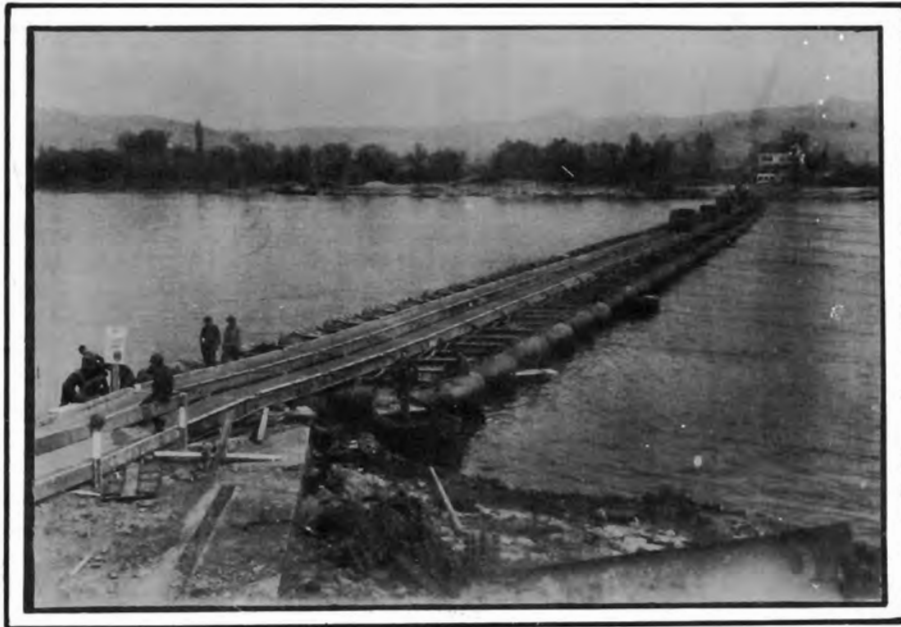

M-2 STEEL TREADWAY BRIDGE

ROLANDSECK, Germany. From the West bank.



M-2 STEEL TREADWAY BRIDGE

ROLANDSECK, Germany. View showing West
abutment.

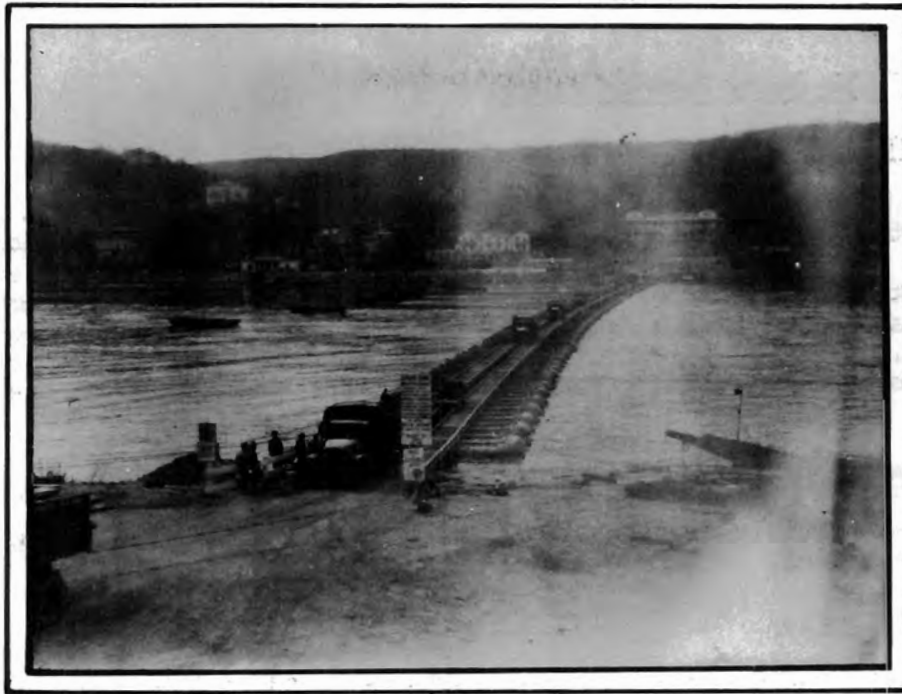

M-2 STEEL TREADWAY BRIDGE

ROLANDSECK, Germany. From East bank.



M-2 STEEL TREADWAY BRIDGE

ROLANDSECK, Germany. Construction scene
from West bank showing screening smoke.

D. KONIGSWINTER Heavy Ponton Bridge.

1. Bridge Site.

The bridge site was chosen in KONIGSWINTER about 200 yards upstream from an existing civilian ferry, as shown on Plate 22. This location gave a good one-way road net on the west bank and an existing road on the east bank. The west bank was a 45 degree stone revetment 4 ft. high behind which was a sandy shelf about 50 yards wide. The east bank was also a 45 degree stone revetment 4 ft. high with a 12 ft. wide shelf backed by a 12 ft. stone retaining wall. A considerable amount of bull-dozer work was necessary on the east bank approach.

2. Assembly Sites.

Three assembly sites, shown photographically in Plate 25, were laid out on the west bank.

3. Anchorage.

Initial anchorage was by means of one standard 150 lb anchor and one heavy (300 lb) barge anchor per ponton. This was followed by upstream and downstream 1/2" steel cable guy lines. Every fourth ponton was anchored downstream. Three Bailey Rubble Box Anchors were sunk upstream from the center and quarter points of the bridge to provide increased anchorage. Rubble Box anchors were attached to 3 adjacent boats at the quarter points by 1 inch steel cables.

4. Bridge Construction.

Construction by 4 boat rafts started during darkness and proceeded slowly until after daylight. The rate of construction increased appreciably after daylight. Initially the 12 ton reinforcing floats were installed in the raft prior to assembly in the bridge, however, experience proved that construction could proceed more rapidly by placing the unreinforced 4 boat raft in the bridge, then installing the float. Raft sections were placed by LCVP's and floats by power utility boats. The bridge was completed in 18 hours, 10 minutes. Plates 23, 24, and 25 illustrate the bridge and approaches.

5. Bridge Chart.

Annex 1, Comparative Bridge Chart, shows all essential construction data such as times, length, etc.



REINFORCED HEAVY PONTON BRIDGE
KÖNIGSWINTER, GERMANY



REINFORCED HEAVY PONTON BRIDGE

KONIGSWINTER, Germany. View from west bank.

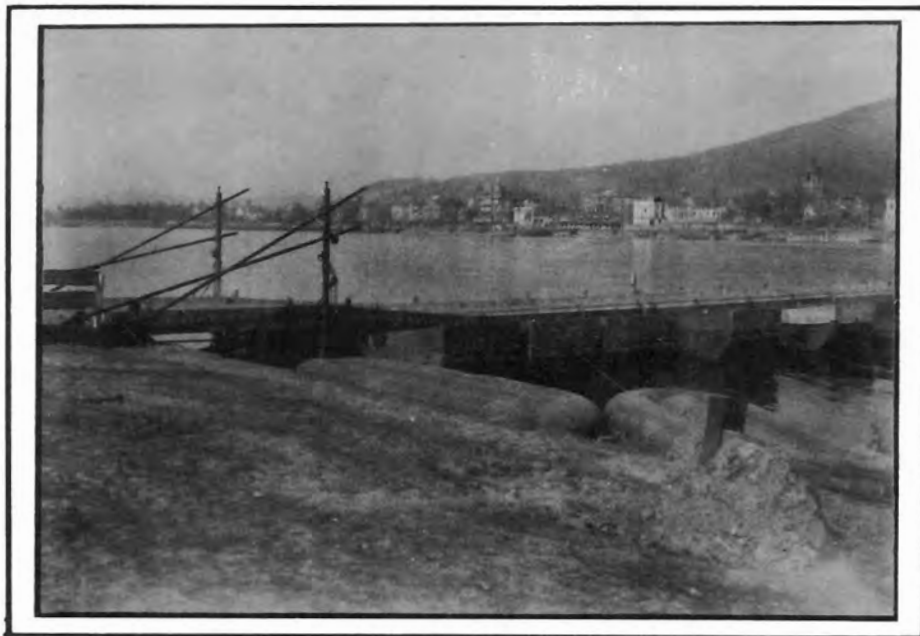

REINFORCED HEAVY PONTON BRIDGE

KONIGSWINTER, Germany. West abutment.



REINFORCED HEAVY PONTON BRIDGE

KONIGSWINTER, Germany. Eastern approach.



REINFORCED HEAVY PONTON BRIDGE

KONIGSWINTER, Germany. East abutment.



REINFORCED HEAVY PONTON BRIDGE

KONIGSWINTER, Germany. Assembly sites on West bank. Note screening smoke in background.

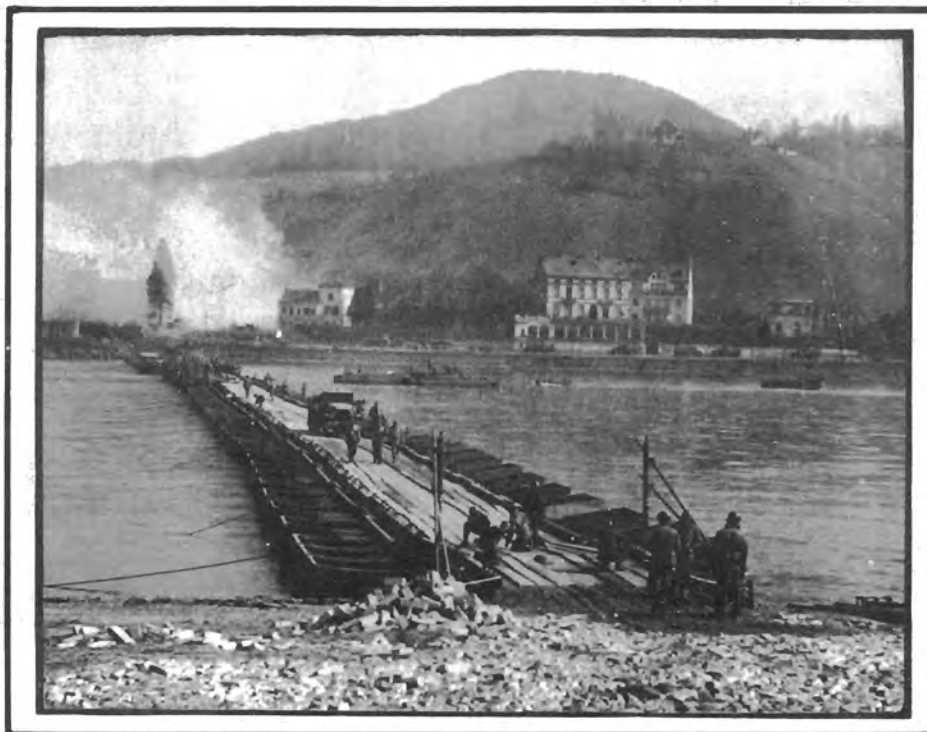

REINFORCED HEAVY PONTON BRIDGE

KONIGSWINTER, Germany. Construction view from West bank. LCVP is placing the final raft.

E. BONN M-2 Steel Treadway Bridge.

1. Bridge Site.

This bridge was constructed at the location of an existing civilian ferry, the map location of which is shown in Plate 26. The west bank was a 45 degree revetment, 6 ft. high, behind which was a sandy loam wooded area rising an additional 20 ft. 100 yards of approach road was constructed through this area. The east bank was a 1 to 8 gravel and loam beach, about 50 ft. wide, behind which was a 45 degree sloped revetment 12 ft. high. The approach road was cut down and a causeway about 30 ft. long constructed out 10 ft. into the shallow water.

2. Assembly Sites.

Three assembly sites were established downstream on the west bank.

3. Anchorage.

Initial anchorage was provided by standard 100 lb. anchors and guy lines. The east bed of the river, however, contained shifting sand, causing the anchors to creep. This was remedied by the replacement of the standard 100 lb anchors in the shifting sand with fluked Bailey bridge panels. Each anchor was constructed by welding eight 3 ft. channel irons to the lower chord of a Bailey panel at an angle of approximately 45 degrees with the panel face. By attaching a cable to the upper chord of the panel the welded flukes provided sufficient resistance to prevent dragging in the sand.

4. Bridge Construction.

Construction on this bridge started during daylight on 210615A March 1945. By starting at first light, construction crews and bridge supply worked more easily and rapidly. The bridge was constructed from both banks by placing single float rafts with power utility boats. LCV's were used to hold the ends of the bridge in place while floats were being placed. Storm boats were employed to lay a protective smoke screen. No difficulties in bridge construction were encountered. The bridge was completed in 11 hours, 30 minutes. The excellent construction time was a direct result of experience gained while building earlier bridges plus the fact that sufficient time was available for making thorough plans which did not have to be changed. Photographs of the bridge and smoke screening operation are shown in Plates 27 and 28.

5. Bridge Chart.

Annex 1, Comparative Bridge Chart, shows all essential construction data, times, lengths, etc.

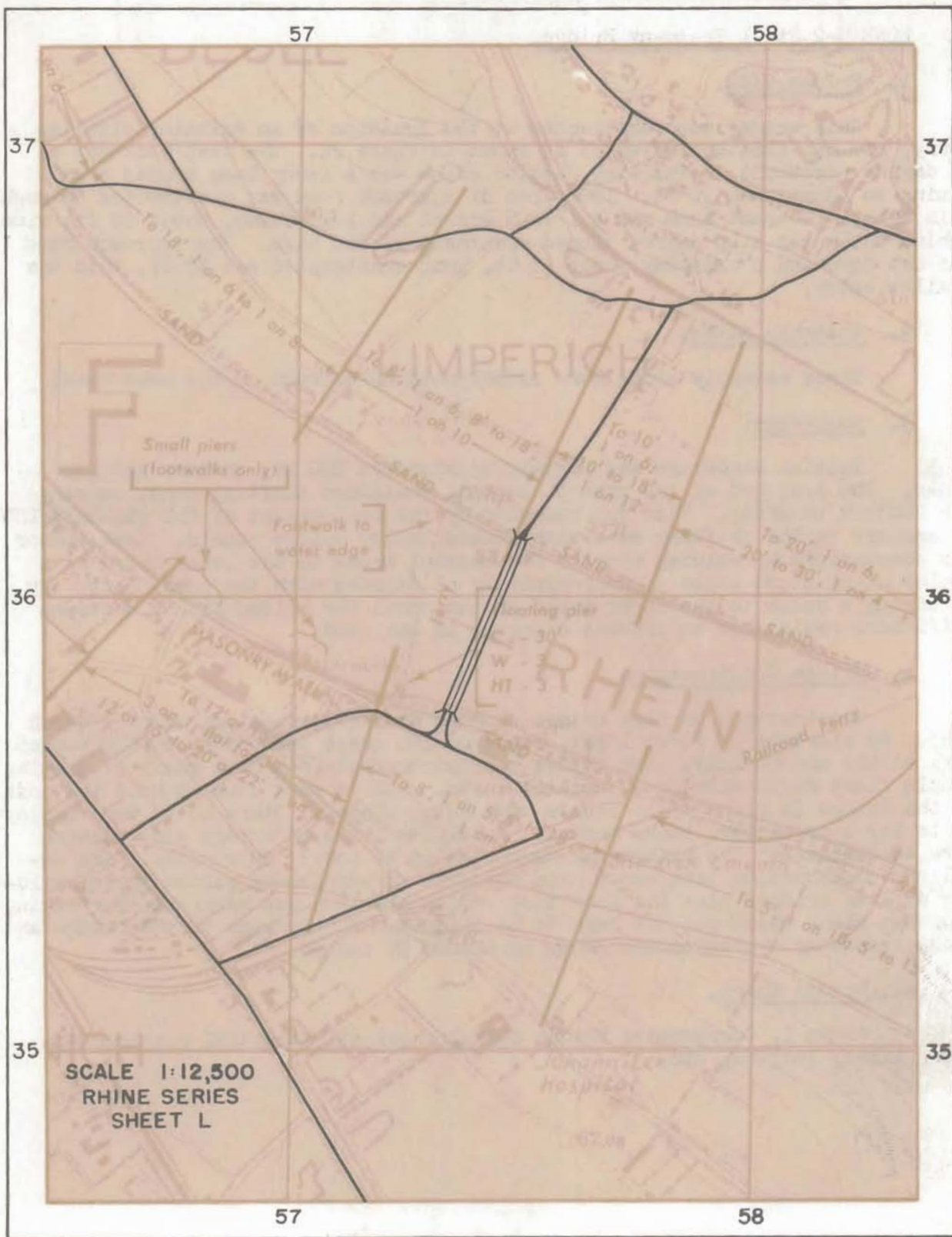

M-2 STEEL TREADWAY BRIDGE
 BONN, GERMANY



M-2 STEEL TREADWAY BRIDGE

BONN, Germany. View from West bank.

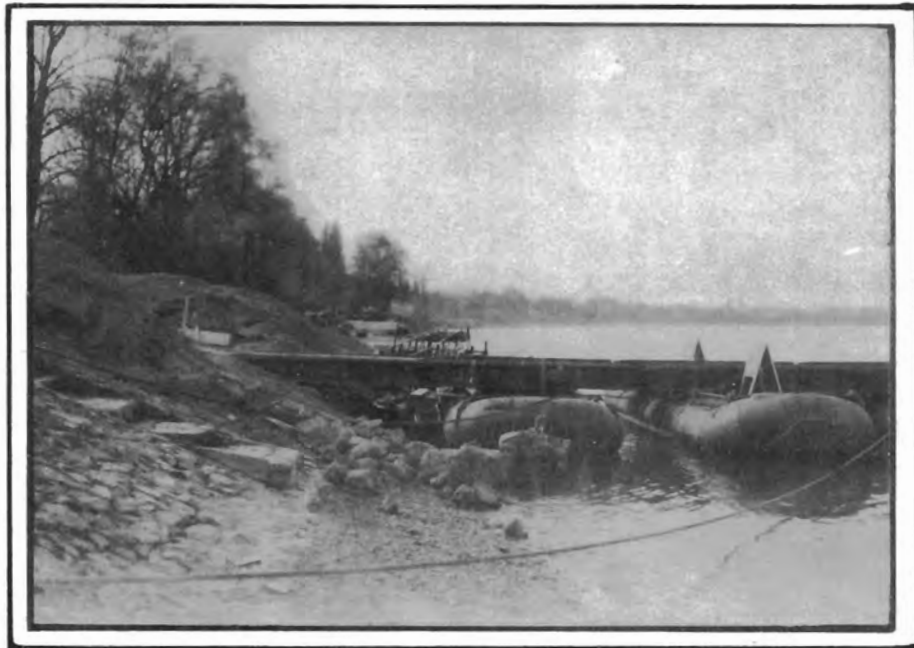

M-2 STEEL TREADWAY BRIDGE

BONN, Germany. West abutment.

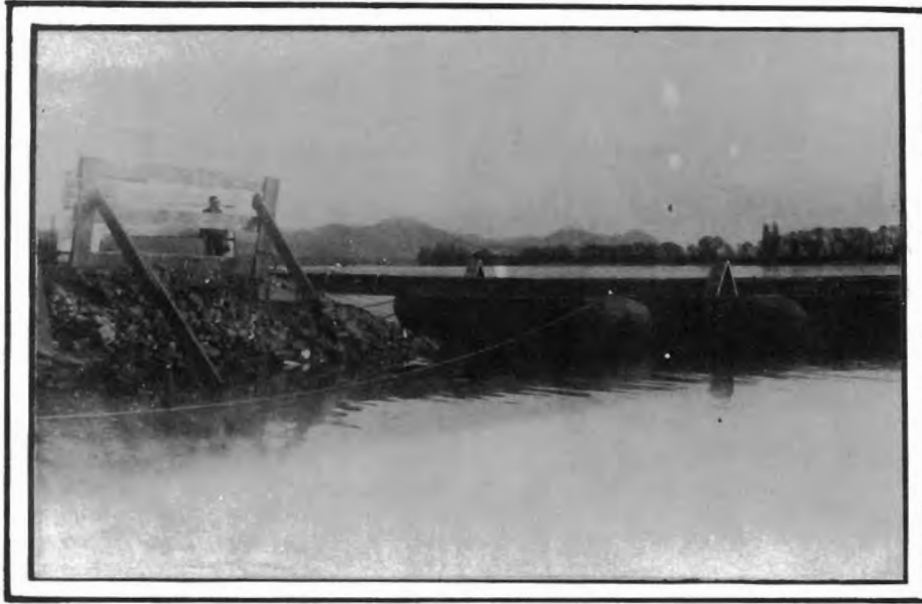

M-2 STEEL TREADWAY BRIDGE

BONN, Germany. East abutment.



M-2 STEEL TREADWAY BRIDGE

BONN, Germany. Air view showing screening effect of fixed and floating smoke generators. Floating smoke generators were mounted in storm boats.

SECTION VI.

MISCELLANEOUS.

A.	Protective River Booms.....	Page 28 - 32
B.	Collapse of LUDENDORF Railroad Bridge..	33 - 35
C.	Security Precautions.....	36 - 42
D.	Bridge Equipage Supply.....	43 - 45
E.	Personalities.....	46 - 48

SECTION VI.

MISCELLANEOUS.

A. Protective River Booms.

1. General.

Protective river booms were installed to protect the bridges and ferries as quickly as possible. Upon the capture of the LUDENDORF Railway Bridge at REMAGEN, Germany, the 164th Engineer Combat Battalion was given the mission of installing protective booms in the Rhine River to protect bridge installations.

2. Troops.

164th Engineer Combat Battalion.

Det., LCVP Unit No. 1.

Det., 329th Harbor Craft Co.

3. River Characteristics.

The width of the river at all boom sites averaged from 1000 ft. to 1200 ft. and river velocity varied from 4.6 ft. per second to 6.2 ft. per second during the construction and maintenance period. Coarse gravel formed the bottom, making standard anchors inefficient.

4. Description of Protective Booms and Equipment.

a. General.

During the fall and winter of 1944 considerable experimental work on protective river booms was performed by engineer units of First US Army. The results of these experiments were crystallized into a river defense system designed to protect bridges against enemy demolition by floating mines, heavy objects such as barges, and swimmers. Three types of booms were installed at each protective boom site. These were the impact, log, and mine net booms.

b. Impact Boom.

(1) Purpose. The function of this boom was the stopping of heavy barges, bridge wreckage or other heavy objects.

(2) Description. This boom was composed of four 1" wire cables, supported every 78 ft. by timber framed buoys so that two criss-crossed cables were above the surface of the water and two criss-crossed cables under the water. The boom was anchored on each shore by deadmen and the timber framed buoys by means of Bailey Panel Rubble Box Anchors which are described below. The timber framed buoy was constructed from two 55 gallon steel drums to which had been welded 30 inch conical hydraulic noses. Two 5'x2 1/2' timber frames made of 8"x8" lumber held together by four 42" bolts provided a frame which held the drums in position. U Bolts and eyes bolted to the timber frame provided fasteners for the 4 impact cables and anchor cables.

c. Log Boom.

(1) Purpose. Its principal function was the stopping and collecting of debris and detonation of floating mines.

Description of Protective Booms and Equipment (Continued).

- (2) Description. The log boom was a cable linked string of 12" diam. by 20 to 25 ft. logs crossing the river at an angle of 45 degrees to thalweg. Each end of the boom was anchored by deadmen on the shore and each log was connected to one 55 gallon drum auxiliary float which was anchored in the river bed. Approximately 8" from the end of each log a 1/2" steel staple driven into the log formed the connection for the 1" steel cable link.

d. Mine Net Boom.

- (1) Purpose. The functions of this type were the detonating or screening of floating mines and impeding swimmers.
- (2) Description. This boom was a net, which was woven of 1/4" wire rope to form 1 ft. squares, suspended in the water by 55 gallon drum buoys. The wire net hung to a depth of 10 ft. below the surface of the river. A double drum buoy suspended the net every 60 ft. At 20 ft. intervals between the double 55 gallon drum buoys the net was suspended by single 55 gallon drum buoys. Each double drum buoy was held together by two 2" formed steel strap saddles to which wire welded rings to hold the mine net and anchor cable were attached. Saddles were formed to fit around two 55 gallon drums when bolted. Each double drum buoy was anchored in the river bed and the ends of the mine net were anchored to deadmen on the shore.

e. Bailey Panel Rubble Box Anchor.

- (1) General. The character of the stream bed made it necessary to depend upon sheer weight for a strong anchorage. The Bailey Rubble Box Anchor provided the solution to the anchorage problem.
- (2) Description. 3 Bailey panels were welded together forming the bottom and two sides of a box. This was lined with wire mesh leaving the top of the box open. The box was filled 3/4 full with rock or rubble, the top lined with additional wire mesh and the fourth top panel welded to the sides to seal the top of the box. Two rubble boxes were constructed on Bailey plain rollers on each end of a reinforced heavy ponton raft thus eliminating a heavy lifting operation. Each rubble box weighed 6 tons. The 1" steel anchor cables were attached to the rubble box prior to casting.

5. Protective Boom Site No. 1.

a. General.

On 7 March 1945 the 164th Engineer Combat Battalion was attached to III Corps for operational control. The battalion moved to REMAGEN on 8 March to start construction work immediately. Two QM truck companies under operational control of the Engineer Depot moved the protective boom equipage from the Engineer Depots to REMAGEN, Germany. Except for small supply detachments the battalion was fully committed on the construction and installation of mine booms.

b. Impact Boom.

On 9 March 1945, work was started on the first protective boom, which was the Impact type, 300 yards upstream of the LUDENDORF Railway Bridge at F 654202 as shown on Plate 39. Both banks at the site were flat and sufficiently wide to

SECTION IV.

V CORPS CROSSINGS.

A. General Situation.....	Page 22
B. HONNINGEN M-2 Steel Treadway Bridge..	23

A. General Situation.

1. General.

After VII Corps had completed crossing the Rhine River, V Corps was ordered to cross in the bridgehead area south of the III Corps crossings. Bridge equipage was available for the construction of one M-2 Steel Treadway Bridge. The V Corps Engineer plan called for the construction of one M-2 Steel Treadway Bridge at HONNINGEN and the crossing of infantry in LCVP's. The LCVP crossings are described on Page 8. Heavy ponton ferries were not used in the V Corps crossings.

2. Road Net.

The road net in the vicinity of SINZIG, NEIDERBREISIG and HONNINGEN was poor, except for two excellent roads which ran parallel to Rhine within 1/2 mile of the river.

3. River Characteristics.

The river varied in width from 1200 ft. to 1500 ft. in the V Corps zone. Velocities were 5 to 6 ft. per second. On the west bank the shore slopes gently for about 50 yards then rises sharply for about 25 yards. On the east bank, the main road runs along the shore line on a shelf approximately 25 yards high. Several commercial ferry sites are located throughout the area. High steep hills dominate both sides of the river valley.

4. Security Precautions.

Security precautions were established on both banks to protect the crossings. These consisted of AA units for air protection, infantry troops for protection of the upstream approaches along the river, and cavalry patrols. Protective booms were installed upstream of the bridge to prevent the approach of floating mines and enemy swimmers. Protective boom installations are described in Section VI. German civilians were moved away from the vicinity of the crossing sites. During construction, civilian movement in the towns near the bridge sites was restricted.

Canal defense lights, tank mounted, were used at night to light the river for the detection of enemy personnel and floating mines.

Screening smoke was not used during the construction of the bridge.

B. HONNINGEN M-2 Steel Treadway Bridge.

1. Bridge Site.

The bridge was constructed at the site of a civilian ferry as shown in Plate 29. The west bank approach was an excellent cobblestone road leading directly to the waters edge. A small amount of bulldozer work was necessary to provide the necessary slope to the bridge. The east bank approach had a 1 to 8 slope for about 50 yards where it connected with a narrow one-way dirt road leading to the main highway. This approach was surfaced with rubble and fine gravel.

2. Assembly Sites.

The banks downstream of the proposed bridge made excellent construction sites. Both banks were relatively flat at the shoreline and were easily accessible to bridge trucks.

3. Anchorage.

Initial anchorage was provided by standard 100 lb. anchors on each section upstream and one anchor for each fourth section downstream. The completed bridge was anchored with guy lines to the upstream quarter points of the bridge and bridle lines to a $1\frac{1}{4}$ inch cable supported on 7 floats anchored upstream of the bridge.

4. Bridge Construction.

Construction of the bridge started on 220800A March 1945, from both banks. Single float rafts were placed with power utility boats; LCVP's were used to hold the ends of the bridge in place while anchors were cast. Bridge construction was completed on 222000A March 1945. Bridge photographs are shown on Plates 30 and 31.

5. Bridge Chart.

Annex 1, Comparative Bridge Chart, shows all essential construction data, times, lengths, etc.

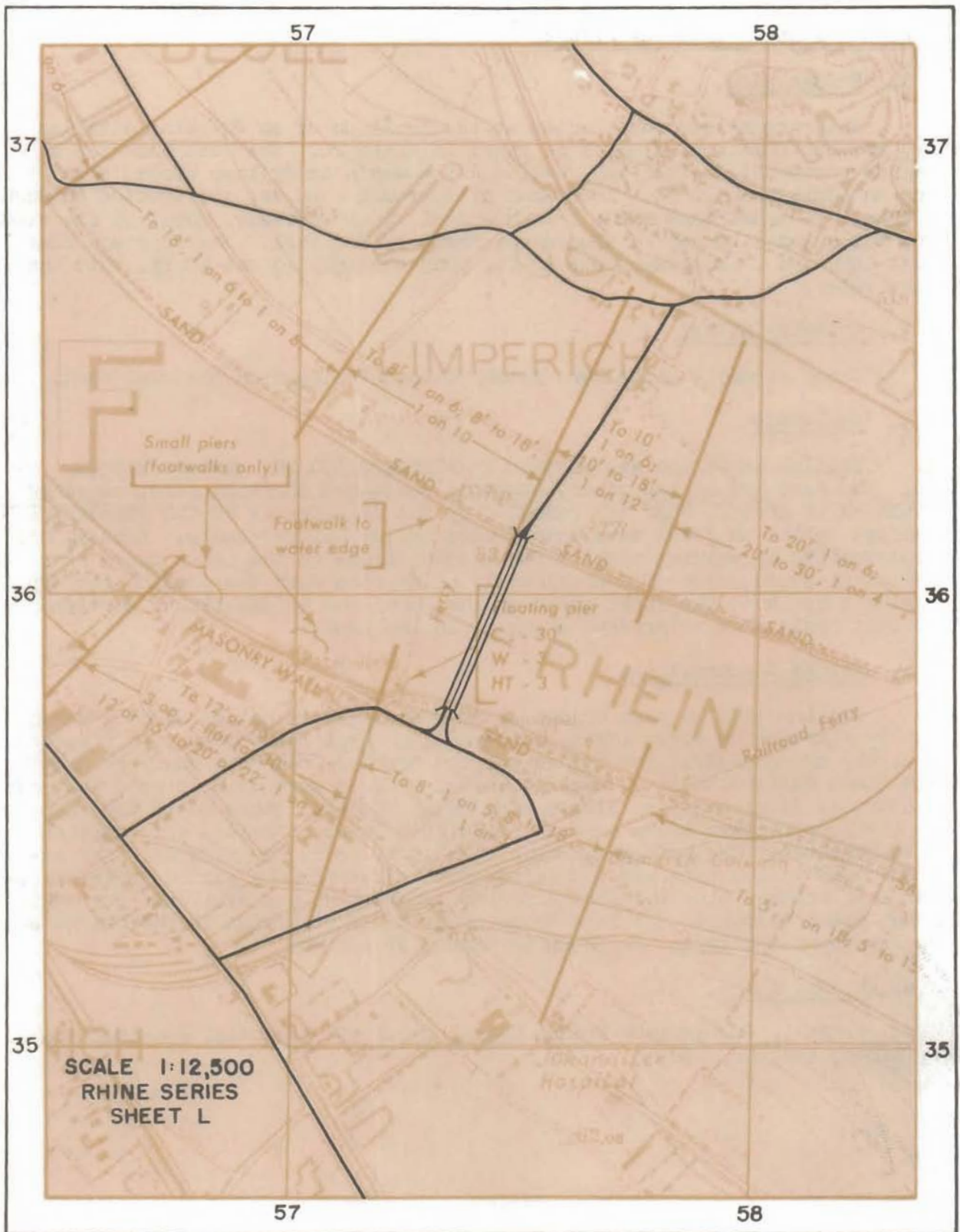

**M-2 STEEL TREADWAY BRIDGE
BONN, GERMANY**

PLATE 26

E. BONN M-2 Steel Treadway Bridge.

1. Bridge Site.

This bridge was constructed at the location of an existing civilian ferry, the map location of which is shown in Plate 26. The west bank was a 45 degree revetment, 6 ft. high, behind which was a sandy loam wooded area rising an additional 20 ft. 100 yards of approach road was constructed through this area. The east bank was a 1 to 8 gravel and loam beach, about 50 ft. wide, behind which was a 45 degree sloped revetment 12 ft. high. The approach road was cut down and a causeway about 30 ft. long constructed out 10 ft. into the shallow water.

2. Assembly Sites.

Three assembly sites were established downstream on the west bank.

3. Anchorage.

Initial anchorage was provided by standard 100 lb. anchors and guy lines. The east bed of the river, however, contained shifting sand, causing the anchors to creep. This was remedied by the replacement of the standard 100 lb anchors in the shifting sand with fluked Bailey bridge panels. Each anchor was constructed by welding eight 3 ft. channel irons to the lower chord of a Bailey panel at an angle of approximately 45 degrees with the panel face. By attaching a cable to the upper chord of the panel the welded flukes provided sufficient resistance to prevent dragging in the sand.

4. Bridge Construction.

Construction on this bridge started during daylight on 210615A March 1945. By starting at first light, construction crews and bridge supply worked more easily and rapidly. The bridge was constructed from both banks by placing single float rafts with power utility boats. LCVP's were used to hold the ends of the bridge in place while floats were being placed. Storm boats were employed to lay a protective smoke screen. No difficulties in bridge construction were encountered. The bridge was completed in 11 hours, 30 minutes. The excellent construction time was a direct result of experience gained while building earlier bridges plus the fact that sufficient time was available for making thorough plans which did not have to be changed. Photographs of the bridge and smoke screening operation are shown in Plates 27 and 28.

5. Bridge Chart.

Annex 1, Comparative Bridge Chart, shows all essential construction data, times, lengths, etc.

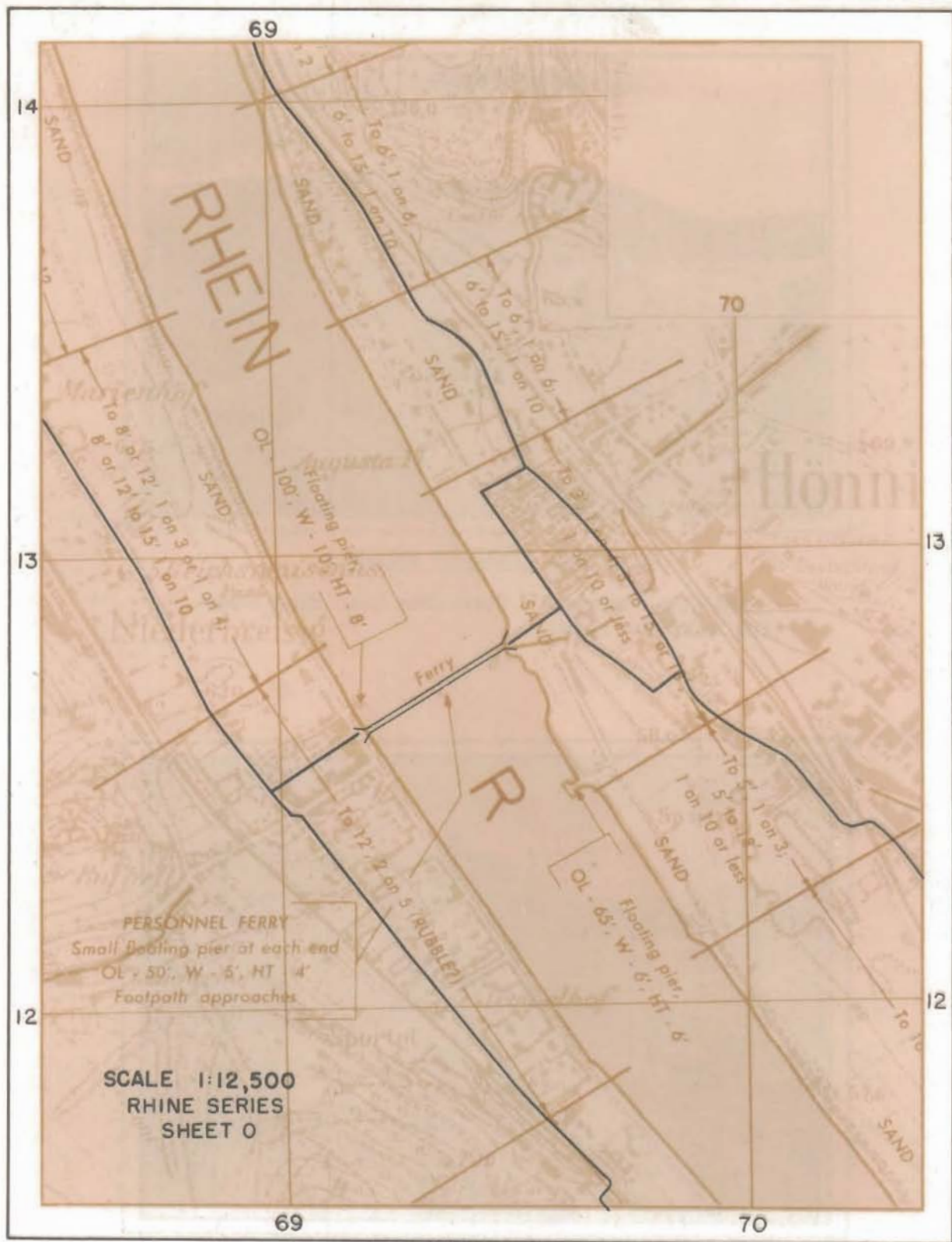

M-2 STEEL TREADWAY BRIDGE
HÖNNINGEN, GERMANY



M-2 STEEL TREADWAY BRIDGE

HONNINGEN, Germany. View from East bank showing approach road.

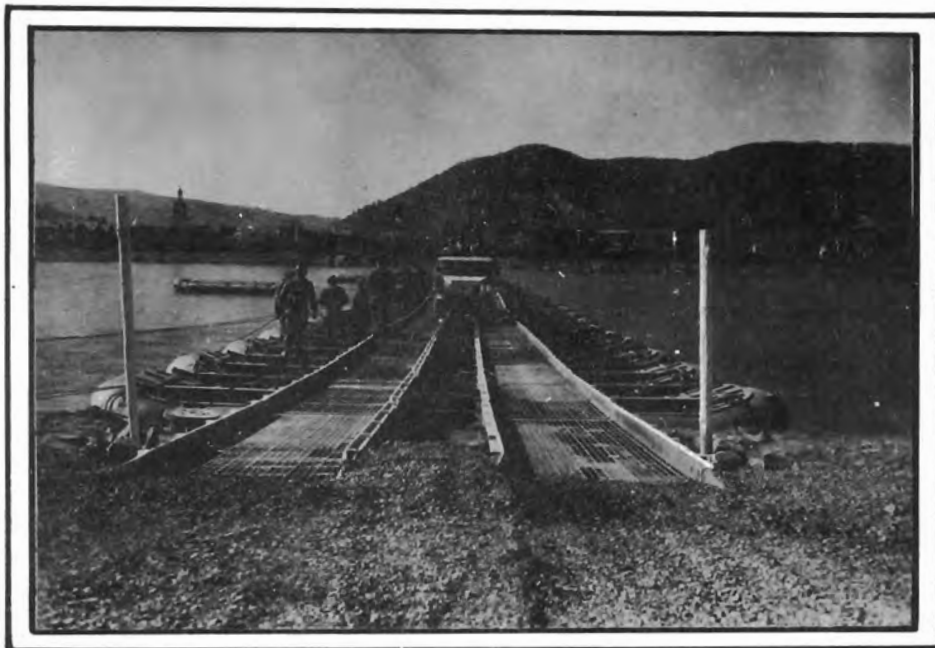

M-2 STEEL TREADWAY BRIDGE

HONNINGEN, Germany. View from East bank showing abutment.

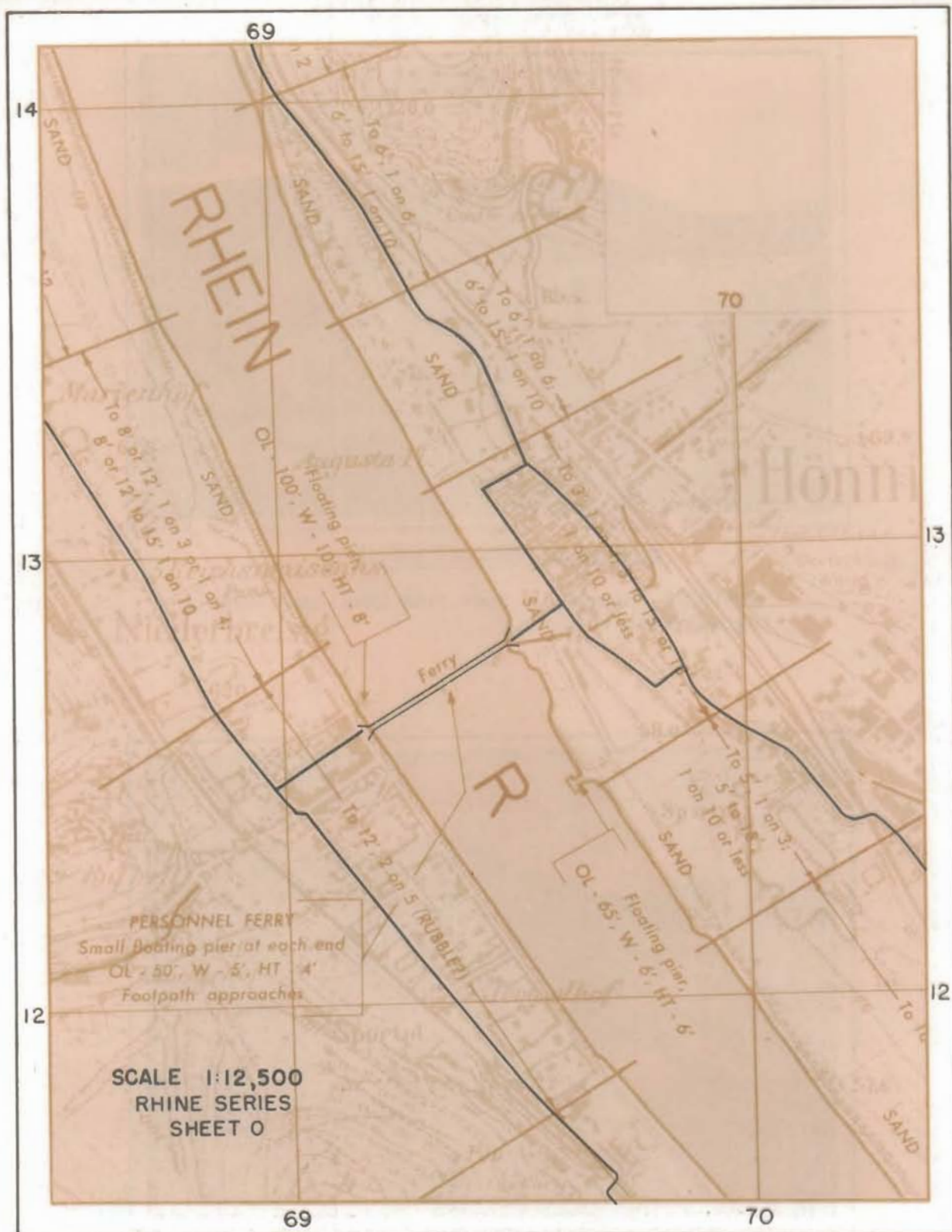

M-2 STEEL TREADWAY BRIDGE
 HÖNNINGEN, GERMANY



M-2 STEEL TREADWAY BRIDGE

HONNINGEN, Germany. View from East bank showing approach road.



M-2 STEEL TREADWAY BRIDGE

HONNINGEN, Germany. View from East bank showing abutment.

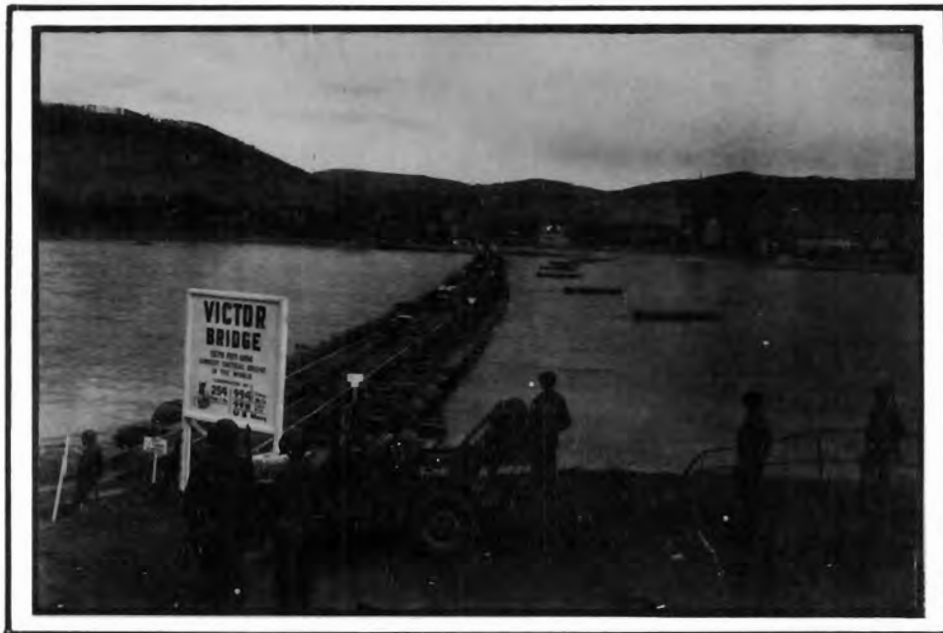

M-2 STEEL TREADWAY BRIDGE

HONNINGEN, Germany. View from West bank. Note pronounced upstream bow and floats supporting bridge cable.



M-2 STEEL TREADWAY BRIDGE

HONNINGEN, Germany. View from West bank showing west approach.

SECTION V.

ARMY CROSSING.

A. Dual Carriageway Bailey Bridge on Barges..... Page 24 - 27

SECTION V.

ARMY CROSSING

A. Dual Carriageway Bailey Bridge on Barges.

1. General Situation.

After the capture of the LUDENDORF Railroad Bridge and establishment of further crossings over the Rhine River, it was decided to construct a Class 70 and a Class 40 Bailey Bridge on barges at BAD GODESBERG approximately 5 miles south of BONN. This bridge was constructed in accordance with the design and procedure developed while experimenting with Bailey barge bridging on the MEUSE River at LIEGE, Belgium during November and December 1944. On 12 March the Commanding Officer, 1110th Engineer Combat Group was directed to institute reconnaissance for barges and make preparations for the construction of the bridge. Actual construction started on 25 March. The bridge was completed on 5 April and opened for traffic the next day.

2. Bridge Site.

BAD GODESBERG was selected as the bridge site because it was centrally located on the axis of advance. The road net to and from the bridge was adequate. The water gap, which was 1140 ft., could be spanned by a 1172 ft. truss. The water was 10 ft. deep at a distance of 70 feet from the bank. The most undesirable features of the site were the bridge approaches which required the movement of 35,000 cu. yds. of earth and the construction of 1700 ft. of approach road. Sites with better approaches were available, however, it was necessary to sacrifice good approaches to take advantage of high banks and deep water near the shore.

3. Bridge Construction.

a. Barges.

Barges were easily found on the river. Two types of barges were used with dimensions as follows:

<u>Beam</u>	<u>Length</u>	<u>Capacity</u>
17' Average	125' to 130'	250 tons
17' Average	220' to 270'	1500 to 2000 tons

b. Design and Construction.

The large barges were used for landing bay piers. The smaller barges, for floating piers. The distance between barge piers was determined in all cases by the design of the most economical type of construction for the Class 70 lane. Plan and Elevation view of the bridge are shown in Plate 32.

(1) Floating Bays.

The length was set at 70 ft. since this is the maximum length for Class 70 without resorting to double story construction.

(2) End Floating Bay.

The end floating bay was designed with 80 feet of Bailey truss. This bay is supported on the landing bay pier by a bearing constructed on the bottom of the special connecting

Bridge Construction (Continued)

posts and set on standard Bailey bearings. The other end rested directly on its floating bay pier at the river end with 15 feet cantilver overhang.

(3) River Landing Bays.

The elevation of the bottom of the Bailey panels having been set at 7'6" above water line for floating sections and 12'6" above water over the intermediate landing bay pier, a 90 foot river landing bay gives a slope of 90/5 or 1 in 18 in the river landing bay.

(4) Shore Landing Bays.

The shore landing bays were constructed 110 feet long so that the intermediate landing bay pier would be located over deeper water and to secure minimum slopes. A rise or fall in water level of 8 feet from mean, will produce a slope of 1 in 14 in the shore landing bay.

(5) Intermediate Landing Bay Pier and Landing Bay Piers.

Piers were built up on two barges by use of I-beam cribbing. Two different methods of gunwale reinforcing were used, one of which employed the use of a wood bent in the center of each barge while the other has the reinforcing directly under each gunwale. To insure that I-beams of piers remained in place they were welded to barge gunwales and bolted in place.

(6) Floating Bay Piers.

The elevations of barge gunwales were built up so that a flat surface was obtained 7'6" above the water line. Blocks were installed so that a support was provided under the truss at each vertical member of the Bailey panels. Floating Bays are illustrated in Plate 33.

(7) Special Connecting Posts.

Special male-male and female-female posts were used. These posts serve the same purpose as the Bailey span junction posts and were designed to overcome a weakness that had developed in Bailey span junction posts on Class 70 trusses.

(8) Telescoping Ramp and Sliding Base Plate.

During periods of high or low water the shore landing bay will assume an inclined position. To allow for the resulting contracting of the bridge, rollers were placed under the base plate of the East end of the bridge. When the elevation of the water rises or falls 11 feet from mean the bridge will shorten approximately 8 inches on each end, therefore, provisions were made for the East shore base plate to roll toward the river 16 inches. It was also necessary to construct a telescoping ramp so that the ramp deck would not tear away from the abutment. Sliding Base Plate details are shown on Plate 33.

SECTION V.

ARMY CROSSING

A. Dual Carriageway Bailey Bridge on Barges.

1. General Situation.

After the capture of the LUDENDORF Railroad Bridge and establishment of further crossings over the Rhine River, it was decided to construct a Class 70 and a Class 40 Bailey Bridge on barges at BAD GODESBERG approximately 5 miles south of BONN. This bridge was constructed in accordance with the design and procedure developed while experimenting with Bailey barge bridging on the MEUSE River at LIEGE, Belgium during November and December 1944. On 12 March the Commanding Officer, 1110th Engineer Combat Group was directed to institute reconnaissance for barges and make preparations for the construction of the bridge. Actual construction started on 25 March. The bridge was completed on 5 April and opened for traffic the next day.

2. Bridge Site.

BAD GODESBERG was selected as the bridge site because it was centrally located on the axis of advance. The road net to and from the bridge was adequate. The water gap, which was 1140 ft., could be spanned by a 1172 ft. truss. The water was 10 ft. deep at a distance of 70 feet from the bank. The most undesirable features of the site were the bridge approaches which required the movement of 35,000 cu. yds. of earth and the construction of 1700 ft. of approach road. Sites with better approaches were available, however, it was necessary to sacrifice good approaches to take advantage of high banks and deep water near the shore.

3. Bridge Construction.

a. Barges.

Barges were easily found on the river. Two types of barges were used with dimensions as follows:

<u>Beam</u>	<u>Length</u>	<u>Capacity</u>
17' Average	125' to 130'	250 tons
17' Average	220' to 270'	1500 to 2000 tons

b. Design and Construction.

The large barges were used for landing bay piers. The smaller barges, for floating piers. The distance between barge piers was determined in all cases by the design of the most economical type of construction for the Class 70 lane. Plan and Elevation view of the bridge are shown in Plate 32.

(1) Floating Bays.

The length was set at 70 ft. since this is the maximum length for Class 70 without resorting to double story construction.

(2) End Floating Bay.

The end floating bay was designed with 80 feet of Bailey truss. This bay is supported on the landing bay pier by a bearing constructed on the bottom of the special connecting

Bridge Construction (Continued)

posts and set on standard Bailey bearings. The other end rested directly on its floating bay pier at the river end with 15 feet cantilver overhang.

(3) River Landing Bays.

The elevation of the bottom of the Bailey panels having been set at 7'6" above water line for floating sections and 12'6" above water over the intermediate landing bay pier, a 90 foot river landing bay gives a slope of 90/5 or 1 in 18 in the river landing bay.

(4) Shore Landing Bays.

The shore landing bays were constructed 110 feet long so that the intermediate landing bay pier would be located over deeper water and to secure minimum slopes. A rise or fall in water level of 8 feet from mean, will produce a slope of 1 in 14 in the shore landing bay.

(5) Intermediate Landing Bay Pier and Landing Bay Piers.

Piers were built up on two barges by use of I-beam cribbing. Two different methods of gunwale reinforcing were used, one of which employed the use of a wood bent in the center of each barge while the other has the reinforcing directly under each gunwale. To insure that I-beams of piers remained in place they were welded to barge gunwales and bolted in place.

(6) Floating Bay Piers.

The elevations of barge gunwales were built up so that a flat surface was obtained 7'6" above the water line. Blocks were installed so that a support was provided under the truss at each vertical member of the Bailey panels. Floating Bays are illustrated in Plate 33.

(7) Special Connecting Posts.

Special male-male and female-female posts were used. These posts serve the same purpose as the Bailey span junction posts and were designed to overcome a weakness that had developed in Bailey span junction posts on Class 70 trusses.

(8) Telescoping Ramp and Sliding Base Plate.

During periods of high or low water the shore landing bay will assume an inclined position. To allow for the resulting contracting of the bridge, rollers were placed under the base plate of the East end of the bridge. When the elevation of the water rises or falls 11 feet from mean the bridge will shorten approximately 8 inches on each end, therefore, provisions were made for the East shore base plate to roll toward the river 16 inches. It was also necessary to construct a telescoping ramp so that the ramp deck would not tear away from the abutment. Sliding Base Plate details are shown on Plate 33.

1110 ENGINEER COMBAT GROUP
**ANCHORAGE & GUY LINE SYSTEM FOR DUAL
 CARRIAGE-WAY BARGE BAILEY BRIDGE**

BAD GODESBERG, GERMANY

(F-600326)

SHEET 2 OF 18 SHEETS

24 MARCH 1945

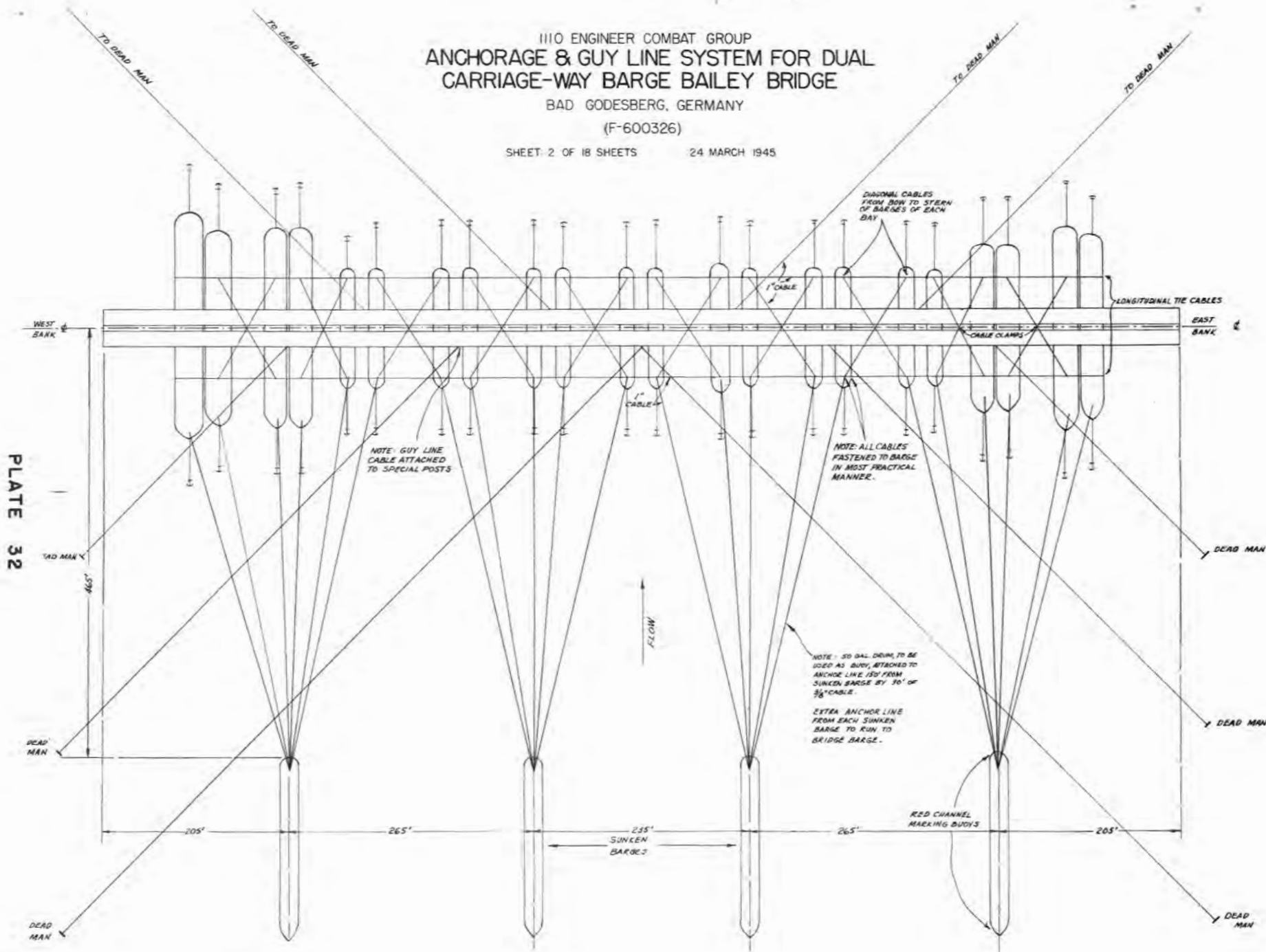
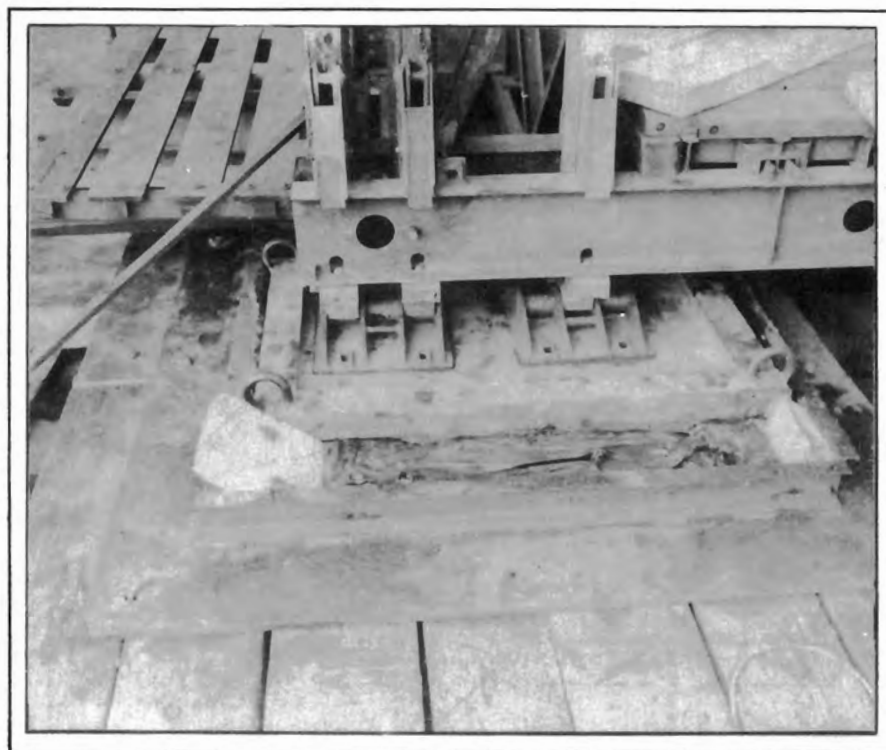

PLATE 32



Floating Bays nearing completion.



East Shore Sliding Base Plate in place.

Bridge Construction (Continued).

c. Work Assignments.

148th Engr C Bn - Construction of East Half of Bridge.
207th Engr C Bn - Construction of West Half of Bridge.
1264th Engr C Bn - Construction of approach roads.

d. Anchorage.

Three types of anchorage were installed to hold the bridge rigidly in place. Anchorage system is shown in Plate 34.

- (1) Barge anchors were dropped upstream and downstream.
- (2) Anchors barges, loaded with scrap iron, were sunk 450 ft. upstream of the bridge on 250 ft. centers. Anchor lines were run from these barges to the bridge barges.
- (3) Guy lines were placed upstream from fifth points of the bridge truss and quarter points downstream. To insure stability diagonal cables were run from bow to stern of all barges in each bay. Cables were run for the full length of the bridge tying all barge bows and all barge sterns in position.

4. Movement and Connection of Bays.

Joining of landing and end floating bays presented no problem as they were constructed and erected together from the approach. However, the connection of the 100 foot floating sections was more difficult. The 100 foot floating bays were towed into place by an 800 HP Diesel tug as shown on Plate 35, from downstream and moved upstream of the bridge at which point the tug dropped its anchors. Barge anchors were dropped at the same time. Following this, the sections were moved into place by letting out on anchor lines of the barges and tow lines of the tug. One small steam tug was used to push the section into place from the side. In most cases the trusses had to be pulled with ratchet hoists so that the M-2 treadway pins could be driven through the holes in the special connecting posts.

5. Bridge Approaches.

Approximately 1700 ft. of approach road was constructed. On the east approach 5000 cu. yds. of fill was placed and 30,000 cu. yds. of excavation was required on the west approach. The following earth moving and road construction equipment were used:

Shovels	5
Carryall Pans	11
Road Graders	3
Tar Distr, Trk Mtd, 800 gal.	2
Tar Distr, Tlr Type	2

Base courses of rock and brick were covered with a bituminous wearing surface. The west bank approach road is shown on Plate 35.

6. Special Features.

- a. Decking. Diagonal tread was used to increase traction.

WEST BANK

EAST BANK

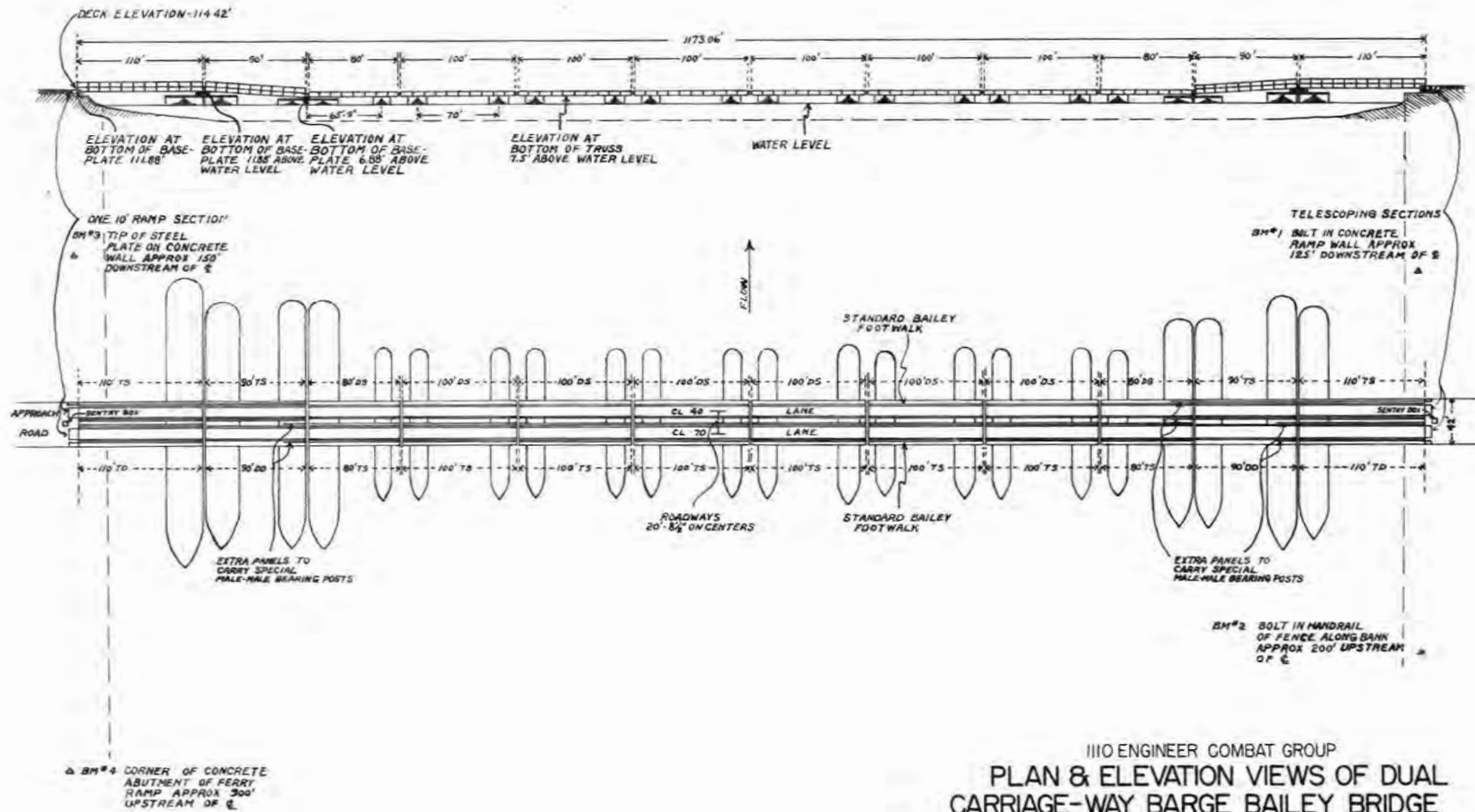

PLATE 34

1110 ENGINEER COMBAT GROUP
 PLAN & ELEVATION VIEWS OF DUAL
 CARRIAGE-WAY BARGE BAILEY BRIDGE

BAD GODESBERG, GERMANY

(F-600326)

SHEET 1 OF 18 SHEETS

30 MARCH 1945



Completed West Shore Approach.

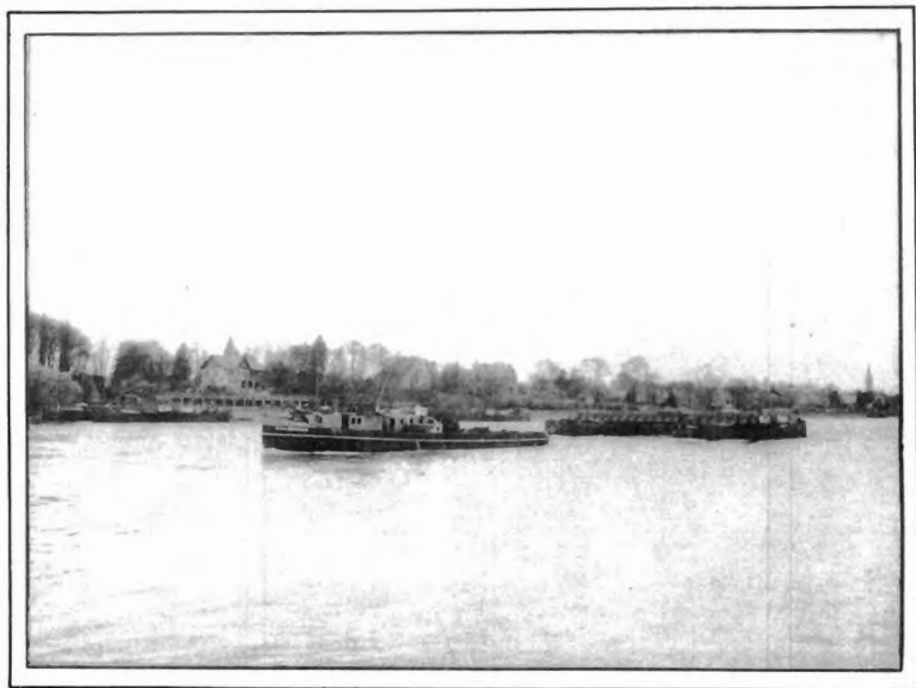

100 foot Floating Bay being towed into place by an 800 HP Tug.

Special Features (Continued).

b. Landing Bay Deck.

Two inch angle irons were laid over the deck with one edge of the angle placed between the planks to increase traction on the slope.

c. Guard Rail.

Instead of using Standard Bailey Ribands, 2" x 2 1/2" hub guards were attached to the sides of the Bailey panels.

d. Fire Protection.

A fire pump was installed in a 40 ft. German launch and used as a fire boat. Two foam type fire extinguishers and six 1 1/2 quart pails of dry sand were placed on each barge.

e. Electric Lighting System.

Trouble lamps connected to the civilian power source were installed so as to reach any part of the bridge.

7. Bridge Maintenance.

A minimum of one engineer combat company is required for the 24 hour maintenance of this bridge.

8. Bridge Data.

Annex 1, Comparative Bridge Data shows lengths, troops employed, construction time, etc. Miscellaneous construction photographs are shown on Plates 36, 37 and 38.



Removing Chain Hoists following connection of Two Bays of Bridge.

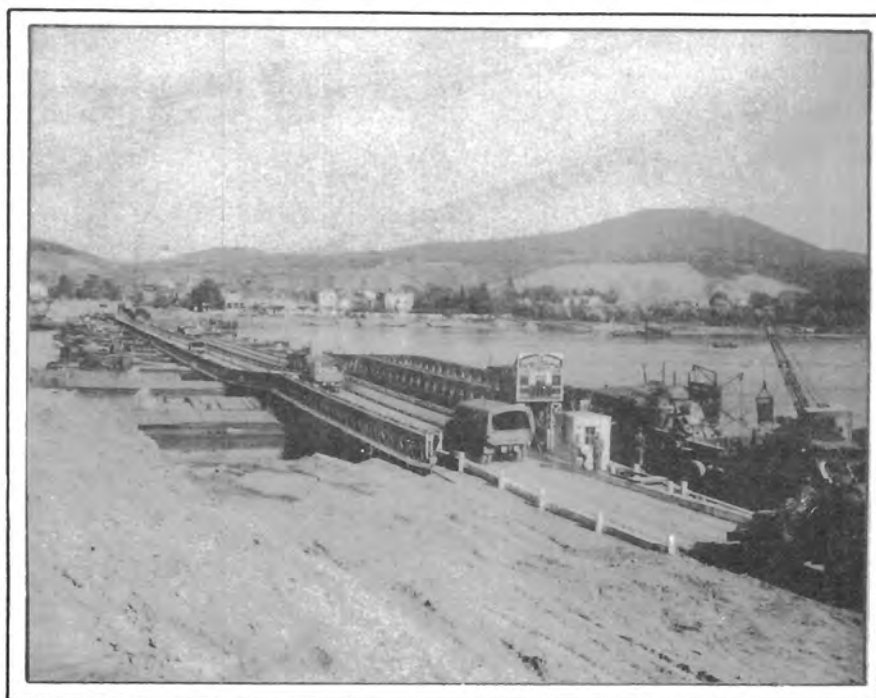

West Bridge Approach showing Curbs.

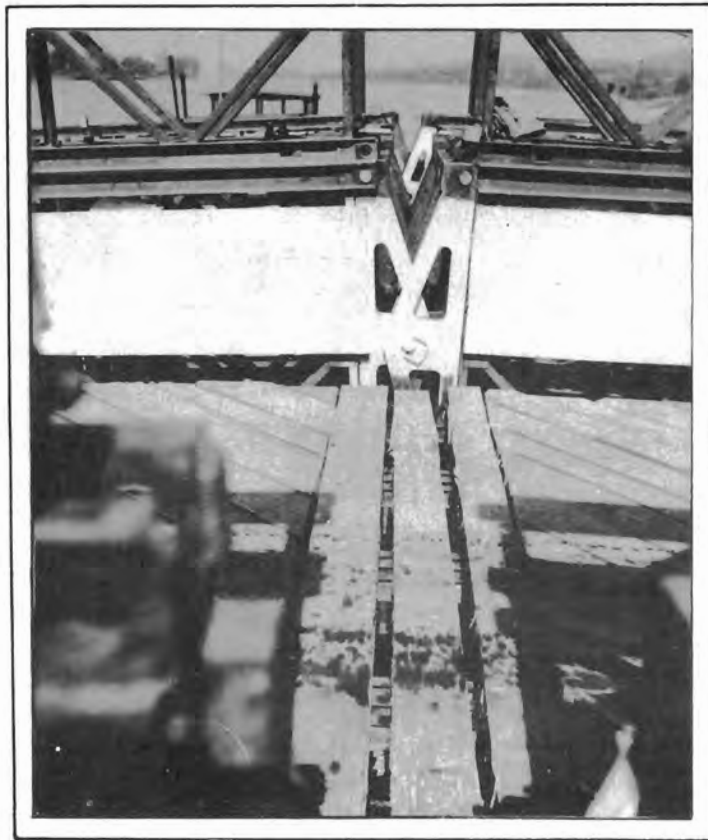

Detail of connection between Bays.
Note Special Connecting Posts, Hub
Guard, Stringers, and Deck over Gap.

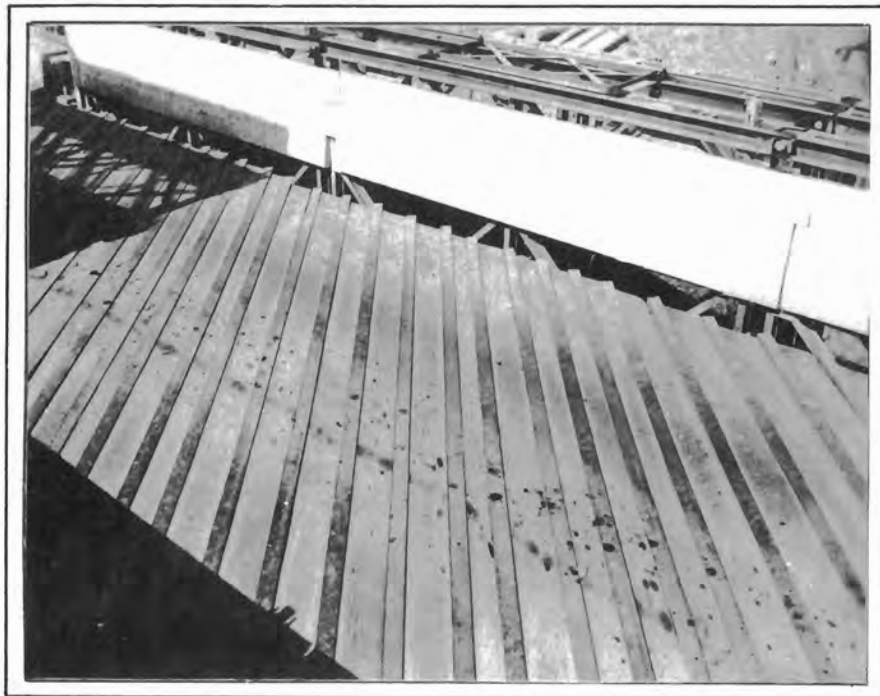

Angle Irons increase traction on Landing Bays.

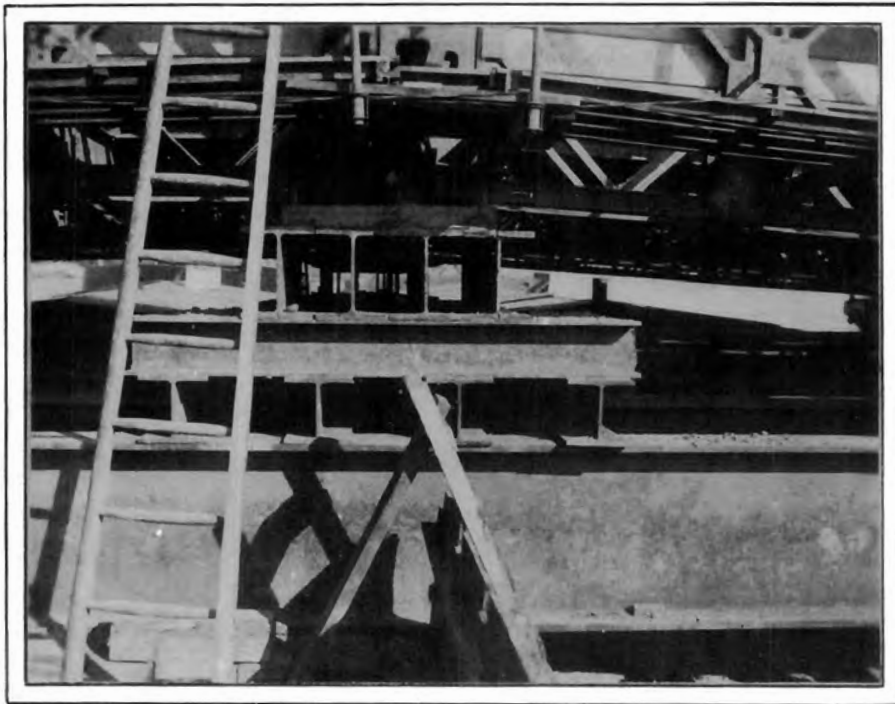

Intermediate Landing Bay Pier.

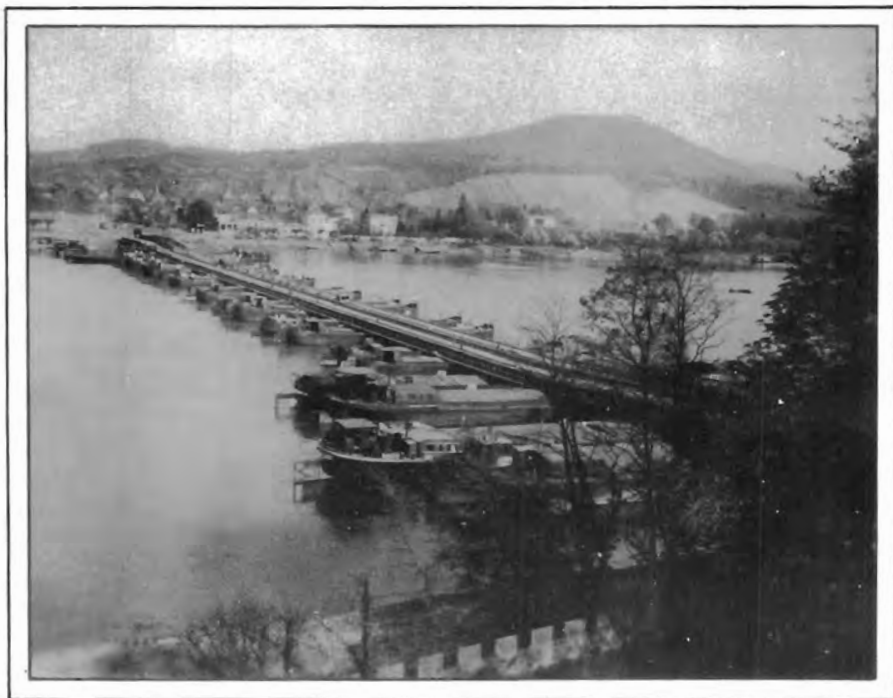

Completed Bridge. View from West Bank.

SECTION VI.

MISCELLANEOUS.

A. Protective River Booms.....	Page 28 - 32
B. Collapse of LUDENDORF Railroad Bridge..	33 - 35
C. Security Precautions.....	36 - 42
D. Bridge Equipage Supply.....	43 - 45
E. Personalities.....	46 - 48

SECTION VI.

MISCELLANEOUS.

A. Protective River Booms.

1. General.

Protective river booms were installed to protect the bridges and ferries as quickly as possible. Upon the capture of the LUDENDORF Railway Bridge at REMAGEN, Germany, the 164th Engineer Combat Battalion was given the mission of installing protective booms in the Rhine River to protect bridge installations.

2. Troops.

164th Engineer Combat Battalion.
Det., LCVP Unit No. 1.
Det., 329th Harbor Craft Co.

3. River Characteristics.

The width of the river at all boom sites averaged from 1000 ft. to 1200 ft. and river velocity varied from 4.6 ft. per second to 6.2 ft. per second during the construction and maintenance period. Coarse gravel formed the bottom, making standard anchors inefficient.

4. Description of Protective Booms and Equipment.

a. General.

During the fall and winter of 1944 considerable experimental work on protective river booms was performed by engineer units of First US Army. The results of these experiments were crystallized into a river defense system designed to protect bridges against enemy demolition by floating mines, heavy objects such as barges, and swimmers. Three types of booms were installed at each protective boom site. These were the impact, log, and mine net booms.

b. Impact Boom.

(1) Purpose. The function of this boom was the stopping of heavy barges, bridge wreckage or other heavy objects.

(2) Description. This boom was composed of four 1" wire cables, supported every 78 ft. by timber framed buoys so that two criss-crossed cables were above the surface of the water and two criss-crossed cables under the water. The boom was anchored on each shore by deadmen and the timber framed buoys by means of Bailey Panel Rubble Box Anchors which are described below. The timber framed buoy was constructed from two 55 gallon steel drums to which had been welded 30 inch conical hydraulic noses. Two 5'x2½' timber frames made of 8"x8" lumber held together by four 42" bolts provided a frame which held the drums in position. U Bolts and eyes bolted to the timber frame provided fasteners for the 4 impact cables and anchor cables.

c. Log Boom.

(1) Purpose. Its principal function was the stopping and collecting of debris and detonation of floating mines.

Description of Protective Booms and Equipment (Continued).

- (2) Description. The log boom was a cable linked string of 12" diam. by 20 to 25 ft. logs crossing the river at an angle of 45 degrees to thalweg. Each end of the boom was anchored by deadmen on the shore and each log was connected to one 55 gallon drum auxiliary float which was anchored in the river bed. Approximately 8" from the end of each log a 1/2" steel staple driven into the log formed the connection for the 1" steel cable link.

d. Mine Net Boom.

- (1) Purpose. The functions of this type were the detonating or screening of floating mines and impeding swimmers.
- (2) Description. This boom was a net, which was woven of 1/4" wire rope to form 1 ft. squares, suspended in the water by 55 gallon drum buoys. The wire net hung to a depth of 10 ft. below the surface of the river. A double drum buoy suspended the net every 60 ft. At 20 ft. intervals between the double 55 gallon drum buoys the net was suspended by single 55 gallon drum buoys. Each double drum buoy was held together by two 2" formed steel strap saddles to which wire welded rings to hold the mine net and anchor cable were attached. Saddles were formed to fit around two 55 gallon drums when bolted. Each double drum buoy was anchored in the river bed and the ends of the mine net were anchored to deadmen on the shore.

e. Bailey Panel Rubble Box Anchor.

- (1) General. The character of the stream bed made it necessary to depend upon sheer weight for a strong anchorage. The Bailey Rubble Box Anchor provided the solution to the anchorage problem.
- (2) Description. 3 Bailey panels were welded together forming the bottom and two sides of a box. This was lined with wire mesh leaving the top of the box open. The box was filled 3/4 full with rock or rubble, the top lined with additional wire mesh and the fourth top panel welded to the sides to seal the top of the box. Two rubble boxes were constructed on Bailey plain rollers on each end of a reinforced heavy ponton raft thus eliminating a heavy lifting operation. Each rubble box weighed 6 tons. The 1" steel anchor cables were attached to the rubble box prior to casting.

5. Protective Boom Site No. 1.

a. General.

On 7 March 1945 the 164th Engineer Combat Battalion was attached to III Corps for operational control. The battalion moved to REMAGEN on 8 March to start construction work immediately. Two QM truck companies under operational control of the Engineer Depot moved the protective boom equipment from the Engineer Depots to REMAGEN, Germany. Except for small supply detachments the battalion was fully committed on the construction and installation of mine booms.

b. Impact Boom.

On 9 March 1945, work was started on the first protective boom, which was the Impact type, 300 yards upstream of the LUDENDORF Railway Bridge at F 654202 as shown on Plate 39. Both banks at the site were flat and sufficiently wide to

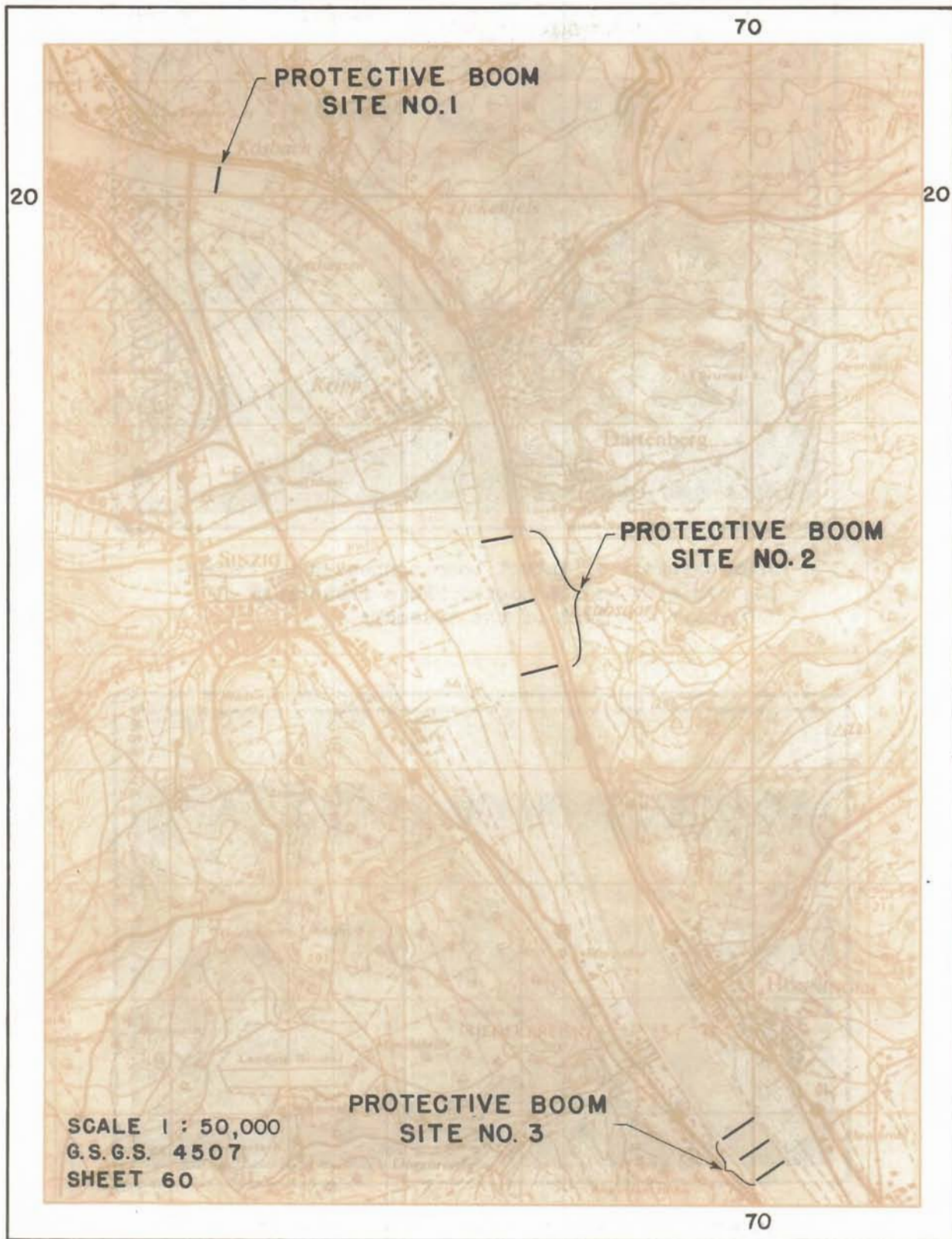

PROTECTIVE BOOM SITES
RHINE RIVER
PLATE 39

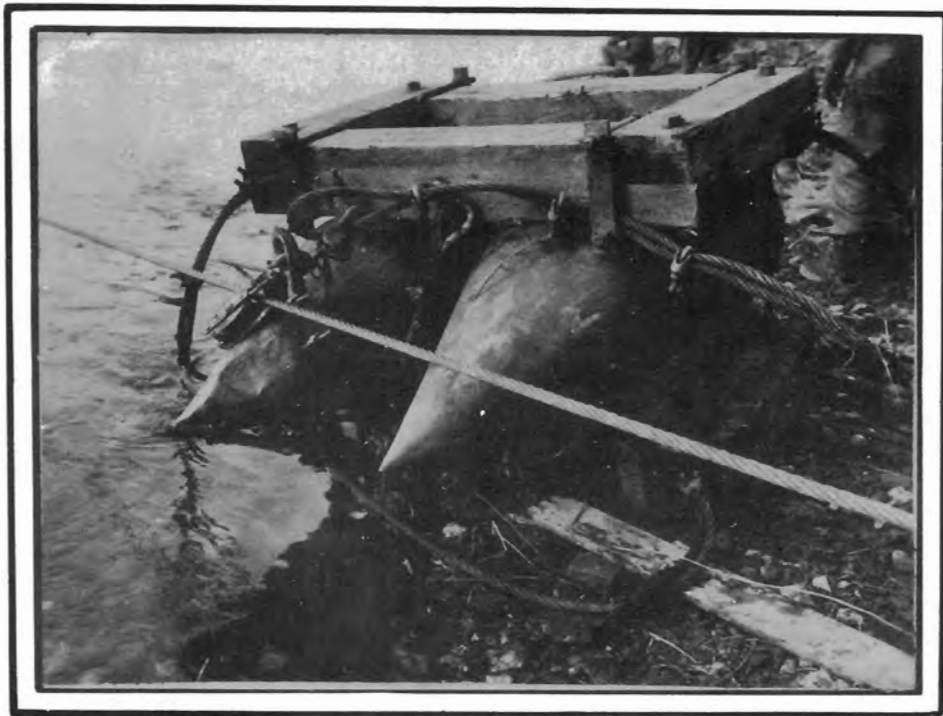

Drum assembly of impact boom connected to launching cable by snatch block. Note fastenings of jacks and bulk of the assembly.



Impact boom with center sections partially submerged.

Protective Boom Site No. 1 (Continued).

lay out the boom construction materials. Considerable difficulty was encountered in launching and placing the Impact Boom, because of the swift current and width of the river. These difficulties were:

- (1) Power boat equipment was inadequate to hold rafts and float assembles in position.
- (2) Float sections could not be anchored in position before the jackstays were connected because of the crossings of the cable and the fact that two cable connections were three feet under water.
- (3) Power utility boats could not handle jackstays because of their length and the effect of the swift current. The boom was finally launched successfully in the following manner:
 - (a) A one-inch cable was stretched across the water gap and anchored to deadmen at both ends.
 - (b) The Impact Boom was completely assembled and connected on the shore.
 - (c) The end of the boom was attached to an LCVP and the entire boom pulled into the water. As each float entered the water it was attached to the one inch cable by means of snatch blocks as shown in Plate 40. This boom was not completed. On 11 May it was decided to discontinue protective boom work at this site and start construction on a new set of Protective booms upstream of the KRIPP Reinforced Heavy Ponton Bridge which was nearing completion.
 - (d) Anchor cables were attached and the anchors dropped.

6. Protective Boom Site No. 2.

a. Boom Sites. The boom sites were selected and installed at the following points and are illustrated on Plate 39.

Impact Boom	-	F 682158
Mine Net	-	F 680164
Log Boom	-	F 678169

The west bank of the river sloped approximately 1 to 10 from the rivers edge for 100 yards and provided excellent construction sites. The east bank, likewise had a slightly sloping beach which ended abruptly about 50 yards from the waters edge at a stone revetment, 25 ft. high.

b. Impact Boom. This boom was constructed and launched as described in paragraph 5 b. At this site, however, the nature of the gravel riverbed, caused all standard anchors to creep and shift. This anchorage problem was solved by the use of the Bailey rubble box anchors described in paragraph 4.

c. Log Boom. The log boom was easily installed with little or no difficulty. Single logs were placed and anchored with power utility boats, then connected with wire cable links. After maintaining this boom for several days the connection of the jackstays to the logs by means of staples and the constant wearing of jackstays were noted as weak points in the design. The continuous wearing action of the logs in the swift current loosened the staples within one or two days and eventually pulled them out. In ten days one inch jackstays were worn in two at the points of the connections and where the logs chafed against the cable. These

Protective Boom Site No. 2. (Continued).

weaknesses were remedied by the use of "J" bolts in place of staples as a fastening device for jackstays and logs and the use of thimbles in the jackstay eyes. The ends of the logs were sharply dressed down to eliminate undue wear.

d. Net Boom. The net boom was constructed as described in paragraph 4. 62 foot sections of net were difficult to connect to the jackstays because the net had to be rolled out on the bow of an infantry support raft as shown in Plate 41 and could not be completely and simultaneously connected. Considerable debris, which collected over a 24 hour period, required constant maintenance. Plate 42 shows debris floating the net in the water, thus decreasing its effectiveness.

e. Construction Times.

	<u>Started</u>	<u>Completed</u>
Impact Boom	151630A March 1945	212000A March 1945
Mine Net	151630A March 1945	220200A March 1945
Log Boom	160600A March 1945	201500A March 1945

7. Protective Boom Site No. 3.

a. General.

After V Corps had announced the proposed location of their M-2 Steel Treadway Bridge at HONNINGEN, it was decided to install another set of booms upstream of this bridge at the following locations, which are illustrated on Plate 39.

Impact Boom	-	F 701115
Log Boom	-	F 700117
Mine Net	-	F 699119

b. Boom Site. The west bank was a broad pebbly beach with a 1 to 10 slope for about 100 yards to a 25 ft. revetment. The east bank sloped approximately 50 yards to a 25 ft. revetment. Both banks were excellent for boom construction.

c. Boom Construction. No new difficulties in boom construction and installation were encountered at this site. The experience gained at the previous sites greatly aided constructing crews. In addition a civilian steam tug was found and used advantageously as a heavy work boat for holding the ends of booms in position against the current during construction.

d. Construction Times.

	<u>Started</u>	<u>Completed</u>
Impact Boom	220600A March 1945	242200A March 1945
Log Boom	220600A March 1945	231700A March 1945
Mine Net	221300A March 1945	240545A March 1945

8. Erection Equipment.

The usefulness of various types of erection equipment for protective boom work varied markedly from the usefulness of the same equipment in bridge construction. The performance of the various types of erection equipment used is described below:



Attaching mine net to jackstays showing use of infantry support raft.



Attaching mine net to jackstays showing net being unrolled across bow of infantry support raft and intermediate float and net weights attached.

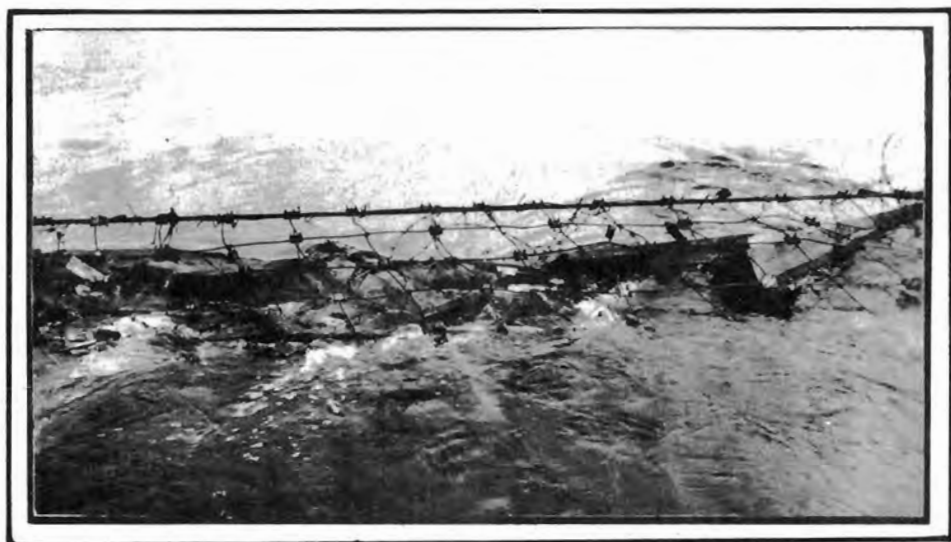

Debris gathered in 12 hours showing tendency to float net up. Note concertina beaten down by debris.

Erection Equipment (Continued).

a. Infantry Support Rafts.

Infantry support rafts powered with two utility boats, which were very effective during the experimental and planning period on the MEUSE River, were operated with great difficulty and under constant threat of swamping in the Rhine River. Large waves and the swift current necessitated extreme care in operation to avoid swamping, precluded the use of anchors over 600 lbs and the launching of the impact boom from the bow of the rafts.

b. Power Utility Boats.

Power utility boats had insufficient power to handle heavy loads, such as 78 feet jackstays of the impact boom, and towing the reinforced 5 ponton raft. Constant maintenance was required, to keep the boats in operation. Because of their inability to perform heavy work, power utility boats were used only for light utility tasks.

c. LCVP.

The LCVP was satisfactory for normal operations in which heavy loads were not towed or maneuvered, however, it also had insufficient power to handle the reinforced 5 ponton raft effectively. The high sides were a disadvantage for close-in work on nets and booms and the after-deck was too small to handle anchors weighing over 600 lbs.

d. Sea Mule.

The Sea Mule was the most satisfactory work boat, other than civilian river tugs, and handled ponton rafts easily. Its deep draft and unprotected rudder and propeller are disadvantageous in river operations of this type. The lack of a power-operated winch or a hand-operated capstan handicapped the handling of anchors and adjustment of anchor lines and cables.

e. Reinforced 5 Ponton Raft.

These rafts were very effective for the handling of Bailey Rubble Box Anchors. (See Plate 43). The raft could not be towed perpendicular to the current, (pontons perpendicular to the current) because of the danger of swamping.

f. Cranes.

Three cranes were necessary for the simultaneous erection of all booms. Of these, one crane of 15 ton capacity was needed for LCVP and Sea Mule operations and also for the loading of Bailey Rubble Box anchors containing ballast.

g. Two arc welding sets were used for the rapid construction of Bailey rubble box anchors.



Loading Rubble Box anchors on reinforced heavy ponton rafts. The landing trestles are needed to permit the sea mule to bring the barge into shore without grounding.



Sea mule towing ponton raft loaded with two Rubble Box anchors. Note high bow wave set up and small amount of free board left.

B. Collapse of the LUDENDORF Railway Bridge.

1. General.

The LUDENDORF Railway Bridge when captured was damaged as shown in Plate 44. Explosives placed by the enemy were removed by the 9th Armored Engineer Battalion and the 276th Engineer Combat Battalion; the amounts and locations of the explosives removed are shown in Plate 45. The bridge carried practically continuous one-way traffic from the time of its capture until 12 March 1945 when two other tactical bridges made it possible to close traffic on the bridge and undertake the necessary repairs. The 276th Engineer Combat Battalion with the assistance of a Technical Team of the 1058th PC & R Group was given the mission of repairing the bridge. This work was nearing completion when the bridge collapsed on 17 March 1945.

2. Condition of Bridge at Time of Collapse.

a. The following repairs had been made prior to the collapse:

- (1) West side flooring of the deck.
- (2) Several hangers had been spliced.
- (3) Several floor members had been replaced.

b. Repairs at two points still remained; these were:

- (1) Repair of the broken lower chord of the upstream arch truss adjacent to the north abutment.
- (2) Replacement of stringers adjacent to the south abutment.

c. Although the bridge was damaged throughout its length, the only unrepaired portion which might have had a serious effect on the load carrying capacity of the bridge, was the broken lower chord of the upstream arch truss. This damage, which had been caused by enemy demolition, had completely torn apart the lower chord, diagonal and vertical of the truss at the first panel point south of the north pier. This caused the upstream arch truss to drop at the north end over one foot below the level of the downstream arch truss at the corresponding point. The side plates of the top chord of this upstream truss directly above the point where the lower chord was cut were slightly buckled. At the time of the collapse the load originally supported by the upstream truss was being supported in three ways:

- (1) By the upstream truss of cantilever action over the south pier due to the original continuous construction.
- (2) By partial support afforded the north end of the upstream arch truss by the slightly buckled top chord.
- (3) By the downstream truss through the floor and bracing system.

3. Collapse of the Bridge.

The actual collapse of the bridge was reconstructed from eye-witness reports. Without apparent immediate cause, at about 171500A March 1945, the main span of the bridge suddenly gave way near the north pier. It is not known whether some part of the members still carrying stress in the upstream truss failed or whether the west truss suddenly failed under the tremendous twisting forces applied to it by the possibly useless upstream truss. Once the initial failure occurred, the main span twisted with its top falling upstream. This caused the members of the main arch trusses to buckle laterally and the entire span dropped into the river pulling the two side spans with it. Photographs of the demolished bridge are shown in Plates 46 and 47.

Collapse of the LUDENDORF Railway Bridge (Cont'd).

4. Factors Contributing to the Collapse.

Available evidence does not indicate one specific cause for the collapse: Theoretically the bridge should have collapsed when the charge which cut the lower chord of the east truss was blown, yet the bridge carried traffic equivalent to an infantry division with attached tanks and was still standing. The various factors which contributed to the collapse are outlined below:

a. Broken Lower Chord of Upstream Arch Truss.

The cutting of this chord effected the remainder of the structure in two ways:

- (1) It forced the downstream truss to carry the load which had previously been carried by the upstream truss. Neglecting the effects of any twisting action, this would cause the members of the downstream to be overstressed by 100% if the upstream truss had been completely severed.
- (2) It subjected the entire bridge to a twisting action for which the structure was never designed.

b. Dead Load of Added Flooring. The additional load of the flooring constructed by the enemy contributed to the collapse of the bridge. The exact weight is unknown, however a 4 inch flooring, 15 feet wide and 515 feet long represents an additional load of approximately 50 tons.

c. Cable Used to Straighten Part of Lower Chord. Attempts had been made the day before to align the broken chord of the upstream truss with a cable attached to a crane. The crane was on the bridge over the north pier with a cable attached which ran through a block on the downstream side of the bridge, through the deck to another block and across under the deck to the part of the bottom chord of the upstream truss which framed into the pier. Attempts to take up on this cable were made once, however, the clamps slipped and the crane was standing idle at the time the bridge collapsed.

d. Vibrations of Machinery and Equipment.

Throughout the repair period, there was a constant hammering and motion set up by air compressors, electric welders, cranes and trucks which were operating on the bridge flooring. All of these could have set up vibrations in the structures.

e. Vibrations by Artillery Firing.

During the repair period, several heavy artillery units moved into the area. The continued vibration and shock effect of hundreds of rounds fired from friendly artillery may have set up vibrations in the structure. 1087 rounds of 8 in. howitzer were fired from positions approximately 2000 yards from the bridge during the period.

f. Vibrations of Enemy Artillery.

A total of 601 rounds were fired at the bridge during the repair period. Of these, many actually struck the bridge and must have had a damaging effect on a structure on the verge of collapse. No hits were noticed on the main chords.

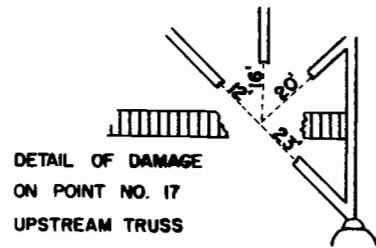
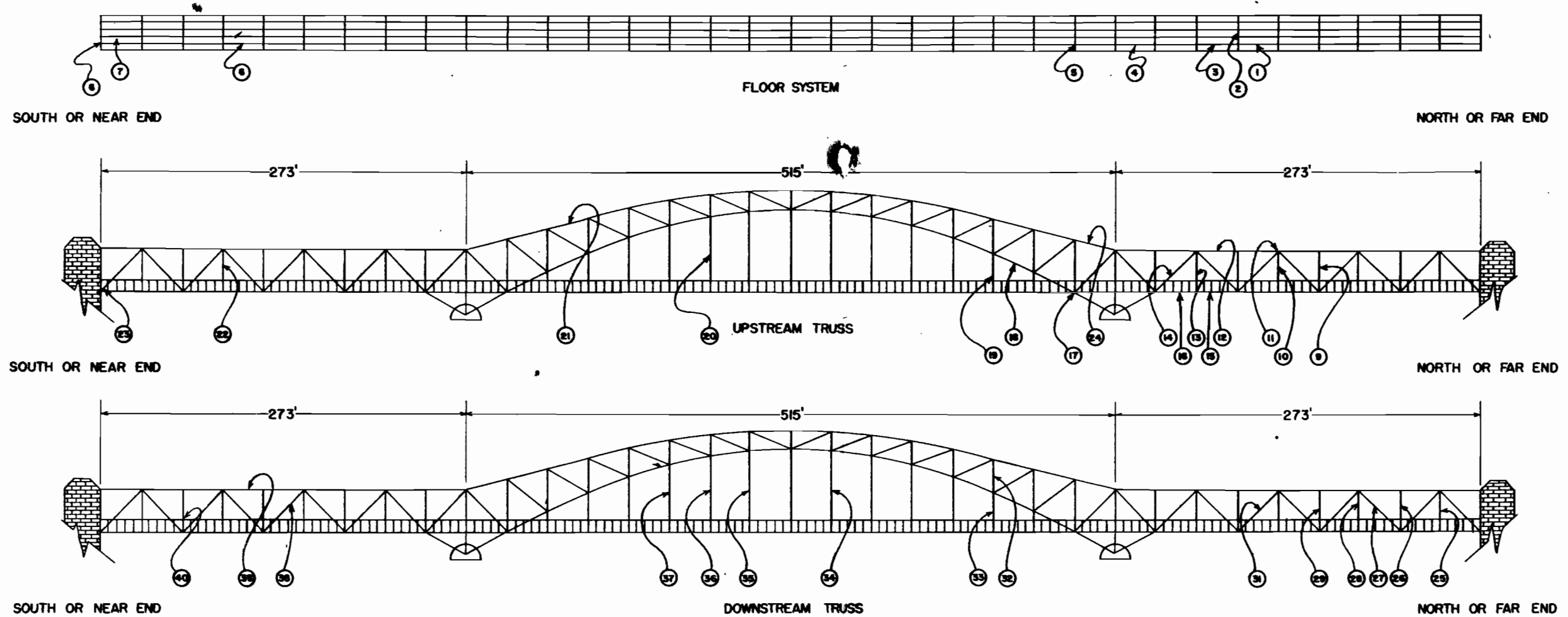

1. Stringer repaired by enemy with hangers.
2. Five feet of floor beam missing from east side repaired by meter beam hung from bottom chord by enemy.
3. Stringer damaged but replaced by our troops.
4. Stringer replaced by enemy.
5. Half floor beam & two stringers out.
6. Four foot section repaired with web & flange splice plates by our troops.
7. Two stringers replaced by meter beams rested on bridge seat by our troops.
8. Up stream half of floor beam out.

9. Four inch hole in flange.
10. Four inch hole in web.
11. Diagonal and horizontal bracing cut half through.
12. Member damaged on top.
- 13, 14, 15 and 16. Members cut but repaired by enemy.
17. See detail at lower left of layout drawings.
18. Two foot hole in top plate.
19. Angle of flange broken.
20. Three foot gap, member severed.
21. Four inch hole in web on east side.
22. Four inch hole in web.
23. Member damaged by shrapnel.
24. Slightly buckled side plate.

25. Two eight inch holes in flange.
26. Shrapnel holes, flange and web.
27. One four inch hole in angle.
28. Two two inch holes in web.
29. Small holes in web.
30. Flange, ten feet to repair.
31. Four inch hole in flange.
- 32 and 33. Four inch holes.
34. Column severed, ten foot repair.
35. Three inch hole.
36. Column severed, six foot repair.
37. Three inch hole.
38. Small holes.
39. Three foot hole.
40. One foot hole.

DAMAGE DETAIL OF LUDENDORF RAILROAD BRIDGE

REMAGEN, GERMANY

7 MARCH 1945

PLATE 44

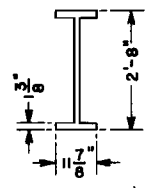
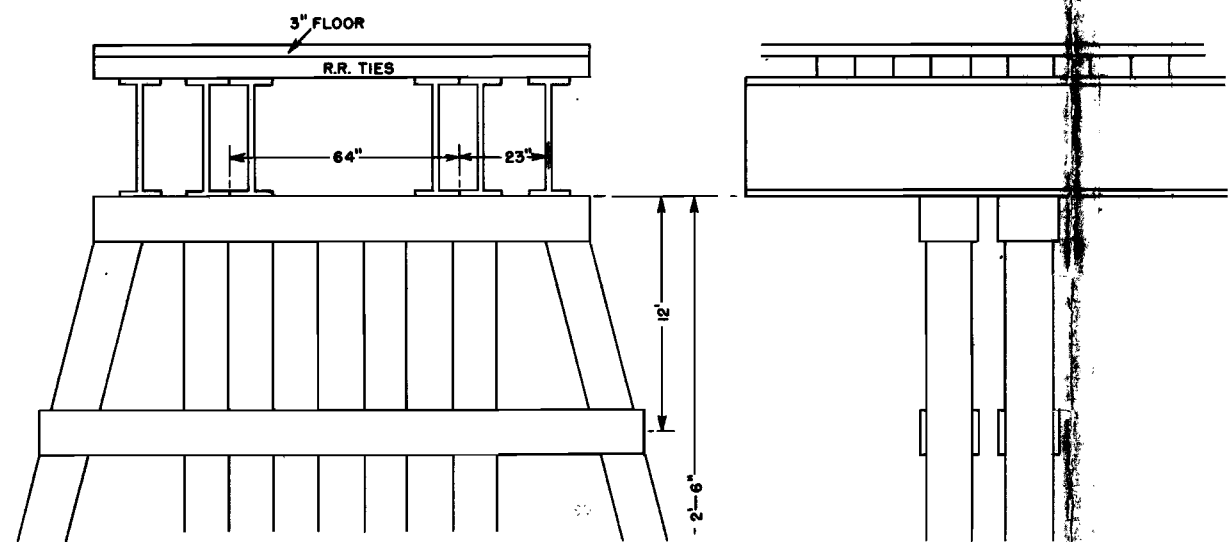
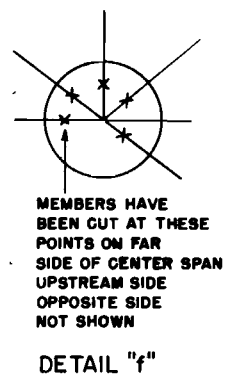
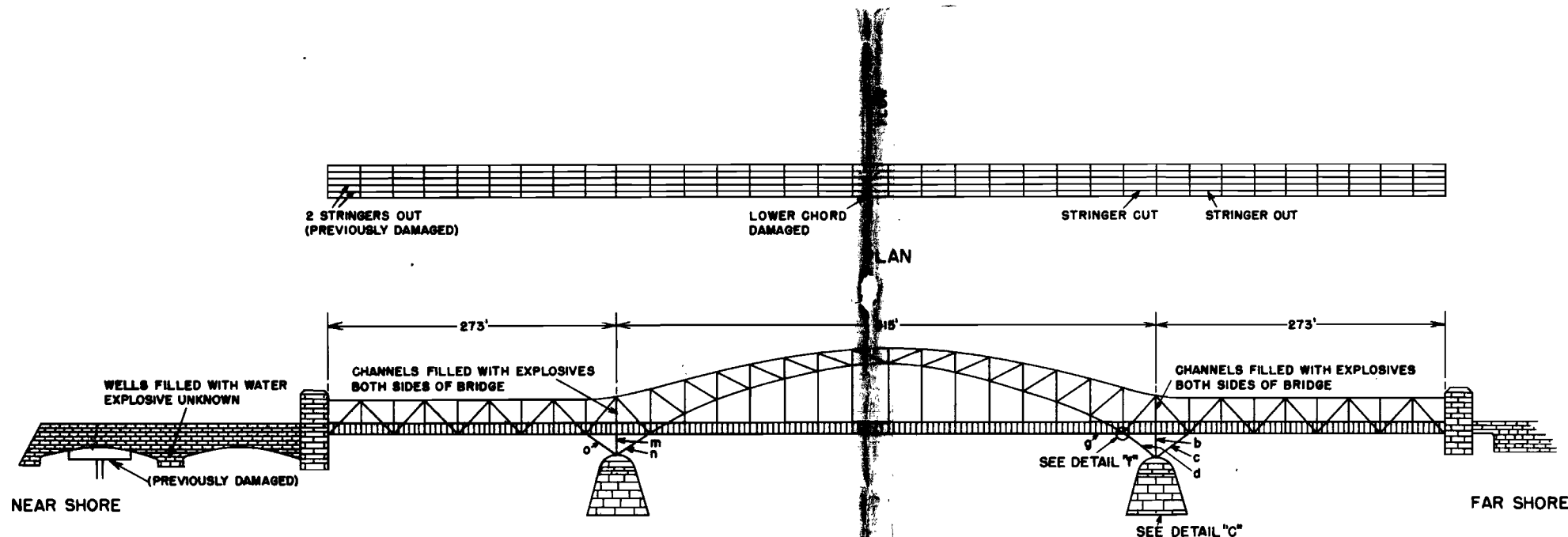

The charges used on the bridge were all tailored to fit the particular member they were to destroy. They consisted of TNT packed in thin metal boxes and the sizes are all estimates.

a. One 8-lb. charge was located at the junction of the floor beam and the downstream vertical chord at (a). Four other similar charges were spaced along the floor beam at this point. No charge was placed on the upstream chord. Each charge contained an electric cap. Since there were no electrical outlets here it is assumed they were wired with a direct line to the main switch.

b. On each open channel side of member (b) downstream there were 6 - 8-lb. charges. Each 8-lb. charge contained an electric cap with leads connected to a central outlet box. This member on the upstream side of the bridge was not prepared for demolition.

c. Spaced along member (c) were 2 8-lb. charges and 9 - 1 kilogram charges. Each 8-lb. charge was prepared with an electric cap with leads going to separate electrical outlets. The kilogram charges were placed to detonate sympathetically. This member on the upstream side was not prepared for demolition.

d. Same as (c).

e. Diagonal bracing at (e) Downstream side

f. At points a and a' there was strapped on 8-lb. charge. No electrical outlets were found near these charges.

f. There was an estimated 600-lbs of TNT stacked on all the members which join at point (f). The charges were packed in cardboard boxes whose exact dimensions are unknown. They appeared to be hastily placed and were to be exploded with time fuse and a non-electric cap. The charges upstream detonated and severed the members. On the downstream charge the cap exploded and the primer block was shattered and neighboring blocks disturbed but the charge did not detonate.

g. 1 - 3' x 12" x 10" charge and 1 - 3' x 10" x 6" charge was located on the upstream side of the downstream chord at point (g). 1 - 3' x 12" x 10" charge was on the downstream side of this chord. 1 - 3' x 6" x 12" charge was placed on each stringer. These charges had leads connected to electrical outlets located on the same members. There were no charges on the upstream chord.

A 2' x 12" x 6" charge was placed at the cross point of the wavy braces under the stringers at this point.

j) Same as (g)
 k) Same as (b)
 l) Same as e
 m) Same as c

Various charges were also scattered on the far shore span, the location of which cannot be determined. These appeared to have been placed in great haste and seemingly without scheme or plan.

NOTE: The above information has been obtained by questioning the man who actually removed the explosives from the bridge. Because of enemy action at the time of removal there is doubt about the exact size and location of some of the charges.

When the engineers first arrived on the bridge the master switch, located on the endmost vertical of the far shore span, downstream side was closed. This was opened and the main cable severed before the charges were removed.

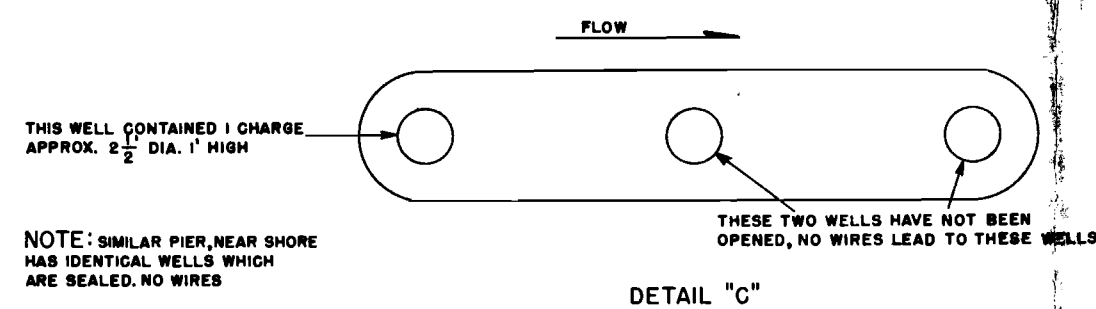

AMOUNTS AND LOCATIONS OF EXPLOSIVES
 LUDENDORF RAILROAD BRIDGE
 REMAGEN, GERMANY
 7 MARCH 1945
 PLATE 45

NOTE: SIMILAR PIER, NEAR SHORE HAS IDENTICAL WELLS WHICH ARE SEALED. NO WIRES

Collapse of the LUDENDORF Railway Bridge (Cont'd).

g. Bridge Traffic.

Before the bridge was closed to traffic for repairs it carried continuous one-way traffic for five days. Some of the vehicles crossed were tanks. Such traffic undoubtedly contributed greatly to the ultimate collapse, however, no traffic had used the bridge for 2 days prior to the collapse.

5. Casualties.

Casualties suffered as the result of the collapse by the two units working on the bridge at the time are:

276th Engineer Combat Battalion

Killed	-	6
Missing	-	11
Died of Wounds	-	3
Wounded	-	57

1058th PG & R Group

Killed	-	1
Missing	-	7
Wounded	-	6

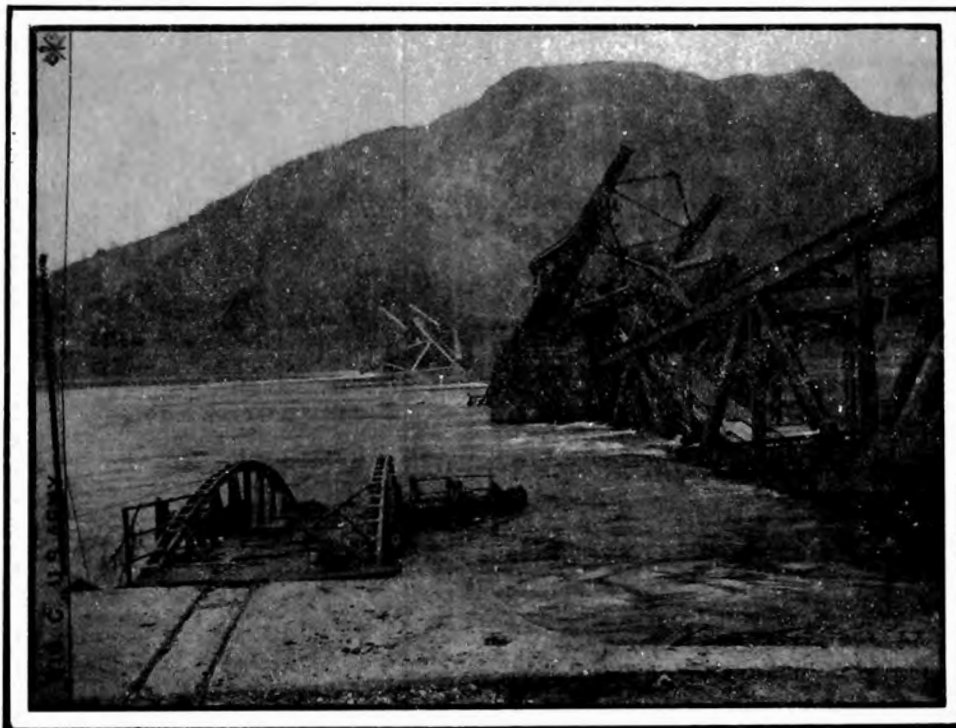
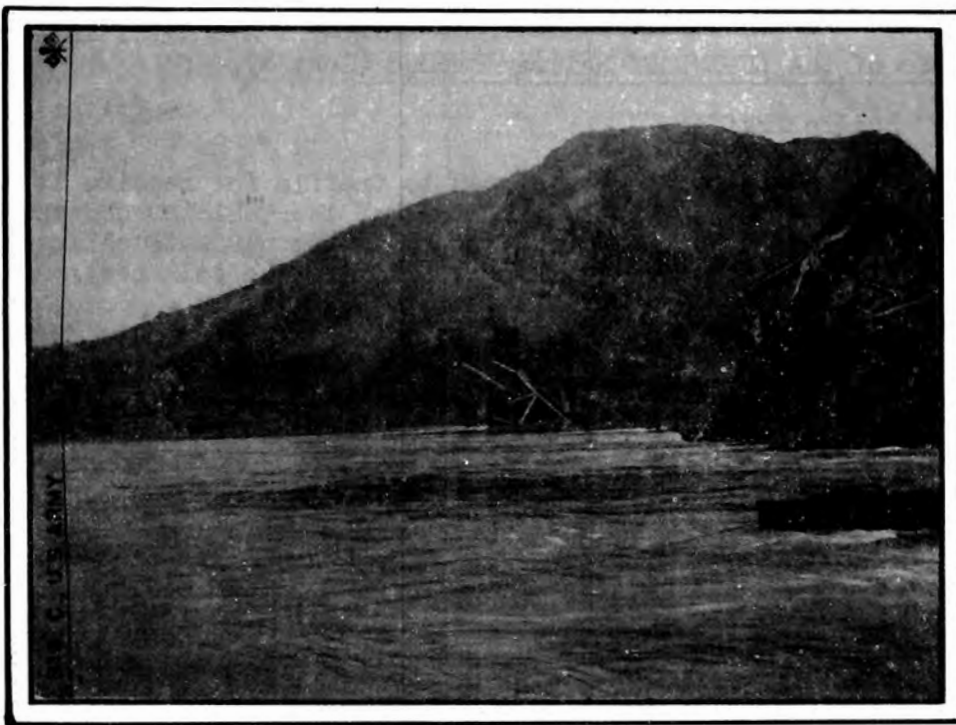

Views of wreckage from a point just downstream from the south abutment.



View of collapsed north span with north pier in the distance.

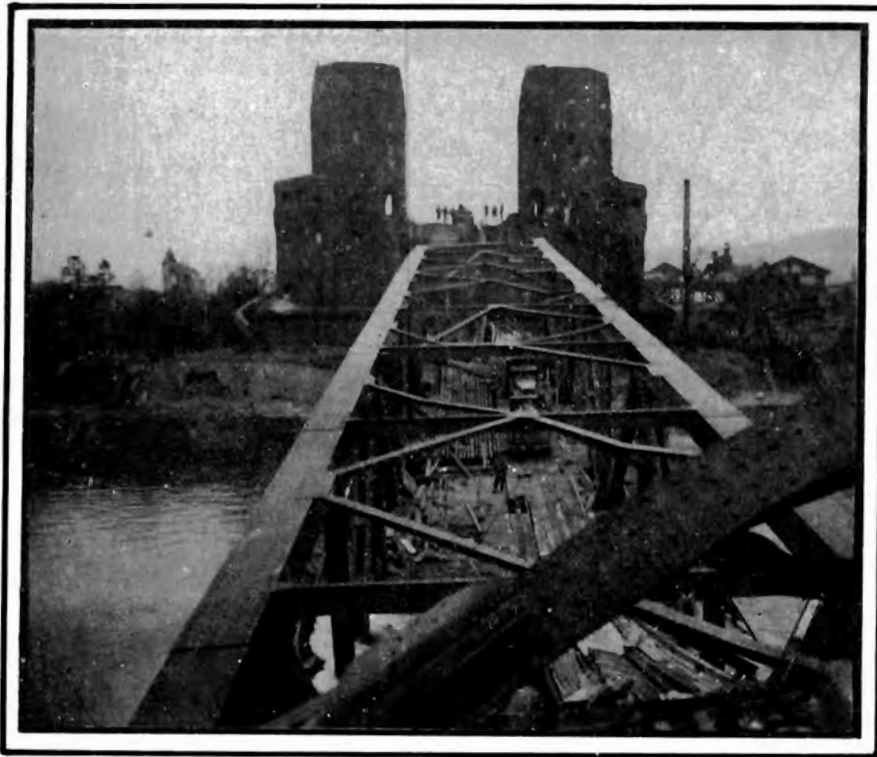

View of collapsed south span from south pier.

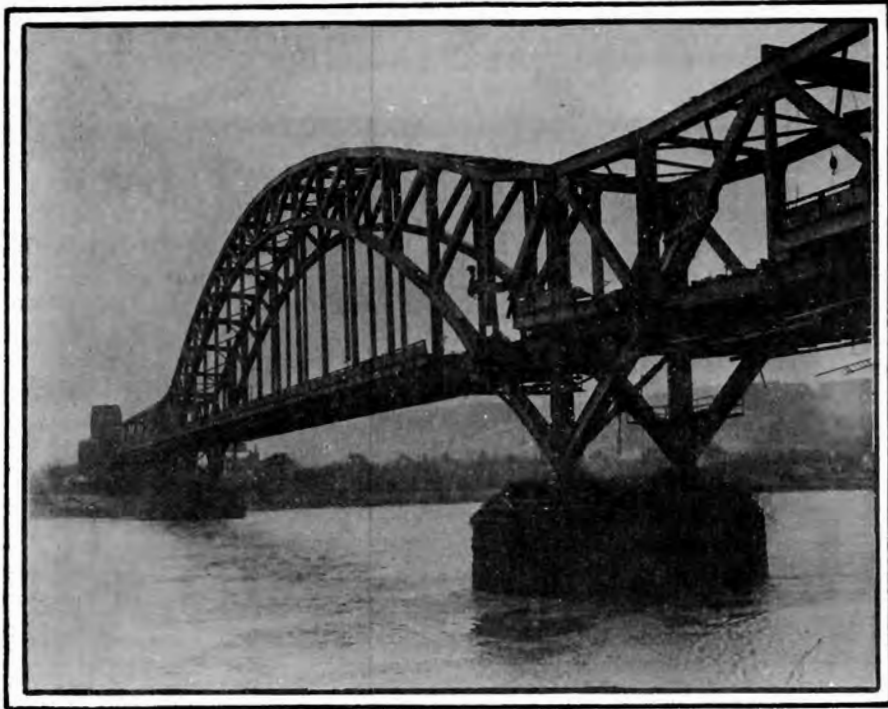

LUDENDORF Railroad Bridge before collapse
NOTE: Damaged panel point, severed hangers
and strain on upper chord.

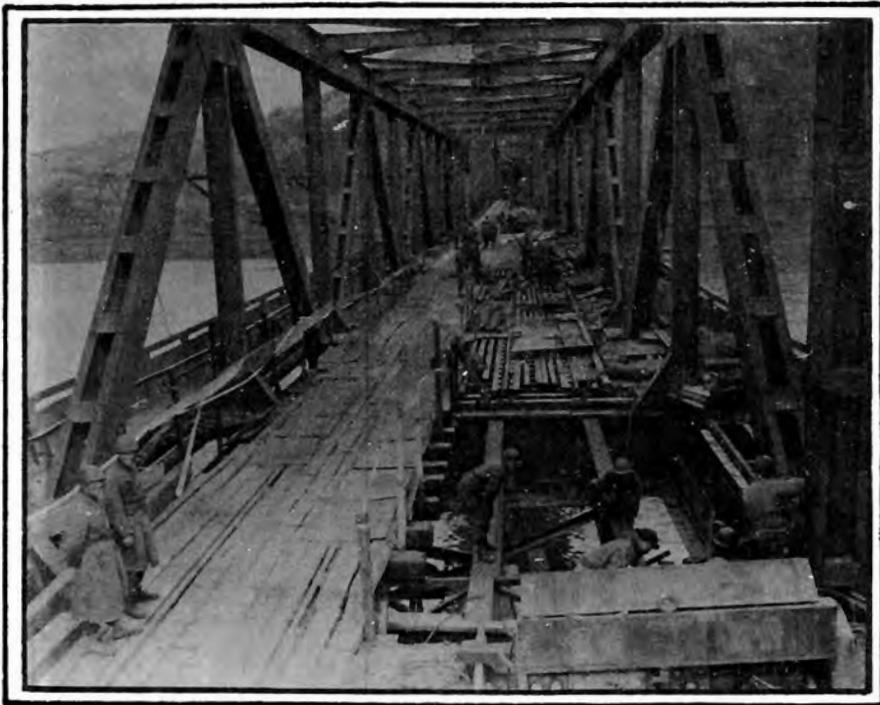

Engineer repair crews working on LUDENDORF
Railroad Bridge just before collapse. View
looking east.

C. Security Precautions.

Source: 1110th Engineer Combat Group.

1. General.

After all tactical bridges over the Rhine had been completed and division and corps engineer units had moved forward in support of the advance, the mission of maintaining and guarding the bridges was given to the 1110th Engineer Combat Group. This mission tied in very closely with the mission of the 49th AAA Brigade, who were responsible for the perimeter defense of the river in the First US Army Sector.

2. Intelligence Instructions.

All possible precautions were taken to guard the bridges and river installations from destruction or damage by the enemy. Enemy attacks could come suddenly and swiftly in any of the following forms:

- a. Air reconnaissance.
- b. Strafing and air bombing.
- c. The dropping of paratroops.
- d. Sabotage by individuals.
- e. Large scale attacks by swimmers.
- f. Small speed boats.
- g. One man torpedoes.
- h. Inflammable fluids.
- i. Floating or submerged mines.
- j. Drifting barges.
- k. Any combination of the above, using one as a diversion to cover the other.

3. Troops.

Troops operationally attached to accomplish the mission were:

a. 5th Engineer Combat Battalion.

- (1) 86th Engineer Heavy Ponton Bn (less Detachments).
- (2) 994th Engineer Treadway Bridge Co (less Detachments).
- (3) Canal Defense Lights, tank mounted - All under operational control of the 49th AA Brigade, but spotted as requested by Engineer Commander concerned. Two were available for each bridge site.
- (4) 2 Quadruple 50 cal. MG's and two 40 mm AA guns, under operational control of 49 AAA Brigade were available at each end of each bridge and would fire a water-borne mission at the request of the Engineer Officer at the bridge.
- (5) Sea Mules, LCVP's, Power Utility Boats, etc. were requested or assigned.

b. 164th Engineer Combat Battalion.

- (1) 552nd Engineer Heavy Ponton Battalion.
- (2) Canal Defense Lights, tank mounted - same as paragraph 4 a (3).
- (3) Same as paragraph 4 a (4). One quadruple .50 cal. MG was available at each end of each set of booms and fired a waterborne mission at the request of the Engineer Officer at the installation.
- (4) 6 Brockway truck loads of M-2 treadway bridge and 19 EM, for maintenance of treadway bridges.

Security Precautions (Continued).

4. Mission of Subordinate Units.

a. 5th Engineer Combat Battalion was given the mission of guarding and maintaining all Rhine River installations from the Class 40 M-2 Steel Treadway Bridge at REMAGEN (inclusive) to BONN (inclusive) effective 290800A March 1945.

b. 164th Engineer Combat Battalion was given the mission of guarding and maintaining all Rhine River installations from the LUDENDORF Railway Bridge at REMAGEN (inclusive) to NEUWIED (inclusive) effective 290800A March 1945.

5. Coordination and Liaison.

a. Both engineer battalions maintained constant liaison with the AA Groups in their areas of responsibility.

b. A troop list, code names and locations of units of the 49 AAA Brigade was given to the engineer units concerned.

6. General Defense Instructions.

a. Bridge Defense.

Bridges were defended in accordance with the following instructions:

- (1) River Banks. Shore defense upstream was accomplished by fixed .30 or .50 cal. MG's with the primary mission of firing on water-borne objects or personnel. Downstream defense was accomplished by listening posts.
- (2) Abutments. These were defended by fire from the bridge guards and traffic inspectors at each end of the bridge and by supporting fire from AAA guns at each end of the bridge on request of the Engineer officer in charge. AAA guns were called upon directly to engage a target.
- (3) Bridge. Sentries were ordered to fire on hostile personnel or vehicles and to permit no civilians and unidentified personnel or vehicles within damaging distance of the bridge.
- (4) River. River defense against any type of floating object or swimmers was accomplished by firing MG's from the upstream bank defenses and sentries at the end of the bridge. Supporting AA fire was available upon request.

b. Protective Booms and Cables.

Defense was conducted as follows:

- (1) A minimum of one NCO and 3 EM were employed as holdfast guards at each end of each boom.
- (2) An outpost was established on the west bank, 200 yards upstream of the Protective Boom Installations at LEUBSDORF, consisting of a .30 cal. MG. This MG fired either water-borne or land attack missions.

Security Precautions (Continued).

- (3) An officer was in charge of net defense and maintenance 24 hours daily.
- (4) Communications were established from outpost, boom to boom, to maintenance hqs. and to Battalion hqs.
- (5) Two Canal Defense Lights, tank mounted, were sited on the north booms at LEUBSDORF, to give the best possible illumination on the river at or near the outpost position.
- (6) One power utility boat was kept between each boom for shore to shore communication and maintenance. An additional boat was placed upstream of the upstream boom.

c. Upstream Security and Depth Charges.

- (1) Depth Charges were dropped upstream of all installations at selected locations. Twenty-five pound charges of TNT were dropped at one-third points in the river at the rate of 2 charges each 5 minutes.
- (2) Three Canal Defense Lights, tank mounted, (one standby) illuminated the depth charge area.
- (3) An OP which reported all suspicious objects by telephone was established above the illuminated area.
- (4) Two MG's were sited on the west bank of the depth charge area to take full advantage of lighting and fired on all suspicious objects. Additional assistance was available for water-borne missions from two quadruple .50 cal. MG's, one on each side of the depth charge area.

d. Miscellaneous.

- (1) The upstream MG post immediately notified the Engineer Officer in charge of the installation of the approach of enemy personnel, vehicles or floating objects.
- (2) Slit trenches to accommodate all personnel were dug near the approaches to bridges and so sited that in the event of attack observation of installation defenses could be maintained.
- (3) Engineer personnel were instructed not to fire air missions.
- (4) In the event of air attack and firing of an uncontrolled barrage by AAA personnel were instructed to take protection.
- (5) Canal Defense Lights, tank mounted, were sited to give the best possible lighting of the river at a point near bridge outposts. Sixty inch searchlights could be called to track any object picked up by Canal Defense Lights. All lights would remain lit in case of air attack.

Security Precautions (Continued).

- (6) Civilians were not permitted near or on the bridges and defensive installations.
- (7) Identification and vehicle checking were accomplished by the Military Police, however, bridge guards had the authority to stop and check any vehicle and its cargo.
- (8) Vehicles were kept moving on the bridge. Speed limits and intervals were:

<u>Trucks</u>		<u>Tanks</u>	
Speed	- 15 MPH	Speed	- 5 MPH
Interval	- 30 yds	Interval	- 100 yds

- (9) Personnel carried gas masks, sleeve detectors and rifles. Personnel on the bridge or in boats were equipped with life preservers.
- (10) In the event barrage balloons VLA were shot down, demolition charges on the guy lines were not to be touched. These would be neutralized by the British who were in charge of the balloons.
- (11) Smoke, when determined necessary by the 49 AAA Brigade, would be used on bridges if they were attacked by jet-propelled aircraft and other means of defense failed.
- (12) The Engineer officer in charge of the installation notified his Battalion Headquarters by telephone or radio immediately where and when any unusual conditions occurred.
- (13) Incendiary bullets were used when firing at any objects in the river.

7. General Maintenance.

a. Bridges were staffed with adequate and capable maintenance personnel under officer supervision to insure that no failures occurred due to neglect. In the event any part was falling, immediate steps were taken to declare the structure unsafe, traffic stopped and necessary repairs accomplished at once.

b. Maintenance Personnel.

(1) Engineer Traffic Control.

One EM was stationed at each end of each bridge. His duties were:

- (a) Maintain a 24 hour traffic count.
- (b) Divert, with MP assistance, all traffic which was too heavy for the bridge.
- (c) Control all heavy traffic to insure maintenance of proper speeds and intervals.

Security Precautions (Continued).

(d) Assist MP's in apprehending suspicious looking vehicles before they crossed the bridge.

- (2) Heavy Ponton Bridges were maintained by personnel of the 86th and 552nd Engineer Heavy Ponton Bns. One platoon was employed as a 24 hour maintenance crew.
- (3) Treadway Bridges were maintained by personnel of the 99th Engineer Treadway Bridge Co. One officer and two squads were necessary to perform 24 hour maintenance.
- (4) Bailey Bridges were maintained by personnel of the responsible maintenance unit. One platoon was required as a 24 hour maintenance crew.

c. Maintenance Duties, Bridge Officer. The bridge officer was responsible for the following:

- (1) Approaches were ditched and gravelled.
- (2) Stockpiles of gravel were on hand.
- (3) Guide rails and approach fences were painted white.
- (4) Traffic signs were properly posted and maintained.
- (5) Traffic instructions were observed.
- (6) During air attacks, vehicles on the bridge kept moving and vehicles on approach roads dispersed.
- (7) Floating debris was guided through the bridge or lifted over the bridge.
- (8) Holdfasts, deadmen and anchor cables were inspected.
- (9) Adequate stocks of replacement parts were available.
- (10) "Bridge Out" and "Detour" signs were available, if the bridge should become impassable.

d. Bridge Maintenance.

Bridges were inspected and necessary repairs, adjustments or replacements immediately accomplished. In order to insure that all precautions against bridge failures were taken, a maintenance check list for each type of bridge was made.

- (1) Heavy Ponton Bridge.
 - (a) Inspect chess, balk, sills and side rails for damaged parts.
 - (b) Inspect and tighten side rail clamps.
 - (c) Inspect pontoons for leaks.
 - (d) Tighten anchor cables, bridle and guy lines.

Security Precautions (Continued).

(2) M-2 Treadway Bridge.

- (a) Insure air pressure of 2 pounds per square inch in floats.
- (b) Inspect connecting pins.
- (c) Tighten anchor cables, bridle and guy lines.
- (d) Inspect treadway retainers.
- (e) Examine saddle straps.

(3) Floating Bailey Bridge.

- (a) Oil hinges on end posts.
- (b) Inspect bolts holding rakers and bracing frames.
- (c) Tighten tie plates.
- (d) Oil panel pins.
- (e) Tighten transom clamps.
- (f) Inspect wooden deck and hub guards.
- (g) Inspect floats for leaks.

(4) Protective Booms.

- (a) Collect debris on nets when necessary.
- (b) Keep all power boats at the site.
- (c) Keep adequate repair materials available.

e. Fire Prevention.

- (1) One bag of sand was placed between the treads on every fifth ponton on the Bailey and Heavy Ponton bridges.
- (2) Foamite extinguishers, one per three pontons, were placed on all bridges.

f. Floating Equipment. Utility boats, LCVP's and Sea Mules were available at each installation manned by qualified operators. Boat personnel wore life belts at all times.

g. Reports. Immediate reports concerning the breakdown of any installation were submitted through Bn. Hqs to the 1110th Engineer Combat Group.

8. Communications.

a. Telephone communication were established from each river installation site to the Bn. Hqs. concerned and to the 1110th Engineer Combat Group.

Security Precautions (Continued).

b. Radio communication was an alternate communication means.

c. Additional communication was available through the 49 AAA Brigade which had both phone and radio communication from each gun position at the bridges and mine booms through the Bn. & Group Hqs. The 1110th Engineer Combat Group was in the 49th AAA Brigade Communication Net.

d. Code names for all river installations and bridges were issued separately.

9. Reports.

a. Routine reports concerning status of all bridges, booms and defensive installations where no action or incident had occurred were reported by telephone to 1110th Engineer Combat Group every six hours at 0600A, 1200A, 1800A and 2400A hours.

b. When an incident or action had occurred, the incident or action was reported to 1110th Engineer Combat Group by the fastest possible means and confirmed by written message.

10. Enemy Swimming Attack Against Remagen Bridges.

a. General.

On the night of 17-18 March enemy swimmers made an attempt to destroy the REMAGEN Bridges. This mission was to have been accomplished by combat swimmers towing explosive charges, however, the river defenses successfully drove the attackers from the water. The four attackers, one of whom died of wounds, were captured by the 164th Engineer Combat Battalion and 14th Cavalry Group. On the night of 19-20 March another swimmer was captured by the 94th Signal Battalion.

b. Plan of Attack.

The primary mission of the enemy was the destruction of the LUDENDORF Railway Bridge at REMAGEN using two large torpedo shaped charges. When they had learned that the LUDENDORF Bridge had collapsed, the mission was changed to the destruction of the Reinforced Heavy Ponton Bridge at KRIPP, using plastic charges on the anchor cables.

The swimmers entered the water from an island (F 7208) just north of HAMMERSTEIN. They were to swim downstream, attach their charges, which were set to detonate at 180130A March 1945 to the bridge anchor cables, and then continue swimming downstream to RÜMLINGHOVEN (F 6034) where two of their comrades would assist them out of the water.

c. Failure of the Attack.

The enemy swimmers were driven ashore by small arms fire on the river, their inability to escape the lights and the terrific underwater concussion of explosives, which were dropped specifically for their apprehension. They went ashore in an effort to proceed to the bridge by land but were captured by guards and patrols.

D. Bridge Equipage Supply.

1. General.

a. Rhine River crossing plans were made during the months of September and October 1944 and continually revised until the actual crossing. These plans were primarily made to establish bridge equipage requirements, provide experience to constructing units and requisition necessary equipment.

b. On the date of the capture of the LUDENDORF Railroad Bridge at REMAGEN, Germany, 7 March 1945, bridge equipage for the Rhine crossings was almost completely assembled. Bridge supplies available on this date were:

<u>Number and Type</u>	<u>In Place</u>	<u>With Units</u>	<u>In Dumps or Depots</u>
Bailey Bridge, 130' DD	32.4	10.5	20
Bailey Bridge, floating, 1300'	0	0	4 *
Steel Twy, M-2	2.19	2.81	3
Heavy Ponton, 25 ton	0	12	9

* 2 Class 40, 2 Class 70

Also available was miscellaneous heavy equipment and supplies such as timber piles, I beams (for timber trestle bridge), NL Pontons, Anti-torpedo nets, Protective booms, 4-skid rig pile drivers, Sea Mules, LCVP's, wire cable, rope, cranes, power utility boats, storm boats, etc.

c. The capture of the LUDENDORF Bridge at REMAGEN on 7 March 1945 was unexpected, hence at the time of the capture, stream crossing equipment was not in the advancing columns in sufficient quantity to support a crossing. M-2 Steel Treadway companies were loaded but not at the site of the crossing. The 998th Engineer Treadway Bridge Company arrived at the proposed bridge site in REMAGEN on 100830A March 1945, roughly 2½ days after the capture of the bridge and approximately 20 to 24 hours after they had been ordered to move. This delay in movement was caused by traffic congestion, artillery shelling and darkness. The Heavy Ponton battalions at the time of the capture were completely unloaded and engaged in the routine job of hauling supplies for Engineer Depots. The 86th Engineer Heavy Ponton Battalion had completed a routine move to a new command post in the vicinity of STOLBERG, Germany on 7 March 1945. After unloading approximately 50% of their equipment, orders were received at 072000A March 1945 alerting the battalion for immediate movement to the vicinity of SINZIG to support the III Corps crossings. The main body arrived in SINZIG at about 082000A March 1945, approximately 24 hours from the time of the alert. The following day at about 091030A March 1945 and roughly 43 hours after the capture of the LUDENDORF Railroad Bridge, the first ferries were put into operation. Considering the factors involved, this time was excellent.

d. Depot stocks of M-2 Steel Treadway, 25 ton Heavy Ponton, floating Bailey bridge, semi-permanent crossing equipment and protective boom material were located at the First US Army Engineer Depots E-7 at MONTZEN, Belgium (K 745370) and E-8 at LEUZE (J 997215). As quickly as the 86th, 181st and 552nd Engineer Heavy Ponton Battalions unloaded their bridge at the ferry and bridge sites in the III Corps crossing zone, the semi-trailers were dispatched back to Engineer Depot E-7 for reloading. 10 additional units of heavy ponton bridge were loaded and dispatched to the VII Corps crossing zone. M-2 Steel Treadway units were similarly dispatched to Engineer Depot E-7 for reloading. 6 additional units of M-2 Treadway Bridge were loaded and dispatched for use in the VII and V Corps crossing zones.

Bridge Equipage Supply (Continued).

2. Transportation of Bridge Equipment.

a. Distances from Depots to REMAGEN (Bridgehead) and WEILLERSWIST (Bridge Park) Germany were as follows:

<u>Depot Location</u>	<u>Distances to WEILLERSWIST</u>
E-7, MONTZEN, K 745370	50 miles
E-8, LEUZE, J 997215	140 miles
	<u>REMAGEN</u>
E-7, Same as above	90 miles
E-8, Same as above	180 miles

b. The 1160th Engineer Combat Group was given the mission of transporting floating Bailey Bridge from the Depots to bridge parks at WEILLERSWIST (F 3941) and LIBLAR (F 3547) which were selected and operated by the 1110th Engineer Combat Group and its attached units.

In order to accomplish this transportation mission, the following units were attached to supply transportation.

4257 QM Truck Co (ADSEC)
4258 QM Truck Co (ADSEC)
3807 QM Truck Co (ADSEC)
3811 QM Truck Co (ADSEC)

Each QM Truck Company was equipped with approximately forty-eight 10 ton Diesel trucks or 10 ton semi-trailers and prime movers. Bridge hauling started on 12 March 1945 and the necessary equipment was in the bridge park by 28 March 1945. A total of 6130 tons of bridge equipment were hauled during the period. This was sufficient for 2- Class 40 and 2- Class 70 floating Bailey bridges. Actually only one Class 40 Bailey bridge was built. Remaining equipment was either used for a dual carriageway barge Bailey bridge or held as a reserve. Eventually much of this material was turned over to Advance Section, Com Z.

c. Special transportation problems were the hauling of LCVP's, Sea Mules, NL Pontons, Skid Rig Pile Drivers, etc. These were satisfactorily transported as follows:

- (1) LCVP's on 20 ton Engineer Flatbed trailers, and Heavy Ponton semi-trailers.
- (2) Sea Mules Half Sections on 16 ton Engineer Flatbed trailers.
- (3) NL Pontons on 2½ ton trucks.
- (4) Skid Rig Pile Drivers on 20 ton Engineer Flatbed trailers.
- (5) Protective River Booms, such as Anti-Mine Nets, Wire Cable, Impact Booms, Anchors and Floats were transported on 2½ ton trucks of the 164th Engineer Combat Battalion, the constructing unit.

d. Due to the poor road net on the west bank it was decided not to construct the timber trestle bridge, for which plans had been made and material assembled. This eliminated the necessity of hauling semi-permanent bridge materials and equipment from the Depots.

Bridge Equipage Supply (Cont'd).

3. Bailey Bridge Park.

a. The Bailey Bridge Park in the vicinity of WEILERSWIST, Germany, was operated by the 148th Engineer Combat Battalion, 207th Engineer Combat Battalion and 1264th Engineer Combat Battalion of the 1110th Engineer Combat Group.

b. Bridge equipment was unloaded and dispersed along the road net of the bridge park. Separate areas for Class 40 and Class 70 equipage were established. All equipment was stacked so that all bridge sections were in one stack, i.e., Shore landing bay equipage, River landing bay equipage, Floating bay equipage, etc.

c. The Bridge park road net was one way in the Class 40 and 70 parks with one two-way road passing between the parks. All of the terrain in the park was flat, agricultural farmland offering very little cover. Camouflage was an immediate problem. The mission of camouflaging the bridge park was given to the 602d Engineer Camouflage Battalion, who after a study of the park, coordinated a camouflage plan with the 1110th Engineer Combat Group. Most of the bridge stacks were camouflaged to resemble the earthen sugar beet piles, which were numerous throughout the area. Other bridge stacks were irregularly shaped and made to conform to the local pattern and color.

E. Personalities.

1. The period of time from the capture of the LUDENDORF Railroad Bridge at REMAGEN, Germany, to the final tactical crossing of Rhine River in the First US Army area is one of the most important, as well as interesting operations during the current campaign. A technical report of the crossings without including a chapter concerning the persons involved in the operation, would be incomplete. In many instances, as in the capture of the LUDENDORF Railroad Bridge, the courageous and quick action of the persons involved resulted in the complete success of the operation with a minimum of casualties.

2. The following personnel were directly involved in the various crossing operations:

a. Capture of LUDENDORF Railway Bridge.

- (1) Brigadier General William M. Hoge - CG, Combat Command B, 9th Armored Division, who ordered the crossing over the LUDENDORF Railway Bridge.
- (2) Lt. Col. Leonard Engamen - CO, 14th Tank Bn, 9th Armored Division, who was commander of the leading elements to seize and cross the bridge.
- (3) Lt. Hugh B. Mott, CO, 2nd Plat., Co "B", 9th Armored Engineer Bn.
S/Sgt. John A. Reynolds, Plat. Sgt., 2nd Plat., Co "B", 9th Armored Engineer Bn.
Sgt. Eugene Dorland, Squad Sgt., 2nd Plat., Co "B", 9th Armored Engineer Bn.
The above officer and NCO's were the first party to cross the bridge as an engineer reconnaissance team. As they proceeded across, they cut all communications and demolition wires, and neutralized all charges in sight. While they were working on the bridge, Co "A", 27th Infantry Regt. crossed to start establishing the bridgehead.
- (4) Col. F. H. Lyons, Engineer, III Corps, who formulated III Corps Rhine Crossing plans after the capture of the LUDENDORF Railway Bridge.
- (5) Col. Harry W. Anderson, CO, 1111th Engineer Combat Group. Commander of units who constructed the M-2 Treadway Bridge at REMAGEN and Reinforced Heavy Ponton Bridge at KRIPP.
- (6) Col. K. E. Fields (then Lt. Col.), 1159th Engineer Combat Group, Commander of units who maintained and repaired LUDENDORF Railway Bridge, REMAGEN, Germany.

b. Heavy Ponton Ferries.

- (1) Lt. Col. Robert O. Haas, CO, 86th Engineer Heavy Ponton Bn. Commander of troops operating heavy ponton ferries for III Corps.

c. DUKW and LCVP Ferries.

- (1) Lt. Wilton Wenker, U.S. Navy, CO, LCVP Unit No. 1, U.S. Navy. Commander of detachments which operated LCVP's for units constructing river crossing installations.

Personalities (Continued).

d. M-2 Steel Treadway Bridge, REMAGEN.

- (1) Lt. Col. David E. Pergrin, CO, 291st Engineer Combat Bn.
Commander of units constructing M-2 Steel Treadway Bridge.
- (2) Capt. Gene E. Hancock, CO, 998th Engineer Treadway Bridge Co.
- (3) Capt. Towner K. Webster, CO, 988th Engineer Treadway Bridge Co.

e. Reinforced Heavy Ponton Bridge, KRIPP.

- (1) Lt. Col. Harvey R. Fraser, CO, 51st Engineer Combat Bn.
Commander of units constructing Reinforced Heavy Ponton Bridge.
- (2) Lt. Col. Clarence F. Martin, CO, 181st Engineer Heavy Ponton Bn.
- (3) Major William F. Tompkins, Jr., CO, 552nd Engineer Heavy Ponton Bn. Killed by enemy bombing during construction of the Reinforced Heavy Ponton Bridge at LINZ. Bridge was dedicated as TUMPKINS Bridge.
- (4) Major James A. Hughes, CO, 552nd Engineer Heavy Ponton Bn. Assumed command when Major Tompkins was killed at the bridge.

f. Class 40 Bailey Bridge.

- (1) Lt. Col. William B. Irby, CO, 148th Engineer Combat Bn.
Commander of units constructing the Class 40 Floating Bailey Bridge.

g. General Situation.

- (1) Colonel Mason J. Young, Engineer, VII Corps. Planned and supervised crossing of VII Corps.
- (2) Colonel Robert Erlenkotter, CO, 1106th Engineer Combat Group. Commander of troops constructing M-2 Steel Treadway Bridge BONN.
- (3) Lt. Col. John G. Schermerhorn, CO, 1120th Engineer Combat Group. Commander of troops constructing Reinforced Heavy Ponton Bridge at KONIGSWINTER and M-2 Steel Treadway Bridge at ROLANDSECK.

h. M-2 Steel Treadway Bridges.

- (1) Lt. Col. Herschel E. Lynn, CO, 237th Engineer Combat Bn.
Commander of troops constructing M-2 Steel Treadway Bridge at BONN.
- (2) Capt. Harvey C. Prine, CO, 990th Engineer Treadway Bridge Co.
- (3) Capt. Towner K. Webster, CO, 988th Engineer Treadway Bridge Co.
- (4) Lt. Col. Julian P. Fox, Jr., CO, 297th Engineer Combat Bn.
Commander of troops constructing M-2 Steel Treadway Bridge at ROLANDSECK.

Personalities (Continued).

i. Reinforced Heavy Ponton Bridge.

- (1) Lt. Col. Charles A. Grennan, CO, 294th Engineer Combat Bn. Commander of troops constructing Reinforced Heavy Ponton Bridge at KONIGSWINTER.

j. General Situation.

- (1) Colonel Lewis C. Patillo, Engineer, V Corps. Planned and supervised crossings of V Corps.
- (2) Colonel Robert K. McDonough, CO, 1121st Engineer Combat Group. Commander of troops constructing M-2 Steel Treadway Bridge at HONNINGEN.

k. M-2 Steel Treadway Bridge.

- (1) Lt. Col. Loren A. Jenkins, CO, 254th Engineer Combat Bn. Commander of troops constructing M-2 Steel Treadway Bridge at HONNINGEN.
- (2) Capt. John J. Pearse, CO, 994th Engineer Treadway Bridge Co.
- (3) Capt. Gene E. Hancock, CO, 998th Engineer Treadway Bridge Co.

l. Protective River Booms.

- (1) Lt. Col. Harry F. Cameron, Jr., CO, 164th Engineer Combat Bn. Commander of troops constructing protective river booms.
- (2) 1st Lt. William J. Johnson, CO, Det. 329th Harbor Craft Co. Commander of Sea Mule Detachment.

m. Collapse of LUDENDORF RR Bridge.

- (1) Lt. Col. Clayton A. Rust, CO, 276th Engineer Combat Bn. Commander of troops repairing the LUDENDORF Railway Bridge.

n. Security Precautions.

- (1) Colonel John T. O'Neill, CO, 1110th Engineer Combat Group. Commander of security and maintenance troops on all First Army Rhine River installations.
- (2) Lt. Col. Charles C. Holbrook, CO, 5th Engineer Combat Bn.
- (3) Lt. Col. Harry F. Cameron, Jr., CO, 164th Engineer Combat Bn.

o. Bridge Equipage Supply.

- (1) Lt. Col. Jackson Graham, CO, 1160th Engineer Combat Group. Commander of Engineer Supply Service Group, First US Army.
- (2) Major Arthur H. Lahlum, CO, 1264th Engineer Combat Bn.
- (3) Lt. Col. Robert E. Kearney, CO, 602nd Engineer Camouflage Bn.

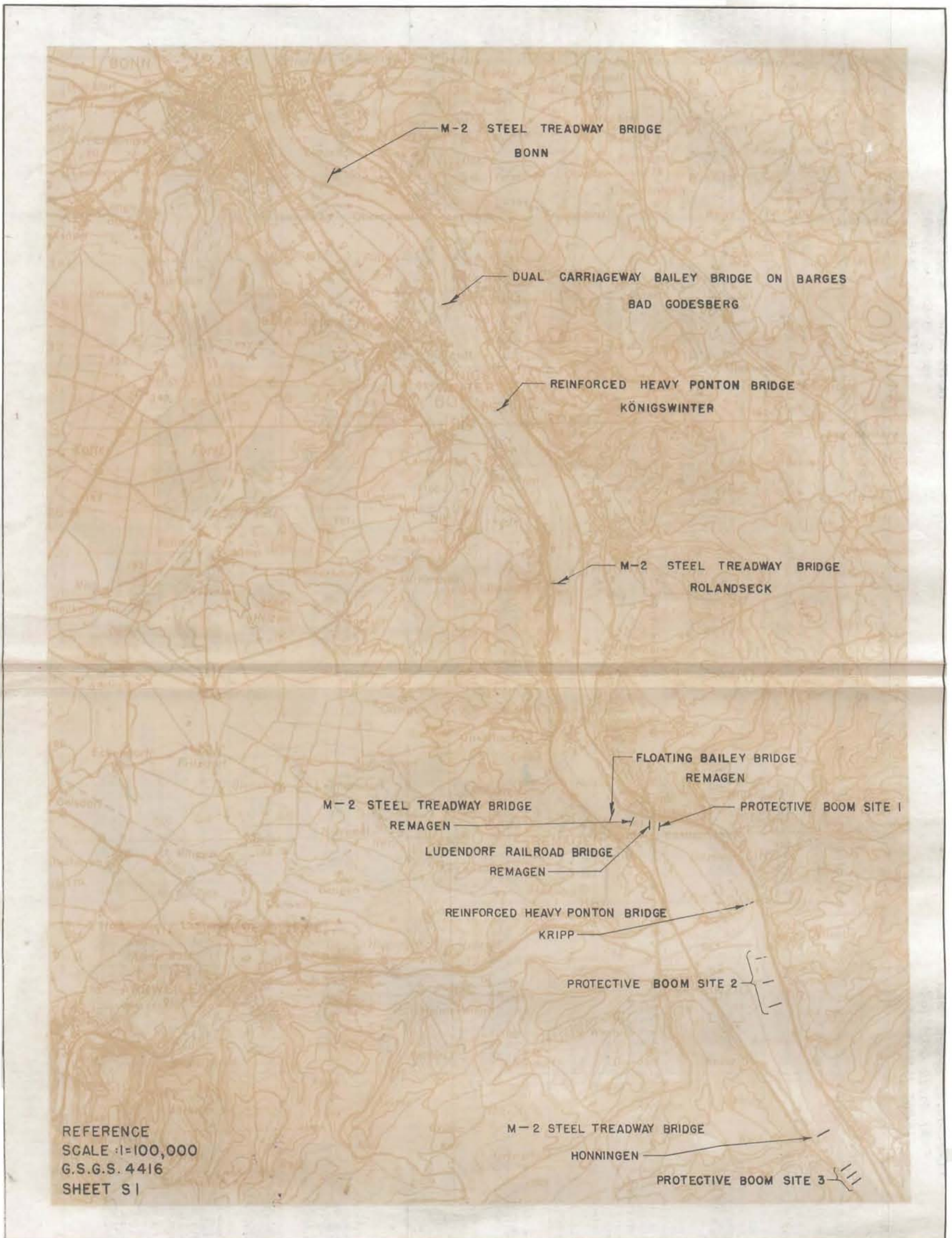

ANNEX 2
RELATIVE LOCATIONS
BRIDGES AND BOOMS

ANNEX I
COMPARATIVE BRIDGE CHART
RHINE RIVER CROSSINGS
FIRST U. S. ARMY

ANNEX I
COMPARATIVE BRIDGE CHART
RHINE RIVER CROSSINGS
FIRST U. S. ARMY

	III CORPS			VII CORPS			V CORPS	ARMY CROSSING
1. LOCATION	REMAGEN (F647205)	KRIIPP (F675182)	REMAOEN (F644205)	ROLANDECK (F628260)	KONIGSWINTER (F614302)	BOHN (F573557)	HONNINGEN (F694127)	BAD GODESBERG (F600326)
2. TYPE	STANDARD M-2 STEEL TREADWAY CLASS 40	REINFORCED HEAVY PONTON, CLASS 36	SINGLE SINGLE STANDARD BAILEY BRIDGE, CLASS 40	STANDARD M-2 STEEL TREADWAY, CLASS 40	REINFORCED HEAVY PONTON, CLASS 36	STANDARD M-2 STEEL TREADWAY, CLASS 40	STANDARD M-2 STEEL TREADWAY, CLASS 40	DUAL CARRIAGEWAY BAILEY BRIDGE ON BARGES.
3. LENGTH	1032 FT.	969 FT.	1258 FT.	1128 FT.	1145 FT.	1308 FT.	1368 FT.	1173 FT.
4. TROOPS	291 ENGR C BN 998 ENGR TWDY BR CO 988 ENGR TWDY BR CO	51 ENGR C BN 181 ENGR HV PON BN 552 ENGR HV PON BN DET LCVP UNIT NO.1 U S NAVY	148 ENGR C BN 291 ENGR C BN DET LCVP UNIT NO.1 U S NAVY	297 ENGR C BN CO "B", 294 ENGR C BN 988 ENGR TWDY BR CO 990 ENGR TWDY BR CO DET, LCVP UNIT NO 1, U S NAVY 80 CML SMOKE GEN CO	294 ENGR C BN 181 ENGR HV PON BN 86 ENGR HV PON BN 552 ENGR HV PON BN DET, LCVP UNIT NO 1, U S NAVY 80 CML SMOKE GEN CO 79 CML SMOKE GEN CO	237 ENGR C BN CO "E" 23 ARMED ENGR BN 990 ENGR TWDY BR CO DET, LCVP UNIT NO 1, U S NAVY 80 CML SMOKE GEN CO 79 CML SMOKE GEN CO.	254 ENGR C BN 994 ENGR TWDY BR CO 998 ENGR TWDY BR CO DET 990 ENGR TWDY BR CO 631 ENGR LT EQUIP CO 1368 ENGR DUMP TRUCK CO DET, LCVP UNIT NO 1, U S NAVY.	1110 ENGR C OP 148 ENGR C BN 207 ENGR C BN 1264 ENGR C BN 631 ENGR LT EQUIP CO 1368 ENGR DUMP TRUCK CO DET, LCVP UNIT NO 1 DET, 329 HARBOR CRAFT CO
5. RIVER STAGE, COLOGNE	37.4 IN ABOVE MEAN (APPROXIMATE)	37.4 IN ABOVE MEAN	26 IN ABOVE MEAN	36.5 IN ABOVE MEAN	30.6 IN ABOVE MEAN	25 IN ABOVE MEAN	22 IN ABOVE MEAN	36 IN ABOVE MEAN
6. RIVER VELOCITIES	5 FT PER SECOND	6 TO 8 FT PER SECOND	6.5 FT PER SECOND	4 TO 6 FT PER SECOND	5 TO 6 FT PER SECOND	4 TO 7 FT. PER SECOND	5 TO 6 FT PER SECOND	6.5 FT PER SECOND
7. RIVER BED	GRAVEL	GRAVEL	GRAVEL AND SAND	GRAVEL	GRAVEL	SAND AND GRAVEL	GRAVEL	GRAVEL
8. NO. FLOATING SPANS	84	55	32 (FLOATING BAYS)	90	72	107	112	6 - 100 FT FLOATING BAYS
9. NO. TRUSS SPANS	2 (LANDING BAY)	5	2 (LANDING BAYS - 90' & 80')	2	2	2 (LANDING BAY)	2 (LANDING BAY)	2 - 80 FT END FLOATING BAYS 2 - 90 FT RING LANDING BAYS
10. NO. HINGE SPANS	NONE	2	2 (END FLOATING BAYS)	2	2	NONE	NONE	2 - 110 FT SHORE LANDING BAYS
11. CONSTRUCTION METHOD	FROM WEST SHORE. SINGLE FLOAT RAFTS PLACED WITH POWER UTILITY BOATS.	FROM WEST SHORE. NORMAL CONSTRUCTION BY PARTS USING 4-BOAT 3 BAY RAFTS. TWO POWER UTILITY BOATS USED TO PLACE RAFTS.	FROM BOTH BANKS. STANDARD CONSTRUCTION LCVP USED FOR PLACING 30 FOOT FLOATING SECTIONS IN POSITION.	FROM BOTH BANKS SINGLE FLOAT RAFTS PLACED WITH UTILITY POWER BOATS.	FROM BOTH BANKS FOUR BOAT RAFTS PLACED WITH LCVP'S. REINFORCING FLOATS PLACED WITH POWER UTILITY BOATS.	FROM EAST BANK. SINGLE FLOAT RAFTS PLACED WITH POWER UTILITY BOATS.	FROM BOTH BANKS. SINGLE FLOAT RAFTS PLACED WITH POWER UTILITY BOATS.	FROM BOTH BANKS. ALL FLOATING BAYS WERE COMPLETELY CONSTRUCTED, THEN TOWED INTO PLACE BY TUGS. TRUSSES WERE JACKED UP AND PINS DRIVEN INTO PLACE.
12. ANCHORAGE	STANDARD 100 POUND ANCHORS. GUY LINES TO QUARTER POINTS UPSTREAM; TO THIRD POINTS DOWNSTREAM. BRIDLE CABLE SUPPORTED ON TREADWAY FLOATS. ANCHOR TO BRIDLE CABLE FROM EVERY THIRD FLOAT.	STANDARD 150 POUND ANCHORS PER PONTON UPSTREAM. IN MAIN CHANNEL STANDARD ANCHORS REPLACED BY COMBINATION OF BARGE ANCHORS (500 lb.) AND TWO STD ANCHORS LASHED TOGETHER GUY LINES TO DEADEN. BRIDLE LINE UPSTREAM TO EVERY FOURTH PONTON. STANDARD ANCHOR DOWNSTREAM FROM EVERY THIRD PONTON.	TWO 150 LB ANCHORS PER PONTON UPSTREAM. ONE 150 LB ANCHOR PER PONTON DOWNSTREAM. GUY LINES UPSTREAM FROM SIXTH POINTS OF BRIDGE. GUY LINES DOWNSTREAM FROM QUARTER POINTS OF BRIDGE. FIVE 1500 LB KEDGE ANCHORS UPSTREAM AT SIXTH POINTS. TWO ROCK FILLED RIVER BARGES UPSTREAM AT THIRD POINTS. HOLDING GUY LINES TO SEVENTH POINTS OF BRIDGE.	100 POUND ANCHOR, 300 FT ANCHOR LINE PER SECTION. GUY LINES. BRIDLE LINES TO ANCHORED 1 INCH CABLE. BRIDE LINES TO 7 ANCHORED PONTONS. DOWNSTREAM ANCHOR EVERY FOURTH SECTION.	150 POUND OR HEAVIER (300 LB) ANCHOR PER PONTON. GUY LINES. THREE BAILEY PANEL RUBBLE BOX. DOWNSTREAM ANCHOR EVERY SECOND PONTON.	STANDARD 100 POUND ANCHOR BOTH UPSTREAM AND DOWNSTREAM ON EACH SECTION. GUY LINES. BAILEY PANEL FLUXE ANCHORS AND HEAVY BARGE ANCHORS REPLACED 100 POUND UP-STREAM ANCHORS ONE FOR EVERY THREE SECTIONS.	100 POUND ANCHOR PER SECTION. SINGLE FLOAT RAFTS PLACED WITH POWER UTILITY BOATS. BRIDLE LINES TO 1 1/4 IN WIRE CABLE SUPPORTED ON 7 ANCHORED FLOATS. DOWNSTREAM ANCHOR EVERY 4TH SECTION.	BARGE ANCHORS DROPPED UP-STREAM AND DOWNSTREAM DEMOLISHED. SCRAP LADEN BARGES ON 250 FT. CENTERS. PROVIDED FURTHER ANCHORAGE. SHORE GUY LINES TO FIFTH POINTS UPSTREAM AND QUARTER POINTS DOWNSTREAM.
13. EQUIPMENT USED	4 - MOTORIZED CRANES 6 - AIR COMPRESSORS 6 - POWER UTILITY BOATS 5 - D-7 DOZERS 4 - R-4 DOZERS 1 - ELECTRIC ARC WELDER	4 - MOTORIZED CRANES 5 - POWER UTILITY BOATS 3 - AIR COMPRESSORS 2 - R-4 DOZERS	5 - CRANES (LOADING SITE) 5 - MOTORIZED CRANES (BR SITE) 2 - POWER UTILITY BOATS 2 - LCVP 2 - D-7 DOZERS 2 - CIVILIAN RIVER TUGS 90 - 2 1/2 TON TRUCKS (FOR HAULING BRIDGE)	5 - MOTORIZED CRANES 5 - AIR COMPRESSORS 5 - POWER UTILITY BOATS 4 - LCVP 2 - D-7 DOZERS	3 - MOTORIZED CRANES 2 - AIR COMPRESSORS 8 - POWER UTILITY BOATS 13 - LCVP 8 - STORM BOATS 4 - D-7 DOZERS	3 - MOTORIZED CRANES 5 - AIR COMPRESSORS 11 - POWER UTILITY BOATS 7 - LCVP 8 - STORM BOATS 4 - D-7 DOZERS	3 - MOTORIZED CRANES 2 - POWER UTILITY BOATS 2 - LCVP'S. 2 - D-7 DOZERS 1 - R-4 DOZER	9 - MOTORIZED CRANES 9 - ACETYLENE TORCHES 9 - ELECTRIC WELDERS 1 - TUG, STEAM, 150 HP 1 - TUG, STEAM, 75 HP 1 - TUG, DIESEL, 800 HP 1 - TUG, STEAM, 600 HP 1 - TUG, DIESEL, 200 HP 4 - SEAM MULES 4 - STREAM BOATS 4 - DIVERS
14. TIMES START CONSTRUCTION FINISH CONSTRUCTION OPEN TO TRAFFIC OVERALL TIME	100830 A MARCH 1945 111700 A MARCH 1945 111700 A MARCH 1945 32 HOURS 30 MIN	101630 A MARCH 1945 112200 A MARCH 1945 112200 A MARCH 1945 29 HOURS 30 MIN.	180730 A MARCH 1945 200715 A MARCH 1945 201800 A MARCH 1945 58 HOURS 30 MIN.	161930 A MARCH 1945 172000 A MARCH 1945 180800 A MARCH 1945 36 HOURS 30 MIN.	182210 A MARCH 1945 191455 A MARCH 1945 191620 A MARCH 1945 18 HOURS 10 MIN.	210615 A MARCH 1945 211626 A MARCH 1945 211745 A MARCH 1945 11 HOURS 30 MIN.	220800 A MARCH 1945 222000 A MARCH 1945 12 HOURS.	26 MARCH 1945 5 APRIL 1945 11 DAYS.
15. COMMENTS	(1) HEAVY ACCURATE OBSERVED ENEMY ARTILLERY FIRE DELAYED CONSTRUCTION. (2) DEBRIS FROM REMAGEN BRIDGE AND UPSTREAM PROTECTIVE BOOMS DELAYED CONSTRUCTION. (3) FOLLOWING EQUIPMENT DAMAGED BY ENEMY ARTILLERY FIRE. 3 - MOTORIZED CRANES 2 - TREADWAY TRUCKS 2 - AIR COMPRESSORS 32 - PNEUMATIC FLOATS 3 - 2 1/2 TON DUMP TRUCKS (4) BRIDGE CONSTRUCTED WITH DEFINITE UPSTREAM BOW. (5) TOTAL CASUALTIES WERE 35	(1) UNOBSERVED ENEMY ARTILLERY FIRE DELAYED CONSTRUCTION. (2) ANCHORAGE WITH STANDARD ANCHORS WAS NOT SUFFICIENT. HEAVIER ANCHORS, GUY LINES AND BRIDLE LINES WERE USED. (3) SUNKEN BARGES FORMED EXCELLENT DEADMEN FOR GUY LINES (4) A 100% RESERVE OF POWER UTILITY BOATS WAS REQUIRED. (5) STANDARD ANCHORS COULD NOT BE DROPPED FROM POWER UTILITY BOATS BECAUSE OF SWIFT CURRENT AND UNWIELDYNESS OF BOAT DURING CASTING. (6) 12,600 MAN HOURS.	(1) 4 FLOATING BAY CONSTRUCTION SITES; ONE NEAR & ONE FAR SHORE CONSTRUCTION SITES WERE ADEQUATE. (2) LCVP WERE IDEAL FOR ROWING BRIDGE SECTIONS INTO PLACE. (3) SUNKEN BARGES PROVIDED EXCELLENT ANCHORAGE POINTS. (4) HUB GUARD PLANKING WAS PLACED ON BAILEY PANELS INSTEAD OF STANDARD RIBBANDS. (5) POWER UTILITY BOATS WERE UNSATISFACTORY FOR HANDLING FLOATING BRIDGE SECTIONS. (6) NO ENEMY INTERFERENCE. (7) 21,170 MAN HOURS.	(1) OPERATION SCREENED WITH SMOKE DURING DAYLIGHT HOURS. (2) CONSTRUCTION STARTED AFTER DARKNESS AND 24 HOURS EARLIER THAN HAD BEEN PLANNED. (3) ARTIFICIAL MOONLIGHT USED DURING NIGHT. (4) NO ENEMY INTERFERENCE. (5) ONE ARTILLERY CASUALTY PRIOR TO START. (6) 1 1/2 HOURS LOST DUE TO FLOATING DEBRIS FROM REMAGEN BRIDGE. (7) 5,140 MAN HOURS.	(1) OPERATION SCREENED WITH SMOKE DURING DAYLIGHT HOURS (2) CONSTRUCTION STARTED AFTER DARKNESS. (3) ARTIFICIAL MOONLIGHT USED DURING NIGHT. (4) NO ENEMY INTERFERENCE. (5) 11,725 MAN HOURS.	(1) OPERATION SCREENED WITH SMOKE DURING DAYLIGHT HOURS. (2) CONSTRUCTION STARTED AT DAYLIGHT. (3) NO ENEMY INTERFERENCE.	(1) CONSTRUCTION STARTED DURING DAYLIGHT. (2) NO SMOKE WAS USED. (3) ARRIVAL OF BRIDGE EQUIPAGE DELAYED CONSTRUCTION ABOUT 2 HOURS. (4) NO ENEMY INTERFERENCE.	(1) ARTIFICIAL MOONLIGHT USED DURING NIGHT. (2) 1700 FT OF BITUMINOUS APPROACH ROAD WAS CONSTRUCTED. (3) LANDING BAYS WERE DECKED WITH ANGLE IRON PLACED BETWEEN PLANKING TO IMPROVE TRACTION. (4) RIBBANDS WERE NOT USED. HUB GUARDS WERE PLACED ON BRIDGE PANELS. (5) TOTAL MAN HOURS 99,018. (6) SPECIAL CONNECTION POSTS WERE USED TO PROVIDE ARTICULATION. (7) PERMANENT FIRE PROTECTION AND ELECTRIC LIGHTS PROVIDED. (8) MAINTENANCE CREW IS ONE ENGINEER COMBAT COMPANY.
16. AVERAGE DAILY TRAFFIC COUNT DURING FIRST WEEK AFTER OPENING	1900	2610	1300	1666	3056	2063	2060	3010

#060779

APR 9 1984