

DEPARTMENT OF THE ARMY TECHNICAL MANUAL

TM 9-1985-3

DEPARTMENT OF THE AIR FORCE TECHNICAL ORDER

TO 39B-1A-10

GERMAN EXPLOSIVE

ORDNANCE

(PROJECTILES

AND

PROJECTILE FUZES)

DEPARTMENTS OF THE ARMY AND THE AIR FORCE
MARCH 1953

TM 9-1985-3/TO 39B-1A-10

GERMAN EXPLOSIVE
ORDNANCE
(PROJECTILES
AND
PROJECTILE FUZES)



United States Government Printing Office
Washington : 1953

Chapters 1 through 4 are published in TM 9-1985-2/TO 39B-1A-9.

DEPARTMENTS OF THE ARMY AND
THE AIR FORCE

WASHINGTON 25, D. C., 16 March 1953

TM 9-1985-3/TO 39B-1A-10 is published for the information and guidance of all concerned.

[AG 471 (20 Feb 53)]

BY ORDER OF THE SECRETARIES OF THE ARMY AND THE AIR FORCE:

OFFICIAL:

WM. E. BERGIN
Major General, USA
The Adjutant General

J. LAWTON COLLINS
Chief of Staff, United States Army

OFFICIAL:

K. E. THIEBAUD
Colonel, USAF
Air Adjutant General

HOYT S. VANDENBERG
Chief of Staff, United States Air Force

DISTRIBUTION:

Active Army:

Tech Svc (1) except 3, 5 (5), 9 (10); Tech Svc Bd (2); AFF (2); OS
Maj Comd (5); Base Comd (2); MDW (1); A (2); CHQ (2); Div
(2); Sch (1) except 5 (5), 9 (50); Dep 9 (3); POE (2); OSD (1);
PRGR 9 (3); Ars 9 (1); Proc Dist 9 (1); T/O & E: 9-500 FA, FB,
FC, FE, FF (1).

NG: None.

Army Reserve: None.

For explanation of distribution formula, see SR 310-90-1.

CONTENTS

| Chapter | Page |
|--------------------------|------|
| 5. PROJECTILES..... | 347 |
| 6. PROJECTILE FUZES..... | 515 |

Chapter 5

GERMAN PROJECTILES

INTRODUCTION

Classes of German Ammunition

German ammunition may be divided into the following classes:

CLASS No. 1 (fixed ammunition). Ammunition, the complete round of which, can be loaded into the weapon in one operation. The cartridge case, containing a primer and propelling charge is permanently crimped to the projectile.

Examples: 2 cm, 2.8/2.0 cm, 3 cm, 3.7 cm, 4 cm, 4.2/2.8 cm, 5 cm, 7.5 cm gun, 7.62 cm, 8.8 cm, 10.5 cm A. A. gun.

CLASS No. 2. Ammunition, the complete round of which, is loaded in two operations.

The cartridge case, containing a primer and a propellant charge is not crimped to the projectile. The propelling charge is in bags and the charge can be varied at the point of firing.

The projectile is packed and shipped separately, and the cartridge case and propellant are packed as one unit.

The Germans employ cartridge cases in all their artillery ammunition. The cases are employed for the main purpose of preventing the escape of gas to the rear.

Examples: 7.5-cm Howitzer, 105-cm Howitzer, 15-cm gun and Howitzer, 17-cm gun, 21-cm, 24-cm ammunition.

Designation of Artillery Projectiles

The Germans designate a round of artillery ammunition by the caliber, type of ammunition (model number of the round), type of weapon fired from, and (model number of the weapon).

The caliber of German artillery ammunition is measured in centimeters. The Germans, refer to calibers approximately; for instance, the 10.5-cm gun is always known as the "s 10-cm K. 18" (heavy 10-cm model No. 18).

In naming the various types of projectiles, the Germans employ the word, "Granate" (abbreviated "gr." or "Gr."). "Granate" is used as a base

word for all the various types of rounds. By adding a prefix and/or a suffix to the word, the exact nature of the projectile is indicated.

PREFIX ADDED TO THE WORD "GRANATE"

| PREFIX | ABBREV. | COMBINED WORD | COMBINED ABBREV. | AMERICAN TYPE |
|-------------|----------|---------------------|------------------|---------------|
| Spreng..... | Spr..... | Spreng-granate..... | Spr. gr..... | H. E. shell. |
| Nebel..... | Nb..... | Nebel-granate..... | Nbgr..... | Smoke shell. |
| Panzer..... | Pz..... | Panzer-granate..... | Pzgr..... | A. P. shell. |

In order to differentiate between the various types of Armor Piercing Rounds, numbers are added after the word Pzgr.

Panzergranate 39, Pzgr. 39—APCBCHE (Armor Piercing Cap, Ballistic Cap [Winsield] [High Explosive]).

Panzergranate 40, Pzgr. 40—A. P. Shot with a tungsten carbide core.

Panzergranate 41, Pzgr. 41—A. P. Shot with a tungsten carbide core for tapered bore gun (Gerlich round).

Sprenggranate 41, Sprgr. 41—H. E. Shell for a tapered bore gun.

SUFFIX ADDED AFTER "GRANATE"

| SUFFIX | ABBREV. | COMBINED WORD | COMBINED ABBREV. | AMERICAN TYPE |
|------------|---------|--------------------|------------------|----------------------|
| Beton..... | Be..... | Granate Beton..... | Gr. Be..... | Anticoncrete shell. |
| HI..... | HI..... | Granate HI..... | Gr. HI..... | Hollow charge shell. |

For the most part the Germans do not give model numbers to their artillery ammunition. In several of the old rounds model numbers are indicated.

The numbers used are the last two of the year in which the round was made standard. These are only used in the nomenclature when there is more than one model of any specific type. In the case of the "Pzgr." (Armor Piercing) rounds, the numbers appearing after the word merely indicates the type of Armor Piercing round and are not model numbers.

Rot. or L'spur. (Leuchtspur) included in the designation indicates tracer.

This nomenclature is followed by the word "Patronen" abbreviated Patr., meaning cartridge.

GERMAN EXPLOSIVE ORDNANCE

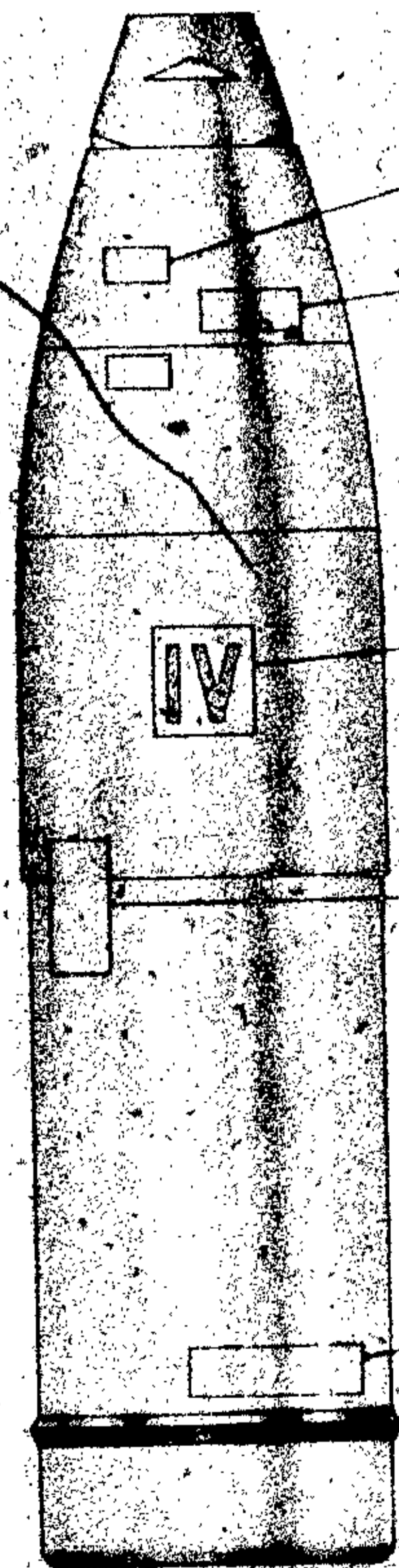

A NUMBER INDICATES THE NATURE OF THE H.E. FILLING NUMBER.

LOCATION; DAY, MONTH AND YEAR; WORKMARK (SHELL ASSEMBLY)
e.g. L.G. 4.11.39 Ab

WEIGHT CLASSIFICATION

Tp (FOR TROPICAL AMMUNITION)
Ub (FOR PRACTICE AMMUNITION)
Nb (FOR SMOKE AMMUNITION)

LOCATION; DAY, MONTH AND YEAR; WORKMARK (FILLING OF SHELL)
e.g. Ab 21.40 Kc

Figure 316—Projectile Stampings

This is the German way of indicating a complete round. It is similar to the British nomenclature, in that the British use the word "cartridge" to designate all their complete rounds.

WEAPON TYPE. The Germans include the name of the type of the weapon in designating their ammunition. This nomenclature is given in the form of an abbreviation.

| ABBREVIATION | TYPE | AMERICAN EQUIVALENT |
|---------------------|------------------------------|--|
| Geb. H. (model No.) | Gebirgshaubitze | Mountain howitzer. |
| Geb. K. (model No.) | Gebirgskanone | Mountain gun. |
| L. F. H. | Leichte Feldhaubitze | Light field howitzer (British equivalent: Gun howitzer). |
| s. F. H. | Schwer Feldhaubitze | Heavy field howitzer. |
| L. I. G. | Leichte Infanterie Geschutz. | Light infantry howitzer. |
| S. I. G. | Schwer Infanterie Geschutz. | Heavy infantry howitzer. |
| s. (cal.) K. | Schwer Geschutz | Heavy gun. |
| L. G. | Leichte Geschutz | Light recoilless gun. |
| k. (model No.) (E) | Kanone (Eisenbahn) | Railway gun. |

| ABBREVIATION | TYPE | AMERICAN EQUIVALENT |
|-------------------|--------------------|---------------------|
| F. K. | Feldkanone | Field gun. |
| Flak | Flugabwehrkanone | Antiaircraft gun. |
| Kwk. | Kampfwagenkanone | Tank gun. |
| Pak | Panzerabwehrkanone | Antitank gun. |
| S. K. | | Naval gun. |
| Stu. K. | Sturmkanone | Assault gun. |
| Stu. G. (caliber) | Sturm Geschutz | Assault gun. |

FOREIGN-ORIGIN DESIGNATION. In some instances a letter in parenthesis is added to the nomenclature after the word indicating the type of projectile. These letters are used to indicate

material of foreign origin. The following are some of the letters used for this purpose: (t) Czech, (f) French, (p) Polish, (r) Russian, (ö) Austrian.

In some cases the following may be included in the nomenclature:

| GERMAN | ENGLISH |
|--------|--------------|
| NAI | New pattern. |
| Uing | Modified. |
| St | Steel. |

STENCILED CODE. The identification of German projectiles can be made by the following means:

Stenciled code figures on the ogive and body of projectile, the color of the projectile, and the stamping marks on the projectile body.

The following details of stenciling on projectiles are arranged in the sequence in which the markings are normally found commencing at the nose of the projectile.

Z. F. Hbgr. (in black) on the windshield of an H. E. B. C. projectile indicates the use of a nose fuze under the windshield.

R or Mr (in black near the tip) indicates the presence of a smoke box.

Arabic numerals (in black on the head of the projectile just below the fuze hole, or on the body of the projectile) indicates the type of H. E. filler. The more common of these follow:

| STENCILING | INDICATION |
|------------|---|
| 1 | TNT in cardboard carton packed with magnesium putty. |
| 1A | TNT in cardboard carton packed with paper. |
| 2 | Picric acid in cardboard carton packed with magnesium putty or wax. |
| 5 | TNT/Wax 95/5 in paper or cardboard carton. |
| 10 | TNT/Wax 90/10 in paper or cardboard carton. |
| 13 | Amatol 40/60, cast. |
| 14 | TNT, cast. |
| 32 | PETN/Wax 90/10. |
| 36/38 | PETN/Wax 60/40 or 65/35. |
| 91 | Cyclonite/Wax 95/5. |
| 95 | Cyclonite/TNT. |

The following are some examples of German ammunition nomenclature.

4.7-cm Sprgr. Patr. Pak(t)—47-mm H. E. projectile for the A. T. gun of Czech make.

3.7-cm Pzgr. Patr. 40 Pak—37 mm A. P. Shot-tungsten carbide core for A. T. gun.

7.62-cm Pzgr. Patr. 40 Pak. 36(r)—76.2 mm (3 inch) A. P. shot—tungsten carbide core for A. T. gun 36 (Russian design).

8.8-cm Sprgr. Patr. Flak 36—88-mm H. E. projectile for the antiaircraft gun 36.

In the following instances the type of projectile, and to some extent the nature of filling, is indicated by 2.4-inch letters stencilled at two positions round the shell midway between the rotating band and bourrelet. (See fig. 316.)

| STENCILING | INDICATION |
|---|--|
| A or LS (White) | Base ejection shell with flash-producing charge. |
| A1 (Black) | Filling includes aluminum powder to produce flash. |
| B1 (White) | Inert filling. |
| Ex (Red) | Drill projectile. |
| NB (White) | Smoke shell. |
| Ub (White) | Practice projectile, filled gunpowder. |
| Ub.B (White) | Practice projectile, filled TNT. |
| Vp (Black) | Dummy projectile. |
| Bö (1-inch lettering midway between the rotating band and shoulder). | Indicates a rotating band of the bimetal type, iron covered with copper. |
| F (Black) | Shell to be fired with super charge F only. |
| Stg (2.4-inch lettering, in black, at a short distance from the rotating band). | Indicates a light case shell of cast steel. |
| KPS (White or red lettering above the rotating band). | Indicates a rotating band of the bimetal type, iron covered with copper. |
| PES (White or red lettering above the rotating band). | Indicates a sintered iron rotating band. |

The place and date of assembly, followed by a lot number, are stencilled in 4-inch black or red lettering above the rotating band, e. g., "Lr 4.640L."

COLOR OF THE PROJECTILE. The following color scheme is always used:

Pzgr.—A. P. shot: Black.

A. P. C. projectile: Black.

A. P. C. projectile (H. E.): Black.

Sprgr.—H. E. projectile (except A. A. and Naval): Deep olive green.

Nbgr.—Smoke projectile: Deep olive green.

Gr. Ba.—Anticoncrete: Deep olive green.

Gr. (H1)—Hollow: Deep olive green.

Naval and flak (antiaircraft) H. E. projectile: Yellow.

GERMAN EXPLOSIVE ORDNANCE

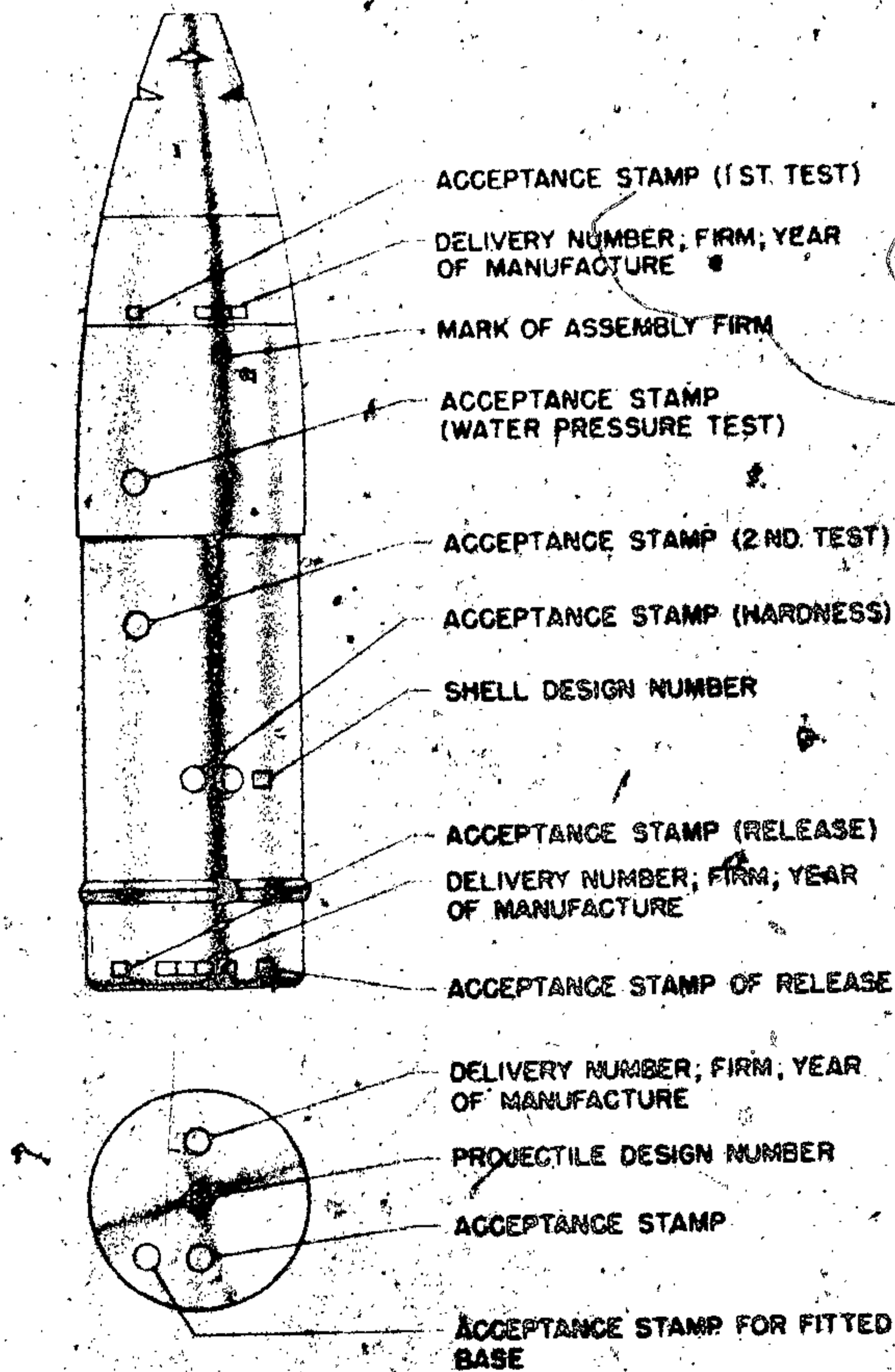

Figure 317—Projectile Stampings

3.7-cm. projectile with a two-compartment cavity, one filled H. E. and the other filled with tracing composition: Aluminum color—yellow band midway between the rotating band and fuze hole.

Projectiles of the latter type are sometimes painted white. This color appears to be used for projectiles in the experimental stage supplied for trial by the Army in the field.

Band marking is not in common use except for a red band above the rotating band in some shells,

indicating a tracer, and a yellow band for the 3.7-cm aluminum colored H. E. tracer shell.

The place and date of the filling of the projectile, followed by lot number in black, is on the shoulder of the projectile in the form of an abbreviation.

The weight zone of the projectile is indicated by Roman numerals, black in color near the bourrelet.

STAMPING ON THE PROJECTILE. The following are stamped on the ogive in the order in which they appear. (See fig. 317.)

1. Acceptance test number.

7.5 CM. PAK 40

FIXED CARTRIDGE CASE

7.5 CM. KWK 40

7.5 CM. KWK

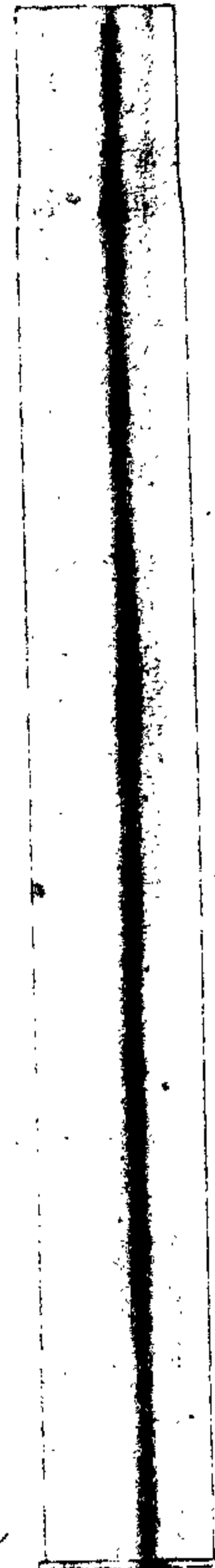
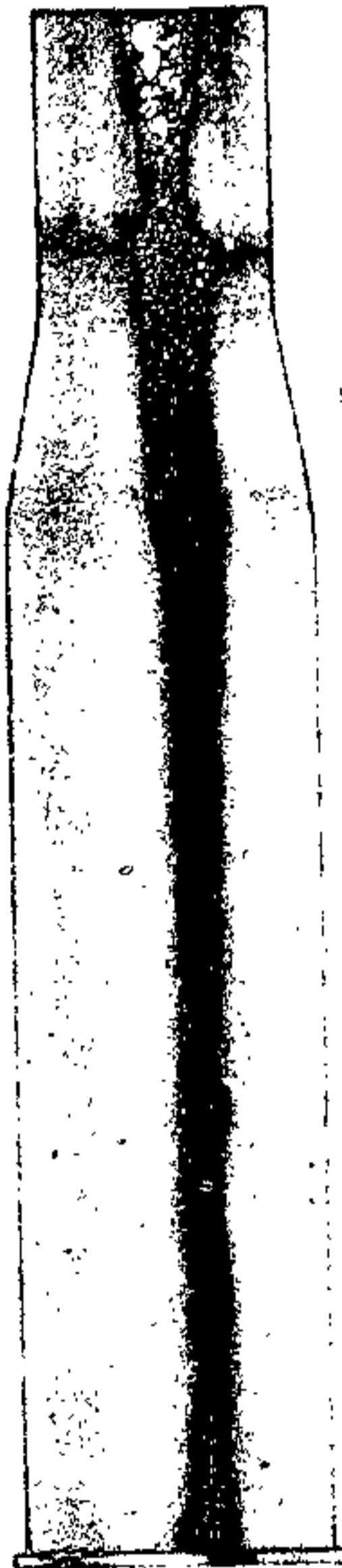

Figure 318—Fixed Cartridge Cases

2. Delivery number, firm and year of manufacture.

3. Firm's proof mark.

The following appear on the body of the projectile:

1. An acceptance stamp, water pressure test and an acceptance stamp, second test.

2. Acceptance stamp (Hardness) 

3. Shell model number.

4. Delivery number, firm, year of manufacture, acceptance stamp of release.

The following appear on the base:

1. Delivery number, firm, year of manufacture.

2. Projectile model number.

3. Acceptance stamp for fitted base.

4. Acceptance stamp.

GERMAN EXPLOSIVE ORDNANCE

Identification of the Fixed Cartridge Cases and Charges

STENCILLING ON SIDE OF CASE. The following details are arranged in the sequence in which the markings are normally found between the approximate center of the case and flange at the base. (See fig. 318.)

1. The caliber, types, and model numbers of the weapons for which the round is suitable are stenciled in the form: 7.5-cm KWK 40 (7.5-cm tank gun model 40). Where a round is suitable for more than one equipment, the designation of the equipment is stenciled in sequence with the letter "u" signifying "and" as a conjunction.

2. The weight of the propellant charge in grams is stenciled in the form of numerals, followed by the letter "g" below the nomenclature of the ammunition (e. g., "164 g").

3. The nature, shape, and size of the propellant are stenciled below the marking indicating the charge weight.

The following markings are used to indicate the nature of the propellant:

| STENCILING | INDICATION |
|------------|---|
| Digl..... | Double base propellant of diethylene glycolinat and nitrocellulose. |
| Gu..... | Double base propellant with the addition of nitroguanidine (Gudof). |
| Ngl..... | Double base propellant of nitroglycerine and nitrocellulose. |
| Nz..... | Nitrocellulose. |

These letters, in the case of double base propellant, are followed by figures or letters which also

(SEMI-FIXED
CARTRIDGE CASE)

7.5 GEB K 15

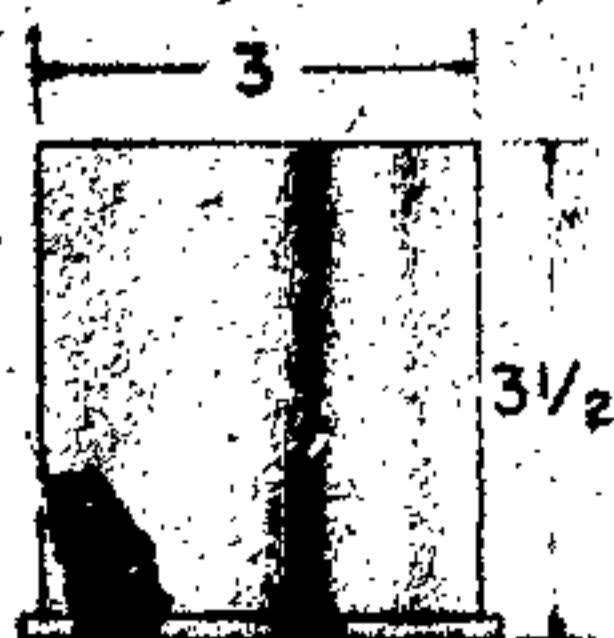

10.5 CM. L. F. H. 18

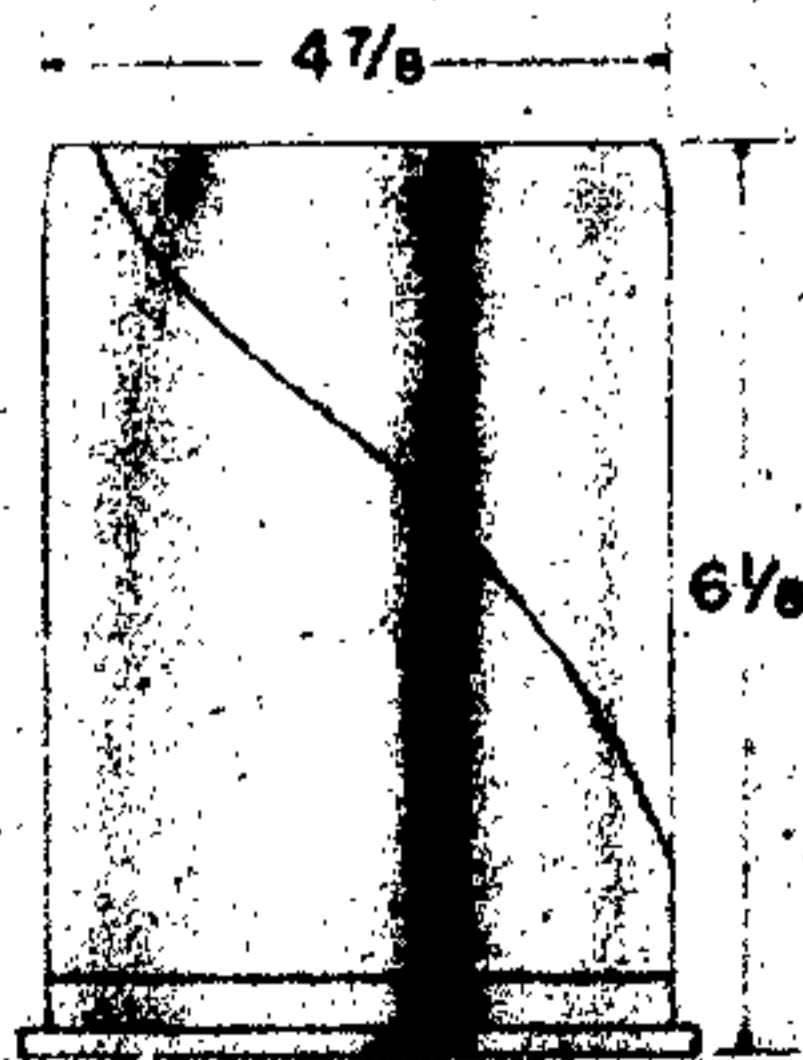

10.5 CM. LG 40

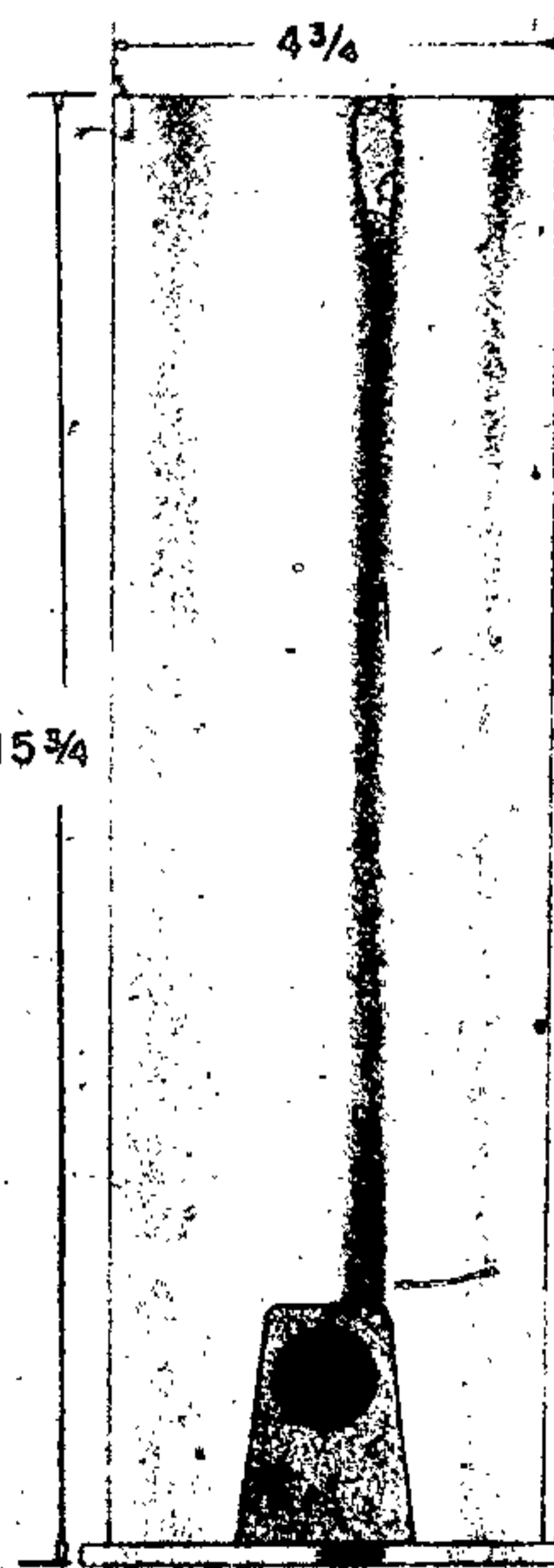

Figure 319—Semi-Fixed Cartridge Cases

appear to relate to the composition. The shape of propellant is indicated by the following letters added to those used to indicate the nature:

Bl. P.—Blatchen Pulver: Flake.

Rg. P.: Perforated disk (resembling a washer).

R. P.—Rohren Pulver: Tubular.

Str. P.—Striefen Pulver: Strip.

In the case of a double base powder the number outside the brackets indicates the percentage of explosive base added to nitrocellulose. The size of the propellant is given by a statement of the dimensions in millimeters following the letters used to indicate the shape. The dimension figures are enclosed in a bracket and are arranged as follows, with commas serving as decimal points:

Flake (length-breadth-thickness) (3.3.0.8).

Perforated disk (thickness, external diameter/internal diameter) (1.9 x 15/4).

Tubular (length with minus tolerance, external diameter/internal diameter) (175-2/0, 85). An "x" is sometimes used instead of the "-" between the length and the tolerance (length-breadth-thickness, e. g. (125 x 5 x 0.5)).

Examples: Digl. R. P. 8, 2 (175-2, 2/0, 85).
Gu. Bl. P. A. O. (4,4, 0, 6). Ngl. Bl. P. 12.5
(40 x 40 x 0, 2). Nz. R. P. (135-5, 5/2). Digl.
Str. P.-9.2-(125 x 5 x 0, 5).

4. The place and year of manufacture of the propellant, followed by a lot number are stenciled below the marking relating to nature, shape, and size. The following is a typical example:

dbg. 1942/3

5. The place and date of the filling of the propelling charge, followed by a lot number are stenciled below the marking relating to the manufacture of the propellant:

17.642 xv)

6. The red stenciling used to indicate propellant charge of a reduced weight for hot climates may be found near the base of the case, just above the flange, or higher up the side of the case, above the other stenciling. The marking used:

Tp — 25° C.

Indicates that the normal or standard charge temperature on which the weight of the charge is based

is 25° C. (77° F.). The German standard charge temperature for normal European temperatures is 10° C. (50° F.).

7. In some instances cases are stenciled:

"Abgebr Ldg" in red.

This marking is found near the base (corresponding to the position of the Tp—25° C. marking) and probably refers to the propelling charges of low stability which are to be given priority in expenditure.

STENCILING ON THE BASE OF FIXED CARTRIDGE CASES. Type of the projectile is stenciled in white or black to the left above the primer hole.

In some instances the Roman numerals indicating the weight classification of the projectile are stenciled in white to the right below the primer hole.

STAMPINGS ON THE BASE OF FIXED CARTRIDGE CASES. Model number of case:

St.—after model number of case—indicates a steel case.

Model, cal., and type of weapon.

Manufacturer's initial.

Delivery number.

Year of manufacture.

MARKINGS ON CARTRIDGE BAGS IN FIXED ROUNDS.

The markings are the same as those stenciled on the side of the case except that the caliber, type and model number of the equipment are not included.

Identification of Semifixed Cartridge Cases and Charge

A cardboard or leatherboard cup is used to close the mouth of the cartridge case in a round where the cartridge case is packed separately. (See Fig. 319.)

A label, found on the closing cup, contains information corresponding to the stenciling on the side of the fixed cartridge case. The information is as follows:

Details of the weapon.

Charge weight.

Kind.

Type (size and shape of the charge).

Place and date of manufacture of propellant.

Place and date of filling.

Indication of propellant charges for hot climates.

GERMAN EXPLOSIVE ORDNANCE

Cases with steel covers for packing and transport, which are removed before loading, have neither labels nor stenciling relating to the propellant charge except the stenciling "Tp 25° C." imprinted on the base where applicable. Details of the propellant are available, however, from the stenciling on the charge bags.

Stamping on the base of the case is the same as that on the base of a fixed round, except that the caliber of the equipment is sometimes omitted.

MARKINGS ON THE CARTRIDGE BAGS OF A "SEMI-FIXED" ROUND. These bags are marked similarly to the markings on fixed bags, except that the designation of the weapon is included. In some cases the caliber is not included. Bleidraht im Beutel indicates lead wire is included in the bag as a decoppering agent.

The number indicating the charge is marked prominently in black. The letter D often follows this number and in some instances the marking is encircled by a red ring.

SONDERKART — SUPERCHARGE. With certain weapons additional charge sections, to be used for long ranges in place of those in the cartridge case, are supplied in cylindrical cardboard packages. These sections are numbered in continuation of

those supplies for use at normal ranges in the case. Cardboard packages containing these additional charge sections are marked "Sonderkart" followed by the numeral of the section.

Marking of Primers for "Fixed" and "Semi-fixed" Ammunition

Designation—C followed by number.

Example: C/33

NA—New Pattern

St—Steel

Markings of Flash Reducing Charges

This charge is found in a flat circular silk bag and is identified by the words Kart. Vorl., followed by the abbreviation indicating the weapon with which used and the weight of the charge in grams.

PERCUSSION PRIMER C/12nA

EMPLOYMENT. German Percussion Primer used in the 5-cm Q. R., H. E. Cartridge. (See fig. 320.)

DESCRIPTION:

1.25 inches, diameter of lip.

1.0 inch, diameter of body.

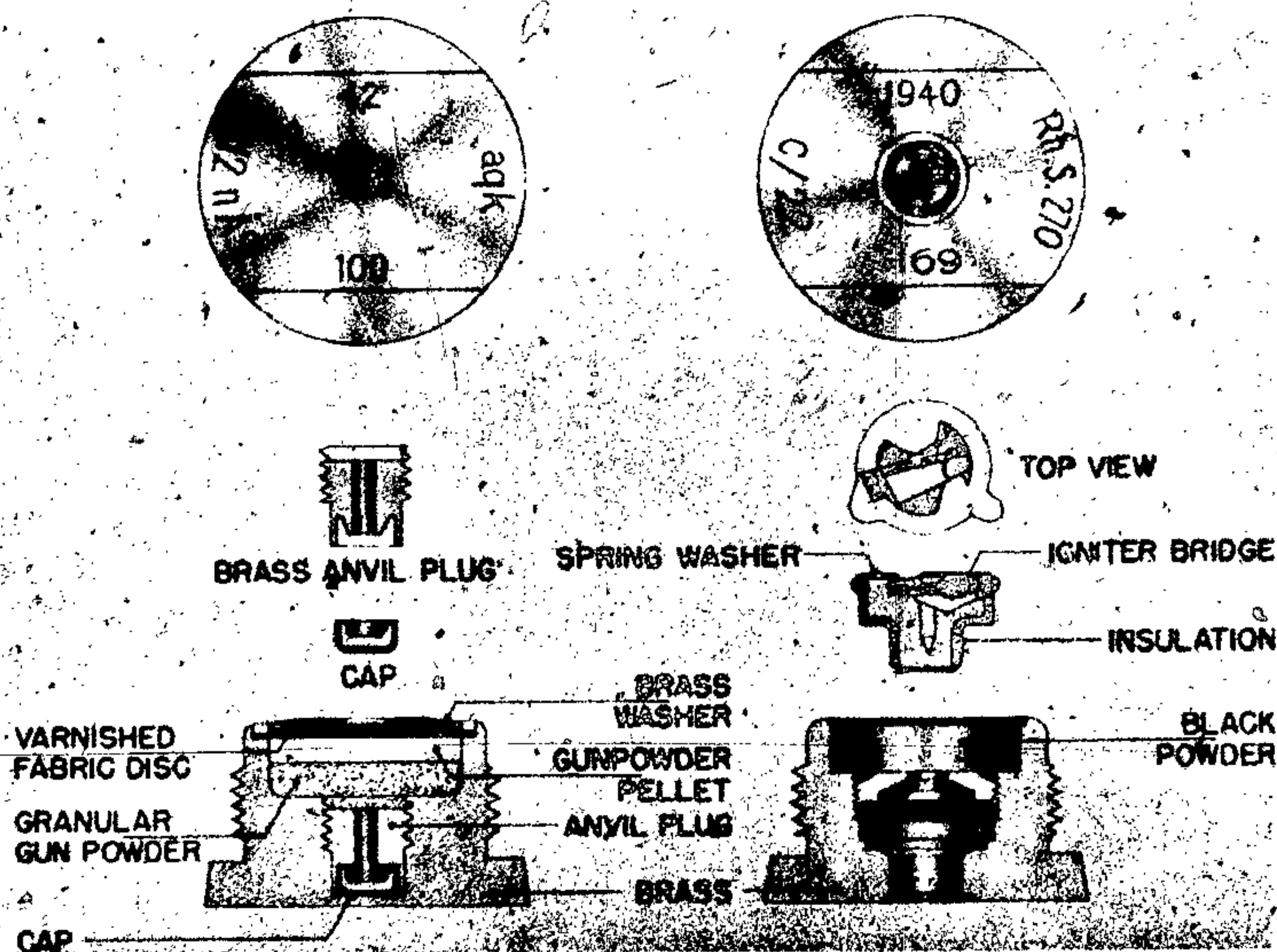

Figure 320—Electric Primers c/12nA and c/22

0.75 inch, length of body.
0.281 inch, threaded length,
0.188 inch, thickness of lip.
Number of threads, 5 RH.

CONSTRUCTION. The primer is of the normal German type consisting of a brass body with the enclosed cap and brass anvil plug. The cap filling is shaped to fit around the anvil and consists of:

28 percent Mercury fulminate.
34 percent potassium chlorate.
32 percent antimony sulphide.
6 percent glass powder.

The cap is a push fit in the underside of the anvil plug. The magazine contains a 1.44-gram pellet of black powder over a 0.65-gram of granular black powder. The primer is closed by a brass washer and a varnished fiber disk.

ACTION. The cap is pressed against the anvil by the firing pin. The flash from the primer fires the two chambers of black powder and these in turn fire the propelling charges.

ELECTRIC PRIMER C/22

EMPLOYMENT. German Electric Primer used in the 7.5-cm Q. F. H. E. Cartridge. (See fig. 320.)

DESCRIPTION. 1.25 inches, diameter at lip.
1.0 inch, diameter of body. 0.28 inch, threaded length. 0.19 inch, thickness of lip. 0.75 inch, length of body. Number of threads, 5 RH.

CONSTRUCTION. The primer houses an igniter bridge which consists of lead styphnate dipped in gelatin. This bridge has a resistance of approximately 2.2 ohms and is in the circuit with the insulated contact plug, the spring washer, and the primer body. A 31 grain black-powder filling, in both pellet and granular forms, is housed in the upper recess of the primer. The top of the primer is closed by an aluminum disk and disks of paper or varnished fiber.

ACTION. An electric current is passed through the insulated contact plug in the base of the cartridge case. The current passes through the igniter bridge, igniting it, and back to the source by way of the spring washer and primer body. The flash from the igniter bridge ignites the black powder and this, in turn, sets off the propelling charge.

PERCUSSION PRIMER C/13nA

EMPLOYMENT. German Percussion Primer used on Q. F. Cartridges. (See fig. 321.)

DESCRIPTION: 0.63 inch, diameter at lip. 0.50 inch, diameter of body. 0.56 inch, length of body. 0.25 inch, threaded length. 0.09 inch, thickness of lip. Number of threads, 5 RH.

CONSTRUCTION. A brass cap is positioned under the anvil in the base of the primer. The cap contains:

23.0 percent potassium chloride.
52.0 percent mercury fulminate.
19.7 percent antimony sulphide.
5.3 percent abrasives.

The composition is sealed by a covering of varnish without the addition of a foil disk.

The anvil, which is screwed into the primer, has a flash channel through its center.

The upper recess of the primer houses 8.7 grains of black powder. The top of the primer is sealed by a brass washer and a plastic disk.

ACTION. The cap is forced against the anvil by the firing pin. The resulting flash passes through the anvil firing the black powder and this, in turn, fires the propelling charge.

PERCUSSION PRIMER C/33

EMPLOYMENT. German Percussion Primer used on Q. F. Cartridges. (See fig. 321.)

DESCRIPTION:
0.56 inch, over-all length.
0.63 inch, diameter at lip.
0.50 inch, diameter of body.
0.31 inch, threaded length.
0.09 inch, thickness of lip.
Number of threads, 5 RH.

CONSTRUCTION. A brass cap is positioned under the anvil in the base of the primer. The cap contains:

24.6 percent mercury fulminate.
37.6 percent potassium chlorate.
29.6 percent antimony sulphide.
8.2 percent abrasives.

The cap is sealed by a tinfoil disk without varnish.

The anvil, which is screwed into the primer, has two flash channels, diametrically opposite along its sides.

The upper recess of the primer houses an 8-grain black-powder charge. The top of the primer is

GERMAN EXPLOSIVE ORDNANCE

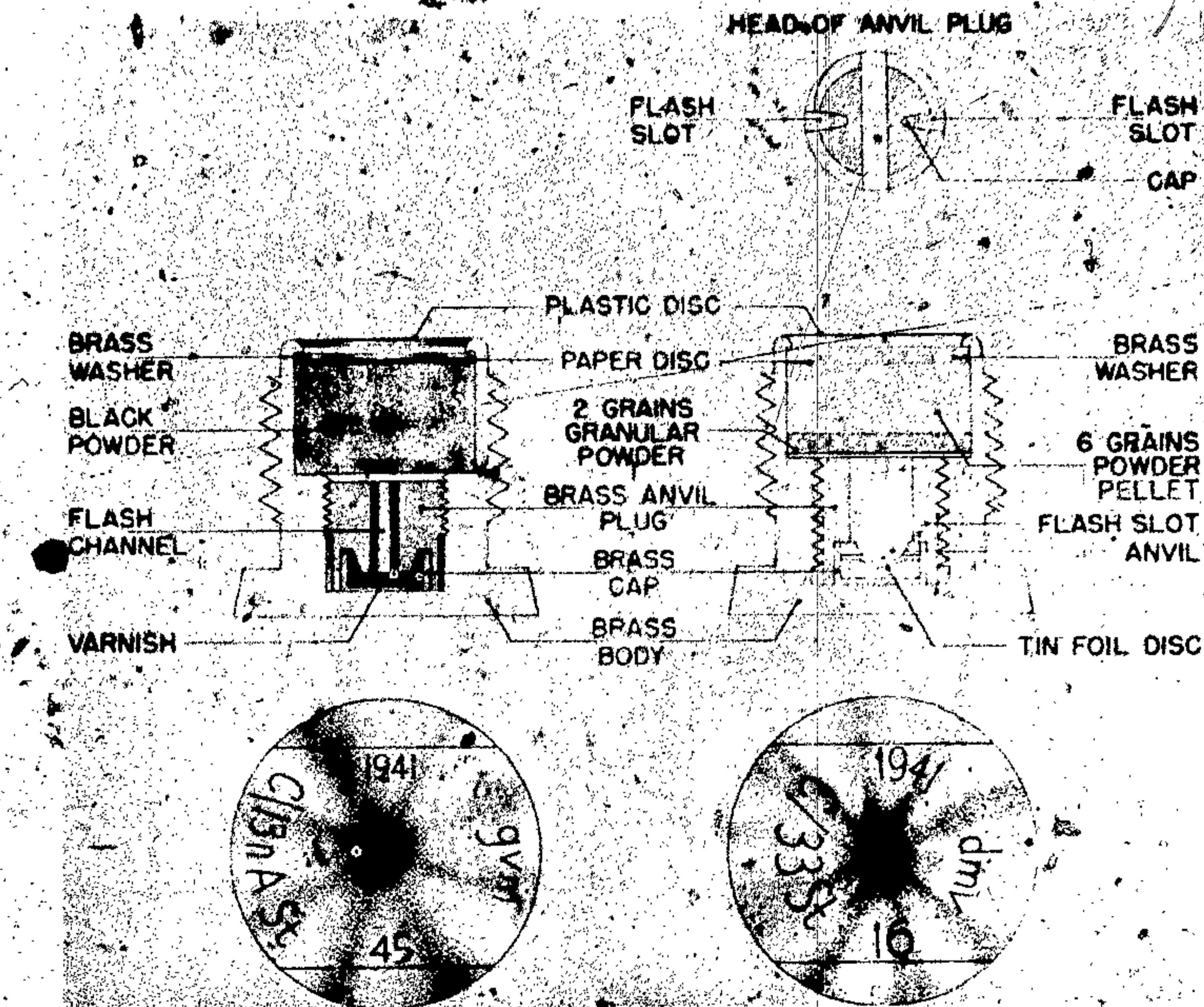

Figure 321—Percussion Primers c/13nA and c/33

sealed by a plastic disk inserted over a brass washer.

ACTION. The cap is forced against the anvil by the firing pin. The resulting flash passes through the two channels in the anvil firing the black powder and this, in turn, fires the propelling charge.

PERCUSSION PRIMER 42/M

EMPLOYMENT. Russian Primer from German 7.62-cm round. (See fig. 322.)

DESCRIPTION:

- 0.875 inch, over-all length.
- 1.188 inches, diameter of lip.
- 0.938 inch, diameter of body.
- 0.375 inch, threaded length.
- 0.094 inch, thickness of lip.
- Number of threads, 5 RH.

CONSTRUCTION. The brass body of the primer houses a percussion cap which fits in the base below a brass anvil. The cap consists of:

- 21 percent mercury fulminate.
- 40.3 percent potassium chlorate.
- 37.8 percent antimony sulphide.

The brass anvil is screwed into the primer body and houses a copper sealing cone. Through the center of the anvil and the sealing cone is a flash channel leading to a black-powder charge in the top of the primer. This 99-grain charge fills the whole upper recess of the primer and extends slightly below the upper end of the anvil.

The top of the primer is sealed by a brass closing ring and the whole primer, except the base, is coated with black varnish:

ACTION. The cap is forced against the anvil by the firing pin. The flash is then transmitted through the anvil igniting the black powder which, in turn, fires the propelling charge.

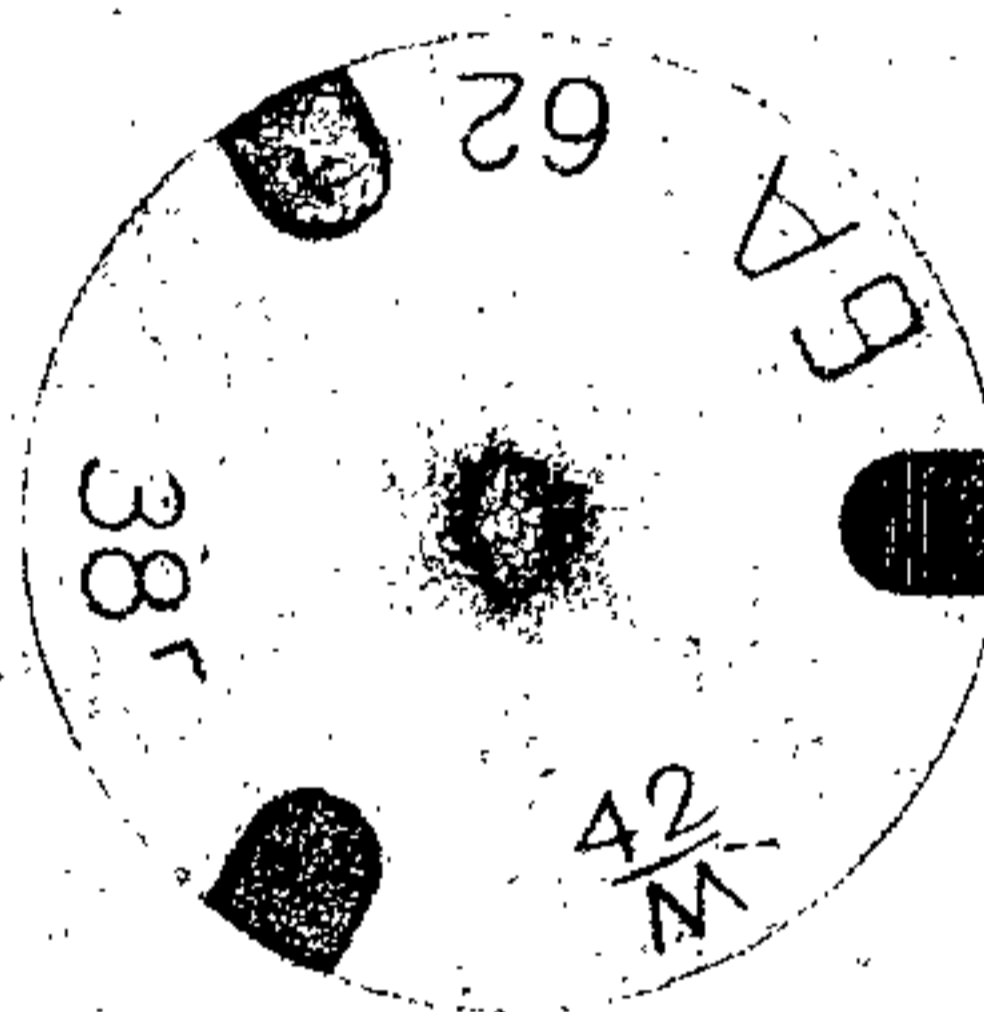
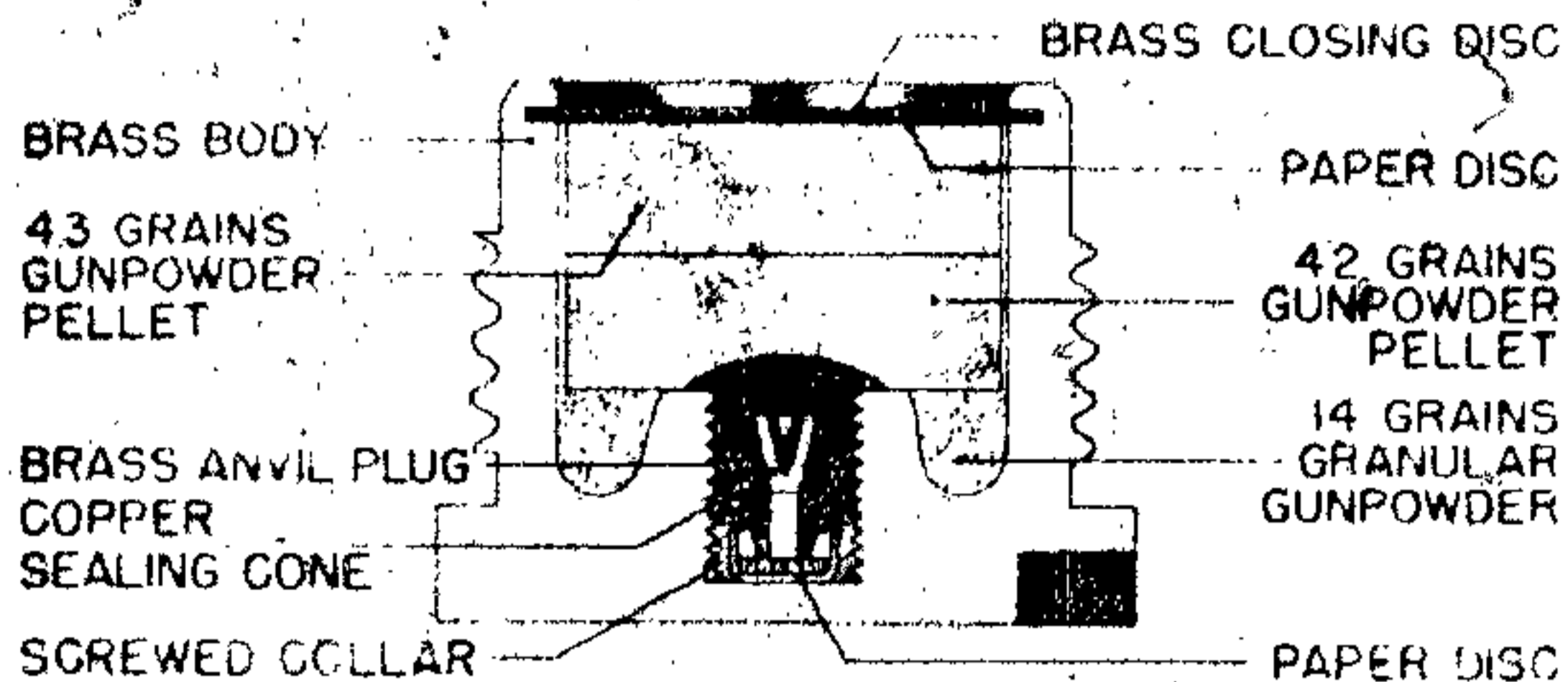

BASE MARKINGS

Figure 322—Percussion Primer 42/M

PERCUSSION PRIMER M33

EMPLOYMENT. Percussion Primer used on the German 47-mm cartridge case. (See fig. 323.)

DESCRIPTION:

- 2.438 inches, over-all length.
- Number of holes, 30.
- 0.094 inch, diameter of holes.
- 0.625 inch, body diameter.
- 0.875 inch, lip diameter.
- 0.250 inch, threaded length.
- Number of threads, 6 RH.

CONSTRUCTION. Into the base of this primer is screwed an extra 3.1-gram charge of black powder. The brass body contains the standard anvil with a flash hole and a cap consisting of:

- 29.1 percent potassium chloride.
- 16.7 percent mercury fulminate.
- 43.4 percent antimony sulphide.
- 10.8 percent abrasives.

ACTION. The firing pin hits the rear of the primer forcing the cap against the anvil. The

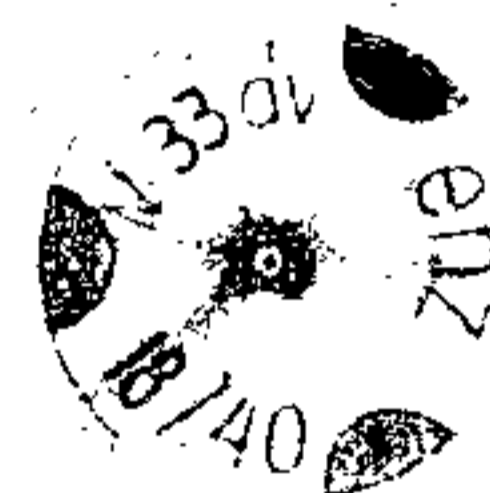

Figure 323—Percussion Primer M33

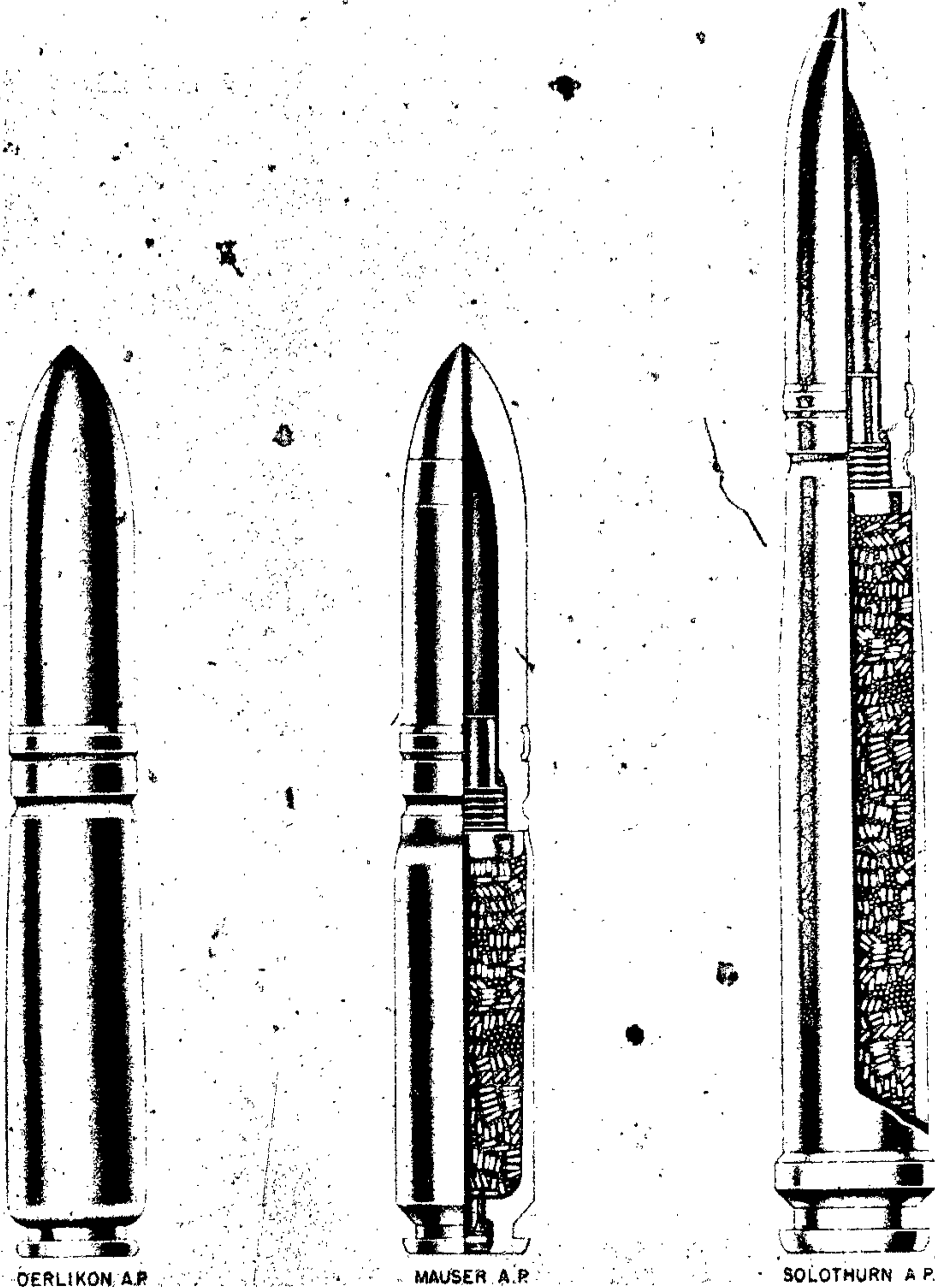

Figure 324A—20-mm Ammunition

flash passes through the anvil firing the black-powder charge which then fires the propelling charge.

20-MM AMMUNITION

DESCRIPTION. The identification of various types of 20 mm ammunition, both high-explosive

and armor-piercing rounds, is shown in figs. 324A and 324B.

The armor-piercing type projectile body is painted black over-all and contains no color bands. However, if the armor-piercing round contains an incendiary mix, or high explosive, corresponding color bands are marked on the projectile body.

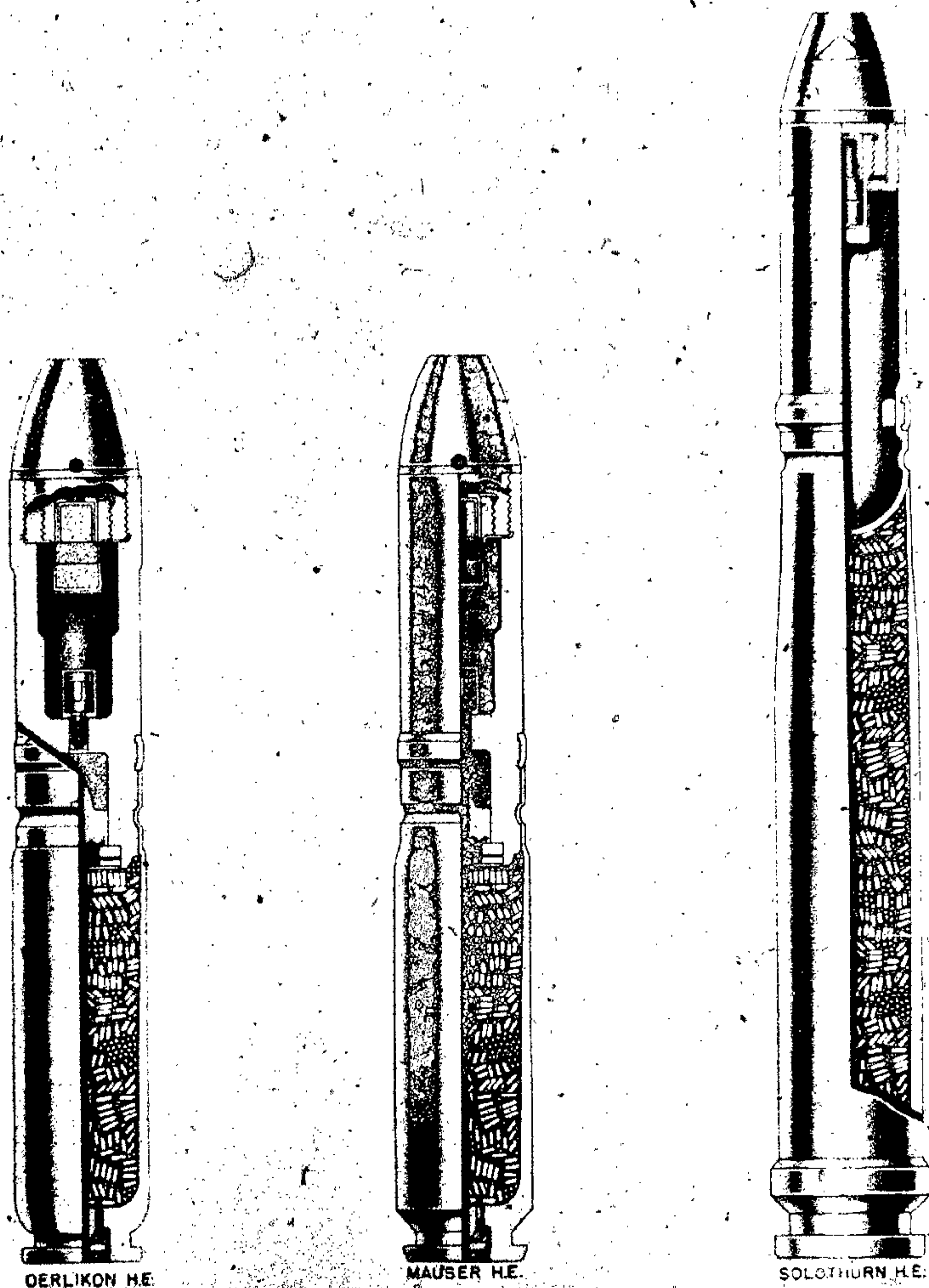

Figure 324B—20-mm Ammunition

No fuzeing is employed in either the oerlikon, mauser, or solothurn armor-piercing ammunition.

The high-explosive type projectile body is painted yellow over-all with the corresponding color bands indicating a high-explosive/tracer, a high-explosive/incendiary or a high-explosive/incendiary/tracer. The AZ 1502, AZ 1504, and

Z. Z. 1505 fuzes are normally employed in 20-mm high-explosive oerlikon, mauser and solothurn ammunition and are discussed in detail in the fuze section.

A chart showing the type projectile, projectile markings, material, filling, trace, penetration at 100 yards, normal impact, and fuzeing for 20-mm

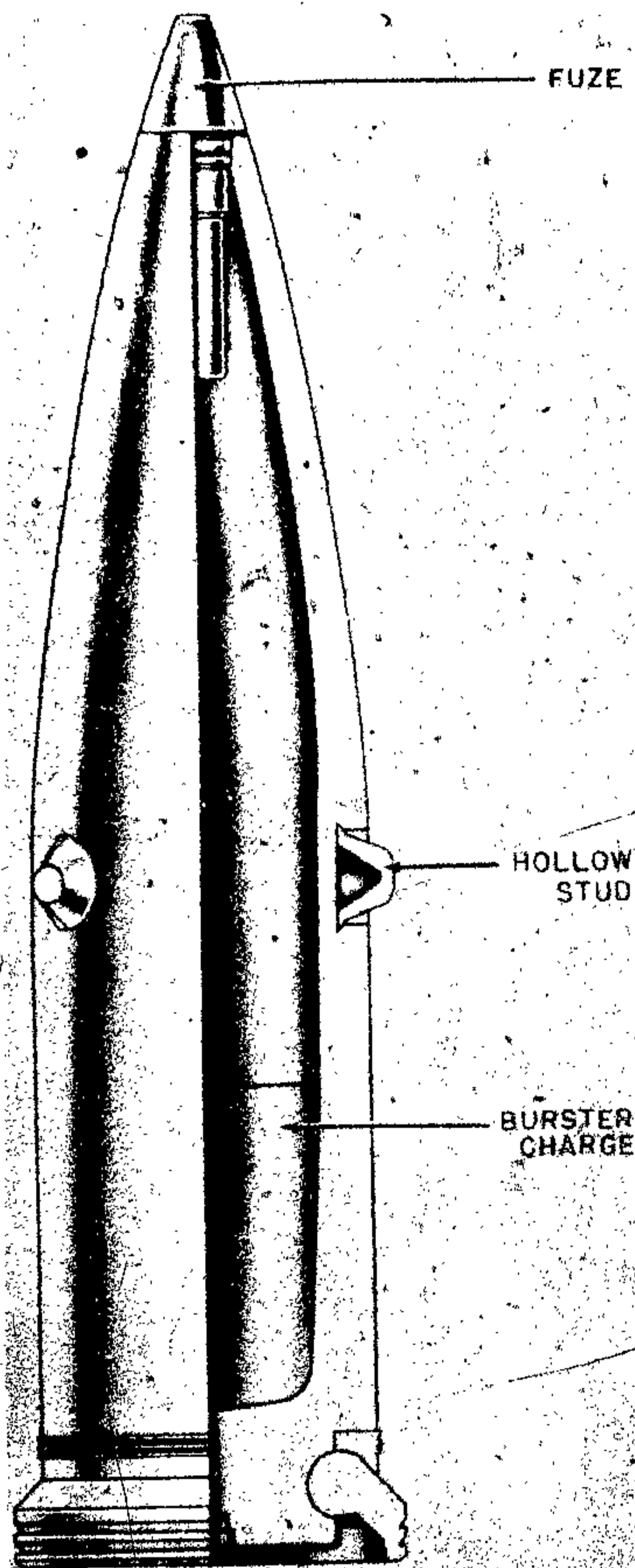

Figure 325A—German Flange Geschoss

mauser and oerlikon ammunition is given at the end of this chapter.

GERMAN FLANGE GESCHOSS

INTRODUCTION. From the start of the war in 1939, German research personnel worked on the projects of developing high-velocity guns and projectiles. In the high-velocity projectile field sub-caliber projectiles were judged by the Germans to show the most possibilities of increasing range and

decreasing the time of flight in comparison to standard type projectiles.

Three types of sub-caliber projectiles were used: The Pfielgeschoss which is a fin stabilized projectile fired from a smooth bored gun, the Triebspiegelgeschoss of Sabot projectile which is fired from a normal rifled gun and the flange geschoss. The flange geschoss is fired from a cylindrical, rifled barrel to which a smooth bored, tapered muzzle extension is attached. This type of projectile is called a "Littlejohn" by the British and a "Squeeze-bore" by other services.

The projectiles fired from guns of the type with the tapered muzzle extension resemble the projectiles which are fired from the Gerlich gun which is a tapered bore, rifled gun. German personnel have stated that projectiles could be interchanged between Gerlich and squeeze-bore guns as the basic problem is the same. This statement is then modified, however, by stating that the projectile fired from a tapered bore gun must be stronger than that fired from the squeeze-bore gun as maximum setback force occurs at the same time that the projectile is being squeezed.

Development and testing of the squeeze-bore projectiles was handled primarily by the private firms in Germany, although all branches of the service were interested in and advised of the developments. The principal firm working on this project was the Rheinmetall-Borsig Co., although the Krupp Co. and Bochumer Verein Co. both built experimental projectiles. The firm of Polte, AG in Magdeburg also built projectiles of this type but had worked only on sizes 5.0 cm and smaller although they were going to build the 5.5/4.1 projectiles which were contemplated.

Projectiles of this type were designated to show the original caliber and end caliber of the gun. Thus the 10.5/8-cm squeeze-bore projectile is one which is fired from a 10.5-cm gun to which is attached a conical muzzle extension tapered to an emergent caliber of 8 cm.

The principal advantage of the squeeze-bore projectile in comparison to the other sub-caliber projectiles is that it has no discarding parts.

CONSTRUCTION. The principal source of information on construction details of the German squeeze-bore projectiles was Dr. Werner Banck. Dr. Banck was in charge of this project for the Rheinmetall-Borsig Co. for the period from late 1939 through until the end of the war. In the

organization chart for the company, Dr. Banck was in charge of the Army high-velocity projectile subsection of the weapons construction and ballistic department of Rheinmetall-Borsig.

Additional information has been gained from interrogation of proving ground personnel at the German Army Proving Grounds at Hillersleben and interrogation of Rheinmetall-Borsig and German Navy ordnance personnel.

TWO FLANGES. The first type of construction developed employed two solid flanges, forward and rear, as Bourrelét and rotating band respectively. This was modified slightly by drilling holes in the forward flange but this type of construction was abandoned in sizes 8.8 cm and above since it proved to be unsatisfactory.

This type of construction proved to be unsatisfactory because it was found that the propellant gases leaked past the rear flange. Then when the projectile passed through the conical muzzle extension the gas was compressed and, even in spite of the drilled holes in the forward flange, large gas pressures were built up (gas pressures up to 6,000 atmospheres were recorded). This resulted in destruction or deformation of the projectile body. Also it was found that at the moment when the projectile left the barrel the extra pressure caused the deformed forward flange to tear and fly off. Several methods of providing a possibility of escape for the enclosed gases were tried other than drilling of the flanges. In the end it was recognized that, in principle, an improvement could be achieved only by splitting up the forward guide into individual supports.

FORWARD BOLTS AND REAR FLANGE. The first type of individual forward supports that was attempted involved the use of three individual bolts in place of the forward flange. They were so placed and arranged that they were pressed into the projectile body when the projectile passed through the muzzle squeeze. On the base of the bolts' ribs were arranged so that once the bolts were pressed into the projectile body, the ribs caught and the bolts could not be thrown out by centrifugal force.

Since these bolts actually extend into the explosive cavity of the projectile, production of the projectile was considerably complicated. Projectiles were actually built in two parts with the explosive cavity divided. This made uncertain the complete detonation of the high-explosive filler

and impaired the efficiency of armor-piercing projectiles since the cap and nose were weakened.

In an attempt to be able to use normal projectiles an attempt was made to enclose the bolts in individual casings which were screwed or attached to drilled holes in the projectile bodies. This eliminated none of the disadvantages of this type of construction and considerably weakened the projectiles due to the drilled holes.

Both of these constructions were made up and fired, in small quantities, in calibers 24/17-cm and 10.5/5-cm sizes. This construction was abandoned, however, because of the disadvantages. No drawings are available for this type of construction.

To attempt to eliminate the disadvantages involved in the use of long bolts various attempts were made with telescoping bolts of various types. Some of these constructions were fired but this construction was also abandoned early in 1942 in favor of the hollow support studs which have been recognized as the best type of forward support.

HOLLOW SUPPORT STUDS. The final type of projectile which was built for the squeeze-bore guns was the type with the so-called hollow support studs. Construction of projectiles of this type was

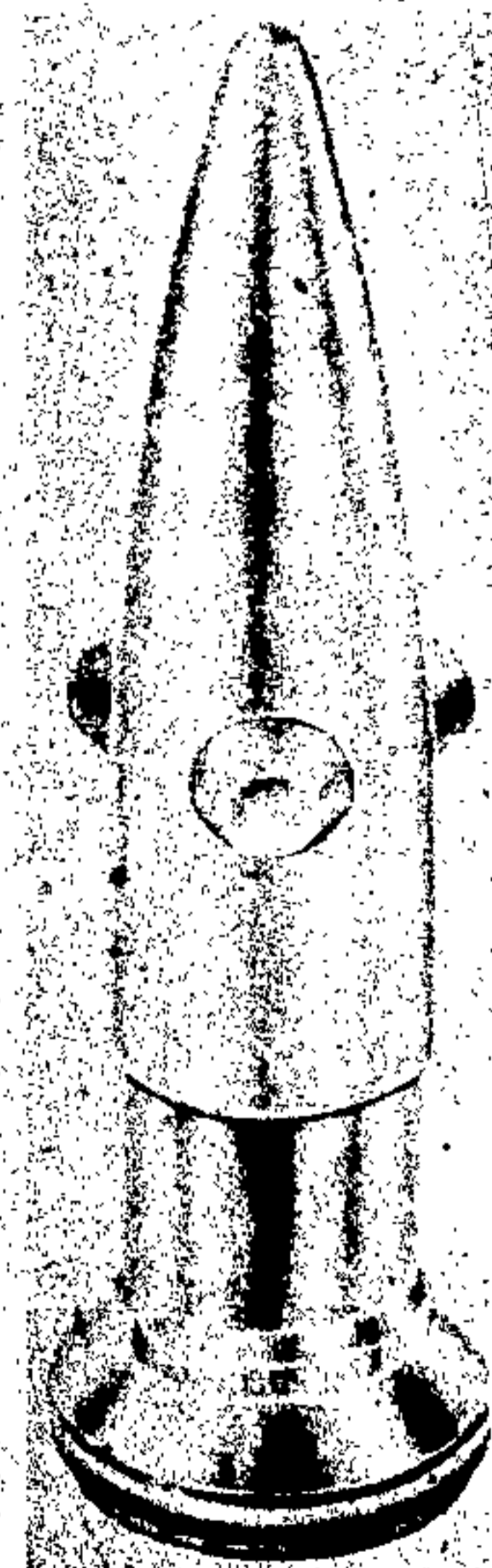

Figure 325B—German Flange Geschoss

GERMAN EXPLOSIVE ORDNANCE

begun in May 1942. Figures 325A and 325B show the 24/21-cm projectile with hollow support studs.

In this type of construction the stud, of soft steel, is pressed into a drilled hole in the projectile body. A sharp edge on the lower portion of stud engages a recess in the drilled hole and thus the stud is secured. Then when the projectile is fixed and passes through the muzzle squeeze the studs are forced down into the drilled holes in the projectile body.

In smaller sizes such as the 8.8/7.0-cm round only three studs were used, whereas, in larger sizes such as the 24/21-cm projectiles five studs were used. In all cases the studs were wider than the grooves of the rifling with the Germans using a figure of 1/5 caliber for the width of the stud.

The advantages claimed for this type (hollow support stud), are as follows:

Considerably less wear of the conical muzzle squeeze.

Use of normal projectile bodies because:

No gas is compressed, consequently there is no pressure on the projectile body.

Because of the small depth of the attached studs the projectile body does not need to be thicker than normal.

If the muzzle extension is worn and studs not completely collapsed. The increase in air resistance caused by the protuberance of the studs is considerably less than that caused by a forward flange not being completely collapsed.

Studs weigh less and use less material than the flange.

Less irregular wear in the cone.

Less sensitive to steep cones in the muzzle piece.

No space is taken from the explosive chamber.

In armor-piercing projectiles the projectile nose is not weakened.

No special machines are necessary to drill the holes for the studs. An ordinary lathe can be used.

All studs for these projectiles were made of soft steel. The most satisfactory method of manufacture was found to be pressing them from sheets and then further pressing of the studs into drilled holes in the projectile body. In this pressing, the material is strained beyond the elastic limit and, for equal thicknesses, it was the German claim that the studs could be constructed lighter and better since the strength is increased.

REAR FITTING. In all cases the rear fitting was of soft iron. This was the only material made

available for experimentation due to the German copper shortage. No experimental work was done with copper or copper alloys. German personnel who have been interrogated have stated that use of copper might be advantageous and feel that it might allow a larger reduction in caliber. All of them pointed out that the material of the forward studs and rear flange should be the same or trouble would be experienced with heavy erosion in the muzzle extension.

The first method of attaching the rear fitting was to machine a groove around the base of the projectile body, then heat the projectile and press the cold flange in. Trouble was experienced with this system due to the projectile base cracking after cooling and it was abandoned.

The most satisfactory method of attaching the rear flange was found to be that of heating the rear flange to a temperature of 1,120° C. and forming it while pressing the flange into the projectile body with a hydraulic press. Pressure used on the 24/21-cm projectile was 400 tons and on the 10.5/8-cm projectile 150 tons. For projectiles ranging up to 8.8/7.0-cm in size it was expected to press the flanges on without heating them.

Rheinmetall-Borsig shop personnel stated that from the manufacturing standpoint it was found that this system of hot pressing the rear flange on was cheaper than the assembly of ordinary rotating bands.

No manufacturing tolerances were available for either the studs or the rear fittings as no quantity production of these projectiles had been made.

In the conversion of existing projectiles difficulty was encountered only when boat-tailed projectiles were worked on. Rotating bands, of course, had to be removed.

EXPLOSIVE LOADING. High explosive loaded projectiles were built and fired in all sizes. Wall thickness was the same as ordinary H. E. projectiles and in some cases such as the 24/21-cm projectile, existing projectiles were built up by the addition of studs and a rear flange. No special H. E. filler was used. Normal loading (same as ordinary H. E. projectiles) was used.

FUZING. In the 24/21-cm size the fuzeing was a sensitive impact fuze. The 10.5/8 cm was fuzed with the standard 30-second time fuze. Other projectiles were fuzed with impact fuzes and an impact fuze with self-destructing device was reportedly under test. The effect of the muzzle squeeze

on the rotation of the projectile was stated to be very little if the squeeze dropped on a ratio of 1-mm with per 30 mm in length. However, if this ratio was changed to 1/50 the revolutions per minute of the projectile was slowed down. Other changes in construction necessary before converting standard fuzes into service in high velocity projectiles were not ascertained.

EXTERIOR BALLISTICS. MUZZLE VELOCITY. The maximum muzzle velocity attained with this type of projectile was stated to be 1,400 m/s; 1,150 to 1,120 m/s was believed, however, to be the most feasible service velocity.

DISPERSION. Dispersion with this type of projectile was expected to be as good as that obtained with normal projectiles. Range dispersion of 1 percent was expected and deflection of around 1.5 mm. Actual service tests showed frequent wild shots, however.

CHANGE IN FORM FACTOR. Lift of the gun was stated as being determined by actual wear on the muzzle extension. For example, the 10.5/8-cm muzzle extension was changed when 2 mm of wear could be measured. As the muzzle extension wears the studs and rear flange are not completely forced down so a change in form factor results. This change, even if muzzle velocity remained constant, means a decrease in range and an increase in flight time.

German personnel stated that the hollow space formed at the base of the projectile due to the folding of the flanges had an effect of increasing the stability.

CONCLUSIONS. The following conclusions have been formed on the German high velocity projectiles of this type designed to be fired from guns with tapered smooth bored muzzle extensions:

Only the 7.5-cm Pak (antitank) gun had been introduced to service. The 10.5/8-cm gun and projectiles were believed to be ready for service but had never gone into production.

Favored construction is the type with collapsing (hollow support) studs forward and soft iron flange pressed on the rear as rotating band.

No material other than soft iron had been made available for manufacture of studs and flanges. German personnel feel that copper or a copper alloy might be more satisfactory.

High explosive loaded projectiles were designed for all sizes and fired in all sizes which reached test status. Standard types of H. E. fillers were

used and well thickness of the projectiles was the same as projectiles fired from normal guns.

SABOT PROJECTILES

GENERAL. The German Army began work on the sabot type of projectile better than a year before the end of the war. Most of their work was done at the Hillersleben Proving Ground. The projectiles of this type that were found at the proving ground were neither loaded nor fuzed. In many instances the projectiles were fitted with dummy fuzes and were ready for test firing. It is obvious from the collection of different kinds and types that an attempt was being made to achieve the most satisfactory and economical discarding sabot elements, and at the same time obtain a profitable increase in muzzle velocity. Different methods of discarding or ejecting the sabot

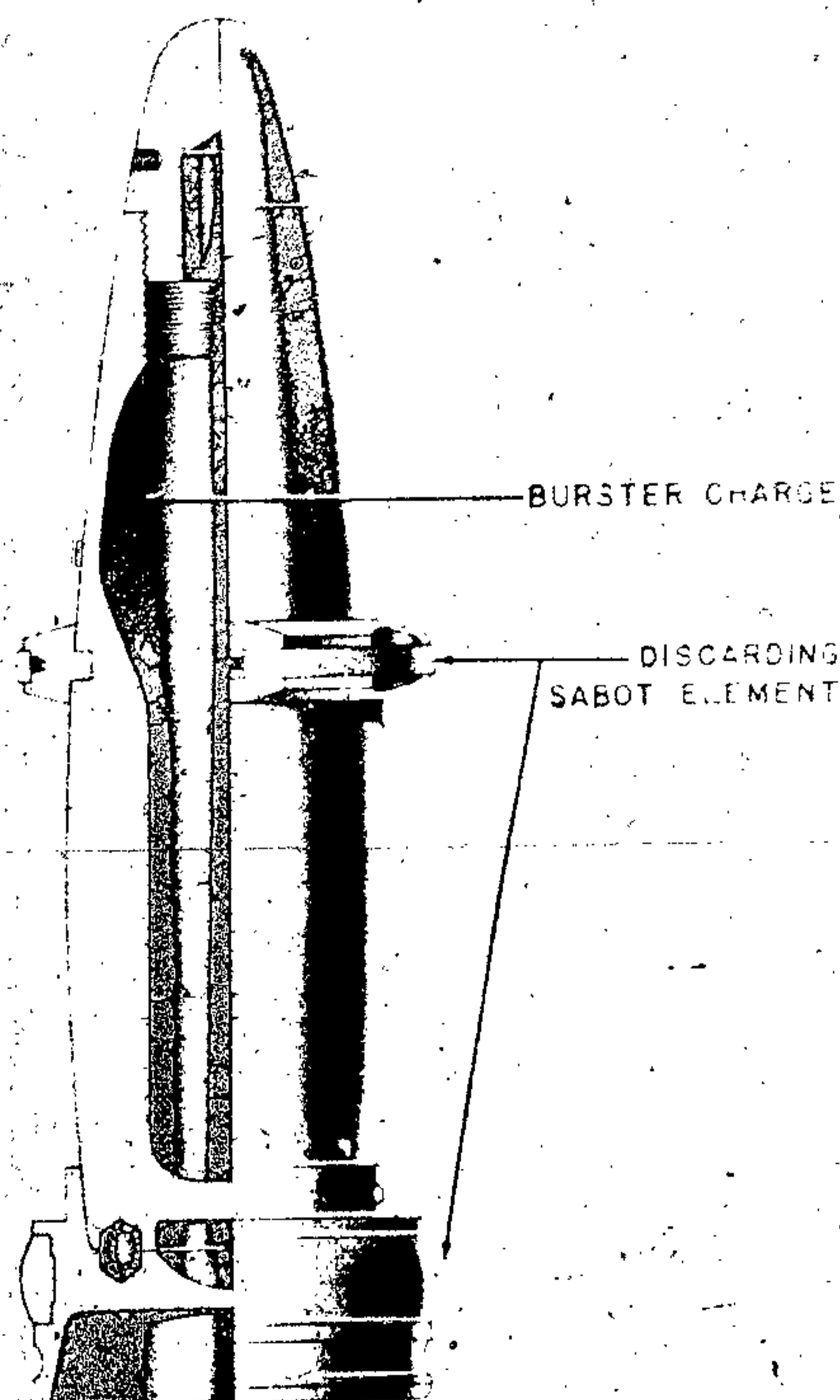

Figure 326A—Sabot Projectile Type A

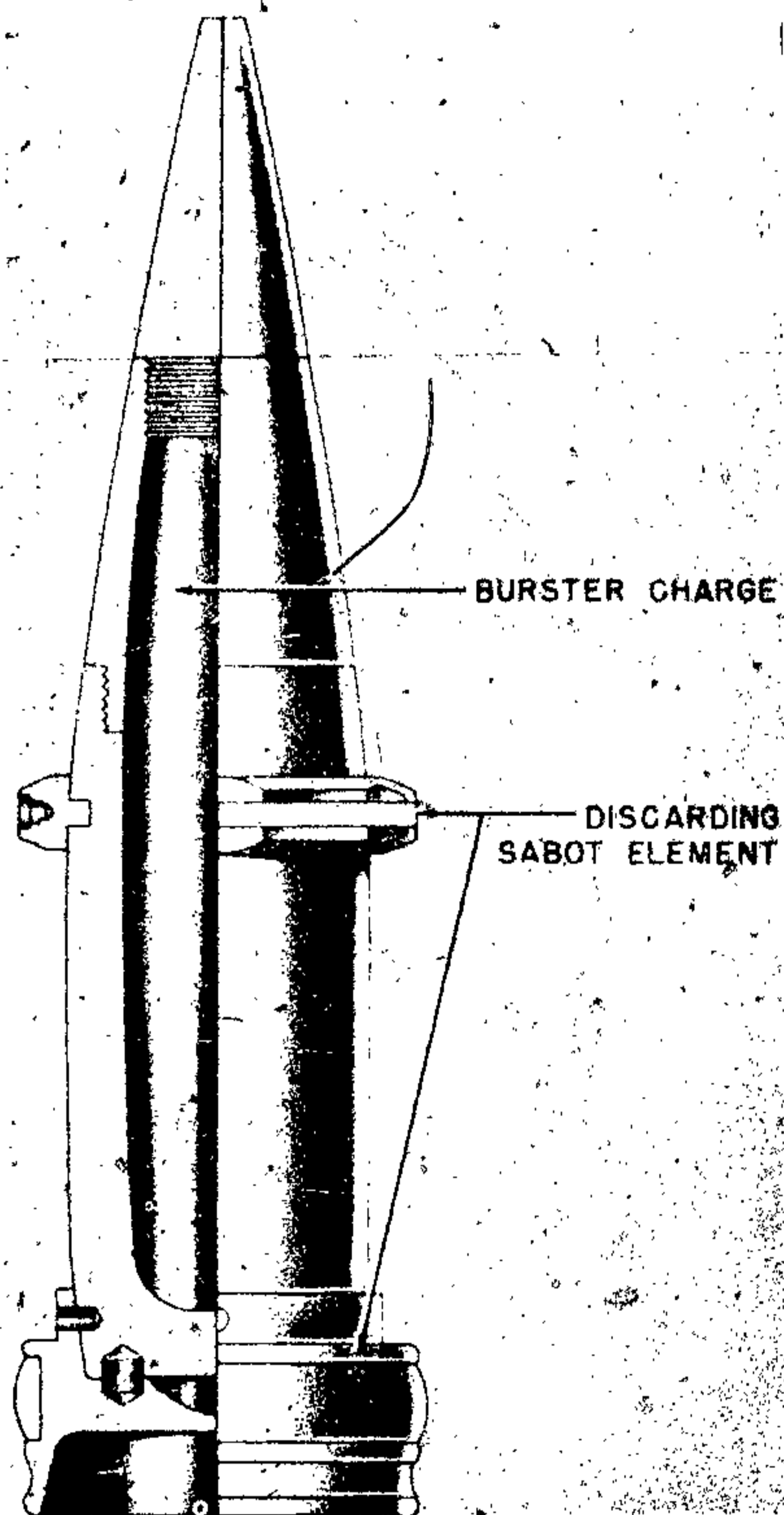

Figure 326B—Sabot Projectile Type A

elements were tested, particular attention being paid to the design of the contour or streamlining of the projectile in order to obtain better flight characteristics.

It was, in most instances, impossible to obtain the nomenclature of the projectiles, therefore the following illustrations will be identified by types A, B, C, D, E, F, G, H, I, and J respectively and each type will have the caliber and subcaliber given.

DESCRIPTION. IN TYPE A (see fig. 326 A) the discarding bourrelet element, divided into three pieces, is held in position by a soft iron band. This band is cut by the rifling of the projector, allowing the segments to fall free due to centrifugal action, after leaving the muzzle. The single

piece discarding base element is held in position by three shear pins and is ejected by trapped gases in the base gas trap. The gases from the propellant powder enter the gas trap by a small hole (see fig. 326B) and are contained therein until the projectile leaves the muzzle of the projector. Upon leaving the muzzle, the projectile is then subject to atmospheric pressure. Since the high pressure gas within the trap cannot escape quickly enough through the small opening, the entire after sabot element is blown free, shearing the three pins.

IN TYPE B (see fig. 327) the discarding bourrelet element of pressed steel is divided into three separate segments held together in a groove in the bourrelet by soft iron wire. This retaining

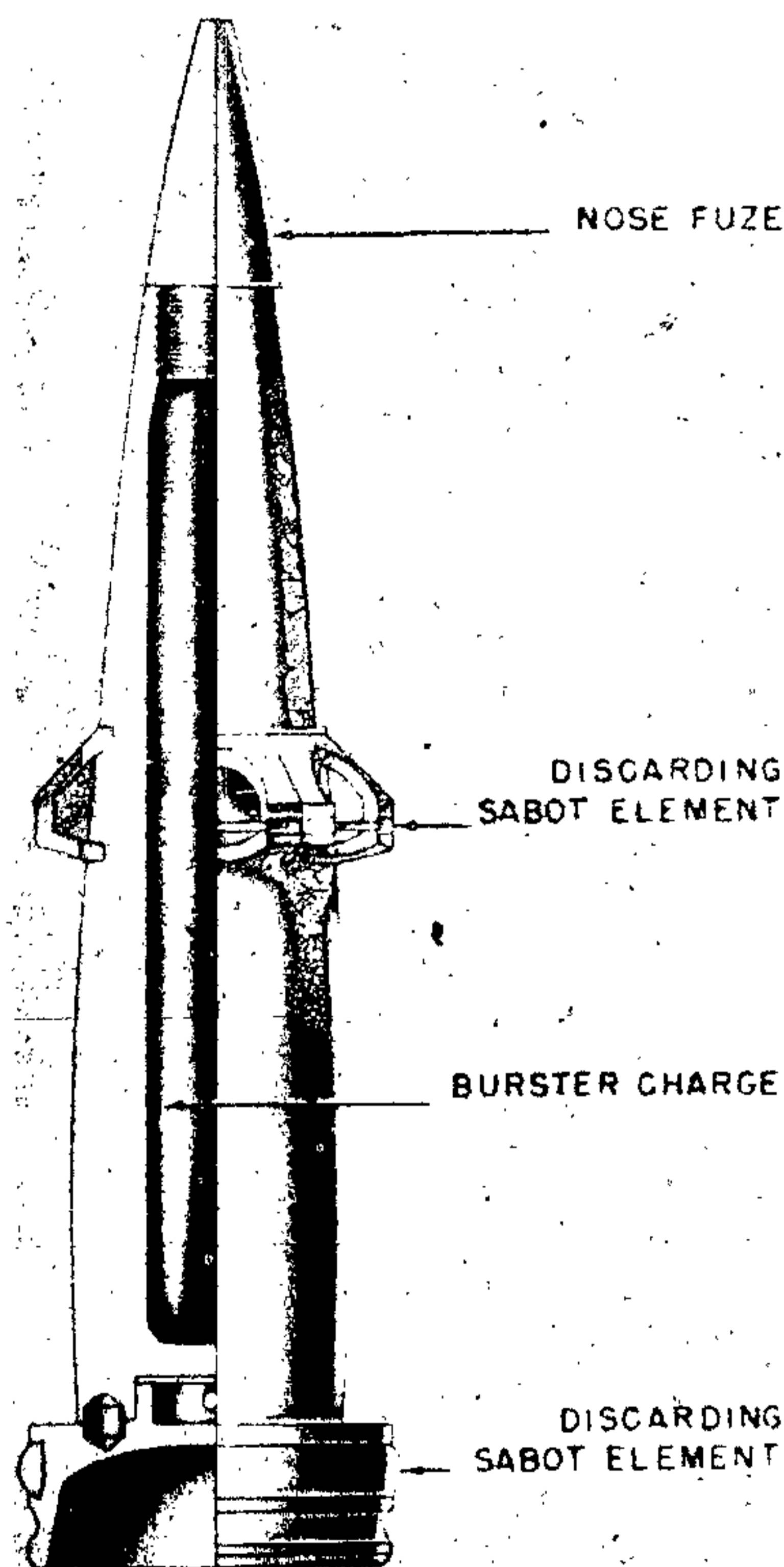

Figure 327—Sabot Projectile Type B

wire is cut by the rifling of the projector, allowing the segments to fall free due to centrifugal action after leaving the muzzle. The single piece discarding base element is held in position by a single shear pin through the base of the projectile. Same type of gas pressure ejection as in type A.

IN TYPE C (see fig. 328) the discarding bourrelet element is a single piece of soft iron, partially divided to break into three segments by centrifugal force. The element is held in position by the nose cap which screws into the main body of the projectile. The single piece base element is held to the base of the projectile with four shear pins. This type also has the same type of base gas pressure ejection as type "A".

IN TYPE D (see fig. 329) the discarding bourrelet element is a single piece of fibre material par-

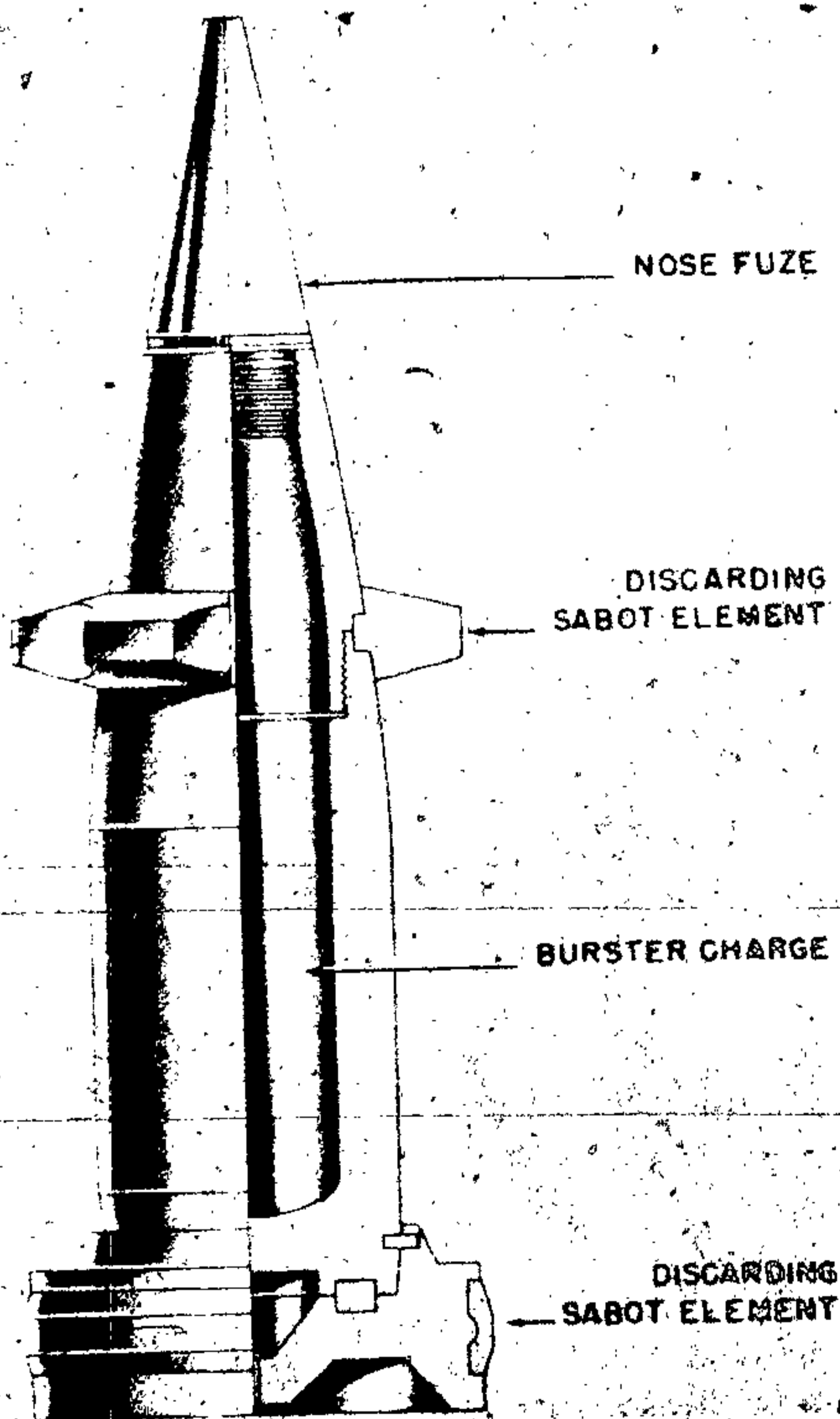

Figure 328—Sabot Projectile Type C

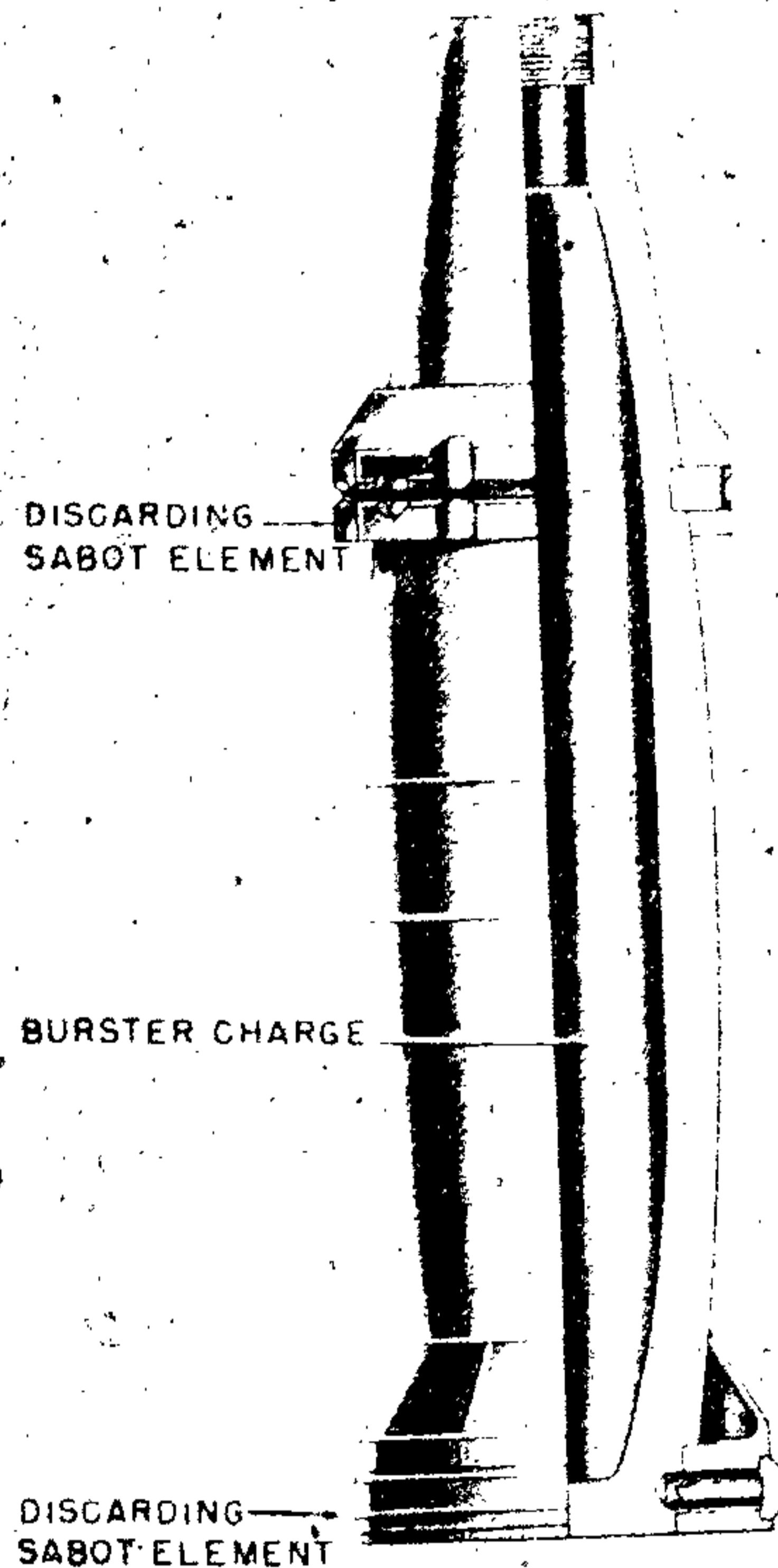

Figure 329—Sabot Projectile Type D

cially divided to break into four segments. The forward element is positioned on the body of the projectile by four wooden plugs extending through the element and into the body. These plugs are retained by soft wire bands which are cut by the rifling of the projector, allowing the segments to fall free due to centrifugal action. The base element is divided into three segments which are held to the body by six steel pins. These segments are held together by a single soft iron rotating band. Both the bourrelet and the base sabot elements are discarded by centrifugal action.

IN TYPE E (see fig. 330) the arrangement is the same as type D except for the bourrelet discarding element. This forward element of pressed steel is partially divided to break into three segments and

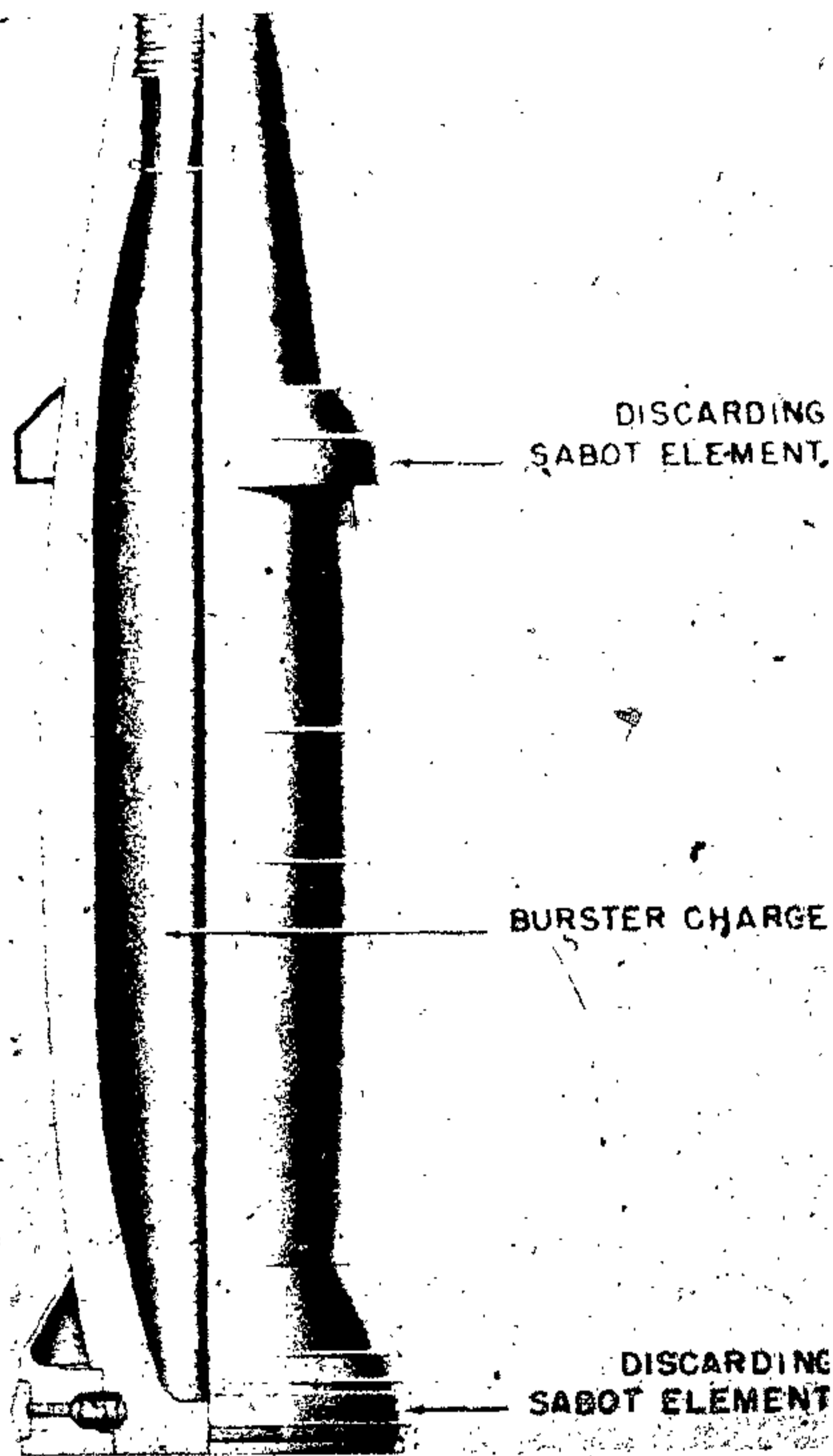

Figure 330—Sabot Projectile Type E

be discarded by centrifugal action. These segments are retained by three steel balls located in holes in the body of the projectile and secured by set-screws.

IN TYPE F the bourrelet discarding element for type F (see fig. 331A) is the same as that for type E. The base discarding element for F-1, constructed by plywood with steel inserts, is base gas pressure ejected the same as type A. In projectile F-2 the base element of fibre material is held in position by two small shear pins. The rotating band is an integral part of the base element on both of these projectiles. (See fig. 331B.)

IN TYPE G (see fig. 332) the discarding bourrelet element is of three sections fitting into a groove in the ballistic cap of the projectile and secured by four turns of iron wire. Method of discarding is

the same as that described for type A. The three segments of the base element are positioned on the body by steel pins and secured by a single iron rotating band.

IN TYPE H (see fig. 333A) the discarding bourrelet element is divided into six separate pressed steel segments held together with copper wires. The copper wires are soldered together to form rings. An after discarding sabot element is effected by eight separate segments located on the body of the projectile above the boat tail. These segments, the details of which are shown in figure 333B, are locked in position by grooves and slots in the body of the projectile and secured by two turns of copper wire. Further obturation is effected by gaskets located off the rear element. Both of

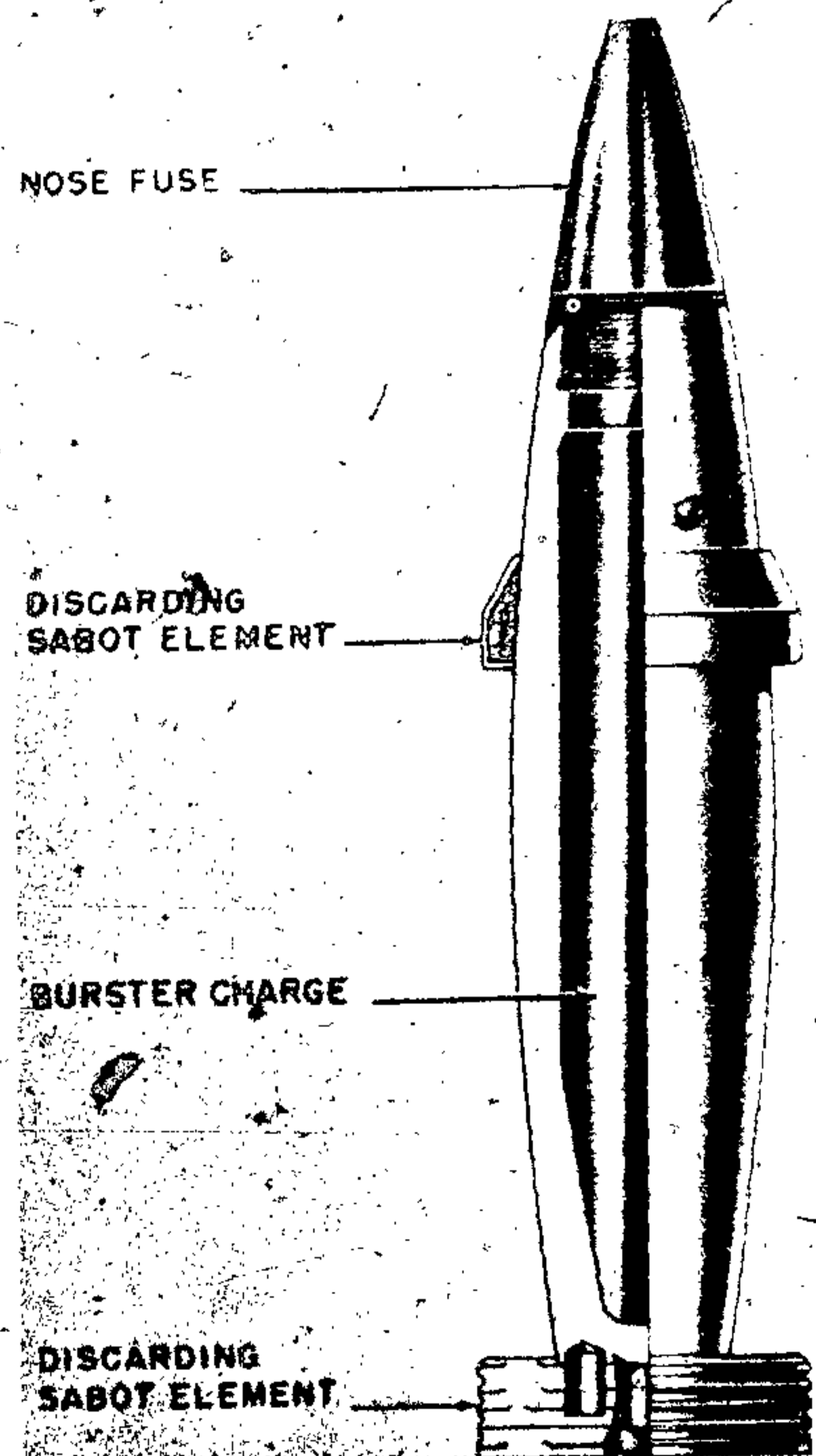

Figure 331A—Sabot Projectile Type F-1

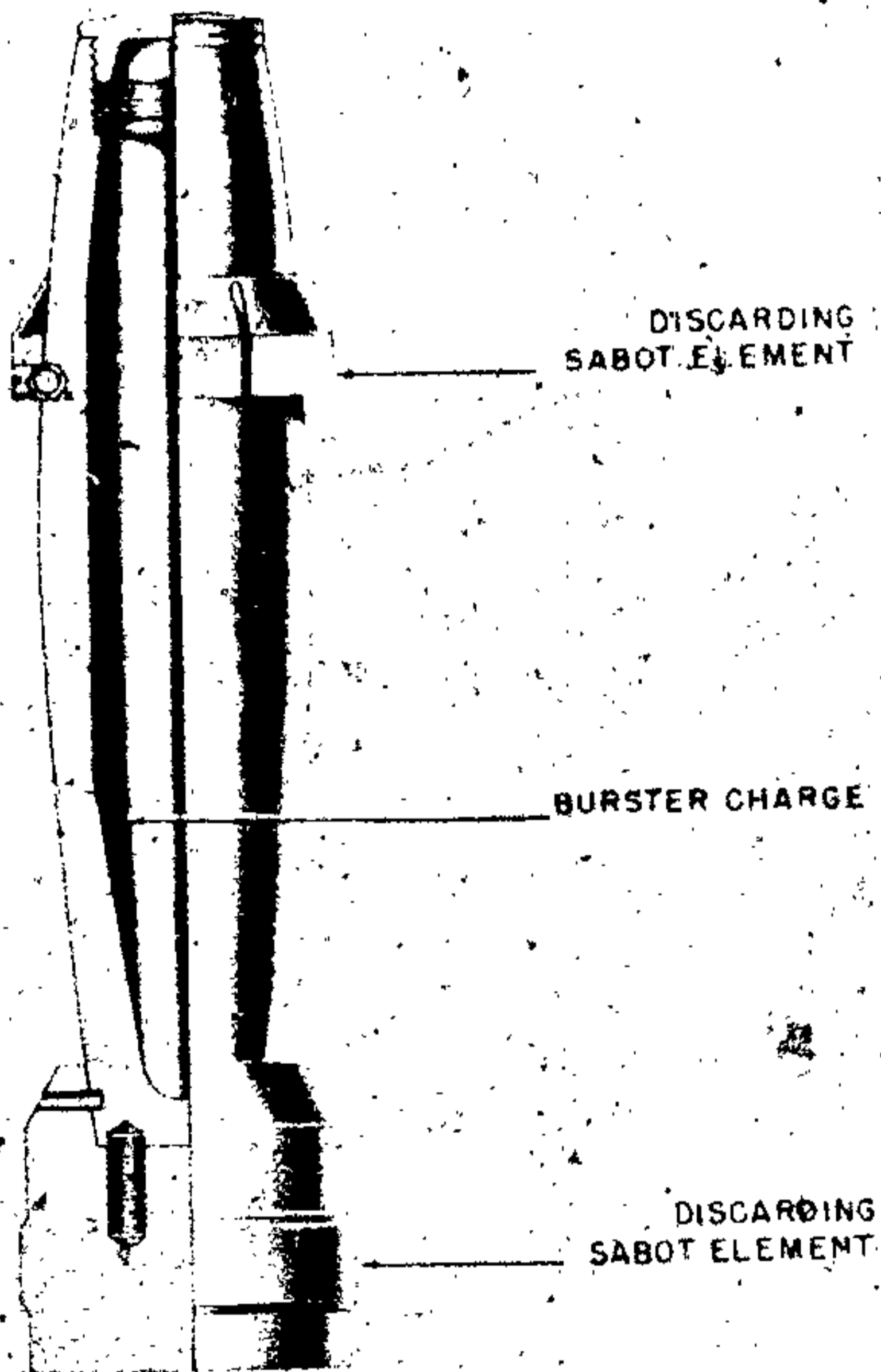

Figure 331B—Sabot Projectile Type F-2

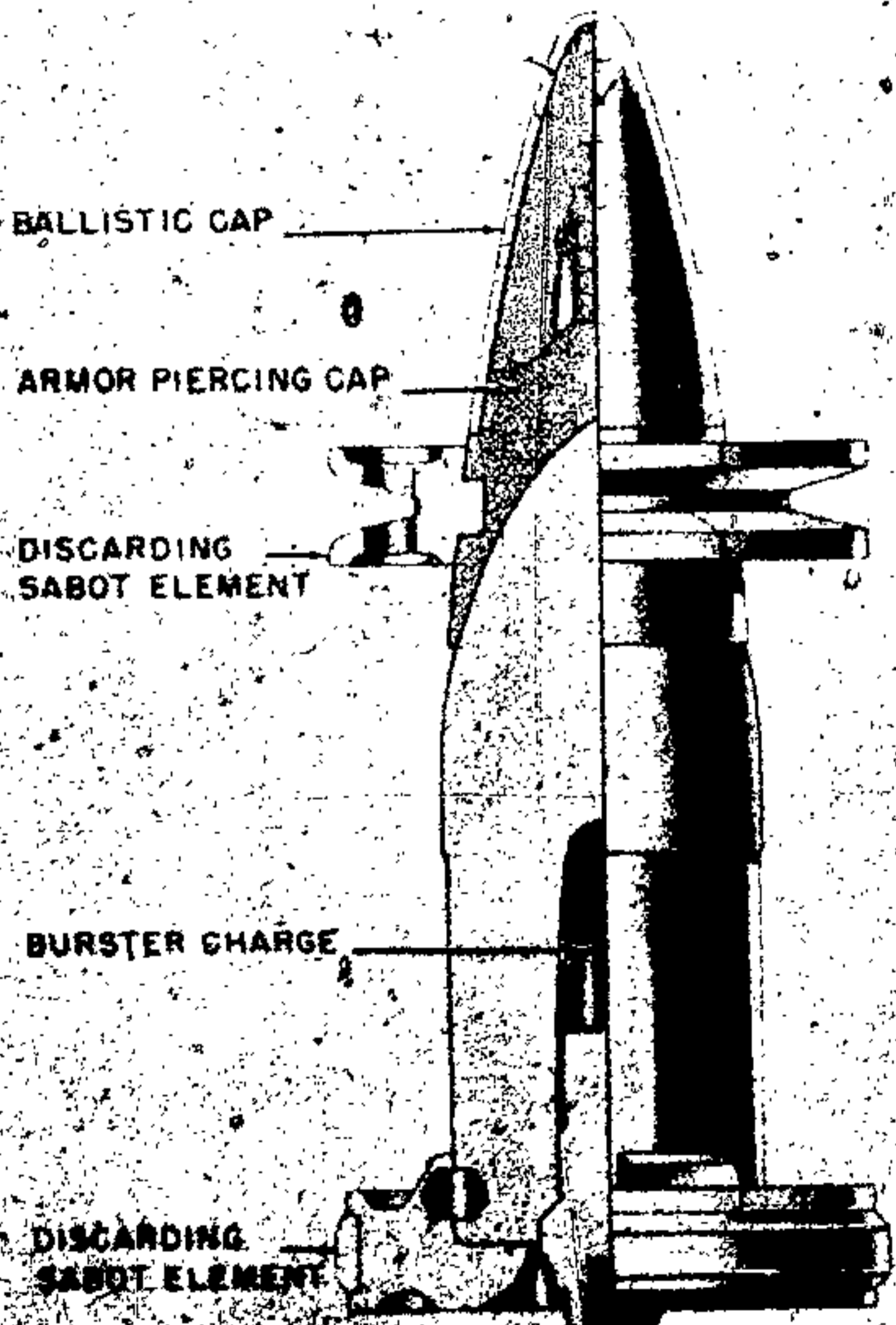

Figure 332—Sabot Projectile Type G

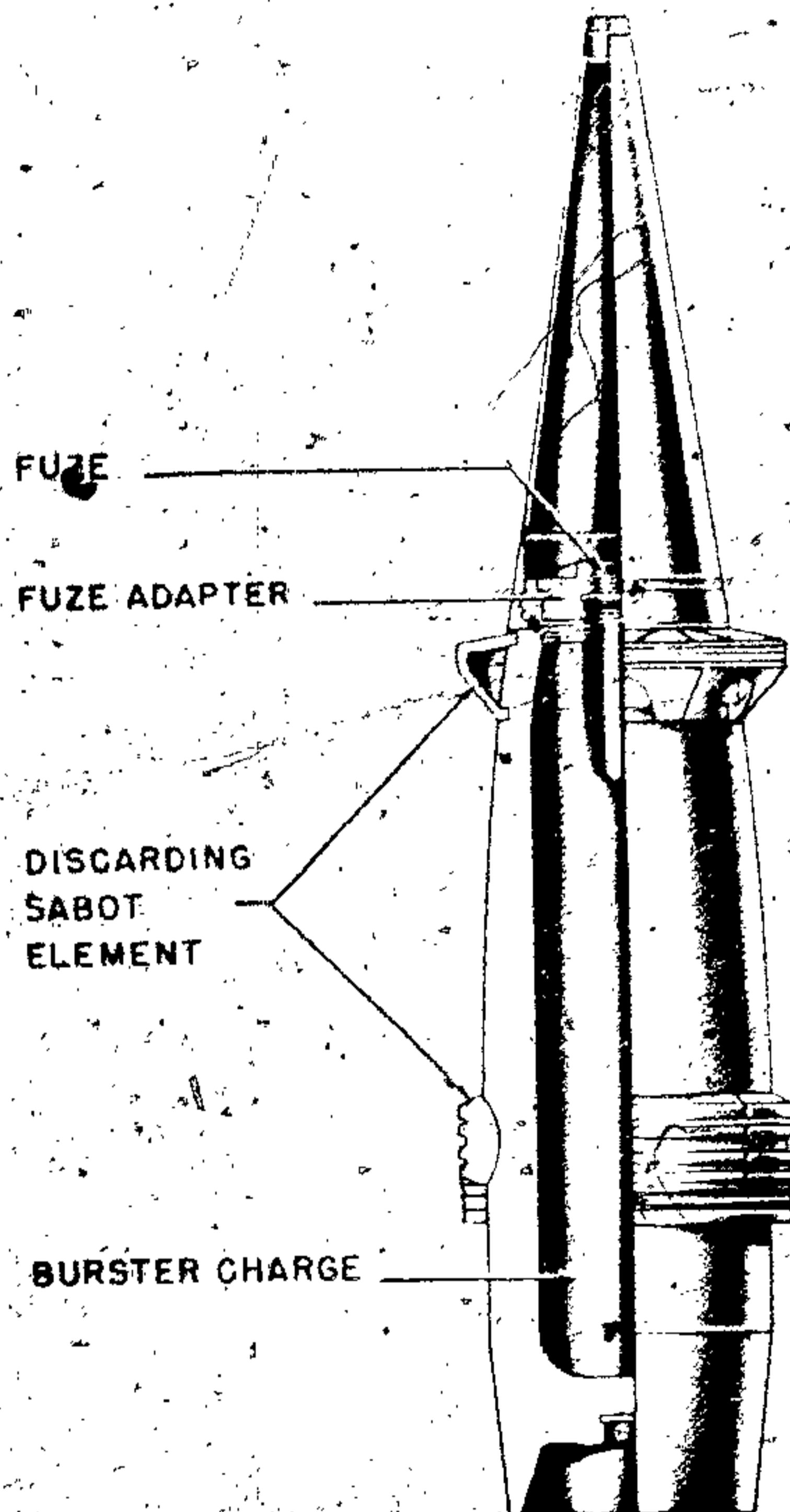

Figure 333A—Sabot Projectile Type H

the sabot elements are freed by the rifling of the projector cutting the wire bindings. These segments are then discarded by centrifugal action.

IN TYPE I the discarding bourrelet element is constructed of pressed steel and is in five separate segments. The segments are held together in grooves in the projectile by soft iron wire. The method of discarding is the same as in type A. There is no base discarding element.

IN TYPE J (see fig. 334) the projectile is fitted in a light metal case welded to a base element. This case forms the bourrelet and the base element forms the rotating band. After leaving the muzzle of the projector, the metal case is ejected by the resistance of the air.

GERMAN EXPLOSIVE ORDNANCE

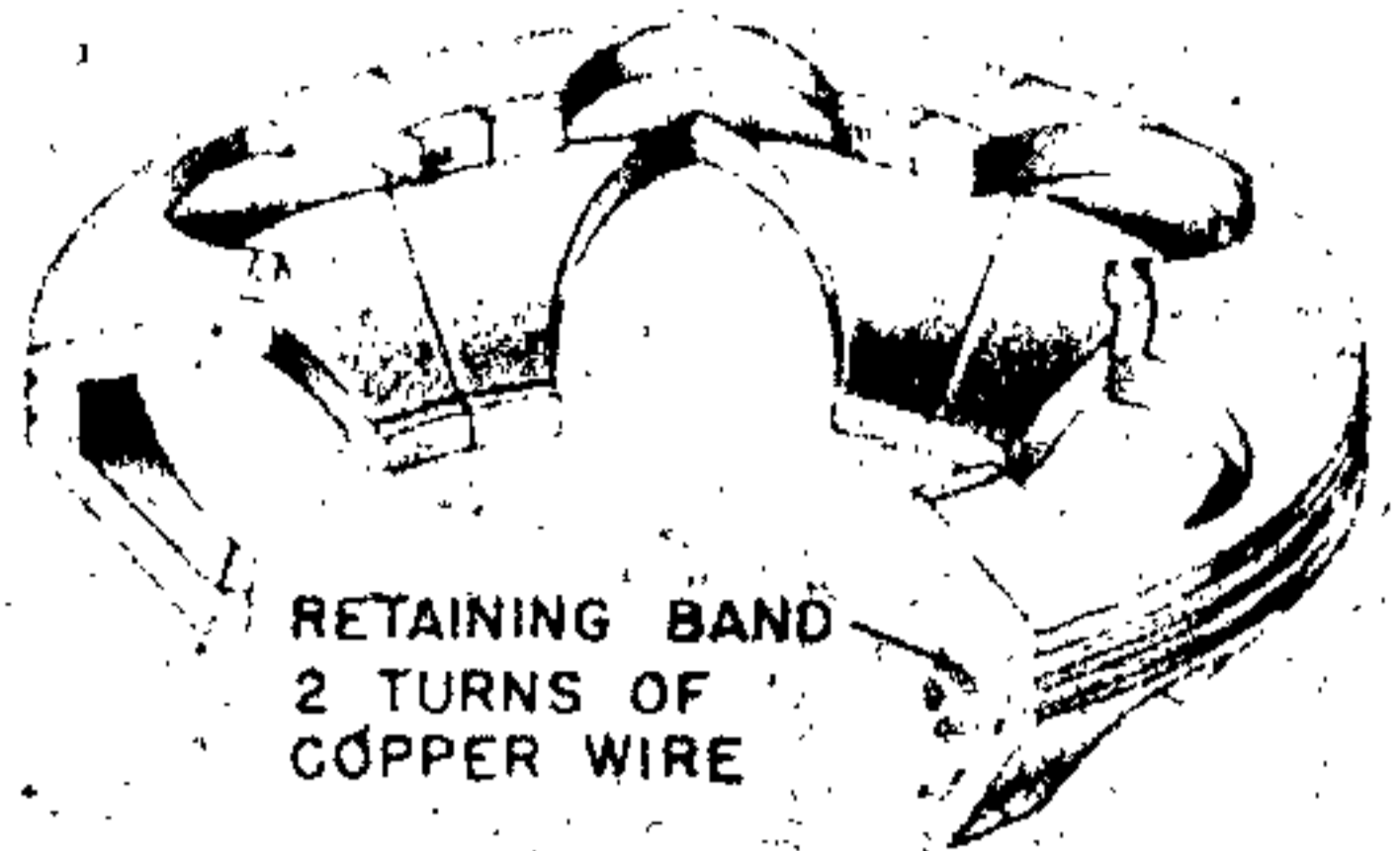

FORWARD DISCARDING SABOT ELEMENT
(4 SEGMENTS OF 6)

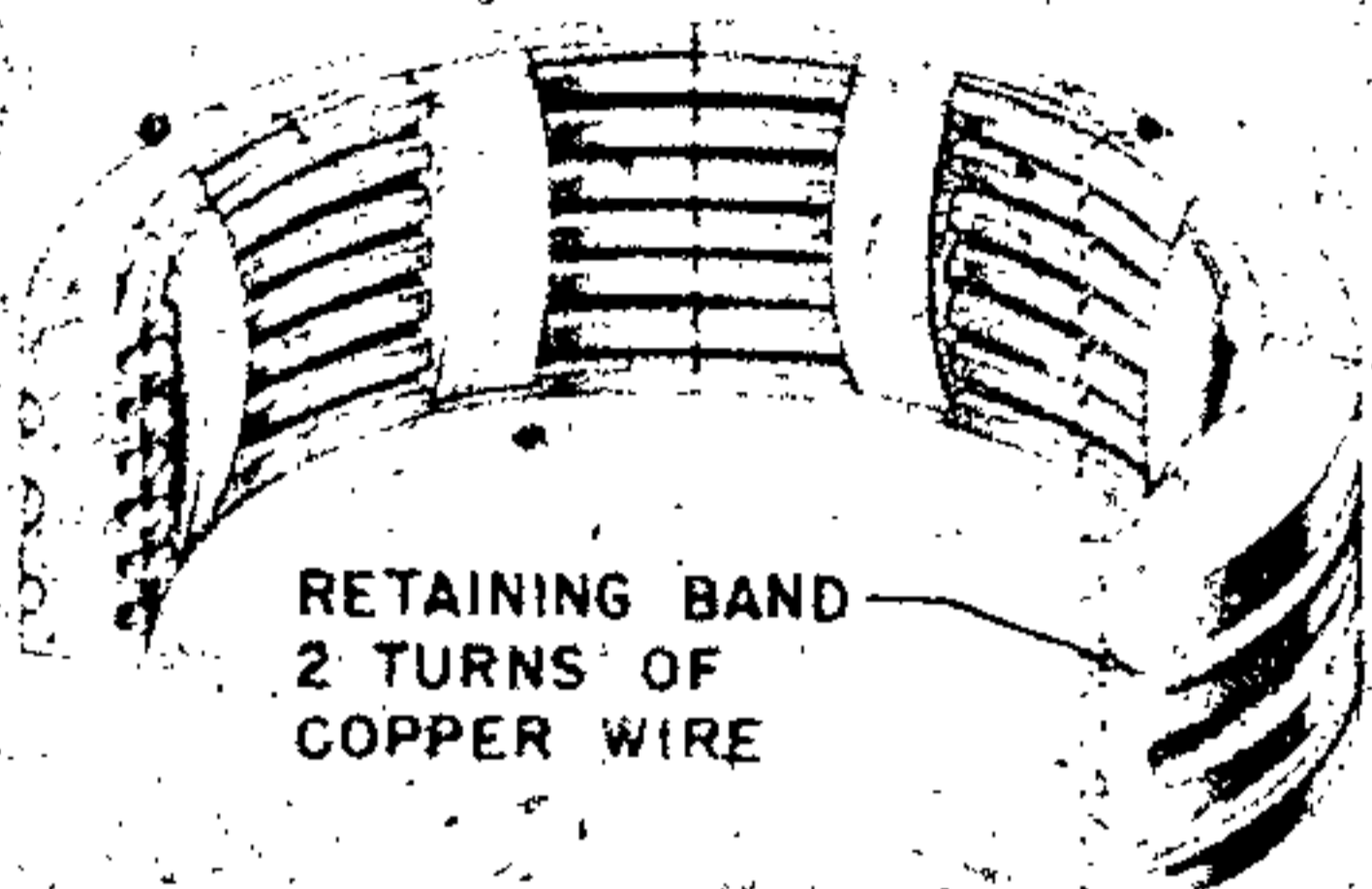

REAR DISCARDING SABOT ELEMENT
(5 SEGMENTS OF 8)

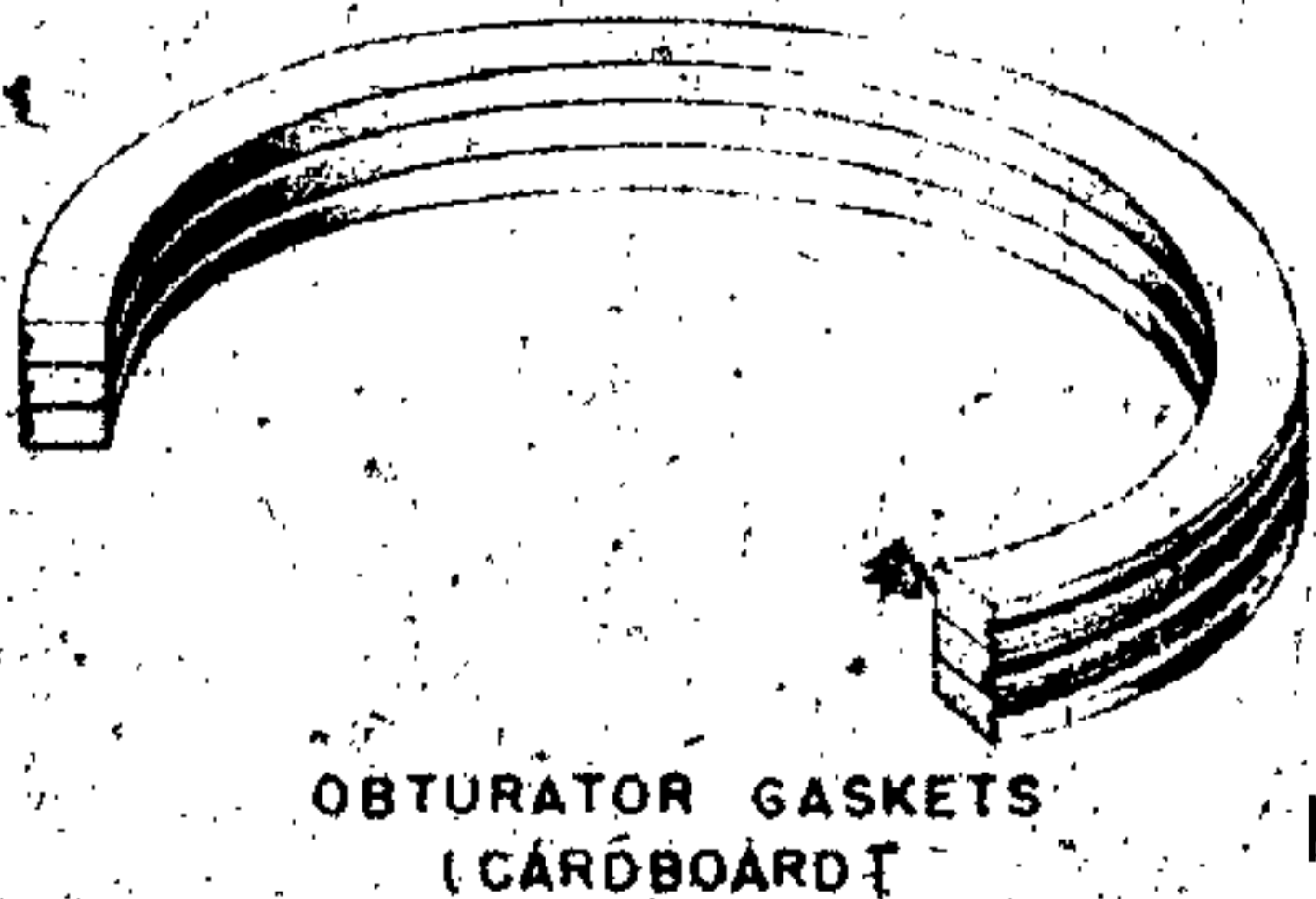
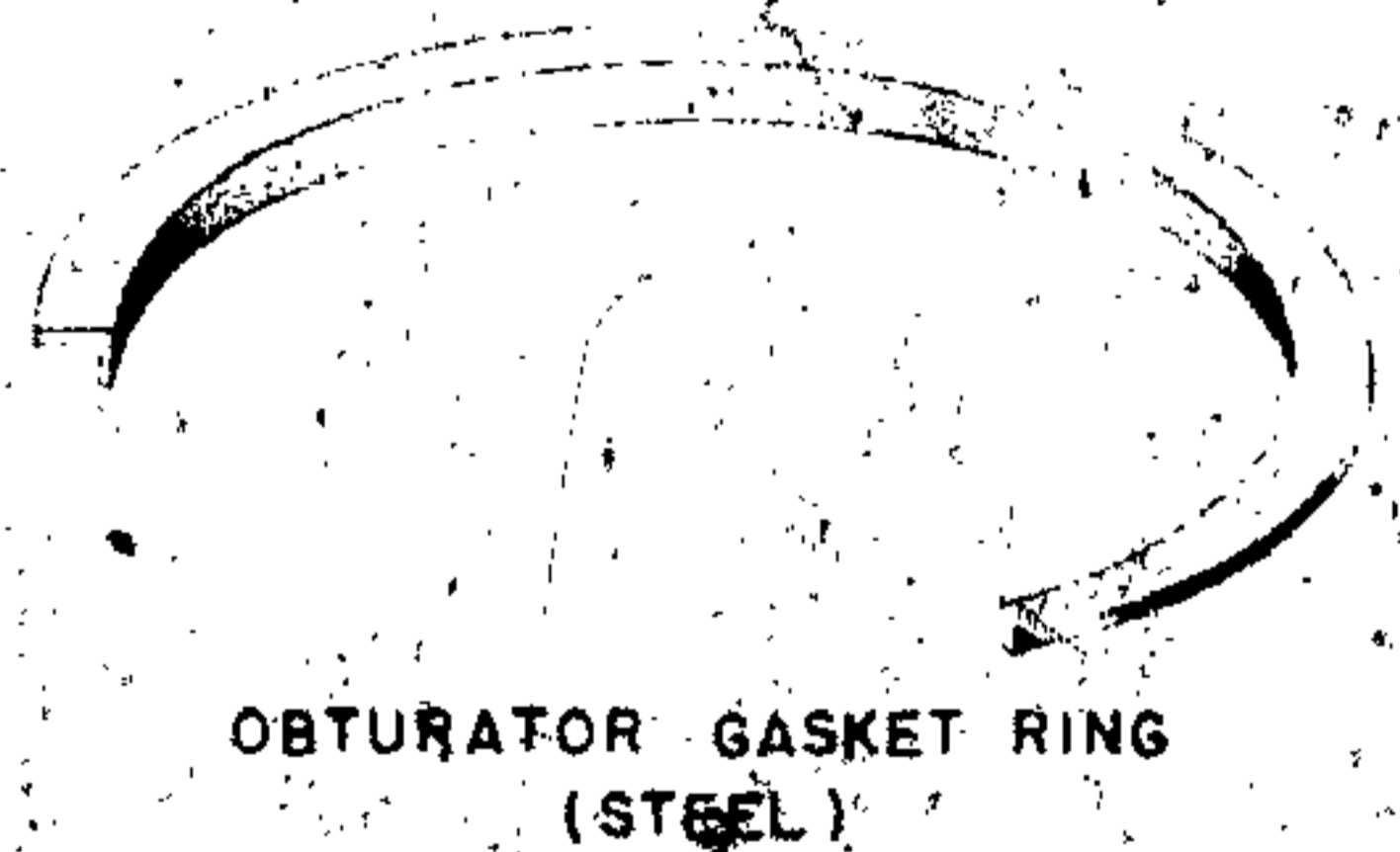

Figure 333B—Sabot Projectile Type H

A. P. "SABOT" PROJECTILE FOR 75-MM GUN

GERMAN NOMENCLATURE: 75/58-mm
Brandt "Sabot" A. P. projectile. (See fig. 335.)

WEAPONS:

French field gun: 7.5-cm F. K. 231 (f) Model 97.

French gun: 7.5.-cm K. 232 (f) Model 97/33.

PROJECTILE:

Caliber: 75/58 mm.

Kind: "Sabot" projectile.

Type: A. P.

Weight: Total weight: 5.93 pounds.

Weight of discarding sabot: 1.171 pounds.

Weight of A. P. core: 4.2 pounds.

Color: Aluminum body, with black ballistic cap.

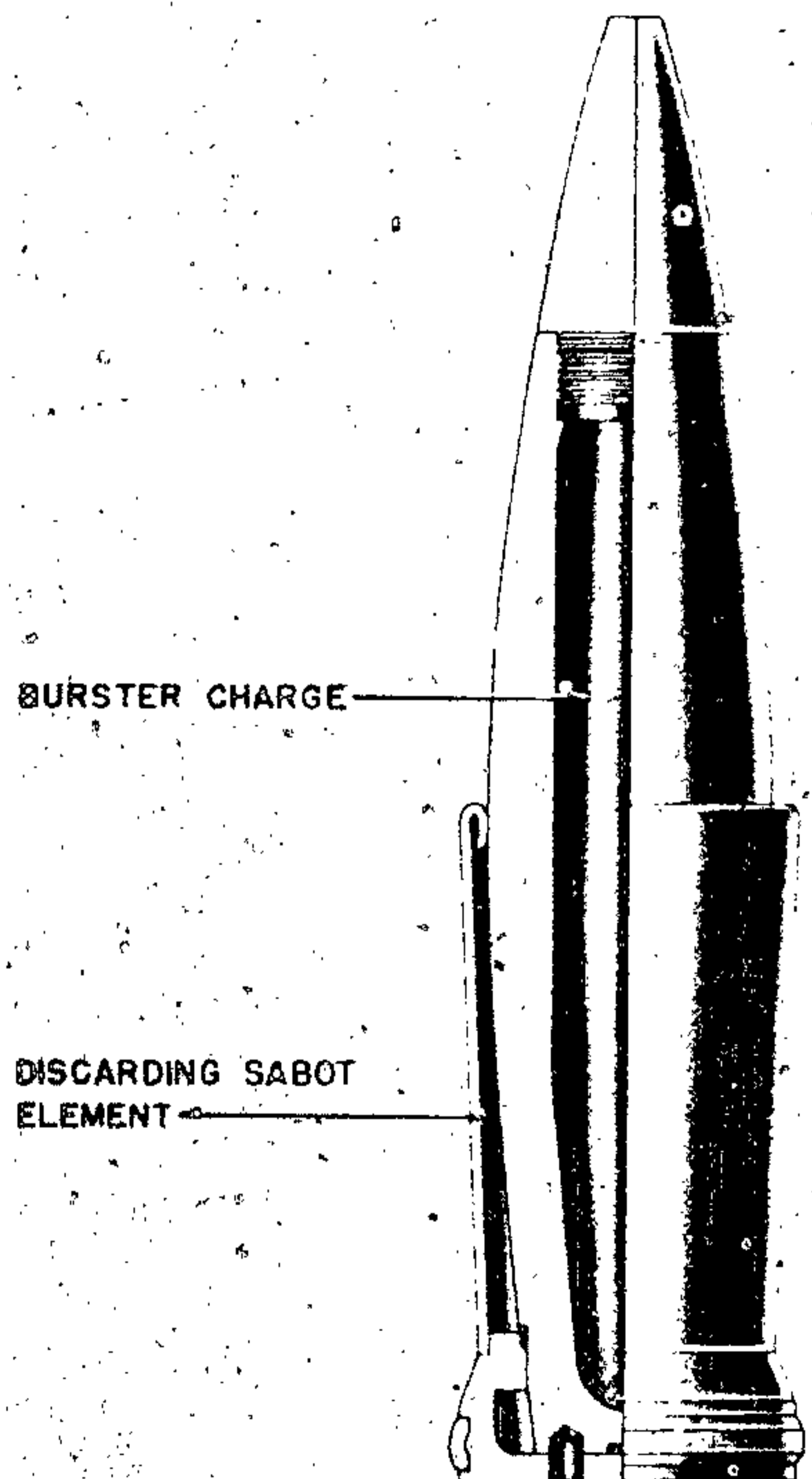
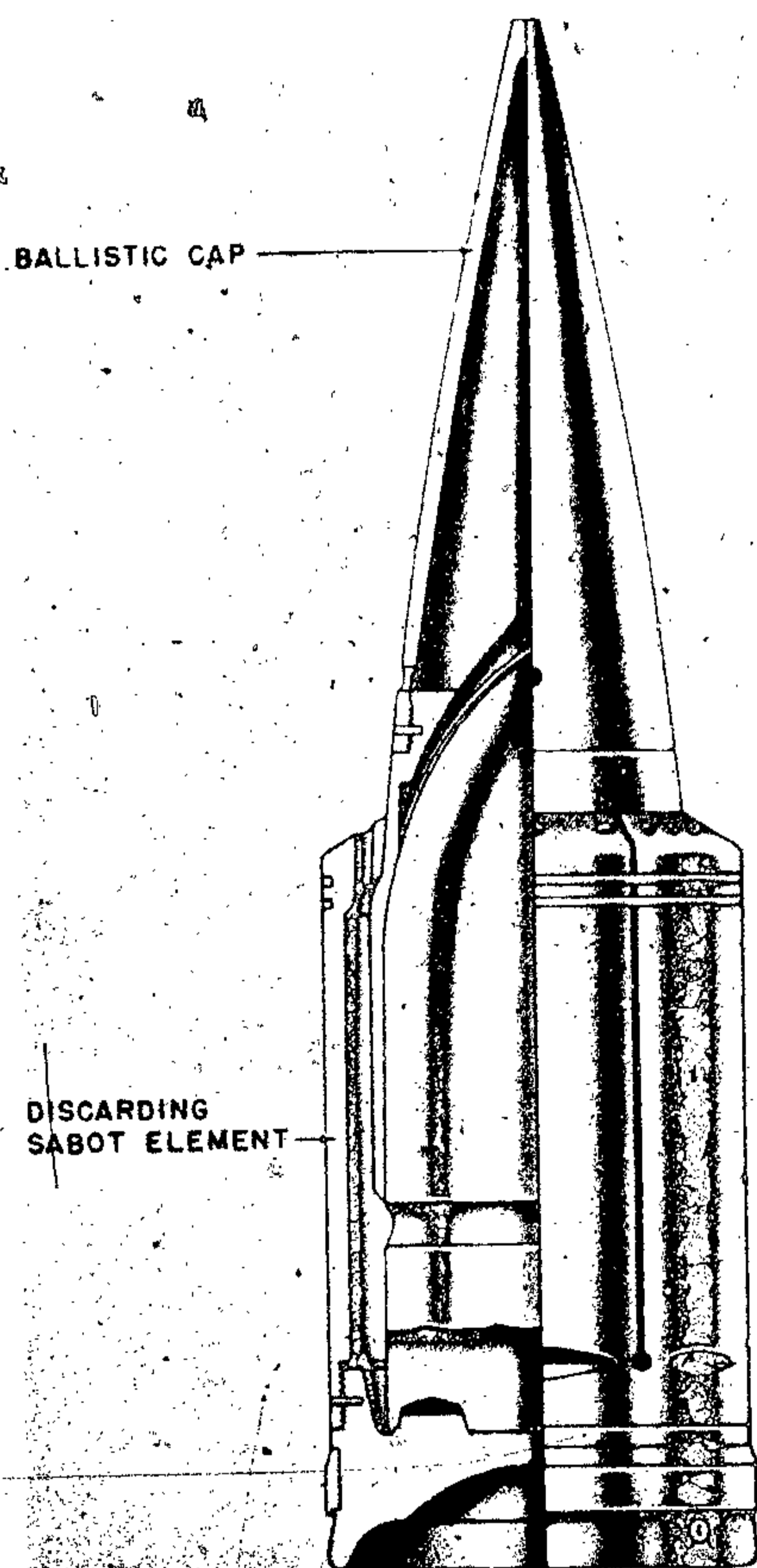

Figure 334—Sabot Projectile Type J



**Figure 335—A. P. Sabot Projectile 75-mm;
75/58-mm Brandt Sabot**

CHARGE: No charge present.

TRACER: None.

BOOSTER: None.

FUZE: None.

REMARKS:

NOTE 1.—It is believed that the 75/58-mm projectile is fired from the above listed weapons.

NOTE 2.—This projectile is a development by the French establishment of Edgar Brandt.

NOTE 3.—The aluminum body is disassociated from the A. P. core and ejected in the shape of

small fragments at a short distance in front of the nozzle.

NOTE 4.—The ballistic cap is of magnesium, thereby causing a flash when striking the armor of a tank; thus indicating a hit.

H. E. PROJECTILE WITH DISINTEGRATING BANDS, 105-MM

GERMAN DESIGNATION: Not known. (See fig. 336.)

EMPLOYMENT: Not known.

PROJECTILE, painted yellow:

23.1 pounds, total weight.

1.1 pounds, weight of bursting charge.

TNT, type of bursting charge.

Zdlg. C/98 Np booster.

CARTRIDGE CASE: Not known.

FUZE: Nose percussion fuze. AZ 23 v.

PACKAGING: One in a wooden crate.

REMARKS. At the shoulder of the projectile is a detachable guide band. This band is trisected by cuts almost completely through the band and the complete band, which is a push fit on the shoulder, is held in position by three ball bearings. These are seated in cavities spaced equally round the periphery of the shoulder of the shell and project into cylindrical drillings through each segment of the guide band. The drillings are threaded toward the outer circumference and the ball bearings after insertion are finally located by screws which seat the outer surface of the bearings. After insertion of the balls and the positioning of the three screws, therefore, the guide band is firmly attached to the shell body, but should trisection of the guide band be completed, each segment, together with its retaining ball, would therefore be free to fall away from the shell body.

The rotating band holder is located at the base of the shell, which is keyed to receive it. The holder itself is in three detached segments held in position only by the soft iron driving band. Movement is prevented by three cylindrical pieces fitting into cavities located in the shell body and the driving band holder. There are also three cylindrical pins between the segments.

It is believed that after leaving the gun the guide band and the rotating band holder are each split into three separate segments, which, together

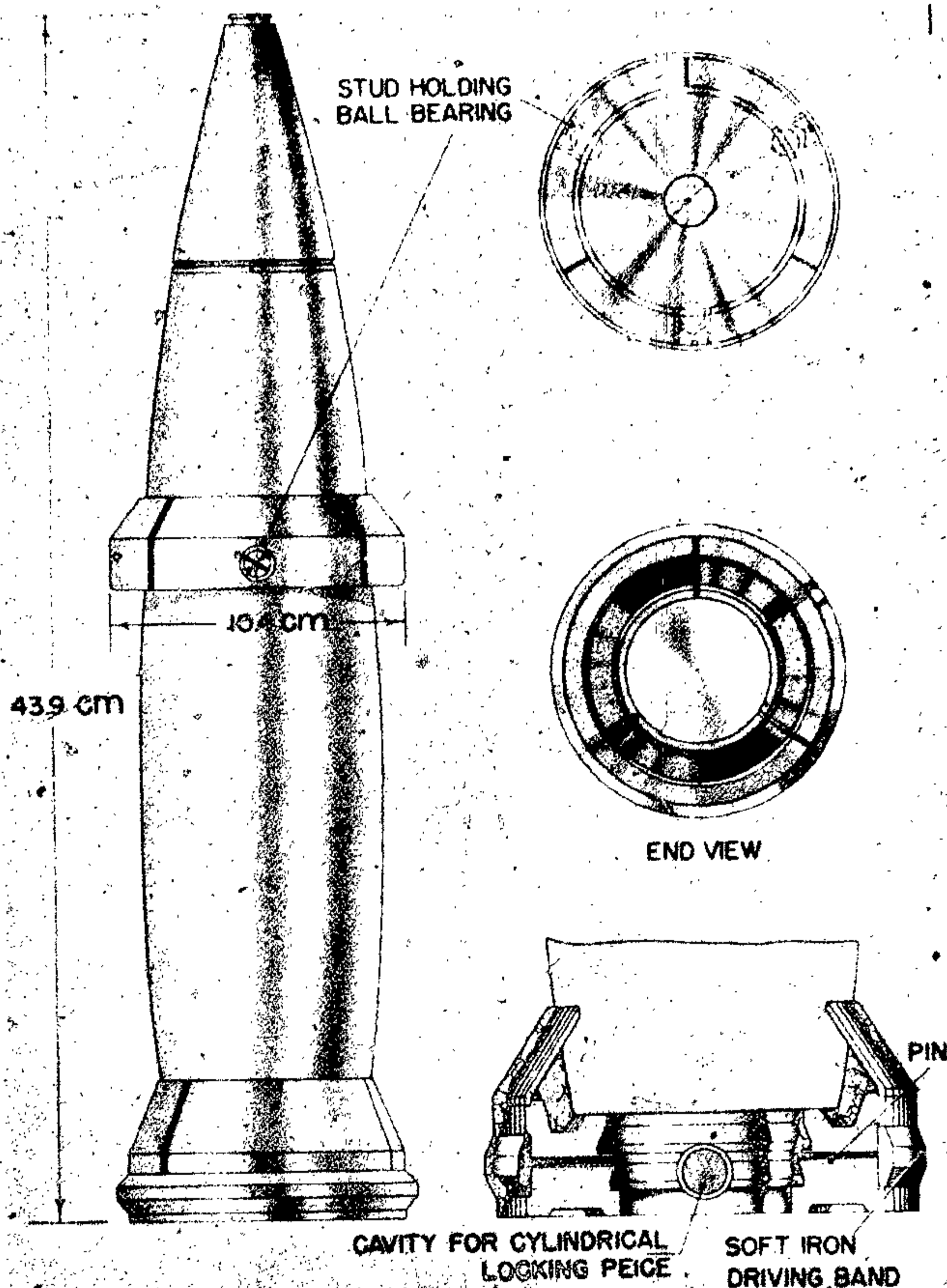

Figure 336—H. E. Projectile with Disintegrating Bands, 105-mm

with the ball bearings, pins and cylindrical pieces retaining them are flung off. The remaining projectile is then of much better aero-dynamic shape than is possible with a conventional projectile.

H. E. PROJECTILE WITH DISINTEGRATING ROTATING BANDS (SABOT TYPE), 150-MM

GERMAN NOMENCLATURE: Not known.
(See fig. 337.)

EMPLOYMENT: Not known.

PROJECTILE:

- 25.6 inches, over-all length.
- 5.84 inches, diameter of bourrelet.
- Soft iron, composition of rotating band.
- 6.01 inches, diameter of base.
- 63.14 pounds, total weight.
- 7.48 pounds, weight of bursting charge.
- Smoke box present beneath booster.
- Zdlg. 36 booster.
- "156" Stamped on base.
- "R 9" stenciled on body.

CARTRIDGE CASE: Not known.

FUZE: Nose Percussion Fuze AZ 23v.

REMARKS: At the shoulder of the projectile is a detachable guide band. This band is trisected by cuts almost completely through the band and the complete band, which is a push fit on the shoulder, is held in position by three ball bearings. These are seated in cavities spaced equally round the periphery of the shoulder of the shell and project into cylindrical drillings through each segment of the guide band. The drillings are threaded toward the outer circumference and the ball bearings after insertion are finally located by screws which seat the outer surface of the bearings. After insertion of the balls and the positioning of the three screws, therefore, the guide band is firmly attached to the shell body, but should trisection of the guide band be completed, each segment, together with its retaining ball, would therefore be free to fall away from the shell body.

The rotating band holder is located at the base of the shell, which is keyed to receive it. The holder itself is in three detached segments held in position only by the soft iron driving band. Movement is prevented by three cylindrical pieces fitting into cavities located in the shell body and the driving band holder. There are also three cylindrical pins between the segments.

It is believed that after leaving the gun the guide band and the rotating band holder are each split into three separate segments which, together with the ball bearings, pins and cylindrical pieces retaining them are flung off. The remaining projectile is then of much better aerodynamic shape than is possible with a conventional projectile.

H. E. PROJECTILE FOR TAPERED BORE GUN, 28.20-MM

GERMAN NOMENCLATURE: Sprgr. Patr. Pz. B41 (Spreng-granate patrone Panzerbuchse 41). (See fig. 338.)

EMPLOYMENT: s. Pz. B41 (schweres Panzerbuchse 41)—Gerlich type tapered bore gun.

COMPLETE ROUND: 8.5 inches, over-all length.

PROJECTILE, painted black:

2.531 inches, over-all length.

1.129 inches, diameter of bourrelet.

0.752 inch, diameter of body midway.

1.128 inches, diameter of base.

3.1 ounces, total weight.

1.8 ounces, weight of bursting charge.

PETN/Wax, type of bursting charge.

Tracer present.

CARTRIDGE CASE. (German nomenclature, P 345.):

7.375 inches, over-all length.

1.175 inches, diameter of neck.

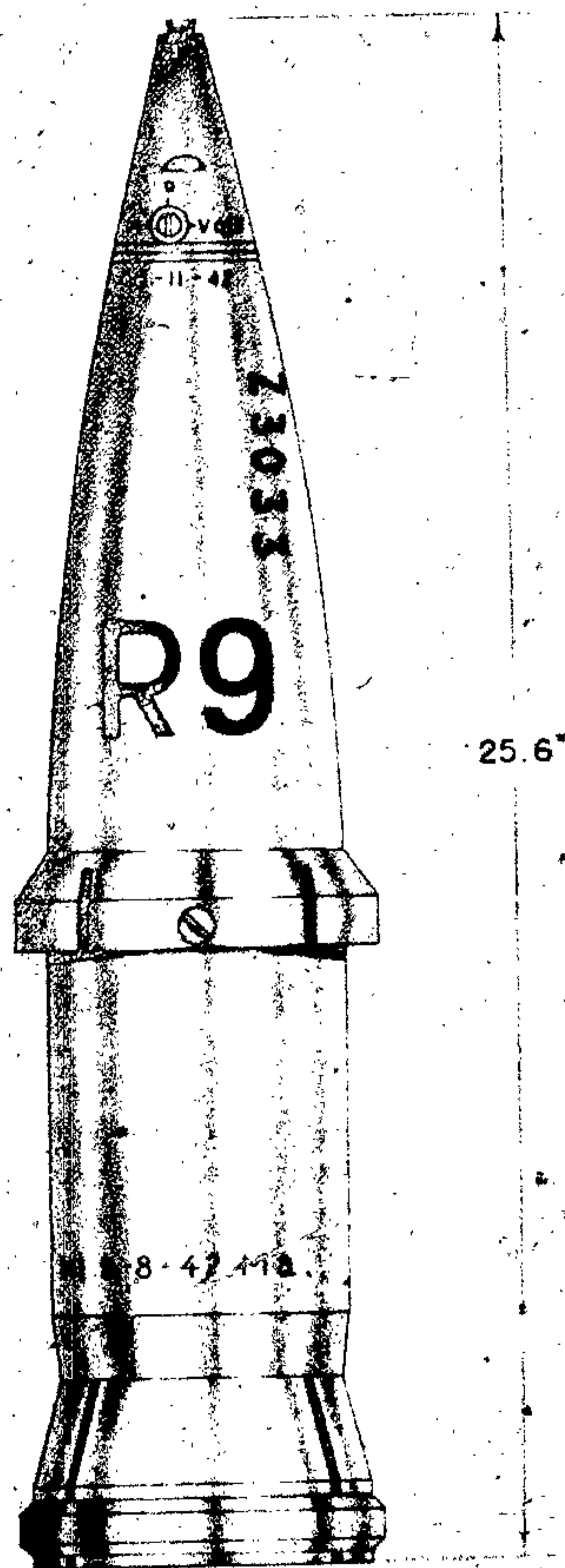

Figure 337—H. E. Projectile (Sabot Type), 150-mm

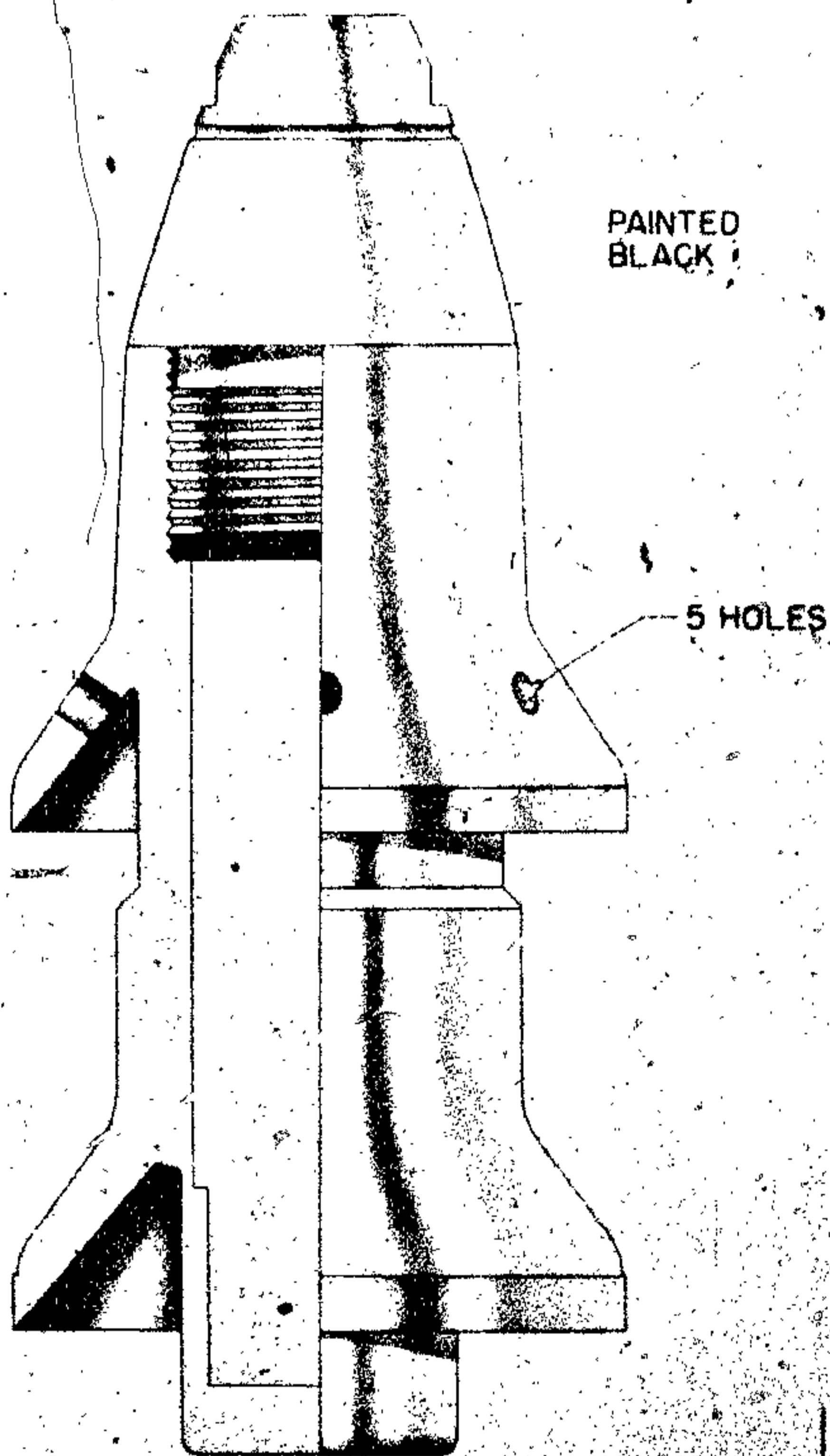

Figure 338—H. E. Projectile for Tapered Bore Gun, 28-20-mm Sprgr. Patr. Pz. B41

1.567 inches, diameter of shoulder.

1.885 inches, depth of extracting groove.

5.3 ounces, weight of propellant.

Nz. RP (tubular nitrocellulose) type of propellant.

C/13nA primer.

FUZE: AZ 5072.

A. P. SHOT WITH CORE, FOR TAPERED BORE GUN, 28-20-MM

GERMAN NOMENCLATURE: Pzgr. Patr. Pz. B 41 (Panzergranate patrone Panzerbuches 41). (See fig. 339.)

EMPLOYMENT: s. Pz. Bu 41 (schweres Panzerbuchse 41)—Gerlich type—Tapered bore gun.

COMPLETE ROUND: 8.5 inches, over-all length.

PROJECTILE: black with red band:

2.531 inches, over-all length.

1.129 inches, diameter of bourrelet.

0.752 inch, width of body midway.

1.128 inches, diameter of base.

4.6 ounces, total weight.

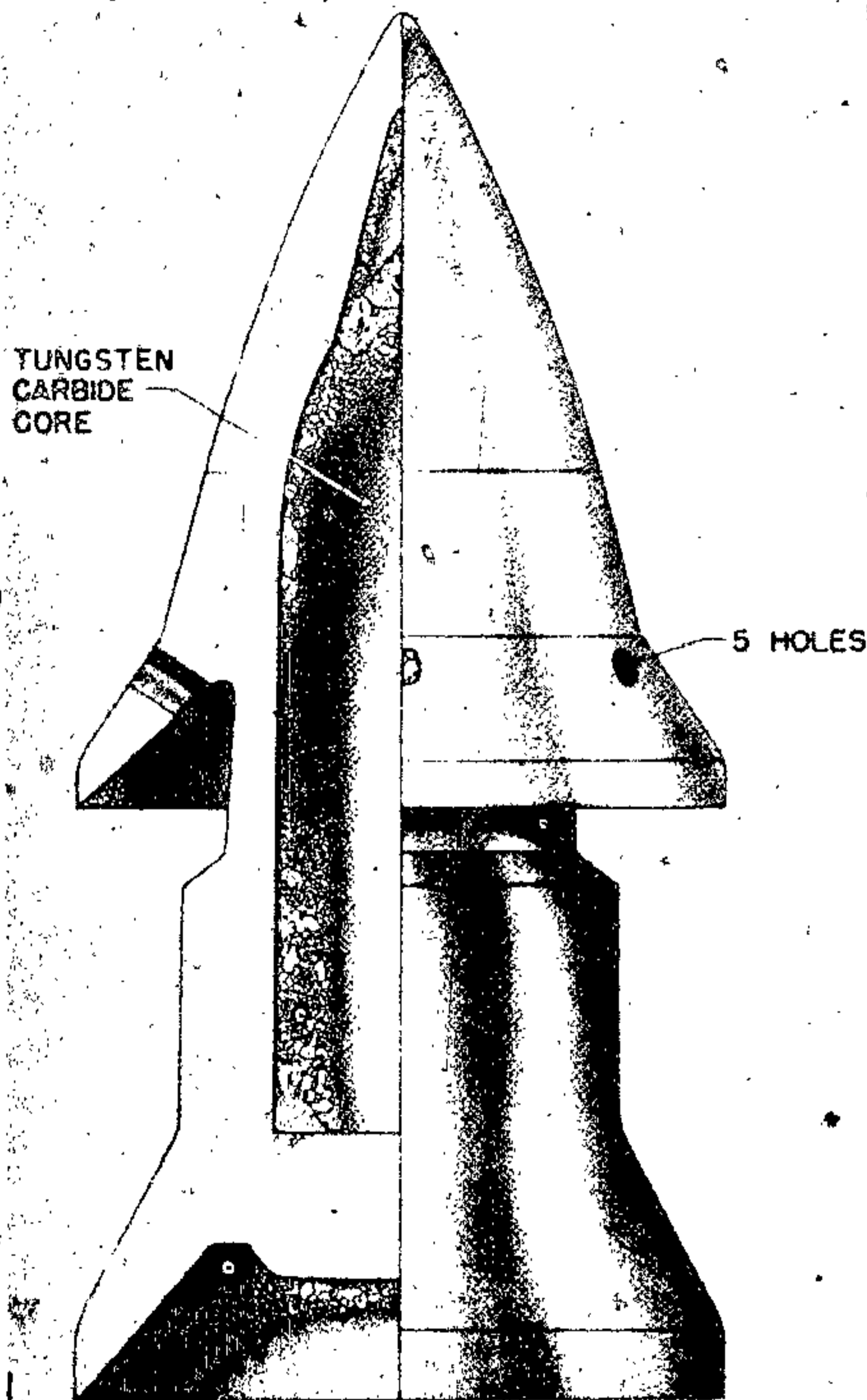

Figure 339—A. P. Shot with Core, for Tapered Bore Gun, 28-20 Pzgr. PZ. B41

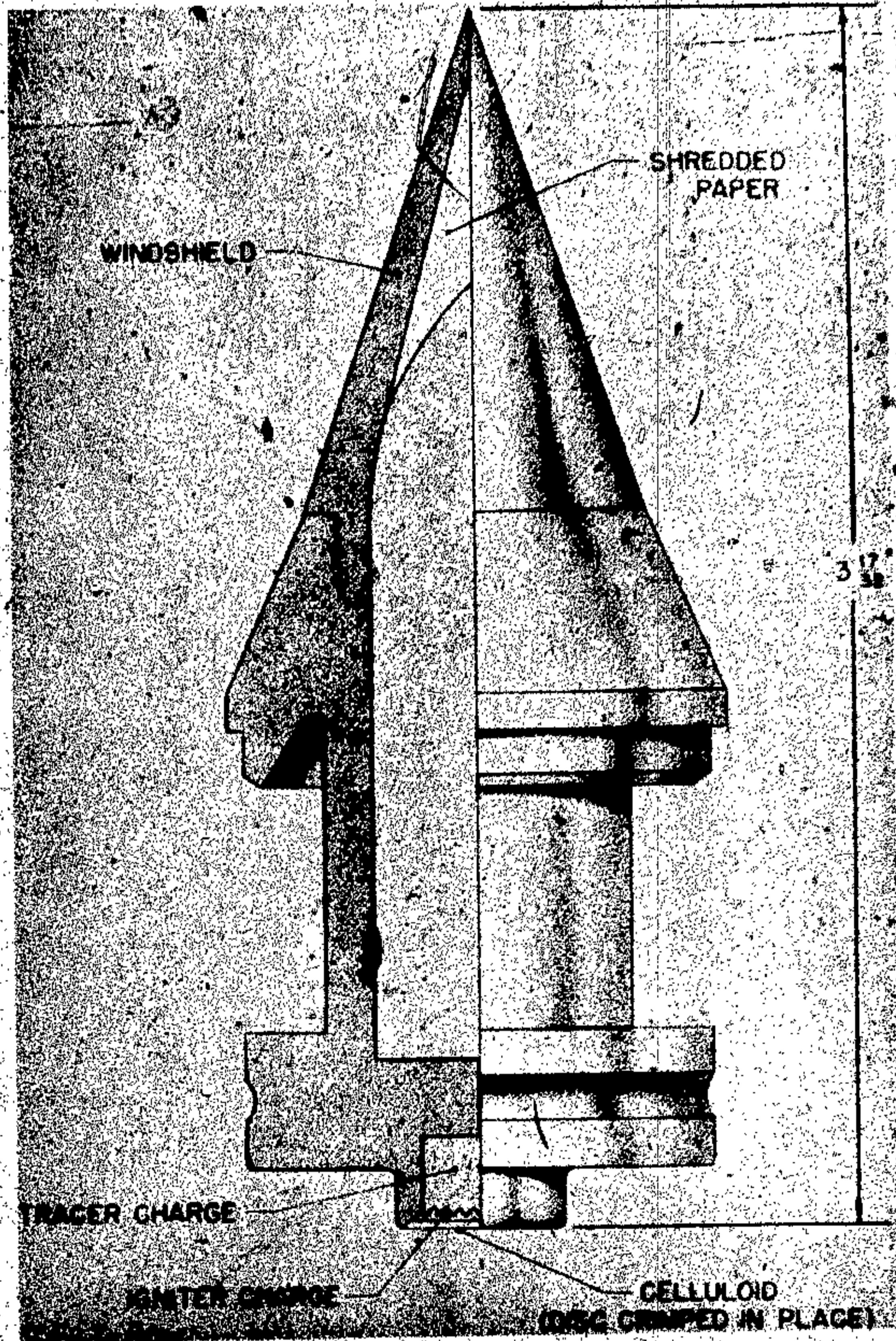

Figure 340—A. P. Projectile with Core (Arrowhead Design), 37-mm, 3.7-cm Pzgr. Patr. 40

1.593 inches, length of core.
0.430 inch, diameter of core.
Tracer present.

CARTRIDGE CASE (German nomenclature, P 345):

7.375 inches, over-all length.
1.175 inches, diameter of neck.
1.567 inches, diameter of shoulder.
1.885 inches, depth of extracting groove.
5.4 ounces, weight of propellant.
Tubular nitrocellulose, type of propellant.
C/13nA primer.

FUZE: None.

A. P. PROJECTILE WITH CORE (ARROW-HEAD DESIGN), 37-MM

GERMAN NOMENCLATURE: 3.7-cm. Pzgr. Patr. 40. (Panzergranate Patrone n° 40) (see fig. 340.)

EMPLOYMENT: 3.7-cm. Pak. (Panzerabwehrkanone).

COMPLETE ROUND: 11.95 inches, over-all length. 2.1 pounds, total weight.

PROJECTILE: 3.531 inches, over-all length.
1.447 inches, diameter of bourrelet.
0.375 inch, width of rotating band.

GERMAN EXPLOSIVE ORDNANCE

1.456 inches, diameter of base.
12.34 ounces, total weight.
2.26 inches, tungsten carbide core.
0.62 inch, diameter of tungsten carbide core.
Tracer is present.
0.937 inch, diameter of body midway.
Markings: "Aux 7a40."

CARTRIDGE CASE (German nomenclature, 6331):

9.75 inches, over-all length.
1.5 inches, diameter of neck.
1.625 inches, diameter of shoulder.
2.0 inches, diameter of rim.
5.0 ounces, weight of propellant.
Tubular double base propellant (nitroglycerine and nitrocellulose).

FUZE: None.

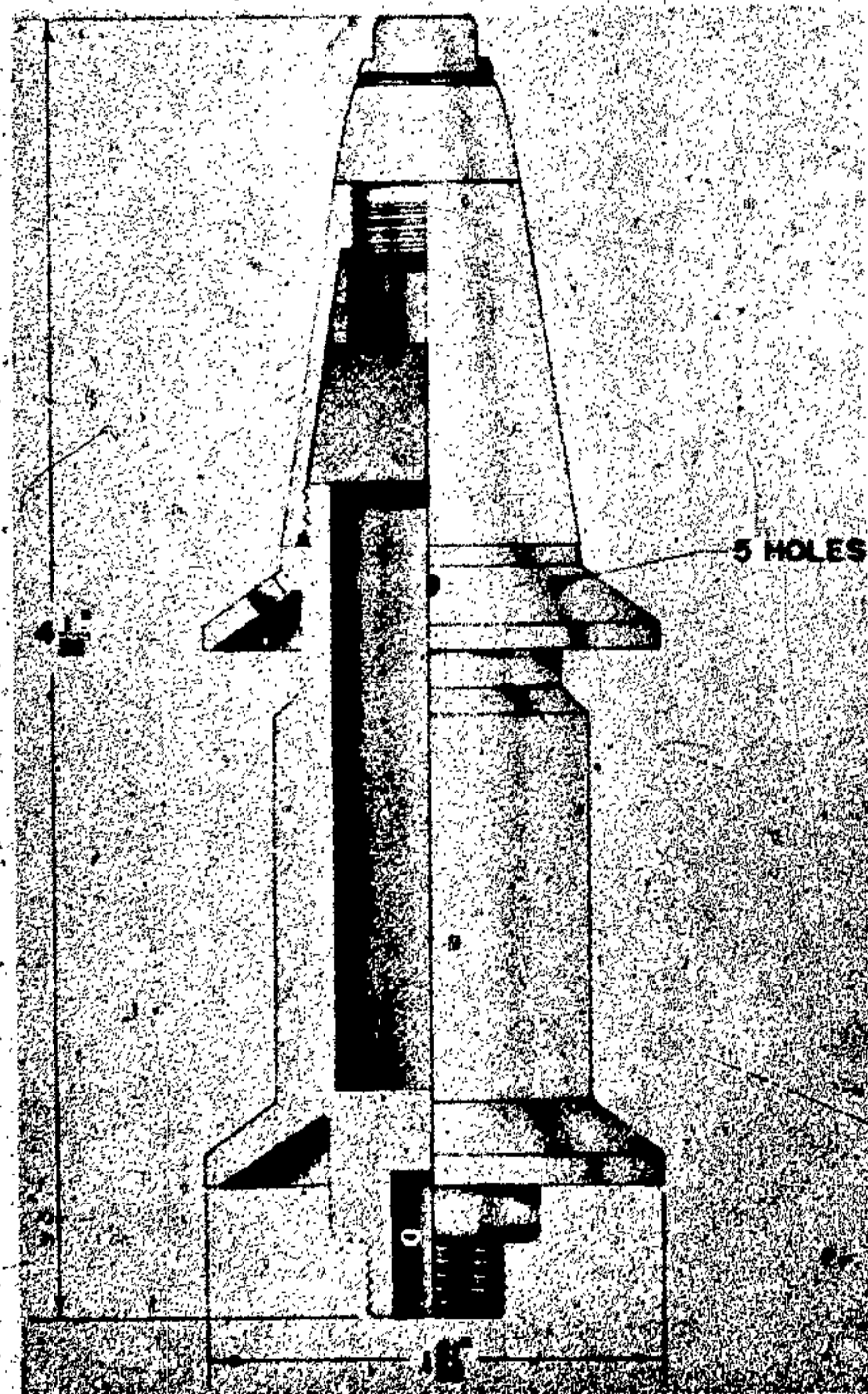

Figure 341—H. E. Projectile for Tapered Bore Gun, 42-28-mm, 4.2-2.8 Sprgr. Patr. L. Pak. 41

H. E. PROJECTILE FOR TAPERED BORE GUN, 42-28-MM.

GERMAN NOMENCLATURE: 4.2-2.8-cm Sprgr. Patr. L Pak. 41 (Sprenggranate Patronen L Pak. 41). (See fig. 341.)

EMPLOYMENT: L Pak. 41 (L. Panzerabwehrkanone 41).

COMPLETE ROUND: 17.875 inches, over-all length. 2.992 pounds, total weight.

PROJECTILE: 4.031 inches, over-all length w/o fuze. 1.125 inches, diameter of body midway. 1.656 inches, diameter of base. 9.87 ounces, total weight. 0.98 ounce, weight of bursting charge. Cyclonite/Wax (90/10) type of bursting charge.

CARTRIDGE CASE (German nomenclature, 6329): 15.748 inches, over-all length. 1.45 inches, diameter of neck. 1.6 inches, diameter of shoulder. 2.0 inches, diameter at extracting groove. 10.94 ounces, weight of propellant. Digl. R. P. (tubular diethylene glycol dinitrate and nitrocellulose) type of propellant. C/13nA primer.

FUZE: AZ 5072 (similar to AZ 5045).

A. P. PROJECTILE WITH CORE FOR TAPERED BORE GUN, 42-28-MM

GERMAN NOMENCLATURE: 4.2-cm—2.8-cm Pzgr. Patr. L. Pak. 41 (Panzergranate Patronen L. Panzerabwehrkanone 41). (See fig. 342.)

EMPLOYMENT: L. Pak. 41 (L. Panzerabwehrkanone 41).

COMPLETE ROUND:

18.1 inches, over-all length.
3.34 pounds, total weight.

PROJECTILE, painted black:

3.76 inches, over-all.
1.062 inches, diameter of body midway.
1.65 inches, diameter of base.
2.25 inches, length of Tungsten carbide core.
0.594 inch, diameter of Tungsten carbide core.
11.86 ounces, total weight.
Tracer present.

CARTRIDGE CASE (German nomenclature, 6329):

15.748 inches, over-all length.

1.45 inches, diameter of neck.
 1.6 inches, diameter of shoulder.
 2.0 inches, depth of extracting groove.
 15.32 ounces, weight of propellant.
 Tubular Gudol, type of propellant.
 C/13nA primer.

A. P. PROJECTILE WITH TUNGSTEN CARBIDE CORE (ARROWHEAD DESIGN), 47-MM

GERMAN NOMENCLATURE: 4.7-cm Pzgr. Patr. 40 (Panzergranate Patronen 40). (See fig. 343.)

EMPLOYMENT: 4.7-cm Pak. (t) (Panzerabwehrkanone (t)).

4.7-cm K 36 (t) (Kanone 36 (t)).

COMPLETE ROUND: 18.94 inches, over-all length. 2.50 kg, total weight.

PROJECTILE painted black:

5.375 inches, over-all length with tracer.

1.187 inches, diameter of body midway.

0.51 inch, width of rotating band.

1.81 pounds, total weight.

3.0 inches, length of Tungsten carbide core.

0.812 inch, diameter of Tungsten carbide core.

Tracer present.

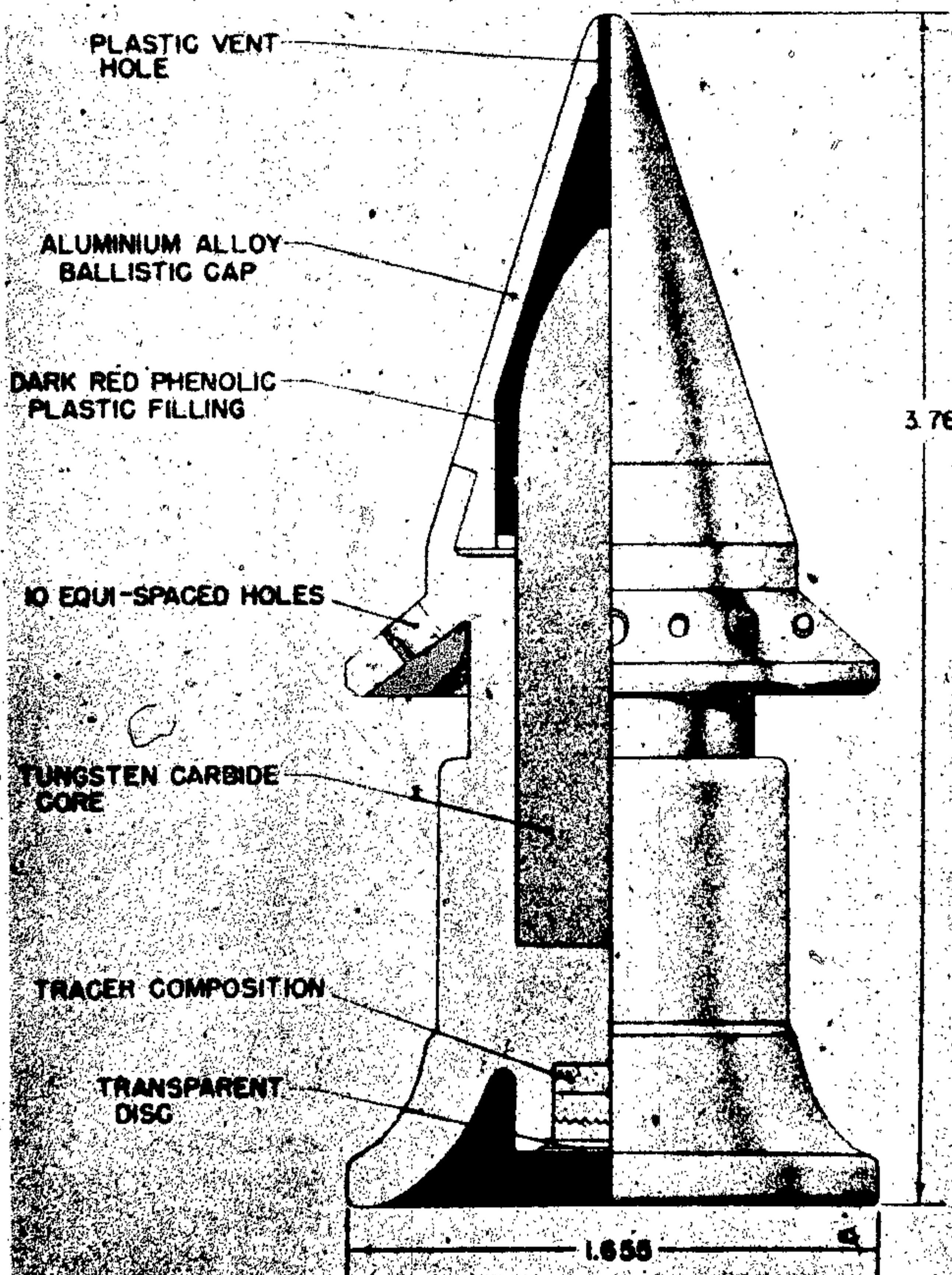

Figure 342—A. P. Projectile with Core for Tapered Bore Gun, 42-28-mm, 4.2-2.8-cm Pzgr. Patr. L. Pak. 41

GERMAN EXPLOSIVE ORDNANCE

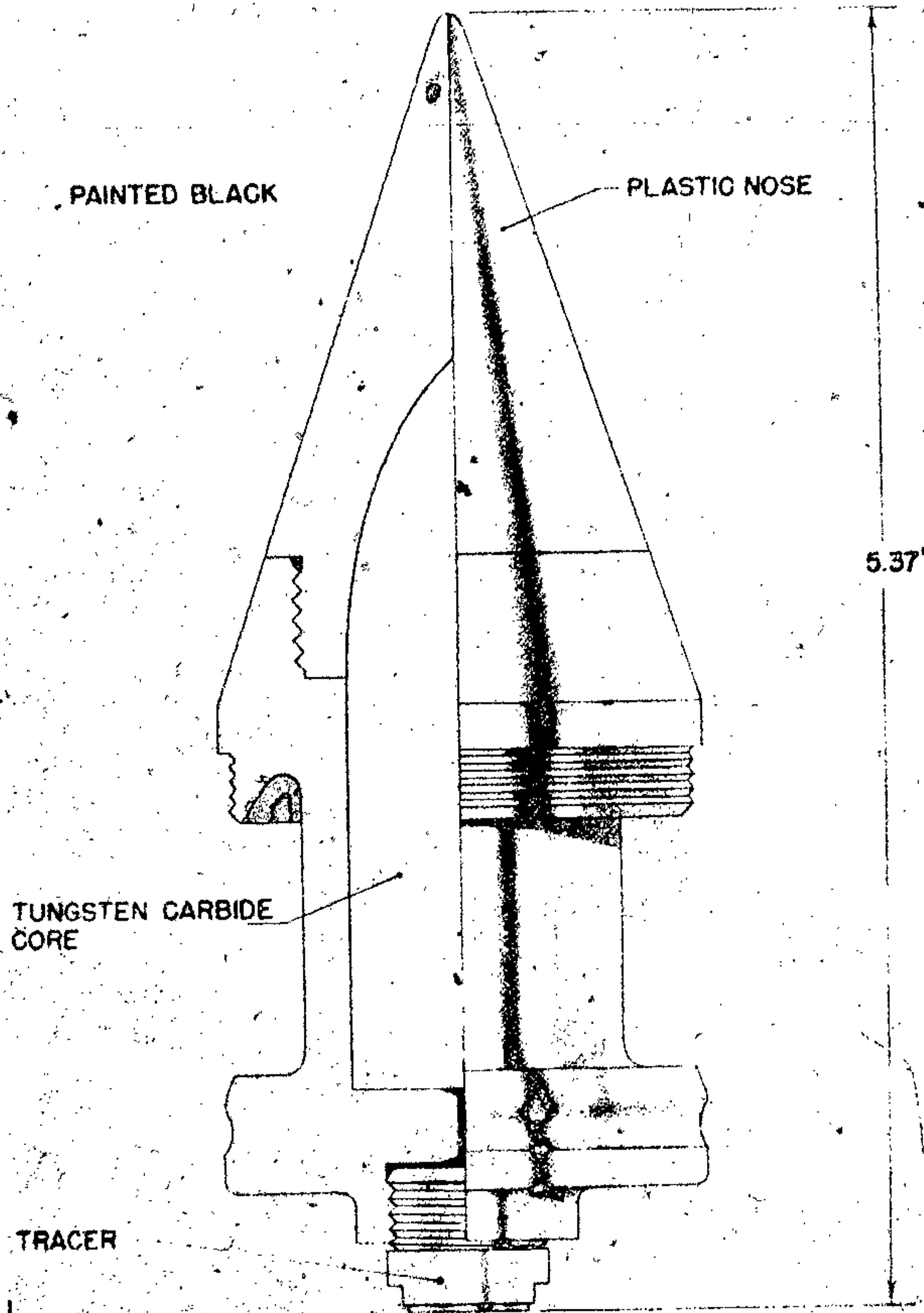

Figure 343—A. P. Projectile with Tungsten Carbide Core (Arrowhead Design), 47-mm

CARTRIDGE CASE (German nomenclature, M 36):

- 15.944 inches, over-all length.
- 1.98 inches, diameter of neck.
- 2.12 inches, diameter of shoulder.
- 2.52 inches, depth of extracting groove.
- Tubular propellant.
- M 33 primer.

A. P. PROJECTILE WITH TUNGSTEN CARBIDE CORE (ARROWHEAD), 50-MM

GERMAN NOMENCLATURE: 5-cm Pzgr. Patr. 40 KwK (Panzergranate, Patrone 40 Kampfwagenkanone). (See fig. 344.)

EMPLOYMENT: 5-cm KwK Kampfwagenkanone—Tank Gun.

5-cm KwK 39 Kampfwagenkanone 39—Tank Gun 39.

5-cm Pak 38 Panzerabwehrkanone 38—Anti-tank Gun 38.

COMPLETE ROUND: Description of c/r is for 5-cm KwK. 14.48 inches, over-all length. 5 pounds 3 ounces, total weight.

PROJECTILE painted black:

5.75 inches, over-all.

length w/tracer.

1.95 inches, diameter of bourrelet.

2.269 inches, diameter of rotating band.

0.5 inch, width of rotating band.

1.258 inches, diameter of body midway.

1.95 pounds, total weight.

2.937 inches, length of tungsten carbide core.

0.81 inch, diameter of core.

0.74 pound, weight of core.

Tracer in cup at base.

CARTRIDGE CASE (German nomenclature, 6317 (fixed)):

11.342 inches, over-all length.

2.035 inches, diameter of neck.

2.668 inches, diameter of shoulder.

3.085 inches, diameter of base.

1.87 pounds, weight of case.

1.2 pounds, tubular diglycol propellant.

C/22 31 grain electric primer.

FUZE: No fuze is employed.

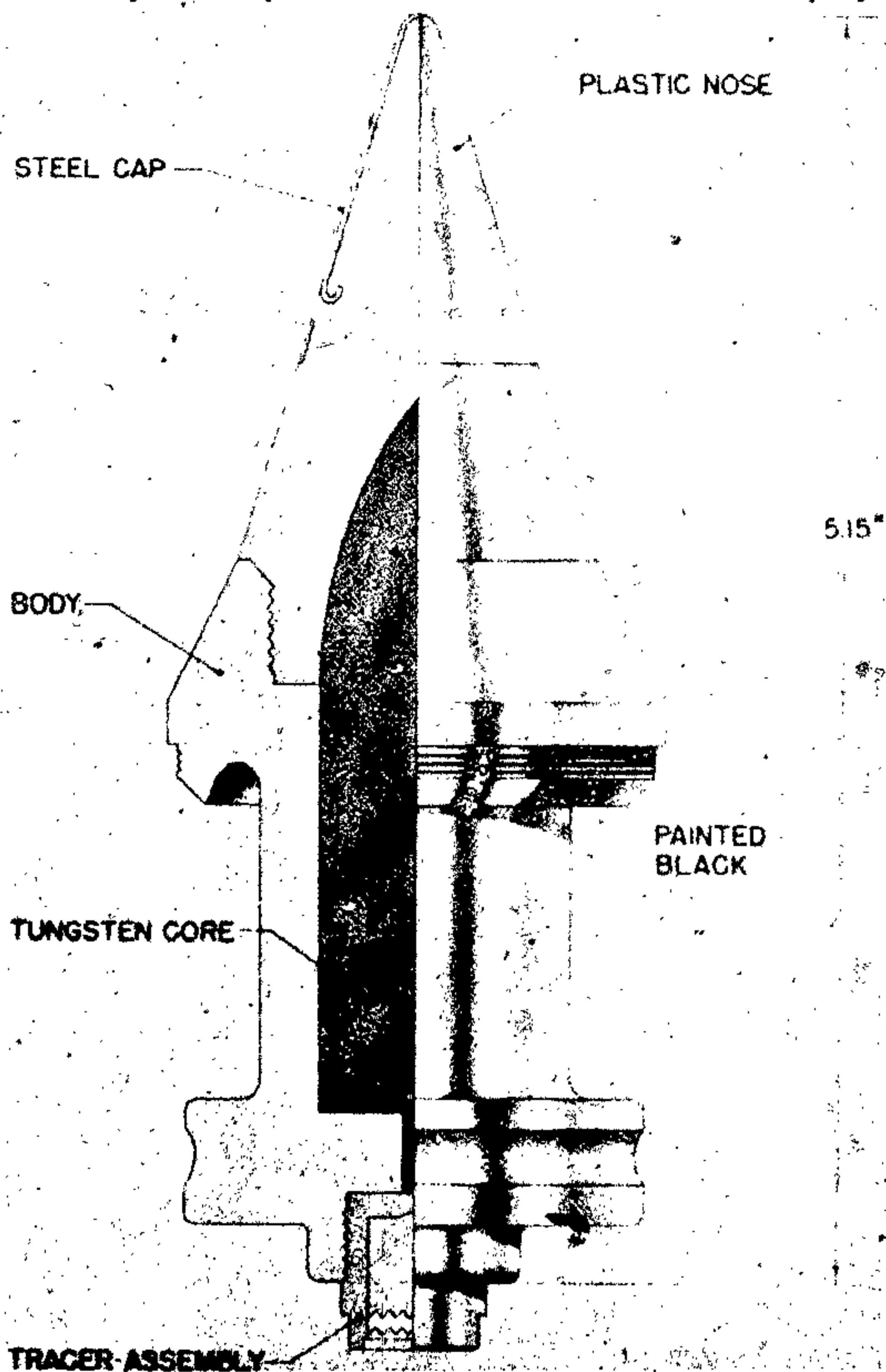

Figure 344—A. P. Projectile with Tungsten Carbide Core (Arrowhead), 50-mm

GERMAN EXPLOSIVE ORDNANCE

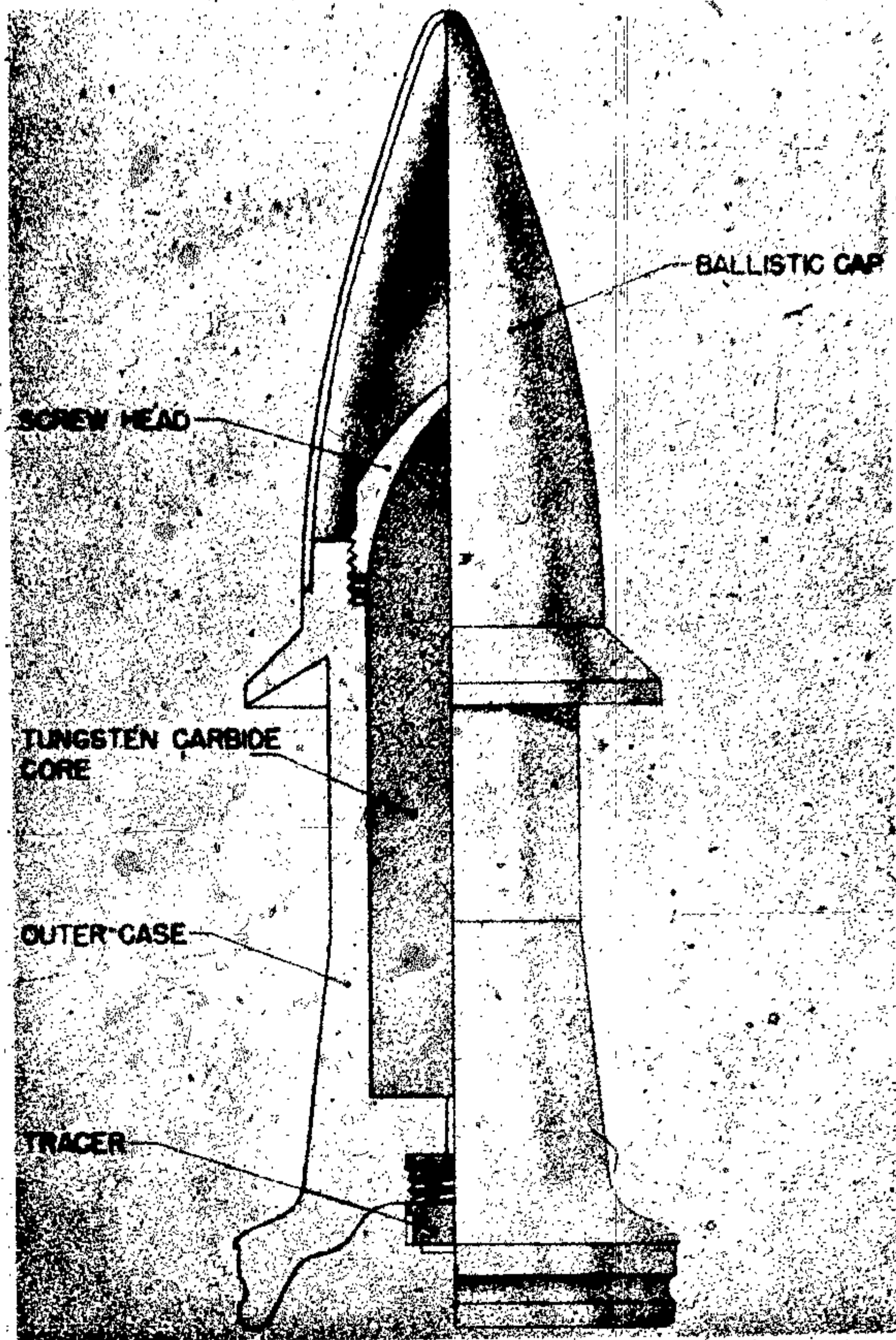

Figure 345—A. P. Projectile with Tungsten Core (Arrowhead), 75-mm, 7.5-cm Pzgr. Patr. 41

REMARKS: Cartridge cases for other weapons are as follows: Pak 38—6360 (fixed); KwK 39—6360 (fixed).

A. P. PROJECTILE WITH TUNGSTEN CORE (ARROWHEAD), 75-MM

GERMAN NOMENCLATURE: Pzgr. Patr. 41 (Panzergranate Patrone 41). (See fig. 345.)

EMPLOYMENT: Pak 41 (Pangerabwehrkanone 41) anti-tank Gun 41.

COMPLETE ROUND: 29.8 inches, over-all length.

16.65 pounds, total weight.

PROJECTILE, painted black:

5.68 pounds, total weight.

2.01 pounds, weight of tungsten carbide core.

1.16 inches, diameter of core.

Tracer is present.

CARTRIDGE CASE (German nomenclature, 6344):

5.43 pounds, tubular Diglycol propellant.

C/12nA primer.

FUZE: No fuze is employed.

REMARKS: This round has not been recovered to date. Information is from captured document.

INERT-LOADED PROJECTILE FOR AIRCRAFT CANNON, 30-MM

GERMAN NOMENCLATURE: 3 cm. (See fig. 346.)

EMPLOYMENT: 3-cm. Solothurn—Aircraft Cannon).

COMPLETE ROUND: 11.719 inches, over-all length.

PROJECTILE, painted grey, yellow band above rotating band: Two cannellures below rotating band. 5.25 inches, over-all length w/fuze. 1.187 inches, diameter, of bourrelet. 0.312 inch, width of rotating band. 1.125 inches, diameter of base. 0.781 inch, base to band. Filled with inert Bituminous composition. Tracer present.

CARTRIDGE CASE, (German nomenclature, K2): 7.25 inches, over-all length. 1.25 inches, diameter of neck. 1.375 inches, diameter of

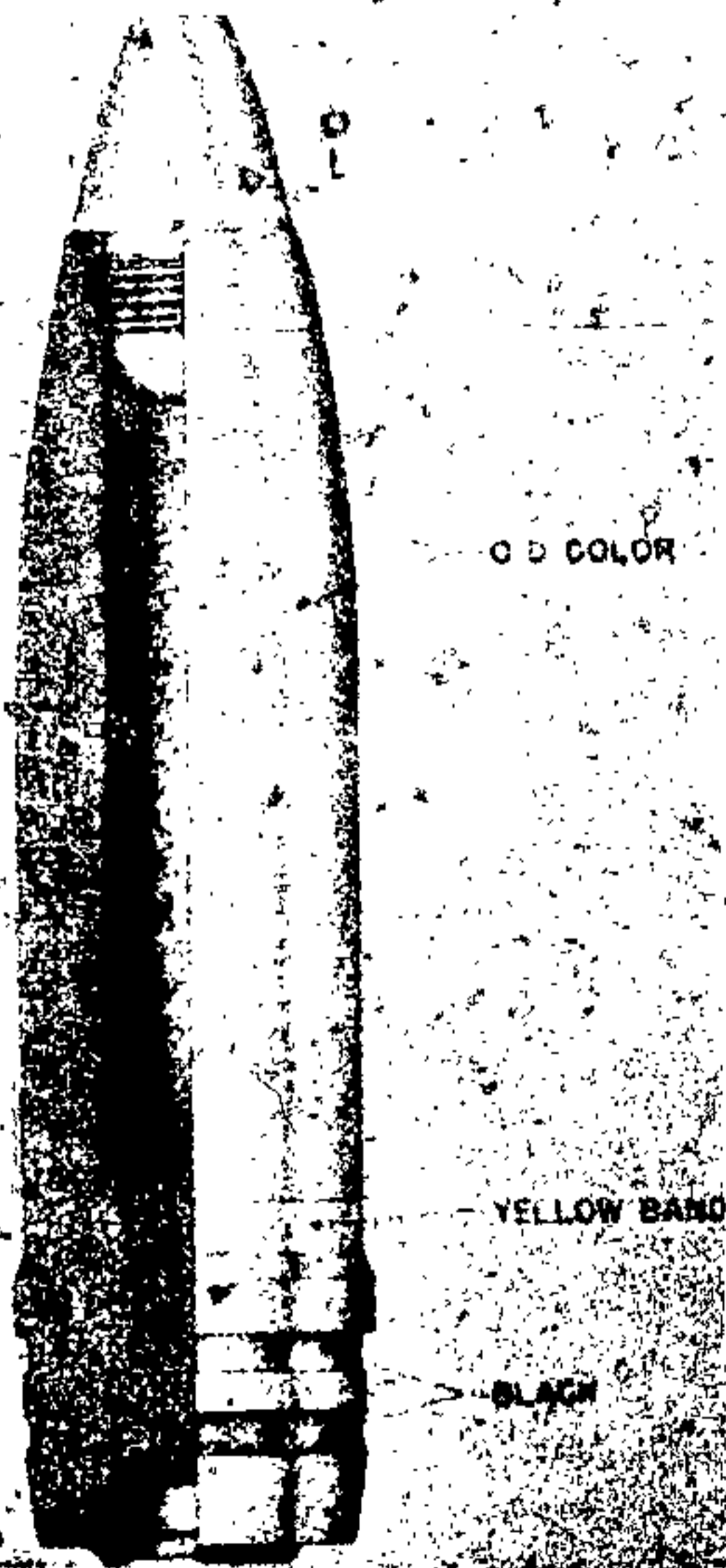

Figure 346—Inert-Loaded Projectile for Aircraft Cannon, 30-mm, 3-cm



Figure 347—A. P. Projectile with Core for Aircraft Cannon, 30-mm, 3-cm Pzgr. 40

shoulder: 1.5 inches, diameter of rim. Smokeless powder, type of propellant. C/33 St primer. "Wb K2 41", markings.

FUZE: Dummy.

A. P. PROJECTILE WITH CORE FOR AIRCRAFT CANNON, 30-MM

GERMAN NOMENCLATURE: 3-cm. Pzgr. 40 (Panzergranate 40.) (See fig. 347.)

EMPLOYMENT: 3-cm Solothurn—(Aircraft cannon).

COMPLETE ROUND: 11.625 inches, over-all length.

1 pound 12.5 ounce total weight.

PROJECTILE painted black; white tip:

1.75 inches long.

5.0 inches, over-all length.

1.187 inches, diameter of bourrelet.

GERMAN EXPLOSIVE ORDNANCE

0.312 inch, width of rotating band—bimetallic.
1.156 inches, diameter of base.
0.375 inch, width of bourrelet.
0.625 inch, base to band.
13.5 ounces, total weight. Tungsten carbide core.
Stenciled in white "UNT 1C" and date.

CARTRIDGE CASE (undesignated Solothurn type):

7.25 inches, over-all length.
1.25 inches, diameter of neck.
1.375 inches, diameter of shoulder.
1.5 inches, depth of extracting groove.
Smokeless powder, type of propellant.
C/33 St primer.
"Wb K2 41", markings.

H. E. PROJECTILE FOR AIRCRAFT CANNON, 30-MM

GERMAN NOMENCLATURE, 3-cm Sprgr. (Sprenggranate). (See fig. 348.)

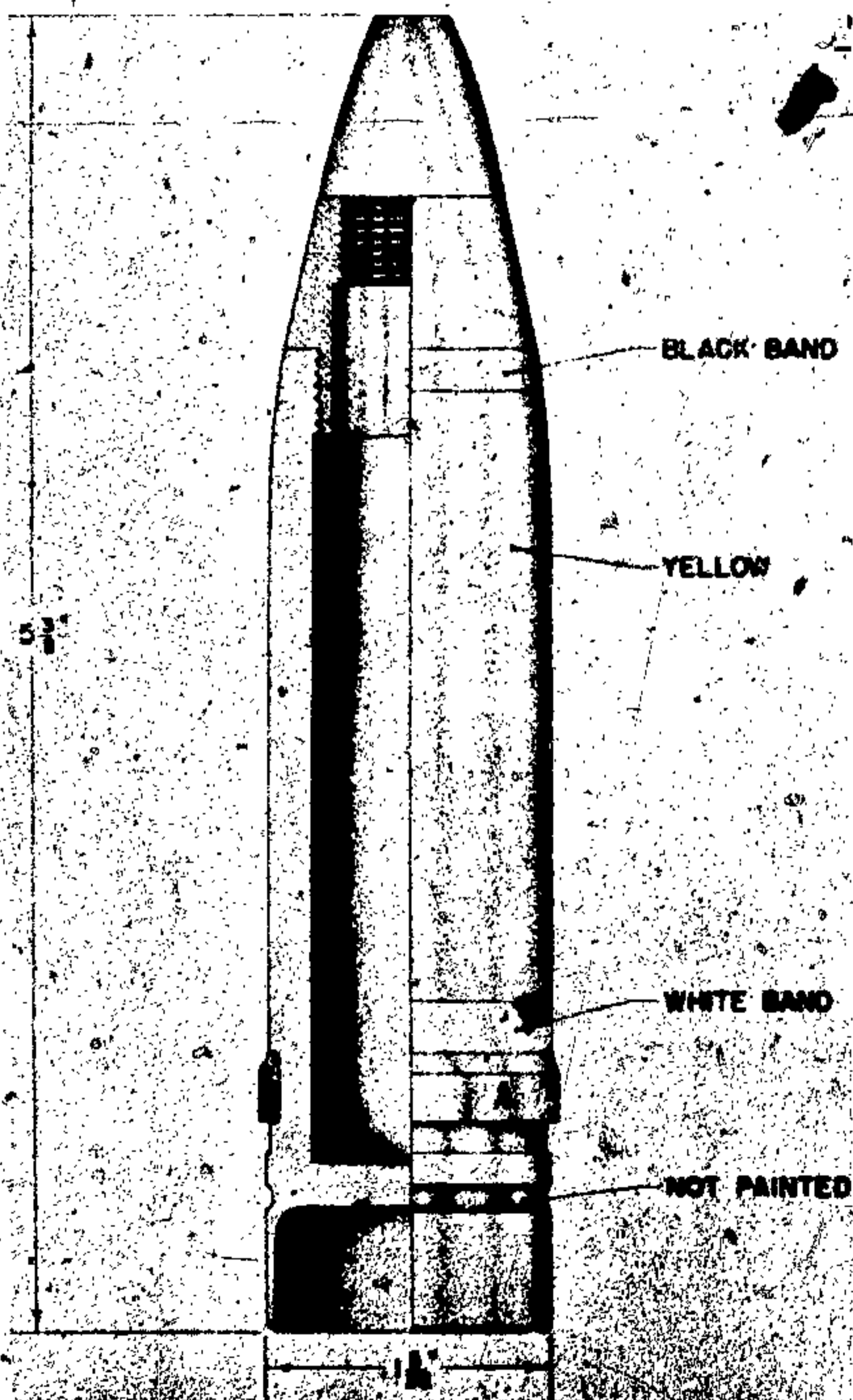

Figure 348—H. E. Projectile for Aircraft Cannon, 30-mm, 3-cm Sprgr.

EMPLOYMENT: 3-cm solothurn (Aircraft).
COMPLETE ROUND: 11.75 inches, over-all length.

PROJECTILE painted yellow; white band above rotating band, black band below screwed-in nose piece:

5.375 inches, over-all length.
1.156 inches, diameter of bourrelet.
0.156 inch, width of rotating band.
1.156 inches, diameter of base.
0.875 inch, base to band.
No tracer present.

CARTRIDGE CASE (German nomenclature, K2):

7.25 inches, over-all length.
1.25 inches, diameter of neck.
1.375 inches, diameter of shoulder.
1.5 inches, depth of extracting groove.
Smokeless powder, type of propellant.
C/33 St primer.
"Wb K2 41," marking.

REMARKS: This projectile has a hollow recess at its base 0.5 inch in depth. There is one cannellure below the rotating band.

H. E. PROJECTILE WITH TRACER FOR AIRCRAFT CANNON, 30-MM

GERMAN NOMENCLATURE: 3-cm Sprgr. L'spur (Sprenggranate Leuchtspur). (See fig. 349.)

EMPLOYMENT: 3-cm Solothurn (Aircraft Cannon).

COMPLETE ROUND: 11.718 inches, over-all length.

PROJECTILE, painted yellow; aluminum fuze:
5.25 inches, over-all length w/ fuze.
1.156 inches, diameter of bourrelet.
0.312 inch, width of rotating band.
1.125 inches, diameter of base.
0.781 inch, base to band.
Tracer present (not self-destroying).

CARTRIDGE CASE (German nomenclature, K2):

7.25 inches, over-all length.
1.25 inches, diameter of neck.
1.375 inches, diameter of shoulder.
1.5 inches, depth of extracting groove.
Smokeless powder, type of propellant.

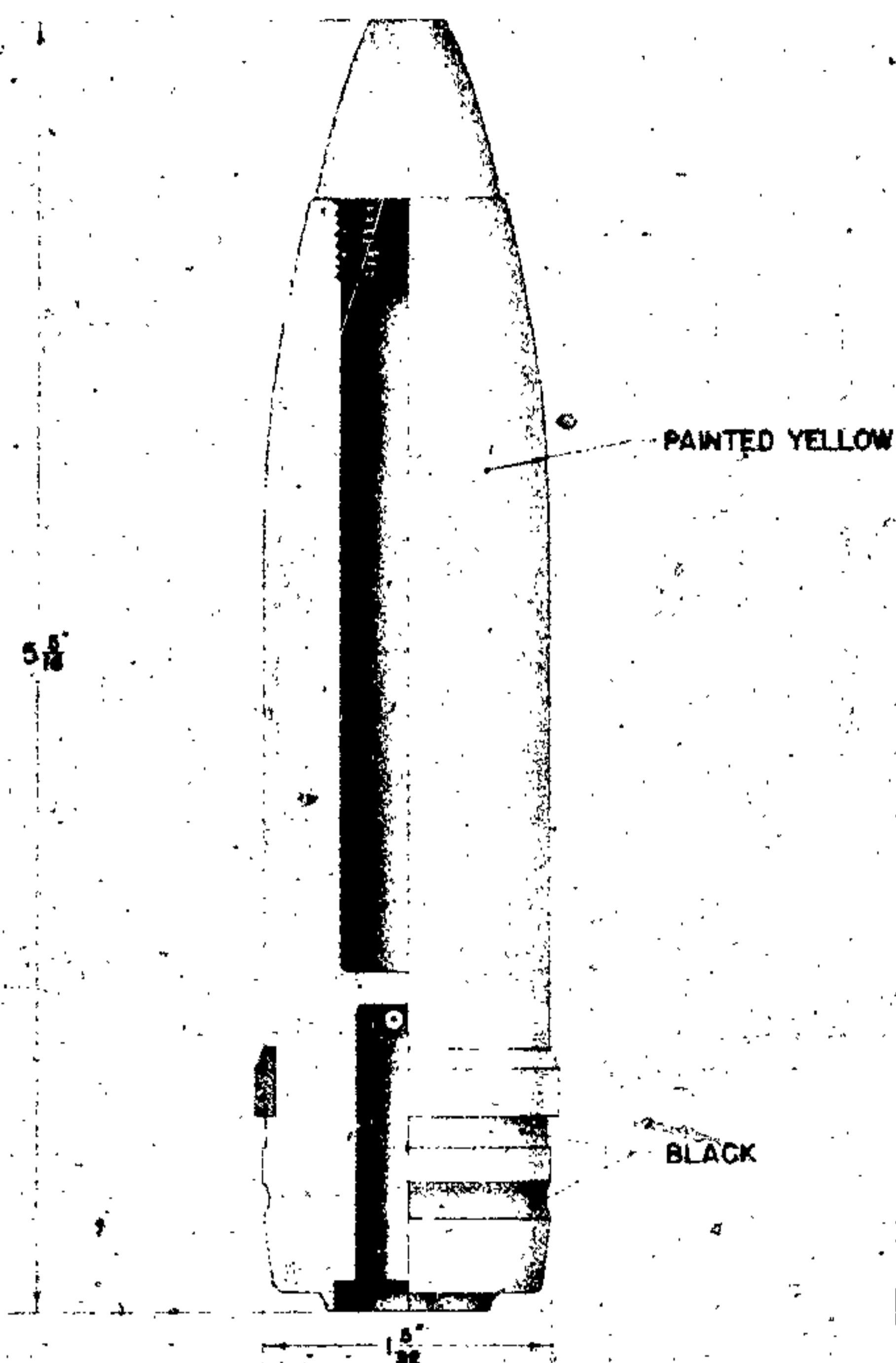

Figure 349—H. E. Projectile with Tracer for Aircraft Cannon, 30-mm, 3-cm Sprgr. L'spur

C/33 St primer.
"Wb K2 41," markings.

FUZE: AZ 1504.

REMARKS: Two cannelures below rotating band.

A. P. PROJECTILE FOR AIRCRAFT CANNON, 30-MM

GERMAN NOMENCLATURE: 3-cm Pzgr. (Panzergranate). (See fig. 350.)

EMPLOYMENT: 3-cm Solothurn (Aircraft Cannon).

COMPLETE ROUND: 12.218 inches, over-all length.

PROJECTILE, painted black; yellow band above bourrelet, red band above rotating band:

5.656 inches, over-all length w/ fuze.

5.187 inches, over-all length w/o fuze.

1.187 inches, diameter of bourrelet.
0.25 inch, width of rotating band.
1.156 inches, diameter of base.
0.687 inch, base to band.
TNT, type of bursting charge.
Tracer present.

CARTRIDGE CASE (German nomenclature, K2):

7.25 inches, over-all length.
1.25 inches, diameter of neck.
1.375 inches, diameter of shoulder.
1.5 inches, depth of extracting groove.
Smokeless powder, type of propellant.
C/33 St primer.

FUZE: Base fuze for 3-cm Pzgr.

REMARKS: Two cannelures below rotating band.

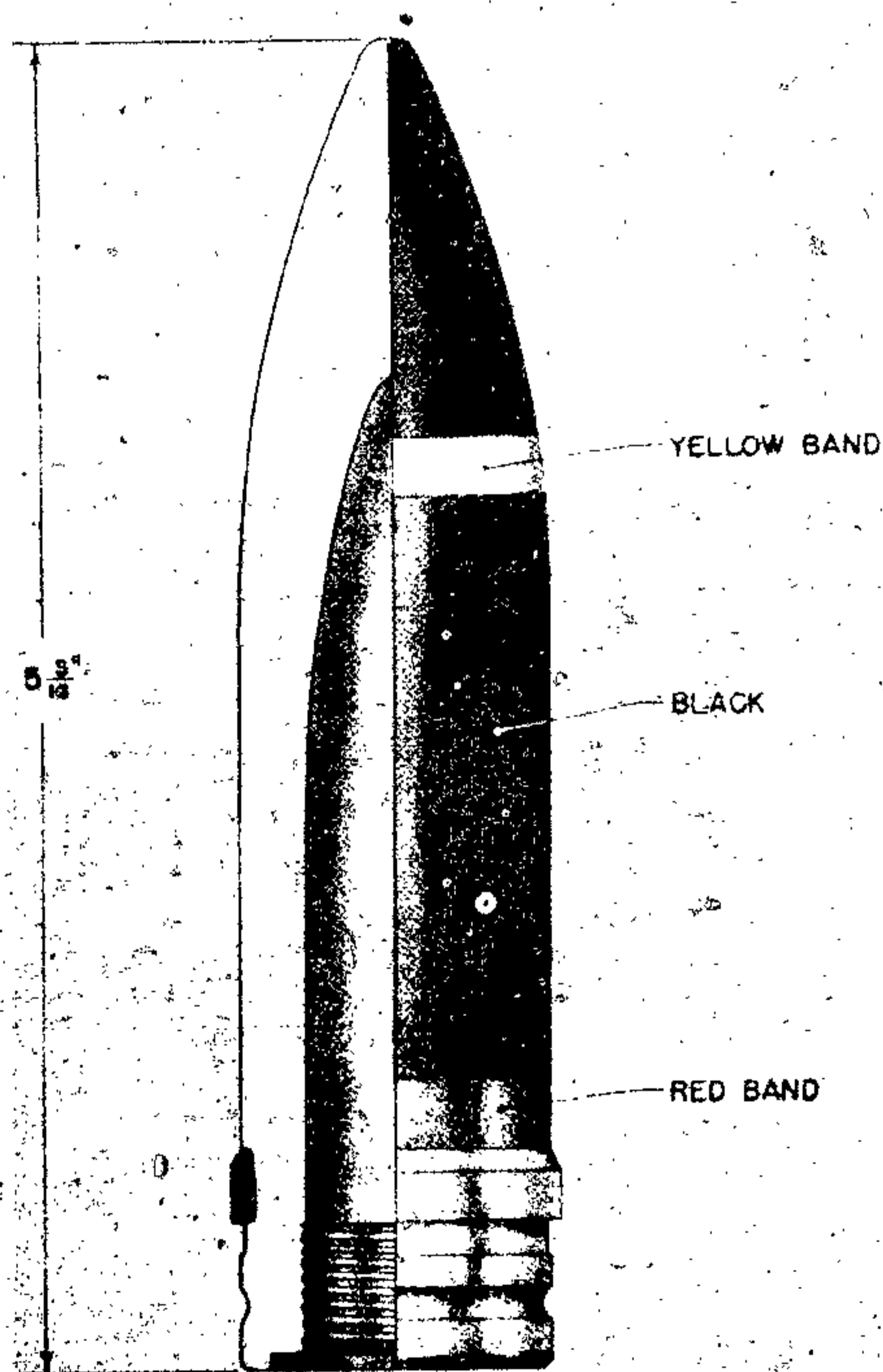

Figure 350—A. P. Projectile for Aircraft Cannon, 30-mm, 3-cm Pzgr.

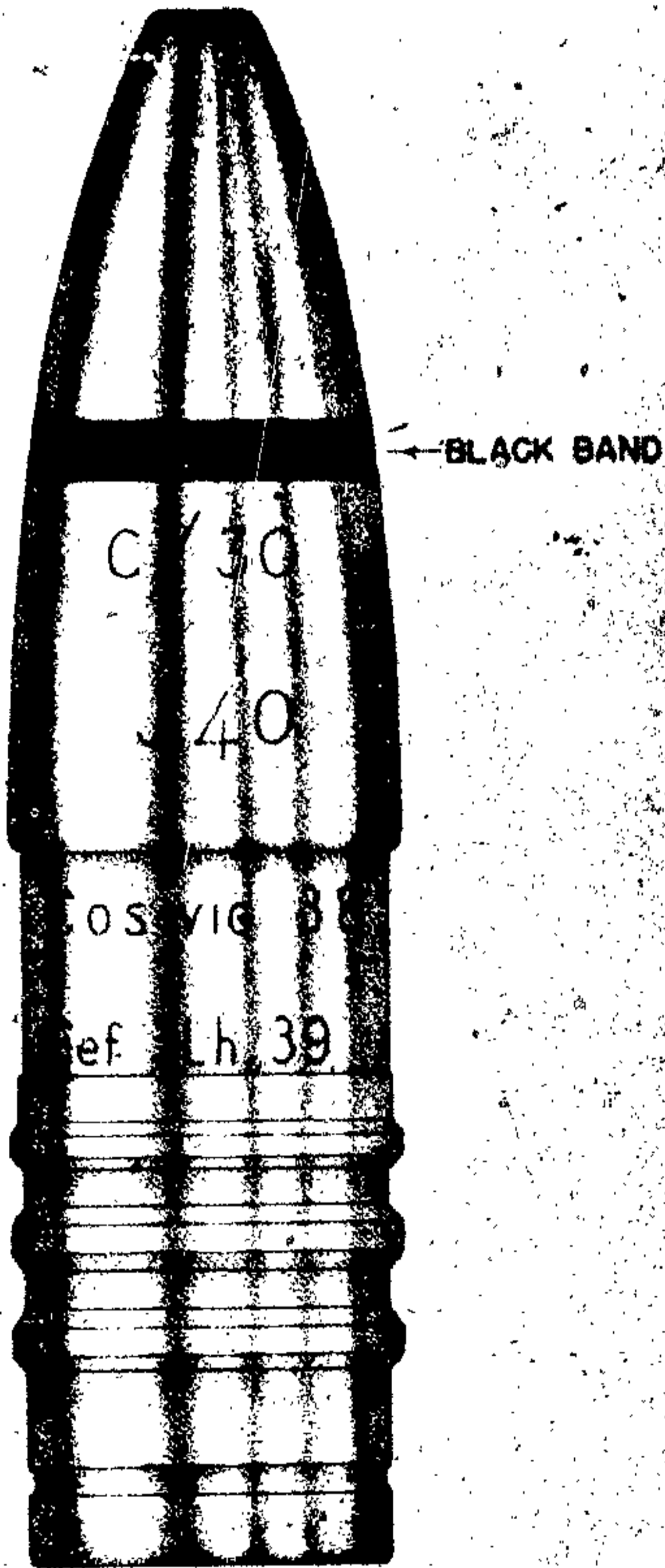

Figure 351—H. E./T. Projectile for Naval Gun C/30, 37-mm, 3.7-cm Sprgr. L'Spur

**H. E./T. PROJECTILE FOR NAVAL GUN
C/30, 37-MM**

GERMAN NOMENCLATURE: 3.7-cm Sprgr. L'spur (Spenggranate Leuchtspur). (See fig. 351.)

EMPLOYMENT: 3.7-cm Naval C/30.

COMPLETE ROUND: 20.0 inches, over-all length. 4.5 pounds, total weight.

PROJECTILE: Yellow body with black and red rings.

Three, number of rotating bands—Bimetallic.

CARTRIDGE CASE: German Nomenclature, P 397. C/13 n A primer.

FUZE: C/30.

**A. P. PROJECTILE WITHOUT CAP FOR
POLISH A.T. GUN, 37-MM**

GERMAN NOMENCLATURE: 3.7-cm Pzgr. Panzergranate). (See fig. 352.)

EMPLOYMENT: 3.7-cm Pak. (P) (Panzerabwehrkanone) (Polish).

COMPLETE ROUND: 13.3 inches, over-all length.

2.97 pounds, total weight.

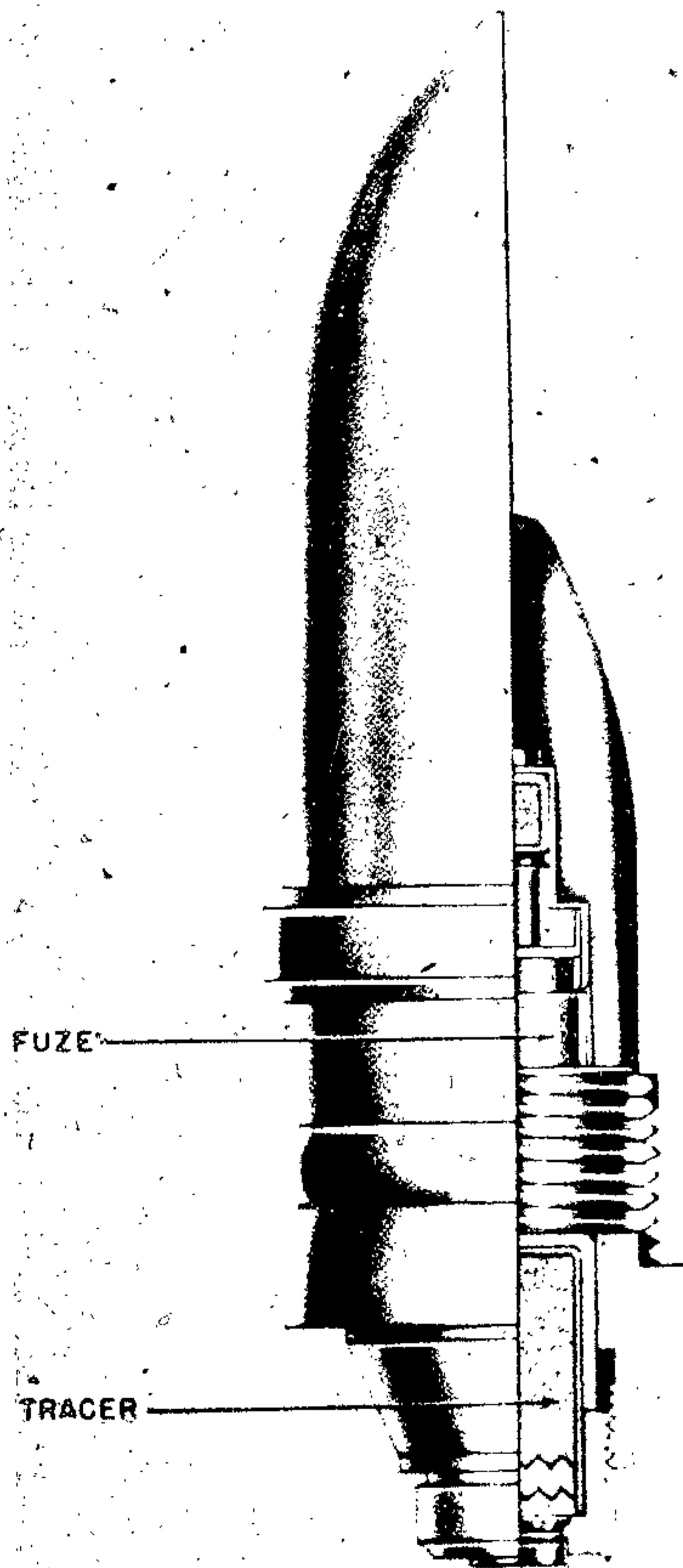

Figure 352—A. P. Projectile without Cap for Polish A. T. Gun, 37-mm, 3.7-cm Pzgr.

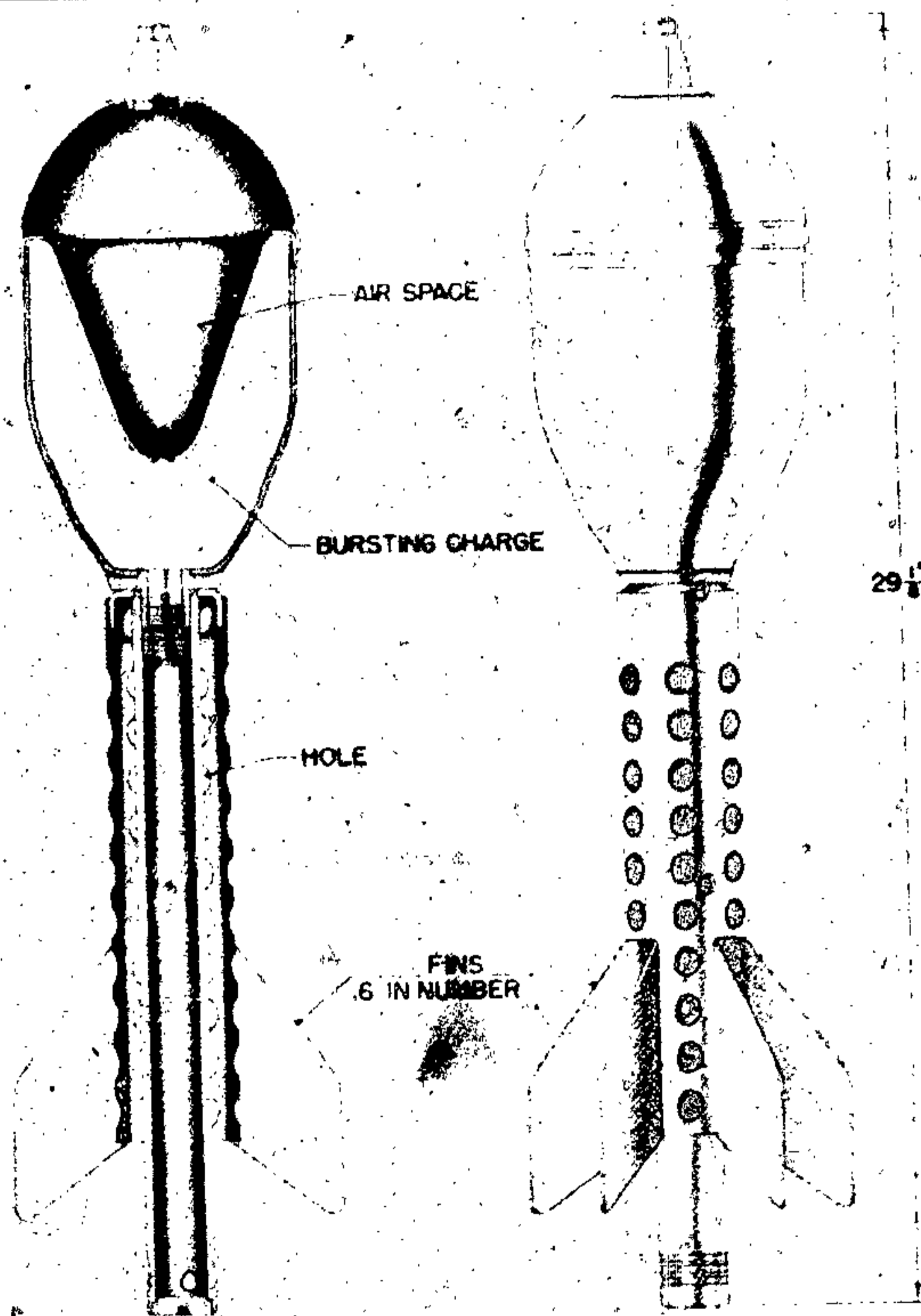

Figure 353—Redded Bomb for A. T. Gun 41, 37-mm,
3.7-cm Pak. 41

PROJECTILE painted yellow, red band below nose:

- 4.625 inches, over-all length with fuze.
- 1.375 inches, diameter of bourrelet.
- 0.437 inch, width of rotating band.
- 0.562 inch, diameter of base.
- 0.812 inch, base to band.
- 1 pound 7.98 ounces, total weight.
- 0.44 ounce, weight of bursting charge.
- TNT, type of bursting charge.
- No tracer present.
- Stamped: C-21 PK-21-38.

CARTRIDGE CASE (German nomenclature, 37 wz 36 Pk 39):

- 10.125 inches, over-all length.
- 1.5 inches, diameter of neck.

1.687 inches, diameter of shoulder.

2.187 inches, depth of extracting groove.

6.5 ounces, weight of propellant.

Strip propellant, type of propellant.

Markings: 3.7 WZ 36.

There is a deep cannelure 0.437 inch from the mouth of this case.

FUZE: 3.7 WZ 36.

**RODDED BOMB FOR A. T. GUN 41,
37-MM**

GERMAN NOMENCLATURE: 3.7 cm. Stielgranat 41. (See fig. 353.)

EMPLOYMENT: 3.7-cm Pak 41 (Panzerabwehrkanone 41).

GERMAN EXPLOSIVE ORDNANCE

PROJECTILE:

27.362 inches, total length.
10.826 inches, length of bomb body.
5.708 inches, diameter of bomb body.
18.26 pounds, total weight.
5.28 pounds, weight of bursting charge.
Cyclonite/TNT (60/40, 2 blocks in wax paper wrapping cemented to interior wall of bomb) type of bursting charge.
Two boosters Kz. Zdlg.
34 Np end to end, one detonator facing forward, the other aft.

CARTRIDGE CASE (German nomenclature, 6331):

Standard cartridge case closed by two cork disks.
6.61 ounces, weight of propellant.

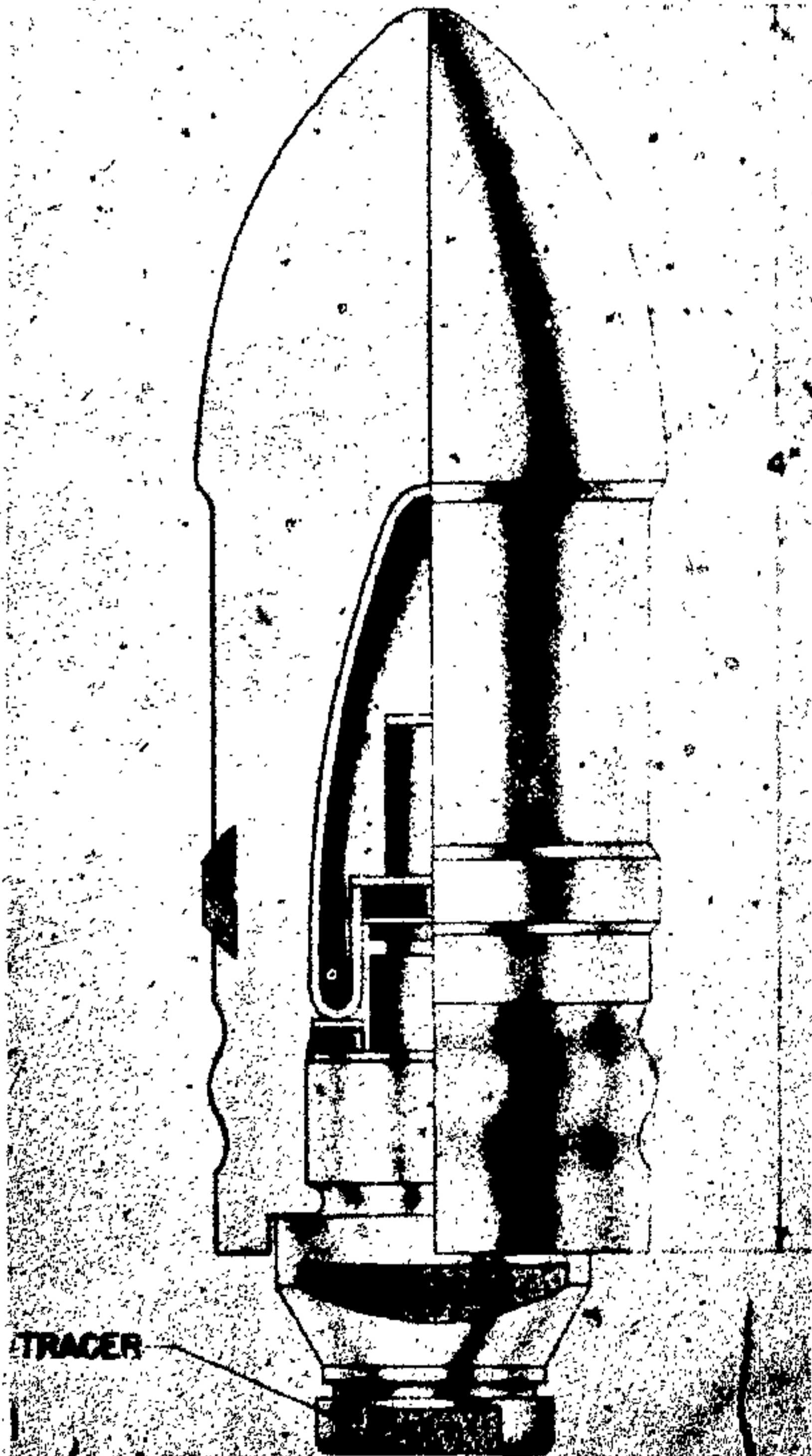

Figure 354—A. P. Projectile without Cap for A. A. Gun, 37-mm, 3.7-cm Pzgr. Patr. 18

Ngl R. P. (tubular double base propellant nitroglycerine and nitrocellulose) type of propellant.

FUZE: AZ 5075 (as in German rifle grenade) and BdZ 5130.

REMARKS: The rodded bomb is fitted with both nose percussion and base fuzes and incorporates the hollow charge principle. The bomb has a rod which fits into the bore, and a concentric perforated sleeve which fits over the barrel of the gun.

A. P. PROJECTILE WITHOUT CAP FOR A. A. GUN, 37-MM

GERMAN NOMENCLATURE: 3.7-cm Pzgr. Patr. 18 (Panzergranate Patronen 18). (See fig. 354.)

EMPLOYMENT:

3.7-cm Flak. 18. (Flugabwehrkanone 18).
3.7-cm Flak. 36. (Flugabwehrkanone 36).

COMPLETE ROUND (C/R is identical for both weapons):

12.519 inches, over-all length.
3.476 pounds, total weight.

PROJECTILE:

4.055 inches, over-all length.
1.49 inches, diameter of bourrelet.
0.312 inch, width of rotating band.
1.427 inches, diameter of base.
24.68 ounces, total weight.
4.58 ounces, weight of bursting charge.
PETN/Wax, type of bursting charge.
Tracer is present.

CARTRIDGE CASE (German nomenclature, 6348):

10.156 inches, overall length.
1.594 inches, diameter of neck.
1.625 inches, diameter of shoulder.
1.844 inches, depth of extracting groove.
6.52 ounces, weight of propellant.

Digl R. P. (tubular diethylene glycol dinatrate and nitrocellulose) type of propellant.

FUZE: Bd. Z. 5103.

H. E. PROJECTILE FOR A. A. GUN, 37-MM

GERMAN NOMENCLATURE: 3.7-cm Sprgr. Patr. 18 (Sprenggranate Patronen 18). (See fig. 355.)

EMPLOYMENT: 3.7-cm Flak. 18 (Flugabwehrkanone 36).

COMPLETE ROUND (C/R is identical for both weapons):

13.779 inches, over-all length.

3.32 pounds, total weight.

PROJECTILE, painted yellow; two deep cannelures below rotating band:

5.0 inches, over-all length.

1.469 inches, diameter of bourrelet.

0.375 inch, width of rotating bands.

Two, number of rotating bands.

1.437 inches, diameter of base.

1.0 inch, base to band.

21.943 ounces, total weight.

0.856 ounce, weight of bursting charge.

PETN/Wax, type of bursting charge.

Tracer is present.

CARTRIDGE CASE (German nomenclature 6348):

10.156 inches, over-all length.

1.594 inches, diameter of neck.

1.625 inches, diameter of shoulder.

1.844 inches, depth of extracting groove.

6.7 ounces, depth of propellant.

Ngl.-R. P. (tubular nitroglycerine and nitrocellulose) type of propellant.

C/13nA primer.

FUZE: 3.7-cm, Kopf. Z. Zerl P. or 3.7-cm Kopf. Z. Zerl Fg.

H. E. PROJECTILE (TYPE 40) FOR A.T. GUN, 37-MM

GERMAN NOMENCLATURE: 3.7-cm Sprgr. Patr. 40 (Sprenggranate Patronen 40). (See fig. 356.)

EMPLOYMENT: 3.7-cm Pak. (Panzerabwehrkanone).

COMPLETE ROUND:

13.937 inches, over-all length.

2.90 pounds, total weight.

PROJECTILE painted silver-grey, no colored bands:

5.039 inches, over-all length.

1.448 inches, diameter of bourrelet.

1.599 inches, diameter of rotating band.

0.33 inch, width of rotating band.

23.454 ounces, total weight.

1.587 ounces, weight of bursting charge.

PETN/Wax (90/10), type of bursting charge. Small tracer present.

CARTRIDGE CASE (German nomenclature, 6331):

9.75 inches, over-all length.

1.5 inches, diameter of neck.

1.625 inches, diameter of shoulder.

2.0 inches, diameter at rim.

6.17 ounces, weight of propellant.

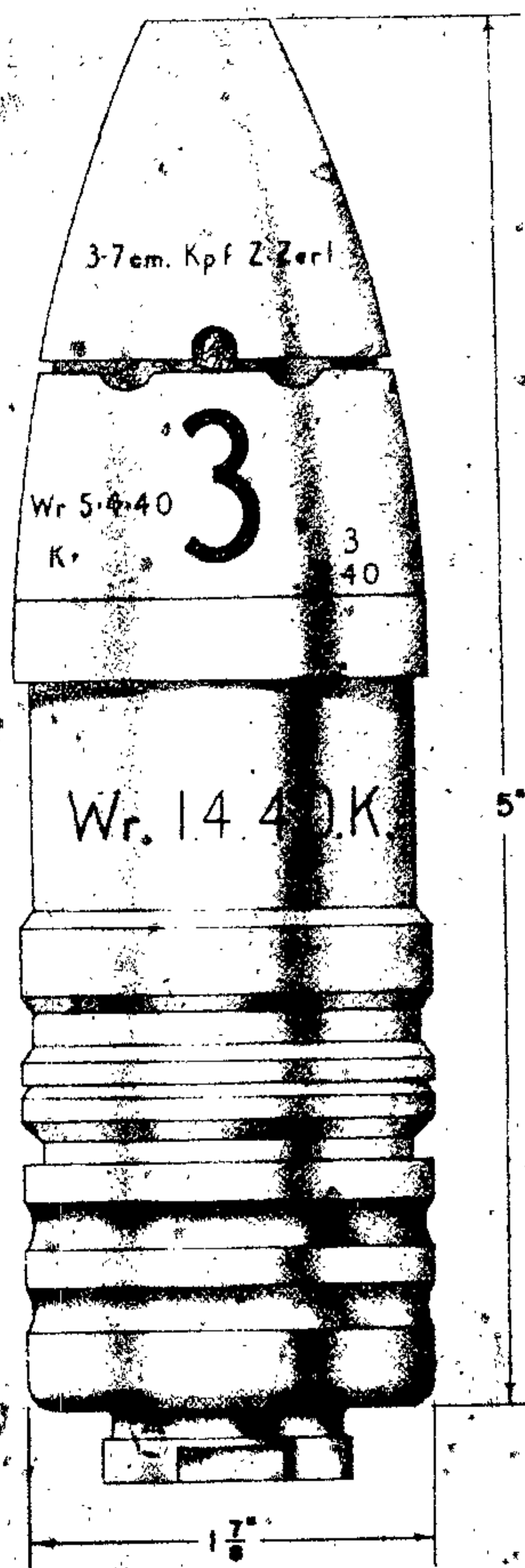

Figure 355—H. E. Projectile for A. A. Gun, 37-mm, 3.7-cm Sprgr. Patr. 18

GERMAN EXPLOSIVE ORDNANCE

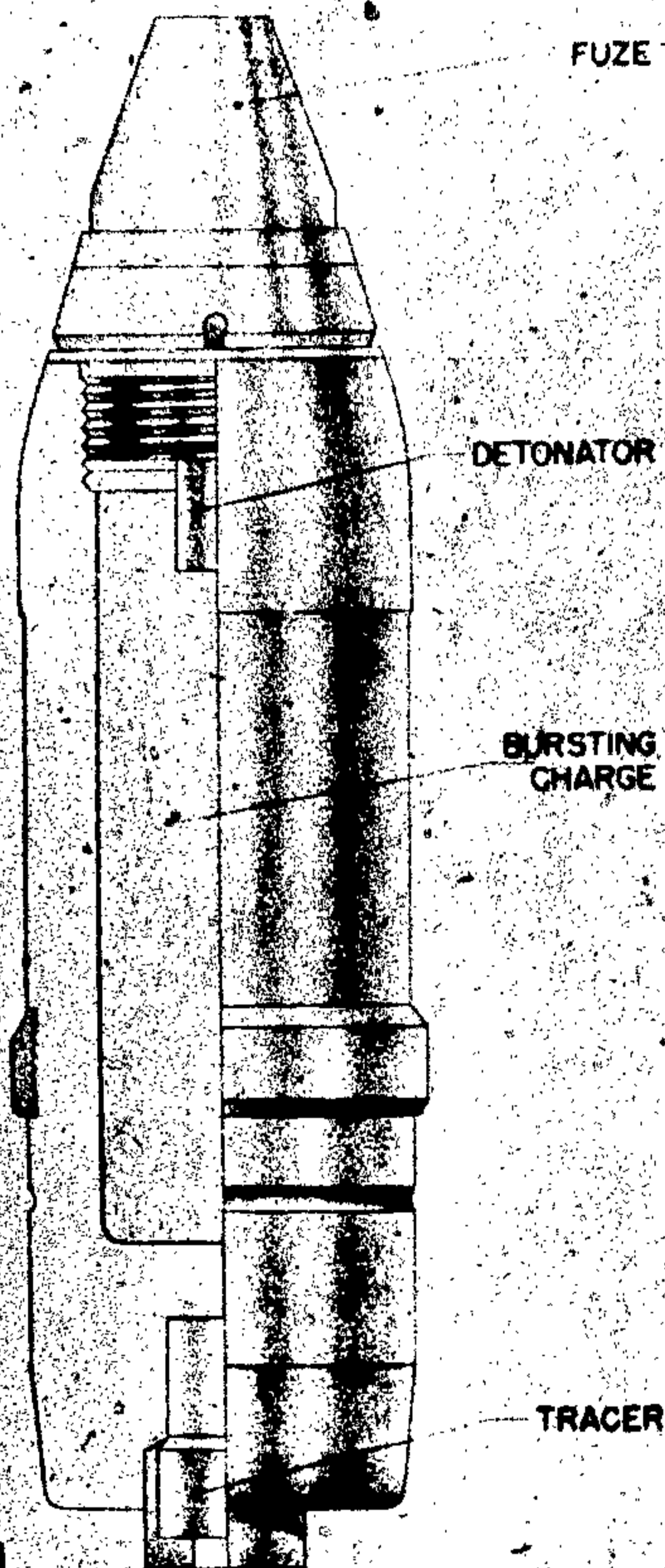

Figure 356—H. E. Projectile (Type 40) for A. T. Gun, 37-mm, 3.7-cm Sprgr. Patr. 40

Digl. R. P. (tubular diethylene diglycoldinitrate and nitrocellulose) type of propellant.

C/13 n A primer.

FUZE: AZ 39.

A. P. PROJECTILE WITHOUT CAP FOR A.T. GUN, 37-MM

GERMAN NOMENCLATURE: 3.7-cm Pzgr. Patr. (Panzergranate Patronen). (See fig. 357.)

EMPLOYMENT: 3.7-cm Pak. (Panzerabwehrkanone).

COMPLETE ROUND: 13.27 inches, over-all length.

2.9 pounds, total weight.

PROJECTILE painted black:

3.897 inches, over-all length.

1.447 inches, diameter of bourrelet.

1.502 inches, diameter of copper rotating band.

0.437 inch, diameter of base.

0.562 inch, base to band.

1.5 pounds, total weight.

0.46 ounce, weight of bursting charge.

PETN/Wax (82/18), type of bursting charge.

Tracer present.

Stenciled in red: "Co 7.741 G Tp 33 11 Cw. G.

1.40." Stamped on base: "G251 DL 608 1939C."

CARTRIDGE CASE (German nomenclature, 6331):

9.75 inches, over-all length.

1.5 inches, diameter of neck.

2.0 inches, depth of extracting groove.

6.66 ounces, weight of propellant.

Digl. R. P. or 177 gm Ngl. R. P. (tubular diethylene glycoldinitrate and nitrocellulose) or (tubular nitroglycerine and nitrocellulose) type of propellant.

C/13nA primer.

FUZE: 5103.

H. E. PROJECTILE, TYPE 18, FOR A.T. GUN, 37-MM

GERMAN NOMENCLATURE: 3.7-cm Sprgr. Patr. 18 umg (Sprenggranate Patronen 18 umgeändert). (See fig. 358.)

EMPLOYMENT: 3.7-cm Pak. (Panzerabwehrkanone).

COMPLETE ROUND:

13.503 inches, over-all length.

2.838 pounds, total weight.

PROJECTILE, painted silver-grey, yellow band:

5.093 inches, over-all length.

1.448 inches, diameter of bourrelet.

1.599 inches, diameter of rotating band.

0.33 inch, width of rotating band.

21.767 ounces, total weight.

0.917 ounce, weight of bursting charge.

PETN/Wax (90/10), type of bursting charge.

Large tracer present.

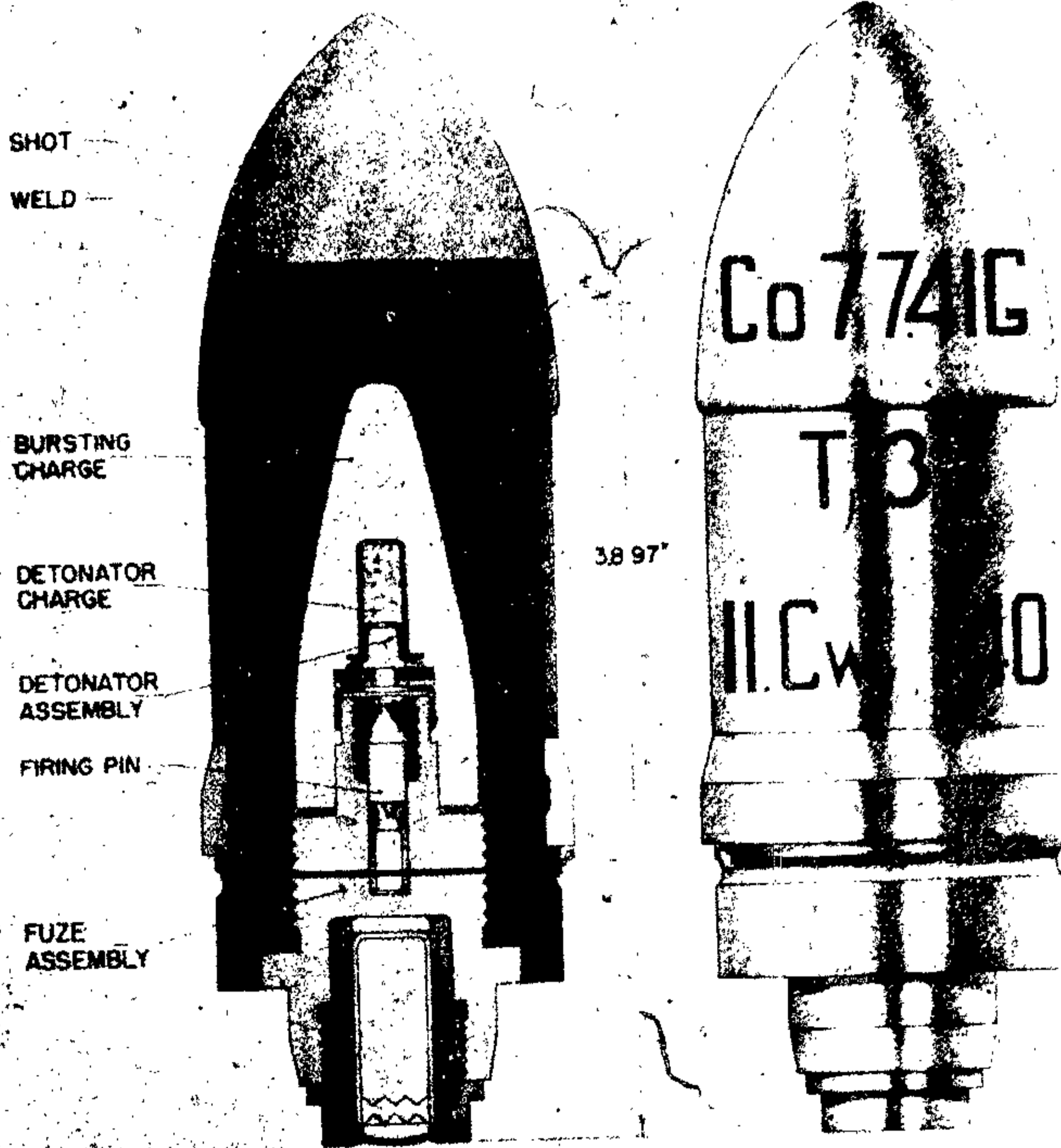

Figure 357—A. P. Projectile without Cap for A. T. Gun, 37-mm, 3.7-cm Pzgr. Patr.

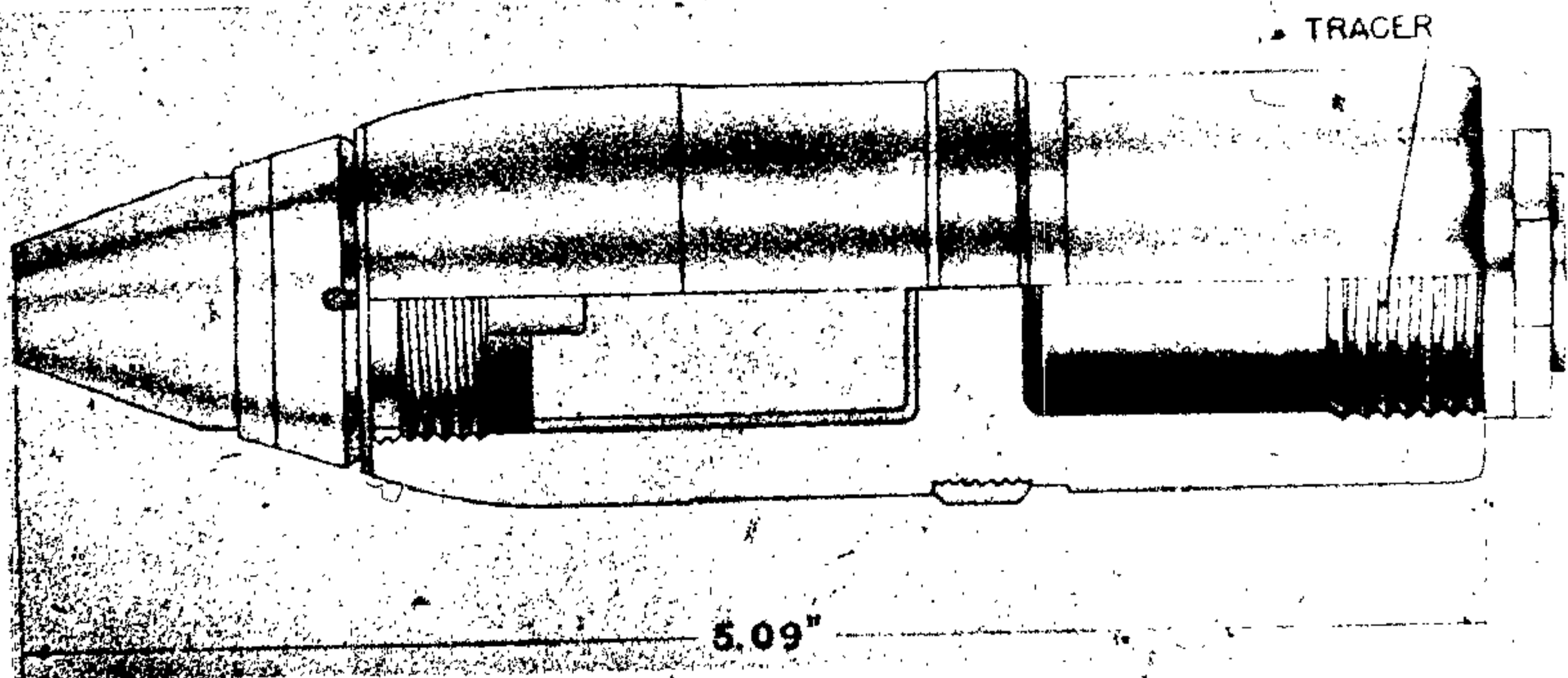

Figure 358—H. E. Projectile, Type 18, for A. T. Gun, 37-mm, 3.7-cm Sprgr. Patr. 18 umg

GERMAN EXPLOSIVE ORDNANCE

CARTRIDGE CASE (German nomenclature, 6331):

1.51 inches, diameter of neck,
1.61 inches, diameter of shoulder,
1.80 inches, diameter of flange,
6.17 ounces, weight of propellant,
Digl. R. P. (tubular diethylene glycoldinitrate and nitrocellulose)—type of propellant.

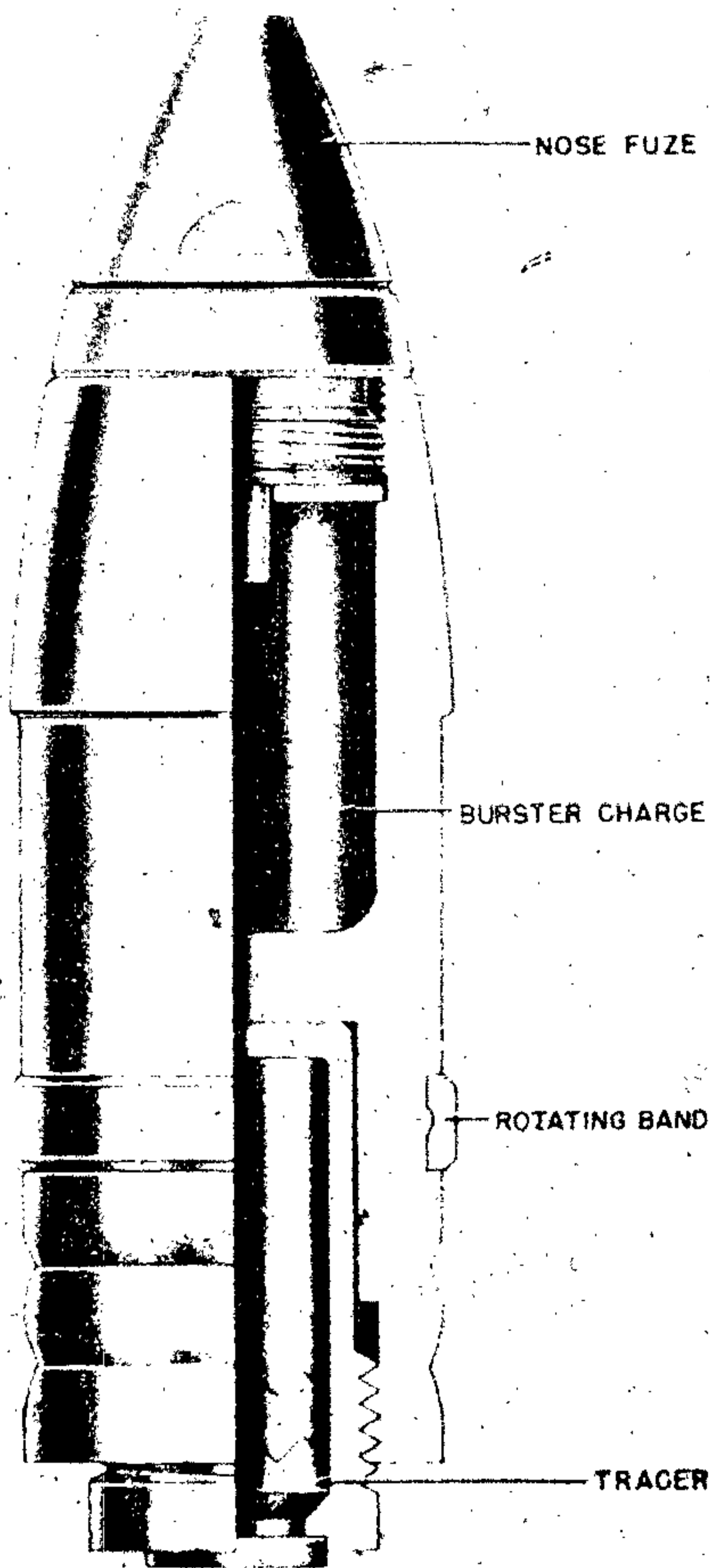

Figure 359—H. E. Projectile for Gun C/30, 37-mm, 3.7-cm Sprgr. Patr. C/30

C/13nA primer.

Stamped in base: "P 180 G d. 7 cm Pak. 6331."

FUZE: 3.7-cm Kopf Z. Zerl P. (red tip); AZ 39 (yellow tip).

PACKAGING: 12 rounds to a metal carrier, 20.0 kg.

H. E. PROJECTILE FOR GUN C/30, 37-MM

GERMAN NOMENCLATURE: 3.7-cm Sprgr. Patr. C/30. (Sprenggranate Patronen 30). (See fig. 359.)

EMPLOYMENT: 3.7-cm C/30.

COMPLETE ROUND: 20.3 inches, over-all length.

4 pounds, total weight.

PROJECTILE: Yellow body with white bands and black lettering.

Three copper rotating bands.

CARTRIDGE CASE: 15 inches, over-all length.

2.28 inches, diameter of base.

ast/amp. 3.7 cm 30 st stamped on base.

FUZE: C/30.

H. E. PROJECTILE FOR ANTI-AIRCRAFT GUN, 40-MM

GERMAN NOMENCLATURE: 4-cm Sprgr. Patr. (Sprenggranate Patronen). (See fig. 360.)

EMPLOYMENT: Flak. 28 (Flugabwehrkanone 28).

COMPLETE ROUND: 17.7 inches, over all length with fuze.

1.571 inches, diameter of bourrelet.

1.437 inches, width of rotating band—Bimetallic.

0.75 inch, diameter of base.

2.2 pounds, total weight.

1.38 ounces, weight of bursting charge.

TNT, type of bursting charge.

Tracer present (11- to 12-second self-destroying).

CARTRIDGE CASE (German nomenclature, 4-cm 28)

12.25 inches, over-all length.

1.6 inches, diameter of neck.

1.88 inches, diameter of shoulder.

2.44 inches, diameter of extracting base.

9.7 ounces, weight of propellant.

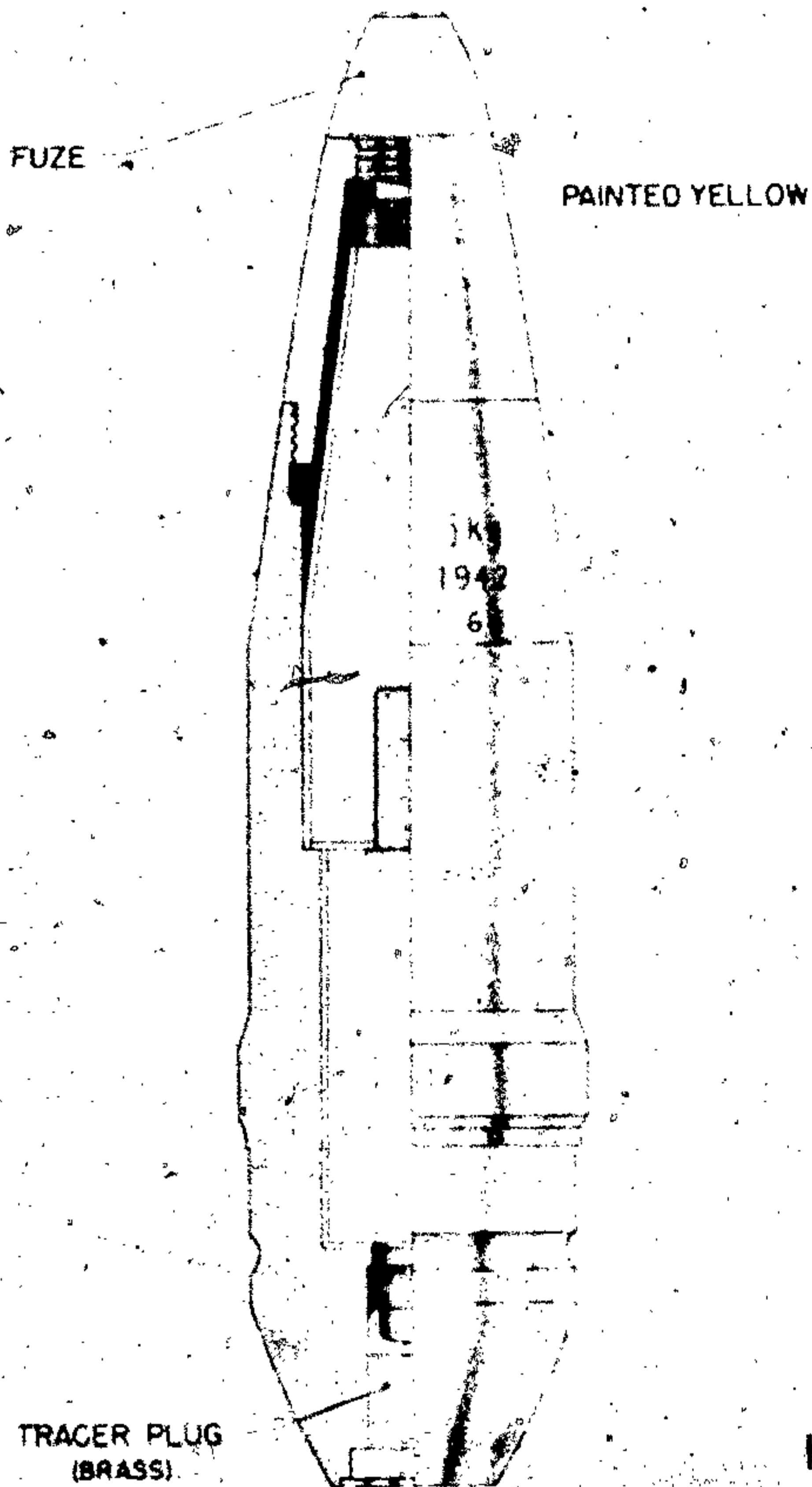

Figure 360—H. E. Projectile for Antiaircraft Gun, 40-mm, 4-cm Sprgr. Patr.

Ngl. R. P. (tubular nitroglycerine and nitro-cellulose) type of propellant.

C/13nA primer.

FUZE: KZ 38.

REMARKS: Similar to British Quickfiring H. E. 40-mm Bofors, Mark 1—T shell except for the following differences:

1. Larger streamlining at base.
2. Larger tracer.
3. Smaller bursting charge.

Fuze same as British DA No. 250.

H. E. FOR ANTI-AIRCRAFT GUN, 40-MM

GERMAN NOMENCLATURE: 4-cm Br. Sprgr. Patr. (Sprenggranate Patronen). (See fig. 361.)

EMPLOYMENT: Flak. 28 (Flugabwehrkanone 28).

COMPLETE ROUND: 17.75 inches over-all length.

PROJECTILE, painted yellow, black lettering, red band:

1.56 inches, diameter of bourrelet.

0.70 inch, width of rotating band (iron D. B.)

1.63 inches, diameter of rotating band.

Tracer present.

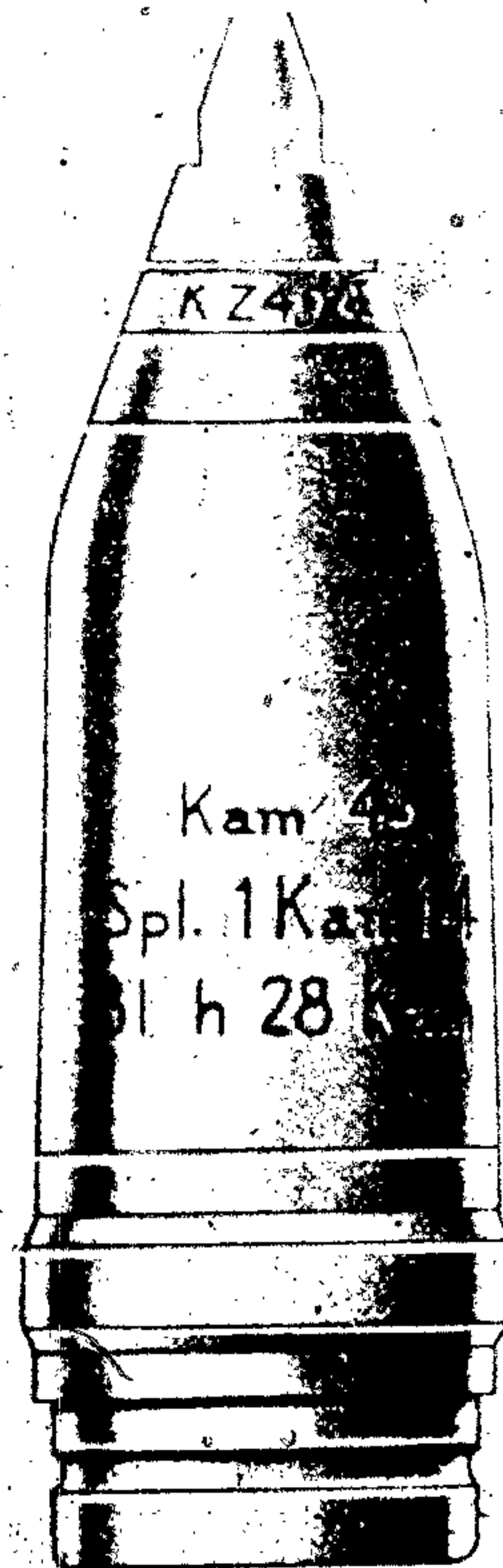

Figure 361—H. E. Projectile for Antiaircraft Gun, 40-mm, 4-cm Br. Sprgr. Patr.

GERMAN EXPLOSIVE ORDNANCE

CARTRIDGE CASE (German nomenclature, 4-cm 28st):

12.20 inches, over-all length.

2.44 inches, diameter of extracting base.

1.61 inches, diameter of neck.

FUZE: KZ 38.

H. E. PROJECTILE TYPE 36 (CZECH DESIGN), 47-MM

GERMAN NOMENCLATURE: 4.7-cm Sprgr.

Patr. 36 (t) (Sprenggranate Patronen 36 [t]).
(See fig. 362.)

EMPLOYMENT:

4.7-cm Pak. (t) (Panzerabwehrkanone [t]).

4.7-cm K 36 (t) (Kanone 36 [t]).

COMPLETE ROUND:

22.44 inches, over-all length.

8.25 pounds, total weight.

PROJECTILE:

7.36 inches, over-all length w/o fuze.

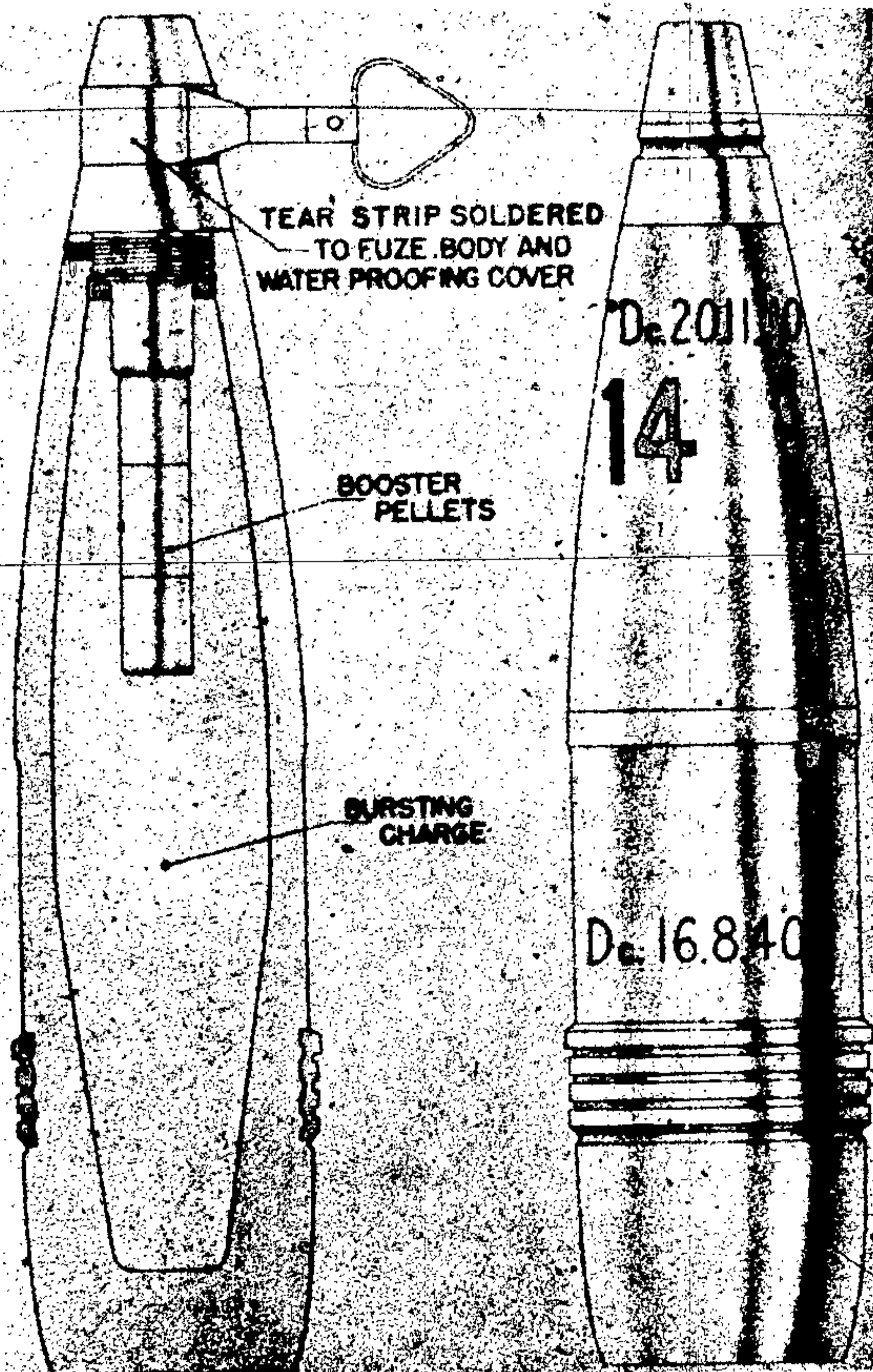

Figure 362—H. E. Projectile Type 36 (Czech. Design) 47-mm, 4.7-cm Sprgr. Patr. 36 (t)

1.84 inches, diameter of bourrelet.
 0.67 inch, width of rotating band.
 1.625 inches, diameter of base.
 3.3 pounds, total weight.
 6.348 ounces, weight of bursting charge.
 TNT, type of bursting charge.

CARTRIDGE CASE (German nomenclature, M 36):

15.944 inches, over-all length.
 1.98 inches, diameter of neck.
 2.12 inches, diameter of shoulder.
 2.52 inches, depth of extracting groove.
 1 pound 15.35 ounces, weight of propellant.
 Strip nitroglycerine and nitrocellulose—type of propellant.

FUZE: Czech time or S/D.

**H. E. PROJECTILE FOR BÖHLER GUN
 (AUSTRIAN DESIGN), 47-MM**

GERMAN NOMENCLATURE: 4.7-cm. Sprgr. Patr. (Ö) (Sprenggranate Patronen [Ö]).
 (See fig. 363.)

EMPLOYMENT: 4.7-cm. Böhler K. (Ö).

COMPLETE ROUND: 16.312 inches, over-all length.

PROJECTILE:

8.625 inches, over-all length.
 0.375 inch, width of rotating band.
 1.594 inches, diameter of base.
 No tracer present.

CARTRIDGE CASE (German Nomenclature M 35):

9.25 inches, over-all length.
 1.875 inches, diameter of neck.
 2.187 inches, diameter of extracting groove.
 193.0 grams, weight of propellant.
 Strip propellant (nitroglycerine and nitrocellulose).

Markings:

4.7-cm Pak. Ö.
 4.7-cm J. K. 35/36 Ö.

FUZE: 4.7-cm M 35.

REMARKS: Fuse is marked 4.7 Pak. 35 or 4.7 M 35.

Fuze is similar to AZ 23 except that it has no optional delay.

There is an AP round which is the 47/32 Italian round in an M 35 case.

**A. P. PROJECTILE FOR A.T. GUN
 (AUSTRIAN DESIGN), 47-MM**

GERMAN NOMENCLATURE: 4.7-cm Pzgr. Patr. 35 (Ö) (Panzergranate Patronen 35 [Ö]).
 (See fig. 364.)

EMPLOYMENT:

4.7-cm Pak. (t) (Panzerabwehrkanone [t]).
 4.7-cm K 36 (t) (Kanone 36 [t]).

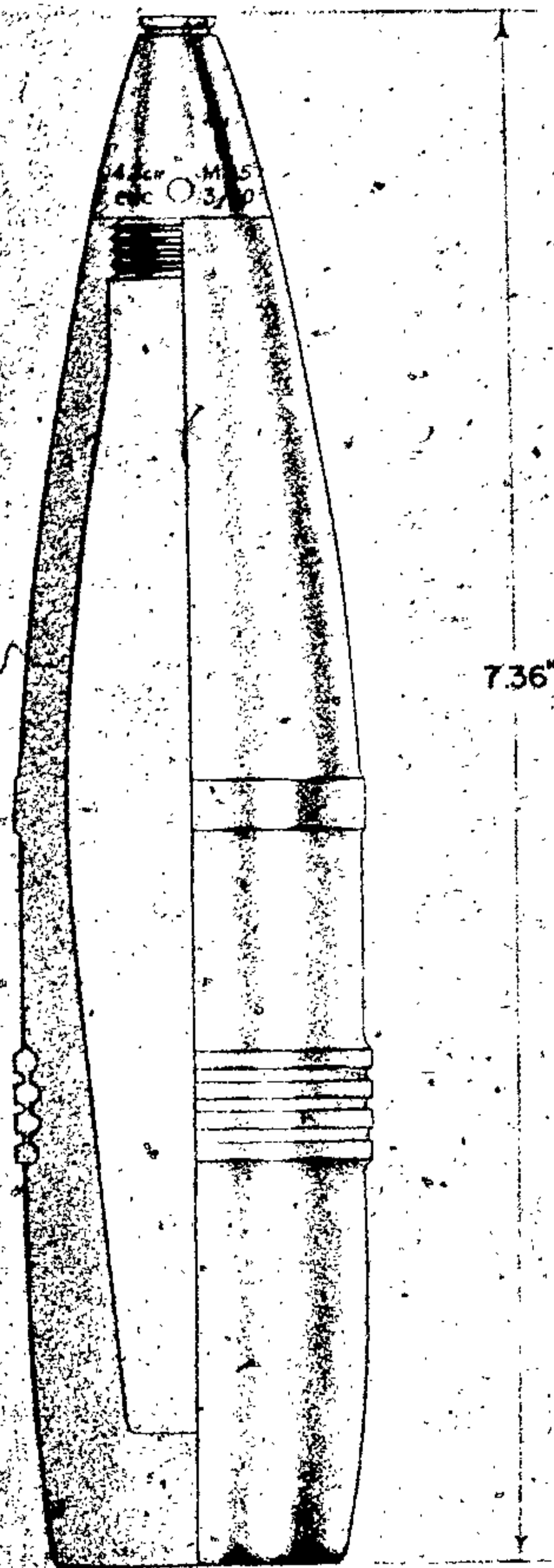

COLOR, DARK
 GREY GREEN

Figure 363—H. E. Projectile for Böhler Gun (Austrian Design) 47-mm, 4.7-cm Sprgr. Patr. (ö)

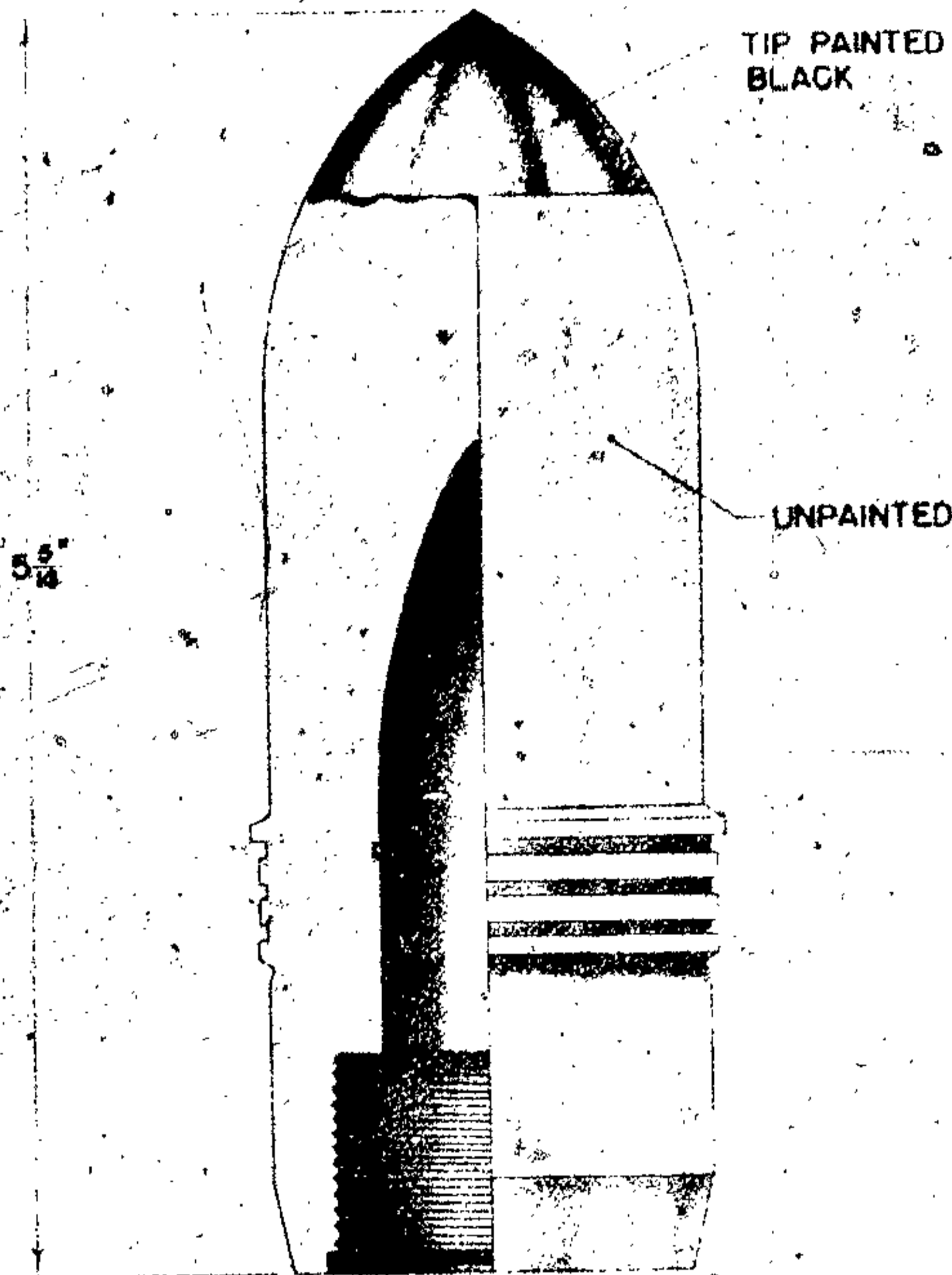

Figure 364—A. P. Projectile for A. T. Gun (Austrian Design),
47-mm, 4.7-cm Pzgr. Patr. 35 (ö)

COMPLETE ROUND:

19.48 inches, over-all length.
6.7 pounds, total weight.

PROJECTILE, black tip. Unpainted projectile, blued from rotating band to beginning of $\frac{3}{8}$ inch boat-tailing:

5.312 inches, over-all length.
1.844 inches, diameter of bourrelet.
0.687 inch, width of copper rotating band.
1.719 inches, diameter of base.
1.25 inches, base to band.
3.14 pounds, total weight.
0.74 ounce, weight of bursting charge.
TNT, type of bursting charge.

Tracer present. Stenciled in red: "ENZ."

CARTRIDGE CASE (German nomenclature, M 36):

15.944 inches, over-all length.
1.98 inches, diameter of neck.

2.12 inches, diameter of shoulder.

2.52 inches, depth of extracting groove.

15.43 ounces, weight of propellant.

Strip propellant (nitroglycerine and nitrocellulose).

M 33 primer.

REMARKS: Same projectile is used in the Böhler gun except that driving band is narrower and has two grooves instead of three.

A red band is painted around the shoulder.

**A. P. C. PROJECTILE TYPE 36
(CZECH DESIGN), 47-MM**

GERMAN NOMENCLATURE:

4.7-cm Pzgr. Patr. 36 (t) (Panzergranate Patronen 36 [t]). (See fig. 365.)

EMPLOYMENT:

4.7-cm Flak. 37 (Flugabwehrkanone 37). 4.7-cm Pak (t) (Panzerabwehrkanone [t]).

COMPLETE ROUND: 21.069 inches, over-all length.

PROJECTILE, painted black, capped:

6.625 inches, over-all length w/o tracer.

1.844 inches, diameter of bourrelet.

0.625 inch, width of copper rotating band.

1.625 inches, diameter of base.

1.5 inches, base to band.

3.64 pounds, total weight.

0.74 ounce, weight of bursting charge.

TNT, type of bursting charge.

Tracer present in fuze.

Stenciled in red: "pla", lot number, "1".

Projectile curved in toward base.

CARTRIDGE CASE (German nomenclature, M 36):

15.944 inches, over-all length.

1.98 inches, diameter of neck.

2.12 inches, diameter of shoulder.

2.52 inches, diameter of extracting groove.

15.49 ounces, weight of propellant.

Strip propellant (nitroglycerine and nitrocellulose).

M 33 primer.

FUZE: Base fuze (2 steel balls). Set screw in projectile holds fuze in place.

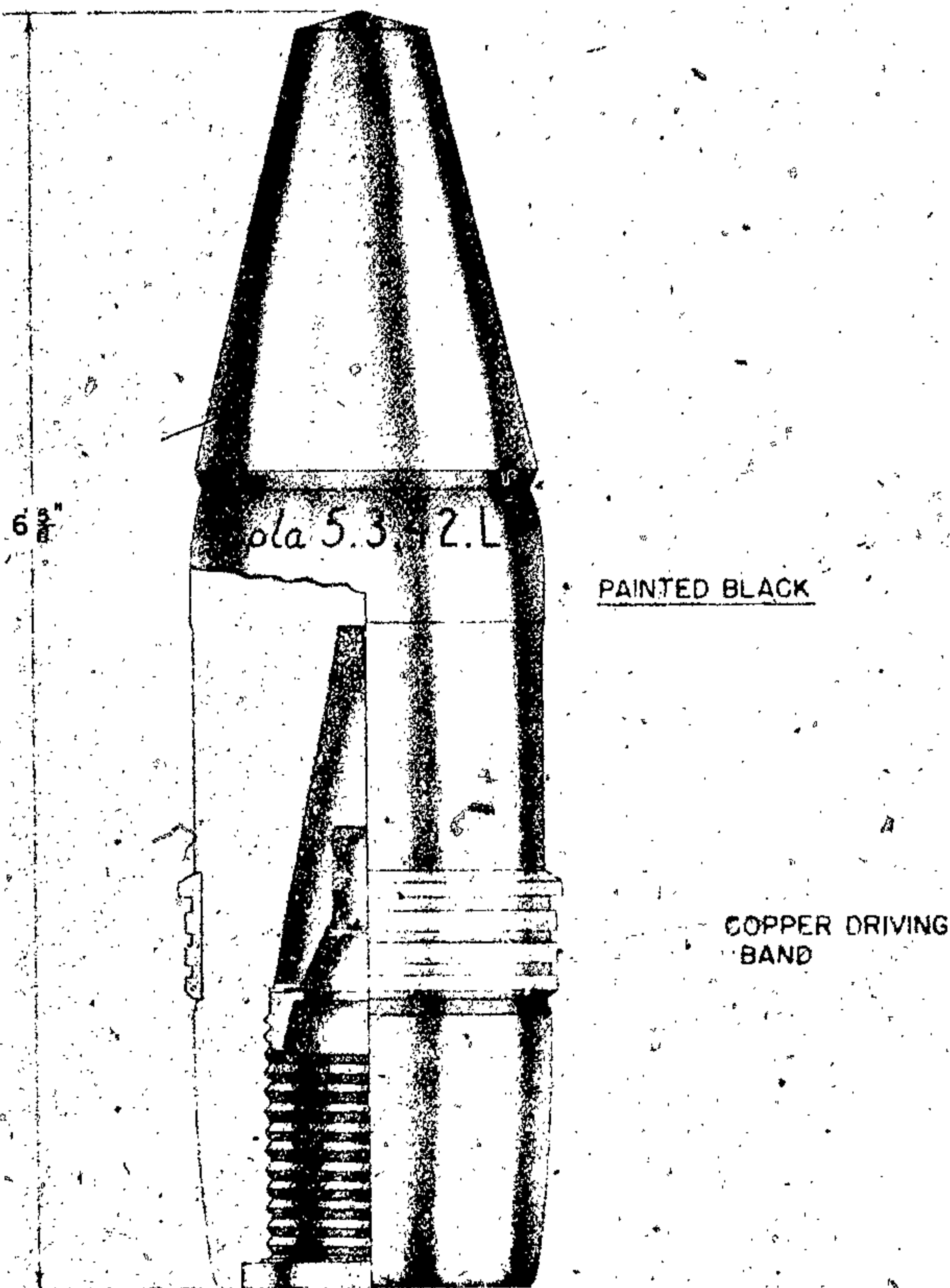

Figure 365—A. P. C. Projectile Type 36 (Czech. Design), 47-mm, 4.7-cm Pzgr. Patr. 36 (t)

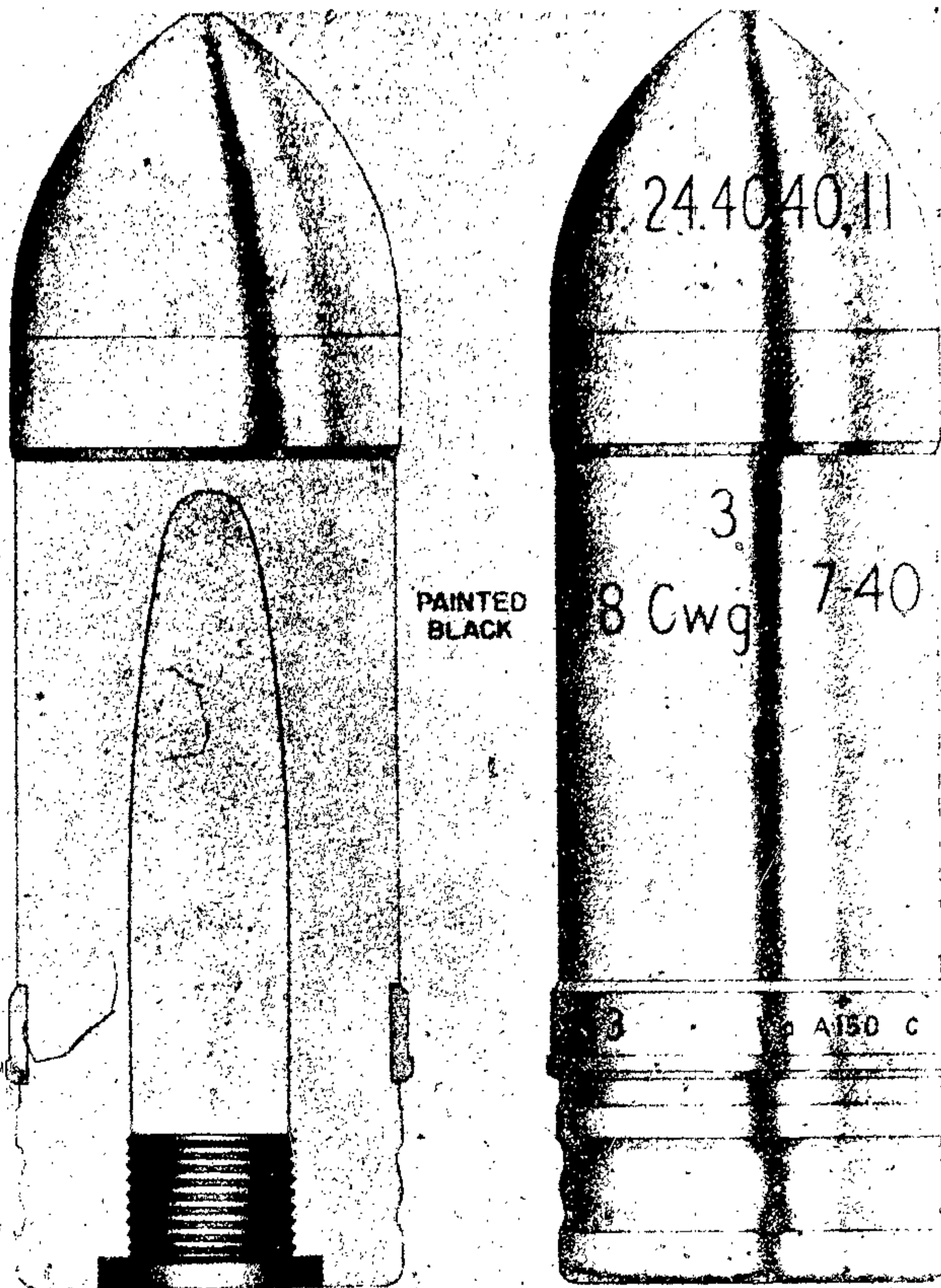

Figure 366—A. P. Projectile Without Cap for Tank Gun, 50-mm, 5-cm Pzgr. Patr. KwK.

A. P. PROJECTILE WITHOUT CAP FOR TANK GUN, 50-MM

GERMAN NOMENCLATURE:

5-cm. Pzgr. Patr. KwK. (Panzergranate Patrone Kampwagenkanone). (See fig. 366.)

EMPLOYMENT: 5-cm KwK. (Kampwagenkanone) tank gun.

COMPLETE ROUND:

16.357 inches, over-all length.
7 pounds 10 ounces, total weight.

PROJECTILE, painted black:

7.5 inches, over-all length.

1.156 inches, distance from base to band.
1.963 inches, diameter of bourrelet.
1.938 inches, diameter of base.
0.406 inch, width of rotating band—soft iron.
4 pounds 8.25 ounces, total weight.
0.58 ounce, PETN/Wax bursting charge.
Tracer present in fuze.
Stamped in base: "164DL 608 1940, C FES."

CARTRIDGE CASE (German nomenclature, 6317) (fixed):

11.342 inches, over-all length.
2.035 inches, diameter of neck.

2.668 inches, diameter of shoulder.
 3.085 inches, diameter of base.
 1 pound 12.76 ounces, weight of case.
 Diglycol propellant C/22 primer.

FUZE: Base detonating fuze—Bd. Z. 5103. There are no markings on this fuze.

H. E. PROJECTILE, TYPE 38, 50-MM

GERMAN NOMENCLATURE: 5-cm Sprgr. Patr. 38 KwK—Sprenggranate. Patrone 38 Kampfwagenkanone. (See fig. 367.)

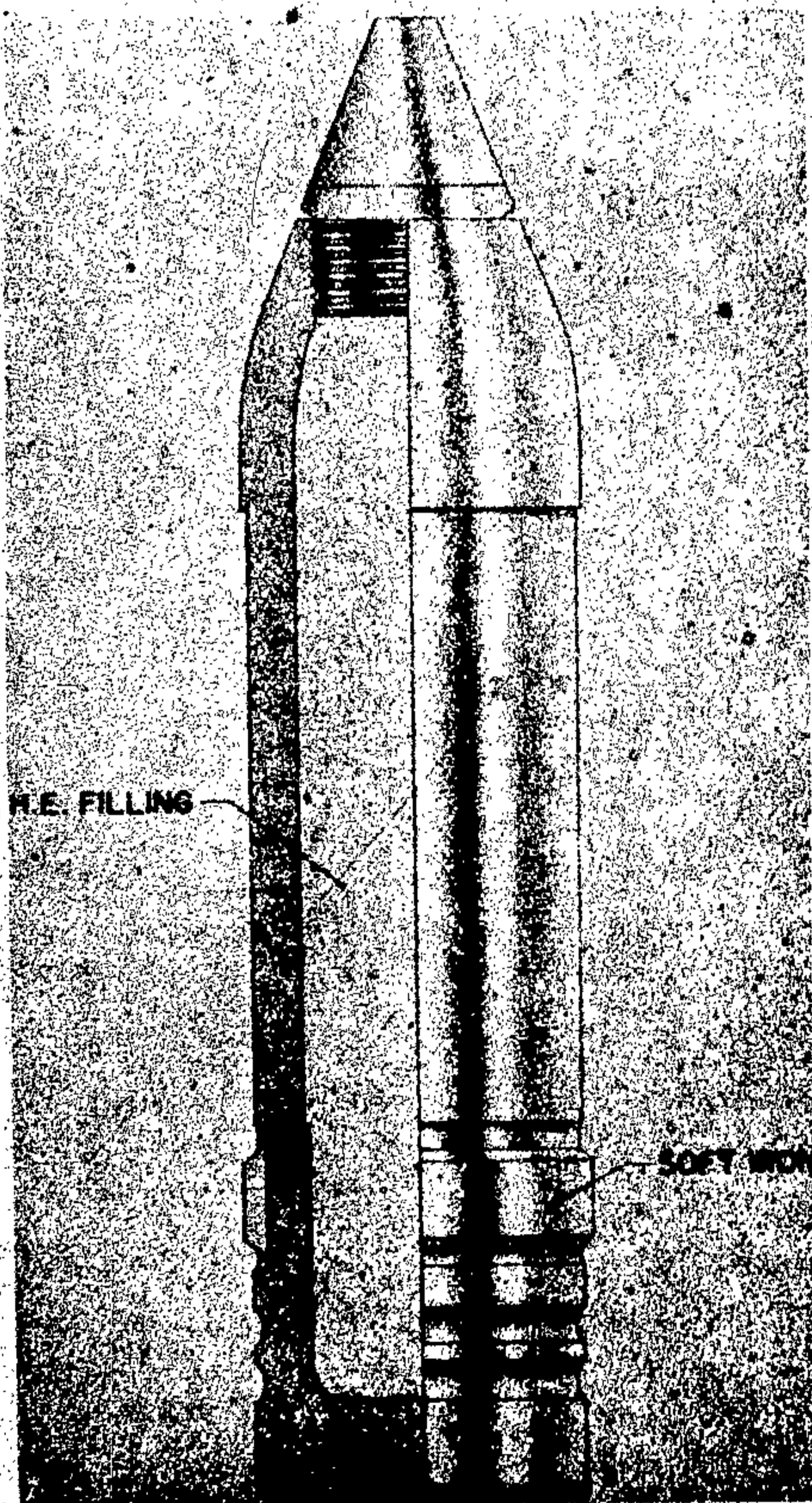

Figure 367—H. E. Projectile, Type 38, 50-mm, 5-cm Sprgr. Patr. 38 KwK.

EMPLOYMENT:

5-cm KwK Kampfwagenkanone—tank gun.
 5-cm Pak 38 Panzerabwehrkanone—antitank gun 38.
 5-cm KwK 39 Kampfwagenkanone—tank gun 39.

COMPLETE ROUND (description of c/r is for 5-cm. KwK):

18.61 inches, over-all length.
 6.85 pounds, total weight.

PROJECTILE, painted green:

8.82 inches, over-all length with fuze.
 1.55 inches, distance from base to band.
 0.376 inch, width of rotating band—soft iron.
 1.873 inches, diameter of base.
 4.16 pounds, total weight.
 5.87 ounces, TNT with red phosphorus smoke box.

PETN/Wax booster.

Stenciled in black in two places on body: "L. R. 25.10.40.9."

CARTRIDGE CASE (German nomenclature, 6317) (fixed):

11.34 inches, over-all length.
 2.035 inches, diameter of neck.
 2.668 inches, diameter of shoulder.
 3.085 inches, diameter at rim.
 1.87 pounds, total weight of case.
 0.332 pound, flaked gudol propellant.
 c/22 3b grain electric primer.

FUZE: Nose percussion fuze AZ 39. Red band around fuze.

REMARKS: Cartridge cases for other weapons as follows: KwK 39—6360 (fixed); Pak 38—6360 (fixed).

A. P. PROJECTILE WITH CAP FOR TANK GUN, 50-MM

GERMAN NOMENCLATURE: 5-cm Pzgr. Patr. KwK (Panzergranate Patrone Kampfwagenkanone). (See fig. 368.)

EMPLOYMENT:

5-cm KwK Kampfwagenkanone—tank gun.
 5-cm KwK 39 Kampfwagenkanone 39—tank gun 39.
 5-cm Pak 38 Panzerabwehrkanone 38—antitank gun 38.

GERMAN EXPLOSIVE ORDNANCE

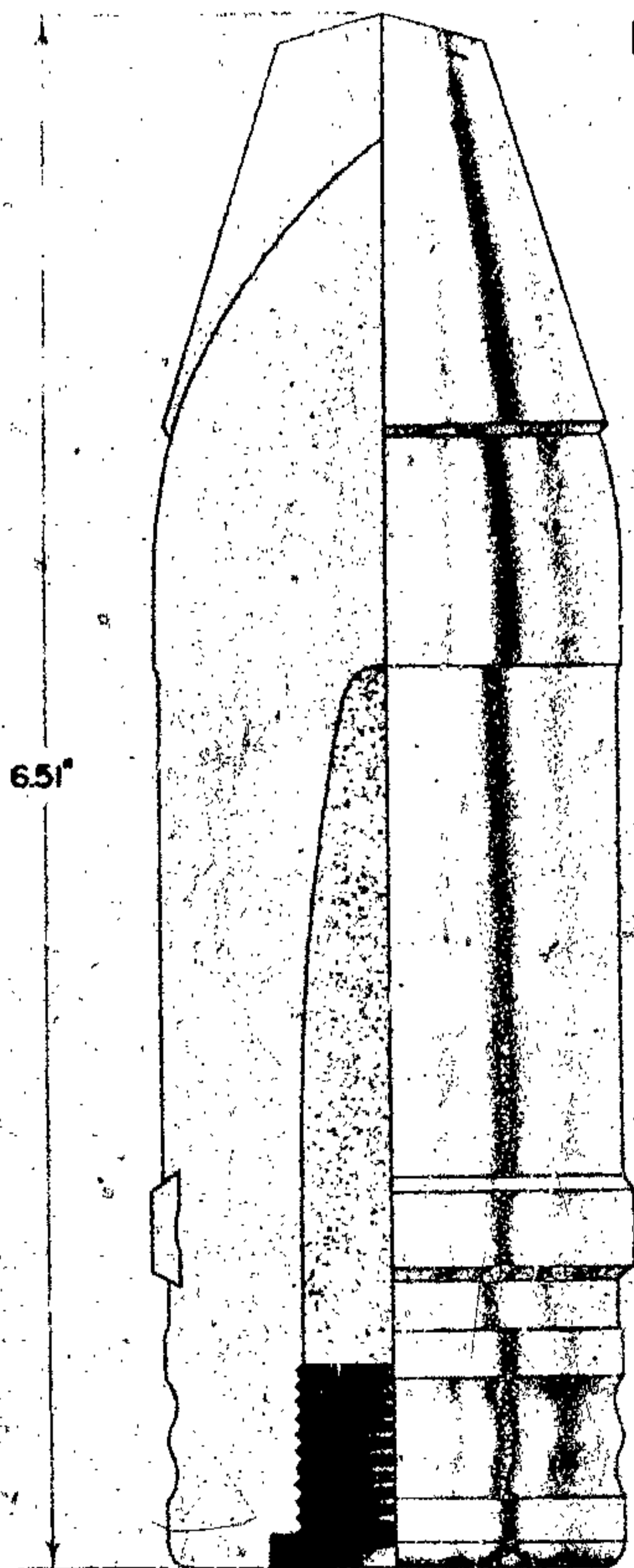

Figure 368—A. P. Projectile with Cap for Tank Gun, 50-mm, 5-cm Pzgr. Patr. KwK.

COMPLETE ROUND (description of c/r is for 5-cm KwK) :

16.683 inches, over-all length.

7.7 pounds, total weight.

PROJECTILE, painted black, unpainted band at nose :

6.51 inches, over-all length.

1.969 inches, diameter of bourrelet.

1.156 inches, distance from base to band.

1.312 inches, diameter of base.

0.406 inch, width of rotating band—soft iron.

4.56 pounds, total weight.

0.87 ounce, PEIN/Wax, 87/13 bursting charge.

Tracer present in fuze.

CARTRIDGE CASE (German nomenclature 6317) (fixed) :

11.34 inches, over-all length.

2.035 inches, diameter of neck.

2.668 inches, diameter of shoulder.

3.985 inches, diameter of base.

1.87 pounds, weight of case.

1.1 pounds, tubular diglycol propellant.

C/22 31 grain electric primer.

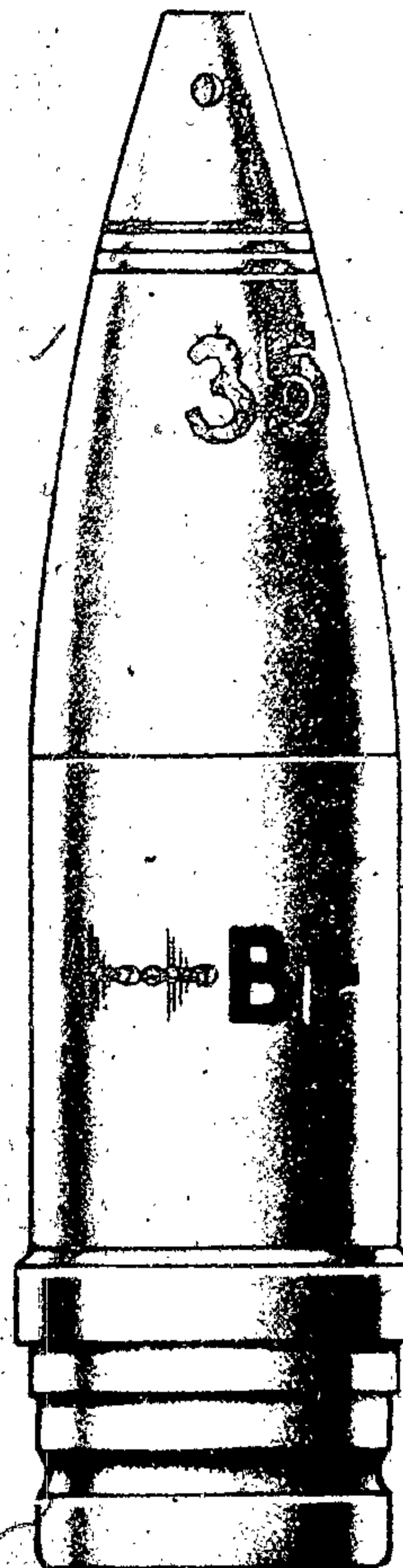

Figure 369—Incendiary with H. E. Projectile, 50-mm, 5-cm Br. Sprgr. Patr. 41 L'Spur

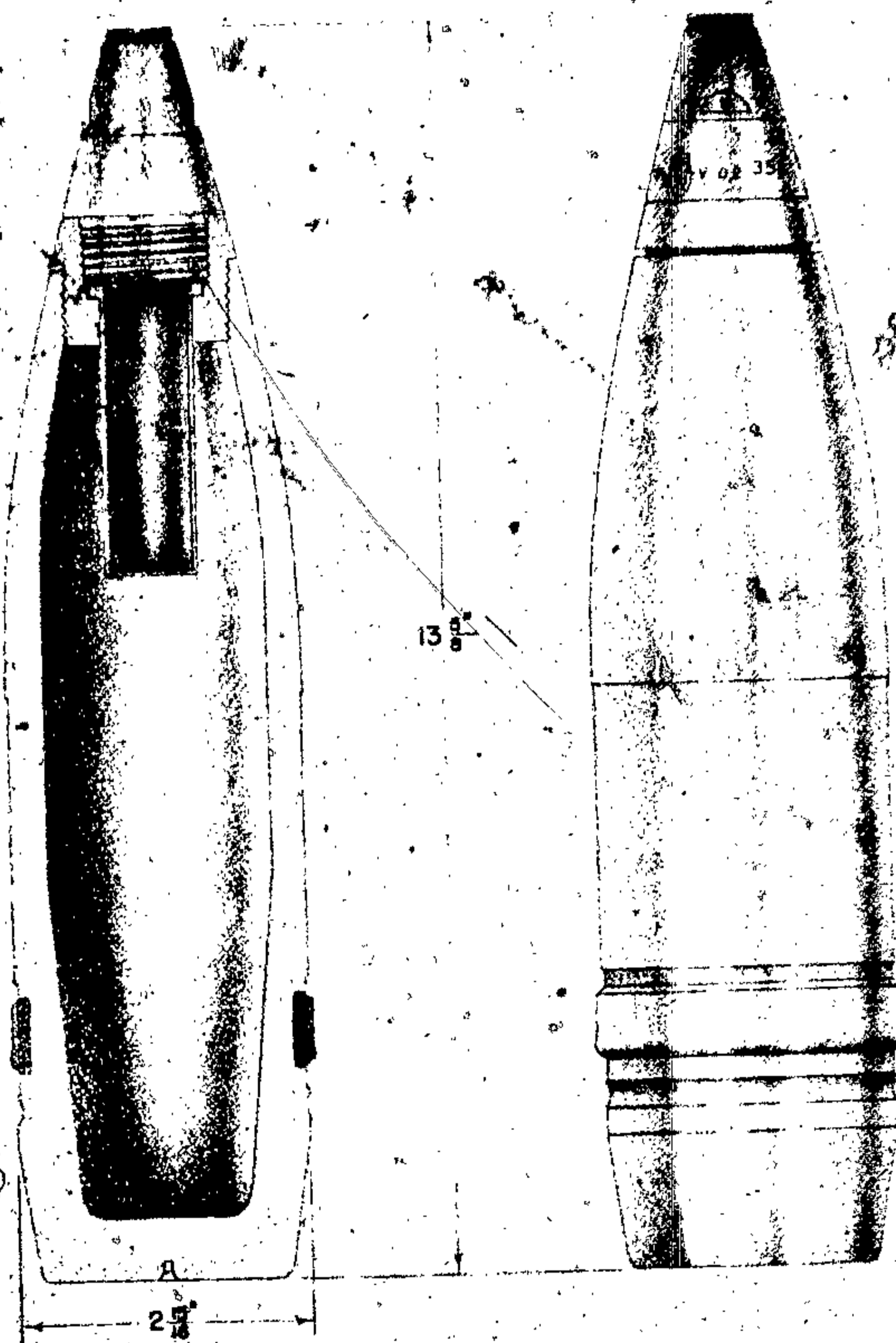

Figure 370—H. E. Projectile, Type 34, 75-mm Sprgr. Patr. KwK. (34)

FUZE: Base detonating fuze—Bd. Z. 5103. This fuze has no distinguishing markings.

REMARKS: Cartridge cases for other weapons as follows: Pak. 38—6360. (fixed); KwK 39—6360 (fixed).

**INCENDIARY WITH H. E. PROJECTILE,
50-MM**

GERMAN NOMENCLATURE 5-cm Br. Sprgr. Patr. 41 L's pur. (See fig. 369.)

EMPLOYMENT: Flak 41, (Flugabwehrkanone 41).

COMPLETE ROUND:

20.9 inches, over-all length.

9 pounds 7 ounces, total weight (not scaled).

PROJECTILE, painted yellow, black lettering:

1.97 inches, diameter of bourrelet.

2.04 inches, diameter of band.

CARTRIDGE CASE (German nomenclature, Patr. St. 5-cm Flak 41):

13.65 inches, over-all length.

2.68 inches, diameter of base.

2.80 inches, diameter of shoulder.

H. E. PROJECTILE, TYPE 34, 75-MM

GERMAN NOMENCLATURE: Sprgr. Patr. KwK (34) (Sprenggranate Patrone Kampfwagenkanone 34). (See fig. 370.)

GERMAN EXPLOSIVE ORDNANCE

EMPLOYMENT:

- 7.5-cm KwK (Kampfwagenkanone) Tank Cannon.
- 7.5-cm Stu. G. (Sturm Geschutz) Assault Gun.
- 7.5-cm KwK 40 (Kampfwagenkanone 40) Tank Cannon 40.
- 7.5-cm Stu. G. 40 (Sturm Geschutz 40) Assault Gun 40.
- 7.5-cm Pak 40 (Panzerabwehakanone 40) Anti-tank Cannon 40.

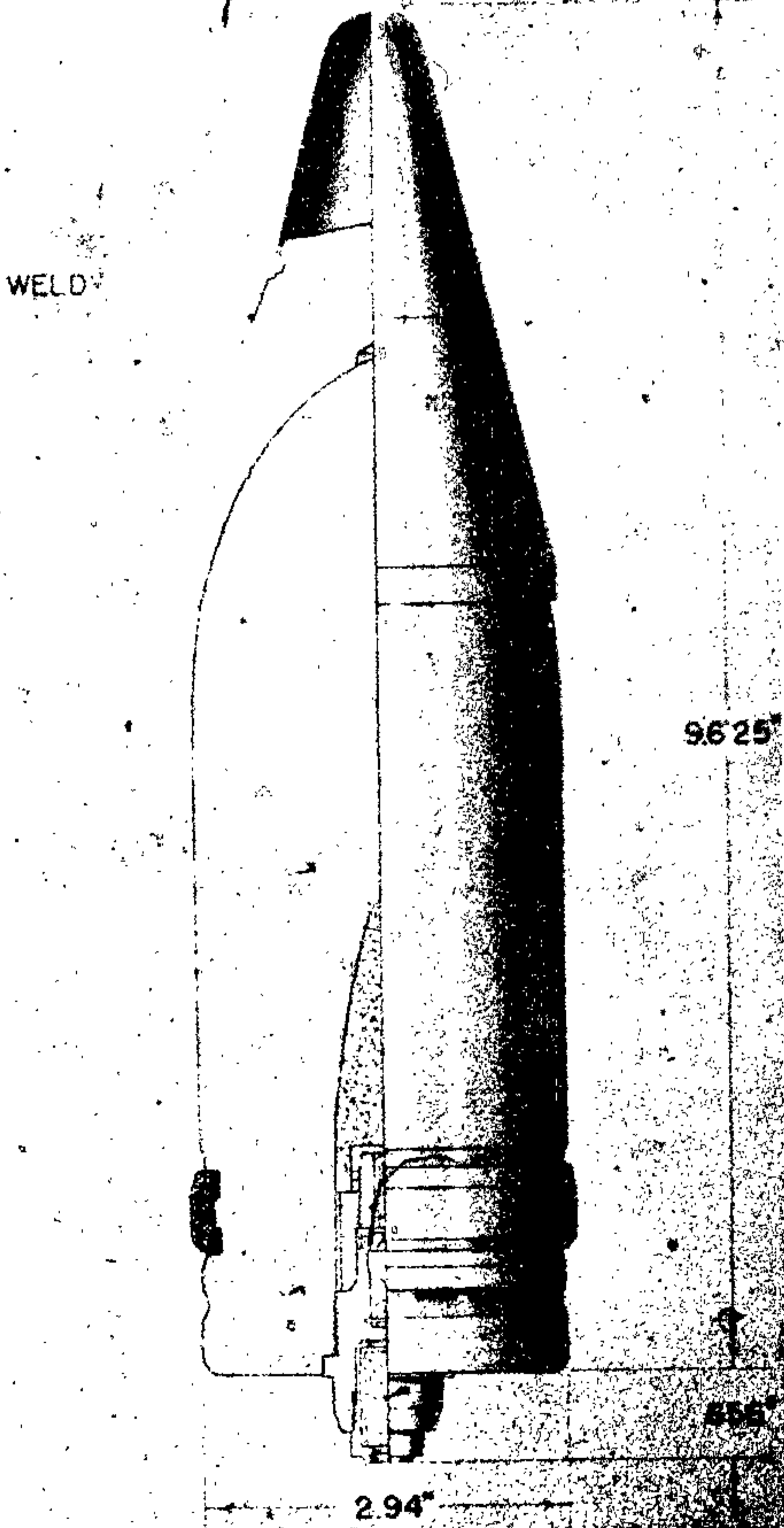

Figure 371—A. P. Projectile with Ballistic Cap and Piercing Cap, Type 39, 75-mm Pzgr. Patr. 39 KwK. 40

- 7.5-cm Geb. G. 36 (Gebirgs Geschutz 36) Mountain Gun 36.
- 7.5-cm L. G. 40 (Leuchtes Geschutz 40) Recoilless Gun for Airborne Troops.
- 7.5-cm L. F. K. 18 (Leuchtes Feld Kanone 18) Light Field Cannon 18.

COMPLETE ROUND: Description of c/r is for KwK (Stu. G.), painted green.

- 13.5 inches, over-all length w/ fuze.
- 11.6 inches, over-all length w/o fuze.
- 2.187 inches, distance from base to band.
- 0.7 inch, width of bimetallic rotating band.
- 2.5 inches, diameter of base.
- 12.6 pounds, total weight.
- 30.0 ounces, amatol 40/60 bursting charge plus smoke box of red phosphorus (TNT/Amatol 90/10 when used for Geb; G. 36), Zdlz. C/98 booster.

CARTRIDGE CASE (German nomenclature, 6354 or 6354 St.) (fixed):

- 9.56 inches, over-all length.
- 2.93 inches, diameter of neck.
- 3.01 inches, diameter of shoulder.
- 3.60 inches, diameter of base.
- 12.25 ounces, tubular nitrocellulose propellant.
- C/22 31 grain electric primer.

FUZE: Nose percussion fuze Fl Az 23.

PACKAGING: Two rounds to a metal container 46.64 pounds.

REMARKS: The projectile as used in the Pak 40 is identical except that its rotating band is soft iron. Cartridge cases for other weapons are as follows:

- Pak. 40—6340 (fixed).
- KwK 40 (Stu. G. 40)—6339 (fixed).
- Geb. G. 36—(semifixed).
- Leuchtes Geschutz 40—plastic base case (S-F).
- L. F. K. 18—6316—(semifixed).

A. P. PROJECTILE WITH BALLISTIC CAP AND PIERCING CAP, TYPE 39, 75-MM.

GERMAN NOMENCLATURE: Pzgr. Patr. 39 KwK 40 (Panzergranate Patrone 39 Kampfwagenkanone 40). (See fig. 371.)

EMPLOYMENT:

- 7.5-cm KwK 40 (Kampfwagenkanone 40) Tank Gun 40.
- 7.5-cm Stu. G. 40 (Sturm Geschutz 40) Assault Gun 40.

7.5-cm Pak. 40 (Panzerabwehrkanone 40) Anti-tank Gun 40.

COMPLETE ROUND (description of c/r is for KwK 40):

29.3 inches, over-all length.

29.4 pounds, total weight.

PROJECTILE painted black with red band and red stenciling:

9.625 inches, over-all length, w/o tracer.

0.98 inch, distance from base to band.

0.67 inch, width of bimetallic rotating band.

2.94 inches, diameter of base.

Cyclonite bursting charge.

Tracer is present in fuze.

PETN/Wax booster.

CARTRIDGE CASE (German nomenclature, 6339 (fixed):

19.4 inches, over-all length.

3.15 inches, diameter at mouth.

3.8 inches, diameter at shoulder.

4.0 inches, diameter at base.

5.35 pounds, tubular diglycol propellant.

C/22 electric primer.

FUZE: Bd. Z. 5103.

PACKAGING: Two round to a metal container.

REMARKS: The bursting charge is in an aluminum container which is a tight fit in the projectile cavity. This projectile may or may not have a cannellure on the cap. A round exists for the Pak. 40 designated "Pzgr. Patr. 40 Pak. 40," which is an A. P. projectile with a tungsten carbide core. It has not been recovered as yet but is reported to weigh 7.06 pounds.

HOLLOW CHARGE PROJECTILE, TYPE 39, 75-MM

GERMAN NOMENCLATURE: 7.5-cm Gr. 39 (Granate 39). (See fig. 372.)

EMPLOYMENT: Geb. K. 15 (Gebirgs. Kanone 15) Mountain Gun 15.

COMPLETE ROUND: 14.68 inches, over-all length.

PROJECTILE painted green:

11.181 inches, over-all length w/fuze.

0.7 inch, distance from base to band.

0.43 inch, width of bimetallic rotating band.

2.95 inches, diameter of base.

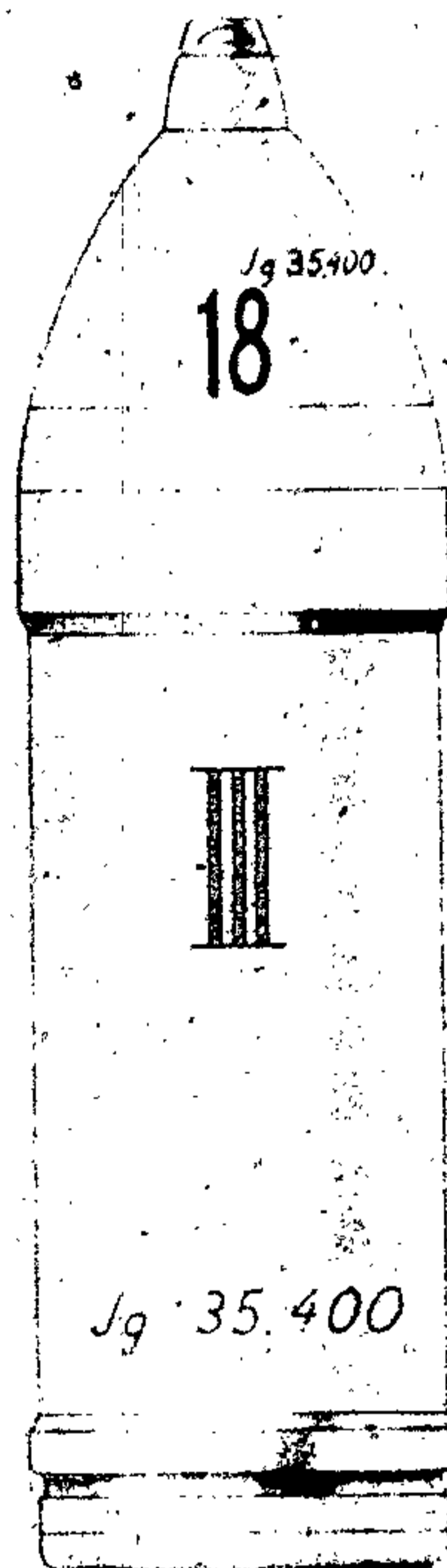

Figure 372—Hollow Charge Projectile Type 39,
75-mm, 7.5-cm Gr. 39

9.9 pounds, total weight.

Cyclonite/Wax/TNT bursting charge.

CARTRIDGE CASE (German nomenclature, 6335) (semi-fixed):

5.078 inches, over-all length.

3.03 inches, diameter at mouth.

No shoulder.

3.34 inches, diameter at base.

11.6 ounces, flaked nitroglycerine and nitrocellulose with Nitroguanidine C/12n/A primer.

FUZE: Nose percussion fuze A. Z. 38.

PACKAGING: Three projectiles and three cartridges in a wicker basket.

REMARKS: When fired, the projectile will be found with 28 grooves in the band.

GERMAN EXPLOSIVE ORDNANCE

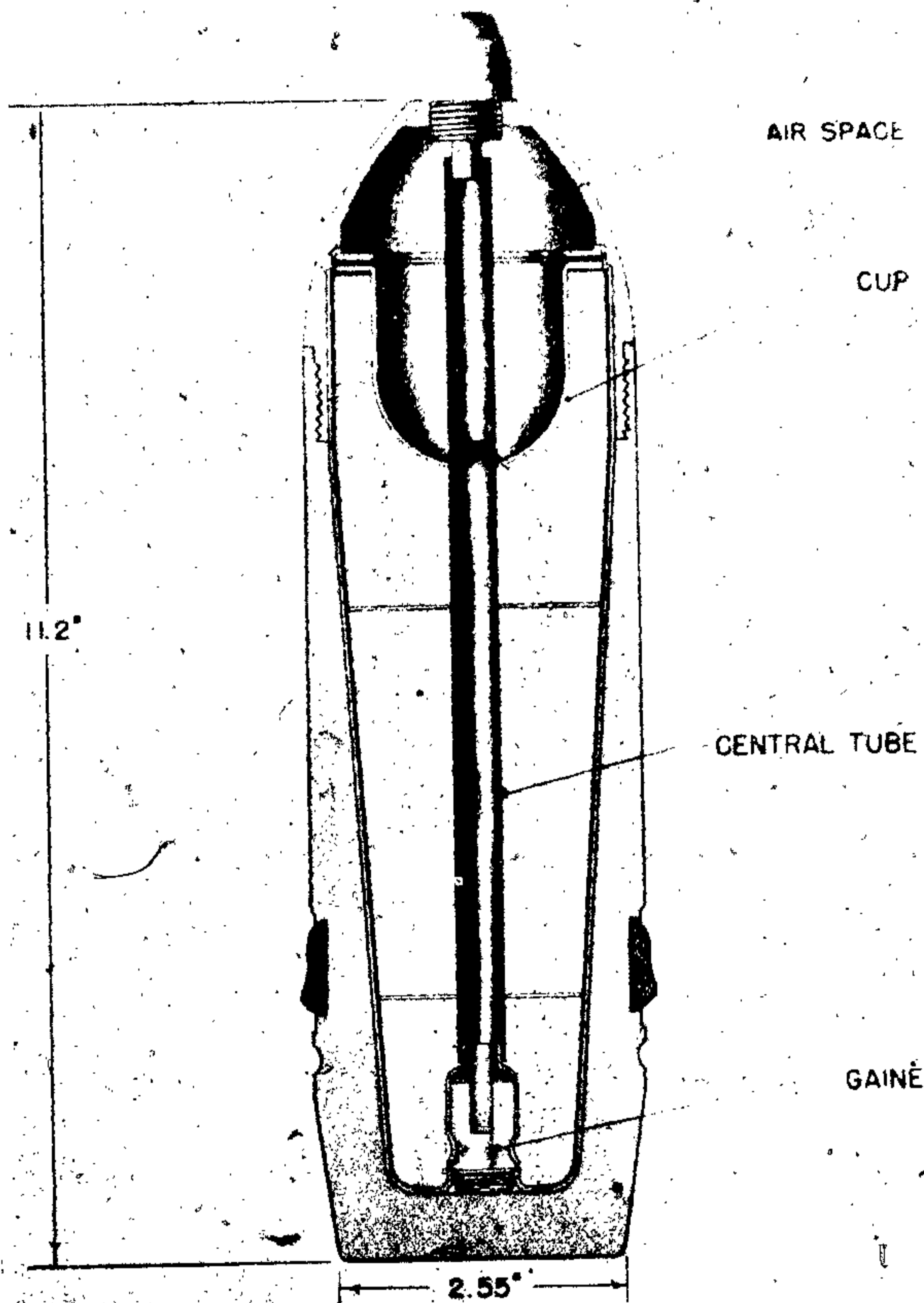

Figure 373—Hollow Charge Projectile for Tank Gun,
75-mm, 7.5-cm Gr. Patr. 38 KwK. (H. L.)

HOLLOW CHARGE PROJECTILE FOR TANK GUN, 75-MM

GERMAN NOMENCLATURE: 7.5-cm Gr. Patr. 38 KwK (H. L.) (Granate Patrone 38 Kampfwagenkanone) (Hohl Ladung). (See fig. 373.)

EMPLOYMENT:

- 7.5-cm. KwK (Kampfwagenkanone) Tank Cannon.
- 7.5-cm Stu. G. (Sturm Geschutz) Assault Gun.
- 7.5-cm KwK 40 (Kampfwagenkanone 40) Tank Cannon 40.

7.5-cm Stu. G. 40 (Sturm Geschutz 40) Assault Gun 40.

7.5-cm L. F. K. 18 (Leuchtes Felf Kanone 18) Light Field Cannon 18.

7.5-cm Geb. G. 36 (Gebirgs Geschutz 36) Mountain Gun 36.

7.5-cm L. G. 40 (Leuchtes Geschutz 40) Recoilless Gun for Airborne Troops.

COMPLETE ROUND (description of c/r is for KwK (Stu. G.)):

18.5 inches, over-all length.

12.0 pounds, 14.0 ounces, total weight.

PROJECTILE painted green:

- 11.2 inches, over-all length, w/fuze.
- 2.2 inches, distance from base to band.
- 0.66 inch, width of bimetallic rotating band.
- 2.55 inches, diameter of base.
- 9.75 pounds, total weight.
- 1.22 pounds, cyclonite wax.
- TNT bursting charge Zdlg. 40 booster.

CARTRIDGE CASE (German nomenclature, 6354 or 6354 St.) (fixed):

- 9.56 inches, over-all length.
- 2.93 inches, diameter of neck.
- 3.01 inches, diameter of shoulder.
- 3.60 inches, diameter of rim.
- 2 pounds, 1.79 ounces, weight of case.
- 12.61 ounces, tubular nitrocellulose propellant.
- C/22 31 grain electric primer.

FUZE: Nose percussion fuze A. Z. 38.**PACKAGING:** Two rounds to a metal container.

REMARKS: Hollow charge projectiles are made in two pieces, the male nose being threaded into the body. There are two spanner flats on the nose piece. Cartridge cases for other weapons are as follows:

- KwK 40 (Stu. G. 40) 6339 (fixed).
- Pak. 40 6340 (fixed).
- Geb. G. 36 (semifixed).
- L. G. 40—Plastic base (semifixed).
- L. F. K. 18—6316 (semifixed).

HOLLOW CHARGE PROJECTILE FOR TANK GUN, TYPE B, 75-MM**GERMAN NOMENCLATURE:** 7.5-cm Gr. Patr.

KwK (H. L/B) (Granate Patrone Kampfwagenkanone (Hohl Ladung/B). (See fig. 374.)

EMPLOYMENT:

- 7.5-cm KwK (Kampfwagenkanone) Tank Cannon.
- 7.5-cm Stu. G. (Sturm Geschutz) Assault Gun.
- 7.5-cm Pak. 40 (Panzerabwehrkanone 40) Anti-Tank Cannon 40.
- 7.5-cm L. F. K. 18 (Leichte Feld Kanone 18) Light Field Cannon 18.
- 7.5-cm Geb. G. 36 (Gebirgs Geschutz 36) Mountain Gun 36.
- 7.5-cm L. G. 40 (Leuchtes Geschutz 40) Recoilless Gun for Airborne Troops.

COMPLETE ROUND: Description of c/r is for KwK 19.36 inches, over-all length; w/fuze.

PROJECTILE (painted green):

- 12.00 inches, over-all length; w/fuze.
- 2.2 inches, distance from base to band.
- 0.63 inch, width of rotating band (bimetallic or sintered iron).
- 2.48 inches, diameter of base.
- Cyclonite/Wax/TNT bursting charge.
- "HL/B" stenciled in black on nose.

CARTRIDGE CASE (German nomenclature, 6354 or 6354 St.) (fixed):

- 9.56 inches, over-all length.
- 2.93 inches, diameter of neck.
- 3.01 inches, diameter of shoulder.
- 3.60 inches, diameter of rim.
- 2 pounds, 1.79 ounces, weight of case.

NOSE FUZE

PERFORATED METAL DISC

BURSTER CHARGE

BASE

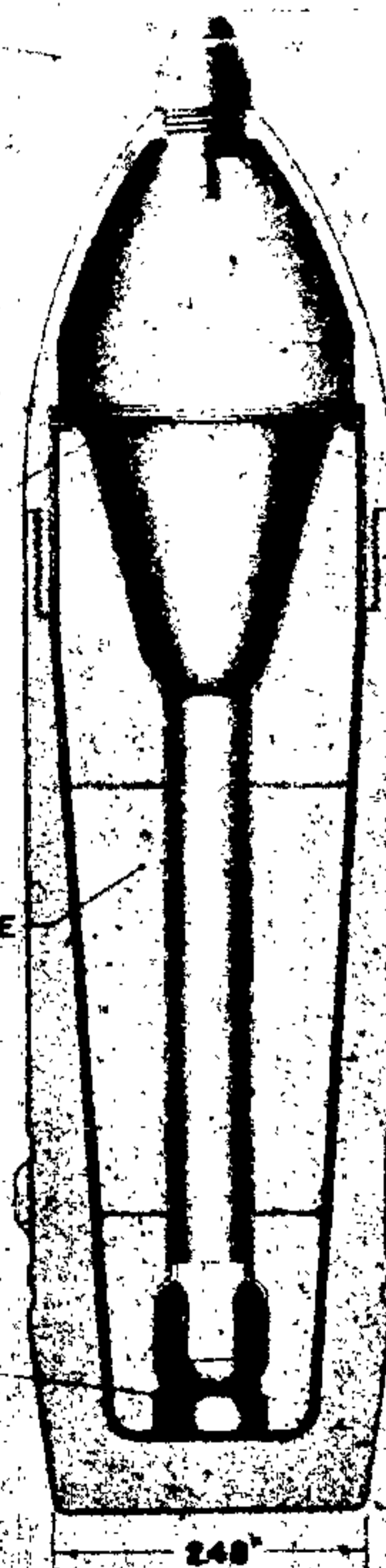

Figure 374—Hollow Charge Projectile for Tank Gun, Type B, 75-mm, 7.5-cm Gr. Patr. KwK. (H.L/B)

GERMAN EXPLOSIVE ORDNANCE

12.61 ounces, tubular nitrocellulose propellant,
C/22 31 grain electric primer.

FUZE: Nose percussion fuze A. Z. 38.

PACKAGING: Two rounds to a metal container.

REMARKS: Hollow charge projectiles are made in two pieces, the male nose being threaded into the body. There are two spanner flats on the nose piece. Cartridge cases for other weapons are as follows:

- KwK 40 (Stu. G. 40) 6339 (fixed).
- Pak. 40 6340 (fixed).
- Geb. G. 36 (Semifixed).
- L. G. 40 plastic base (semifixed).
- L. F. K. 18 6316 (semifixed).

SMOKE PROJECTILE FOR TANK GUN, 75-MM

GERMAN NOMENCLATURE: 7.5-cm Nbgr.

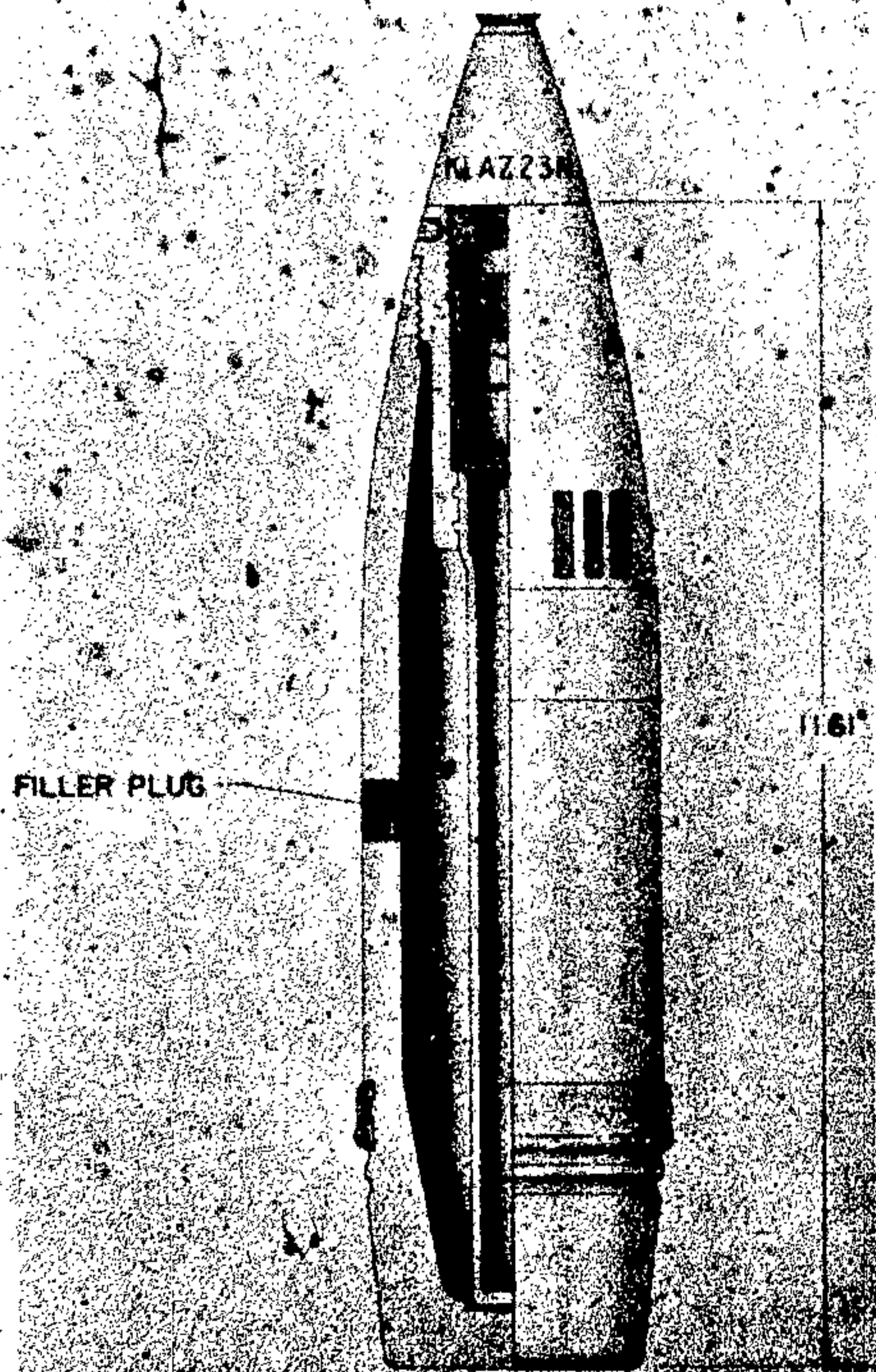

Figure 375—Smoke Projectile for Tank Gun, 75-mm,
7.5-cm Nbgr. Patr. KwK.

Patr. KwK. (Nebelgranate Patrone Kampfwa-
genkanone): (See fig. 375.)

EMPLOYMENT:

- 7.5-cm KwK (Kampfwagenkanone) Tank Can-
non.
- 7.5-cm Stu. G. (Sturm Geschutz) Assault Gun.
- 7.5-cm KwK (Kampfwagenkanone 40) Tank
Cannon.
- 7.5-cm Stu. G. 40 (Sturm Geschutz 40) Assault
Gun 40.
- 7.5-cm L. F. K. 18 (Leichte Feld Kanone 18)
Light Field Cannon, 18.
- 7.5-cm L. G. 40 (Leuchtes Geschutz 40) Recoil-
less Gun for Airborne Troops.

COMPLETE ROUND (description of c/r is for KwK):

20.9 inches, over-all length.

PROJECTILE, painted green:

- 13.5 inches, over-all length, w/ fuze.
- 11.6 inches, over-all length, w/o fuze.
- 2.187 inches, distance from base to band.
- 0.67 inch, width of rotating band.
- 2.5 inches, diameter of base.
- 13.6 pounds, total weight.
- 2.0 ounces, picric acid burster charge.
- 80/20 Oleum impregnated in putnice, smoke
mixture.
- PETN/Wax booster.
- "Nb" stenciled on body in white.

CARTRIDGE CASE (German nomenclature, 6354 or 6354 St. (fixed):

- 9.56 inches, over-all length.
- 2.93 inches, diameter of neck.
- 3.01 inches, diameter of shoulder.
- 3.60 inches, diameter of rim.
- 2 pounds, 1.79 ounces, weight of case.
- 12.61 ounces, tubular nitrocellulose propellant.
- C/22 31 grain electric primer.

FUZE: Nose percussion fuze K1 A. Z. 23 Nb.

PACKAGING: Two rounds in a metal box.

REMARKS: This projectile is machined to the same design as the H. E. projectile. Type 34, with the exception of a recess one inch in diameter, 0.08 inch in depth provided at base of cavity for seating lower end of burster tube. There is a threaded plug in the side wall used to close the filling hole. Cartridge cases for other weapons are as follows:

- L. F. K. 18—6316 (semifixed).

KwK 40 (Stu. G. 40) 6339 (fixed).
 Pak. 40 6340 (fixed).
 L. G. 40 plastic base (semifixed).

A. P. C. TANK GUN PROJECTILE, 75-MM

GERMAN NOMENCLATURE: Pzgr. Patr. KwK (Panzergranate Patrone Kampfwagenkanone). (See fig. 376.)

EMPLOYMENT:

7.5-cm KwK (Kampfwagenkanone) Tank Cannon.
 7.5-cm Stu. G (Sturm Geschutz) Assault Gun.
 7.5-cm L. F. K. 18 (Leuchtes Feld Kanone) Light Field Cannon 18.
 7.5-cm L. G. 40 (Leuchtes Geschutz 40) Recoilless Gun for Airborne Troops.

COMPLETE ROUND: Description of c/r is for KwK. 19.89 inches, over-all length.

PROJECTILE, painted black:

11.312 inches, over-all length, w/o tracer.
 0.98 inch, distance from base to band.
 0.67 inch, width of rotating band (bimetallic).
 2.93 inches, diameter of base.
 15.5 pounds, total weight.
 2.92 pounds, TNT and PETN/Wax bursting charge.

Tracer is present in fuze.

CARTRIDGE CASE (German nomenclature, 6354 or 6354 St. (fixed)):

9.56 inches, over-all length.
 2.93 inches, diameter of neck.
 3.01 inches, diameter of shoulder.
 2.60 inches, diameter of base.
 12.39 ounces, tubular nitrocellulose propellant.
 Case will be stamped on base: "6354 7.5-cm KwK."

FUZE: Bd. Z. F. 7.5-cm (so marked).

PACKAGING: Two rounds to a metal container:

REMARKS: There are two cannellures below the rotating band. Cartridge cases for other weapons are as follows:

L. F. K.—18—6316 (semifixed).
 L. G.—40—plastic base case.

H. E. PROJECTILE FOR MOUNTAIN GUN, 75-MM

GERMAN NOMENCLATURE: Geb. G. 15 Al. (Gebirgs Granate 15 Aluminum). (See fig. 377.)

EMPLOYMENT: 7.5-cm Geb. K. 15 (Gebirgs Kanone 15) Mountain Gun 15.

COMPLETE ROUND: 15.75 inches, over-all length.

PROJECTILE, painted green:

12.99 inches, over-all length, w/fuze.
 0.687 inch, distance from base to band.
 0.433 inch, width of rotating band.
 2.95 inches, diameter of base.
 12.0 pounds, total weight.
 TNT/Aluminum, 90/10 and red phosphorus smoke box bursting charge.
 C/98 Np. Booster.

CARTRIDGE CASE (German nomenclature, 6335) (semifixed):
 5.078 inches, over-all length.

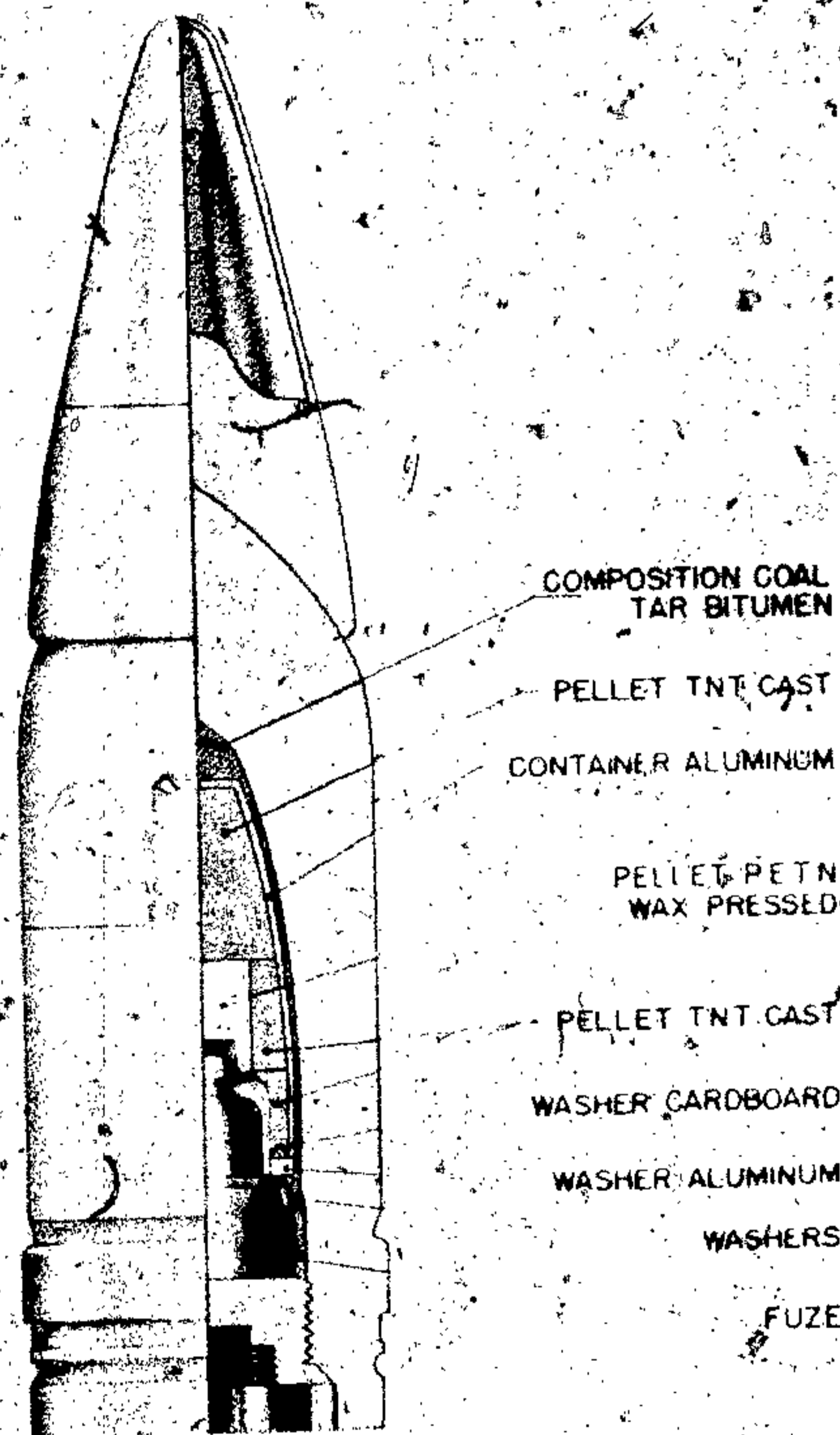

Figure 376—A. P. C. Tank Gun Projectile, 75-mm Pzgr. Patr. KwK.

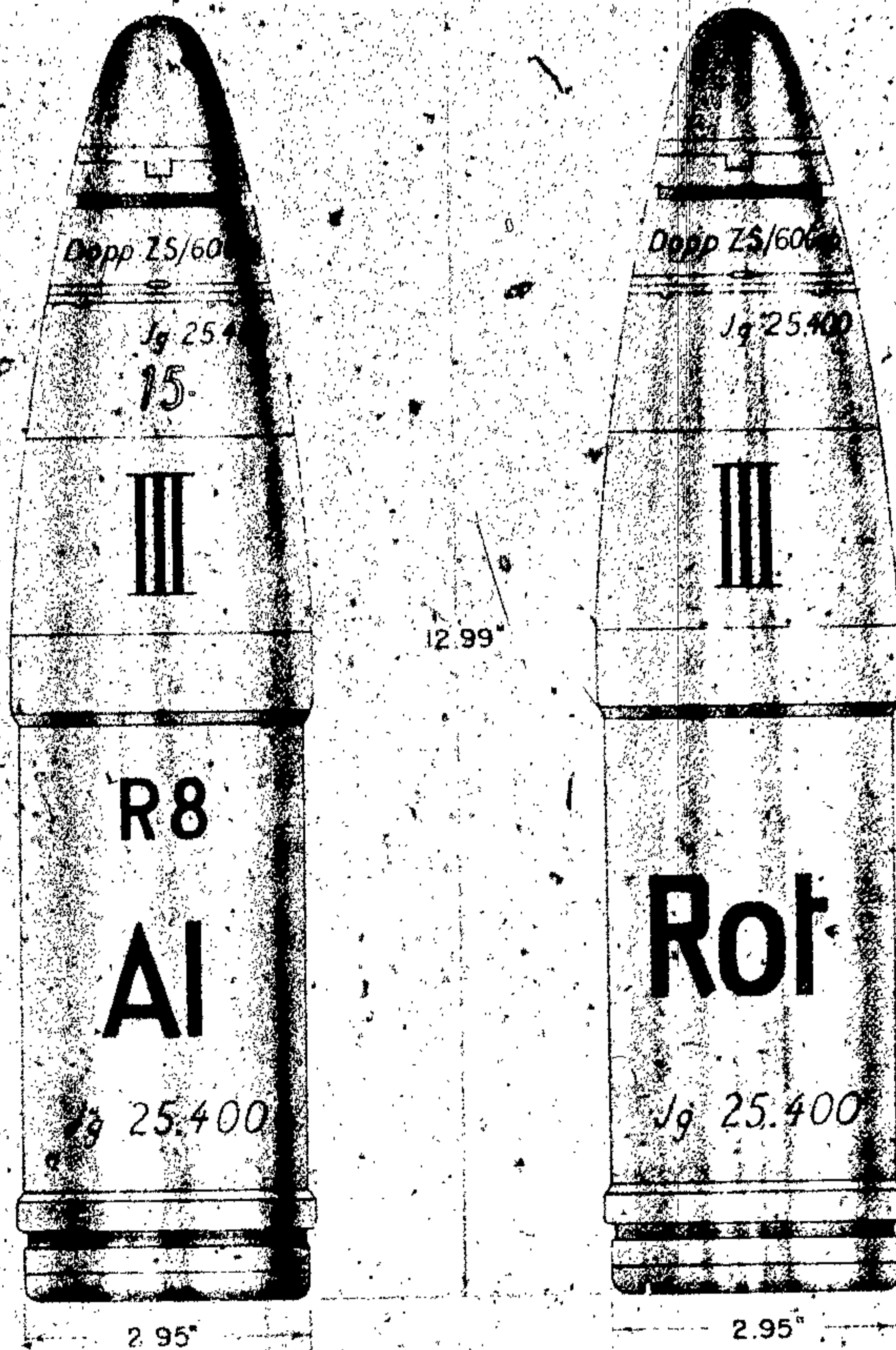

Figure 377—H. E. Projectile for Mountain Gun, 75-mm Geb. Gr. 15 Al.

3.03 inches, diameter of neck.

No shoulder.

3.34 inches, diameter of rim.

11.6 ounces, flaked nitroglycerine and nitrocellulose with nitroguanadine.

C/12nA primer.

FUZE: Nose percussion fuze A. Z. 23 Geb. Time and percussion fuze Dopp Z. s/60 Geb.

PACKAGING: Three projectiles and three cartridges in a wicker basket.

REMARKS: There is round designated: "Geb. Gr. 15 rot" which is identical with the above except that it does not contain any aluminum.

HOLLOW CHARGE PROJECTILE FOR INFANTRY GUN, 75-MM

GERMAN NOMENCLATURE: 7.5-cm Igr. 38 (Iager 38). (See fig. 378.)

EMPLOYMENT:

7.5-cm L. I. G. 18 (Leichte Infanterie Geschutz 18) Light Infantry Gun 18.

7.5-cm L. Geb. I. G. 18 (Leichte Gebirgs Infanterie Geschutz 18) Light Mountain Infantry Gun 18.

COMPLETE ROUND: Description of c/r is identical for both weapons. 11.562 inches, over-all length.

PROJECTILE, painted green:

- 9.134 inches, over-all length w/o fuze.
- 1.125 inches, distance from base to band.
- 0.236 inch, width of bimetallic rotating band.
- 2.875 inches, diameter of base.
- 6 pounds 10 ounces, total weight.
- Cyclonite bursting charge.
- Zdlg. 40 booster.

CARTRIDGE CASE (German nomenclature, 6341 or 6341 St.) (semi-fixed):

- 3.5 inches, length.
- 3.0 inches, diameter at mouth.
- No shoulder.
- 3.375 inches, diameter at base.
- 2.52 ounces, nitroglycerine.
- Disk powder.
- C/12nA primer.

FUZE: Nose percussion fuze A. Z. 38.

PACKAGING: Three projectiles and three cartridges in a wicker basket.

REMARKS: This is evidently an H. L. type projectile. An H. L/A type is to be introduced.

H. E. PROJECTILE FOR INFANTRY GUN, 75-MM

GERMAN NOMENCLATURE: Igr. 18 A. Z. 23nA (Iager 18 Aufschlag Zunder neu Abteilung). (See fig. 379.)

EMPLOYMENT:

- L. I. G. 18 (Leichte Infanterie Geschutz 18) Light Infantry Gun 18.
- L. Geb. I. G. 18 (Leichte Gebirgs Infanterie Geschutz 18) Light Mountain Infantry Gun 18.

COMPLETE ROUND (description of c/r is for L. I. G. 18):

- 15.49 inches, over-all length.
- 13 pounds 10 ounces, total weight.

PROJECTILE painted green:

- 12.99 inches, over-all length w/fuze.
- 1.102 inches, distance from base to band.
- 0.236 inch, width of rotating band, bimetallic or sintered iron.
- 2.95 inches, diameter of base.
- 1.21 pounds, Amatol 40/60 bursting charge.
- Stenciled: "7.5-cm Igr. 18, L. Igr. Z, 23nA."
- Gr. Zdlg. C/98 Np. Booster.

CARTRIDGE CASE (German nomenclature,

- 6341 or 6341 St.) (semi-fixed):
- 3.5 inches, over-all length.
- 3.0 inches, diameter of neck.
- No shoulder.
- 3.375 inches, diameter of base.
- 2.52 ounces, nitroglycerine.
- Disk powder.
- C/12nA primer.

FUZE: Nose percussion fuze L. Igr. Z. 23nA.

PACKAGING: Three projectile and three cartridges in a wicker basket with metal bottom and metal cradle—49 pounds.

REMARKS: This projectile is sometimes filled TNT/Amatol—90/10. Cartridge case for L. Geb. I. G. 6341 (semi-fixed). When this projectile has been fired from the L. I. G. 18, the rotating band will show 24 riflings.

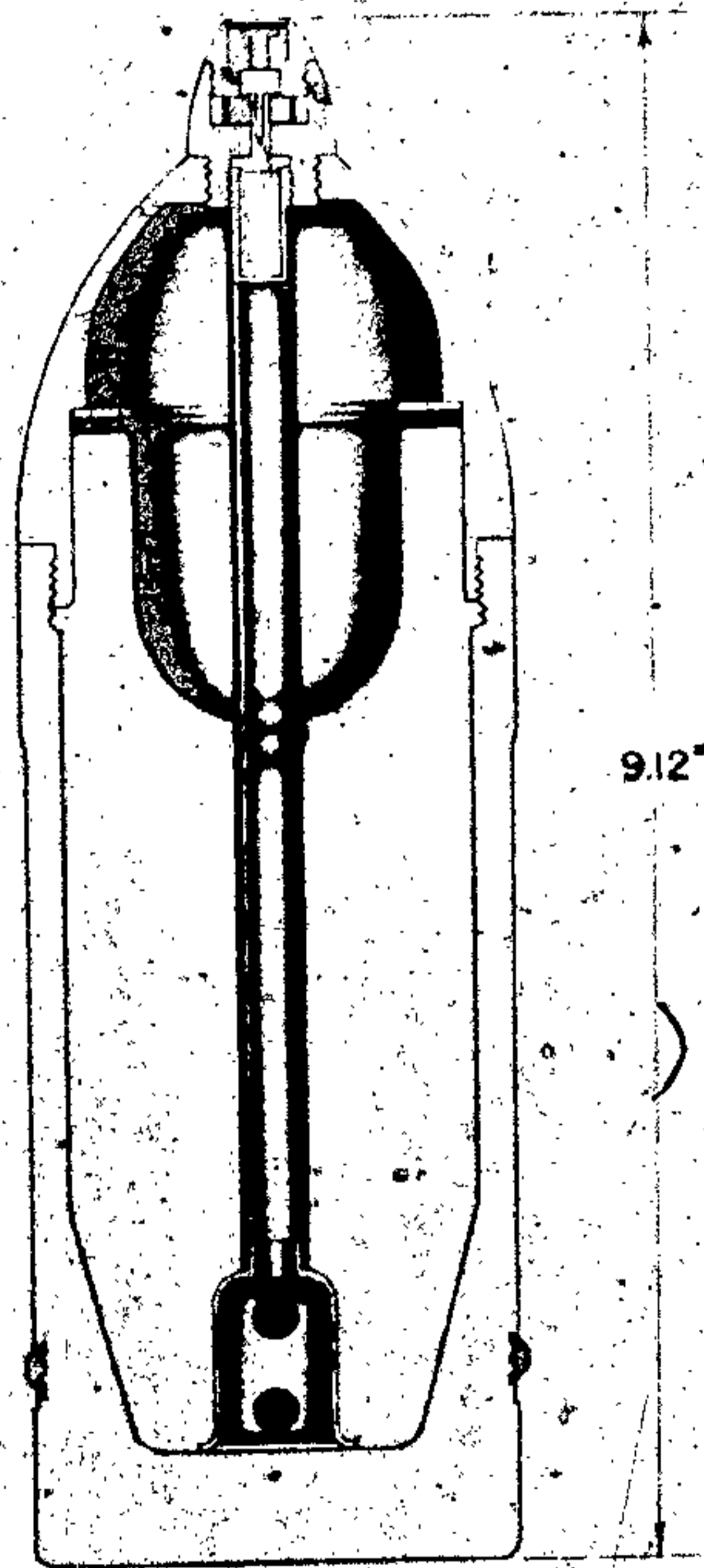

Figure 378—Hollow Charge Projectile for Infantry Gun, 75-mm, 7.5-cm Igr. 38

GERMAN EXPLOSIVE ORDNANCE

H. E. PROJECTILE FOR DUAL-PURPOSE SKODA GUN, 75-MM

GERMAN NOMENCLATURE: Sprgr. Patr.
75/50 (Sprenggranate Patrone 75/50). (See
fig. 380.)

EMPLOYMENT: 75/50 Skoda dual-purpose gun.

COMPLETE ROUND: 27.5 pounds, total weight.

PROJECTILE, red banded, stenciled in red:

14.96 inches, over-all length w/fuze.

2.948 inches, diameter of bourrelet.

0.472 inches, width of rotating bands 2, number
of rotating bands.

510.0 grams, TNT bursting charge.

0.511 inches, width of bourrelet.

CARTRIDGE CASE (German nomenclature, not
known):

This is a brass case.

22.83 inches, over-all length.

3.15 inches, diameter of neck.

3.228 inches, diameter of shoulder.

3.740 inches, diameter at rim.

4.201 pounds, tubular propellant.

M39s percussion primer (f).

Stamped-on base: "1941 38 75AA".

FUZE: Time fuze of combustion type is fitted.
A brass gaine attached to fuze in distinction
from German system contains detonator.

REMARKS: This projectile is the most common
of a number of types seized by the Germans for

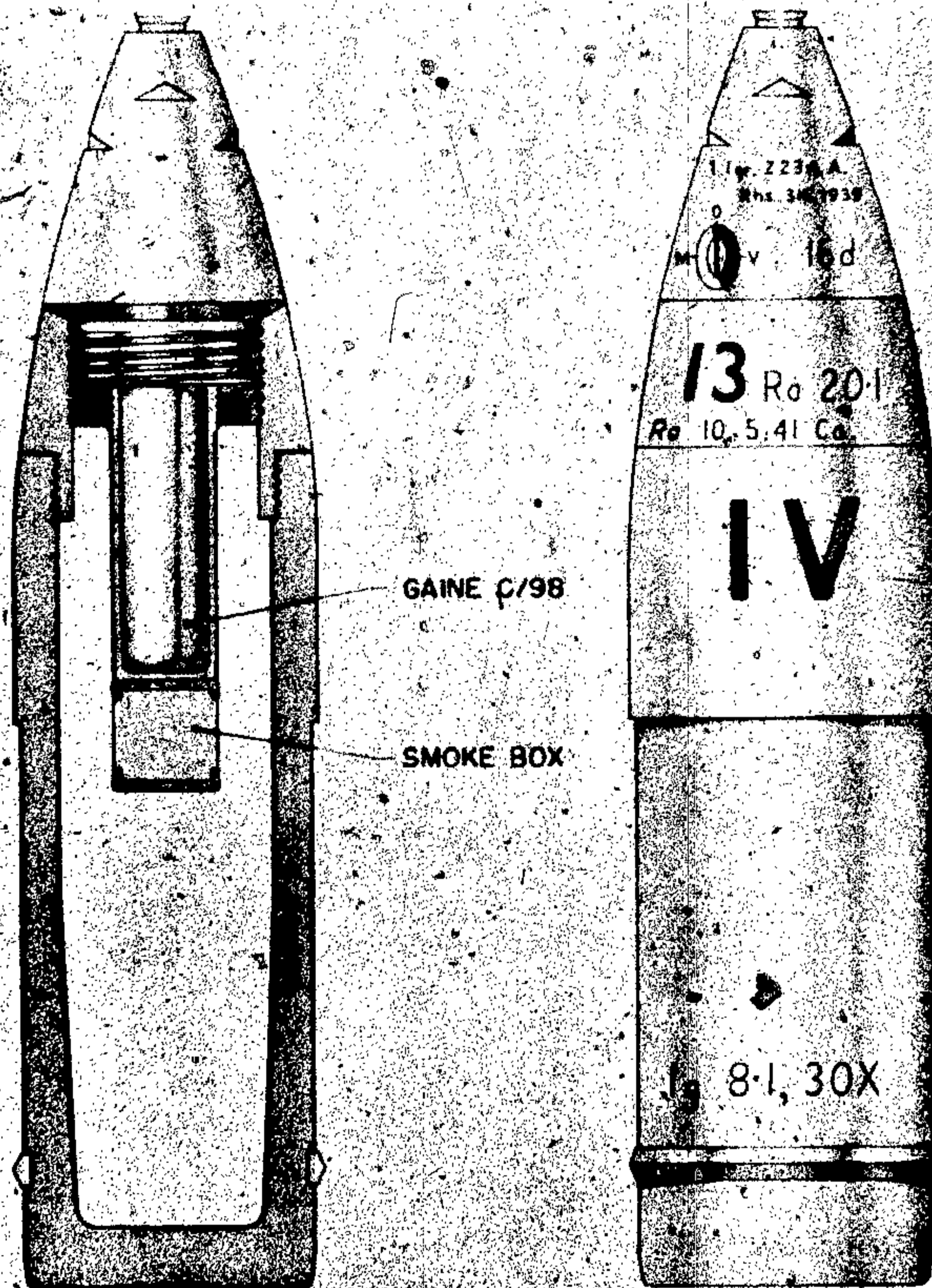

Figure 379—H. E. Projectile for Infantry Gun, 75-mm, 7.5-cm 18 A. Z. 23nA

COLOR: Light gray—dark olive green below rotating band.

REMARKS: Experimental shell, 2 wrench grooves in Ogive. Bimetallic or iron rotating band. 1 row vertical serrations.

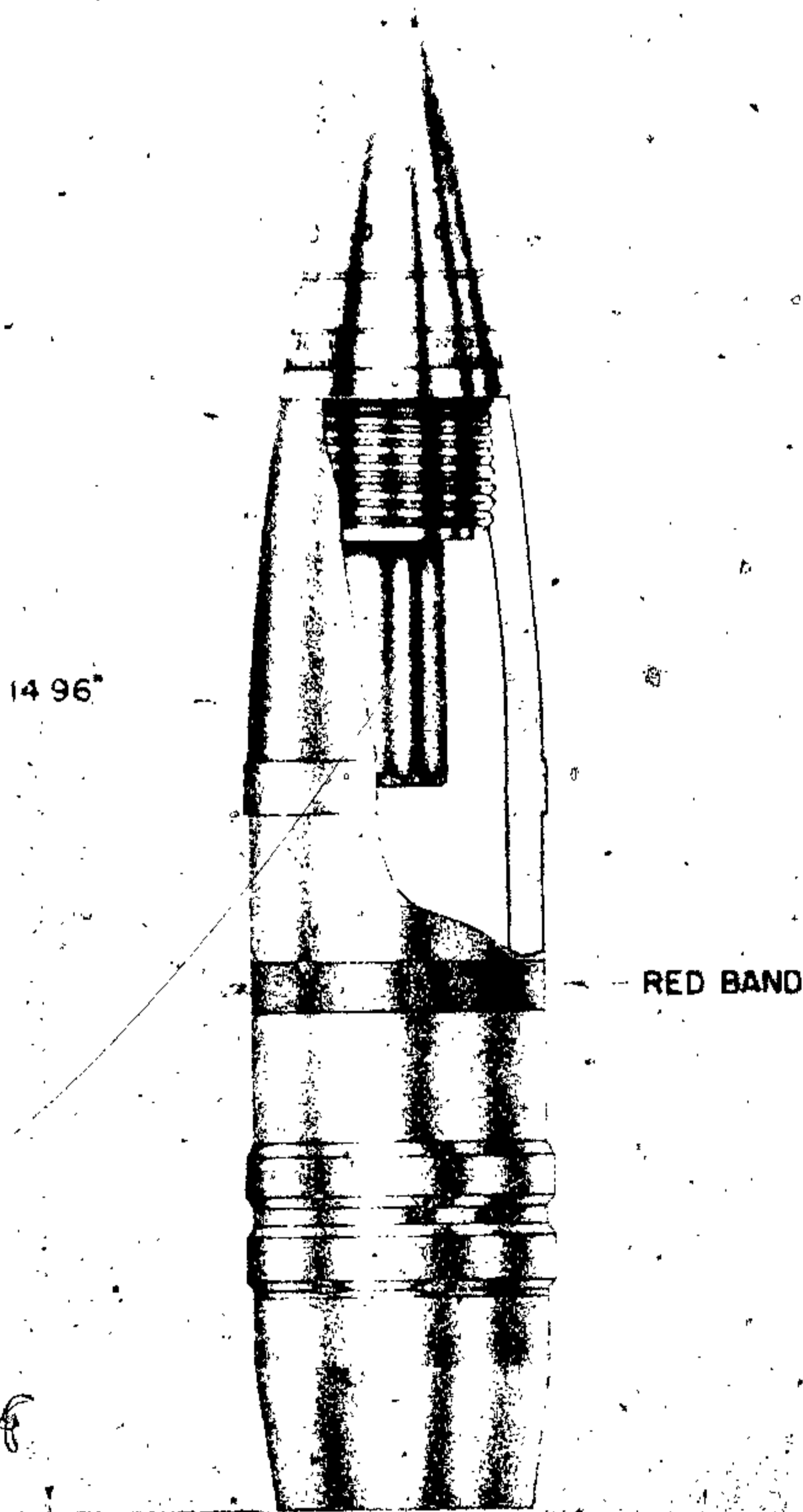

Figure 380—H. E. Projectile for Dual-Purpose Skoda Gun, Sprgr. Patr. 75/50

use in captured French 75/50 dual-purpose guns, of which one authority estimates there may be 20,000 pieces on the Continent.

HOLLOW CHARGE PROJECTILE, TYPE 38, 75-MM

GERMAN NOMENCLATURE: 7.5-cm Gr. 38 HL/A. (See fig. 381.)

WEAPONS: 7.5-cm light field gun 18. 1. F. K. 18.

FUZE: A. Z. 38.

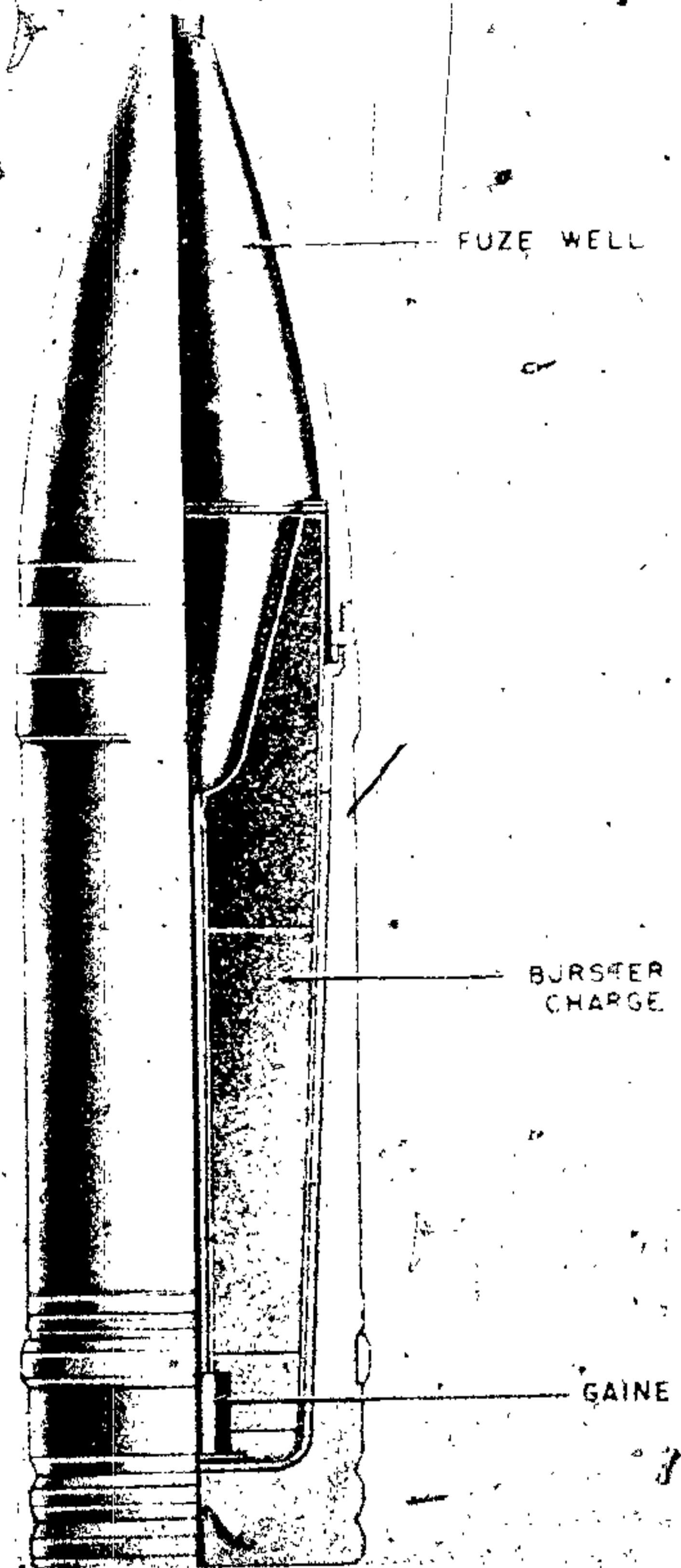

Figure 381—Hollow Charge Projectile, Type 38, 75-mm, 7.5-cm Gr. 38 HL/A.

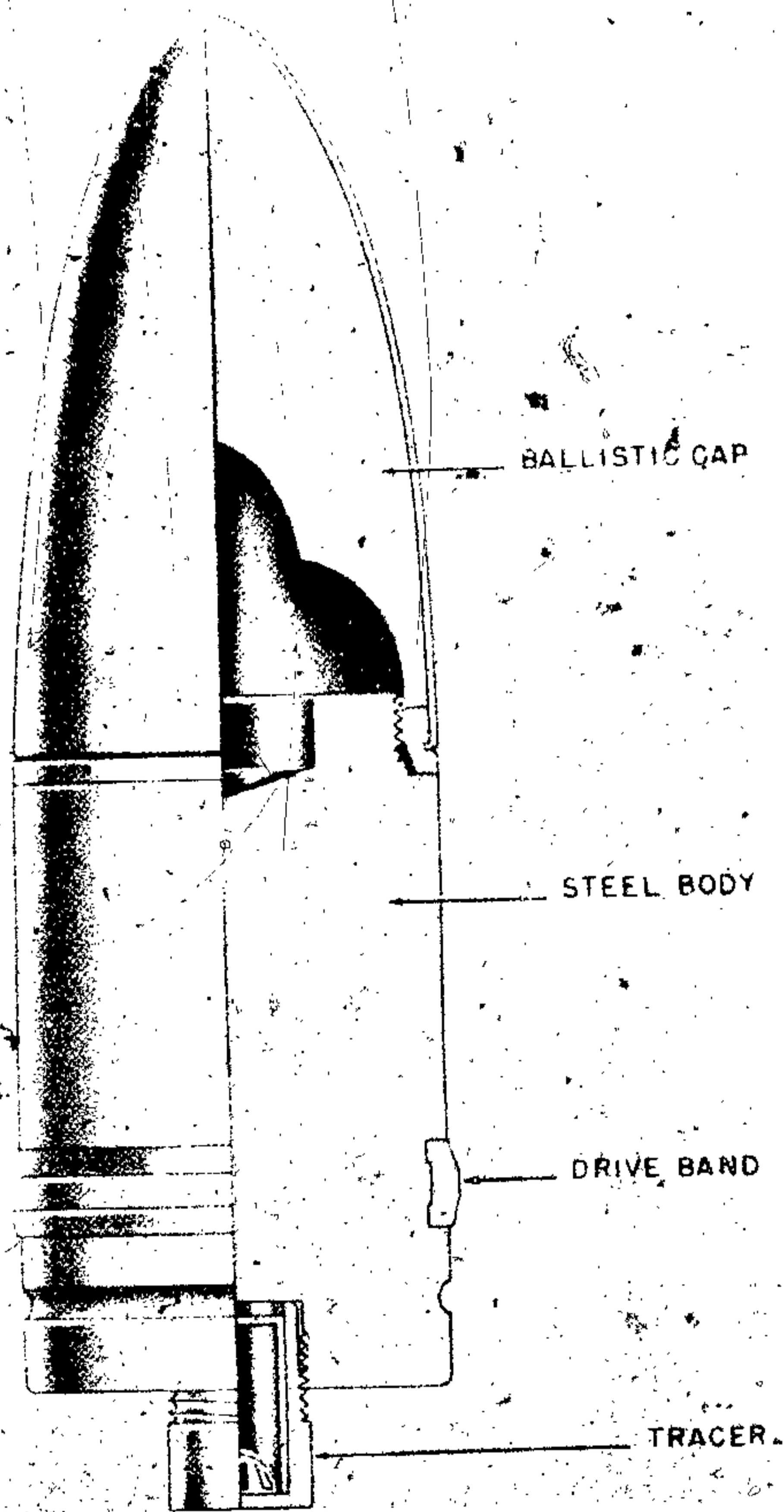

Figure 382—A. P. Projectile 75-mm, 7.5-cm Pzgr. 40 (W) Pack. 40

A. P. PROJECTILE, 75-MM

GERMAN NOMENCLATURE: 7.5-cm Pzgr. 40 (W) Pack. 40 (Panzergranate Patrone 40.) (See fig. 382.)

EMPLOYMENT: Pac. 40 (Panzerabwehr-Kanone 40) Antitank Gun 41.

COMPLETE ROUND: 20.25 pounds total weight.

PROJECTILE, painted black with white W stenciled on body:

9.125 pounds; total weight.
240 mm, total length.

CARTRIDGE CASE, propellant charge:

- (a) An igniter containing 25 gm of the usual German igniter powder.
- (b) 2.25 kg tubular "diglykol" propellant size:
Length: 6.25 mm.
External diameter, 4 mm.
Internal diameter, 1.8 mm.
- (c) A flash reducer containing 35 gm of potassium sulphate.

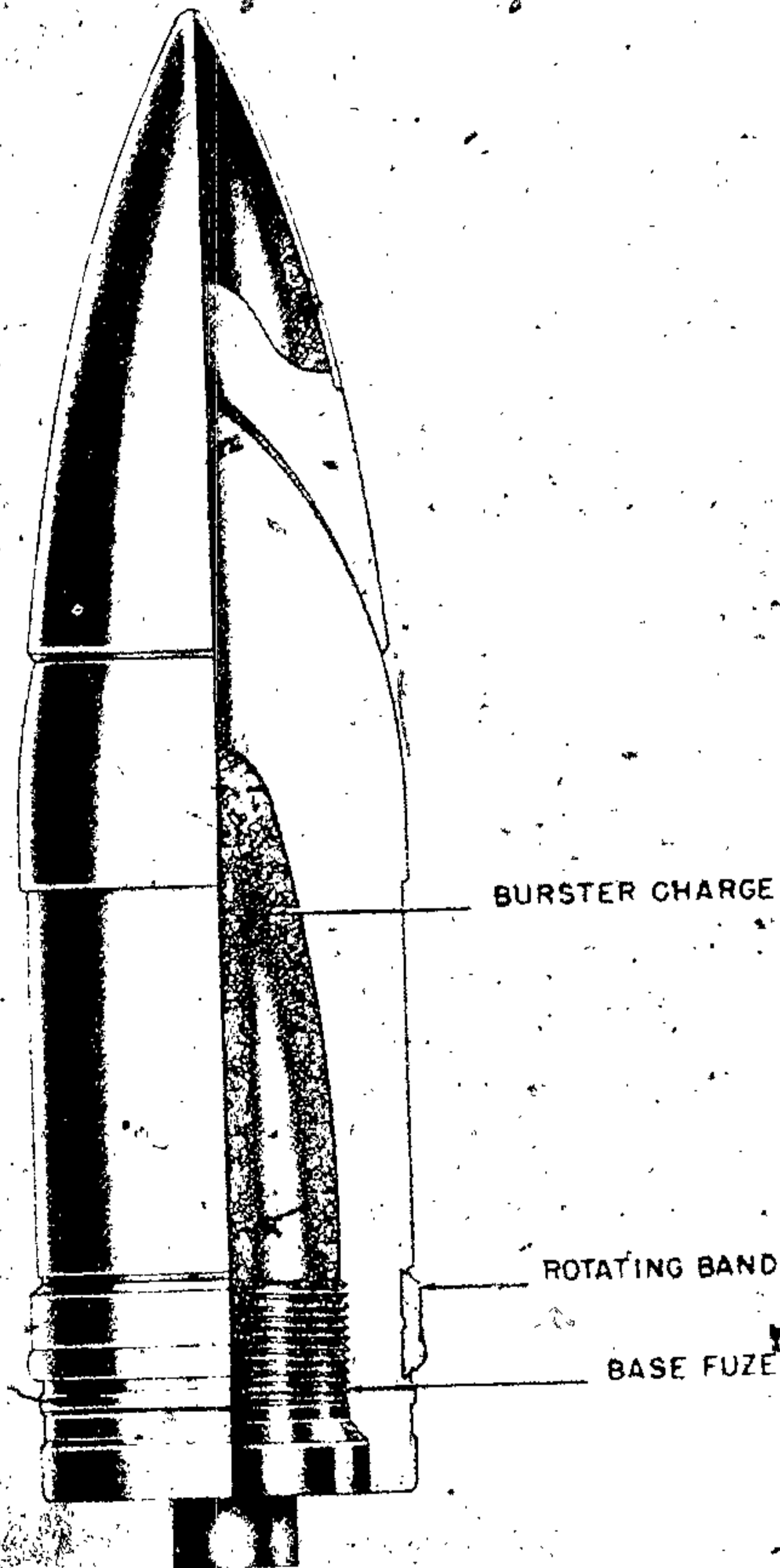

Figure 383—A. P. C. Tank Gun Projectile, 75-mm Pzgr. Patr. (KwK. 38)

APC TANK GUN PROJECTILE, 75-MM

GERMAN NOMENCLATURE: Pzgr. Patr. (KwK 38). Panzergranate Patrone Kampfwagen Kanone. (See fig. 383.)

WEAPONS:

7.5-cm Tank Cannon—KwK. 7.5-cm Assault Gun—Stu. G.

7.5-cm Light Field Cannon 18—I. F. K. 18.

7.5-cm Recoilless Gun for Airborne Troops—L. C. 40.

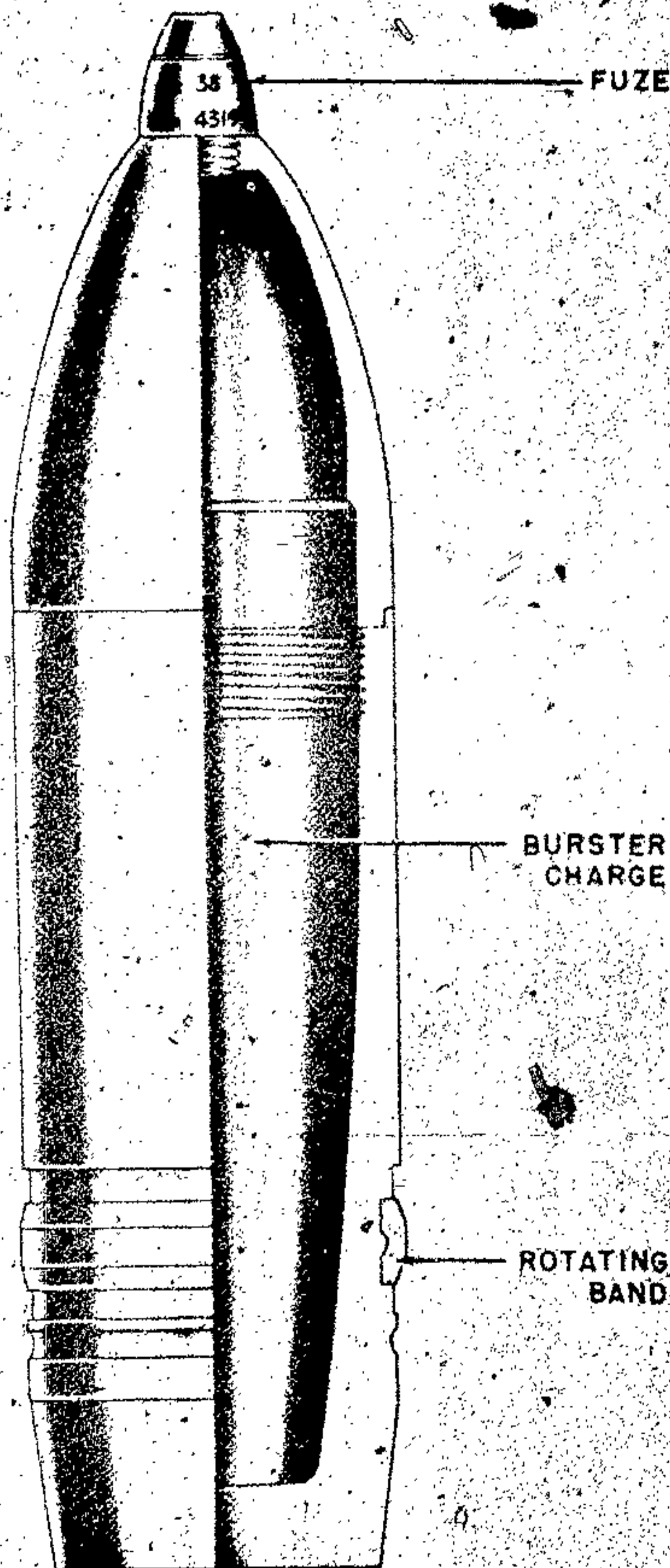

Figure 384—Hollow Charge Projectile for Tank Gun, 75-mm, 7.5-cm Gr. Patr. 38 HL/A KwK.

FUZE: Base fuze Bd. Z. f., 7.5-cm. Pzgr.

COLOR: Black.

WEIGHT: 15.4 pounds.

BURSTING CHARGE: TNT and Petn/wax 2.92 pounds.

REMARKS: One row of vertical serrations.

HOLLOW CHARGE PROJECTILE FOR TANK GUN, 75-MM

GERMAN NOMENCLATURE: 7.5-cm Gr. Patr. 38 HL/A KwK. (See fig. 384.)

WEAPONS:

7.5-cm Tank Cannon 38—KwK. 38.

7.5-cm Tank Cannon 40—KwK. 40.

7.5-cm Light Field Cannon 18 I. F. K. 18.

7.5-cm Mountain Gun 36—Geb. G. 36.

7.5-cm Recoilless Gun for Airborne Troops 40—L. G. 40.

7.5-cm Assault Gun 40—Stu. G. 40.

7.5-cm Antitank Gun 40—Pak. 40.

7.5-cm Field Gun 16 (new type)—F. K. 16.

FUZE: A. Z. 38.

COLOR: Dark olive green.

REMARKS: One vertical row of serrations. Threads: Fuze hole 6. Adaptor hole 11. Iron rotating band. Width of bourrelet 1.36 inches. Gr. Patr. 38 HL/B has same external dimensions as this shell.

H. E. PROJECTILE FOR 75-MM GUN

GERMAN NOMENCLATURE: 7.5-cm. Sprgr. 2432 (h). (See fig. 385.)

WEAPONS:

Dutch field gun: 7.5-cm. F. K. 243 (h), model L 30.

PROJECTILE:

Caliber: 75 mm.

Kind: Shell.

Type: H. E.

Weight: 13.5 pounds. (loaded and fuzed).

Color: Green with black band at rotating band.

CHARGE:

Number: T.

GERMAN EXPLOSIVE ORDNANCE

A. P. C. PROJECTILE FOR 75-MM GUN

GERMAN NOMENCLATURE: 7.5-cm Pzgr. 39 FES. (See fig. 386.)

WEAPONS:

German antitank gun: 7.5-cm Pak 40, 40/1, 40/2, 40/3 (Sf).

German tank gun: 7.5-cm KwK. 40.

German assault gun: 7.5-cm Stu. K. 40 (L/43).

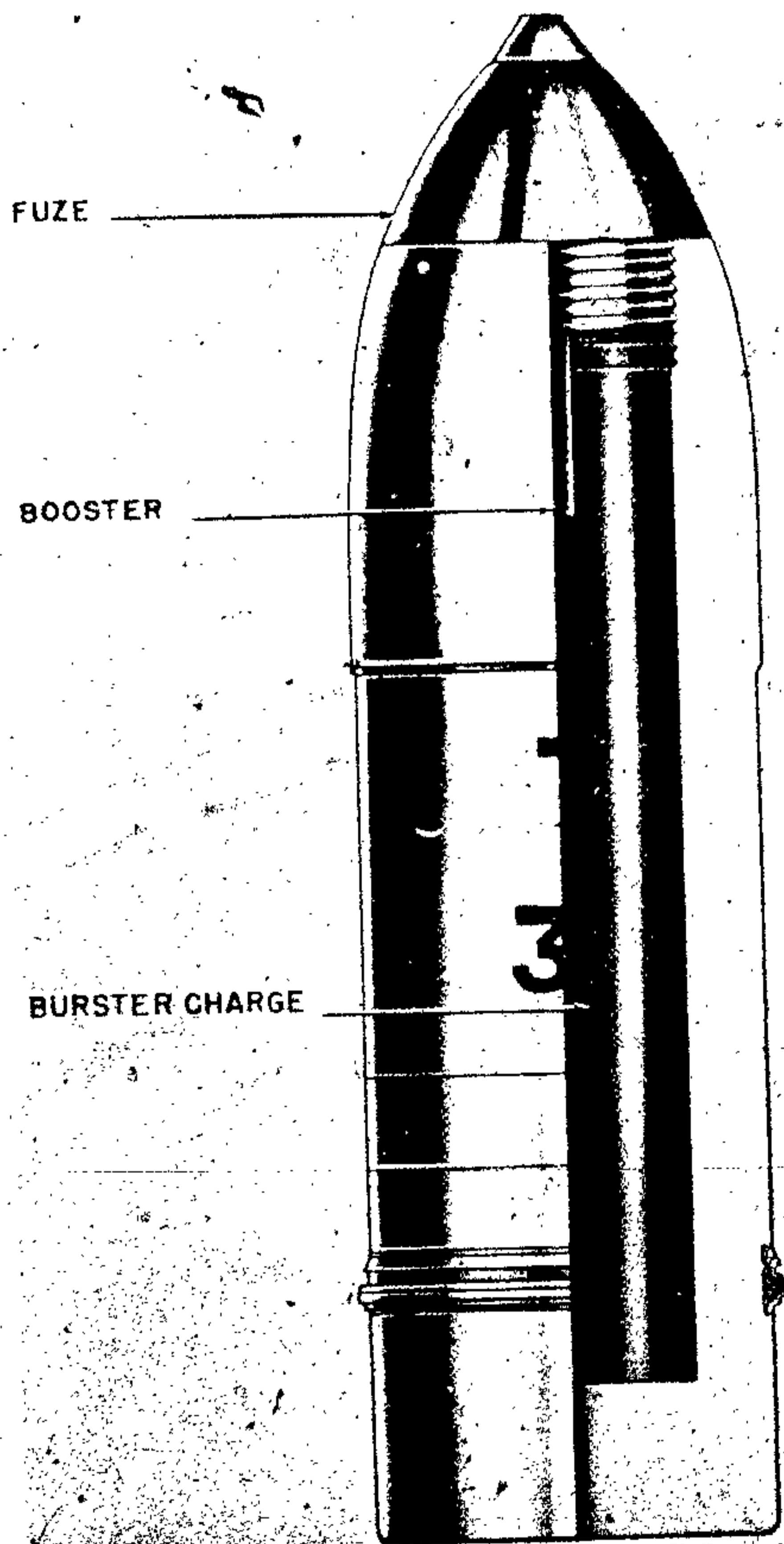

Figure 385—H. E. Shell for 75-mm Gun, 7.5-cm Sprgr. 2432 (h)

Weight: 0.75 pounds.

Kind: TNT.

BOOSTER: Integral with fuze.

FUZE:

Nomenclature: Zunder Nr. 13 28.

Type: P. D.

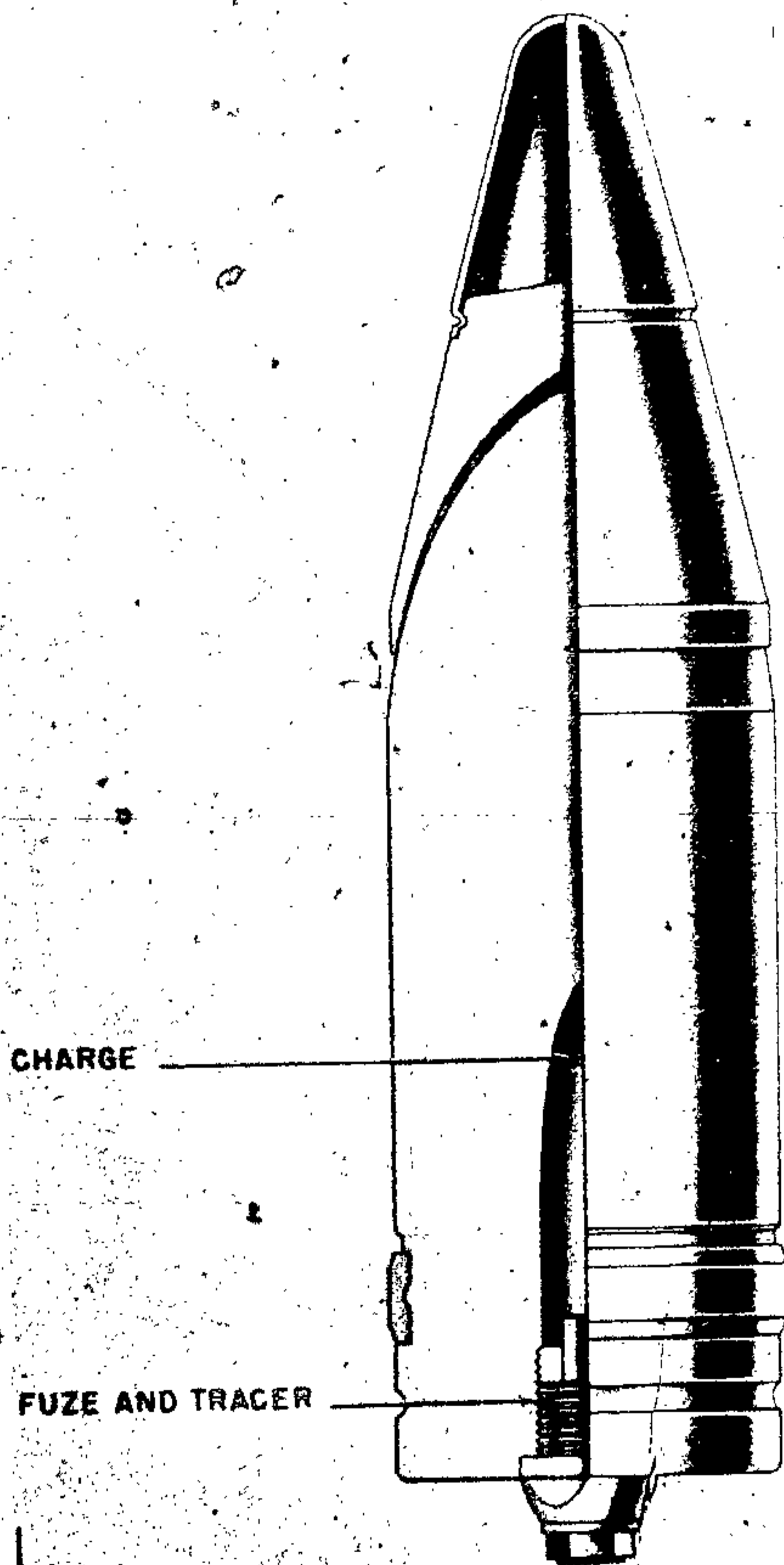

Figure 386—A. P. C. Shell for 75-mm Gun, 7.5-cm Pzgr. 39 FES

PROJECTILE:

Caliber: 75 mm.
 Kind: Shell.
 Type: A. P. C.
 Weight: 15.13 pounds (loaded and fuzed).
 Color: Black with red markings.

CHARGE:

Number: 92.
 Weight: 2.92 ounces.
 Kind: R. D. X./wax (90/10) pressed in blocks—wrapped in wax paper.

TRACER: Nr. 1 in fuze.

BOOSTER: Petn/wax.

FUZE:

Nomenclature: Bd. Z 5103.
 Type: Base.

HOLLOW CHARGE PROJECTILE FOR 75-MM GUN

GERMAN NOMENCLATURE: 7.5-cm Gr. 38
 HL/B. (See fig. 387.)

WEAPONS:

German Antitank Gun: 7.5-cm Pak. 40.
 German Antitank Gun: 7.5-cm Pak. 40/1.
 German Antitank Gun: 7.5-cm. Pak. 40/2.
 German Antitank Gun: 7.5-cm Pak. 40/3 (Sf).
 German Antitank Gun: 7.5-cm KwK. 40.
 German Assault Gun: 7.5-cm Stu. K. 40 (L/43).
 German Assault Gun: 7.5-cm Stu. K. 40 (L/48).
 German Light Airborne Gun (recoilless):
 7.5-cm L. G. 40.

PROJECTILE:

Caliber: 75 mm.
 Kind: Shell.
 Type: Hollow charge.
 Weight: 10 pounds (loaded and fuzed).
 Color: O. D.

CHARGE:

Number: 91.
 Weight: 1.25 pounds.
 Kind: Cyclonite/wax (95/5) pressed in blocks wrapped in waxed paper.

TRACER: None.

BOOSTER: None.

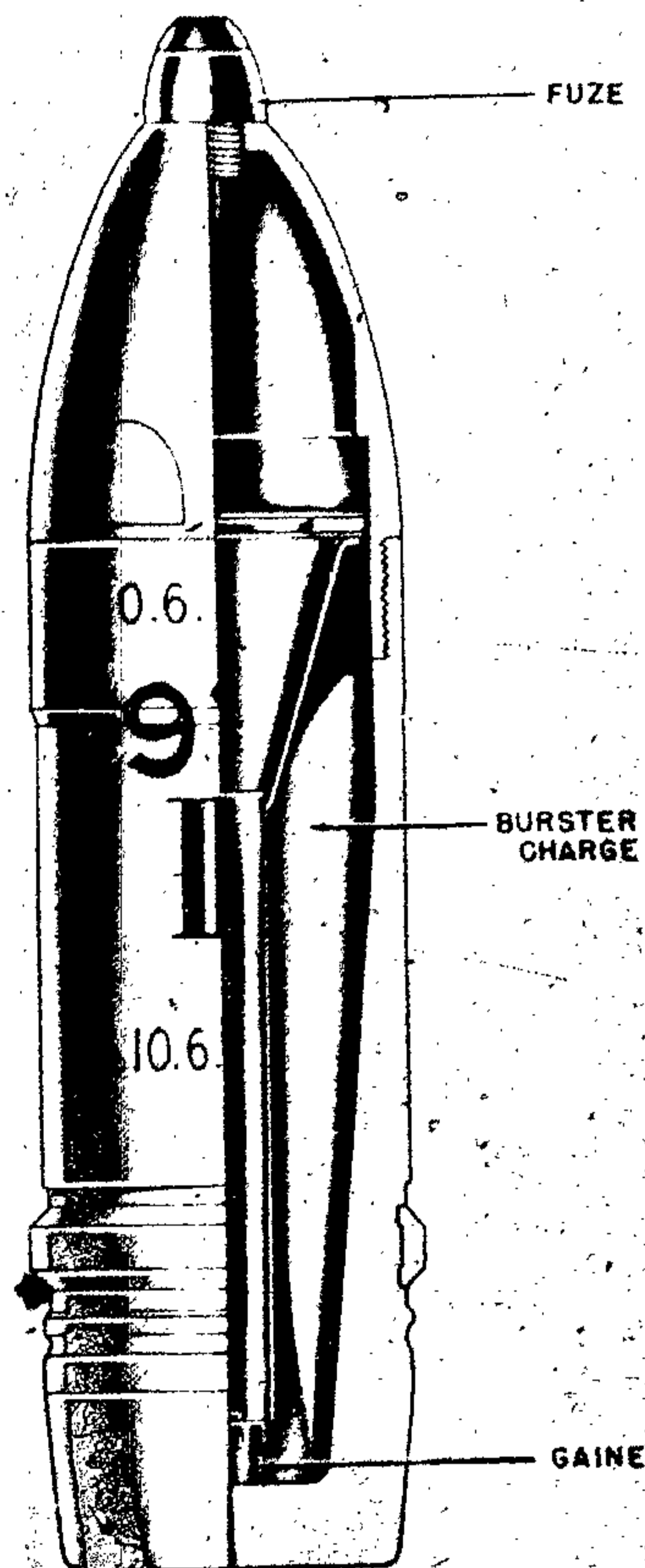

Figure 387—Hollow Charge Shell for 75-mm Gun,
7.5-cm Gr. 38 HL/B.

FUZE:

Nomenclature: A. Z. 38.
 Type: P. D.

H. E. PROJECTILE FOR 75-MM GUN

GERMAN NOMENCLATURE: 7.5-cm Sprgr. 42.
 (See fig. 388.)

WEAPONS:

German Tank Gun: 7.5-cm KwK. 42.
 German Assault Gun: 7.5-cm Stu. K. 42 (L/70).

GERMAN EXPLOSIVE ORDNANCE

TRACER: None.

BOOSTER: wlf. Np. 10.

FUZE:

Nomenclature: Kl. A. Z. 23 (0.15).

Type: P. D.

H. E. PROJECTILE FOR 75-MM HOWITZER

GERMAN NOMENCLATURE 7.5-cm Jgr. 18

FES. (See fig. 389.)

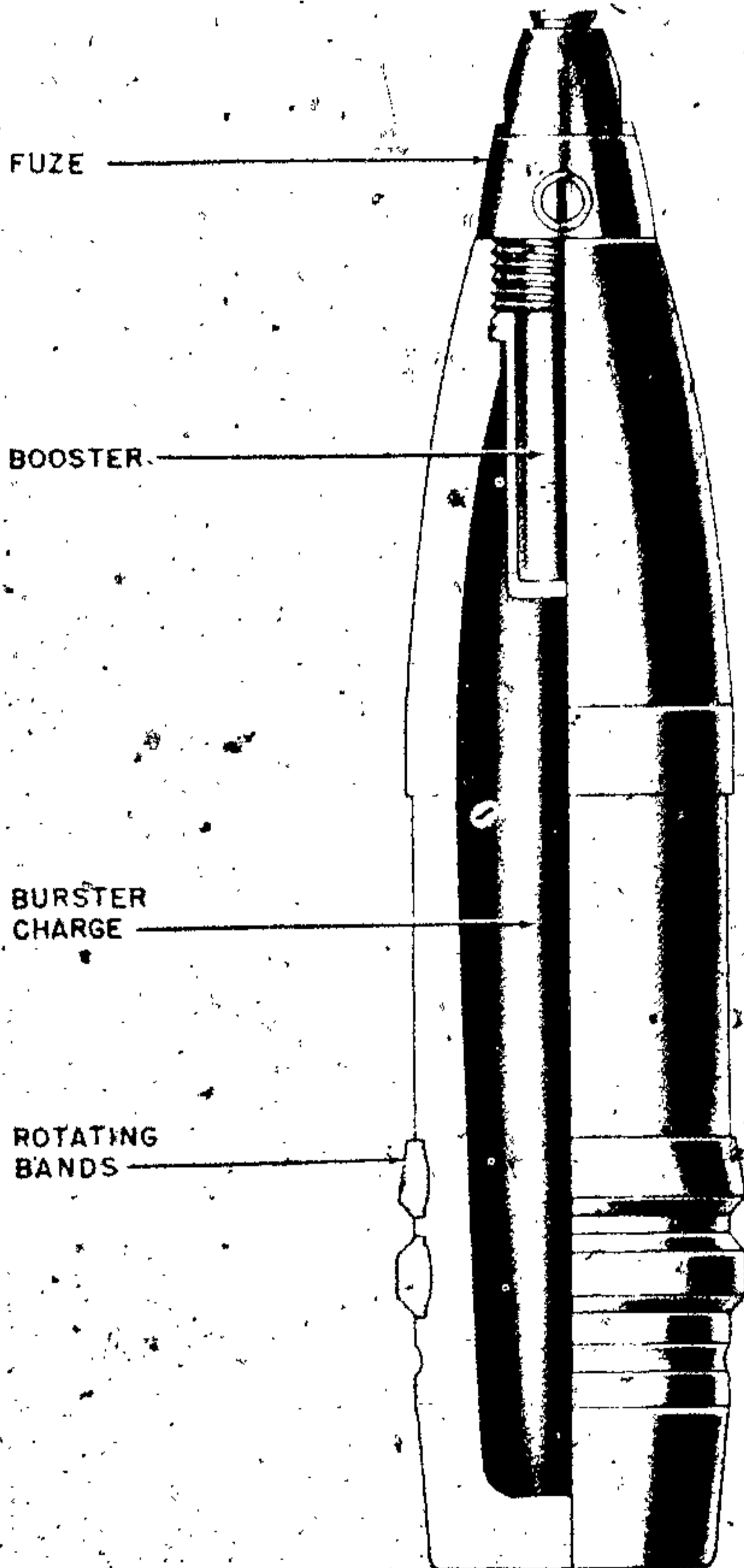

Figure 388—H. E. Shell for 75-mm Gun, 7.5-cm Sprgr. 42

PROJECTILE:

Caliber: 75 mm.

Kind: Shell.

Type: H. E.

Weight: 12.7 pounds (loaded and fuzed).

Color: OD.

CHARGE:

Number: 13.

Weight: 1.44 pounds.

Kind: Amatol 60/40 (poured).

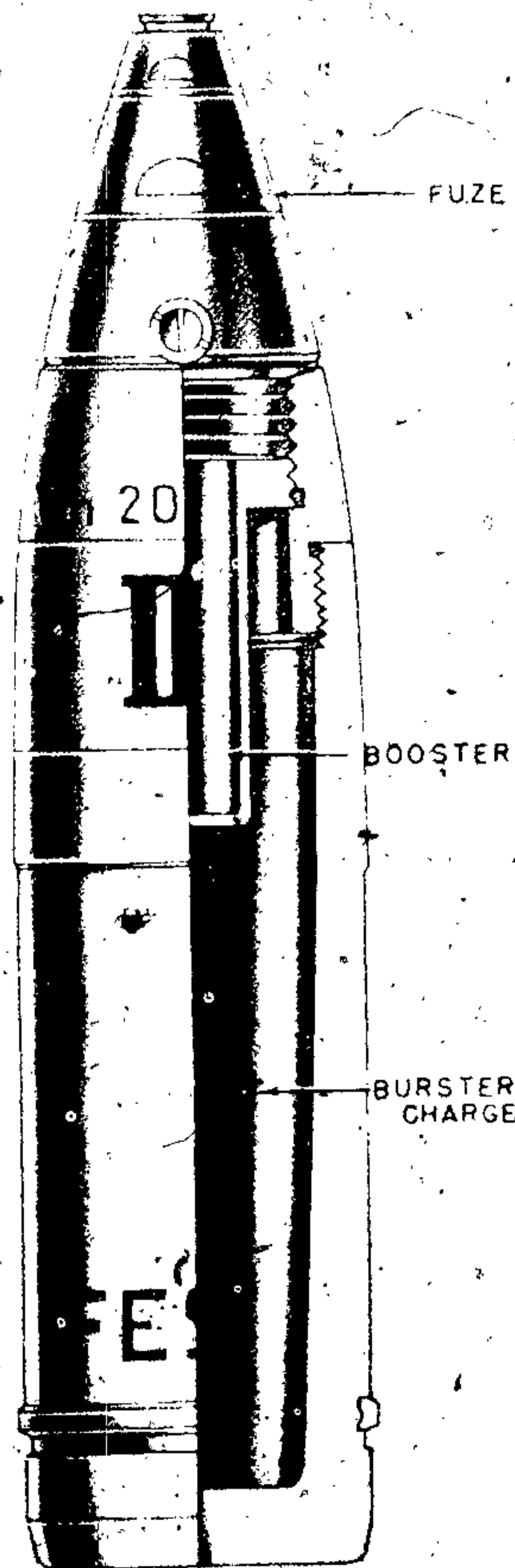

Figure 389—H. E. Shell for Howitzer 75, 7.5-cm Jgr. 18 FES

WEAPONS:

German Light Infantry Howitzer; le J. G. 18.
German Light Infantry Mountain Howitzer;
le Geb. J. G. 18.

PROJECTILE:

Caliber: 75 mm.
Kind: Shell.
Type: H. E.
Weight: 12.03 pounds with fuze I. Jgr. Z. 23 n.
A. (loaded and fuzed) 13.23 pounds, with fuze
I. Jgr. Z. 23.
Color: O. D.

CHARGE:

Number: 14.
Weight: 1.25 pounds.
Kind: TNT poured.

BOOSTER: wlf. NP 10.

FUZE:

Nomenclature: I. Jgr. Z. 23 n. A.; I. Jgr. Z. 23.
Type: F. D.

HOLLOW CHARGE PROJECTILE FOR 75-MM GUN

GERMAN NOMENCLATURE: 7.5-cm Gr. 38
HL/C (h). (See fig. 390.)

WEAPONS:

Dutch field gun: F. K. 243 (h)—holl. L/30.

PROJECTILE:

Caliber: 75 mm.
Kind: Shell.
Type: Hollow charge.
Weight: 11 pounds (loaded and fuzed).
Color: O. D. with white markings.

CHARGE:

Number: 25.
Weight: 2 pounds.
Kind: Cyclonite/wax (60/40) pressed in blocks
wrapped in waxed paper.

TRACER: This round may or may not have a
tracer.

BOOSTER: None.

FUZE:

Nomenclature: A. Z. 38.
Type: P. D.

REMARKS:

NOTE 1.—An "f" is stenciled in white on shell
body. Its meaning is unknown.

H. E. PROJECTILE FOR 75-MM GUN

GERMAN NOMENCLATURE: 7.5-cm Sprgr.
231 (f). (See fig. 391.)

WEAPONS:

French Mountain Gun: 7.5-cm Geb. K. 238 (f)
Model 1928.
French Tank Gun: 7.5-cm KwK. 251 (f)
Model 1935.

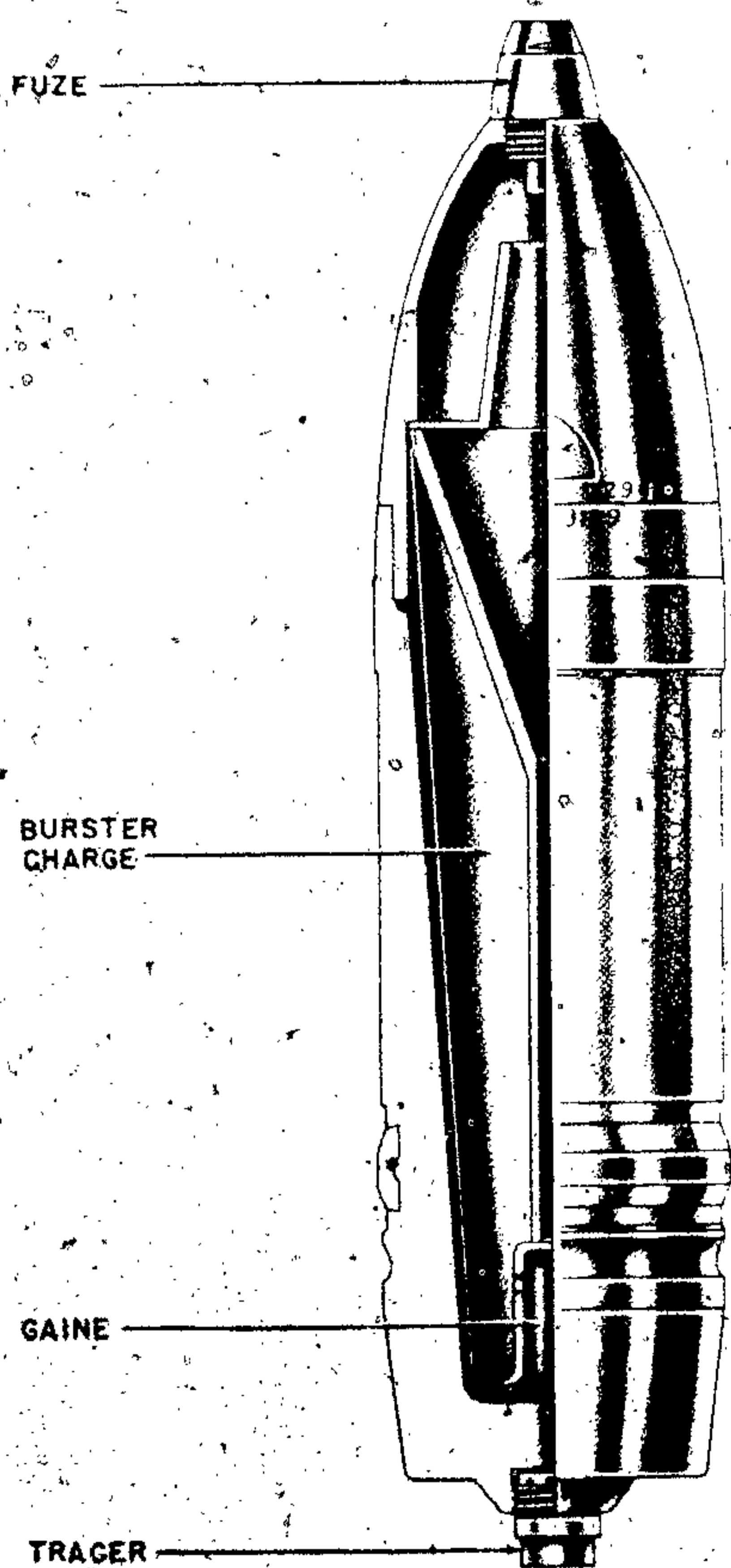

Figure 390—Hollow Charge Shell for 75-mm Gun,
7.5-cm Gr. 38 HL/C (h)

GERMAN EXPLOSIVE ORDNANCE

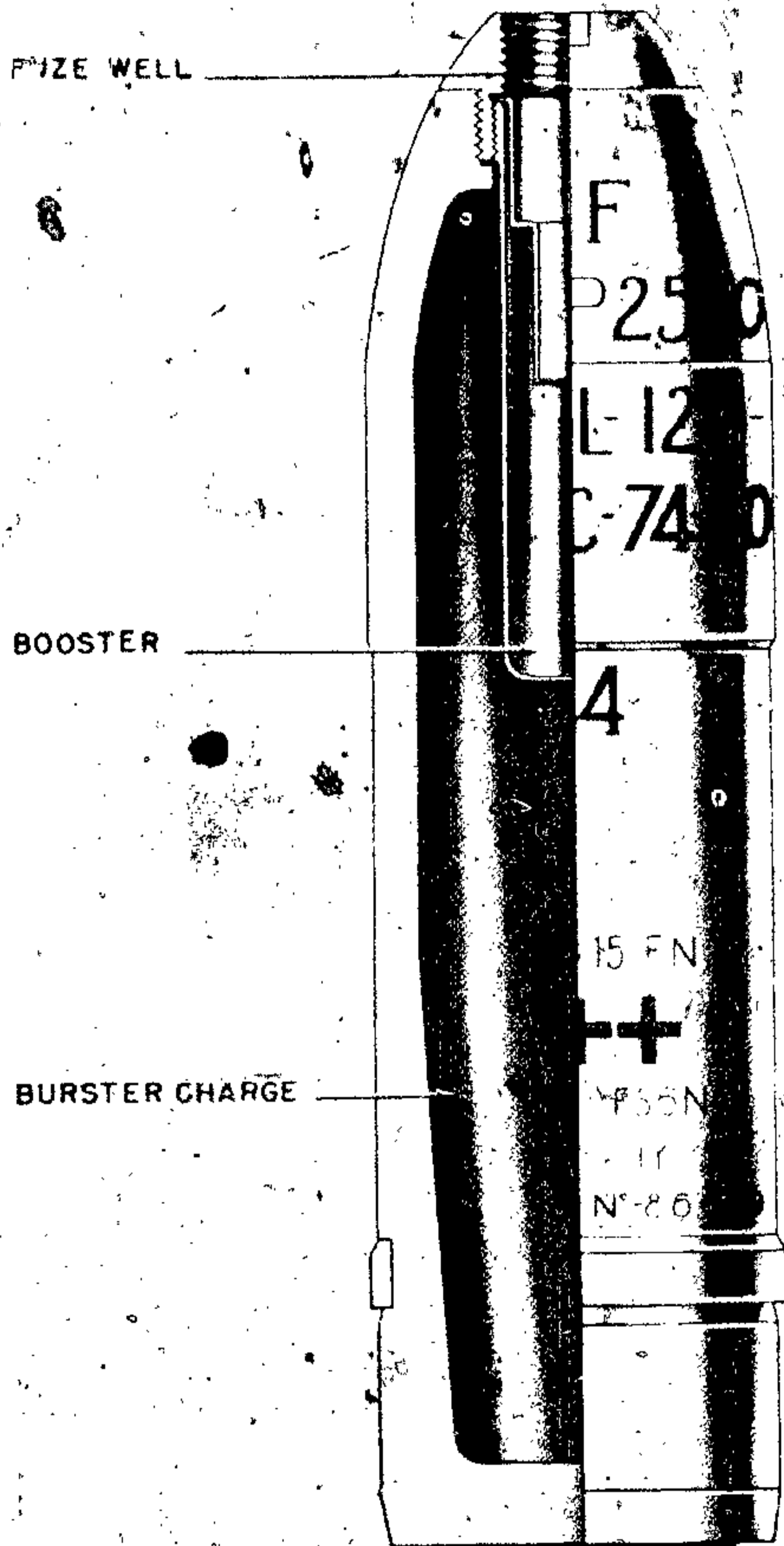

Figure 391—H. E. Shell for 75-mm Gun, 7.5-cm Sprgr. 231 (f)

PROJECTILE:

Caliber: 75 mm.
 Kind: Shell.
 Type: H. E.
 Weight: 12 pounds (loaded and fuzed).
 Color: Yellow.

CHARGE:

Number: MF.
 Weight: 2 pounds.
 Kind: Cast melinite.

TRACER: None.

BOOSTER: Integral with fuze.

FUZE:

Nomenclature:

| GERMAN | FRENCH |
|------------------------------------|-------------------|
| (1) A. Z. 269 (f) o. V. m. Sto. | (1) 24/31 RYG 21. |
| (2) A. Z. 335 (f). | (2) 24/31 99. |
| (3) A. Z. 237 (f). | (3) 24/31 99-08. |

Type: (1) P. D. (2) P. D. (3) P. D.

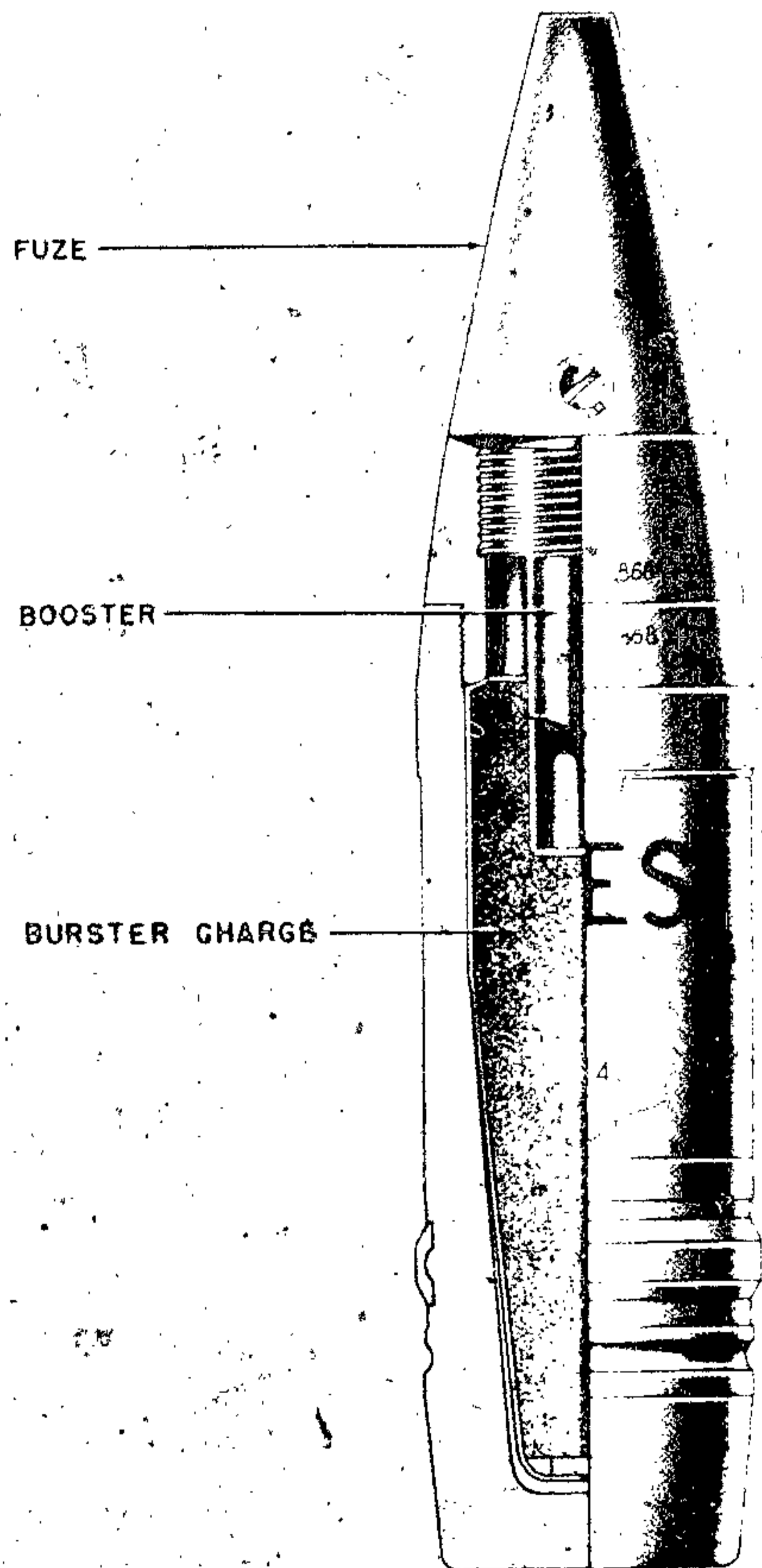

Figure 392—H. E. Shell for 75-mm Field Gun, 7.5-cm K. Gr. Rot FES

H. E. PROJECTILE FOR 75-MM FIELD GUN

GERMAN NOMENCLATURE: K. Gr. Rot FES. (See fig. 392.)

WEAPONS: German Field Gun: 7.5-cm F. K. 38.

PROJECTILE:

Caliber: 75 mm.

Kind: Shell

Type: H. E.

Weight: 12 $\frac{3}{4}$ pounds (loaded and fuzed).

Color: O. D. with red band above rotating band.

CHARGE:

Number: 1b.

Weight: $\frac{3}{4}$ pound.

Kind: TNT pressed in blocks in cardboard container packed with montan wax in a metal container.

TRACER: Nope.

BOOSTER: Gr. Zdlg. C/98 Np.

FUZE:

Nomenclature: Z. Z. 23.

Type: P. D.

HOLLOW CHARGE PROJECTILE FOR 75-MM GUN

GERMAN NOMENCLATURE: 7.5-cm Gr. 15/38 HL/B (f). (See fig. 393.)

WEAPONS:

Belgian Field Gun: 7.5-cm F. K. 234 (b) Model G. P. II.

Jugoslav Field Gun: 7.5-cm F. K. 249 (j) Model 12.

French Field Gun: 7.5-cm F. K. 231 (f) Model 1897.

French Field Gun: 7.5-cm F. K. 232 (f) Model 1897-1933.

German Antitank Gun: 7.5-cm Pak. 97/38.

German Antitank Gun: 7.5-cm Pak. 97/40.

PROJECTILE:

Caliber: 75 mm.

Kind: Shell.

Type: Hollow charge.

Weight: 10.3 pounds (loaded and fuzed).

Color: O. D.

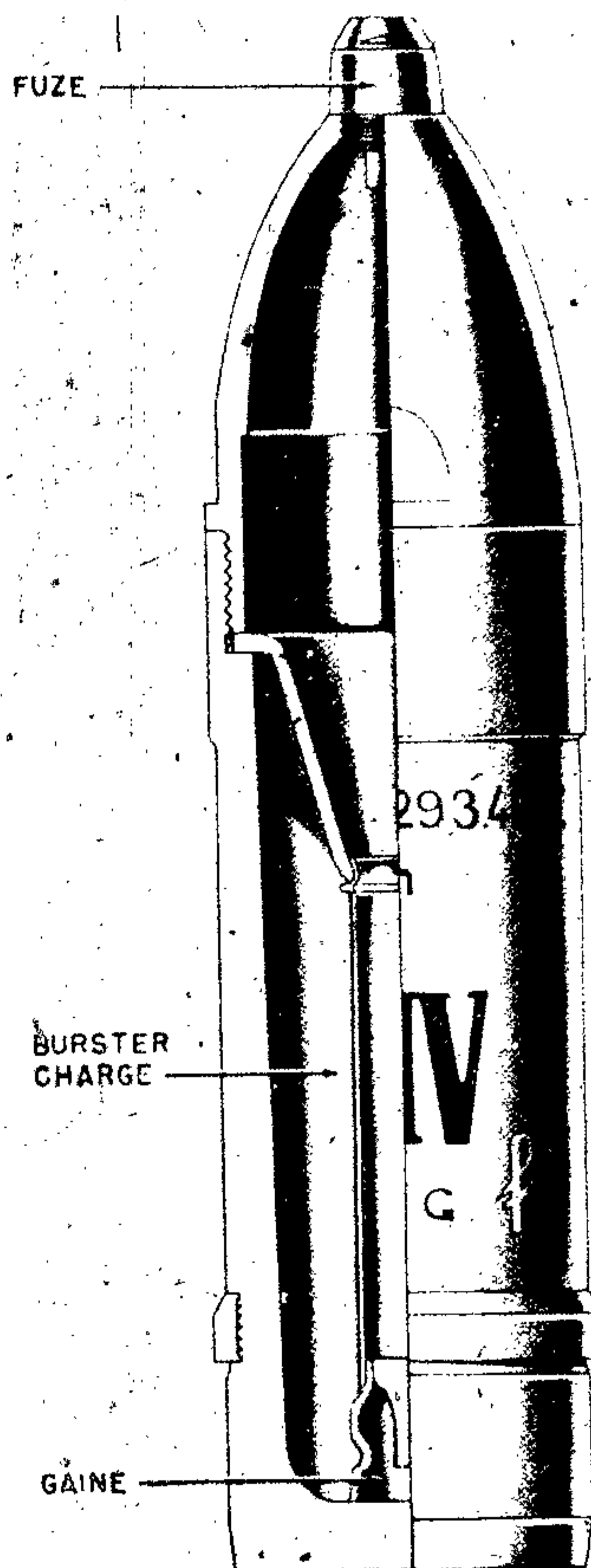

Figure 393—Hollow Charge Shell for 75-mm Gun, 7.5-cm Gr. 15/38 HL/B (f)

CHARGE:

Number: 91.

Weight: 1 pound.

Kind: Cyclonite/wax (95/5) pressed in blocks.

BOOSTER: Integral with fuze.

FUZE:

Nomenclature: A. Z. 38.

Type: P. D.

NOTE 1.—This projectile of German manufacture for use in the weapons listed above.

GERMAN EXPLOSIVE ORDNANCE

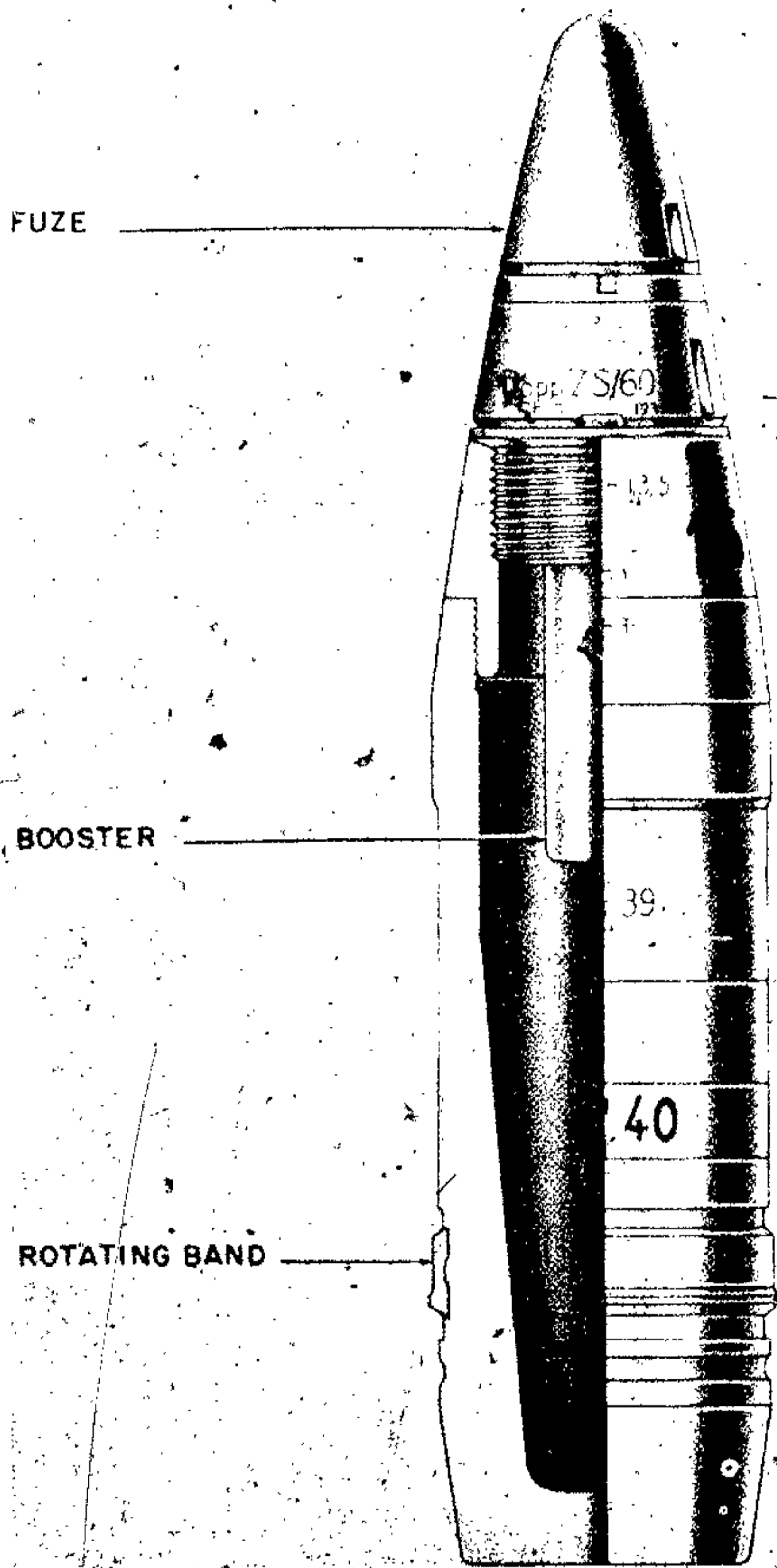

**Figure 394—H. E. Shell for 75-mm Mountain Gun,
7.5-cm K. Gr. Rot Al. Dopp. Z.**

H. E. PROJECTILE FOR 75-MM MOUNTAIN GUN

GERMAN NOMENCLATURE: K. Gr. Rot Al. Dopp. Z. (See fig. 394.)

WEAPONS: German Mountain Gun, Geb. G: 36.

PROJECTILE:

Caliber: 75 mm.
Kind: Shell.
Type: H. E.

Weight: 13¼ pounds (loaded and fuzed).
Color: O. D. with red and yellow bands around body.

CHARGE:

Number: 15.
Weight: 11¼ pounds.
Kind: TNT/Aluminum powder (90/10) poured.

TRACER: None.

BOOSTER: Gr. Zdlg. c/98 Nitropenta:

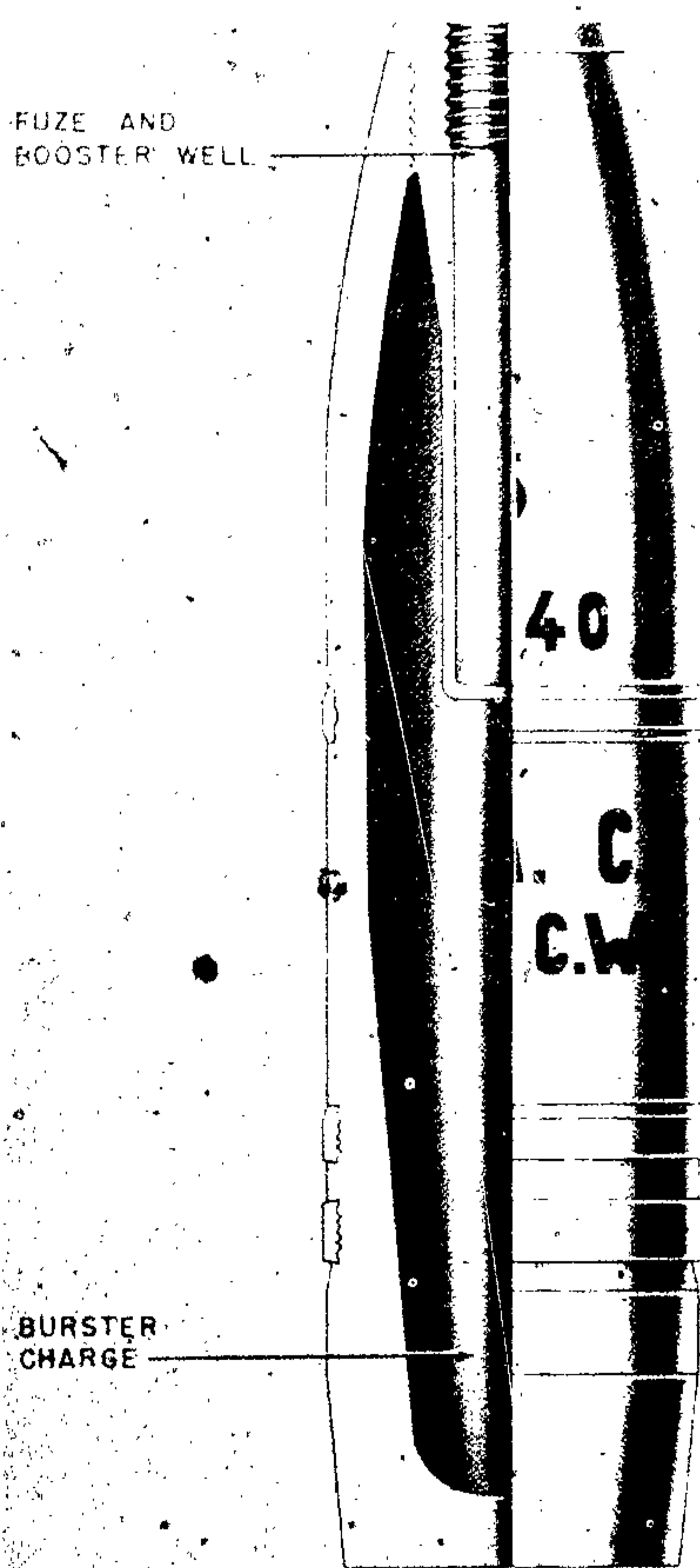

**Figure 395—H. E. Shell for French 75-mm A. A.,
7.5-cm Sprgr. 28 (f)**

FUZE:

Nomenclature: Dopp. Z. S./60s.
Type: T. and P.

REMARKS:

NOTE 1.—R S smoke box contained in shell.
NOTE 2.—KPS rotating band.

H. E. PROJECTILE FOR FRENCH 75-MM A. A. GUN

GERMAN NOMENCLATURE: 7.5-cm Sprgr. 28
(f). (See fig. 395.)

WEAPONS:

French A. A. Gun 7.5-cm Flak M. 36 (f).
French A. A. Gun 7.5-cm Flak M 17/34 (f)—
75-mm sur plateforme Mle 17/34.

PROJECTILE:

Caliber: 75 mm.
Kind: Shell.
Type: H. E.
Color: Yellow with black markings.

CHARGE:

Number: MDN.
Weight: 2 pounds.
Kind: Melinite with dinitronaphthaline added.

TRACER: None.**BOOSTER:** Separate, but unknown.**FUZE:**

Nomenclature: Unknown.
Type: Time.

REMARKS: Upper band at bourrelet.**H. E. PROJECTILE FOR 75-MM GUN**

GERMAN NOMENCLATURE: 7.5-cm Sprgr. 34.
(See fig. 396.)

WEAPONS:

German Assault Gun:
7.5-cm Stu. K. 40 (L/43).
7.5-cm Stu. K. 40 (L/48).
German Tank Gun: 7.5-cm KwK. 40.
German Anti-Tank Gun: 7.5-cm Pak. 40, 40/1,
40/2, 40/3 (Sf).

PROJECTILE:

Caliber: 75 mm.
Kind: Shell.
Type: H. E.
Weight (loaded and fuze) 9¾ pounds.
Color: Shell, O. D.; fuze, machined metal.

FUZE**BOOSTER****BURSTER CHARGE****ROTATING BAND**

Figure 396—H. E. Projectile for 75-mm Gun, 7.5-cm Sprgr. 34

CHARGE:

Number: 13.
Weight: 1 pound.
Kind: Amatol (60/40) poured.

TRACER: None.**BOOSTER:** Zdlg. Np. 10.**FUZE:**

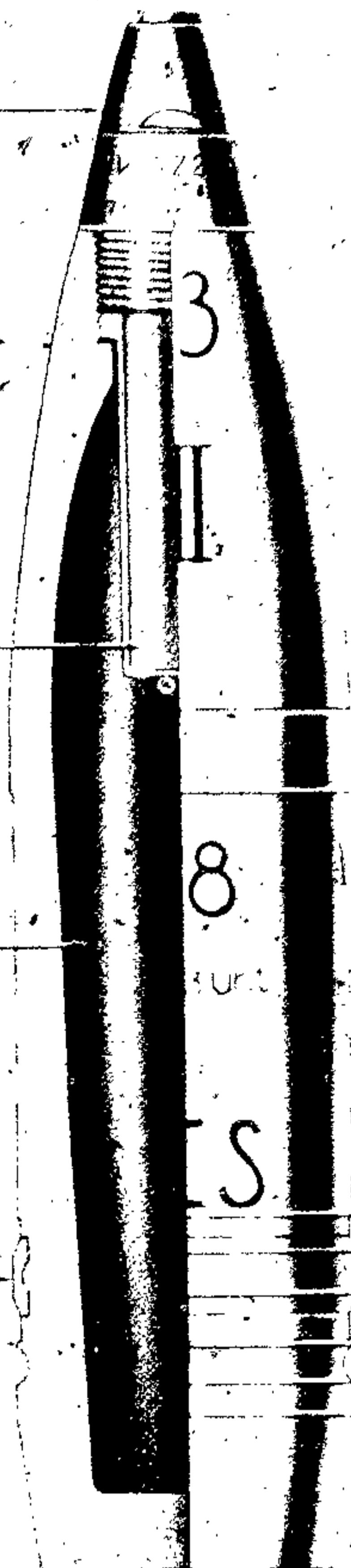
Nomenclature: Kl. A. Z. 23 umg (0.15-second delay).
Type: P. D.

GERMAN EXPLOSIVE ORDNANCE

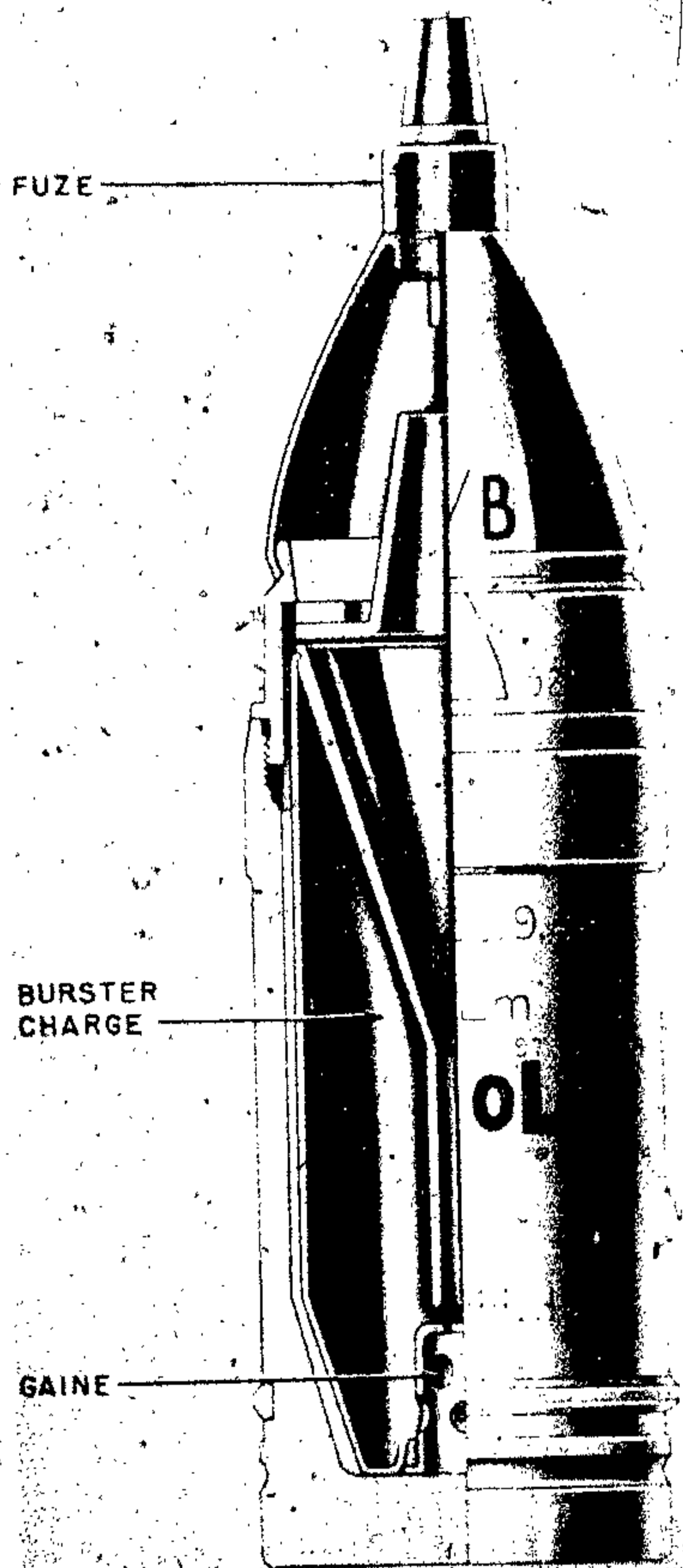

**Figure 397—Hollow Charge Shell for Howitzer
75-mm, 7.5-cm Jgr. 38 HL/B**

**HOLLOW CHARGE PROJECTILE FOR 75-MM
LIGHT INFANTRY HOWITZER**

GERMAN NOMENCLATURE: 7.5-cm Jgr. 38
HL/B. (See fig. 397.)

WEAPONS. German Light Infantry Howitzer—
1e J. G. 18. German Mountain Infantry How-
itzer—1e. Geb. J. G. 18.

PROJECTILE:

Caliber: 75 mm.
Kind: Shell.

Type: Hollow charge.
Weight (loaded and fuzed): 7½ pounds.
Color: O. D.

CHARGE:

Number: 97.
Weight: 1 pound.
Kind: Unknown (believed to be a cyclonite/wax
mixture).

TRACER: None.

BOOSTER: None.

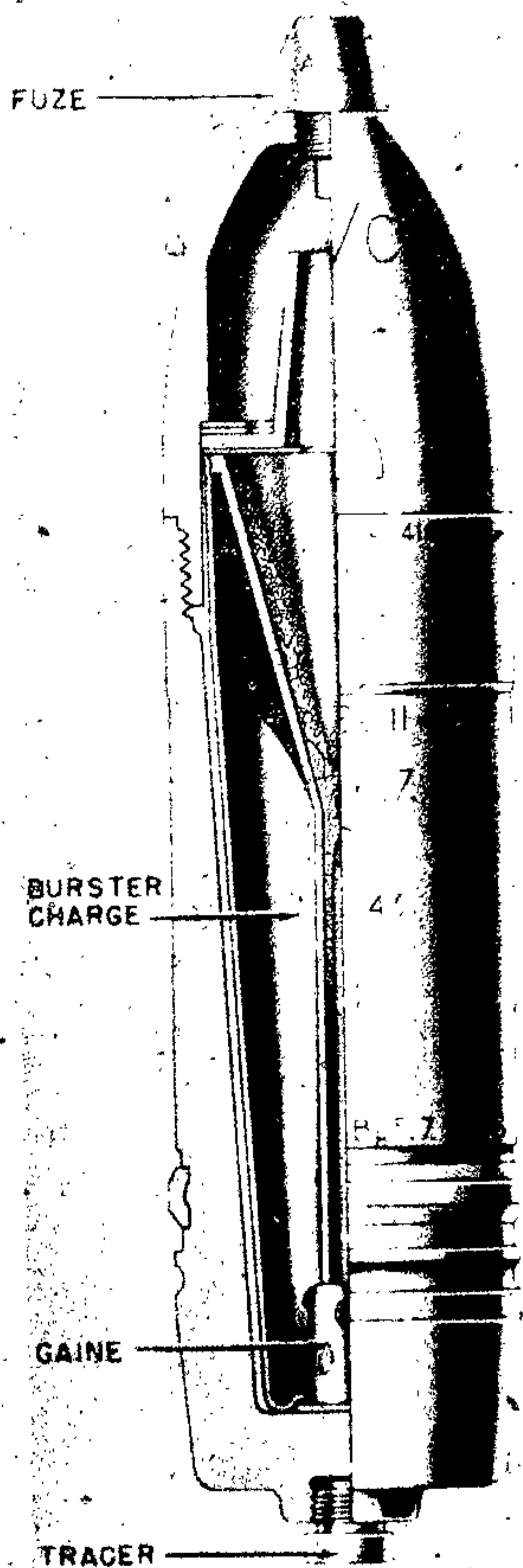

**Figure 398—Hollow Charge Projectile 75-mm,
7.5-cm Gr. 38/97 H1/C (f)**

FUZE:

Nomenclature: A. Z. 38 St.

Type: P. D.

REMARKS:

Note 1.—The A. Z. 38 St. Fuze is essentially the same as the standard A. Z. 38, except that a steel body has replaced the older aluminum one.

HOLLOW CHARGE PROJECTILE FOR 75-MM GUN

GERMAN NOMENCLATURE: 7.5-cm Gr. 38/97
H1/c (f). (See fig. 398.)

WEAPONS:

French Field Gun:

7.5-cm F. K. 231 (f) M1e 1897 ("97").

7.5-cm K. 232 (f) M1e 1897-1933.

Belgian Field Gun:

7.5-cm F. K. 234 (b) G. P. H. II.

7.5-cm F. K. 296 (b) 16 G. P. III.

German Antitank Guns: 7.5-cm Pak. 97/38,
97/40.

Polish Field Gun:

7.5-cm F. K. 97 (p) Model 97 (French "97").

7.5-cm F. K. 02/26 (p) Model 02/26.

Jugoslav Field Gun: 7.5-cm F. K. 249 (j) Model
12 (Schneider).**PROJECTILE:**

Caliber: 75 mm.

Kind: Projectile.

Type: Hollow charge.

CHARGE:

Number: 97.

Weight: ¾ pound.

Kind: Unknown (believed to be a cyclonite/wax
mixture).

TRACER: Yes, no markings.

BOOSTER: None.

FUZE:

Nomenclature: A. Z. 38.

Type: P. D.

H. E. PROJECTILE FOR 75-MM GUN

GERMAN NOMENCLATURE: 7.5-cm Sprgr.
231/1 (f). (See fig. 399.)

FUZE AND
BOOSTER WELL

BURSTER CHARGE

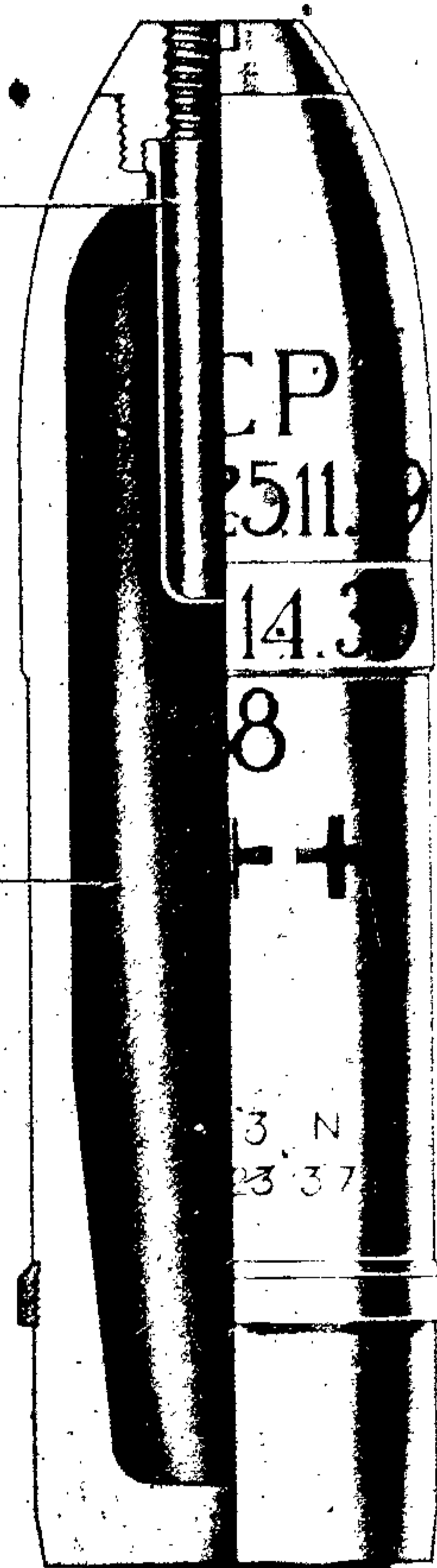

Figure 399—H. E. Shell for 75-mm Gun, 7.5-cm
Sprgr. 231/1 (f) iii

WEAPONS:

French Field Guns:

| GERMAN NOMENCLATURE | ORIGINAL MODEL |
|---------------------------|-------------------|
| (7.5-cm F. K. 231 (f). | Model 1897. |
| (7.5-cm F. K. 232 (f). | Model 1897-1933. |

PROJECTILE:

Caliber: 75 mm.

GERMAN EXPLOSIVE ORDNANCE

Kind: Shell.
 Type: H. E.
 Weight (loaded and fuzed): 12½ pounds.
 Color: Yellow.

CHARGE:

Number: M. C. P.
 Weight: 1½ pounds.
 Kind: Pressed melinite.

TRACER: None.

BOOSTER: Integral with fuze.

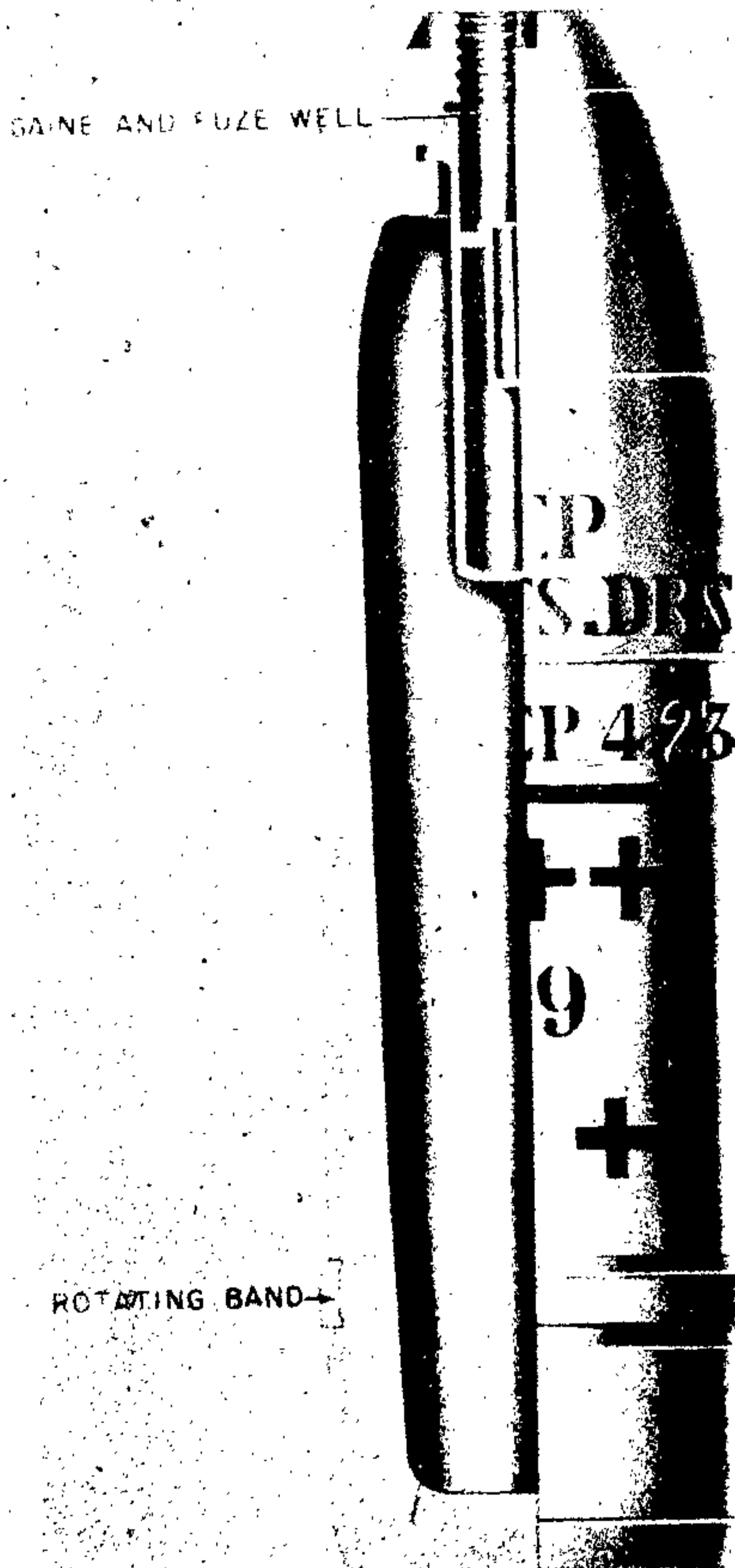

Figure 400—H. E. Shell for 75-mm Gun, 7.5-cm Sprgr. 1900/15 (f)

H. E. PROJECTILE FOR 75-MM GUN

GERMAN NOMENCLATURE: 7.5-cm Sprgr. 1900/15 (f) (See fig. 400.)

WEAPONS:

| NOMENCLATURE | MODEL |
|---|-----------------|
| French Field Gun: | |
| 7.5-cm F. K. 231 (f) | Model 97 97/3. |
| 232 (f) | |
| Polish Field Gun (also on A. A. mount): | |
| 7.5-cm F. K. 97 (p) | Model 97 (fr.) |
| Polish Field Gun: | |
| 7.5-cm F. K. 02/26 | Model 02/06 (p) |
| Belgian Field Gun: | |
| 7.5-cm F. K. 234 (b) | Model GP II |
| Belgian Field Gun: | |
| 7.5-cm F. K. 236 (b) | Model 16 GP II |
| Jugoslav Field Gun: | |
| 7.5-cm F. K. 249 (j) | Model 12 |
| German Antitank Gun: | |
| 7.5-cm Pak. 97/38 | |
| 7.5-cm Pak. 97/40. | |

PROJECTILE:

Caliber: 75 mm.
 Kind: Projectile.
 Type: H. E.
 Weight (loaded and fuzed) 12 pounds.
 Color: Brick-red body, yellow ogive.

CHARGE:

Number: S. C. P.
 Weight: 1½ pounds.
 Kind: TNT with pressed pellet of ammonium nitrate and dinitro naphthalene.

TRACER: None.

BOOSTER: Integral with fuze.

FUZE:

Designation:

| | NOMENCLATURE | |
|-----|------------------------------------|--------------------------------|
| | GERMAN | FRENCH |
| (1) | A. Z. 229 (f) o. V. | frz 24/31 Schn 16 B SR |
| (2) | A. Z. 235 (f) | frz 24/31 99 |
| (3) | A. Z. 237 (f) | frz 24/31 99/08 |
| (4) | A. Z. 245 (f) | frz 24/31 TCAL 17 |
| (5) | A. Z. 247 (f) | frz 24/31 TCAL 18 |
| (6) | A. Z. 251 (f) o. V. | frz 24/31 RYG 18J |
| (7) | A. Z. 253 (f) kz. V. | frz 24/31 RYG 18, CR |
| (8) | A. Z. 259 (f) o. V. (m. verst. F.) | frz 24/31 RY 17. SR (a. r. r.) |

| GERMAN | FRENCH |
|------------------------------|----------------------|
| (9) A. Z. 261 (f) | frz 24/31 JAL 16 |
| (10) A. Z. 277 (f) kz. V. | frz 24/31 TCAL 26 CR |
| (11) A. Z. 281 (f) o. V. | frz 24/31 TCAL 26 3 |
| (12) Zt. Z. 415 (f) | frz 24/31 15 |
| (13) Zt. Z. 416 (f) | frz 24/31 A 16 |
| (14) Dopp. Z. 448 (f) | frz 24/31 16 |
| (15) Dopp. Z. 449 (f) | frz 24/31 A 18 |

Type:

| | |
|-----------|--------------|
| (1) P. D. | (9) P. D. |
| (2) P. D. | (10) P. D. |
| (3) P. D. | (11) P. D. |
| (4) P. D. | (12) Time |
| (5) P. D. | (13) Time |
| (6) P. D. | (14) T. & P. |
| (7) P. D. | (15) T. & P. |
| (8) P. D. | |

Weight (loaded and fuzed): 11 pounds.

Color: O. D.

H. E. PROJECTILE FOR 75-MM GUNGERMAN NOMENCLATURE: k. Gr. rot KPS.
(See fig. 401.)

WEAPONS:

German Field Gun (new model): F. K. 16 n/A.

German Field Gun: F. K. 16/1.

Dutch Field Gun: 7.5-cm F. K. 243 (h) L30.

German Light Field Gun: k. F. K. 18.

PROJECTILE:

Caliber: 75 mm.

Kind: Projectile.

Type: H. E.

Weight (loaded and fuzed): 15 pounds.

Color: Dark O. D. with yellow and red bands
around shell body.

CHARGE:

Number: 14.

Weight: 1 pound.

Kind: TNT poured.

TRACER: None.

BOOSTER: Gr. Zdlg. C/98 Nitropenta.

FUZE:

Nomenclature: Dopp. Z. S/60. A. Z. 23 (0.15).

Type: T. and P.; P. and D.

H. E. PROJECTILE FOR 75-MM GUNGERMAN NOMENCLATURE: 7.5-cm Sprgr.
240/2 (b). (See fig. 402.)WEAPONS: Belgian Field Gun: 7.5-cm F. K.
235 (b) belg 06 TR.

PROJECTILE:

Caliber: 75 mm.

Kind: Projectile.

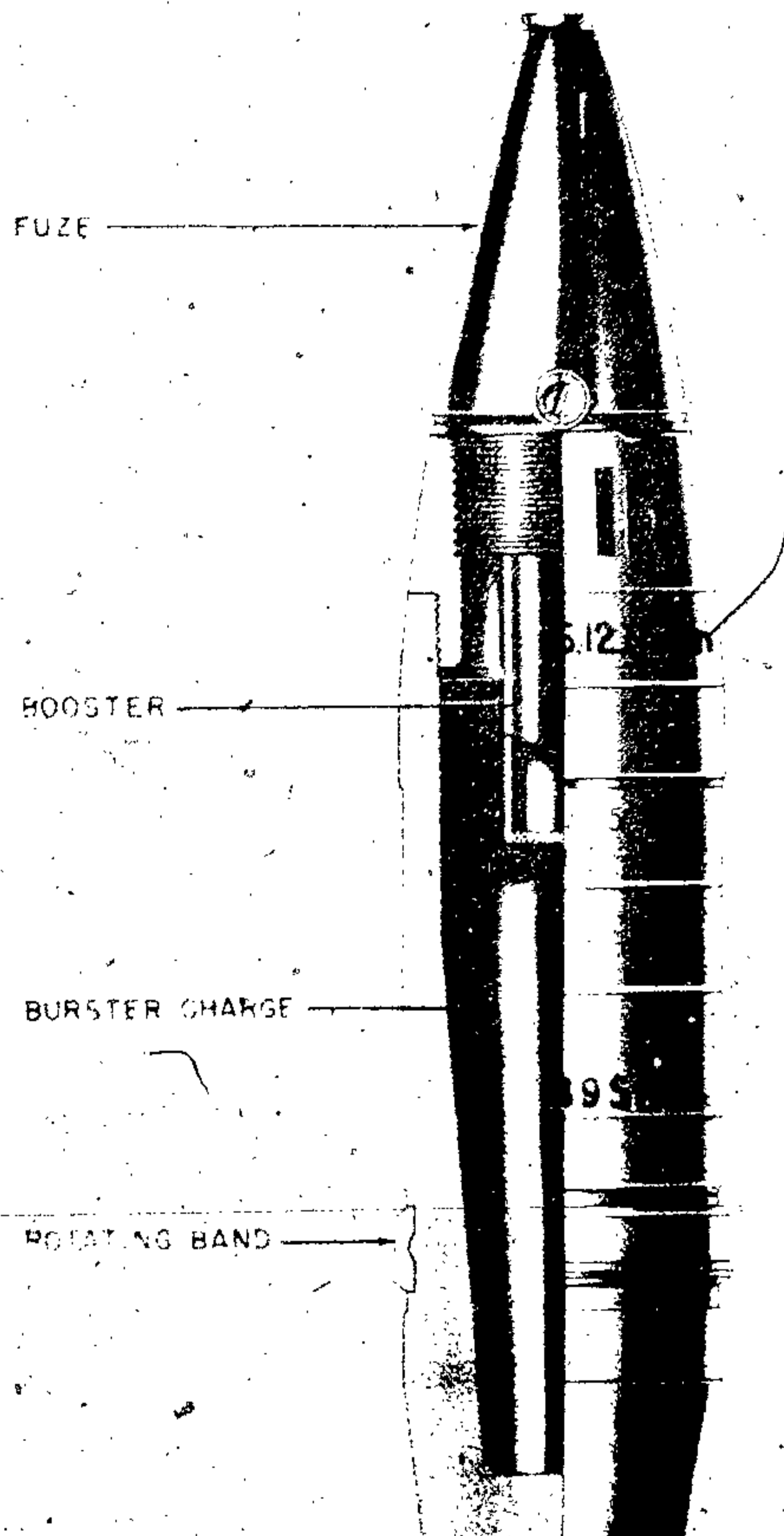
Figure 401—H. E. Projectile, 75-mm, 7.5-cm. K. Gr.
Rot KPS

GERMAN EXPLOSIVE ORDNANCE

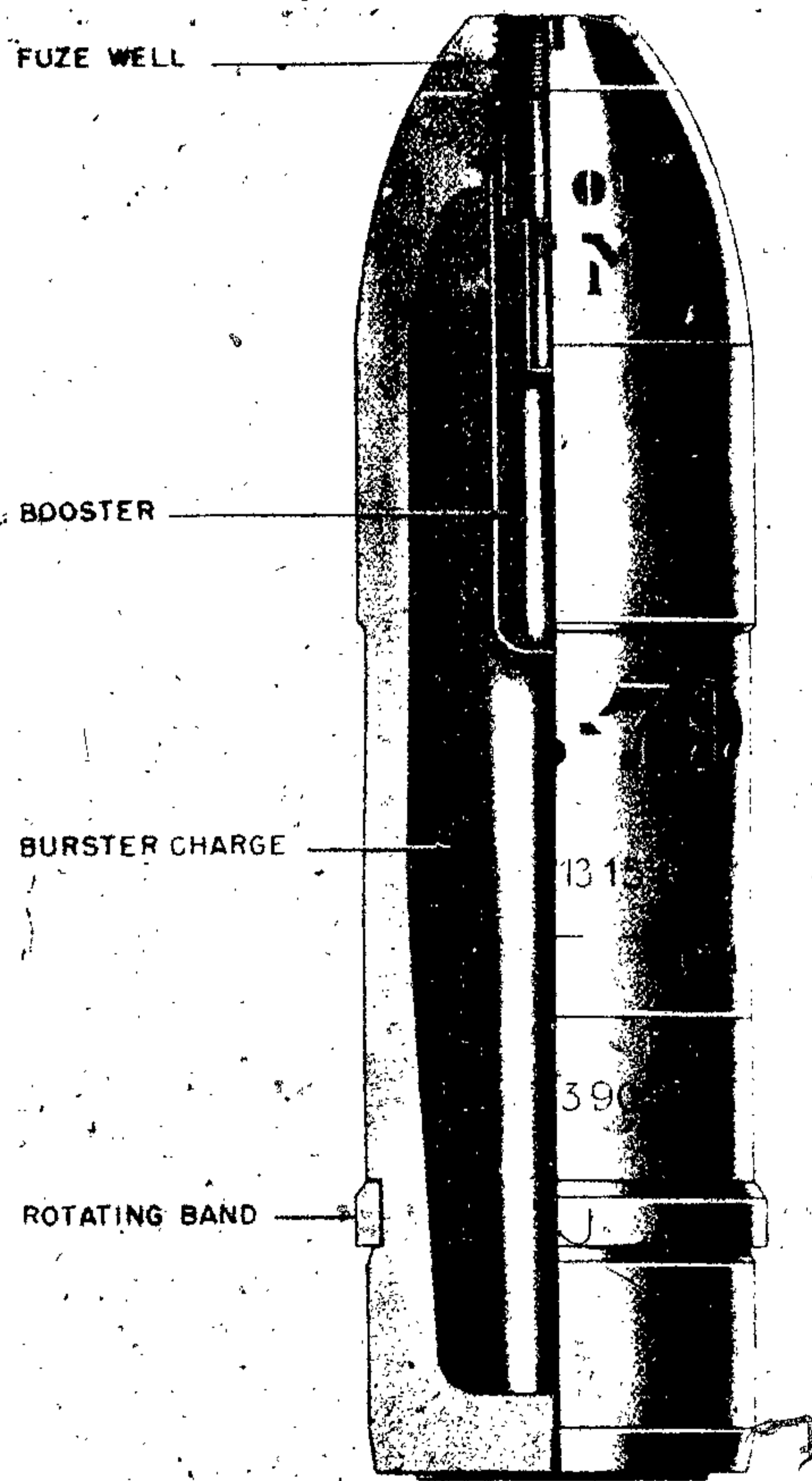

Figure 402—H. E. Projectile, 75-mm, 7.5-cm Sprgr. 240/2 (b)

Type: H. E.
 Weight (loaded and fuzed) : 12 pounds.
 Color: Yellow with black band above rotating band.

CHARGE:
 Number: None.
 Weight: 2¼ pounds.
 Kind: Unknown.

TRACER: None.

BOOSTER: Integral with fuze.

FUZE:
 Nomenclature: Unknown.
 Type: Unknown.

REMARKS:
 Note 1.—This projectile was not fitted with a fuze but from the adapter it appears that French fuzes of the 24/31 series may be used.

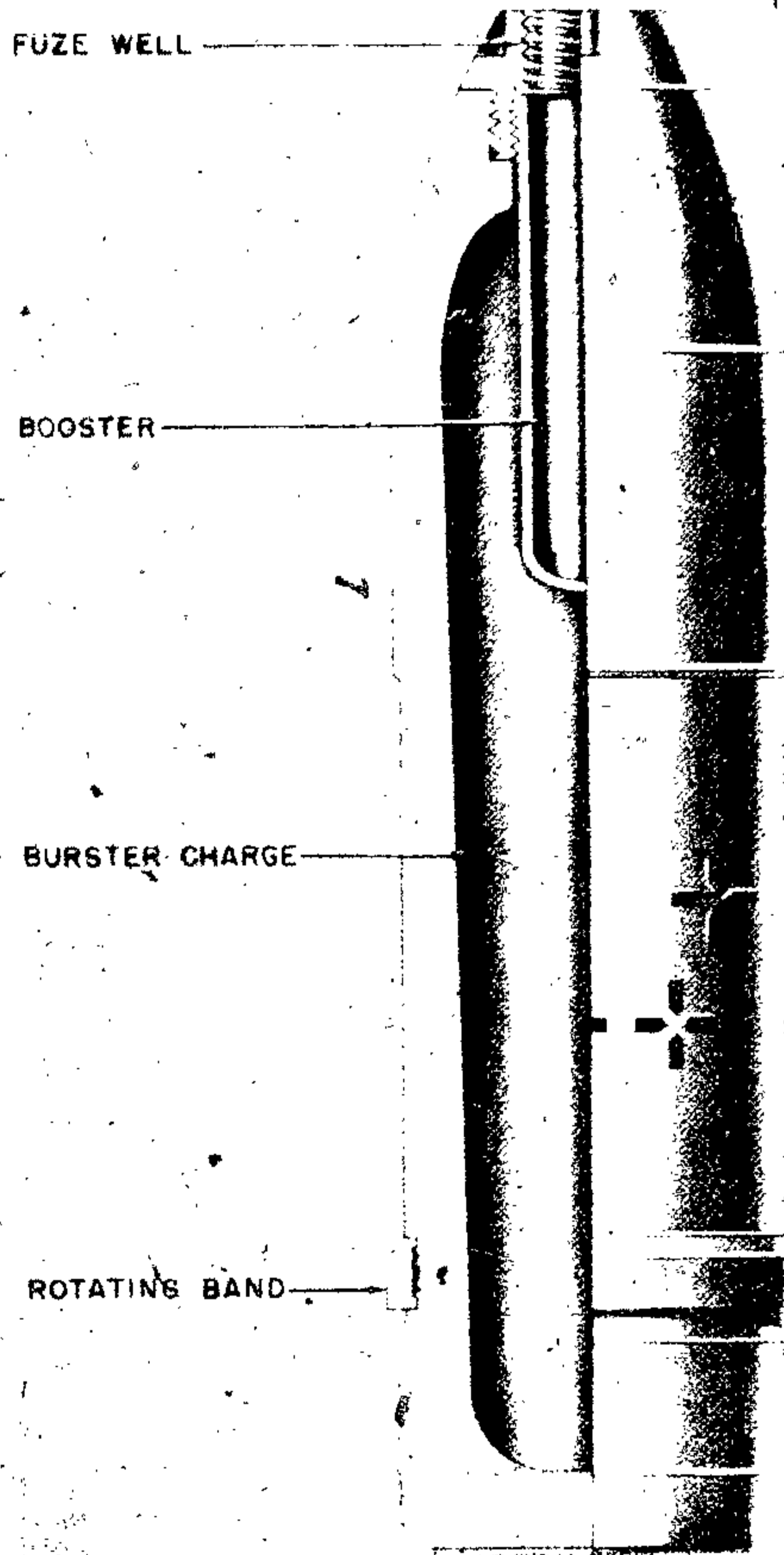

Figure 403—H. E. Projectile, 75-mm, 7.5-cm Sprgr. 264 (j)

H. E. PROJECTILE FOR 75-MM GUN
GERMAN NOMENCLATURE: 7.5-cm Sprgr. 264 (j). (See fig. 403.)

WEAPONS:

French Field Gun: 7.5-cm F. K. 231 (f) M1e 1897.

French Field Gun: 7.5-cm F. K. 232 (f) M1e 1897-1933.

Jugoslav Field Gun: 7.5-cm F. K. 249 (j) Jug 12.

PROJECTILE:

Caliber: 75 mm.

Kind: Projectile.

Type: H. E.

Weight (loaded and fuzed): 11½ pounds.

Color: Body, red; ogive, yellow.

CHARGE:

Number: None.

Weight: 2 pounds.

Kind: Unknown.

TRACER: None.

BOOSTER: Integral with fuze.

FUZE:

Nomenclature: A. Z. 237 (f) 24/31 99-08.

Type: P. D.

ARMOR PIERCING PROJECTILE FOR 75-MM GUN

GERMAN NOMENCLATURE: 7.5-cm Pzgr. 39/42. (See fig. 404.)

WEAPONS:

German Tank Gun: 7.5-cm KwK. 42.

German Assault Gun: 7.5-cm Stu. K. 42 (L/70).

PROJECTILE:

Caliber: 75 mm.

Kind: Projectile.

Type: A. P.

Weight (loaded and fuzed): 16 pounds.

Color: Black with red markings.

CHARGE:

Number: 92.

Weight: ¼ pound.

Kind: Cyclonite/wax (90/10) pressed in blocks wrapped in waxed paper.

TRACER: No. 1A.

BOOSTER: Integral with charge.

FUZE:

NOMENCLATURE: Bd. Z. 5103.

Type: B. D.

ARMOR PIERCING PROJECTILE FOR 75-MM TANK AND FIELD GUN

GERMAN NOMENCLATURE: K. Gr. rot Pz. (See fig. 405.)

WEAPONS:

German Light Field Gun: le F. K. 18.

German Field Gun (new model): F. K. 16 n./a. F. K. 16/1.

Dutch Field Gun: 7.5-cm F. K. 243 (h) mit aufgeb. Model L 30 Idgs. Raam.

German Tank Gun: 7.5-cm KwK.

German Assault Gun: 7.5-cm Stu. G.

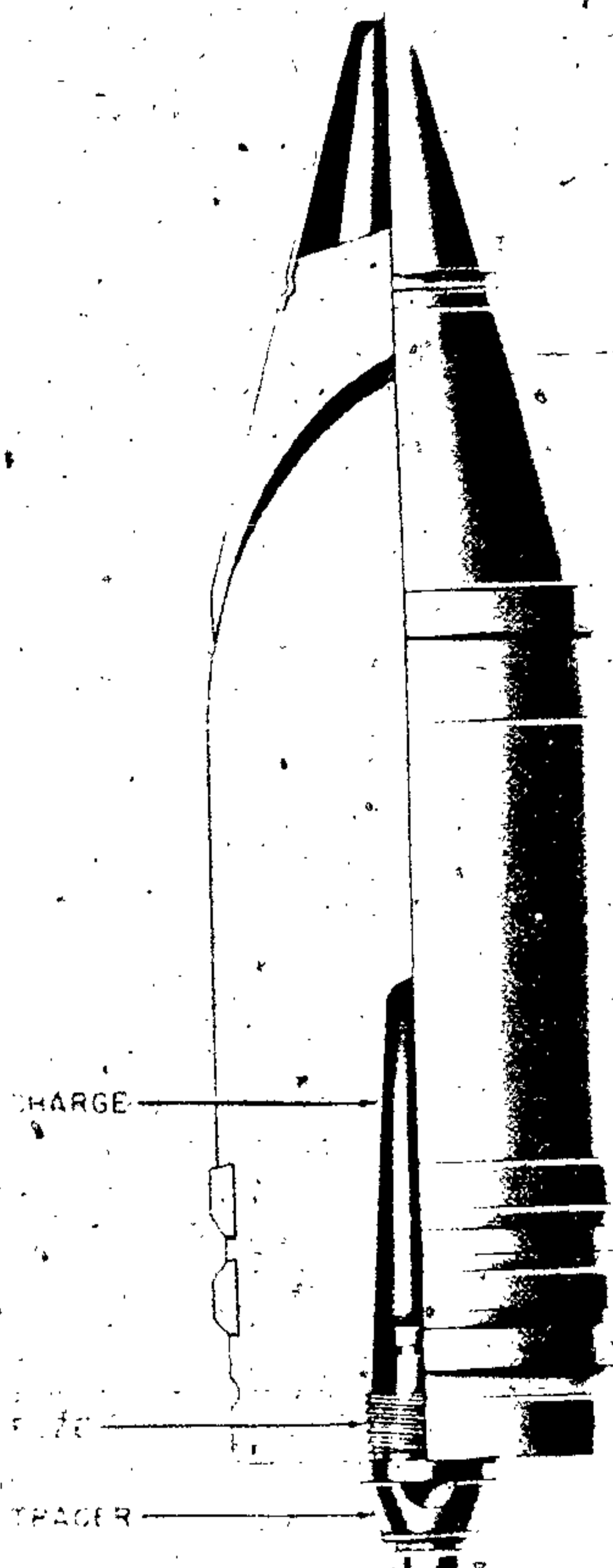

Figure 404—A. P. Projectile, 75-mm, 7.5-cm Pzgr. 39/42

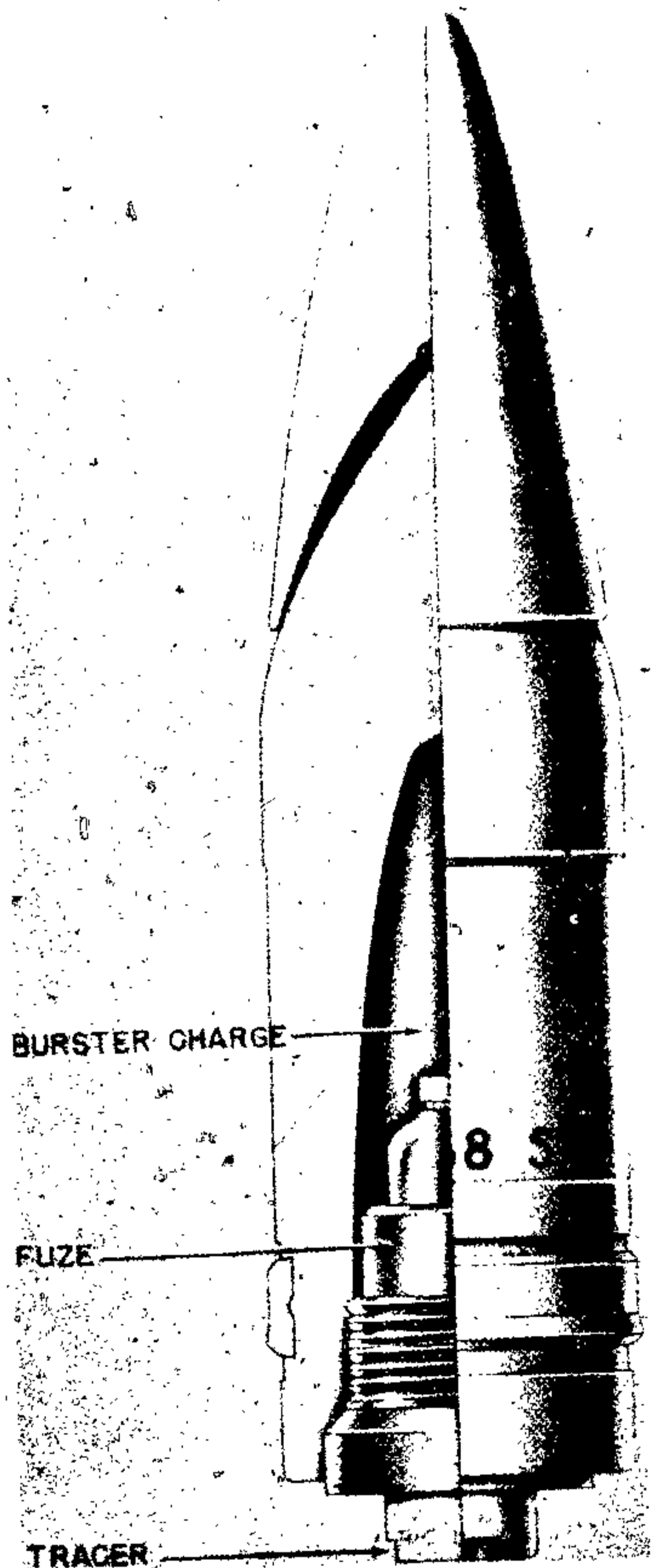

Figure 405—A. P. Projectile for Tank and Field Gun, 75-mm, 7.5-cm K. Gr. Rot Pz.

PROJECTILE:

Caliber: 75 mm.
 Kind: Projectile.
 Type: A. P.
 Weight (loaded and fuzed): 15¼ pounds.
 Color: Black with red band.

CHARGE:

Number: 16.
 Weight: ¼ pound.
 Kind: TNT poured in aluminum container and PETN/wax (90/10) as exploder.

TRACER: No. 2a.

BOOSTER: Integral with charge.

FUZE:

Nomenclature: Bd. Z. f 7.5-cm Pzgr.

Type: B. D.

HOLLOW CHARGE PROJECTILE FOR 75-MM LIGHT INFANTRY HOWITZER

GERMAN NOMENCLATURE: 7.5-cm Jgr. 38 HL/A. (See fig. 406.)

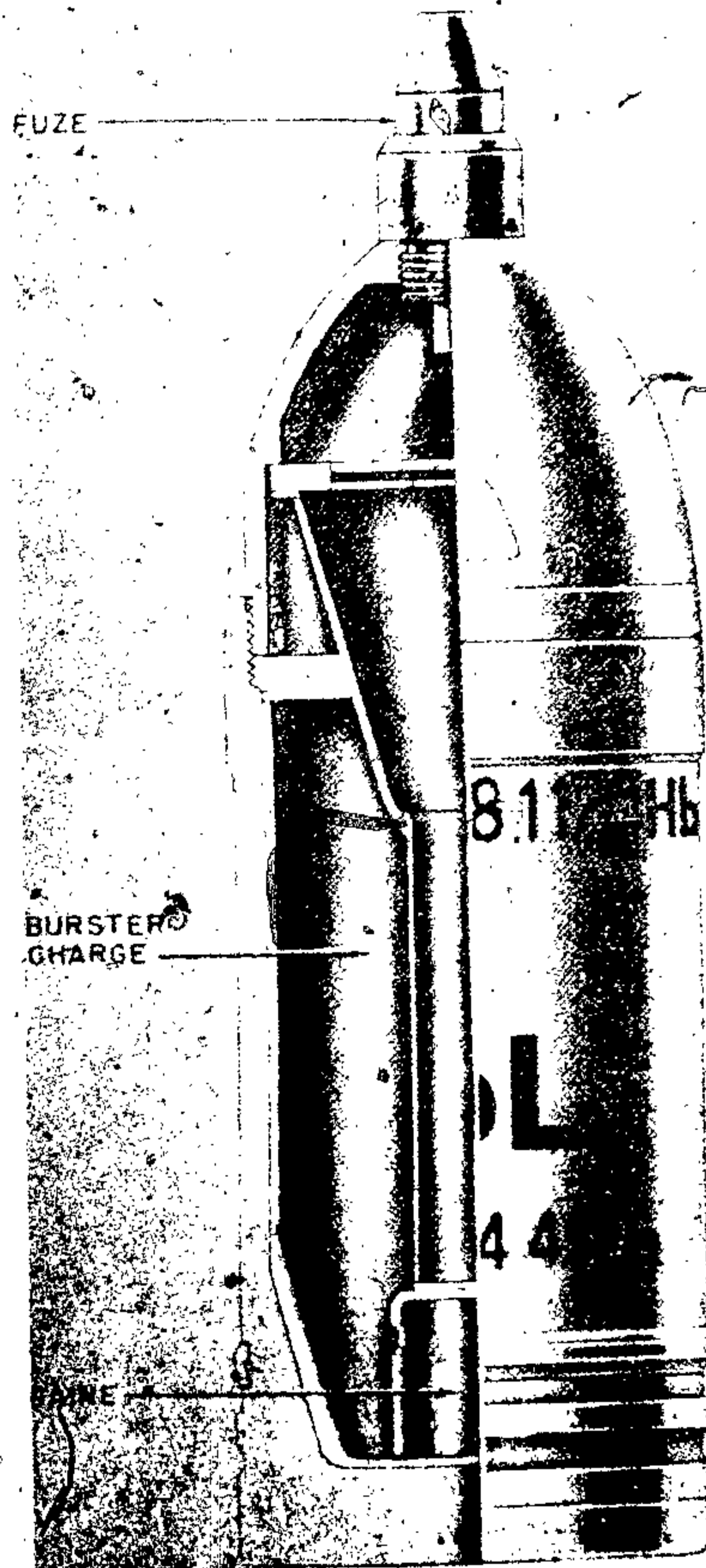

Figure 406—Hollow Charge Shell for Light Infantry Howitzer, 75-mm, 7.5-cm Jgr. 38 HL/A

WEAPONS:

German Light Infantry Howitzer: le J. G. 18.
 German Mountain Infantry Howitzer: le Geb.
 J. G. 18.

PROJECTILE:

Caliber: 75 mm.
 Kind: Projectile.
 Type: Hollow charge.
 Weight (loaded and fuze): 6¾ pounds.
 Color: O. D.

CHARGE:

Number: 91.
 Weight: 1¼ pounds.
 Kind: Cyclonite/wax (95/5) pressed in blocks
 wrapped in waxed paper.

TRACER: None.

BOOSTER: None.

FUZE:

Nomenclature: A. Z. 38 St.
 Type: P. D.

REMARKS:

NOTE 1.—The A. Z. 38 St. fuze is essentially the same as the standard A. Z. 38 except that a steel body has replaced the older aluminum one.

H. E. PROJECTILE FOR 75-MM GUN

GERMAN NOMENCLATURE: 7.5-cm Sprgr. 230/1 (f) (French 1900). (See fig. 407.)

WEAPONS:

French Field Gun: 7.5-cm F. K. 231 (f), 232 (f), Model 97, 97/33.

Belgian Field Gun: 7.5-cm F. K. 234 (b), Model G. P. II.

Belgian Field Gun: 7.5-cm F. K. 236 (b), Model 16 G. P. III.

German Antitank gun: 7.5-cm Pak. 97/38.

PROJECTILE:

Caliber: 75 mm.
 Kind: Projectile.
 Type: H. E.
 Weight (loaded and fuze): 12 pounds.
 Color: Yellow with black markings.

CHARGE:

Number: M.
 Weight: 1½ pounds.
 Kind: Melinite.

TRACER: None.

BOOSTER: Integral with fuze.

FUZE WELL

BOOSTER

BURSTER CHARGE

ROTATING BAND

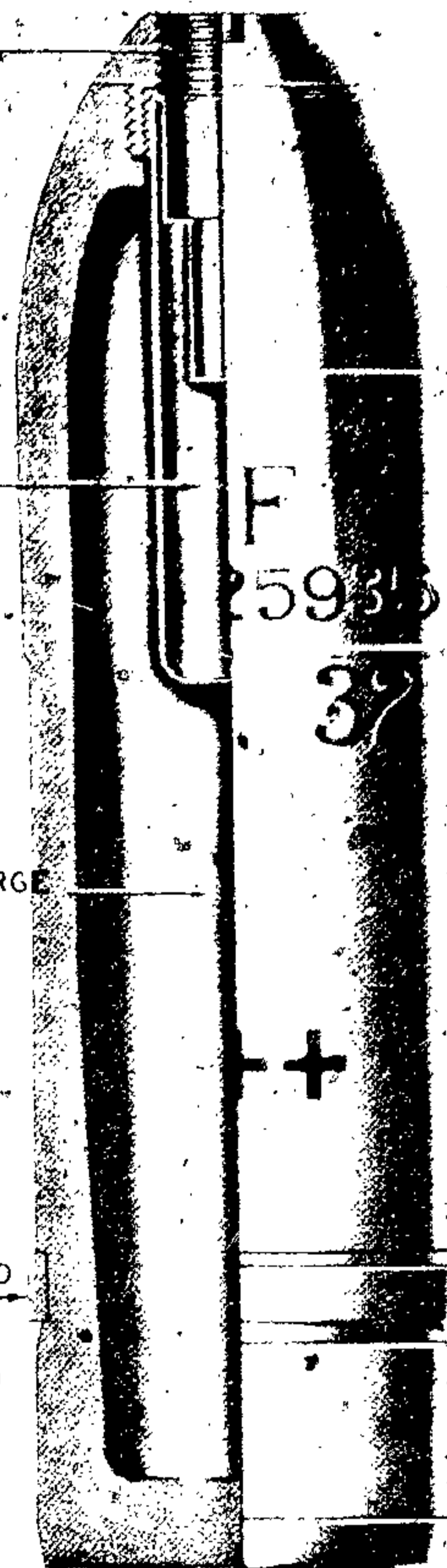

Figure 407—H. E. Projectile, 75-mm, 7.5-cm. Sprgr. 230/1 (f) (French 1900)

FUZE:

NOMENCLATURE

| GERMAN | FRENCH |
|--------------------------|----------------------|
| (1) A. Z. 229 (f) o. V. | frz 24/31 Schn 16 B. |
| (2) A. Z. 235 (f) | frz 24, 31 99 |
| (3) A. Z. 237 (f) | frz 24, 31 99 08 |
| (4) A. Z. 245 (f) | frz 24/31 TCAL 17 |
| (5) A. Z. 247 (f) | frz 24/31 TCAL 18 |
| (6) A. Z. 251 (f) o. V. | frz 24/31 RYG 18J |
| (7) A. Z. 253 (f) kz. V. | frz 24/31 RYG 18 CR |
| (8) A. Z. 259 (f) o. V. | frz 24/31 RY 17 SR |
| (m. verst. F.) | (a. r. r.) |

GERMAN EXPLOSIVE ORDNANCE

| GERMAN | FRENCH |
|------------------------------|----------------------|
| (9) A. Z. 261 (f) | frz 24/31 JAL 16 |
| (10) A. Z. 277 (f) kz. V. | frz 24/31 TCAL 26 CR |
| (11) A. Z. 281 (f) o. V. | frz 24/31 TCAL 26 3 |
| (12) Zt. Z. 415 (f) | frz 24/31 15 |
| (13) Zt. Z. 416 (f) | frz 24/31 A 16 |
| (14) Dopp. Z. 448 (f) | frz 24/31 16 |
| (15) Dopp. Z. 449 (f) | frz 24/31 A 18 |

Type:

| | |
|-----------|--------------|
| (1) P. D. | (9) P. D. |
| (2) P. D. | (10) P. D. |
| (3) P. D. | (11) P. D. |
| (4) P. D. | (12) Time |
| (5) P. D. | (13) Time |
| (6) P. D. | (14) T. & P. |
| (8) P. D. | (15) T. & P. |

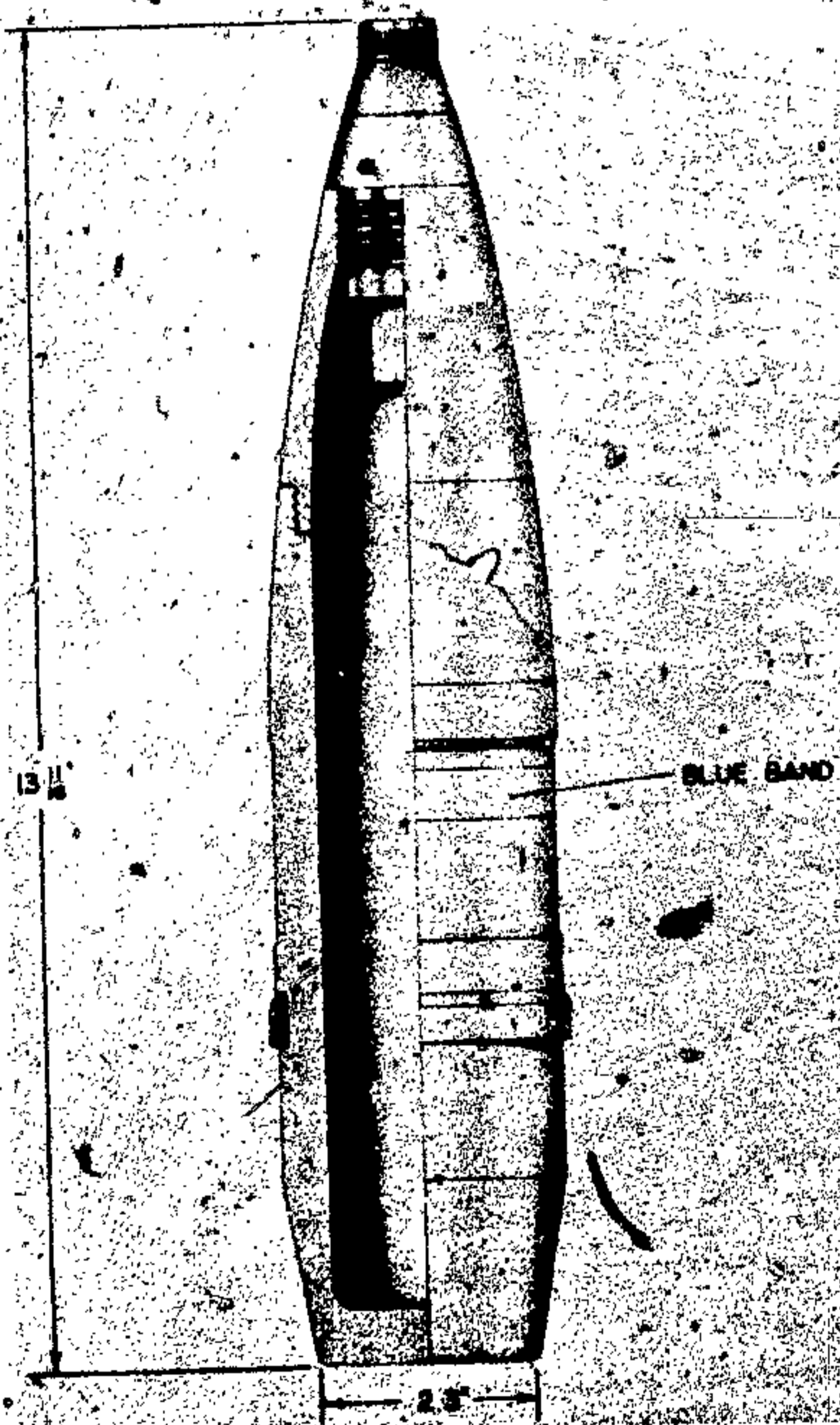

Figure 408—H. E. Projectile, Type 284 Russian,
76.2-mm, 7.62-cm Sprgr. Patr. 284 (r)

H. E. PROJECTILE FOR 76.2-MM MOUNTAIN GUN

GERMAN NOMENCLATURE: 7.62-cm Sprgr. 284/4 (r). (See fig. 408.)

WEAPONS (German nomenclature, original model):

Russian Mountain Gun: 7.62-cm Geb. K. 307 (r)—russ 38.

PROJECTILE:

Caliber: 76.2 mm.

Kind: Projectile,

Type: H. E.

Weight (loaded with fuze): 13 1/2 pounds.

Color: O. D. with black markings.

CHARGE:

Number: T.

Weight: 1 1/2 pounds.

Kind: TNT.

TRACER: None.

BOOSTER: Integral with fuze.

FUZE:

Nomenclature: A. Z. 368 (r) (Russian-KTM-1).

Type: P. D.

REMARKS:

NOTE 1.—Shell has second bourrelet just forward of rotating band.

H. E. PROJECTILE TYPE NO. 39, 76.2-MM

GERMAN NOMENCLATURE: 7.62-cm Sprgr. Patr. 39 (Sprenggranate Patrone 39). (See fig. 409.)

EMPLOYMENT:

7.62-cm F. K. 36 (r) (Feld Kanone 36 [russ])
Field Gun 36 (Russian).

7.62-cm. Pak. 36 (r) (Panzerabwehrkanone 36 (russ)). Antitank gun 36 (Russian).

COMPLETE ROUND:

39.52 inches, over-all length.

22.0 pounds, total weight:

PROJECTILE painted green, white band below nose fuze:

13.97 inches, over-all length.

3.187 inches, distance from base to band.

2.95 inches, diameter of bourrelet.

0.687 inch, width of rotating band—soft iron.

2.312 inches, diameter of base.

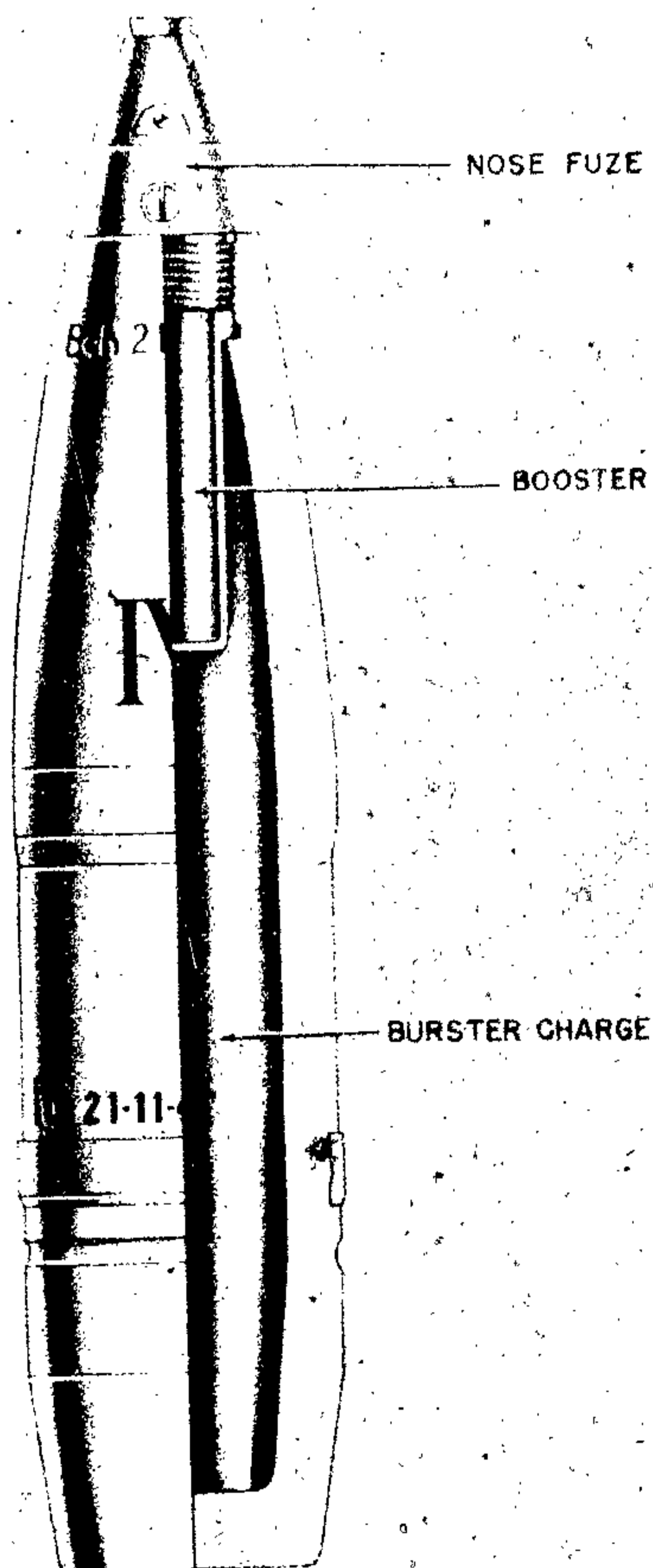

Figure 409—H. E. Projectile, Type 39, 76.2-mm,
7.62-cm Sprgr. Patr. 39

12.64 pounds, total weight.

568.0 grams, Amatol bursting charge.

Gr. Zdlg. C/98 Np booster.

CARTRIDGE CASE (German and Russian designations, 37r or 42M [fixed]):

15.16 inches, over-all length.

3.07 inches, diameter of neck.

3.11 inches, diameter of shoulder.

3.44 inches, diameter of base.

775.0 grams, Flaked Gudol propellant plus.

20.0 grams, potassium sulphate flash reducer.

42M or 33 primer.

FUZE: Nose percussion fuze—K1 A. Z. 23.

PACKAGING: One round to a metal container, 28 pounds.

REMARKS: This German projectile may also be found (fixed) in the cartridge case 6340 for use in rebored Russian equipment.

A. P. PROJECTILE WITH TUNGSTEN CARBIDE CORE, 76.2-MM

GERMAN NOMENCLATURE: Pzgr. Patr. 40 (r) (Panzergranate Patrone 40 [russ]). (See fig. 410.)

EMPLOYMENT:

7.62-cm F. K. 296 (r) (Feld Kanone 296 [russ])
Field Gun 296 (Russian).

7.62-cm. F. K. 36 (r) (Feld Kanone 36 [russ])
Field Gun 36 (Russian).

7.62-cm Pak. 36 (r) (Panzerabwehrkanone 36
(russ)) Antitank Gun 36 (Russian).

COMPLETE ROUND: (description of c/r is for projectile in Russian cartridge case):

24.28 inches, over-all length.

14.74 pounds, total weight.

PROJECTILE, painted black:

10.157 inches, over-all length.

1.0 inches, distance from base to band.

0.687 inch, width of rotating band.

2.91 inches, diameter of base.

9.13 pounds, total weight.

4.344 inches, length of tungsten carbide core.

1.125 inches, diameter of core.

4.921 inches, length of ballistic cap.

Tracer present in base of projectile.

Stamped on body:

"41 $\frac{CYW}{COB}$ "

CARTRIDGE CASE (German and Russian nomenclature, 42m or 37r (fixed):

15.125 inches, over-all length.

3.07 inches, diameter of neck.

3.062 inches, diameter of shoulder.

3.531 inches, diameter of base.

364.0 grams, tubular Diglycol propellant.

42/m or 33 primer.

FUZE: No fuze is employed.

PACKAGING: Either five rounds to a box—110 pounds or six rounds to a box—145 pounds.

GERMAN EXPLOSIVE ORDNANCE

REMARKS: There is a bakelite sheath forward of the core, and a setscrew forward of the bourrelet. This German projectile may be found (fixed) in the German case 6340 for use in captured weapons which the Germans have rebored.

A. P. PROJECTILE WITH CAP TYPE 39, 76.2-MM

GERMAN NOMENCLATURE: 7.62-cm. Pzgr. Patr. 39 (r) rot (Panzergranate Patrone 39 (russ) rot). (See fig. 411.)

EMPLOYMENT: 7.62-cm Pak. 36 (r) (Panzerabwehrkanone 36 (russ)). Antitank Gun 36 (Russian).

COMPLETE ROUND:

26.219 inches, over-all length.

28.6 pounds, total weight.

PROJECTILE, painted black, with white tip:

12.062 inches, over-all length.

0.969 inch, distance from base to band.

0.687 inch, width of rotating band.

2.906 inches, diameter of base.

16.72 pounds, total weight.

2.519 pounds, Russian nitrocellulose powder; or

2.886 pounds, tubular diglycol.

Tracer is present in fuze.

CARTRIDGE CASE (German and Russian nomenclature, 42m or 37r (fixed):

15.125 inches, over-all length.

3.07 inches, diameter of mouth.

3.062 inches, diameter of shoulder.

3.44 inches, diameter of base.

775.0 grams, flaked Gudol propellant plus.

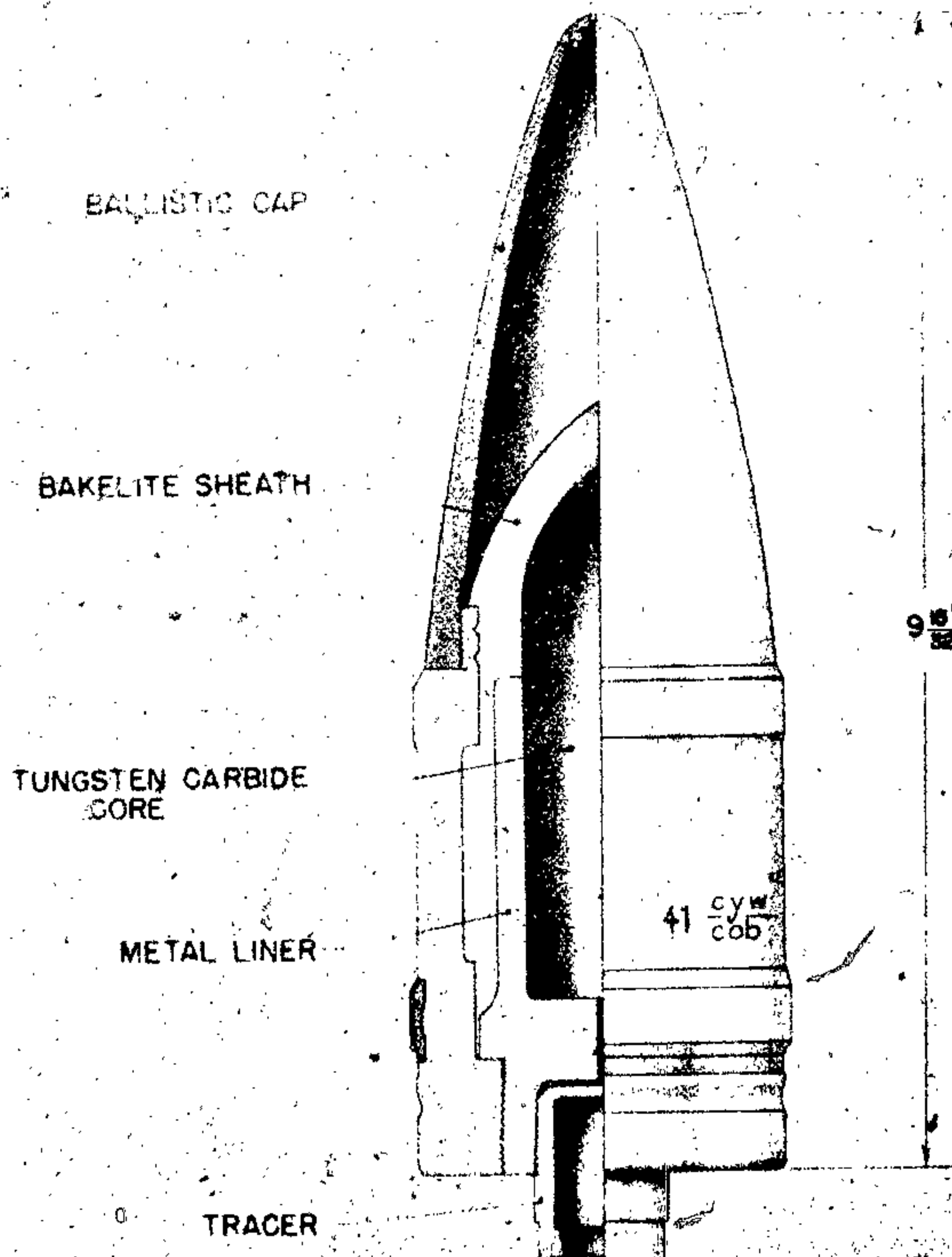

Figure 410—A. P. Projectile With Tungsten Carbide Core, 76.2-mm.
7.62-cm. Pzgr. Patr. 40 (r)

H. E. PROJECTILE FOR 76.2-MM GUN HOWITZER

GERMAN NOMENCLATURE: 7.62-cm Sprgr. 280/2 (r). (See fig. 412.)

WEAPONS:

Russian Infantry Gun Howitzer: 7.62-cm J. K. H., 290 (r)—russ 27.

PROJECTILE:

Caliber: 76.2 mm.

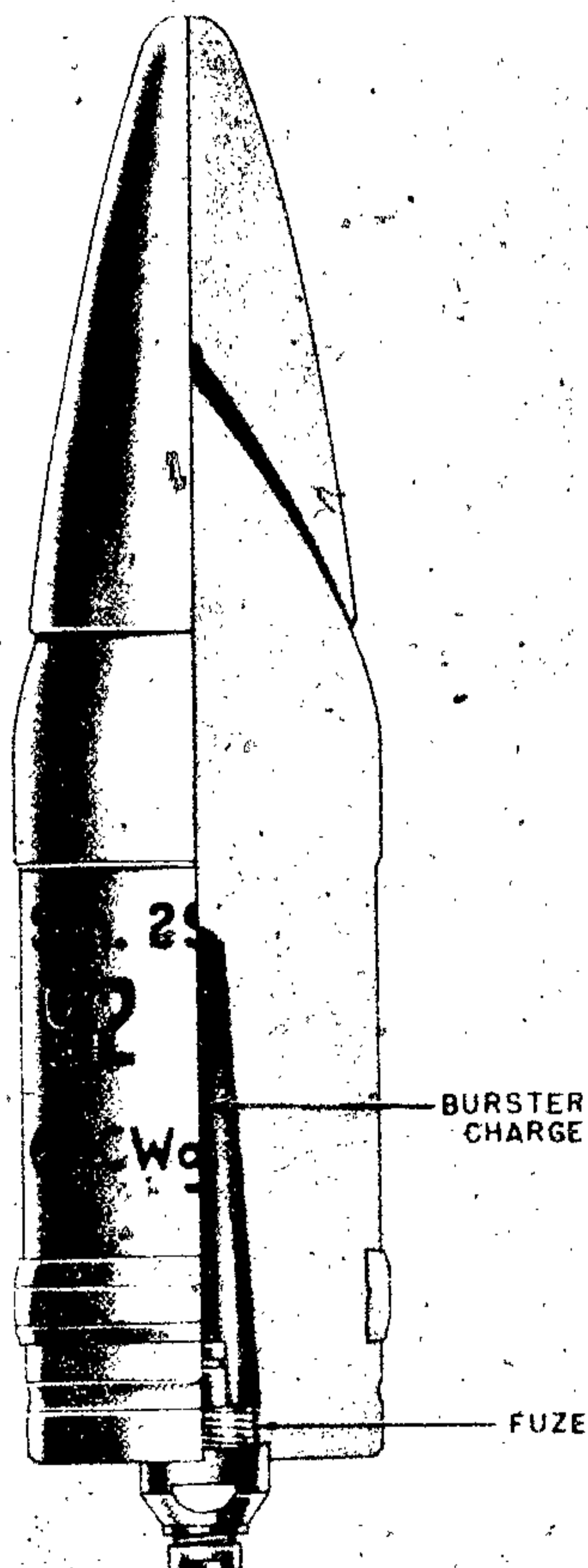

**Figure 411—A. P. Projectile With Cap, Type 39,
76.2-mm, 7.62-cm Pzgr. Patr. 39 (r) Rot**

20.0 grams, potassium sulphate flash reducer.
33 or 42m or C/12nA primer.

FUZE: Base detonating fuze—Bd. Z. f 7.5-cm.

PACKAGING: One round to a metal container—
34.32 pounds.

REMARKS: This German projectile may also be found (fixed) in the cartridge case 6340 for use in rebored Russian equipment. A 7.62 A. P. projectile with a small bursting cavity containing RDX is also made. Bd. Z 5103 will be found in this type.

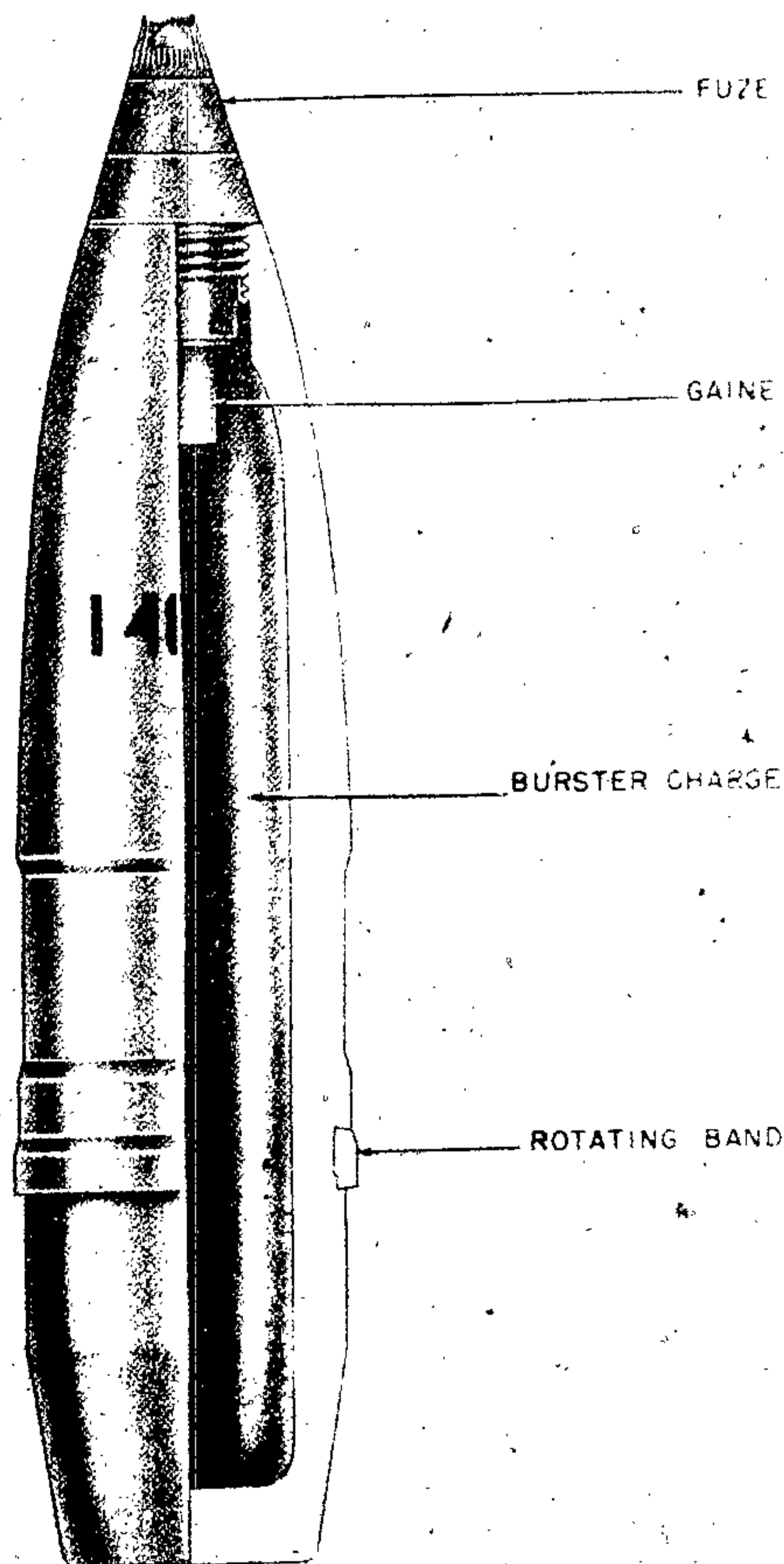

**Figure 412—H. E. Shell for Howitzer, 76.2-mm,
7.62-cm Sprgr. 280/2 (r)**

GERMAN EXPLOSIVE ORDNANCE

Kind: Projectile.
 Type: H. E.
 Weight (loaded and fuzed): 14¾ pounds.
 Color: Grey with black markings; bourrelets unpainted.

CHARGE:

Number: T.
 Weight: 2¾ pounds.
 Kind: TNT.

TRACER: None.

BOOSTER: Integral with fuze.

FUZE:

Nomenclature: A. Z. 367 (r) (Russian—KT-1).
 Type: P. D.

REMARKS:

NOTE 1.—Shell has a second bourrelet just forward of rotating band.

H. E. PROJECTILE FOR 76.2-MM MOUNTAIN GUN

GERMAN NOMENCLATURE: 7.62-cm Sprgr. 284/4 (r). (See fig. 413.)

WEAPONS:

Russian Mountain Gun: 7.62-cm Geb. K. 307 (r) russ 38.

PROJECTILE:

Caliber: 76.2 mm.
 Kind: Shell.
 Type: H. E.
 Weight (loaded and fuzed): 13½ pounds.
 Color: O. D. with black markings.

CHARGE:

Number: T.
 Weight: 1½ pounds.
 Kind: TNT.

TRACER: None.

BOOSTER: Integral with fuze.

FUZE:

Nomenclature: A. Z. 368 (r) (Russian—KTM-1).
 Type: P. D.

REMARKS:

NOTE 1.—Shell has second bourrelet just forward of rotating band.

HOLLOW CHARGE PROJECTILE FOR 76.2-MM HOWITZER

GERMAN NOMENCLATURE: 7.62-cm Gr. 38/2 HL/B. (See fig. 414.)

Russian Infantry Gun Howitzer: 7.62-cm J. K. H. 290 (r), Model 27.

PROJECTILE:

Caliber: 76.2 mm.
 Kind: Projectile.
 Type: Hollow charge.

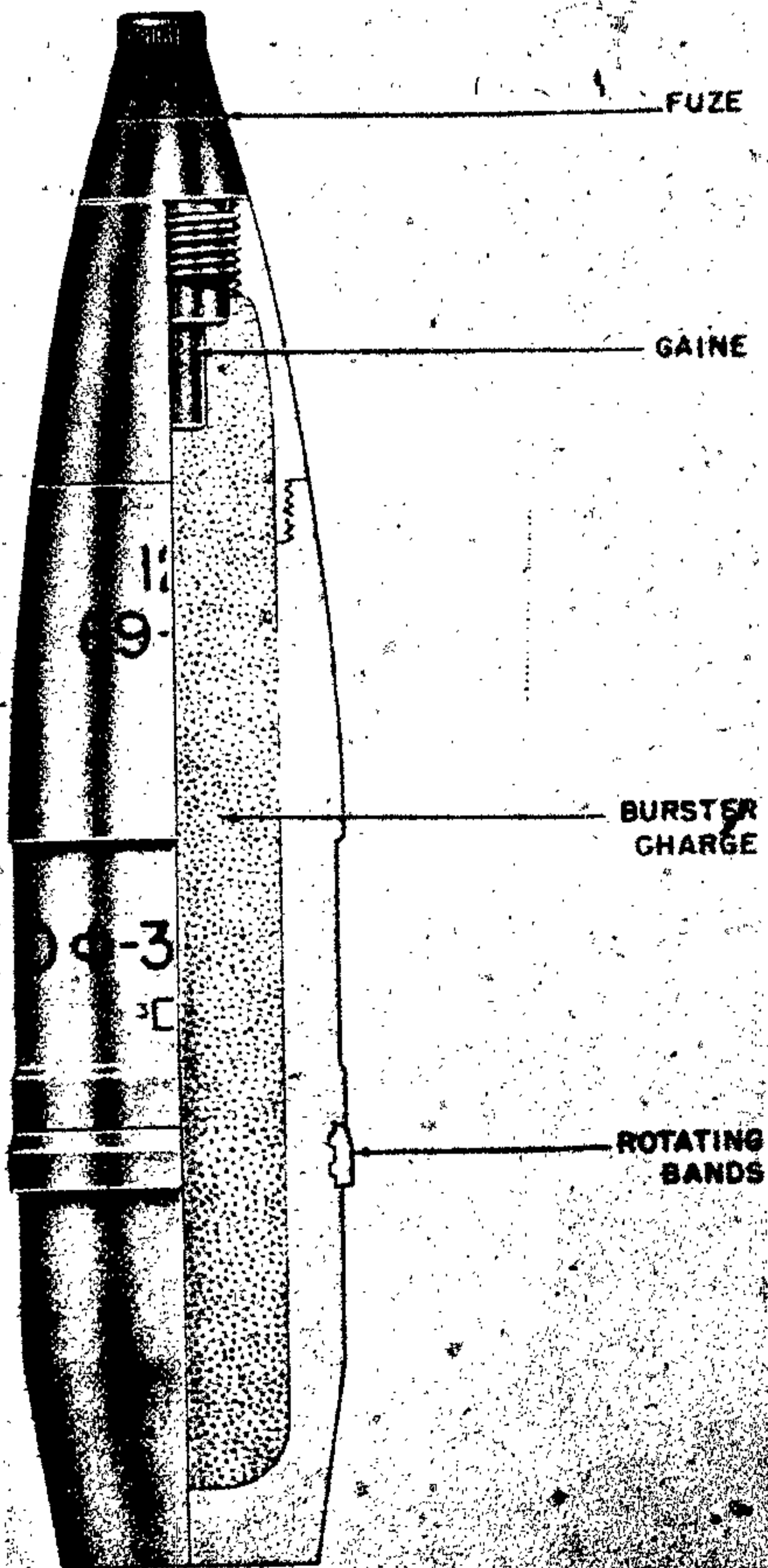

Figure 413—H. E. Shell for Mountain Gun, 76.2-mm, 7.62-cm Sprgr. 284/4 (r)

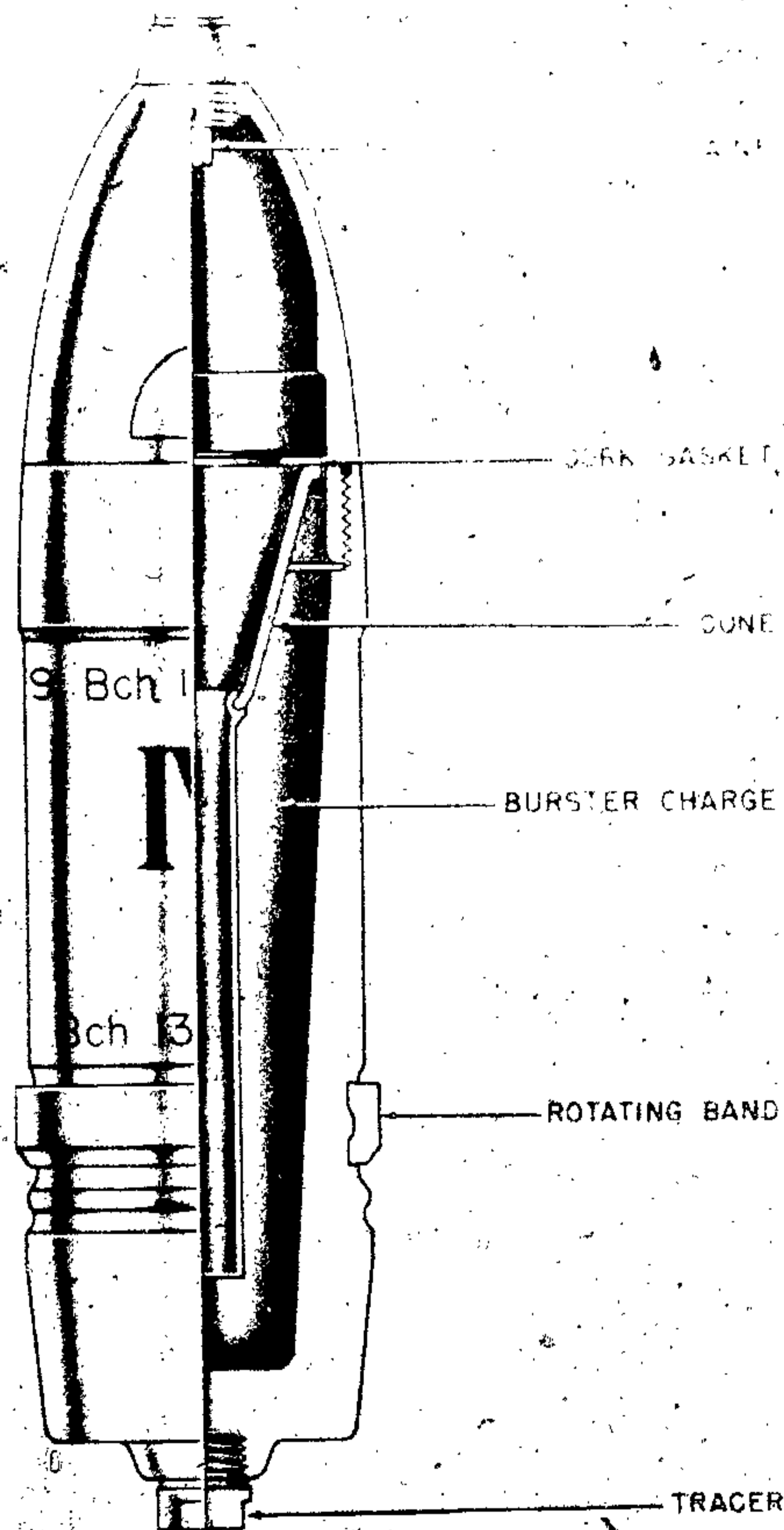

Figure 414—Hollow Charge Projectile for Howitzer, 76.2-mm, 7.62-cm Gr. 38/2 HL/B

Weight (loaded and fuzed) : 10½ pounds.
 Color: O. D. with white band below fuze.

CHARGE:

Number: 91.
 Weight: 1 pound.
 Kind: Cyclonite/wax (95/5) pressed in blocks wrapped in waxed paper.

TRACER: Yes, but un-numbered.

BOOSTER: Integral with fuze.

FUZE:

Nomenclature: A. Z. 38.

Type: P. D.

H. E. PROJECTILE FOR 76.2-MM GUN HOWITZER

GERMAN NOMENCLATURE: 7.62-cm Sprgr. 39/2 (r). (See fig. 415.)

WEAPONS:

Russian Infantry Gun Howitzer: 7.62-cm J. K. H. 290 (r), Model 27.

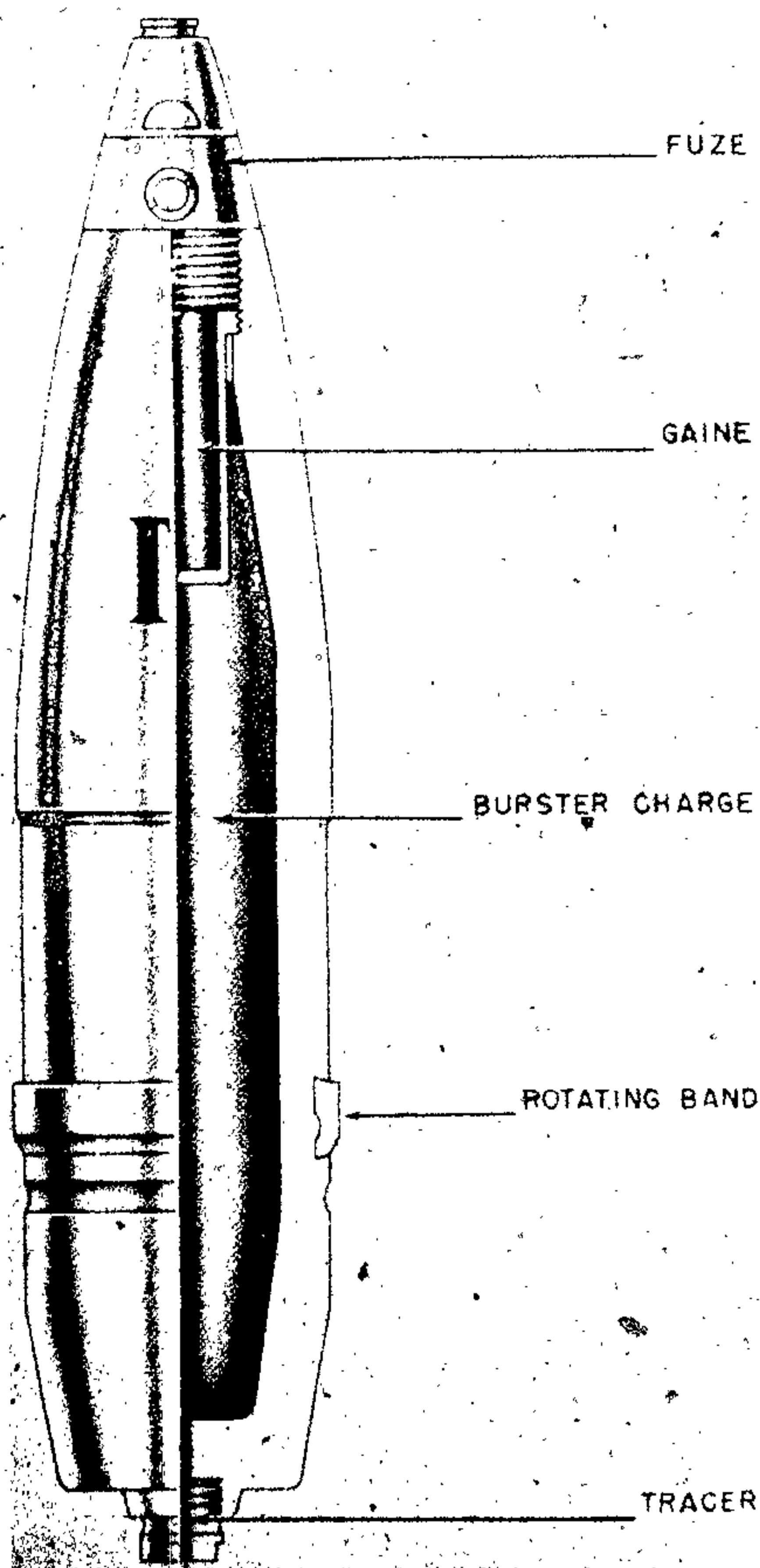

Figure 415—H. E. Shell for Howitzer, 76.2-mm, 7.62-cm. Sprgr. 39/2 (r)

GERMAN EXPLOSIVE ORDNANCE

PROJECTILE:

Caliber: 76.2 mm.
Kind: Projectile.
Type: H. E.
Weight (loaded and fuzed): 13.75 pounds.
Color: O. D.

CHARGE:

Number: 13.
Kind: Amatol 60/40 (poured).

TRACER: cpn 43.

BOOSTER: Np 10 1dn.

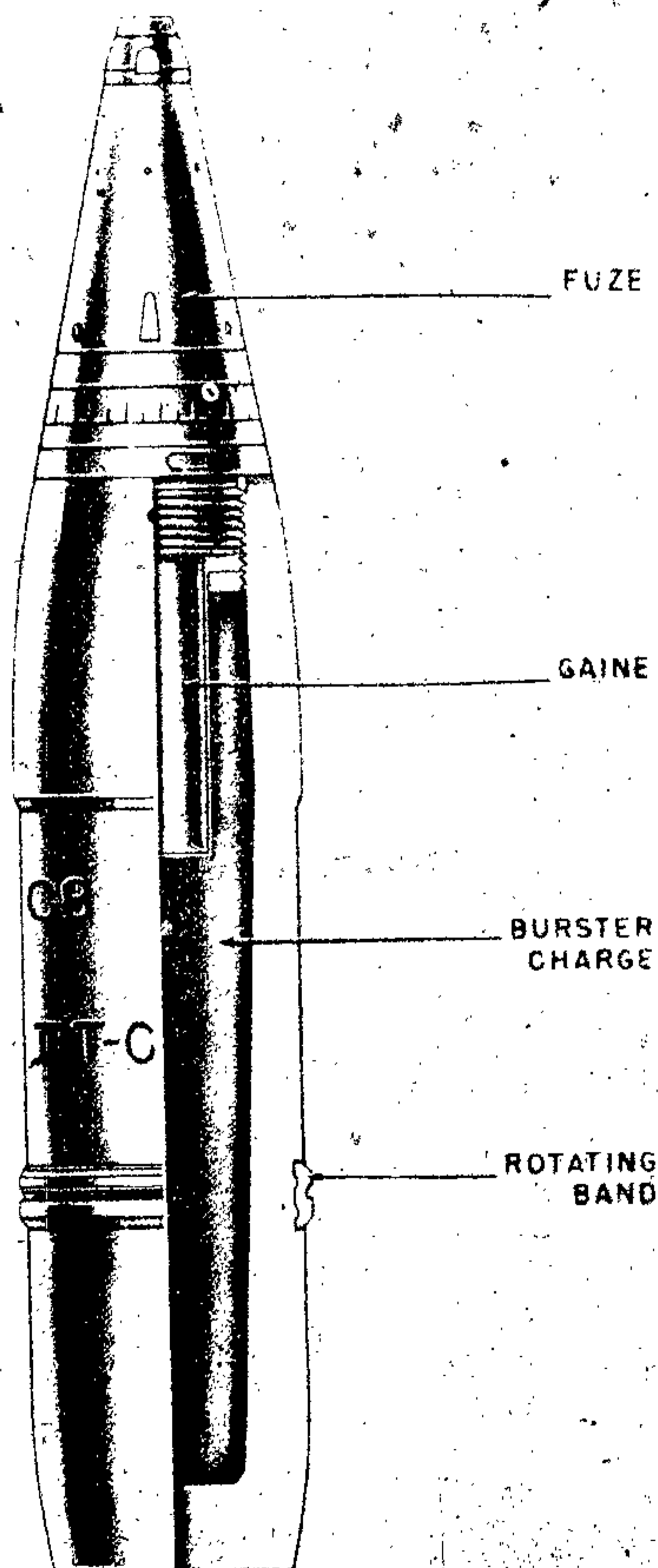

Figure 416—H. E. Projectile for Field Gun, 76.5-mm,
7.65-cm Sprgr. (Dopp. Z.) 276 (j)

FUZE:

Nomenclature: K1. A. Z. 23 umg. (0.15).
Type: P. D.

HIGH EXPLOSIVE PROJECTILE FOR 76.5-MM FIELD GUN

GERMAN NOMENCLATURE: 7.65-cm. Sprgr.
(Dopp. Z.) 276 (j). (See fig. 416.)

WEAPONS:

Jugoslav Field Gun: 7.65-cm F. K. 404 (k),
Model 28 Skoda.

PROJECTILE:

Caliber: 76.5 mm.
Kind: Projectile.
Type: H. E.
Weight (loaded and fuzed): 18 pounds.
Color: Yellow.

CHARGE:

Number: TTT.
Weight: 1½ pounds.
Kind: TNT?

TRACER: None.

BOOSTER: Integral with fuze.

FUZE:

Nomenclature: Dopp. Z. VG—SKR (t); Dopp.
Z. VG—CR (t).
Type: T. and P.; T. and P.

HIGH EXPLOSIVE PROJECTILE FOR 76.5-MM FIELD GUN

GERMAN NOMENCLATURE: 7.65-cm Sprgr
(A. Z.) 275 (j). (See fig. 417.)

WEAPONS:

Jugoslav Field Gun: 7.65-cm F. K. 304 (j),
Model 28 Skoda.

PROJECTILE:

Caliber: 76.5 mm.
Kind: Projectile.
Type: H. E.
Weight (loaded and fuzed): 18 pounds.
Color: Yellow.

CHARGE:

Number: T.
Weight: 2¾ pounds.
Kind: TNT?

TRACER: None.

BOOSTER: Integral with fuze.

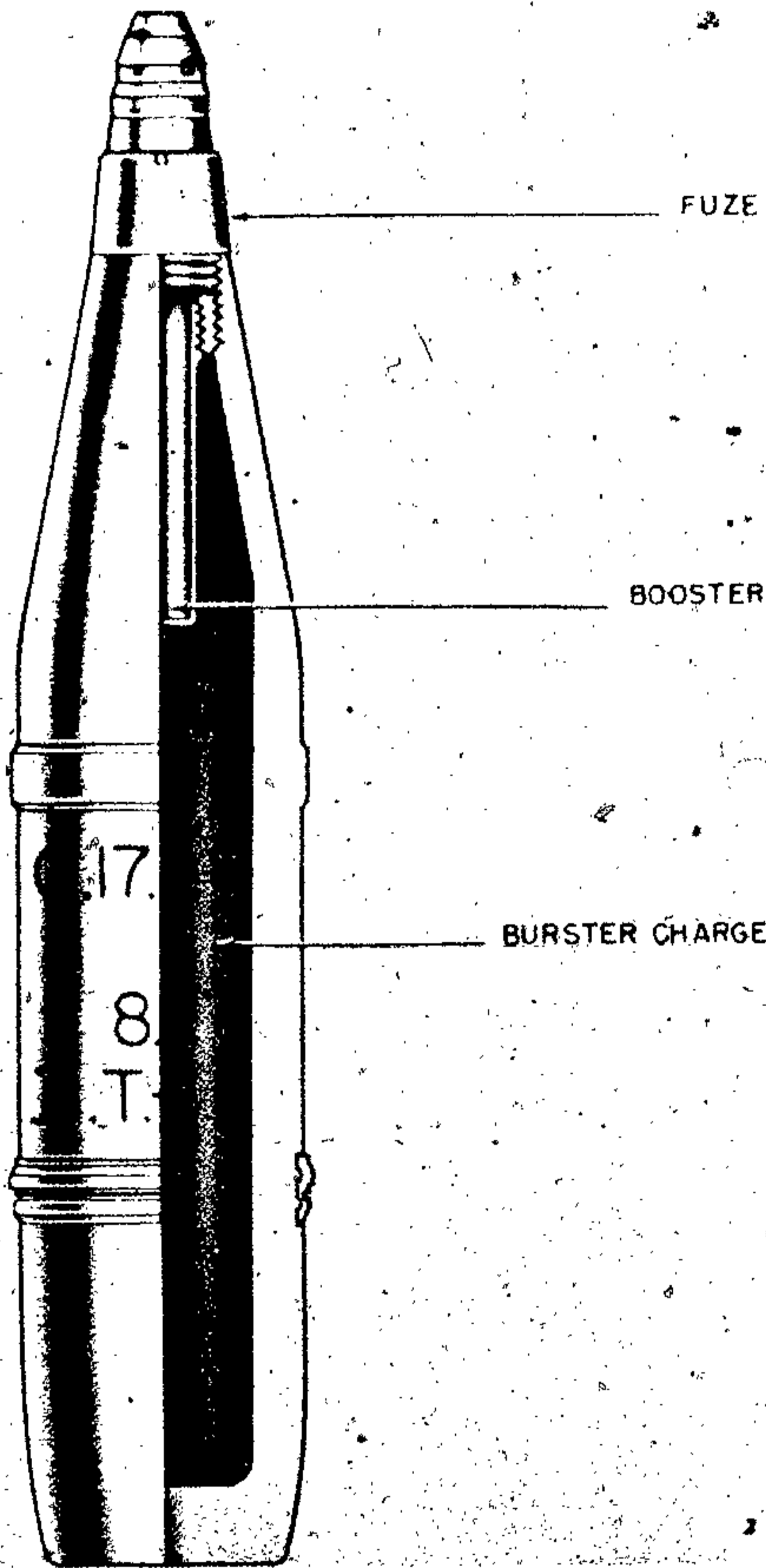

Figure 417—H. E. Projectile for Field Gun, 76.5-mm, 7.65-cm Sprgr. (A. Z.) 275 (j)

FUZE:

Nomenclature: A. Z. CHZR (t) or A. Z. SKHZR (t).
Type: P. D.

A. P. PROJECTILE FOR 76.5-MM GUN

GERMAN NOMENCLATURE: 7.65-cm Pzgr. 277 (j). (See fig. 418.)

WEAPONS: Jugoslav Field Gun: 7.65-cm F. K. 304 (j), 28 Skoda.

PROJECTILE:

Caliber: 76.5 mm.
Kind: Projectile.
Type: A. P.
Weight (loaded and fuzed): 18 pounds.
Color: Machined metal.

CHARGE:

Number: T.
Weight: 1/2 pound.
Kind: TNT in cardboard container (?)

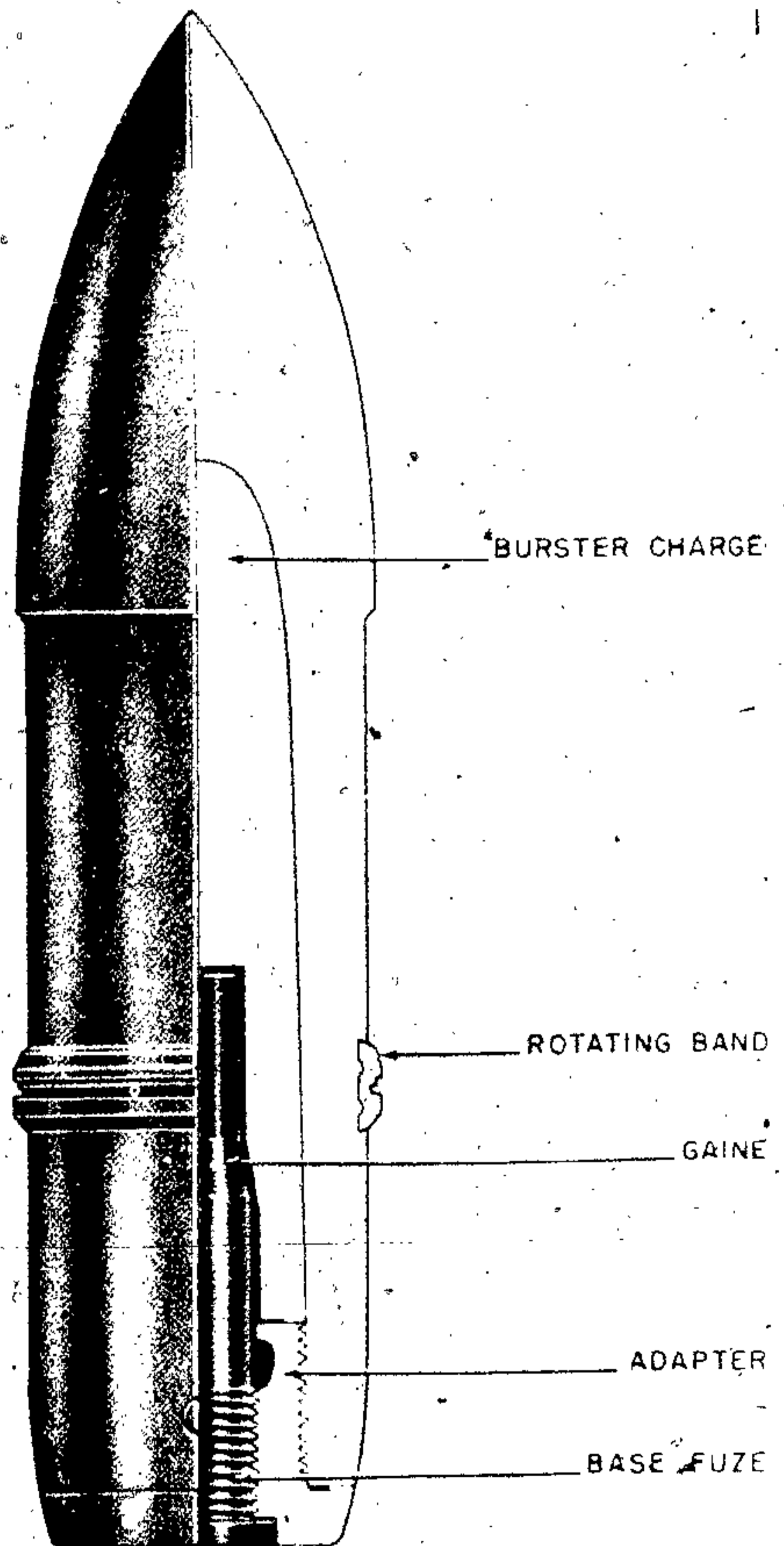

Figure 418—A. P. Projectile for 76.5-mm, 7.65-cm Pzgr. 277 (j)

GERMAN EXPLOSIVE ORDNANCE

TRACER: None.

BOOSTER: Integral with fuze.

FUZE:

Nomenclature: Unknown.

Type: B. D.

H. E. PROJECTILE FOR 7.65-CM GUN

GERMAN NOMENCLATURE: 7.65-cm Zt. Z.
Gr. M 19 (t). (See fig. 419.)

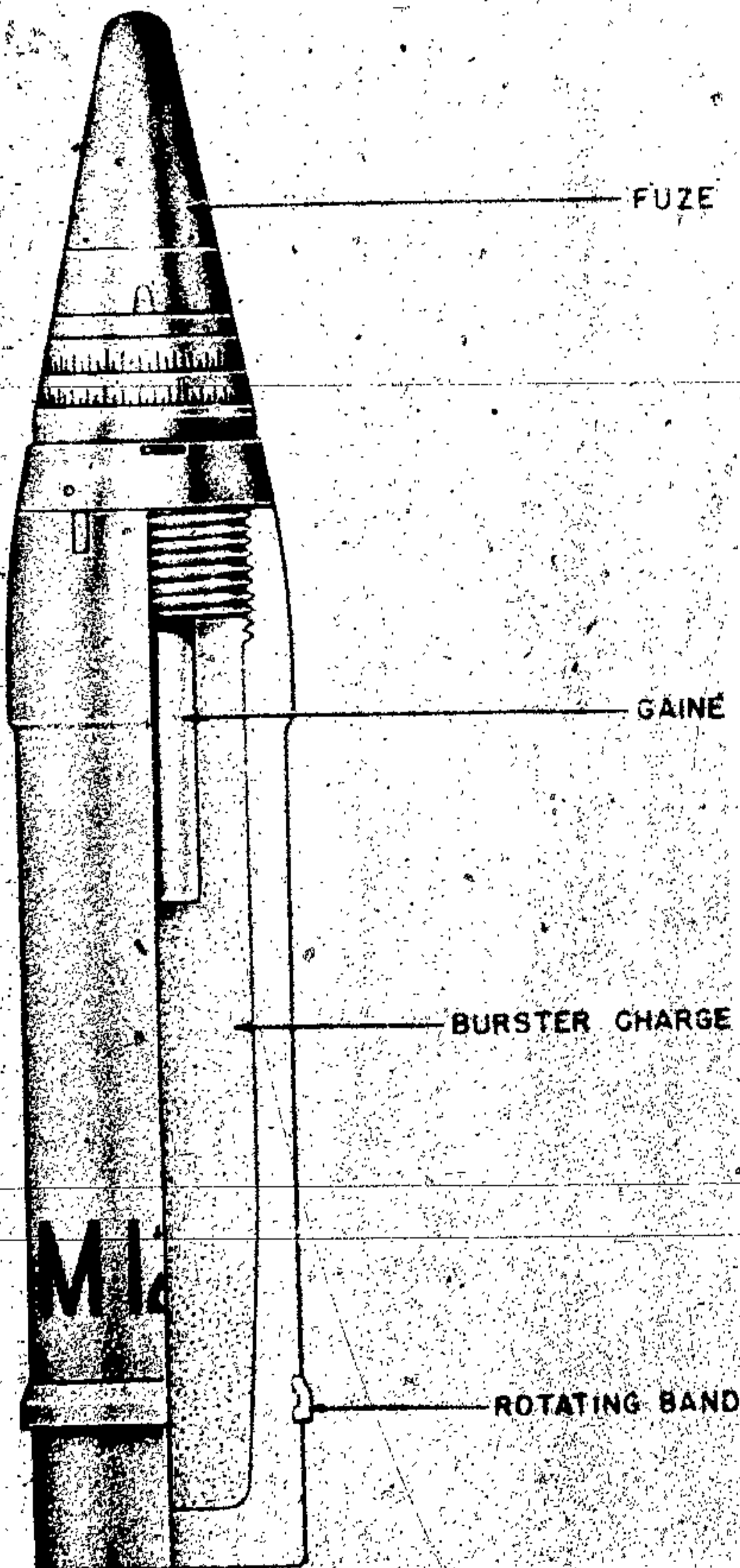

Figure 419—H. E. Projectile for 7.65-cm Gun,
7.65-cm Zt. Z. Gr. M 19 (t)

WEAPONS:

Czech Field Gun: 7.65-cm F. K. 5/8 (t), Model 5/8.

Austrian Field Gun: 7.65-cm F. K. 5/8 (o), Model 5/8.

Austrian Field Gun: 7.65-cm F. K. 17 (o), Model 17.

Czech Field Gun: 7.65-cm F. K. 17 (t), Model 17.

Jugoslav Field Gun: 7.65-cm F. K. 300 (j), Model 5/8 (Skoda).

Jugoslav Field Gun: 7.65-cm F. K. 303 (j), Model 17 (Skoda).

PROJECTILE:

Caliber: 7.65 mm.

Kind: Projectile.

Type: H. E.

Weight (loaded and fuzed): 19 pounds.

Color: Unpainted with red and black markings and red band around body.

CHARGE:

Number: TR.

Weight: 2½ pounds.

Kind: Cast TNT.

TRACER: None.

BOOSTER: Integral with fuze—without bore safety device.

FUZE:

Nomenclature: VZ 19.

Type: Timé (powder train).

REMARKS: Very slight, if any, bourrelet.

H. E. PROJECTILE FOR 76.5-MM GUN

GERMAN NOMENCLATURE: 7.65-cm Sprgr. M25 (j). (See fig. 420.)

WEAPONS:

Czech Field Gun: 7.65-cm F. K. 5/8 (t), Model 5/8.

Austrian Field Gun: 7.65-cm F. K. 5/8 (o), Model 5/8.

Austrian Field Gun: 7.65-cm F. K. 17 (o), Model 17.

Czech Field Gun: 7.65-cm F. K. 17 (t), Model 17.

Jugoslav Field Gun: 7.65-cm F. K. 300 (j), Model 5/8 (Skoda).

Jugoslav Field Gun: 7.65-cm F. K. 303 (j), Model 17 (Skoda).

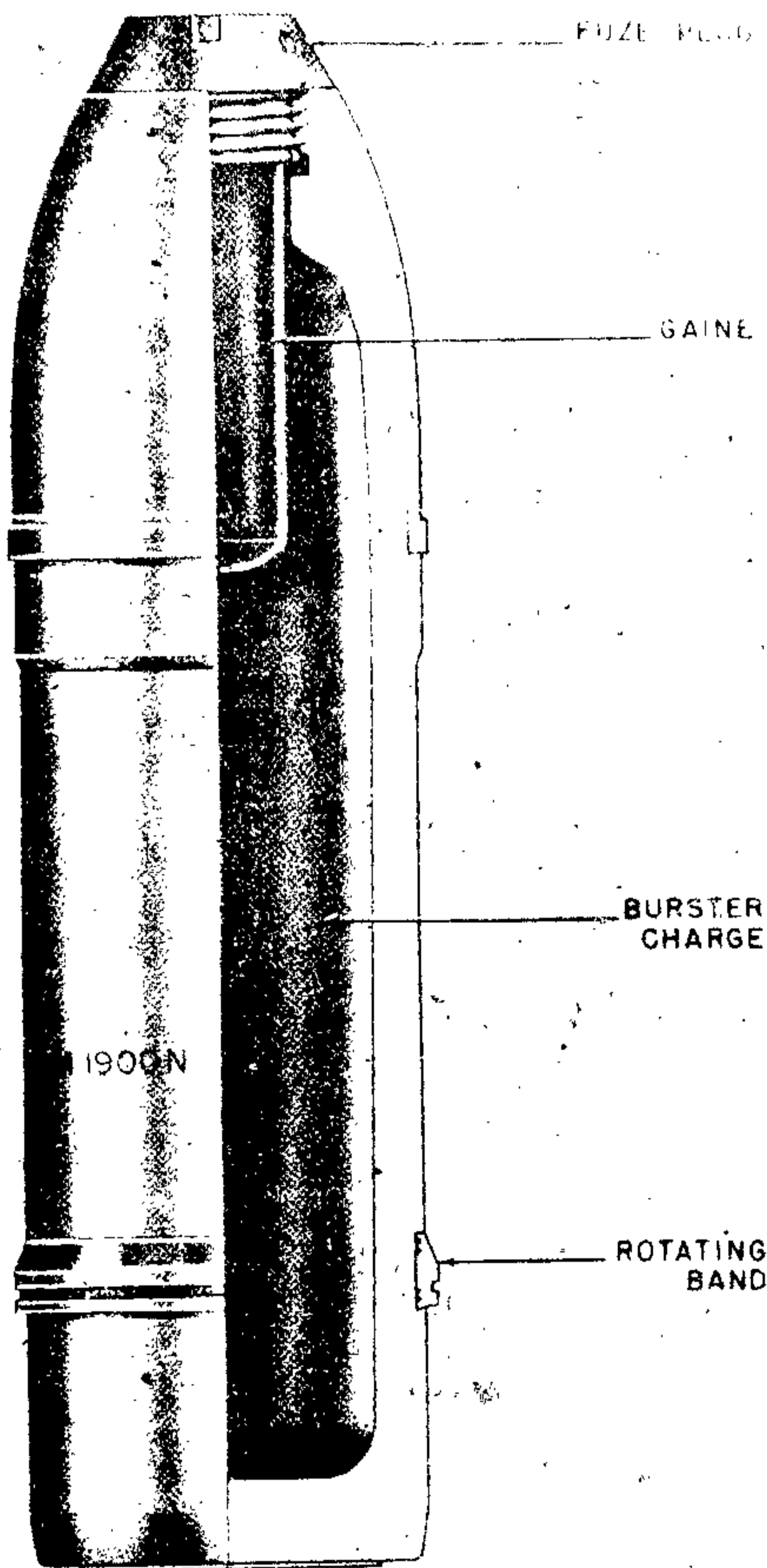

Figure 420—H. E. Projectile for 76.5-mm Gun,
7.65-cm Sprgr. M 25 (j)

PROJECTILE:

Caliber: 76.5 mm.
Kind: Projectile.
Type: H. E.
Weight (loaded and fuzed): 12 pounds.
Color: Brick red with bright red band below
bourelet.

CHARGE:

Number: None.
Weight: 2 pounds.

Kind: Unknown (believed to be picric acid).
TRACER: None.
BOOSTER: Integral with fuze.
FUZE:
Nomenclature: Unknown.
Type: Unknown.

H. E. PROJECTILE FOR 76.5-MM GUN

GERMAN NOMENCLATURE: 8 cm A. Z. Gr. M. 30 (t) or 8-cm A. Z. Gr. 30 (t). (See fig. 421.)

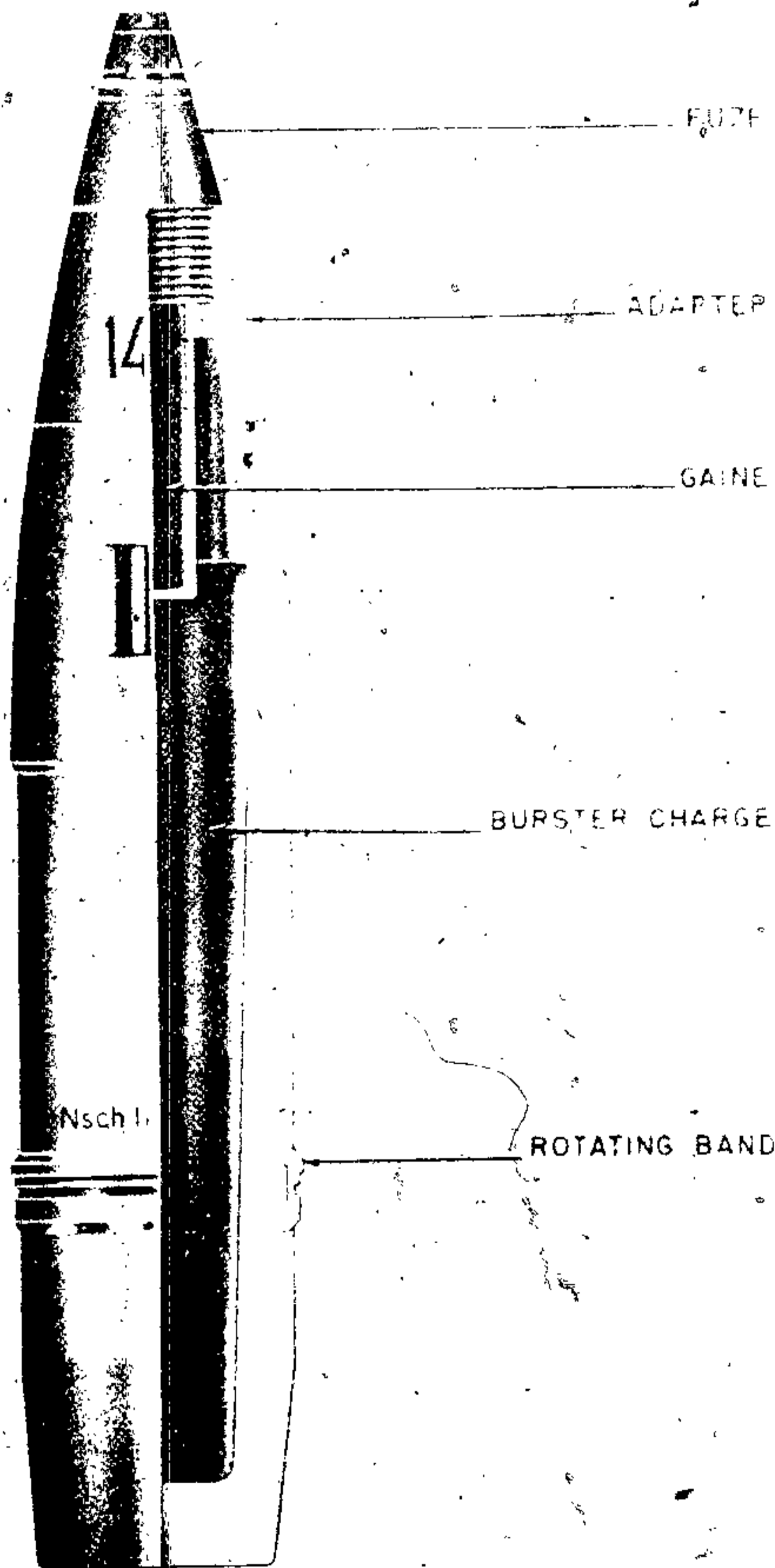

Figure 421—H. E. Projectile for 76.5-mm Gun, 8-cm
A. Z. Gr. M 30 (t) or 8-cm A. Z. Gr. 30 (t)

GERMAN EXPLOSIVE ORDNANCE

WEAPONS:

Czech Field Gun: 8-cm F. K. 30 (t), Model 30.

PROJECTILE:

Caliber: 76.5 mm.

Kind: Shell.

Type: H. E.

Weight (loaded and fuze): 18.2 pounds.

Color: Machined metal or O. D.

CHARGE:

Number: 14 or TP.

Weight: 2.5 pounds.

Kind: TNT poured.

TRACER: None.

BOOSTER: Integral with fuze.

FUZE:

Nomenclature: A. Z. CHZR (t) or Z. Z. SKHZR (t).

Type: P. D.; P. D.

REMARKS:

NOTE 1. This projectile is of German manufacture for the 8-cm F. K. 30 (t).

NOTE 2.—This projectile may have either German or Czech markings.

A. P. PROJECTILE FOR 83.5-MM GUN.

GERMAN NOMENCLATURE: 9.45-cm Pzgr. (t). (See fig. 422.)

WEAPONS:

Czech A. A. gun: 8.35-cm Flak M/22 (t), Model 22.

PROJECTILE:

Caliber: 83.5 mm.

Kind: Shell.

Type: A. P.

Weight (loaded and fuze): 22 $\frac{1}{3}$ pounds.

Color: Black.

CHARGE:

Number: 16.

Weight: $\frac{1}{3}$ pound.

Kind: TNT poured in aluminum container PETN/WAX (90/10) as exploder.

TRACER: Yes.

BOOSTER: Integral with fuze.

FUZE:

Nomenclature: Bd. Z. f 7.5-cm Pzgr.

Type: B. D.

H. E. PROJECTILE FOR 83.5-MM GUN.

GERMAN NOMENCLATURE: 8.35-cm. Gr. 23/30 (t); 8.35-cm Gr. (t). (See fig. 423.)

WEAPONS:

Czech AA. Gun: 8.35-cm. Flak M/22 (t), Model 22.

PROJECTILE:

Caliber: 83.5-mm.

Kind: Shell.

Type: H. E.

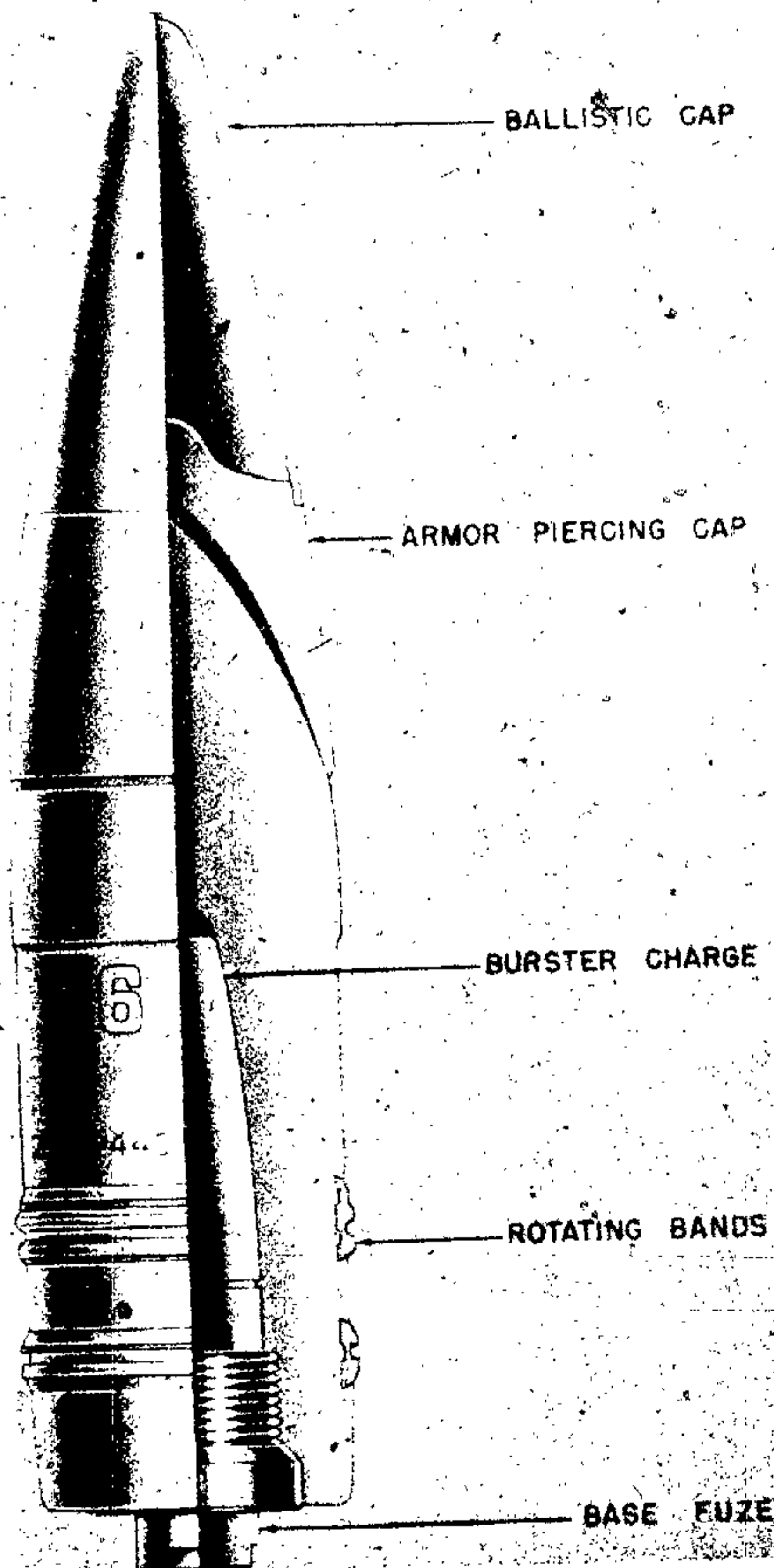

Figure 422—A. P. Projectile for 83.5-mm Gun, 8.35-cm Pzgr. (t)

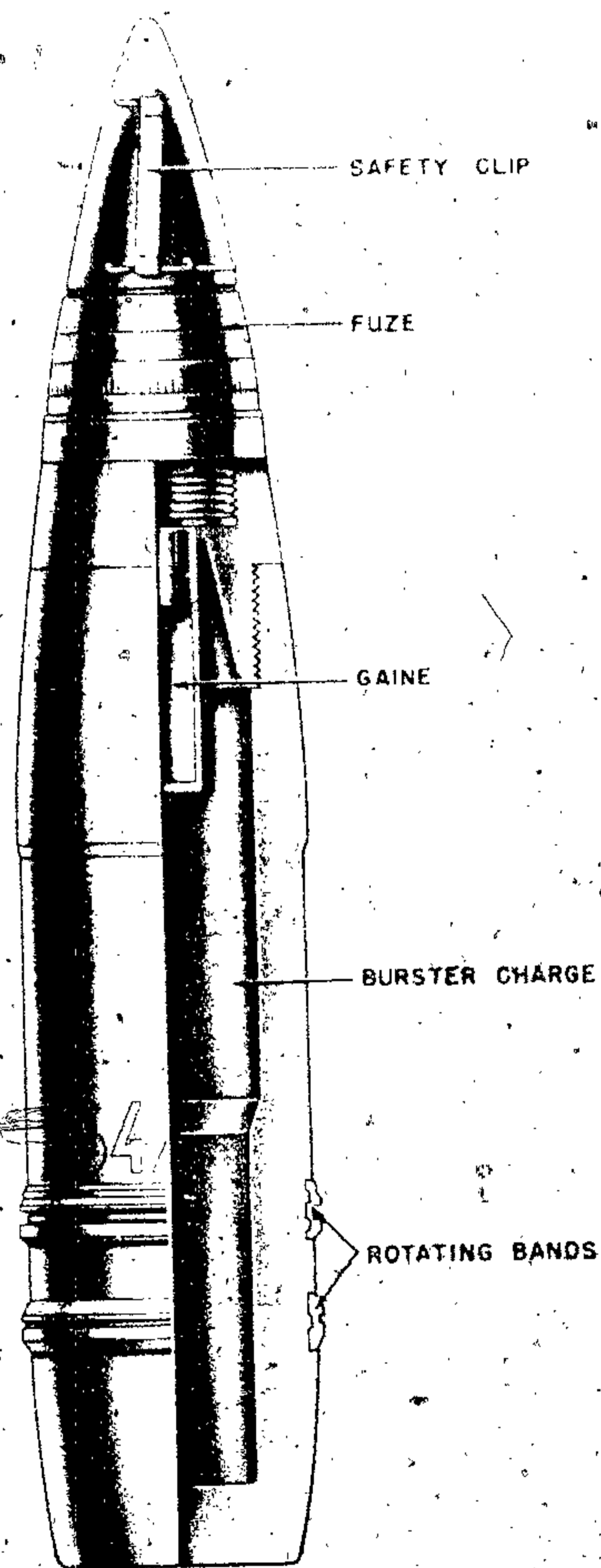

Figure 423—H. E. Shell for 83.5-mm Gun, 83.5-mm Gr. 23/30 (t) or 83.5-mm Gr. (t).

Weight (loaded and fuze): 22.5 pounds.
 Color: Yellow or machined metal with red markings.

CHARGE:

| | | |
|--------|-------------------------------------|--------|
| | CZECH | GERMAN |
| Number | TTRP | 13 |
| Weight | 3.2 pounds. | |
| Kind: | TNT pressed; Amatol (60/40) poured. | |

TRACER: None.

BOOSTER: Integral with fuze.

FUZE:

Nomenclature: Dopp. Z. 23/30 (t).

Type: Time.

REMARKS:

Note. 1.—This projectile may have either Czech or German markings and color.

A. P. C. PROJECTILE, TYPE 39, 88-MM

GERMAN NOMENCLATURE: Pzgr. Patr. 39
 Panzergranate Patrone 39). (See fig. 424.)

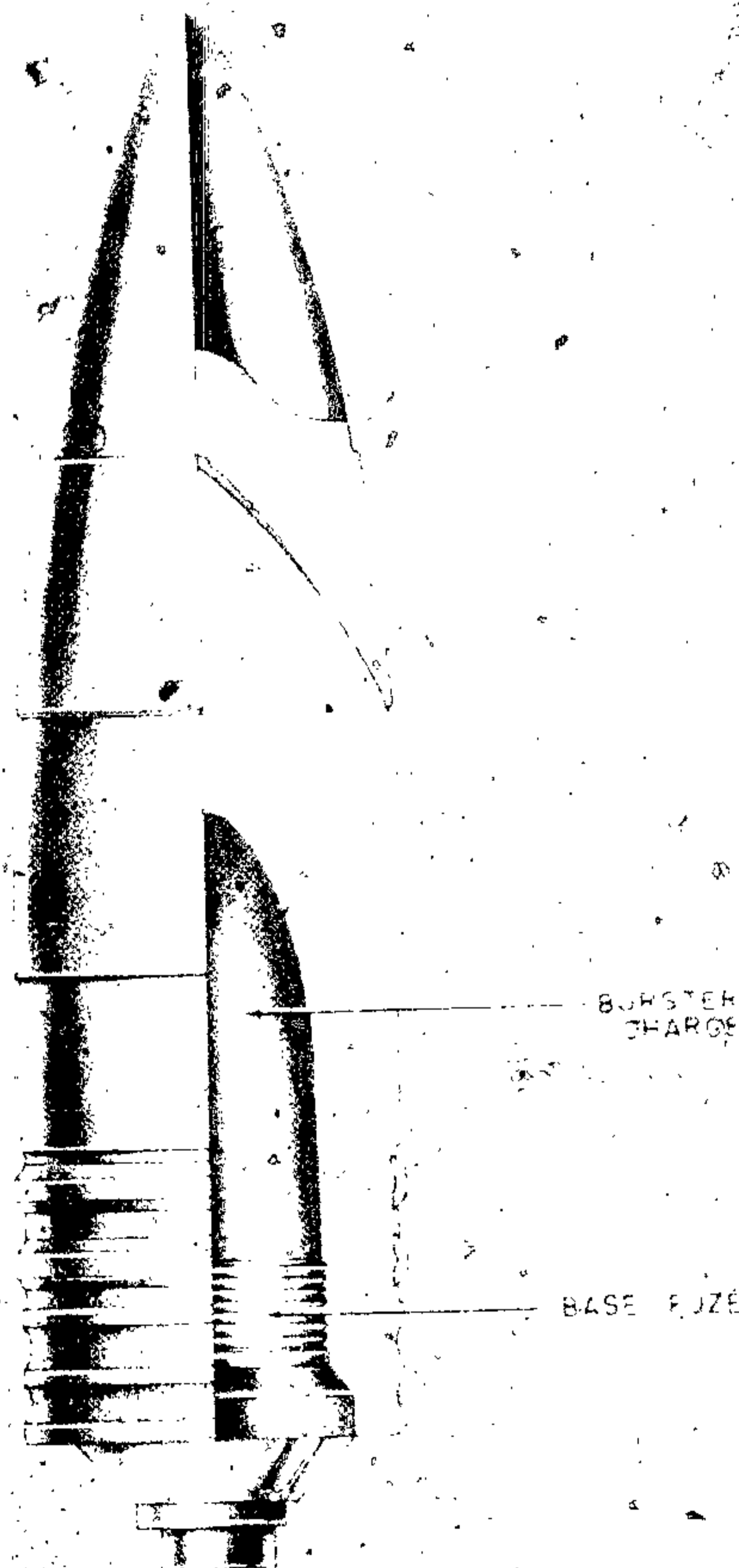

Figure 424—A. P. C. Projectile, Type 39, 88-mm Pzgr. Patr. 39

GERMAN EXPLOSIVE ORDNANCE

EMPLOYMENT: 8.8-cm Flak. 41 (Flugabwehrkanone 41). Antiaircraft Gun 41.

COMPLETE ROUND:

45.5 inches, over-all length.
46.0 pounds, total weight.

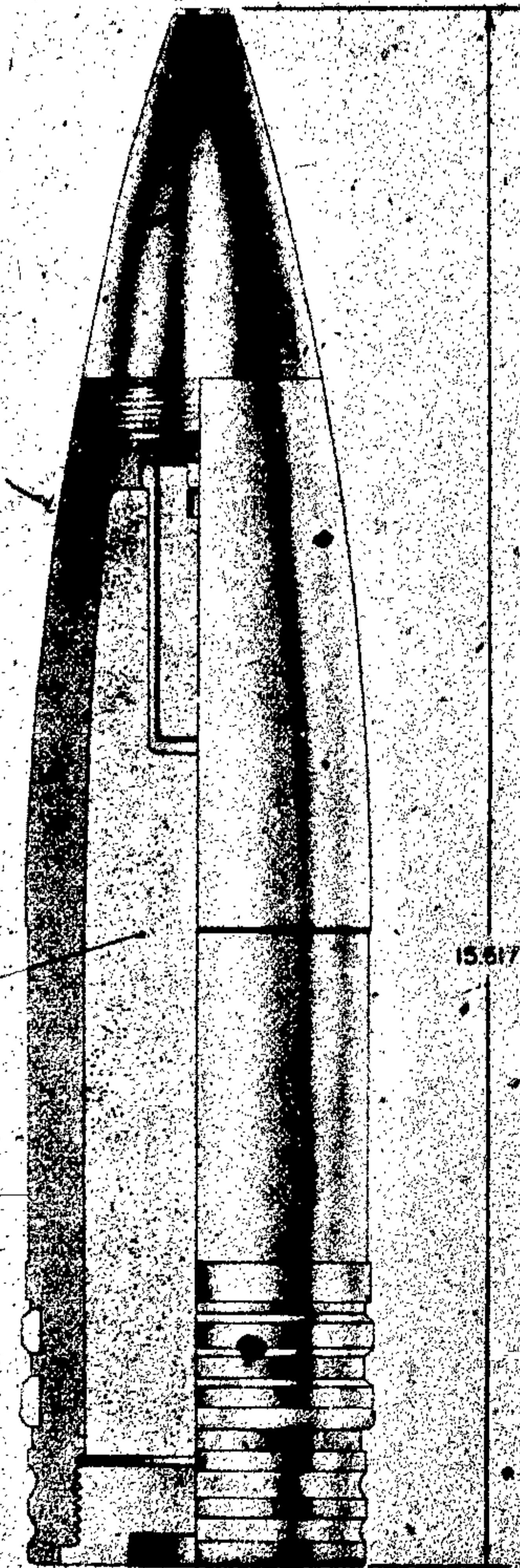

Figure 425—H. E. Projectile, Type L/4.5, 88-mm Sprgr. Patr. L/4.5 (Kz.)

PROJECTILE, painted black with white tip.
13.5 inches, over-all length.
1.937 inches, distance from base to band.
0.469 inch, width of rotating bands.
Two, number of rotating bands.
3.437 inches, diameter of base.
22.44 pounds, total weight.
2.12 ounces, Cyclonite bursting charge.
Tracer present in fuze.

CARTRIDGE CASE (German nomenclature 8.8-cm Flak. 41 (fixed)).
33.687 inches, over-all length.
3.562 inches, diameter of neck.
4.094 inches, diameter of shoulder.
4.844 inches, diameter of base.
11.91 pounds, tubular Gudol propellant.
C/22 primer.

FUZE: Base detonating fuze—Bd. Z. r. 8.8-cm (unmarked).

REMARKS: This is the "small cavity" type of German APCBCHE with Cyclonite bursting charge and a spring-loaded fuze.

H. E. PROJECTILE TYPE L/4.5, 88-MM

GERMAN NOMENCLATURE: Sprgr. Patr. L/4.5 (Kz) (Sprenggranate Patrone Ladung/4.5 [Kopfzunder]). (See fig. 425.)

EMPLOYMENT:

8.8-cm Flak 18 (Flugabwehrkanone 18), Anti-aircraft Gun 18.
8.8-cm Flak 36 (Flugabwehrkanone 36), Anti-aircraft Gun 36.
8.8-cm Flak 37 (Flugabwehrkanone 37), Anti-aircraft Gun 37.

PROJECTILE, painted yellow or green:
15.51 inches, over-all length. 1.375 inches, distance from base to rotating band.
0.531 inch, width of lower rotating band.
0.469 inch, width of upper rotating band.
Two, number of rotating bands.
3.446 inches, diameter of boufretlet.
3.447 inches, diameter of base.
20.35 pounds, total weight.
1.9 pounds, weight of bursting charge.
40/60 Amatol, type of bursting charge.
C/98 booster.
No tracer is present.

CARTRIDGE CASE (German nomenclature 6347 (fixed)):

22.4 inches, over-all length.
 3.625 inches, diameter of neck.
 3.812 inches, diameter of shoulder.
 4.02 inches, diameter of base.
 11.625 pounds, weight of case.
 5.03 pounds, weight of propellant.
 Tubular Diglycol, type of propellant.
 C/12 nA primer.

FUZE: Nose percussion fuze—A. Z. 23/28 or
 Mechanical time fuze—Zt. Z. 3/30.

PACKAGING:

Three rounds in wicker basket—123.0 pounds.
 One round in metal cylinder—47.3 pounds.

REMARKS: All three weapons employ the same cartridge case.

There are two types of this projectile. One has a screwed-in base plate and a bursting charge in a cardboard container. The other has a solid base and is poured filled.

A. P. PROJECTILE FOR 88-MM ANTITANK GUN

GERMAN NOMENCLATURE: 8.8-cm Pzgr. Patr. 41 (Panzergranate Patrone 41). (See fig. 426.)

EMPLOYMENT:

8.8-cm Flak 36 (Flugabwehrkanone 36), Anti-aircraft Gun 36.
 8.8-cm Flak 41 (Flugabwehrkanone 41), Anti-aircraft Gun 41.

PROJECTILE: 13.0 inches, over-all length without fuze.

1.375 inches, distance from rotating bands to base.
 0.48 inch, width of rotating bands.
 3.45 inches, diameter of base.
 22.8 pounds, total weight.

CARTRIDGE CASE (German nomenclature 8.8 cm Flak 41):

33.625 inches, over-all length.
 3.55 inches, diameter of neck.
 4.1 inches, diameter of shoulder.
 4.65 inches, diameter of base.
 5.38 kg, weight of propellant.
 Type of propellant—Tubular Diglycol.
 C/22 electric primer.

FUZE: Bd. Z. 5127.

A. P. PROJECTILE WITH TUNGSTEN CARBIDE CORE (TYPE 40), 88-MM

GERMAN NOMENCLATURE: 8.8-cm Pzgr. 40 (Panzergranate 40). (See Fig. 427.)

EMPLOYMENT:

8.8-cm Flak 36 (Flugabwehrkanone 36), Anti-aircraft Gun 36.
 8.8-cm Flak 36 (Flugabwehrkanone 36), Anti-aircraft Gun 41.

COMPLETE ROUND: Description of c/r is for Flak 36. 33.99 inches, over-all length.

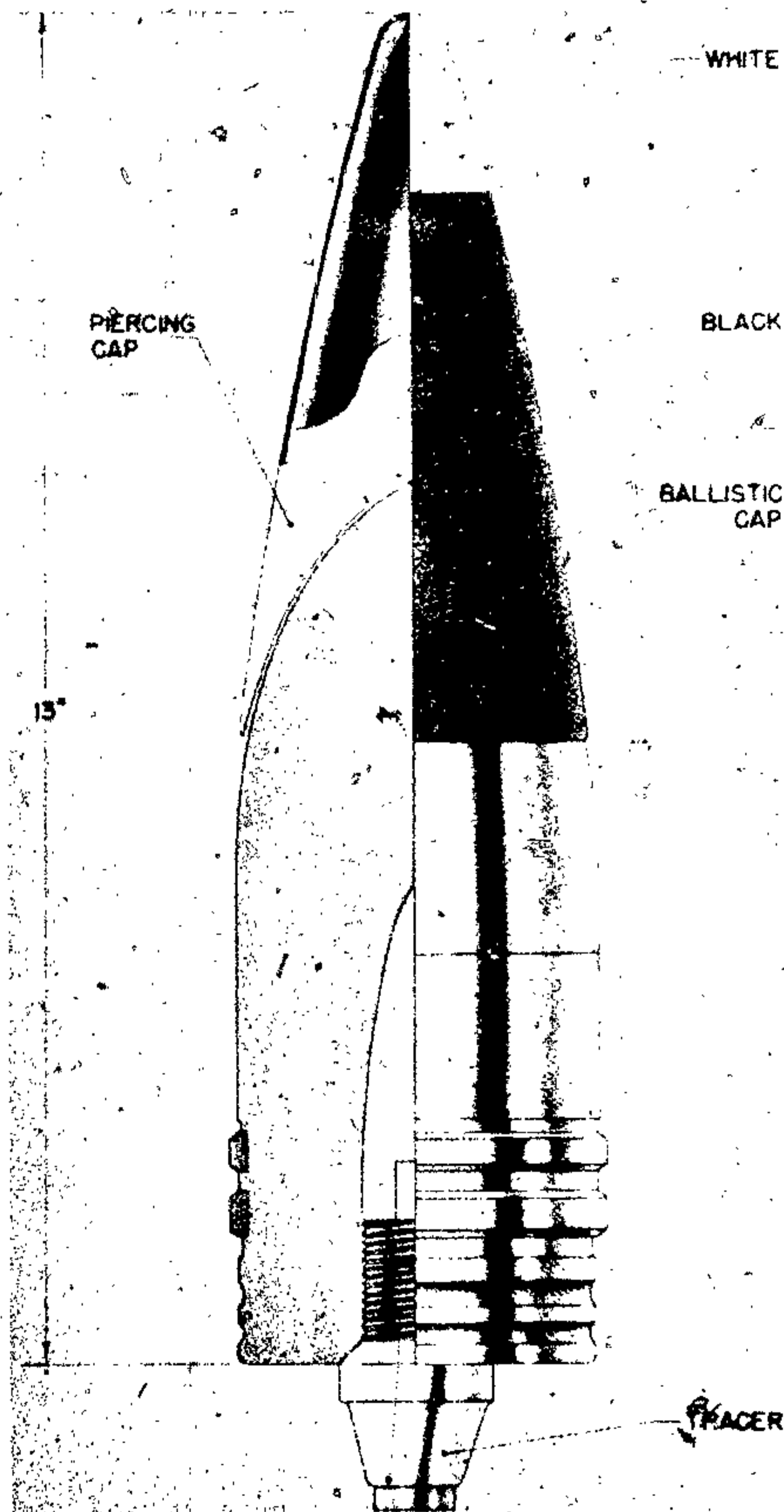

Figure 426—A. P. Projectile for 88-mm Antitank Gun, 8.8-cm Pzgr. Patr. 41

GERMAN EXPLOSIVE ORDNANCE

HEAD AND CAP

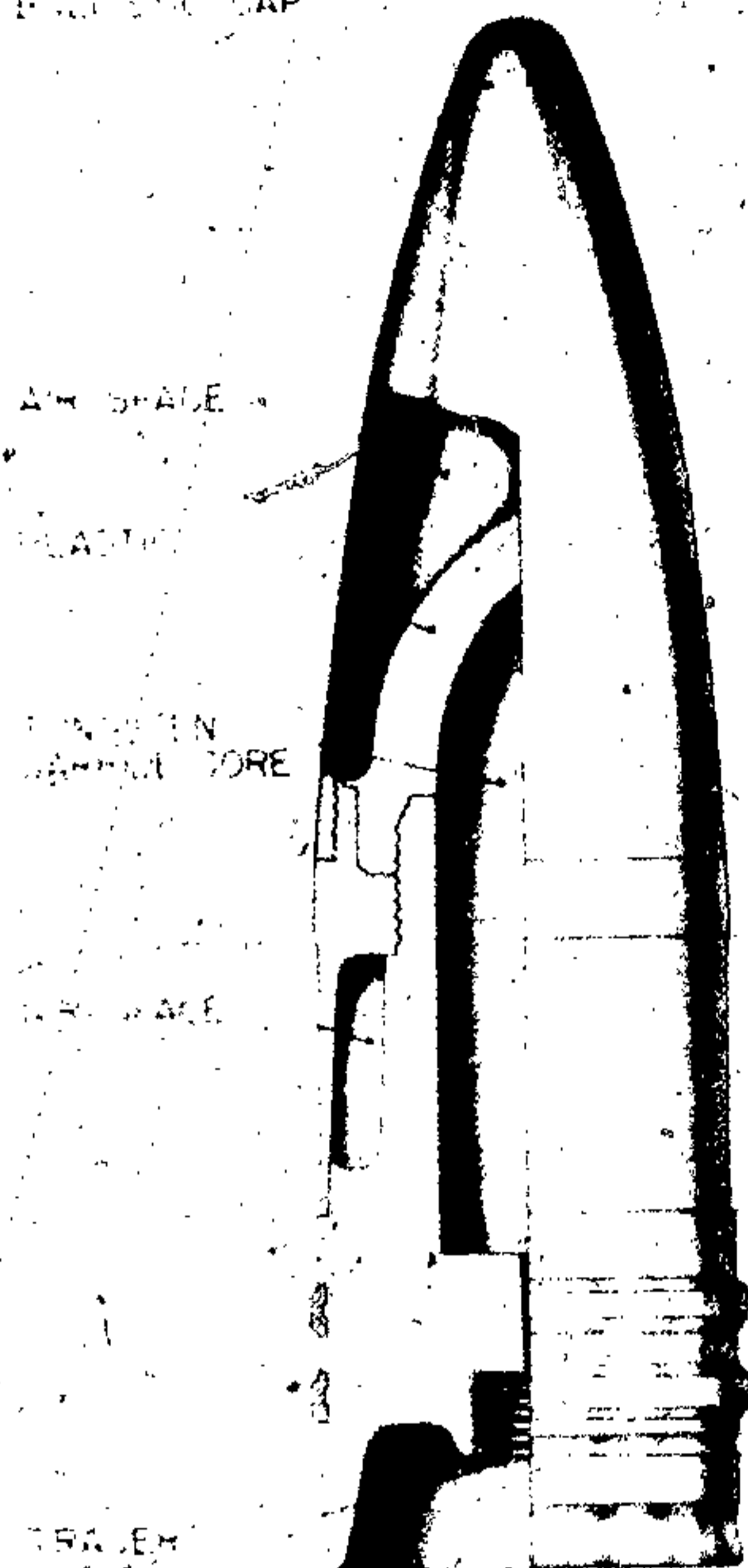

Figure 427—A. P. Projectile with Tungsten Carbide Core (Type 40), 88-mm, 8.8-cm Pzgr. 40

PROJECTILE, painted black:

- 12.75 inches, over-all length.
- 1.166 inches, distance from base to band.
- 0.437 inch, width of rotating bands.
- Two, number of rotating bands.
- 3.437 inches, diameter of bourrelet.
- 3.562 inches, diameter of base.
- 5.437 inches, length of tungsten carbide core.
- 1.406 inches, diameter of core.
- 4.25 pounds, weight of core.
- 16.0 pounds, total weight.
- Tracer is present in base of projectile.

CARTRIDGE CASE (German nomenclature.

- .6347 (fixed) :
- 22.4 inches, over-all length.
- 3.625 inches, diameter of neck.
- 3.812-inches, diameter of shoulder.
- 4.02 inches, diameter of base.
- 11.625 pounds, weight of case.

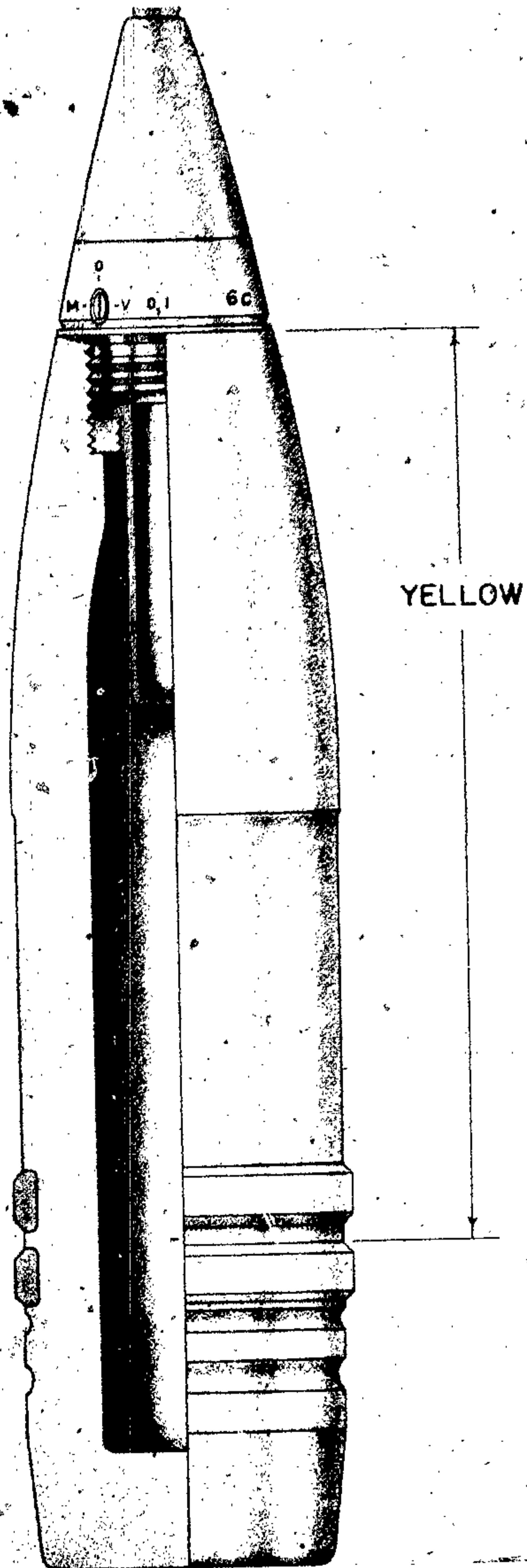

Figure 428—H. E. Projectile, Type L/4.7, 88-mm Sprgr. Patr. L/4.7 FES

Diglycol, type of propellant.
C/22 electric primer.

FUZE: No fuze is employed.

REMARKS: The cartridge case employed, for Flak 41 is "8.8-cm Flak 41" (fixed).

H. E. PROJECTILE, TYPE L/4.7, 88-MM

GERMAN NOMENCLATURE: Sprgr. Patr. L/4.7 FES (Sprenggranate Patrone Ladung/4.7 FES). (See fig. 428.)

EMPLOYMENT:

- 8.8-cm Flak 41 (Flugabwehrkanone 41), Anti-aircraft Gun 41.
- 8.8-cm Flak 43 (Flugabwehrkanone 43), Anti-aircraft Gun 43.

COMPLETE ROUND (description of c/r is for Flak 41):

- 47.0 inches, over-all length.
- 46.42 pounds, total weight.

PROJECTILE, painted yellow:

- 16.35 inches, over-all length.
- 2.905 inches, distance from base to rotating band.
- 0.51 inch, width of rotating bands—soft iron.
- Two, number of rotating bands.
- 3.425 inches, diameter of bourrelet.
- 3.031 inches, diameter of base.
- 20.68 pounds, total weight.
- 1.9 pounds, 40/60 Amatol bursting charge.

CARTRIDGE CASE (German nomenclature 8.8-cm Flak 41 (fixed)):

- 33.387 inches, over-all length.
- 3.562 inches, diameter of neck.
- 4.094 inches, diameter of shoulder.
- 4.844 inches, diameter of base.
- Tubular Gudol propellant.
- C/22 electric primer.

FUZE: Nose percussion fuze—A. Z. 23/28v or Mechanical time fuze—Zt. Z. s/30.

REMARKS: No information is available on cartridge case for Flak 43.

A. P. C. PROJECTILE FOR A. A. GUN 18, 88-MM

GERMAN NOMENCLATURE: Pzgr. Patr. m. Bd. Z. (Panzergranate Patrone mit Boden Zunder). (See fig. 429.)

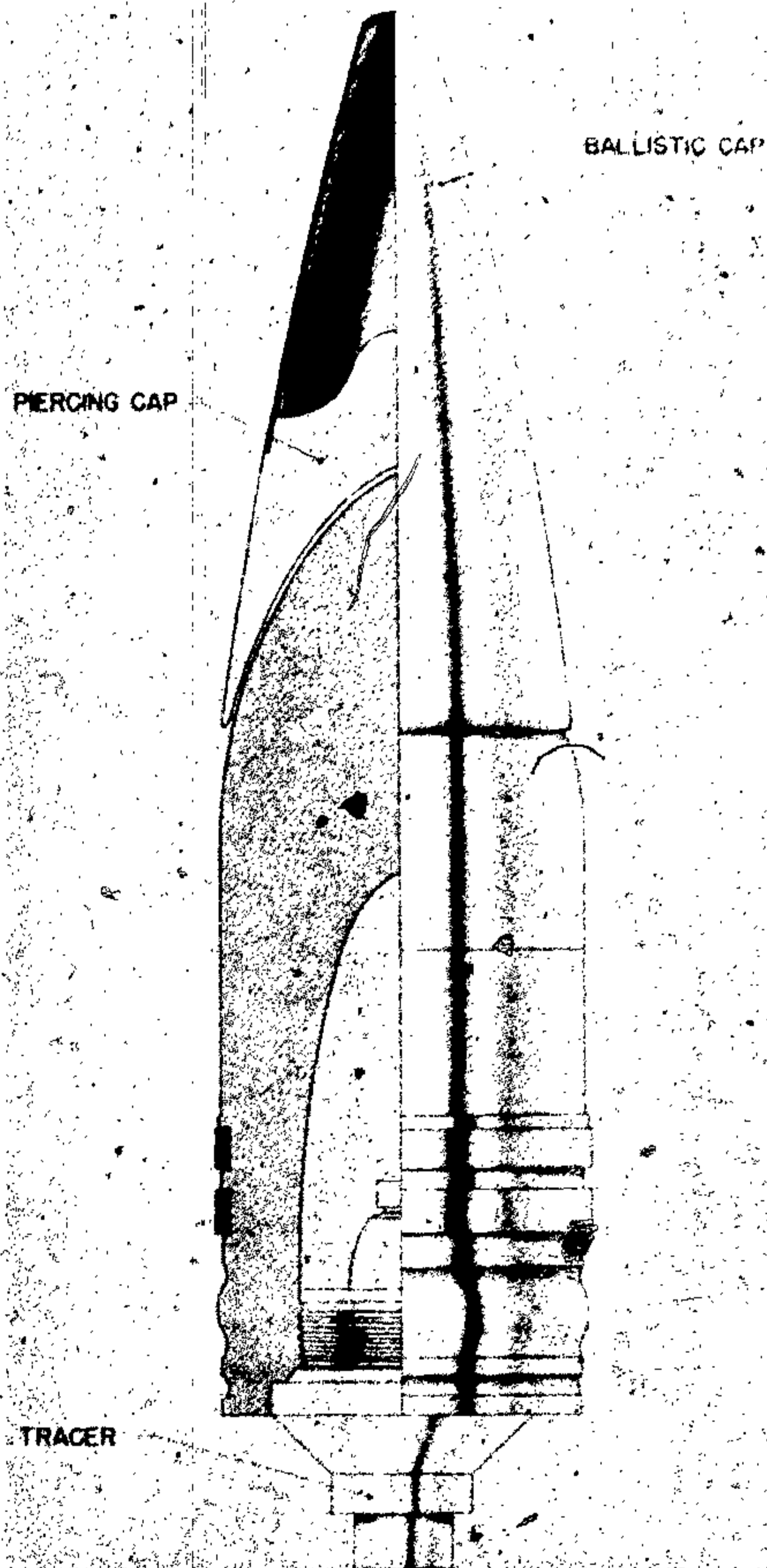

Figure 429—A. P. C. Projectile for A. A. Gun 18, 88-mm Pzgr. Patr. m. Bd. Z.

EMPLOYMENT:

- 8.8-cm Flak 18 (Flugabwehrkanone 18), Anti-aircraft Gun 18.
- 8.8-cm Flak 36 (Flugabwehrkanone 36), Anti-aircraft Gun 36.
- 8.8-cm Flak 37 (Flugabwehrkanone 37), Anti-aircraft Gun 37.

COMPLETE ROUND:

- 34.25 inches, over-all length.
- 35.2 pounds, total weight.

GERMAN EXPLOSIVE ORDNANCE

PROJECTILE painted black:

- 13.25 inches, over-all length.
- 0.469 inch, width of bimetallic rotating bands.
- Two, number of rotating bands.
- 3.437 inches, diameter of base.
- 20.75 pounds, total weight.
- 5.5 ounces, weight of bursting charge.
- TNT/WAX, type of bursting charge.
- Tracer is present in fuze.

CARTRIDGE CASE (German nomenclature 6347 (fixed)):

- 22.4 inches, over-all length.
- 3.625 inches, diameter of neck.
- 3.812 inches, diameter of shoulder.
- 4.02 inches, diameter of base.
- 5.65 pounds, weight of propellant.
- Tubular Diglycol, type of propellant.

FUZE: Base detonating fuze—Bd. Z. f. 8.8-cm.

PACKAGING: Three rounds to a wicker basket.
One round to a metal container.

REMARKS: This projectile is the large cavity design of German A. P. C.

H. E. PROJECTILE FOR 88-MM GUN

GERMAN NOMENCLATURE: 8.8-cm Sprgr. 43. (See fig. 430.)

WEAPONS:

- German Tank Gun: 8.8-cm kw. K. 43.
- German Assault Gun: 8.8-cm Stu. K. 43 (L/71).
- German Antitank Gun: 8.8-cm Pak. 43, 43/41 (L/71).

PROJECTILE:

- Caliber: 88 mm.
- Kind: Shell.
- Type: H. E.
- Weight (loaded and fuzed): 21 pounds.
- Color: O. D.

CHARGE:

- Number: 13.
- Weight: 2¼ pounds.
- Kind: Amatol 60/40 poured.

TRACER: None.

BOOSTER: Zdlg. Np. 10.

FUZE:

- Nomenclature: A. Z. 23/28 (0.15); Dopp. Z.
- Type: P. D.; T. and P.

A. P. PROJECTILE FOR 88-MM GUN

GERMAN NOMENCLATURE: 8.8-cm Pzgr. 39/43. (See fig. 431.)

WEAPONS:

- German Antitank Gun: 8.8-cm Pak. 43.
- German Antitank Gun: 8.8-cm Pak. 43/41 (L/71).
- German Tank Gun: 8.8-cm Kw. K. 43.
- German Assault Gun: 8.8-cm Stuka 43 (L/71).

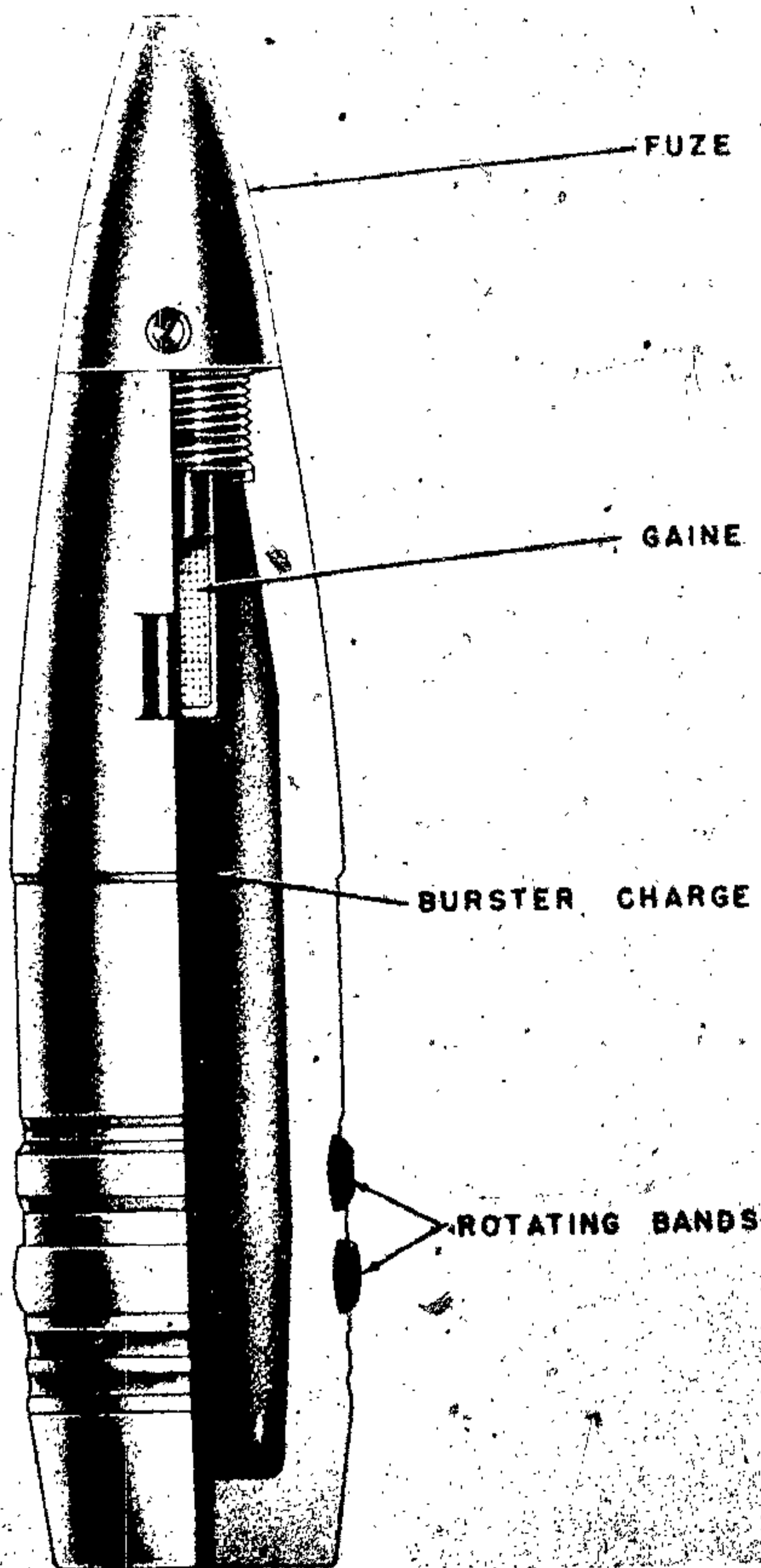

Figure 430—H. E. Shell for 88-mm Gun, 8.8-cm Sprgr. 43

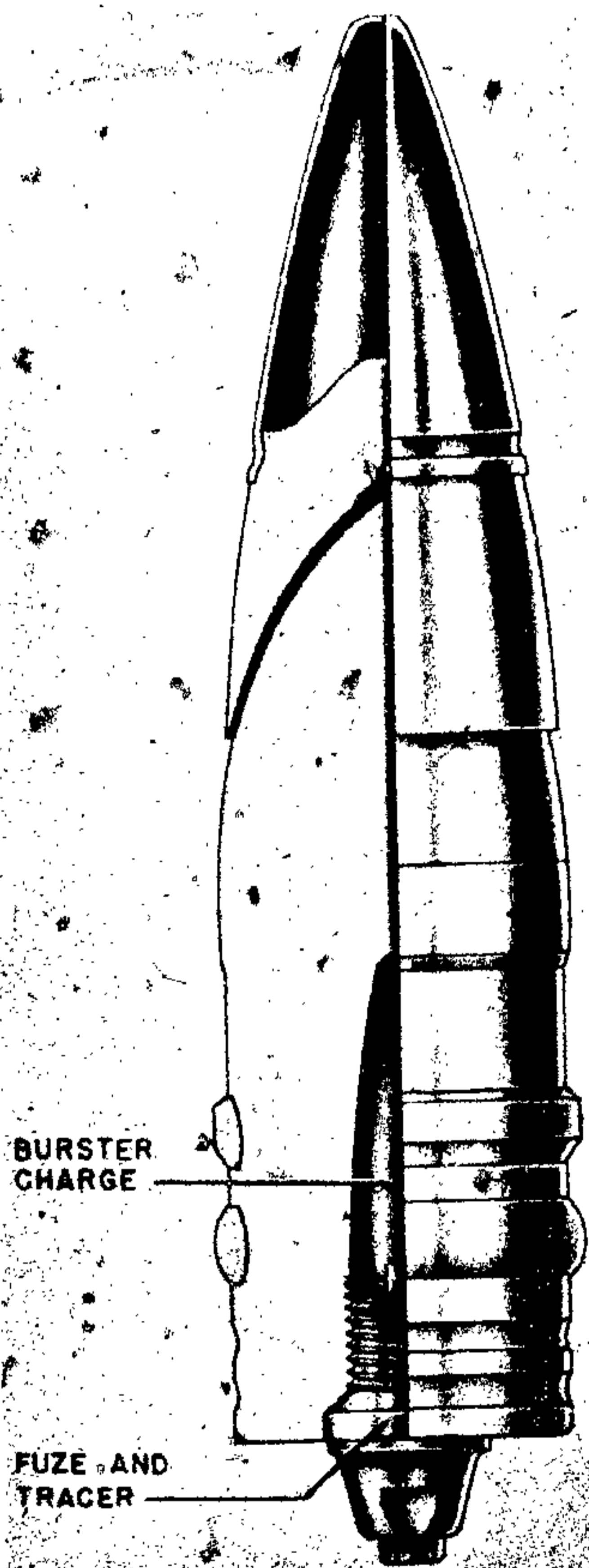

Figure 431—A. P. Projectile for 88-mm Gun, 8.8-cm Pzgr. 39/43

PROJECTILE:

Caliber: 88 mm.
 Kind: Shell.
 Type: Armor piercing.
 Weight (loaded and fuzed): 22.8 pounds.
 Color: Black with white nose.

CHARGE:

Number: 92.
 Weight: 0.3 pound.
 Kind: Cyclonite/wax (990/10) pressed in blocks wrapped in waxed paper.

TRACER: Yes, in fuze.
 BOOSTER: Integral with fuze.
 FUZE:
 Nomenclature: Bd. Z. 5127.
 Type: B. D.

H. E. PROJECTILE FOR 88-MM GUN

GERMAN NOMENCLATURE: 8.8-cm Sprgr. Flak 41. (See fig. 432.)

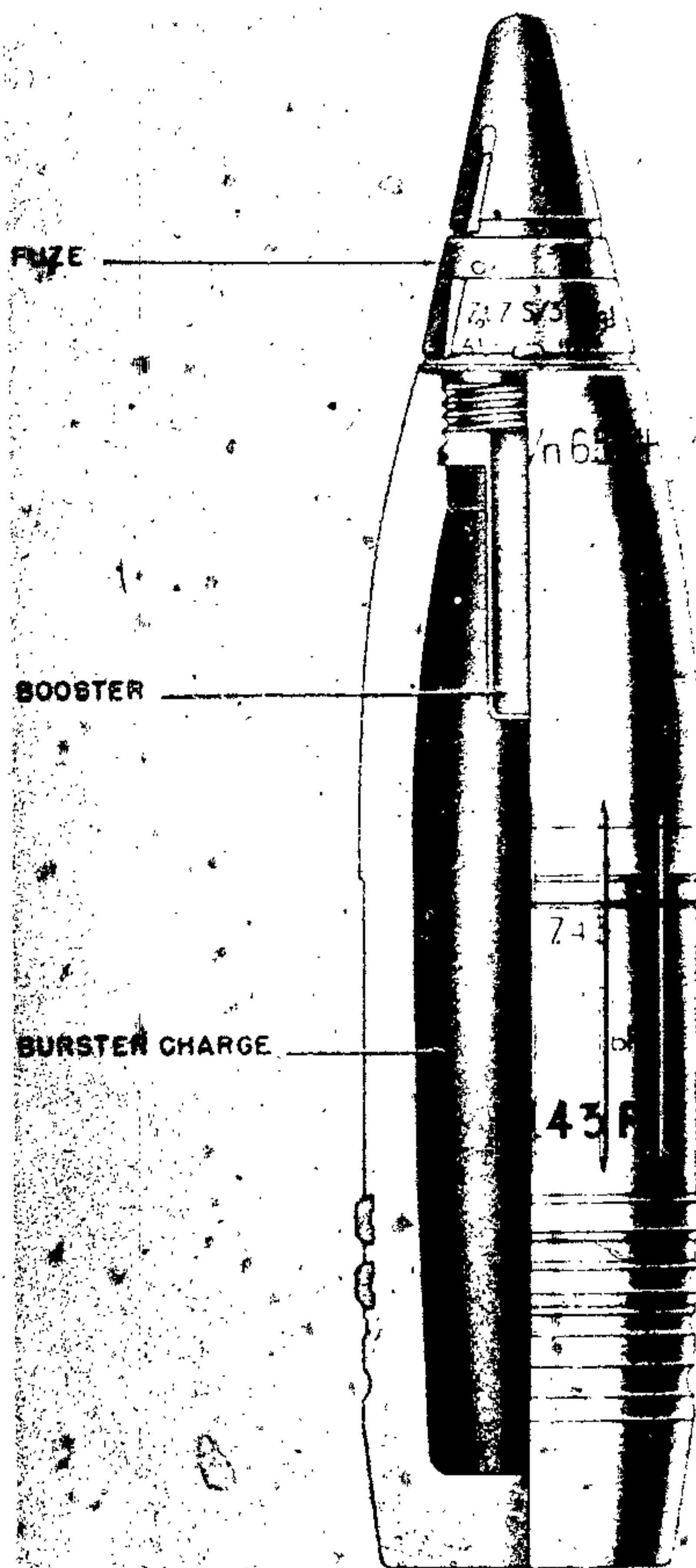

Figure 432—H. E. Projectile for 88-mm Gun, 8.8-cm Sprgr. Flak 41

GERMAN EXPLOSIVE ORDNANCE

WEAPONS:

German A. A. Gun: 8.8-cm Flak 41.

PROJECTILE:

Caliber: 88 mm.

Kind: Shell.

Type: H. E.

Weight (loaded and fuzed): 20½ pounds.

Color: Yellow with black markings.

CHARGE:

Number: 13.

Weight: 11½ pounds.

Kind: Amatol 60/40 poured.

TRACER: None.

BOOSTER: Np 10.

FUZE:

Nomenclature: Zt. Z. S/30 Fg¹.

Type: Time.

REMARKS:

NOTE 1.—FES rotating band.

NOTE 2.—Controlled fragmentation.

HOLLOW CHARGE PROJECTILE FOR 88-MM TANK GUN

GERMAN NOMENCLATURE: 8.8-cm Gr. 39 H. L. (See fig. 433.)

WEAPONS:

German Tank Gun: 8.8-cm Kw. K 36 (L/56).

PROJECTILE:

Caliber: 88 mm.

Kind: Shell.

Type: Hollow charge.

Weight (loaded and fuzed): 17 pounds.

Color: O. D.

CHARGE:

Number: 91.

Weight: 2 pounds.

Kind: Cyclonite/wax (95/5) pressed in blocks wrapped in waxed paper.

TRACER: Yes.

BOOSTER: None.

FUZE:

Nomenclature: A. Z. 38.

Type: P. D.

H. E. PROJECTILE FOR 88-MM GUN

GERMAN NOMENCLATURE: 8.8-cm Sprgr., L/4.5. (See fig. 434.)

WEAPONS:

German Tank Gun: 8.8-cm Kw. K 36.

German A. A. gun: 8.8-cm Flak 18.

German A. A. Gun: 8.8-cm Flak 36.

German A. A. Gun: 8.8-cm Flak 37.

Modified Russian A. A. Gun: 18.5/8.8-cm Flak 39 (r).

PROJECTILE:

Caliber: 88 mm.

Kind: Shell.

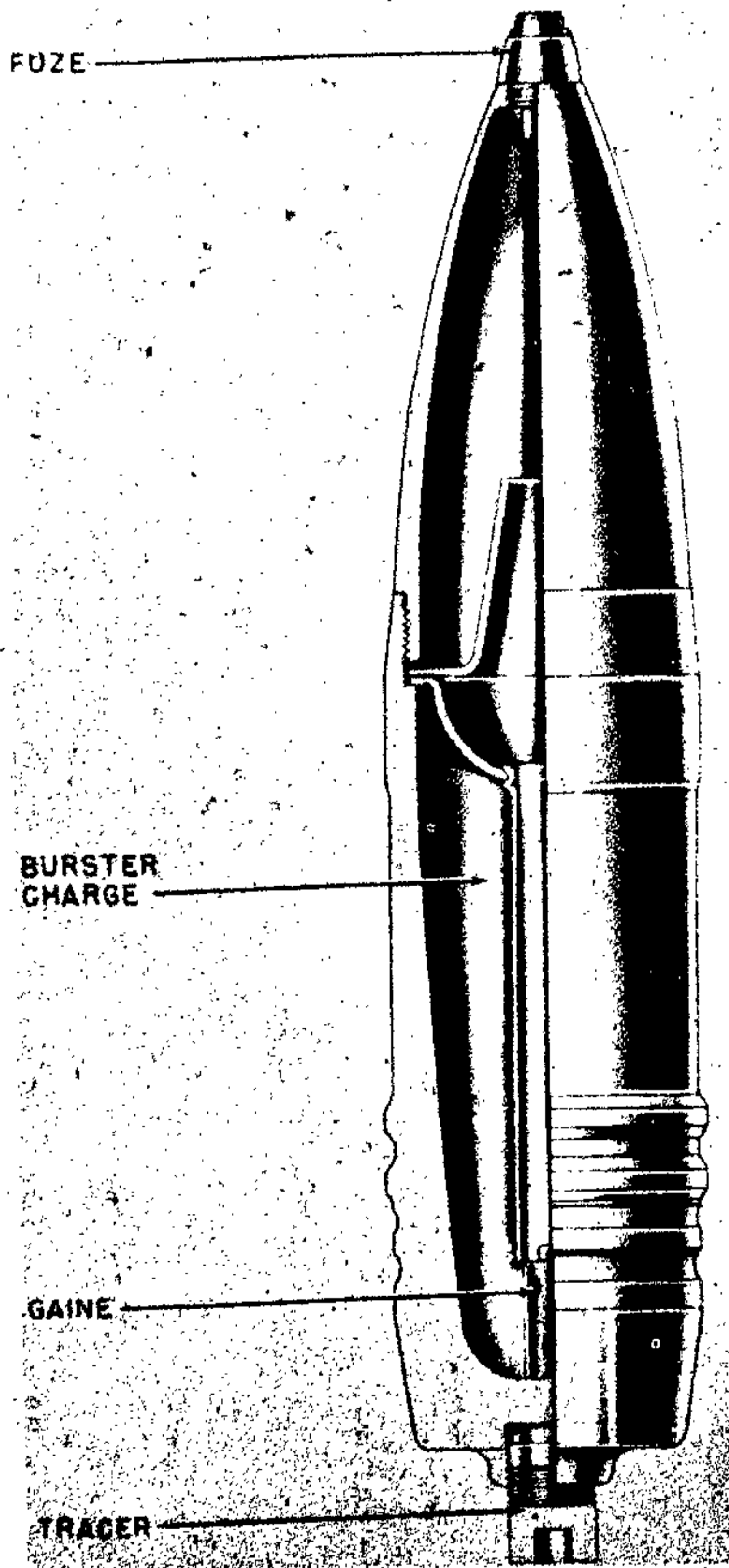

Figure 433—Hollow Charge Projectile for 88-mm Tank Gun, 8.8-cm Gr. 39 H.L.

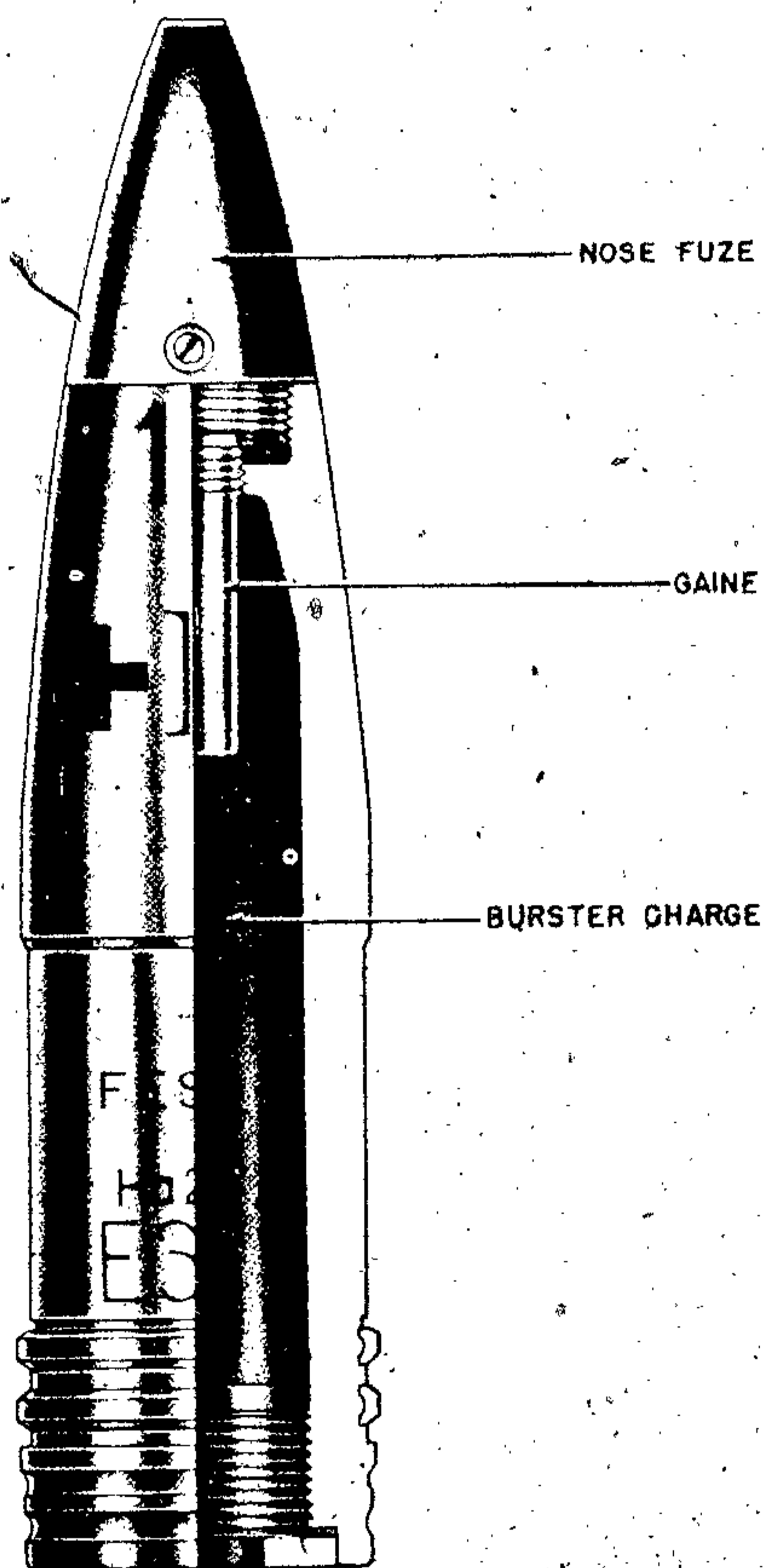

Figure 434—H. E. Shell for 88-mm Gun, 8.8-cm Sprgr. L/4.5

Type: H. E.
Weight (loaded and fuzed): 20.5 pounds.
Color: Yellow.

CHARGE:

Number: 13.
Weight: 2 pounds.
Kind: Amatol 60/40 poured.

TRACER: None.

BOOSTER: Wlf Np 10.

FUZE:

Nomenclature: A. Z. 23/28.
Type: P. D.

REMARKS:

NOTE 1.—FES rotating band.

HIGH EXPLOSIVE PROJECTILE FOR 88-MM A. A. GUNS

GERMAN NOMENCLATURE: 8.8-cm Sprgr. L/4.5 Zt. Z (Controlled Fragmentation). (See fig. 435.)

WEAPONS:

German Tank Gun: 8.8-cm Kw. K. 36 (L/56).

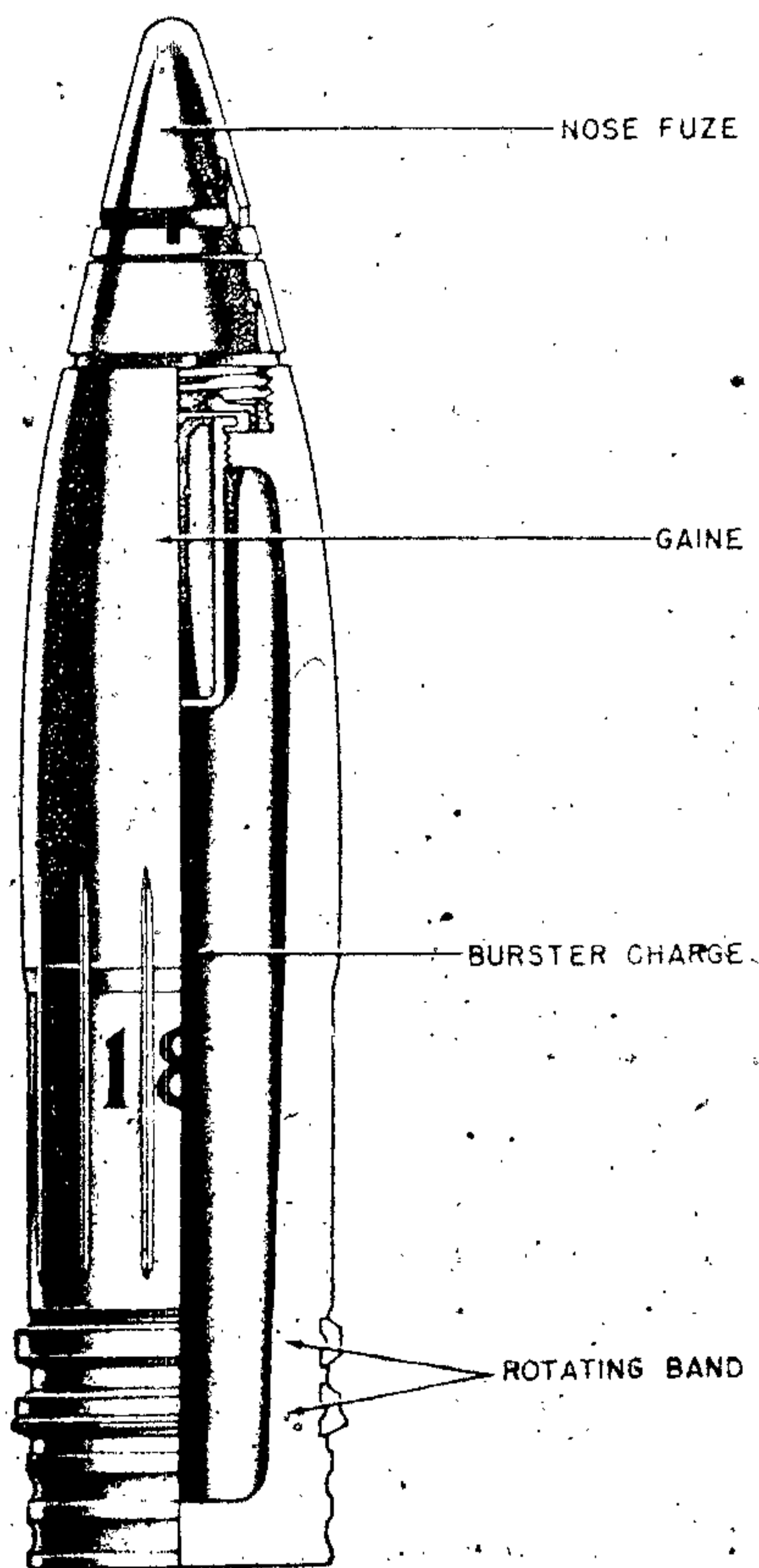

Figure 435—High-Explosive Projectile for 88-mm A. A. Guns, 8.8-cm Sprgr. L/4.5 Zt.Z.

GERMAN EXPLOSIVE ORDNANCE

German A. A. Gun (Modified Russian) : 8.5/8.8-
cm Flak 39 (r).
German A. A. Guns 8.8-cm Flak 18, 36, 37.

PROJECTILE:

Caliber: 88 mm.
Kind: Shell.
Type: H. E.
Weight (loaded and fuzed) : 21 pounds.
Color: Yellow.

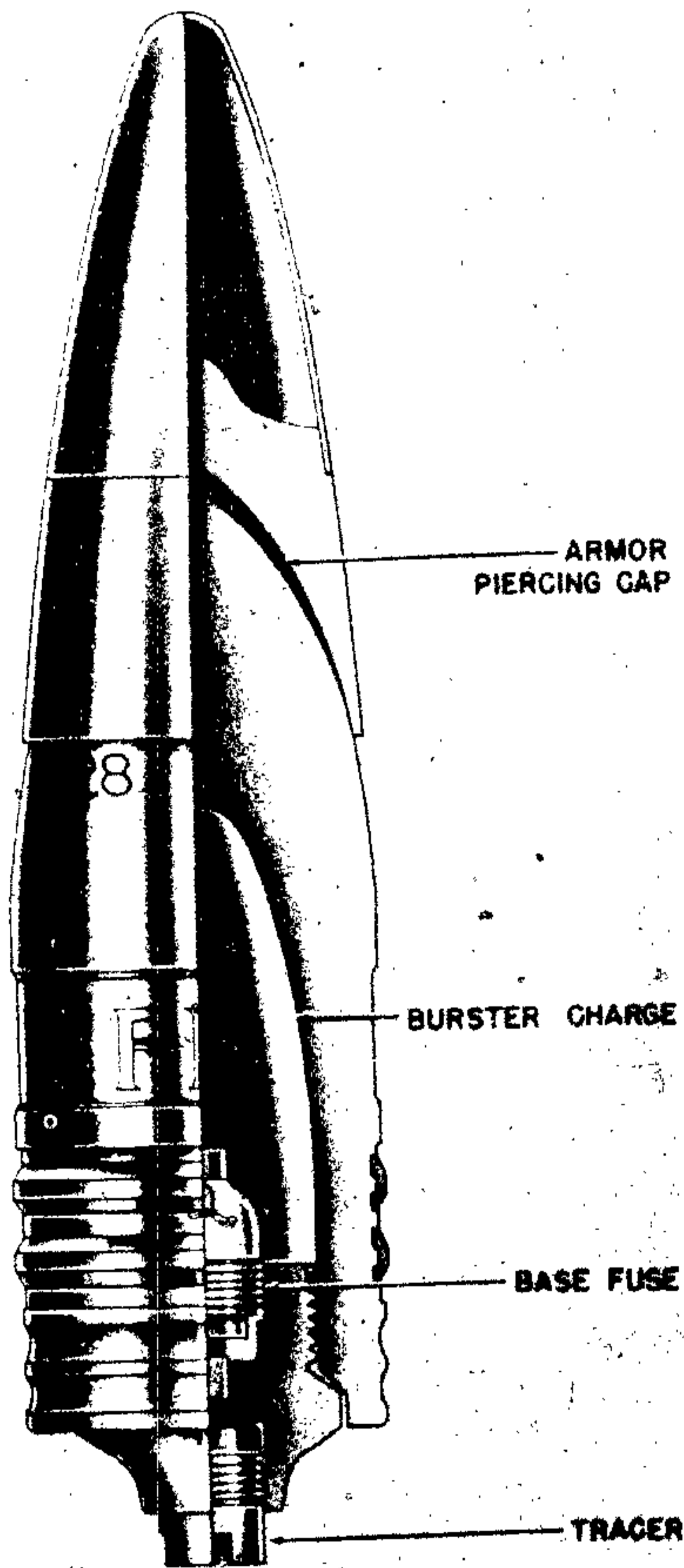

Figure 436—Armor-Piercing Projectile for 88-mm
Gun, 8.8-cm Pzgr.

CHARGE:

Number: 13.
Weight: 2 pounds.
Kind: Amatol 60/40 poured.

TRACER: None.

BOOSTER: Gr. Zdlg. C/98 Np.

FUZE:

Nomenclature: Zt. Z. S/30.
Type: Time.

REMARKS:

NOTE 1.—Shell has a circumferential groove just to rear of bourrelet, and 15 longitudinal grooves, equally spaced, extending from rotating band to just forward of bourrelet. Assumed purpose of grooves is to control fragmentation. Grooves may vary slightly between different shells.

NOTE 2.—Rotating bands for this shell may be KPS or soft steel (FES), with two different contours.

ARMOR PIERCING PROJECTILE FOR 88-MM GUN

GERMAN NOMENCLATURE: 8.8 cm Pzgr.
(See fig. 436.)

WEAPONS:

German A. A. Guns: 8.8-cm Flak 18, 36, 37.
German A. A. Gun (Modified Russian) 8.5, 8.8-
cm Flak 39 (r).

PROJECTILE:

Caliber: 88 mm.
Kind: Projectile.
Type: Armor-piercing.
Weight: 21 pounds (loaded and fuzed).
Color: Black with red markings.

CHARGE:

Number: 28.
Weight: 1/3 pound (approximately).
Kind: TNT/WAX (90/10) and PETN/WAX
(90/10) pressed in blocks in aluminum con-
tainer.

TRACER: Yes, but no number.

BOOSTER: Integral with charge.

FUZE:

Nomenclature: Bd. Z. f. 8.8-cm Pzgr.
Type: B. D.

A. P. PROJECTILE FOR 88-MM A. A. GUN

GERMAN NOMENCLATURE: 8.8-cm Pzgr.
39/1. (See fig. 437.)

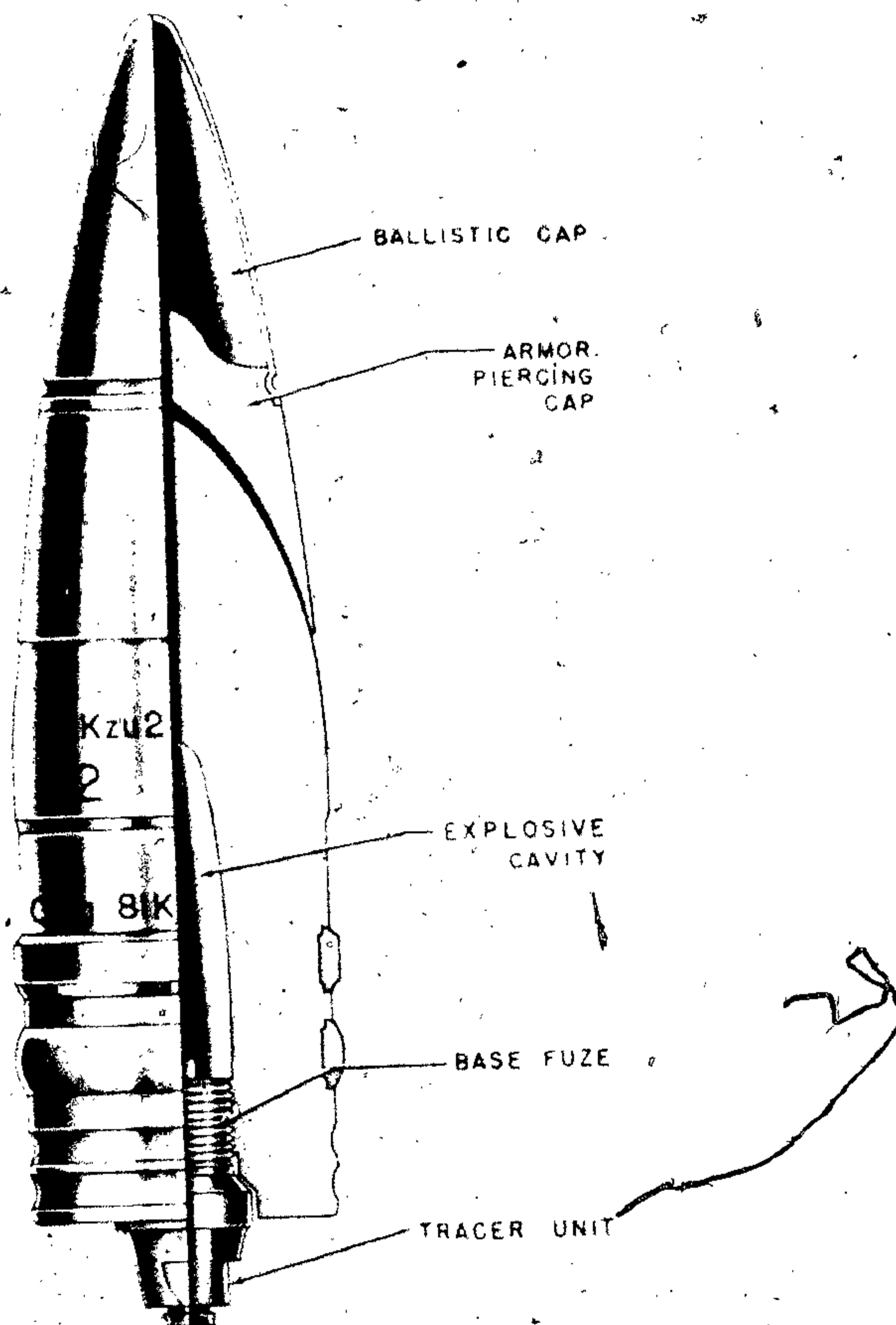

Figure 437—A. P. Projectile for 88-mm Gun, 8.8-cm Pzgr. 39/1

WEAPONS:

- German Antitank Gun: 8.8-cm Pak. 43.
- German Antitank Gun (self propelled): 8.8-cm Pak. 43/41 (L/71).
- German Tank Gun: 8.8-cm Kw. K. 43.
- German Antitank Gun (Self propelled): 8.8-cm Stu. K. 43 (L/71).

PROJECTILE:

- Caliber: 88 mm.
- Kind: Projectile.
- Type: A. P.

Weight: 22½ pounds (loaded and fuzed).
Color: Black with red markings and white tip at nose.

CHARGE:

- Number: 92.
- Weight: 1½ pound.
- Kind: Cyclonite/wax (90/10) pressed in blocks, wrapped in waxed paper.

TRACER: Yes. Marked "E".

BOOSTER: Integral with charge.

GERMAN EXPLOSIVE ORDNANCE

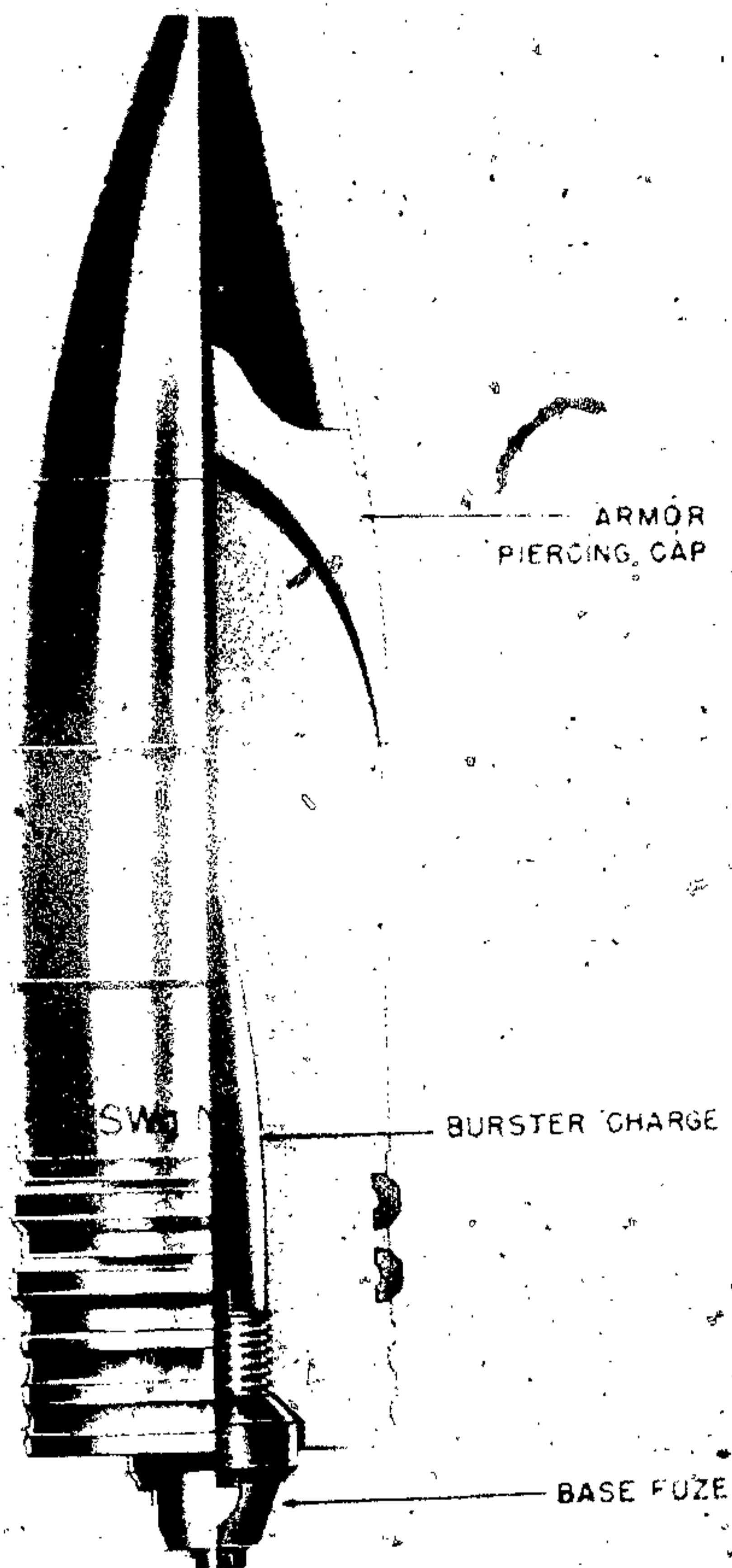

Figure 438—A. P. Projectile for 88-mm Gun, 8.8-cm Pzgr. 39

FUZE:

Nomenclature: Bd. Z. 5127.
Type: B. D.

REMARKS: FES rotating band.

ARMOR PIERCING PROJECTILE FOR 88-MM GUNS

GERMAN NOMENCLATURE: 8.8-cm Pzgr. 39. (See fig. 438.)

WEAPONS:

German A. A. Guns: 8.8-cm Flak 18, 36, 37.

German Tank Gun: 8.8-cm Kw. K. 36 (L/56).
German A. A. Gun (Modified Russian): 8.5/8.8-cm Flak 39 (r).

PROJECTILE:

Caliber: 88 mm.
Kind: Projectile.
Type: Armor-piercing.
Weight: 22 pounds (loaded and fuzed).
Color: Black with red markings.

CHARGE:

Number: 92.
Weight: 1/4 pound.
Kind: Cyclonite/wax (90/10) pressed in blocks wrapped in wax paper.

TRACER: Yes, marked "AB."

BOOSTER: Integral with charge.

FUZE:

Nomenclature: Bd. Z. 5103 or Bd. Z. 5103/1.
Type: B. D.

INCENDIARY SHRAPNEL PROJECTILE FOR 88-MM A. A. GUN

GERMAN NOMENCLATURE: 8.8-cm Gr. Br. Schr. Flak. (See fig. 439.)

WEAPONS:

German Antiaircraft Gun:
8.8-cm Flak 18.
8.8-cm Flak 36.
8.8-cm Flak 37.

PROJECTILE:

Caliber: 88 mm.
Kind: Shell.
Type: Incendiary shrapnel.
Weight: 20 pounds (loaded and fuzed).
Color:

Body—blue, ogive—red.
Fuze—unpainted with green tip.

EXPELLING CHARGE:

Weight: 2 ounces (approximately).
Kind: Smokeless powder.

BURSTING CHARGE:

Number:
Weight: 4 ounces (approximately).
Kind: TNT or Amatol and Wax pressed in pellets.

INCENDIARY CHARGE:

Dimensions:
Length: 144 inches.
Diameter: 0.58 inch.
Number of pellets: 72.

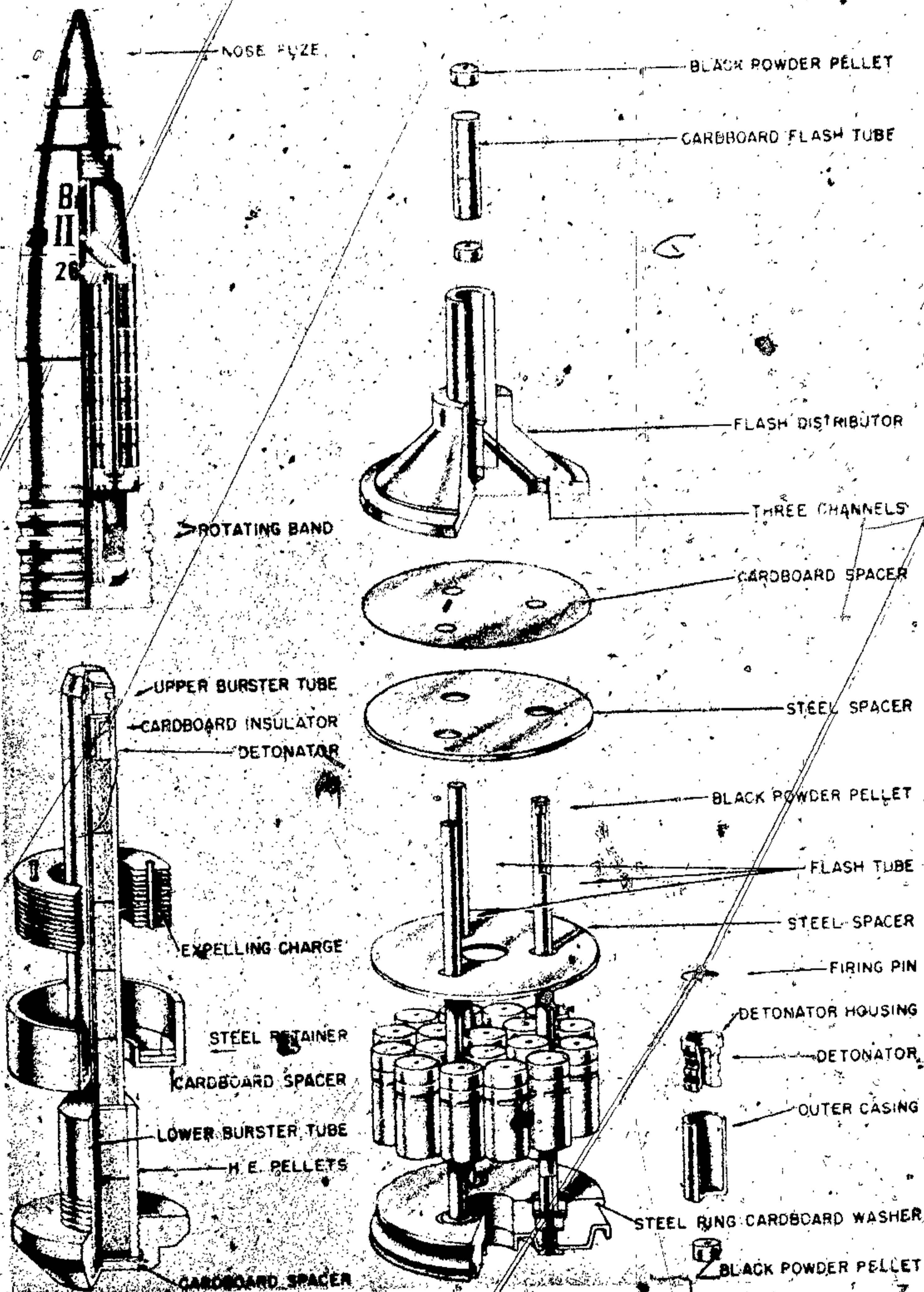

Figure 439—Incendiary Shrapnel Shell for 88-mm A. A. G. H. 8.8-cm Gr. Br. Schr. Flak

Composition:

- Barium nitrate, 48 percent.
- Magnesium alloy, 24.6 percent.
- Aluminum alloy, 24.6 percent.
- Acid insoluble, 2.8 percent.

TRACER: None.

BOOSTER: None.

FUZE:

Nomenclature: Zt. Z. S/30 Kurz.

Type: Time.

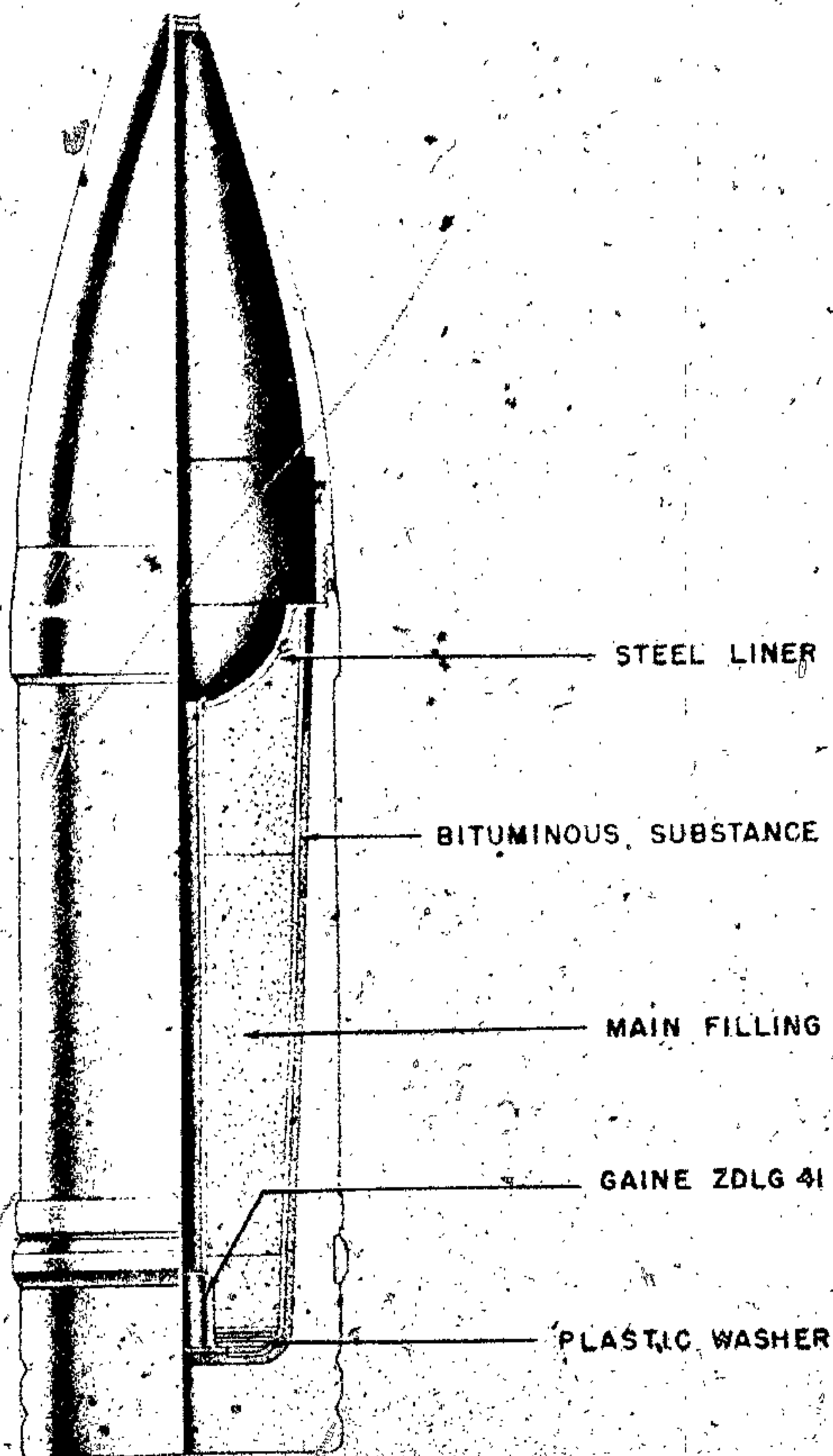

Figure 440—Hollow Charge Projectile, 100-mm, 10-cm 39 Rot H1/B 1FH 18

H1/B HOLLOW CHARGE PROJECTILE 10-CM

GERMAN NOMENCLATURE: 39 rot H1/B
1FH 18 (Sprengladung). (See fig. 440.)

PROJECTILE: 18.9 inches, over-all length.

Semispherical cone,
Steel cavity liner.

Filling, RDX, 95.1 percent; Wax, 4.9 percent.

U.S. A. Z. 38.

PERFORMANCE: Performance against homogeneous
155-mm (static) 100-mm (dynamic).

Label on shipping box: Sprengladung d.10-cm.
Gr. 39 H1/B, Versch. H5 42 cwg 91 541/42.

H1/C HOLLOW CHARGE PROJECTILE 10-CM

GERMAN NOMENCLATURE: 39 rot H1/C
1FH 18 (Sprengladung). (See fig. 441.)

PROJECTILE: 18.9 inches, over-all length

Semispherical cone.

Steel cavity liner.

Filling, RDX, 95.1 percent; Wax, 4.9 percent.

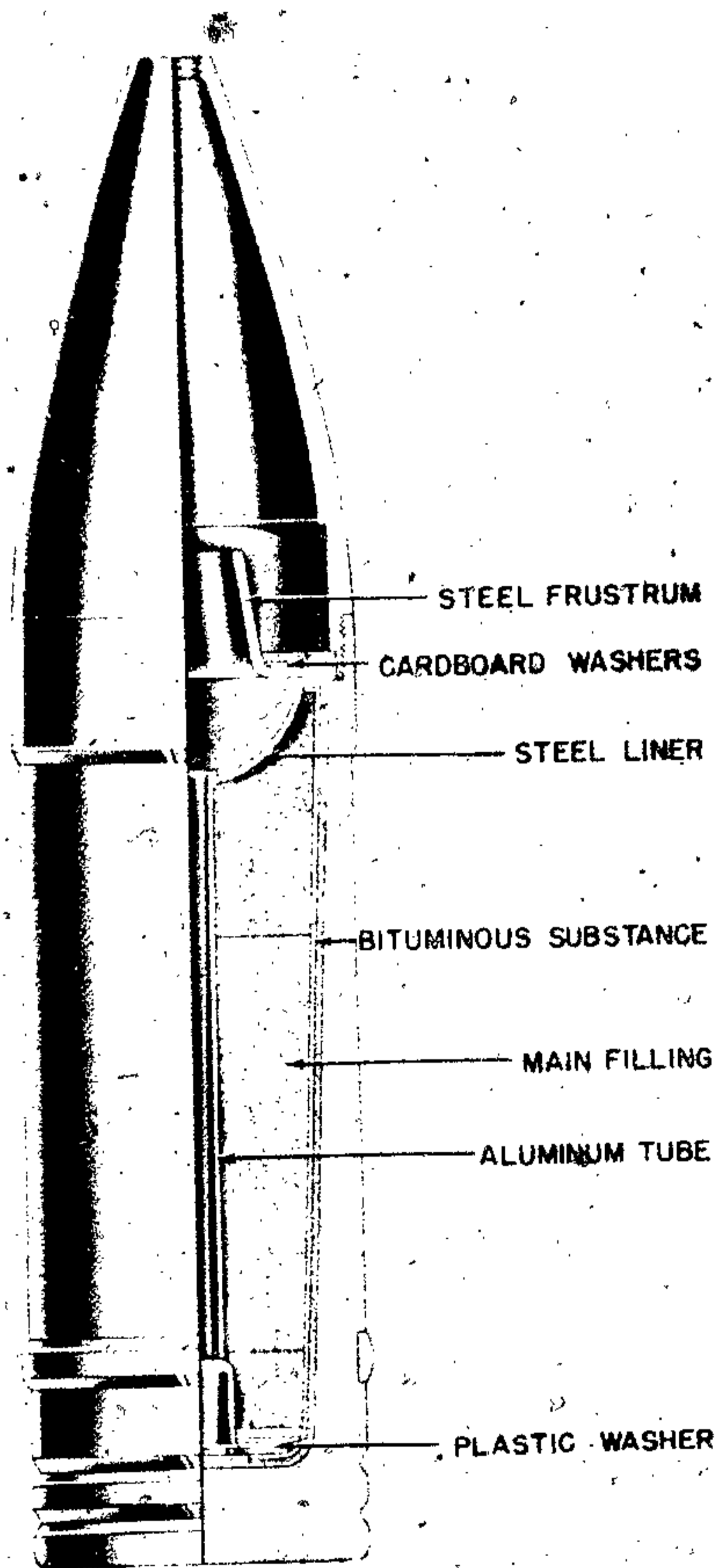

Figure 441—H. E. Hollow Charge Projectile,
100-mm, 10-cm 39 Rot H1/C 1FH 18

FUZE: A. Z. 38.

REMARKS: Performance against homogeneous armour; 155-mm (static) 100-mm (dynamic). Label on shipping box: Sprengladung d.10-cm Gr. 39 H1/B; Versch. H5 42, cwg 91 55/43.

H. E. PROJECTILE FOR 100-MM HOWITZER

GERMAN NOMENCLATURE: 10-cm Dopp. Z. Gr. M. 21 (t) or 10-cm Dopp. Z. Gr. 21 (t). (See fig. 442.)

WEAPONS:

- Czech Light Field Howitzer: 10-cm le. F. H. 14/19 (t), Model 14/19.
- Polish Light Field Howitzer: 10-cm le. F. H. 14/19 (p), Model 14/19.
- Jugoslav Light Field Howitzer: 10-cm le. F. H. 316 (j), Model 14/10 (Skoda).
- Jugoslav Light Field Howitzer: 10-cm le. F. H. 317 (j), Model 28 (Skoda).

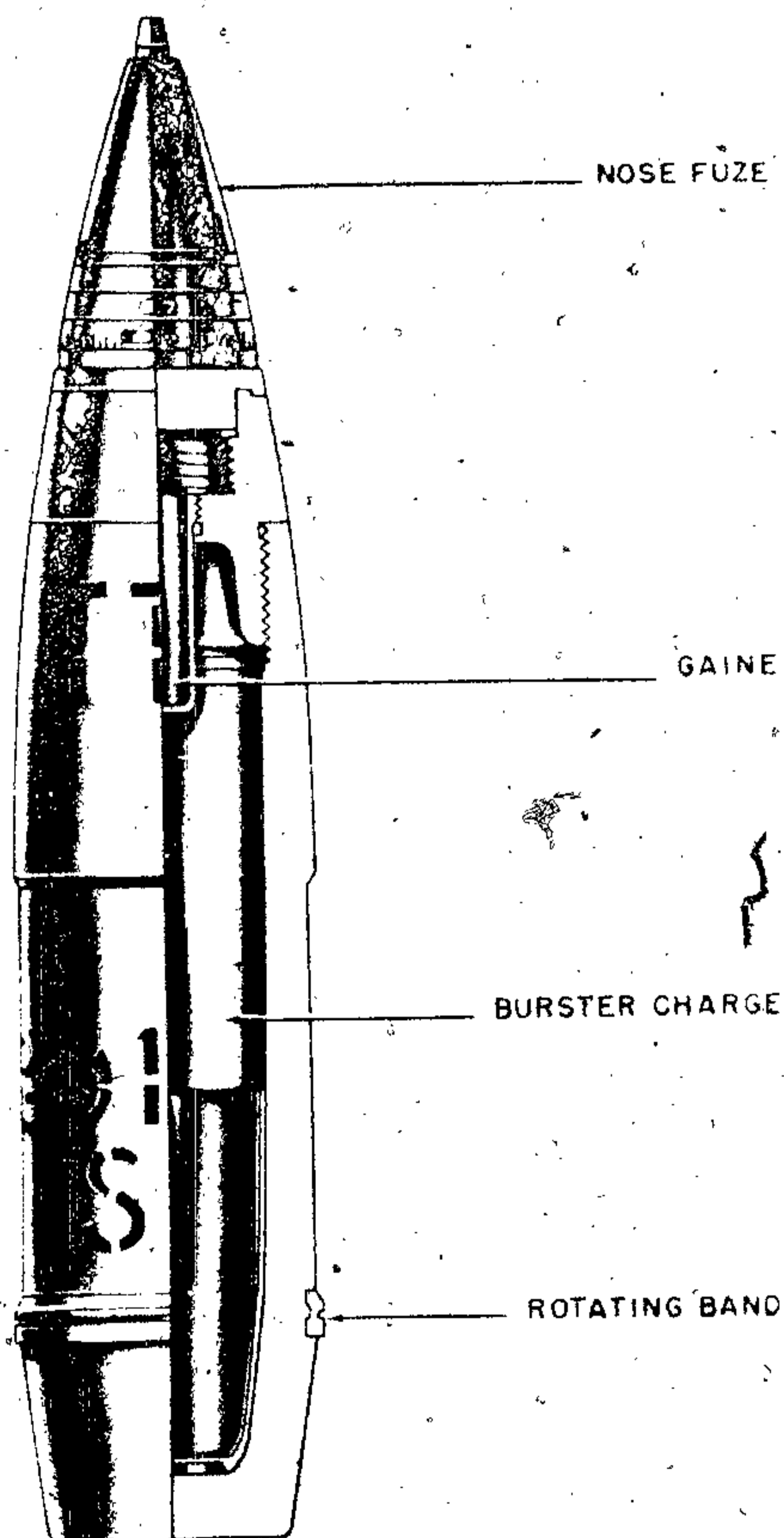

Figure 442—H. E. Projectile for 100-mm Howitzer,
10-cm Dopp. Z. Gr. M. 21 (t)

GERMAN EXPLOSIVE ORDNANCE

PROJECTILE:

Caliber: 100 mm.
Kind: Shell.
Type: H. E.
Weight: 35.3 pounds (loaded and fuzed).
Color: Machined metal with red markings.

CHARGE:

Number: TTR.
Weight: 3.5 pounds.
Kind: TNT pressed.

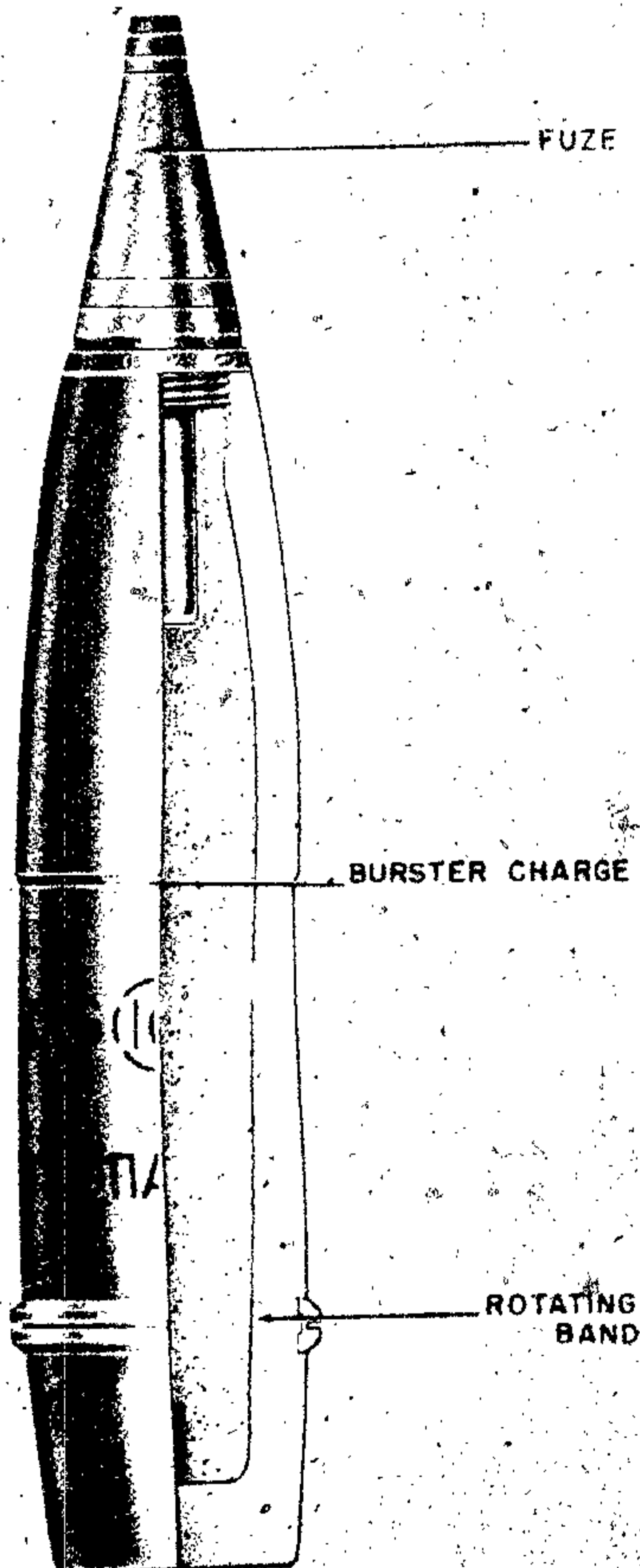

Figure 443—H. E. Projectile for 100-mm Howitzer,
10-cm Sprgr. (Dopp. Z.) 311 (j)

TRACER: None.

BOOSTER: Integral with fuze.

FUZE:

Nomenclature: Dopp. Z. 21 (t).
Type: T. and P.

REMARKS:

NOTE 1.—Red band around body of projectile at ogive indicates T. and P. fuze.

NOTE 2.—This round may also be fired from the 10-cm Geb. H. M. 16/19 (t) which is a Czech mountain Howitzer.

H. E. PROJECTILE FOR 100-MM HOWITZER

GERMAN NOMENCLATURE: 10-cm Sprgr.
(Dopp. Z.) 311 (j). (See fig. 443.)

WEAPONS:

Jugoslav Light Field Howitzer: 10-cm le. F. H.
317/1 (j), Model 28 (Skoda).
Jugoslav Mountain Howitzer: 10-cm Geb. H.
317/2, Model 28 (Skoda).
Czech Light Field Howitzer: 10-cm le. F. H.
14/19 (t), Model 14/19.
Polish Light Field Howitzer: 10-cm le. F. H.
14/19 (p), Model 14/19.
Jugoslav Light Field Howitzer: 10-cm le. F. H.
3r6 (t), Model 14/19 (Skoda).

PROJECTILE:

Caliber: 100 mm.
Kind: Shell.
Type: H. E.
Weight: 36.75 pounds (loaded and fuzed).
Color: Yellow—unpainted on the boat tail and
bourellet.

CHARGE:

Number: T.
Weight: 3.50 pounds.
Kind: TNT (?).

TRACER: None.

BOOSTER: Integral with fuze.

FUZE:

Nomenclature: Dopp. Z. VG-Skr (t); Dopp. Z.
VC-Cr (t).
Type: T. and P.; T. and P.

H. E. PROJECTILE FOR 100-MM HOWITZER

GERMAN NOMENCLATURE: 10-cm Sprgr.
(A. Z.) 310 (j). (See fig. 444.)

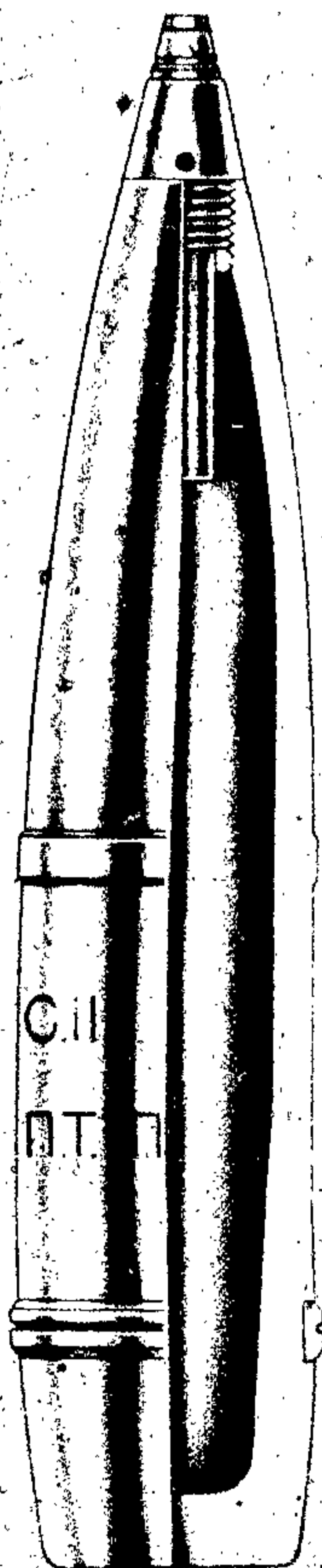

Figure 444—H. E. Projectile for 100-mm Howitzer,
10-cm Sprgr. (A. Z.) 310 (j)

WEAPONS:

- Czech Light Field Howitzer: 10-cm le. F. H. 14/19 (t), Model 14/19.
- Polish Light Field Howitzer: 10-cm le. F. H. 14/19 (p), Model 14/19.
- Yugoslav Light Field Howitzer: 10-cm le. F. H. 316 (j), Model 14/19 (Skoda).
- Yugoslav Light Field Howitzer: 10-cm le. F. H. 317/1 (j), Model 28 (Skoda).
- Yugoslav Mountain Howitzer: 10-cm Geb. H. 317/2 (j), Model 28 (Skoda).

PROJECTILE:

Caliber: 100 mm,
Kind: Shell.
Type: H. E.
Weight: 32 pounds.
Color: Yellow.

CHARGE:

Number: T.
Weight: 4.5 pounds.
Kind: TNT (†)

TRACER: None.

BOOSTER: Integral with fuze.

FUZE:

Nomenclature: A. Z. CHZR (t); A. Z. SKHZR (t). P. D.; P. D.

REMARKS:

NOTE 1.—The two Czech P. D. fuzes listed above are identical to the fuzes in the Yugoslav projectile, 10-cm Sprgr. (A. Z.) 310 (j).

H. E. PROJECTILE FOR 100-MM HOWITZER

GERMAN NOMENCLATURE: 10-cm Dopp. Z. Gr. 30 (t). (See fig. 445.)

WEAPONS:

- Czech Light Field Howitzer: 10-cm le. F. H. 14/19 (t), Model 14/19.
- Polish Light Field Howitzer: 10-cm le. F. H. 14/19 (p), Model 14/19.
- Yugoslav Light Field Howitzer: 10-cm le. F. H. 316 (j), Model 14/19 (Skoda).
- Yugoslav Light Field Howitzer: 10-cm le. F. H. 317 (j), Model 28 (Skoda).
- Czech Light Field Howitzer: 10-cm le. F. H. 30 (t), Model 30.

PROJECTILE:

Caliber: 100 mm.
Kind: Shell.
Type: H. E.
Weight: 35.3 pounds (loaded and fuzed).
Color: O. D. or machined metal with red markings.

CHARGE:

Number: 14.
Weight: 3.5 pounds.
Kind: TNT poured.

TRACER: None.

BOOSTER: Integral with fuze.

GERMAN EXPLOSIVE ORDNANCE

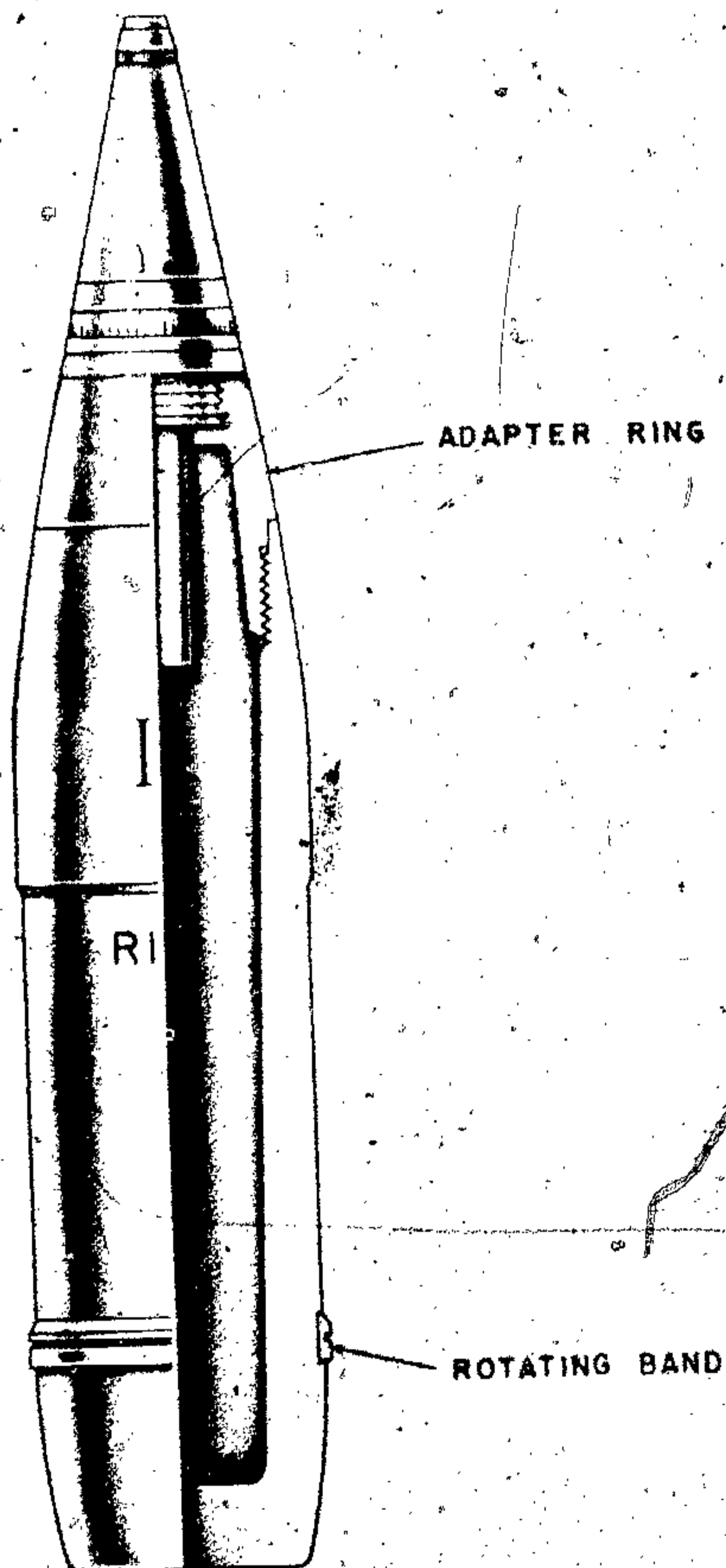

Figure 445—H. E. Projectile for 100-mm Howitzer, 10-cm Dopp. Z. Gr. 30 (f)

FUZE:

Nomenclature: Dopp. Z. VG-SK R. (t); Dopp. Z. VG-OR (t).
 Type: T. and P.; T. and P.

REMARKS:

NOTE 1.—Red band on projectile indicates T. and P. fuze.

H. E. PROJECTILE FOR 100-MM HOWITZER

GERMAN NOMENCLATURE: 10-cm Spr. Gr. 38 rum. (See fig. 446.)

WEAPONS:

- Czech Light Field Howitzer: 10-cm le. F. H. 14/19 (t), Model 14/19.
- Polish Light Field Howitzer: 10-cm le. F. H. 14/19 (p), Model 14/19.
- Jugoslav Light Field Howitzer: 10-cm le. F. H. 316 (j), Model 14/19 (Skoda).
- Jugoslav Light Field Howitzer: 10-cm le. F. H. 317 (i), Model 28 (Skoda).

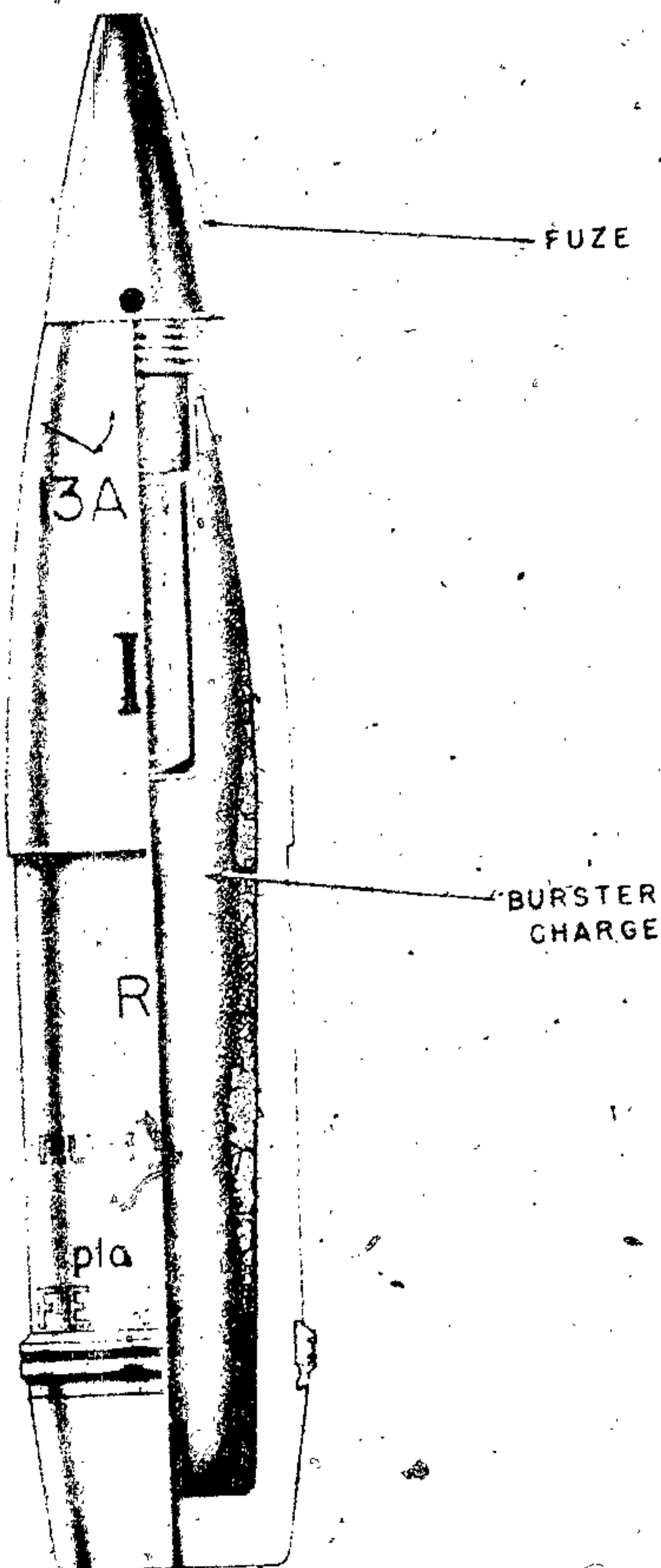

Figure 446—H. E. Projectile for 100-mm Howitzer, 10-cm Spr. Gr. 38 rum

PROJECTILE:

Caliber: 100 mm.

Kind: Shell.

Type: H. E.

Weight: 30.0 pounds (loaded and fuzed).

Color: O. D.

CHARGE:

Number: 13A.

Weight: 3 pounds.

Kind: Amatol 50/50.

TRACER: None.

BOOSTER: hlu Np 10 or wlf Np 10.

FUZE:

Nomenclature: AZ. 23.

Type: P. D.

REMARKS:

NOTE 1.—Bimetallic rotating band—FEW.

NOTE 2.—This projectile is of German manufacture and apparently made to supplement the diminishing supply of rounds for the above weapons.

H. E. PROJECTILE FOR 100-MM HOWITZER

GERMAN NOMENCLATURE: 10-cm Stg. Gr.

(p). (See fig. 447.)

WEAPONS:

Czech Light Field Howitzer: 10-cm le. F. H. 14/19 (t), Model 14/19.

Polish Light Field Howitzer: 10-cm le. F. H. 14/19 (p), Model 14/19.

Jugoslav Light Field Howitzer: 10-cm le. F. H. 316 (j), Model 14/19 (Skoda).

Jugoslav Light Field Howitzer: 10-cm le. H. 317 (j), Model 28 (Skoda).

PROJECTILE:

Caliber: 100 mm.

Kind: Shell.

Type: H. E.

Weight: 32 pounds (loaded and fuzed).

COLOR: Yellow.

CHARGE:

Number: Tt.

Weight: 5 pounds.

Kind: TNT (?)

TRACER: None.

BOOSTER: Integral with fuze.

FUZE:

Nomenclature:

(1) A. Z. 24/31 R. Y. GM. 18.

(2) A. Z. 24/31 M, 99/15 B. Z.

(3) A. Z. 24/31 M, 9/15 K. Z.



Figure 447—H. E. Projectile for 100-mm Howitzer, 10-cm Stg. Gr. (p)

(4) A. Z. 24/31 M. 99/15 D. Z.

(5) Dopp. Z. 24/31, AM 18.

(6) Dopp. Z. 24/31, LDM 31.

Type:

(1) P. D.

(4) P. D.

(2) P. D.

(5) T. and P.

(3) P. D.

(6) T. and P.

REMARKS:

NOTE 1.—The marking "Tt" for shell charge is believed to denote TNT.

GERMAN EXPLOSIVE ORDNANCE

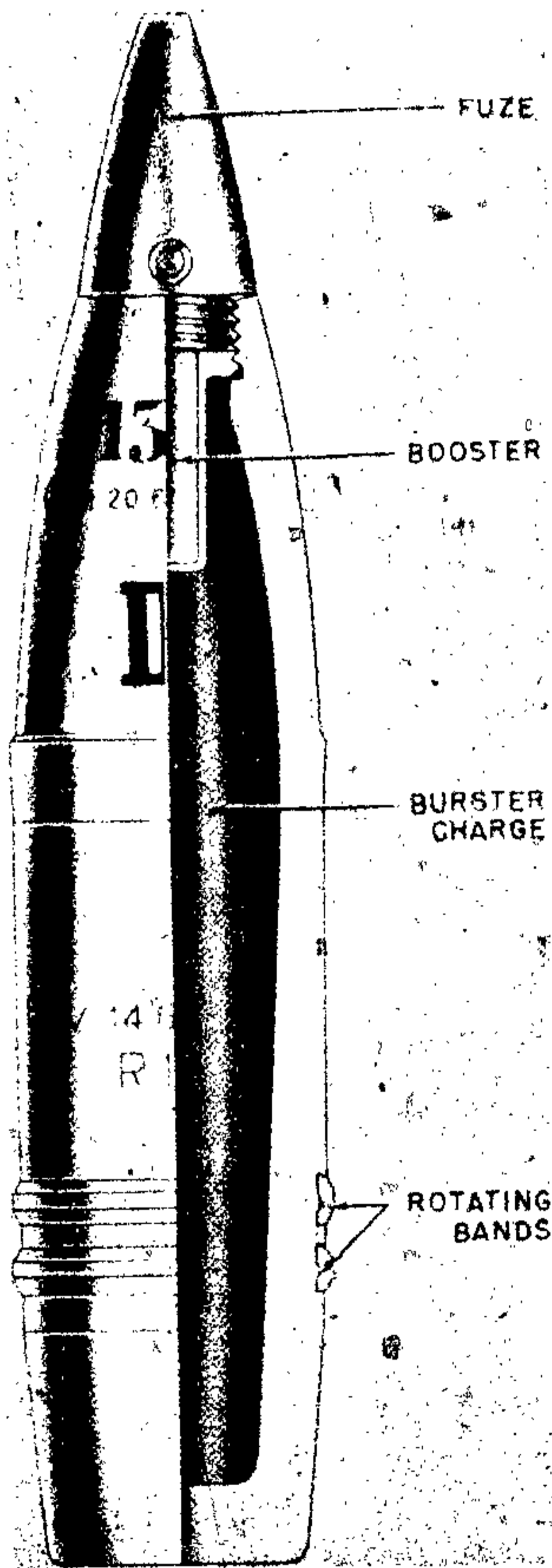

CHARGE:

Number: 13A.
 Weight: 3.5 pounds.
 Kind: Amatol 50/50.

TRACER: None.

BOOSTER: hlu Np 10 St.

FUZE:

Nomenclature: A. Z. 23 v (0.25), (0.15); Dopp.
 S/60 P. D.

Figure 448—H. E. Shell for 105-mm Gun, 10-cm Gr. 19

H. E. PROJECTILE FOR 105-MM GUN

GERMAN NOMENCLATURE: 10-cm Gr. 19.

(See fig. 448.)

WEAPONS:

German Gun: S. 10-cm K 18.

PROJECTILE:

Caliber: 105 mm.

Kind: Shell.

Type: H. E.

Weight: 33.4 pounds (loaded and fuzed).

Color: O. D.

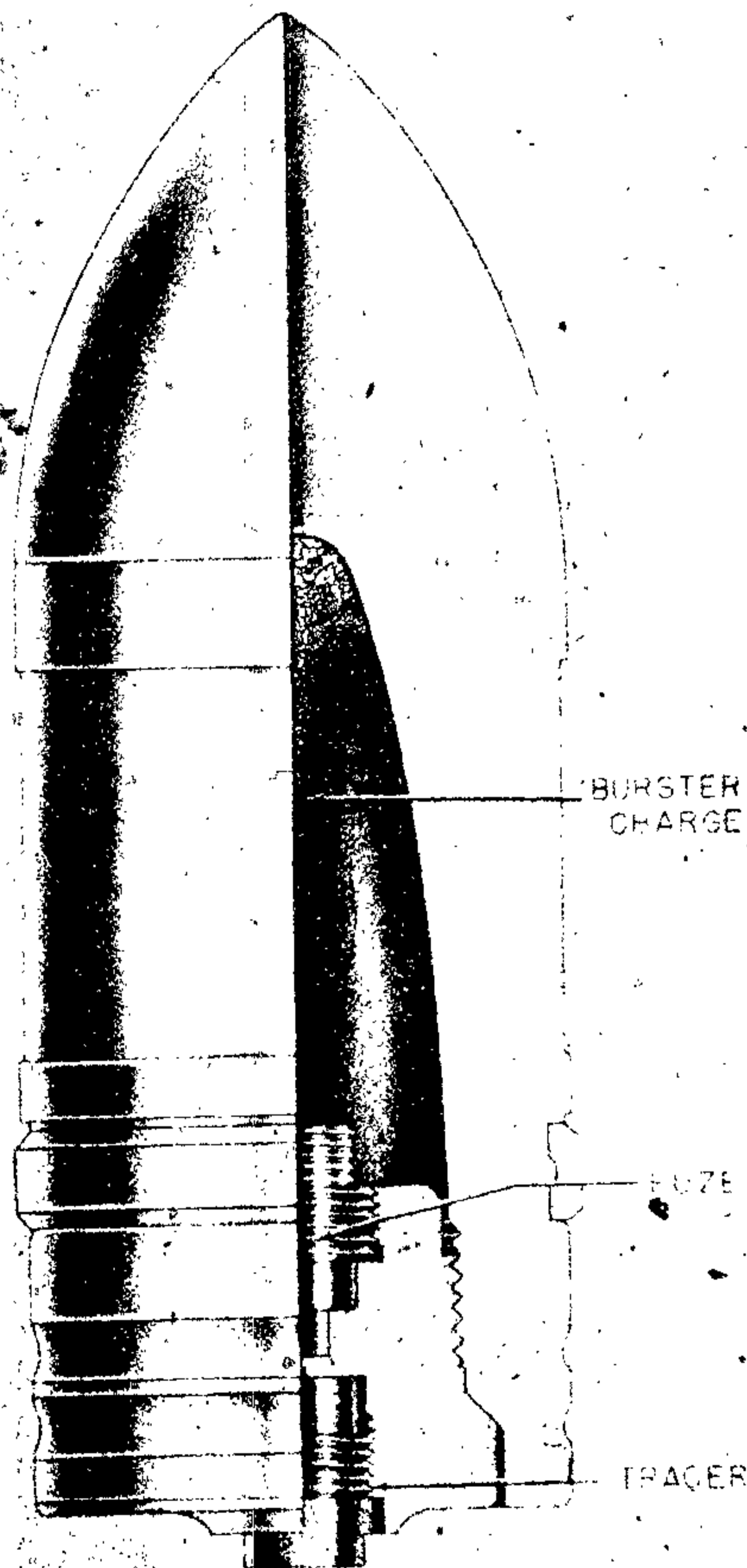

Figure 449—A. P. Shell for 105-mm Howitzer, 10-cm Pzgr.

REMARKS:

NOTE 1.—Projectile has two rotating bands.

A. P. PROJECTILE FOR 105-MM HOWITZER

GERMAN NOMENCLATURE: 10-cm Pzgr.

(See fig. 449.)

WEAPONS:

German Light Field Howitzer:

le. F. H. 18.

le. F. H. 18/1.

le. F. H. 18/2.

le. F. H. 18 mM.

le. F. H. 18/39.

le. F. H. 18/40.

le. F. H. 16.

PROJECTILE:

Caliber: 105 mm

Kind: Shell.

Type: A. P.

Weight: 30.9 (loaded and fuze).

Color: Black with red markings.

CHARGE:

Number: 16.

Weight: 1.5 lbs.

Kind. TNT poured in aluminum container plus
PETN/wax 90/10) as exploder.

TRACER: In base of fuze.

BOOSTER: Integral with fuze.

FUZE:

Nomenclature: Bd. Z. Für 10-cm. Pzgr.

Type: Base.

H. E. PROJECTILE FOR 105-MM GUN

GERMAN NOMENCLATURE: F. H. Gr. rot.

(See fig. 450.)

WEAPONS:

German Gun:

10-cm K 17/04 n A.

10-cm K 17.

PROJECTILE:

Caliber: 105 mm.

Kind: Shell.

Type: H. E.

Weight: 33.07 pounds. (loaded and fuze).

Color: O. D. with red band at rotating band.

CHARGE:

Number: 1a.

Weight: 3 pounds.

Kind: TNT pressed in blocks in cardboard con-
tainer.



Figure 450—H. E. Projectile for 105-mm Gun, F. H. Gr. Rot

TRACER: None.

BOOSTER: wlf Np. 10.

FUZE:

Nomenclature: A. Z. 23v. (0.25), (0.15); Dopp.
Z. S/60s.

Type: P. D. or T. and P.

REMARKS:

NOTE 1.—Red band around the projectile at ro-
tating band indicates high velocity round.

GERMAN EXPLOSIVE ORDNANCE

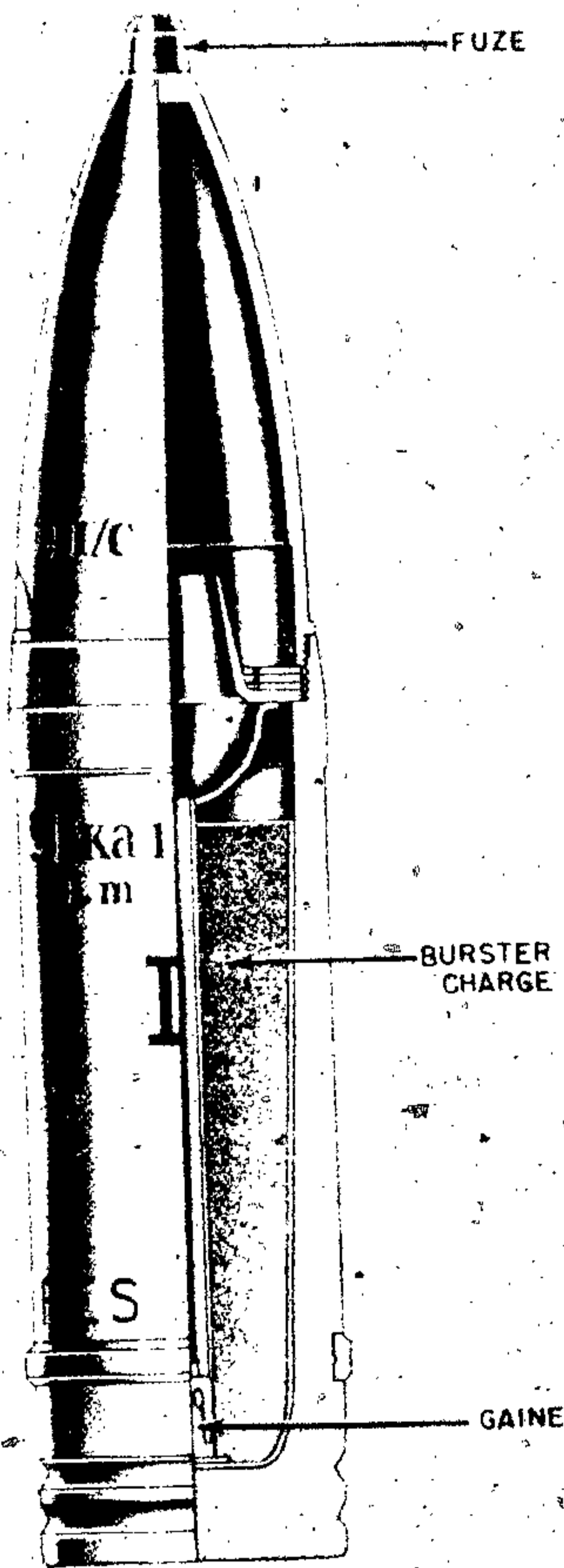

Figure 451—Hollow Charge Projectile for 105-mm Howitzer, 10.5-cm K. HL/C Granate 39 FES

HOLLOW CHARGE PROJECTILE FOR 105-MM HOWITZER

GERMAN NOMENCLATURE: 10.5-cm K. HL/C Granate 39 FES (f). (See fig. 451.)

WEAPONS:

French Light Field Howitzer: le. F. H. 324 (f), Model: C34S; 324 (f) C35B.

PROJECTILE:

- ~ Caliber: 105 mm.
- ~ Kind: Shell.

Type: Hollow charge.
 Weight: 26.45 pounds (loaded and fuzed).
 Color: O. D., red band around body of rotating band.

CHARGE:

Number: 91.
 Weight: 3.3 pounds.
 Kind: Cyclonite wax (95/5).

TRACER: None.

BOOSTER: Integral with fuze.

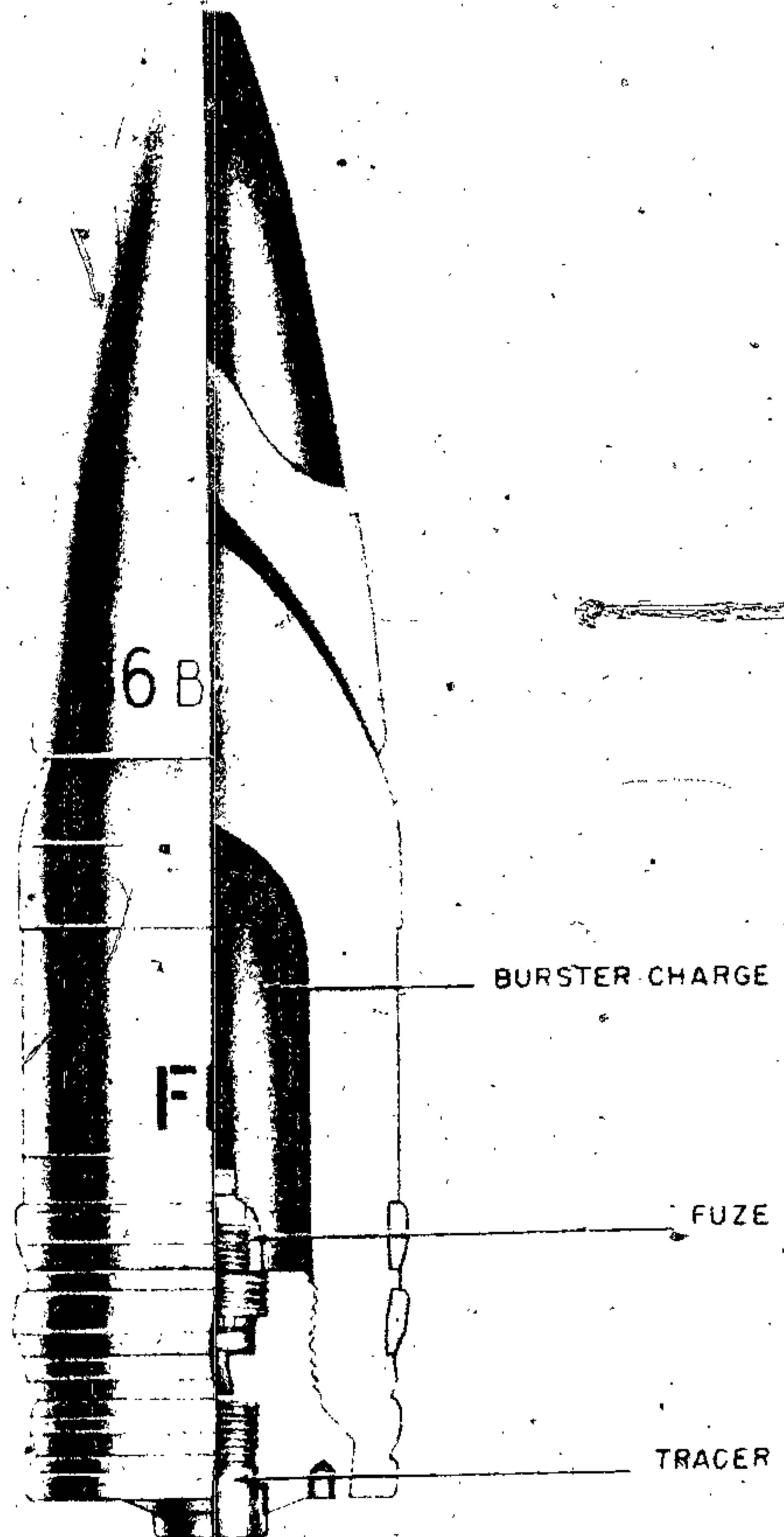

Figure 452—A. P. Projectile, 105-mm, 10-cm Pxgr. Rot FES

FUZE:

Nomenclature: A. Z. 38; A. Z. 38 St.

Type: P. D.

ARMOR PIERCING PROJECTILE FOR 105-MM GUN**GERMAN NOMENCLATURE:** 10-cm Pzgr. rot FES. (See fig. 452).**WEAPONS:** German Medium Gun: s. 10-cm K 18.**PROJECTILE:**

Caliber: 105 mm.

Kind: Shell.

Type: A. P.

Weight: 34½ pounds (loaded and fuzed).

Color: Black.

CHARGE:

Number: 86.

Weight: ½ pound.

Kind: Ethyl/enediamine dinitrate/cyclonite/wax (46/18/36) pressed in blocks wrapped in waxed paper in aluminum container.

TRACER: Yes.**BOOSTER:** Integral with charge.**FUZE:**

Nomenclature: Bd. Z. F. 10-cm Pzgr.

Type: Base.

ARMOR PIERCING PROJECTILE FOR 105-MM GUN**GERMAN NOMENCLATURE:** 10-cm Pzgr. (f). (See fig. 453).**WEAPONS:**

French Medium Gun: 10.5-cm K 331 (f) 1913 S.

Polish Medium Gun: 10.5-cm K 13 (p) 13.

Belgian Medium Gun: 10.5-cm K 333 (b) L 13 S.

Jugoslav Medium Gun: 10.5-cm K 338 (j) 13 (Schneider).

PROJECTILE:

Caliber: 105 mm.

Kind: Projectile.

Type: A. P.

Weight: 31 pounds (loaded and fuzed).

Color: Black with red markings.

CHARGE:

Number: 16.

Weight: ¾ pound.

Kind: TNT poured in aluminum container PETN/Wax (90/10) as exploder.

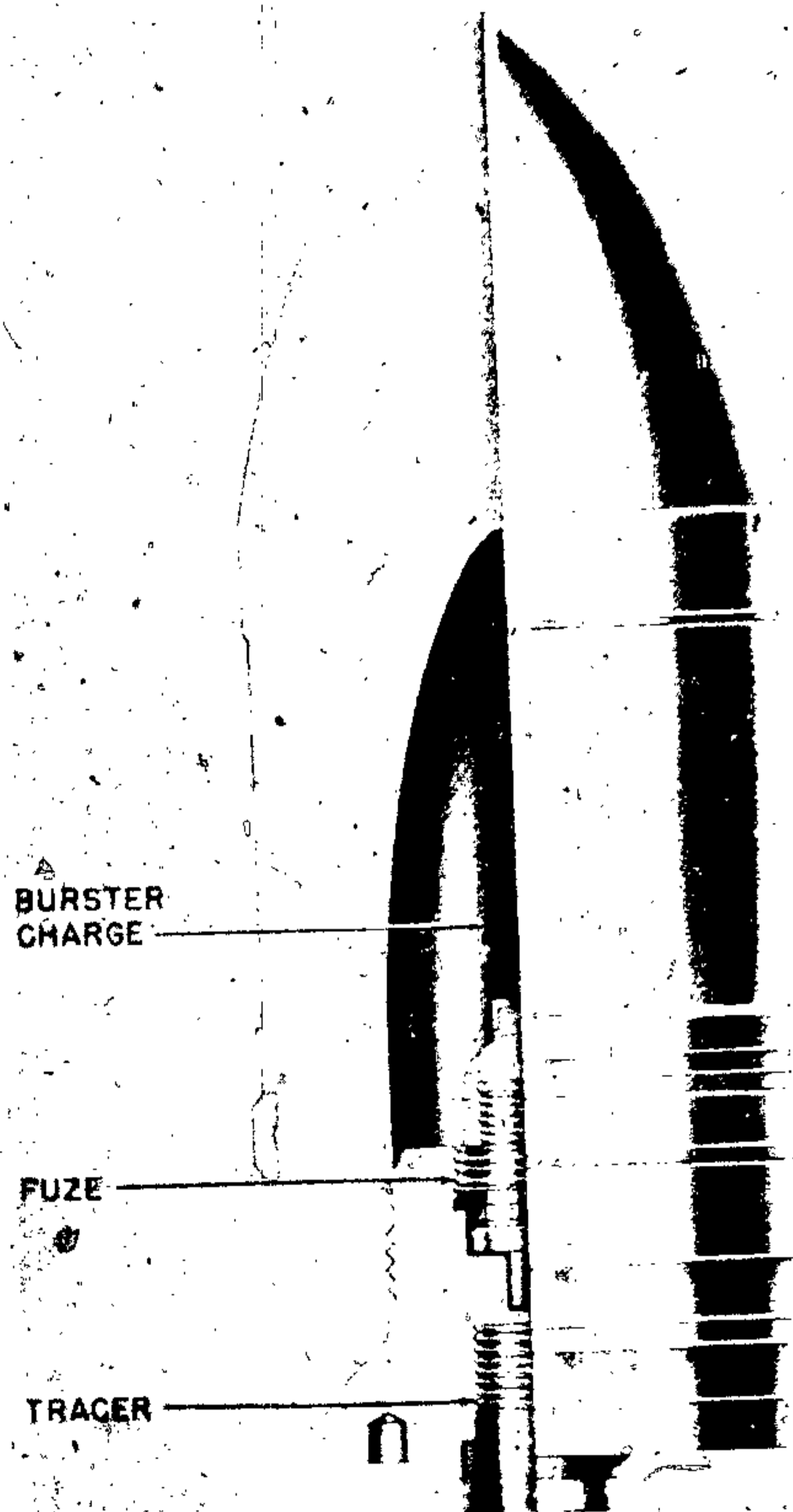
**Figure 453—A. P. Projectile, 105-mm, 10-cm Pzgr. (f)****TRACER:** No. 5.**BOOSTER:** Integral with fuze.**FUZE:**

Nomenclature: Bd. Z. f. 10-cm Pzgr.

Type: B. D.

REMARKS:

NOTE 1.—KPS rotating band.

H. E. PROJECTILE FOR 105-MM GUN**GERMAN NOMENCLATURE:** 10.5-cm Sprgr. 43 (PG). (See fig. 454.)

GERMAN EXPLOSIVE ORDNANCE

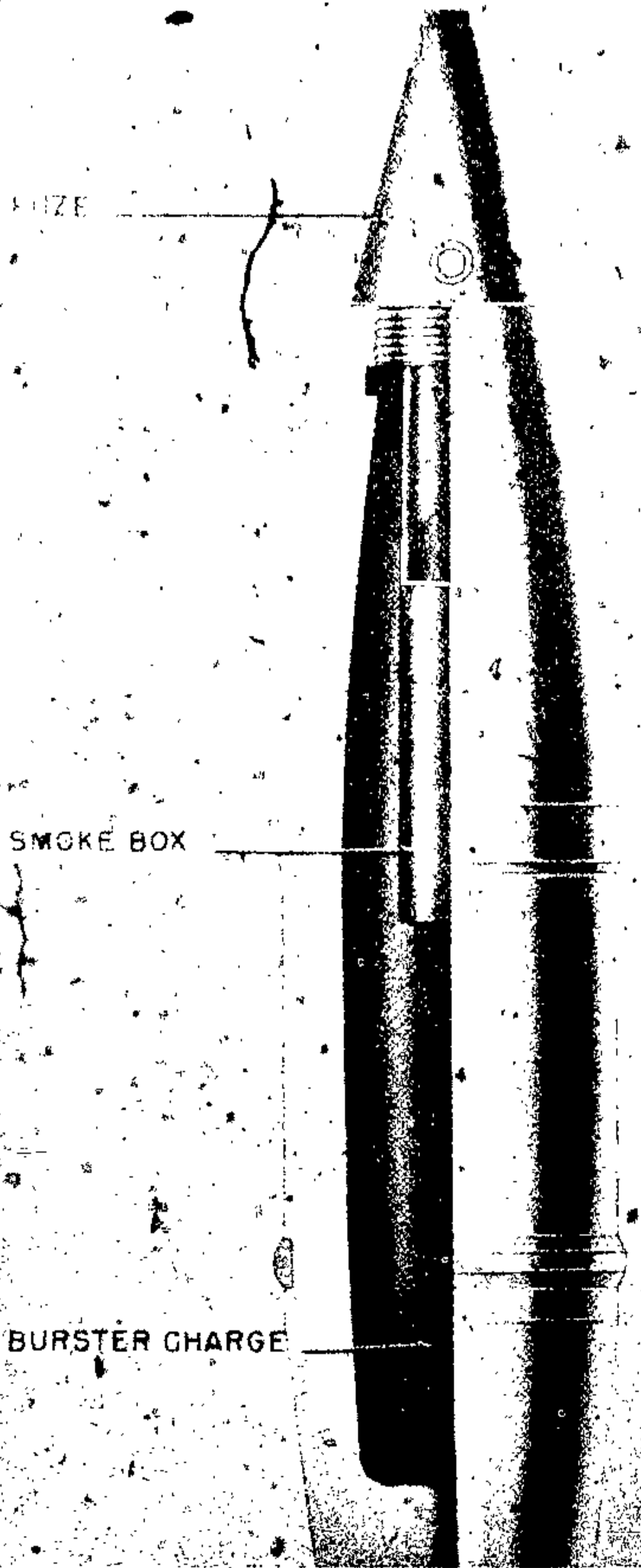

Weight: 3 pounds.
 Kind: Unknown (believed to be TNT/Wax).
 TRACER: None.
 BOOSTER: Np 10.
 FUZE:
 Nomenclature: A. S.-23 (0.15).
 Type: P. D.
 REMARKS:
 Note 1.—Contains R 14 smoke box.

Figure 454—H. E. Projectile, 105-mm, 10-cm Sprgr. 43 (PG)

WEAPONS:

German Light Field Howitzer: ie. F. H. 18, 18/1, 18/2, 18 m.M, 18/39, 18/40.

PROJECTILE:

Caliber: 105 mm.
 Kind: Shell.
 Type: H. E.
 Weight: 32³/₄ pounds (loaded and fuzed).
 Color: Brick red.

CHARGE:

Number: 9.

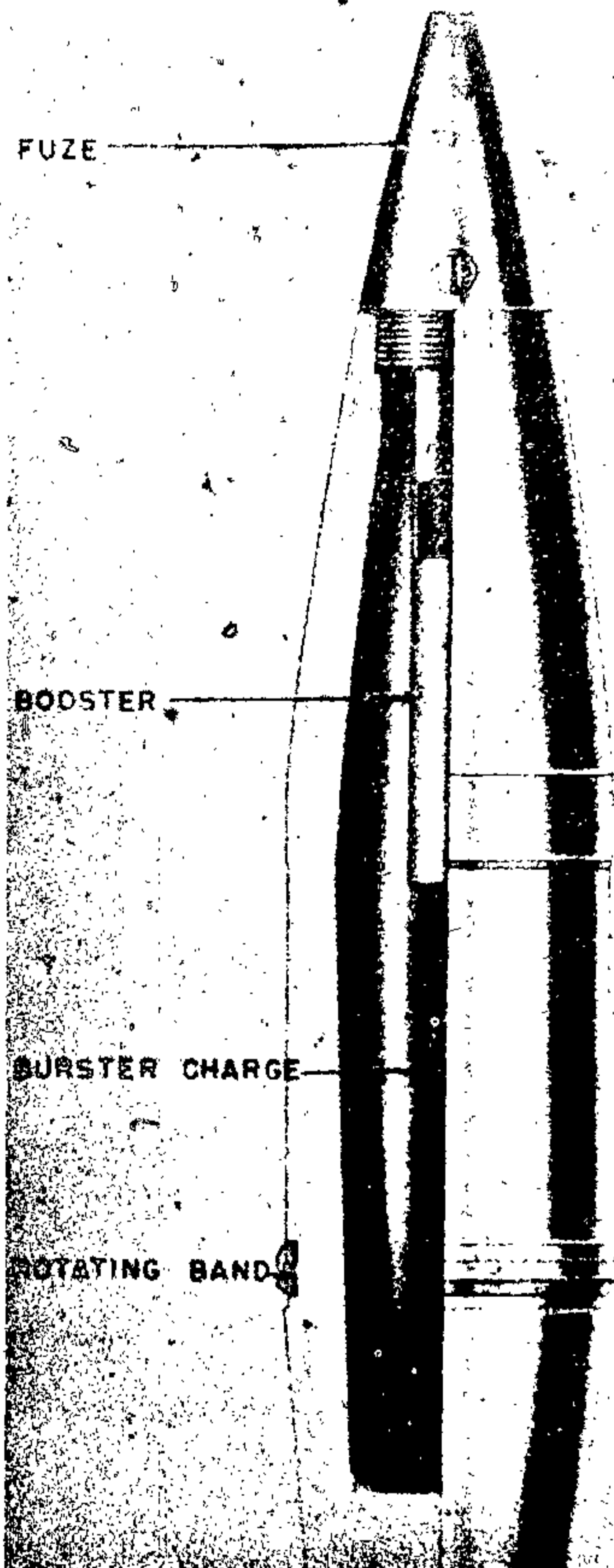

Figure 455—H. E. Projectile for 105-mm Light Field Howitzer, F. H. Gr. 38 Stg. FES

H. E. PROJECTILE FOR 105-MM LIGHT FIELD HOWITZER

GERMAN NOMENCLATURE: F. H. Gr. 38 Stg. FES. (See fig. 455.)

WEAPONS:

German Light Field Howitzer: ie. F. H. 16.
ie. F. H. 18, 18/1, 18/2 18 m.M., 18/39, 18/40.

PROJECTILE:

Caliber: 105 mm.
Kind: Shell.
Type: H. E.
Weight: 33½ pounds (loaded and fuzed).
Color: O. D.

CHARGE:

Number: 13A.
Weight: 4 pounds.
Kind: Amatol (50/50).

TRACER: None.

BOOSTER: Np 10.

FUZE:

Nomenclature:

- (1) A. Z. 23 (0.15 or 0.25).
- (2) Dopp. Z. S/60s.
- (3) Dopp. Z. S/60 F1.
- (4) A. Z. 1 (0.15).

Type:

- (1) P. D.
- (2) T. and P.
- (3) T. and P.
- (4) P. D.

REMARKS:

NOTE 1.—Shell contains B 11 smoke box.

H. E. PROJECTILE FOR 105-MM HOWITZER

GERMAN NOMENCLATURE: 10.5-cm Gr. 324 (f). (See fig. 456.)

WEAPONS:

French Light Field Howitzer:
ie. F. H. 324 (f), Model C 34 S.
ie. F. H. 344 (f), Model C 35 B.

PROJECTILE:

Caliber: 105 mm.
Kind: Shell.
Type: H. E.

FUZE AND BOOSTER WELL

BOOSTER CHARGE

ROTATING BAND



Figure 456—H. E. Projectile for 105-mm Howitzer, 10.5-cm Gr. 324 (f)

Weight: 34.6 pounds (loaded and fuzed).
Color: Yellow-brown or red body with yellow olive.

CHARGE:

Number: 13 (German); or MF (French).
Weight: 3.5 pounds.
Kind: Amatol 60/40 (German); picric acid, cast (French).

TRACER: None.

BOOSTER: Booster integral with fuze.

GERMAN EXPLOSIVE ORDNANCE

FUZE:

NOMENCLATURE:

| GERMAN | FRENCH |
|-------------------------------|-----------------|
| (1) A. Z. 251 (f) oV | 24/31 RYG 18 I |
| (2) A. Z. 253 (f) (Kz. V.) | 24/41 RYG 18 CR |
| (3) Dopp. Z. 445 (f) | 24/31 LD 17 |
| (4) Zt. Z. 417 (f) | 24/31 LD 18 |

Type:

| | |
|-----------|---------------|
| (1) P. D. | (3) T. and P. |
| (2) P. D. | (4) T. |

REMARKS:

NOTE 1.—Insert band on bourrelet.

NOTE 2.—The le. F. H. 324 (f) and 325 (f) weapons are actively being used by German manufactured projectiles.

PROPAGANDA PROJECTILE FOR 105-MM HOWITZER

GERMAN NOMENCLATURE: 10-cm Weiss Rot Geschoss. (See fig. 457.)

WEAPONS:

German Eight Field Howitzer:

- le. F. H. 18.
- le. F. H. 18/1.
- le. F. H. 18/2.
- le. F. H. 18m. M.
- le. F. H. 18/39.
- le. F. H. 18/40.

PROJECTILE:

- Caliber: 105-mm.
- Kind: Shell.
- Type: Propaganda.
- Weight: 28¼ pounds (loaded and fuzed).
- Weight less leaflets—27¼ pounds.
- Color: Red body, white ogive.

CHARGE:

- Number: None.
- Weight: ¼ pound.
- Kind: Black powder in wooden block.

TRACER: None.

BOOSTER: None.

- Nomenclature: Dopp. Z. s/60 Fl.
- Type: T. and P.

REMARKS:

NOTE 1.—Shell contained roll of two types of leaflets.

NOTE 2.—Marking "EI" in black letters on opposite sides of shell body.

H. E. PROJECTILE FOR 105-MM ITALIAN GUN

BRITISH NOMENCLATURE: Italian 105-mm 28-cal H. E. Shell. (See fig. 458.)

WEAPONS:

Italian Gun: 10.5-sm K338 (i) 105/28.

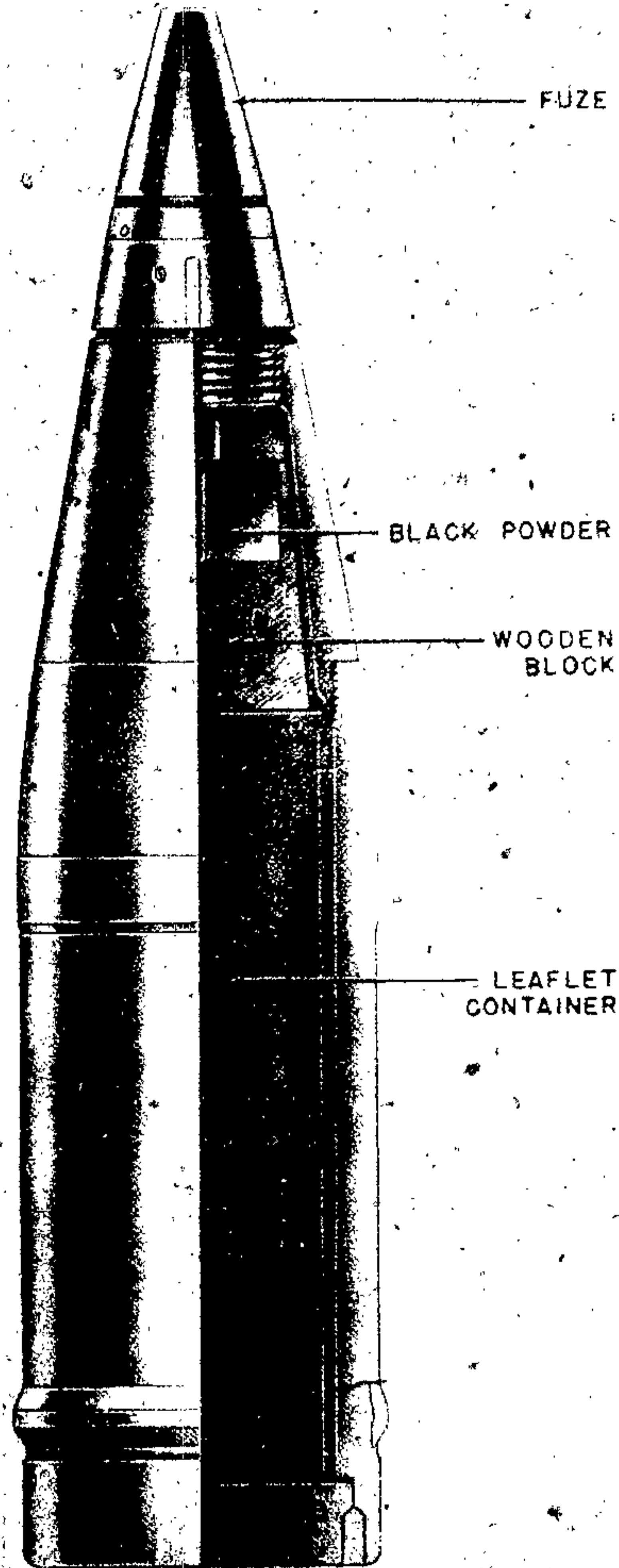

Figure 457—Propaganda Projectile for 105-mm Howitzer, 10-cm Weiss, Rot Geschoss

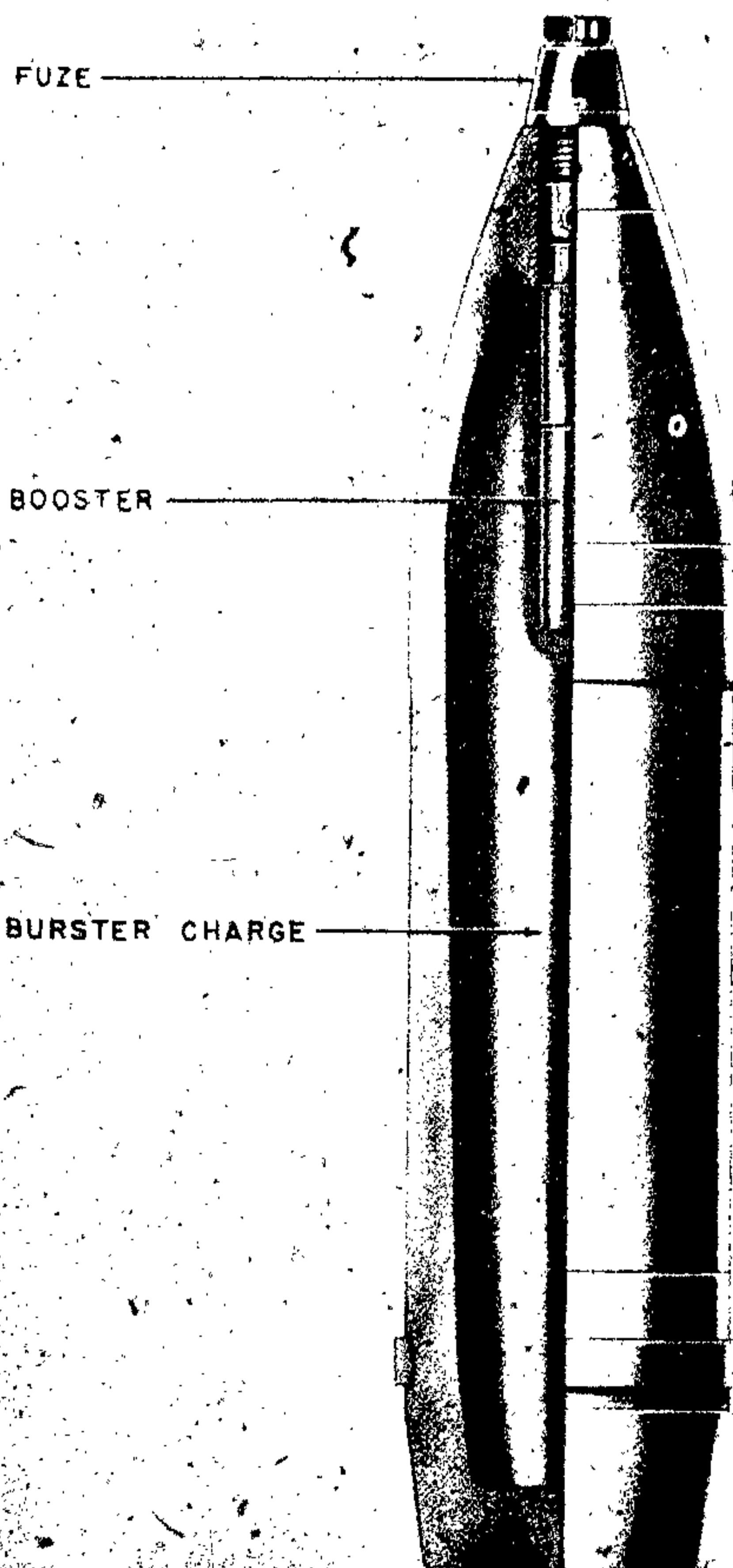

Figure 458—H. E. Shell for 105-mm Italian Gun,
Italian 105-mm, 28-Cal. H. E.

PROJECTILE:

Caliber: 105 mm.

Kind: Shell.

Type: H. E.

Weight: 36 pounds (loaded and fuzed).

Color: Gray with orange ogive and green band just forward of rotating band.

CHARGE:

Weight: 6 pounds.

Kind: Tritolo (TNT) or Amatolo (Amatol)
80/20.

TRACER: None.

BOOSTER: Det. Sec. AE No. 2 Mod 38.

FUZE:

Nomenclature: I. O. Mod 40 P. C.

Type: P. D.

H. E. PROJECTILE FOR 105-MM GUN

GERMAN NOMENCLATURE: 10.5-cm Sprgr.
348 (f) (French 36). (See fig. 459.)

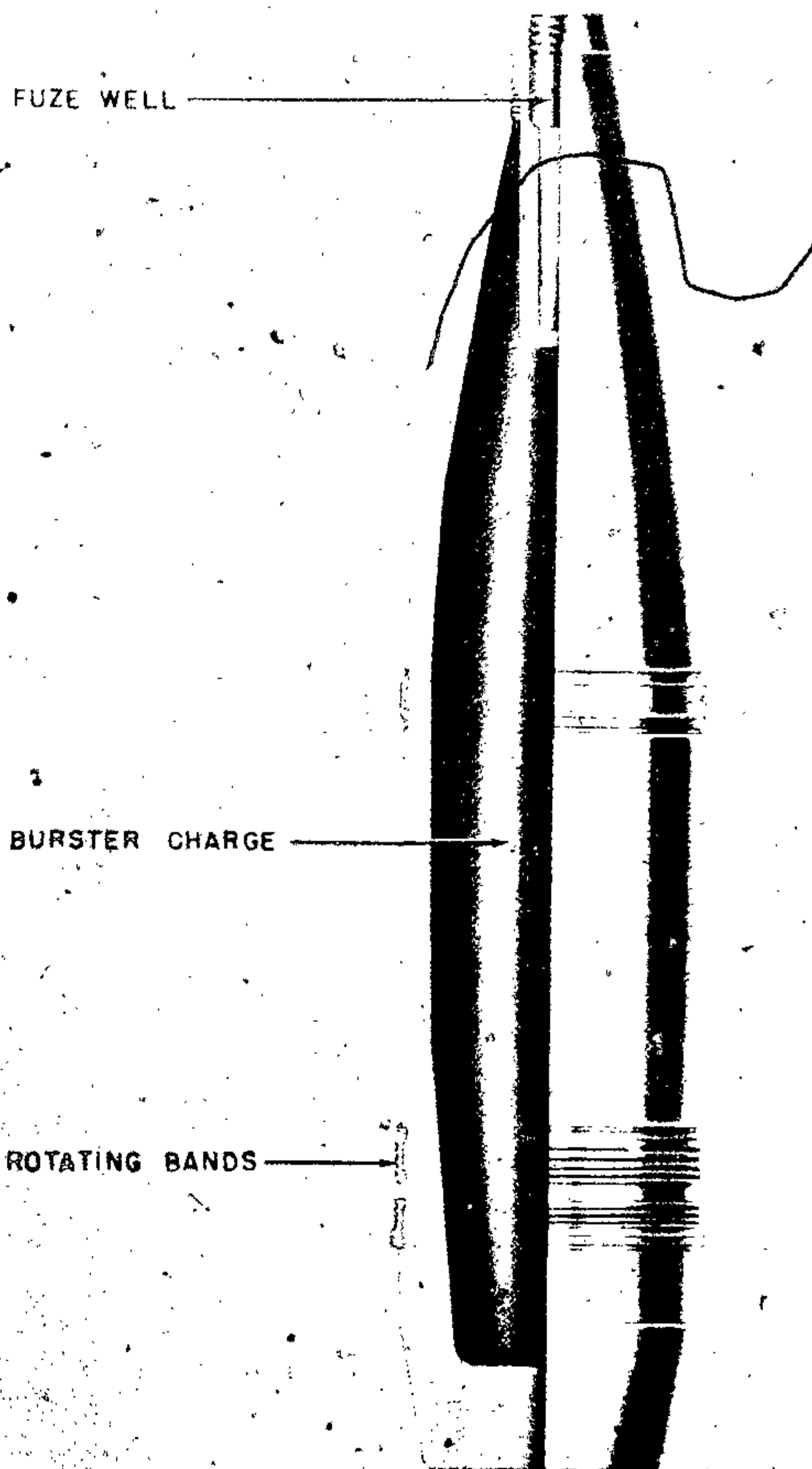

Figure 459—H. E. Projectile, 105-mm, 10.5-cm
Sprgr. 348 (f) (French 36)

GERMAN EXPLOSIVE ORDNANCE

WEAPONS:

French Gun: 10.5-cm K 322 (f), Model L-36 S.

PROJECTILE:

Caliber: 105 mm.

Kind: Shell.

Type: H. E.

Weight: 34.5 pounds (15.48 kg). Empty, 28.75 pounds.

Color: Yellow.

CHARGE:

Number: DM (French).

Weight: 5.75 pounds.

Kind: Dinitronaphthaline.

TRACER: None.

BOOSTER: Integral with fuze.

ADAPTER: LJT. Mle. 1915 Type B.

FUZE:

NOMENCLATURE

| GERMAN | FRENCH |
|-------------------------------------|----------------------------|
| (1) A. Z. 251 (f) o. V. | (1) 24/31 RYG 18 I |
| (2) A. L. 253 (f) Kz. V. | (2) 24/31 RYG 18 CR |
| (3) Dopp. Z. 446 (f) m. verst F. | (3) 24/31 LD 17 (a. r. r.) |

Type: (1) P. D. (2) P. D. (3) T. and P.

STAR PROJECTILE FOR 105-MM GUN

GERMAN NOMENCLATURE: 10.5-cm Lt. Gs. FES. (See fig. 460.)

WEAPONS:

French Gun: 10.5-cm K. 331 (f), Model L Mle 1913 S.

Polish Gun: 10.5-cm K. 13 (p), Model 13.

Belgian Gun: 18.5-cm K. 333 (b), Model L 13 S.

Jugoslav Gun: 10.5-cm K. 331 (j), Model 13 S.

PROJECTILE:

Caliber: 105 mm.

Kind: Shell.

Weight: 31.3 pounds (loaded and fuzed).

Color: Light green.

CHARGE:

Kind: Small expelling charge.

TRACER: None.

BOOSTER: Primer relay to ignite expelling charge.

FUZE:

Nomenclature: Dopp. Z. S/60 v.

Type: T. and P.

REMARKS:

Note 1.—The parachute and illuminating container are base ejected.

H. E. PROJECTILE FOR 105-MM GUN

GERMAN NOMENCLATURE: F. H. Gr. 38 FES. (See fig. 461.)

WEAPONS:

German Light Field Howitzer:

le. F. H. 18.

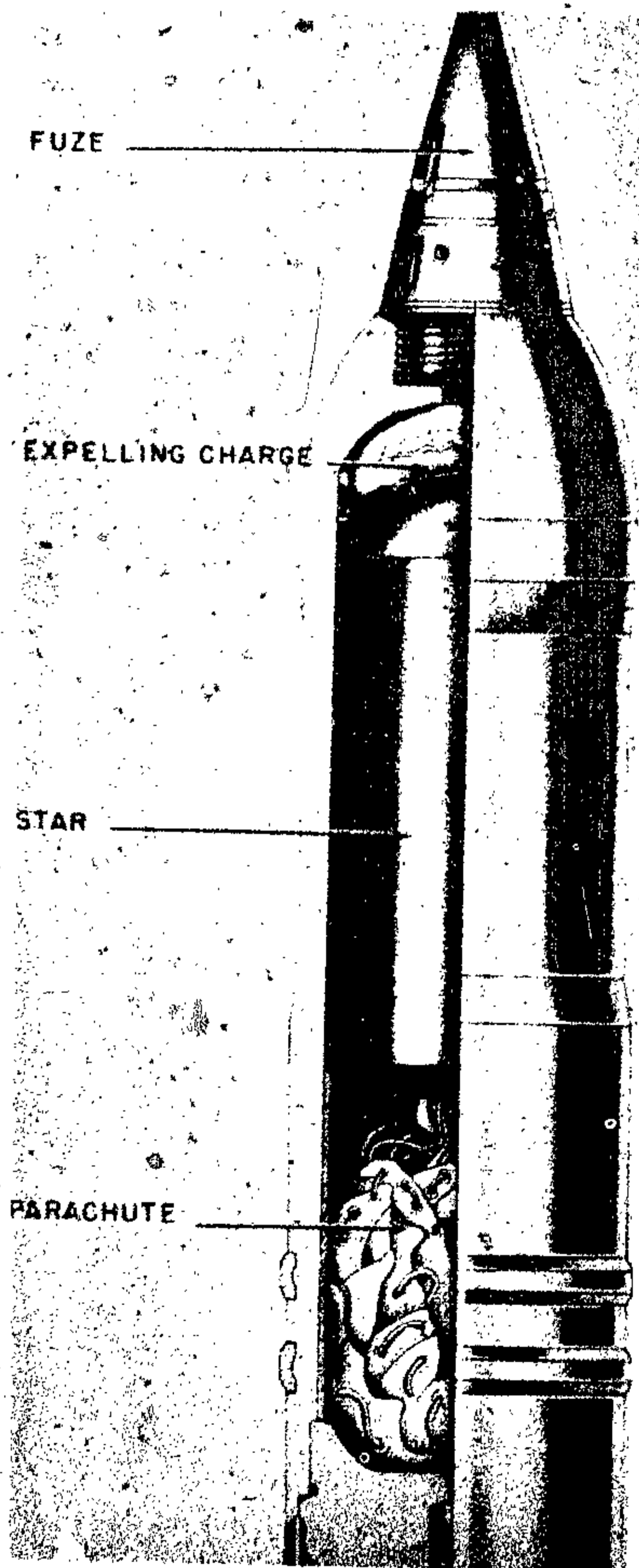

Figure 460—Star Shell, 105-mm, 10.5-cm Lt. Gs. FES

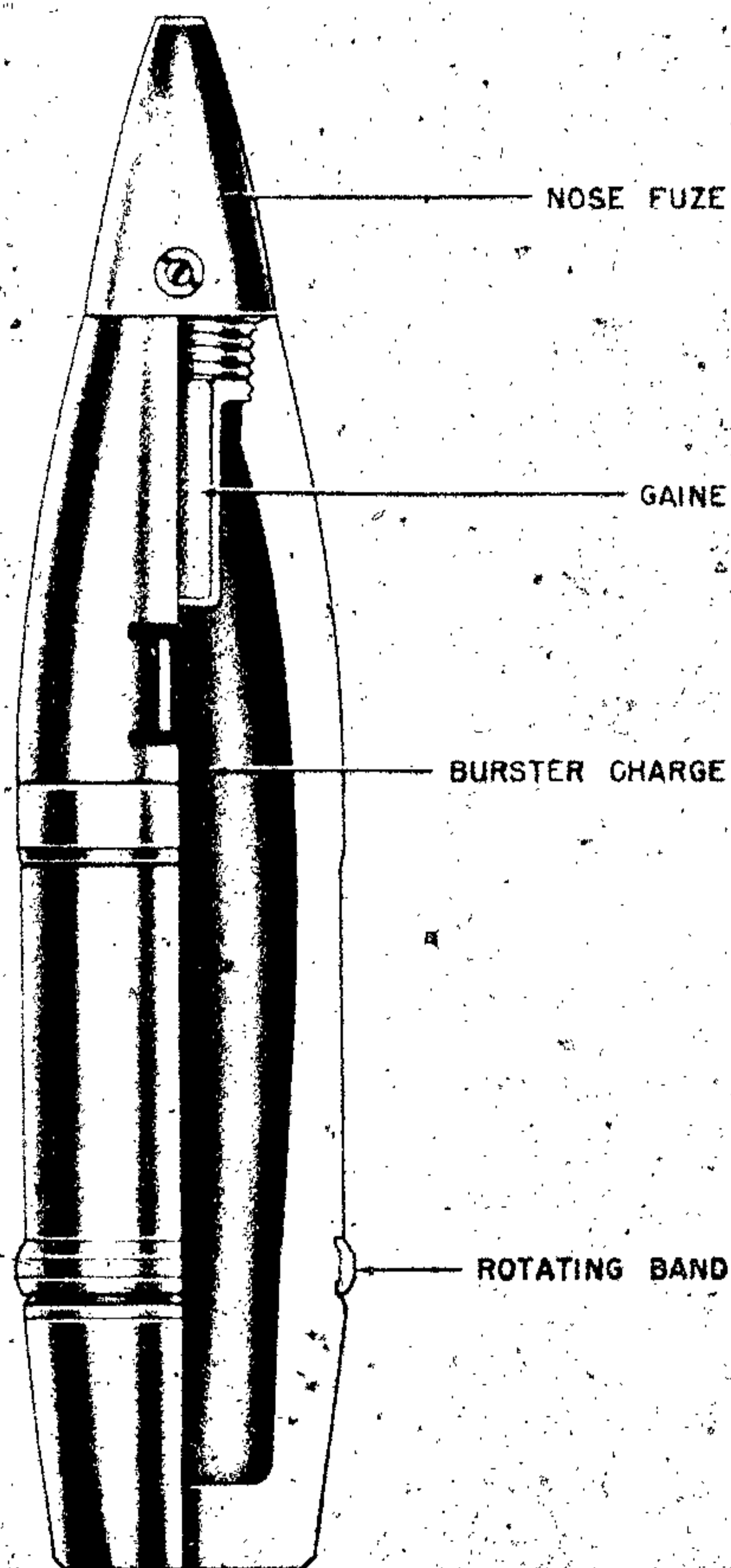

Figure 461—H. E. Projectile, 105-mm, 10.5-cm F. H.
Gr. 38 FES

le. F. H. 18/1.
le. F. H. 18/2.
le. F. H. m. m. (muzzle brake).
le. F. H. 18/39.
le. F. H. 18/40.

PROJECTILE:

Caliber: 105 mm.
Kind: Shell.
Type: H. E.
Weight: 33.08 pounds (loaded and fuzed).
Color: O. D.

CHARGE:

Number: 13.
Weight: 3 pounds.
Kind: Amatol 50/50.

TRACER:

BOOSTER: Grid Np. 10.

FUZE:

Nomenclature: A. S. 23 (0.15) or (0.25); Dopp.
Zs/60 F. II.
Type: P. D.

H. E. PROJECTILE FOR 105-MM GUN

GERMAN NOMENCLATURE: 10.5-cm Gr.
346 (f). (See fig. 462.)

WEAPONS:

French Gun: 10.5-cm K. 331 (f), Model L Mle
1913S.
Polish Gun: 10.5-cm K. 13 (p), Model 13.
Belgian Gun: 10.5-cm K. 333 (b), Model L 13
S.
Jugoslav Gun: 10.5-cm K. 338 (j), Model S.

PROJECTILE:

Caliber: 105 mm.
Kind: Shell.
Type: H. E.
Weight: 35.5 pounds (loaded and fuzed).
Color: Body, brick-red, olive-yellow.

CHARGE:

Number: S.
Weight: 7 pounds.
Kind: Tolute.

TRACER: None.

BOOSTER: Integral with fuze.

FUZE:

NOMENCLATURE

| GERMAN | FRENCH |
|-----------------------------|---------------------|
| (1) A. Z. 235 (f) | (1) 24/31 99 |
| (2) A. Z. 237 (f) | (2) 24/31 99-08 |
| (3) A. Z. 251 (f) o. V. | (3) 24/31 RYG 18 |
| (4) A. Z. 253 (f) Kz. V. | (4) 24/31 RYG 18 CR |
| (5) A. Z. 257 (f) Kz. V. | (5) 24/31 RY 17 CR |
| (6) A. Z. 261 (f) | (6) 24/31 JAL 16 |
| (7) A. Z. 274 (f) Kz. V. | (7) 24/31 JAL 16 |
| (8) 281 (f) o. V. | (8) 24/31 TCAL 26 J |
| (9) Dopp. Z. 445 (f) | (9) 24/31 LD 17 |
| (10) Zt. Z. 417 (f) | (10) 24/31 LD 18 |

GERMAN EXPLOSIVE ORDNANCE

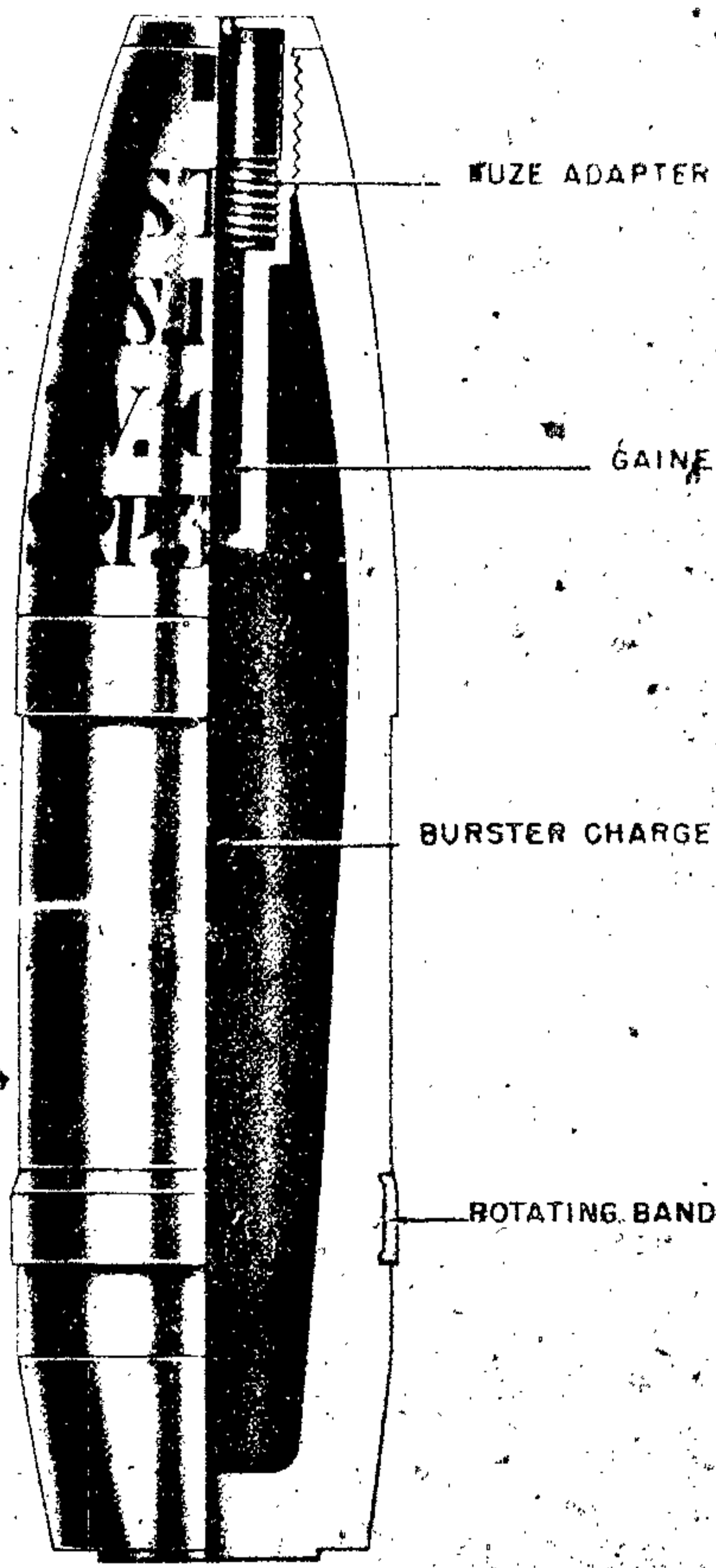

Belgian Gun: K. 333 (b), L 13 S.
 Yugoslav Gun: K. 338 (j), 13 S.

PROJECTILE:
 Caliber: 105 mm.
 Kind: Shell.
 Type: H. E.
 Weight: 33.016 pounds (loaded and fuzed).
 Color: O. D.

CHARGE:
 Number: 13 A.

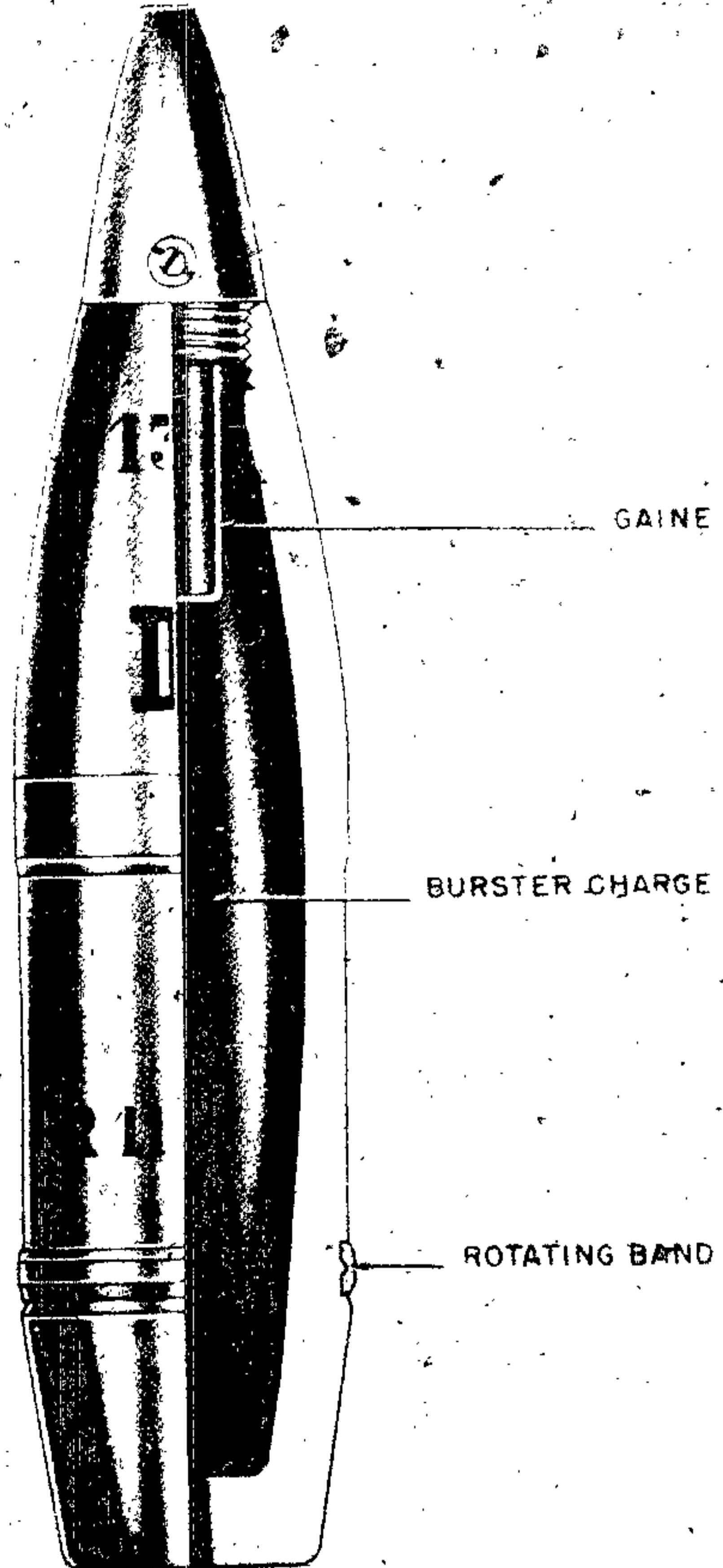

Figure 462—H. E. Projectile for French 105-mm Howitzer, 10.5-cm Gr. 346 (f)

- Type (1) P. D. (2) P. D. (3) P. D. (4) P. D.
 (5) P. D. (6) P. D. (7) P. D. (8) P. D.
 (9) T. and P. (10) T.

H. E. PROJECTILE FOR 105-MM GUN

GERMAN NOMENCLATURE: 10.5-cm K. Spr. 38 (f). (See fig. 463.)

WEAPONS:

French Gun: K. 331 (f), L 1913 S.
 Polish Gun: K. 13 (p), 13.

Figure 463—H. E. Projectile, 105-mm, 10.5-cm K. Spr. 38 (f)

Weight: 4.0 pounds.

Kind: Amatol 50/50.

TRACER: None.

BOOSTER: None.

FUZE:

Nomenclature: A. Z. 23 (0.15) Dopp. s/60 T. and P.

Type: P. D.

REMARKS:

NOTE 1.—This round is of German manufacture for the above-listed weapons.

NOTE 2.—The FEW stenciled on the body of the projectile in white letters denotes soft iron rotating band.

H. E. PROJECTILE FOR 105-MM GUN

GERMAN NOMENCLATURE: 10.5-cm FES Gr. 345 (f). (See fig. 464.)

WEAPONS:

French Gun: 10.5-cm K. 331 (f), L Mle 1913 S.

Polish Gun: 10.5-cm K. 13 (p), Model 13.

Belgian Gun: 10.5-cm K. 333 (b), Model L 13 S.

Jugoslav Gun: 10.5-cm K. 338 (j), Model 13 S.

PROJECTILE:

Caliber: 105 mm.

Kind: Shell.

Type: H. E.

Weight: 34 pounds (loaded and fuzed).

Color: Yellow with white band around body, black markings.

CHARGE:

Number: M.

Weight: 5¼ pounds.

Kind: Melinite.

TRACER: None.

BOOSTER: Integral with fuze.

FUZE:

NOMENCLATURE

| GERMAN | FRENCH |
|-------------------|--------------------|
| (1) A. Z. 235 (f) | (1) 24/31 99 |
| (2) A. Z. 237 (f) | (2) 24/31 99-08 |
| (3) A. Z. 251 (f) | (3) 24/31 RYG 18J |
| o. V. | |
| (4) A. Z. 253 (f) | (4) 24/31 RYG 18CR |
| Kz. | |
| (5) A. Z. 257 (f) | (5) 24/31 RY 17CR |
| , Kz. V | |
| (6) A. Z. 261 (f) | (6) 24/31 JAL 16 |
| (7) Dopp. Z. 445 | (7) 24/31 DD 17 |
| (f) | |

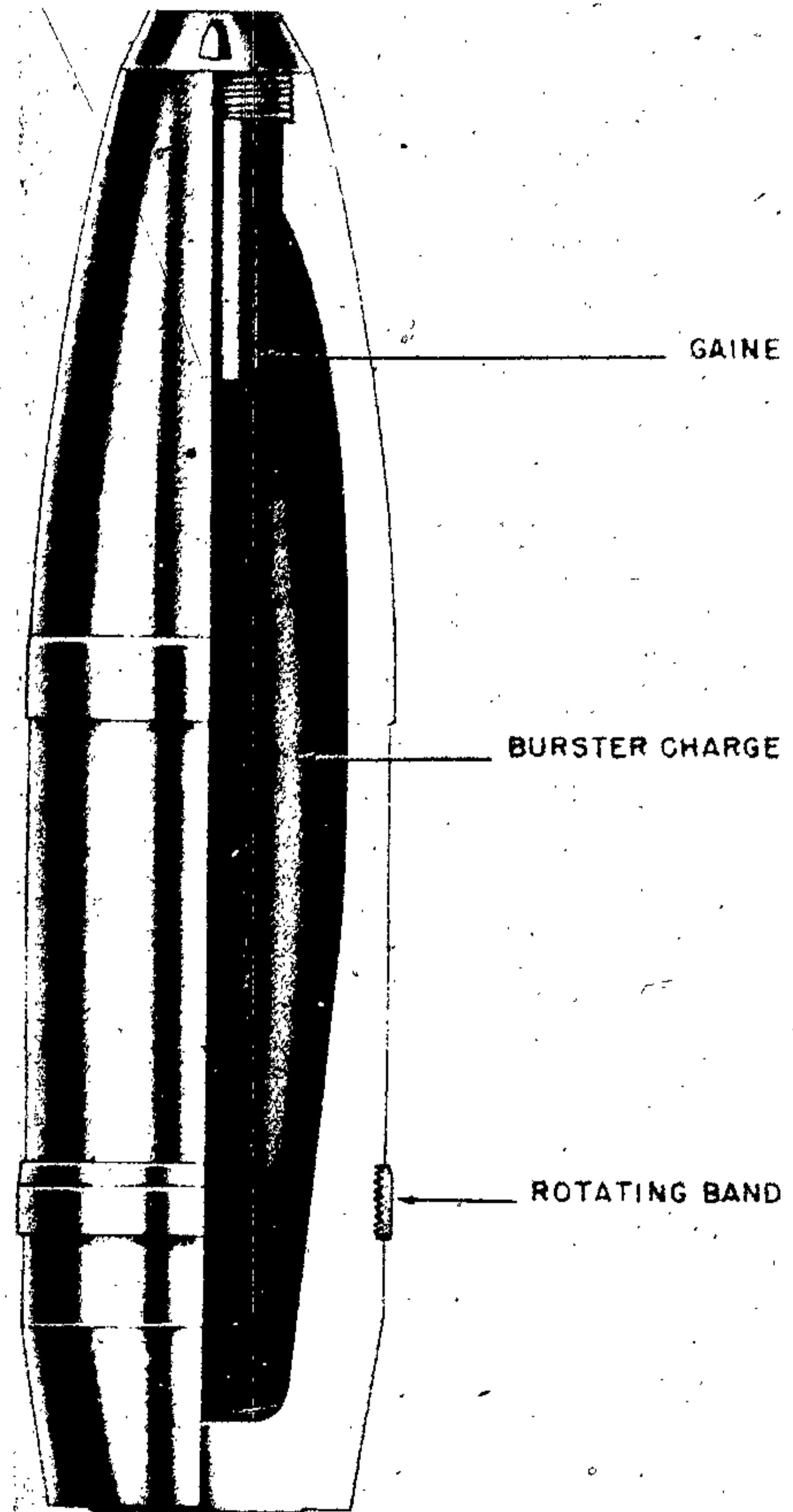

Figure 464—H. E. Projectile, 105-mm, 10.5-cm FES Gr. 345 (f)

Type:

(1) P. D.

(5) P. D.

(2) P. D.

(6) P. D.

(3) P. D.

(7) T. and P.

(4) P. D.

H. E. PROJECTILE FOR 105-MM ANTI-AIRCRAFT GUN

GERMAN NOMENCLATURE: 10.5-cm Sprgr. L/4.4. (See fig. 465.)

GERMAN EXPLOSIVE ORDNANCE

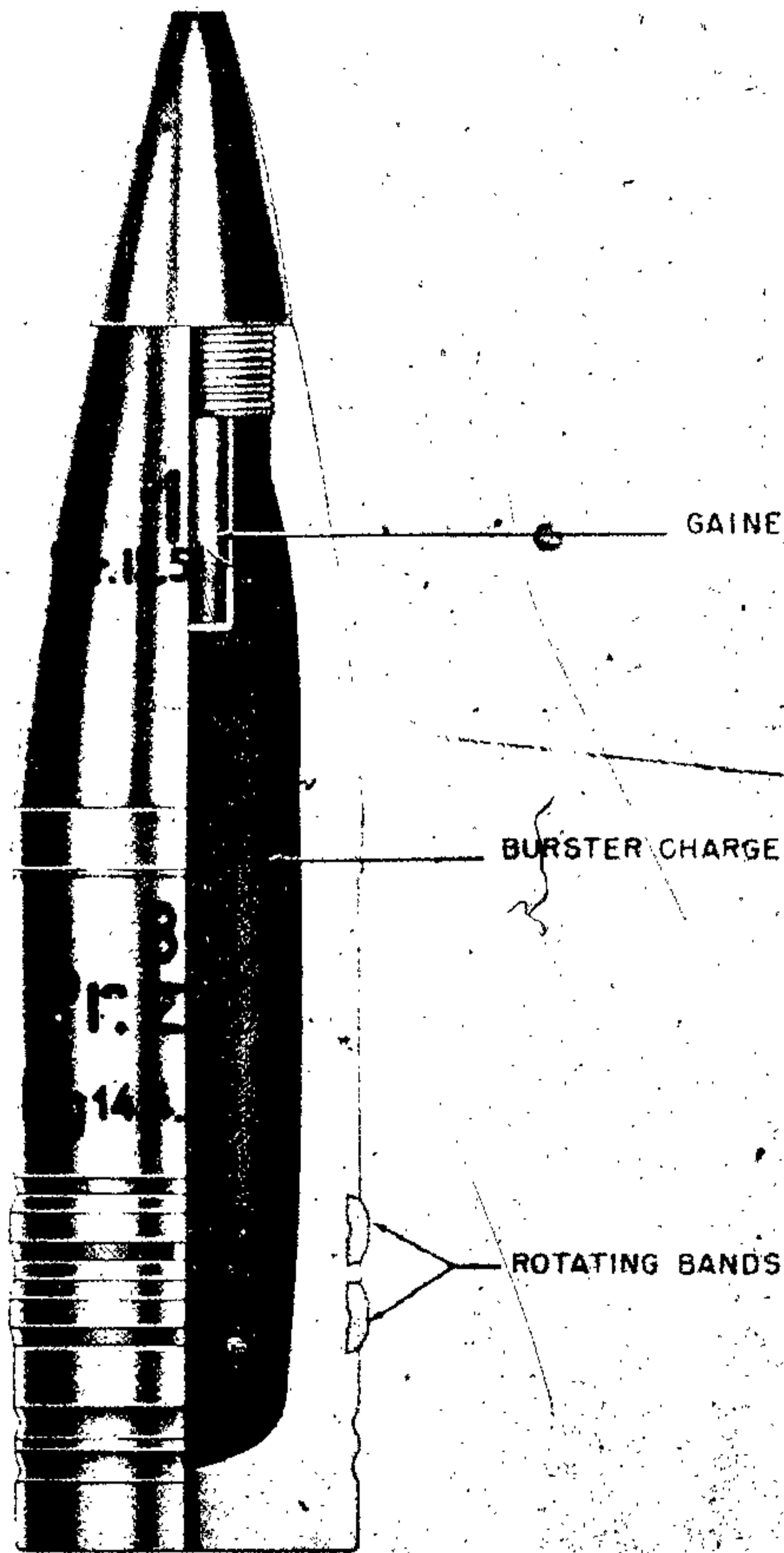

Figure 465—H. E. Projectile for 105-mm A. A. Gun,
10.5-cm Sprgr. L/4.4

WEAPONS: German Antiaircraft Gun, 10.5-cm Flak 38.

PROJECTILE:

Caliber: 105 mm.
Kind: Shell.
Type: H. E.
Weight: 33½ pounds (loaded and fuze).
Color: Yellow with black markings.

CHARGE:

Number: 13.
Weight: 3½ pounds.

Kind: Amatol (60/40) (poured).

TRACER: None.

BOOSTER: No. 10.

FUZE:

Nomenclature: A. Z. 23/28 ZT. Z. Z./60.
Type: P. D. time.

A. P. C. PROJECTILE WITH TRACER, 105-MM

GERMAN NOMENCLATURE: 10-cm Pzgr. rot (Panzergranate rot). (See fig. 466.)

EMPLOYMENT:

10-cm Flak 38 (Flugabwehrkanone 38) Anti-aircraft Gun 38.
10-cm Flak 39 (Flugabwehrkanone 39) Anti-aircraft Gun 39.
s 10-cm K. T. (Schweres Kanone Turren) Heavy Turret Gun
s 10-cm K. 18 (Schweres Kanone 18) Heavy Gun 18.

COMPLETE ROUND (Description of c/r is for Flak 38 and Flak 39):

44.25 inches, over-all length.
57.625 pounds, total weight.

PROJECTILE (painted black with 0.5 inch red band above rotating band):

15.4 inches, over-all length.
w/o fuze.
1.15 inches, distance from base to band.
0.905 inch, width of rotating band.
4.125 inches, diameter of bourrelet.
4.133 inches, diameter of base.
34.7 pounds, total weight.

TNT in aluminum container, type of bursting charge.

0.812 inch, width of bourrelet.

Tracer is present in fuze.

CARTRIDGE CASE (German nomenclature 6307 (fixed)):

30.17 inches, over-all length.
4.204 inches, diameter of neck.
4.628 inches, diameter of shoulder.
5.450 inches, diameter of base.
12.85 pounds, weight of propellant.
Tubular Diglycol, type of propellant.
C/22 primer.

FUZE: Base detonation fuze—Bd. Z. f. 10-cm (so marked).

REMARKS: There are two cannellures below the

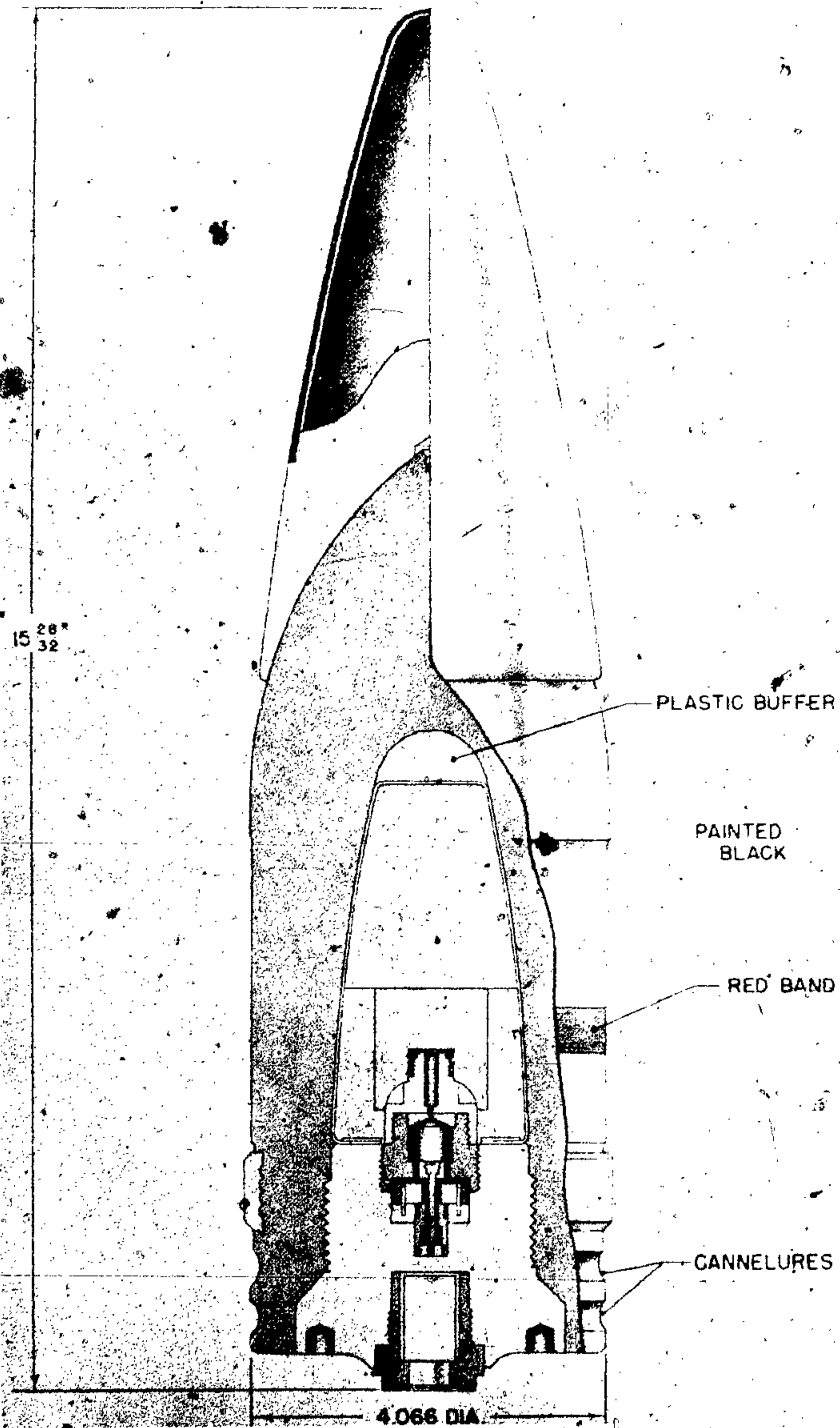

Figure 466—A. P. C. Projectile with Tracer, 105-mm, 10-cm Pzgr. Rot

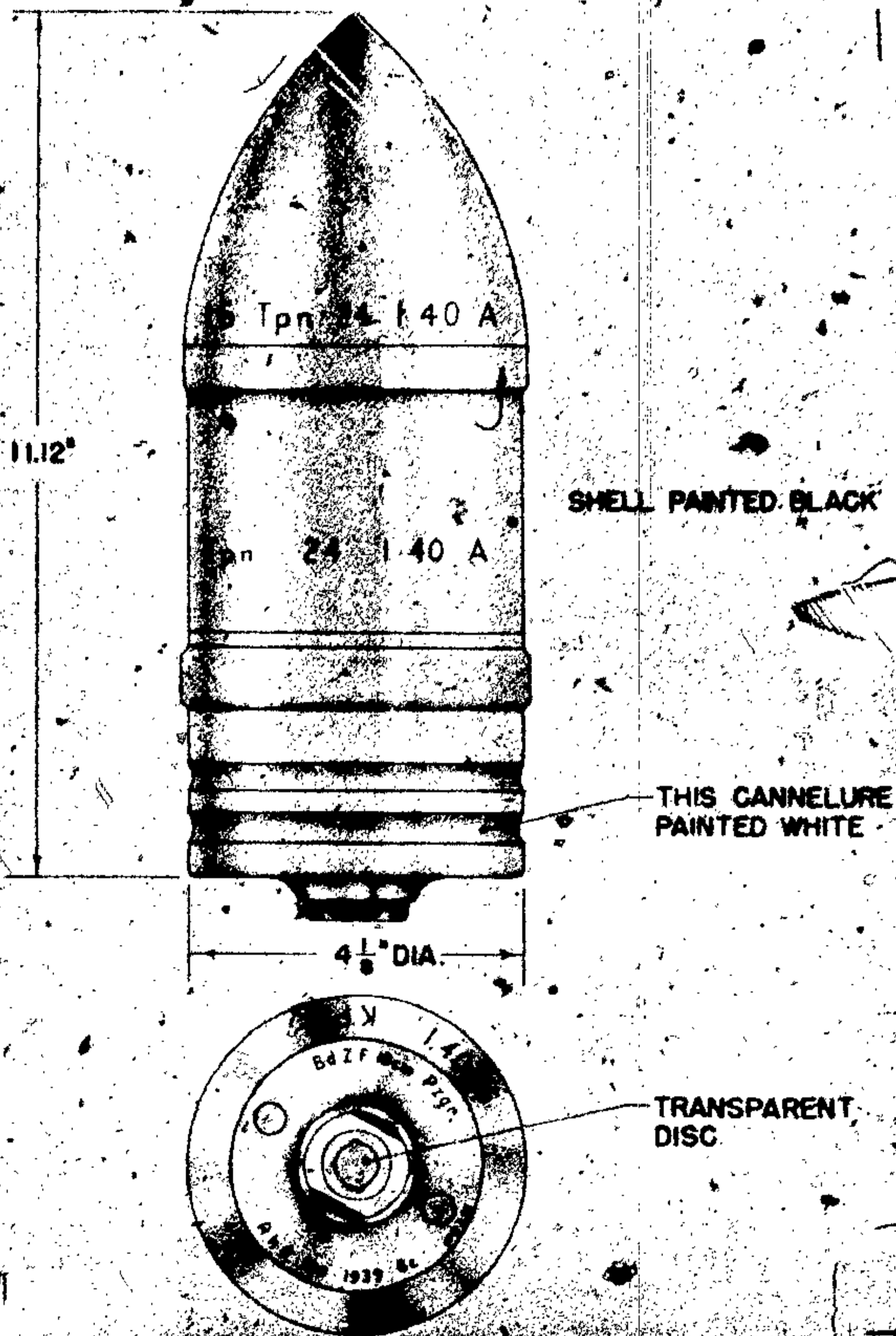

Figure 467—A. P. Projectile for Light Field Howitzer, 105-mm Pzgr. Rot L'Spur

rotating band. Cartridge cases for other weapons as follows:

- 10-cm K. T.—6356 (semifixed).
- 10-cm K. 18—6349 (semifixed).

A. P. PROJECTILE FOR LIGHT FIELD HOWITZER, 105-MM

GERMAN NOMENCLATURE: Pzgr. rot L'-Spur (Panzergranate rot Leuchtspur). (See fig. 467.)

EMPLOYMENT:

- 10-cm LFH 16. (Leichte Feld Haubitze 16)

Light Field Howitzer 16.

- 10-cm LFH 18 (Leichte Feld Haubitze 18) Light Field Howitzer 18.
- 10-cm LFH 18M (Leichte Feld Haubitze 18 Mundungsbremse) Light Field Howitzer 18 Muzzle Brake.

10-cm K. K. (Kanone Kasematte) Casemate Cannon.

10-cm K. T. (Kanone Turren) Turret Cannon.

COMPLETE ROUND: Description of c/r is for LFH 16. 37.441 inches, over-all length.

PROJECTILE, (painted black with red stenciling):

- 11.5 inches, over-all length w/ fuze.
- 10.285 inches, over-all length w/o fuze.
- 2.579 inches, distance from base to band.
- 0.625 inches, width of rotating band.
- 4.062 inches, diameter of base.
- 34.62 pounds, total weight.
- 8.11 ounces, weight of bursting charge.
- TNT, type of bursting charge.
- Tracer present in fuze.

CARTRIDGE CASE (German nomenclature, 6342 [semifixed]):

- 6.125 inches, over-all length.
- 4.375 inches, diameter of neck.
- 4.5 inches, diameter of shoulder.
- 4.937 inches, diameter of base.
- 1.54 pounds, weight of propellant.
- Flaked Diglycol, type of propellant.

FUZE: Base detonating fuze—Bd. Z. f. 10-cm.

REMARKS: There are two cannelures below the rotating band. Cartridge cases for other weapons are as follows:

- LFH 18—6342 (semifixed).
- LFH 18 M—6342 (semifixed).
- K. K.—6356 (semifixed).
- K. T.—6356 (semifixed).

When projectile has been fired from LFH 16 there will be 32 engravings on the band.

H. E. PROJECTILE FOR FIELD HOWITZER, 105-MM

GERMAN NOMENCLATURE: F. H. Gr. (Feld Haubitze Granate). (See fig. 468.)

EMPLOYMENT:

- 10-cm LFH 16 (Leichte Feld Haubitze 16) Light Field Howitzer 16.
- 10-cm LFH 18 (Leichte Feld Haubitze 18) Light Field Howitzer 18.
- 10-cm LFH 18 M (Leichte Feld Haubitze 18 Mundungsbremse) Light Field Howitzer 18 Muzzle Brake.
- 10-cm Stu. H 42 (Sturm Haubitze 42) Assault Howitzer 42.
- 10-cm LG 40 (Leuchtes Geschutz 42) Recoilless Gun for Airborne Troops.
- 10-cm LG 42 (Leuchtes Geschutz 42) Recoilless Gun for Airborne Troops.

COMPLETE ROUND: Description of c/r is for LFH 16. 25.295 inches, over-all length.

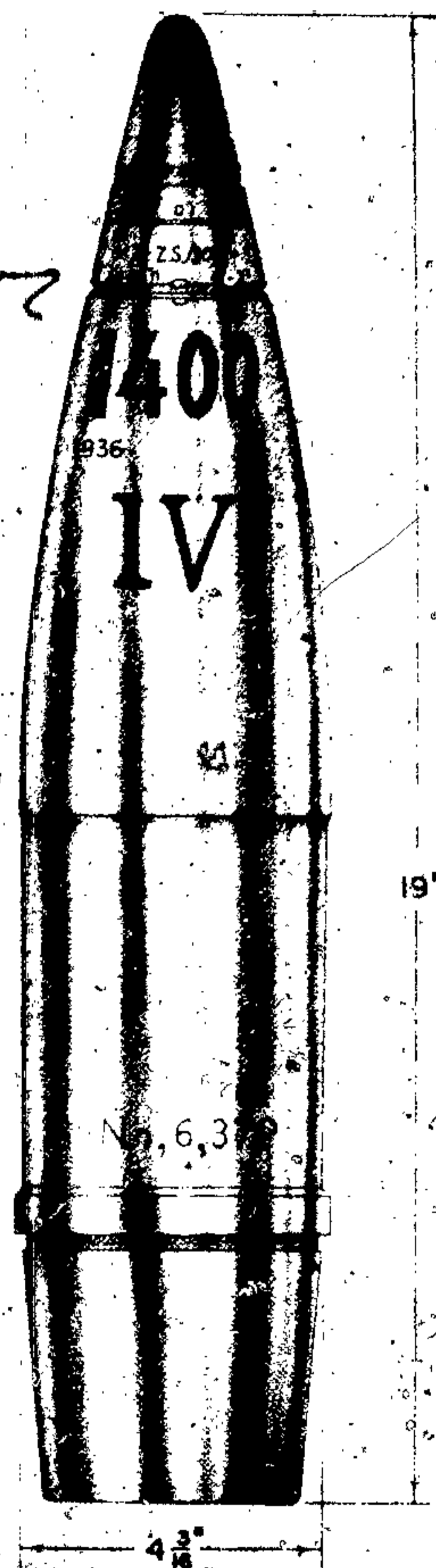

Figure 468—H. E. Projectile for Field Howitzer, 105-mm F. H. Gr.

PROJECTILE, painted green:

- 19.17 inches, over-all length w/ fuze.
- 15.55 inches, over-all length w/o fuze.
- 3.385 inches, distance from base to rotating band.
- 0.59 inch, width of single rotating band.
- 33.08 pounds, total weight.
- 3.0 pounds, weight of bursting charge plus.
- 4.0 ounces, red phosphorus smoke box.

GERMAN EXPLOSIVE ORDNANCE

TNT or Amatol, type of bursting charge.
Gr. Zdlg. C/98 Np booster.

CARTRIDGE CASE (German nomenclature—6342 [Semifixed]):

6.125 inches, over-all length.
4.375 inches, diameter of neck.
4.5 inches, diameter of shoulder.
4.937 inches, diameter of base.
1.54 pounds, weight of propellant.
Flaked Diglycol, type of propellant.
C/12nA primer.

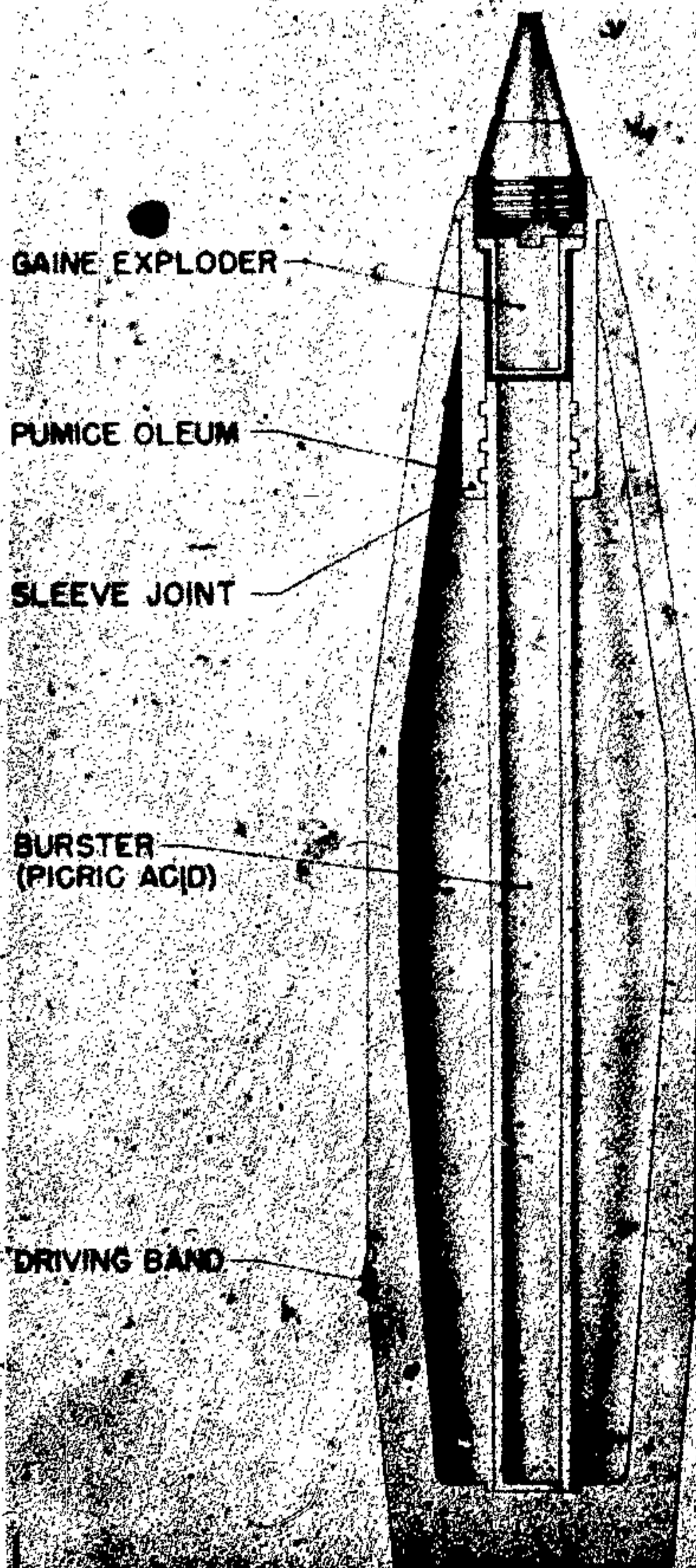

Figure 469—Smoke Projectile for Field Howitzer, 105-mm, 10-cm F. H. Gr. Nb.

This case may be of brass-coated steel, unpainted steel, or black steel spirally wound. In the last instance, it is designated and marked, 6342/h5C.

FUZE: Nose Percussion Fuze AZ 23v (0.15), (0.25), or Time and Percussion Fuze Dopp. Z. s/60.

PACKAGING: One projectile in a wooden crate—41.8 pounds.

REMARKS: Four types of H. E. are fired. They do not differ materially from each other and have approximately the same weight. Their ballistic qualities are the same. They use the same fuzes. Are designated: FH-Gr., FH Gr. 38, FH Gr. Stg., FH Gr. FES. FH Gr. 33 Stg. is of cast steel and the bursting charge is poured.

When the projectile is fired from the LFH 16 there will be 32 engravings on the band.

Cartridge cases for other weapons are as follows:

LFH 18—6342 (semifixed).

LFH 18—6342 (semifixed).

LG 40—Plastic disk base side primer (semifixed).

LG 42—Plastic disk base side primer (semifixed).

Stu H 42—

SMOKE PROJECTILE FOR FIELD HOWITZER, 105-MM

GERMAN NOMENCLATURE: 10-cm F. H. Gr. Nb. (Feld Haubitze Granate Nebel). (See fig 469.)

EMPLOYMENT:

LFH 16 (Leichte Feld Haubitze 16) Light Field Howitzer 16.

LFH 18 (Leichte Feld Haubitze 18) Light Field Howitzer 18.

LFH 18 M (Leichte Feld Haubitze 18 Mündungsbremse) Light Field Howitzer Muzzle Brake.

Stu H 42 (Sturm Haubitze 42) Assault Howitzer 42.

COMPLETE ROUND: Description of c/4 is for LFH 16. 15.905 inches, over-all length.

PROJECTILE, painted green, stenciled in white:

19.29 inches, over-all length w/ fuze.

17.32 inches, over-all length w/o fuze.

3.385 inches, distance from base to band.

0.59 inch, width of rotating bands.

3.3 inches, diameter of base.

30.8 pounds, total weight.

4.3 ounces, weight of bursting charge.

Picric acid, type of bursting charge.
 4.1 pounds, weight of smoke mixture.
 Oleum impregnated in pumice, type of smoke mixture.
 Adlg C/98 booster.
 "Nb" Stenciled on body.

CARTRIDGE CASE (German nomenclature 6342 [semifixed]):

6.125 inches, over-all length.
 4.375 inches, diameter of neck.
 4.5 inches, diameter of shoulder.
 4.937 inches, diameter of base.
 1.54 pounds, weight of propellant.
 Flaked Diglycol, type of propellant.
 C/12nA primer.

FUZE: Nose percussion Fuze K1 A. Z. 23 Nb.

PACKAGING: One round in wooden crate—40 pounds.

REMARKS: There is also a round designated: "F. H. Gr. 40Nb" believed to be of the ejector type, and a round, "F. H. Gr. 38 Nb" similar to the above but producing a large cloud of smoke, and a round "F. H. Gr. 40 Deut" which emits a cloud of blue smoke lasting one to two minutes and is used as a marker for air support.

Cartridge cases for other weapons are as follows:

LFH 18—6342 (semifixed).
 LFH 18 M—6342 (semifixed).
 Stu H 42—

When this projectile has been fired from LFH 16 there will be 32 engravings on the band.

H. E. PROJECTILE FOR LONG DISTANCE USE IN FIELD HOWITZER, 105-MM

GERMAN NOMENCLATURE: 10-cm F. H. Gr. F. (Feld Haubitze Granate (distance)). (See fig. 470.)

EMPLOYMENT: LFH 18 M (Leichte Feld Haubitze Mundungsbremse) Light Field Howitzer 18 Muzzle Brake.

COMPLETE ROUND: 24.233 inches, over-all length.

PROJECTILE, Painted green:

20.47 inches, over-all length w/ fuze.
 16.77 inches, over-all length w/o fuze.
 2.362 inches, distance from base to band.
 0.59 inch, width of rotating band.
 32.58 pounds, total weight.
 Amatol, type of bursting charge.

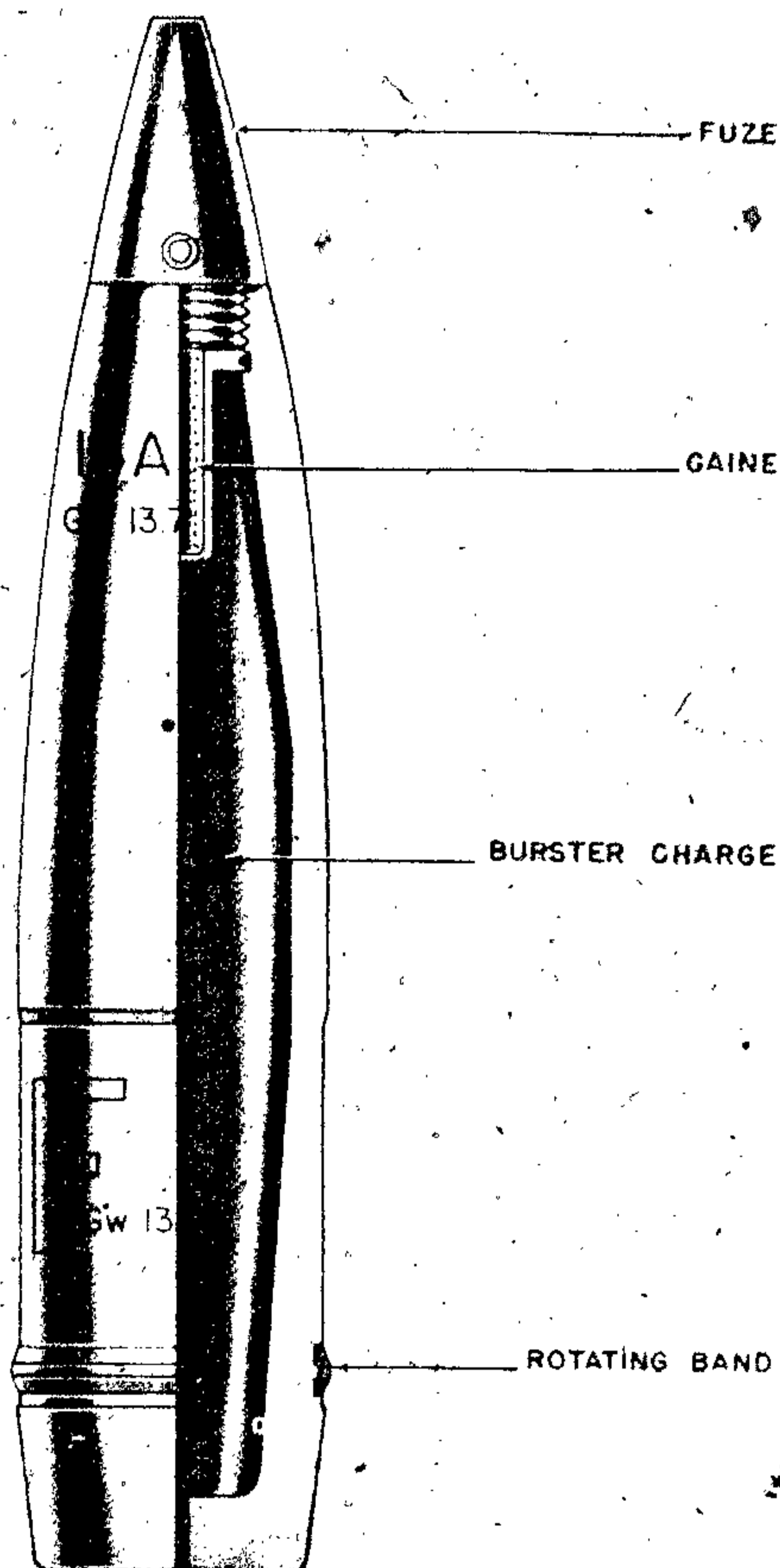

Figure 470—H. E. Projectile for Long Distance Use in Field Howitzer, 105-mm, 10-cm F. H. Gr. F.

CARTRIDGE CASE (German nomenclature 6342):

6.125 inches, over-all length.
 4.375 inches, diameter of neck.
 4.5 inches, diameter of shoulder.
 4.937 inches, diameter of base.
 3.4 pounds, weight of propellant.
 Gudol, type of propellant.

FUZE: Nose percussion fuze—Dopp. (0.15) or Time and percussion fuze—Dopp. Z. s/60 Fl.

GERMAN EXPLOSIVE ORDNANCE

REMARKS: LFH 18 M uses same projectiles, charges, and cartridge cases as the LFH 18 with the above addition.

HOLLOW CHARGE PROJECTILE, 105-MM

GERMAN NOMENCLATURE: 10-cm Gr. 39 rot HL (Granate 39 rot Hohl Ladung). (See fig. 471.)

EMPLOYMENT:

- 10-cm LFH 16 (Leichte Feld Haubitze 16) Light Field Howitzer 16.
- 10-cm LFH 18 (Leichte Feld Haubitze 18) Light Field Howitzer 18.
- 10-cm LFH 18 M (Leichte Feld Haubitze 18 Mundungsbremse) Light Field Howitzer 18 Muzzle Brake.
- 10-cm LG 40 (Leichtes Geschutz 40) Light Recoilless Gun for Airborne Troops.



Figure 471—Hollow Charge Projectile, 105-mm, 10-cm Gr. 39 Rot HL

10-cm LG 42 (Leichtes Geschutz 42) Light Recoilless Gun for Airborne Troops.

COMPLETE ROUND: Description of c/r is for LFH 16. 12.699 inches, over-all length.

PROJECTILE, painted green, with red band above rotating band:

15.314 inches, over-all length w/ fuze.

2.165 inches, distance from base to band.

0.669 inch, width of rotating band.

4.055 inches, diameter of base.

25.56 pounds, total weight.

3.91 pounds, weight of bursting charge.

Cyclonite/Wax/TNT, type of bursting charge.

Zdlg. 40 booster.

CARTRIDGE CASE (German nomenclature 6342 [semifixed]):

6.125 inches, over-all length.

4.375 inches, diameter of neck.

4.5 inches, diameter of shoulder.

4.937 inches, diameter of base.

1.54 pounds, weight of propellant.

Flaked Diglycol, type of propellant.

C/12nA primer.

FUZE: Nose percussion fuze Az 38.

REMARKS: When used with Lg 40, rotating band is 0.59 inch in width.

Cartridge cases for other weapons are as follows:

LG 40—Plastic disk base with side primer (semifixed).

LG 42—Plastic disk base with side primer (semifixed).

LFH 18—6342.

LFH 18 M—6342.

When projectile has been fired from LFH 16 there will be 32 engravings on the band.

HOLLOW CHARGE PROJECTILE, TYPE A, 105-MM

GERMAN NOMENCLATURE: 10-cm Gr. 39 rot HL/A (Granate 39 rot Hohl Ladung/A). (See fig. 472.)

EMPLOYMENT:

10-cm LFH 16 (Leichte Feld Haubitze 16) Light Field Howitzer 16.

10-cm LFH 18 (Leichte Feld Haubitze 18) Light Field Howitzer 18.

10-cm LFH 18 M (Leichte Feld Haubitze 18 Mundungsbremse) Light Field Howitzer 18 Muzzle Brake.

10-cm LG 40 (Leuchtes Geschütz 40) Light Recoilless Gun for Airborne Troops.

10-cm LG 42 (Leuchtes Geschütz 42) Light Recoilless Gun for Airborne Troops.

COMPLETE ROUND: Description of c/r is for LFH 16. 23.76 inches, over-all length.

PROJECTILE, painted green, with red band above rotating band:

19.803 inches, over-all length w/fuze.

2.165 inches, distance from base to band.

0.699 inch, width of rotating band.

4.074 inches, diameter of base.

27.156 pounds, total weight.

Cyclonite/Wax/TNT, type of bursting charge.

Zdlg. 40 booster.

CARTRIDGE CASE (German nomenclature 6342 [semifixed]):

6.125 inches, over-all length.

4.373 inches, diameter of neck.

4.5 inches, diameter of shoulder.

4.937 inches, diameter of base.

1.54 pounds, weight of propellant.

Flaked Diglycol, type of propellant.

C/12nA primer.

FUZE: Nose percussion fuze A. Z. 38.

REMARKS: When used with LG 40, rotating band is 0.59 inch in width.

Cartridge cases for other weapons are as follows:

LG 40—Plastic disk base with side primer (semifixed).

LG 42—Plastic disk base with side primer (semifixed).

LFH 18—6342.

LFH 18 M—6342.

When projectile has been fired from LFH 16, there will be 32 engravings on the band.

HOLLOW CHARGE PROJECTILE, TYPE B, 105-MM

GERMAN NOMENCLATURE: 10-cm Gr. 39 HL/B (Granate 39 Hohl Ladung/B). (See fig. 473.)

EMPLOYMENT:

10-cm LFH 16 (Leichte Feld Haubitze 16) Light Field Howitzer 16.

10-cm LFH 18 (Leichte Feld Haubitze 18) Light Field Howitzer 18.

10-cm LFH 18 M (Leichte Feld Haubitze 18 Mündungsbremse) Light Field Howitzer 18 Muzzle Brake.

10-cm LG 40 (Leuchtes Geschütz 40) Light Recoilless Gun for Airborne Troops.

10-cm LG 42 (Leuchtes Geschütz 42) Light Recoilless Gun for Airborne Troops.

COMPLETE ROUND: Description of c/r is for LFH 16. 23.76 inches, over-all length.

PROJECTILE, painted green, with red band above rotating band:

19.803 inches, over-all length w/fuze.

2.165 inches, distance from base to band.

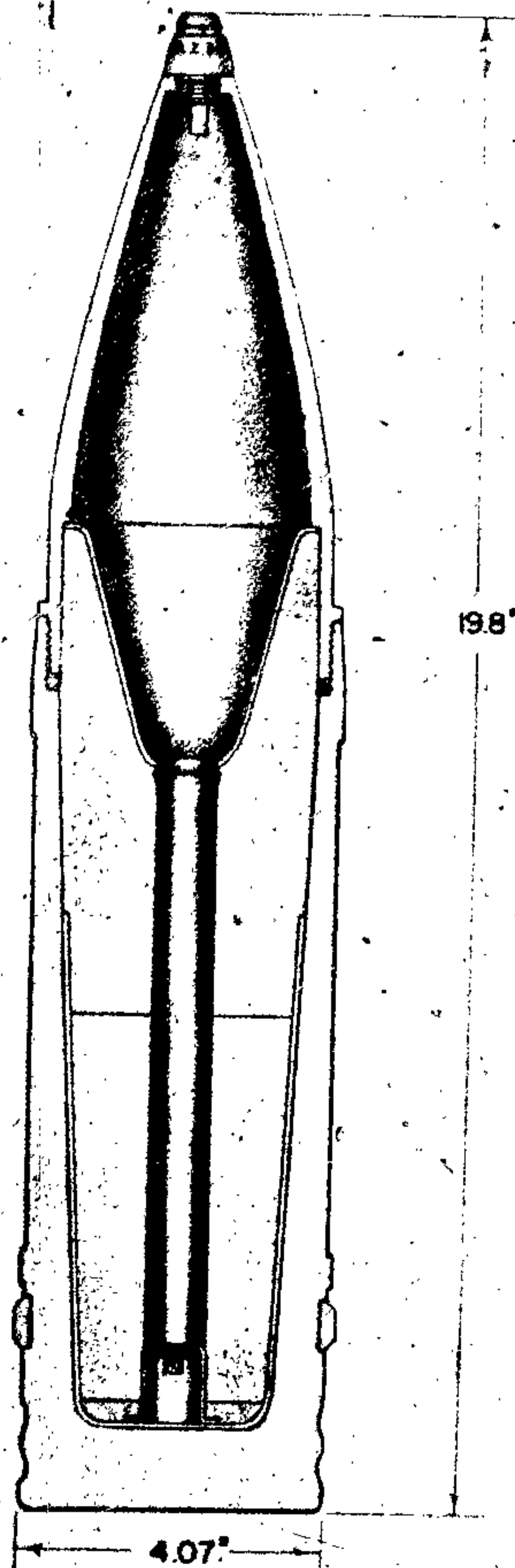
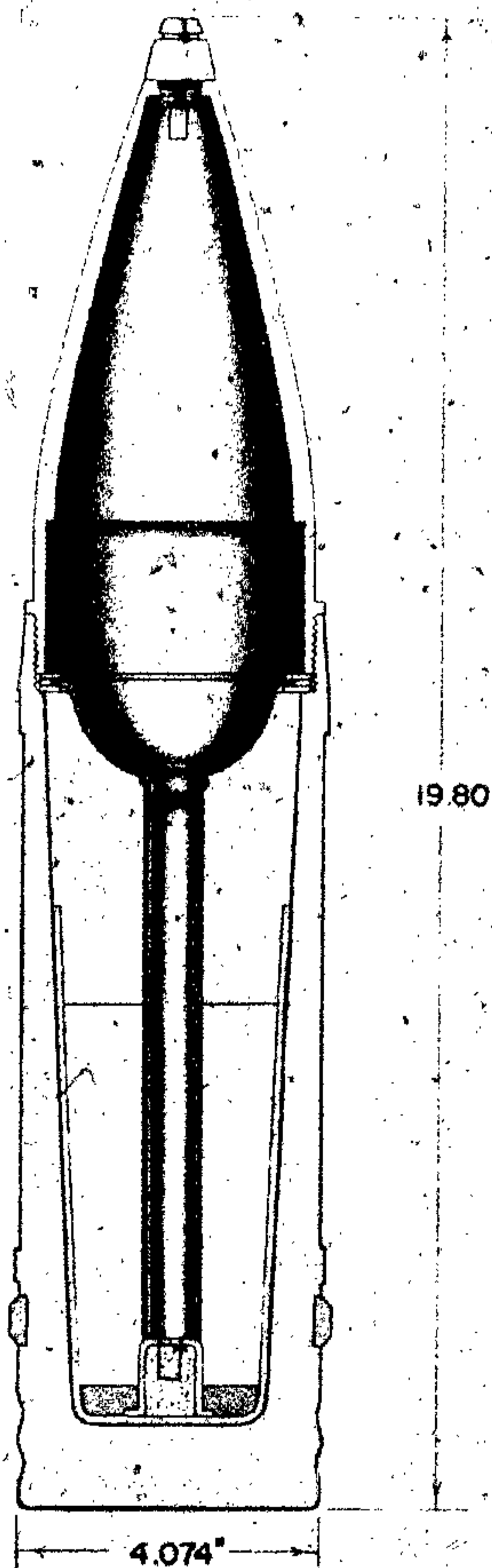

Figure 472—Hollow Charge Projectile, Type A, 105-mm, 10-cm Gr. 39 Rot HL/A

GERMAN EXPLOSIVE ORDNANCE



**Figure 473—Hollow Charge Projectile, Type B,
105-mm, 10-cm Gr. 39 HL/B**

0.669 inch, width of rotating band.
4.074 inches, diameter of base.
26.179 pounds, total weight.
Cyclonite/Wax/TNT, type of bursting charge.
Zdlg, 40 booster.

CARTRIDGE CASE (German nomenclature 6342 [semifixed]):
6.125 inches, over-all length.
4.375 inches, diameter of neck.
4.5 inches, diameter of shoulder.

4.937 inches, diameter of base.
1.54 pounds, weight of propellant.
Flaked Diglycol, type of propellant.
C/12nA primer.

FUZE: Nose percussion fuze-A. Z. 38.

REMARKS: When used with LG 40, rotating band is 0.59 inches in width.

Cartridge cases for other weapons are as follows:

LG 40—Plastic disk base with side primer (semifixed).

LG 42—Plastic disk base with side primer (semifixed).

LFH 18—6342.

LFH 18 M—6342.

When projectile has been fired from LFH 16, there will be 32 engravings on the band.

HOLLOW CHARGE PROJECTILE, TYPE C, 105-MM

GERMAN NOMENCLATURE: 10-cm Gr. 39 rot HL/C (10-cm Granate 39 rot Hohl Ladung/C). (See fig. 474.)

EMPLOYMENT:

10-cm LFH 16 (Leichte Feld Haubitze 16) Light Field Howitzer 16.

10-cm LFH 18 (Leichte Feld Haubitze 18). Light Field Howitzer 18.

10-cm LFH 18 M (Leichte Feld Haubitze 18 Mundungsbremse) Light Field Howitzer 18 Muzzle Brake.

10-cm LG 40 (Leuchtes Geschutz 40) Light Recoilless Gun for Airborne Troops.

10-cm LG 42 (Leuchtes Geschutz 42) Light Recoilless Gun for Airborne Troops.

COMPLETE ROUND: Description of c/r is for LFH 16. 23.76 inches, over-all length.

PROJECTILE, painted green, red band above rotating band:

19.803 inches, over-all length w/fuze.

2.165 inches, distance from base to rotating band.

0.650 inch, width of rotating band:

4.074 inches, diameter of base.

28.875 pounds, total weight.

3.286 pounds, weight of bursting charge.

Cyclonite/Wax/TNT, type of bursting charge.
Zklg. 40 booster.

CARTRIDGE CASE (German nomenclature 6342 [semifixed]):

6.125 inches, over-all length.
 4.375 inches, diameter of neck.
 4.5 inches, diameter of shoulder.
 4.937 inches, diameter of base.
 1.54 pounds, weight of propellant.
 Flaked Diglycol, type of propellant.
 C/12nA primer.

FUZE: Nose percussion fuze AZ 38.

REMARKS: When used with LG 40, rotating band is 0.59 inches in width.

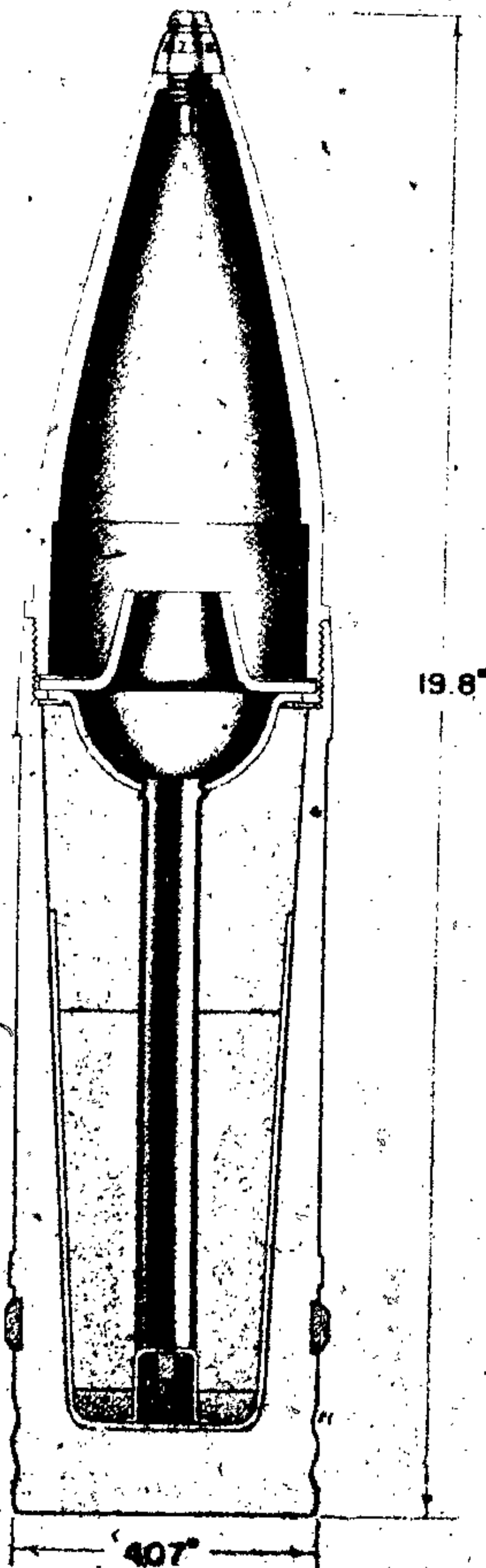

Figure 474.—Hollow Charge Projectile, Type C,
 105-mm, 10-cm Gr. 39 Rot HL/C

Cartridge cases for other weapons are as follows:
 LG 40—Plastic disk base with side primer (semi-fixed).

LG 42—Plastic disk base with side primer (semi-fixed).

LFH 18—6342.

LFH 18M—6342.

When projectile has been fired from LFH 16, there will be 32 engravings on the band.

H. E. PROJECTILE, MODEL 15, FOR SKODA HOWITZER, 105-MM

GERMAN NOMENCLATURE: Not known.
 (See fig. 475.)

EMPLOYMENT: 10-cm Skoda Howitzer.

PROJECTILE, unpainted: There are two types:

| I | II |
|---------------|--|
| 15.12 inches; | 15.12 inches, over-all length w/o fuze. |
| 0.55 inch; | 0.55 inch, width of rotating band. |
| 28.62 pounds; | 28.62 pounds, total weight. |
| 0.58 inch; | 1.57 inches, distance from base to band. |
| TNT | TNT—type of bursting charge. |

CARTRIDGE CASE (Nomenclature unknown).

There are two types of cartridge cases: (1) is used for a plug-in style of primer (diameter of primer 0.83 inch); (2) is used for screw-in type of primer (diameter of primer 1.3 inches).

On base of case is stamped year of manufacture, lot number, and caliber of piece.

FUZES: Fuzes of French origin are used as follows:

1. Nose Percussion Fuze Model 18. German designation, AZ 24/31 RYC wz 18.

2. Nose Percussion Fuze Model 15. German designation, A. Z. 24/31 Wz. 99/15.

3. Time and Percussion Fuze Model 18. German designation, Dopp. Z. 24/31 A wz. 18.

4. Time and Percussion Fuze Model 15. German designation, Dopp. Z. 24/31 L. D. 17.

There are three types of the Nose Percussion Model 18:

(1) Instantaneous (B. Z.) tip painted green.

(2) Short delay (K. Z.), black.

(3) Long delay (D. Z.), black, detonator violet.

And three types of the Nose Percussion Fuze

GERMAN EXPLOSIVE ORDNANCE

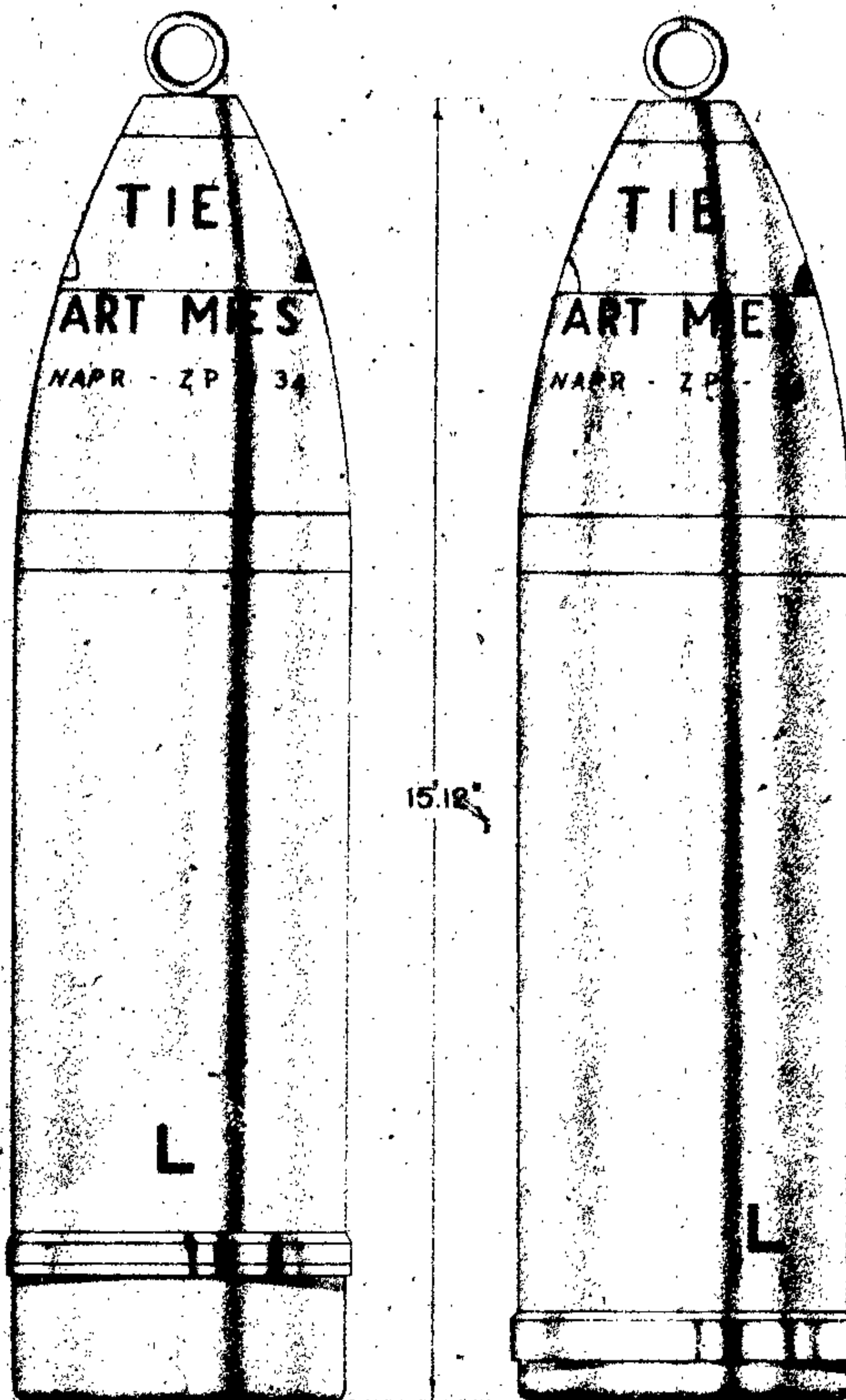

Figure 475—H. E. Projectile, Model 15, for Skoda Howitzer, 105-mm

Model 15:

(1) Instantaneous (B. Z.), upper part of fuze painted white.

(2) Short delay (0.05 second), upper part of fuze painted black.

(3) Long delay (0.15 second), upper part of fuze painted black; detonator violet.

Time and percussion fuze Model 18 has a cap which is black with a green strip on its lower edge. Maximum time of delay, 31 seconds.

Time and percussion fuze Model 17 is similar to 18. Maximum time of delay, 51 seconds.

REMARKS: The position of the rotating band, it will be noted, is the only distinction between these two projectiles.

These projectiles have fallen into German hands in considerable quantities and are reported to be in use with the German Army.

H. E. PROJECTILES, MODELS 23 AND 28 FOR SKODA HOWITZER 105-MM

GERMAN NOMENCLATURE: Not known. (See fig. 476.)

EMPLOYMENT: 10-cm Skoda Howitzer.

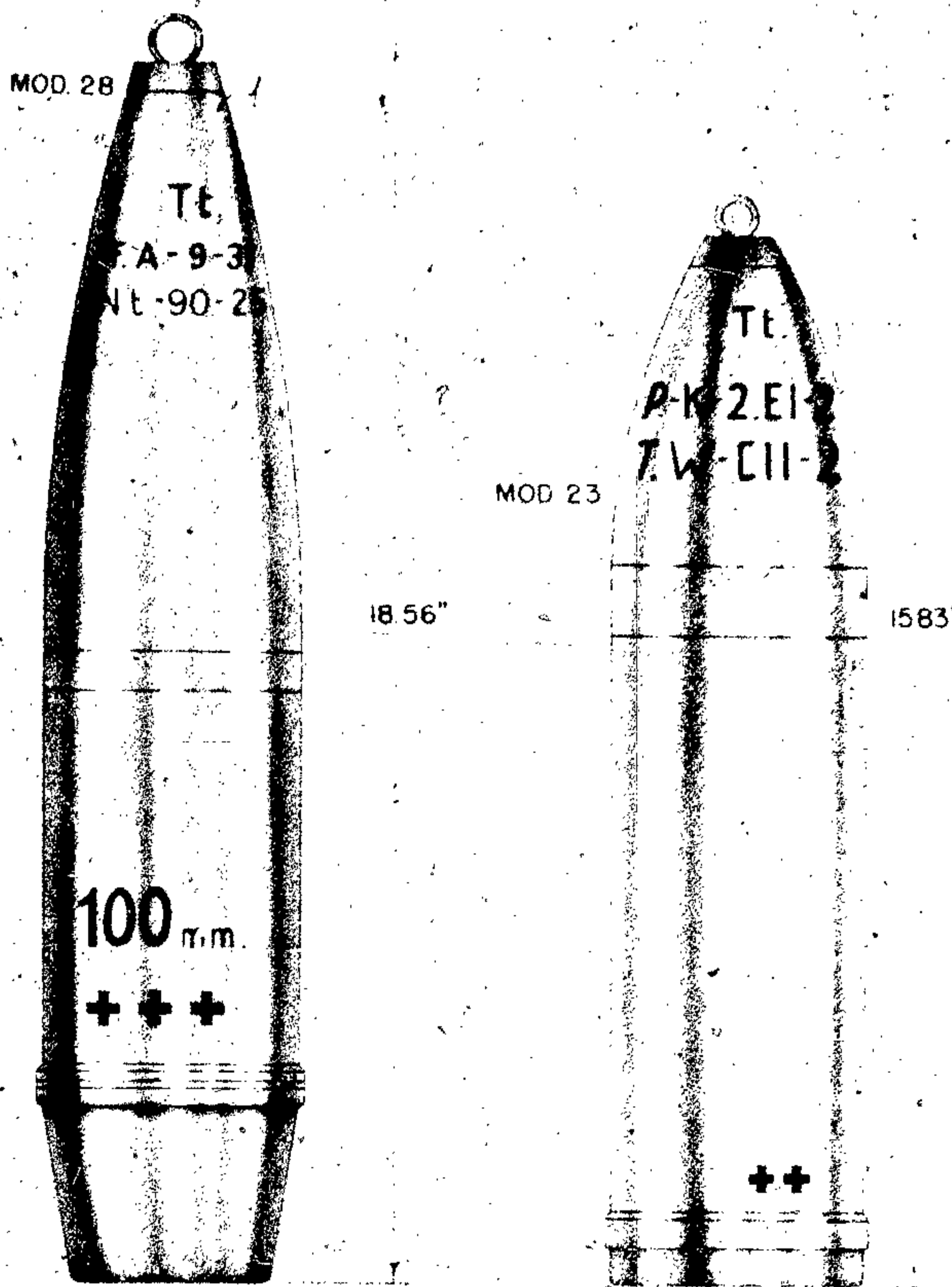

Figure 476—H. E. Projectile, Models 23 and 28 for Skoda, 105-mm

PROJECTILE:

| MODEL 23 | MODEL 28 |
|---------------|--|
| 15.83 inches; | 18.56 inches, over-all length. |
| 0.51 inch; | 0.63 inch, width of rotating band. |
| 30.6 pounds; | 31.21 pounds, total weight. |
| TNT | TNT—type of bursting charge. |
| 0.59 inch; | 2.74 inches, distance from base to band. |
| Yellow | Unpainted—color of projectile. |

CARTRIDGE CASE: Nomenclature unknown.

There are two types of cartridge cases: (1) is used for a plug-in style of primer (diameter of primer 0.83 inch); (2) is used for screw-in type of primer (diameter of primer 1.3 inches).

On base of case is stamped year of manufacture, lot number and caliber of piece.

FUZES: Fuzes of French origin are used as follows:

1. Nose Percussion Fuze Model 18. German designation, A. Z. 24/31 RYC. wz. 18.
2. Nose Percussion Fuze Model 15. German designation, A. Z. 24/31 Wz. 99/15.
3. Time and Percussion Fuze Model 18. German designation, Dopp. Z. 24/31-A. wz. 18.

GERMAN EXPLOSIVE ORDNANCE

4. Time and Percussion Fuze Model 15 German designation, Dopp. Z. 24/31 L. D. 17.

There are three types of the Nose Percussion Fuze Model 18:

- (1) Instantaneous (B. Z.), tip painted green.
- (2) Short delay (K. Z.), black.
- (3) Long delay (D. Z.), black, detonator violet.

And three types of the Nose Percussion Fuze Model 15:

- (1) Instantaneous (B. Z.), upper part of fuze painted white.

- (2) Short delay (0.05 second), upper part of fuze painted black.

- (3) Long delay (0.15 second), upper part of fuze painted black, detonator violet.

Time and percussion fuze Model 18 has a cap which is black with a green stripe on its lower edge. Maximum time of delay, 31 seconds.

Time and percussion fuze Model 17 is similar to 18. Maximum time of delay, 51 seconds.

REMARKS: These projectiles have fallen into German hands in considerable quantities and are reported to be in use with the German Army.

H. E. PROJECTILE, TYPE L/4.4 KZ., 105-MM

GERMAN NOMENCLATURE: 10-cm Sprgr. Patr. L/4.4 Kz. (Sprenggranate Patrone Ladung/4.4 Kopfzunder). (See fig. 477.)

EMPLOYMENT:

10-cm Flak 38 (Flugabwehrkanone 38) Anti-aircraft Gun 38.

10-cm Flak 39 (Flugabwehrkanone 39) Anti-aircraft Gun 39.

COMPLETE ROUND: Description of c/r fits either weapon. 46.0 inches, over-all length.

PROJECTILE, painted yellow:

14.369 inches, over-all length w/o fuze.

2.480 inches, distance from base to rotating band.

0.669 inch, width of rotating bands.

Two—number of rotating bands.

4.133 inches, diameter of base.

33.2 pounds, total weight.

3.3 pounds, weight of bursting charge.

TNT—type of bursting charge.

CARTRIDGE CASE (German nomenclature 6307 [fixed]):

30.17 inches, over-all length.

4.204 inches, diameter of neck.

4.628 inches, diameter of shoulder.

5.450 inches, diameter of base.

10.9 pounds, weight of propellant.

Diglycol, type of propellant.

C/22 primer.

FUZE: Nose percussion fuze A. Z. 23/28 v; or Mechanical time fuze Zt. Z. s/30.

REMARKS: There are two cannelures below the rotating band on this projectile. When fired, projectile will be found with 36 engravings on the rotating band.

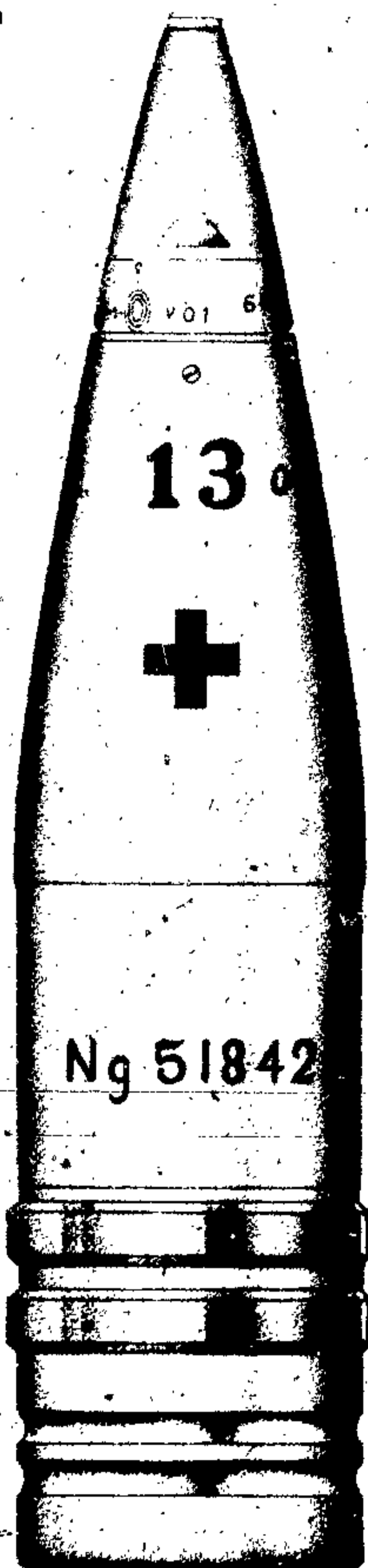

Figure 477—H. E. Projectile, Type L/4.4 Kz., 105-mm, 10-cm Sprgr. Patr. L/4.4 Kz.

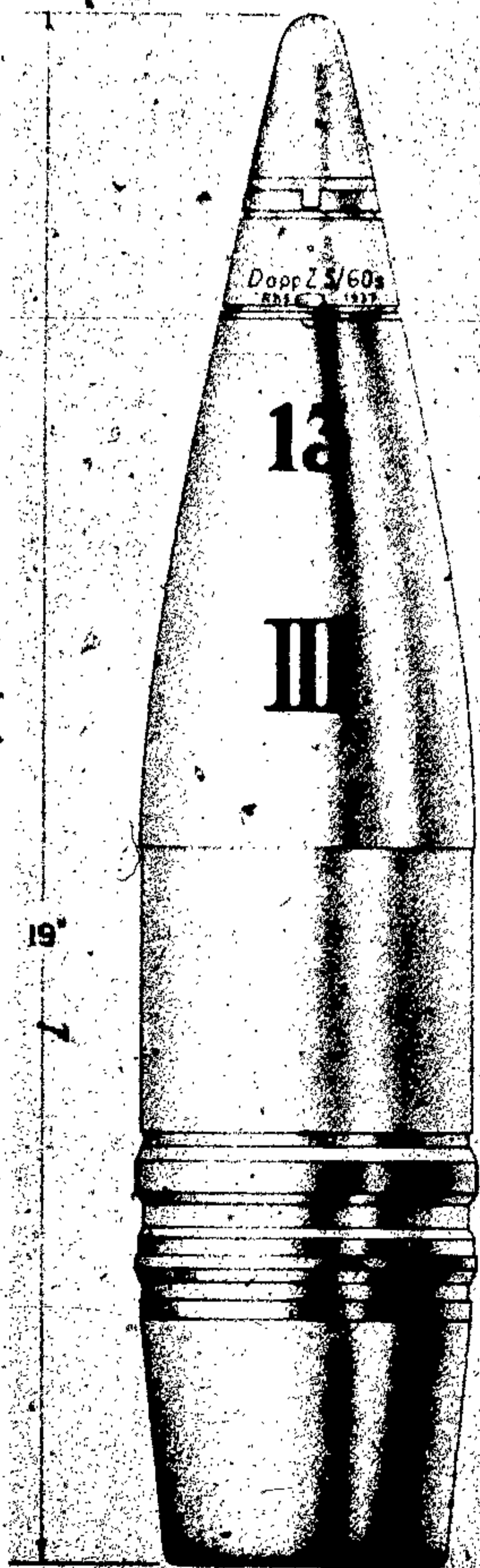

Figure 478—H. E. Projectile, Type 19, 105-mm Gr.,
19 Kz. 13

H. E. PROJECTILE, TYPE 19, 105-MM

GERMAN NOMENCLATURE: Gr. 19 Kz. 13
(Granate 19 Kopfzunder 13). (See fig. 478.)

EMPLOYMENT:

s. 10-cm K. 18 (Schweres 10-cm Kanone 18)
Heavy 10-cm Gun 18.
10-cm K. T. (Kanone Turren) Turret Gun.
l g. 10-cm K. T. (lange 10-cm Kanone Turren)
Long 10-cm Turret Gun.

COMPLETE ROUND: Description of c/r is for s.
10-cm K 18. 33.09 inches, over-all length.

PROJECTILE, painted green:

19.17 inches, over-all length w/fuze.
3.582 inches, distance from base to band.
0.669 inch, width of rotating bands.
Two, number of rotating bands.
3.464 inches, diameter of base.
32.58 pounds, total weight.
3.5 pounds, weight of bursting charge.
TNT, type of bursting charge.
C/98 Np booster.

CARTRIDGE CASE (German nomenclature 6349 [semifixed]):

17.5 inches, over-all length.
4.41 inches, diameter of neck. No shoulder.
5.12 inches, diameter of base.
12.85 pounds, weight of propellant.
Tubular Diglycol, type of propellant.
C/12nA primer.

FUZE: Nose percussion fuze—A. Z. 23v (0.15) or
Time and percussion fuze—Dopp. A. s/60.

REMARKS: When fired from s. 10-cm K 18
projectile will bear 36 engravings on rotating band.
Cartridge cases for other weapons are as follows:
10-cm K. T. 6356 (semifixed) lg. 10-cm K. T.

H. E. PROJECTILE FOR 122-MM GUN

GERMAN NOMENCLATURE: 12.2-cm Sprgr.
F. E. W. (r). (See fig. 479.)

| WEAPONS: | 12.2 CM. | MODEL |
|--------------|-------------|-------|
| Russian Gun: | K 390/1 (r) | 31 |
| Russian Gun: | K 390/2 (r) | 31/37 |

PROJECTILE:

Caliber: 122 mm.
Kind: Shell.
Type: H. E.
Weight: 49.75 pounds (loaded and fuze).
Color: O. D.

CHARGE:

Number: 13A.
Weight: 7.75 pounds.
Kind: Amatol 50/50.

TRACER: None.

BOOSTER: wlf Np 10.

GERMAN EXPLOSIVE ORDNANCE

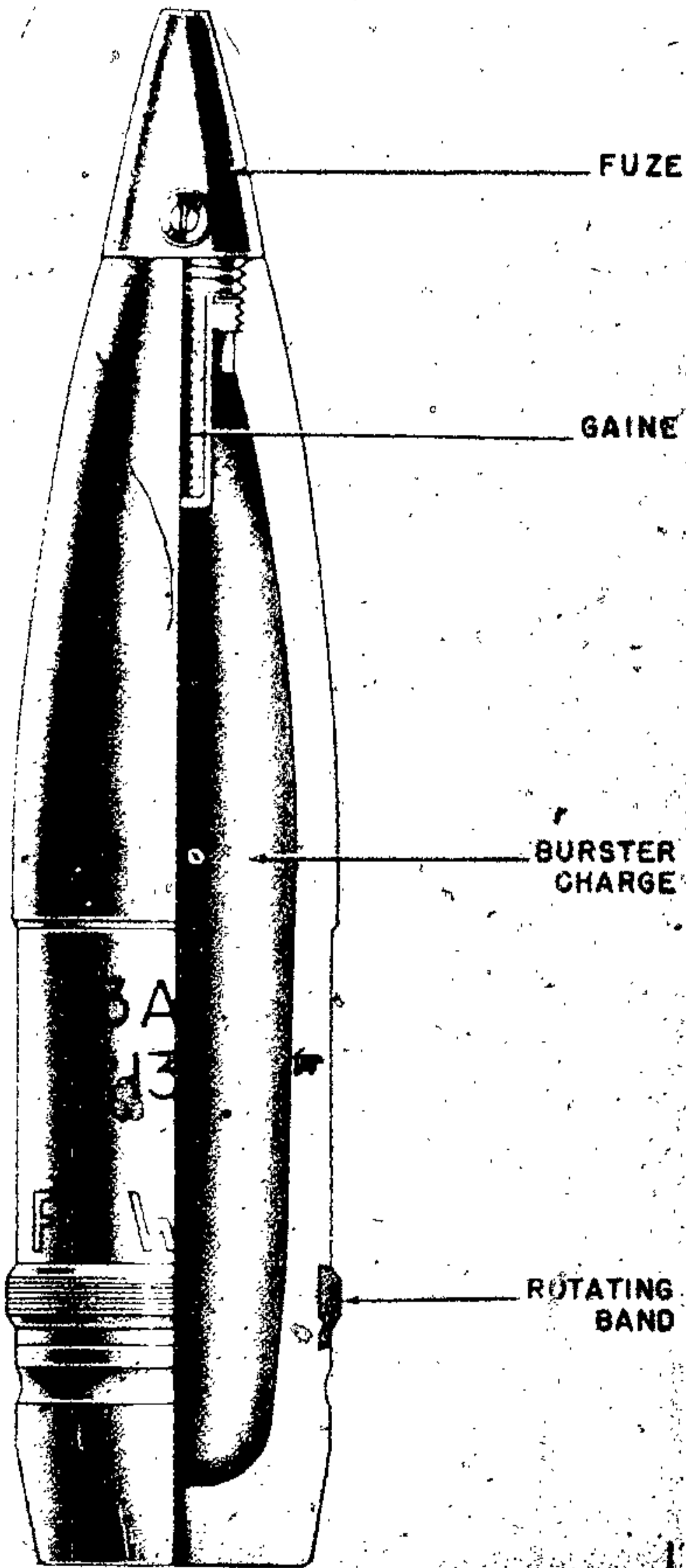

Figure 479—H. E. Projectile, 122-mm, 12.2-cm Sprgr. (FEW) (r)

FUZE:

Nomenclature: A.Z. 23 (0.15) Dopp. Z. s/90 T. & P.

Type: P. D.

REMARKS:

NOTE 1.—This projectile is of German manufacture for the Russian weapons listed above.

NOTE 2.—FEW on the body of the projectile indicates the presence of a bimetallic rotating band.

H. E. 12.8-CM PROJECTILE

GERMAN NOMENCLATURE: 12.8-cm Sprgr. Patr. 1/4.5 Sprenggranate Patrone Ladung/4.5). (See fig. 480.)

EMPLOYMENT: 58.5 inches, over-all length, 100.25 pounds, total weight.

PROJECTILE (Painted yellow, stenciled in black):

Filling: Amatol 40/60 cast (7 pounds, 7½ ounces.)

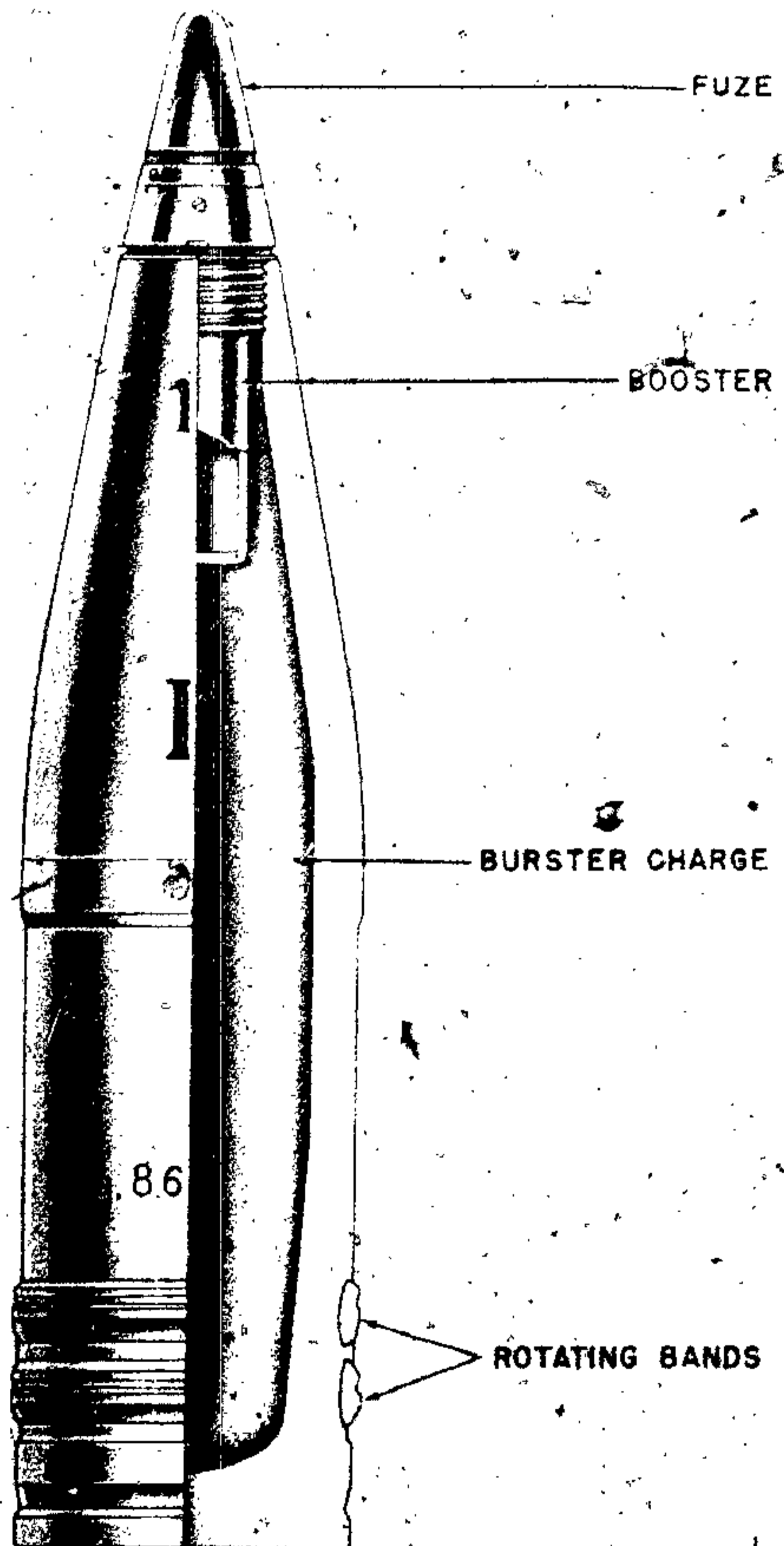

Figure 480—H. E. Projectile, 128-mm, 12.8-cm Sprgr. Patr. 1/4.5

57 pounds, 5 ounces, weight of projectile filled and fuzed.

PROJECTILE CASE:

Material—brass.

Over-all length—37.75 inches.

Propellant charge—9.62 kg.

Dig RP-Kn (850-5,6/2).

Igniter—239 grams nitrocellulose composition.

Primer—A c/22 electric.

FUZE: Zt. Z. S/30.

**ARMOR PIERCING PROJECTILE FOR 128-MM
A. A. GUN**

GERMAN NOMENCLATURE: 12.8-cm Pzgr. FES. (See fig. 481.)

WEAPONS: German A. A. Gun, 12.8-cm Flak 40.

PROJECTILE:

Caliber: 128 mm.

Kind: Projectile.

Type: Armor piercing.

Weight: 58½ pounds (loaded and fuzed).

Color: Black with red markings.

CHARGE:

Number: 86.

Weight: 1½ pounds.

Kind: Ethylenediamine dinitrate/cyclonite/wax (46/18/36) pressed in blocks in waxed paper in aluminum container.

TRACER: No. 4.

BOOSTER: Part of charge.

FUZE:

Nomenclature: Bd. Z. 5121; B. D.

REMARKS:

Note 1.—This projectile is identical to the 12.8 Pzgr. KPS except for type and contour of rotating band.

**ARMOR PIERCING PROJECTILE FOR 128-MM
A. A. GUN**

GERMAN NOMENCLATURE: 12.8-cm Pzgr. KPS. (See fig. 482.)

WEAPONS: German A. A. Gun, 12.8-cm Flak 40.

PROJECTILE:

Caliber: 128 mm.

Kind: Projectile.

Type: Armor-piercing.

Weight: 58¼ pounds (loaded and fuzed).

Color: Black with red marking.

CHARGE:

Number: 86.

Weight: 1½ pounds.

Kind: Ethylenediamine dinitrate/cyclonite/wax (46/18/36) pressed in blocks wrapped in waxed paper in aluminum container.

TRACER: No. 4.

BOOSTER: Part of charge.

FUZE:

Nomenclature: Bd. Z. 5121.

Type: B. D.

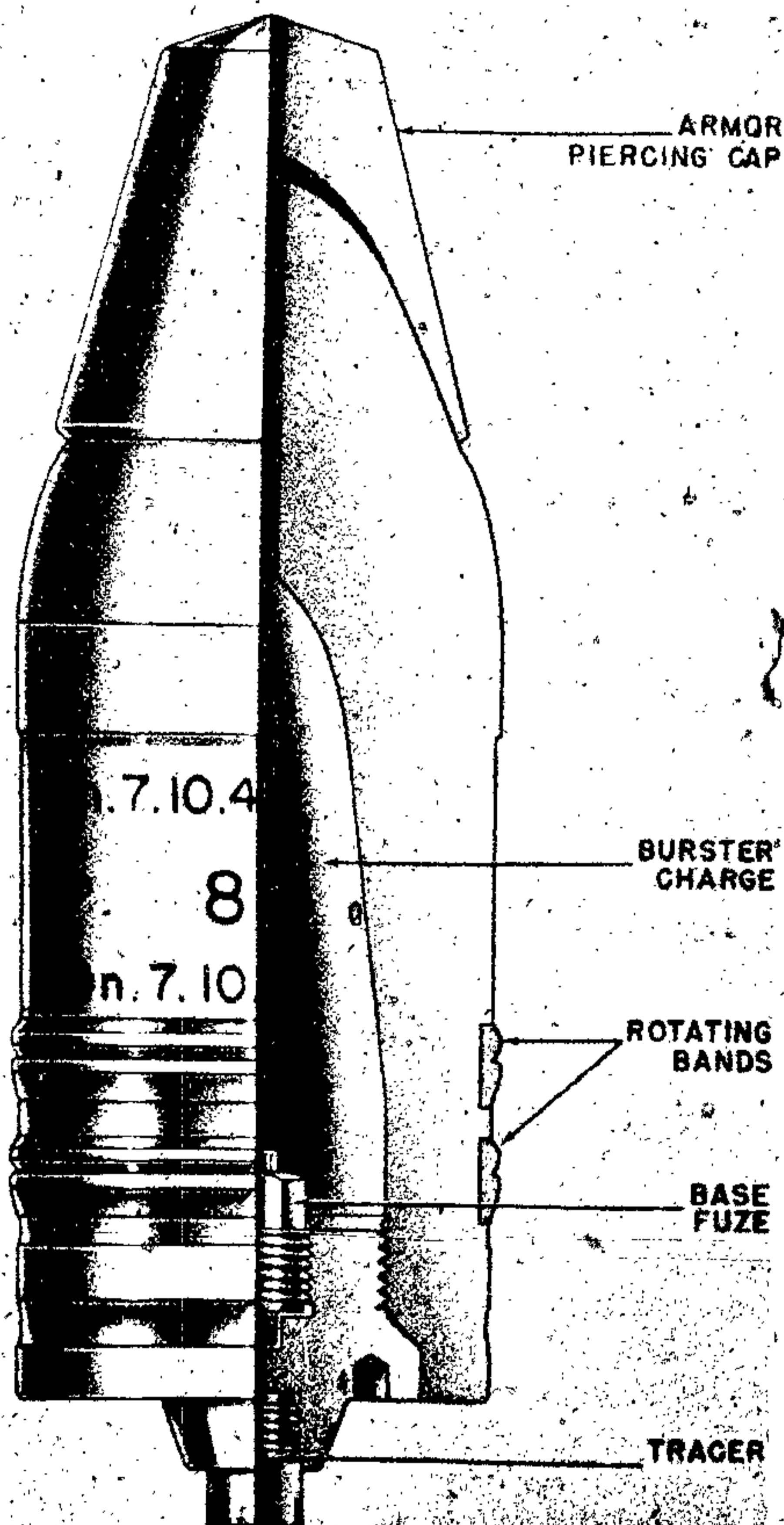

Figure 481—A. P. Projectile for 128-mm A. A. Gun,
12.8-cm Pzgr. FES

GERMAN EXPLOSIVE ORDNANCE

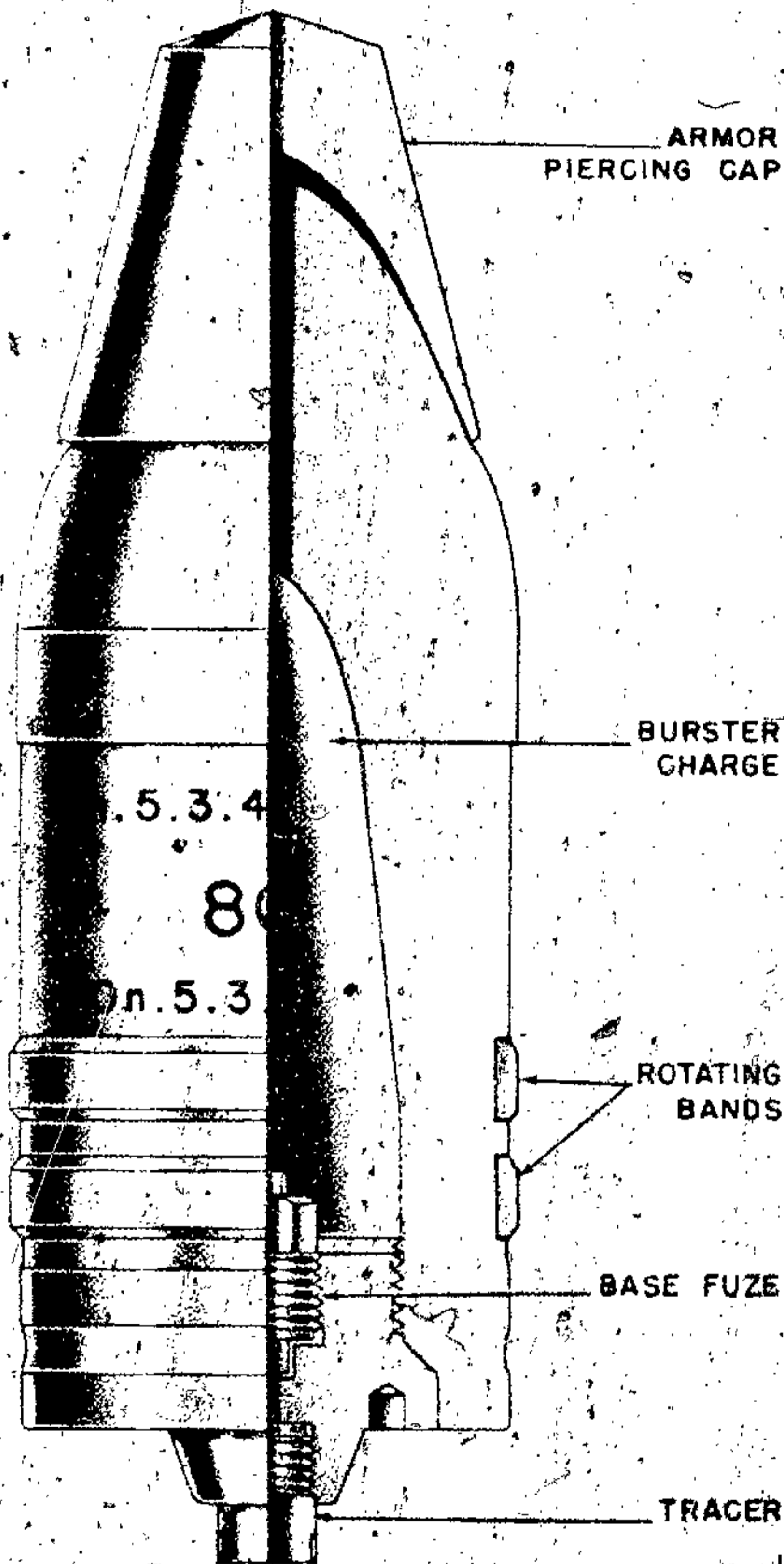

Figure 482—A. P. Projectile, 128-mm, 12.8-cm Pzgr. KPS

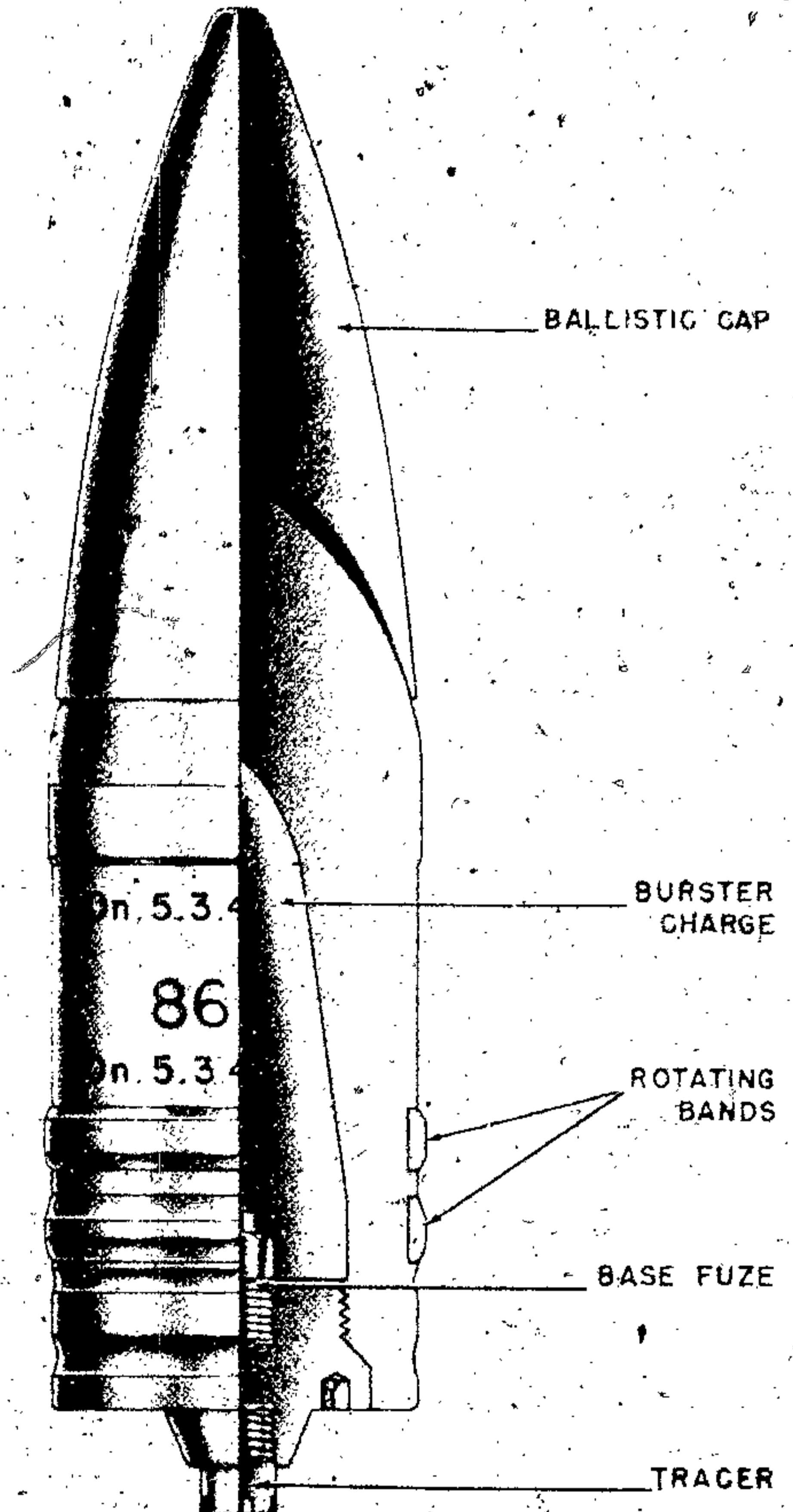

Figure 483—A. P. Projectile, 128-mm, 12.8-cm Pzgr. 43

REMARKS:

Note 1.—This projectile is identical to the 12.8-cm Pzgr. FES except for type and contour of rotating band.

ARMOR PIERCING PROJECTILE FOR 128-MM GUN

GERMAN NOMENCLATURE: 12.8-cm. Pzgr. 43. (See fig. 483.)

WEAPONS: German self-propelled antitank Gun, 12.8-cm Pak. 44.

PROJECTILE:

Caliber: 128 mm.
Kind: Projectile.
Type: Armor-piercing.
Weight: 62¼ pounds (loaded and fuzed).
Color: Black with red markings.

CHARGE:

Number: 86.

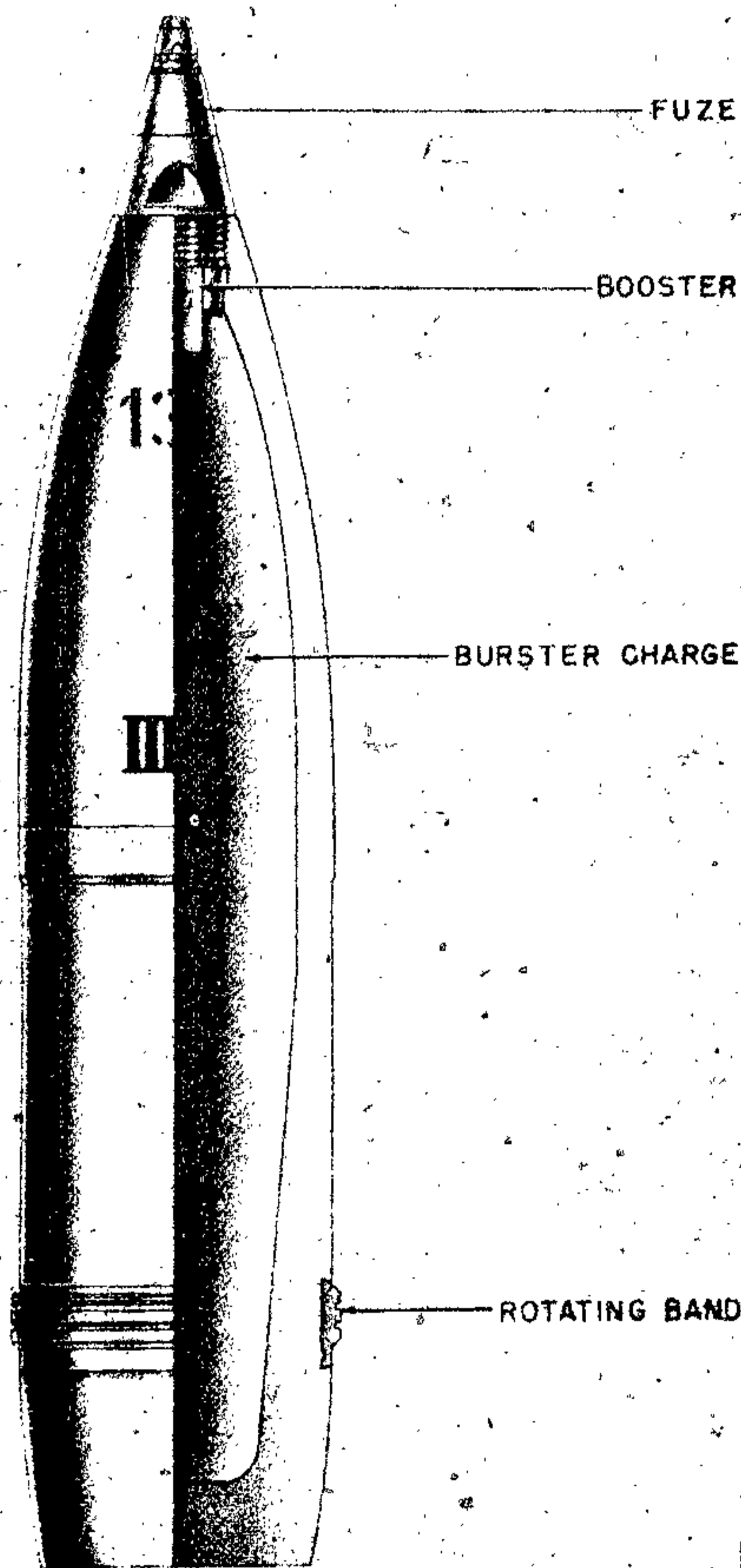

Figure 484—H. E. Projectile for Czech 150-mm Howitzer, 15-cm A. Z. Gr. 37 (t)

Weight: $1\frac{1}{4}$ pounds.

Kind: Ethylenediamine dinitrate/cyclonite/wax (46/18/36) pressed in blocks, wrapped in waxed paper, in aluminum container.

TRACER: 1 spurhulse Nr. 4.

BOOSTER: Part of shell charge.

FUZE:

Nomenclature: Bd. Z. 5121.

Type: B. D.

H. E. PROJECTILE FOR CZECH 150-MM HOWITZER

GERMAN NOMENCLATURE: 15-cm A. Z. Gr 37 (t). (See fig. 484.)

WEAPONS: Czech Medium Howitzer: s. F. H. 25 (t). Model 25.

PROJECTILE:

Caliber: 150 mm.

Kind: Shell.

Type: H. E.

GERMAN EXPLOSIVE ORDNANCE

Weight: 92.3 pounds (loaded and fuzed).
Color: machined metal with red band around body.

CHARGE:

Number: TP.
Weight: 13.8 pounds.
Kind: Pressed TNT.

TRACER: None.

BOOSTER: Integral with fuze with bore safety device.

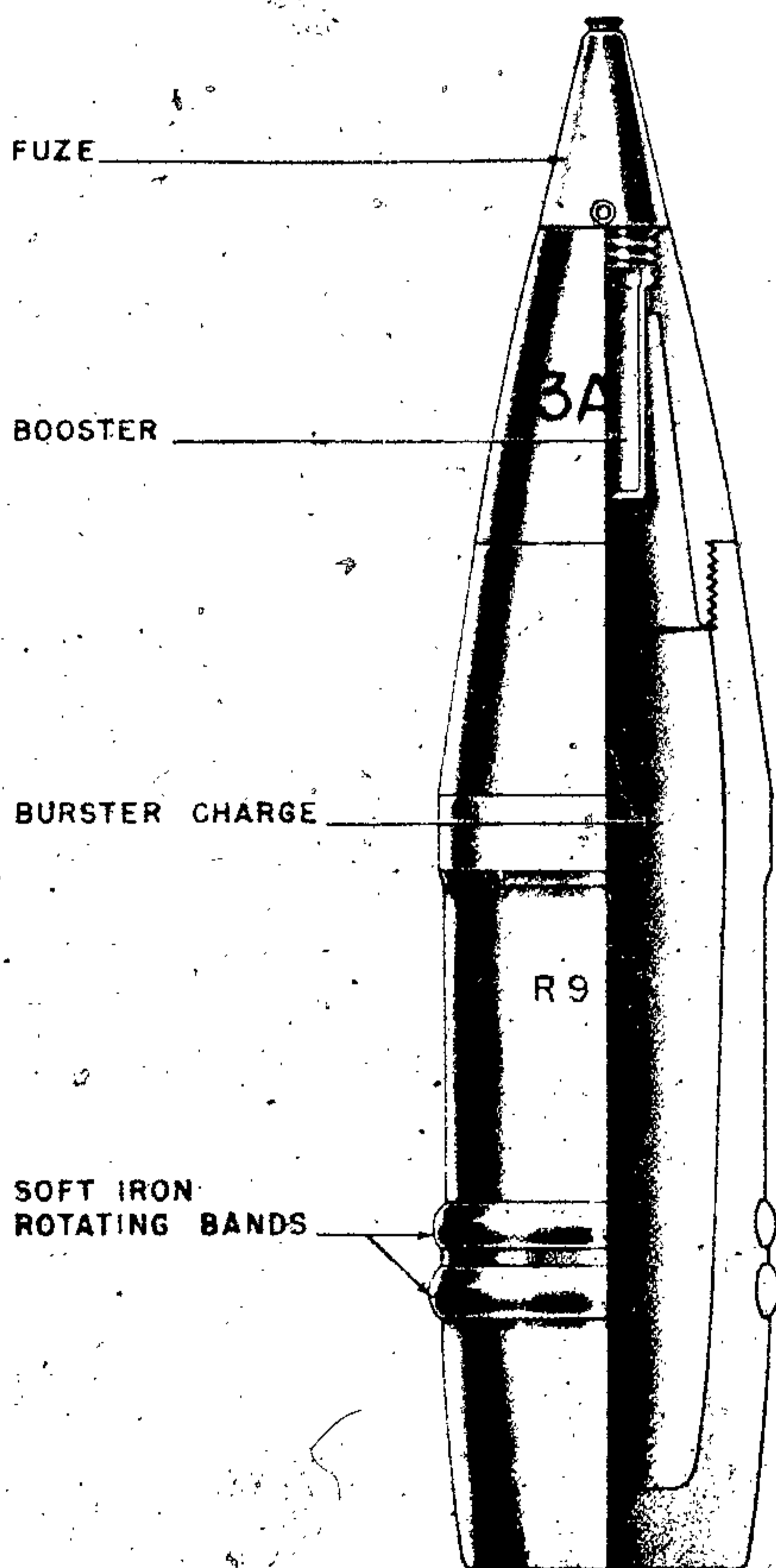

Figure 485—H. E. Projectile, 150-mm, 15-cm K. Gr. 42

FUZE:

Nomenclature: (1) AZ-SKHZR (t); (2) AZ-SKHZR (t).

Type: (1) P. D.; (2) P. D.

H. E. PROJECTILE FOR 150-MM GUN

GERMAN NOMENCLATURE: 15-cm K. Gr. 42.
(See fig. 485.)

WEAPONS: German Gun, 15-cm K. 18.

PROJECTILE:

Caliber: 150 mm.
Kind: Shell.
Type: H. E.
Weight: 94.8 pounds (loaded and fuzed).
Color: O. D.

CHARGE:

Number: 13A.
Weight: 13.5 pounds.
Kind: Amatol 50/50.

TRACER: None.

BOOSTER: dmz Np 10.

FUZE:

Nomenclature: AZ-1 Vo (0.15) or Dopp Zs/90
T. and P.

Type: P. D.

REMARKS:

Note 1.—This projectile has soft iron rotating bands.

HOLLOW CHARGE PROJECTILE FOR 150-MM HOWITZER

GERMAN NOMENCLATURE: 15-cm. Jgr. 39
HL/A. (See fig. 486.)

WEAPONS:

German Assault Howitzer: 15-cm Stu. H. 43
(L/12).

German Heavy Infantry Howitzer: s. J. G. 33.

PROJECTILE:

Caliber: 150 mm.
Kind: Shell.
Type: Hollow charge.
Weight: 55 pounds (loaded and fuzed).
Color: O. D.

CHARGE:

Number: 95.
Weight: 8.5 pounds.
Kind: Cyclonite/TNT (60/40) pressed in
block; wrapped, waxed paper.

TRACER: Yes.

BOOSTER: fde Np 10.

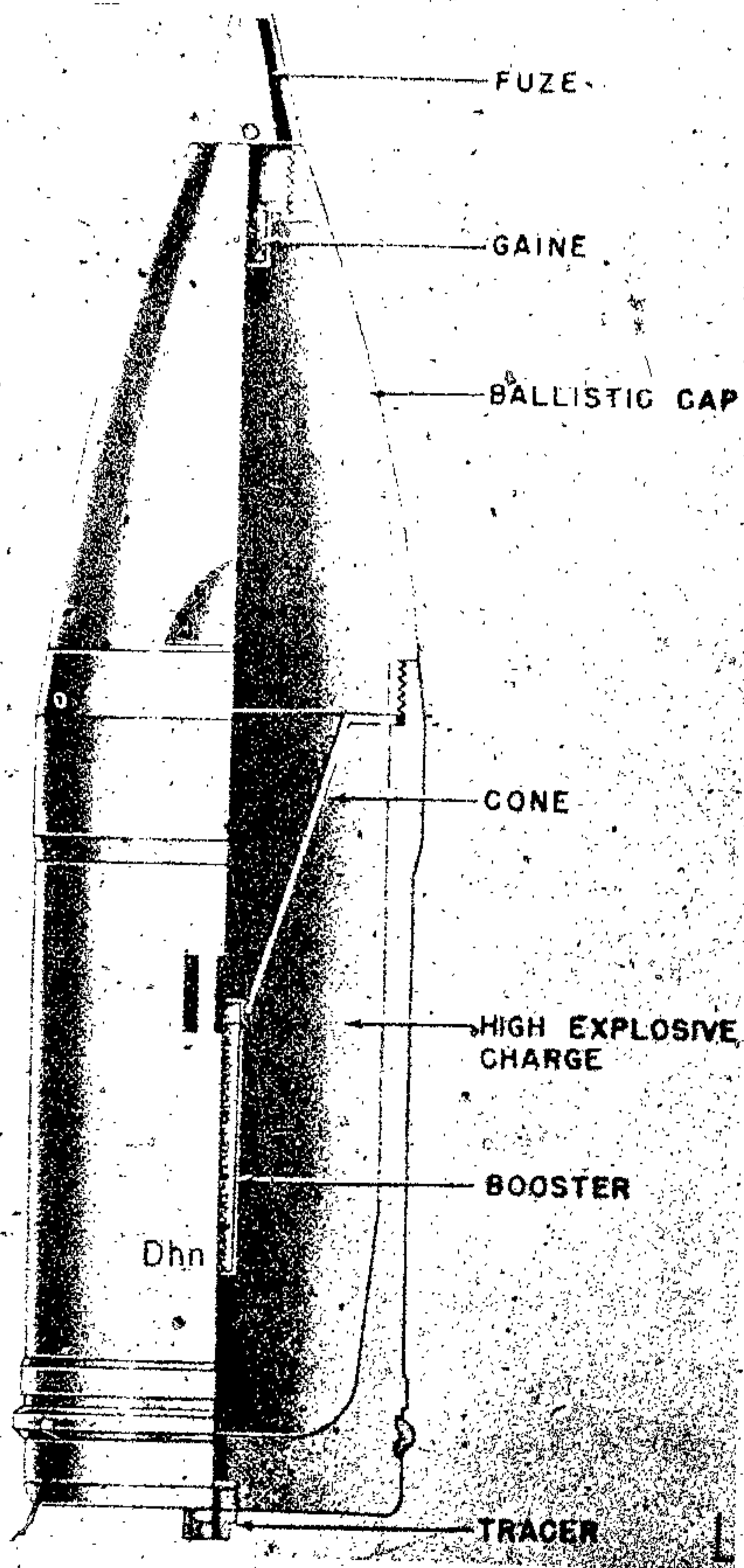

Figure 486—Hollow Charge Projectile for 150-mm Howitzer, 15-cm Jgr. 39 HL/A

FUZE:

Nomenclature: KLAZ 40 N5 ans.

Type: P. D.

REMARKS:

NOTE 1.—Narrow rotating band; no upper cone.

ANTICONGRETE PROJECTILE FOR 150-MM GUN

GERMAN NOMENCLATURE: 15-cm Gr. 19 rot Be. (See fig. 487.)

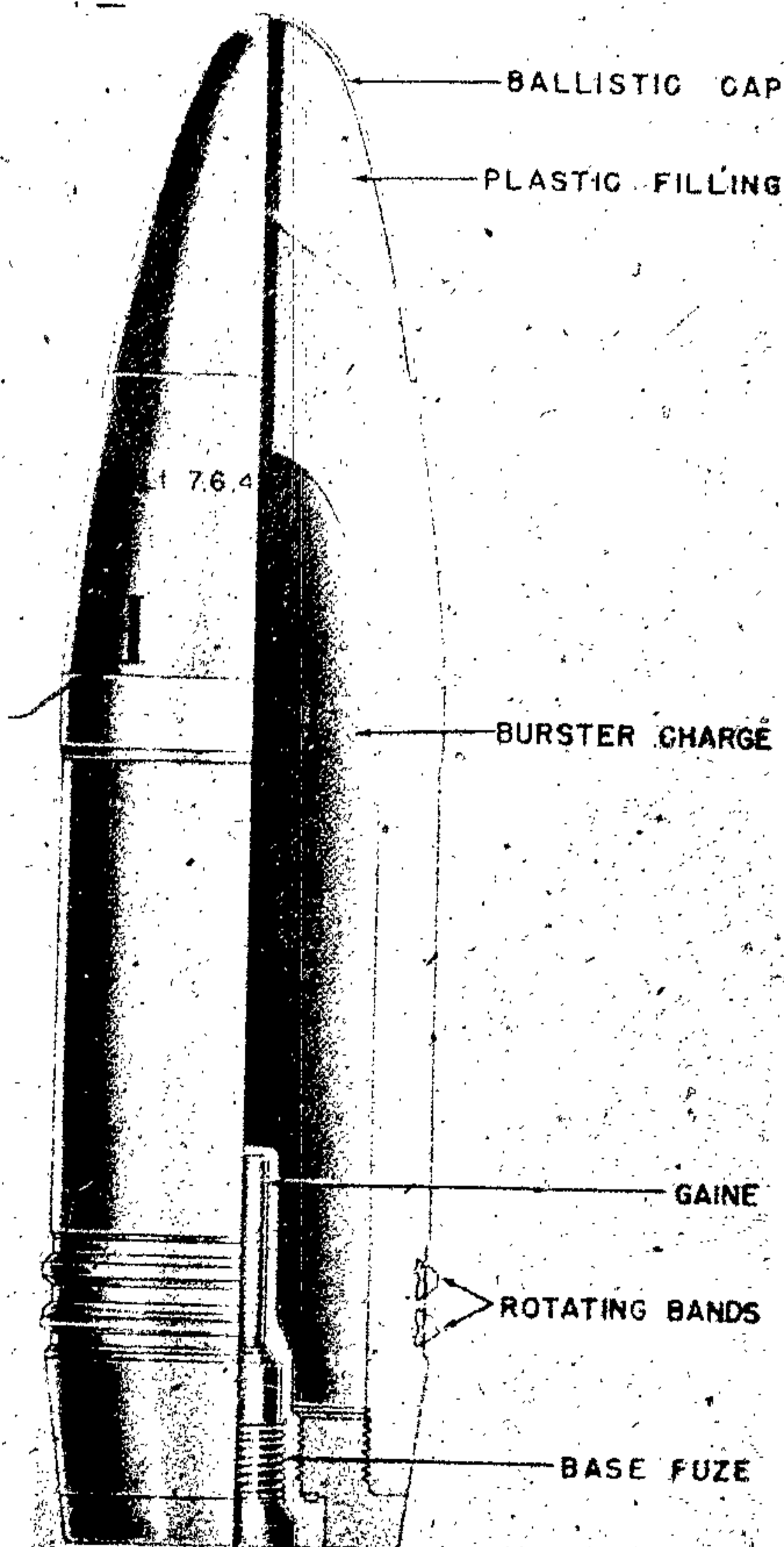

Figure 487—Anticoncrete Projectile for 150-mm Gun, 15-cm Gr. 19 Rot Be.

WEAPONS:

German Gun: 15-cm. K. 18.

German Gun: 15-cm. K. 39.

PROJECTILE:

Caliber: 150 mm.

Kind: Shell.

Type: Anticoncrete.

Weight: 95.5 pounds. (loaded and fuzed).

Color: O. D.

CHARGE:

Number: 1.

GERMAN EXPLOSIVE ORDNANCE

Weight: 10.5 pounds.

Kind: TNT pressed in blocks in cardboard container.

TRACER.

BOOSTER: Gr. Zflg. C/98 c. V.

ADAPTER: D. L.

FUZE:

Nomenclature: Bd. Z. f. 15-cm. Gr. 19^{Be}.

Type: B. D.

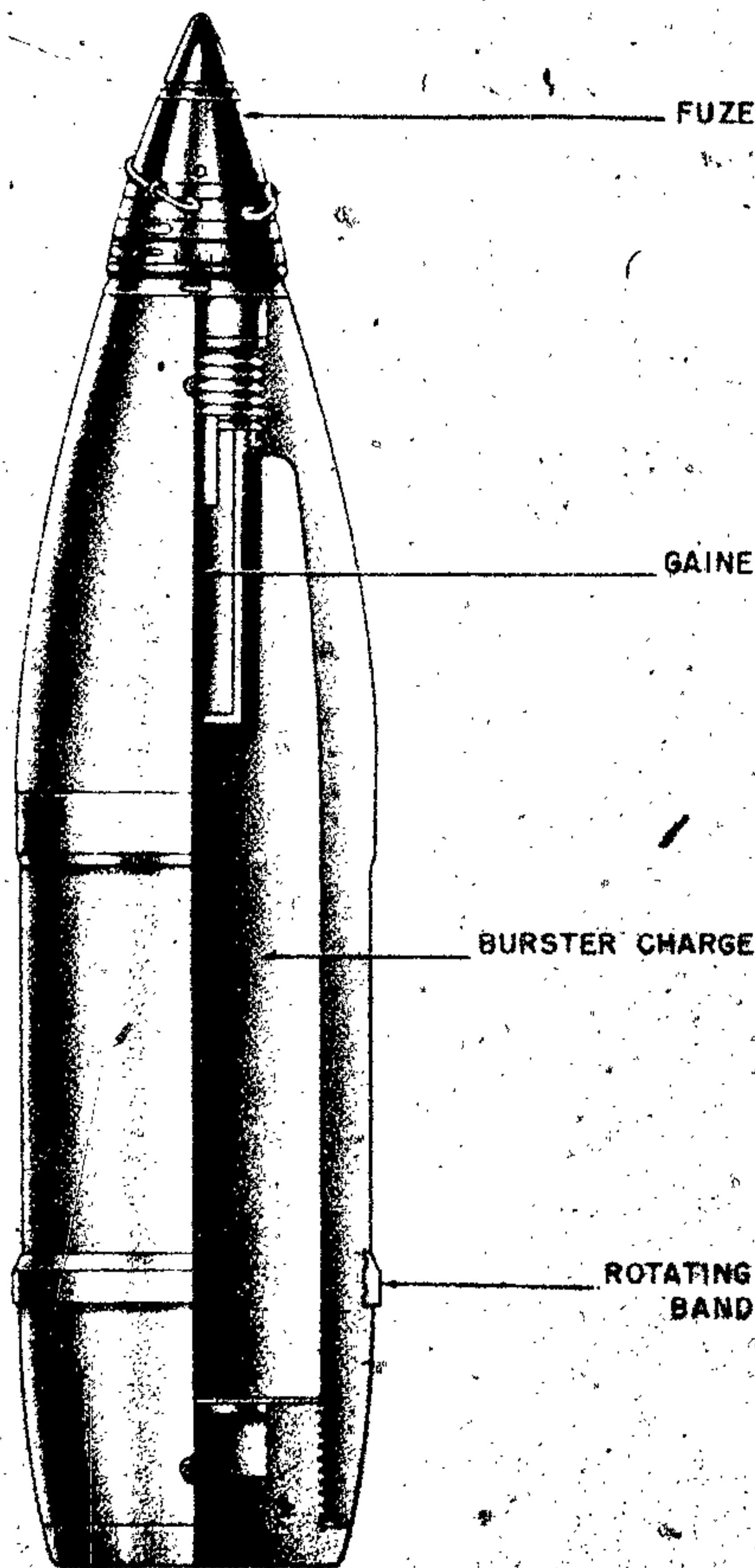

Figure 488—H. E. Projectile for 150-mm Howitzer,
15-cm Gr. M. 25 (t)

REMARKS:

NOTE 1.—This projectile has a coating of sulphur on the interior surfaces.

H. E. PROJECTILE FOR 150-MM HOWITZER

GERMAN NOMENCLATURE: 15-cm. Gr. M. 25 (t). (See fig. 488.)

WEAPONS: Czech Heavy Field Howitzer: s. F. H. 25 (t), Model 25.

PROJECTILE:

Caliber: 150 mm.

Kind: Shell.

Type: H. E.

Weight: 94 pounds (loaded and fuzed).

Color: Machined metal with red markings.

CHARGE:

Number: TTR.

Weight: 9 pounds.

Kind: Pressed TNT in cardboard container.

TRACER: None.

BOOSTER: Integral with fuze, auxiliary booster tube in shell body.

FUZE:

Nomenclature: Dopp. Z. 25 (t).

Type: T. and P.

REMARKS:

NOTE 1.—Red band around body of projectile at the ogive indicates T. and P. fuze.

H. E. PROJECTILE FOR 150-MM HOWITZER

GERMAN NOMENCLATURE: 15-cm. A. Z. Gr. M. 34 (t). (See fig. 489.)

WEAPONS: Czech Heavy Field Howitzer: 15-cm. s. F. H. 14/16 (t), Model 14/16.

PROJECTILE:

Caliber: 150 mm.

Kind: Shell.

Type: H. E.

Weight: 82 pounds (loaded and fuzed).

Color: Machined metal with red markings.

CHARGE:

Number: TP.

Weight: 12 pounds.

Kind: TNT pressed.

TRACER: None.

BOOSTER: Integral with fuze.

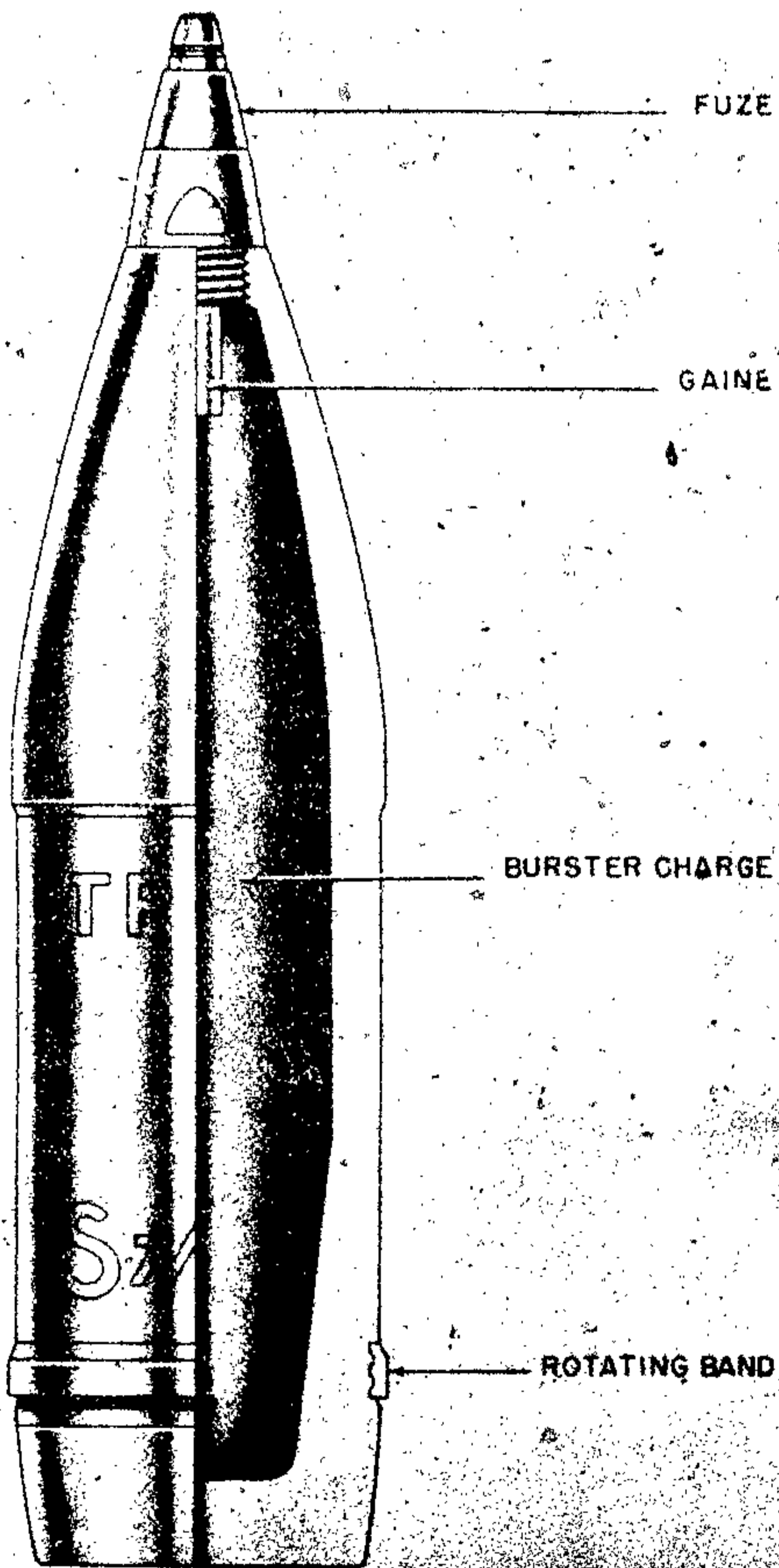

Figure 489—H. P. Projectile for 150-mm Howitzer,
15-cm A. Z. Gr. M. 34 (t)

FUZE:

Nomenclature: CHZB (A. Z.)

Type: P. D.

H. E. PROJECTILE FOR 150-MM HOWITZER

GERMAN NOMENCLATURE: 15.0-cm. Min.
Gr. M. 13/19 (t). (See fig. 490.)

WEAPONS: Czech Heavy Field Howitzer: a
F. H. 14/16 (t); Model 14/16.

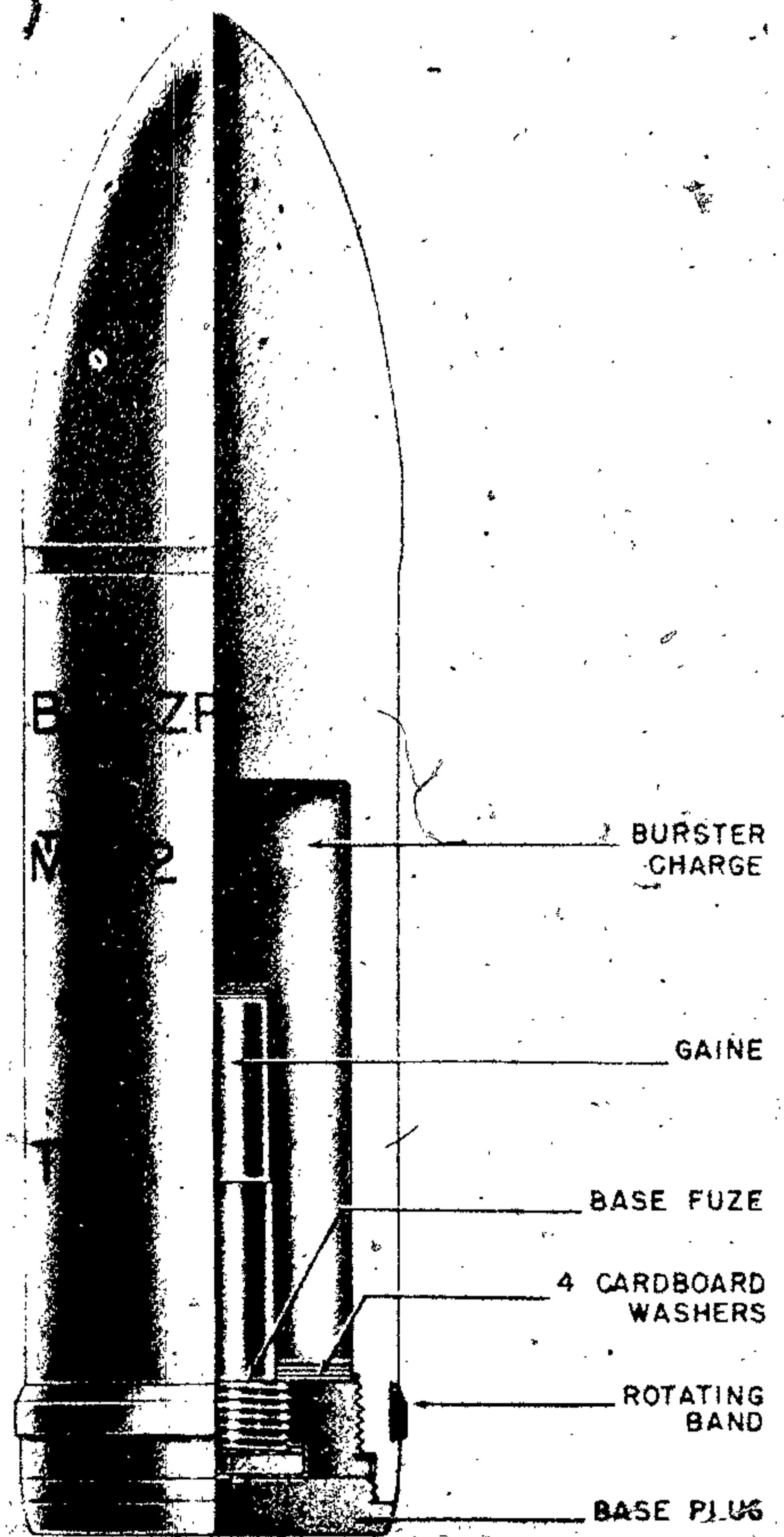

Figure 490—H. E. Projectile for 150-mm Howitzer,
15-cm Min. Gr. M. 13/19 (t)

PROJECTILE:

Caliber: 150 mm.

Kind: Shell.

Type: A. P.

Weight: 94 pounds (loaded and fuzed).

Color: Polished metal, red and black markings.

CHARGE:

Number: TT.

Weight: 10 pounds.

Kind: Pressed tetryl.

GERMAN EXPLOSIVE ORDNANCE

TRACER: None.

BOOSTER: R.

FUZE:

Nomenclature: BEZ ZP.

Type: Base fuze—instantaneous or short delay.

REMARKS:

NOTE 1.—This Czechoslovakian round is unusual in construction and is rarely used by the Germans.

S. A. P. PROJECTILE FOR 150-MM HOWITZER

GERMAN NOMENCLATURE: 15-cm. Min. Gr. 28 (t); 15-cm. Min. Gr. M. 28 (t). (See fig. 491.)

WEAPONS: Czech Medium Field Howitzer: s. F. H. 25 (t), Model 25.

PROJECTILE:

Caliber: 150 mm.

Kind: Shell.

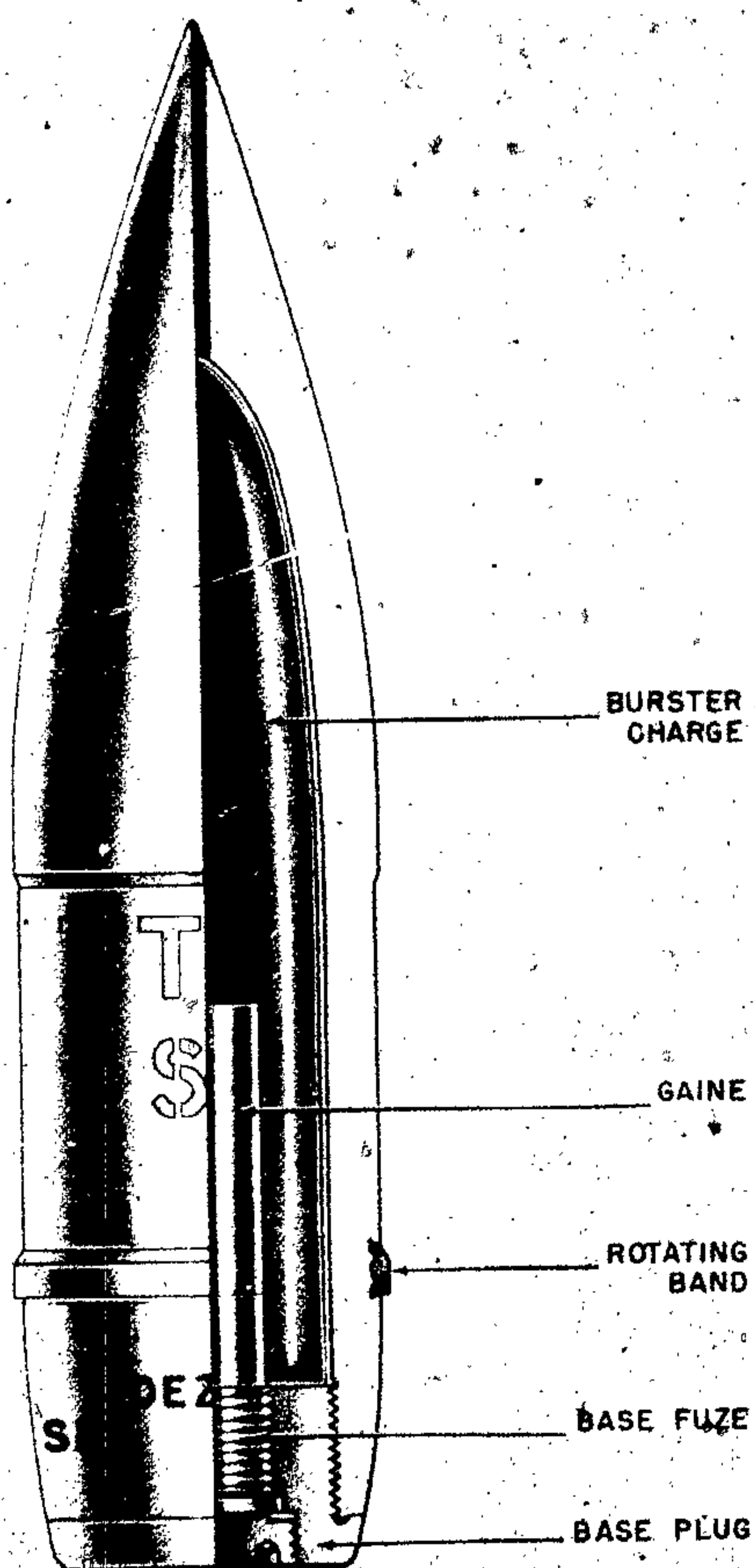

Figure 491—S. A. P. Projectile for 150-mm Howitzer, 15-cm Min. Gr. M. 28 (t)

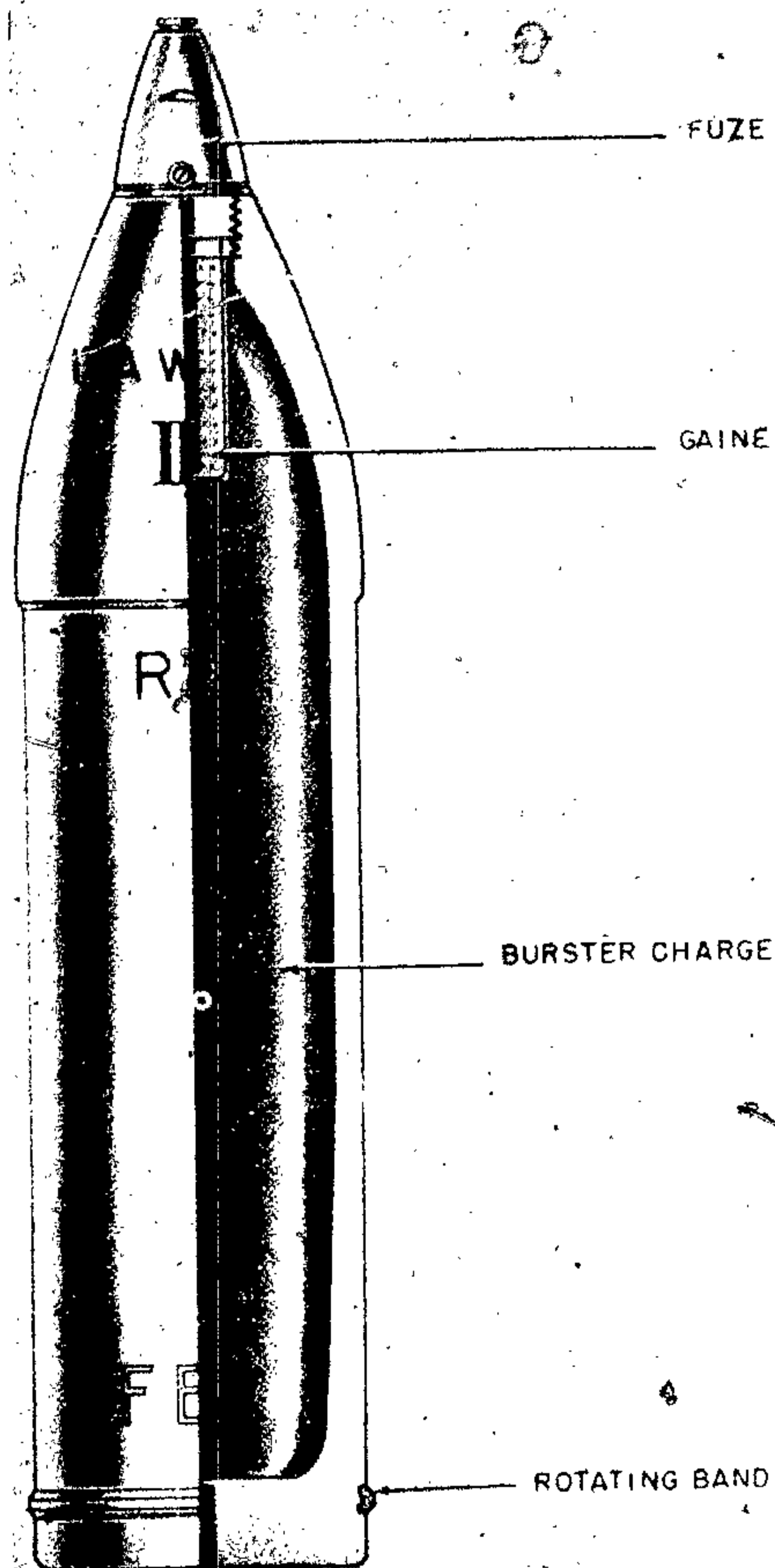

Figure 492—H. E. Projectile for 150-mm Assault Howitzer, 15-cm Jgr. 38 FES

Type: S. A. P.

Weight: 92.5 pounds (loaded and fuzed).

Color: Machined metal with red markings.

CHARGE:

Number: TTR.

Weight: 12.5 pounds.

Kind: TNT (pressed).

TRACER: None.

BOOSTER: Integral with fuze.

FUZE:

Nomenclature: Bd. Z 28 (t).

Type: Base.

H. E. PROJECTILE FOR 150-MM ASSAULT HOWITZER

GERMAN NOMENCLATURE: 15-cm. Jgr. 38 FES. (See fig. 492.)

WEAPONS: German Assault Howitzer: 15-cm. Stu. J. 43 (L/12).

PROJECTILE:

Caliber: 150 mm.

Kind: Shell.

Weight: 84 pounds (loaded and fuzed).

Color: O. D.

CHARGE:

Number: 13A.

Weight: 19 pounds.

Kind: Amatol (50/50).

TRACER: None.

BOOSTER: Dmz Np 10.

FUZE:

Nomenclature: Jgr. Z. 23.

Type: P. D.

REMARKS:

NOTE 1.—FES rotating band.

ARMOR PIERCING PROJECTILE FOR 150-MM HEAVY GUN

GERMAN NOMENCLATURE: 15-cm Pz. Sprgr. L/37 m. Hbc. (See fig. 493.)

WEAPONS: German Heavy Gun, 15-cm K18.

PROJECTILES:

Caliber: 150 mm.

Kind: Projectile.

Type: Armor-piercing.

Weight: 99¼ pounds (loaded and fuzed).

Color: Blue with black markings.

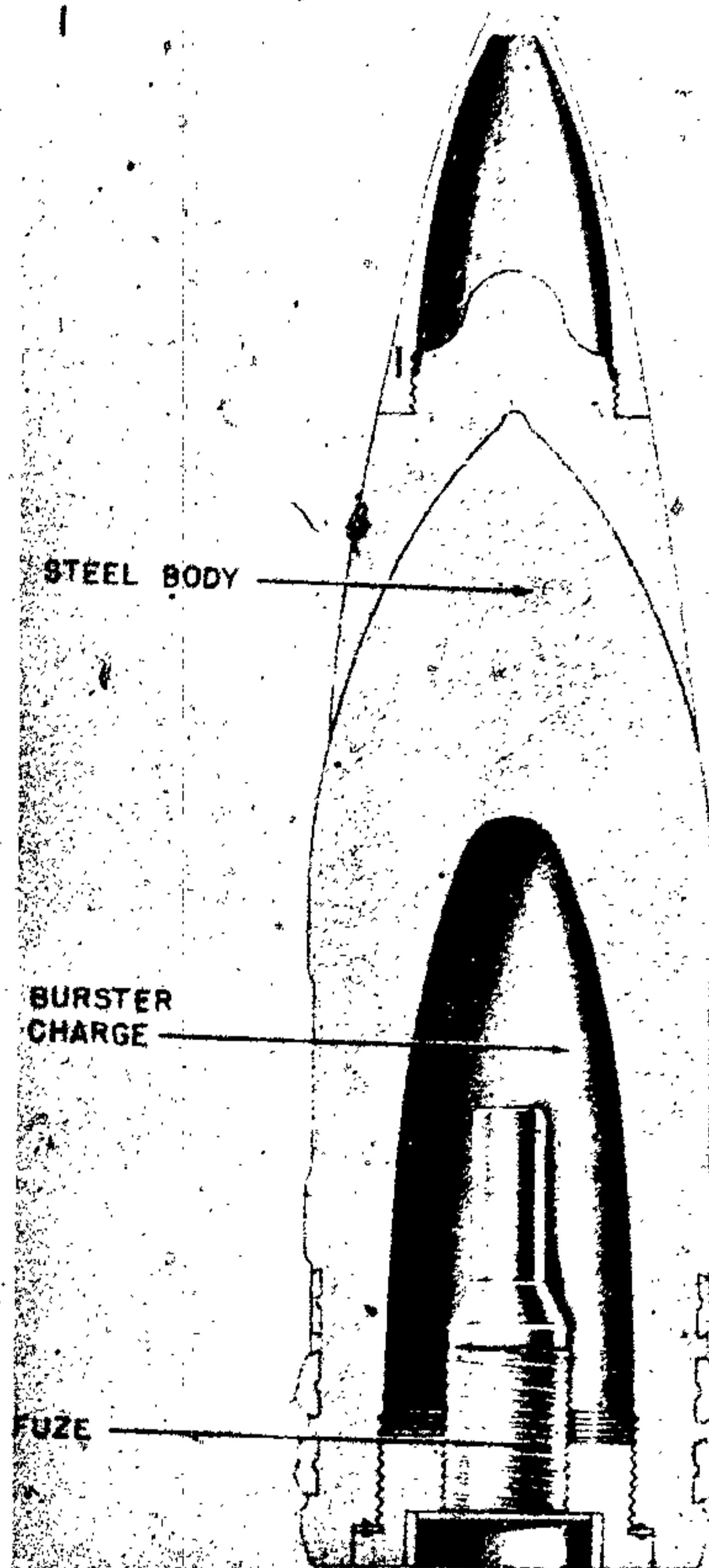

Figure 493—A. P. Projectile, 150-mm, 15-cm Pz. Sprgr. L/37 m. Hbc.

CHARGE:

Number: Unknown.

Weight: 2¼ pounds.

Kind: Unknown.

TRACER: None.

DETONATOR: Integral with fuze.

FUZE:

Nomenclature: Bd. Z. C/38.

Type: B. D.

REMARKS:

NOTE 1.—Of three original rotating bands, the forwardmost one has been machined off.

GERMAN EXPLOSIVE ORDNANCE

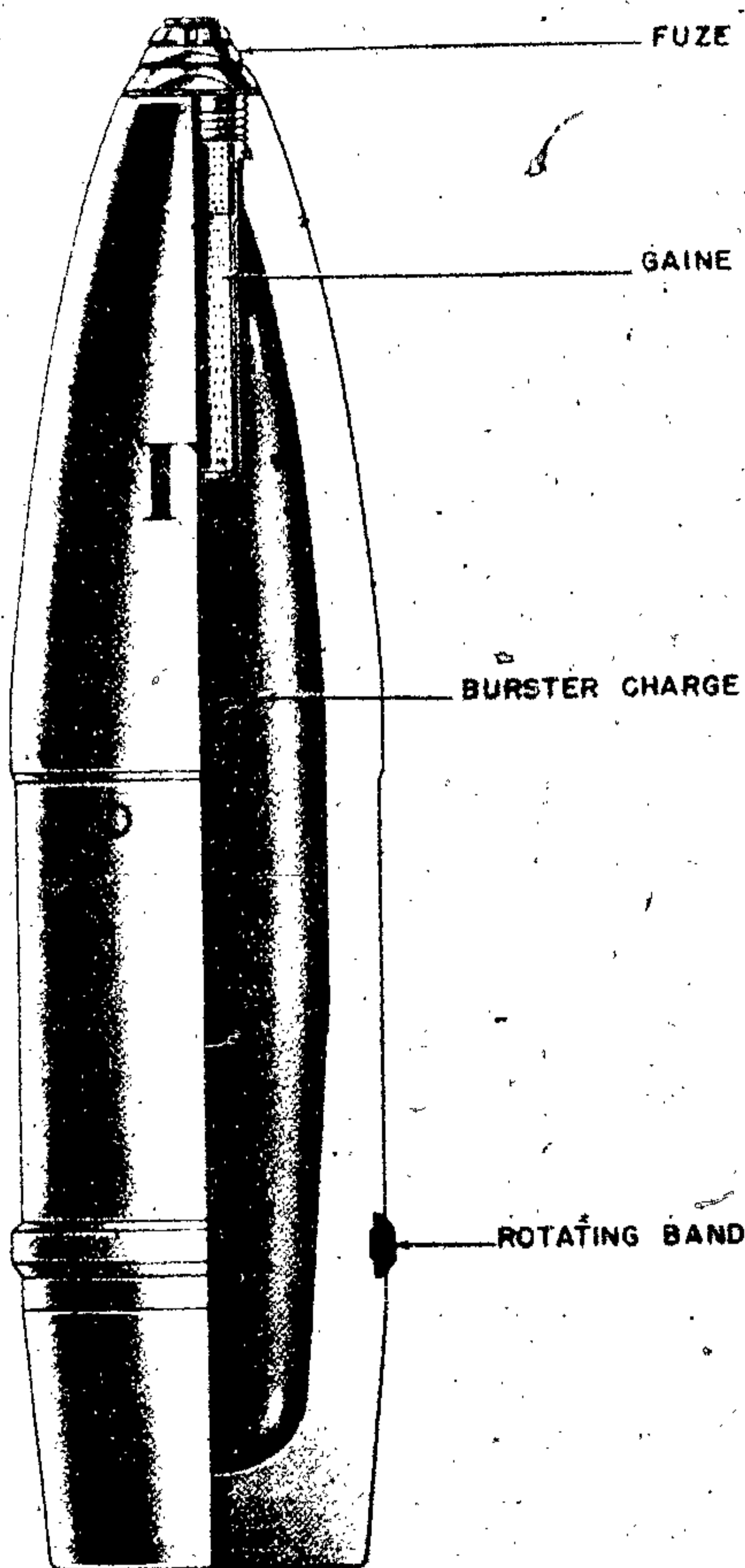

Figure 494—H. E. Projectile, Type 36, 150-mm,
15-cm Gr. 36 FES

H. E. PROJECTILE, TYPE 36, 150-MM

GERMAN NOMENCLATURE: 15-cm Gr. 36 FES (Granate 36 FES). (See fig. 494.)

EMPLOYMENT: 15-cm s. F. H. 18 (Schweres Feld Haubitze 18) Heavy Field Howitzer 18.

COMPLETE ROUND: 28.916 inches, over-all length.

PROJECTILE, painted green:
23.07 inches, over-all length.

4.409 inches, distance from base to band.
0.866 inch, width of rotating band-sintered iron.
5.196 inches, diameter of base.
84.7 pounds, total weight.

CARTRIDGE CASE: (German nomenclature 6350):

10.255 inches, over-all length.
6.338 inches, diameter of mouth.
No shoulder.
7.007 inches, diameter of base.
C/12nA primer.

FUZE: Nose Percussion Fuzes: A. Z. 23 (0.8) umg; A. Z. 23 (0.2) umg; A. Z. 23 m. 2 V umg or Time and Percussion Fuzes: Dopp. Z. s/60 Fl.
REMARKS: This round has not been recovered as yet. Information is from captured documents. After firing, rotating band will bear 40 engravings.

HOLLOW CHARGE PROJECTILE, TYPE 39, 150-MM

GERMAN NOMENCLATURE: 15-cm Gr. 19 HL (15-cm Granate 19 Hohl Ladung). (See fig. 495.)

EMPLOYMENT:

15-cm s. F. H. 18 (schweres Feld Haubitze 18)
Heavy Field Howitzer 18.
15-cm s. F. H. 13 (schweres Feld Haubitze 13)
Heavy Field Howitzer 13.

PROJECTILE, painted green:

22.834 inches, over-all length.
5.905 inches, diameter of base.
54.076 pounds, total weight.
Cyclonite/Wax. type of bursting charge.
Tracer is fitted in base of projectile.

CARTRIDGE CASE (German nomenclature 6350 [semifixed]):

10.255 inches, over-all length.
6.388 inches, diameter of neck.
No shoulder.
7.007 inches, diameter of base.
C/12nA primer.

FUZE: Nose Percussion Fuze Kl. Az. 40 Nb.

PACKAGING: One projectile in a wicker basket, 58.3 pounds.

REMARKS: Cartridge case for s. F. H. 13-6303 (semifixed). Information is from captured documents. Projectile has not as yet been recovered. After firing from s. F. H. 18, rotating band will bear 40 engravings.

ANTICONCRETE PROJECTILE, 150-MM

NOMENCLATURE, GERMAN DESIGNATION: 15-cm Gr. 19 rot Be (Granate 19 rot Beton). (See fig. 496.)

EMPLOYMENT:

- 15-cm K. 18 (Kanone 18) Gun 18.
- 15-cm K. 39 (Kanone 39) Gun 39.
- 15-cm-K. (e) (Kanone [Eisenbahn] Gun. [Railway]).

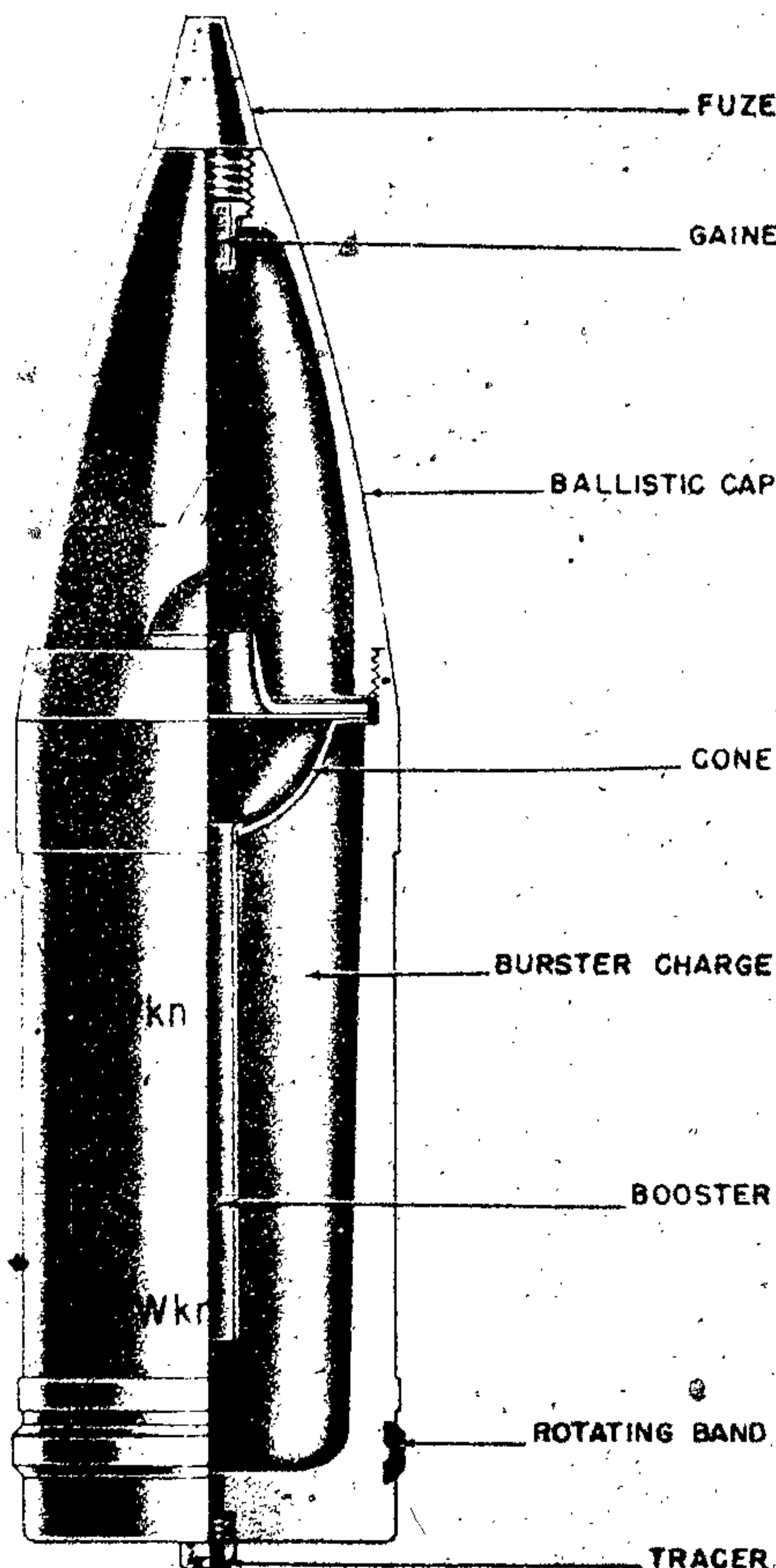

Figure 495—Hollow Charge Projectile, Type 39, 150-mm, 15-cm Gr. 19 HL/A

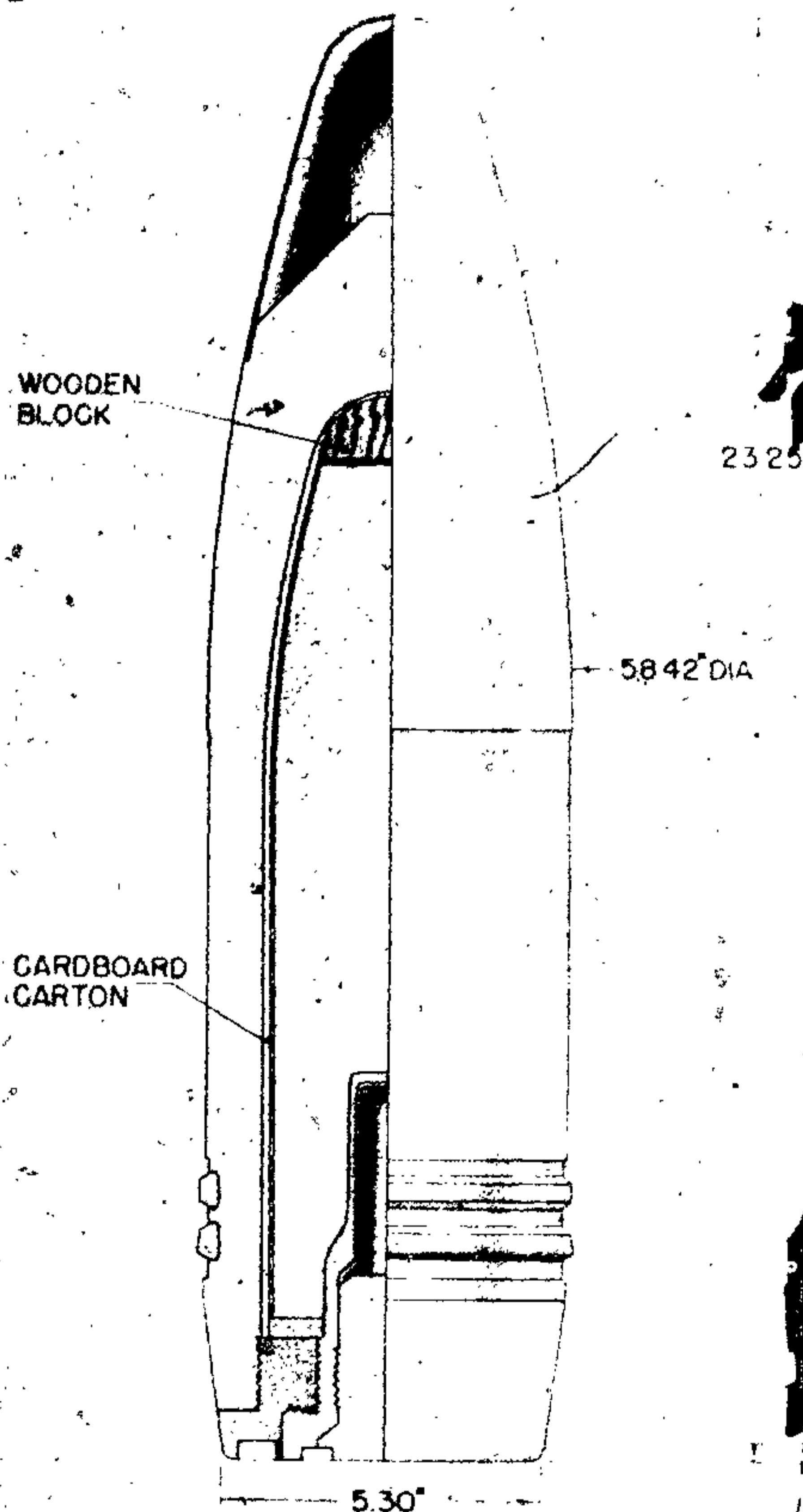

Figure 496—Anticoncrete Projectile, 150-mm Tracer, 15-cm Gr. 19 Rot Be.

PROJECTILE (Red band above rotating bands):
 23.25 inches, over-all length.
 5.86 inches, diameter of bourrelet.
 95.37 pounds, total weight.
 7.12 pounds, weight of bursting charge.
 TNT, type of bursting charge.
 Tracer is fitted in base of fuze.

CARTRIDGE CASE (for K. 18) (German nomenclature 6352 [semifixed]):
 32.07 inches, over-all length.
 No shoulder.

GERMAN EXPLOSIVE ORDNANCE

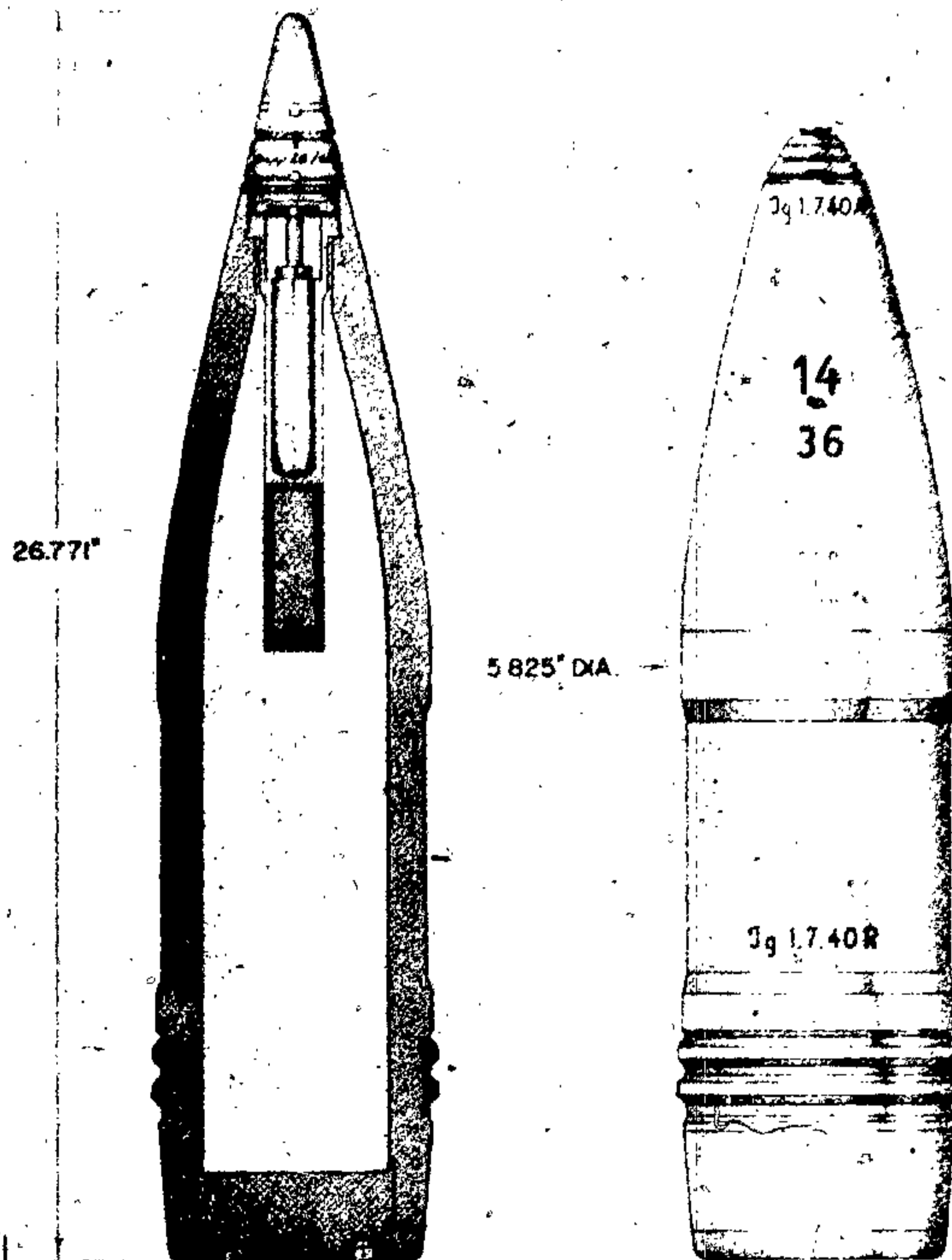

Figure 497—H. E. Projectile, Type 19 with Gaine 36, 150-mm 15-cm Gr. 19 mit Zdlg. 36

7.007 inches, diameter of base.
 Tubular Diglycol, type of propellant.
 20.0 pounds, weight of propellant, small charge plus:
 3.0 ounces, igniter powder.
 39.0 pounds, weight of propellant, medium charge plus.
 3.0 ounces, igniter powder.
 43.0 pounds, weight of propellant, large charge plus. •
 3.0 ounces, igniter powder.
 C/12nA primer.

FUZE: Base Detonating Fuze Bd. Z. f. 15-cm Gr. 19 Be.

PACKAGING: One projectile in a wicker basket, 102 pounds.

REMARKS: Cartridge cases for other weapons are as follows:

K. 39—6318 (semifixed).
 K. (E)—6352 (semifixed).

H. E. PROJECTILE, TYPE 19 WITH GAINE 36, 150-MM

GERMAN NOMENCLATURE: 15-cm Gr. 19 mit Zdlg. 36 (Granate 19 mit Zundladung 36). (See fig. 497.)

EMPLOYMENT: 15-cm s. F. H. 18 (schweres Feld Haubitze 18) Heavy Field Howitzer 18.

COMPLETE ROUND:

31.239 inches, over-all length w/AZ fuze.
 33.799 inches, over-all length w/Dopp. Z. fuze.

PROJECTILE, painted green:

24.211 inches, over-all length w/AZ fuze.
 26.771 inches, over-all length w/Dopp. Z. fuze.
 3.22 inches, distance from base to band.
 0.472 inch, width of rotating bands.
 Two, number of rotating bands.

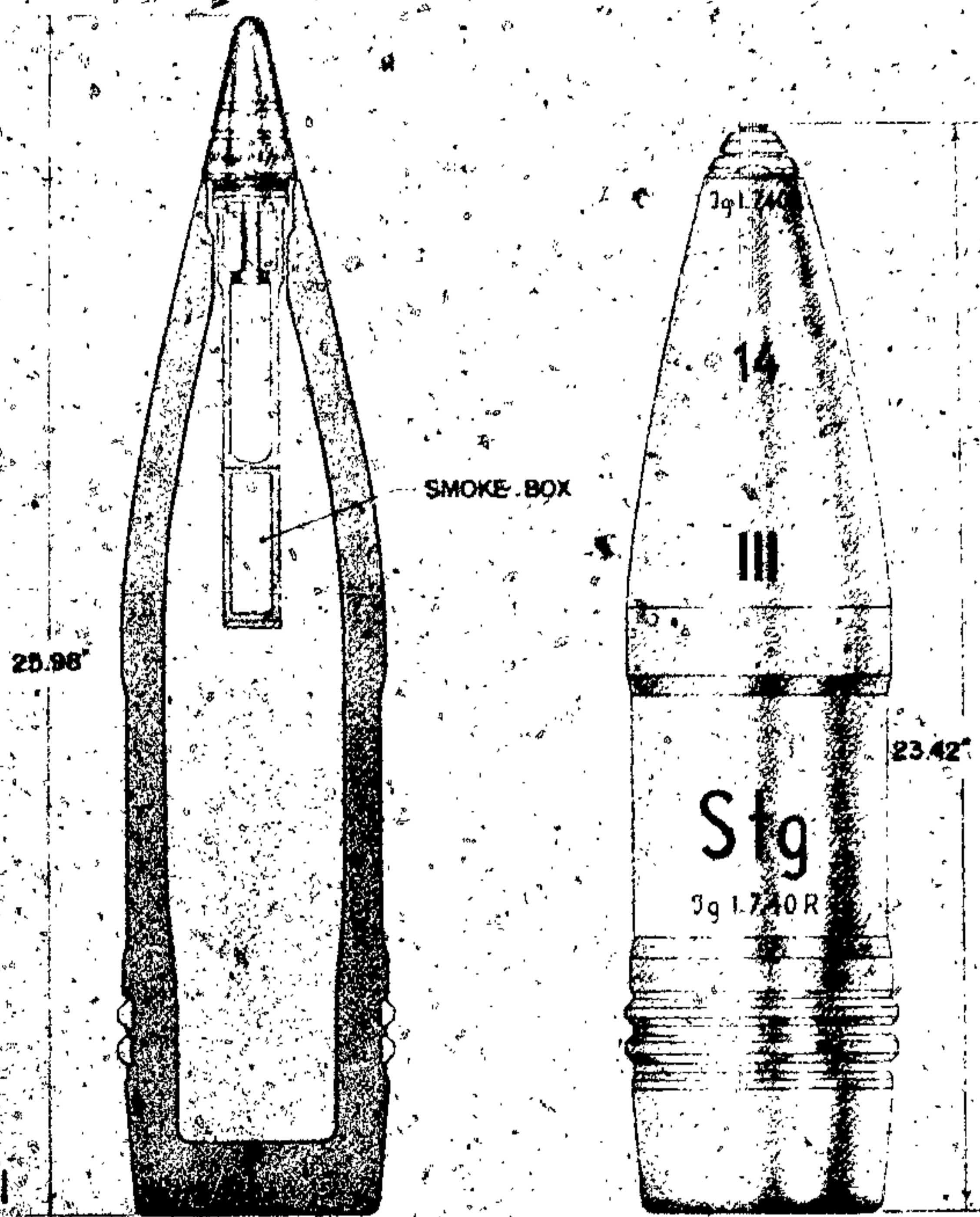

Figure 498—H. E. Projectile of Cast Steel, 150-mm, 15-cm Gr. 19 Stg.

5.825 inches, diameter of bourrelet.
 5.196 inches, diameter of base.
 95.7 pounds, total weight.
 11.22 pounds, weight of bursting charge.
 Poured TNT, type of bursting charge.
 Projectile has screwed-in base plate.

CARTRIDGE CASE (German nomenclature 6350 [semifixed]);

10.235 inches, over-all length.
 6.838 inches, diameter of neck.
 No shoulder.
 7.007 inches, diameter of base.
 Flaked Diglycol propellant.
 C/12nA primer.

FUZE: Nose Percussion Fuzes: A. Z. 23 (0.8) umg;
 A. Z. 23 m. 2 V umg or Time and Percussion Fuzes:
 Dopp. Z. s/60s; Dopp. A. s/60 lm.

PACKAGING: One projectile to a wicker basket, 100 pounds.

REMARKS: After firing, projectile will bear 40 engravings on rotating band.

H. E. PROJECTILE OF CAST STEEL, 150-MM

GERMAN NOMENCLATURE: 15-cm Gr. 19 Stg. (Granate 19 Stg.). (See fig. 498.)

EMPLOYMENT:

15-cm s. F. H. 18 (Schweres Feld Haubitze 18)
 Heavy Field Howitzer 18.
 15-cm s. F. H. 13 (Schweres Feld Haubitze 13)
 Heavy Field Howitzer 13.
 15-cm s. H. T. (Schweres Haubitze Turren)
 Heavy Turret Howitzer.

COMPLETE ROUND (description of c/r is for s. F. H. 18):

32.991 inches, over-all length w/Dopp. Z. fuze.

GERMAN EXPLOSIVE ORDNANCE

30.431 inches, over-all length, w/AZ fuse/.

PROJECTILE, painted green, stenciled in black:

23.424 inches, over-all length w/AZ fuze/.

25.984 inches, over-all length w/Dopp. Z. fuze. ϕ

3.228 inches, distance from base to band.

0.472 inch, width of rotating bands.

Two, number of rotating bands.

5.826 inches, diameter of bourrelet.

5.196 inches, diameter of base.

95.7 pounds, metal weight.

9.68 pounds, weight of bursting charge.

TNT (poured), type of filling plus smoke box below gaine.

Zdlg. 36 booster.

CARTRIDGE CASE (German nomenclature 6350 [semifixed]):

10.255 inches, over-all length.

6.338 inches, diameter of mouth.

No shoulder.

7.007 inches, diameter of base.

11.750 pounds, weight of case.

Flaked Diglycol, type of propellant.

C/12nA primer.

FUZE: Nose Percussion Fuzes: A. Z. 23 (0.8) umg; A. Z. 23 (0.2) umg; A. Z. 23m. 2V umg or

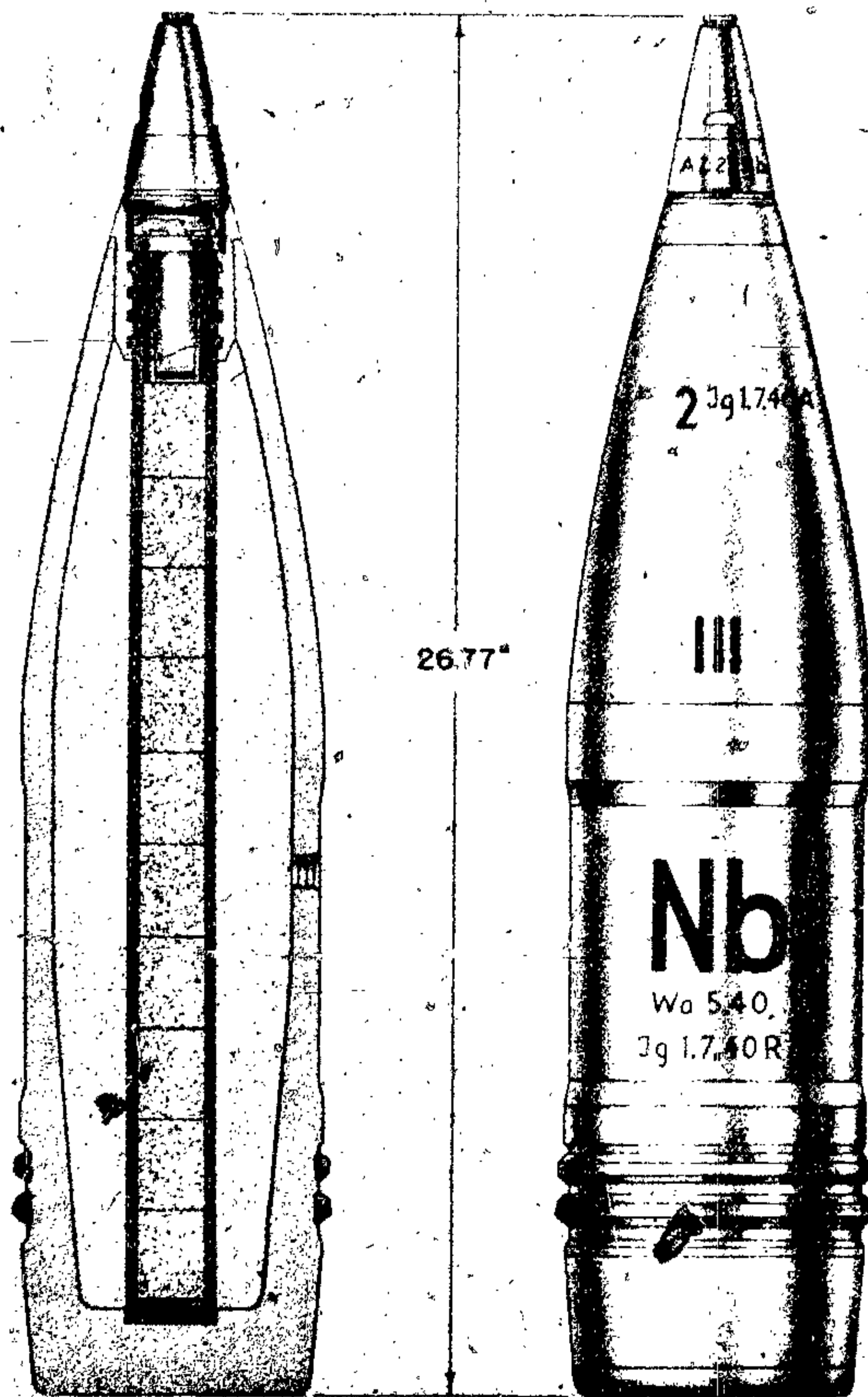

Figure 499—Smoke Projectile, Type 19, 150-mm, 15-cm Gr. 19 Nb.

Time and Percussion Fuzes; Dopp. Z. s/60s; Dopp Z. s/60 lm.

REMARKS: This projectile is made of cast steel. Cartridge cases for other weapons are as follows:

s. F. H. 13—6303 (semifixed).

s. H. T.—6357 (semifixed).

SMOKE PROJECTILE, TYPE 19, 150-MM

GERMAN NOMENCLATURE: 15-cm Gr. 19 Nb. (Granate 19^e Nebel). (See fig. 499.)

EMPLOYMENT:

15-cm s. F. H. 18 (Schweres Feld Haubitze)
Heavy Field Howitzer 18.

15-cm s. F. H. 13 (Schweres Feld Haubitze 13)
Heavy Field Howitzer 13.

COMPLETE ROUND: Description of c/r is for s. F. H. 18. 33.778 inches, over-all length.

PROJECTILE, painted green, stenciled in white: 26.771 inches, over-all length w/fuze.

3.22 inches, distance from base to band.

0.472 inch, width of rotating band—Bimetallic.

5.825 inches, diameter of bourrelet.

5.196 inches, diameter of base.

85.8 pounds, total weight.

1.21 pounds, weight of bursting charge.

Picric acid, type of bursting charge.

Gr. Zdlg. C/98 Np booster.

14.08 pounds, weight of smoke mixture.

Oleum impregnated in pumice, type of smoke mixture.

"Nb" stenciled on body.

CARTRIDGE CASE (German nomenclature 6350 [semifixed]):

10.255 inches, over-all length.

6.338 inches, diameter of neck.

No shoulder.

7.007 inches, diameter of base.

C/12nA primer.

FUZE: Nose Percussion Fuze A. Z. 23 Nb.

PACKAGING: One projectile in wicker basket, 90.2 pounds.

REMARKS: Cartridge case for s. F. H. 13—6303 (semifixed).

SMOKE PROJECTILE FOR HEAVY INFANTRY GUN, 150-MM

GERMAN NOMENCLATURE: 15-cm Jgr. 38 Nb (Jaeger 38^e Nb). (See fig. 500.)

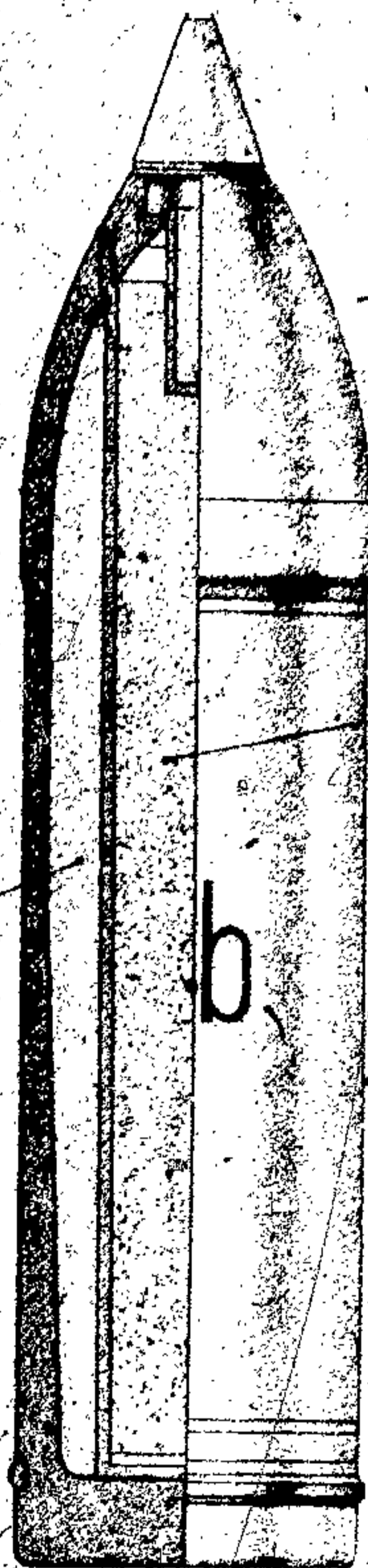

SMOKE MIXTURE

BURSTING CHARGE

Figure 500—Smoke Projectile for Heavy Infantry Gun, 150-mm, 15-cm Jgr. 38 Nb.

EMPLOYMENT: 15-cm s. I. G. 33 (schweres Infanterie Geschutz 33) Heavy Infantry Gun 33.

PROJECTILE, painted green, stenciled in white: 25.747 inches, over-all length.

0.433 inch, width of rotating band.

Bimetallic or sintered iron, composition of rotating band.

5.905 inches, diameter of base.

84.0 pounds, total weight.

4.93 pounds, weight of bursting charge.

Picric acid, type of bursting charge.

Gr. Zdlg. C/98 Np booster.

Oleum impregnated in pumice, type of smoke mixture.

"Nb" stenciled on body.

GERMAN EXPLOSIVE ORDNANCE

CARTRIDGE CASE (German nomenclature 6303 [semifixed]):

- 4.448 inches, over-all length.
- 6.102 inches, diameter of mouth.
- No shoulder.
- 6.653 inches, diameter of base.
- C/12nA primer.

FUZE: Nose percussion Fuze Kl. Az. 23 Nb.

PACKAGING: One projectile in a wicker basket, 90.2 pounds.

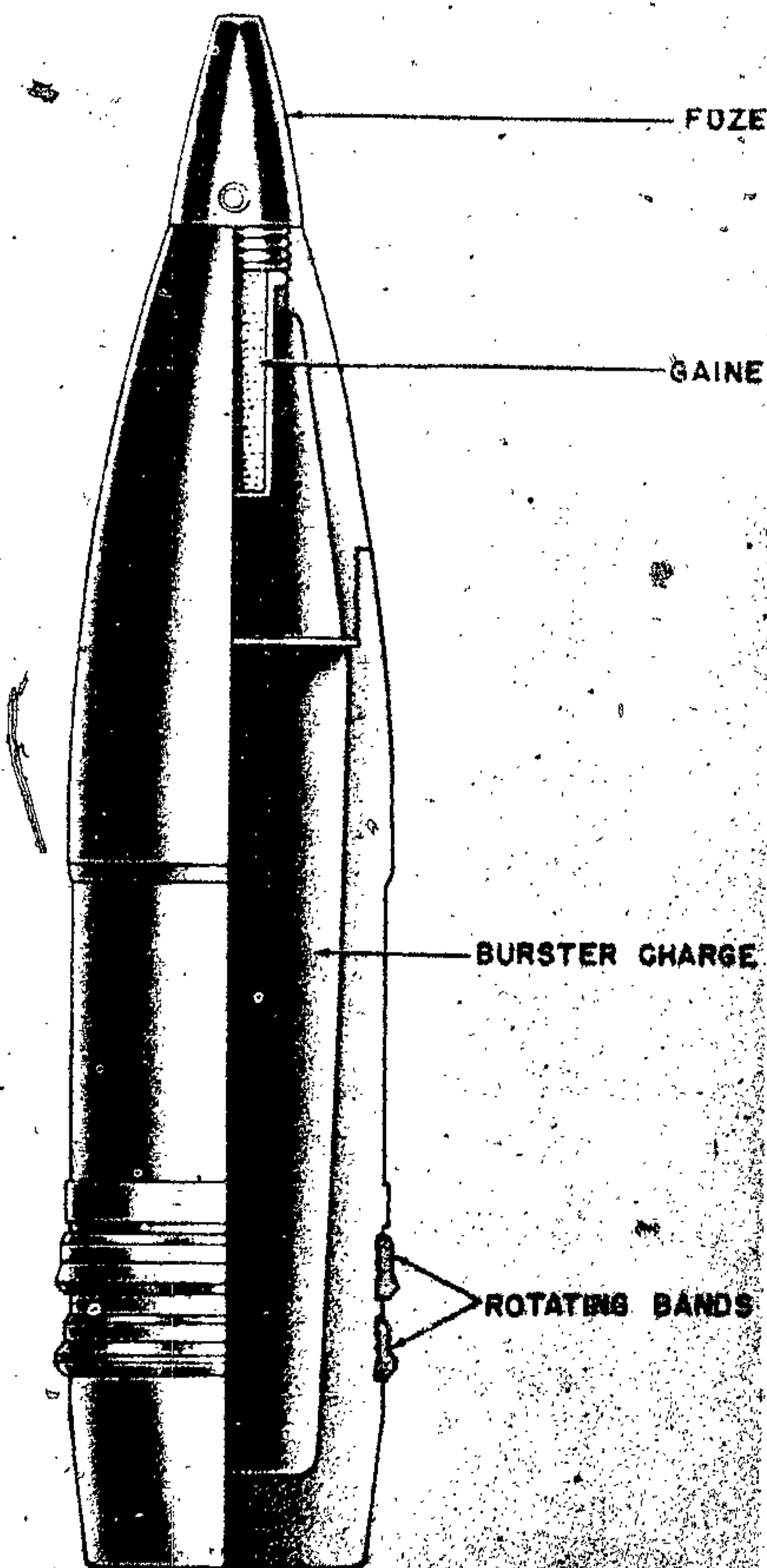

Figure 501—H. E. Projectile, Type 18, 150-mm,
15-cm K. Gr. 18

H. E. PROJECTILE, TYPE 18, 150-MM

GERMAN NOMENCLATURE: 15-cm K. Gr. 18 (Kanone Granate 18). (See fig. 501.)

EMPLOYMENT:

- 15-cm K. 18 (Kanone 18) Gun 18.
- 15-cm K. 39 (Kanone 39) Gun 39.
- 15-cm K. (E) (Kanone [Eisenbahn] Gun [Railway]).

PROJECTILE:

- 27.35 inches, over-all length.
- 5.86 inches, diameter of bourrelet.
- Two, number of rotating bands.
- 94.75 pounds, total weight.

CARTRIDGE CASE (for K 18) (German nomenclature 6352 [semifixed]):

- 32.07 inches, over-all length.
- No shoulder.
- 7.007 inches, diameter of base.
- Tubular Diglycol, type of propellant.
- 20.0 pounds, weight of propellant small charge plus.
- 3.0 ounces, igniter powder.
- 39.0 pounds, weight of propellant medium charge plus.
- 3.0 ounces, igniter powder.
- 43.0 pounds, weight of propellant large charge plus.
- 3.0 ounces, igniter powder.

FUZE: Nose percussion Fuze A. Z. 23v. or Time and Percussion Fuze Dopp. Z. s/90.

PACKAGING: One projectile in a wicker basket, 102.3 pounds.

REMARKS: Cartridge cases for other weapons as follows:

- K.39—6318 (semifixed).
- K. (E)—6352 (semifixed).

RODDED BOMB FOR HEAVY INFANTRY GUN 33, 150-MM

GERMAN NOMENCLATURE: 15-cm Stielgranat 42. (See fig. 502.)

EMPLOYMENT: 15-cm s. I. G. 33 (Schweres Infanterie Geschutz 33) Heavy Infantry Gun 33.

PROJECTILE, painted field grey, stenciled in black:

- 50.5 inches, over-all length.
- 11.5 inches, maximum diameter.
- 105.0 pounds, total weight.

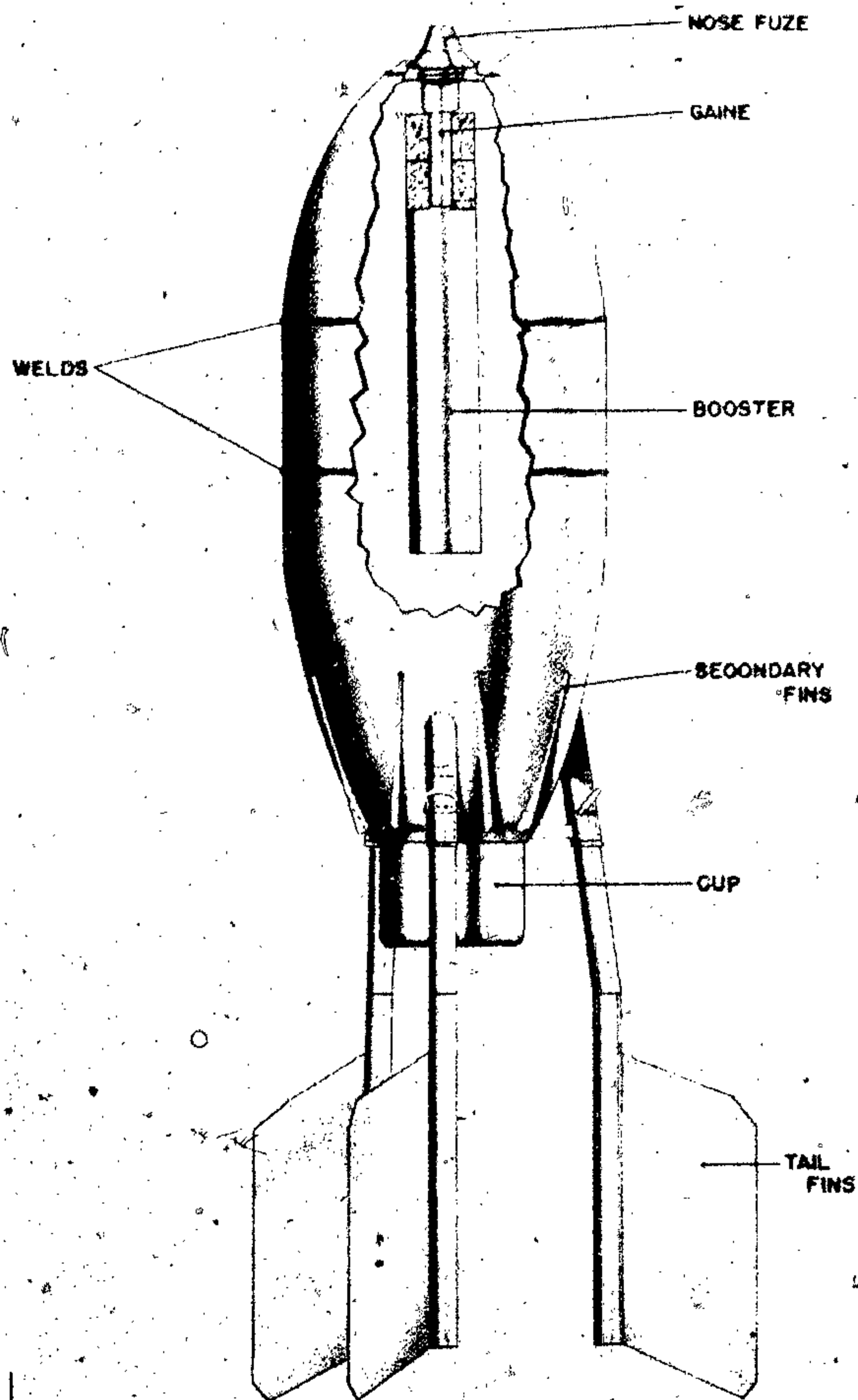

Figure 502—Rodded Bomb for Heavy Infantry Gun 33, 150-mm, 15-cm Stielgranat 42

60.0 pounds, weight of bursting charge.
 40/60 Amatol, type of bursting charge.
 "13 A" stenciled on nose.

CARTRIDGE CASE (German nomenclature 6803 [semifixed]):

4.448 inches, over-all length.
 6.102 inches, diameter of neck.
 No shoulder.

6.653 inches, diameter of base.
 12.1 pounds, weight of propellant.
 C/12 nA primer.

FUZE: Nose Percussion Fuze Wgr. Z. 36.

REMARKS: It is presumed that a stick unit fits over cup at the base of the bomb; this cup has a machined surface. The stick unit has not been

GERMAN EXPLOSIVE ORDNANCE

recovered but is reported to weigh 48.4 pounds and leaves projectile 150 yards from muzzle of the gun. This projectile is used against personnel and to clear minefields and wire obstacles.

H. E. PROJECTILE TYPE 18, 150-MM

GERMAN NOMENCLATURE: 15-cm Gr. 18 (Granate 18). (See fig. 503.)

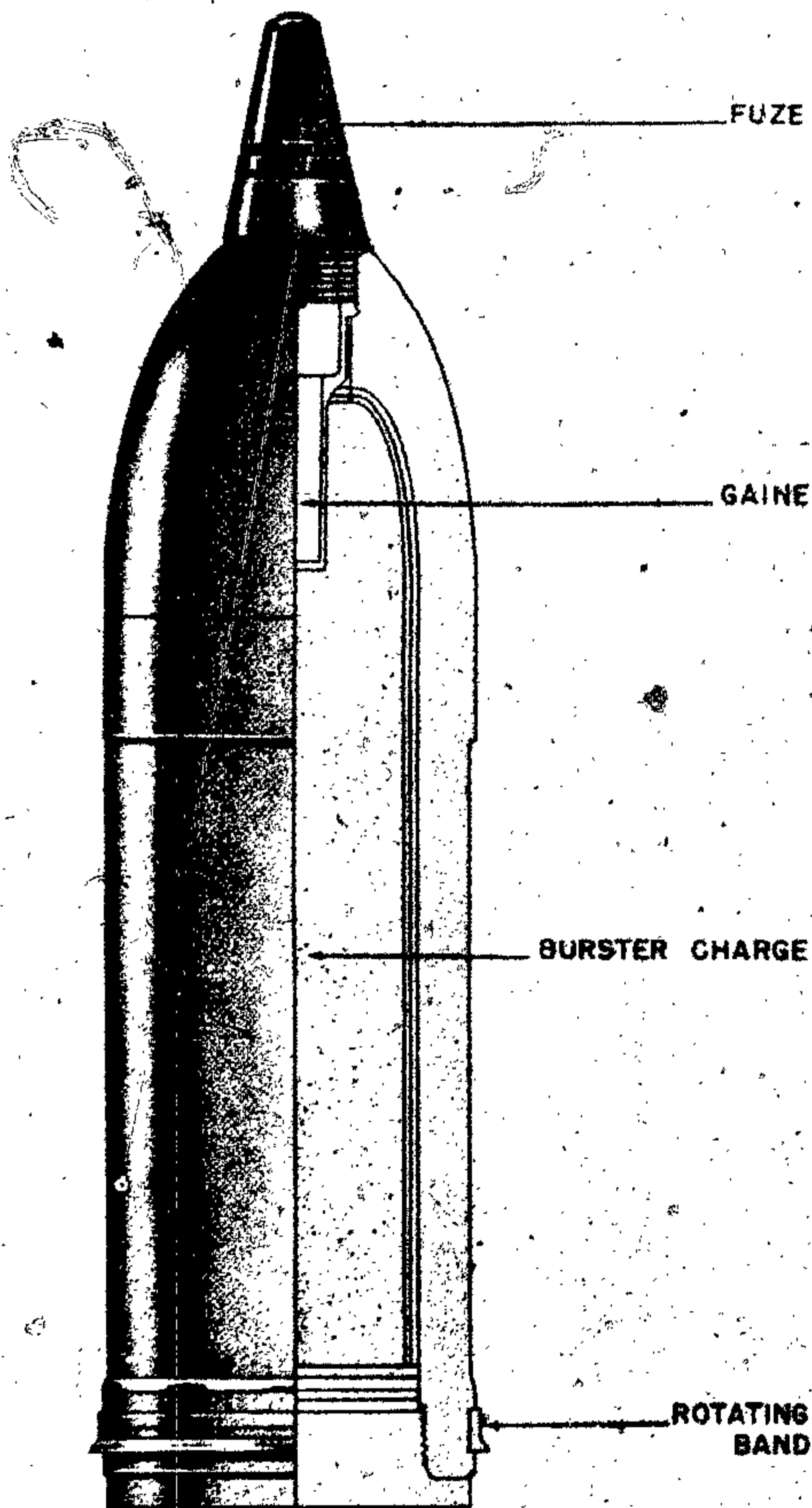

Figure 503—H. E. Projectile, Type 18, 150-mm, 15-cm Gr. 18

EMPLOYMENT: 15-cm s. F. G. 13 (Schweres Feld Haubitze 13) Heavy Field Howitzer 13.

COMPLETE ROUND: 24,605 inches, over-all length.

PROJECTILE, painted green:

21.062 inches, over-all length, w/fuze.

19.842 inches, over-all length, w/o fuze.

0.095 inch, distance from base to band.

0.59 inch, width of bimetallic rotating band.

5.905 inches, diameter of base.

89.76 pounds, total weight.

Gr. Zdlg. C/98 Np or Zdlg.

C/98 booster.

CARTRIDGE CASE (German nomenclature 6303 [semifixed]):

4.448 inches, over-all length.

6.702 inches, diameter of neck.

Nc shoulder.

6.653 inches, diameter of base.

C/12nA primer.

FUZE: Nose Percussion Fuzes: AZ 23 (0.8) umg; AZ 23 (0.2) umg; AZ 23 m 2 V umg or Time and Percussion Fuzes: Dopp Z s/60s, Dopp Z s/60. Im.

PACKAGING: One projectile in wicker basket— ϕ 4.1 pounds.

H. E. PROJECTILE, TYPE 19, FOR HEAVY FIELD HOWITZER, 150-MM

GERMAN NOMENCLATURE: 15-cm Gr. 19 (Granate 19). (See fig. 504.)

EMPLOYMENT:

15-cm s. F. H. 18 (Schweres Feld Haubitze 18) Heavy Field Howitzer 18.

15-cm s. F. H. 13 (Schweres Feld Haubitze 13) Heavy Field Howitzer 13.

15-cm s. H. T. (Schweres Haubitze Turren) Heavy Turret Howitzer.

COMPLETE ROUND (Description of c/r is for s. F. H. 18):

33.778 inches, over all length, w/Dopp Z. Fuze.

31.218 inches, over-all length, w/AZ fuze.

PROJECTILE (Painted green):

24.211 inches, over-all length, w/AZ fuze.

26.711 inches, over-all length, w/Dopp. Z. fuze.

3.22 inches, distance from base to band.

0.472 inch, width of rotating bands.

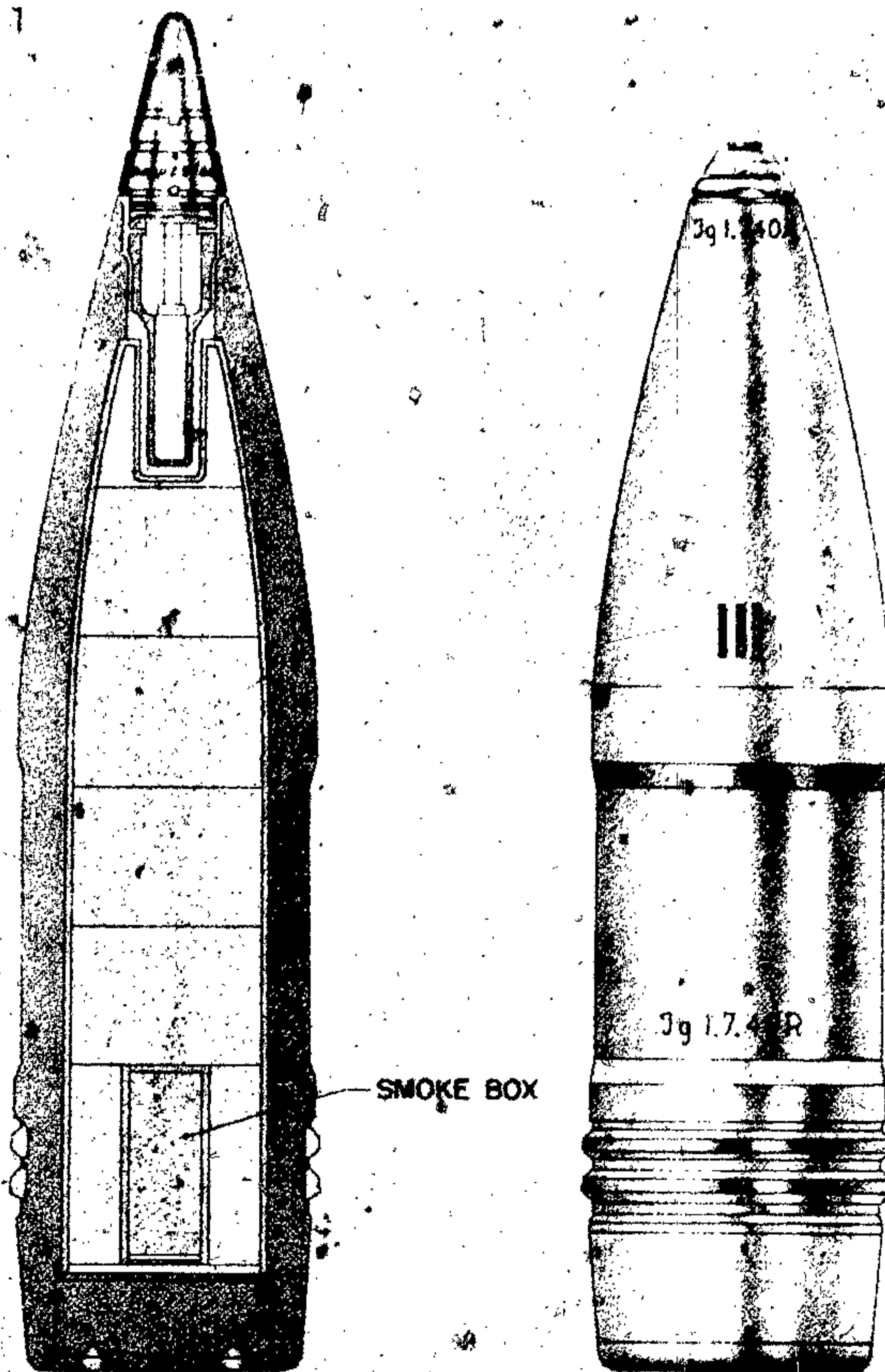

Figure 504—H. E. Projectile, Type 19, 150-mm, 15-cm Gr. 19

Two, number of rotating bands.
 5.196 inches, diameter of base.
 5.825 inches.
 95.7 pounds, total weight.
 9.46 pounds, weight of bursting charge.
 TNT in carboard container with smoke box at its base, type of bursting charge.
 Gr. Zdlg. C/98 N_g or Zdlg. C/98 booster.
 Projectile has a screwed-in base plate.

CARTRIDGE CASE (German nomenclature 6350) (semifixed):
 10.255 inches, over-all length.

6.338 inches, diameter of neck.
 No shoulder.
 7.007 inches, diameter of base.
 11.750 pounds, weight of case.
 4.1 pounds, weight of propellant.
 Flaked Diglycol, type of propellant.
 C/12nA primer.

FUZE: Nose Percussion Fuzes: A. Z. 23 (0.8) umg; AZ 23 (0.2) umg; AZ 23 m. 2V umg or Time and Percussion Fuzes: Dopp. Z. s/60s; Dopp. Z. s/60 lm.

PACKAGING: One projectile in a wicker basket—100 pounds.

GERMAN EXPLOSIVE ORDNANCE

REMARKS: There is also a projectile designated: "15-cm Gr. 19 mit Zdlg 35/2000" of approximately the same dimensions but with poured TNT filler. It has "35/2000" stenciled on body. Cartridge cases for other weapons are as follows:

- s. F. H. 13-6303 (semifixed).
- s. H. T.—6357 (semifixed).

H. E. PROJECTILE FOR GUN 16, 150-MM

GERMAN NOMENCLATURE: 15-cm Hbgr. 16 (Haubitzergranate 16). (See fig. 505.)

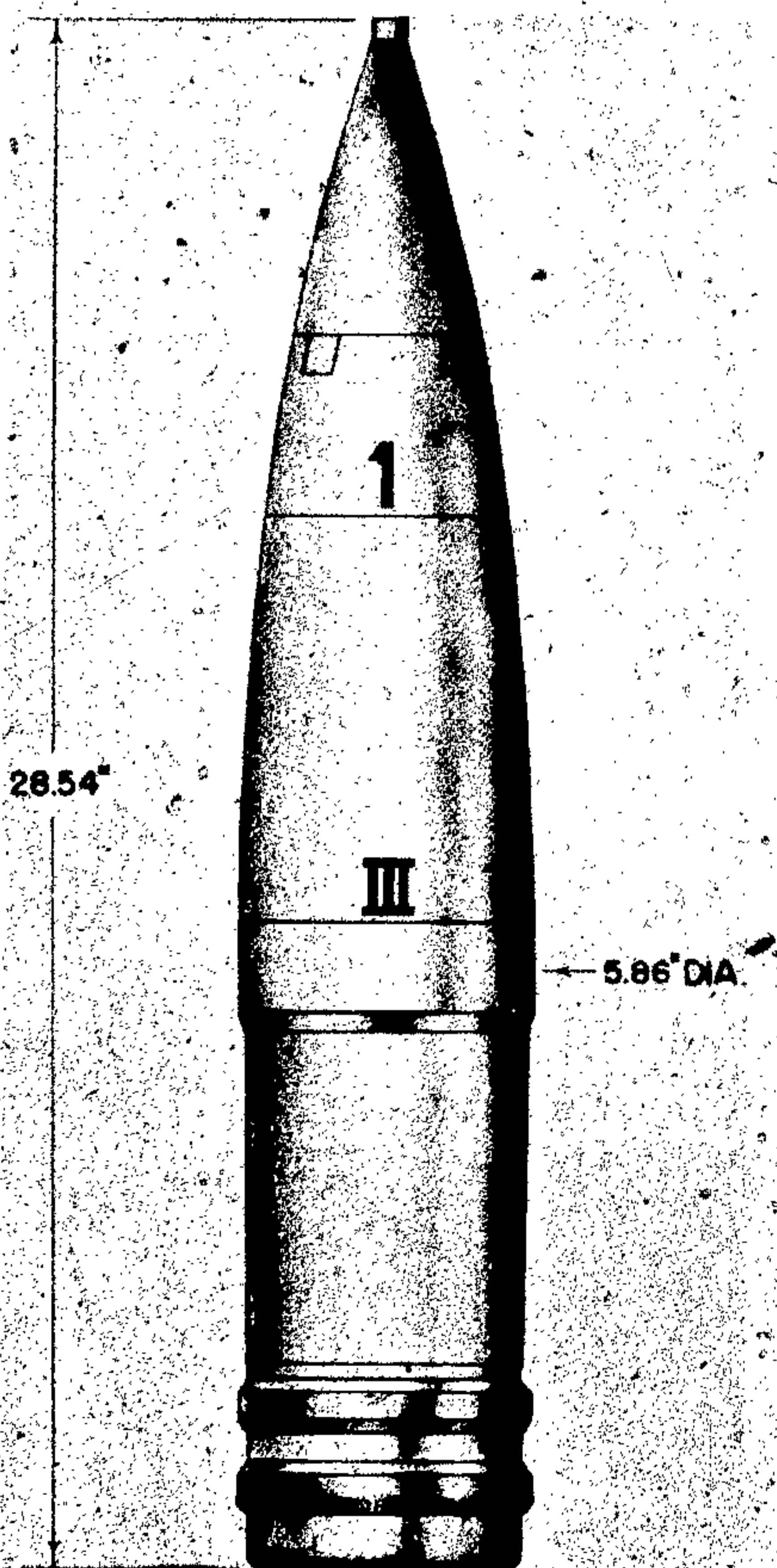

Figure 505—H. E. Projectile for Gun 16, 150-mm, 15-cm Hbgr. 16

EMPLOYMENT: 15-cm. K. 16 (kanone 16) Gun 16.

PROJECTILE:

- 29.59 inches, over-all length.
- 5.86 inches, diameter of bourrelet.
- 5.89 inches, diameter of base.
- 113.0 pounds, total weight.
- TNT in cardboard container, type of bursting charge.
- Ballistic cap.
- Unstreamlined base.

CARTRIDGE CASE (German nomenclature, 6304 (semifixed)):

- 28.54 inches, over-all length.
- No shoulder.
- 6.929 inches, diameter of base.
- Tubular nitroglycerine and nitrocellulose with nitroguanadine, type of propellant.
- 16.0 pounds, weight of propellant small charge plus.
- 3.0 ounces, igniter powder.
- 26.0 pounds, weight of propellant medium charge plus.
- 3.0 ounces, igniter powder.
- 29.0 pounds, weight of propellant large charge plus.
- 3.0 ounces, igniter powder.

FUZE: Nose Percussion Fuze Hbgr. Z. 17/23 or 17/23 umg or Time and Percussion Fuze Dopp. Z. 16mK or 16 mF.

PACKAGING: One projectile to a wicker basket—118.8 pounds.

REMARKS: There is also a round designated "15-cm Hbgr. 16 umg" using fuzes AZ. f. Hbgr. or Dopp. Z. s/60 (ms). It is the same weight and employs the same propellant charges.

H. E. PROJECTILE FOR HEAVY INFANTRY GUN 150-MM

GERMAN NOMENCLATURE: 15-cm-Jgr. 38 (Jaeger 38). (See fig. 506.)

EMPLOYMENT: 15-cm schweres Infanterie Geschutz 33 (Heavy Infantry Gun 33).

PROJECTILE, painted green:

- 25.747 inches, over-all length.
- 0.433 inch, width of rotating band—single.
- Bimetallic or soft iron, composition of rotating band.
- 5.905 inches, diameter of base.
- 83.6 pounds, total weight.

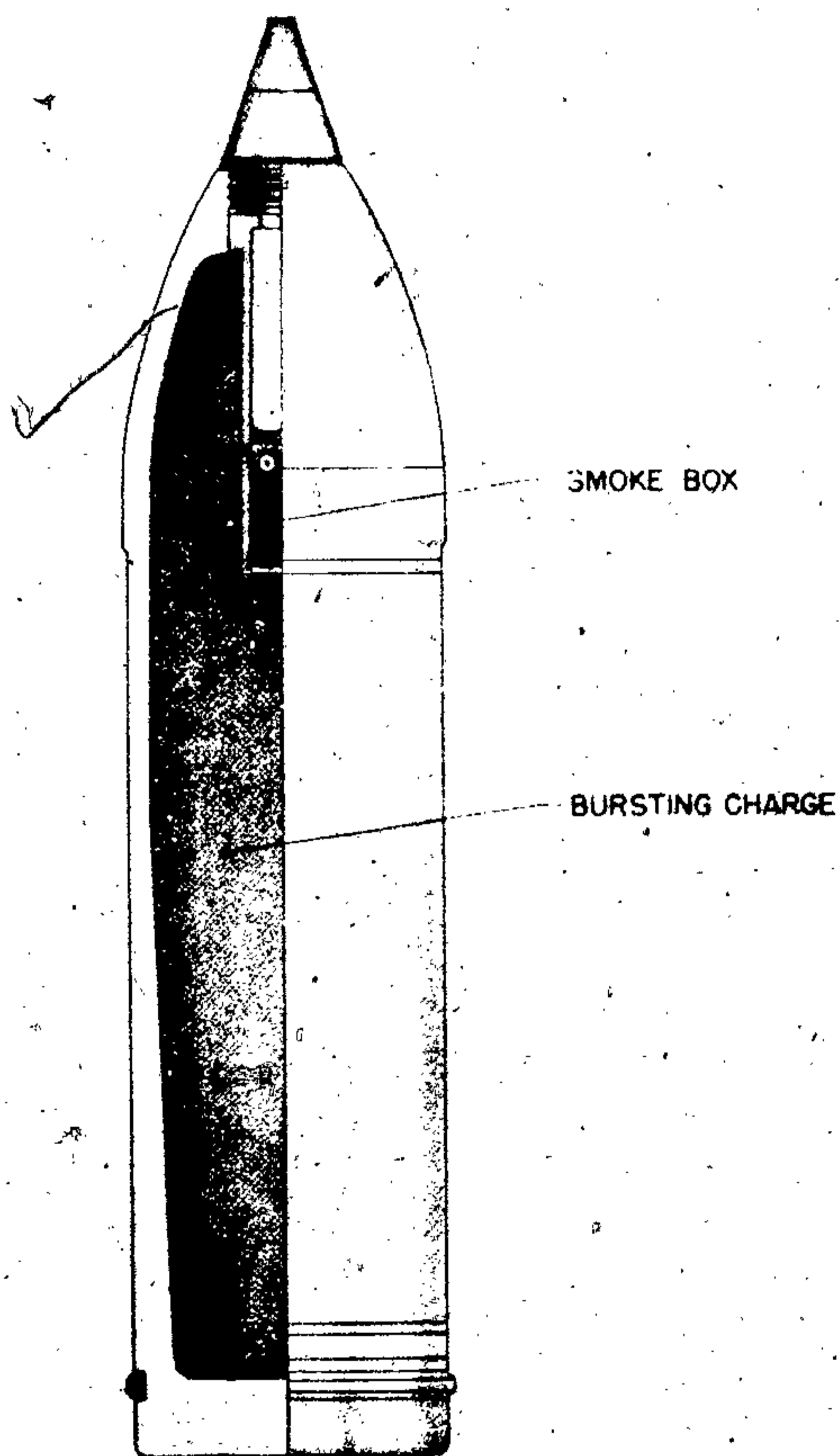

Figure 506—H. E. Projectile for Heavy Infantry Gun,
150-mm, 15-cm Jgr. 38

18.26 pounds, weight of bursting charge.
TNT plus Smoke Box, type of bursting charge.
Zdlg. 36 booster.

CARTRIDGE CASE (German nomenclature
6303 [semifixed]):

4.448 inches, over-all length.
6.102 inches, diameter of mouth.
No shoulder.
6.653 inches, diameter of base.
1.2 pounds, weight of propellant.
Flaked Diglycol, type of propellant.
C/12nA primer.

FUZE: Nose Percussion Fuze s. Jgr. Z. 23 (0.4).
PACKAGING: One projectile to a wicker basket.
REMARKS: When this projectile has been fired,
there will be 44 engravings on its rotating band.
There is also a round designated "15-cm Jgr. 33"
which is similar except that the projectile has a
screwed-in base plate.

H. E. PROJECTILE, TYPE L 4/5 WITH BASE
FUZE AND BALLISTIC CAP, 150-MM
GERMAN NOMENCLATURE: 15-cm Sprgr

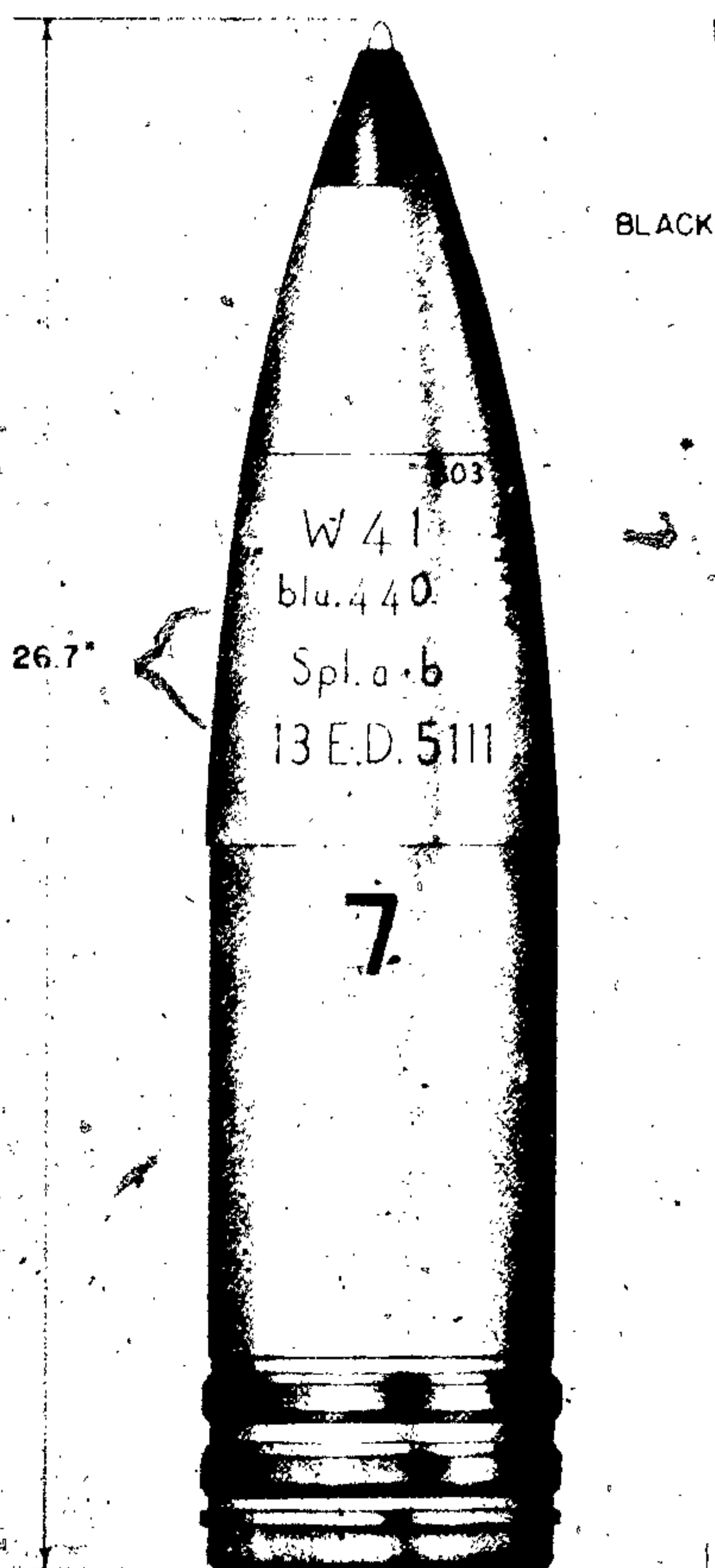

Figure 507—H. E. Projectile, Type L 4/5, 150-mm,
15-cm Sprgr. L 4/5 Bd. Z. m. Haube

GERMAN EXPLOSIVE ORDNANCE

L 4/5 Bd. Z. m. Haube (Sprenggranate Ladung 4/5 Boden Zunder mit Haube). (See fig. 507.)

EMPLOYMENT: 15-cm K. ins. Mrs. Laf. (kanone ins Morser Lafette) Gun in Mortar Mounting.

PROJECTILE, painted yellow, with black tip, black arrow on cap, stenciled in black:

26.7 inches, over-all length.

Two, number of rotating bands, with one lead band behind them.

100.0 pounds, total weight.

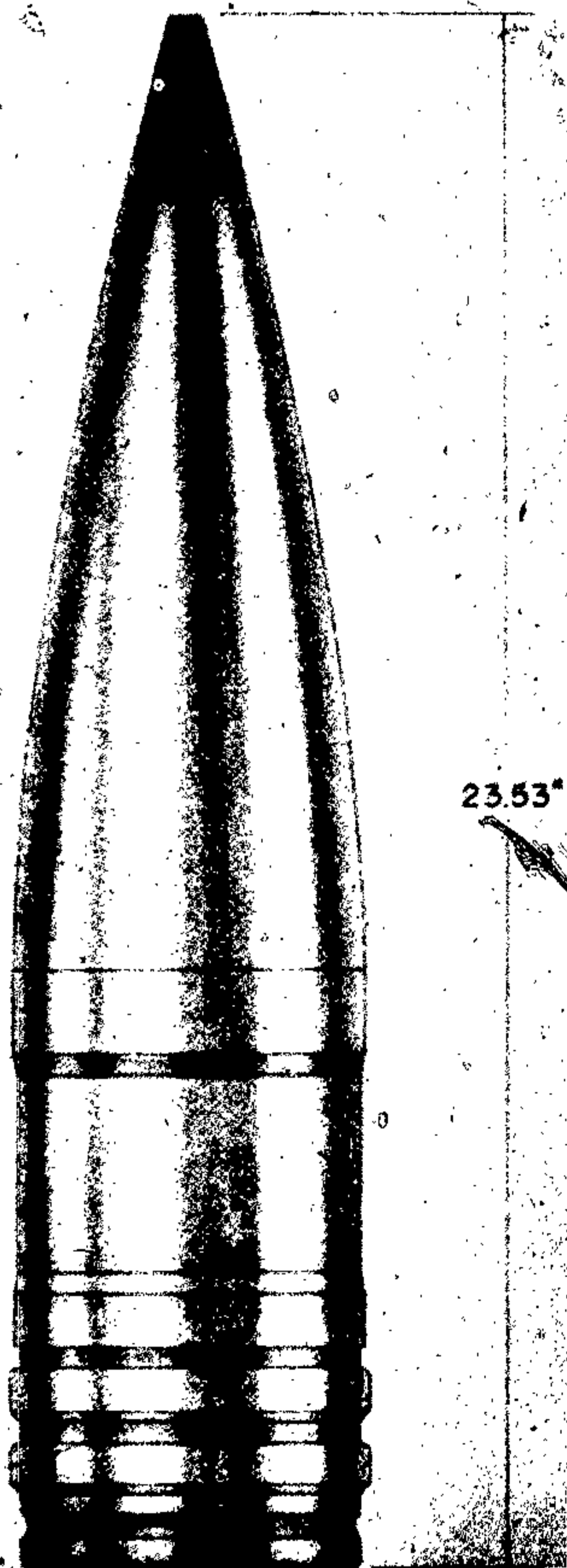

Figure 508—S. A. P. Projectile for Gun 39, 150-mm, 15-cm Hpzgr.

Stenciled markings, "303-W41 blu. 4.40 fl. 44.9 prg. Spl. a+b. 13Ed. 5111."

Ballistic cap.

Unstreamlined base.

Screwed-in plug in ballistic cap.

CARTRIDGE CASE (not known):

RPC/32 propellant.

Tubular in form and composed as follows:

Nitrocellulose—64.76%.

Nitroglycerine—26.87%.

Ethyl Centralite—5.71%.

Sodium Nitrate—0.56%.

Volatile Matter—1.90%.

Graphite—0.20%.

FUZE: Base detonating Fuze Bd. Z. C/38.

S. A. P. PROJECTILE FOR GUN 39, 150-MM

GERMAN NOMENCLATURE. 15-cm Hpzgr. (Halbpanzergranate). (See fig. 508.)

EMPLOYMENT: 15-cm K. 39 (Kanone 39) Gun 39.

PROJECTILE (black tip):

23.53 inches, over-all length.

5.866 inches, diameter of bourrelet.

6.102 inches, diameter of base.

99.0 pounds, total weight.

CARTRIDGE CASE (German nomenclature 6318) (semifixed):

20.66 inches, over-all length.

No shoulder.

7.28 inches, diameter of base.

C/12nA primer.

FUZE: Base detonating type.

REMARKS: Information is from captured documents.

A. P. PROJECTILE FOR GUN 39, 150-MM

GERMAN NOMENCLATURE: 15-cm Pzgr. (Panzergranate). (See fig. 509.)

EMPLOYMENT: 15-cm K. 39 (Kanone 39) Gun 39.

PROJECTILE:

23.542 inches, over-all length.

5.866 inches, diameter of base.

99.0 pounds, total weight.

CARTRIDGE CASE (German nomenclature 6318 (semifixed)):

20.67 inches, over-all length.

7.283 inches, diameter of base.

C/12nA primer.

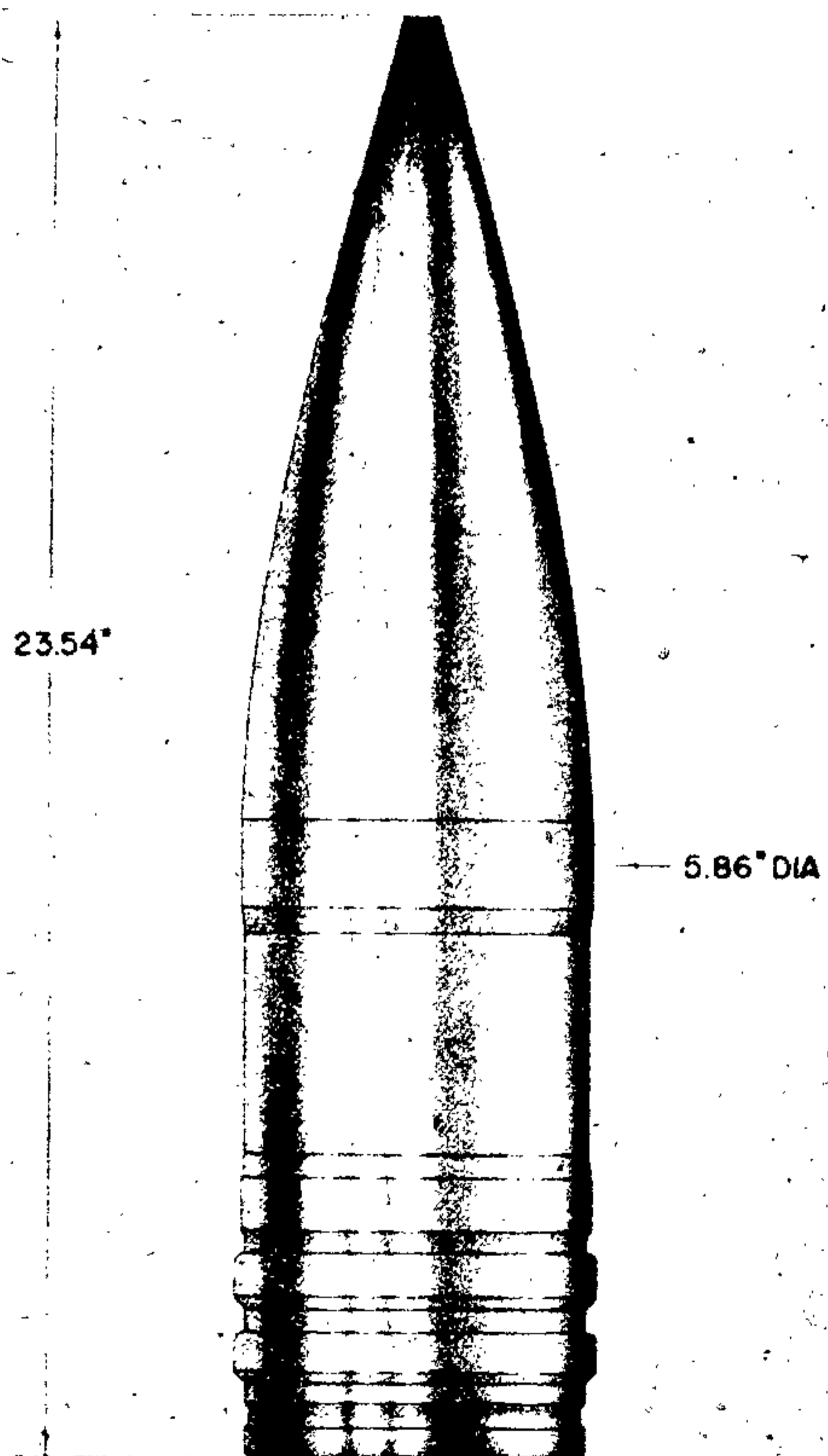

Figure 509—A. P. Projectile for Gun 39, 150-mm,
15-cm Pzgr.

FUZE: Base detonating type.

REMARKS: Information is from captured documents.

**H. E. PROJECTILE TYPE L/4.6 WITH NOSE
FUZE, 150-MM**

GERMAN NOMENCLATURE: 15-cm Sprgr.
L/4.6 (Kopfzunder). (See fig. 510.)

EMPLOYMENT: 15-cm K. 39 (Kanone 39)
Gun 39.

PROJECTILE:

26.88 inches, over-all length.
5.86 inches, diameter of bourrelet.

99.0 pounds, total weight.
Unstreamlined base.

CARTRIDGE CASE (German nomenclature
3318 (semifixed):

20.67 inches, over-all length.

No shoulder.

7.28 inches, diameter of base.

31.9 pounds, weight of propellant.

Tubular Diglycol, type of propellant.

C/12nA primer.

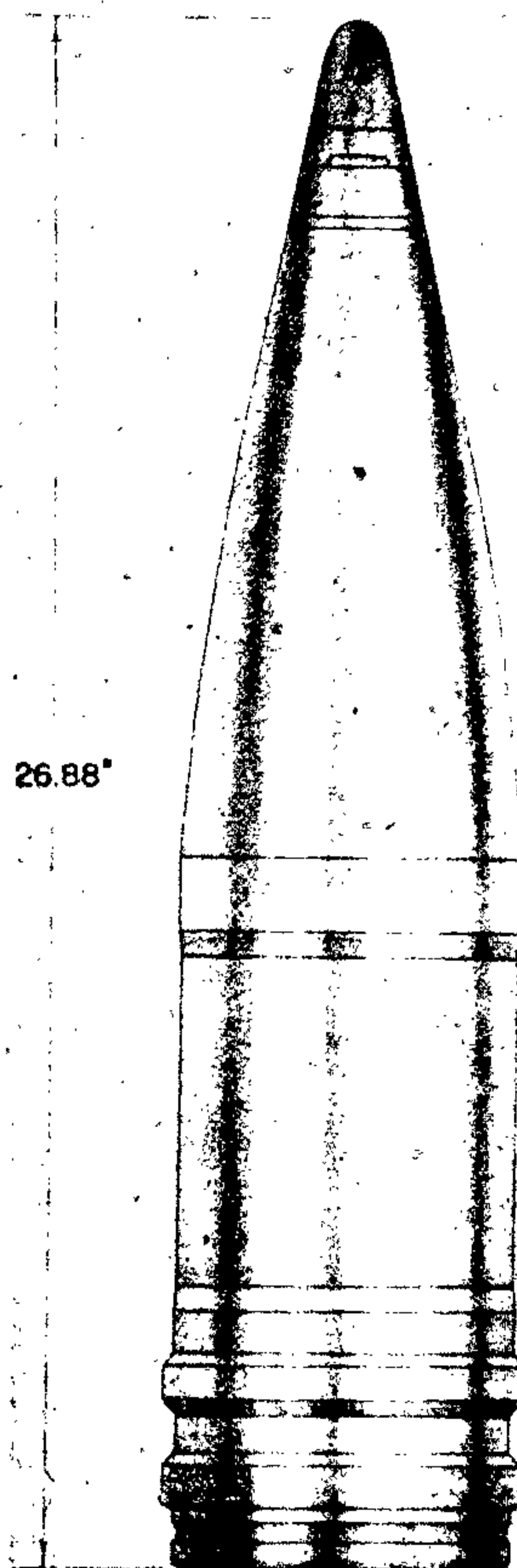

Figure 510—H. E. Projectile, Type L/4.6, 150-mm,
15-cm Sprgr. L/4.6 (Kopfzunder)

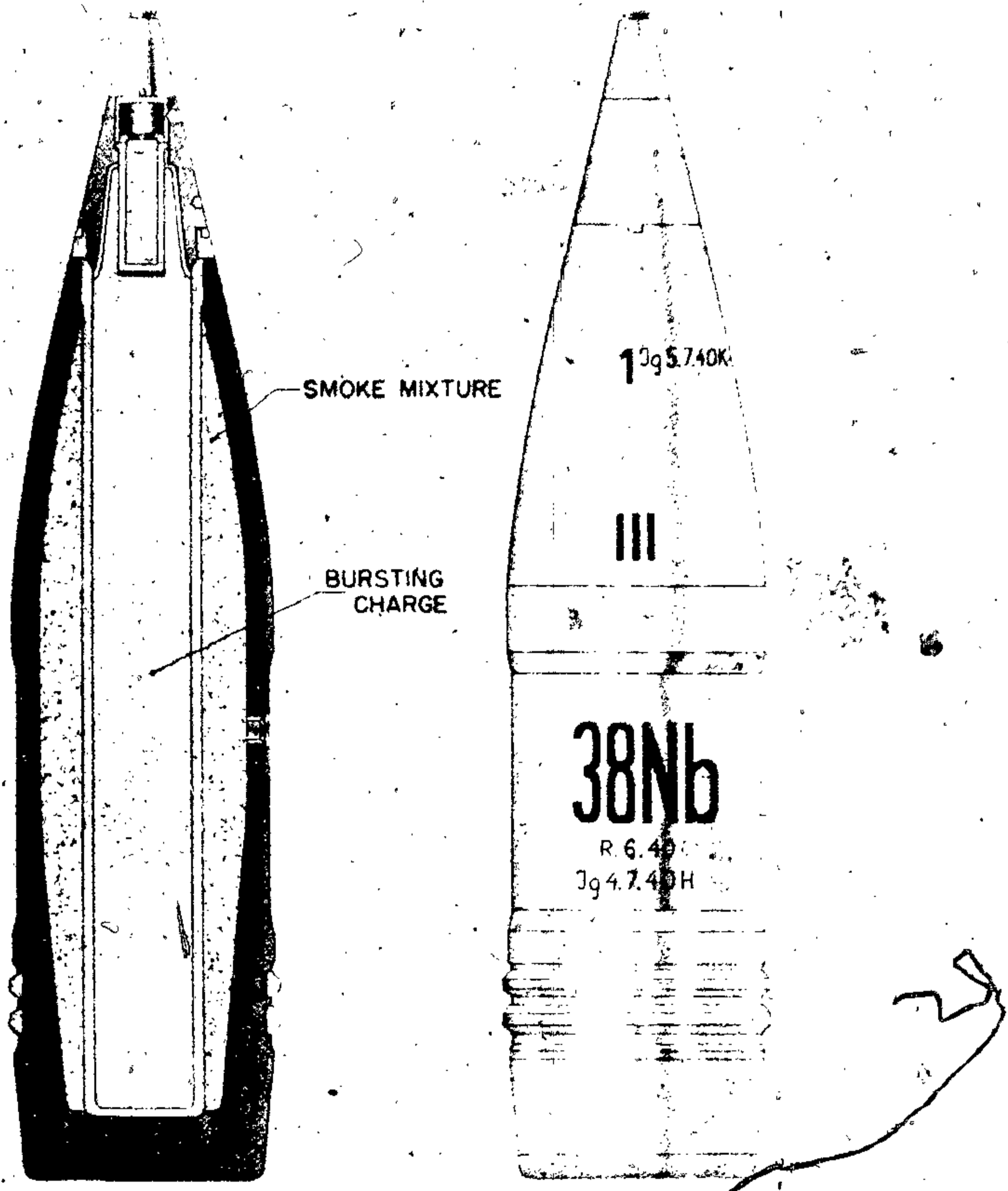

Figure 511—Smoke Projectile, Type 38, 150-mm, 15-cm Gr. 38 Nb.

FUZE: Nose Percussion Fuze E. Kz. m. V. (0.12), or Time and Percussion Fuze Dopp. Z. s/60.

REMARKS: Information is from captured documents.

SMOKE PROJECTILE, TYPE 38, 150-MM

GERMAN NOMENCLATURE: 15-cm Gr. 38 Nb (Granate 38 Nebel). (See fig. 511.)

EMPLOYMENT: 15-cm s. F. H. 18 (Schweres Feld Haubitze 18) Heavy Field Howitzer 18.

COMPLETE ROUND: 31.751 inches, over-all length.

PROJECTILE (painted green, stenciled in white):

24.732 inches, over-all length w/fuze.

3.22 inches, distance from base to band.

0.472 inch, width of rotating bands.

Two, number of rotating bands.

5.825 inches, diameter of bourrelet.

5.196 inches diameter of base.

TNT, type of bursting charge.

Oleum impregnated in pumice, type of smoke mixture.

"38 Nb" stenciled on body.

Gr. Zdlg. C/98 Np booster.

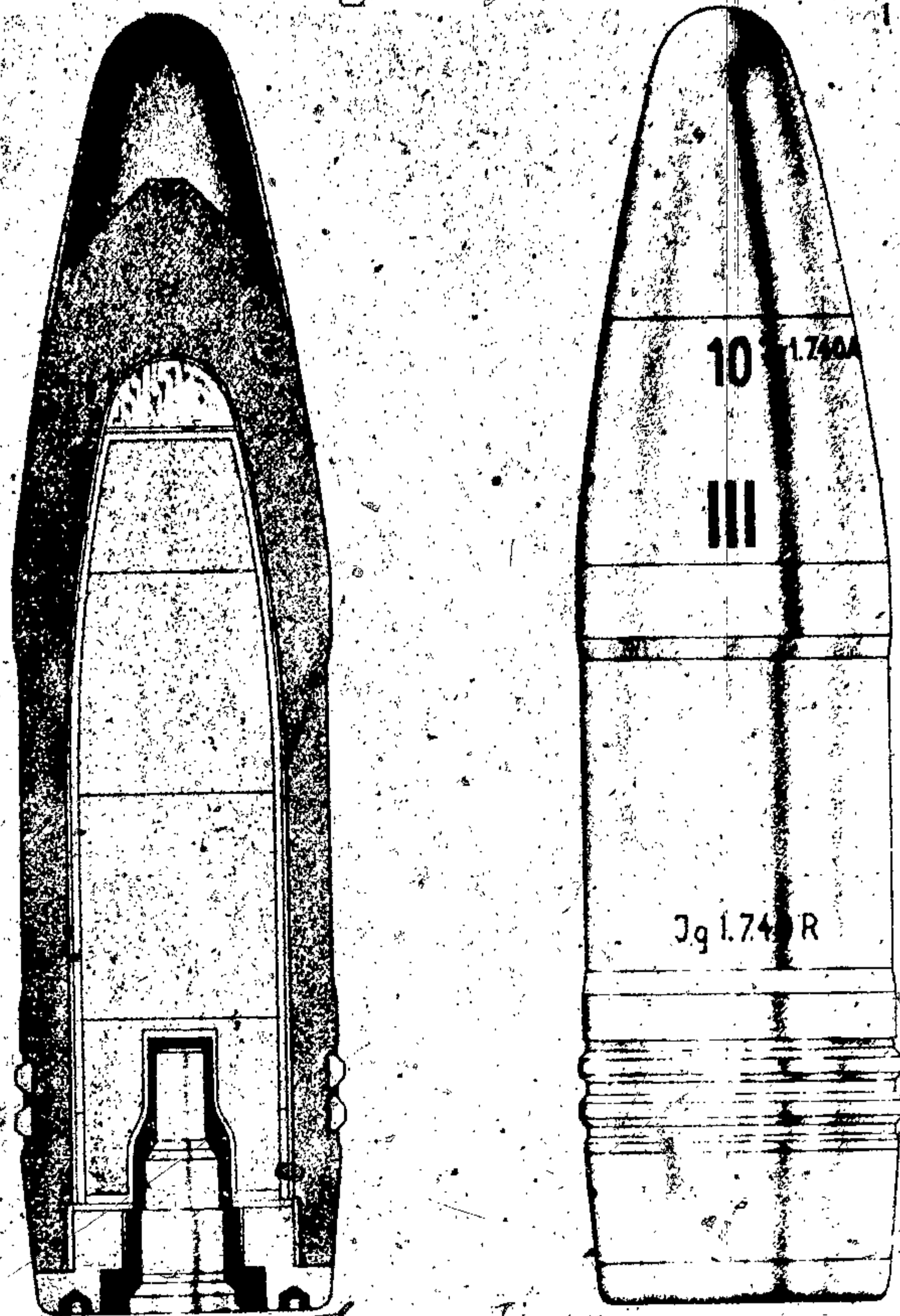

Figure 512—Anticoncrete Projectile, Type 19, 150-mm, 75-cm Gr. 19 Be.

CARTRIDGE CASE (German nomenclature 6350 (semifixed)):

- 10.255 inches, over-all length.
- 6.338 inches, diameter of mouth.
- No shoulder.
- 7.007 inches, diameter of base.
- C/12nA primer.

FUZE: Nose Percussion Fuze K1, AS 40 Nb.

PACKAGING: One projectile in wicker basket.

**ANTICONCRETE PROJECTILE, TYPE 19.
150-MM**

GERMAN NOMENCLATURE: 15-cm Gr. 19 Be (Granate 19 Beton). (See fig. 512.)

EMPLOYMENT:

- 15-cm s. F. H. 18 (Schweres Feld Haubitze 18), Heavy field Howitzer 18.
- 15-cm s. F. H. 13 (Schweres Feld Haubitze 13), Heavy Field Howitzer 13.
- 15-cm s. H. T. (Schweres Haubitze Turm), Heavy Turret Howitzer.

COMPLETE ROUND (description of c/r is for s. F. H. 18):

- 30.215 inches, over-all length.
- 3.228 inches, distance from base to band.
- 0.472 inch, width of rotating bands—bimetallic.
- Two, number of rotating bands.

GERMAN EXPLOSIVE ORDNANCE

5.825 inches, diameter of bourrelet.
 5.196 inches, diameter of base.
 95.7 pounds, total weight.
 7.1 pounds, weight of bursting charge.
 TNT, type of bursting charge.
 Four blocks in cardboard carton cemented to
 internal walls of projectile. From base to
 nose: TNT.
 TNT/Wax 95/5.
 TNT/Wax 90/10.
 Gr. Zdlg. C/98 Np booster.

Projectile has screwed-in base plate.
 Ballistic cap is welded to shell.

CARTRIDGE CASE (German nomenclature
 6850 [semifixed]):

10.255 inches, over-all length.
 6.338 inches, diameter of mouth.
 No shoulder.
 7.007 inches, diameter of base.
 C/12nA primer.

FUZE: Base Detonating Fuze Bd. Z. F. 15-cm
 Gr. 19 Be.

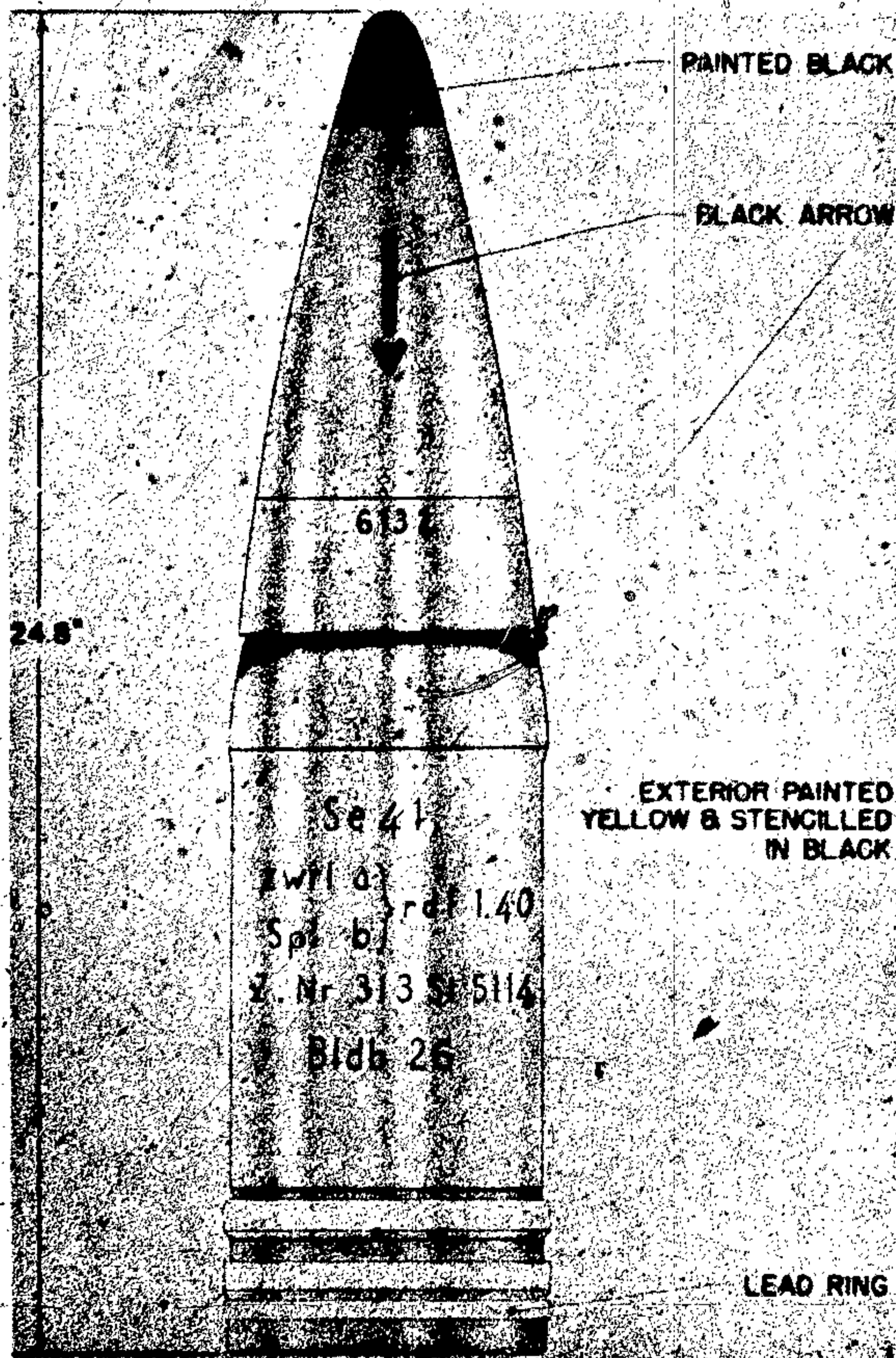

Figure 513—A. P. C. Projectile, 150-mm for Unknown Weapon

PACKAGING: One projectile in a wicker basket, 100 pounds.

REMARKS: Cartridge cases for other weapons are as follows:

- s. F. H. 13—6303 (semifixed).
- s. H. T.—6357 (semifixed).

A. P. C. PROJECTILE FOR UNKNOWN WEAPON, 150-MM

GERMAN NOMENCLATURE: Not known. (See fig. 513.)

EMPLOYMENT: Not known but believed to be for naval use.

PROJECTILE (painted yellow with black tip,

black arrow pointed down towards base, black stenciling):

24.8 inches, over-all length (approximately).
98.47 pounds, total weight.

CARTRIDGE CASE: Not known.

FUZE: Not known.

REMARKS: Information is from captured documents.

ROCKET ASSISTED PROJECTILE, 150-MM

GERMAN NOMENCLATURE: 15-cm R. Granate 19. (See fig. 514.)

EMPLOYMENT: s. F. H. 18 (schweres Feld Haubitze 18), Heavy Field Howitzer 18.

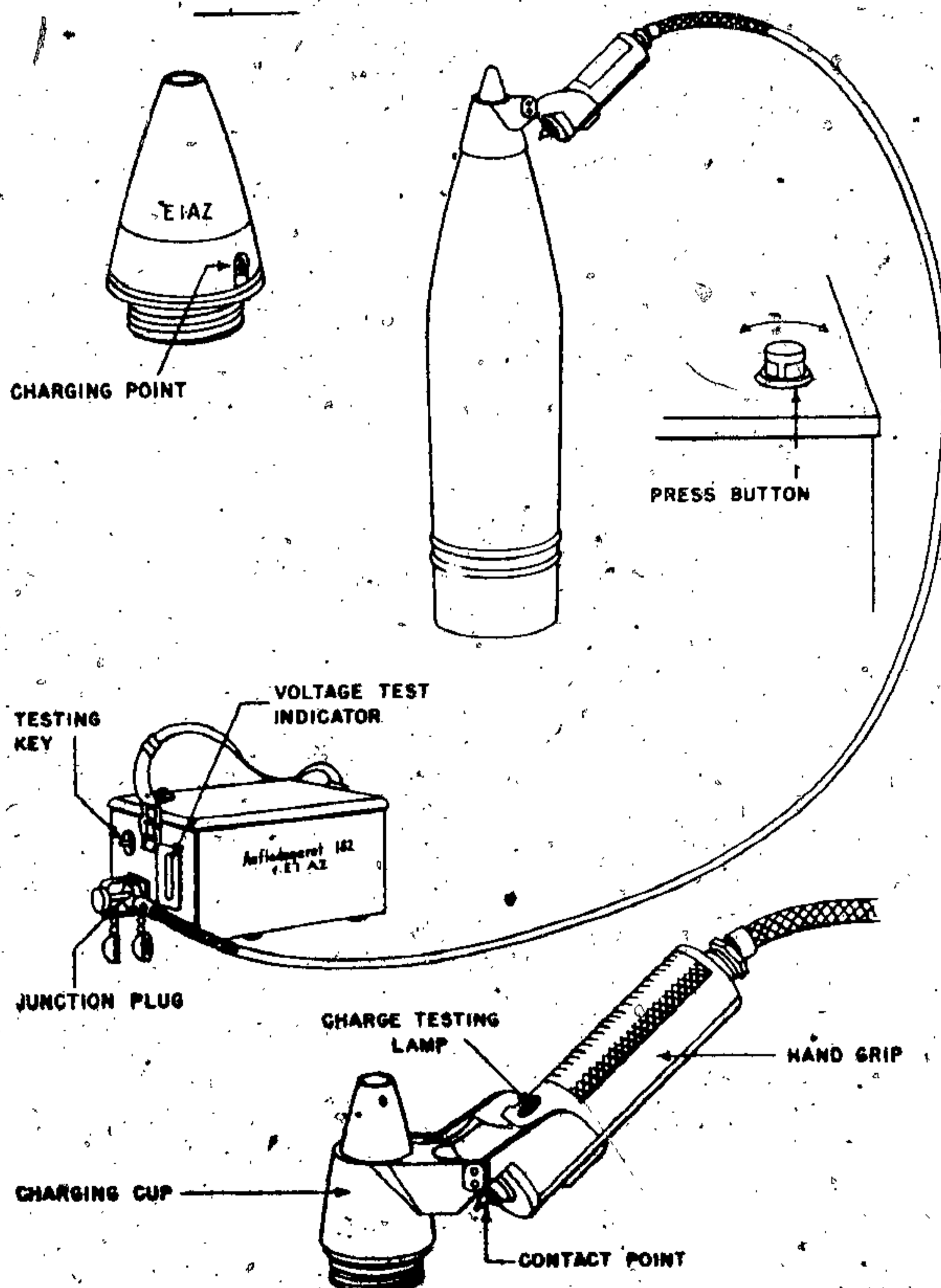

Figure 514—Rocket Assisted Projectile, 15-cm R. Granate 19

GERMAN EXPLOSIVE ORDNANCE

PROJECTILE: 99.5 pounds, total weight.

CARTRIDGE CASE (German nomenclature 6350 [semifixed]):

10.23 inches, over-all length.

6.338 inches, diameter of mouth.

No shoulder.

7.007 inches, diameter of base.

13.64 pounds, weight of propellant.

Tubular Diglycol, type of propellant.

C/12nA primer.

"R" stenciled in red on charge bag.

FUZE: Electric Nose Percussion Fuze, graze operated, instantaneous: El. A. Z. m. R. Base Fuze R (transition fuze).

REMARKS: This is an experimental projectile. No specimens have been recovered as yet. Two types were designed. On the first the base plate is held in position with magnesia luting. It is thrown clear when the gun fires. In the new pattern the jets are closed by small individual plugs which fall out when the gun fires.

H. E. PROJECTILE FOR 152-MM GUN

GERMAN NOMENCLATURE: 15.2-cm Sprgr 436 (r). (See fig. 515.)

WEAPONS:

Russian Gun Howitzer:

15.2-cm K. H. 433/1 (r), Model 37.

15.2-cm K. H. 433/2 (r), Model 10/34.

PROJECTILE:

Caliber: 152 mm.

Kind: Shell.

Type: H. E.

Weight 96.5 pounds (loaded and fuzed).

Color: O. D. with blue band near bourrelet.

CHARGE:

Number: T.

Weight: 14.25 pounds.

Kind: Tetryl.

BOOSTER: Integral with fuze.

FUZE:

Nomenclature: German: (1) A. Z. 360 (r).

Russian: (1) PM N 65 60 39 (r).

Type: (1) P. D.

H. E. PROJECTILE FOR 152-MM GUN

GERMAN NOMENCLATURE: 15.2-cm Sprgr. F. E. W. (See fig. 516.)

WEAPONS:

Russian Gun Howitzer:

15.2-cm K. H. 433/1 (r) Model 17.

15.2-cm K. H. 433/2 (r) Model 10/34.

PROJECTILE:

Caliber: 152 mm.

Kind: Shell.

Type: H. E.

Weight: 101 pounds (loaded and fuzed).

Color: Dark O. D.

CHARGE:

Number: 13A.

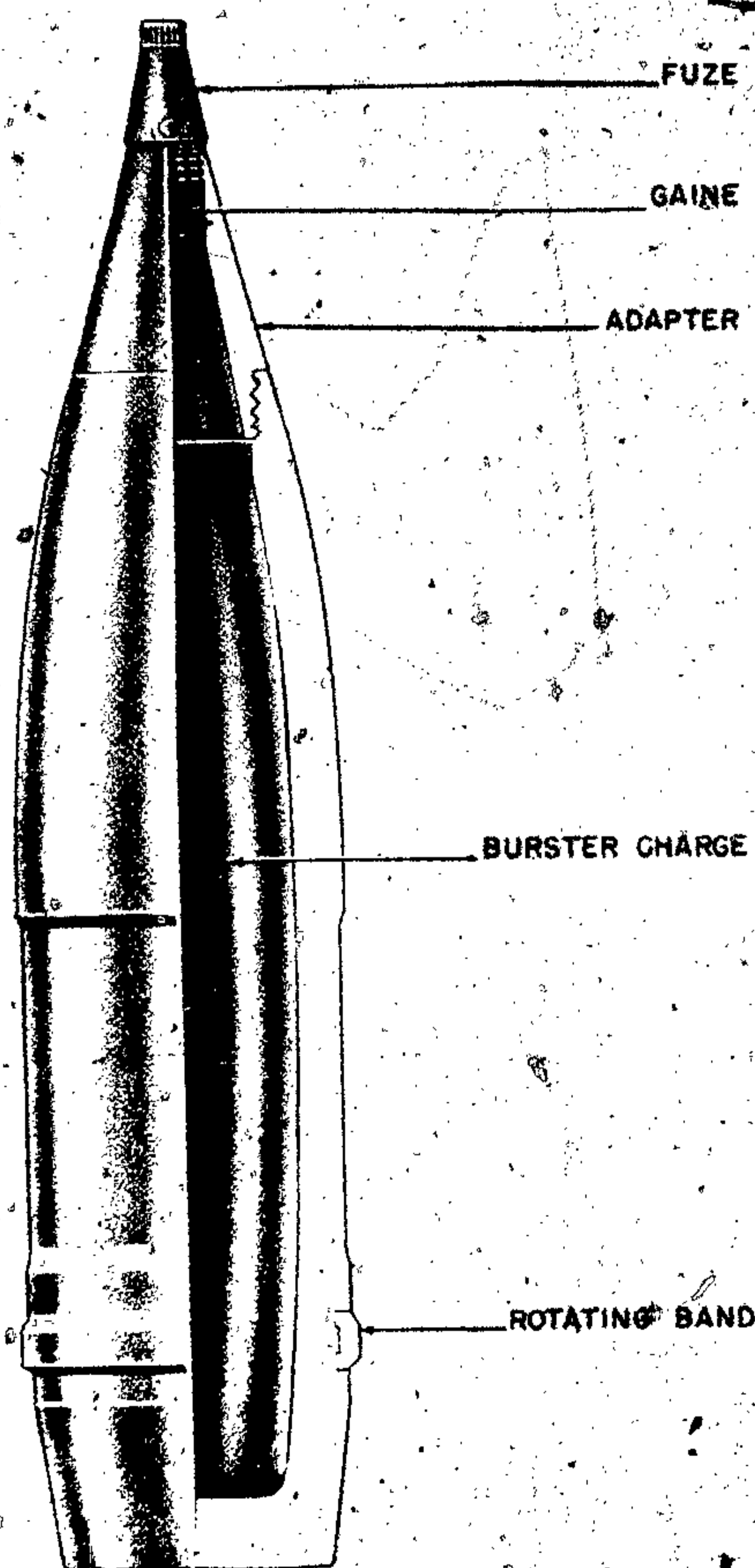

Figure 515—H. E. Projectile, of Russian Origin, 152-mm, 15.2-cm Sprgr. 436 (r)

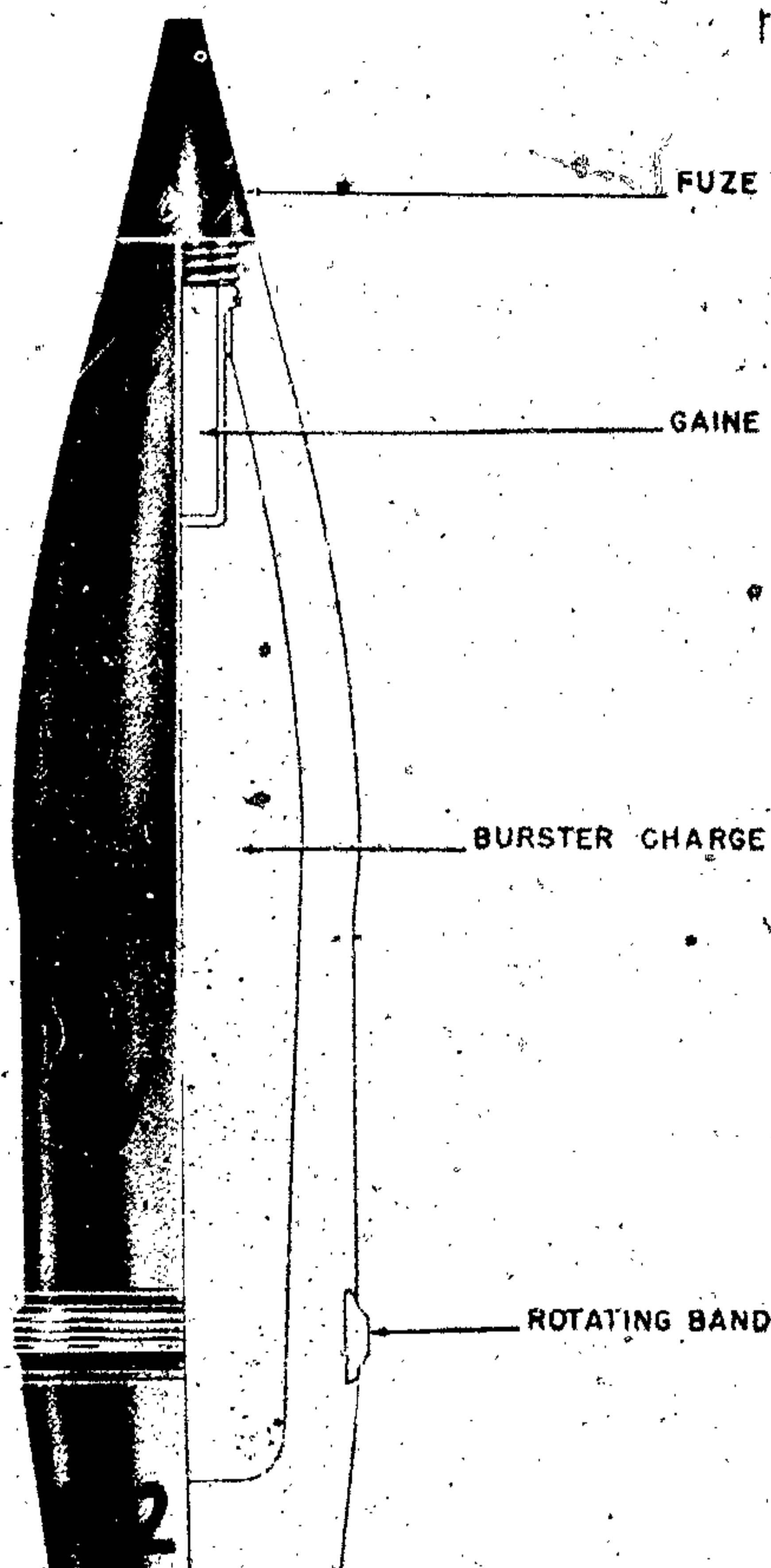

Figure 516—H. E. Projectile, 152-mm, 15.2-cm Sprgr. F. E. W.

Weight: 9 pounds.

Kind: Amatol 50/50.

TRACER: None.

BCOSTER: cwg Np 10.

FUZE:

• Nomenclature: A. S. 23 (0/15) Pr.

Type: P. D.

REMARKS:

NOTE 1.—This projectile is of German manufacture for the weapons listed above.

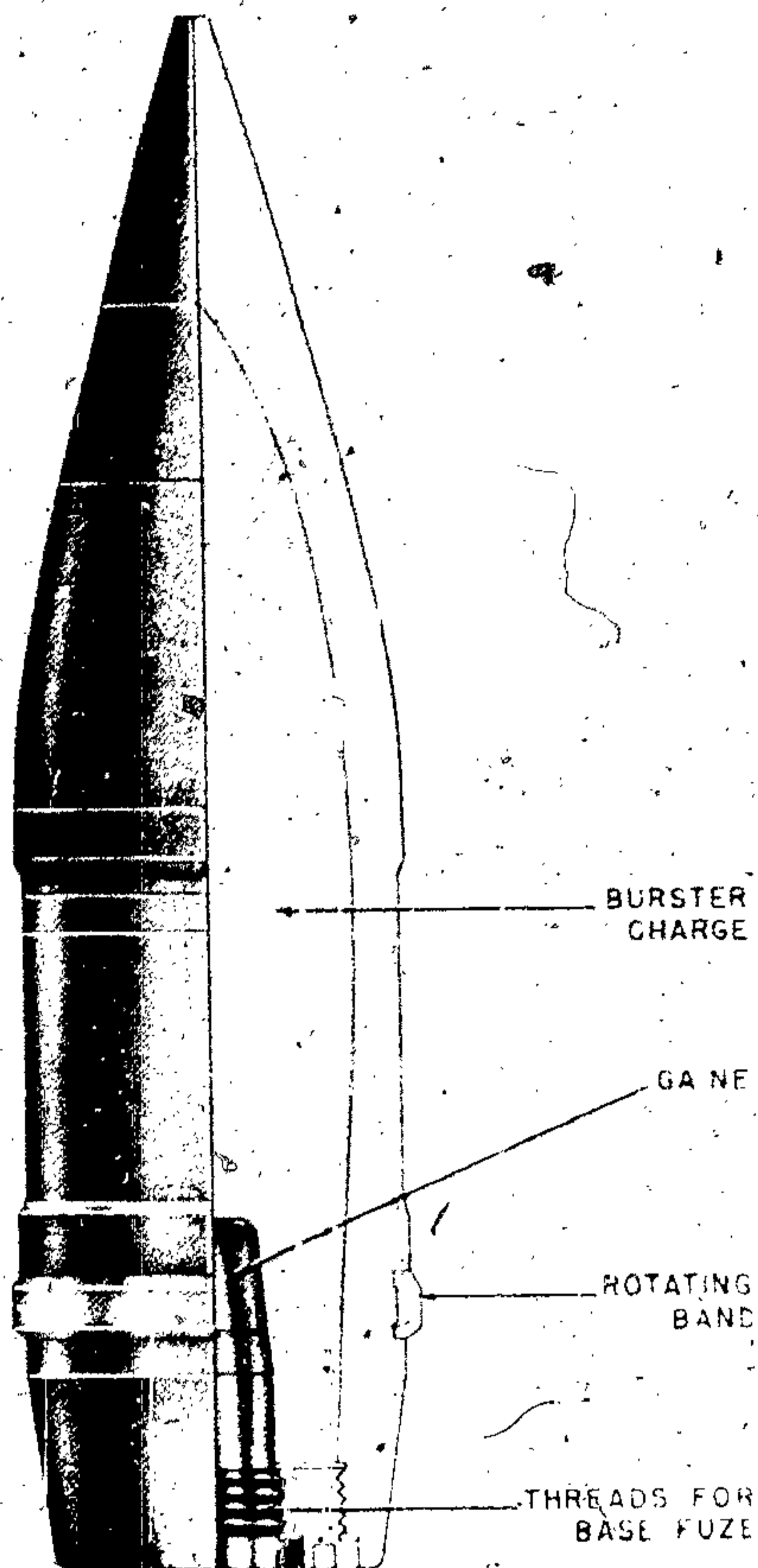

Figure 517—Anticoncrete (H. E.) Projectile 152-mm, 15.2-cm Gr. 434 Be. (r)

ANTICONCRETE (H. E.) PROJECTILE FOR 152-MM GUN

GERMAN NOMENCLATURE: 15.2-cm Gr. 434 Be (r). (See fig. 517.)

WEAPONS:

Russian Gun Howitzer:

15.2-cm K. H. 433/1 (r), Model 37.

15.2-cm K. F. 322/2 (r), Model 10, 34.

PROJECTILE

Caliber: 152-mm.

Kind: Shell.

GERMAN EXPLOSIVE ORDNANCE

Type: Anticoncrete (high explosive).
Weight: 87.8 pounds (loaded and fuzed).
Color: Shell may be unpainted and greased; or painted gray with two red stripes around shell body, without red stripes, or with blue stripe around ogive.

CHARGE: None.

Number: T.

Weight: 10.8 pounds.

Kind: TNT.

BOOSTER: Integral with fuze.

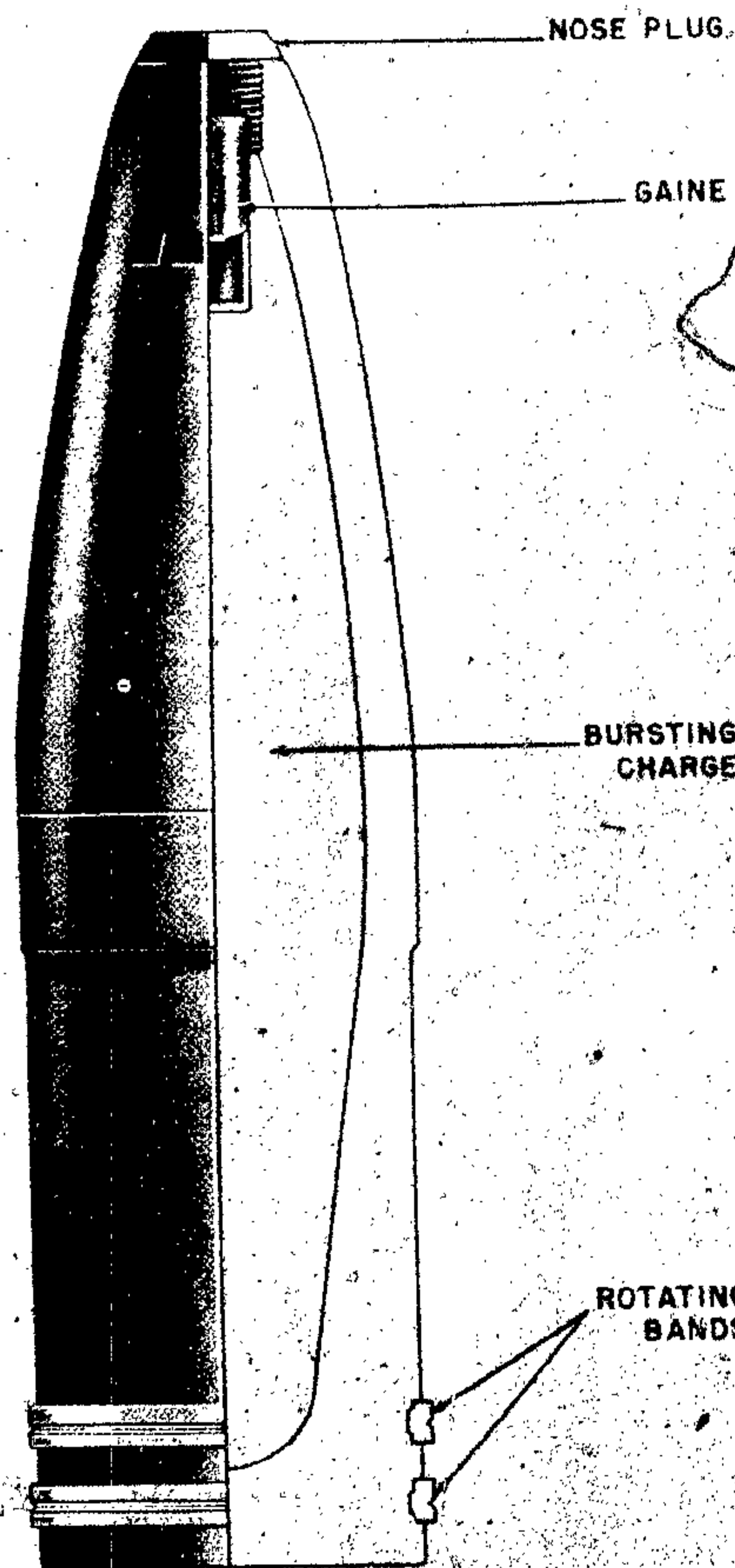

Figure 518—H. E. Projectile for 155-mm French Gun,
15.5-cm Gr. 422 (f)

FUZE:

Nomenclature: Bd. Z. 493 (r) russ K. T. D.

Type: B. D.

H. E. PROJECTILE FOR 155-MM GUN

GERMAN NOMENCLATURE: 15.5-cm Stg. Gr. 422 (f). (See fig. 518.)

WEAPONS:

French Gun:

15.5-cm K. 418 (f), Model G. P. F.

15.5-cm. 419 (f), Model G. P. F.—T.

15.5-cm K. 420 (f), Model 1916 St. CH.

PROJECTILE:

Caliber: 155 mm.

Kind: Shell.

Type: H. E.

Weight: 99.7 pounds (loaded and fuzed).

Color: O. D.

CHARGE:

Number: 13A.

Weight: 12 pounds.

Kind: Amatol 50/50.

TRACER: None.

BOOSTER: Integral with fuze.

SMOKE PROJECTILE FOR 155-MM FRENCH GUN

GERMAN NOMENCLATURE: 15.5-cm Gr. 427 (f). (See fig. 519.)

WEAPONS: French Heavy Gun, 15.5-cm K. 420 (f), L. Mle., 1916 St. CH.

PROJECTILE:

Caliber: 155 mm.

Kind: Shell.

Type: Smoke.

Weight: 97¼ pounds (loaded and fuzed).

Color: Base to bourrelet olive green, ogive black.

CHARGE:

Number: Unknown.

Weight: 11¼ pounds.

Kind: Unknown.

TRACER: None.

BOOSTER: Separate type but unknown.

ADAPTER: PEK 10 18.

FUZE: Nomenclature: Unknown.

H. E. PROJECTILE FOR 155-MM HOWITZER

GERMAN NOMENCLATURE: 15.5-cm Gr. 417 (f). (See fig. 520.)

WEAPONS:

French Heavy Field Howitzer: 15.5-cm s. F. H. 414 (f), C Mle 1917S.

Polish Heavy Field Howitzer: 15.5-cm s. F. H. 17 (p) Model 17.

PROJECTILE:

Caliber: 155 mm.

Kind: Shell.

Type: H. E.

Weight: 96.2 pounds (loaded and fuzed).

Color: Black body with yellow ogive.

CHARGE:

Number: M.

Weight: 10.8 pounds.

Kind: Melinite.

TRACER: None.

BOOSTER: Integral with fuze.

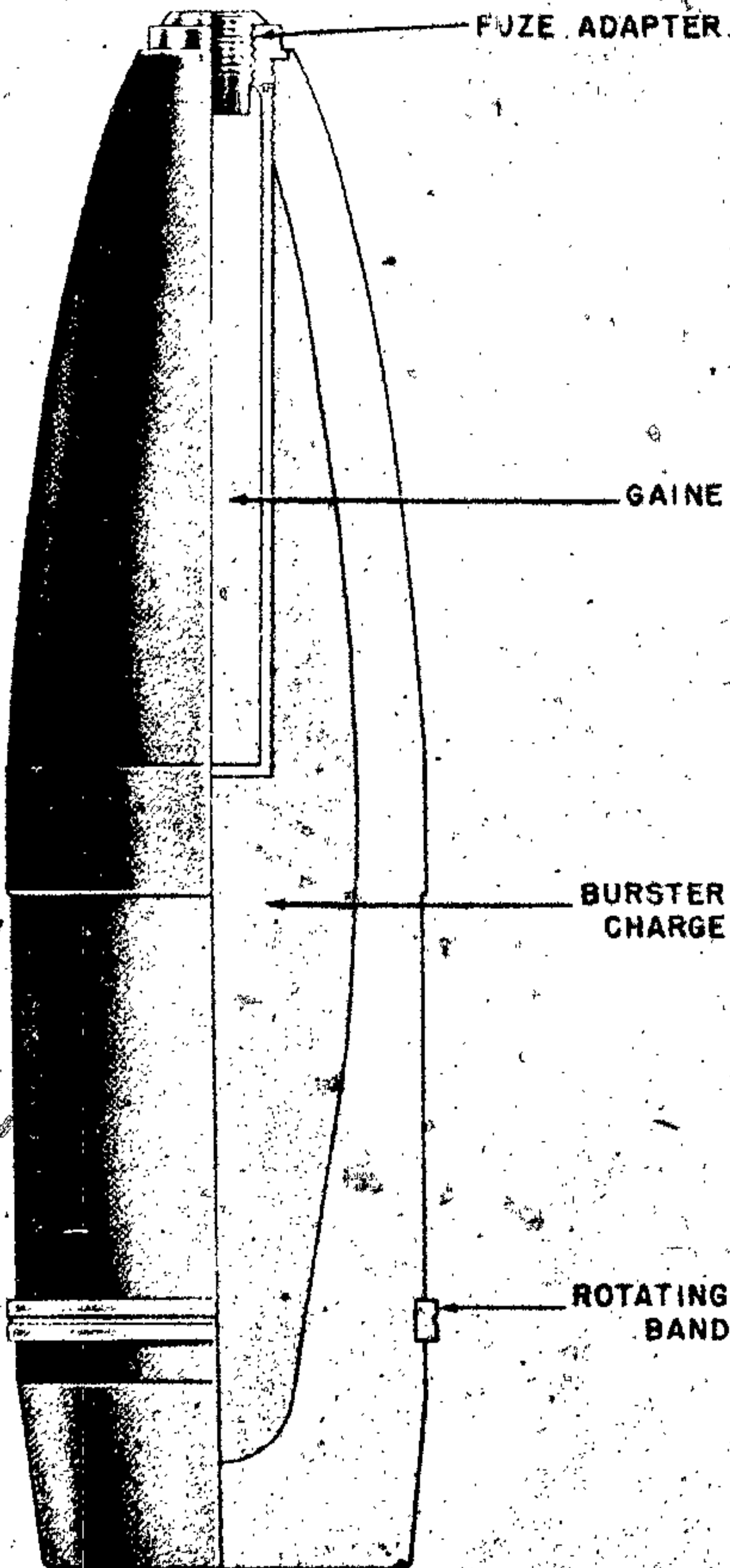

Figure 519—Smoke Projectile for 155-mm French Gun, 15.5-cm Gr. 427 (f)

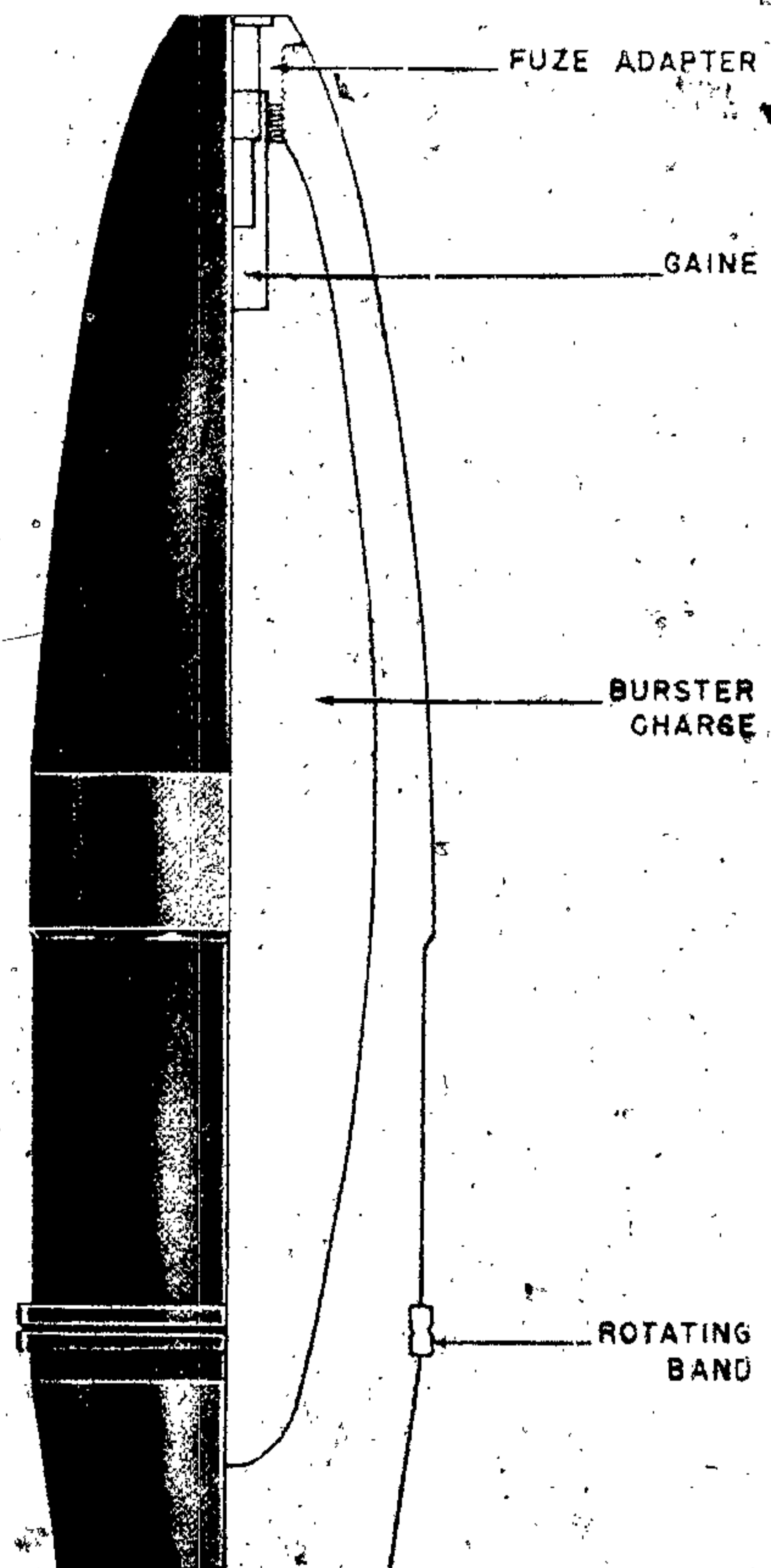

Figure 520—H. E. Projectile, 155-mm, 15.5-cm Gr. 417 (f)

GERMAN EXPLOSIVE ORDNANCE

FUZE:

NOMENCLATURE

| GERMAN | FRENCH |
|----------------------|----------------|
| (1) A. Z. 251 (f) | 24/31 RYG 18 J |
| (2) A. Z. 240 (f) | 24/21 99-15 SR |
| (3) A. Z. 259 (f) | 24/31 RY 17 SR |
| (4) Dopp. Z. 445 (f) | 24/31 ID 17 |

Type: (1) P. D. (2) P. D. (3) P. D. (4) Dopp. Z.

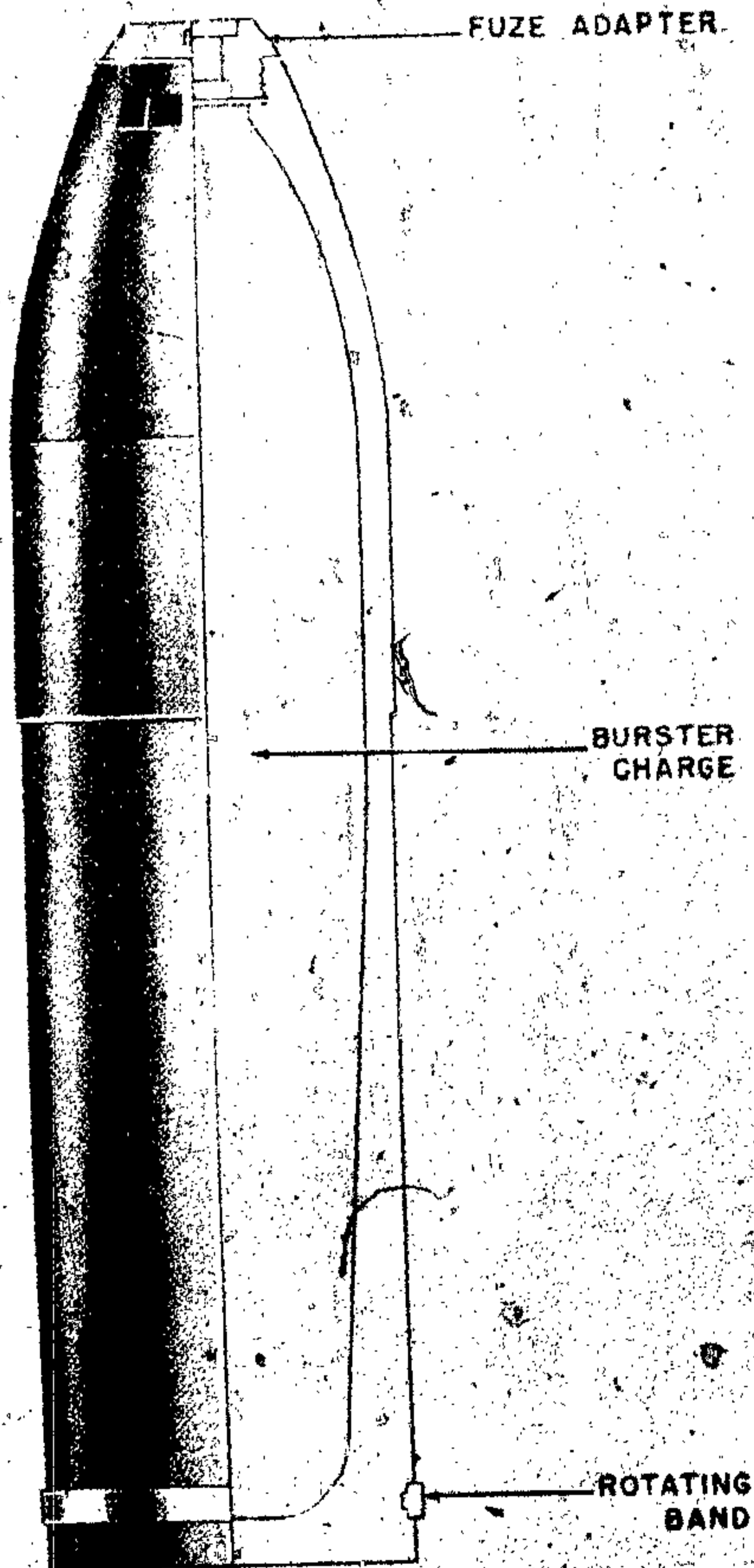

Figure 521—H. E. Projectile, 155-mm, 15.5-cm Langgr. 415 (f)

H. E. PROJECTILE FOR 155-MM GUN

GERMAN NOMENCLATURE: 15.5-cm Langgr. 415 (f). (See fig. 521.)

WEAPONS:

French Heavy Field Howitzer: 15.5-cm s. F. H. 414 (f), Model C/Mc 1917 S.
Polish Heavy Field Howitzer: 15.5-cm s. F. H. 17 (p), Model 17.

PROJECTILE:

Caliber: 155 mm.
Kind: Shell.
Type: H. E.
Weight: 94.8 pounds (loaded and fuzed).
Color: Yellow.

CHARGE:

Number: MF.
Weight: 23.3 pounds.
Kind: Cast Melinite.

TRACER: None.

BOOSTER: Integral with fuze.

FUZE:

NOMENCLATURE

| GERMAN | FRENCH |
|----------------------|-----------------|
| (1) A. Z. 251 (f) | 24/31 RYG 18 J |
| (2) A. Z. 253 (f) | 24/31 RYG 18 CR |
| (3) A. Z. 255 (f) | 24/31 RYG 18 LR |
| (4) A. Z. 240 (f) | 24/31 99-16 SR |
| (5) A. Z. 241 (f) | 24/31 99-15 CR |
| (6) A. Z. 239 (f) | 24/31 99-15 LR |
| (7) A. Z. 259 (f) | 24/31 RY 17 SR |
| (8) Dopp. Z. 445 (f) | 24/31 LD 17 |

Type: (1) P. D. (2) P. D. (3) P. D. (4) P. D. (5) P. D. (6) P. D. (7) P. D. (8) T. and P.

H. E. PROJECTILE FOR 155-MM GUN

GERMAN NOMENCLATURE: 15.5-cm Stg. 423 (f). (See fig. 522.)

WEAPONS:

French Gun:
K 420 (f), L 1916 St. CH.
K 419 (f), GPF—T.
K 418 (f), GPF.

PROJECTILE:

Caliber: 155 mm.
Kind: Shell.
Type: H. E.
Weight: 82 pounds empty (loaded and fuzed).
Color: O. D.

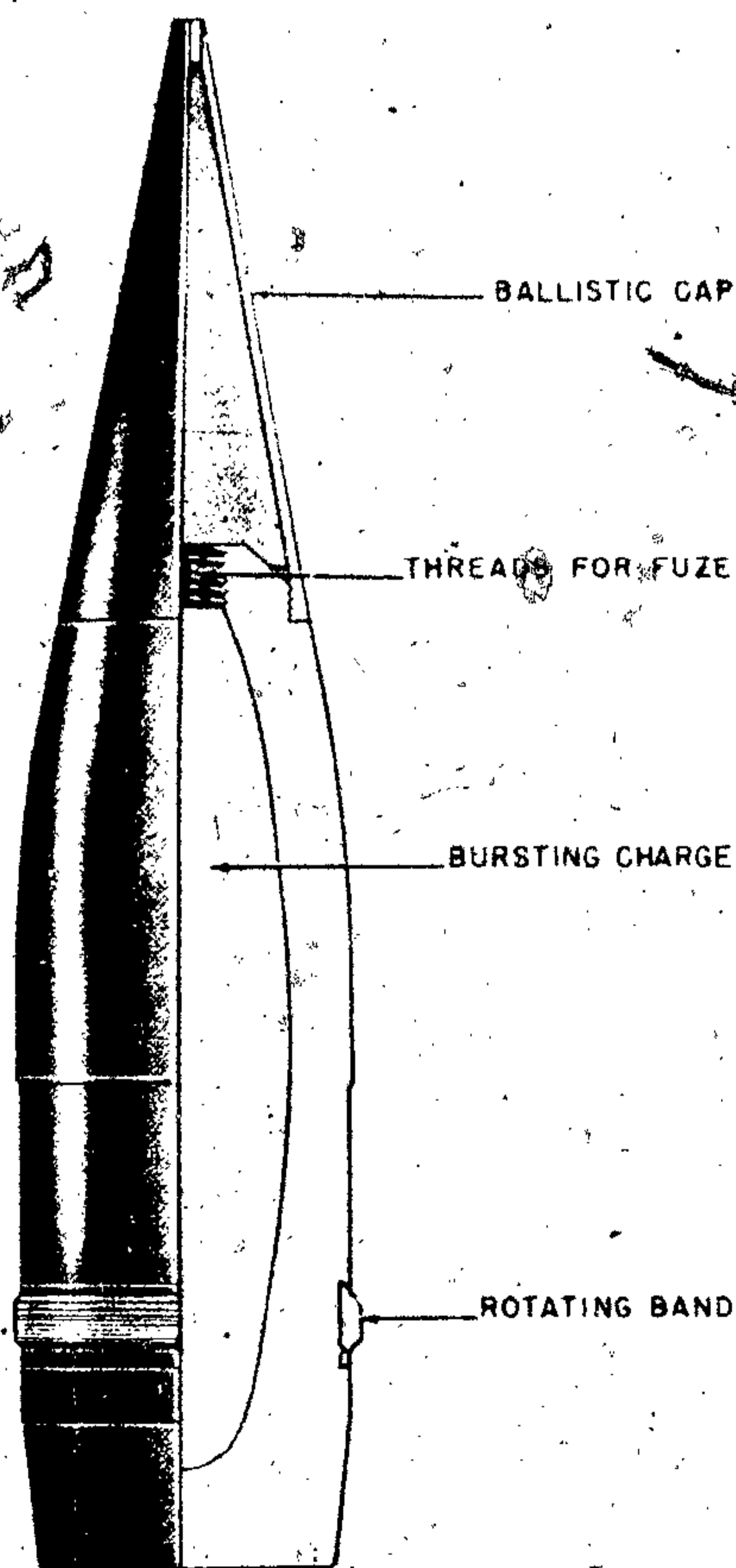

Figure 522—H. E. Projectile 155-mm, 15.5-cm Stg. Gr. 423 (f)

TRACER: None:

BOOSTER: Booster integral with fuze.

FUZE:

Nomenclature: same as 15.5-cm Stg. Gr. 423 (f).
frz 18 FATO.

REMARKS:

NOTE 1.—This projectile has been found in large quantities in German Dumps, but in all instances empty of explosives.

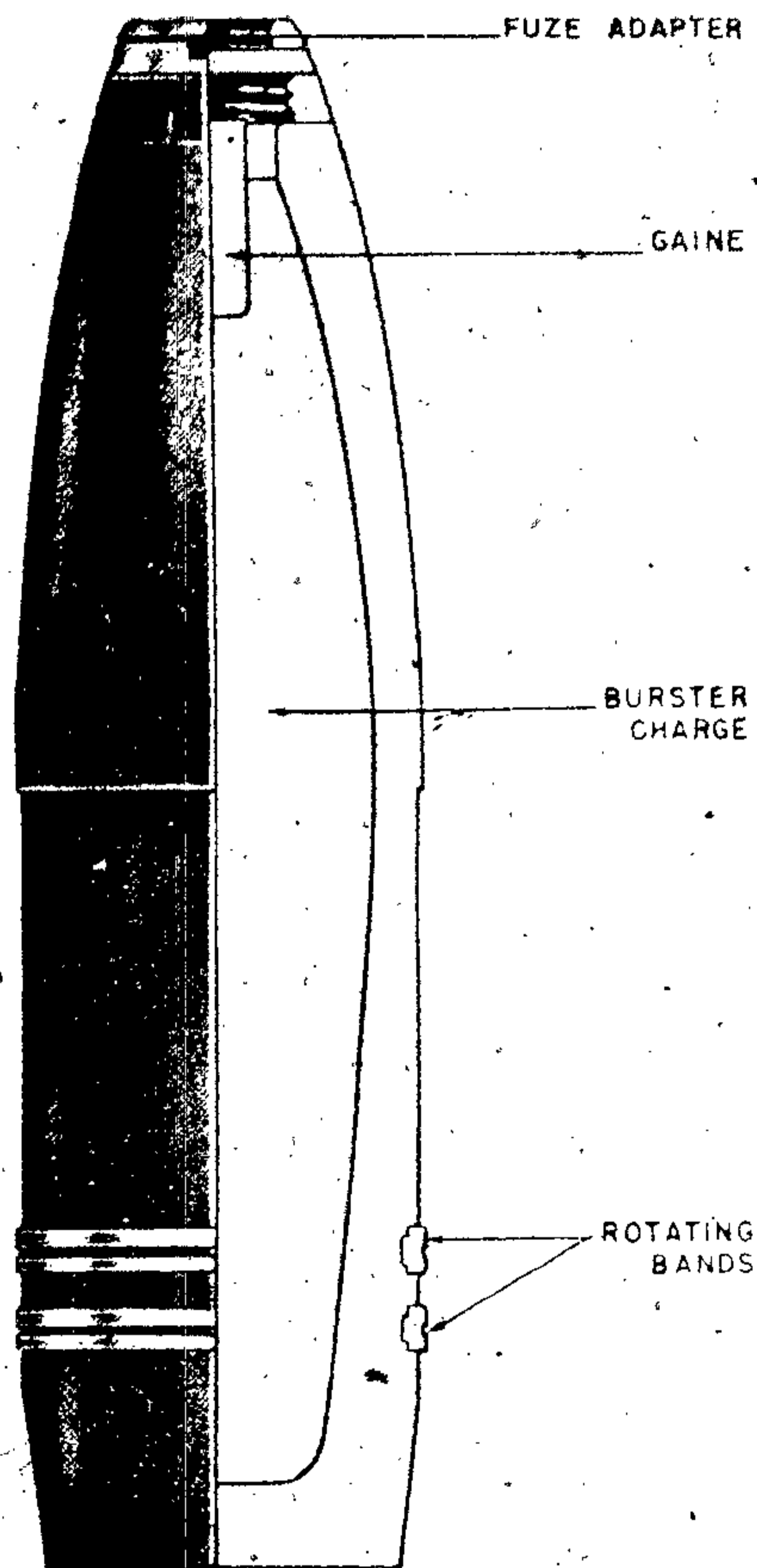

Figure 523—H. E. Projectile, 155-mm, 15.5-cm Gr. 421 (f)

NOTE 2.—This projectile is of German manufacture for the above-mentioned weapons and differs from the French in that it has only one rotating band which is bimetallic.

H. E. PROJECTILE FOR 155-MM GUN

GERMAN NOMENCLATURE: 15.5-cm Gr. 421 (f). (See fig. 523.)

WEAPONS: French Gun: 15.5-cm K 420 (f), Model L 1916 St. Ch.

GERMAN EXPLOSIVE ORDNANCE

PROJECTILES:

Caliber: 155 mm.
 Kind: Shell.
 Type: H. E.
 Weight: 95.3 pounds (loaded and fuze).
 Color: O. D.

CHARGE:

Number: 13 A.
 Weight: 15.3 pounds.
 Kind: Amatol 50/50.

BOOSTER: Integral with fuze.

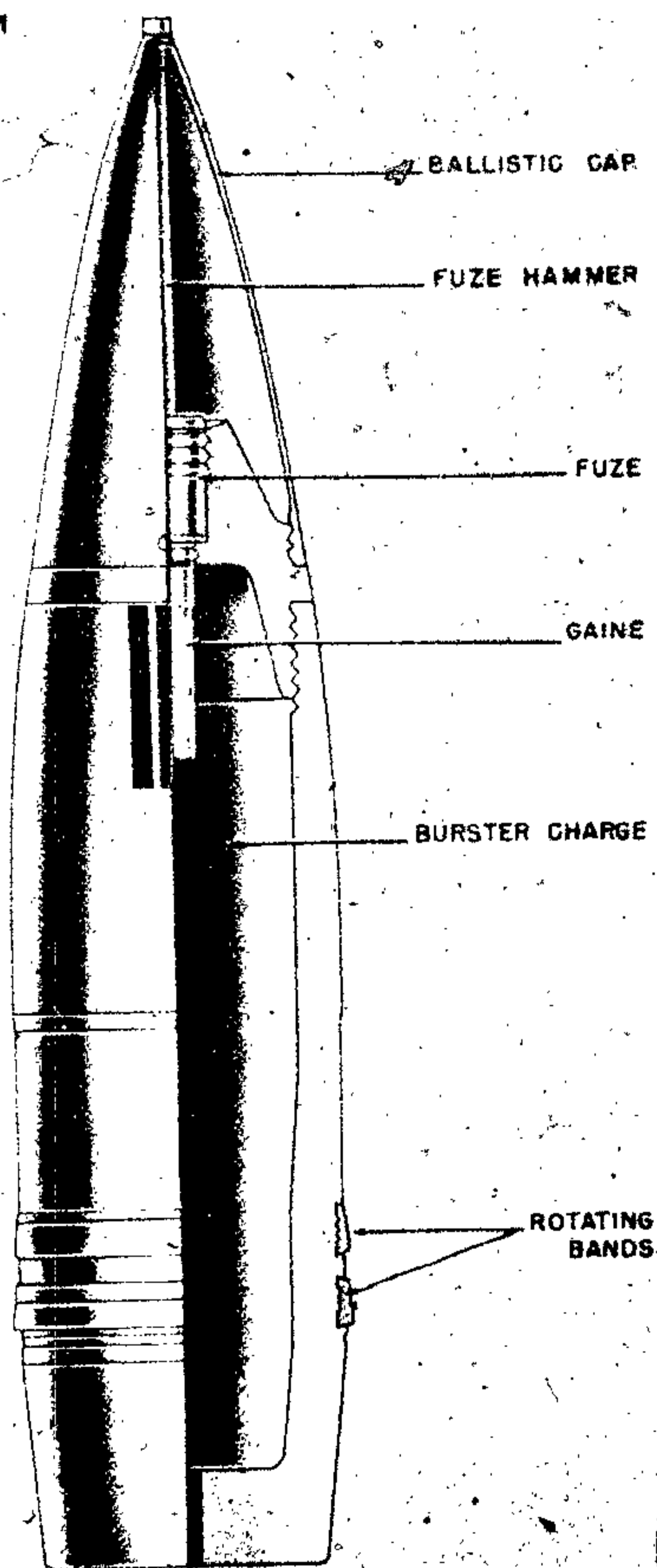

Figure 524—H. E. Projectile, Type 38, 170-mm
 17-cm K. Gr. 38 (Hb)

H. E. PROJECTILE, TYPE 38, WITH BALLISTIC CAP, 170-MM

GERMAN NOMENCLATURE: 17-cm K. (Gr. 38 (Hb) (Kanone Granate 38 [Haube]). (See fig. 524.)

EMPLOYMENT: 17-cm K. i. Mrs. Laf. (Kanone ins Morser Lafette) Gun in Mortar Mounting.

COMPLETE ROUND: 54.622 inches, over-all length.

PROJECTILE, painted green:

30.983 inches, over-all length w/o fuze.

4.921 inches, distance from base to band.

1.023 inches, width of rotating bands.

Two, number of rotating bands.

Bimetallic, composition of rotating bands.

6.967 inches, diameter of bourrelet.

5.984 inches, diameter of base.

138.0 pounds, total weight.

15.37 pounds, weight of bursting charge.

TNT in cardboard container cemented in projectile, type of bursting charge.

Smoke box present.

Zdlg. 36 booster.

CARTRIDGE CASE (German nomenclature 6324 [semifixed]):

28.56 inches, over-all length.

7.5 inches, diameter at mouth.

No shoulder.

8.5 inches, diameter at base.

Tubular Diglycol, type of propellant.

C/12nA primer.

FUZE: Nose Percussion Fuze Hbgr. Z. 35 K. or Time and Percussion Fuze Dopp. Z. s/90s.

PACKAGING: One projectile to wicker basket, 145.2 pounds.

REMARKS: Fuze is under ballistic cap. Projectile has streamlined base. After firing, rotating band will bear 48 engravings.

H. E. PROJECTILE, TYPE 39, 170-MM

GERMAN NOMENCLATURE: 17-cm K. Gr. 39
(Kanone Granate 39). (See fig. 525.)

EMPLOYMENT: 17-cm K. i. Mrs. Laf. (Kanone
ins Morser Lafette) Gun. Gun in Mortar
Mounting.

PROJECTILE, painted green:

29.172 inches, over-all length w/o fuze.

3.35 inches, distance from base to band.

1.023 inches, width of rotating bands.

Two—number of rotating bands.

Bimetallic—composition of rotating bands.

6.771 inches, diameter of bourrelet.

5.984 inches, diameter of base.

150.0 pounds, total weight.

TNT in cardboard container cemented in pro-
jectile, type of bursting charge.

Tracer present in base.

Zdlg. 36 booster.

CARTRIDGE CASE (German nomenclature
6324 [semifixed]):

29.562 inches, over-all length.

7.5 inches, diameter at mouth. No shoulder.

8.5 inches, diameter at base.

64 pounds, weight of propellant.

Tubular Diglycol, type of propellant.

C/12nA primer.

FUZE: Nose Percussion Fuze A. Z. 35 K or Time
and Percussion Fuze Dopp. Z. s/90K.

PACKAGING: One projectile to a wicker basket.
156.8 pounds.

REMARKS: Projectile has streamlined base.
Adapter in base for tracer.

**H. E. PROJECTILE FOR 194-MM FRENCH
RAILWAY GUN**

GERMAN NOMENCLATURE: 19.4-cm Stg.
Gr. 486 (f). (See fig. 526.)

WEAPONS: French Railway Gun; 19.4-cm K.
(E) 486 (f) Mle 1870-1893.

PROJECTILE:

Caliber: 194 mm.

Kind: Shell.

Type: H. E.

Weight: 182 pounds (loaded and fuzed).

Color: Black body; yellow ogive.

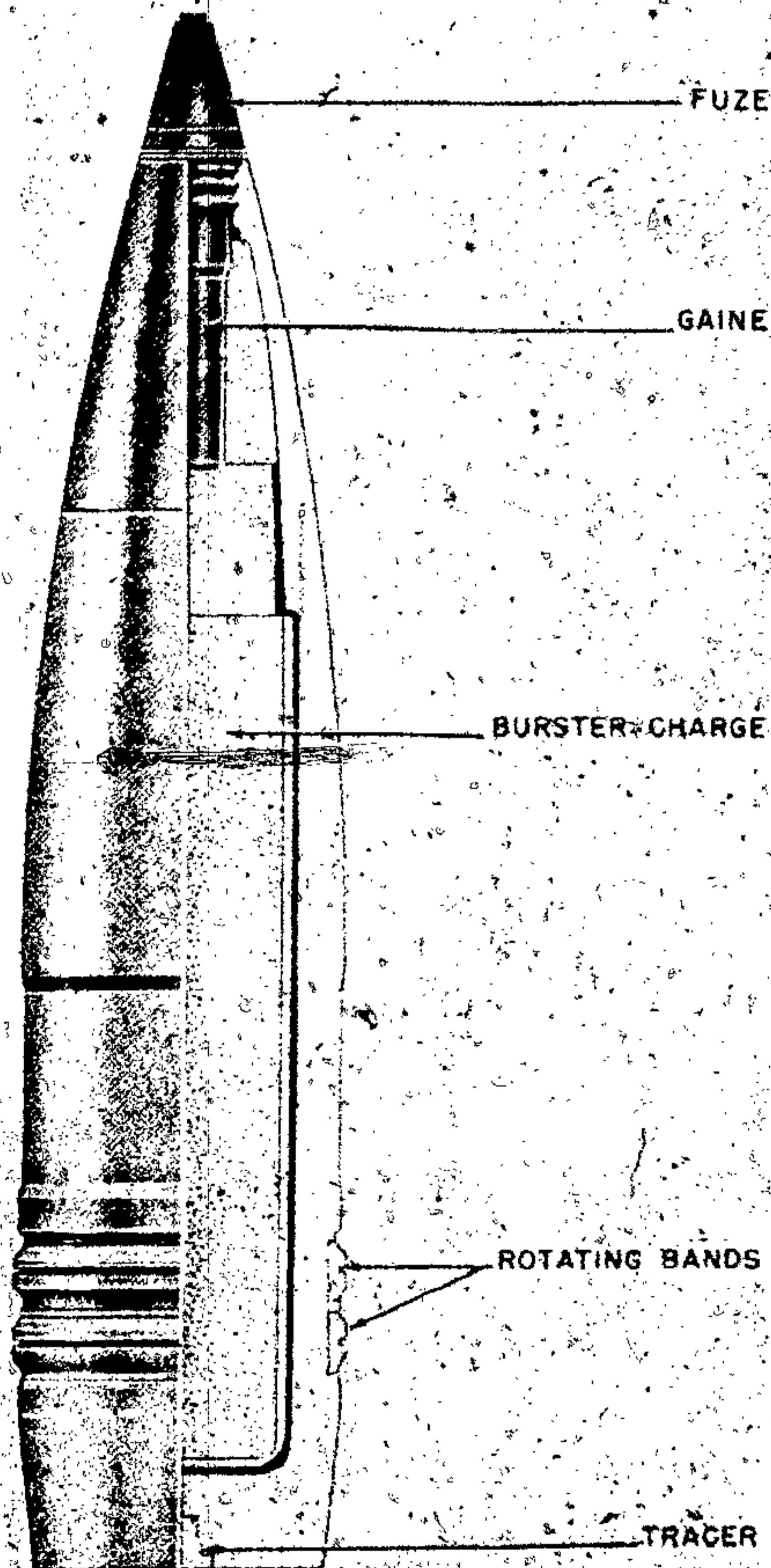

Figure 525—H. E. Projectile, Type 39, 170-mm
17-cm K. Gr. 39

GERMAN EXPLOSIVE ORDNANCE

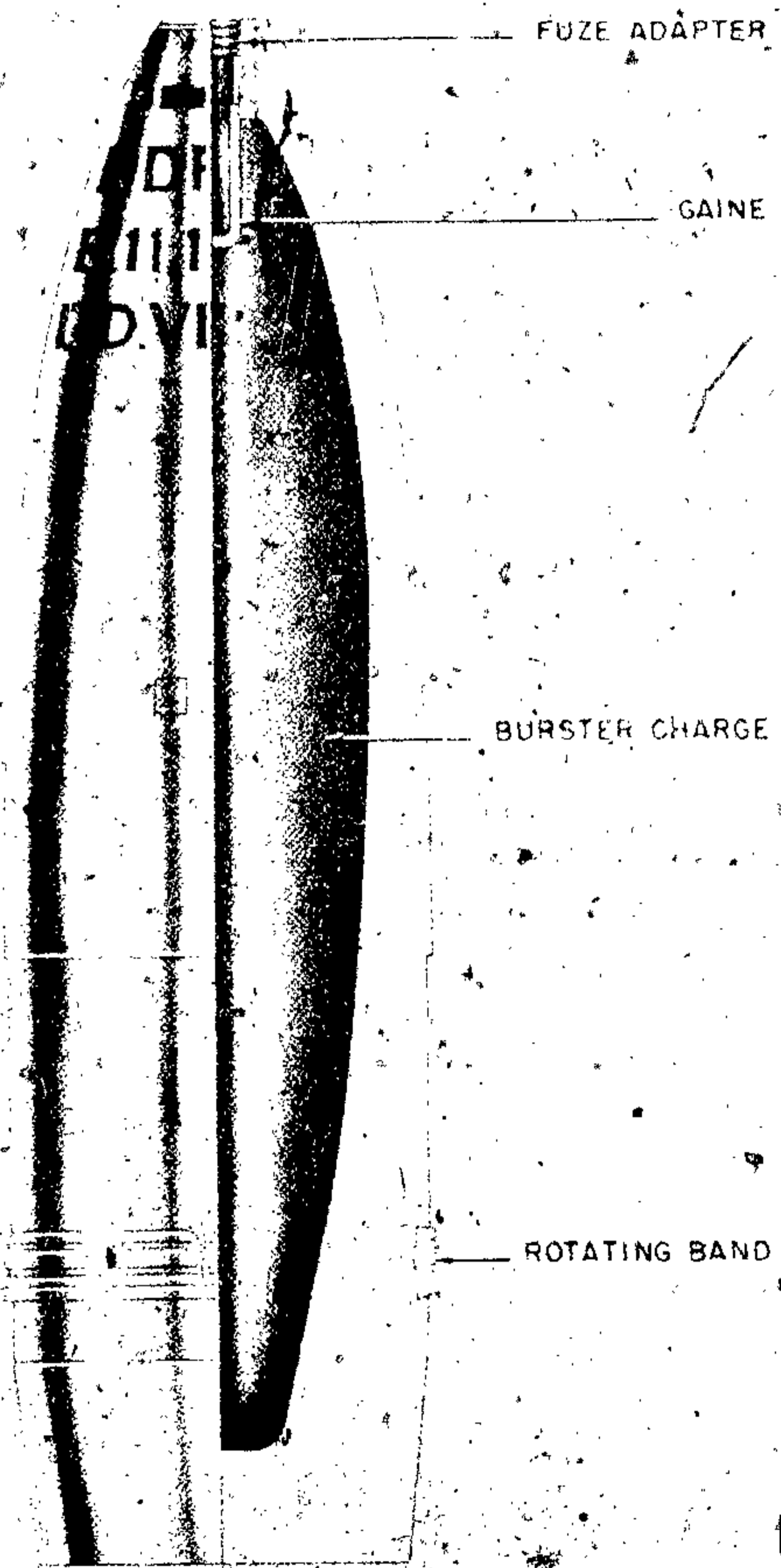

Figure 526—H. E. Projectile for 194-mm French Railway Gun, 19.4-cm Stg. Gr. 486 (f)

CHARGE:
 Number: MDN.
 Weight: 22 pounds.
 Kind: Melinite with dinitronaphthaline added.

TRACER: None.

BOOSTER: Integral with fuze.

FUZE: Nomenclature: Unknown.

ANTICONCRETE PROJECTILE FOR 203-MM HOWITZER

GERMAN NOMENCLATURE: 20.3-cm Gr. 503/2 Be (r). (See fig. 527.)

WEAPONS: Russian Heavy Howitzers:
 20.3-cm Haubitze.
 503-russ. 31.
 20.3 cm Haubitze.
 503/2 russ. 31.

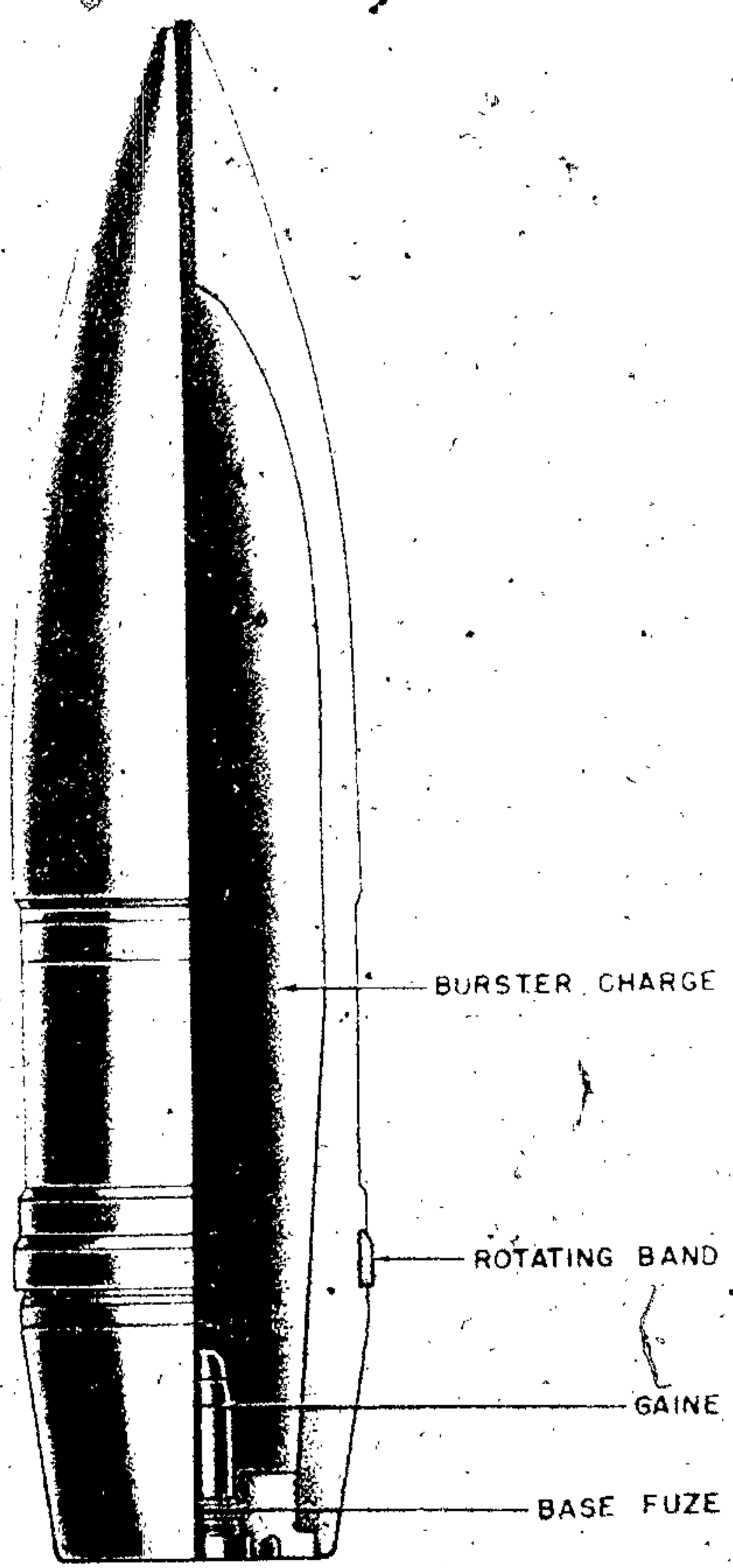

Figure 527—Anticoncrete Projectile for 203-mm Howitzer, 20.3-cm Gr. 503/2 Be. (r)

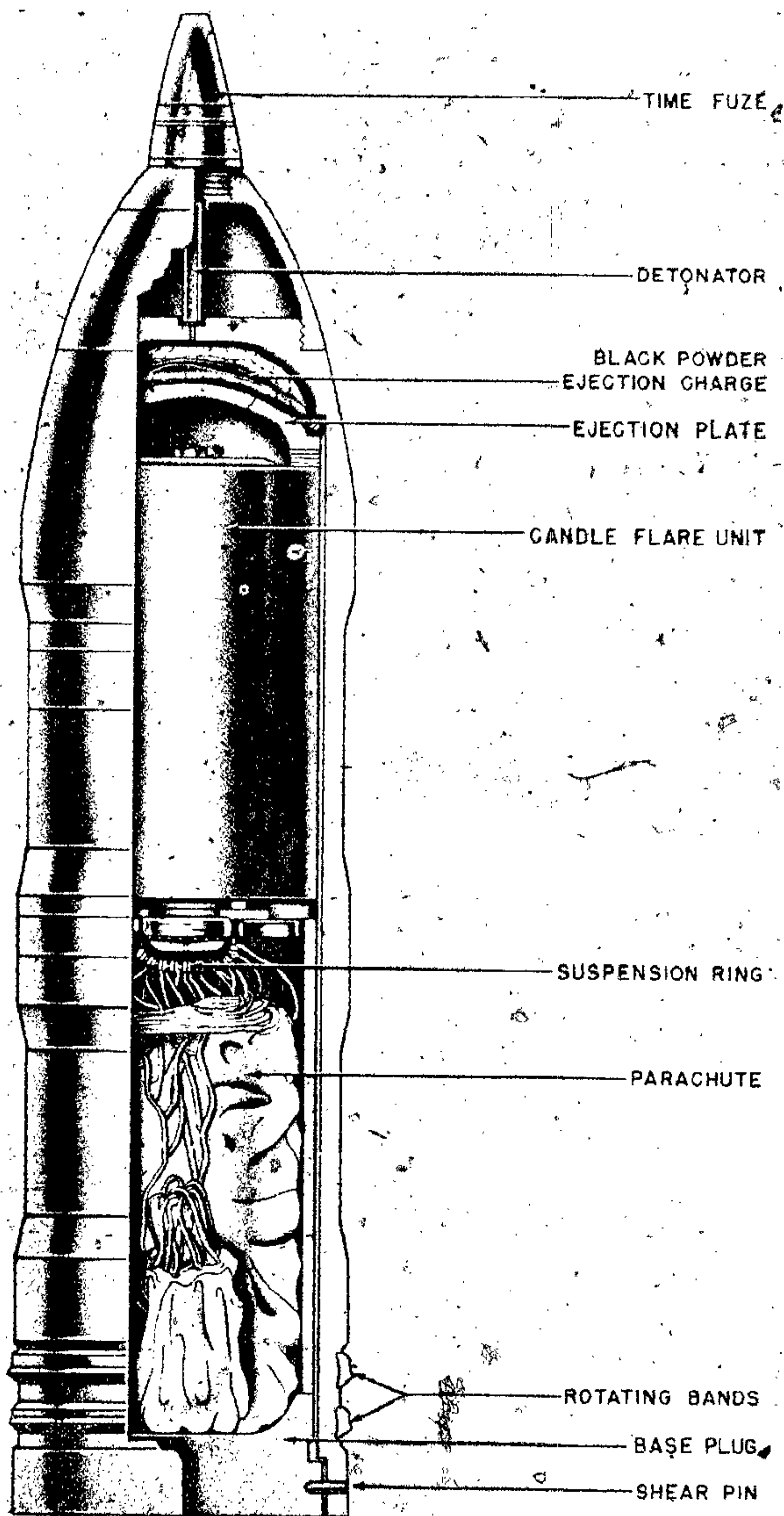

Figure 528—Flare Projectile for 203-mm Railway Gun, 20.3-cm Leuchtgr

GERMAN EXPLOSIVE ORDNANCE

PROJECTILE:

Caliber: 203 mm.
Kind: Shell.
Type: Anticoncrete.
Weight: 220 pounds (loaded and fuzed).
Color: O. D. with blue band below bourrelet (unpainted).

CHARGE:

Number: T.

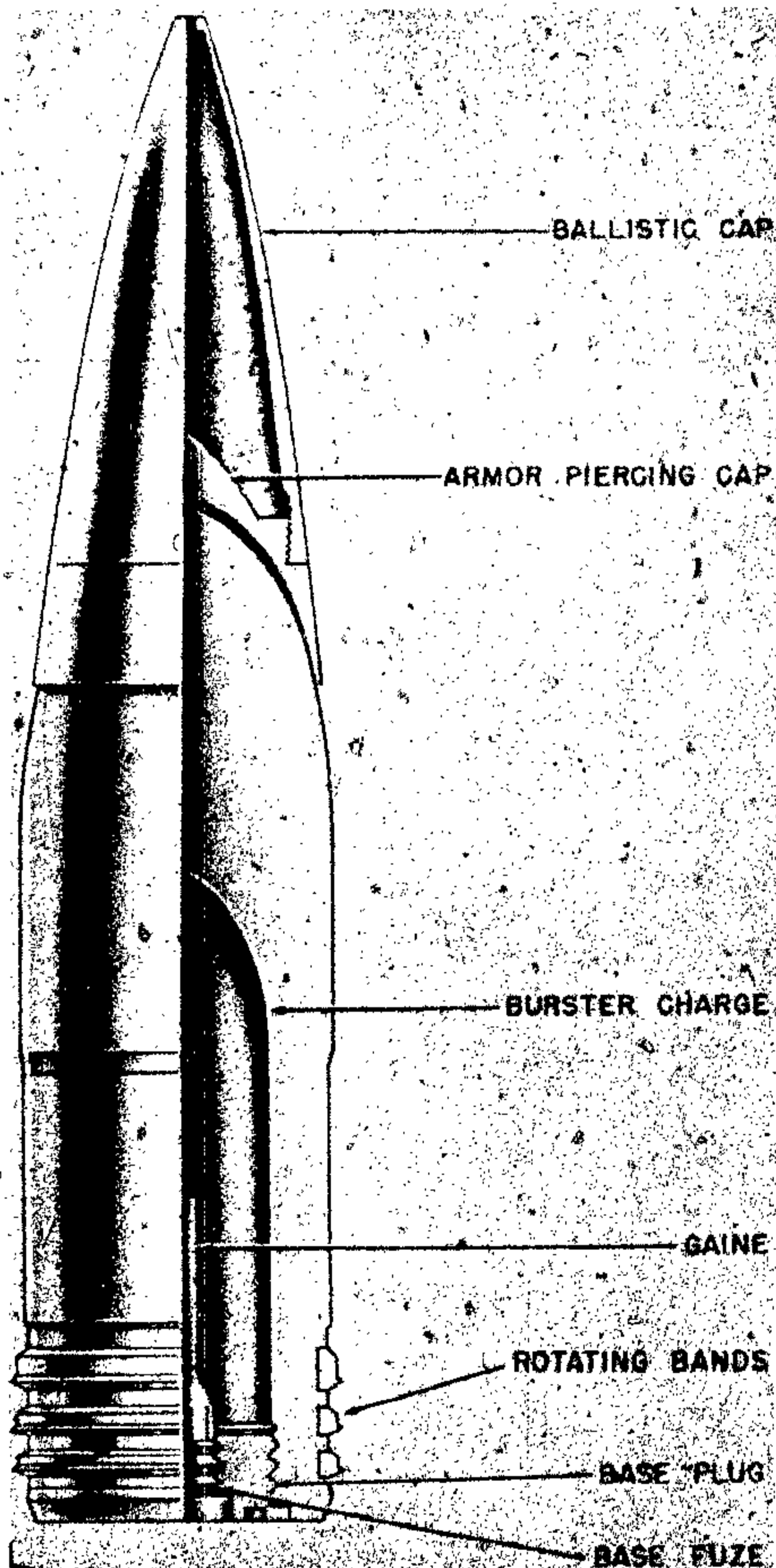

Figure 529—S. A. P. Projectile for 203-mm Railway Gun, 20.3-cm Sprgr. L/4.7 Bd. Z. m/Hb

Weight: 33 pounds.

Kind: TNT.

TRACER: None.

BOOSTER: Integral with fuze.

FUZE:

Nomenclature: Bd. Z. 493 (r).

Type: B. D.

REMARKS:

NOTE 1.—Second bourrelet forward of rotating band.

FLARE PROJECTILE FOR 203-MM RAILWAY GUN

GERMAN NOMENCLATURE: 20.3-cm Leuchtgr. (See fig. 528.)

WEAPONS: German Railway Gun: 20-cm K. (E).

PROJECTILE:

Caliber: 203 mm.

Kind: Shell.

Type: Flare.

Weight: 226 $\frac{1}{4}$ pounds (loaded and fuzed).

Color: Green, with red band above upper bourrelet; black band below nose, and white band around middle bourrelet.

CHARGE (expelling):

Number:

Weight: $\frac{1}{2}$ pound.

Kind: Black powder.

TRACER: None.

BOOSTER: None.

FUZE:

Nomenclature: Unknown, but undoubtedly a At. Z. (time) of some type.

Type: Time.

REMARKS:

NOTE 1.—Weight of flare and parachute ass'y, is 47 pounds.

NOTE 2.—Shell is somewhat unique in having an additional bourrelet machined near middle of shell body.

SEMI-ARMOR-PIERCING PROJECTILE FOR 203-MM GERMAN RAILWAY GUN

GERMAN NOMENCLATURE: 20.3-cm Sprgr. L/4.7 Bd. Z. m/Hb. (See fig. 529.)

WEAPONS: German Railway Gun: 20-cm. K. (E).

PROJECTILE:

Caliber: 203 mm.

Kind: Shell.

Type: S. A. P.

Weight: 270 pounds (loaded and fuzed).

Color: Dark O. D.

CHARGE:

Number: 1.

Weight: 11¼ pounds.

Kind: TNT pressed in blocks in cardboard container packed with magnesium putty.

TRACER: None.**BOOSTER:** Zdlg. B.**FUZE:**

Nomenclature: Bd. Z. C/38.

Type: B. D.

REMARKS:

NOTE 1.—This projectile has a magnesium-aluminum alloy ballistic cap, which provides a spotting flash upon impact.

H. E. PROJECTILE FOR 203-MM GUN**GERMAN NOMENCLATURE:** 20.3-cm Sprgr. L/14. Kz. (Hb). (See fig. 530.)**WEAPONS:** German Railroad Gun: 20-cm K. (E).**PROJECTILE:**

Caliber: 203 mm.

Kind: Shell.

Type: H. E.

Weight: 268.5 pounds (loaded and fuzed).

Color: Dark O. D.

CHARGE:

Number: 1.

Weight: 22¼ pounds.

Kind: TNT pressed in blocks in cardboard container.

TRACER: None.**BOOSTER:** 4 separate boosters: 1-Zdlg. A. 3-L. Zdlg. A.**FUZE:**

Nomenclature: (1) Kz. C/27 St. (2) Kz. C/27 Im. (3) M. Dopp. Z. 28. K.

Type: (1) P. D. (2) Kz. C/27 Im. (3) M. Dopp. Z. 28 K.

H. E. PROJECTILE, TYPE L/4.7 WITH NOSE FUZE AND BALLISTIC CAP, 203-MM**GERMAN NOMENCLATURE:** 20.3-cm Sprgr.

L/4.7 Kz. (m. Haube) (Sprenggrante Ladung Köpfzunder [mit Haube]). (See fig. 531.)

EMPLOYMENT: 20-cm Kan. (e) (Kanone (Eisenbahn)), Gun (Railway).**PROJECTILE:** 37.519 inches, over-all length.

Three, number of rotating bands.

26.84 pounds, weight of bursting charge.

TNT in cardboard container, type of bursting charge.

Ballistic cap.

Unstreamlined base.

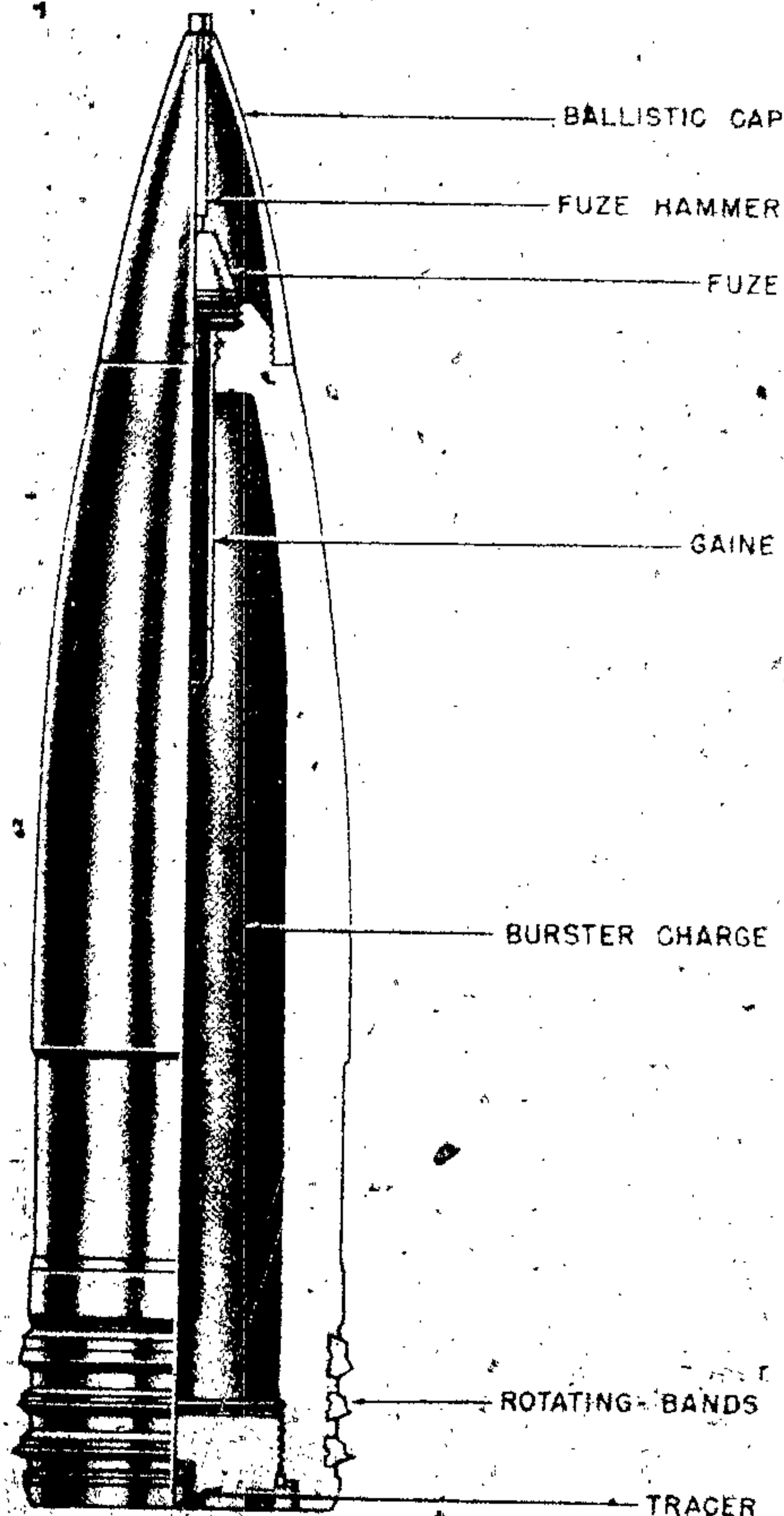

Figure 530—H. E. Projectile, 203-mm, 20.3-cm Sprgr. L/14 Kz. (Hb)

GERMAN EXPLOSIVE ORDNANCE

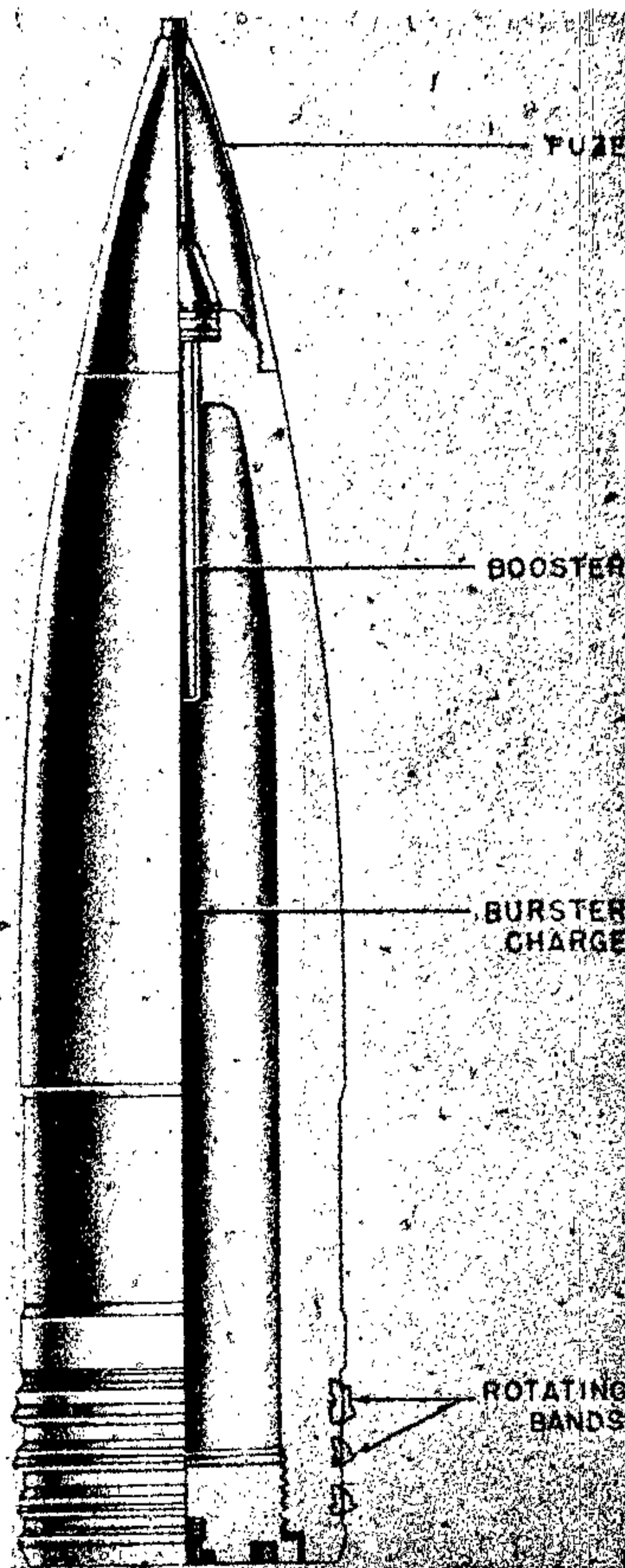

Figure 531—H. E. Projectile, 203-mm, 20.3-cm
Sprgr. L/4.7 Kz. (m. Haube)

CARTRIDGE CASE (German nomenclature C/34):

61.6 pounds, weight of propellant.
PRC/32, type of propellant.
C/12nA primer.

FUZE: Nose Percussion Fuze Kz. C/27 Lm., St. or Ms.

PACKAGING: One projectile in wicker basket, 286 pounds.

REMARKS: There is also a round designated: "20.3-cm Aprgr. L/4.7m Bd. Z. m. Haube," which is identical except that this type is also fitted with base fuze Bd. Z. C/38.

**ANTICONCRETE PROJECTILE, TYPE 18,
210-MM**

GERMAN NOMENCLATURE: 21-cm Gr. 18 Be. (Granate 18 Beton). (See fig. 532.)

EMPLOYMENT: 21-cm Mrs. 18 (Morser 18),

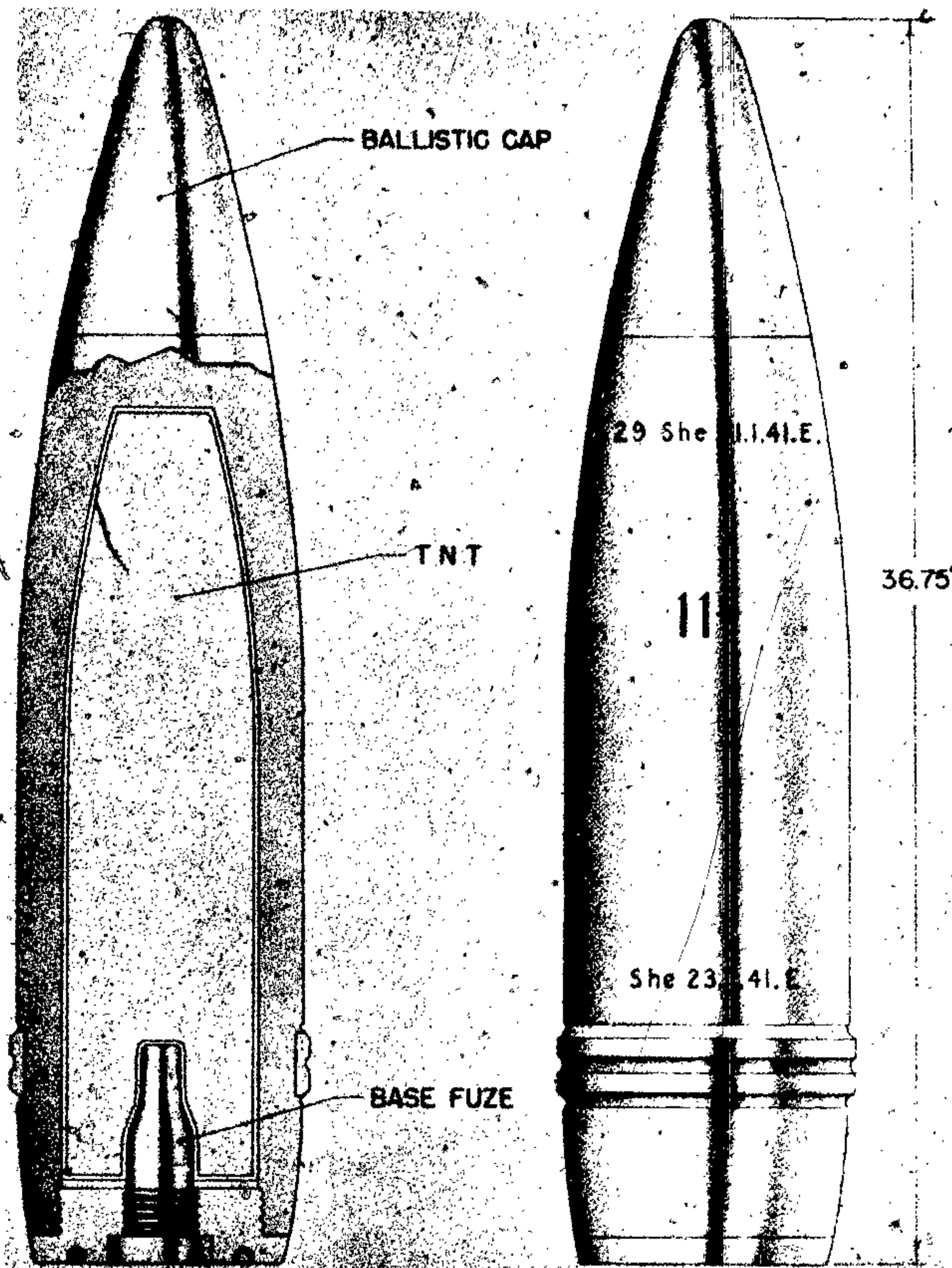

Figure 532—Anticoncrete Projectile, Type 18, 210-mm, 21-cm Gr. 18 Be.

Mortar 18 lg. 21-cm Mrs. 18 (lange Morser 18),
Long Mortar 18.

PROJECTILE, painted green:

- 36.534 inches, over-all length.
- 4.606 inches, distance from base to band.
- 0.590 inch, width of rotating bands.
- Two, number of rotating bands.
- 7.480 inches, diameter of base.
- 268.0 pounds, total weight.
- 25.6 pounds, weight of bursting charge.
- TNT, type of bursting charge.
- Zdlg. C/98 booster (peric acid).

CARTRIDGE CASE (German nomenclature 6351 (semifixed)):

- 16.125 inches, over-all length.
- 8.75 inches, diameter of neck.
- No shoulder.
- 9.50 inches, diameter of base.
- 31.0 pounds, weight of propellant.
- Diglycol, type of propellant.
- C/12nA primer.

FUZE: Base Detonating Fuze Bd. Z. f. 21-cm.

PACKAGING: One to a wicker basket.

REMARKS: Projectile has streamline base, ballistic cap.

GERMAN EXPLOSIVE ORDNANCE

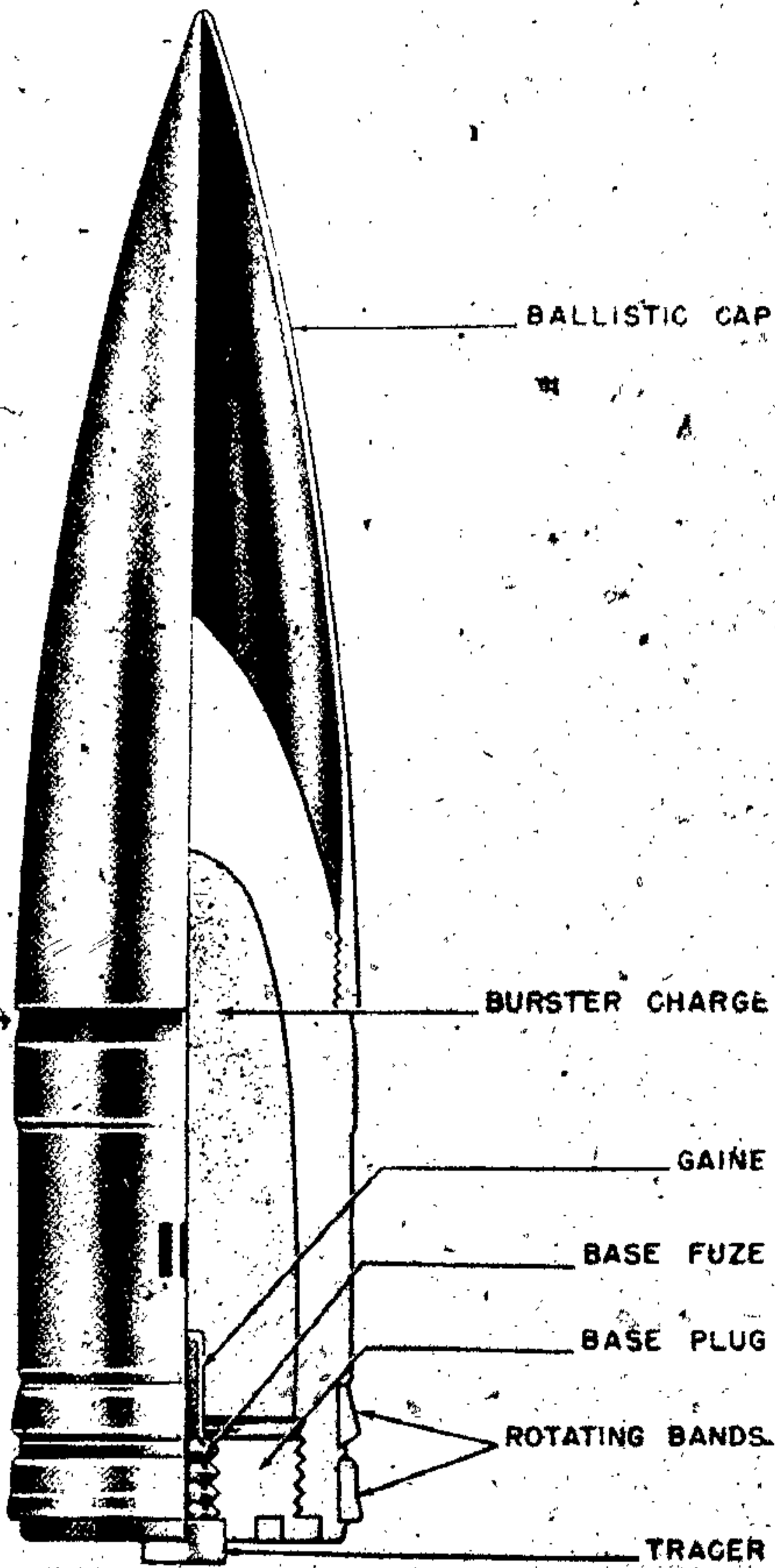

**Figure 533—H. E. Projectile, Type L/4.5, 240-mm,
24-cm Sprgr. L/4.5 m. Bd. Z. (m. Haube)**

**H. E. PROJECTILE TYPE L/4.5 WITH BASE
FUZE AND BALLISTIC CAP, 240-MM**

GERMAN NOMENCLATURE: 24-cm Sprgr. L/4.5-m. Bd. Z. (m. Haube); Sprenggranate Ladung/4.5 mit Bodent Zunder (mit Haube). (See fig. 533.)

EMPLOYMENT: 24-cm Th. Br. K. (E) Theodor Bruno, Kanone (Eisenbahn) Theodor Bruno Gun (Railway).

PROJECTILE:

- 42.175 inches, over-all length.
- 9.448 inches, diameter of base.
- 2. Number of rotating bands.
- 332.0 pounds, total weight.
- TNT in cardboard container, type of bursting charge.

CARTRIDGE CASE (German Nomenclature—Karth S. Th. Br. K. (E)):

- 68.2 pounds, weight of propellant.

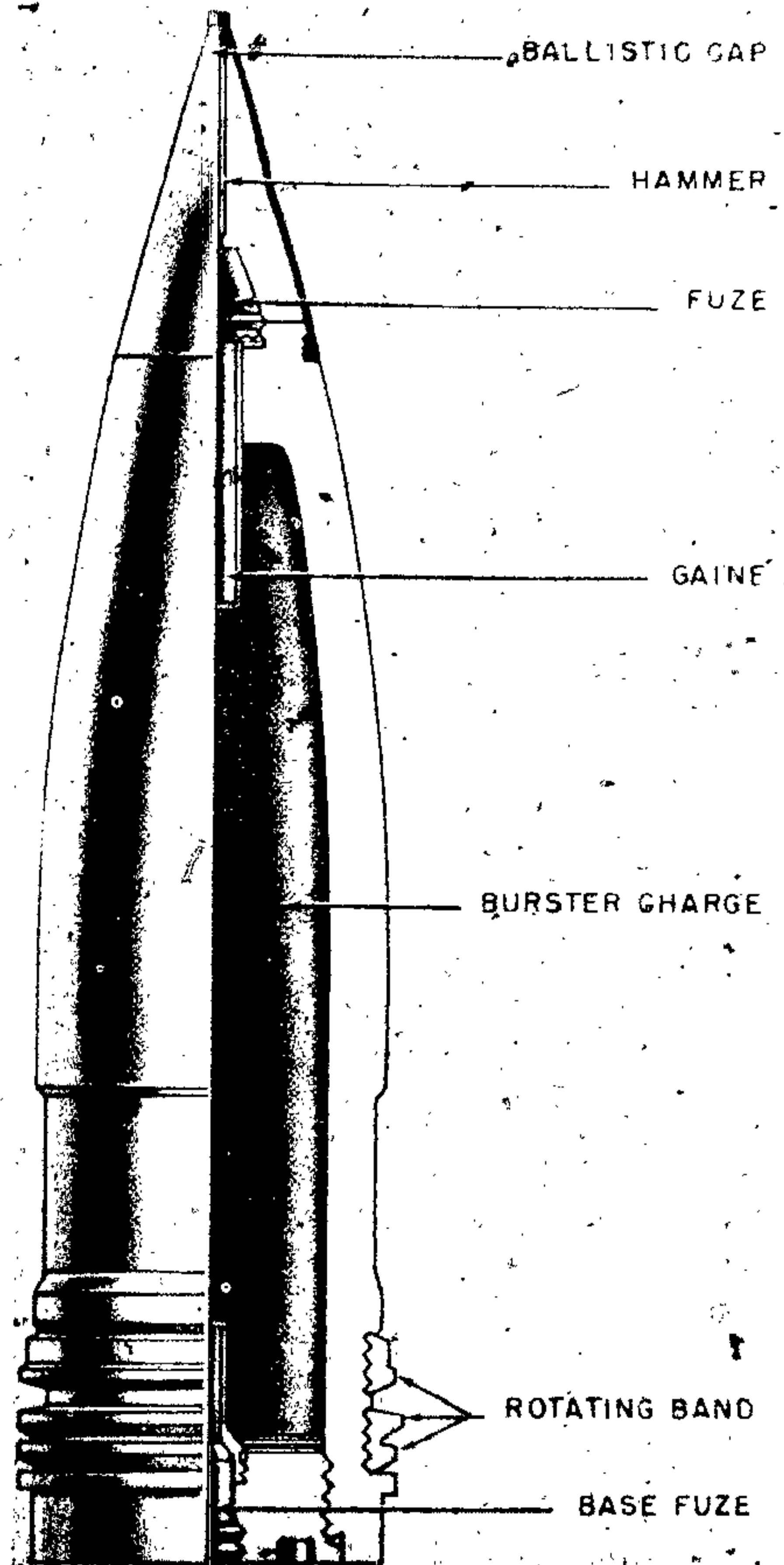

**Figure 534—H. E. Shell for 240-mm Gun, 24-cm
Sprgr. L/4.2 m. lb.**

RPC/32—type of propellant.

FUZE: Base detonating fuze: Bd. Z. f. Sprgr. m. K.

REMARKS: Projectile has ballistic cap, unstreamlined base. Information is from captured document.

H. E. PROJECTILE FOR 240-MM GUN

GERMAN NOMENCLATURE: 24-cm Sprgr. L/4.2-m. ltb. (See fig. 534.)

WEAPONS: German Railroad Gun: Th. Kan. (E).

PROJECTILE:

Caliber: 240 mm.

Kind: Shell.

Type: H. E.

Weight: 326 pounds (loaded and fuzed).

Color: Dark O. D.

CHARGE:

Number: 1.

Weight: 36 pounds.

Kind: TNT pressed in blocks in cardboard containers.

TRACER: None.

BOOSTER: 4 separate boosters: 1—Zdlg. A; 3—L. Zdlg. A.

FUZE:

Nomenclature: (1) Kz. C/27 Lm. (2) Kz. C/27 St. (3) Kz. C/27 Ms. (4) M. Dopp. A. S. 60 St. (5) Bdz. C/38.

TYPE: (1) P. D. (2) P. D. (3) P. D. (4) T. and P. (5) Base.

H. E. PROJECTILE FOR 240-MM CZECH HEAVY GUN

GERMAN NOMENCLATURE: 24-cm Gr. 40 (t). (See fig. 535.)

WEAPONS: Czech Heavy Gun: S. 24-cm K (t).

PROJECTILE:

Caliber: 240 mm.

Kind: Shell.

Type: H. E.

Weight: 437 pounds (loaded and fuzed).

Color: O. D. with white band around body.

CHARGE:

Number: 1.

Weight: 70 pounds.

Kind: TNT pressed in blocks in cardboard container packed with magnesium.

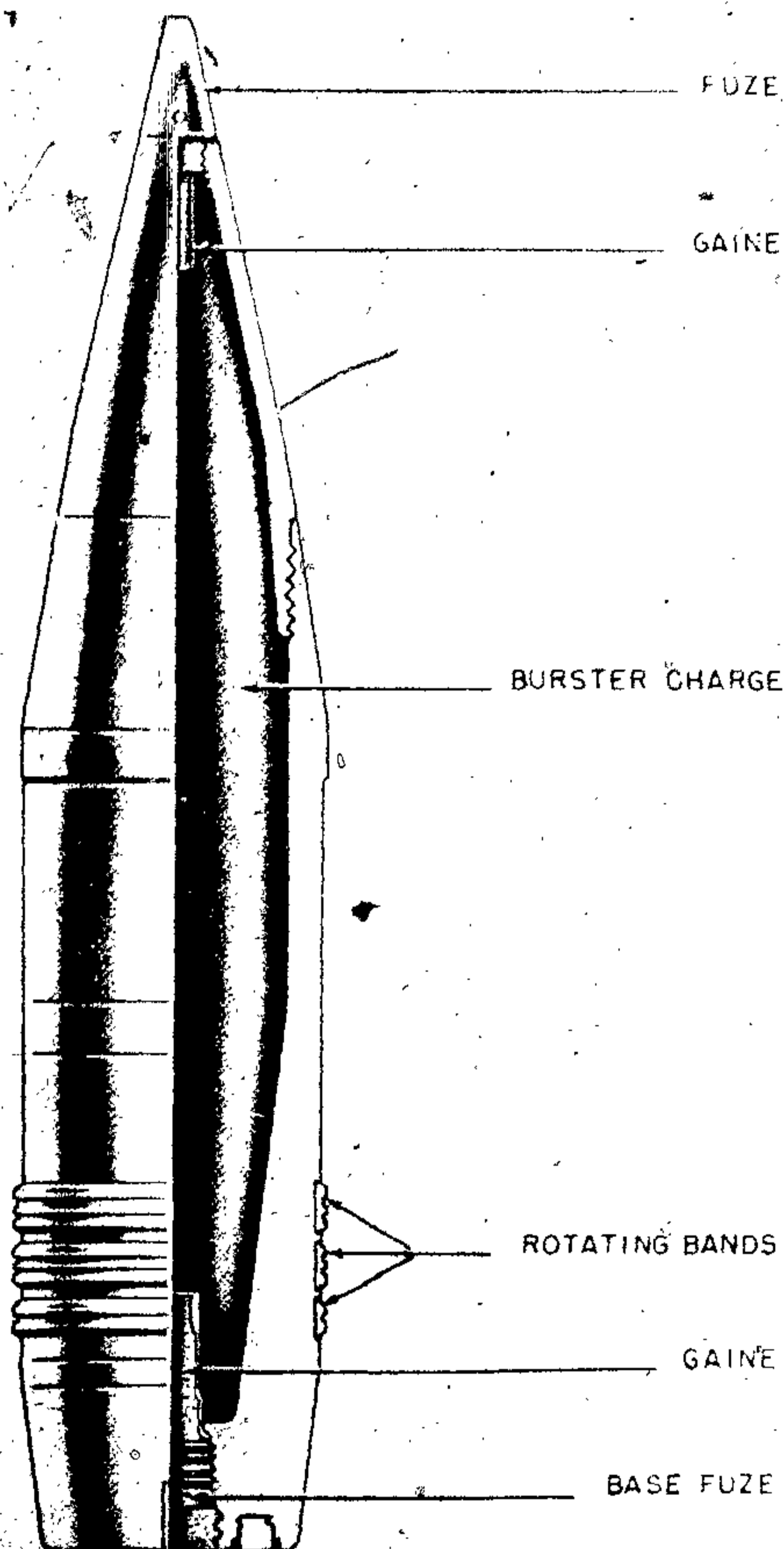

Figure 535—H. E. Projectile for 240-mm Czech Heavy Gun, 24-cm Gr. 40 (t)

TRACER: Two tracer cavities, but only plugs provided.

BOOSTER: Base booster, integral with fuze. Nose booster, Np. 10.

FUZE:

Nomenclature: (1) A. Z. 23v (0.15) and Bd. A. DVR (t). (2) A. Z. 1v (0.15). (3) Dopp. Z. s/90 St.

Type: (1) Combination using both P. D. and B. D. Fuzes. (2) P. D. (3) T. and P.

GERMAN EXPLOSIVE ORDNANCE

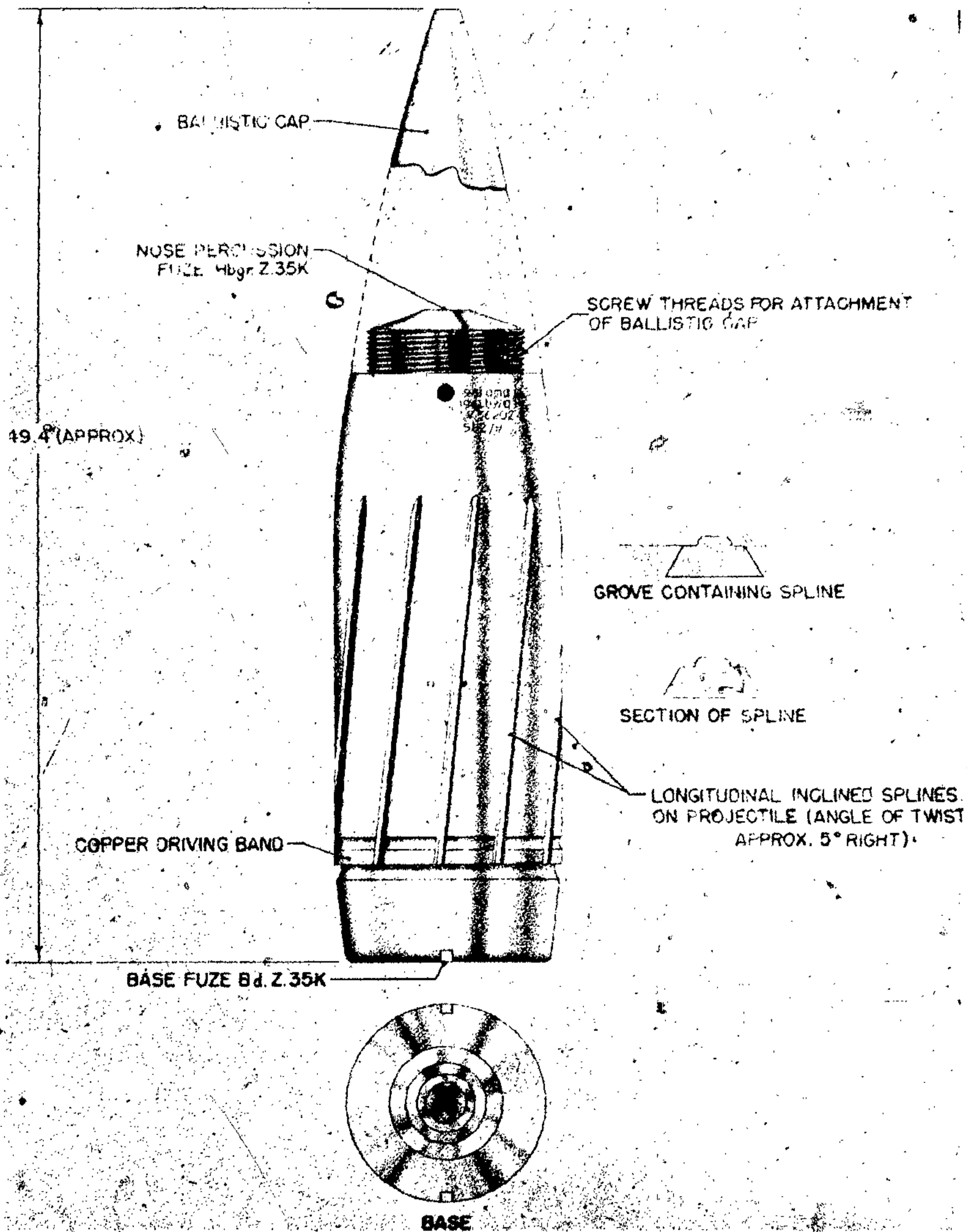

Figure 536—H. E. Projectile, Rifled, 280-mm, 28-cm

RIFLED H. E. PROJECTILE, 28-CM

GERMAN NOMENCLATURE: Not known.
(See fig. 536.)

EMPLOYMENT: Not known.

COMPLETE ROUND: Not known. Total weight not known.

PROJECTILE:

5.079 inches, base to band.
 49.4 inches, over-all length (approximately).
 0.787 inch, width of rotating band-bimetallic.
 551.0 pounds, total weight.
 66.0 pounds, weight of bursting charge.
 18.897 inches, length of splines.
 Bursting charge in cardboard container.
 Small-tracer is fitted.
 Gr. Zdlg. C/98 booster.

CARTRIDGE CASE: Not known.

FUZE: Nose, Hbgr. Z. 35 K; Base, Bd. Z. 35 K.

REMARKS: Slightly streamlined base. Ballistic cap threaded to body of projectile.

Projectile has rifled design which takes the form of 12 longitudinal inclined splines (inclination 5° (approximate)). These are approximately 60 mm apart and are probably intended to engage in the rifling of the gun. The splines do not appear to be machined from the main projectile body but are constructed separately on strips of steel which are then fitted into grooves cut in the projectile body. These grooves are undercut to produce secure attachment. To the rear is a copper or bimetallic driving band, the probable function of which is to act as a gas seal.

H. E. ROCKET-ASSISTED PROJECTILE FOR 280-MM RAILWAY GUN

GERMAN NOMENCLATURE: 28-cm R. Gr. 4331. (See fig. 537.)

WEAPONS: German Railway Gun: K. 5 (E).

PROJECTILE:

Caliber: 28 cm.
 Kind: Shell.
 Type: H. E. rocket-assisted.
 Weight: $546\frac{3}{4}$ pounds (without rocket ignition fuze) (loaded and fuzed).
 Color: O. D.

EXPLOSIVE CHARGE:

Number: Unknown.
 Weight: $30\frac{3}{4}$ pounds.
 Kind: Unknown.

PROPELLANT CHARGE:

Weight: 43 pounds.
 Kind: Double base powder.

TRACER: None.

BOOSTER: (2) Z. Zdlg. C/98 Np.

FUZE:

Nomenclature: (2) AZ 4331 and Zt. Z S/30.
 Type: Percussion and Time.

REMARKS:

NOTE 1.—Zt. Z S/30 Fuze functions after 19 seconds to ignite the rocket propellant. The two A. Z. 4331 fuzes initiate the explosive charge on impact.

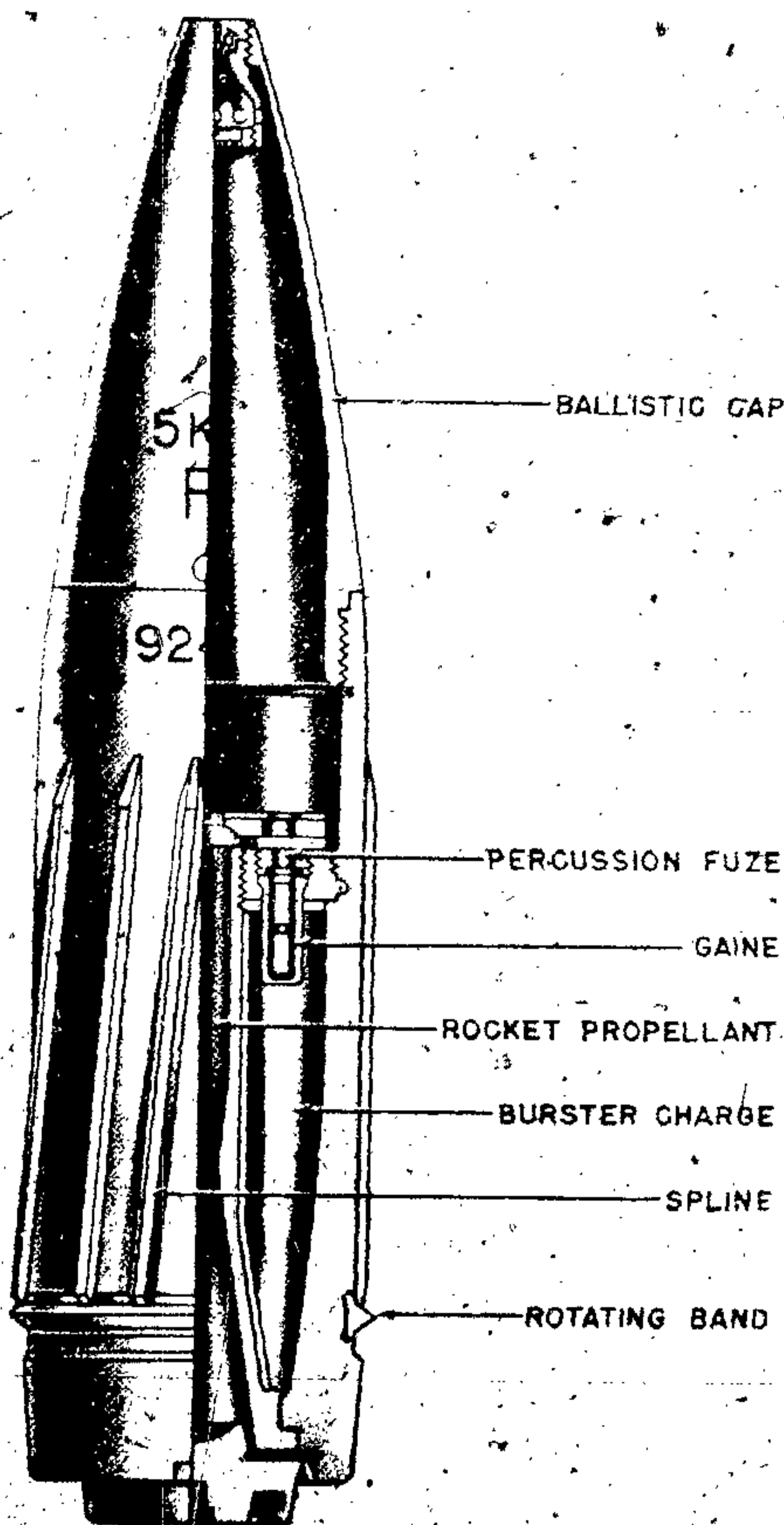

Figure 537—H. E. Rocket Assisted Projectile for 280-mm R. R. Gun, 28-cm R. G. 4331

GERMAN EXPLOSIVE ORDNANCE

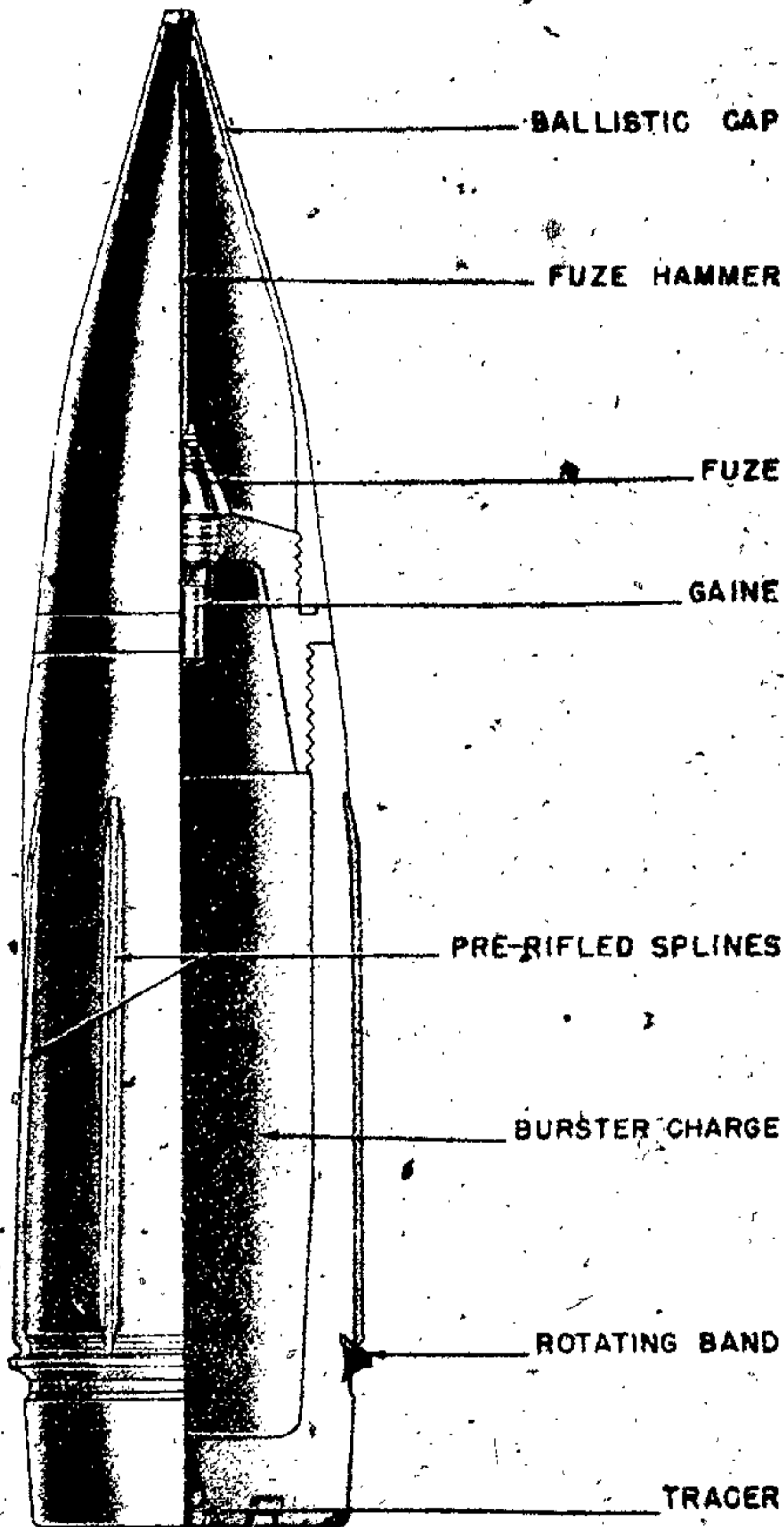

Figure 538—H. E. Projectile for 280-mm Railway Gun, 28-cm Gr. 35

HIGH EXPLOSIVE PROJECTILE FOR 280-MM RAILWAY GUN

GERMAN NOMENCLATURE: 28-cm Gr. 35.
(See fig. 538.)

WEAPONS: German Railway Gun: K 5 (E).

PROJECTILE:

Caliber: 280 mm.

Kind: Shell.

Type: H. E.

Weight: 562 pounds (loaded and fuze).

Color: O.D.

CHARGE:

Number: 30.

Weight: 67¼ pounds.

Kind: TNT and TNT/wax (95/b) pressed in blocks in carboard carton.

TRACER: L'spur No. 5, cavity provided but no tracer found.

BOOSTER: Zdlg. 36 Np. or Zdlg. 36 F.

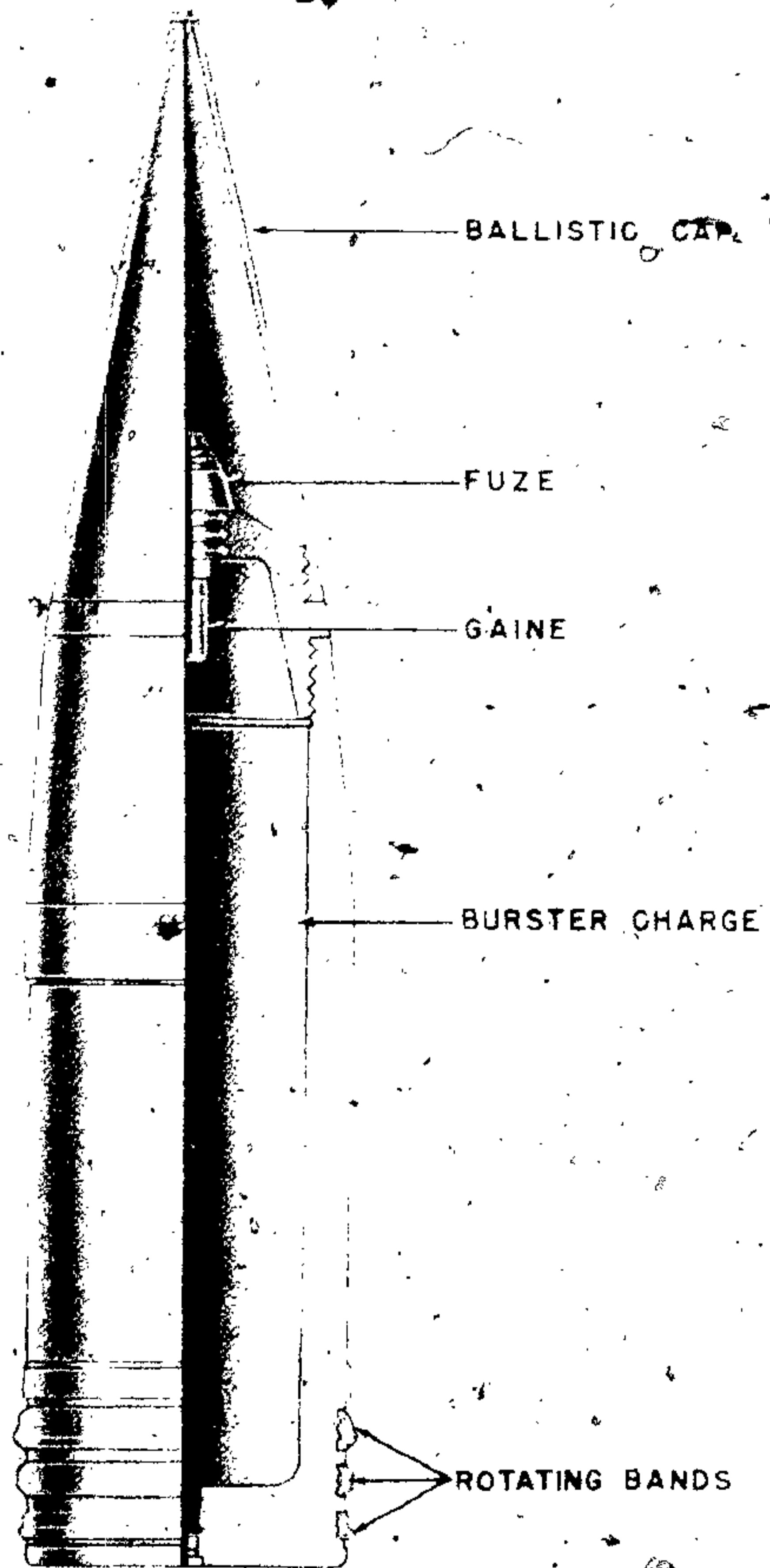

Figure 539—H. E. Projectile for 280-mm Railway Gun, 28-cm Gr. 39 m. Hbgr. Z.

FUZE:

Nomenclature: (1) Hbgr. Z. 35K (0.10). (2) Hbgr. Z. 35K (0.15). (3) Hbgr. Z. 35K (0.05). (4) Dopp. Z. 45K.

Type: (1) P. D. (2) P. D. (3) P. D. (4) T. and P.

REMARKS:

NOTE 1.—Four (4) R 10 smoke boxes.

H. E. PROJECTILE FOR 280-MM RAILWAY GUN

GERMAN NOMENCLATURE: 28-cm Gr. 39 m. Hbgr. Z. (See fig. 539.)

WEAPONS: German Railway Gun; Bruno N. K. (E).

PROJECTILE:

Caliber: 280 mm.

Kind: Shell.

Type: H. E.

Weight: 585 pounds (loaded and fuzed).

Color: O. D.

CHARGE:

Number: 30.

Weight: Approximately 93 pounds.

Kind: TNT and TNT/Wax (95/5) pressed in blocks in carboard container.

TRACER: None.

BOOSTER: Np 10.

FUZE:

Nomenclature: Hbgr. Z. 35K.

Type: P. D.

PROJECTILE FOR 35.3-CM HOWITZER M1

GERMAN NOMENCLATURE: 35-cm Gr. Be. (See fig. 540.)

PROJECTILE:

Total Weight: 1,265 pounds.

Weight of Filling: 75 pounds.

Filling: TNT.

PROJECTILE CASE: Brass cartridge case.
Propellant—Tubular nitrocellulose.

H. E. MORTAR PROJECTILE TYPE 38, 80-MM

GERMAN NOMENCLATURE: 8-cm Wgr. 38 (Werfergranate 38). (See fig. 541.)

EMPLOYMENT: 8-cm s. Granat Werfer 34.

COMPLETE ROUND: 12.99 inches, over-all length.

PROJECTILE (painted grey green):

8.5 inches, length of body.

3.188 inches, diameter of bourrelet.

1.187 inches, width of bourrelet.

3.189 inches, diameter of fins.

Twelve, number of fins.

7.75 pounds, total weight.

1.11 pounds, weight of bursting charge.

"38" stenciled on body.

Kz. Zldg. 34 Np. booster.

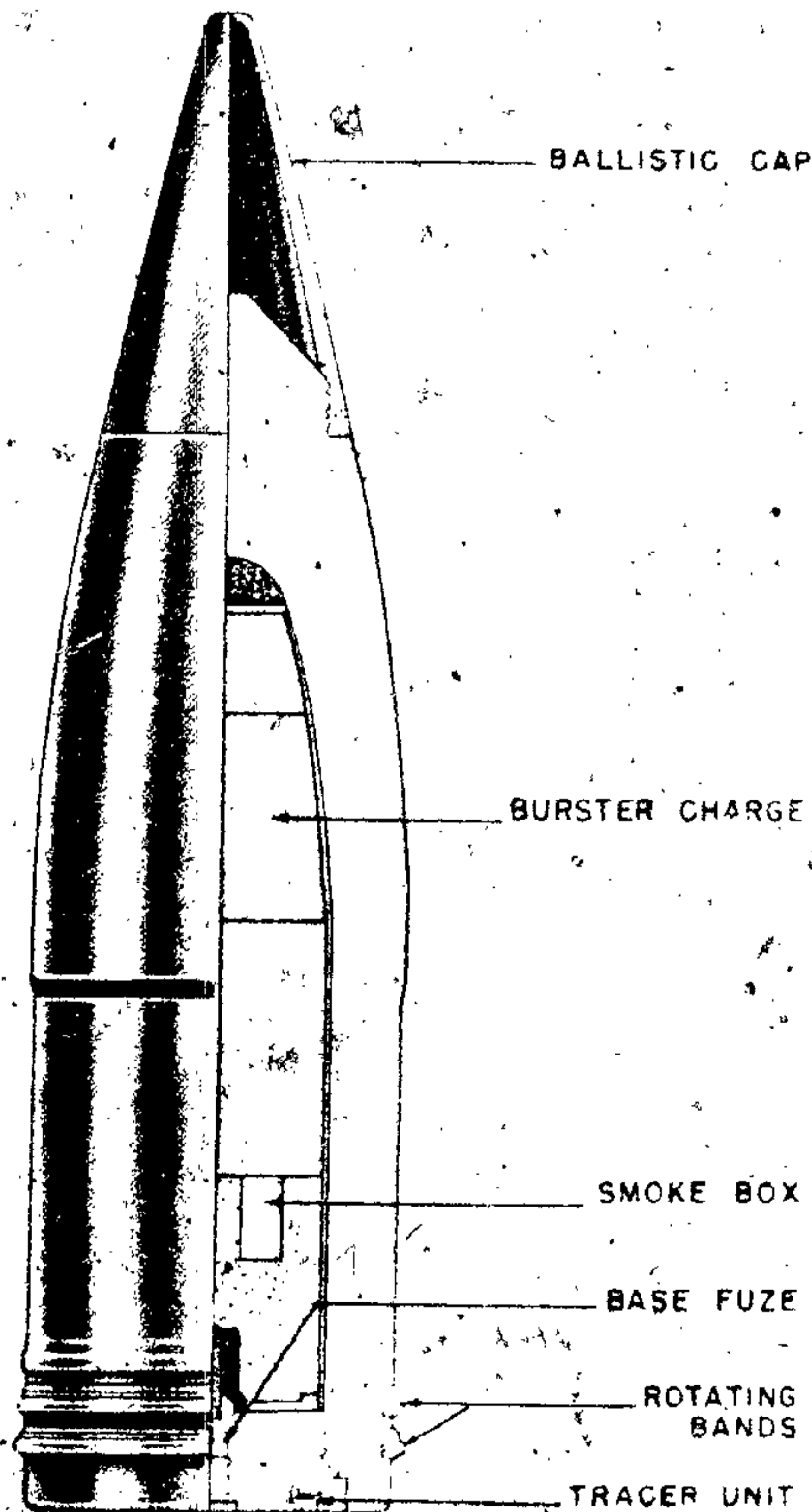

Figure 540—C. M. Howitzer M1, 353-mm, 35.3-cm Gr. Be.

GERMAN EXPLOSIVE ORDNANCE

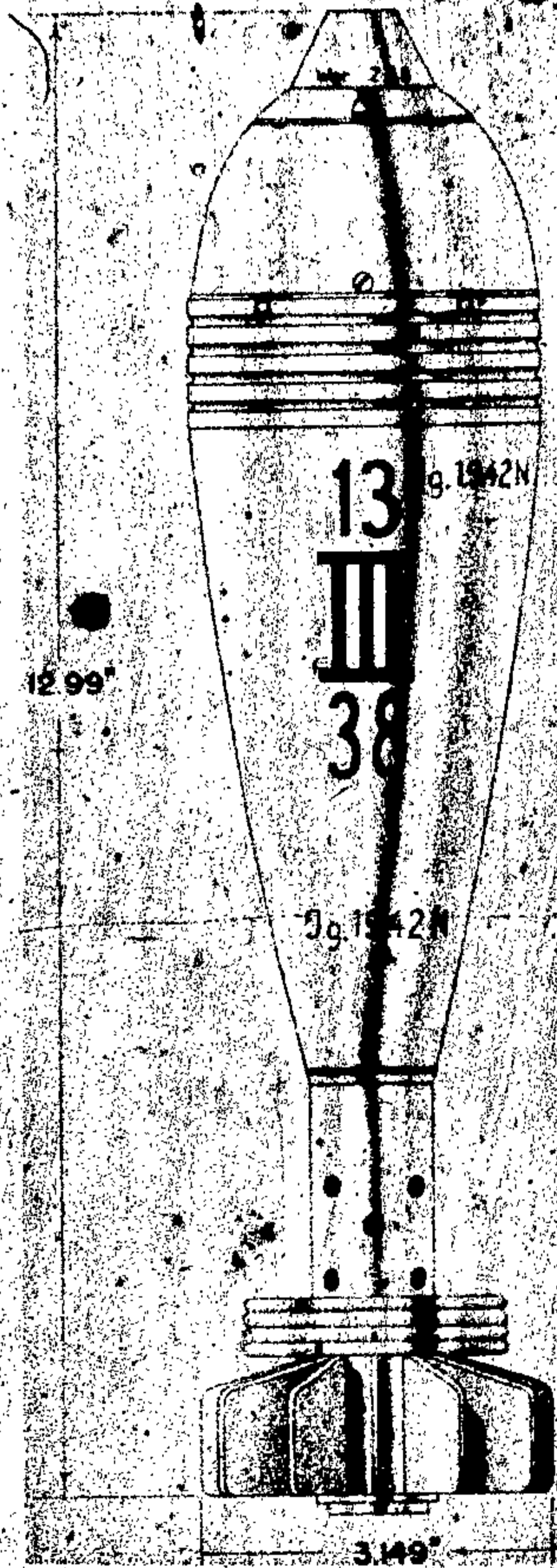

Figure 541—H. E. Mortar Projectile, Type 38,
80-mm, 8-cm Wgr. 38

FUZE: Wgr. Z. 38 or 34.

REMARKS: Contains a powder pellet under fuze to give delay action.

H. E. MORTAR PROJECTILE, 50-MM

GERMAN NOMENCLATURE: 5-cm H. E. Bomb. (See fig. 542.)

EMPLOYMENT: 5-cm L. Granat Werfer 36.

PROJECTILE (painted dull red):

- 8.625 inches, over-all length.
- 4.25 inches, length of body.
- 1.312 inches, diameter of bourrelet.
- 1.0 inch, width of bourrelet.
- 0.937 inch, diameter of base.
- 2.2 pounds, total weight.
- Eight, number of fins.
- 112 grams TNT type of bursting charge.
- Kz. Zldg. 34 Np, booster.

CARTRIDGE CASE 4 grams or powder, type of propellant. One charge only in firing cartridge.

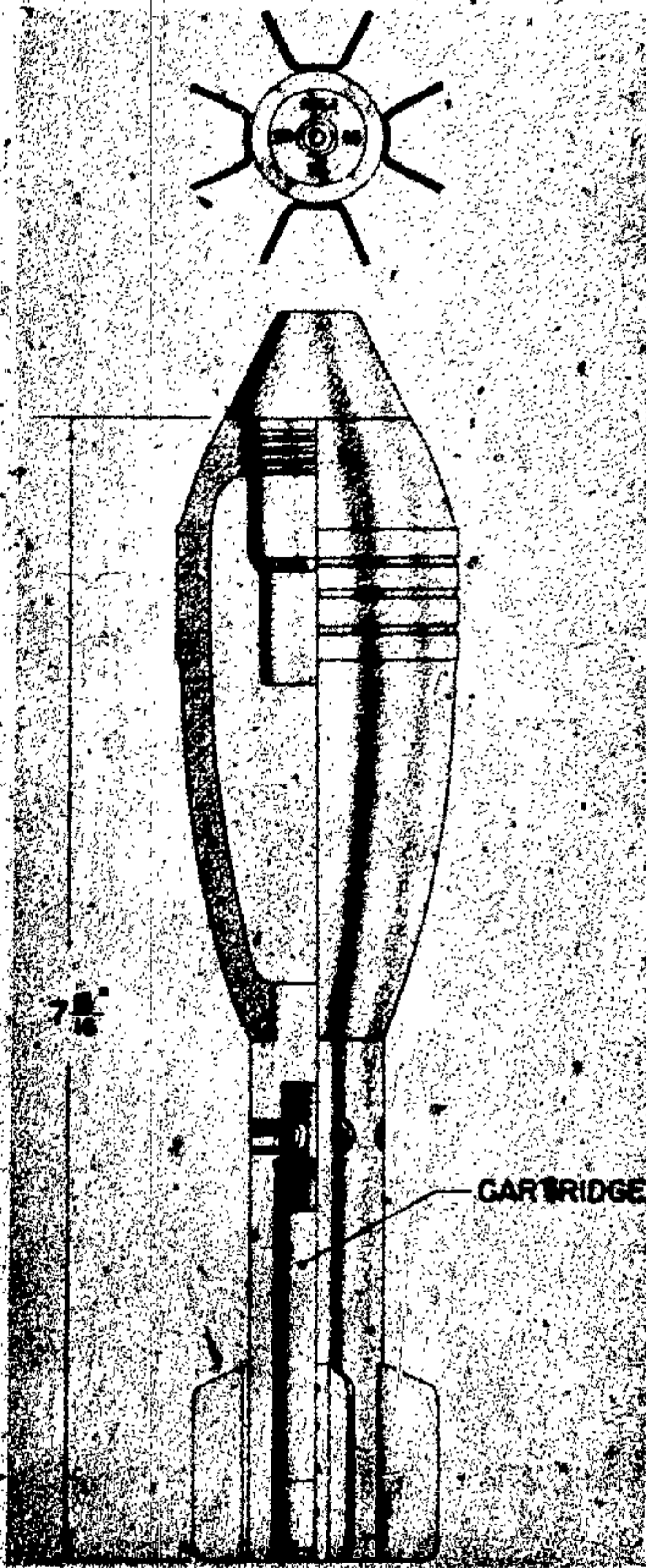

Figure 542—H. E. Mortar Projectile, 50-mm, 5-cm
H. E. Bomb

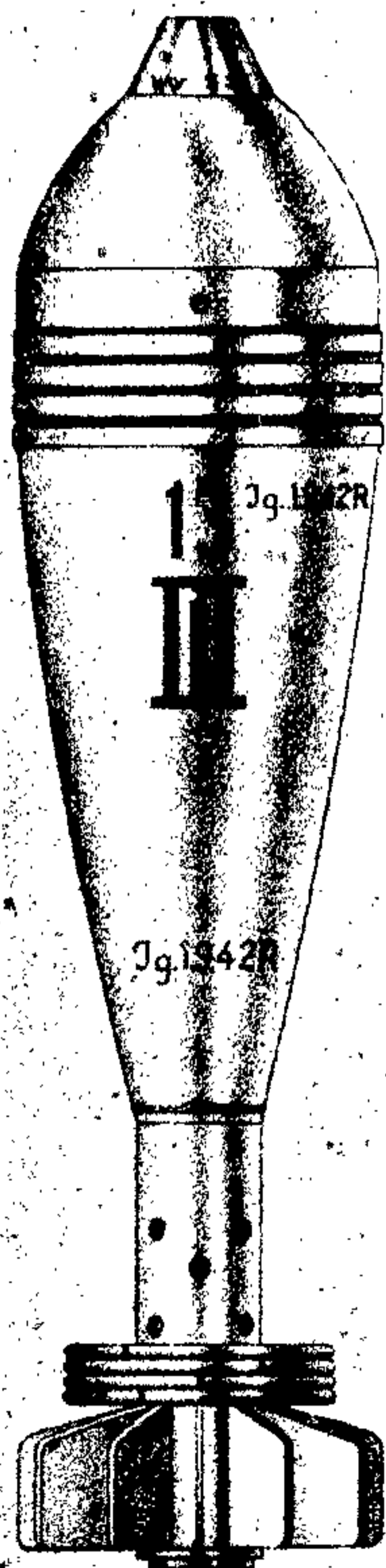

Figure 543—H. E. Mortar Projectile, Type 39,
80-mm, 8-cm Wgr. 39

FUZE: Wgr. Z. 38.

REMARKS: Ten rounds in metal container, 12.5 kg.

**H. E. MORTAR PROJECTILE, TYPE 39,
80-MM**

GERMAN NOMENCLATURE: 8-cm Wgr. 39 (Werfergranate 39). (See fig. 543.)

EMPLOYMENT: 8-cm s. Grant Werfer 34.

COMPLETE ROUND: 13.109 inches, over-all length.

PROJECTILE:

8.5 inches, length of body.

3.188 inches, diameter of bourrelet.



Figure 544—Colored Smoke Mortar Projectile,
80-mm, 8-cm Wgr. 38 Deut.

1.187 inches, width of bourrelet.

3.189 inches, diameter of fins.

Twelve, number of fins.

7.75 pounds, total weight.

1.11 pounds, weight of bursting charge.

TNT, type of bursting charge.

FUZE: Wgr. Z. 38 or 34; Z. Z. Zdlg. 34 Np, booster.

REMARKS: An improved model of 38.

**COLORED SMOKE MORTAR PROJECTILE,
80-MM**

GERMAN NOMENCLATURE: 8-cm Wgr. 38 Deut. (Werfergranate 38 Deut.) (See fig. 544.)

GERMAN EXPLOSIVE ORDNANCE

EMPLOYMENT: 8-cm s. Gr. Werfer 34.

COMPLETE ROUND: 12.874 inches, over-all length.

PROJECTILE:

- 8.5 inches, length of body.
- 3.187 inches, diameter of bourrelet.
- 1.187 inches, width of bourrelet.
- 1.187 inches, diameter of base.
- Twelve, number of fins.

FUZE: Wgr. 38 or 34.

H. E. MORTAR PROJECTILE TYPE 34, 80-MM

GERMAN NOMENCLATURE: 8-cm Wgr. 34 Nb. (Werfergranate 34 Nebel). (See fig. 545.)

EMPLOYMENT: M. Gr. W. 34; Kz. Gr. W. 42.

COMPLETE ROUND: 12.937 inches, over-all length.

PROJECTILE:

- 8.5 inches, length of body.
- 3.187 inches, diameter of bourrelet.
- 1.187 inches, width of bourrelet.
- 1.187 inches, diameter of base.
- 7.85 pounds, total weight.
- Twelve, number of fins.
- 36 grams of Penthrite Wax.
- Sulphur Trioxide smoke mixture—type of bursting charge.
- Kz. Zdlg. 34 Np booster.

FUZE: Wgr. Z. 38 or 34.

H. E. MORTAR PROJECTILE TYPE 34, 80-M GERMAN NOMENCLATURE: 8-cm Wgr. 34

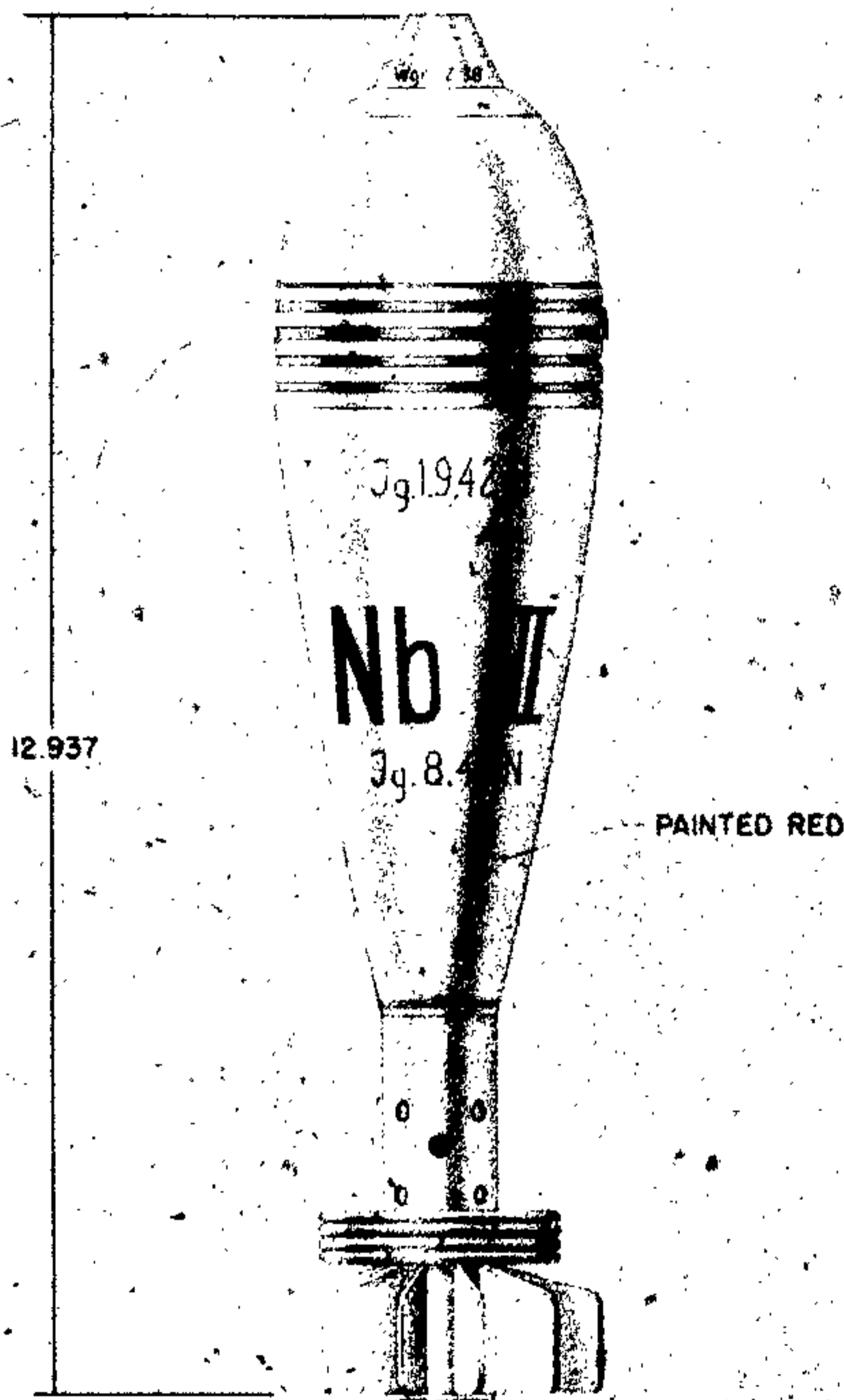

Figure 545—Smoke Mortar Projectile, Type 34, 80-mm, 8-cm Wgr. 34 Nb.



Figure 546—H. E. Mortar Projectile, Type 34, 80-mm, 8-cm Wgr. 34

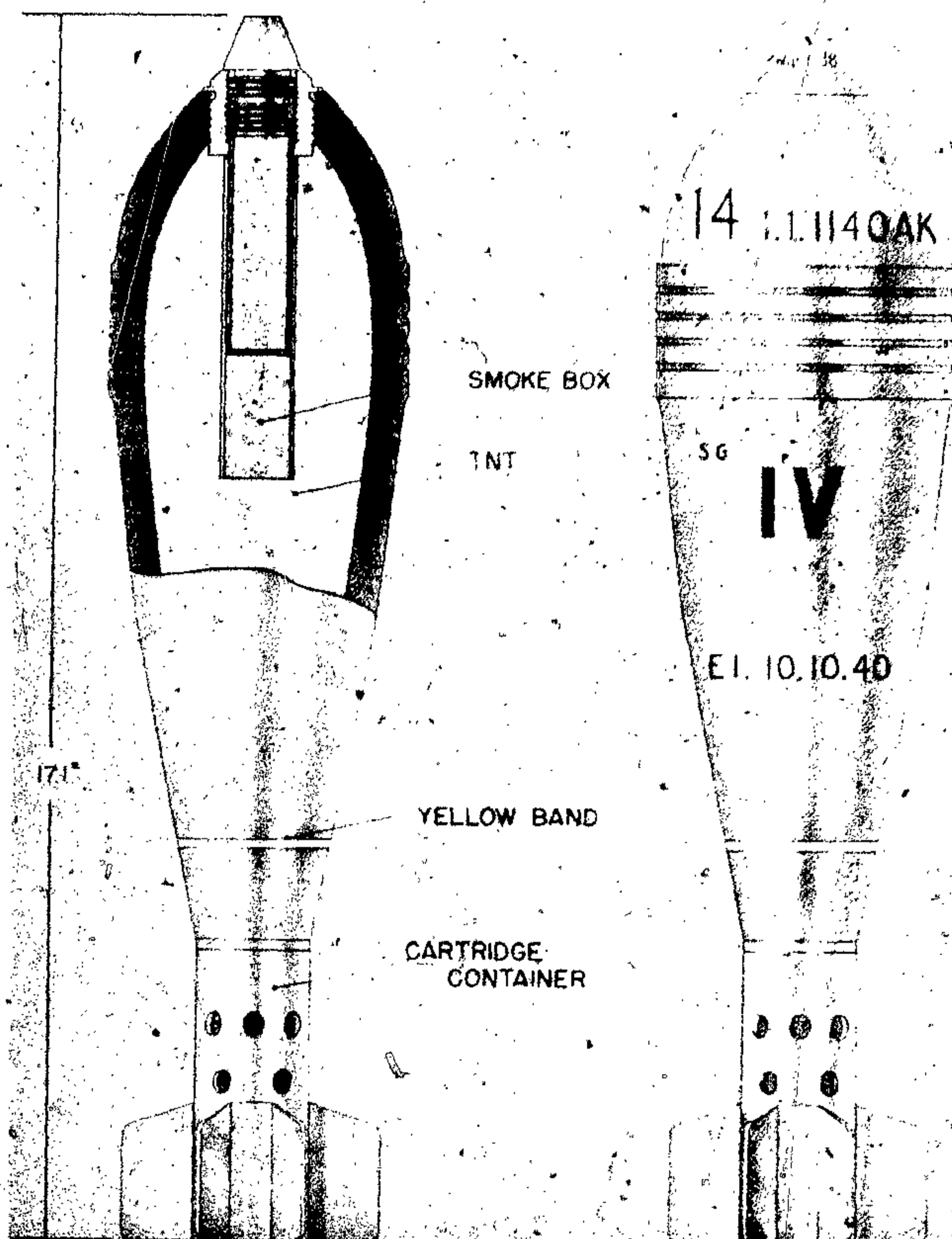

Figure 547—H. E. Mortar Projectile, 100-mm, 10-cm Wgr. 37

(Werfergranate 34). (See fig. 546.)

EMPLOYMENT: Kz. Gr. W. 42; 8-cm s. Granat Werfer 34.

COMPLETE ROUND: 13.070 inches, over-all length.

PROJECTILE (painted reddish brown):

8.5 inches, length of body.

3.188 inches, diameter of bourrelet.

1.187 inches, width of bourrelet.

3.189 inches, diameter of fins.

Twelve, number of fins.

1.11 pounds, weight of bursting charge.

7.75 pounds, total weight.

Gr. Zdlg. C/98 Np. booster gaine.

FUZE: Wgr. Z. 38 or 34.

PACKING: Three rounds in a metal carrier.

REMARKS: Propelling charge for this weapon consists of a primary cartridge and four augmentary charges. The latter consists of strip propellant in silk bag.

H. E. MORTAR PROJECTILE, 100-MM

GERMAN NOMENCLATURE: 10-cm Wgr. 37 (Werfergranate 37). (See fig. 547.)

EMPLOYMENT: 19-cm Nb. W. 35.

PROJECTILE: (painted grey green):

17.12 inches, over-all length.

4.09 inches, diameter of bourrelet.

GERMAN EXPLOSIVE ORDNANCE

16.0 pounds, total weight.

3.125 pounds, weight of bursting charge.

TNT, type of bursting charge.

Gr. Zdlg. C/98 Np. Booster.

FUZE: Wgr. Z. 38.

REMARKS: Information is from captured documents.

H. E. MORTAR PROJECTILE, 200-MM

GERMAN NOMENCLATURE: 20-cm Wgr. 40
(Werfergranate 40.) (See fig. 548.)

EMPLOYMENT: 20-cm L. Ladingswerfer.

COMPLETE ROUND: 30.86 inches, over-all length.

PROJECTILE:

13.0 inches, length of body.

7.5 inches, diameter of body.

49.94 pounds, total weight.

16.94 pounds, weight of bursting charge.

TNT, type of bursting charge.

10.63 inches, diameter of fins.

Six, number of fins.

CARTRIDGE CASE: Propellant—three parts, each weighing 12 grams. C/23 primer.

FUZE: Wgr. Z. 36.

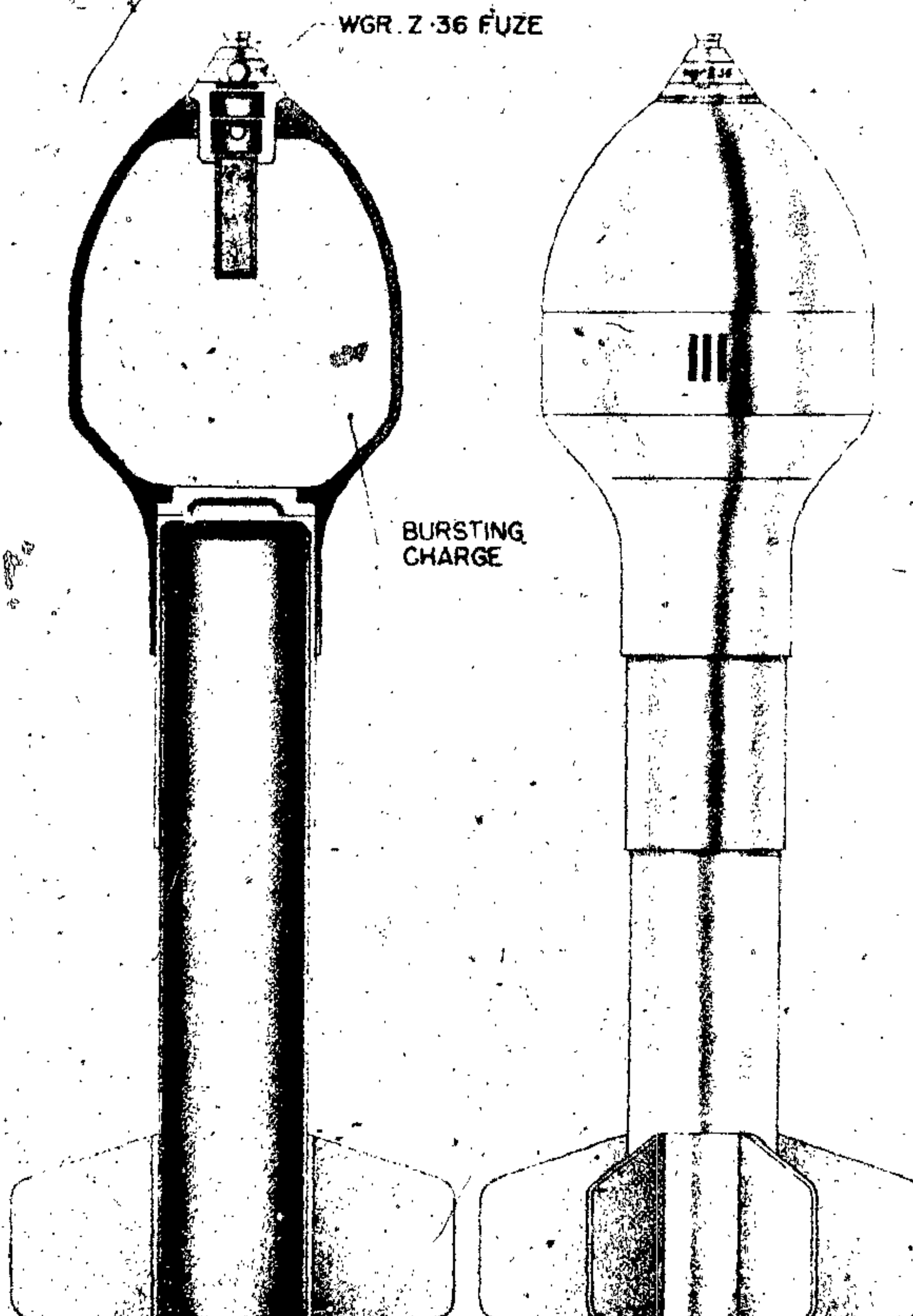

Figure 548—H. E. Mortar Projectile, 200-mm, 20-cm Wgr. 40

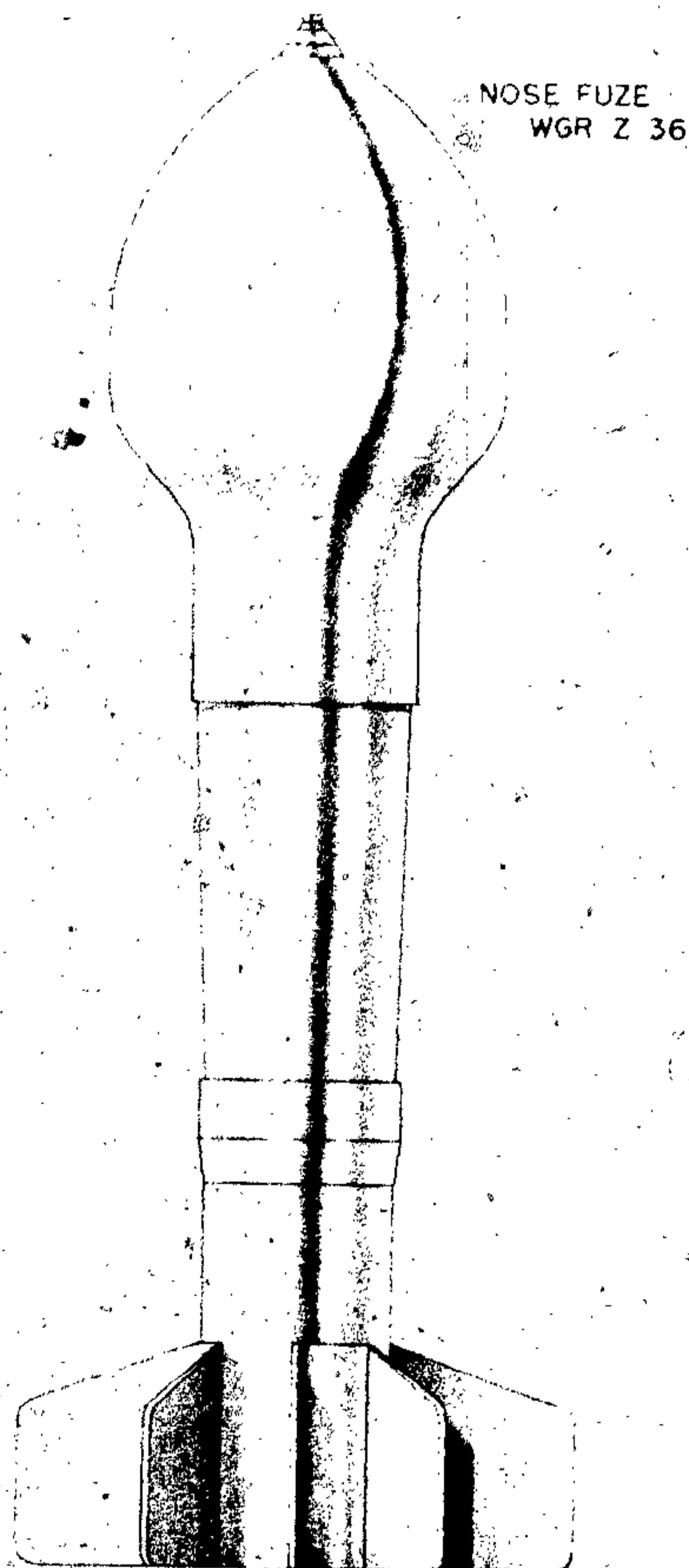

Figure 549—H. E. Mortar Projectile, 380-mm, 38-cm
Wgr. 40

H. E. MORTAR PROJECTILE: 380-MM

GERMAN NOMENCLATURE: 38-cm Wgr. 40 (Werfergranate 40). (See fig. 549.)

EMPLOYMENT: 38-cm s. Ladingswerfer.

COMPLETE ROUND: 59.21 inches, over-all length.

PROJECTILE:

24.606 inches, length of body.

14.96 inches, maximum diameter of body.

327.8 pounds, total weight.

110.0 pounds, weight of bursting charge.

21.18 inches, diameter of fins.

Six, number of fins.

CARTRIDGE CASE: C/23 primer.

FUZE: Wgr. Z. 36.

REMARKS: A smoke bomb exists with the nomenclature: "38-cm Wgr. 40 Nb."

GERMAN EXPLOSIVE ORDNANCE

H. E. PROJECTILE FOR 105-MM HOWITZER

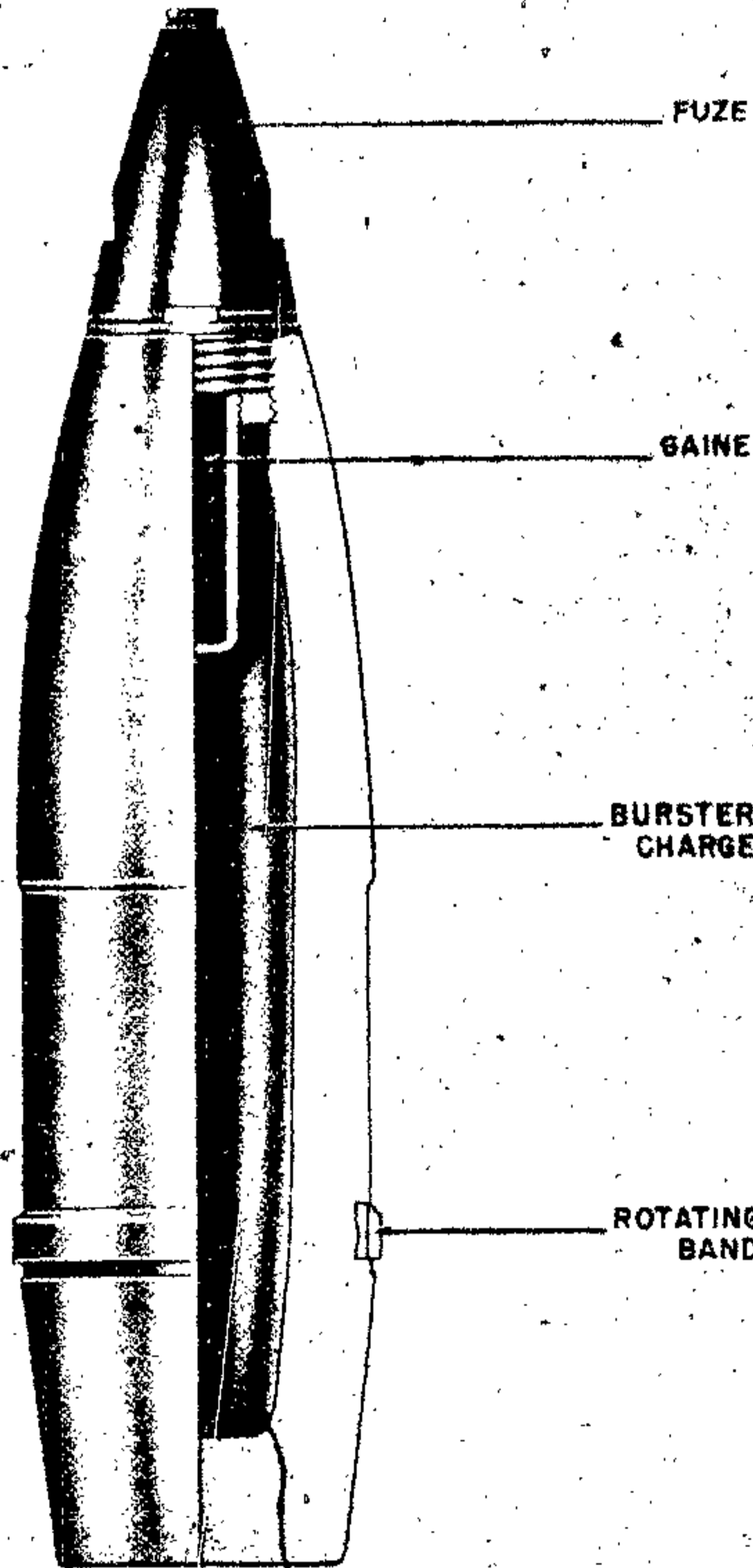

GERMAN NOMENCLATURE: F. H. Gr. Stg. m. R. 11. (See fig. 550.)

WEAPONS:

German Light Field Howitzers:

- 1. F. H. 18.
- 1. F. H. 18/1.
- 1. F. H. 18/2.
- 1. F. H. 18 m. M.
- 1. F. H. 18/39.
- 1. F. H. 18/49.

PROJECTILE:

Caliber: 105 mm.
 Kind: Shell.
 Type: H. E.
 Weight: 35 pounds (loaded and fuzed).
 Color: Red Body, O. D. ogive.

CHARGE:

Number: 14.
 Weight: 3 pounds.
 Kind: TNT poured.

TRACER: None.

BOOSTER: Gr. Zdlg. C/98 Nitropenta.

FUZE:

Nomenclature: AZ 23 v (0.25).
 Type: P. D.

REMARKS:

- NOTE 1.—KPS rotating band.
- NOTE 2.—R-11 smoke box.

Figure 550—H. E. Projectile for 105-mm Howitzer

GERMAN H. E. FILLINGS

| CODE No. | NATURE OF FILLING | USE |
|----------|---|---|
| 1..... | Fp. 02 (pressed) in cardboard containers with: (a) paper, papier mâché wrappings. (b) with Montan wax or paraffin binder in metal containers. | Shell filling; depth charges. Engineer explosives, mines and bulk charges. |
| 2..... | Grf. 88 (pressed)—As for 1..... | As for 1..... |
| 3..... | Np..... | Primers; filling for small shells. |
| 4..... | Fp. 02—Loose in paper cartons | Stick hand grenade 24. |
| 5..... | Grf. 88—Loose in paper cartons | Stick hand grenade 24. |
| 7..... | Fp. 02 (pressed)..... | H. E. shells. |

| CODE No. | NATURE OF FILLING | USE |
|----------|---|---|
| 8..... | Fp. 02 (poured)..... | H. E. shells. |
| 10..... | Fp. 02, Fp. 5, Fp. 10 (pressed)..... | H. E. shells. |
| 11..... | Fp. 02, Fp. 10, Fp. 15, Fp. 20 (pressed). | H. E. shells. |
| 12..... | Fp. 02, Fp. 5, Fp. 10..... | H. E. shells. |
| 13..... | Fp. 60/40 (poured)..... | Substitute H. E. for grenades and bombs S. D. 1; S. D. 2, S. D. 250, S. D. 500, S. C. 50, S. C. 250, S. C. 500, S. C. 1000, S. C. 1800. |
| 13A..... | Fp. 50/50..... | Tellermine S. C. 250, S. C. 500. |

PROJECTILES

| CODE No. | NATURE OF FILLING | USE | CODE No. | NATURE OF FILLING | USE |
|----------|--|--|----------|---|---|
| 14 | Fp. 02 (poured) | H. E. shells and bombs. S. D. 1, S. D. 2, S. D. 50, S. D. 250, S. D. 500, P. C. 1000, P. C. 1400, S. C. 10, S. C. 50, S. C. 250, S. C. 500, S. C. 1800, S. Be. 50. | 70 | Trinitrobenzene (pressed) | Primers. |
| 15 | Fp. 02, 10 percent aluminum | H. E. shells. | 83 | Ethylenediaminedinitrate (E. D. D.)-(poured) | H. E. mixtures. |
| 16 | Fp. 02, Np. 10 (pressed in containers) | H. E. shells. | 84 | E. D. D./Amm. Nit., 55/45 | Projectiles. |
| 17 | (Fp. 02, 10 percent aluminum) with Np. 10 | H. E. shells. | 86 | E. D. D./H. Wax/E. D. D., 46/18/36. Three pressed pellets in waxed paper. | A. P. shell. |
| 18 | Fp. 02/H. 5, 80/20 | H. E. shells. | 88 | Amatol 41 | S. C. 50. |
| 19 | Fp. 02/Amm. Nit./Al., 56/35/10 | H. E. shells. | 89 | H. (poured) | H. E. mixtures. |
| 20 | 45/55 Diamin/Amm. Nit./Al., 53.5/1.5/45. | H. E. shells. | 90 | H. (pressed) | H. E. mixtures. |
| 24 | Grf. 88 (poured) | H. E. shells. | 91 | H. 5 | Primers. |
| 27 | Fp. 02, Fp. 10 (pressed) | H. E. shells. | 92 | H. 10 | Primers. |
| 28 | Fp. 10, Np. 10 (pressed) | H. E. shells, 8.8-cm Pzgr. Armor-piercing shell. | 95 | H/Fp. 02, 60/40 (pressed in waxed paper) | H. E. shell. |
| 29 | Fp. 10 Fp. 02 crystallized. Fp. 10, Pot. chlorate (70/30). Fp. 10, Pot. chlorate (50/50). | H. E. shell, 21-cm Gr. 18 Bc. | 101 | Fp. 8 percent Montan wax | P. C. 500, P. C. 1000, S. D. 500 S. D. 1000. |
| 30 | Fp. 02, Fp. 5 (pressed) | H. E. shells. | 102 | (T) | P. C. 500, P. C. 1000, P. C. 1400. |
| 32 | Np. 10 (pressed in waxed paper) | Primer for H. E. shell; A/tk Mines, etc. | 105 | Trialen (Fp. 02/Al/Naphthalene, 74/12/14). Trialen (Fp. 02/H/Al., 70/15/15, poured). | S. C. 1000, S. C. 1200, S. C. 1800. S. C. 500 L2, S. C. 250. |
| 33 | Np. 15 | Primer for H. E. shell, A/tk Mines, etc. | 106 | Trialen (Fp. 02/H/Al. 50/25/25) | S. C. 250 JA. |
| 34 | Np. 30 | Special projectiles. | 109 | H/Al/Wax, 70/25/5 (pressed) | P. C. 1800 R. S. |
| 36 | Np. 40 | Practice H. E. rounds. | 110 | Amm. Nit./Naphthalene/Al/Woodmeal 90/5/2.5/2.5/ (Stemmed ammonal) | S. C. 250, S. Be. 50, S. Be. 250. |
| 37 | Np. 50 | H. E. shell. | 111 | Stemmed Ammonium Nit./Carbon/Mineral Matter, 90/6/4. | S. C. 250. |
| 38 | Np. 65 | Practice H. E. rounds. | 112 | Fp. 02/Amatol, 20/80 | S. C. 250, S. Be. 50. |
| 42 | Pentol (pressed) | H. E. shell. | 13-113 | Amm. Nit./TNT/Al-70/20/10 or Amm. Nit./TNT-74/26. | S. C. 1000. |
| 43 | Plastic pentrit. | H. E. shell. | | | |
| 45 | Np. 30/H, 50/50 | Special projectile. | | | |
| 52 | Dinitrobenzene/Amm. Nit./Cast RDX. | Poured filling for projectiles and bombs. S. C. 50, S. C. 250, S. C. 500. | | | |
| 52A | Biscuit Filling: Amm. Nit./Calc. Nit./H, 53/30/17. | Nose: S. C. 250, S. D. 500A, S. C. 500, S. B. 1000. Body is (52). | | | |
| 56 | Donarit. | Hand grenades. | | | |
| 57 | Abonacht 2 | Stick hand grenade 24. | | | |
| 60 | Trinitrochlorobenzene | Projectiles. | | | |
| 61 | Trinitrochlorobenzene (poured) | Projectiles. | | | |
| 61 | Trinitrochlorobenzene/Amm. Nit. 60/40. | Projectiles. | | | |

KEY

| | |
|-----------------------------|-------------------------|
| Fp. 02 (Fullpulver) | TNT. |
| Grf. 88 (Grenat Fullung) | Picric acid. |
| Fp. (X)/(Y) | (Y)/(X) Amatol. |
| Fp. (X) | Fp. 02 (X) percent wax. |
| Np. (Nitro-ponta) | PETN. |
| Np. (X) | PETN. (X) percent wax |
| H. (Hexogen) | RDX. |
| H. (X) | RDX (X) percent wax. |
| Al | Aluminum. |
| U. Kr. - Übertragungskörper | Primer. |

ABBREVIATIONS USED IN CONNECTION WITH GERMAN ORDNANCE AND AMMUNITION

| Abbreviation | Signification | English Equivalent | Abbreviation | Signification | English Equivalent |
|--------------|-----------------------------------|---|---------------------|-----------------------|--|
| A | Artillerie | Artillery | B. | Bat., Battr. | Batterie |
| a/A | alter Art. | of old pattern. | b., belg. | belgisch | Belgian. |
| abg. | abgeändert. | converted. | B. A. K. | Balloon-Abwehr-Kanone | Antiaircraft gun. |
| abr. | Abpraller | Ricochet. | Bd. G., Brd. Gesch. | Brand-Geschoss | Incendiary shell. |
| Am | Ammonsalpeter | Ammonium nitrate. | Brand, Gr. | Brand-Granate | |
| Ar | Trinitroanisol | Trinitroanisole. | Be. | Beton | Concrete. |
| An. 60/40 | Anisol 60/40 | 60 percent trinitroanisole and 40 percent ammonium nitrate. | Bett. Gesch. | Bettungs-Geschütz | Gun on platform mountings. |
| As. | Arsenik | Arsenic. | Bd. Z. | Boden-Zünder | Base fuse. |
| Az. | Aufschlag-Zünder | Percussion fuse. | Bl. | Blind | Blind (inert) (dud). |
| Az. m. V. | Aufschlagszünder mit Verzögerung. | Delay action percussion fuse. | Blaukreuz. | | Blue cross. |
| Az. u. Bz. | Aufschlag- und -Brenn-Zünder. | Percussion and time fuse (T. and P.). | Bleiplombe | | Lead seal of protective cap (of fuse). |
| | | | Br. | Brand | Incendiary. |

GERMAN EXPLOSIVE ORDNANCE

| Abbreviation | Signification | English Equivalent | Abbreviation | Signification | English Equivalent |
|-------------------|-------------------------------|---|------------------|------------------------------|---|
| Br. Mrs | Bronze-Mörser | Bronze mortar. | Gr. Zdlg. | Grosse-Zündladung | Large exploder. |
| Bl. P. | Blättchen-Pulver | Flaked powder. | Gu. | Gudol | A flashless propellant. |
| B. Stelle | Beobachtungs-Stelle | Observation post. | Gwr. Sprgr. | Gewehrgranate Spreng. | H. E. rifle grenade. |
| Bu | Buntrauch | Colored smoke. | H. | Haubitze | Howitzer. |
| Bz. | Brenn-Zünder | Time fuze. | Haub. | Haube | False cap. |
| C-Gesch. | C-Geschoss | "C" shell (streamline). | Haub. Gr. | Hauben-Granate | Shell with false cap. |
| c/92 | Construction/92 | 1892 pattern. | Haub. Schr. | Hauben-Schrapnel | Shrapnel with false cap. |
| D. d. G. | Dum-dum Geschoss | Dum-dum bullet. | H. Gr. | Haubitze-Granate | Howitzer shell. |
| Deut. | Dinitrobenzol | Indicator (colored smoke) | H. Rg. P. | Haubitze-Ring-Pulver | Powder in rings for light field howitzer. |
| Di | Diglykolnitrat | Dinitrobenzene. | | Hölzenreisser | Split cartridge base (steel). |
| Digl. | Diglykolnitrat | Diglycolnitrate. | | | |
| Dz., Dopp. Z. | Doppel-Zünder | Time and percussion fuze. | H. Schr. | Haubitze-Schrapnel | Howitzer shrapnel. |
| Dopp. Z. | Doppel-Zünder | Time and percussion fuze. | H. Z. | Haubitze-Zünder | Howitzer fuze. |
| E. | Empfindlich | Sensitive, i. e., instantaneous (fuze). | Hulsenkart. | Hulsen-Kartusche | Cartridge case as opposed to bag. |
| E. Eis | Eisenbahn | Railway, i. e., on railway mounting. | I. H. | in Haubitze-Lafette | On howitzer carriage. |
| Ec. | Eisen-Centrierung | With rear driving band only. | Inf. Gesch. | Infanterie-Geschütz | Infantry gun. |
| E. H. Z. | Empfindlicher Haubitze-Zünder | Sensitive, i. e., instantaneous howitzer fuze. | I. Kas. L. | in Kasematten-Lafette | On casemate mounting. |
| E. K. Z. | Empfindlicher Kanonen-Zünder | Instantaneous gun fuze. | A. Kat. L. | in Kusten-Lafette | On coast defence mounting. |
| E. P., Ers. R. P. | Ersatz Röhren-Pulver | Substitute tubular powder. | I. P. L. | in Panzer-Lafette | On shielded mounting. |
| Ers. | Ersatz | Substitute. | I. R. L. | in Rad-Lafette | On wheeled carriage. |
| f., fr. franz. | französisch | French. | I. S. L. | in Schirm-Lafette | On carriage with overhead shield. |
| f., 10-cm, K. | für 10-cm Kanone | For 10-cm gun. | Is. | Innen-Zünder | Internal fuze. |
| Fb. or Flihb. | Flihbolzen | Centrifugal bolt (safety device). | J., jap. | japanisch | Japanese. |
| Fest. | Festung | Fortress. | K. | Kanone | Gun. |
| F. Gr. | Feld-Granate | Field gun H. E. shell. | KK. | Kanone-Kasement | Casement gun. |
| F. H. | Feld-Haubitze | Field howitzer. | Kwk. | Kampfwagen Kanone | Tank gun. |
| F. H. Schr. | Feld-Haubitz-Schrapnel | Light field howitzer shrapnel. | K., Kz. | Kurz. | Short. |
| F. K. | Feld-Kanone | Field gun. | K., Kt. | Kartatsche | Case shot. |
| Fl. | Flügel | Vane (on bomb). | Kal. | Kaliber | Caliber. |
| Flak. | Flug-Abwehr-Kanone | Antiaircraft gun. | Kart. | Kartusche | Cartridge. |
| Flug. | Flugzeug | Aircraft. | Kart., einf. | Kartusche einfach | Cartridge in bag, as opposed to metal case. |
| F. Patr. | Feld-Patronen | Field gun cartridge (fixed ammunition). | Kart. Hulse | Kartusch-Hülse | Cartridge case (separate ammunition). |
| Fp.02 or Fp.C/02 | Füllpulver Construction 02. | 1902 pattern explosive (TNT). | Kg. | Kilogramm | Kilogramme (2.2 pounds). |
| Fp.00/40 | Füllpulver 00/40 | 40/60 amatol (i. e., 40 percent ammonium nitrate and 60 percent TNT). | -kg. m. B. | -Kilogramm mit Beutel | -kg. including weight of bag. |
| F. Schr. | Feld-Schrapnel | Field gun shrapnel. | K. Gr. | Kanonen-Granate | Gun shell. |
| G. | Granate | H. E. shell. | K. I. H. | Kanone-in-Haubitz-Lafette | Gun on howitzer carriage. |
| g. | Gramm | Gramme. | Kl., kl. | Kleine | Small. |
| Gb. | Gebirgs | Mountain (gun). | Kl. Ldg. | kleine Ladung | Reduced propelling charge. |
| gel. | geliefert | Manufactured. | Kl. Zdlg. | kleine Zündladung | Small exploder. |
| Gel. | Geladen | Loaded. | Kp. | Kappe | cap (of fuze). |
| Gesch. | Gelbkreuz | Yellow cross. | Kst. | Küste | Coast (defence). |
| ges. | Geschütz | Gun. | Kst. H. | Küsten-Haubitze | Coast defence howitzer. |
| | Geschoss | Projectile. | Kst. K. | Küsten-Kanone | Coast defence gun. |
| | gezogen | Rifled. | Kst. Mrs. | Küsten Mörser | Coast defence mortar. |
| | Geschütz-Fabrik | Gun factory. | K. Z. | Kanonen-Zünder | Gun fuze. |
| | Geschoss-Fabrik | Shell factory. | Kz. | Kopf-Zünder | Nose fuze. |
| Gg. | Graugum | Cast iron. | Kz. Bd. Z. | kurzer Boden-Zünder | Short base fuze. |
| G. Gr. | Gas-granate | Gas shell. | Kz. Gr. W. | Kurzen Granatwerfer | Short mortar. |
| gl. | glatt | smooth bore. | Kz. Mar. Kan. 14 | kurze Marine-Kanone 14 | 1914 pattern short naval gun. |
| Gr. | granate | H. E. shell. | L., l. | Leicht | light. |
| Gr. | Gross | large. | L. | lang | long. |
| (gr) | grau | grey. | L. | Lafette | Carriage. |
| gr. Bl. P. | grobes Blättchen-Pulver | Powder in large flakes (propellant). | Ldg. | Ladung | Propellant charge. |
| Grf. 88 | Granatfüllung 88 | 1888 pattern explosive (picric acid). | L. E. Munition | Lift-Einschless Munition | Explosive tracer ammunition (rifle). |
| Grks. | Grünkreuz | Green cross. | L. S. Munition | Light-Spur-Munition | Tracer ammunition. |
| Gr. W. | Granatwerfer | Bomb thrower (mortar). | Lg. Bd. Z. | langer Boden-Zünder | Long base fuze. |
| Gr. Z. | Granat-Zünder | Fuze for H. E. shell. | Lg. Brlg., I. B. | lange Brennlänge | Long burning (fuze). |
| | | | L. Gr., Lgr. | Lang-Granate | Long shell. |
| | | | Lg., Zdr. | Leuchtgeschoss-Zünder | Fuze for star shell. |
| | | | J. F. G. | leichte Feld-Haubitze | Light field howitzer |
| | | | lg. Mrs. | langer Mörser | Long mortar (21-cm). |
| | | | L. I. G. | leichte Infanterie Geschütz. | Light infantry howitzer. |

PROJECTILES

| Abbreviation* | Signification | English Equivalent |
|---------------------------|--|--|
| B. K. Z. | Langer Kanonen-Zünder | Long fuze for gun. |
| L. Pist. | Leuchtpistol | Flare pistol. |
| L. Pz. Mi. | Leichte Panzermine | Light antitank mine. |
| L. S. Gesch. | Licht-Spur-Geschoss | Tracer shot. |
| L. S. Gr. | Licht-Spur-Granate | Tracer shell. |
| L/40, etc. | Used in the nomenclature of naval guns to indicate that the length is 40 &c., calibres. | |
| L/3.1 &c. | Used in the nomenclature of naval projectiles to indicate that the length is 3.1, &c calibres. | |
| L'Spur | Leuchtspur | Tracer. |
| M. | Mundungsbremse | Muzzle brake. |
| m | Meter | Mètre. |
| m | mit | with. |
| Mdlochb. | Mundlochbüchse | Old pattern type of fuze. |
| Mdlochf. | Mundlochfutter | Galne. |
| M. Flak | 3.7-cm Flug-Abwehr-Maschinen-Kanone | 3.7-cm automatic anti-craft gun. |
| M. G. | Maschinen-Gewehr | Machine gun. |
| m. ger. Sprgdg. | mit geringerer Sprengladung. | With reduced bursting charge. |
| m. Osdg. | mit Oberzündung | With overhead ignition. |
| m. P. | mit Panzerkopf | With armour-piercing head. |
| Mrs. | Mörser | Mortar. |
| Mtl. K. | Mantel-Kanone | Jacketed gun. |
| M. V., m. V. | Mit Verzögerung | with delay action. |
| m. Vorl. | mit Vorlage | with flash reducer. |
| m. v. F. | mit vorwärtsm. Führungsring. | with forward driving band. |
| m. V. u. K. | mit Verzögerung und Klappensicherung. | With delay action and centrifugal safety device. |
| N | Nebel | Smoke (shell) of new pattern. |
| n/A, n. A. | neuer Art | of new pattern. |
| Nb. | Nebel | Smoke. |
| Nb. w. | Nebelwerfer | smoke mortar (or rocket projector). |
| n. F. | neuer Form | of new shape. |
| n. Gew. P. 71 | Neues Gewehr-Pulver 71 | '71 pattern powder (for igniters). |
| Ngl. | Nitroglycerin | Nitroglycerine. |
| Nr. | Nummer | Number. |
| Nz. | Nitrozellulose | Nitrocellulose. |
| o. Az. | ohne Aufschlagzündung | Without percussion system. |
| o. V. | Ohne Verzögerung | Without delay action (direct action). |
| P | Phosphor | Phosphorus. |
| P. (P). | Pulver | Powder (usually black powder, i. e., common shell). |
| Pak | Panzerabwehr Kanone | Antitank gun. |
| Patr | Patrone | Cartridge (fixed ammunition). |
| Patrh. | Patronen-Hülse | Cartridge case (fixed ammunition). |
| Propgr. | Propagandagrenate | Propaganda grenade. |
| Pgr | Panzer granate | A. P. shell. |
| R. | Rauchentwickler | Smoke producer. |
| r.; rüs. | russisch | Russian. |
| Rev. K. | Revolver-Kanone | Revolver gun. |
| Rg. P. | Ring-Pulver | Powder in rings (propellant). |
| R. L. | Rad-Lafette | Wheeled carriage. |
| R. K. | Ring-Kanone | Gun with chase rings. |
| R. Munition | Rillen-Munition | S. A. A. (groove round bullet into which cartridge case is crimped). |
| R. P. | Röhren-Pulver | Tubular powder (propellant). |
| S. | Schwer | Heavy. |
| S. Sch., Schr. | Schrapnel | Shrapnel. |
| Sch. Grab. K. | Schützen-Graben-Kanone | Trench gun. |
| Schlagschr., Schlagschrb. | Schlagschraube | Primer (to screw cartridge case). |

| Abbreviation | Signification | English Equivalent |
|---------------------|---|--|
| Schusstafel | Schusstafel | Range table. |
| Sek. | Sekunden | Seconds. |
| s. P. H. | schwere Feld-Haubitze | Heavy field howitzer. |
| s. H. T. | schwere Haubitze Turin | Heavy Howitzer Turret. |
| S. m. K-Munition | Spitz-Munition mit Kern | Armor piercing S. A. ammunition. |
| s/Mi. | Schrapnellmine | Shrapnel mine (anti-personnel). |
| S-Munition | Spitz-Munition | Ordinary S. A. A. (pointed bullet). |
| Sprgr., Spgr. | Spreng-Granate | H. E. shell. |
| Sprgdg. | Sprengladung | Bursting charge. |
| Spgr. m. K. | Sprenggranatenzünder mit Klappensicherung | Fuze with centrifugal safety device, H. E. shell. |
| S. Pz. B. | Schwere Panzerabwehrge- wehr. | Heavy antitank rifle. |
| St. | Stahl | Steel (bullets). |
| | Schlagstift | Percussion rod (inserted in instantaneous firing before firing). |
| St. | Stellstift | Fuze setter. |
| | Stellschlüssel | |
| Stgr. | Stielgrenate | Stick bomb. |
| St. O. Gas | Stabs-Offizier für Gas | Army gas officer. |
| Stogas | | |
| Str. | Streifen | Strip. |
| Stu. G. | Sturm Geschütz | Assault gun. |
| T. Mi. | Tellermine | Antitank mine. |
| T. H. | Turm-Haubitze | Howitzer in turret. |
| T. K. | Turm-Kanone | Gun in turret. |
| T. K. | Teilladung | Partial propellant charge for howitzer. |
| Tl. | Treibladung | Propellant charge. |
| U | Unterrichts | Instructional. |
| u | und | and. |
| ub. | Übungs | Practice. |
| Ubgr. | Übungsgranate | Practice shell. |
| Ub. Ldg. | Übungsladung | Practice charge. |
| Umg. | Umgeändert or umgear- beltet. | Converted. |
| Uz umg. | 1892 umgeändert | 1892 pattern converted. |
| 1. V. | erste Verzögerung | Short delay. |
| 2. V. | Zweite Verzögerung | Long delay. |
| 0.05 Sek. Verz. | 0.05 Sekunden Verzögerung. | 1/20th second delay. |
| Vers. | Versuchs | Experimental. |
| Verst. | Verstärkt | Reinforced. |
| V. H. | Versuchs-Haubitze | Experimental howitzer. |
| V. K. | Verkürzte Kammerhülse | Shortened central tube (of shrapnel). |
| Vrst., Vst., Vorst. | Vorstecker | Safety pin (on fuze). |
| V. R. P. | Verkürztes Röhren-Pul- ver. | Tubular powder cut in short lengths. |
| W. P. | Würfel-Pulver | Flaked powder (propellant in small rectangular tablets). |
| Wgr. | Wertgrenate | Mortar shell (or rocket). |
| Z. | Zerlegung | Self destroying. |
| Z. Zdr. | Zünder | Fuze. |
| Zdg. | Zündung | Fuze. |
| Zldg., Zldg. | Zündladung | Explosive (booster). |
| Zi. | Zinklegierung | Zinc alloy. |
| Zt. Z. | Zeltzünder | Tine fuze. |
| Z. V. | Zünder-Vorrichtung | Fuze (Austrian term). |
| Zyl. P. | Zylinder-Pulver | Powder in cylindrical pellets. |
| 14A | 1914A | Designation of cast-iron shell introduced in 1914. |

AMMUNITION SUPPLY DIVISION
ORDNANCE SERVICE HQ. SOS ETOUSA,

1 June 1944.

GERMAN EXPLOSIVE ORDNANCE

Table 3.—German

| WEAPON, CALIBER | CART- RIDGE CASE DESIGN NO. | TYPE | DIMENSIONS | | | | PRIMER | MARKINGS | REMARKS |
|------------------------------------|---|-------|------------|---------------------------|-----------------------------------|-------------------------|-----------------|---|---------|
| | | | LENGTH | DIAM- ETER AT MOUTH | DIAM- ETER AT SHOUL- DER | DIAM- ETER AT RIM | | | |
| 10-cm L. G. 40 | | | 15.825" | 4.75" | | 5.5" | C/13N/A | Plastic Base primer on side base 3.312" diameter. | |
| 15-cm K. 18 and 15-cm K. (E) | 6352 | | 32.13" | | | 7.007" | C/12N/A | | |
| 15-cm K. 16 | 6304 | | 28.54" | | | 6.929" | C/12N/A | | |
| 15-cm s. H. T. | 6357 | | | | | | C/12N/A | | |
| 15-cm K. 39 | 6318 | | 20.67" | | | 7.283" | C/12N/A | | |
| 15-cm K. ins. Mrs. Laf. | | | | | | | C/12N/A | | |
| 15-cm s. FH. 13 and IO. 33 | 6303 | | 4.448" | 6.102" | | 6.653" | C/12N/A | 6303 lgs. FH. 13 | |
| 15-cm SFH. 18 | 6350 | Sep | 10.23" | 6.338" | | 7.007" | C/12N/A | SFH. 18. A black painted steel case also is in use. It has a vertical lap joint and is stamped 6350/17. | |
| 17-cm KAN. (E) | | | | | | | C/12N/A | 17-cm KAN. (E) C/95 | |
| 17-cm K. I. Mrs. L. | 6324 | | 28.562" | 7.5" | | 8.5" | C/12N/A | A black spiral steel case 6324/78C also exists. | |
| 20-cm KAN. (E) | C/34 | | | | | | C/12N/A | | |
| 21-cm Ep. Mrs. 18 | 6305 | | | | | | C/12N/A | | |
| 21-cm Mrs. 18 | 6351 | | 16.125" | 8.75" | | 9.5" | C/12N/A | 21-cm Mrs. 18 | |
| 24-cm Th. Br. Kan. (E) | | Sep | | | | | C/12N/A | Th. Br. Kan. (E) | |
| 24-cm Th. Kan. (E) | | | | | | | C/12N/A | C/95 Th. Kan. (E) | |
| 28-cm Lg. U. S. Br. Kan. (E) | L/45/50 | | | | | | C/12N/A | L/45/40 | |
| 7.5-cm Geb. K. 16 | 6335 | Sep | 5.075" | 3.031" | | 3.34" | C/12N/A | | |
| 7.5-cm K. W. K. 38 | 6354 | | 9.56" | 2.93" | 3.01" | 3.62" | C/22 | 5.7-cm KWK | |
| 7.5-cm Pak. 40 | 6340 | Fixed | 28.1" | 3.062" | 3.187" | 3.937" | C/12N/A | 6340 st. 7.5-cm Pak. 40 Same as 7.62 Pak. 36. | |
| 7.62-cm Pak. 36 | 6340 | Fixed | 28.1" | 3.062" | 3.187" | 3.937" | C/12N/A | 6340 st. 7.5-cm Pak. 40 Same as 7.5-cm Pak. 40. | |
| 7.62-cm FK. 290 (r) | 42 M or | | 15.125" | 3.07" | 3.062" | 3.531" | 42 M or 33 | Same case except for primer. | |
| 7.62-cm Inf. KH. 290 (r) | 37 (r). | | | | | | | | |
| 8.8-cm Flak 18, 36 and 37 KWK. 36. | 6347 | Fixed | 22.375" | 3.625" | 3.812" | 4.02" | C/12N/A C/22 | Same case except for primer. | |
| 8.8-cm Flak 41 | | Fixed | 34.687" | 3.562" | 4.125" | 4.844" | C/22 | 8.8-cm Flak 41 | |
| s. 10-cm K. 18 | 6349 | Sep | 17.5" | 4.312" | | 5.062" | C/12 | | |
| 10-cm K. 17 and 17/04n/a | 6302 | Sep | | | | | C/12N/A | | |
| m. 10-cm K.K. and m. 10-cm K.T. | 6356 | Fixed | | | | | C/22 | | |

PROJECTILES

Cartridge Cases

| WEAPON, CALIBER | CART-RIDGE CASE DESIGN NO. | TYPE | DIMENSIONS | | | | PRIMER | MARKINGS | REMARKS |
|---------------------------|----------------------------|-------|------------|--------------------|------------------------|------------------|--------------|------------------------|--|
| | | | LENGTH | DIAM-ETER AT MOUTH | DIAM-ETER AT SHOUL-DEE | DIAM-ETER AT RIM | | | |
| Lg. 10-cm KT | | | | | | | G/12N/A | | |
| 10-cm LFH. 18 and 18M | 6342 | Sep | 6.125" | 4.375" | 4.5" | 4.937" | C/12N/A | 6342 st. LFH | This case may be of brass coated steel, unpainted steel, or black-painted steel spirally wound. In the last case it is marked: 6342/65C. |
| 10-cm Flak 38 | 6307 | Fixed | 30.25" | 4.187" | 4.625" | 5.375" | C/22 | 10-cm Flak 38 | *Usually absent. |
| 28/20 s.Pz. Bu. 41 | 345 R. | Fixed | 7.375" | 1.187" | 1.562" | 1.875" | C/13N/A | | |
| 47/28 L. Pak. 41 | 6329 | Fixed | 18.0" | 1.75" | 1.875" | 2.625" | C/13N/A | 4.2-cm Pak. 41 | |
| 3.7-cm Pak | 6331 | Fixed | 9.75" | 1.5" | 1.625" | 2.0" | C/13N/A | 3.7-cm Pak | |
| 3.7-cm Flak 18 and 36 | 6348 | Fixed | 10.166" | 1.594" | 1.625" | 1.844" | C/13N/A | | |
| 3.7-cm Polish AT | | Fixed | 10.125" | 1.5" | 1.687" | 2.187" | | 3.7 WZ. 36 Pk. 4 398m. | |
| 3.7-cm C/30 (Nayal) | P-397 | Fixed | 14.96" | | | | C/13 | P-397 C/30 | |
| 4-cm Flak 28 | | Fixed | 12.25" | 1.625" | 1.812" | 2.437" | C/12 or C/33 | 4-cm 28 st. | |
| 4.7 Czech | M 36 | Fixed | 15.875" | 1.937" | 2.125" | 2.5" | | 4-cm M. 36 | |
| 4.7 Böhler Gun | | | 9.25" | 1.875" | | 2.187" | | Enz. 4.7-cm M. 35 | |
| 5-cm KWK 38 | 6317 | Fixed | 11.375" | 2.0" | 2.687" | 3.062" | C/22 | 5-cm KWK | |
| 5-cm Pak. KUT. (Kz. L.) | | Fixed | | | | | C/22 | 5-cm Pak. KZ | |
| 5-cm Pak | | Fixed | | | | | C/22 | 5-cm Pak | |
| 5-cm Pak 38 | 6360 | Fixed | 16.5" | 2.0" | 2.625" | 3.062" | C/12N/A | 5-cm Pak. 6360 st | |
| 75/50 Skoda | | | 22.83" | 3.15" | 3.228" | 3.74" | M 39 s. | 1941-38 75 AA | |
| 7.5-cm KWK 40 | 6339 | | 19.4" | 3.15" | 3.8" | 4.0" | C/22 | | |
| 7.5-cm LIG. 18 | 6341 | | 3.5" | 3.0" | | 3.375" | C/22 | L. I. G. 18 | |
| 7.5-cm LGEB. IG18 | 6341 | | 3.5" | 3.0" | | 3.375" | C/22 | L. I. G. 18 | |
| 7.5-cm L. G. 40 | | | 8.062" | 4.409" | 4.5" | 4.921" | C/13 | | |
| 7.5-cm GEB. G 36 | 6350 | | | | | | C/12N/A | | |
| 7.5-cm FK. 16 n/a | 6349 | Sep | | | | | C/12N/A | | |
| 7.5-cm self-propelled gun | 6310 | | | | | | C/22 | | |
| 7.5-cm L. F. K. 18 | 6316 | Sep | 13.97" | 3.070" | | 3.582" | C/12N/A | | |
| 28-cm K. st. H | | | | | | | C/12N/A | | |
| 28-cm Kz. Br. Kan. (E) | | | | | | | C/12N/A | 28-cm Karth. C/95 | |

GERMAN EXPLOSIVE ORDNANCE

Table 4.—German Cartridges, S. A. A., 7.92 mm

| TYPE | IDENTIFICATION MARKING | | MATERIAL | FILLING AND/OR CORE | PENETRATING HARD ARMOR AT 100 YARDS N. E. | REMARKS |
|-------------------------------------|--------------------------------------|---|--|--|---|---|
| | CARTRIDGE CASE | PROJECTILE | | | | |
| Practice tracer | 5 mm green lacquer band across base. | 10 mm black tip | Steel coated gilding metal. | Aluminum 25 grains | | White trace 800 yards. |
| Ball | Green annulus | Plain | Steel, coated, gilding metal (both sides). | Lead | | |
| Practice Ball (H. V.) | 5 mm green lacquer band across base. | Plain | Steel, coated, gilding metal. | Aluminum 42 grains | | Used in practice manoeuvres. |
| Incendiary observing. | Black annulus | Chromium plated tip (obsolete) or plain tip with black rear part. | Steel, coated gilding metal (both sides). | Phosphorus 6 grains | | Base fuze detonator, striker and split sleeve in tube. |
| H. V. I. O. | Black annulus | Black body, plain tip, with green ring. | Steel, coated gilding metal (both sides). | Phosphorus 6 grains | | Base fuze detonator, striker and split sleeve in tube. |
| A. P. | Red annulus | Plain or red ring above cartridge case. | Steel, coated gilding metal (both sides). | Steel 89 grains | 12 mm | |
| H. V. A. P. | Red annulus | Green tip (10 mm) or 1.5 mm green ring or green tip with R. R. | Steel, coated gilding metal (both sides). | Steel 89 grains | 14.5 mm | |
| A. P. (with tungsten carbide core). | Red annulus or red cap. | Black, plain or copper nickel coated steel. | Steel, coated gilding metal (both sides). | Tungsten carbide 127 grains. | 19.0 mm, 13.5 mm at 30° | |
| A. P./I. | Black or red annulus or red stripe. | Plain or Black Band above cartridge case. | Steel, coated gilding metal (both sides). | Steel core 38 grains. Phosphorus 6 grains | 8 mm | White smoke 400-500 yards. |
| H. A. V. P./I. | Black annulus | Green tip (10 mm) or 1.5 mm green ring. | Steel, coated gilding metal (both sides). | Steel core 38 grains. Phosphorus 6 grains. | 8 mm | White smoke 400-500 yards. |
| A. P./F. | Red annulus | Black tip (10 mm) | Steel, coated gilding metal (both sides). | Steel 39 grains | 8 mm | Green changing to red. All yellow or all green. Change at 400-500 yards. 900-1,000 yards. |
| H. V. A. P./T. | Red annulus | Black tip (10 mm) green ring 1.5 mm below black. | Steel, coated gilding metal (both sides). | Steel 39 grains | 10.5 mm | Green changing to red. All yellow or all green. Change at 400-500 yards. 900-1,000 yards. |
| Semi-A. P. | Deep green annulus. | Copper nickel | Steel, coated copper nickel. | Machine steel core 90 grains. | 12 mm | |

PROJECTILES

Table 5.—German 13-mm. Solothurn

| TYPE | PROJECTILE MARKINGS | | MATERIAL | FILLING (GRAINS) | TRACE (SECS.) | PENETRATION AT 100 YARDS N. I. | FUZE |
|----------------------|---------------------|---|------------------|----------------------------------|--|--------------------------------|----------------------|
| | BODY | BANDS | | | | | |
| H. E./T..... | Yellow..... | None, or red or brown band. | Steel..... | Penthrite wax—18. | Pale green or red or night trace 1.8 sec. | 4-5 mm..... | Brass A. A. or 1532. |
| H. E./I/T..... | Yellow..... | Blue band at center of body or below fuze. | Steel..... | Penthrite wax—14. Thermite—4. | Pale green 2.2 sec..... | 3-4 mm..... | Brass A. A. or 1532. |
| Tracer..... | Green..... | White band or brown band above driving band. | Steel..... | None..... | Brilliant white or night. | 6 mm..... | None. |
| Practice Tracer..... | Grey..... | Yellow band above driving band. | Steel..... | None..... | Yellow 2.2 sec..... | | |
| A. P./T..... | Black..... | Red, yellow or brown band above driving band. | A. P. steel..... | None..... | Red, pale green or night trace 0.800 yard. | 17 mm, 10 mm at 30°. | None. |

Table 6.—German 15-mm. Mauser

| TYPE | PROJECTILE MARKINGS | | MATERIAL | FILLING (GRAINS) | TRACE (SECS.) | PENETRATION AT 100 YARDS N. I. | FUZE |
|------------------------------|----------------------------|---|------------------|--|--------------------------|--|---------------------|
| | BODY | BANDS | | | | | |
| Tracer..... | Olive green..... | 0.3" yellow band in front of driving band. | Steel..... | None..... | Pale green 2.8 secs..... | | None. |
| A. P./T..... | Black..... | 0.25" yellow band in front of driving band. | A. P. steel..... | None..... | Pale green 2.2 secs..... | 26 mm, 23.5 mm at 20°. | None. |
| A. P. Tungsten Carbide core. | Black 10-mm tip unpainted. | None..... | Light alloy..... | Tungsten carbide 580. | None..... | 38 mm at 200 yards. Normal 0.20 mm at 200 yards 30°. | None. |
| H. E./T..... | Yellow..... | Black band in front of driving band. | Steel..... | | Pale green 2.0 secs..... | | A. Z. 1551 (brass). |
| H. E./T (S. D.)..... | Yellow or unpainted. | None..... | Steel..... | Penthrite wax 43. | Pale green 2.0 secs..... | | A. Z. 1551 (brass). |
| H. E./I/T. (S. D.)..... | Yellow..... | 0.25" blue band 1.0" from nose or in middle of projectiles. | Steel..... | Penthrite wax 29. 4 incendiary pellet 21.8. | | | A. Z. 1551 (brass). |

GERMAN EXPLOSIVE ORDNANCE

Table 7.—German 20-mm Mauser and Oerlikon Ammunition

| TYPE | PROJECTILE MARKINGS | | MATERIAL | FILLING (GRAINS) | TRACE (SECS.) | PENETRATION AT 100 YARDS NORMAL IMPACT | FUZE |
|-------------------------------|---------------------|--|---------------------------------|--|----------------------------|--|--------------------------------------|
| | BODY | BANDS | | | | | |
| Ball | Olive green | None | Steel | None | None | | None |
| A. P. | Black | None | A. P. steel | Inert | None | 17 mm normal, 10 mm 100 yards, 30° | None |
| A. P./I. | Black | 0.2" blue band at 0.7" from nose or 0.2" blue band at 0.4" above D. B. | A. P. steel | Phosphorus 52. In light alloy case. | None | 17 mm | None |
| A. P./H. E. | Black | 0.7" yellow band at 0.2" above D. B. or 0.2" yellow band 0.7" below nose. | A. P. steel | Penthrate wax 78. | None | 17 mm | None |
| Tracer ¹ | Olive green | Yellow and mauve above driving band. | Steel | None | Brilliant white 1.8. | 7.5 mm at 200 yards 20° | None |
| Tracer | Olive green | Yellow above driving band and white below nose with 3 arrows stamped on nose plug. | Steel | None | Brilliant white or yellow. | | None |
| I/T | Navy blue | 0.2" red band or maroon band. | Steel | Incendiary filling similar to green band type. | Approx. 4 secs | | Aluminum det. by nose (strikerless). |
| H. E./T. (S. D.) ¹ | Yellow | Black 0.4" above driving band. | Steel | Penthrate wax—57.1. | Yellow, 2.0. | | A. Z. 1501 (Brass). |
| H. E./T. (S. D.) | Yellow | None | Steel | Penthrate wax—57.1. | Pale green, 1.4. | None | A. Z. 1504 Alum. |
| H. E./T. (S. D.) ¹ | Steel, unpainted. | White band above driving band. | Steel | Penthrate wax—49.2. | Brilliant white, 6.0. | | A. Z. 1502 (Brass). |
| H. E. (M Projectile) | Yellow | Black below fuze | Drawn steel hemispherical base. | Penthrate wax—262. | None | 6 mm at 200 yds. 20°. | A. Z. 1502 (Brass). |
| H. E./I. (M) Projectile. | Yellow | Green below fuze | Drawn steel hemispherical base. | Penthrate wax, incendiary pellet. | None | | Z. Z. 1505, steel, brass coated. |
| H. E./I/T (S. D.) | Yellow | 0.2" blue 0.4" above driving band or 0.25" blue below fuze. | Steel | Penthrate wax—55. Incendiary 8. | | | Alum. A. Z. 1504. |
| H. E./I/T (S. D.) | Yellow | Brown above DB, blue below fuze. | Steel | | Bright night | | Aluminum plated A. Z. 1504. |
| H. E./I/T (S. D.) | Yellow | 0.25" green band below fuze, 0.2" red band above DB. | Steel | Penthrate wax—36. Incendiary 34. | Deep yellow | | Aluminum plated A. Z. 1504. |

¹ These types are out-of-date but may be still in service.

GERMAN PROJECTILE FUZES

INTRODUCTION

Nose Fuzes

Nose fuzes, with the exception of one of the models used in the 3.7-cm Pak. (antitank gun) ammunition, are designated in a numbered series. In some instances—as, for example, the 23 fuze—there is more than one type of the model, but these are all designated under the same number.

The letter “S” with an oblique stroke immediately in front of the fuze number indicates a mechanical fuze.

The following letters included in the designation of nose fuzes will precede the model number (or letter and number):

- A. Z.: Point detonation fuze.
 - E. K. Zdr.: Sensitive type of point detonating fuze.
 - K. Z.: Point detonating type under a ballistic cap, except in the case of the K. Z. 38, an ordinary P. D. fuze.
 - Kl. A. Z.: Smaller size of a point detonating fuze model.
 - Wgr. Z.: Fuze for infantry gun or howitzer shell. Zt. Z.: Time fuze.
 - Zt. Z.: Time fuze.
 - Dopp. Z.: Combination fuze—time and impact.
- Fuzes for smoke shells have the letters NB following the fuze number.

The exception 3.7-cm fuze referred to is designated 3.7-cm Kpf. Z. Zerl. P. The letters “Kpf. Z.” indicates a nose fuze, while Zerl. P. indicates the presence of a gunpowder pellet which is destroyed on firing to release a centrifugal safety device.

Base Fuzes

Base fuzes are designated to include the calibre of the equipment and the nature of projectile in which used.

The following are typical examples: Bd. Z. f 7.5-cm Pzgr.—Indicates base fuze for 7.5-cm armor-

piercing projectile. Bd. Z. f 15-cm Gr. 19 Be—indicating base fuze for 15-cm anticoncrete shell Model 19.

Delay and Superquick Settings

Fuzes with a setting device for optional delay are stamped with the letters “M,” “V,” “O,” to indicate the positions to which the slot in the setting plug must be set to obtain either delay or nondelay action.

With nose fuzes the “M” and the “V” are normally diametrically opposite and the plug is turned so that the slot in its head is aligned with them to obtain “with delay” action.

With base fuzes the “M” and “V” are stamped together as “MV” and the slot in the setting plug is aligned with this stamping to obtain delay action.

The “O” stamping indicates the setting position for “without delay.”

The stamping settings are colored in red. With these types of fuzes the letter “V” followed by numerals enclosed in brackets, is printed after the fuze number on package labels and also on the fuze body. The letter indicates delay and the figures the period of delay.

Examples: A. Z. 23 n. V (0.25) or A. Z. 23 v. (0.25)—Point Detonating Fuze No. 23 with 0.25-second delay. MV (mit versögerung) with delay, O or OV without delay. (Ohne versögerung.)

Markings on Fuze Boxes

Fuze markings give the type of fuze, the manufacturer, the lot number, and the number of fuzes packed.

In addition, point detonating fuze boxes are marked at each end with vertical stripes.

Examples: One (1) red band at each end. Box contains a point detonating fuze. One (1) white band at each end. Box contains a point detonating superquick fuze. One (1) black band at each end. Box contains fuzes with a short delay. One (1) violet band at each end. Box contains fuzes with long delay.

GERMAN EXPLOSIVE ORDNANCE

If the fuzes are of the type with reinforced springs, one of the bands mentioned above is replaced by a green band.

Boosters

Boosters are designated in a numbered series, sometimes with a letter and an oblique stroke immediately in front of the number.

| BLACK MARKINGS | INDICATIONS |
|----------------|-----------------------------------|
| Zdlg. A | Booster A. |
| Zdlg. B | Booster B. |
| Zdlg. C/98 | Booster C/98. |
| Zdlg. C/98Np | Booster C/98 filled. PETN/Wax. |
| Gr. Zdlg. C/98 | Larger booster C/98. |

Auxiliary Boosters

Where paper wrappers are used, the marking "Zdlg" is also used as the designation for auxiliary boosters and for the bursting charge similar to a burster which is used in smoke shells.

The Cyclonite/Wax used in exploders is colored blue or bluish-green.

The PETN/Wax used in exploders is colored pink.

NOSE FUZE Z. ZERL. FG.

EMPLOYMENT: Nose fuze for 20-mm A. A. projectile with self-destructing arrangement. (See fig. 551.)

DATA:

Over-all length: 1.062 inches.
Maximum diameter: 0.75 inch.
Threaded length: 0.375 inch.
Number of threads: 8 RH.

ACTION: As the projectile leaves the gun, the rotation imparted to it by the rifling causes the spiral bore safety ribbon to unwind enabling the firing pin to pass on to the primer on impact.

The following is the self-destructing actions: Preparatory to firing, the firing spring bushing is under tension because of the firing spring and is held in a cocked position by the firing lever. This lever is held in position by the catch. The centrifugal segment allows the catch to remain in the locking position and prevents the lever from unhooking itself. Should this lever unhook itself the firing spring bushing, because of the firing spring, would force the lever out of position and the firing pin would be shoved through the central hole stopping on the spiral bore safety ribbon.

Upon firing, centrifugal force causes the centrifugal lever to move outward. This movement

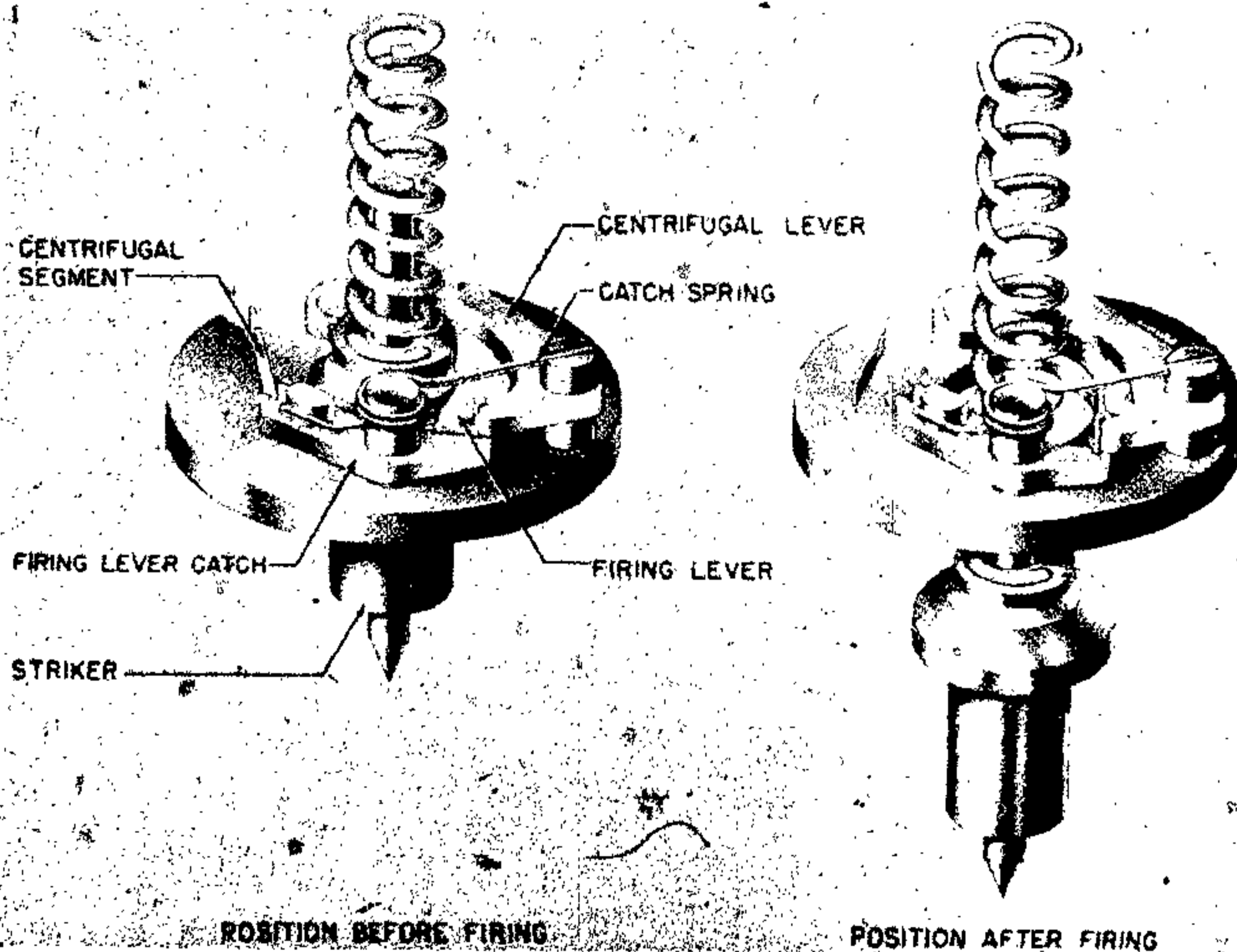

Figure 551—Z. Zerl. Fg.

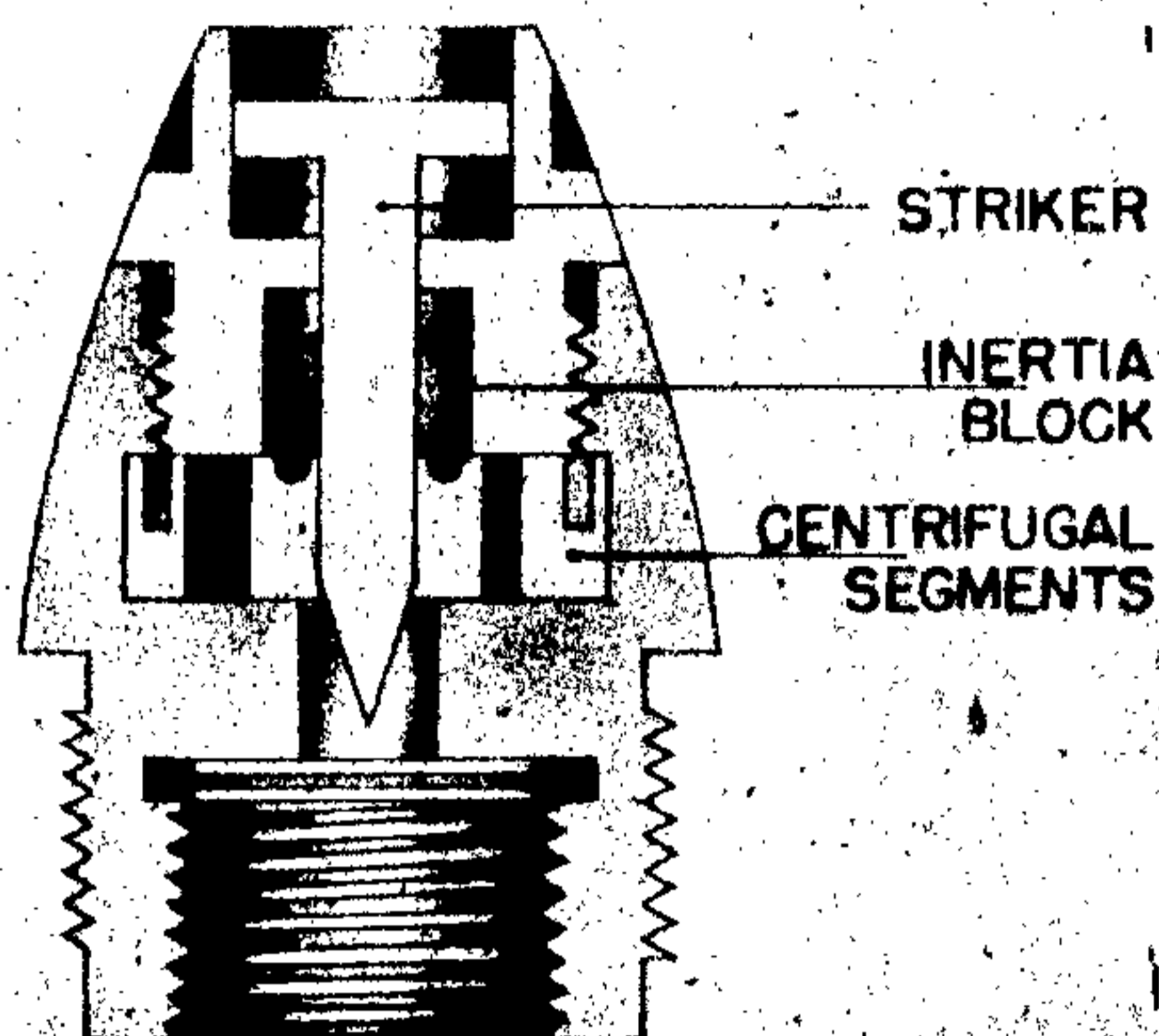

Figure 552—A. Z. 1502 F

causes the catch to pivot slightly taking the strain off of the segment. As soon as the segment is set free, it is bent outward because of centrifugal force. Since the metal in the segment is soft, there is no spring action to bring it back to its former position. During flight the lever, because of centrifugal force, continues to hold the catch in the locked position. The mechanism remains in this position as long as centrifugal force can equal the tension created by the spring which tends to release the catch.

As the rotation of the projectile decreases, the centrifugal force accordingly decreases causing the centrifugal lever to relax its pressure on the catch. The tension of the spring opens the catch which releases the firing lever. The firing spring and bushing, together with centrifugal force, moves the lever outward, allowing the firing spring bushing to pass through the central hole. Since the spiral bore safety ribbon has now completely unwound, the firing pin will carry through and fire the primer.

Of special note in the mechanism is the highly polished surface of the firing spring bushing. This smoothness is probably necessary for the proper functioning of the fuze.

NOSE FUZE A. Z. 1502 F

EMPLOYMENT: Nose fuze used on German 20-mm. ammunition. (See fig. 552.)

DATA:

Over-all length: 1.000 inch.

Maximum diameter: 0.781 inch.
 Threaded length: 0.250 inch (with washer).
 Number of threads: 6 RH.

CONSTRUCTION: The fuze is aluminum and has a recess in the base which houses a detonator cup. A floating striker is held in position by a coiled aluminum tape bearing against a shoulder on the striker body. A wooden hammer rests against the striker head and is just below the nose closing cap.

ACTION: Centrifugal force unwraps the aluminum tape freeing the striker. On impact, the hammer forces the striker into the detonator.

REMARKS: The A. Z. 1502, an earlier version of the 1502 F, employs the standard German centrifugal segments surrounded by a coiled strip of brass, but that is the only difference in the two fuzes.

NOSE FUZES A. Z. 1503 AND A. Z. 1504

EMPLOYMENT: Nose fuzes used in German 20-mm. ammunition. (See fig. 553.)

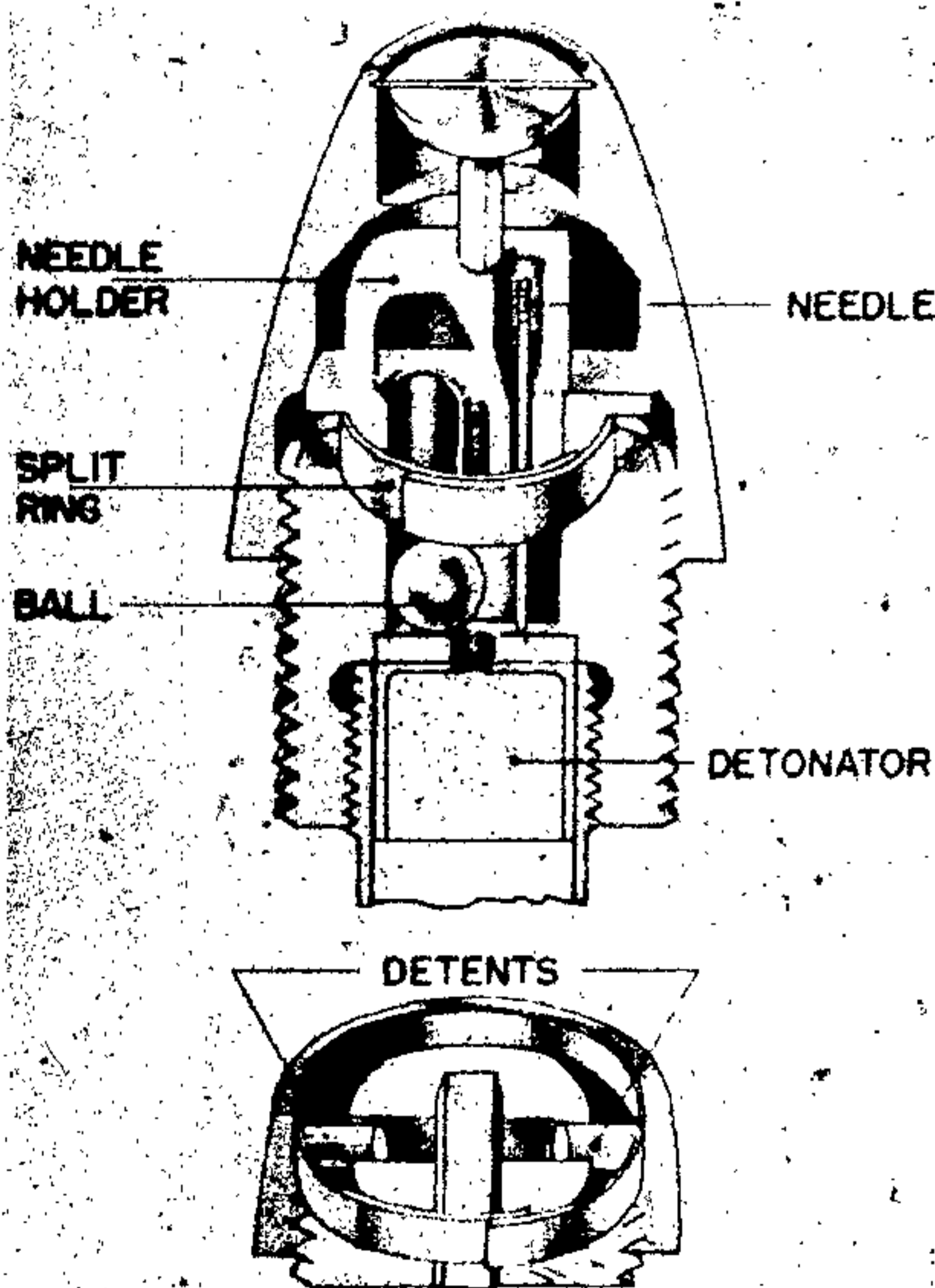

Figure 553—A. Z. 1503 and A. Z. 1504

GERMAN EXPLOSIVE ORDNANCE

DATA:

- Over-all length: 1.094 inches.
- Maximum diameter: 0.750 inch.
- Threaded length: 0.375 inch.
- Number of threads: 9 RH.

CONSTRUCTION: The steel body has a closing disk in the nose and threads on the base of the fuze for engaging the projectile. A detonator screws into a recess in the base of the fuze body.

Inside the fuze body, a striker holder keeps the striker out of line with the detonator. This holder is kept from moving down by two detents attached to a split ring which surrounds the holder.

A small steel ball rides in a slot below the striker holder and keeps it in the offset position.

ACTION: Centrifugal force opens the split ring withdrawing the detents from the striker holder. During deceleration, the small ball creeps forward into a recess in the top of the striker holder. The holder is then free to move over bringing the striker in line with a central channel so that, on impact, it may pierce the detonator.

REMARKS: The only difference between the A. Z. 1503 and the A. Z. 1504 is that the 1504 is made of aluminum not steel.

NOSE FUZE Z. Z. 1505

EMPLOYMENT: German self-destroying nose fuze used in the 2-cm Mauser (H. E. ammunition). (See fig. 554.)

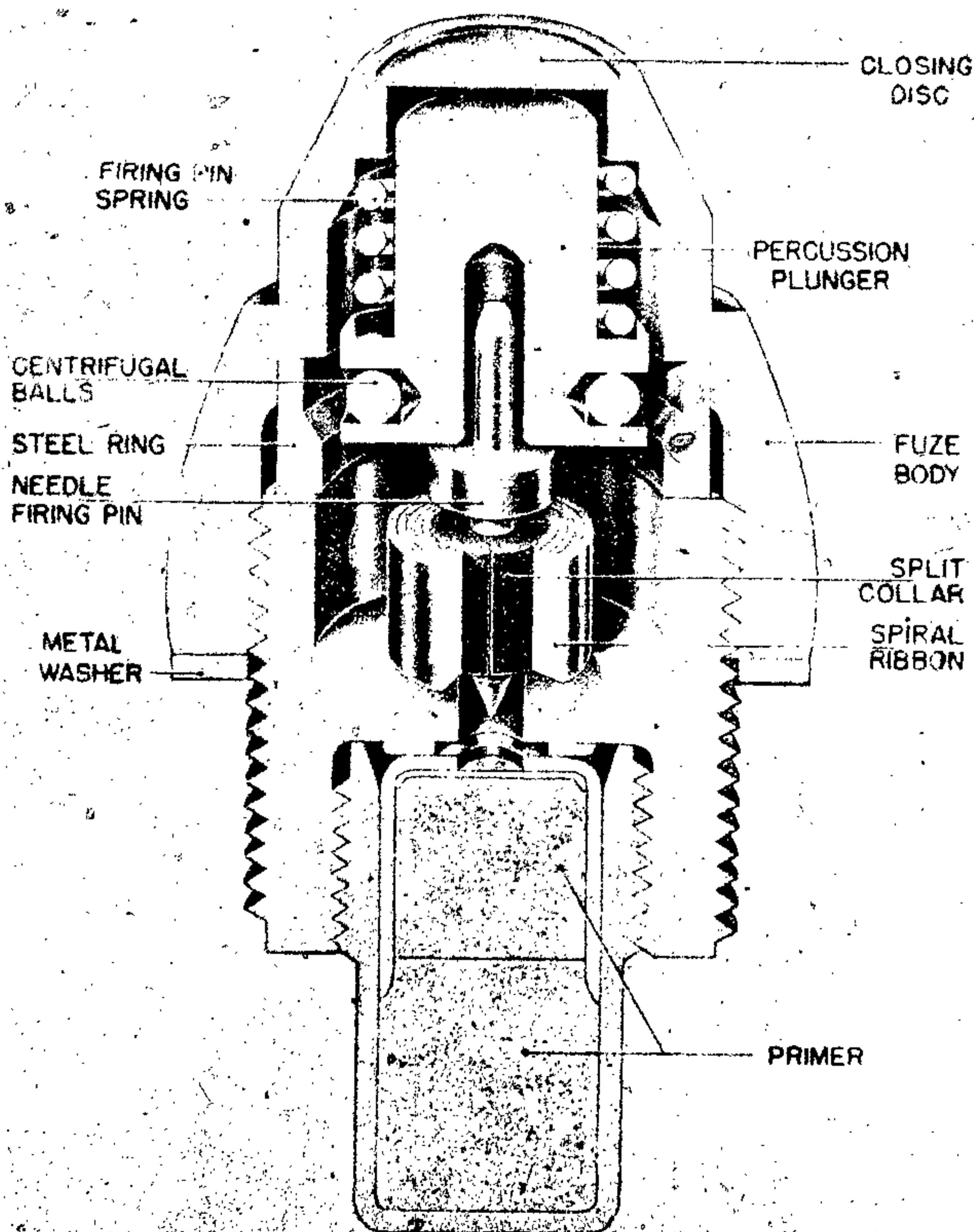

Figure 554—Z. Z. 1505

DATA:

Over-all length: 1.063 inches.
 Maximum diameter: 1.781 inches.
 Threaded length: 0.250 inch.
 Number of threads: 7 RH:

CONSTRUCTION: The steel body of the fuze has a metal closing disc at the nose which protects the striker from air pressure and it is threaded at the base to engage the threads of the projectile. A primer detonator is screwed into the base of the fuze.

Inside the fuze a shoulder on the firing pin bears against a split collar on the bottom and a percussion plunger on the top. The split collar is housed in a recess in the center of the fuze and is held together by a spiral brass ribbon. The percussion plunger in the upper recess of the fuze is surrounded by a compressed spring bearing against the fuze body at the top and a shoulder on the plunger at the bottom. The shoulder on the plunger is grooved to house eight steel centrifugal balls. The balls are retained in position by a steel ring which increases in its internal diameter towards the top and is supported by the body of the fuze. There is a central hole in the fuze to permit the striker to reach the primer.

ACTION: Centrifugal force causes the steel balls to fly out into the enlarged portion of the retaining ring thus locking the percussion plunger and its compressed spring in place. Centrifugal force also loosens the brass ribbon permitting the split

collar to be thrown free of the striker. Upon impact the steel balls are cammed back into their housing and the compressed spring aids in activating first the plunger and then the firing pin, the latter piercing the primer.

When impact does not occur before a certain length of time, the spring overcomes the decreasing centrifugal force and causes the balls to be cammed back into their housing again releasing the plunger so that it may force the firing pin into the primer.

NOSE FUZE A. Z. 1531

EMPLOYMENT: Nose fuze used in 20-mm Aircraft Cannon Ammunition. (See fig. 555.)

CONSTRUCTION: The single piece body has a closing disk in the nose and threads at the base to engage the projectile.

A shoulder on the floating striker bears against two half collars on the bottom and a light spring on the top. The bottoms of the half collars are locked in a seat in the fuze body and are kept there by the force of the light spring.

ACTION: The striker and half collars are held in position during the initial phases of the projectile's flight. Upon deceleration, however, the striker creeps forward, compressing the spring and thus freeing the half collars. These collars creep forward out of the seat and are separated by centrifugal force. The striker is then permitted to pierce the detonator upon impact.

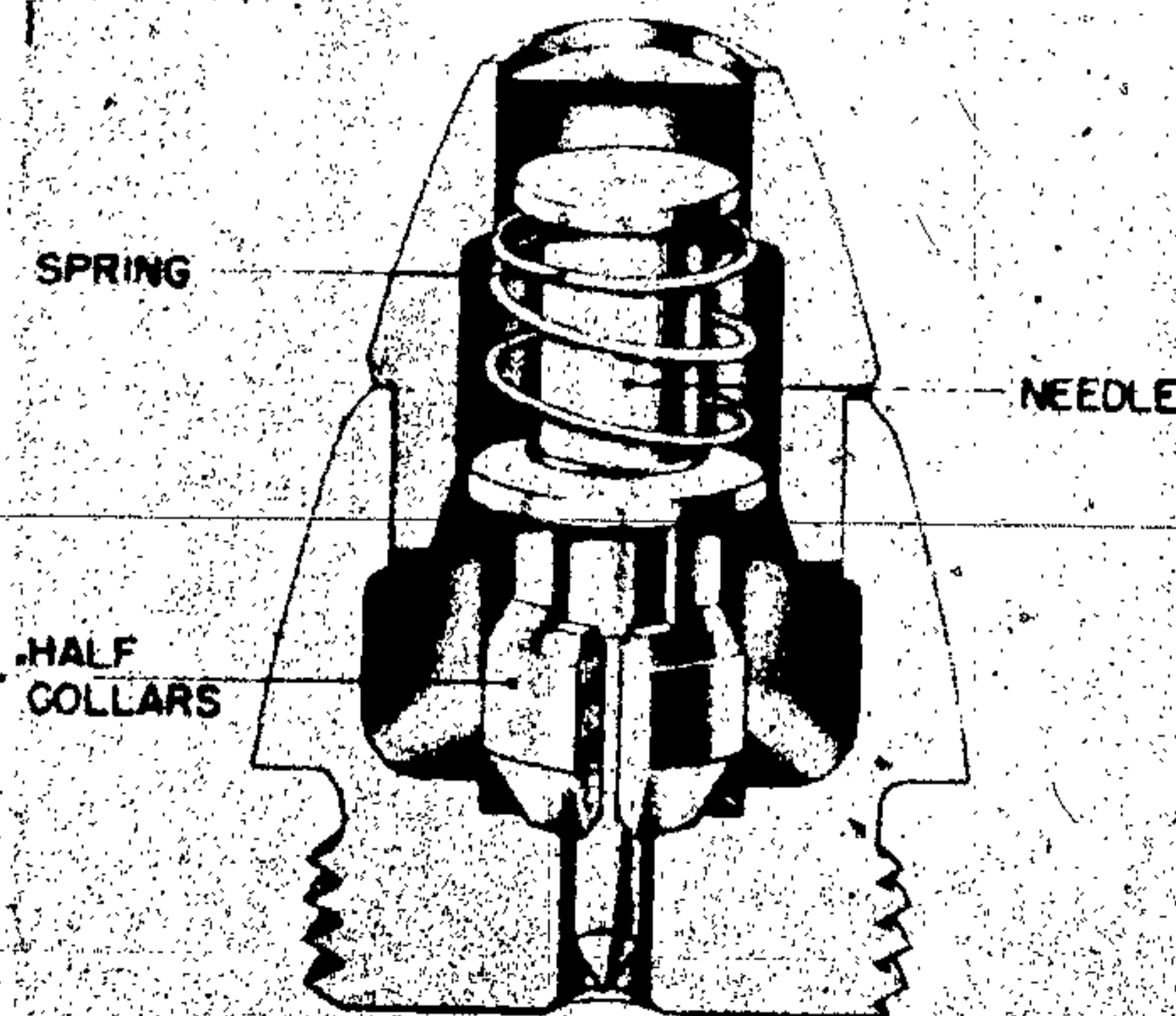

Figure 555—A. Z. 1531

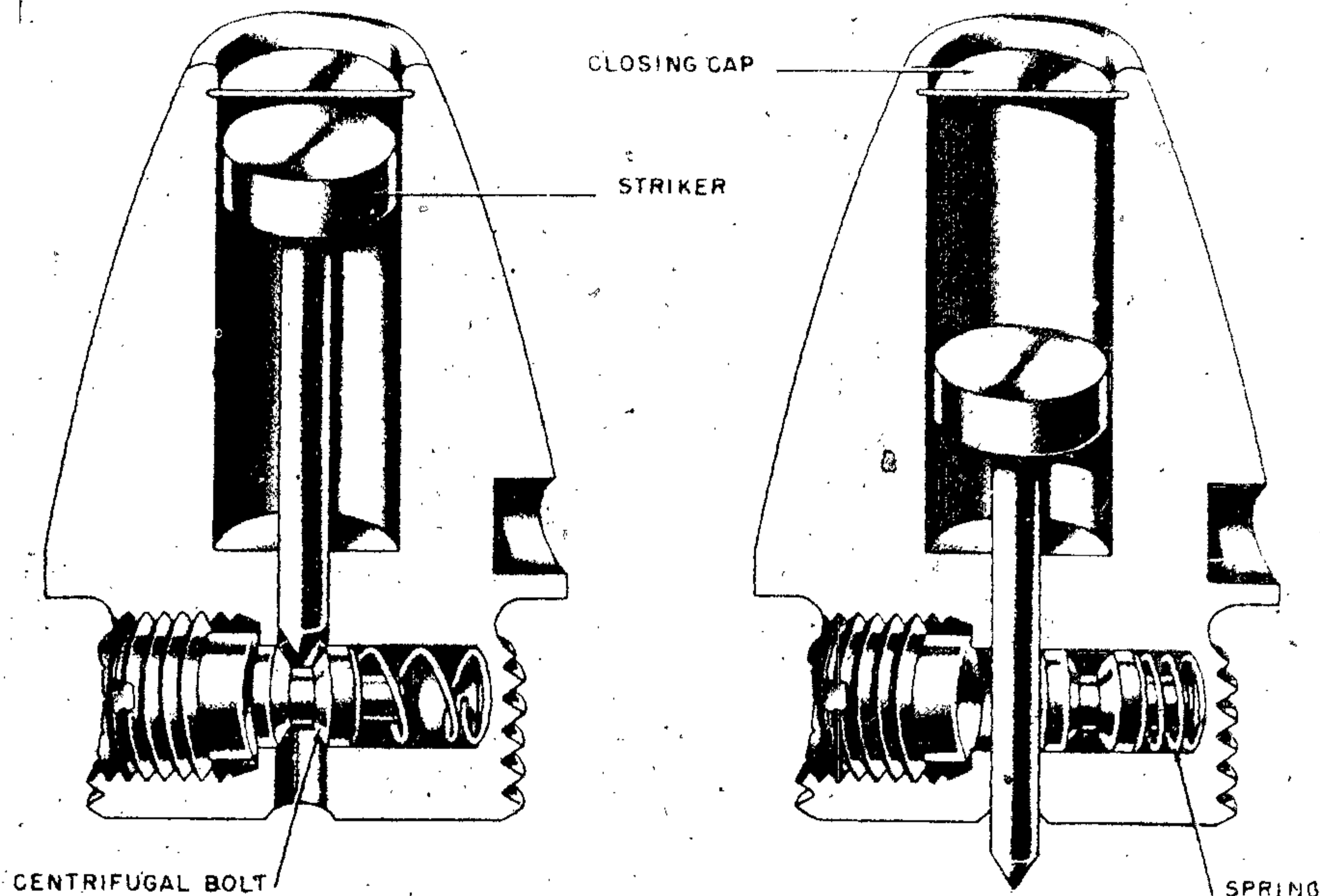

Figure 556—A. Z. 1532

NOSE FUZE A. Z. 1532

EMPLOYMENT: Nose fuze used in German 13-mm ammunition. (See fig. 556.)

DATA:

- Over-all length: 0.594 inch.
- Maximum diameter: 0.406 inch.
- Threaded length: 0.156 inch.
- Number of threads: 5 RH.

CONSTRUCTION: The fuze is of single piece construction with a closing cap in the nose and threads on the base for engaging the projectile. A long striker is housed in a central cavity and it is held in place by a centrifugal bolt.

ACTION: On set-back, the striker engages a groove in the centrifugal bolt locking it in place. During deceleration, the striker creeps forward permitting the bolt to move outward clearing the central channel. The striker is then free to strike the detonator upon impact.

NOSE FUZES A. Z. 1551 AND A. Z. 1552

EMPLOYMENT: Nose fuzes used in German 15-mm ammunition. (See fig. 557.)

DATA:

- Over-all length: 0.688 inch.
- Maximum diameter: 0.500 inch.
- Threaded length: 0.188 inch.
- Number of threads: 5 RH.

CONSTRUCTION: The brass body has a closing disc in the nose and threads near the base of the fuze for engaging the projectile. A detonator screws into a recess in the base of the fuze body.

A striker is supported in a central recess of the fuze by two half collars surrounded by a split ring. The under side of the shoulder on the striker is grooved to engage the top of the half collars holding them in place during set-back.

ACTION: After set-back has been overcome, the striker creeps forward freeing the hold collars.

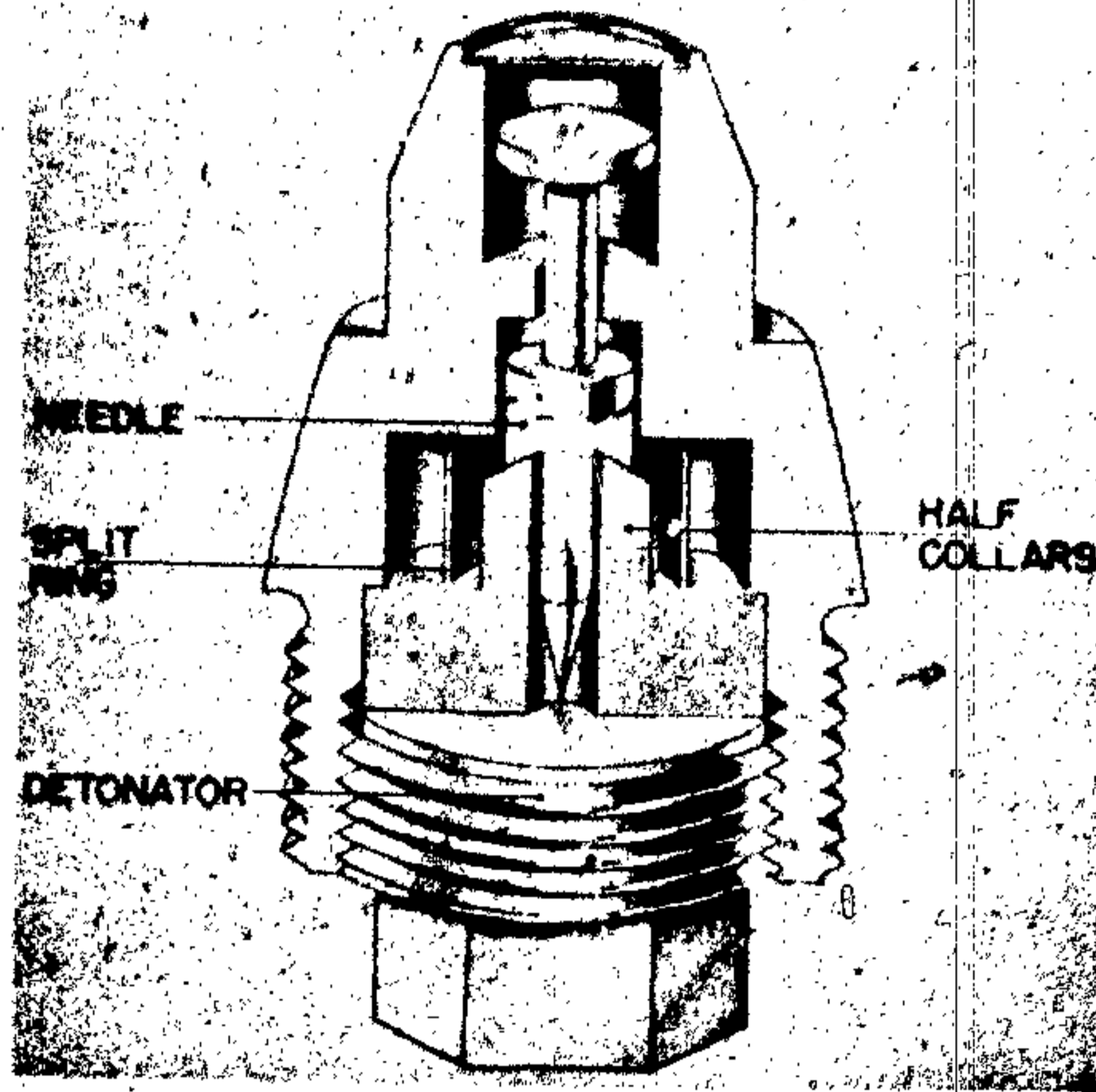

Figure 557—A. Z. 1551 and 1552

Centrifugal force then throws the half collars and the split ring outward permitting the striker to pierce the detonator upon impact.

REMARKS: The A. Z. 1552 is the same fuze as the A. Z. 1551 except that it is made of steel.

NOSE FUZE Z. 45

EMPLOYMENT: Nose fuze used on German 20-mm ammunition. (See fig. 558.)

DATA:

- Over-all length: 1.000 inch.
- Maximum diameter: 0.781 inch.
- Threaded length: 0.250 inch (with washer).
- Number of threads: 6 RH.

CONSTRUCTION: The body construction is similar to the A. Z. 1502 F.

This fuze, however, employs the standard centrifugal segments surrounded by a coiled brass strip.

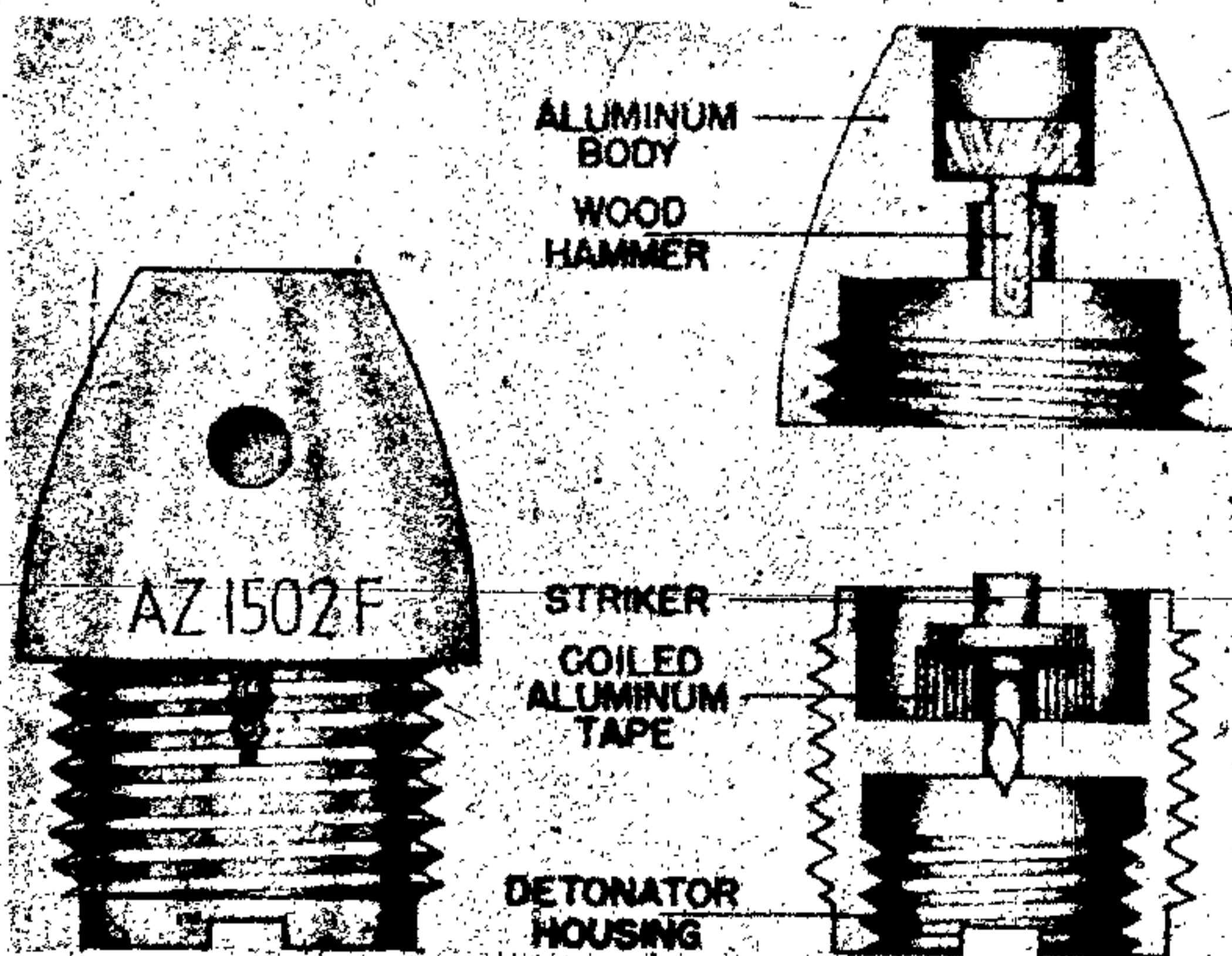

Figure 558—Z. 45

GERMAN EXPLOSIVE ORDNANCE

These segments are grooved on the top to engage the small projections on the bottom of an inertia block which surrounds the striker. The striker and hammer of the 1502 F are replaced in Z. 45 by a striker of single piece construction.

ACTION: On set-back, the inertia block engages the centrifugal segments preventing them from releasing the striker. During flight, the inertia block creeps forward and the segments are permitted to fly out as the brass strip uncoils. On impact, the striker is driven into the detonator.

FUZE, PERCUSSION, D. A., A. Z. 5045

DESCRIPTION: This fuze is of the detonating type with a direct action of the floating striker type. The fuze is used in the 2-cm shell (See fig. 559.)

The aluminum head is recessed at the nose to accommodate a wooden hammer. The hammer is in the form of a disc with a stem on its underside which passes through a hole in the base of the recess and is aligned with the head of the striker. The recess is closed against air pressure by a brass closing disc at the nose. The head is screwed to the body and secured by a small set screw.

The aluminum body is screw-threaded externally for insertion in the shell and internally at the base to receive the magazine. The front face of the body is recessed to house the split collar and is bored centrally to receive the striker.

The striker assembly consists of a steel striker fitted with an aluminum head. The underside of the head is shaped to retain the brass split collar in the safe position. The split collar prevents the striker being driven into the detonator before the fuze is armed and is further retained by $1\frac{1}{2}$ turns of phosphor bronze strip surrounding it.

The magazine is of aluminum and is similar to the type described for the A. Z. 1501.

ACTION: On acceleration the split collar is held by the set-back of the striker.

During flight the phosphor bronze spring uncoils and the split collar is thrown clear by centrifugal force. The striker, now unsupported and the hammer are moved forward by creep during deceleration and are protected from air pressure by the brass closing disc. On impact the hammer is forced in and drives the striker into the detonator.

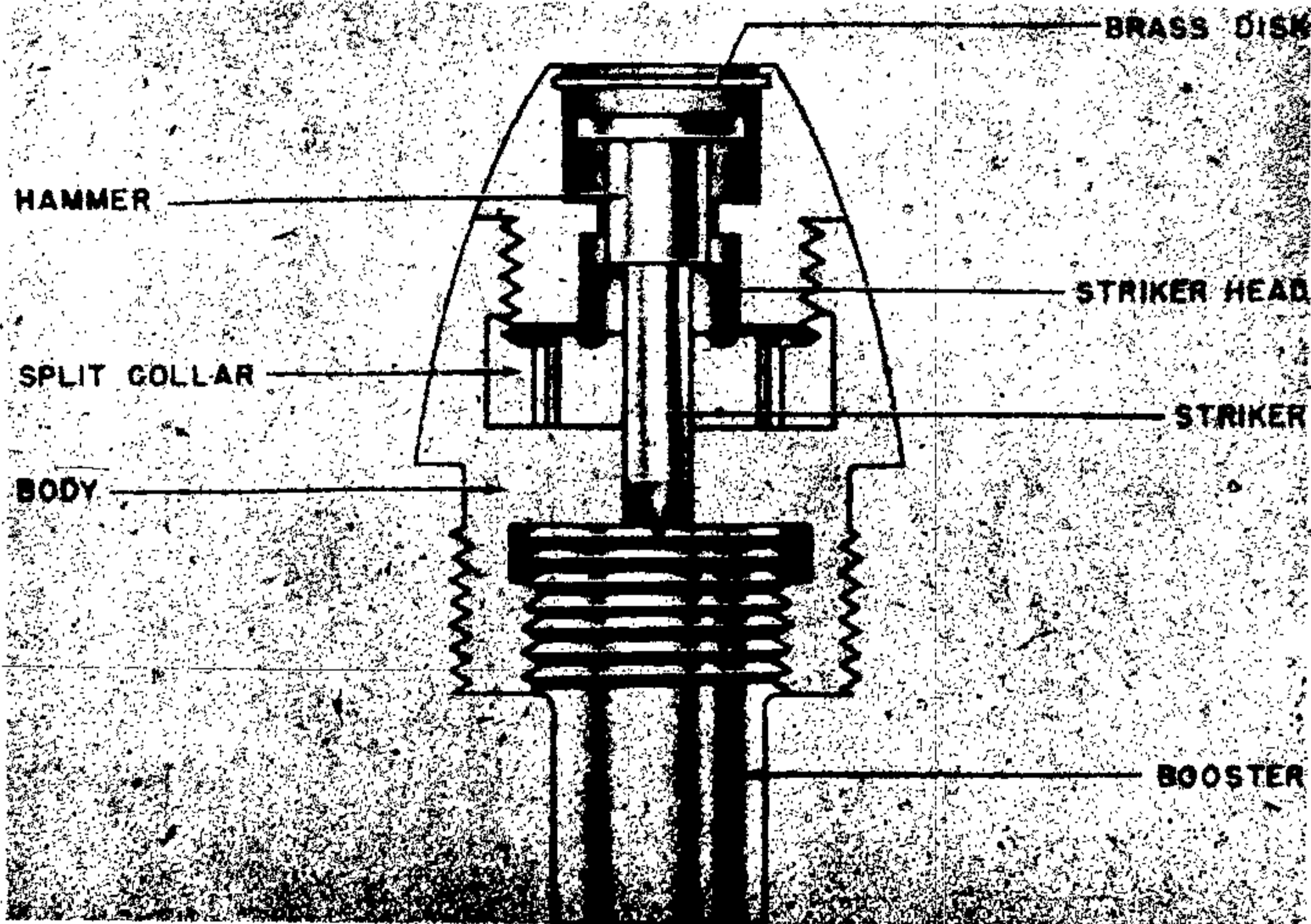

Figure 559—A. Z. 5045

CLOSING CAP

ALUMINUM BODY
STEEL RING

CENTRIFUGAL SEGMENTS

STRIKER

SPRING BAND

DETONATOR RECESS

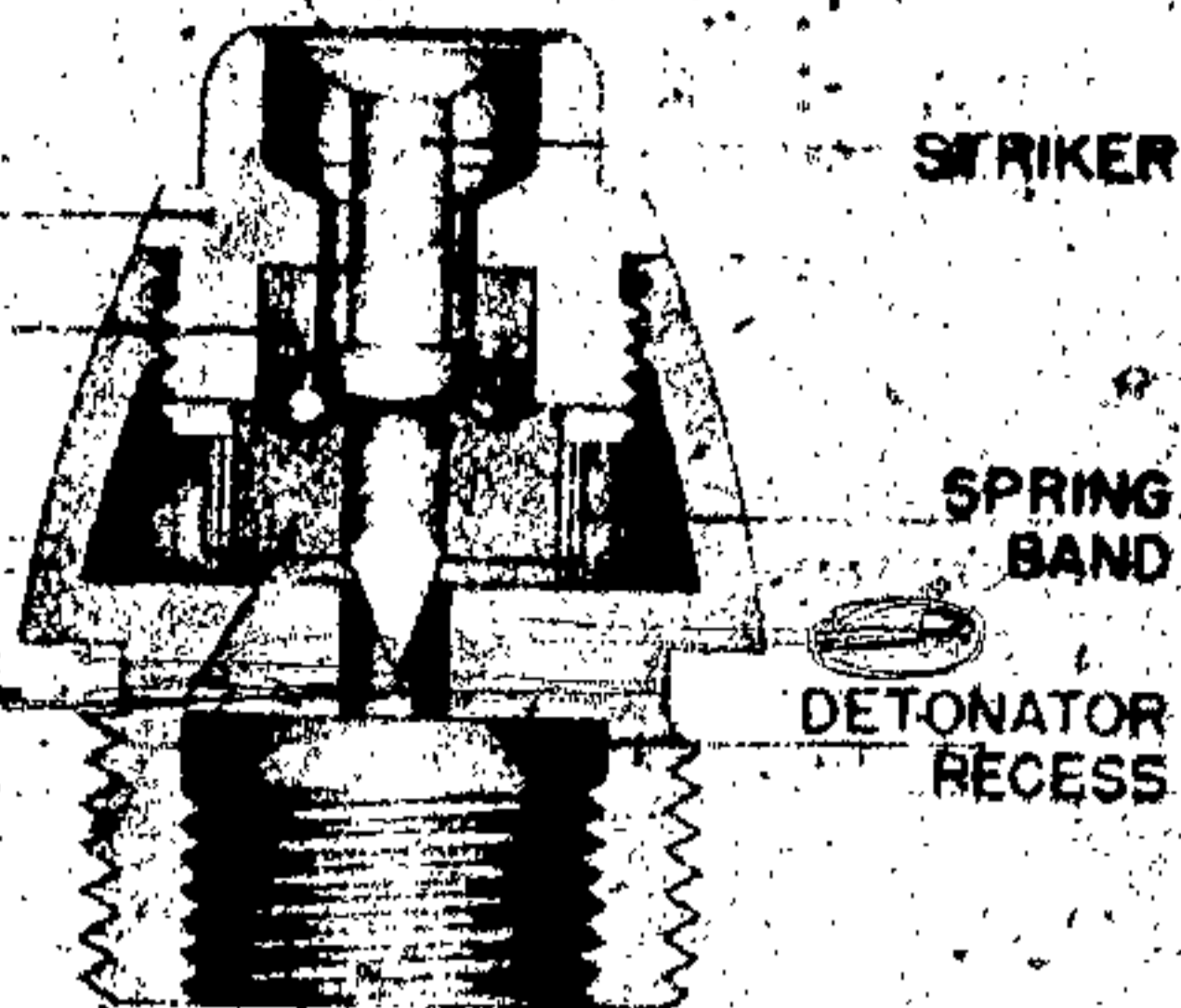

Figure 560—A. Z. 5072.

MECHANICAL NOSE FUZE A. Z. 5072

EMPLOYMENT: Mechanical impact nose fuze for H. E. projectile in 28-20 and 42-28 tapered bore guns. (See fig. 560.)

DATA:

Over-all length: 0.937 inch.

Maximum diameter: 0.687 inch.

Threaded length: 0.25 inch.

Number of threads: 6 RH.

CONSTRUCTION: Aluminum body with brass and bronze internal parts. Contains expanding centrifugal segments in a phosphor bronze spring and a movable striker and creep spring.

ACTION: Initial set-back of the steel ring causes the lip on its lower edge to engage with notches on the centrifugal segments thereby keeping the segments from opening while the projectile is in the bore of the gun. This is a bore safety feature. After the projectile leaves the weapon, deceleration causes the steel ring to creep forward, disengaging the lip from the centrifugal segments. Centrifugal force causes the segments to expand the centrifugal spring so that on impact the striker may pass through the segments and pierce the primer.

FUZE BODY

COILED SPRING

INERTIA PELLET

STIRRUP SPRING RETAINER

DETONATOR HOLDER

STRIKER

NEEDLE

CREEP SPRING

STIRRUP SPRING

DETONATOR

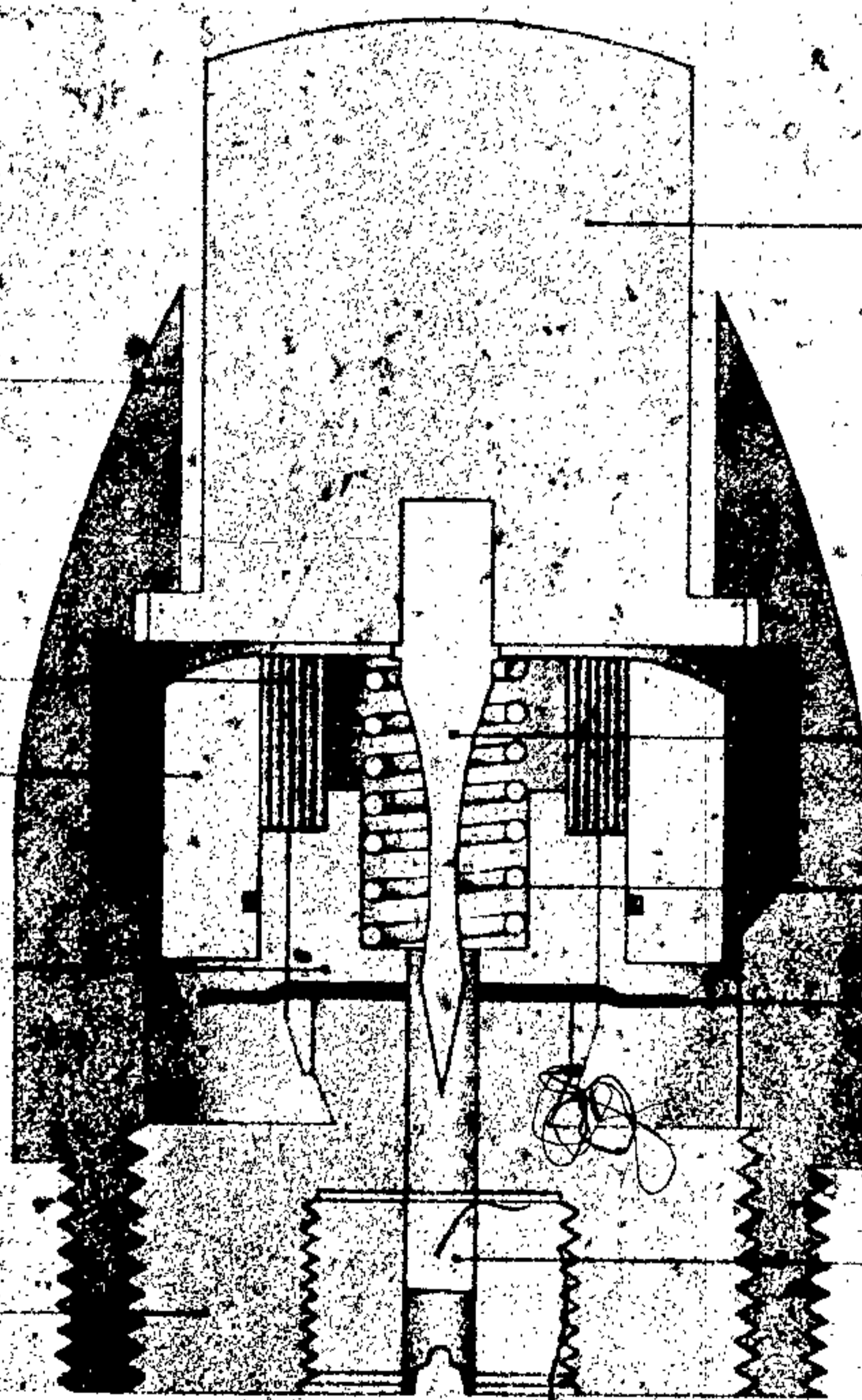

Figure 561—A. Z. 5075, A. Z. 5075 M. K.

GERMAN EXPLOSIVE ORDNANCE

NOSE FUZE A. Z. 5075, A. Z. 5075 M. K.

EMPLOYMENT: Nose fuze for the 3.7-cm Strel-granate (3.7-cm Rodded Bomb) fired from the 3.7-cm Pak. (See fig. 561.)

DATA:

Over-all length: 1.875 inches.

Maximum diameter: 1.187 inches.

Threaded length: 0.25 inch.

Number of threads: 7 RH.

CONSTRUCTION: The fuze is of aluminum and has an ogival body with a hole at the nose through which the cylindrical striker protrudes. The body is screw-threaded for insertion in the grenade and has an internal circumferential recess below the striker to permit the expansion of the coiled spring in flight. The striker carries a needle surrounded by a spiral spring which is held between the underside of the striker and a cup-shaped retainer. The retainer has a central hole for the needle and has a step formed near the front end around which a length of flat spring is coiled. The coiled spring is retained by a cylindrical arming ferrule with an internal groove near its base end. A stirrup

spring is held between the retainer and the detonator holder. The detonator holder is screwed into the base of the fuze and carries an igniferous detonator in a perforated screwed plug. The holder is secured in the fuze body by a set screw.

ACTION: On acceleration the arming ferrule in the fuze sets back over the stirrup spring which engages in its groove and retains it clear of the coiled spring. During this period the coiled spring is held by the set-back of the striker, and propellant gases, entering the flash hole in the screwed closing plug at the base, ignite the delay pellet. During flight the coiled spring is expanded into the annular recess in body by centrifugal force, thus leaving the striker with its needle supported only by the striker spring.

On impact, the striker is driven in and the needle pierces the igniferous detonator of the fuze. The flash from this detonator initiates the detonator in the grenade, which in turn, brings about the detonation of the bursting charge.

REMARKS: This fuze is also used in the German H. E. Rifle and Hand Grenade "Gewehrgranate Spreng."

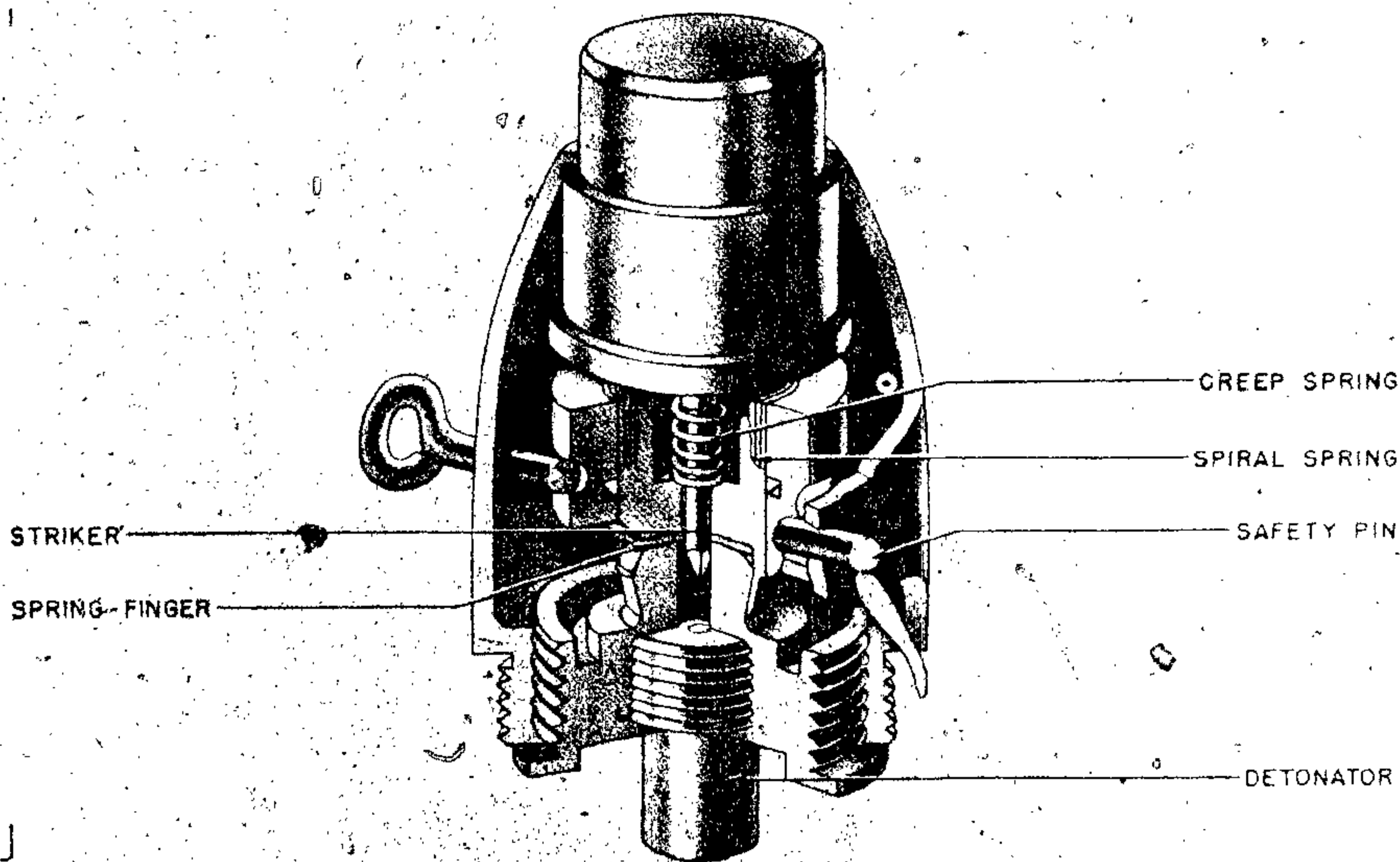

Figure 562—A. Z. 5095

FUZE, PERCUSSION, D. A., A. Z. 5075 AND A. Z. 5095

DESCRIPTION: The fuze A. Z. 5075 is used in the nose of the 3.7 Pak. Stielgranate 41 or hollow charge muzzle stick bomb and, excepting the magazine and magazine assembly, is similar to the nose fuze described for the rifle and hand, selfdestroying grenade. (See fig. 562.) ●

The aluminum body protruding from the nose of the bomb is ogival in shape with an aluminium striker protruding from a hole at the top. The weight of the fuze is 2-oz. 4½-drs. The designation has not been stamped on fuzes examined to date.

The ogival aluminium body is screw-threaded externally for insertion in the bomb and is screw-threaded internally at the base to receive the adapter for the magazine. The interior is recessed for the mechanism, the recess being enlarged near the top to permit the expansion of a coiled spring strip.

The aluminium striker is cylindrical with a flange at the base which engages a step in the body and so limits its upward movement. A steel needle protruding from the base of the striker is secured by an aluminium screw inserted in the head. The striker is supported by a spiral spring and a coiled spring strip, both of which are positioned between the base of the striker and an aluminium spring holder.

The spring holder is in the form of a cylinder with a central hole for the needle and a recess in the top to receive the base end of the spiral spring surrounding the needle. Near the top the holder is reduced in diameter to form a step for the assembly of the coiled spring strip. The lower part of the spring holder is recessed to fit over the top of the magazine holder. The wall of the recess is cut away at four places to permit the four arms of the retaining spring to protrude for the support of the arming sleeve. The retaining spring consisting of a steel disc with a hole for the needle in the center and four arms curved slightly upwards, is held between the spring holder and the top of the magazine holder. The four portions remaining of the wall of the recess in the base of the spring holder are bent inwards to engage an inclined surface near the top of the magazine holder.

The steel arming sleeve, surrounding the coiled spring strip fits around the upper part of the

spring holder and is supported by the retaining spring. Inside the sleeve, near the base, a circumferential groove is cut to engage the arms of the retaining spring when the sleeve is in the armed position.

The magazine holder consists of a cylindrical aluminium plug recessed and screw-threaded internally at the base for the insertion of the magazine. A shoulder formed around the exterior engages a corresponding shoulder in the adapter and carries a locating pin which enters a hole in the shoulder of the adapter. A projection at the top of the holder is bored centrally for the needle and is chamfered near its base for the attachment of the spring holder. The aluminium magazine contains 6.2 grains of PETN under a 5.4-grain detonator. The detonator contains 93.7 percent of lead azide and 6.3 percent of tetrazene.

The aluminium adapter for the attachment of the magazine consists of a screwed ring with a stepped hole for the magazine holder. A rubber ring, to cushion the set back of the arming sleeve, is fixed in a groove in the top of the adapter.

ACTION: With the arming sleeve supported on the retaining spring, the coiled spring strip prevents the striker spring being compressed and thus holds the needle away from the detonator.

On acceleration the arming sleeve sets back on the rubber ring in the adapter and bends back the four arms of the retaining spring. Rebound of the sleeve is prevented by the arms entering the groove inside the sleeve. The coiled spring strip is then free to expand into the enlarged part of the body recess, leaving the striker supported only by the spiral spring.

On impact the striker is forced in and the needle pierces the detonator.

REMARKS: The fuze A. Z. 5095 is used in the nose of the German 8.8-cm A. Tk. Hollow Charge Rocket projectile. Except for the undermentioned differences, it is identical with the fuze 5075.

1. The body is made of steel.
2. The striker is made of black plastic.
3. The retaining spring supporting the arming sleeve has only two arms, instead of four, and these are thinner to permit the fuze to be armed at a much smaller acceleration.
4. The spring holder is cut in two places to accommodate the arms.

GERMAN EXPLOSIVE ORDNANCE

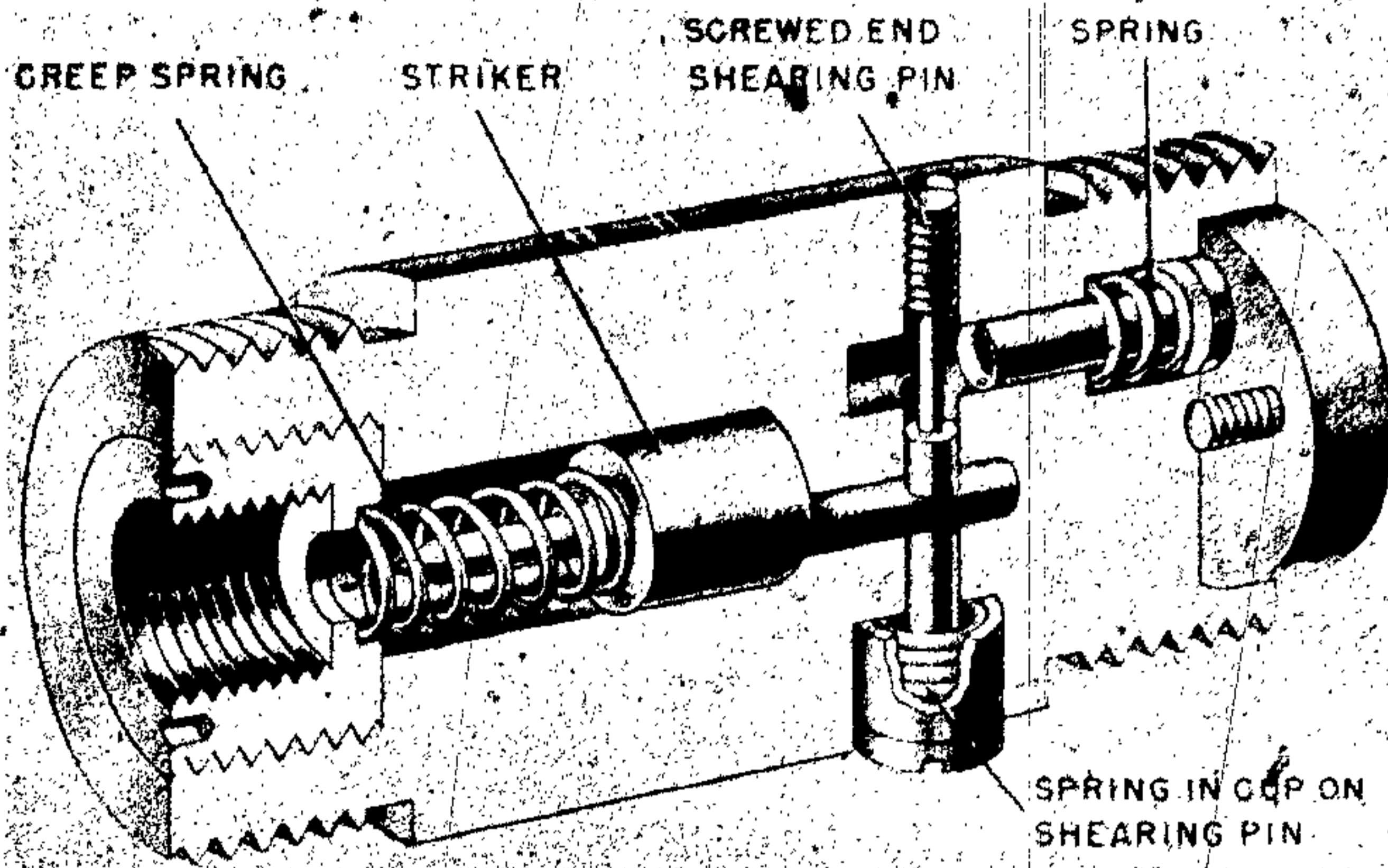

Figure 563—A. Z. 2492

5. The magazine holder, which is of steel, screws into the fuze body direct. The adapter has been omitted.

6. A safety pin is provided. This passes through the fuze body and a circumferential groove cut in the arming collar.

The weight of the fuze is 3.02 ounces. The diameter of the threads is 1.057 inches and the over-all length 2.12 inches.

FUZE, D. A., A. Z. 2492

DESCRIPTION: This fuze body is cylindrical with an external screw-thread at each end for assembly as the connecting piece between the tail unit and the body. A central recess contains the striker and creep spring and is closed at its enlarged front end by an aluminum magazine which is screwed in and contains a detonator and intermediary explosive. A transverse channel near the base contains a spring-loaded screwed shearing pin which engages in a recess in the stem of the striker. Another channel, containing a cutting pin with spring, is bored from the base of the body and communicates with the shearing pin channel at a point where the shearing pin is reduced in diameter. A circular plate, secured in a recess in the base of the body by two screws, retains the cutting pin in its channel. The base end of the cutting pin passes through a hole in the circular plate and is thus exposed to the pressure of the propellant gases. (See fig. 563.)

Details of the magazine filling and the composition in the detonator are not available.

ACTION: The rubber plug is removed from the tail unit and with the cartridge loaded into the rifle in the normal way the tube of the tail unit is placed over the spigot device at the muzzle.

On firing, the hollow wooden bullet is shattered by the propellant gases which project the grenade and, overcoming the spring of the cutting pin, drive the pin forward, causing it to cut the shearing pin away from its screwed end. The shearing pin is then ejected by the spring held in compression under its head, and thus leaves the striker held off the detonator only by the creep spring. On graze the momentum of the striker overcomes the creep spring and the detonator is pierced.

NOSE FUZE K. Z. 40

EMPLOYMENT: Mechanical Nose Fuze with self-destructing arrangement for 3.7-cm H. E. shells. (See fig. 564.)

DATA:

- Over-all length: 2.0 inches.
- Maximum diameter: 1.125 inches.
- Length of threads: 0.312 inch.
- Number of threads: 5 R. H.

CONSTRUCTION: this fuze is essentially the same in construction as the 3.7-cm Kopfzunder

Zerl. Pv. (Z. Z. 16) and the 3.7-cm Kpf. Z. Zerl. P. except that the delay in the self-destroying arrangement is longer.

ACTION: On acceleration the igniferous detonator in the displaced recess sets back on the striker. The flash from the detonator passes through the flash channels to the powder pellet in the radial channel and to the lower end of the delay filling in the first of the vertical channels. When the pellet in the radial channel disintegrates the bolt is thrown outwards by centrifugal force leaving the striker held off from the detonator in the magazine by the creep action resulting from deceleration. On impact, the striker is driven in by the hammer and pierces the detonator in the top of the magazine. During flight, the burning of the delay composition in the first vertical channel is transmitted by the gunpowder in the traverse channel to the delay composition in the second vertical channel. When direct action does not occur before the composition burns to the base of the second channel, the disk of gunpowder confined to the top of the magazine adapter is ignited and

explodes and thus initiates the detonation of the magazine.

NOSE FUZE 3.7-CM KOPFZUNDER ZERL. PV.

EMPLOYMENT: Mechanical Nose Fuze with self-destroying arrangement for 3.7 A. A. gun H. E. shells. (See fig. 565.)

DATA:

Over-all length: 1.75 inches.

Maximum diameter: 1.25 inches.

Threaded length: 0.312 inch.

Number of threads: 5 R. H.

CONSTRUCTION: The above is apparently an improved type of the earlier version of the 3.7-cm Kopfzunder Zerl. P. Only minor modifications are incorporated. The centrifugal bolt holding the striker off the detonator is flat and is held in position by a detent which sits on a gunpowder pellet.

ACTION: On acceleration the igniferous detonator in the displaced recess sets back on the striker.

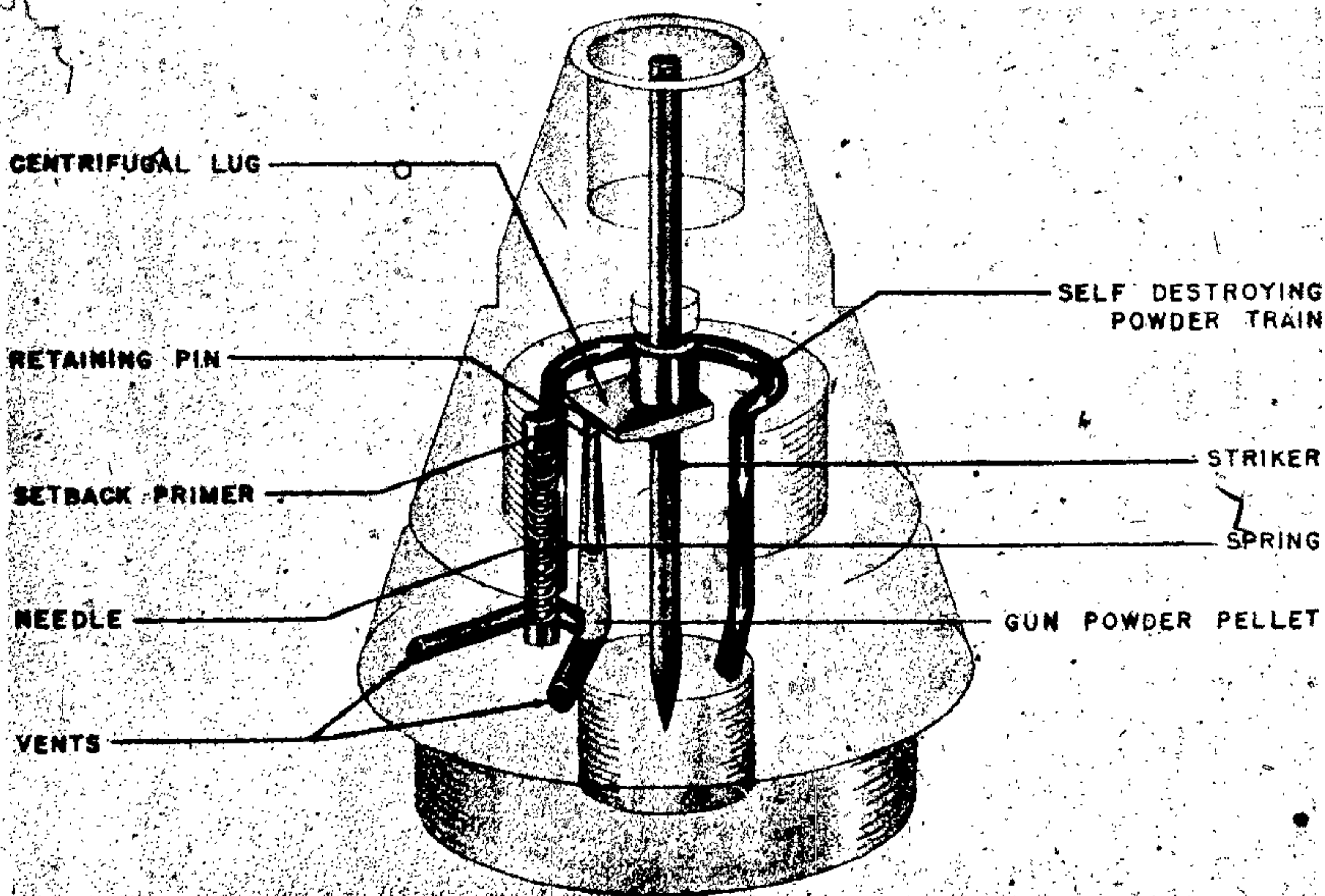

Figure 564—K. Z. 40

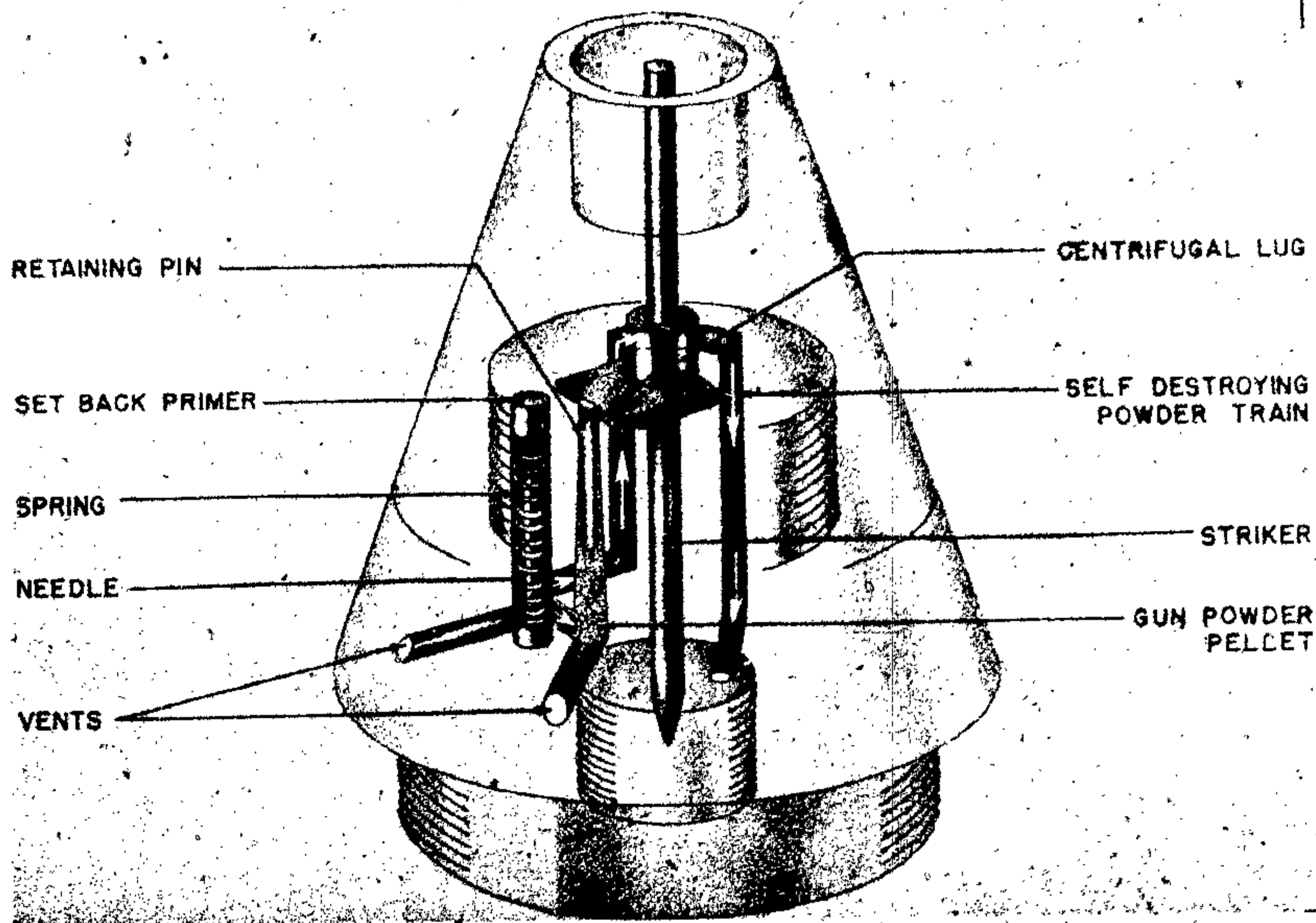

Figure 565—3.7-cm Kopfzunder Zerl. Pv.

The flash from the detonator passes through the flash channels to the powder pellet in the radial channel and to the lower end of the delay filling in the first of the vertical channels. When the pellet in the radial channel disintegrates the bolt is thrown outwards by centrifugal force leaving the striker held off the detonator in the magazine by the creep action resulting from deceleration. On impact the striker is driven in by the hammer and pierces the detonator in the top of the magazine. During flight, the burning of the delay composition in the first vertical channel is transmitted by the gunpowder in the traverse channel to the delay composition in the second vertical channel. When direct action does not occur before the composition burns to the base of the second channel, the disk of gunpowder confined in the top of the magazine adapter is ignited and explodes and thus initiates the detonation of the magazine.

REMARKS: Now issued in a light steel body and known as Z. Z. 16.

NOSE FUZE 3.7-CM KPF. Z. ZERL. P.

EMPLOYMENT: Mechanical nose fuze with self-destroying arrangement for 3.7-cm Pak H. E. shells. (See fig. 566.)

DATA:

- Over-all length: 1.75 inches.
- Maximum diameter: 1.25 inches.
- Threaded length: 0.437 inch.
- Number of threads: 5 RH.

CONSTRUCTION: The fuze is of aluminum alloy with a body tapering towards the flat topped nose. The tip of the fuze is red and the stamping, "3.7-cm. Kpf. Z. Zerl. P." on the side of the body, is also colored red. The fuze is of the direct action type and includes a safety device which is released by the disintegration of a pellet of gunpowder. The detonator which ignites the powder pellet also ignites a delay composition which connects with the magazine of the fuze and provides a self-destroying action when direct action does not occur.

The direct action mechanism is contained in a central recess in the body and consists of an aluminum hammer supported by a steel pellet which is integral with the striker. The striker pellet is supported by a centrifugal bolt which protrudes from a radial channel in the body. The hammer consists of a circular disk with a stem which passes through a guide screwed into the body recess. The recess is closed at the top by a thin brass disc and has a hole at the base for the stem of the striker which enters a guide in the magazine adapter.

The brass centrifugal bolt is slotted at its inner end to fit around the stem of the striker and has a collar formed round its center which limits its inward movement. A stem formed on its outer end bears against a pellet of gunpowder contained in an aluminum perforated capsule attached to the inner side of the closing plug of the radial channel. The capsule is cylindrical with a concave wall with perforations equally spaced around it. The inner end of the capsule, which bears against a lead washer supported by a shoulder in the radial channel has a hole in the center to receive the stem of the centrifugal bolt. The screwed closing plug

carrying the capsule has a lightly closed vent at its center for the escape of pressure when the powder is ignited. Two inclined flash channels connect the radial channel with a recess containing a detonator and striker assembly.

The recess containing the detonator with its spiral supporting spring and screwed striker is displaced from the center of the fuze. The two inclined flash channels connecting the recess with the radial channel are located one near the top of the recess and the other near the bottom. An additional inclined flash channel, also near the bottom of the recess, connects with the channels containing the delay composition for the self-destroying action.

The delay composition for the self-destroying action is contained in two vertical channels with a transverse connecting channel. The flash channel from the detonator recess leads into the closed lower end of the first vertical channel. This channel is filled from the upper end with delay composition and closed at the top by a plug which is machined to correspond with the tapering body of the fuze. Near the top of the channel a transverse

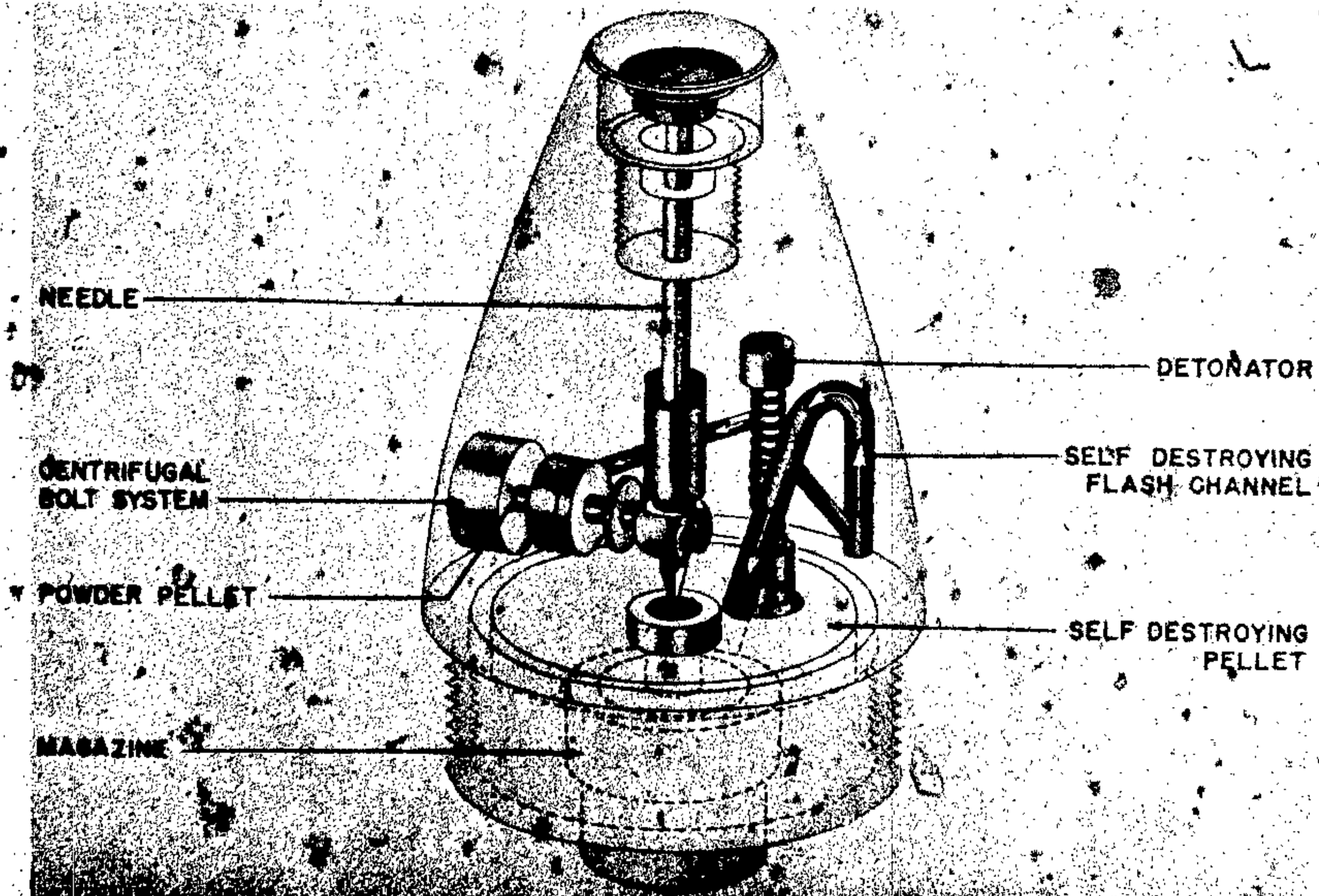

Figure 566—3.7-cm Kopfzunder Zerl. P.

GERMAN EXPLOSIVE ORDNANCE

channel containing pressed gunpowder leads into the upper end of the second vertical channel which also contains delay composition and is open at the base where it is in contact with a circular disk of pressed gunpowder carried in a recess in the top of the magazine adapter.

The magazine adapter screws into the underside of the body and carries a magazine similar to that of the A. Z. 39. The circular recess in the top of the adapter has a cylindrical projection in the center which is drilled to form a guide for the

striker. The pressed pellet of gunpowder contained in the recess is in the form of a washer to fit over the needle guide.

ACTION: On acceleration the igniferous detonator in the displaced recess sets back on the striker. The flash from the detonator passes through the flash channels to the power pellet in the radial channel and to the lower end of the delay filling in the first of the vertical channels. When the pellet in the radial channel disintegrates, the bolt

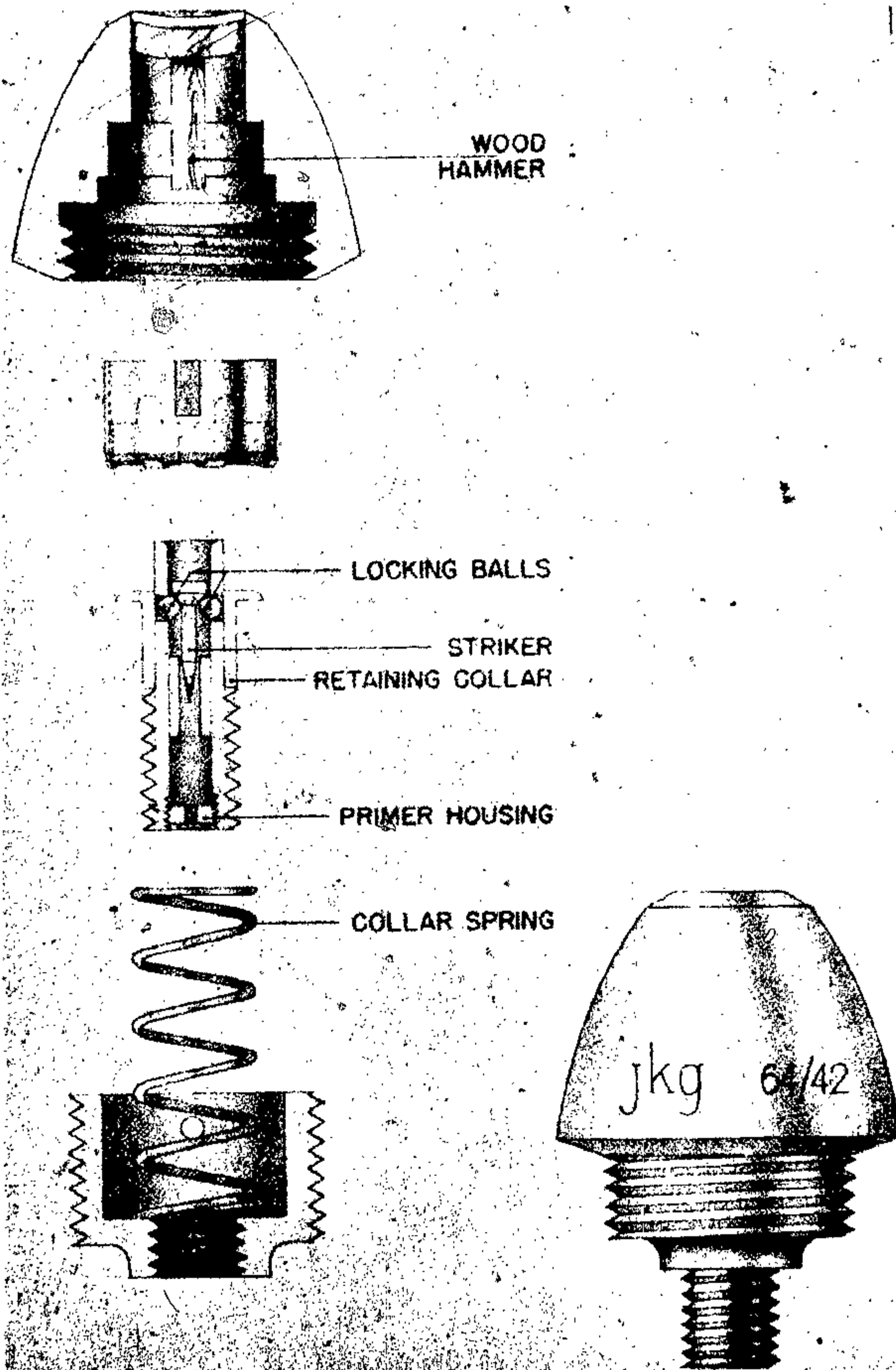

Figure 567—K. Z. 38

is thrown outwards by centrifugal force, leaving the striker held off from the detonator in the magazine by the creep action resulting from deceleration. On impact, the striker is driven in by the hammer and pierces the detonator in the top of the magazine. During flight, the burning of the delay composition in the first vertical channel is transmitted by the gunpowder in the traverse channel to the delay composition in the second vertical channel. When direct action does not occur before the composition burns to the base of the second channel, the disk of gunpowder confined in the top of the magazine adapter is ignited and explodes and thus initiates the detonation of the magazine.

NOSE FUZE K. Z. 38

EMPLOYMENT: Mechanical Impact Nose Fuze for 40-mm Bofors Gun H. E. shell. (See fig. 567.)

DATA:

Over-all length: 1.125 inches.

Maximum diameter: 0.75 inch.

Threaded length: 0.219 inch.

Number of threads: 5 RH.

CONSTRUCTION: Fuze is identical with the British Type No. 250. The fuze is made of brass and steel. The upper and lower body surround the inner housing which contains the retaining collar and the retaining collar spring. In the lower body is the primer housing, striker, striker retaining balls. In the top of the upper body is a wooden hammer.

ACTION: Set-back causes the inner housing to move back, releasing the pressure on the centrifugal pin. Centrifugal force causes the pin to move out and upon deceleration, the retaining collar moves up under pressure from its spring. As the collar moves up, the balls in the primer housing are free to move out under centrifugal force. This releases the striker and it drops into position so that on impact, the hammer forces the striker onto the primer.

REMARKS: The self-destroying element is in the tracer.

FUZE, D. A. K. Z. 38

DESCRIPTION: This fuze, which may be identified by the stencilling "Kz. 38" on the dome-shaped body is, including the gaine, 1 ounce in weight and

2 inches in length; the length of the body protruding from the nose of the shell is 0.06 inch. The empty fuze is similar to the British Fuze No. 250 Mk II. The fuze is of the direction action type, and the principal parts are, the body with adapter, striker guide, striker and hammer, arming sleeve and arming spring, stirrup spring and ferrule, three balls, igniferous detonator and gaine. (See fig. 568.)

The dome-shaped body has a flat nose and is prepared with an internal channel stepped in four diameters and screw-threaded internally at its base to receive an adapter. The smaller diameter at the forward end houses the head of a wooden hammer, and below it, is a chamber to accommodate the arming sleeve after firing, and a second step which forms a shoulder and bearing surface for the upper end of the ferrule. The channel is closed at its front end by a copper disk 0.006 inch thick.

The adapter is screw-threaded externally to receive the body and to screw into the shell. Internally it is screw-threaded to receive the striker guide and its upper end has a chamber to receive an arming sleeve and arming spring which surround the upper end of the striker guide. The sleeve and spring are retained in the unarmed position by a stirrup spring and ferrule. A pin through the side of the adapter prevents the ferrule from turning.

The striker guide is screw-threaded externally to suit the adapter and to receive a gaine body, and has a central channel. The upper part of the channel forms a guide for the hammer and striker, and the lower part accommodates an igniferous detonator held between a shoulder and a plug, with a central fire channel, which screws into the bottom of the channel. Three radial holes are bored in the upper part of the channel and partially accommodate three balls which rest against the underside of the striker head and thereby hold the striker off the detonator. Before firing, they are retained in position by the arming sleeve.

The striker is of steel and flanged at its upper end to enable it to be engaged by the three balls and held in the safe position. A wooden hammer, shaped with a head, rests on the top of the striker and is retained in position by a copper disk, which closes the nose of the fuze.

GERMAN EXPLOSIVE ORDNANCE

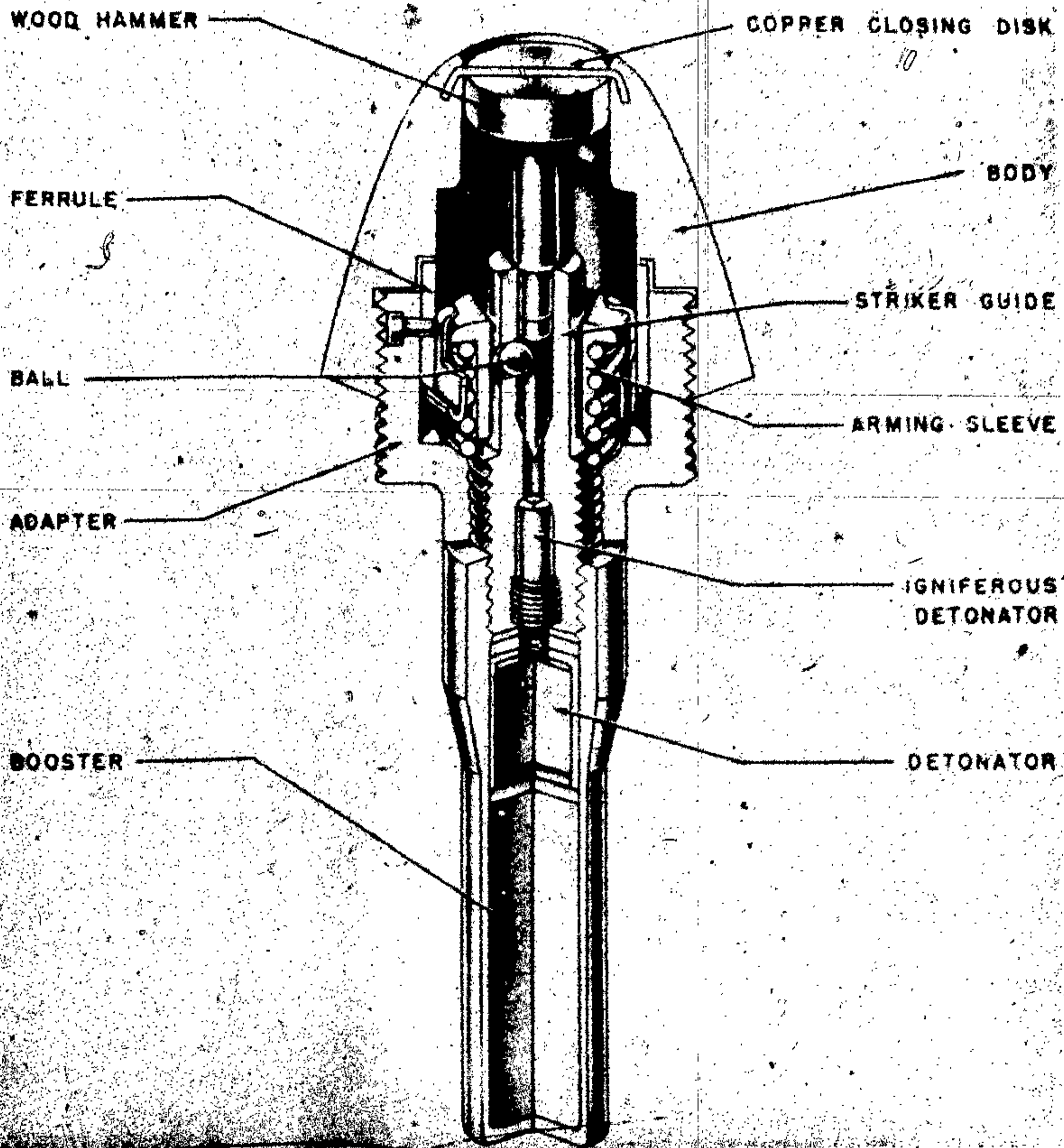

Figure 568—D. A. K. Z. 38

The arming sleeve is cylindrical and fits around the striker guide to retain the balls. It is flanged at its upper end to form a seating for the arming spring and has a curved periphery to suit the stirrup spring.

The stirrup spring is cylindrical, its lower edge has a number of external projections which fit under the ferrule, and its upper edge has a number of internal projections which fit over the arming sleeve and keep the arming spring under compression.

The ferrule is cylindrical, its upper end engages a shoulder in the body and its lower end the stir-

rup spring. A pin engages a slot cut vertically in one side of the ferrule and prevents its rotary movement in the fuze.

The igniferous detonator contains about 0.5 grain of a mixture of mercury fulminate, potassium chlorate, antimony sulphide (with, possibly, a small proportion of ground glass), followed by a thin layer of gunpowder. It is the same size as the ignitory detonator in Fuze No. 250.

The gaine, approximately 1.05 inches long is a steel cylindrical body closed at its bottom end and containing 7 grains of CE/TNT (40/60) pressed extremely hard into the base with a thin layer of the same composition in the form of loose crystals

on top. Above this is an inverted cup-shaped capsule containing a detonator composition consisting of 0.46 grain of C. E. under 6 grains of fulminate of mercury. The flash hole in the top of the capsule is closed by a fabric disk on its underside. The mouth of the gaine is screw-threaded to enable it to be screwed on the striker guide of the fuze, and contains a leather washer under a metal washer which fits over the detonator cap.

ACTION: This fuze is of the floating striker type and is not provided with a supporting spring; it, therefore, cannot be overemphasized that before being fired the closing disk in the nose of the fuze should be examined to see that it is not damaged or perforated, otherwise the round may be fired prematurely by air pressure acting directly on the hammer.

On firing, the ferrule sets back and takes the

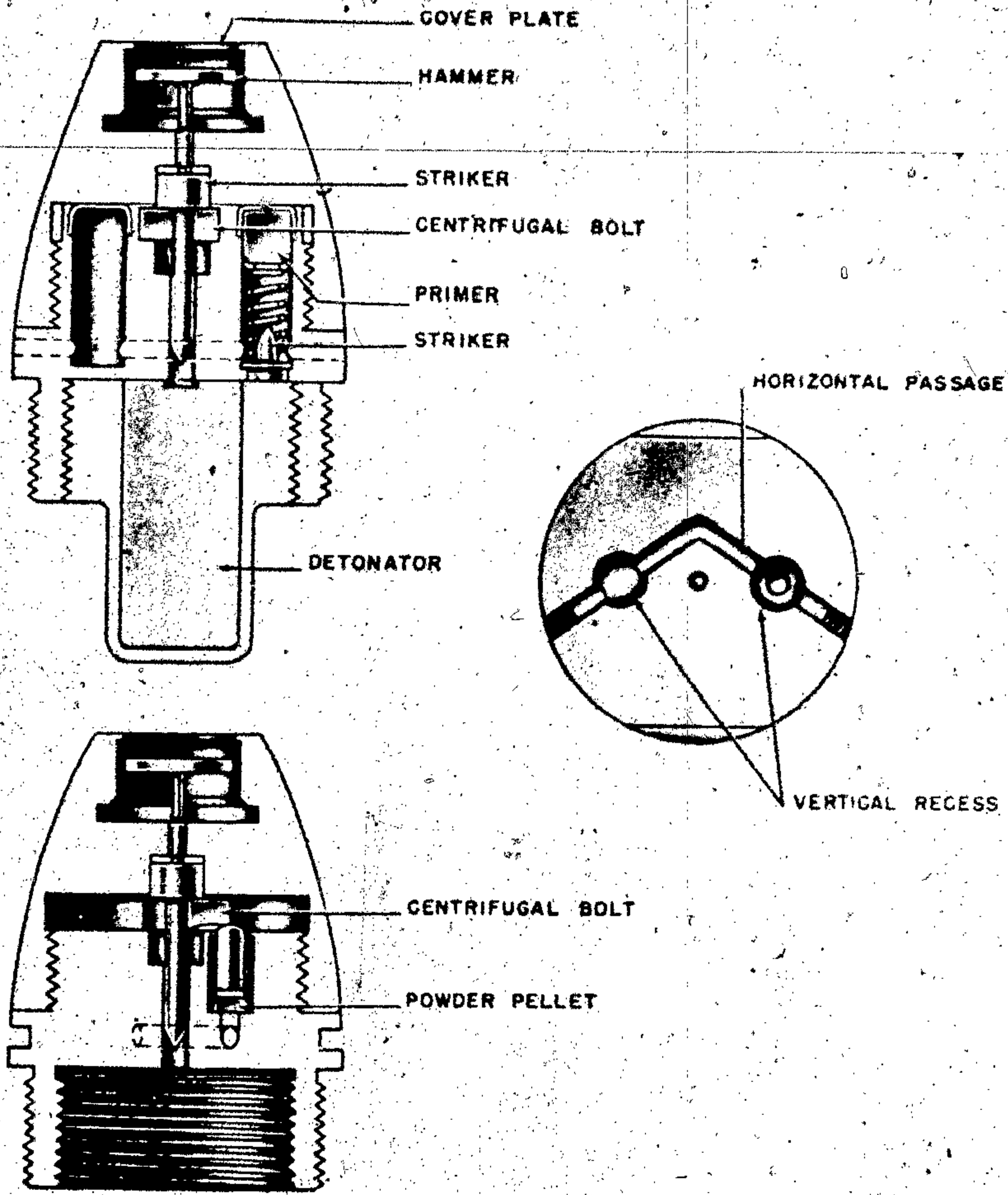

Figure 569—A. Z. 150 Rh. S.

GERMAN EXPLOSIVE ORDNANCE

stirrup spring with it, thereby releasing the arming sleeve, which is forced upwards by its spring and unmasks the three holes in the striker guide.

During flight, the striker and hammer tend to creep forward owing to deceleration, the three balls are released and fly outwards under centrifugal action and so release the striker.

On impact, the hammer is forced in, driving the striker into the detonator, which is fired and in turn set off the main detonator and main which detonates the shell filling.

PERCUSSION FUZE A. Z. 150 RH. S.

DESCRIPTION: This fuze is of the detonating type with a direct action of the floating striker type. (See fig. 569.)

The head of the fuze which screws on to the body is recessed at the front end to accommodate the hammer. The recess has a central hole through which the stem of the hammer passes and is closed against air pressure at the front by a cover plate. The hammer is aligned with the striker in the fuze body.

The body is screw-threaded externally behind the flange for insertion into the projectile and has an internal left-hand screw-thread for the gaine.

A channel is formed through the center of the body for the striker, the channel being of larger diameter at the front end to receive the head of the striker on functioning. A centrifugal bolt, shaped to fit the stem of the striker below the enlarged head, is retained in the safe position in its slot by a detent carried in the body. A flash channel in the recess behind the powder pellet leads to another recess containing a primer held off a striker in the base of this recess by a spiral spring. A similar empty recess is diametrically opposite in the fuze body, and is probably intended to preserve the balance of the fuze and to divert some of the pressure produced by the functioning of the primer in the connected recess.

ACTION: On acceleration, the primer in the recess sets back against its spring and is pierced by the striker. The flash passes through the channel to the detent recess and ignites the gunpowder pellet thus depriving the detent of this support. Centrifugal force, set up by the rotation of the projectile and fuze, causes the centrifugal bolt to move outwards, away from the striker head. During flight, creep action and protection from air pressure provided by the cover plate results in a forward movement of the hammer and striker.

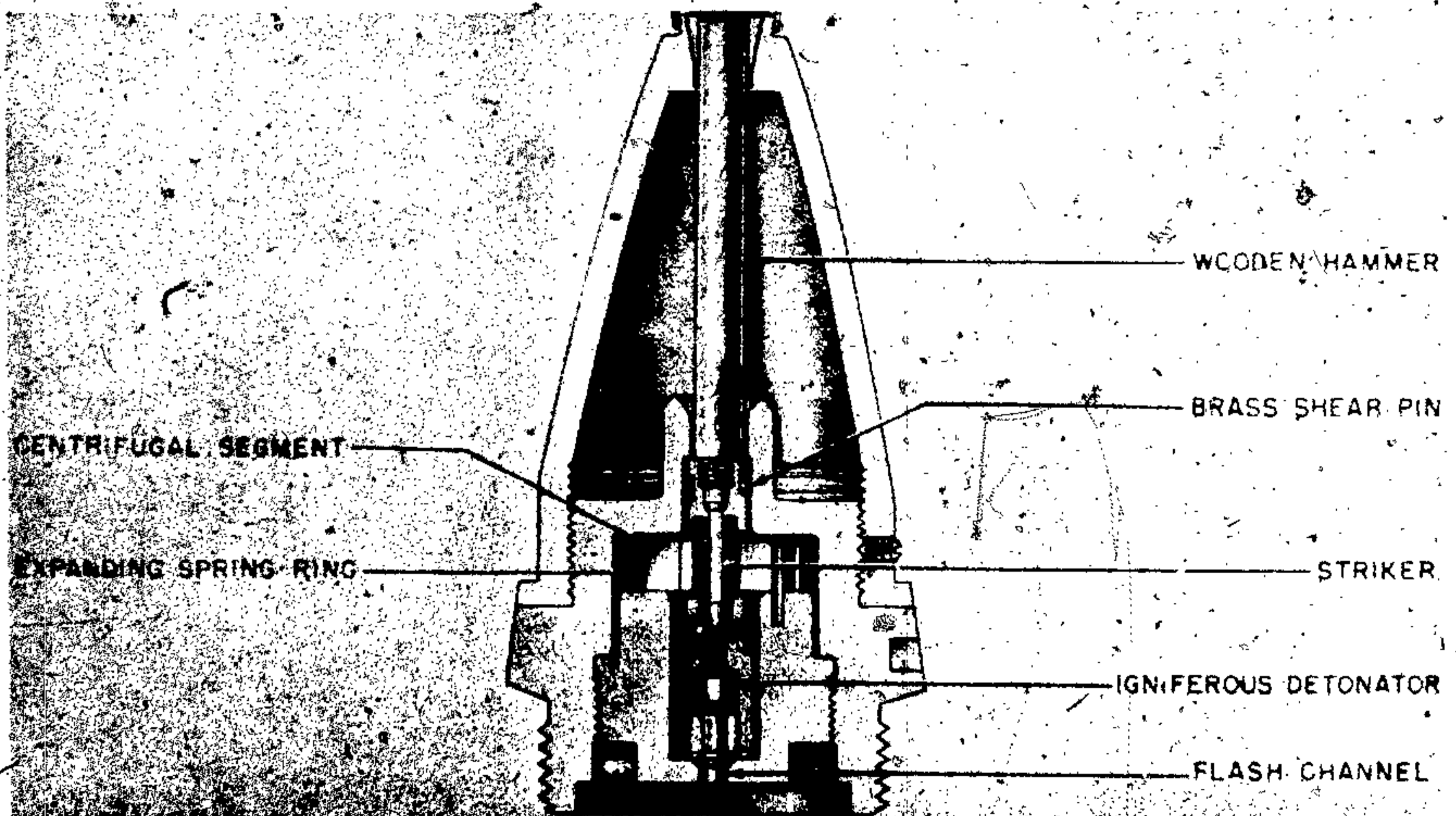

Figure 570—E. K. Zdr. C/28

On impact, the striker is driven into the detonator by the hammer.

FUZE, PERCUSSION, E.K. ZDR. C/28

DESCRIPTION: This fuze is used over a gaine and is designed on the combined direct and graze action principles for sensitivity and instantaneous functioning. (See fig. 570.)

The hollow ogival aluminum head of the fuze is screwed on the body and secured by a grub screw. The hole formed in the nose of the head to receive the outer end of the wooden hammer is closed by a brass disk. The disk is secured by a brass ring.

The aluminum body has a hollow cylindrical projection on its front face in which the base end of the wooden hammer is housed in contact with a striker holder. The striker holder carries a steel striker, secured by a screwed plug, and is supported by a brass shearing wire. The body is recessed and screw-threaded from the underside to receive the pellet holder.

The pellet holder is of steel and is recessed to carry the inertia pellet. A flash hole is formed in the base of the recess for the passage of the flash from the detonator to the gaine. Five centrifugal segments of brass with steel pivot pins are fitted on the front face of the holder and are positioned to overlap the inertia pellet by an expanding spring ring.

The inertia pellet carries an igniferous detonator secured by a perforated screwed plug and has a creep spring position between it and the striker holder.

ACTION: During flight, the expanding spring ring is opened and the segments rotated clear of the inertia pellet by centrifugal force. The striker and the pellet are then held apart by the shearing wire and creep spring only. On impact, or graze, the striker is driven in by the wooden hammer, and the wire sheared, whilst the inertia pellet overcomes the creep spring and carries the detonator forward. The flash produced by the piercing of the detonator passes through the hole in the base of the pellet holder to the gaine in the exploder container of the projectile.

FUZE BODY NAVAL TYPE

K. Z. C/27 (LM)

DESCRIPTION: It is used in shell for heavy guns, the ammunition of which is often of naval design.

The fuze is of the combined direct action and graze type and, with the exception of the igniferous detonator, has no explosive filling. (See fig. 571.) The design includes a hole at the nose to receive an extended form of hammer for use under a ballistic cap.

The aluminum body of the fuze is screw-threaded externally at the base for insertion into the shell

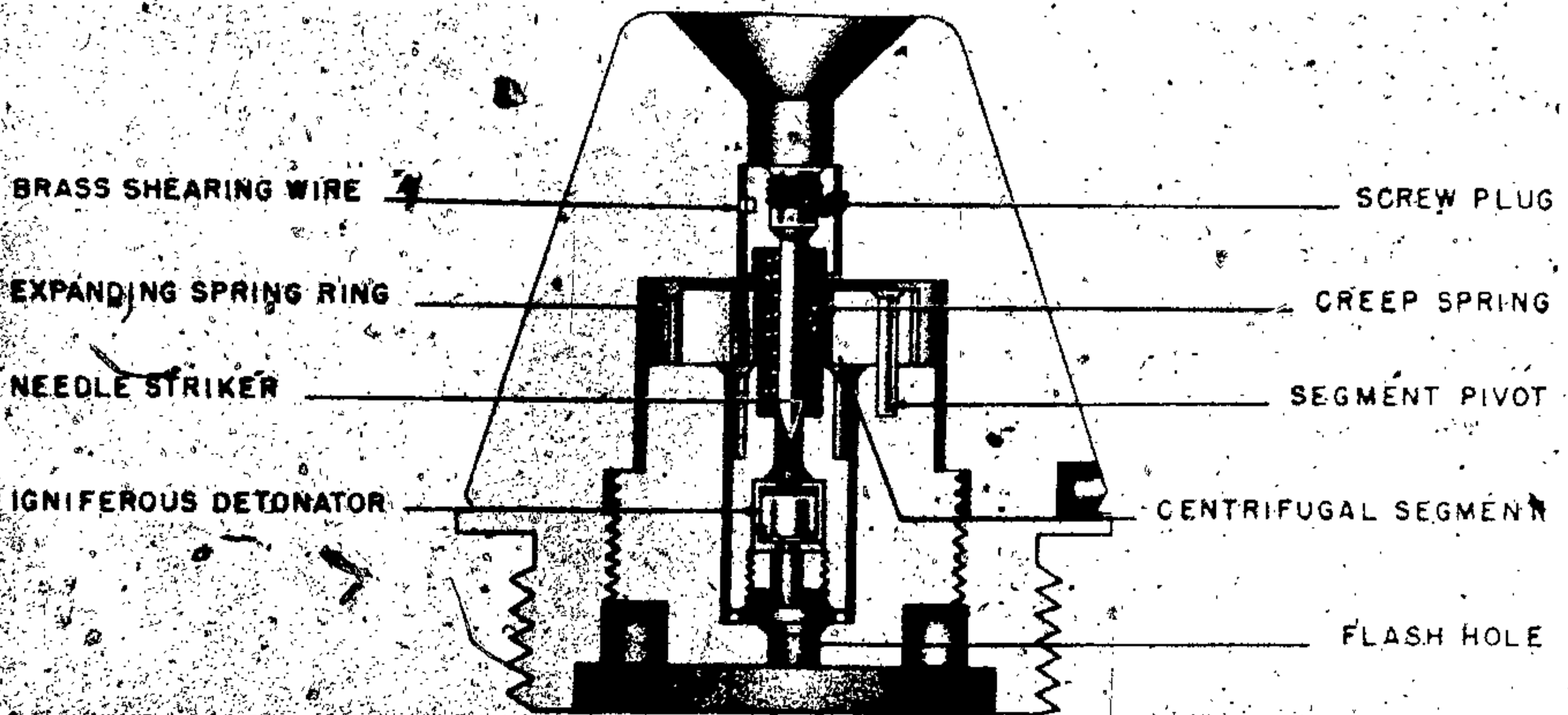

Figure 571—K. Z. C/27 (LM)

GERMAN EXPLOSIVE ORDNANCE

and recessed internally to take an aluminum striker holder and the graze mechanism.

The striker is of steel and is secured by a steel plug which screws into the striker holder. The striker holder is supported in the body by a brass shearing wire. The stem of the striker is surrounded by a creep spring and the point protrudes into the top of the inertia pellet.

An aluminum pellet holder with a central flash hole at the base and recessed internally to house the inertia pellet is screwed into the base of the fuze. On top of this holder are fixed five pivots on which are mounted five brass centrifugal segments surrounded by an expanding spring ring of phosphor bronze which maintains them in position overlapping

ping the top of the inertia pellet and preventing it from forward movement.

The inertia pellet which is of steel, brass plated, has a central cavity housing the igniferous detonator and is closed at the base by a paper washer and a brass screwed plug with a central flash hole.

The detonator consists of a copper shell closed at each end by a copper disk 0.003 inch thick and contains 2.3 grains of composition above 0.86 grain of glazed gunpowder. The composition is made up of mercury fulminate 27.7 percent; potassium chlorate 38.7 percent, antimony sulphide 26.9 percent, and ground glass 6.7 percent.

ACTION: On acceleration the striker is prevented from setting back onto the detonator by the shear wire. Centrifugal force set up by the projectile in flight causes the spring ring to expand and permit the segments to rotate clear of the inertia pellet thus leaving the striker and inertia pellet held apart by the shear wire and creep spring. On graze or impact the shear wire is broken and the spring is compressed by the striker being driven in the graze pellet setting forward. The flash produced by the striker piercing the detonator passes through the flash channel to the gaine of the shell.

NOSE FUZE FOR 4.7-CM. H. E. SHELL

EMPLOYMENT: Used in 4.7-cm H. E. Shell (4.7-cm Pak. Spgr.). (See fig. 572.)

DATA:

Over-all length: 1.312 inches.

Maximum diameter: 1.0 inch.

Threaded length: 0.312 inch.

Number of threads: 3 RH.

CONSTRUCTION: This fuze is of the direct action detonating type in which the striker is held off the detonator by four steel balls.

The hollow stemmed aluminum striker with enlarged head passes through a cup-shaped ferrule and is supported at the cone, near the point, by four steel balls. The balls are located in the internally coned metal cup and retained by the ferrule which is pressed on to them by the spiral spring. The cone of the striker corresponds with the coned interior of the cup so that a force acting along the axis of the striker will not displace the balls. The head of the striker is housed in a

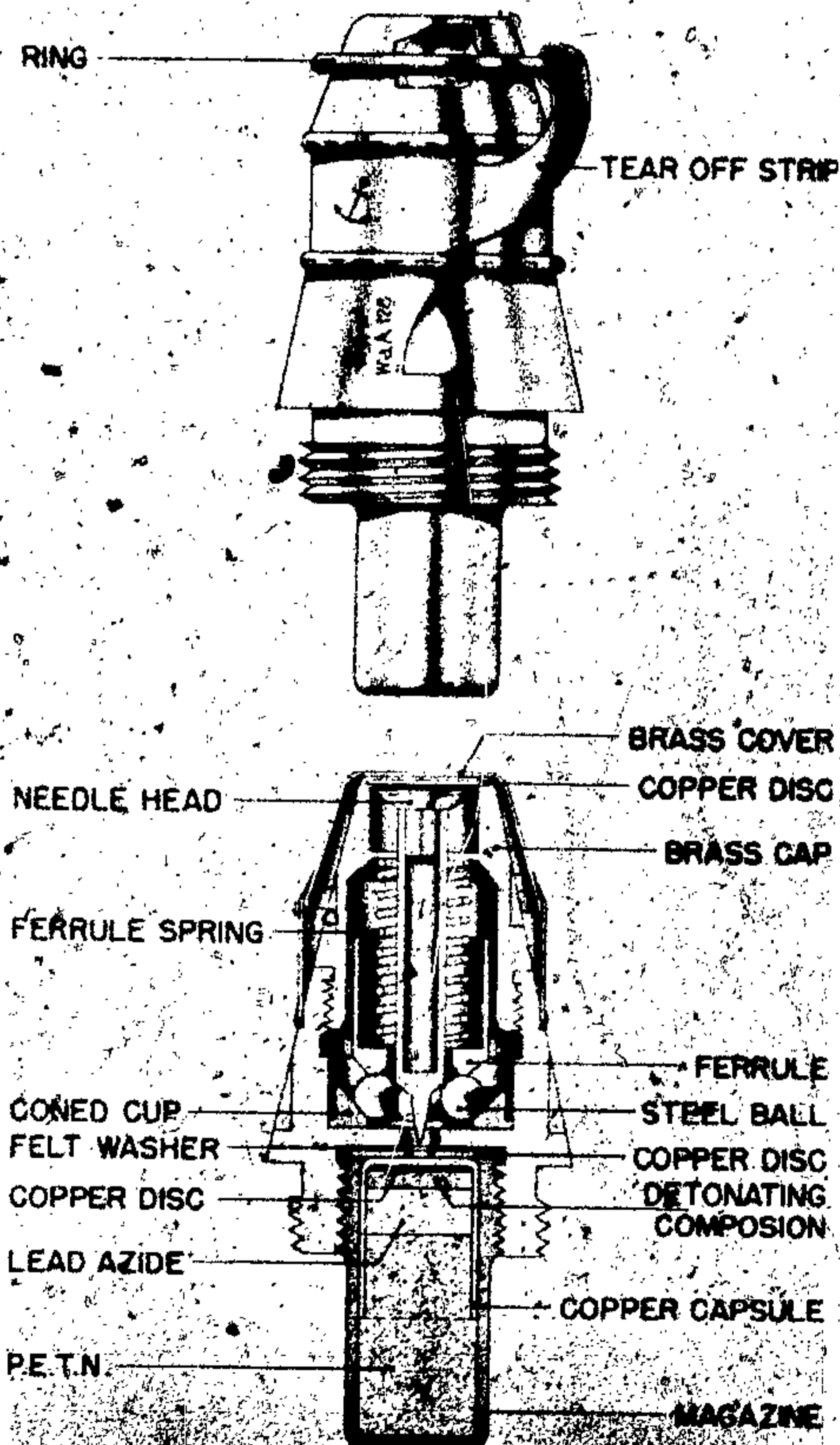

Figure 572—Fuze for 4.7-cm Pak. Spgr.

recess in the cap of the fuze, the recess being closed against air pressure by a copper disk.

The magazine is screwed into the underside of the fuze and contains the initiator compositions in a copper capsule over a 48-gram filling of PETN. The copper capsule has a copper disk soldered in the front end and a second copper disc, with felt washer attached, interposed between it and the striker point. The initiator filling in the capsule consists of a 25-gram layer of detonating composition over 31 grams of lead azide. The detonating composition consists of:

Mercury fulminate 28.7 percent, potassium chlorate 39.8 percent, and antimony sulphide 31.5 percent.

The fuze is fitted with a brass cover secured by a tear-off strip. The strip is provided with a finger ring which is lightly soldered to the cover.

ACTION: The cover is removed before loading. During the acceleration, the balls are held by set-back and the ferrule. When acceleration ceases and the rate of spin is sufficient, the balls are forced outwards by centrifugal force and retained in this position by the ferrule under the pressure of the spring. The striker is then held off from the detonator by creep action. On impact, the striker is driven in and pierces the detonator.

REMARKS: The copper disc over the initiator capsule is probably intended to act as a resistance to the striker and to prevent premature action by wind pressure acting on the striker, such as might occur if the copper disc in the cap of the fuze were punctured.

Neither the striker, ferrule, nor the spring are positively located, and it appears that the striker

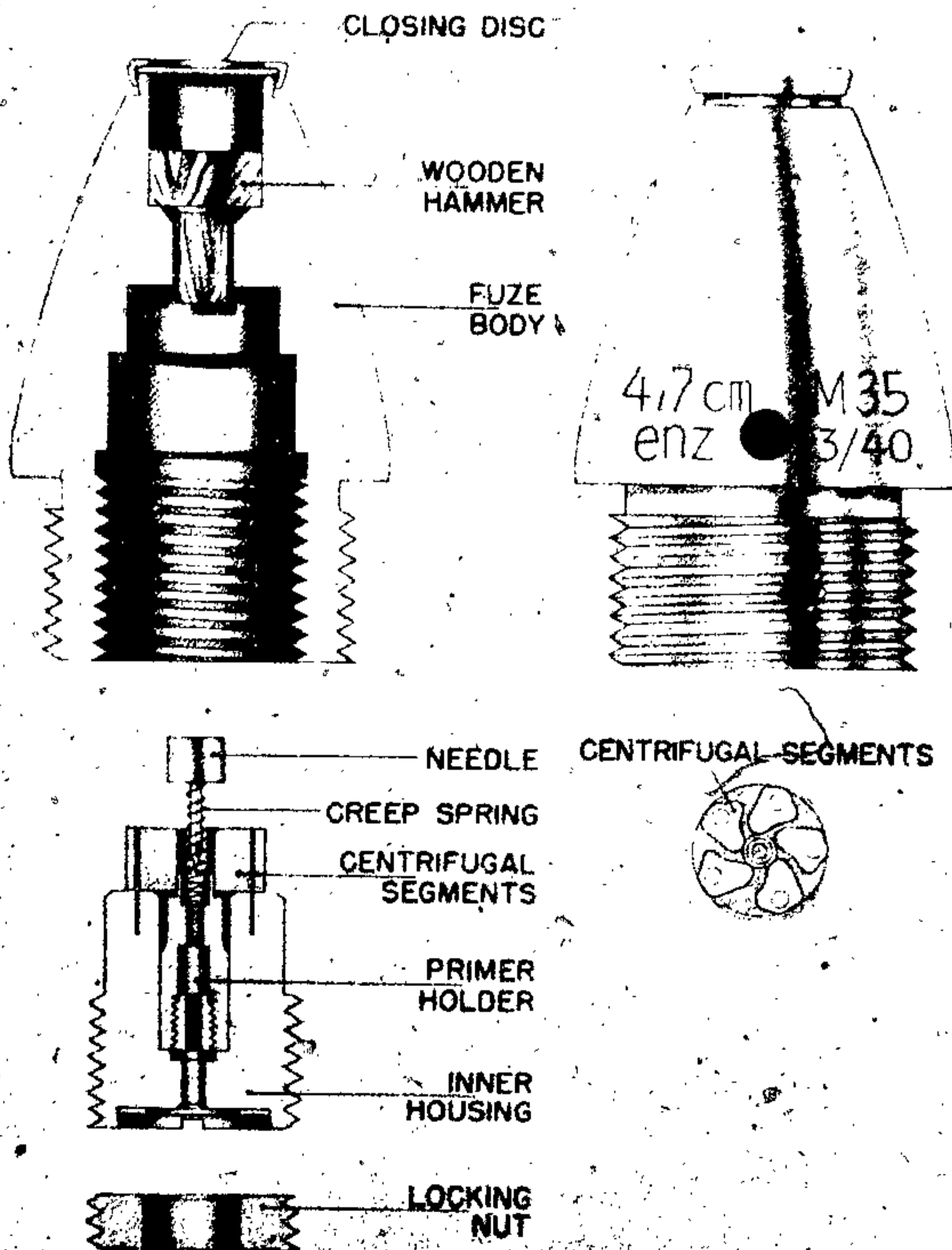

Figure 573—M35 enz. 3/40

GERMAN EXPLOSIVE ORDNANCE

is so designed that the point of the striker may move considerably off its normal axis without jamming, which, should it occur, would render the fuze insensitive on a light target.

NOSE FUZE M. 35 ENZ. 3/40

EMPLOYMENT: Czech nose fuze used in German 4.7-cm ammunition. (See fig. 573.)

DATA:

Overall length: 2.438 inches.
Maximum diameter: 1.625 inches.

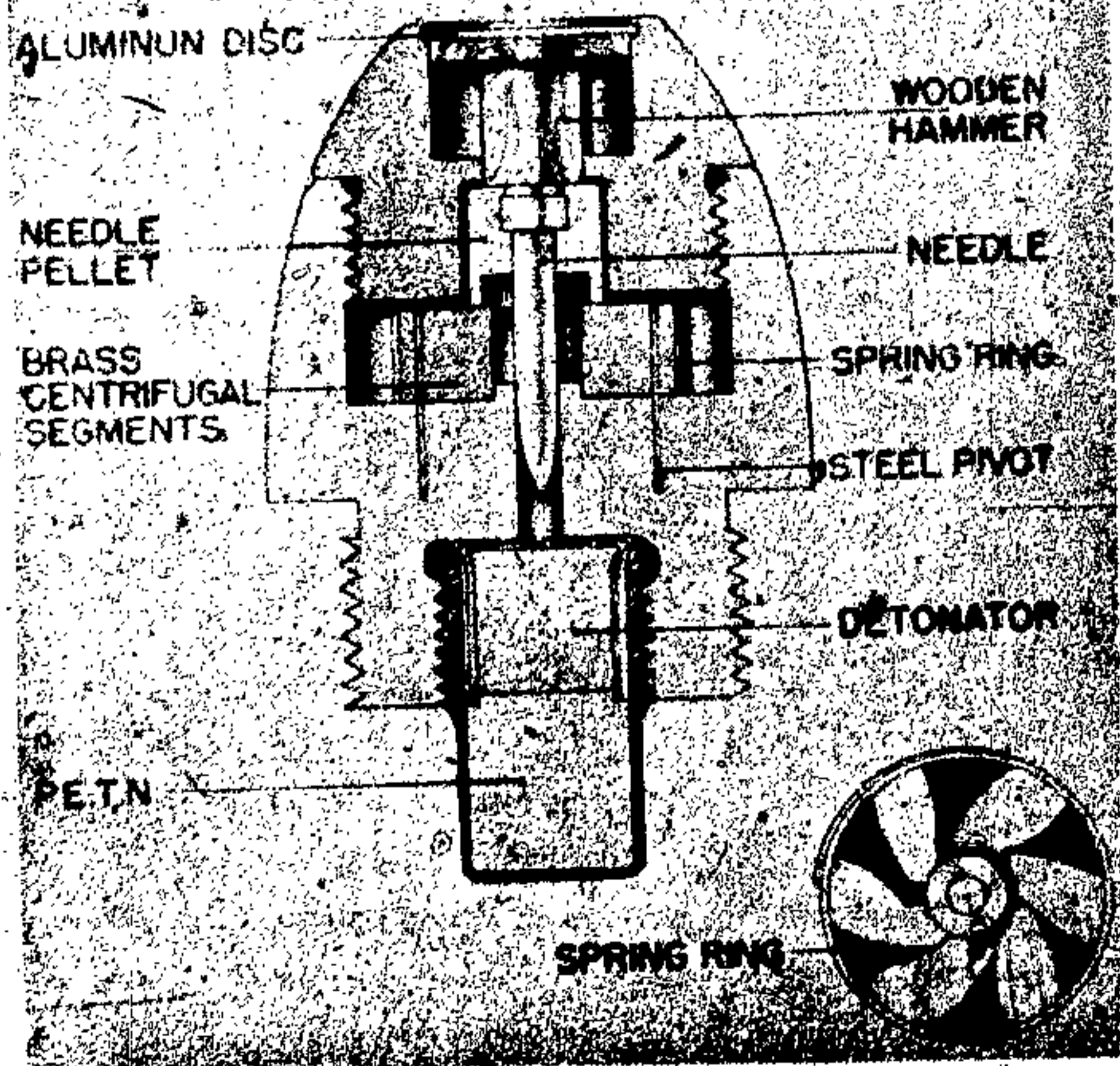
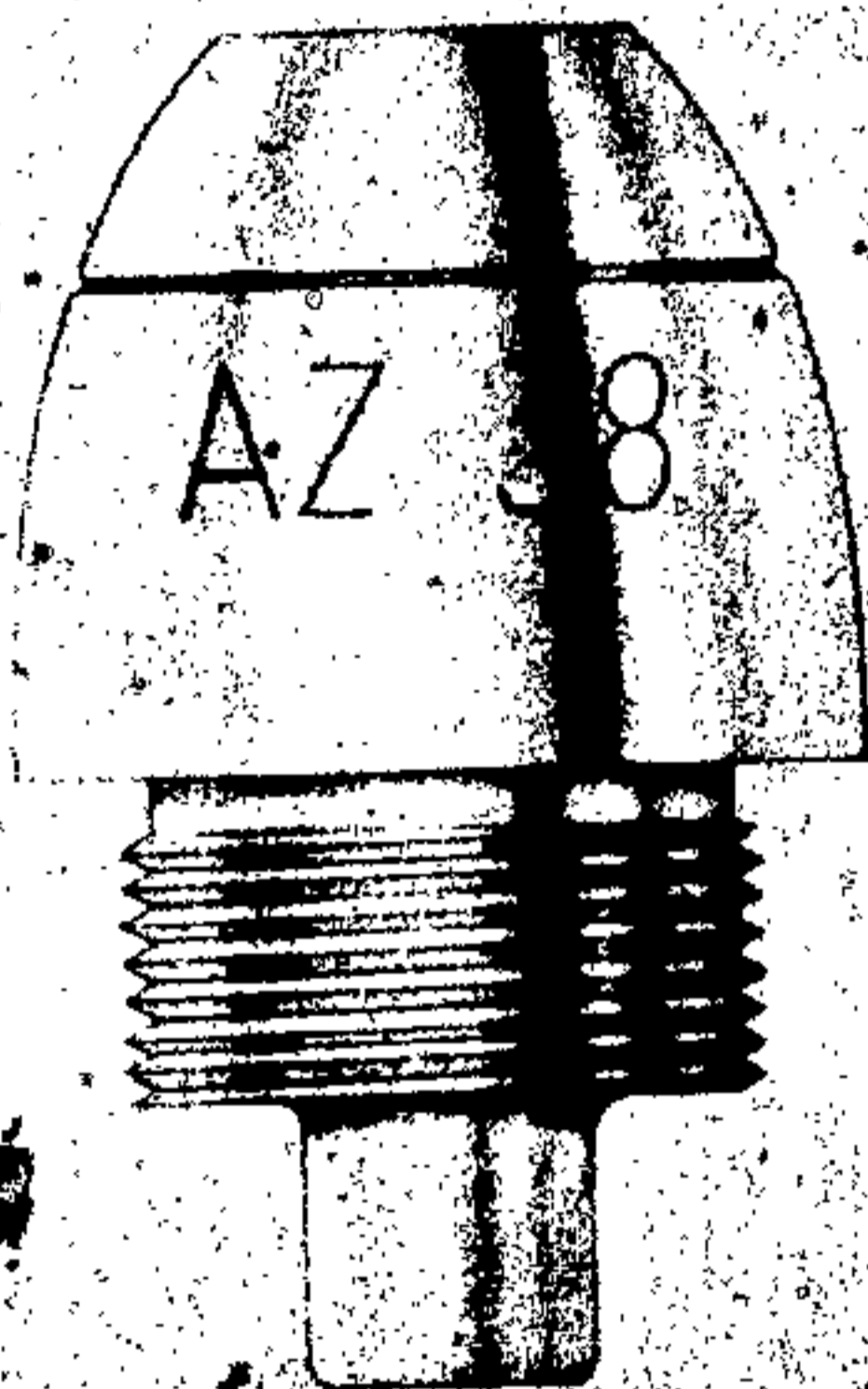

Figure 574—A. Z. 38

Threaded length: 0.625 inch.

Number of threads: 10 RH.

CONSTRUCTION: The body has a closing disk in the nose and threads on the base to engage the projectile. Beneath the closing disk is a wooden hammer which bears against the striker.

The striker, creep spring, primer holder, and centrifugal segments are all contained in a single inner housing which screws into the base of the fuze body and is secured by a locking nut.

The centrifugal segments are interposed between the striker and primer housing. A light creep spring surrounds the striker and bears against a lip on the primer housing.

ACTION: Centrifugal force throws the centrifugal segments outward freeing both the striker and the primer housing which are then separated only by the creep spring.

Upon impact, the hammer forces the striker back to meet the primer which has been thrown forward by inertia. The resulting flash passes through the central channel into the detonator.

NOSE FUZE A. Z. 38

EMPLOYMENT: Mechanical Impact Fuze used in Hollow Charge shells. (See fig. 574.)

DATA:

Over-all length: 1.125 inches.

Maximum diameter: 0.937 inch.

Threaded length: 0.25 inch.

Number of threads: 7 RH.

CONSTRUCTION: The body of the fuze is screw-threaded externally to 0.69 inch gage with a pitch of approximately 1 mm for insertion in the shell. A recess formed in the underside is screw-threaded to receive the magazine which contains a 5.2-grain filling of PETN under a 5.9-grain detonator of lead azide/calcium silicide 65/35. The upper part of the body is recessed to accommodate six pivoted centrifugal segments and threaded internally to receive the aluminum head of the fuze. A central channel is formed between the upper and lower recess for the striker.

The steel striker is carried in an aluminum pellet supported by the centrifugal segments which are retained in the supporting position by an expanding spring ring.

The aluminum head of the fuze is recessed in the underside to accommodate the striker pellet.

and recessed at the nose to take the hammer which passes through a hole in the diaphragm between the recesses. The hammer is of wood and rests on the head of the striker pellet. The recess containing the hammer is closed at the nose against air pressure by an aluminum disk sealed with a fillet of synthetic resin.

ACTION: During flight, the coil of the expanding spring ring is enlarged and the segments rotated clear of the striker pellet by centrifugal force. The striker is then held off the detonator by the creep action resulting from deceleration. On impact, the hammer and striker are driven in and the detonator is pierced. The impulse setup by the

detonation is communicated through the aluminum tube in the shell to the gaine in the base of the shell cavity. The construction of the detonator in the gaine is such that it could be initiated either by a flash or a pressure gaine.

NOSE FUZE A. Z. 39

EMPLOYMENT: Used in 5-cm H. E. shell. (See fig. 575.)

DATA :

- Overall length: 1.719 inches.
- Maximum diameter: 1.312 inches.
- Threaded length: 0.312 inch.
- Number of threads: 5 RH.

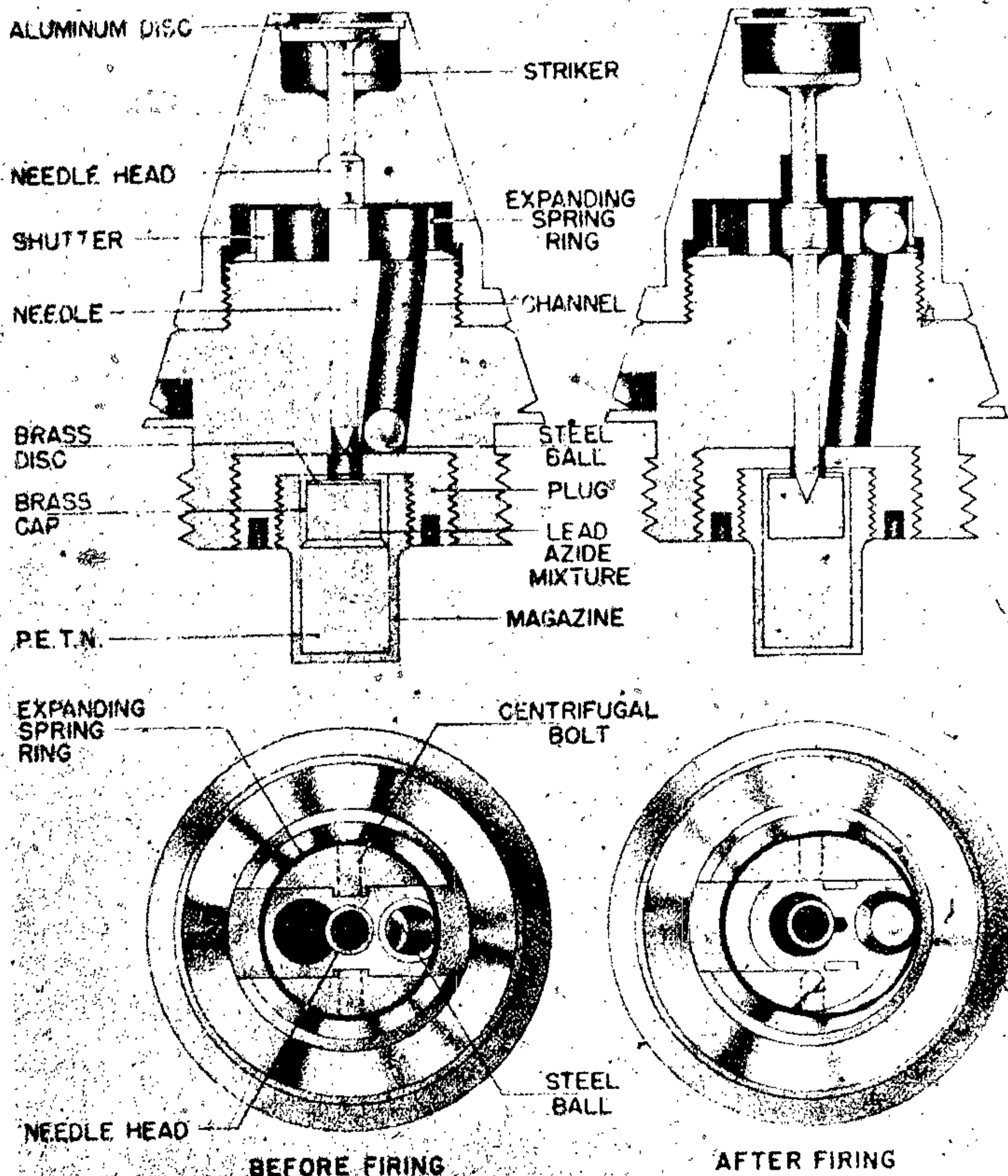

Figure 575—A. Z. 39

GERMAN EXPLOSIVE ORDNANCE

CONSTRUCTION: This is a detonating type with a direct action in which the needle is supported by a shutter.

The direct action mechanism consists of an aluminum needle supported over the detonator by the shutter, which engages under the enlarged head on the needle. An aluminum striker is positioned in front of the needle in a recess in the cap of the fuze. The recess is closed against air pressure by an aluminum disc.

The shutter slides in a diametrical groove in the front face of the body where it is retained in the safe position by means of two centrifugal steel bolts. The bolts are housed in holes in the body within an expanding spring ring and engage in slots in the shutter. The shutter has two holes formed in it, one on each side of its center. One of these holes has formed in the inner side of its periphery, a recess which expands to the center of the shutter and receives the needle. The dimensions of the recess prevents the head of the needle passing it but the hole will permit this movement when the shutter is in the armed position. With

the shutter in the unarmed position, the second hole coincides with a channel in the body which houses a shell ball.

The brass magazine of the fuze is fitted to the underside of the body by means of an aluminum screwed plug. The magazine is fitted with a brass detonator containing 0.33 gram of lead azide with calcium silicide over a filling of 48 grams PETN.

ACTION: On acceleration, the ball is held in the channel by set-back. During flight, the ball is caused to move forward by creep action combined with the effort of the slope of the channel and centrifugal force until it enters the hold in the shutter. The rotation of the shell also causes the spring ring to expand and the bolts to disengage the shutter which, with the ball as a displaced weight, slides across the body and ceases to support the needle at the head. The needle is then held off the detonator by creep action. On impact, the needle is driven in and pierces the detonator.

REMARKS: Sometimes marked A. Z. 39ZN.

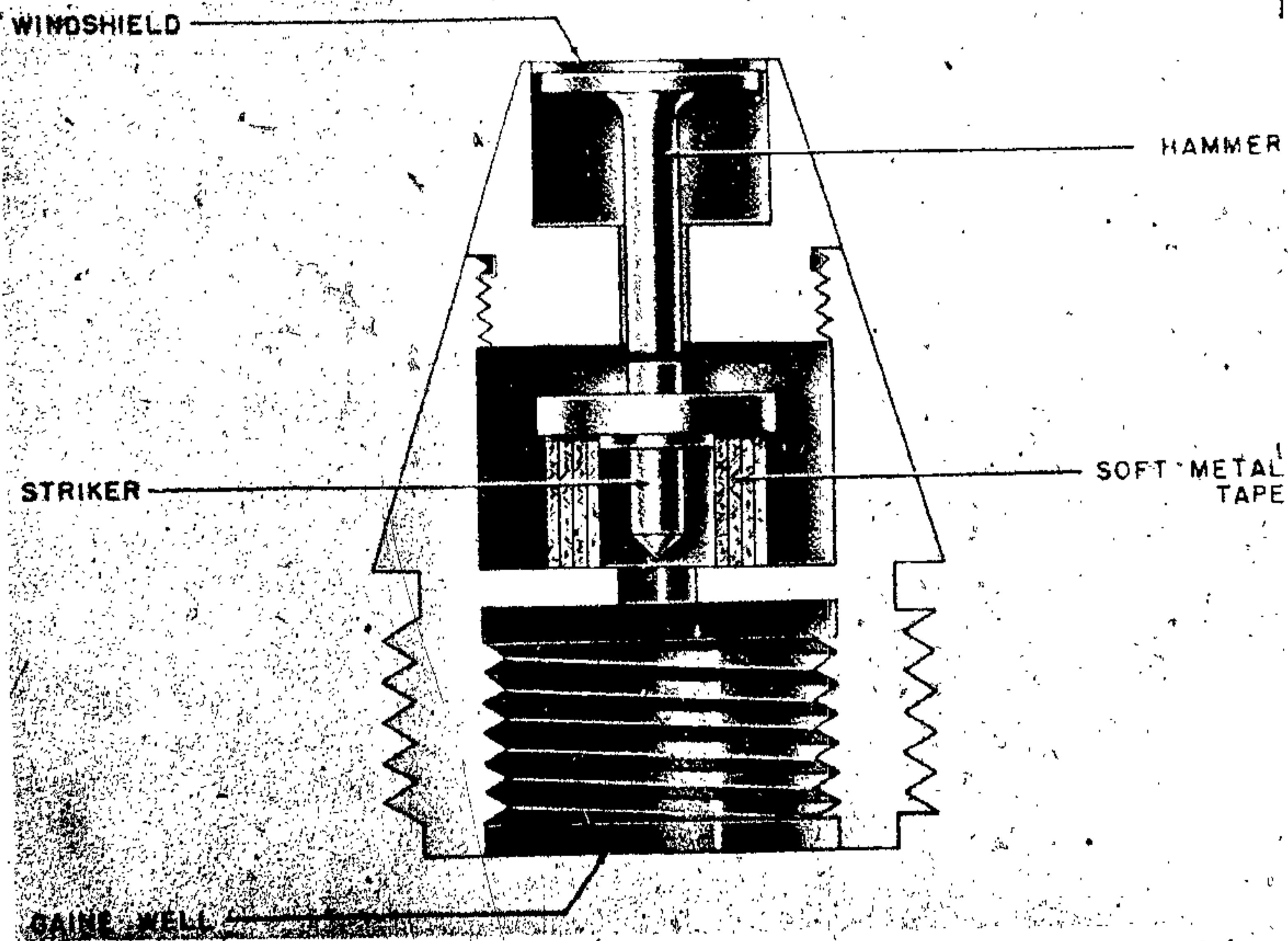

Figure 576—A. Z. 49

NOSE PERCUSSION FUZE A. Z. 49

EMPLOYMENT: Nose fuze for 20-mm ammunition. (See fig. 576.)

DESCRIPTION: This fuze is constructed mainly of aluminum. The main components consist of:

1. Aluminum hammer head.
2. Steel needle.
3. Soft metal tape.
4. "Duplexkapsel" containing a detonator and magazine.

ACTION: The striker is held off the detonator by a coiled soft metal tape. As a result of centrifugal force, the tape unwinds so that on impact the striker is forced onto the detonator. The fuze has a circular groove on the body.

REMARKS: Fuzes similar in construction and operation to the A. Z. 49 are:

- A. Z. 47
- A. Z. 48
- A. Z. 5045

NOSE PERCUSSION FUZE, 23 SERIES

GENERAL: There are a large number of fuzes of this series which are designed for use with projectiles for a wide range of equipments. Some are designed for use with H. E. projectiles and are normally fitted with an optional delay and others for use with smoke projectiles and have no optional delay.

A. Z. 23 v (0.15) or (0.24)

The designation "A. Z. 23" is stamped above the flange of the aluminum body diametrically opposite the optional delay setting plug. The period of delay is stamped adjacent to the plug in the form "V. O. 15." To obtain delay the slot in the head of the setting plug is set coincident with the index marks letter "M" and "V". For action without delay the plug is set to the "O" index.

EMPLOYMENT: This percussion fuze, with 0.15 or 0.25 second delay, is used in the 105-mm howitzer and also in 75-mm separate ammunition. It is designed to function on impact or graze.

DATA:

- Over-all length: 4.375 inches.
- Maximum diameter: 2.375 inches.

Threaded length: 0.625 inch.

Number of threads: 4 RH.

CONSTRUCTION: The aluminum body of the fuze is in two parts. The head portion, which is screwed to the lower part, is solid and tapers towards the nose. A channel is formed through its center to accommodate the wooden hammer and the striker pellet. The channel is closed against air pressure at the top of a brass disc which is secured by a brass collar fitted around a stop formed in the nose of the fuze. The head is secured to the lower part by a fixing screw. (See fig. 577A.)

The lower portion of the body is tapered above the flange to correspond to the head and is screw-threaded below the flange for insertion in the shell. Near the top it is reduced in diameter and screw-threaded to receive the head and it is recessed to accommodate the graze pellet. Another recess, formed in the base, contains the delay holder with a shutter and is screw-threaded to receive the magazine. The two recesses are connected by a central flash hole and an inclined flash channel. A radial channel for the optional delay assembly leads from the exterior to the lower recess.

The aluminum striker pellet, fitted with a steel striker, is supported above the graze pellet by a creep spring and by five centrifugal aluminum segments pivoted on the top of the lower portion of the body. The segments are held between the base of the striker pellet and a shoulder on the graze pellet by an expanding spring ring.

The graze steel pellet carries an igniferous detonator supported by a perforated screwed plug.

The delay holder consists of a cylindrical aluminum pellet with a flash channel through the center and a second channel, displaced from the center, which contains a delay filling and coincides with the inclined flash channel from the recess containing the graze pellet. A slot formed in the top of the holder to receive the shutter extends to just beyond the central flash channel. At the outer end of the slot the holder is recessed to receive the inner end of a centrifugal bolt forming part of the shutter. A tin disk with perforations corresponding to the channels in the holder is inserted above the holder.

The shutter assembly consists of a copper plate attached to a cylindrical bolt and is contained in the delay setting plug with a spiral spring which tends to retain the shutter in a position to close

GERMAN EXPLOSIVE ORDNANCE

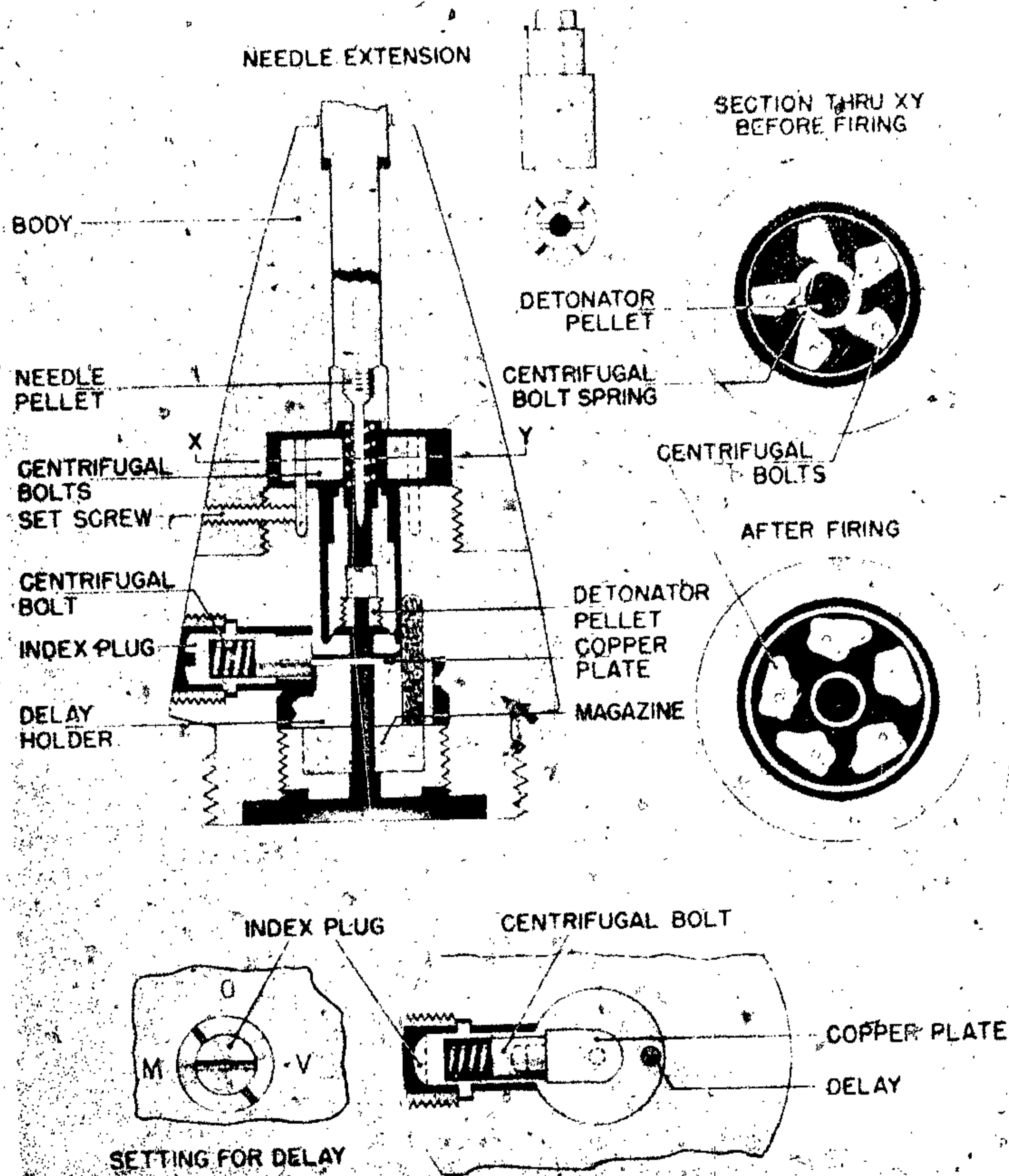

Figure 577A—A. Z. 23 (0.15)

the central flash channel. The width of the shutter is greater than the diameter of the centrifugal bolt.

The delay setting plug is recessed from the inner end to accommodate the centrifugal bolt and the spiral spring and has two slots to receive the sides of the shutter projecting beyond the bolt. The outer end of the setting plug is closed and has a groove for the setting key. The plug is retained in the fuze body by a screwed securing ring which engages a flange on the plug but does not prevent it being turned in setting.

The magazine contains a pressed perforated pellet of gunpowder weighing approximately 2 grams and has a flash hole in the base closed by a paper disk.

ACTION: Before loading, the fuze is set for delay or nondelay action by means of the setting plug.

During flight, the coil of the expanding spring ring is enlarged and the segments swing clear of the graze and striker pellets by centrifugal force. The striker pellet is then held in the forward position by "creep" while the graze pellet is held

back by the creep spring. The action of the shutter is governed by the setting plug. With the plug set to "O," the slots at its inner end are aligned with the projecting sides of the shutter and permit the centrifugal bolt to move outwards, taking with it the shutter and exposing the central flash channel in the delay holder. With the plug set in alignment with the "M" and "V" markings the slots in its inner end are not in a position to receive the protruding sides of the shutter. The movement of the shutter and bolt is thus prevented and the shutter remains closed.

On graze, the graze pellet moves forward, compressing the creep spring, and impinges the detonator on the striker. With suitable impact, the hammer and striker pellet are driven in as the graze pellet moves forward and a more rapid action is obtained.

The flash from the detonator ignites the delay composition in the delay holder through the inclined flash channel and, if the shutter has opened, at the same time passes through the central flash

hole and explodes the powder pellet in the magazine. With the fuze set for delay action, the central flash hole is masked by the shutter and the explosion of the magazine filling is brought about by the delay composition.

REMARKS:

1. A. Z. 23/42 (0.15). This is similar to the A. Z. 23 v. (0.15), but is fitted with brass centrifugal segments and has an optional delay of 0.15 second.

2. A. Z. 23 v. (0.15) OR (0.25) Zn. This is similar to the A. Z. 23 v. (0.15) except that it is constructed mainly of zinc alloy. It is distinguishable by having a yellow tip.

3. A. Z. 23 v. (0.15) OR (0.25) Pr. This is similar to the A. Z. 23 v. (0.15) except that it is constructed mainly of plastic.

4. A. Z. 23. This is an early version which was constructed mainly of brass. It is fitted with an optional delay of 0.10 or 0.15 second.

5. A. Z. 23 (0.8). This is an early version which was constructed mainly of brass and is fitted with an optional delay of 0.8 second. It is fitted with

SETTING FOR NON-DELAY

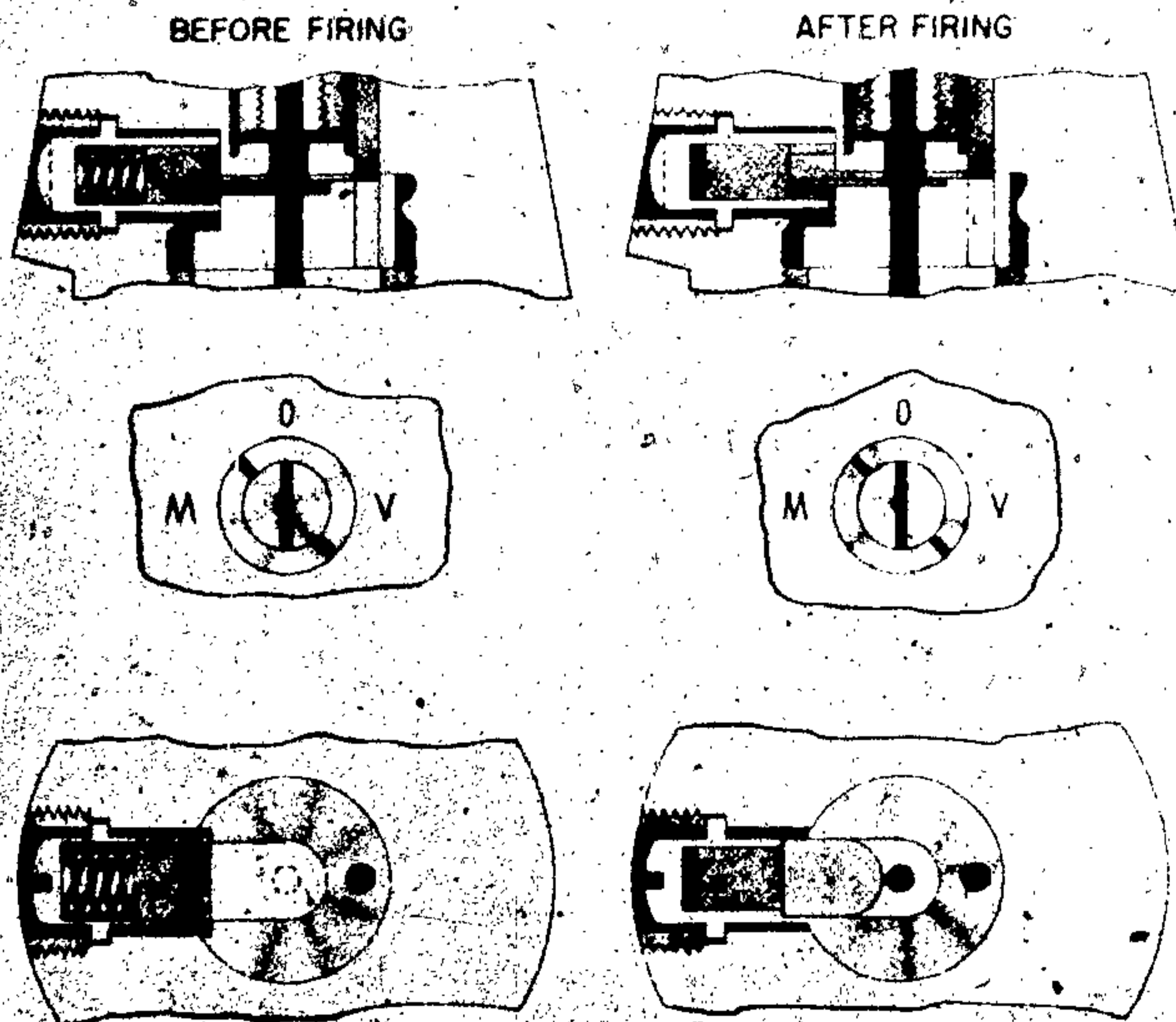

Figure 577B—KI. A. Z. 23 (012)

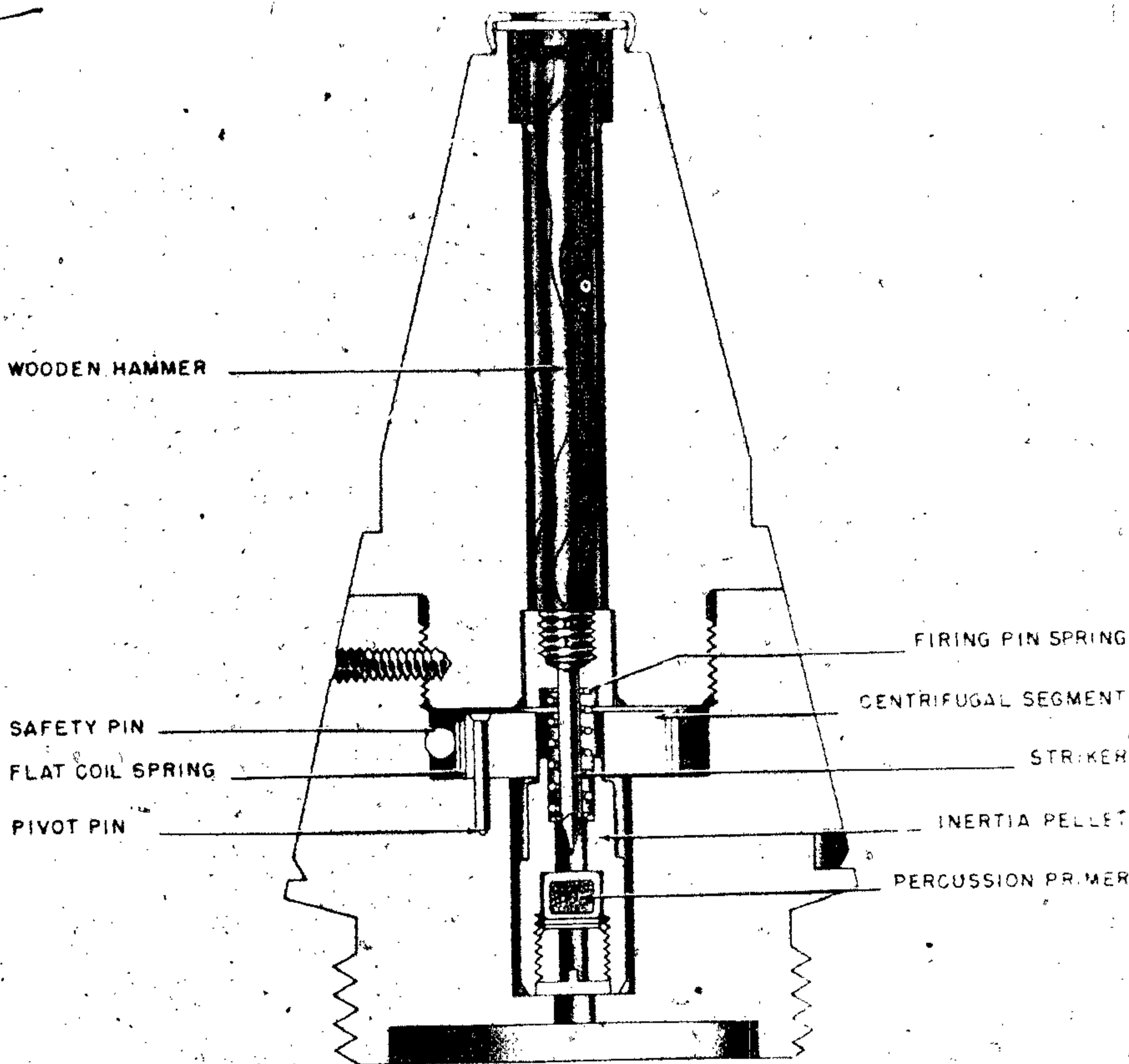

Figure 577C—A. Z. 23 Nb

a safety pin, which must be withdrawn before firing and prevents the centrifugal segments opening.

6. Kl. A. Z. 23 (0.2). This is constructed of aluminum and is of similar construction and operation to the A. Z. 23 v. It has an optional delay of 0.2 second and a noteworthy feature is that it is fitted with four centrifugal segments instead of the usual five. (See fig. 577B.)

7. Kl. A. Z. 23 (0.2) umg. The above fuze was found to arm too quickly when used in the following high velocity guns:

- 7.5-cm PAK 40, KwK 40 and 42
- 7.62-cm PAK 36 and FK 39

This fuze was introduced to overcome this difficulty. On introduction, however, it was found to be unsatisfactory and is to be replaced by Kl. A. Z. 23/1.

In construction and operation, the fuze is similar to Kl. A. Z. 23 (0.2).

8. Kl. A. Z. 23 (0.2) Pr. This is similar to Kl. A. Z. 23 (0.2) but is constructed mainly of plastic.

The following fuzes are of the same gage as the A. Z. 23 v. (0.15), but they are designed for use with smoke shell and as a result are not fitted with an optional delay:

- 1. A. Z. 23 Nb. This is similar to A. Z. 23 v. except that there is no optional delay and also a

safety pin passes through the body of fuze. (See fig. 577C.)

2. s. Igr. Z. 23 Nb. This is similar to the s. Igr. Z. 23 except that there is no optional delay.

A. Z. 23 UMG

EMPLOYMENT: Used in 15-cm H. E. projectiles.

DATA:

- Over-all length: 3.125 inches.
- Maximum diameter: 2.312 inches.
- Threaded length: 0.5 inch.
- Number of threads: 4 RH.

DESCRIPTION: The A. Z. 23 umg fuzes differ externally from the A. Z. 23 fuzes, in having a much shorter coned head and are longer between the flange and the base. This lower part, which enters the fuze hole in the projectile, has only a few screw-threads below the flange, the remainder being plain. Three types of the "umg" fuze have been found. These are:

- A. Z. 23 umg 0.8
- A. Z. 23 umg m. 2V
- A. Z. 23 umg 0.15

The "m-2V" fuze is also an optional delay fuze with two alternate delays. Details of the fuze are not yet available. Both this and the "0.8" fuze are being replaced by the "0.15" fuze.

The "0.15" fuze with an optional delay of 0.15 of a second is here described and differs from the later type of "0.8" fuze only in the time of the delay.

Each of these fuzes can be identified by the designation stamped above the flange.

CONSTRUCTION: The A. Z. umg 0.15 has the usual combined D. A. and graze mechanism consisting of a steel graze pellet carrying the detonator and an aluminum striker pellet held apart by a creep spring and five brass centrifugal segments encircled by an expanding spring ring. (See fig. 578.) The graze pellet is contained in a central recess in the body which has two flash channels at the base. One channel leads direct to the magazine through an open channel in the delay holder, the other leads to the magazine through the delay composition in the delay holder. The striker pellet with a steel sleeve surrounding it and a wooden hammer above it is carried in the head of the fuze. The steel head is retained in

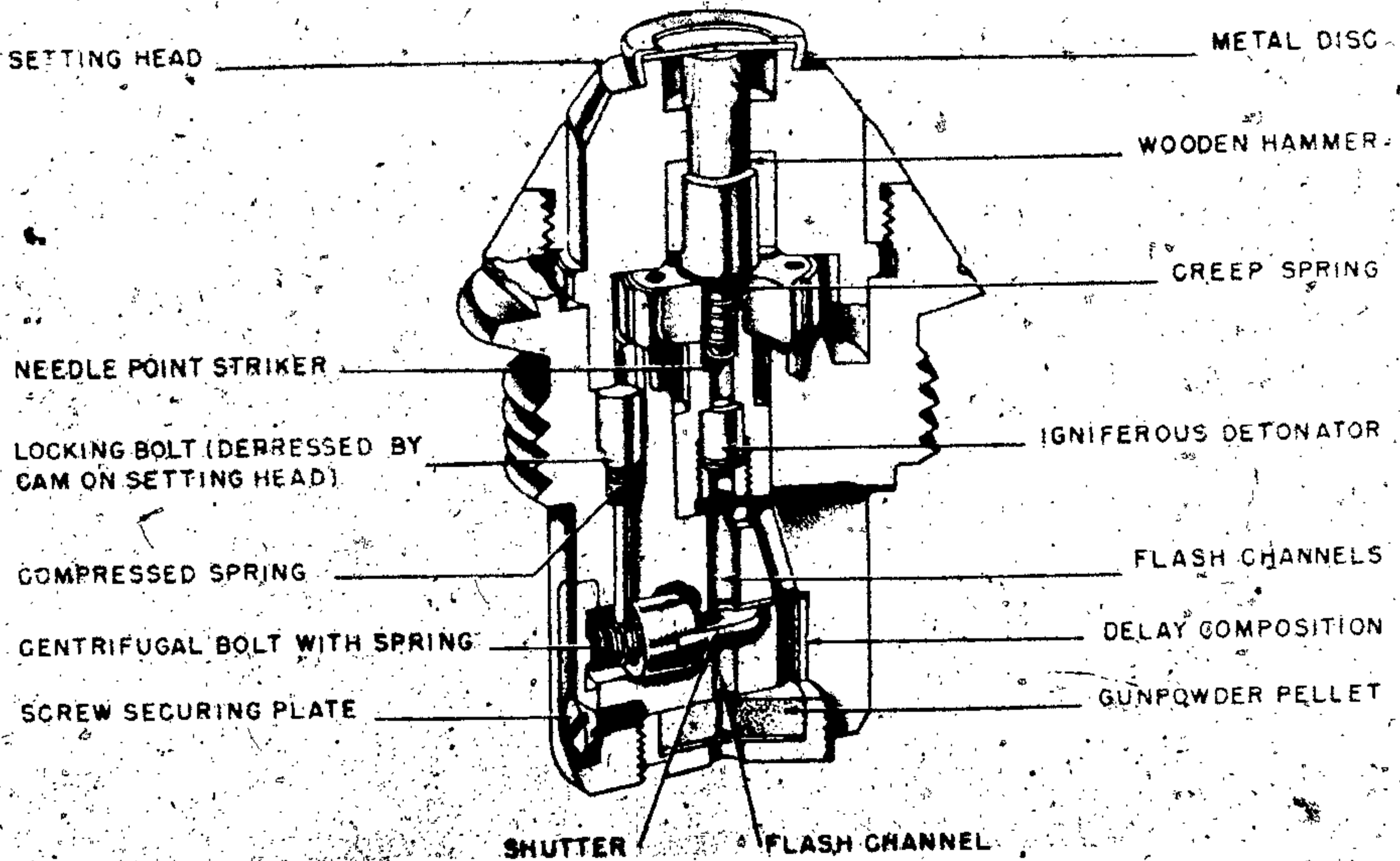

Figure 578—A. Z. 23 umg

the body by a retaining ring which screws into the top of the body and engages an external flange near the lower part of the head. The circumferential rim at the bottom of the head varies in depth to act as a cam which positions the spring loaded locking bolt of the shutter. Thus, when the head is rotated to bring the deepest portion of the rim over the locking bolt, the bolt is pressed down into the radial recess containing the shutter in the lower part of the fuze and prevents the shutter from opening. The setting positions of the head are marked on its protruding part by two lines at right angles which are set to an index line on the retaining ring and body. The setting line for delayed action is marked "MV" and that for nondelay "OV."

The delay holder, shutter assembly and magazine are all of the same type described for other fuzes of the A. Z. 23 type.

ACTION: The fuze is set for "delay" or "nondelay" by turning the head to bring the appropriate setting marking into coincidence with the index line. When set to MV the locking bolt is pressed down by the deep part of the rim at the bottom of the head and locks the shutter in the closed position. When set to OV the short part

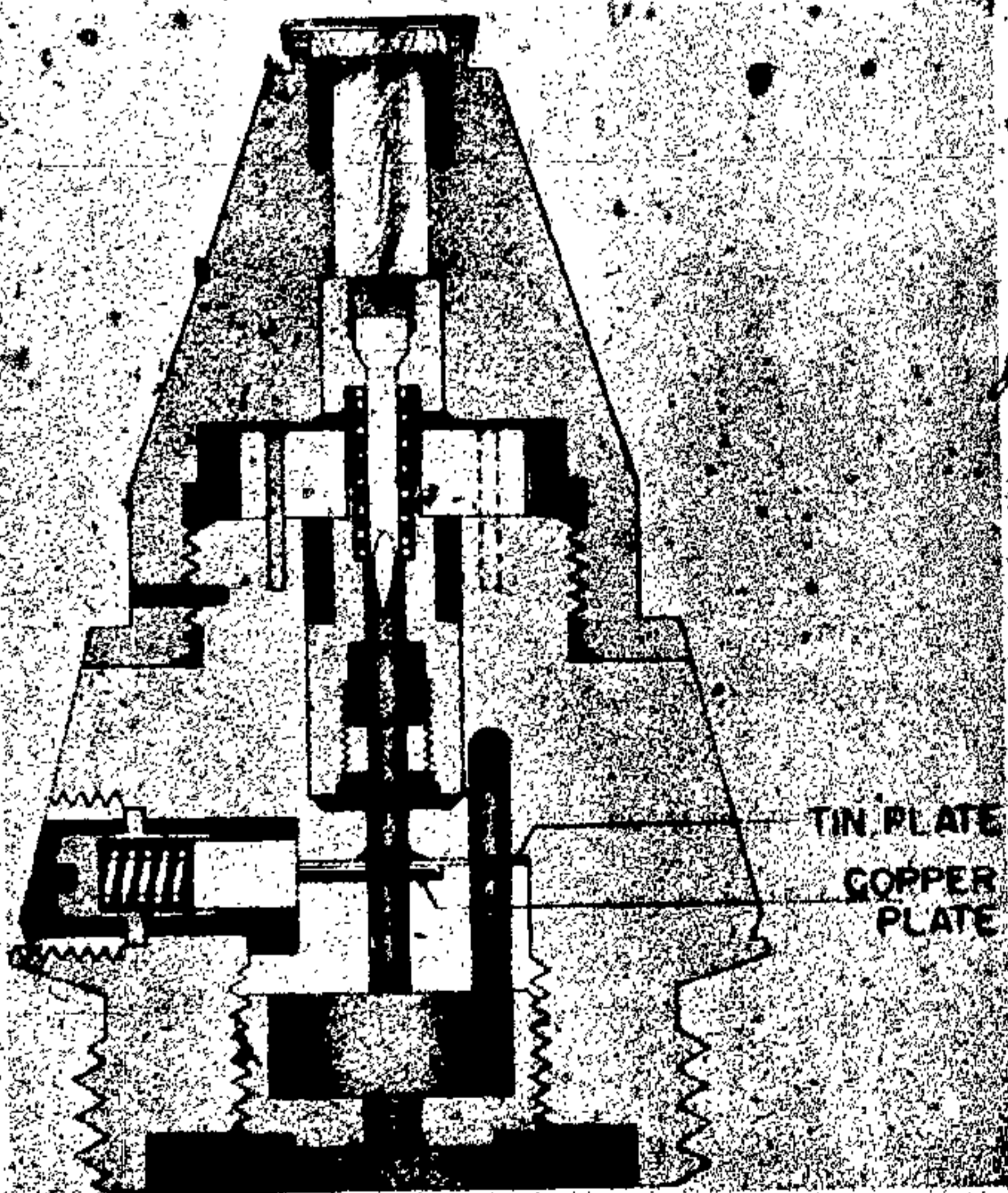

Figure 579—A. Z. 23 GEB

of the rim is over the locking bolt thus, permitting the bolt to be raised clear of the shutter recess by its spring.

During flight, the coil of the expanding spring ring is enlarged and the segments swung clear of the graze pellet by centrifugal force. If set for "nondelay" the shutter is also thrown outwards and the open flash channel in the delay holder is exposed. Forward movement of the graze pellet is prevented by the creep spring.

On graze, the detonator is carried forward by the graze pellet and pierced by the striker. When suitable impact is obtained, the hammer and striker pellet are driven in as the graze pellet moves forward, thus accelerating the action. With the head set for "nondelay" the flash from the detonator passes direct to the magazine. If set for "delay" the open channel in the delay holder is masked by the shutter so the flash has to burn through the delay composition to reach the magazine.

NOSE FUZE A. Z. 23 GEB.

EMPLOYMENT: It is used in the 75-mm Mountain Gun. (See fig. 579.)

DATA:

- Overall length: 3.562 inches.
- Maximum diameter: 2.375 inches.
- Threaded length: 0.5 inch.
- Number of threads: 4 RH.

CONSTRUCTION AND ACTION: This fuze is identical with the A. Z. 23/28 except that the detonator housing is steel rather than brass and that a paper-thin aluminum shield has been inserted between the copper slider and the black powder pellet.

NOSE FUZE KL. A. Z. 23)

EMPLOYMENT (used in):

- 7.5 Geb. G. 36 H. E. projectile.
 - 7.5 KwK. Ster G. H. E. projectile.
 - 7.5-cm K. Gr. Rot. Nb. projectile.
 - 7.5-cm F. H. Gr. Nb. 38 projectile.
 - 7.5-cm F. H. Gr. 41 Nb. projectile.
 - 10-cm Gr. 38 Nb. projectile.
- (See fig. 580.)

DATA:

- Overall length: 2.687 inches.
- Maximum diameter: 1.687 inches.

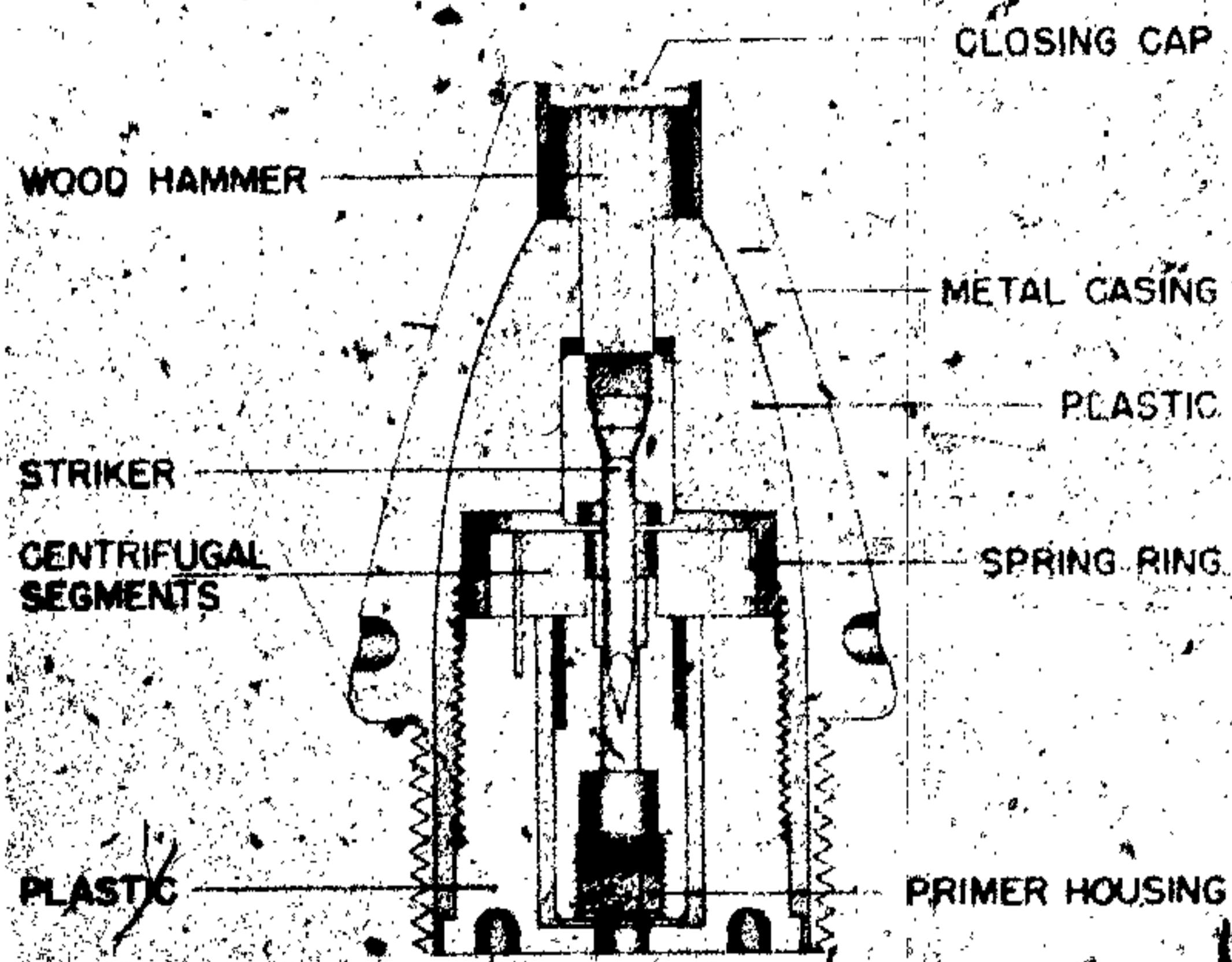

Figure 580—KI. A. Z. 23

Threaded lengths: 0.625 inch.

Number of threads: 10 RH.

CONSTRUCTION: This fuze is made up in two sections, both aluminum, the cap and the body. To assemble, the cap is screwed into the body and held by a set screw. Underneath the impact cap is a wooden plunger which rests on an aluminum plug containing a firing pin approximately 1 inch long. This firing pin is pointed downward and is held away from the upper detonator by four centrifugal detents and a spring which is fitted around the firing pin.

This fuze is made of aluminum with the exception of some small parts which are made of copper and brass.

ACTION: When the round gains sufficient centrifugal force, the centrifugal detents spread a split ring spring which is wrapped around the blocks. After pivoting outward their maximum distance the blocks lock in place and the fuze is then in the armed position. On impact the fuze upper detonator compresses the spring and impales itself on the firing pin. Beneath the brass housing containing the upper detonator is a circular aluminum block which contains two holes. The hole in the center is for instantaneous action and the one on the side has a charge of compressed black powder which is used for the delay element. The center hole is covered by a sliding copper plate which is locked in place for delay action or slides

out due to centrifugal force for instantaneous action. Beneath the aluminum circular block is a large black powder pellet which has a hole through its center and this hole is lined up with the center hole in the aluminum circular block.

Selection of action is accomplished by turning a set screw in the side of the fuze. When the groove in the set screw head points toward O the fuze is set for instantaneous action and when it points to M and V the fuze is set for 10-second delay action. This set screw turns a split hollow shaft inside of which is a spring-loaded centrifugal plug. This centrifugal plug holds the sliding copper plate, on top of the aluminum circular block, in place until centrifugal force overcomes the spring and allows the plate to slide from over the center hole if set for instantaneous action. If set for delay action, the split hollow shaft is turned so that the copper plate is locked in place covering the center hole and the split of flame goes through the side hole into the black powder pellet contained below.

REMARKS: This fuze is identical in operation with the A. Z. 23/28. It is smaller, a difference chiefly made up in the length of the wooden hammer. There are four centrifugal detents in place of five. It is set for delay in the same manner as the other fuze.

The A. Z. 23/28 fuze has the same construction as the A. Z. 23V nose fuze, the only difference being in the time of delay.

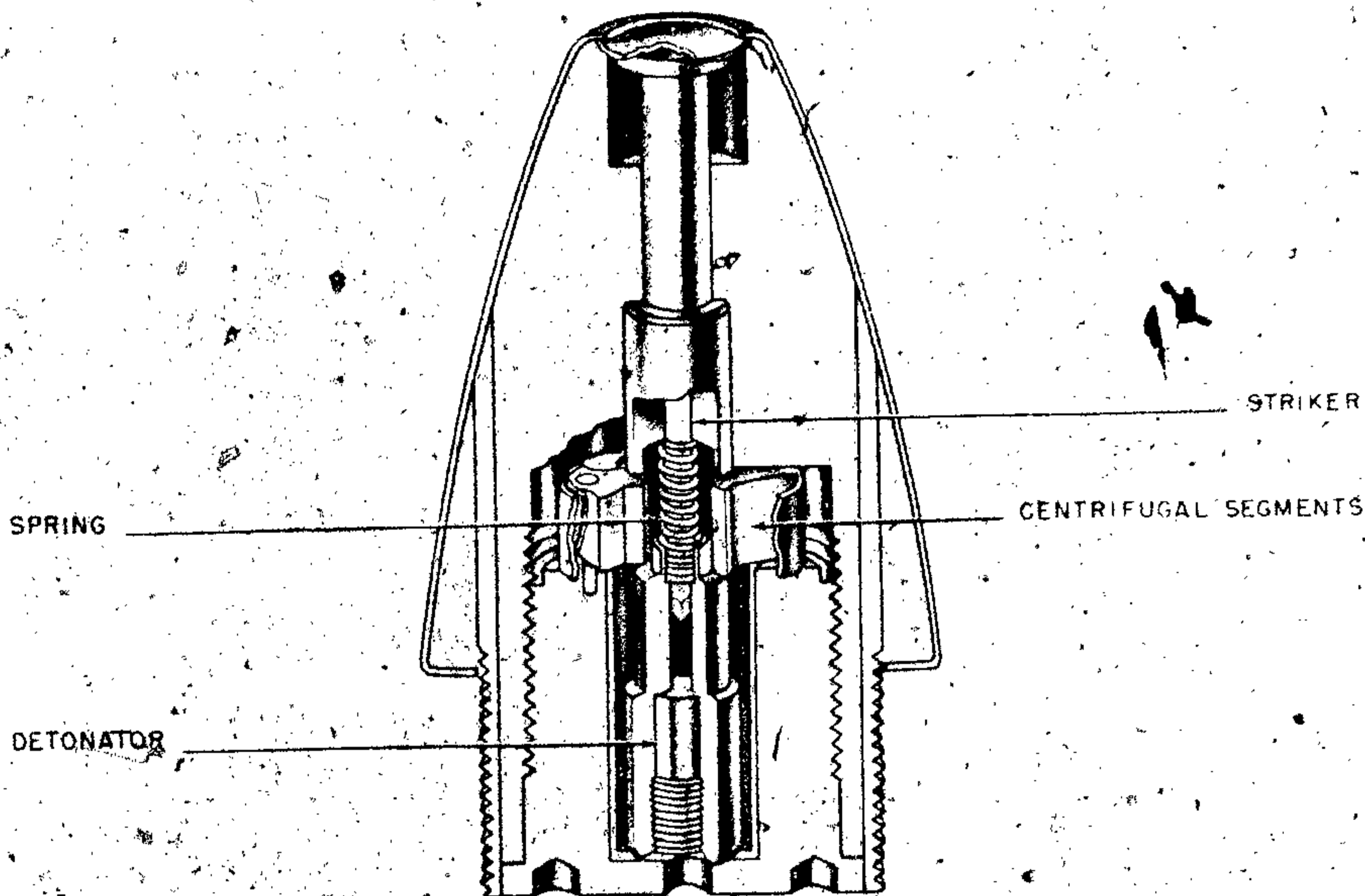

Figure 581A—Kl. A. Z. 23 Nb

FUZE, D. A. AND GRAZE KL. A. Z. 23 NB.

DESCRIPTION: This fuze has a combined direct and graze action and, excepting the igniferous detonator, has no explosive filling. (See fig. 581A.) The aluminum body of the fuze, which is closed at the top by a brass cap, carries a wooden striker positioned over a steel striker secured in an aluminum holder. An aluminum plug screwed into the base of the body contains the brass graze pellet with its 3.16-grain igniferous detonator and receives the pointed end of the striker. A steel spiral spring, fitted between the striker holder and graze pellet, keeps these two members apart during flight when the centrifugal safety segments which prevent the striker approaching the detonator in transport and in the bore are of aluminum and are pivoted on steel pins at the front end of the plug, where they are retained in the safe position by an expanding spring ring of

phosphor bronze. A flash hole is formed in the base of the plug.

ACTION: Centrifugal force set up by the spin of the projectile in flight causes the spring ring to expand and permit the segments to rotate clear of the graze pellet, thus leaving the striker and graze pellet held apart by the spiral spring. On graze or impact, the spring is compressed by the striker being driven in and the graze pellet setting forward. The flash produced by the striker piercing the detonator passes through the flash hole in the base of the plug to the detonator in the gaine. The recess in the underside of the striker holder fitting over the projection on the front of the graze pellet prevents the flash escaping in the wrong direction.

REMARKS: The KLAZ 23 Nb (Pr), KLAZ 40 Nb and KLAZ 40 Nb (Pr) fuzes are similar in operation and construction to the KLAZ 23 Nb and are likewise designed for use in smoke projectiles. (See figs. 581B and 581C.)

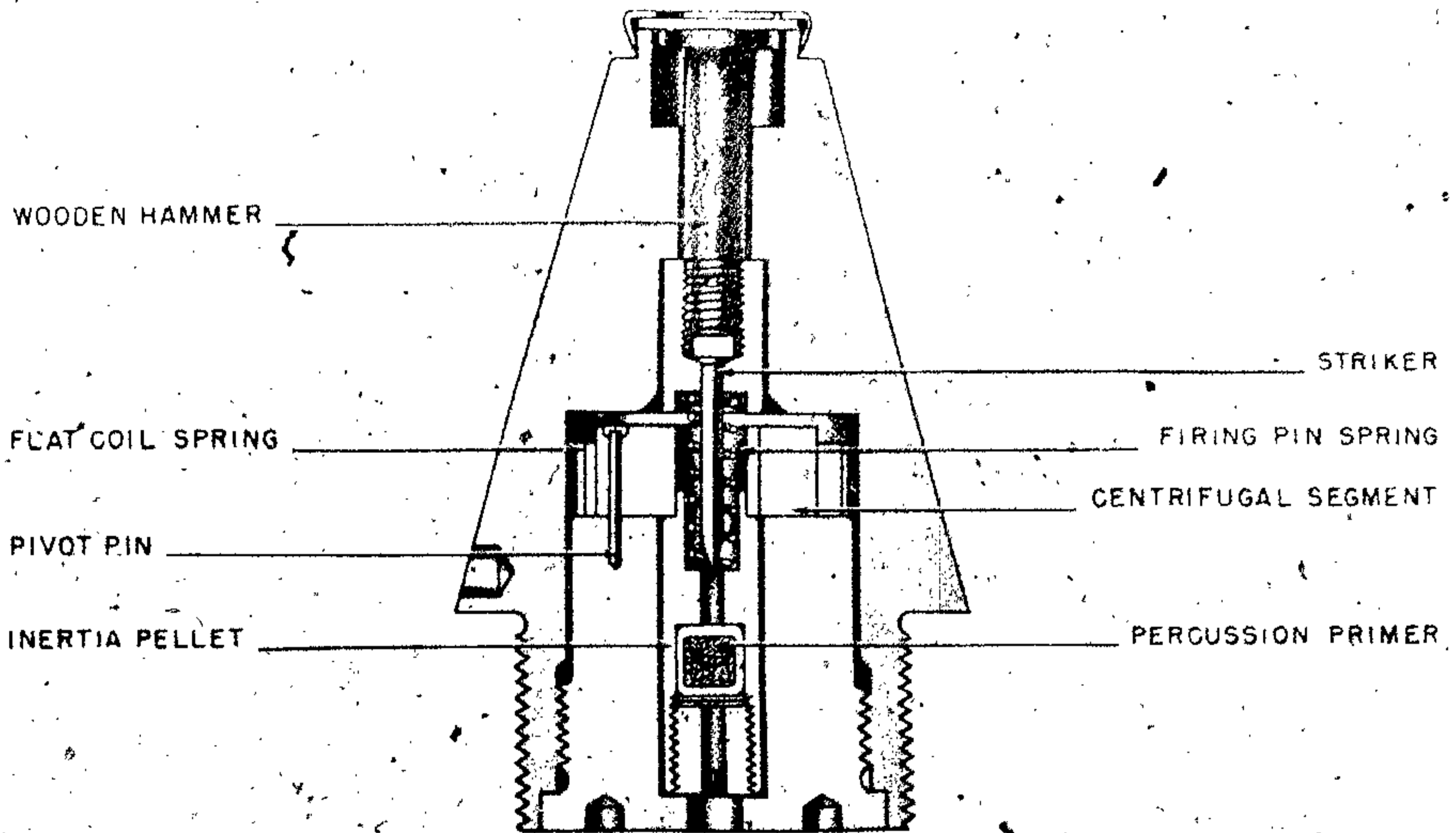

Figure 581B—Kl. A. Z. 40 Nb

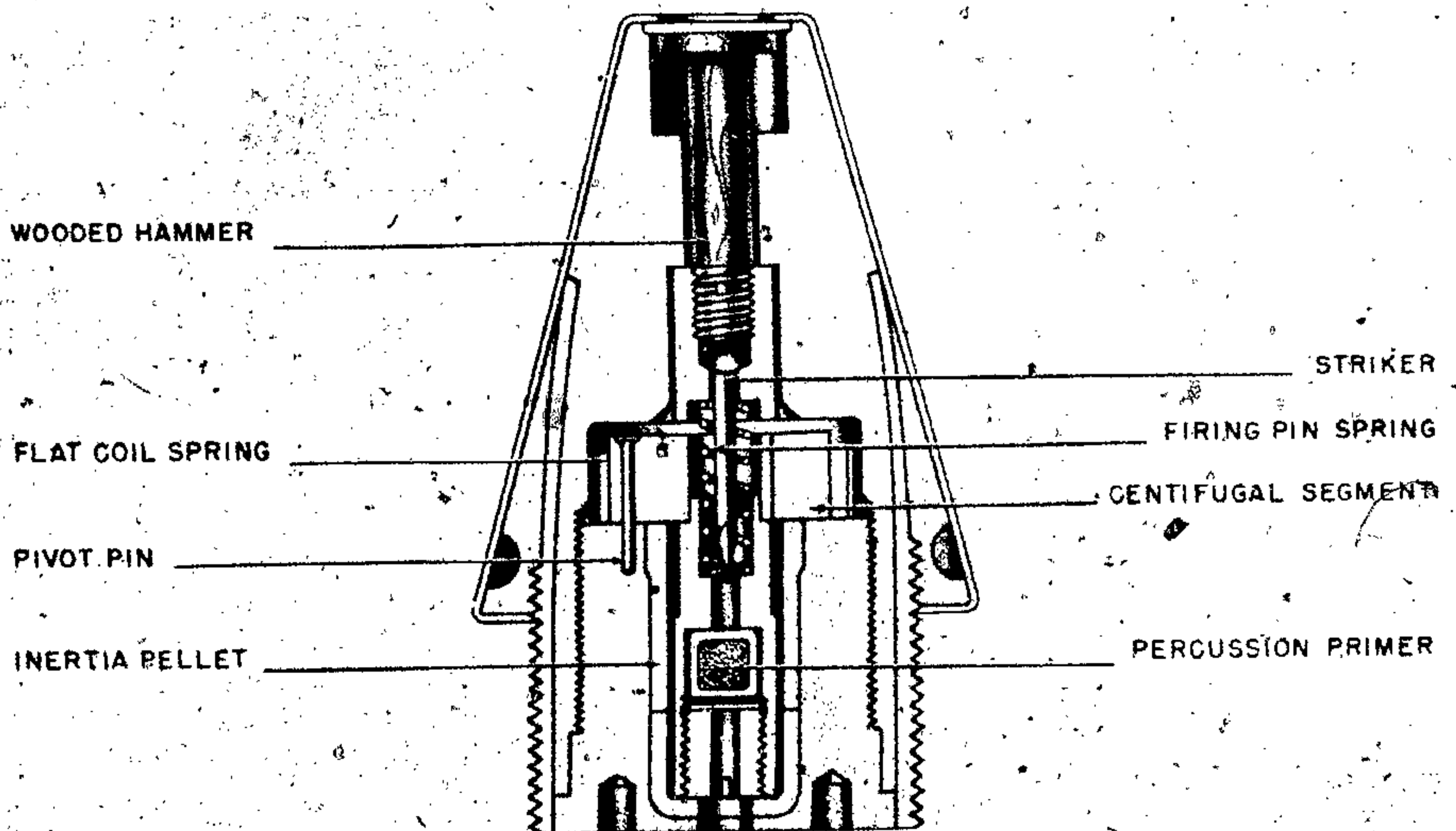

Figure 581C—Kl. A. Z. 40 Nb (Pr)

GERMAN EXPLOSIVE ORDNANCE

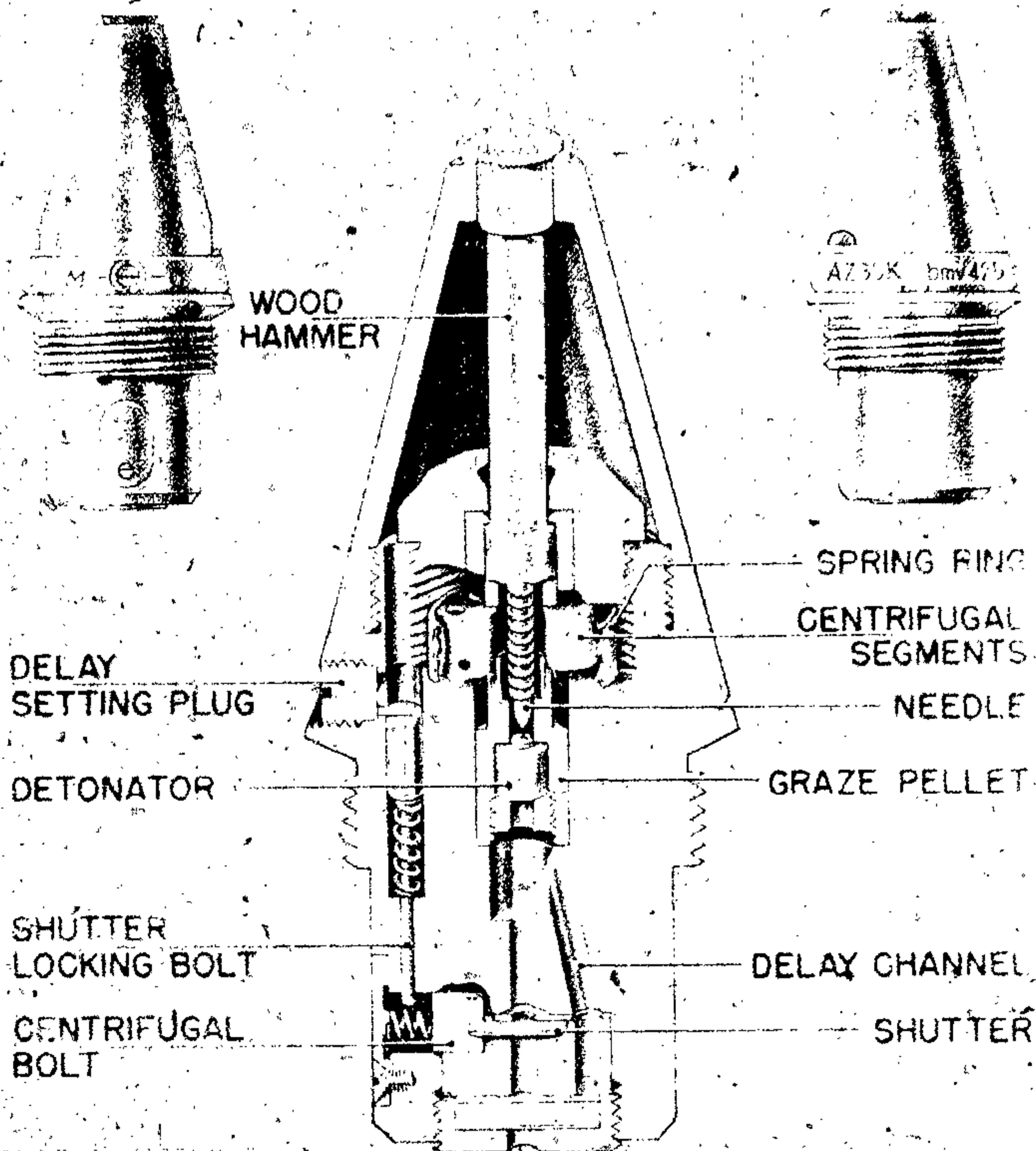

Figure 582—A. Z. 35 K

NOSE FUZE A. Z. 35 K

EMPLOYMENT: Use in H. E. shell "K Gr. 39" in the 17-cm Mrs. L. equipment. (See fig 582.)

DATA:

- Over-all length: 4.937 inches.
- Maximum diameter: 2.312 inches.
- Threaded length: 0.5 inch.
- Number of threads: 4 RH.

CONSTRUCTION: The fuze is of the igniferous type with a combined graze and direct action mechanism and an optional delay setting device which produces a 0.3-second delay.

Constructed mainly of steel, the portion protruding from the shell is coned with a flat top and is closed at the nose by a brass disk. The designation, "A. Z. 35K" is stamped near the base of

the cone head. Diametrically opposite is a delay setting plug with setting marks lettered "M" and "O" stamped adjacent to it on either side. The over-all length of the fuze is 4.94 inches and the weight 2 pounds 3 ounces 5 drams. The portion which is exposed when in the shell protrudes to a length of 3 inches.

The fuze body is screw-threaded externally for insertion in the shell and below the thread it is reduced in diameter and has a side aperture for the assembly of a centrifugal bolt attached to a shutter. The aperture is closed by a plate secured by a screw. Above the threaded portion a flange is formed which is coned to match the head. Above the flange the body is reduced in diameter and screw-threaded externally to receive the head. The delay setting plug, engraved with an arrowhead,

is screwed into a radial hole in the flange, and on its inner end has an eccentric projection which bears on the upper end of the shutter locking bolt. The body is recessed from the base to accommodate the delay arrangement with a perforated pellet of gunpowder, and is closed by a screwed plug with a central flash hole. A flash channel in the top of the recess communicates with an upper recess containing a steel graze pellet carrying the detonator. This recess contains a steel graze pellet carrying the detonator. This recess is enlarged near the top to form a platform for five pivoted centrifugal segments of aluminum. The segments are held in a position to overlap a shoulder on the graze pellet by an expanding spring ring surrounding them. The striker, carried in a cylindrical pellet of aluminum, is supported above the graze pellet by a spiral creep spring, the pellet being kept in alignment with the wooden hammer in the fuze head by a steel sleeve which fits over and protrudes above the pellet. The pellet and sleeve are accommodated in a central hole in a screwed plug which closes the top of the upper recess.

The delay holder consists of an aluminum cylindrical pellet with a flash channel through the center and a second channel, displaced from the center, which contains a pressing of delay composition. A guideway for the shutter is cut in the top of the pellet and extends beyond the central open flash hole. The figures 0.30 (indicating a delay of 0.3 second) are stamped in the base of the holder. A thin disk of tin placed over the top of the holder has two perforations which correspond with the holes in the holder and is cut away to permit movement of the centrifugal bolt.

The shutter consists of a copper plate which fits in the guideway on the delay holder and is connected at its outer end to a centrifugal bolt. The bolt is pressed towards the center of the body by a spiral spring held between the outer end of the bolt and a ring-shaped recess in the plate closing the aperture in the side of the body. The shutter locking bolt is contained in a vertical channel between the top of the aperture and the top of the body and consists of a solid cylindrical pellet of steel with a stem at its base. A spiral spring surrounding the stem supports the pellet, the upper end of which is engaged by the eccentric projection on the inner end of the delay setting plug.

ACTION: When delayed action is required the delay setting plug is turned so that the arrow-

head engraved in its head is set to the M graduation on the flange. At this setting the eccentric on its inner end is lowered and the shutter locking bolt is pushed, against this spring, down into the aperture in the side of the fuze body, thus preventing the centrifugal bolt from moving outwards. For nondelay action the plug is set to the O graduation. The eccentric is then in the raised position and the shutter locking bolt is clear of the path of the centrifugal bolt.

During flight, the coil of the expanding spring ring is enlarged and the segments swung clear of the graze pellet by centrifugal force. When set for nondelay, the centrifugal bolt is also thrown outwards, taking with it the shutter and thus exploding the open flash hole in the center of the delay holder. If set for delay, the centrifugal bolt is held by the locking bolt. During the period of deceleration, "creep" of the graze pellet is prevented by the creep spring. On graze, the pellet overcoming the spring by its momentum, moves forward and the detonator is pierced by the striker. When suitable impact is obtained, the hammer, and consequently the striker, is driven in at the same time as the pellet moves forward and direct action results. The path of the flash from the detonator to the magazine is governed by the setting. If set for delay, the empty channel in the delay holder is masked by the shutter and the path is through the channel containing the delay composition. If set for nondelay, the flash passing through the exposed empty channel will reach the magazine first.

LE. JGR. Z. 23 N. A.

EMPLOYMENT: This aluminum fuze has so far only been found in 7.5-cm separate ammunition.

DESCRIPTION: This fuze, which consists of a slightly modified le. Jgr. Z. 23 nA with the addition of a wooden striker extension rod and nose bush to fit into the ballistic cap, is used in projectiles with ballistic caps. It is being replaced by the Hbgr. Z. 35 K, which has been described.

It is designed to function on impact through a wooden extension rod or on graze and has an optional delay of 0.15 second.

The fuze consists of an aluminum body, striker, striker holder, creep spring, centrifugal segments, expanding spring ring, detonator pellet, detonator collar, delay mechanism and a magazine.

GERMAN EXPLOSIVE ORDNANCE

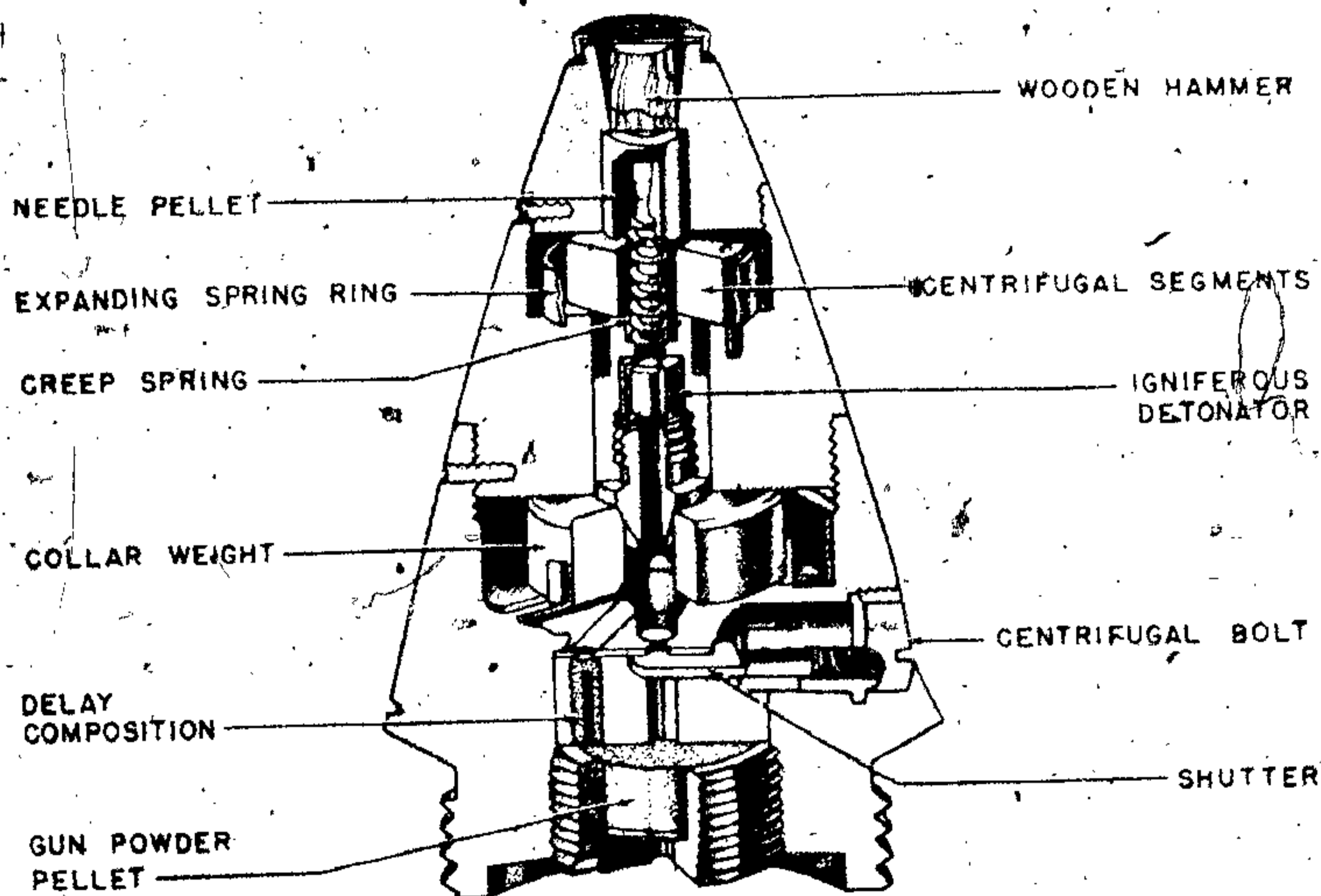

Figure 583—Le Jgr. Z 23 n. A.

The body is in three sections, to facilitate the assembly of the mechanism which is screwed together and secured by splining.

CONSTRUCTION: The nose section is bored centrally in two diameters to form a chamber at the base to accommodate the striker holder and above it, a recess to accommodate a wooden rod forming an extension to the striker. The top of the recess is coned outwards. Externally, at the bottom, it is screw-threaded for insertion in the center section. The steel cylindrical striker holder is bored centrally in two diameters to receive the steel striker. The striker is secured in the holder by turning the metal at the top of the boring over the head of the striker. The underside of the holder is recessed to form a bearing for one end of the creep spring which surrounds the stem of the striker. (See fig. 583.)

The center section is bored centrally in two diameters, screw-threaded internally at the top to receive the nose section and externally at the bottom for insertion in the base section. The chamber formed in the top houses five brass centrifugal segments each pivoting on a pin. The segments are surrounded by an expanding spring

ring which, at rest, prevents the striker and detonator pellet moving towards each other to fire the detonator. The lower chamber houses the detonator pellet.

The detonator pellet is of steel, cylindrical in shape, and smaller in external diameter at its forward end. It is bored centrally in three diameters to form an internal flange separating two chambers. The upper chamber receives the base end of the creep spring and the point of the striker and the lower chamber the detonator. The detonator is retained in the pellet by a light alloy plug with central fire channel. The plug is secured by a steel pivot. The base of the plug is coned and located in an iron inertia collar. Paper washers are inserted between the plug and detonator.

The base section of the fuze body is bored centrally to form chambers for the collar, delay holder and magazine, and radially to accommodate the delay mechanism. It is screw-threaded internally at the top to receive the center section and externally at the base below the flange for insertion in the shell. The chamber at the top houses an iron inertia ring rustproofed by some process which leaves a matt surface. The ring

PROJECTILE FUZES

is square in section and coned internally at the top to match the coned portion of the plug in the detonator pellet. The diameter of the ring is considerably less than that of the chamber which houses it. The ring is centered by five up-turned lugs of a rustproofed steel washer which fits closely at the bottom of the chamber. The chamber at the bottom houses the delay holder above a magazine which closes the base of the fuze.

The delay holder is an aluminum pellet with a central flash channel and another channel, displaced from the center, filled with delay composition. Both channels are in communication with the magazine filling and there is an inclined channel between the delay composition and the center of the fuze. A recess in the top surface of the holder accommodates a centrifugal shutter. The delay composition in a similar fuze, consisted of sulphur 9.2 percent, potassium nitrate 72.6 percent, charcoal 18.2 percent.

The magazine is screw-threaded externally and contains a perforated pressed pellet of gunpowder. A flash hole in the base of the magazine is closed by a paper disc inserted below the pellet.

The central flash channel in the delay holder may be closed or opened by an optional delay mechanism. The delay mechanism consists of a setting plug, centrifugal bolt, spiral spring, plate and screwed ring. The setting plug is tubular steel closed at one end and has a slot on the outside which serves as a setting index. The plug is retained in the fuze body by the steel screwed ring. The cavity in the plug houses a cylindrical steel centrifugal bolt and spiral spring. When the fuze is set to nondelay, a slot cut diametrically across the mouth of the cavity, receives a centrifugal copper shutter that slides in a recess in the top surface of the delay holder and un.masks the central fire channel. A brass plate with holes bored to correspond with the delay and central fire is placed on the holder and forms an upper surface for the copper plate.

ACTION: BEFORE FIRING. The striker is separated from the detonator by the centrifugal segments, which are retained in the closed position by the expanding spring. The shutter of the delay mechanism closes the central fire channel by pressure from the centrifugal bolt. This position

is maintained whether the fuze is set for delay or nondelay. The delay channel is always uncovered.

To set the fuze for nondelay action the slot in the setting plug is turned to a position in prolongation with the axis of the fuze to the marking O on the fuze body, thereby bringing the slotted recess in the plug opposite the shutter. For delay action, the setting plug is turned at right angles to the axis of the fuze to the marking M and V on the fuze body, and in this position the plug prevents movement of the shutter during flight, so closing the central fire channel.

DURING FLIGHT—NONDELAY ACTION. The centrifugal segments swing outwards one after another, and the surrounding spring expands. During deceleration, only the creep spring prevents the detonator pellet carrying the detonator on to the striker. The centrifugal bolt of the delay mechanism moves outwards compressing its spring, and the plate under centrifugal action slides into the plug and opens the central flash channel.

DELAY ACTION. When set to delay, the plug prevents the shutter sliding under centrifugal action and the central fire channel remains closed.

ON IMPACT. By direct action the extension rod forces the striker directly on to the detonator. On graze, the detonator pellet is carried forward on to the striker, or it may be forced on to the striker by a sideways movement of the inertia collar. The flash from the detonator passes either through the delay channel or through the central channel to the magazine, according to the setting of the fuze, and thence to the game in the shell.

L. JGR. Z. 23 N. A. ROCKET NOSE FUZE

DATA:

- Over-all length: 3.6 inches
- Diameter: 2.35 inches.
- Threaded length: 0.5 inch.
- Number of threads: 4 RH.
- Employment: 21-cm Wgr. 42 Spr.

DESCRIPTION: This fuze is designed to operate on impact, through a wooden extension rod, or on graze, and has an optional delay of 0.15 second. The fuze consists of a three-section aluminum body containing a striker and spring, five

GERMAN EXPLOSIVE ORDNANCE

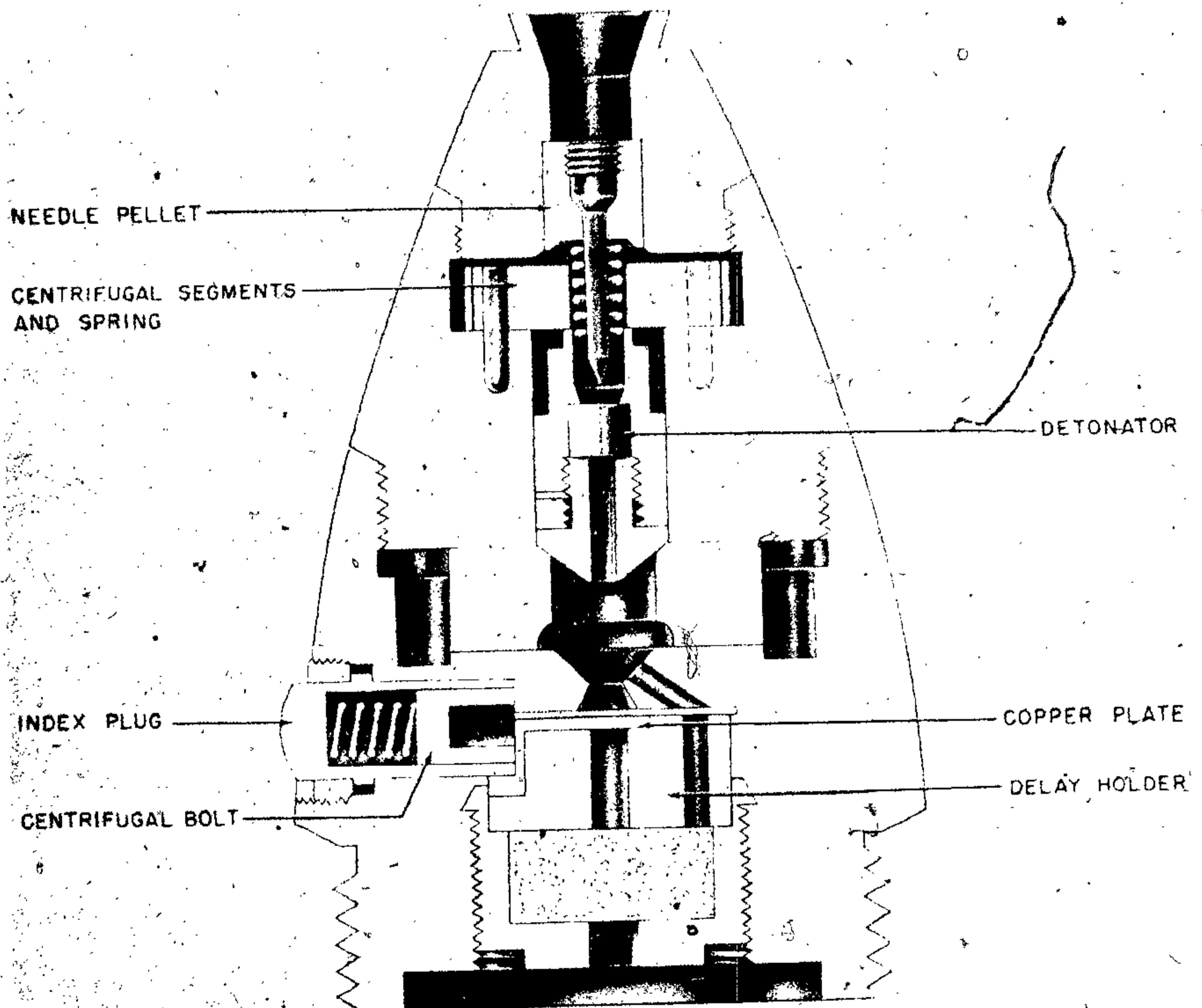

Figure 584—L. Jgr. Z 23 n. A.

pivoted centrifugal segments retained by an expanding circular spring, a detonator carrier containing the detonator, an inertia collar, a delay mechanism, and a magazine. (See fig. 584.)

In the unarmed position, the striker is separated from the detonator by a light spring and by the five segments. The shutter of the delay mechanism is held over the instantaneous flash channel by pressure of the centrifugal bolt and its spring. The delay chamber is uncovered.

To set the fuze for instantaneous action, the screw driver slot in the setting plug is turned to the O mark stamped on the fuze body, thereby bringing a slotted recess in the plug into alignment with the shutter. When set for delay action, with the slot in the setting plug at the M

and V marks, the plug prevents movement of the shutter, thus keeping the instantaneous flash channel closed.

A wooden actuating rod extends from the forward end of the striker in the nose of the fuze to the inside of the top of the ballistic cap.

OPERATION: During flight the centrifugal segments swing outwards, leaving the detonator carrier riding only on the light spring. If set for instantaneous action, the centrifugal bolt in the delay mechanism moves outward, allowing the shutter to slide into the setting plug and open the instantaneous channel. If set for delay action, the plug prevents movement of the shutter, leaving only the delay channel open.

Direct impact will force the striker into the detonator through the medium of the wooden actuating rod. On graze impact, the detonator carrier may ride forward against the striker, or it may be forced against the striker, by the camming action of sideways movement of the inertia collar.

The flash from the detonator passes through the delay or instantaneous channel to the black powder pellet in the magazine and initiates the booster in the shell.

HBGR. Z. 35 D ROCKET NOSE FUZE

DATA:

Over-all length: 3.5 inches.
 Diameter: 2.375 inches.
 Threaded length: 0.5 inch.
 Number of threads: 4 RH.
 Employment: 21-cm Wgr. 42 Spr.

DESCRIPTION: This fuze is screwed into the nose of the projectile, and a long ballistic cap is fitted over the fuze, screwing directly to the projectile. An actuating rod reaches from the nose cap to the nose of the fuze and transmits the shock of impact directly to the striker. (See fig. 585.)

The fuze itself is fitted with a plunger in the nose which bears against a striker. The striker is held in the safe position by the standard German centrifugal segments. The primer housing is also held in position by these same segments.

To one side of the striker assembly is a spring-loaded plunger which rides against the cam-shaped base of the upper fuze housing. This upper housing is free to turn in order to set the cam with relation to the spring-loaded plunger. The base of the plunger forms a lock for a centrifugal slider in the side of the fuze body. This slider is used to open or close the instantaneous firing channel through the center of the fuze.

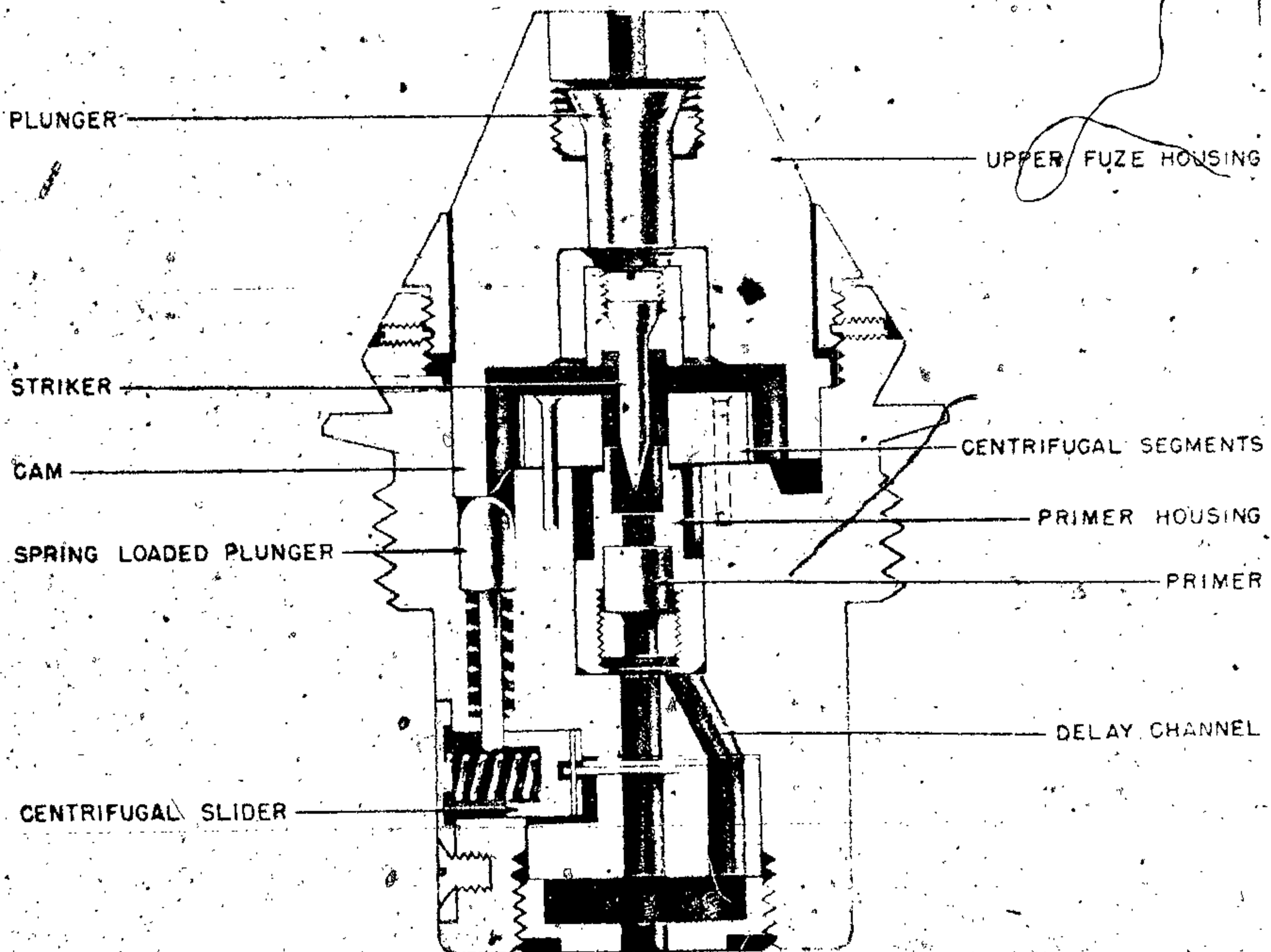

Figure 585—Hbgr. Z. 35 D

GERMAN EXPLOSIVE ORDNANCE

This fuze also has a 0.15-second delay firing channel which is always open.

OPERATION

DELAY SETTING. The head of the fuze is turned so that cam holds the spring-loaded plunger in place thus locking the centrifugal slider. In the locked position the central or instantaneous channel is closed. Centrifugal force throws the segments outward, freeing the striker and the primer housing.

Upon impact the ballistic cap crushes, forcing the actuating rod into the fuze. The striker is thus pushed backwards to meet the primer, which is thrown forward by inertia. The resulting flash fires the delay pellet, which fires the projectile.

INSTANTANEOUS SETTING. The head of the fuze is turned so that the cam does not hold the spring-loaded plunger in place, and it is free to move up and release the centrifugal slider. The fuze is armed in the same manner as with the delay setting, but in addition, the centrifugal slider moves out to open the instantaneous channel. If the fuze does not fire immediately, it will fire after the short delay expires.

NOSE FUZE A. Z. F. HBGR.

EMPLOYMENT: This fuze is used in the 15-cm Hbgr. 16 umg projectile. (See fig. 586.)

DESCRIPTION: The body of the fuze which is closed at the top by a discharge plate, carries a wooden hammer positioned over a steel striker. The striker and striker spring are held away from the primer by centrifugal segments held in position by a flat coil spring. These segments which pivot on cylindrical pins prevent the striker and defonator to contact each other during transport.

OPERATION: After the projectile has been fired, the centrifugal segments start to pivot on their cylindrical pins, moving out against the expanding flat coil spring, due to centrifugal force thereby leaving the striker resting on its spring. On impact, the striker moves forward, compressing the spring and fires the primer.

A. Z. 1 V. (©. 15) NOSE FUZE

DESCRIPTION: This fuze can be used in place of fuze A. Z. 23v and appears to be an attempt to overcome some of the difficulties that have been encountered with the latter.

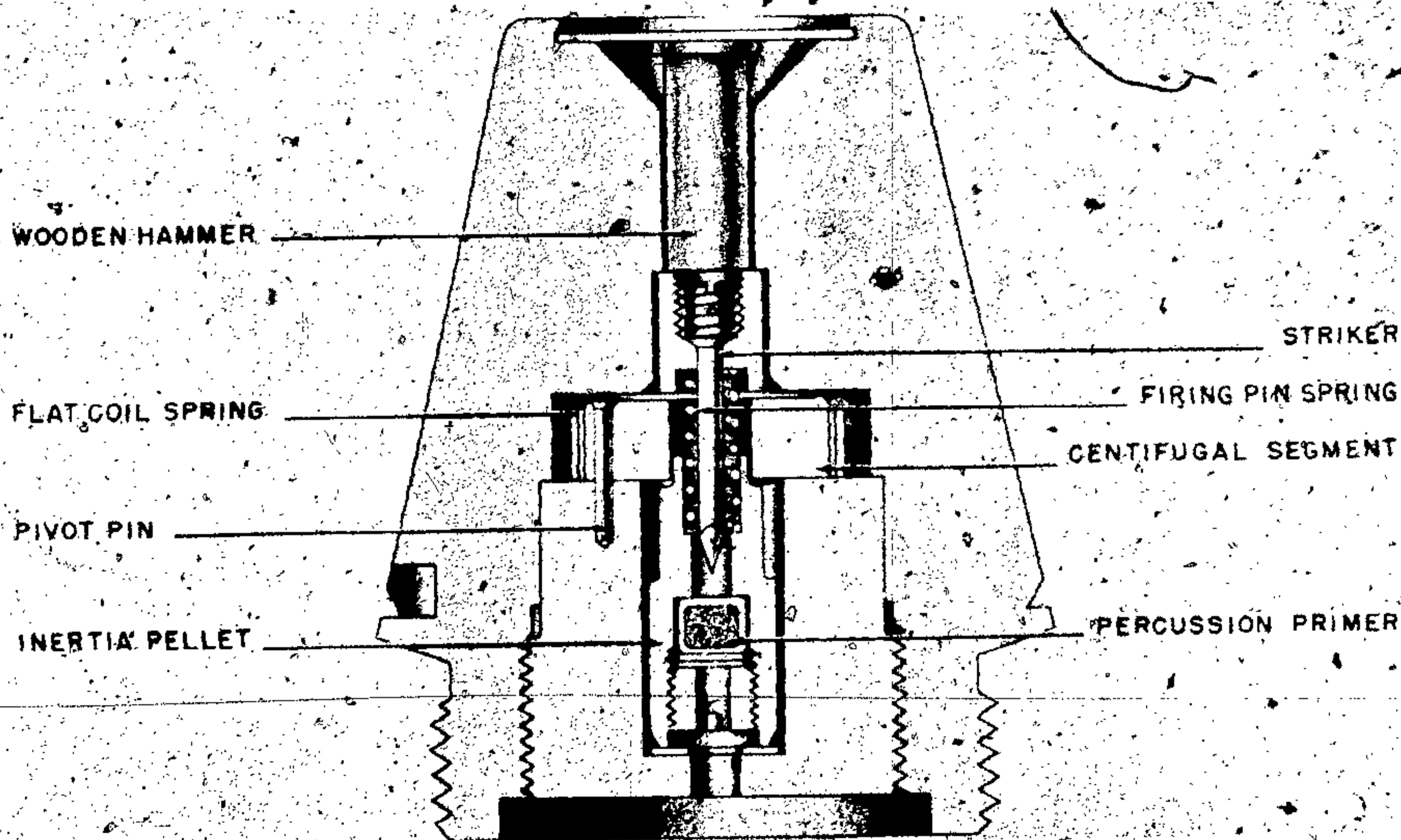

Figure 586—A. Z. f. Hbgr.

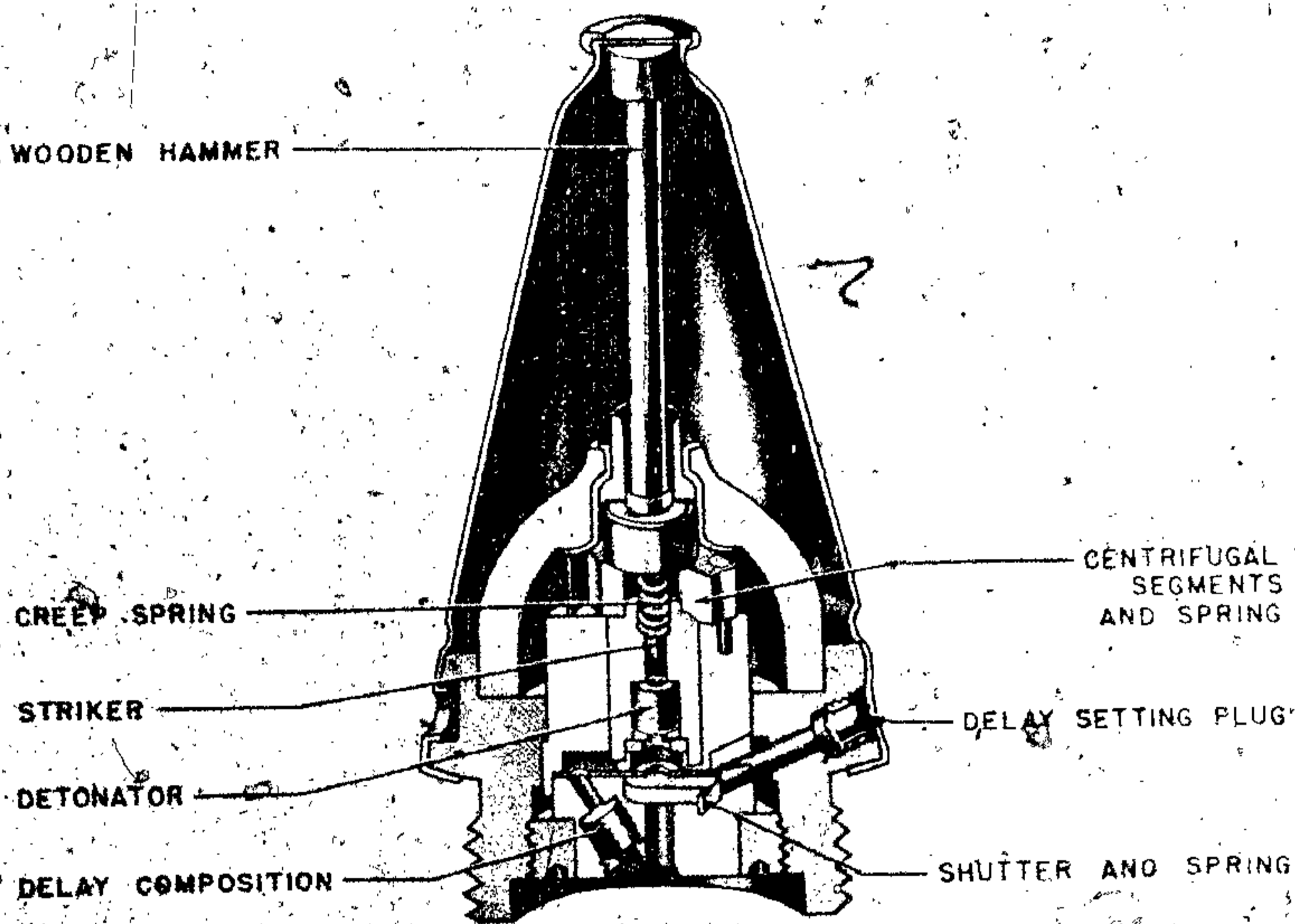

Figure 587—A. Z. 1

Externally, it is similar to A. Z. 23v, and as in the case of the latter, it is fitted with an optional delay which is operated externally in a similar manner.

The fuze is constructed largely of steel.

Internally it is similar to A. Z. 23v, except for some modifications.

The wooden hammer extension is longer and that part of the fuze body containing it is hollow.

As in the A. Z. 23v there is a steel striker and a detonator pellet which are kept apart by centrifugal segments which are kept closed by a split spring. The holder for the detonator pellet is made of plastic. There are 6 aluminum centrifugal segments. In this fuze, however, there is in addition a detent which prevents the "opening" segment from opening until after firing, i. e., the detent sets back on firing and so permits the segments to open out through centrifugal force during deceleration. A creep spring is present. (See fig. 587.)

The lower part of the fuze shows some modification. Below the detonator pellet is an aluminum plate containing a central flash hole and a flash hole to the side which contains a delay

element. The latter joins the central flash hole at its base. There is no gunpowder magazine. The central flash hole is covered by a plate which is kept in place by a semicircular spring. This plate can move outwards or remain fixed, depending on the setting of the index peg.

OPERATION

BEFORE FIRING. The striker is separated from the detonator by the centrifugal segments which are retained in the closed position by their spring. The shutter of the delay mechanism closes the central fire channel by the pressure of its spring.

To set the fuze for nondelay action, the slot in the index plug is turned to a position parallel to the axis of the fuze thereby permitting the shutter to slide out under centrifugal action when in flight. For delay action the plug is turned until the slot is positioned at right angles to the fuze axis and in alignment with the stampings M and V O, 5 on the ballistic cap; in this position the plug retains the shutter in the closed position.

ON FIRING: The detent locking the centrifugal segments sets back, the spring surrounding the segments expands, and the segments swing outwards

GERMAN EXPLOSIVE ORDNANCE

one after the other under centrifugal action, thus allowing the striker and inertia pellet free movement towards each other. The creep spring however prevents creep action. If the fuze is set for delay action, the setting plug retains the shutter which masks the central flash channel. If the fuze is set for nondelay action, the position of the setting plug permits the shutter to slide outwards and unmask the central flash channel.

ON IMPACT. The striker is forced on to the detonator by direct action. On graze, the inertia pellet carries the detonator on to the striker. The

flash from the detonator passes either through the central flash channel or the delay channel according to the setting of the fuze.

NOSE FUZE A. Z. 2

DESCRIPTION: The A. Z. 2 fuze consists of a steel striker and a detonator pellet which are kept apart by centrifugal segments which are kept closed by a split spring. There is a detent in the fuze which prevents the opening segment from opening until after firing, i. e., the detent sets back on firing thereby permitting the segments to

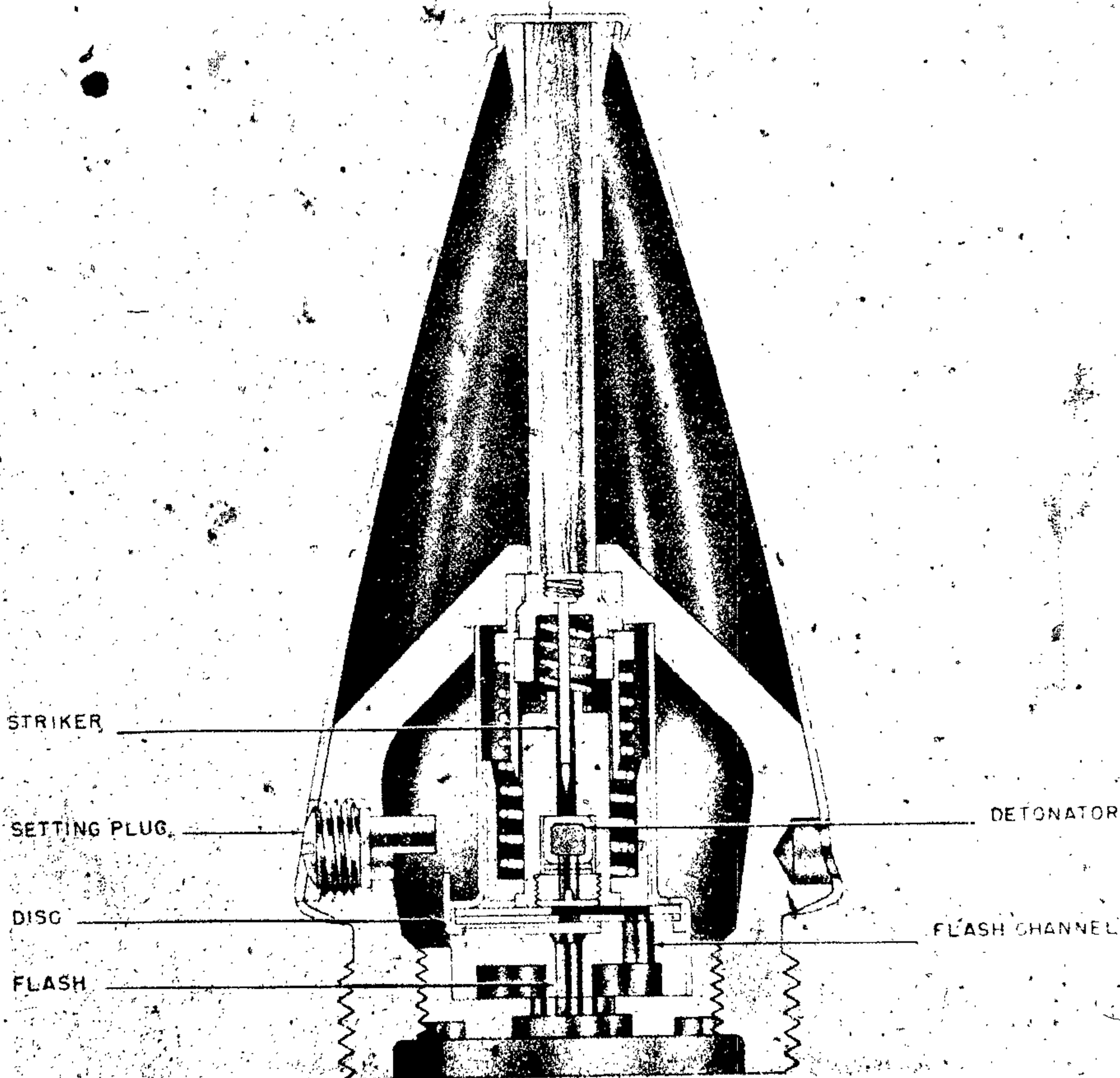

Figure 588—A. Z. 2

swing out through centrifugal force during deceleration. (See fig. 588.)

The setting plug can be so set to include non-delay or delay action pending the amount of travel the disk is allowed to move out by centrifugal force opening the central flash hole or the flash hole to the side containing the delay element.

OPERATION: After the projectile is fired, the detent locking the centrifugal segments sets back, the spring surrounding the segments expands, and the segments swing out one by one due to centrifugal force. This leaves the striker resting on the creep spring. Upon impact the striker moves forward to fire the detonator, the flash from which, passes through either the central flash channel or the delay channel depending on the position of the setting plug.

SKODA PERCUSSION FUZE

EMPLOYMENT: This fuze was found in a 100-mm projectile. Fragments of this type of fuze were also found with splinters which appear to be from 75-mm and 83.5-mm projectiles. (See fig. 589.)

DESCRIPTION: The principal parts of the fuze are the steel body, percussion mechanism, setting device for delay or instantaneous action and gaine.

STEEL BODY. The conical steel body is fitted with a brass nose which can be screwed in or out of the body and forms the means of setting the fuze for instantaneous or delay action. The lower part of the body is threaded to take the gaine and the upper part hollowed, screw-threaded, and sealed with solder. Externally the body is given a protective coating (nature not specified) and fitted with a brass cover, soldered on, which is removed before firing.

PERCUSSION MECHANISM. The striker (percussion mechanism) is of nickel steel with a head of duralumin screwed on to it. It is protected by a bronze cover plate set into the nose of the fuze and retained with sealing composition. The striker is prevented from striking the detonator before impact by:

1. Four polished nickel steel balls which fit between the striker and the detonator holder.
2. A creep spring which keeps the striker away from the detonator during flight.

3. Four castellated notches formed by cutting and bending the top end of a small tube of sheet iron through which the striker passes.

The detonator, (copper tube) is secured in the detonator holder by a screwed plug. It consists of equal parts by weight of fulminate of mercury and inflammable composition. A transverse hole is drilled through the detonator holder to form a seating for the spiral spring which holds the lower set of balls in the circular run in the body.

The detonator holder is seated in a brass tube which has at its lower end two semicircular notches which retain the lower set of balls in position before firing. The upper part of the tube has three equidistant rectangular notches through which the upper set of balls pass by centrifugal force after firing and two lateral grooves in which the lower set of balls are forced when the brass tube sets back on firing.

The delay holder contains two parallel delay fillings of loose powder and compressed powder. The holder has a central fire channel which, when the nose of the fuze is unscrewed, is closed by a ball.

SETTING DEVICE—INSTANTANEOUS ACTION. The nose is screwed into the body and its lower portion, being coned, displaces the ball from the central channel. The flash from the detonator can then pass direct through the continuous central channel of the fuze.

DELAY. The nose is unscrewed and the ball, due to gravity, closes the central channel. The flash from the detonator can then only pass through the transverse channels in the base of the nose and so through the delay filling to the gaine.

After unscrewing, and with the ball closing the central channel, the nose of the fuze must then be screwed in again in order to seal hermetically the junction of the ball and channel and to prevent the ball from moving outwards due to centrifugal action in flight.

The amount of unscrewing is limited by a ball which is carried in a seating in the body and is free to move in a groove out in the threaded portion of the nose.

The gaine, of steel varnished black, is screwed into the lower part of the fuze. It consists of a detonator, exploder, and safety devices.

The detonator consists of fulminate of mercury and compressed TNT grains carried in a holder and retained by a washer.

GERMAN EXPLOSIVE ORDNANCE

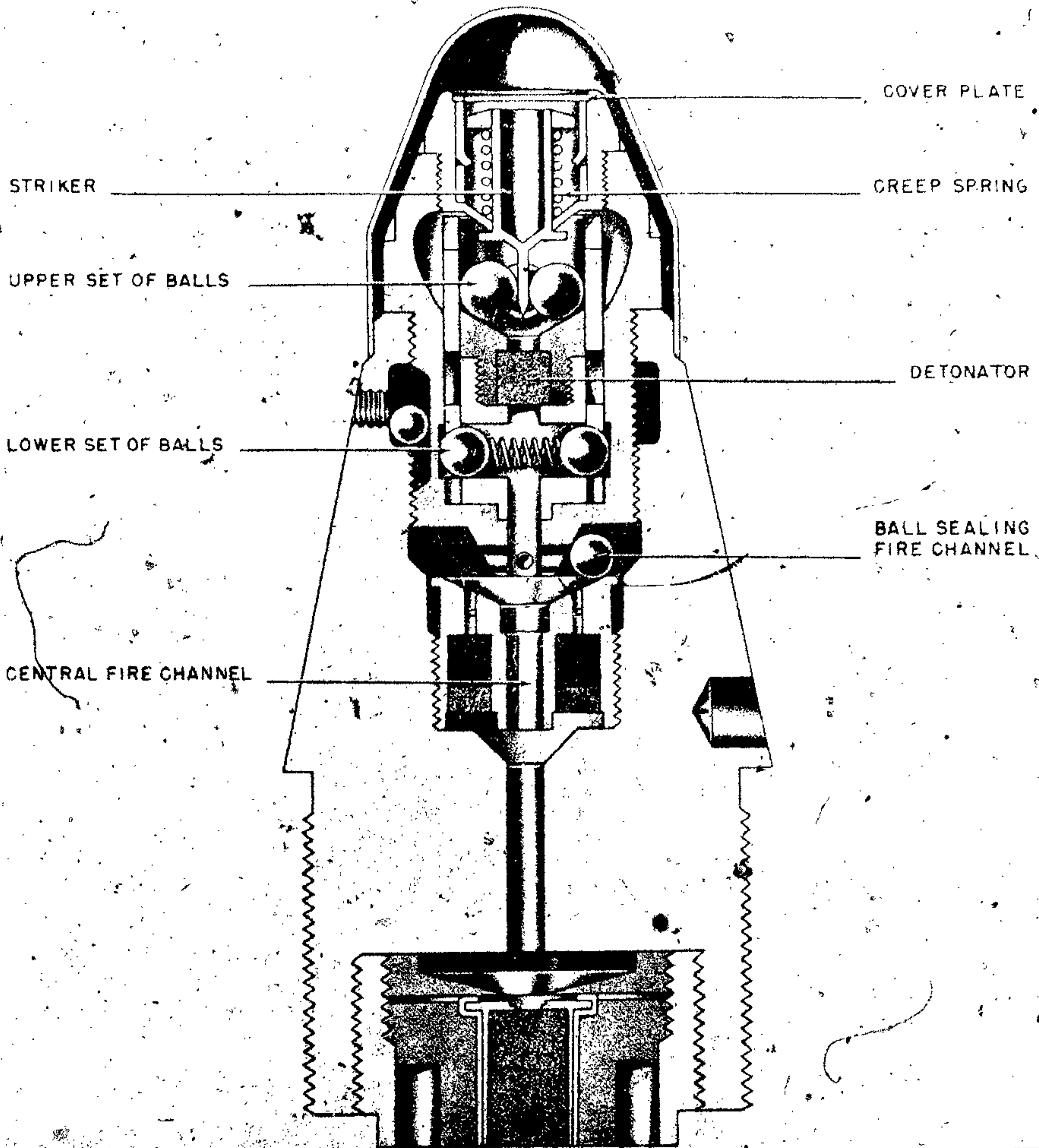

Figure 589—Skoda Percussion Fuze

The exploders consist of TNT pellets in varying degrees of compression and are held in a brass tube. The bottom of the tube is filled with a larger charge of TNT.

The safety device consists of a rotating bolt containing an explosive pellet. The normal position of the bolt is at right angles to the axis of

the fuze where it is retained by a ring held in position by a spiral spring. A ball limits the upward movement of the ring. In this position the explosive pellet in the bolt is at right angles to the axis of the fuze, there is, therefore, no communication between the detonator and the exploders.

On firing, the ring sets back compressing its

PROJECTILE FUZES

spring. The ball, which is designed to prevent the upward movement of the ring, is now free to move outwards under centrifugal force.

On acceleration, after the shell has left the bore, the ring is forced forward by its spring and this movement rotates the bolt through 90°. The pellet in the bolt is then in line with the axis of the fuze and completes the transmission of the detonation to the exploders.

ACTION: On firing, the brass tube which retains the lower set of balls in position, sets back. The balls are thrust into the hole of the detonator holder, pass along the grooves and return in the circular runway. Centrifugal force causes the upper set of balls to pass one after the other through the upper notches of the brass tube and come to rest in the runway of the fuze body. Allowing the balls to escape one at a time is an added safety device against prematures.

During flight, the striker is kept from the detonator by the creep spring and by the notches cut in the sheet iron tube in the nose. The detonator holder is held by the lower set of balls, bearing in the circular runway.

On impact, the striker is forced inwards, stripping the notches of the tube and compressing

the creep spring. The detonator holder slides through the brass tube overcoming the resistance of the lower set of balls and is carried on to the striker.

NOSE FUZE WGR. ZT. ACB

EMPLOYMENT: Plastic nose fuze in German 8-cm smoke mortar shells. (See fig. 590.)

DATA:

Over-all length: 1.625 inches.

Maximum diameter: 1.313 inches.

Threaded length: 0.375 inch.

Number of threads: 5 RH.

CONSTRUCTION: The black colored plastic body has a closing plate in the nose to protect the striker from air pressure and it is threaded at its midsection for screwing into the mortar shell.

The striker is held in the top of the fuze by a light creep spring and extends down into a central cavity.

The primer fits into the base of a sleeve which is slipped into the bottom of the fuze. A stud on the sleeve rides in a zig-zagged groove in the inside wall of the fuze body.

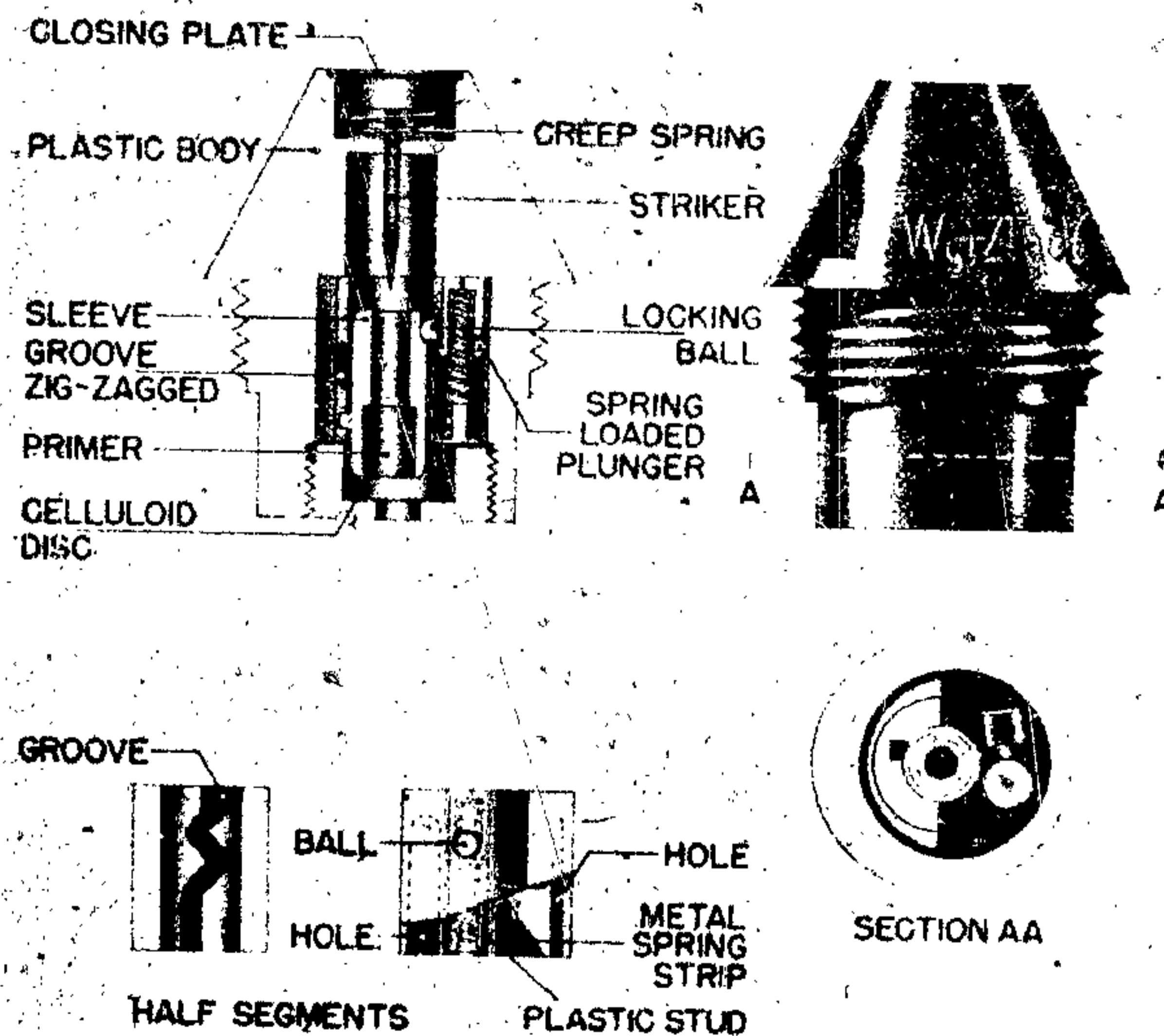

Figure 590—Wgr. ZT. acb

GERMAN EXPLOSIVE ORDNANCE

A locking ball which is held in place by a spring-loaded plunger locks the primer sleeve in the unarmed position.

In the base of the fuze, is a metal spring strip which causes a plastic stud to catch and hold the spring-loaded plunger on set-back.

A celluloid disk seals the base of the fuze and helps to hold the sleeve from falling out of the bottom of the fuze.

ACTION: Set-back throws the spring-loaded plunger back until it is caught and held by the plastic stud. This releases the locking ball and the primer sleeve is free to creep forward toward the striker during flight.

Upon impact, the primer will impinge upon the striker and at the same time the nose of the fuze will give, forcing the striker into the primer.

The flash from the primer melts the celluloid disk and fires the round.

NOSE FUZE WGR. Z. 38

EMPLOYMENT: Mechanical Impact Nose Fuze for German H. E. 5-cm Mortar Bomb. (See fig. 591.)

DATA:

Overall length: 2.563 inches (with gaine).

Overall length: 1.563 inches (without gaine).

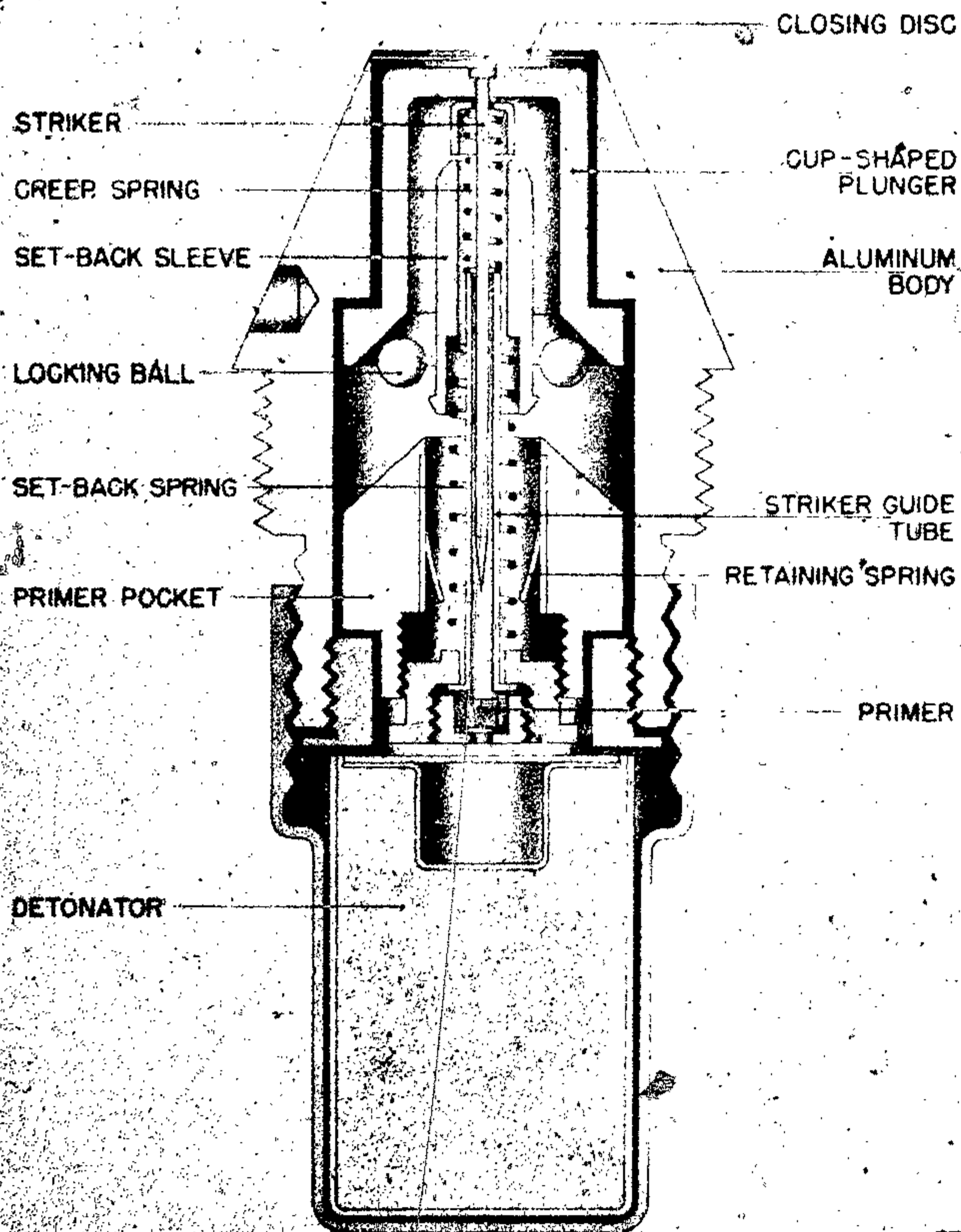

Figure 591—Wgr. Z. 38

Maximum diameter: 1.250 inches.
 Threaded length: 0.375 inch.
 Number of threads: 5 RH.

CONSTRUCTION: The fuze body is aluminum and houses a steel primer pocket and a brass retaining spring. Within the fuze there is a striker secured to a cup-shaped movable plunger in the head and a striker guide tube which leads to a primer in the base. The tube is attached to the primer pocket and is separated from the striker plunger by a creep spring. The fuze is kept in the unarmed position by nine steel balls located between the striker plunger and the primer pocket. These balls are arranged around a central set-back sleeve which is held in position by a set-back spring. The set-back sleeve has a flange formed around the rear end to engage with the tongues of the retaining spring (fitted in the primer pocket) when the fuze is armed.

ACTION: Upon discharge, the set-back sleeve is driven down compressing the set-back spring and engaging the tongues of the retaining spring. This creates a clearance in the striker plunger into which the nine steel balls are forced by a creep action during flight. In this position, the fuze is armed with only the creep spring preventing contact of the striker with the primer. There is a brass closing disk over the head of the fuze which prevents air pressure from functioning the fuze in flight. Upon impact or graze, the creep spring is overcome and the striker pierces the primer.

REMARKS: According to a German firing table, the fuze can be made more sensitive in order to function in mud or snow, by removing the brass closing disk. Another fuze which can be used on the 5-cm mortar is the plastic fuze, Mgr. Zt., which differs internally from the Wgr. Z. 38.

The fuze, Wgr. Z. 38 is interchangeable with all German 5- and 8-cm mortars. It is believed the German nomenclature, stamped near the base, designates the model number and the type of metal used in the fuze construction:

Wgr. Z. 38—Aluminum.

Wgr. Z. 38 st—Steel.

Wgr. Z. 38 z—Zinc.

Wgr. Z. 38—Ausf. C.

All of the fuzes are of the set-back armed, instantaneous ignition type.

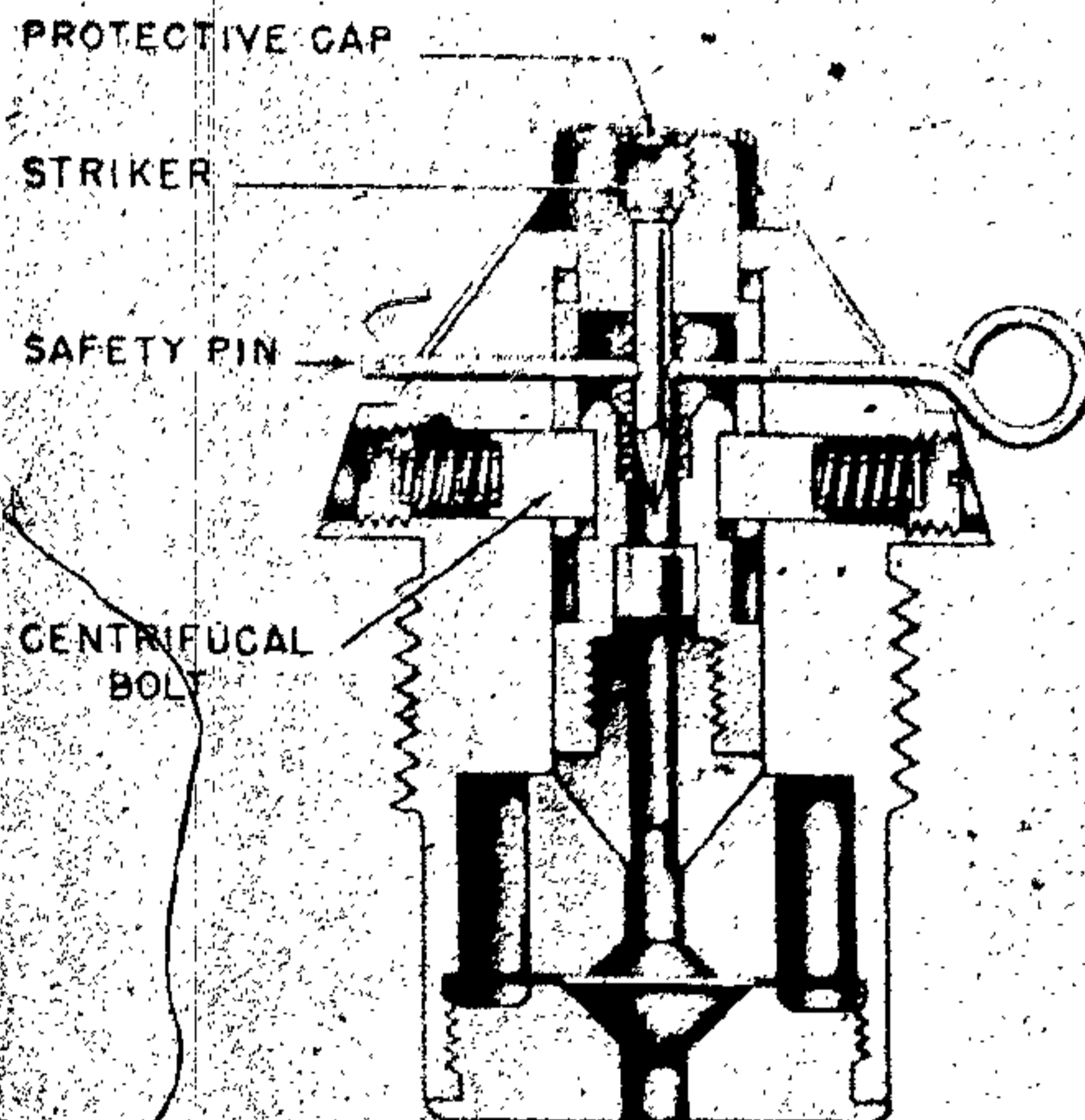

Figure 592—Wgr. Z. 50

WGR. Z. 50 ROCKET NOSE FUZE

DATA:

Over-all length: 2.87 inches.

Diameter: 1.69 inches.

Threaded length: 0.625 inch.

Number of threads: 11 R. H.

Employment:

28-cm. Wfk. Spr.

30-cm. Wfk. 42 Spr.

32-cm. Wfk. M. Fl. 50.

DESCRIPTION: This fuze consists of an aluminum body containing a floating striker, floating detonator carrier, and an inertia weight. The striker and detonator carrier are separated by a light spring. The striker extends through the forward end of the fuze body, and in the unarmed position, both striker and detonator carrier are held in place by a pair of centrifugal detents. A shipping safety pin passes through the fuze body, striker, and a protective cap. (See fig. 592.)

OPERATION: The safety pin is withdrawn and protective cap removed before firing. As the projectile leaves the launcher, centrifugal force causes the detents to move outward, freeing the striker and the detonator carrier. Upon impact the striker is forced aft, and the detonator carrier rides forward due to inertia against the firing pin.

GERMAN EXPLOSIVE ORDNANCE

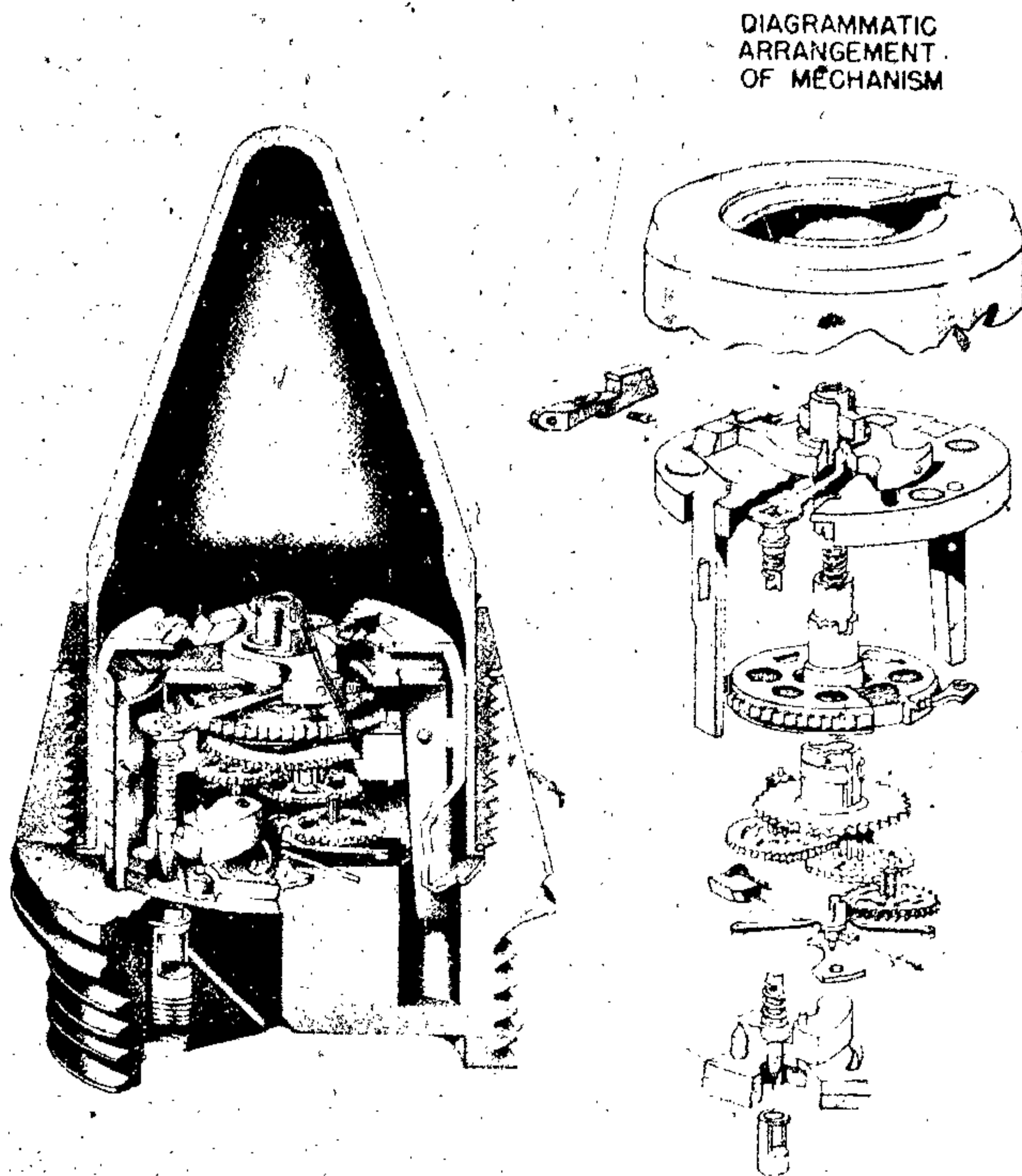

Figure 593A—Zt. Z. S/30

REMARKS: 1. Either a steel or a bakelite fuze adapter may be found fitted to this fuze.

2. When this fuze is armed, a red line is visible around the protruding end of the striker.

3. A modification of this fuze has been recovered, similar in construction and operation, but with centrifugal detents which expand a steel wire and fall clear rather than move outward against a spring. Externally the fuzes are similar, except that the modified version is cannellured near the nose to receive the expanding wire.

FUZE NOSE MECHANICAL TIME Zt. Z. S/30

EMPLOYMENT: Mechanical Time Fuze used in 8.8-cm and 105-cm H. E. antiaircraft shells. (See fig. 593A.)

DATA:

Over-all length: 4.375 inches.

Maximum diameter: 2.375 inches.

Threaded length: 0.5 inch.

Number of threads: 4 RH.

CONSTRUCTION: The fuze has a time of running of 30 seconds and is similar in design to the British No. 207 fuze. The base piece is not graduated for setting and the dome, with its hand race, is inserted into the cap where it is held, to turn with the cap, by four lugs on its base flange which engage in stops formed in the base of the cap. The tensioning of the cap is approximately 400 inch/ounce.

The mechanism is assembled in a cylindrical unit of superimposed brass plates and consists of:

The center arbor in the form of a tubular shaft with a pinion at its base end. The upper end of

the shaft is open and has two slots formed in the wall which engage the hand center. An external projection is formed near the base of the shaft to engage one end of the main spring.

The main spring coiled under tension in a brass barrel or casing. One end of the spring engages the center arbor whilst the other engages the casing. The cylindrical casing fits around the lower end of the center arbor and has ratchet teeth formed around its periphery. These teeth are engaged by a ratchet and provide the means of revolving the case to wind the spring during the assembly of the fuze.

An escapement engaging the base pinion of the center arbor comprising two spurs with pinions and a spur with the escapement wheel. The ratchet teeth of the escapement wheel are engaged by two vertical arms on the pallet which is weighted at each end and controlled by a straight adjustable hair spring.

The hand assembly carried at the upper end of the center arbor consists of the hand center, the hand and the hand spring. The hand center consists of a short hollow cylinder, open at the base, fitted with two rectangular brass arms carrying a ring near the head. The hand is of aluminum

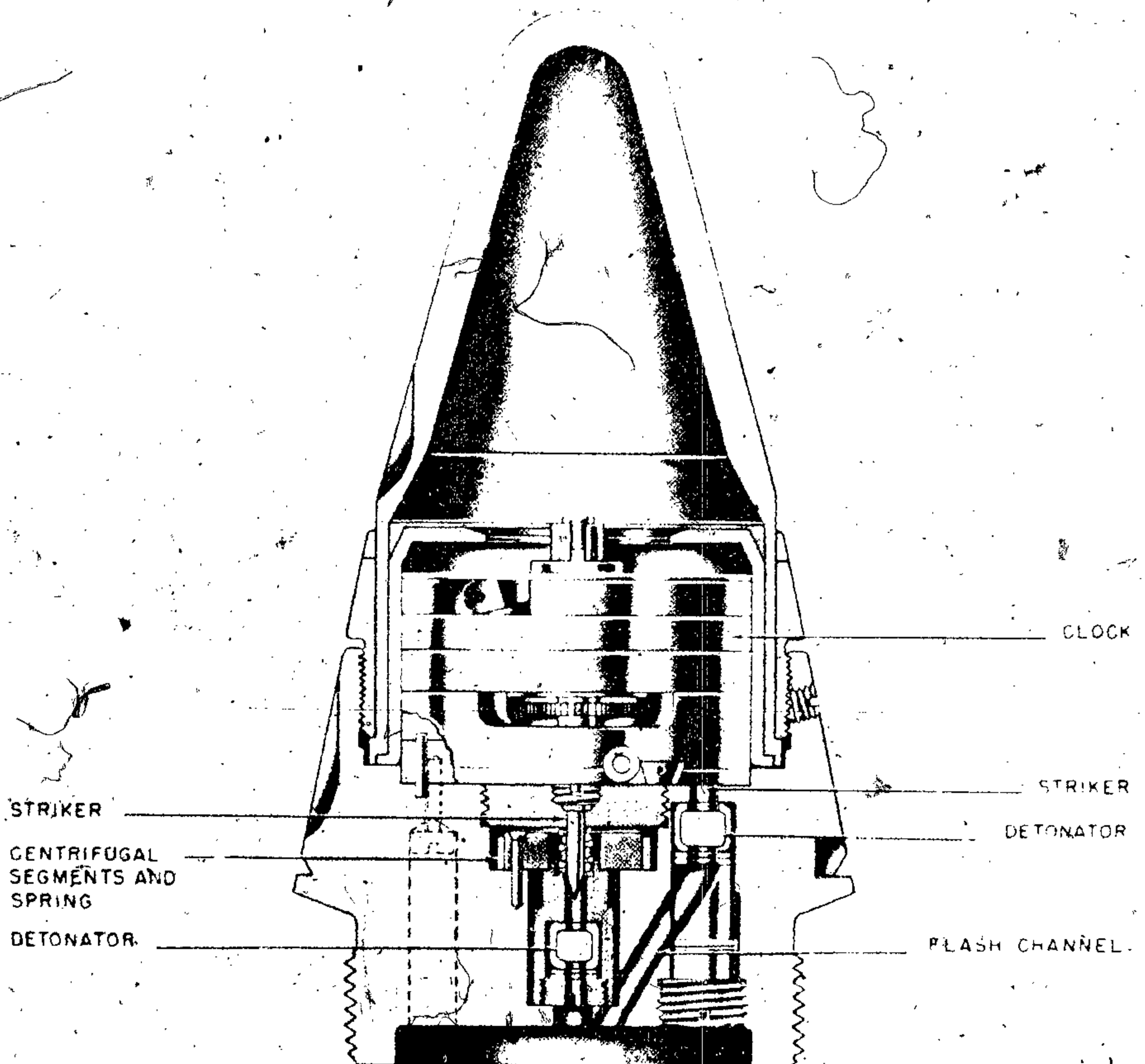

Figure 593B—Dopp. Z. S/90

GERMAN EXPLOSIVE ORDNANCE

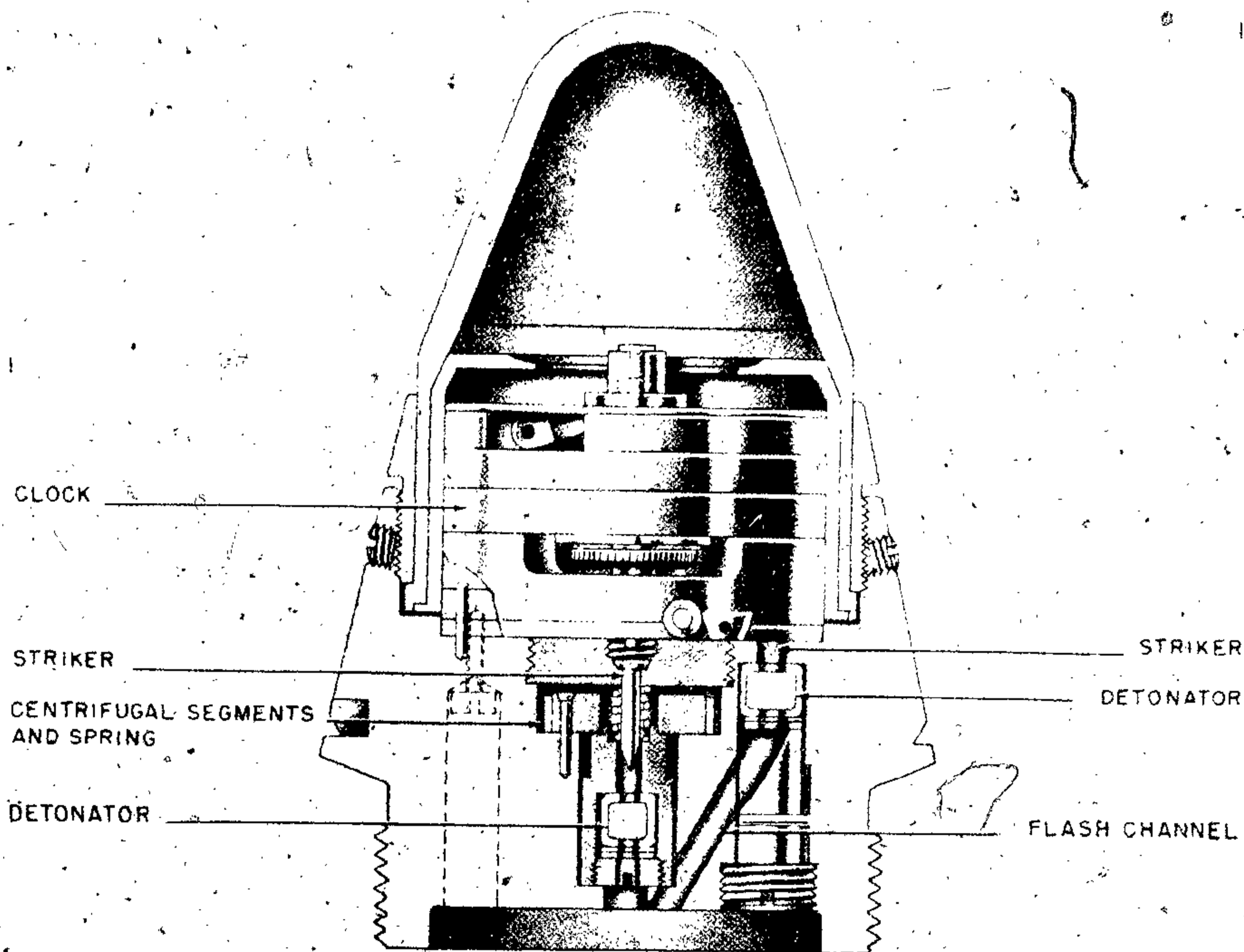

Figure 593C—Dopp. Z.S./160 Geb

and is fixed to the ring of the hand center. The outer end of the hand is recessed at one side to engage the spring catch on the trigger. The spiral hand spring is inserted in the open base end of hollow cylinder in the hand center and is compressed when the hand assembly is inserted in the center arbor and depressed to engage the rectangular arms in the slots of the arbor. The hand is retained in this position by the hand race on the dome inset and is thus prevented from rising until it has been rotated into alignment with the cut-away portion of the hand race.

The brass trigger, holding the outer end of the hand, consists of a brass arm pivoted at one end and stepped at the other to engage the hand. The step is slightly undercut. A small hole in the outer side of the trigger contains a minute spring-loaded plunger. The plunger is pressed into the hole by contact with the side of the slot in the top plate in which the trigger is located.

A safety bridge, fitted across the slot has a projection which overlaps the hand and thus prevents the hand rising until it has been rotated clear of the projection. This movement takes approximately 1 second of time.

The striker, located near the circumference of the cylindrical mechanism unit, is a steel spindle with a cam collar near the lower end and a pyramid shaped point at the base. Two flats are formed at the upper end of the spindle to engage with corresponding surfaces in the safety lever. The striker is held off the detonator by its cam collar resting on a conical headed steel pillar and on a step in the centrifugal safety catch. The spiral striker fits over the spindle and is compressed between the cam collar and the sleeve portion of the safety lever.

The safety lever is of steel and consists of a sleeve, shaped internally to fit the flat surfaces on the spindle of the striker, and carrying an arm

with an upturned end. The arm bears against the underside of the top plate and the upturned end is held adjacent to the center arbor by the ring of the hand center. A curved slot is cut in the top plate to permit a swinging movement of the arm.

The centrifugal safety catch pivoted in the lower plate is of brass and has a step formed in one side to support the cam collar on the striker. The pivot pin is slotted to engage a coil spring which keeps the catch in the safe position. The swinging movement of the catch is limited by a steel pin fixed in the catch near the free end and a curved slot, through which the pin moves, in the lower plate.

Two tapered steel locking plungers are carried in vertical slots formed down the side of the cylindrical mechanism unit. The slots are diametrically opposed and each has a hemispherical recess in one side to receive a corresponding projection on the side of the tapered plunger. The plungers are comparatively weighty and consist of steel strips tapering towards the base on the inner side. On the outer side of each, approximately at the center, a projecting vertical knife edge is formed. The plungers project below the base of the mechanism unit into recesses formed in the platform of the fuze body. The recesses are sufficiently deep to permit the plungers to set back during acceleration.

ACTION: The time of running is governed by the size of the arc extending counterclockwise between the position of the hand when held by the trigger and the position of the cut away portion of the hand race. The fuze is set by turning the cap with the aid of a setting device. The dome inset, with the hand race formed in its upper part, is rotated with the cap to the set position. The turning of the cap is retarded by the wavy wire tension spring between the screwed collar and the flange at the base of the cap.

On acceleration, the two tapered plungers set back into the recesses in the platform. As their wider portions with the projecting knife edge move back through the slots, the knife edges cut into the wall of the dome and thus prevent rotation of the dome relative to the mechanism. At the same time, the trigger, hinging on its pivot, sets back and releases the hand. The spring-loaded plunger in the side of the trigger then emerges and prevents rebound of the trigger. The release

of the hand enables the main spring to rotate the center arbor, under the control of the escapement. The rotating hand, moving clear of the safety bridge, is pressed up against the hand race by the spiral spring in the hand center.

During flight, the safety catch is swung clear of the striker which is then supported only by the pillar. When the hand reaches the part of the hand race which is cut away, it is forced upwards and the ring on the hand center moves clear of the upturned end of the safety lever. The end of the safety lever is then swung outwards by centrifugal force. The striker is turned by the lever so that the cam collar loses the support of the pillar. The spring, bearing on the cam collar, then drives the striker away from the safety lever on to the detonator.

REMARKS: The Dopp Z. S/90 and Dopp Z. S/160 Geb fuzes are identical to the Zt. Z. S/30 time fuze in construction and arrangement. The difference comes in the length of running time for the clock. (See figs. 593B and 593C.)

In some instances a substitute material has been used in the construction of the fuze.

FUZE, NOSE, MECHANICAL TIME, Zt. Z. S/30 FGL.

EMPLOYMENT: Mechanical Time Nose Fuze used in 8.8-cm and 10.5-cm H. E. antiaircraft shells. (See fig. 594.)

DATA:

- Overall length: 4.375 inches.
- Maximum diameter: 2.375 inches.
- Threaded length: 0.5 inch.
- Number of threads: 4 RH.

CONSTRUCTION: The fuze shell resembles the Zt. Z. S/30 in external appearance but differs in the internal mechanism in which the motive power is derived from centrifugal force instead of from a clock spring. The type is identified by the stamping "Zt. Z. S/30 Fgl" around the side of the body above the flange. The fuze is igniferous and has a maximum time of running of 30 seconds. The mechanism governing the setting is designed to prevent the fuze functioning at settings shorter than approximately 1 second.

The fuze consists of the base piece or body, the cap, the screwed collar, and the mechanism.

DIAGRAMMATIC ARRANGEMENT OF MECHANISM

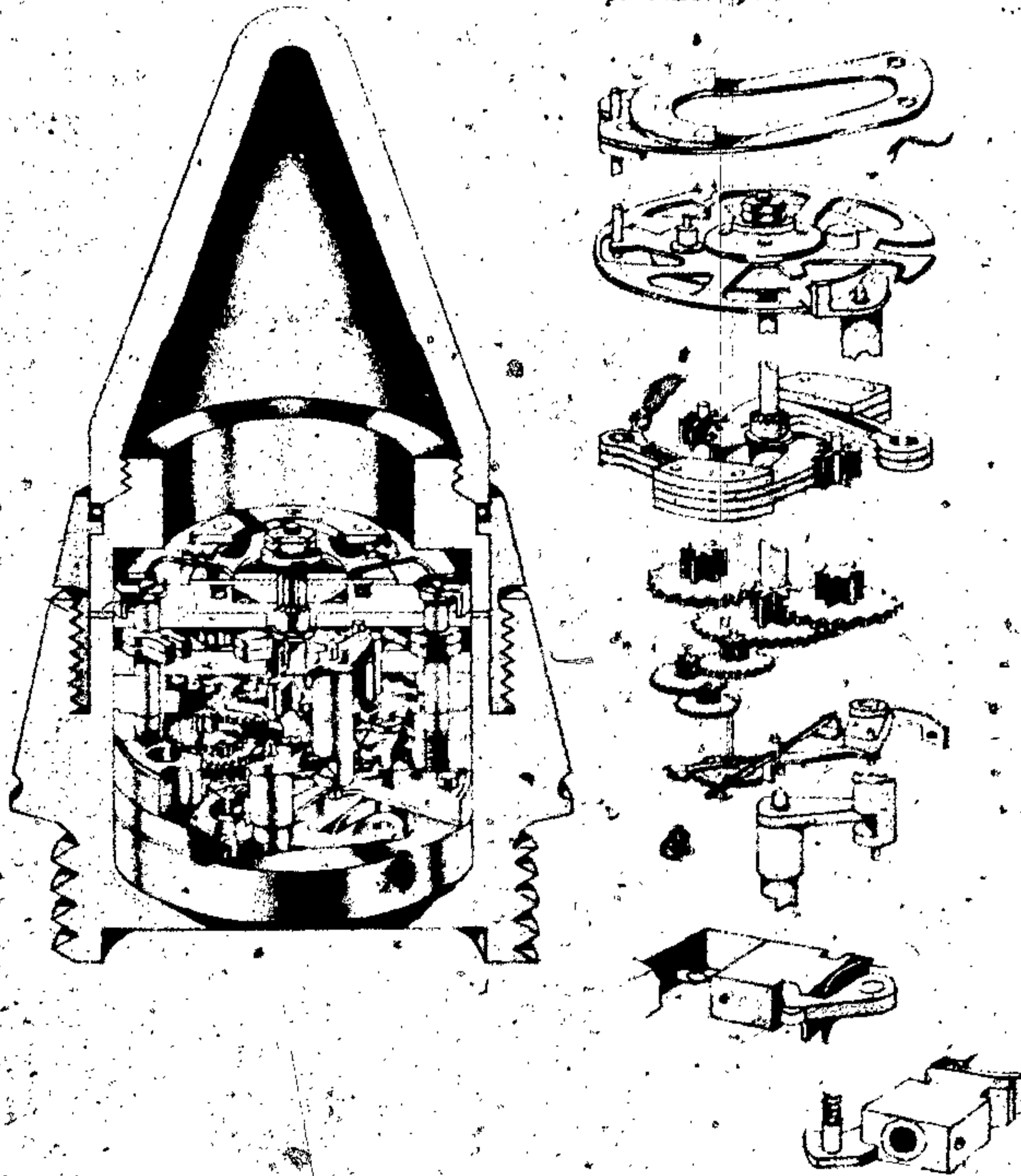

Figure 594—Zt. Z. S/30 Fgl.

The base piece is screw-threaded externally below the flange for insertion in the shell and has a large cylindrical recess in which the mechanism is located. The recess is screw-threaded internally for the assembly of the screwed collar retaining the cap and has a flash hole and a number of holes for the retaining bolts of the mechanism in the base.

The cap is cone shaped with a rounded head and is screwed to a base ring with which it forms a groove to receive an internal rib on the screwed collar and the waved tensioning wire. The base ring carries the setting pin and the hammer spring and is secured by a fixing screw. The steel pin is let into the base and engages an upturned forked strip on the setting disk of the mechanism. The hammer spring is secured to the shoulder in the cap base by two screws at one end and extends

diametrically across the interior of the cap. The unsupported end is forked to fit around the setting pin and is fitted with three brass hammer pieces on the underside. The two larger of these pieces are fitted one on each projection of the fork, i. e., each side of the setting pin, and the third smaller piece is nearer the center of the spring. These positions coincide respectively with the projections on the fork end of the strip on the setting disk and a locking pin carried in the setting disk.

The screwed collar fitting over the lower portion of the cap is attached to the cap but is free to turn for insertion in the base piece.

The mechanism is assembled in a cylindrical unit of superimposed plates of brass and aluminum and consists of a central shaft with a spur near the lower end and a pinion at the base. The upper part of the shaft is reduced in diameter to receive

the bush carrying the setting and safety disk and is screw-threaded to receive the tensioning and locking nuts. The sloping shoulder formed by the reduction of the diameter is serrated to engage with similar serrations on the bush so that the bush is locked to the shaft. The pinion at the base of the shaft is fitted with a stop pin which limits its rotation.

Two weighted centrifugal toothed segments pivot near the circumference of a circular plate and each meshes with a spur. The spurs carry pinions at their base ends which mesh with the spur on the central shaft. The plate carrying the centrifugal segments is cut away to provide clearance for the movement of the segments and the recesses thus formed are fitted with a spring strip which imparts the initial movement to the segment.

An escapement engages the base pinion of the central shaft and is comprised of three spurs with pinions and a spur with the escapement wheel. The wheel is engaged by two vertical arms on the pallet which is weighted at each end and controlled by a straight adjustable hair spring. The pallet is locked at one end by a centrifugal safety lever which is fitted with a weighting pin and held by a retaining spring. A step formed on the pivoted end of the lever is engaged by the end of the spring strip when the lever has swung to the armed position.

A disk assembly fitted at the upper end of the central shaft consists of a bush carrying two disks and a tensioning arrangement. The bush is in the form of a sleeve with a hemispherical flange at the base. The sleeve portion fits over the head of the central shaft and is serrated at the lower end to engage a corresponding shoulder on the shaft. The lower of the two disks, the safety disk, is keyed to the flange of the bush and so must always turn with the central shaft. The disk is smaller in diameter than the upper disk but has a projecting leaf formed at one part of its circumference to close a slot in the upper disk and so prevent the operation of the firing mechanism. The upper disk is the setting disk and is held on the sleeve of the bush under the tension of a saucer-shaped spring compressed and locked by two nuts on the central shaft. Before firing, the setting disk can be rotated relative to the bush and safety disk, but after firing, the disks are locked together when the locking pin carried in the setting disk is driven into the safety disk by the hammer spring. The setting

disk has an upturned forked strip which engages the setting pin in the cap and, diametrically opposite, a curved slot which when aligned with a projection of the firing arm releases the firing mechanism.

The firing arm, operated by centrifugal force, consists of a shaft with a flat formed by a recess near its lower end and with a cross head at its upper end. The cross head has a weight attached to the underside at the end of one arm and a vertical strip projecting upwards from the end of the other arm. The strip bears against the edge of the setting disk and the lower end of the shaft obstructs the rotation of the retaining bolt.

The retaining bolt securing the retaining catch in contact with the detonator pellet is a centrifugal device held in the safe position by the shaft of the firing arm. The bolt consists of a short shaft with a radial arm attached at the head and a flat formed near the base. The radial arm engages the firing arm and provides the weight for centrifugal action whilst the flat engages the end of the flat side of the retaining catch.

The retaining catch in the form of a hook is pivoted at one end and hooked to engage the detonator pellet at the other.

The detonator pellet contained in a transverse rectangular slot in the base of the mechanism unit is of brass and is rectangular in shape. A notch is cut in the two vertical sides and the detonator is contained in a recess at the inner end. A flash channel from this recess emerges at the underside of the pellet. A curved spring strip between the outer end of the pellet and one end of the pellet slot is held under compression by the retaining catch engaging in one of the side recesses of the pellet. The striker is fixed in the opposite end of the slot. The detonator pellet is also held by a centrifugal safety catch.

The safety catch, located in a channel cut in the side of the pellet slot, consists of a flat brass plate shaped at its inner end to engage the front end and one side of the detonator pellet. The catch is retained in the safe position by a spring-loaded plunger with a rounded base which enters a recess in its surface.

ACTION: The time of running is governed by the size of the arc extending clockwise between the curved slot in the setting disk and the position of the vertical projection on the cross head of the firing arm.

GERMAN EXPLOSIVE ORDNANCE

The fuze is set by turning the cap with the aid of a setting device. The rotation of the cap is transmitted to the setting disk by the setting pin engaging in the forked strip of the setting disk whilst the safety disk is held keyed to the stationary bush on the central shaft. The curved slot in the setting disk is thus rotated clear of the projecting leaf on the safety disk. The width of the leaf and its position relative to the vertical projection on the firing arm are so arranged that the leaf still closes the slot at settings up to approximately 1 second and so prevents the fuze functioning dangerously near the gun.

On acceleration, the hammer spring sets back, flattening permanently the forked strip on the setting disk and thus disengaging it from the setting pin. At the same time, the hammer spring strikes the small locking pin and drives it into an unsupported part of the safety disk. The setting disk is then locked to the safety disk. When the safety lever has been thrown clear of the pallet by centrifugal force, it is retained in this position by its spring engaging a step at its outer end. The toothed segments, operated initially by the springs fitted in the plate and subsequently by centrifugal force, then revolve the central shaft by means of the spur, and pinions. The disk assembly rotates with the shaft, the rate of rotation being controlled by the escapement. Whilst this movement is in progress, the weighted end of the cross head on the firing arm is tending to swing outwards but is prevented from so doing by the upturned end bearing against the edge of the rotating disk. Also, the spring-loaded plunger of the safety catch is eased from the catch by deceleration and the catch is thrown clear of the detonator pellet by centrifugal force.

When the slot in the setting disk reaches alignment with the upturned end of the cross head, the firing arm is revolved to the extent permitted by the slot and the recess cut in its lower part is turned to provide clearance for the arm of the retaining bolt. The arm then moves outwards and the flat surface on its shaft is rotated through a right angle so that it clears the side and the curved end of the retaining catch. The catch is then thrown clear of the detonator pellet which is driven onto the striker by its spring.

NOSE FUZE DOPP. Z. S/90/45

EMPLOYMENT: The fuze is presumably used as an alternative in the H. E. shell (K. Gr. 39) and the H. E. B. C. shell (K. Gr. 38 (Hb)) for the 17-cm K. Mrs. Laf. (See fig. 595A.)

DATA:

Over-all length: 4.812 inches.

Maximum diameter: 2.25 inches.

Threaded length: 0.5 inch.

Number of threads: 4 RH.

CONSTRUCTION: The fuze has a mechanical time action with a maximum time of running of 90 seconds and a graze action of the normal German type. The time mechanism appears to be a 45-second mechanism modified by a change in the ratio of the gear train and an increase in the strength of the main spring. The weight of the fuze is 1 pound 12 ounces.

In external appearance the fuze consists of a flat-topped cone-shaped head of aluminum secured to a dull steel body near its base by a bright steel securing ring. The upper part of the body is coned above the flange to match the head. Below the flange it is screw-threaded for insertion in the shell and below the thread there is a plain cylindrical portion.

The designation of the fuze, "Dopp. Z. S/90/45," is stamped in the body above the flange. Rectangular key slots for setting are formed in the head and the body and a setting arrow for percussion action is engraved in the head adjacent to the slot. When inserted in the shell the fuze protrudes to the extent of approximately 3 inches. The diameter of the screw-threaded part is 1.96 inches.

Body: The body is recessed at the base to accommodate the shutter assembly and, equally spaced around the recess, there are three vertical channels for the bolts securing the time mechanism unit. An additional vertical channel, closed at the base by a screwed plug, accommodates the holder of the detonator for the time action. A radial channel in the wall of the recess contains a brass centrifugal bolt and is closed at the outer end of a screwed plug. A portion of the top of the recess is cut away to permit movement of the bolt, and a flash channel in the center of the top connects with a recess in the upper part of the body.

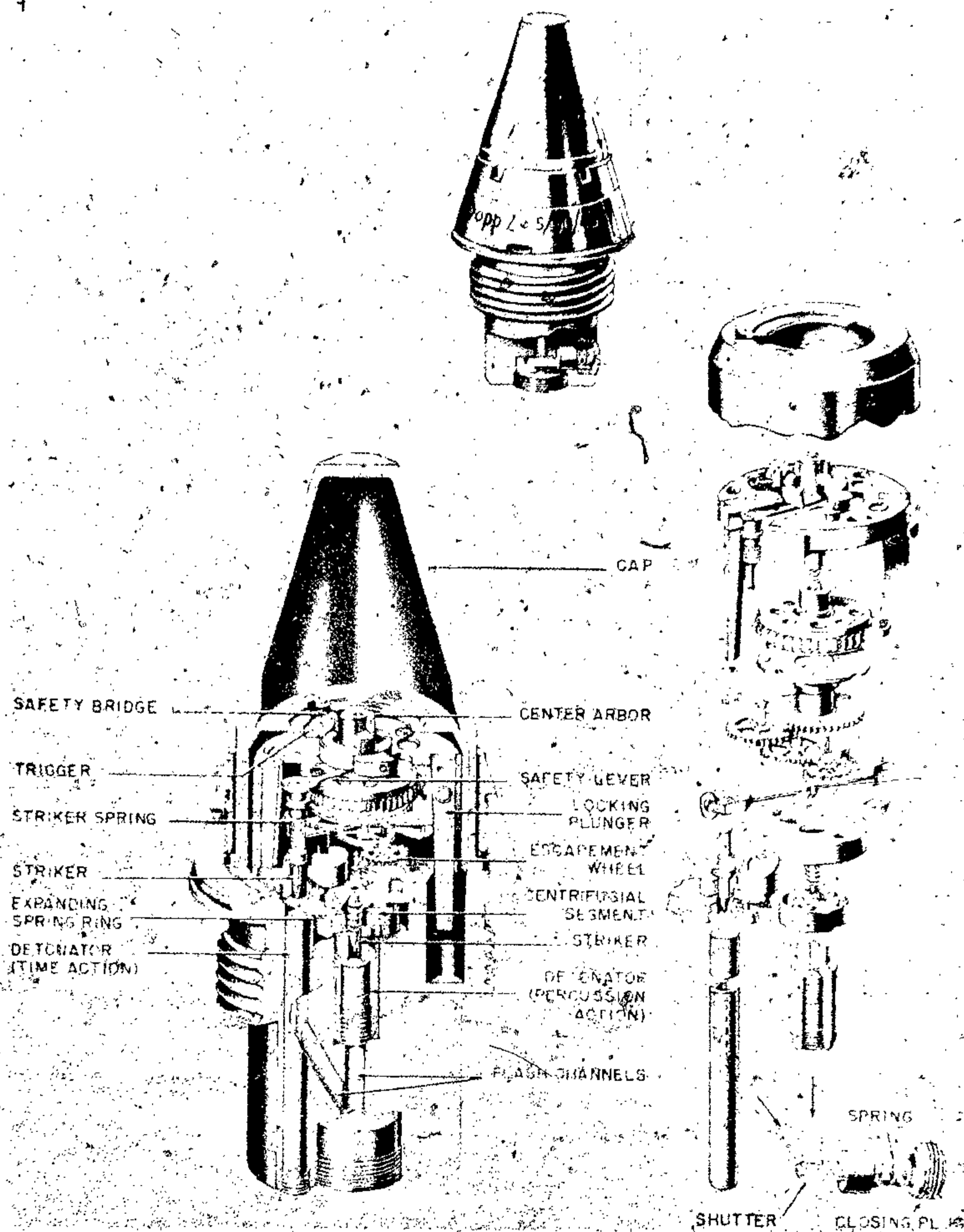

Figure 595A—Dopp. Z. S/90/45

The upper recess contains the graze pellet of the percussion mechanism and is connected to the channel containing the detonator for the time action by an inclined channel which enters the recess near its base. Near the top, the recess is enlarged to form a platform on which four centrifugal segments of brass are fitted on steel pivots. Above this the recess is screw-threaded to receive

the percussion striker holder. The coned flanged top of the body is recessed to form a platform for the time mechanism unit and is screw-threaded internally to receive the securing ring for the aluminum head. Two holes, diametrically opposite, are formed in the platform to receive the locking plungers of the time unit. There is also a locating stud for the unit, and a circular seating for

GERMAN EXPLOSIVE ORDNANCE

a fiber washer. Four small screws are inserted through the coned flange to lock the securing ring when the fuze is tensioned during assembly.

PERCUSSION MECHANISM. The graze pellet, carrying an igniferous detonator secured by a perforated screwed plug, is of brass with a shoulder near the top which is engaged by the four centrifugal brass segments. The segments are retained in a position overlapping the pellet by an expanding spring ring. A spiral creep spring is fitted between the pellet and a striker holder which consists of a steel disk screwed into the top of the recess containing the graze mechanism. The striker protruding from its underside has a pyramid shaped point.

SHUTTER ASSEMBLY. The assembly contained in the lower recess in the body consists of a copper plate shutter moving in a guideway formed in the top of a cylindrical aluminum holder. The holder has a central flash hole and is recessed at one side of the centrifugal bolt which, under the pressure of its spiral spring, bears against the outer end of the shutter and keeps the shutter in a position masking the flash hole in its aluminum holder. The centrifugal bolt is a cylindrical pellet of brass with a recess at its outer end to locate the inner end of its spiral spring. The outer end of the spring is held under the compression by the screwed plug closing the radial channel in the wall of the recess and located by a circular groove in the inner face of the plug. A thin disk of tin, with a central flash hole and with part of its circumference cut away for the centrifugal bolt, is placed on top of the shutter holder. The recess containing the shutter assembly is closed at the base by a screwed plug which has a central flash hole. The flash hole is closed by a thick disk of tin fitted between the inner face of the plug and the base of the shutter holder.

HEAD ASSEMBLY. The flat-topped aluminum head is in the shape of a cone with a cylindrical portion near the base. An external flange is formed at the base which supports the tensioning wire. The underside of the flange is cutaway at four places to receive corresponding projections at the base of the dome. The dome, fitted inside the head, is of thin aluminum and is in the form of an inverted cup which fits over the time-mechanism unit and is keyed to the flange at the base of the aluminum head by four projections at its base. The inside of the top of the dome is shaped to form a

race against which the hand on the top of the time unit bears when rotating. Part of the race is cut away so that the hand can be pushed upwards by its spring when in alignment with the slot so formed. The head of the fuze is secured to the body by a steel securing ring which screws into the internal screw-thread above the flange. Between the base of the securing ring and the flange at the base of the head there is a length of waved spring wire which is compressed between the ring and the flange when the ring is screwed down. By this means the tensioning of the head is adjusted during the assembly so that it can be turned for setting but will not slip.

TIME MECHANISM UNIT. The time mechanism is assembled in a cylindrical unit of superimposed brass plates with an aluminum hand on the top and two locking plungers in slots cut down diametrically opposite sides of the cylindrical assembly. The plungers are comparatively weighty and consist of steel strips tapering toward the base on the inner side. On the outer side of each, approximately at the center, a projecting vertical knife edge is formed. A spring-loaded ball protruding from one side of the plunger engaged a corresponding recess in the slots and thus supports the plungers which protrude below the base of the unit into recesses in the fuze body. The mechanism is similar to that in the S/30 and S/60s fuzes; that is, it consists principally of a spring-loaded striker held off the detonator by an eccentric cam collar on the striker which is supported by a pillar and a centrifugal safety catch. The cam collar is kept in this position by a safety lever which fits over flats formed on the forward end of the striker and is held by the ring shaped center of the hand. The hand, with a spiral spring beneath it, is keyed to rotate with the center arbor under the control of a train of gear wheels and an escapement and, before firing is held by the pivoted trigger. Adjacent to the trigger a safety bridge is fitted which overlaps the hand to prevent functioning at settings of less than approximately 1 second. The spring plunger supporting the trigger engages in the end of the trigger instead of the inner side as with the S/30 and S/60s fuzes. The use of a stronger main spring, which is of wider strip than the original, has resulted in the use of a thin steel disk instead of the normal base of the spring barrel to support the spring.

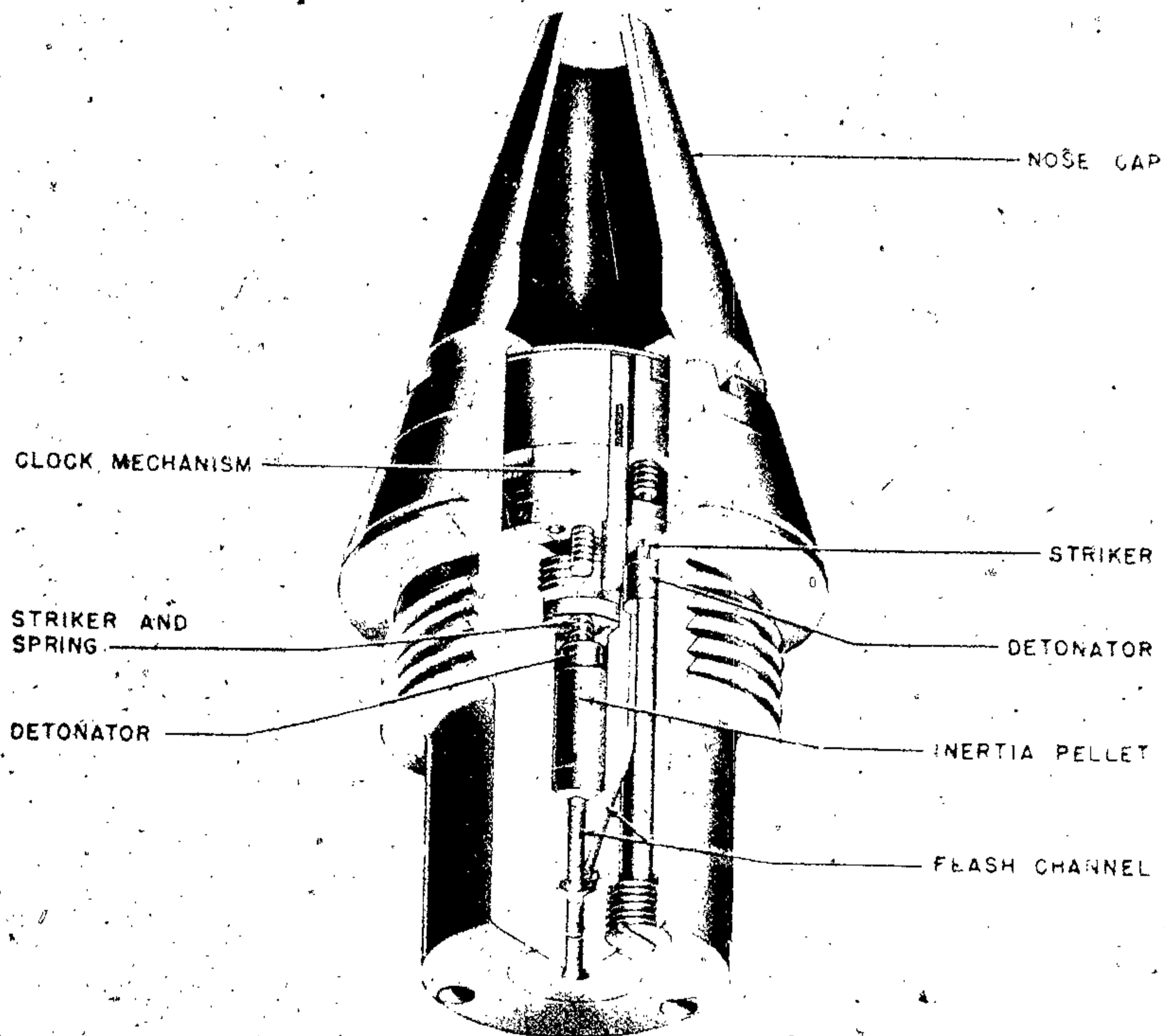

Figure 595B—Dopp. Z. 28 K

ACTION: The time of running is governed by the size of the arc extending counterclockwise between the position of the hand when held by the trigger and the position of the slot in the dome hand race. The fuze is set by turning the head with the aid of a setting device which consists of a graduated ring surrounding a movable ring on which there is a setting index and a handle. The device is placed over the fuze; and the outer ring, bearing the graduations, is clamped by a key engaging in the key slot above the flange in the fuze body. A key in the inner ring, bearing the index, engages in the key slot in the head of the fuze. The inner ring is then rotated by means of its handle until the index is aligned with the required graduation and takes with it the head of the fuze. The dome inset, with the hand race formed in its upper part, is rotated with the head to the set position. The turning of the head is retarded by

the waved wire tension spring between the securing ring and flange at the base of the head.

On acceleration the two tapered locking plungers set back into the recesses in the top of the body. As their wider portions with the protruding knife edges move back through the slots, the knife edges cut into the wall of the dome and thus prevent rotation of the dome relative to the mechanism unit. At the same time, the trigger hinging on its pivot, sets back and releases the hand.

The small spring-loaded plunger in the trigger is then free to emerge and thus prevents the trigger rebounding. The release of the hand enables the main spring to rotate the center arbor, moves clear of the safety bridge and is pressed up against the hand race in the top of the dome by the spiral spring in the top of the arbor beneath the hand center.

GERMAN EXPLOSIVE ORDNANCE

During flight, the safety catch is swung clear of the cam collar on the striker by centrifugal force and the striker is then supported only by the pillar. When the rotating hand reaches the slot in the hand race, it is forced upwards by its spring and thus releases the safety lever keyed to the top of the striker. The striker, with the lever, is then rotated by the pressure of its spring combined with the effect of the inclined surface of the pillar. The striker is driven away from the safety lever by its spring and pierces the detonator. The flash from the detonator, directed by the shape of the detonator holder, passes into the lower part of the recess containing the graze pellet and follows the same course as that described for the percussion action.

PERCUSSION ACTION. When set for percussion, the arrow on the head of the fuze coincides with the index line on the securing ring, and the key slots in the head and body are in alignment. At this setting, the slot in the hand race of the dome

is masked by the safety bridge so that although the hand is released when acceleration occurs, it cannot rise through the slot to release the safety lever and the striker.

During flight, the coil of the expanding spring ring, surrounding the segments engaging the shoulder of the graze pellet, is enlarged and the segments are swung clear of the pellet by centrifugal force. At the same time, the centrifugal bolt is thrown outwards, compressing its spring, and the shutter opens.

On graze, the graze pellet overcomes the creep spring by its momentum and carries the detonator forward to be pierced by the striker. The flash from the detonator passes through the hole in the base of the recess, through the channel exposed by the open shutter, perforates the tin disk and emerges through the hole in the screwed plug at the base of the fuze.

REMARKS: The Dopp. Z. 28 K is identical to the Dopp. Z. S/90/45 except for variations in

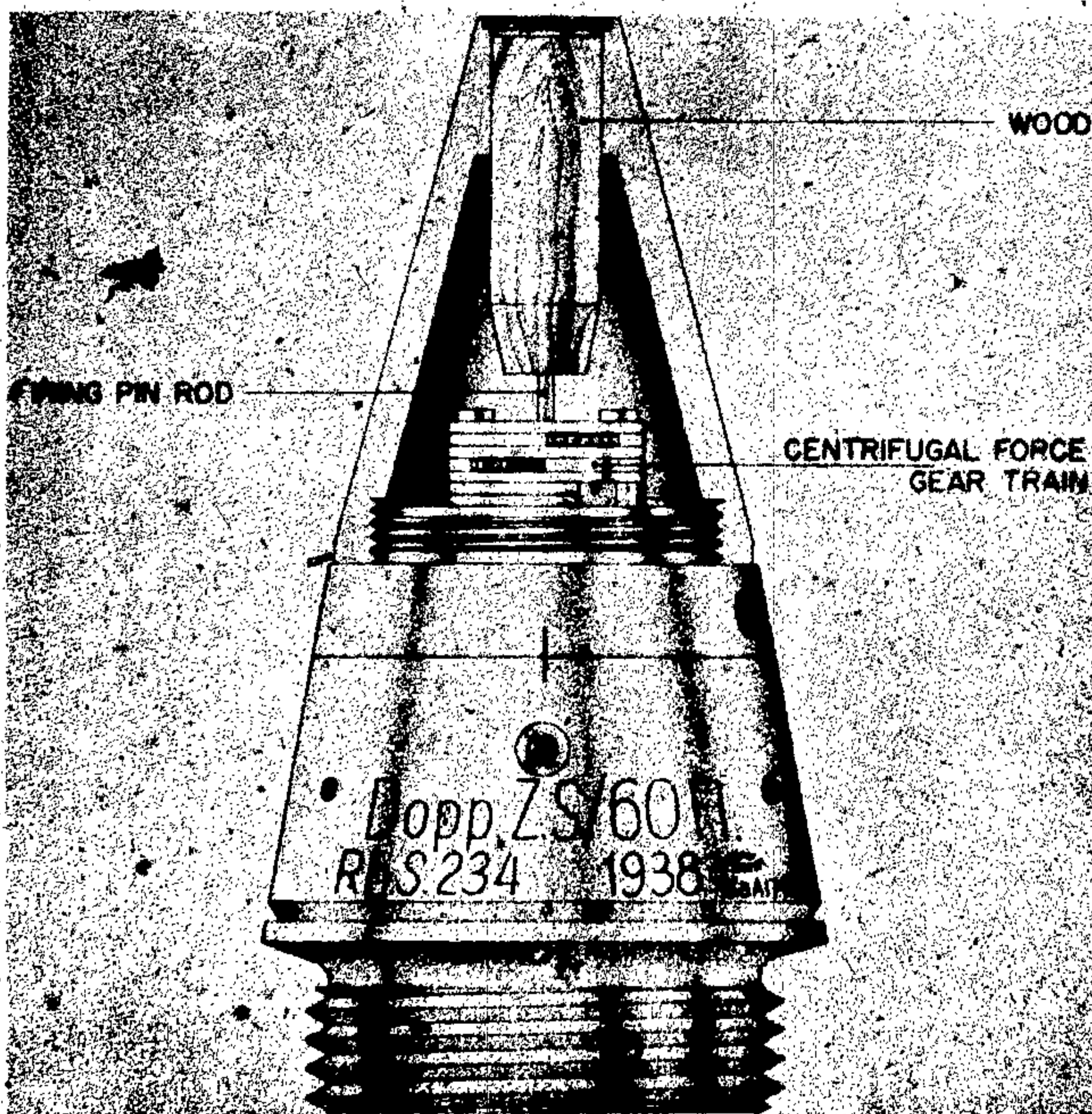

Figure 596—Dopp. Z. S/60 FI.

the gear train ratios used in the clockwork mechanism. (See fig. 595B.)

The Dopp. Z. 28 K is employed in the 21-cm. K. Gr. 38 and 28-cm Gr. 39 projectiles.

DOPP. Z. 5/60 FL.

EMPLOYMENT: Mechanical time and/or impact nose fuse used in German 8.8-cm and 10.5-cm H. E. antiaircraft shells. (See fig. 596.)

DATA:

Over-all length: 4.375 inches.

Maximum diameter: 2.375 inches.

Threaded length: 0.500 inch.

Number of threads: 4 RH.

CONSTRUCTION: The body construction and clock mechanism are similar to the Zt. Z. S/30 Fgl. It differs in that the time can be set up to 60 seconds and it has an impact firing pin. A firing pin rod passes through the hollow center of the fuze. This rod is kept in place by the fact that its diameter is larger than the hollow center hole. The whole diameter is enlarged, however, by the action of a gear train which is activated by centrifugal force.

The firing pin is also released during flight by a centrifugal arm.

ACTION: The clockwork delay action is the same as that in the Zt. Z. S/30 Fgl.

When the fuze is set for impact, the firing pin rod is driven through the enlarged hole in the hollow shaft forcing the firing pin into the detonator.

EL. ZT. Z. S/30

DESCRIPTION: The electrical time fuze has been worked on in Germany for about 15 years and has been in standard service in bombs with the armed services for some time. All electrical time and influence fuzes have fundamentally the same firing circuit, and this has been standardized. (See fig. 597B.) The triggering voltage may then come from either the output of the influence device or from the charging of a condenser network in the case of the electrical time fuze. Electrical firing is also used in some contact fuzes. This section will deal only with the electrical time fuze for projectiles.

Before firing, the fuze is hand or machine charged by putting 300 to 500 volts across the



Figure 597A—El. Zt. Z. S/30

shell and an insulated contact, which puts voltage on the annular storage condenser. This may also be accomplished by allowing the feeler wire, see figure 597A, to contact a muzzle charging ring as the projectile leaves the gun. This muzzle charging ring will be described at the end of this section. In various types of fuzes this condenser varies from 0.2 to 2.0 mfd. It may be charged as long as 30 minutes before firing. At set-back, by means of a switch, this energy is leaked onto the actual firing condenser through a charging resistor (rang 0.25 to 3.0 meg). The usual values for the firing condenser vary from 0.2 to 0.5 mfd.

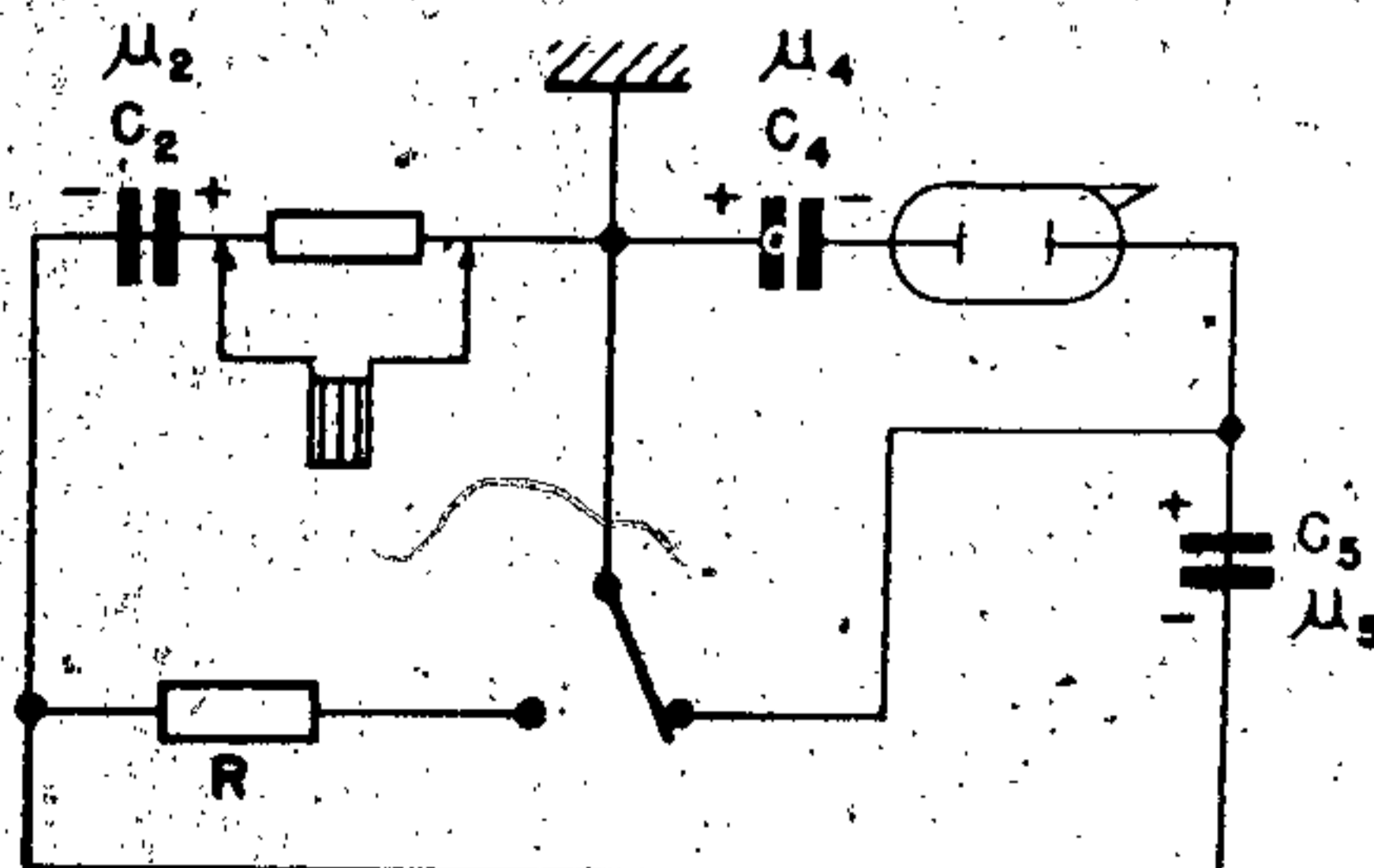

Figure 597B—Wiring Diagram

GERMAN EXPLOSIVE ORDNANCE

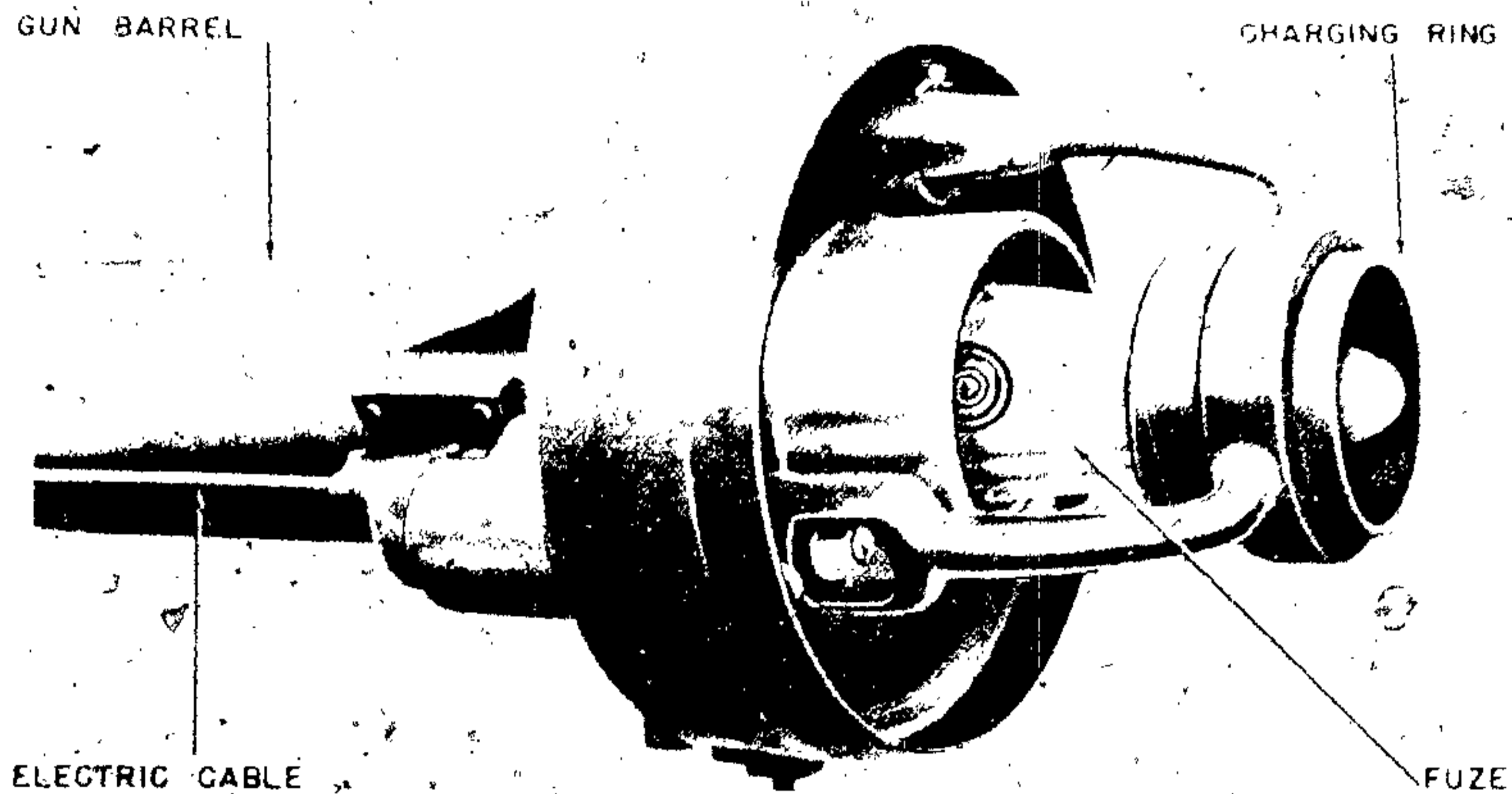

Figure 597C—Muzzle Charging Ring

Condenser values are kept fairly high to insure firing of the primer with a minimum of delay. The sketch shows the position of the set-back switch before and during set-back, also its position during flight. The electrical connections to the set-back switch are the same before and during set-back. On set-back the spring is depressed and a 4- to 5-mm ball is allowed to spin out, which, after the set-back forces are over and the projectile is out of the muzzle, allows the switch to come back up 4 or 5 mm further than before, thus making new connections. This set-back switch, RC safety, and a spin operated plug under the squib are the only safety features except for the booster which is separate.

The squib itself has a resistance of 5 to 10 ohms and is of bridge wire construction. It is packaged into a small capsule with explosive around it and sealed up. Formerly, they had used squibs with resistances of 1,000–5,000 ohms but the newer type had been much more reliable. The squibs can be fired 100 percent from an 0.35-mfd. condenser charged to 42–50 volts.

Molded plastic blocks hold all the parts securely in individual holes, and are further potted in place with pitch, wax, or putty. The number and size of parts varies only slightly between models so standard molds may be used for all types of electrical fuzes. The outside metal parts used in influence fuzes also use standard electrical time fuze parts.

Electrical time fuzes usually receive an initial charge of about 500 volts (on C2) some time before firing and a "vernier" charge from about +120 to -90 volts (on C5), giving a range of about 3–30 seconds. If no vernier charge is applied the time to burst is 16.0 seconds. This "vernier" charge is either applied before firing with the time interval to the gun very accurately controlled, or by use of a "feeler wire" from the nose contacting a metal charging ring at the muzzle of the gun and picking up the charge as it is fired.

The control tube is of the cold cathode arc discharge type. Various types are used anywhere from 2 to 4 elements. In the general types used, one has a 160-volt break-down and the other 190-volt for bomb and shell respectively. Two element tubes are used in electrical time fuzes and the 3- and 4-element types are used in the influence types. The 2-element tube is used with 10- to 15-volt control. The initial charge on the storage condenser determines the sensitivity. The correct initial voltage has to be applied so that when this storage condenser voltage is leaked through a resistor onto the firing condenser a margin of safety is left, say 187 volts for a 190-volt tube. The remaining 3 volts to trigger the fuze then comes from the control device. The control element is sometimes center-tapped on a 10,000-megohm voltage divider in parallel with the firing condenser and the glow tube. This is done to give the control element the correct initial voltage.

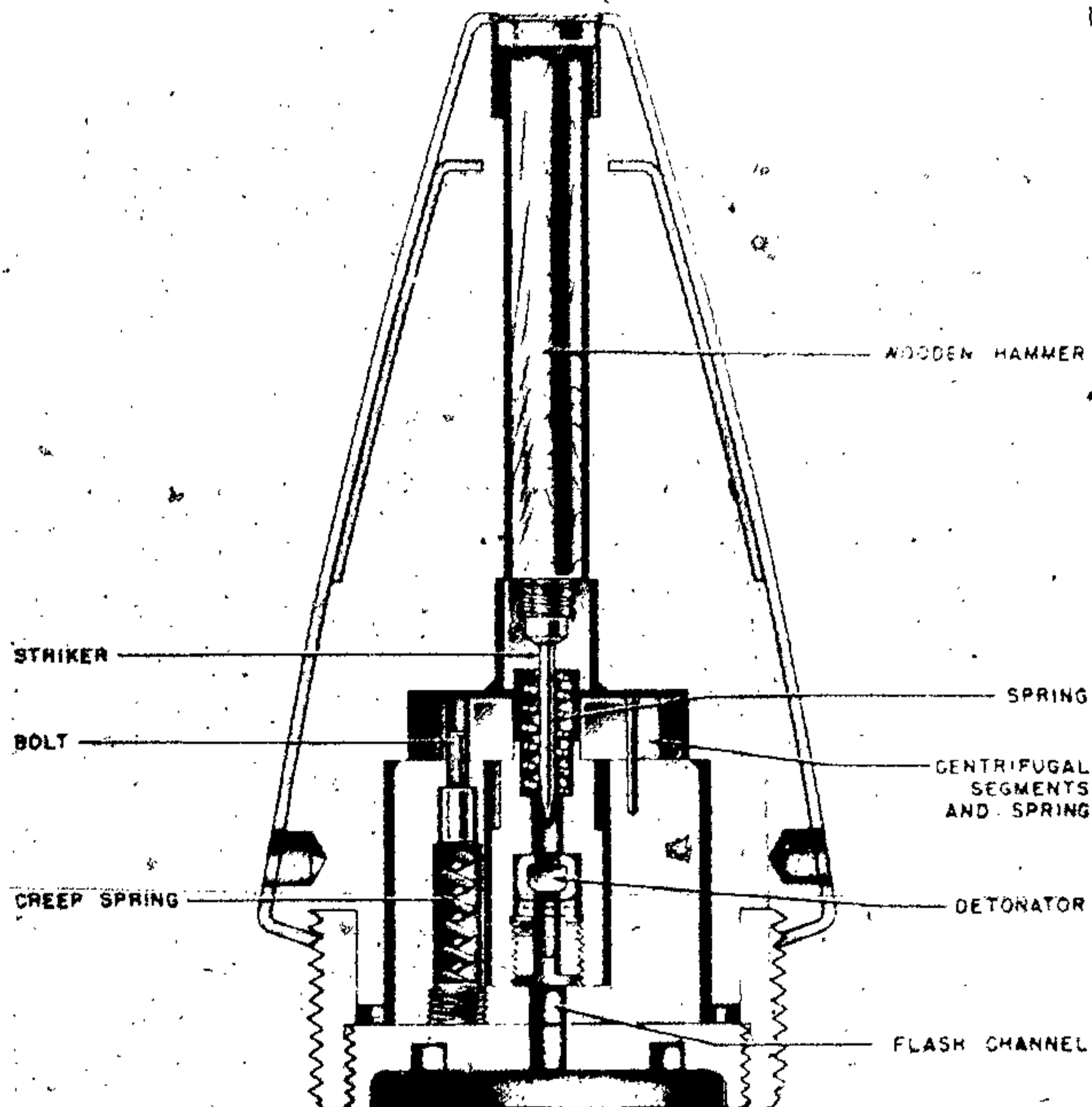

Figure 598—A. Z. 23 NB (Prebstoff)

Some of the tubes are externally coated with graphite or a similar material to leak off any stray charges. The glow tubes generally have iron or steel electrodes, nickel plated and then potassium or barium coated. They are argon or krypton filled to a 20- to 30-mm pressure. In manufacture the striking voltage cannot be held close enough by the spacing of the elements alone, so the gas pressure is controlled as well (over the above range), being regulated for each tube when it is made to get the striking voltage exact. When the tubes are finished they are supposed to stand 12,000 g.

MUZZLE CHARGING RING: The muzzle-loading device consists of a cylinder which fits around the barrel of the gun just behind the muzzle and the charging ring which is held out in front of the muzzle by means of three arms located 120° apart. (See fig. 597C.) The cylinder is connected by means of a cable to the battery and voltage-control mechanism; at the breech end of the gun. Direct connection is made be-

tween the cylinder and the charging ring via the three arms welded to the charging ring.

The hand charging device consists of a truncated cone so designed that it will fit snug on the fuze. The charging point inside the cone that contacts the insulated charging point on the fuze is connected to the switch on the handle. This enables the operator to charge the storage condenser and govern the charging time to the exact second necessary.

A. Z. 23 NB (PREBSTOFF)

EMPLOYMENT:

| GUN | PROJECTILE |
|--------------------|----------------------|
| s. F. H. 18 | 15-cm Gr. 19 Nb. |
| s. F. H. 36 | |
| lg. s. F. H. 13 | |
| lg. s. F. H. 13/02 | |
| s. F. H. 15 (t) | 15-cm Gr. 19 Nb. (t) |
| s. F. H. 25 (t) | |
| s. F. H. 37 (t) | |
| (See fig. 598.) | |

GERMAN EXPLOSIVE ORDNANCE

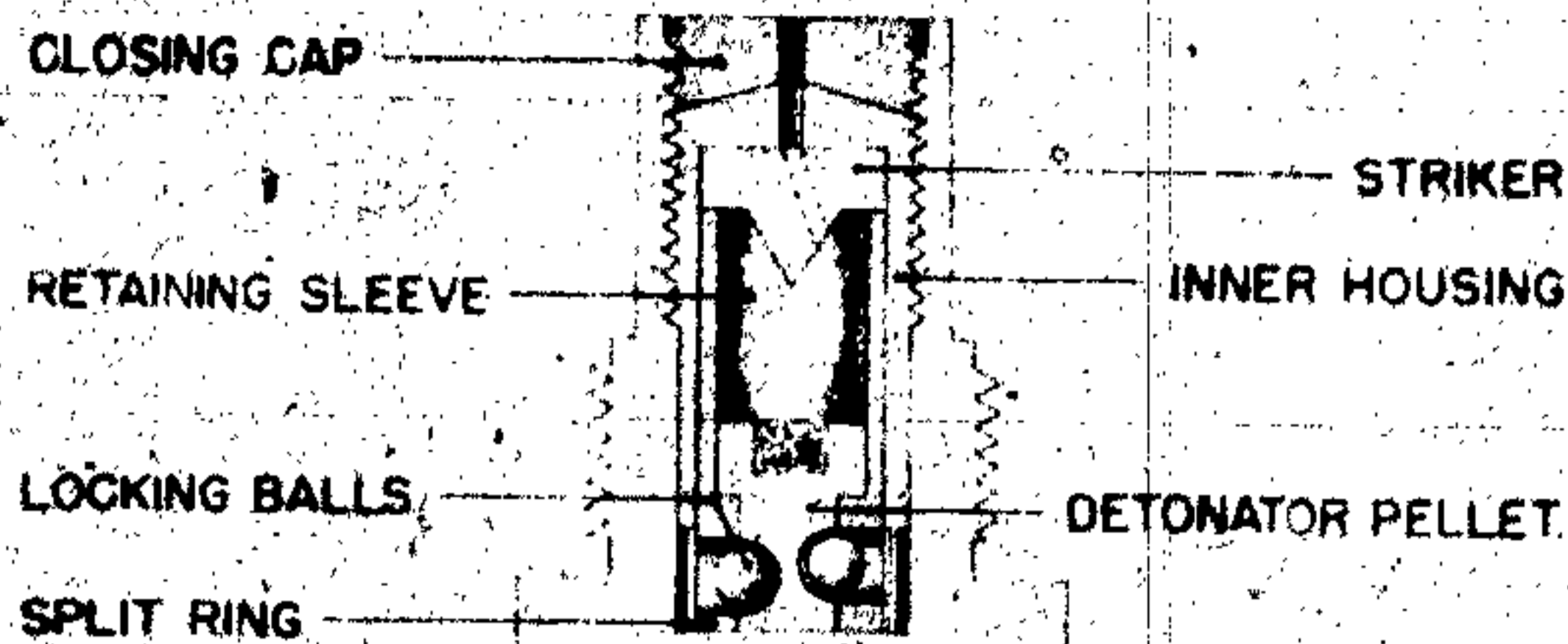

Bd. Z. 1513
(NOMENCLATURE UNCERTAIN)

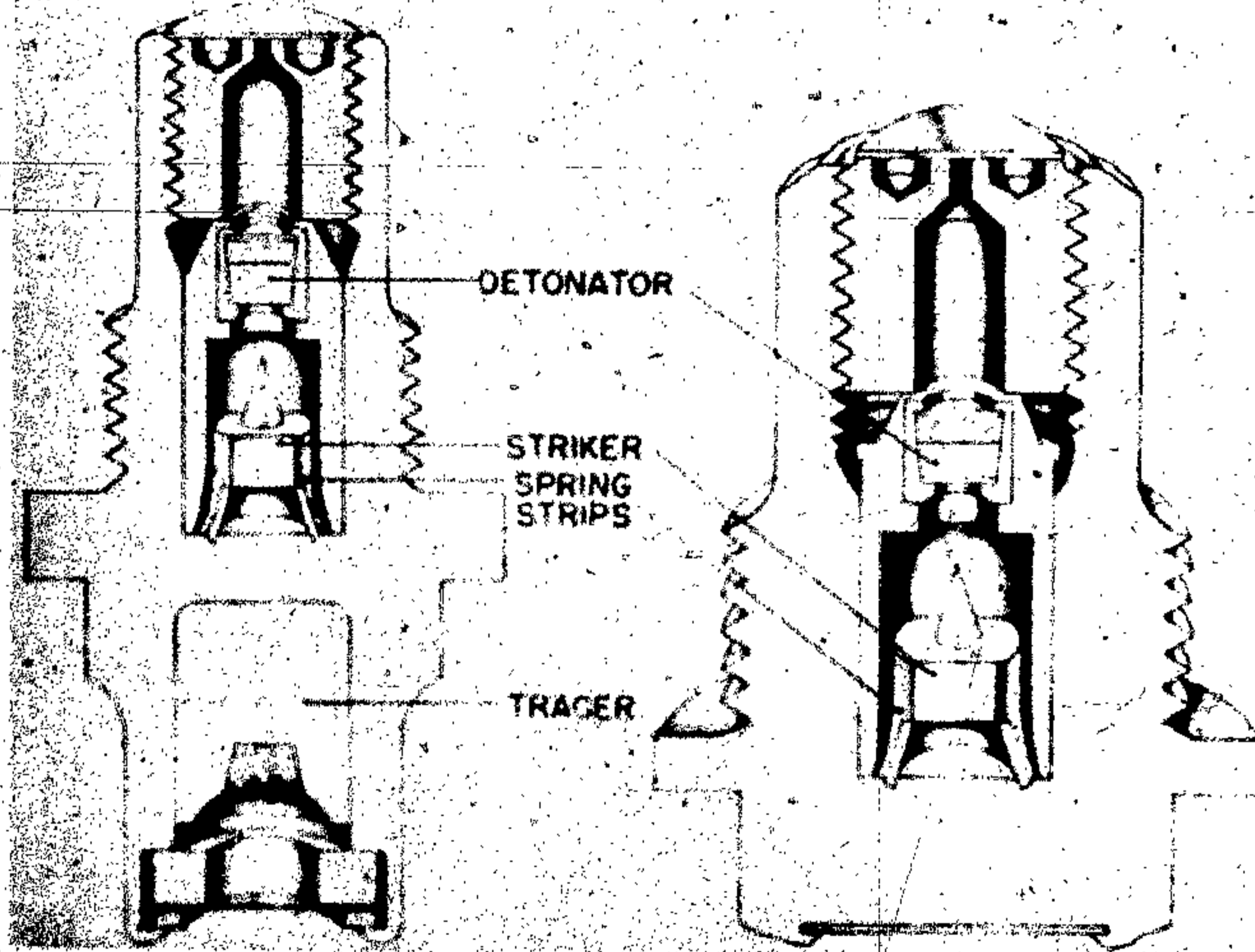

Figure 599—Bd. Z. 1511 and Bd. Z. 1512

DESCRIPTION: This fuze combines graze and direct action. It carries a wooden hammer positioned over a steel striker. The striker is held off the detonator by centrifugal segments which bear against a flat coil spring and which, in turn, are held in position by a safety bolt.

ACTION: After the projectile is fired, the safety bolt moves back on its spring thereby allowing the centrifugal segments to pivot outwards against the flat coil spring due to the centrifugal force set

up by the spin of the projectile in flight. The striker is now resting on the firing pin spring and on impact moves forward to fire the detonator. The flash from the detonator passes through the flash channel to the detonator in the gaine.

BASE FUZES BD. Z. 1511 AND BD. Z. 1512

EMPLOYMENT: Base fuzes used in German 20-mm ammunition. (See fig. 599.)

PROJECTILE FUZES

CONSTRUCTION: The fuzes are threaded at the center of the body to engage the threads of the projectile.

A fixed detonator is held in the central flash channel of the fuze body. A striker with a large circular head which tapers outward is retained by two spring strips which partially surround the head. One end of each spring is fixed to the fuze body and the remainder follows the contours of the striker head fitting closely against it.

ACTION: On impact, inertia forces the striker forward onto the detonator. As the striker is pulled free from the springs, the enlarged diameter of the tapered striker head spreads the springs apart.

REMARKS: Both fuzes function in the same manner, but the 1511 has a tracer and the 1512 does not have a tracer.

BASE FUZE BD. Z. 1513 (NOMENCLATURE UNCERTAIN)

EMPLOYMENT: Base fuze used in German 20-mm ammunition.

CONSTRUCTION: The fuze which screws into the base of 20-mm ammunition contains no tracer element.

A movable detonator pellet is retained by two small locking balls in the base of the fuze body. A split ring holds the balls in the unarmed position.

A fixed striker is housed in the top of the fuze. The nose is closed by a cap containing a central flash hole.

ACTION: Centrifugal force opens the split ring releasing the locking balls. Upon impact, inertia causes the detonator pellet to set forward impinging upon the striker.

REMARKS: It is believed that this fuze is being used extensively today, but the exact nomenclature is uncertain.

Since it is used interchangeably with the Bd. Z. 1511 and Bd. Z. 1512 fuzes, it is assumed that the fuze is designated Bd. Z. 1513.

FUZE BASE BD. Z. 5127

DESCRIPTION: This is a base fuze fitted with a tracer and is used in the A. P. C. B. C. shell for

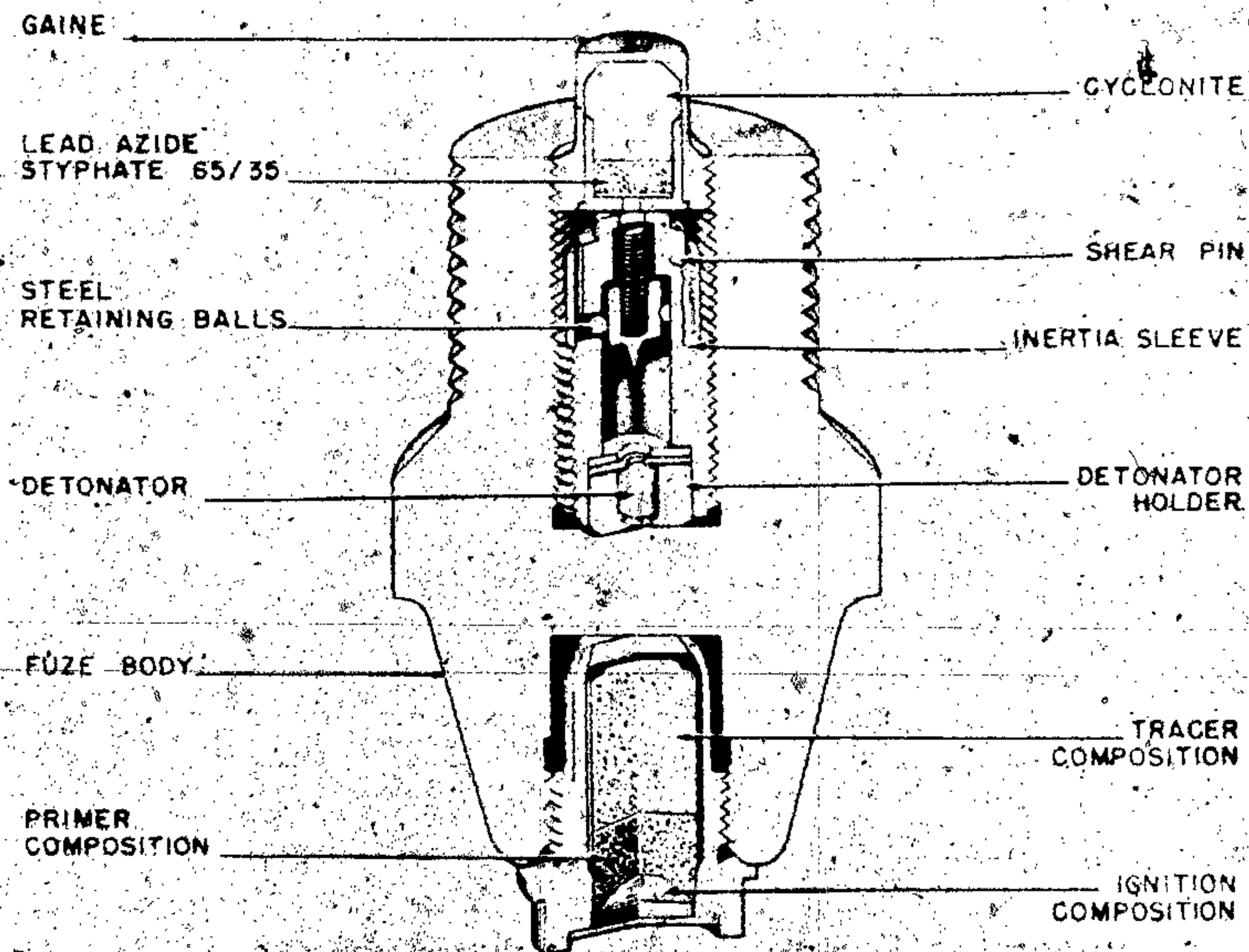

Figure 600—Bd. Z. 5127

GERMAN EXPLOSIVE ORDNANCE

the 8.8-cm Flak 41 multiple-purpose gun and for the 8.8-cm Pak. 43 antitank gun. The weight of the fuze with tracer is 1 1/4 ounces. The tracer alone weighs 3/4 ounce. The fuze body is approximately 2.3 inches long, and screw-threaded externally at one end for insertion in the shell. The interior is divided into two compartments by a diaphragm forced into the body. The rear compartment contains the tracer and is smaller than that in the front which is screw-threaded internally and contains the fuze mechanism.

The fuze mechanism consists mainly of a tubular mechanism holder having at its rear end a fixed pellet containing a detonator and at its front end a striker with a compressed spiral spring, two steel balls and an inertia collar. (See fig. 600.)

The tubular holder is screw-threaded externally for approximately two-thirds of its length from the base, its forward end is slightly less in di-

ameter and is surrounded by a loose fitting inertia collar secured by a shear wire. The base of the holder is closed by a cup-shaped pellet containing an igniferous detonator. Nearer the forward end of the holder are two radial channels diametrically opposite, closed on the outside by the inertia collar.

Two steel balls are held partially in the channels and partially in two recesses in the body of the striker thereby holding the latter off the detonator. One end of the striker spring, which is held under compression bears against a shoulder in the channel at the forward end of the holder whilst the other end fits into the cup-shaped body of the striker. Two flash holes are formed in the base of the striker body on diametrically opposite sides of the striker.

The front end of the fuze body is closed by a gaine containing cyclonite over lead azide and lead styphnate.

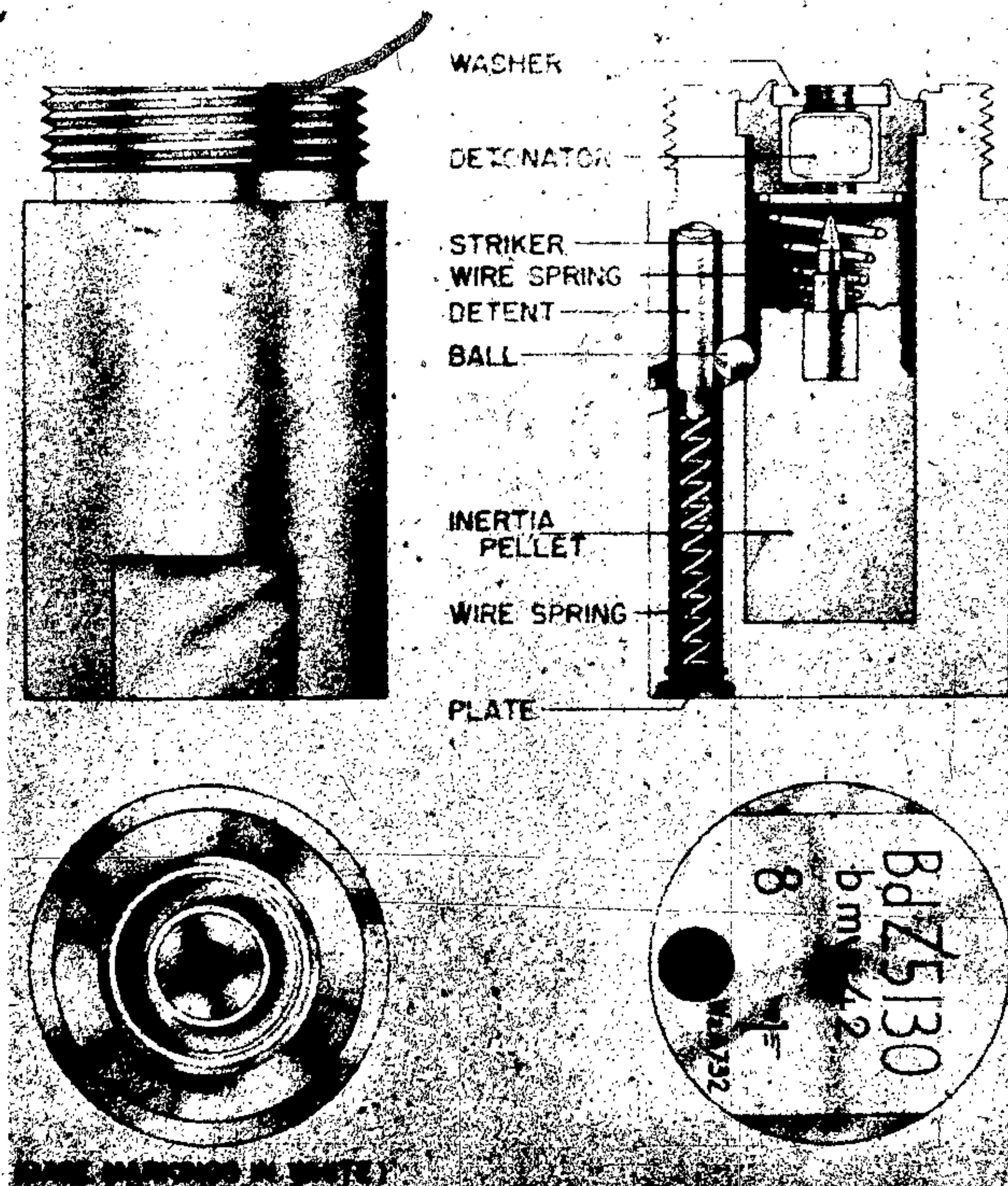

Figure 601—Bd: Z. 5130

ACTION: On impact, the inertia collar sets forward and breaks the shear wire thereby allowing the steel balls, under centrifugal action, to move outwards and unlock the striker. The striker, under the action of its spring, is forced back on to the detonator. The flash from the detonator passes through the flash channels on either side of the striker to the gaine at the forward end of the fuze.

BASE FUZE BD. Z. 5130

EMPLOYMENT: Base fuze for the 3.7-cm Stick Bomb (3.7-cm Stiel Gr 41). (See fig. 601.)

DATA:

Over-all Length: 1.65 inches.

Maximum Diameter: 1.0 inch.

Threaded Length: 0.25 inch.

Number of Threads: 5 RH.

CONSTRUCTION: The fuze is used in the 3.7-cm Pak, hollow charge, muzzle stick bomb and is of the igniferous type with a graze action. The designation of the fuze "Bd, Z. 5130" is stamped in the base. The weight of the fuze is 4 ounces 12 drams.

The body of the fuze is cylindrical with a threaded portion of reduced diameter at the head for insertion in the bomb. A large recess formed from the head, contains the graze pellet and is closed at the top by the detonator holder. A smaller recess near the periphery is formed from the base and contains a detent supported by a spiral spring. This recess is closed at the base by a disk secured by the turned over metal of the body. A channel, with a downward incline towards the side, is drilled from the exterior of the body, through the recess containing the detent and into the recess containing the graze pellet. A ball which engages a shoulder on the graze pellet is held in this channel, between the two recesses, by the detent. Two key flats are formed near the base end of the body.

The graze pellet consists of a solid cylindrical pellet fitted with a striker at the head. An inclined shoulder, with which the ball engages, is formed below the head. A helical spring is held between the head of the pellet and the base of the detonator holder, the smaller end of the spring fitting around the striker.

The detonator holder consists of a flanged cup with a flash hole in its base and contains an igniferous detonator stamped with the number "26." The detonator is retained by the mouth of the cup

being turned in to overlap a washer. The holder is supported at its flange by a step formed in the top of the recess and is secured by turned in metal of the body.

The detent is a solid cylindrical pellet with a concave head and a short stem at the base around which the upper end of spiral supporting spring is positioned.

ACTION: During transport the graze pellet is held away from the detonator by the ball which is held in contact with the shoulder on the pellet by the detent.

On acceleration the detent, overcoming the spring, sets back and thus releases the ball which moves down the inclined channel and leaves the graze pellet held off the detonator only by the helical creep spring. The concave head of the detent is apparently designed to receive the ball when the detent rises again so as to push the ball up into the top of the recess.

On graze, the pellet moves forward, compressing the creep spring and the striker pierces the detonator.

FUZE, BASE, SKODA B. Z. 15-28-39

DESCRIPTION: This fuze is screwed into the base of the shell on a copper washer and is secured by a fixing screw.

It consists of a body, detonator holder, striker pellet, creep spring and gaine. (See fig. 602.)

The body is of steel, varnished black, threaded externally and formed with two recesses at the base to take a key for screwing into the base of the shell. Internally it is recessed and threaded to take the gaine and detonator holder. Two inclined grooves are cut in the body near the base, these lead into a lateral recess in the body into which the safety balls move after the shell has left the bore.

The aluminum striker pellet with steel striker is housed inside the detonator holder. The pellet contains two polished nickel steel safety balls which are carried in a recess at the bottom of the pellet. The function of the safety balls together with the creep spring is to retain the pellet in a safe position before firing.

The gaine is of steel, varnished black. It contains the detonator and exploder and is screwed into the upper end of the fuze body against the detonator holder.

GERMAN EXPLOSIVE ORDNANCE

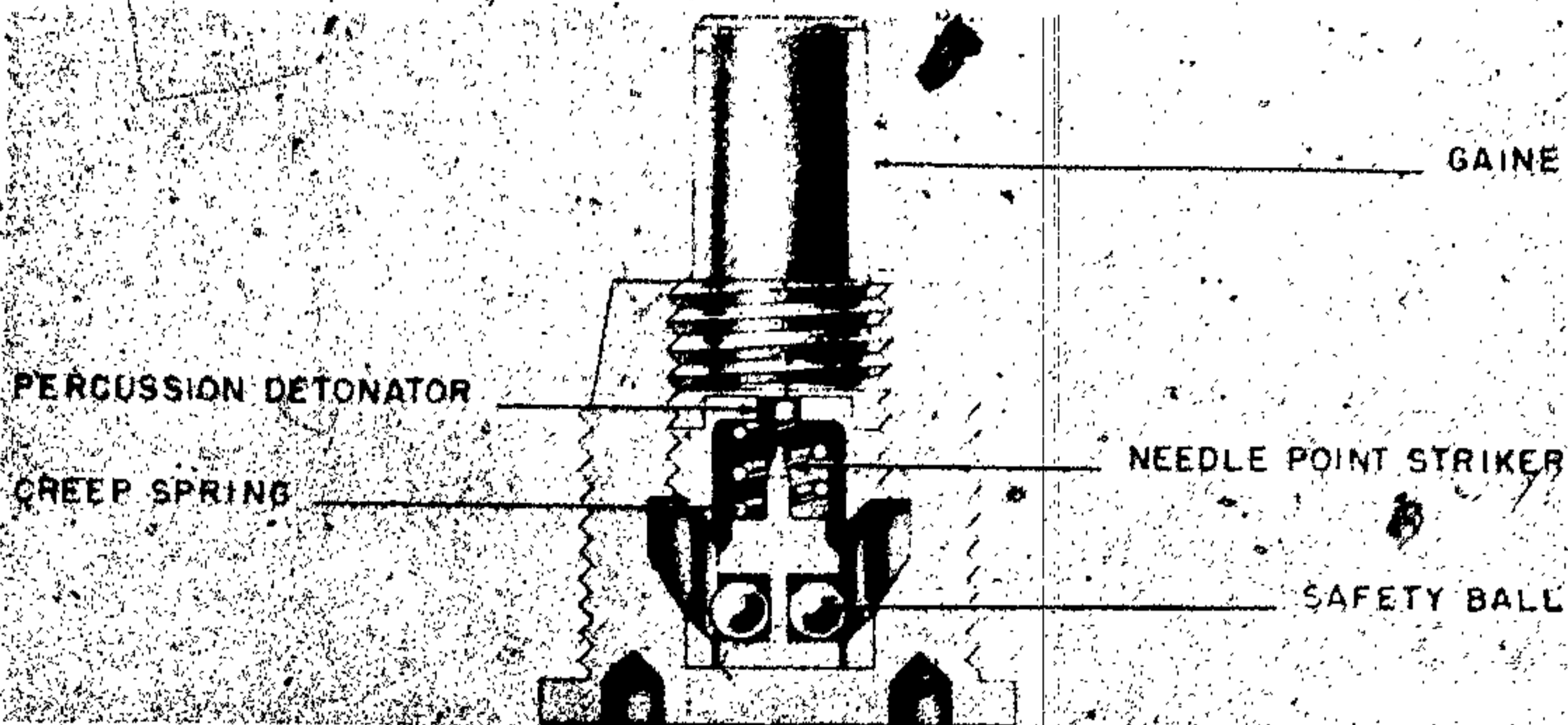

Figure 602—Skoda B. Z. 15-28-39

ACTION: Before firing the striker pellet is kept from the detonator by the creep spring and the two safety balls. The latter, when the fuze is at rest, lock the pellet to the detonator holder.

After firing, the effect of set-back keeps the pellet held against the fuze body.

On deceleration, after the shell has left the bore, the pellet tends to creep forward overcoming the resistance of the creep spring. This movement is assisted by the safety balls which, acting under centrifugal force, are caused to ride up the inclined planes in the detonator holder into the lateral recess in the body. The forward pressure of the safety balls on the pellet having ceased, the creep spring reasserts itself and returns the pellet to its original position. This movement locks the safety balls in the recess in the body. The pellet is now held from the detonator only by the creep spring. On impact, the pellet is carried forward on to the detonator overcoming the spring. The flash ignites the detonator in the gaine which, in turn, detonates the bursting charge of the shell.

BASE FUZE BD. Z. C/38

EMPLOYMENT: Used in shells for heavy guns the ammunition for which is often of Naval design. (See fig. 603.)

CONSTRUCTION: The fuze is an igniferous base fuze of the graze type with a delay action.

The body is of steel, brass plated, and closed at the forward end by a screwed-in brass head with a central cavity and flash hole, sealed with a brass disk and varnish. The body is screw-threaded ex-

ternally with a right-handed thread for insertion into the shell and recessed internally to take the grazed mechanism.

The brass head is internally screw-threaded to take a brass plug which holds a screwed brass delay unit at its forward end.

The striker is of steel and is secured by a steel plug which screws into the striker holder. The point of the striker protrudes into the top of the graze pellet. The recess in the fuze body houses a steel platform which carries five centrifugal segments overlapping the top of the brass graze pellet. The segments are encircled by an expanding ring of phosphor bronze which retains them in the overlapping position and thus prevents forward movement of the graze pellet.

The brass graze pellet, which is closed at the base by a screwed in steel plug, houses a detonator holder resting on a fibre washer. The detonator consists of a copper shell closed at the top by a copper disk and at the bottom by a copper disk with a square hole in the center covered by a paper disk. The filling consists of 1.2 grains of detonating composition over 13 grains of gunpowder. The composition is made up of mercury fulminate 21.3 percent, potassium chlorate 44.0 percent, antimony sulphide 34.0 percent and grit 0.7 percent.

The delay unit is in the form of a brass plug with a central flash hole in the base and a recess filled with 0.8 grain of pressed powder. An eccentric flash hole leads to a larger recess in the forward end of the unit which contains 1.2 grains of pressed gunpowder. Above the delay unit is

PROJECTILE FUZES

a filling of 23 grains of pressed gunpowder contained in a recess in the brass head of the fuze.

OPERATION: Centrifugal force set up by the spin of the projectile in flight causes the spring

ring to expand and permit the segments to rotate on their pivots thus freeing the graze pellet which, as there is no creep spring, tends to creep forward toward the striker. The detonator is pierced immediately on graze or impact and the flash pro-

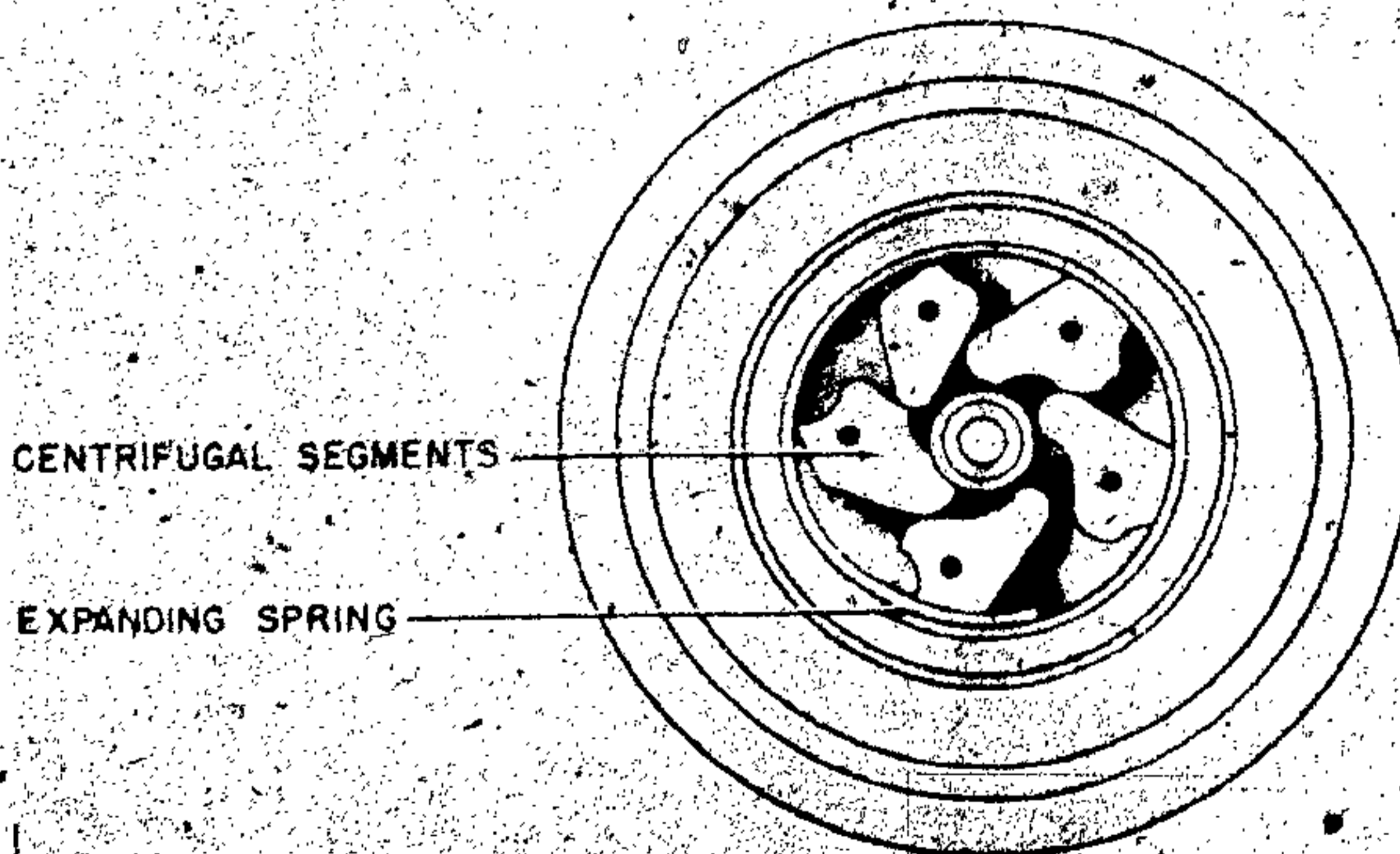
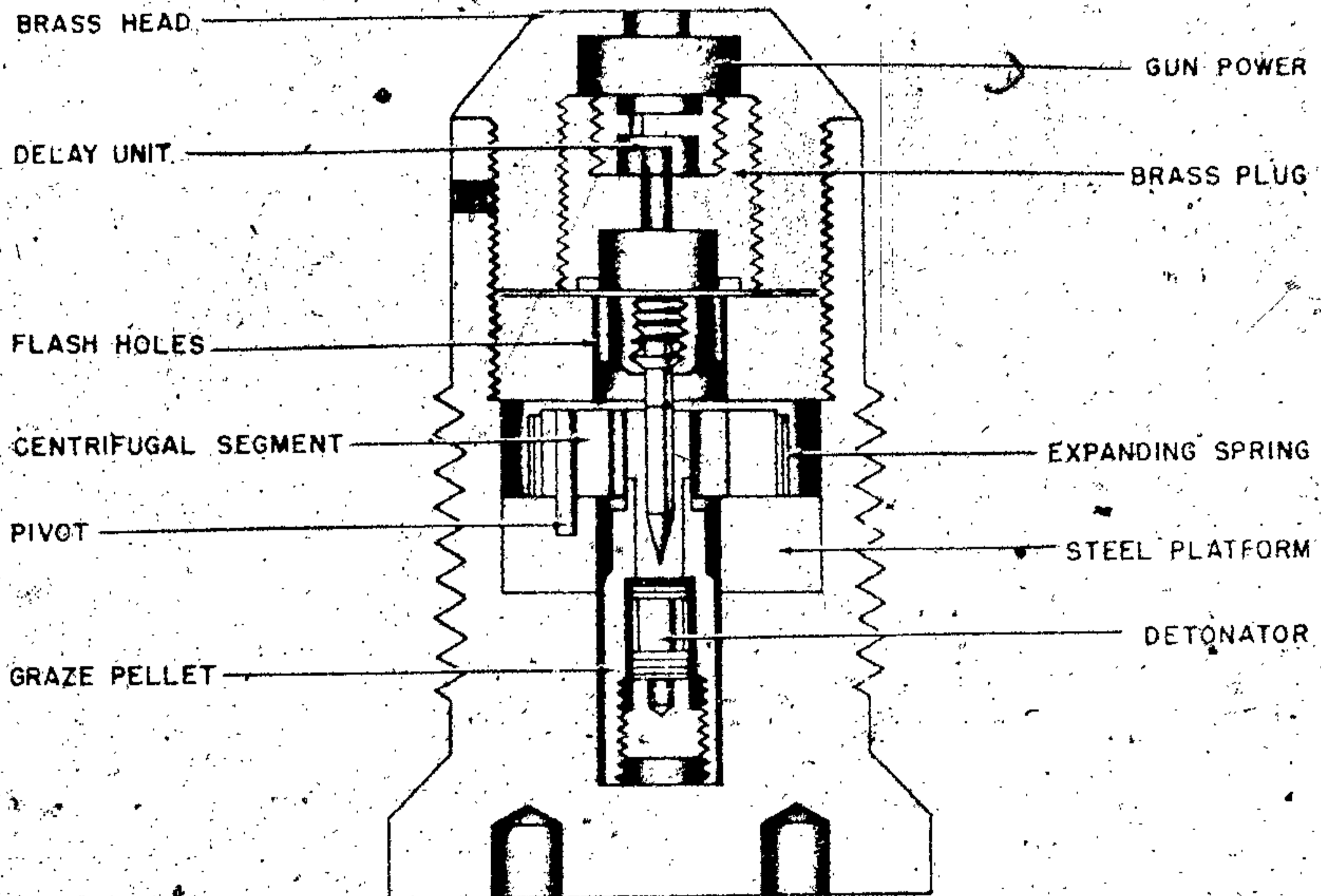

Figure 603—Bd. Z. C/38

GERMAN EXPLOSIVE ORDNANCE

duced passes through the flash holes in the striker holder to the delay unit.

REMARKS: The Bd. Z. C/36 fuze is similar to Bd. Z. C/38, except that it is of smaller gage. It is constructed largely of steel and is fitted with brass segments. It operates with a delay of 0.03 second. The fuze is used in the 28-cm range of shell.

The Bd. Z. 40 K base fuze is also similar to Bd. Z. C/38 except that it has a larger gage and is fitted with a creep spring. The fuze is constructed largely of steel and the segments are of aluminum.

FUZE, BASE, 27/34 W. Z. 36

EMPLOYMENT: This base fuze is of the graze type and used in German 3.7-cm A. P. Shell of Polish origin. (See fig. 604.)

DESCRIPTION: The fuze consists principally of

a steel body, steel inertia pellet containing detonating composition, brass ferrule, two steel balls, brass arming sleeve, a small and a large stirrup spring, and a felt disk.

The body is in two parts. The rear part is flanged, and screw-threaded externally for insertion in the shell. Internally, it is screw-threaded to receive the front portion, and bored in two diameters to accommodate the fuze mechanism. The front part is screw-threaded externally at one end for attachment to the rear part, and is tapered to the front to a tubular closed end. The tapered portion is bored radially to form two rows of three holes each. An internal striker is formed in the closed end and is integral with the body.

The inertia pellet is cylindrical with a solid closed base end. Externally, near the base, it is recessed circumferentially, and above the recess are two indents, diametrically opposed, which partly accommodate the two balls.

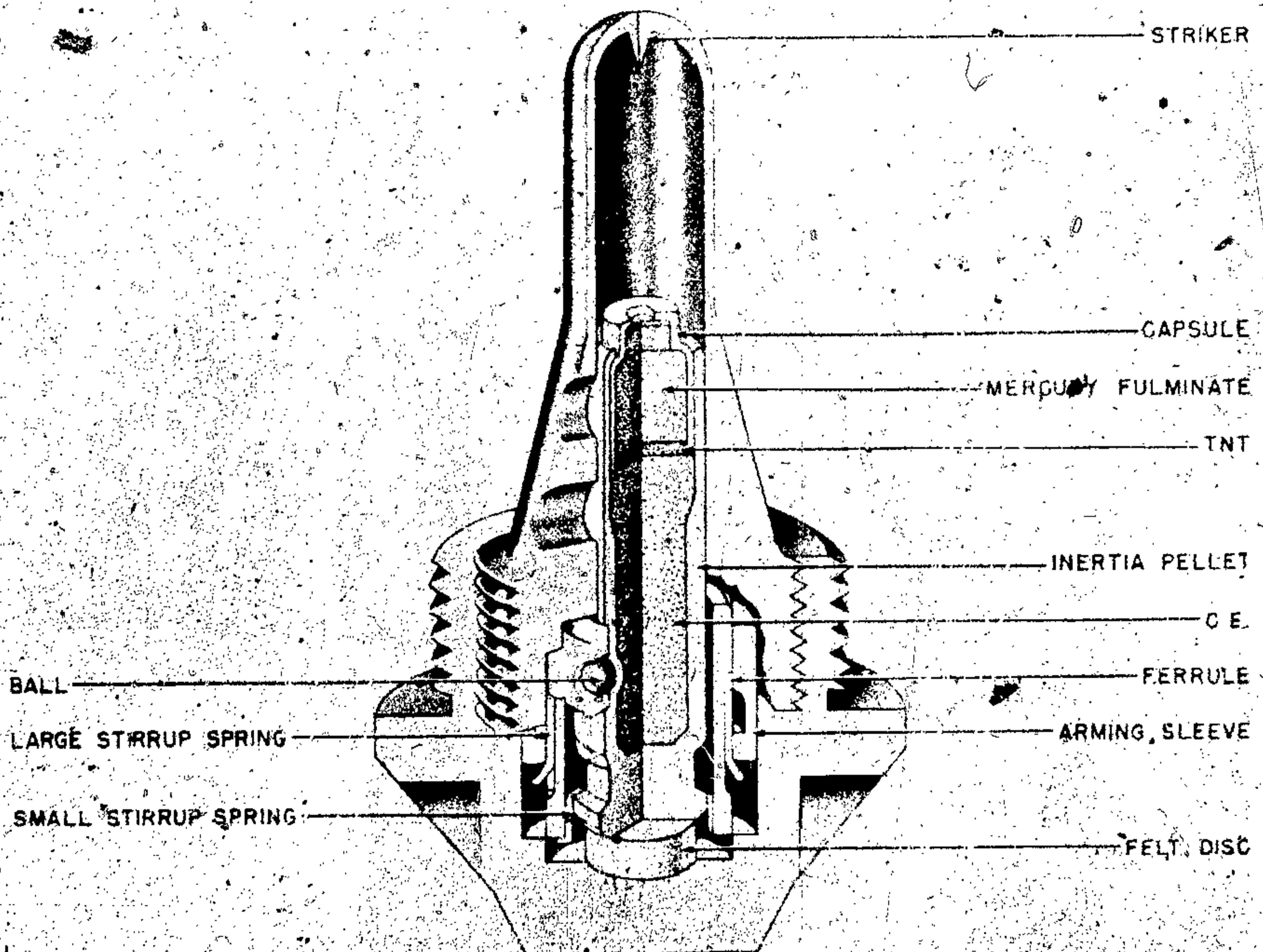

Figure 604--27/34 W. Z. 36

The pellet contains 0.89 gram of C. E. and a capsule of detonating composition. The copper capsule is cup shaped with a hole in its base which is closed on its inside by a copper disk 0.003 inch thick. Above the disk is a composition weighing 0.026 gram, and consisting of mercury fulminate 22.0 percent, potassium chlorate 40.5 percent, antimony sulphide 33.6 percent and ground glass 3.9 percent. Above this composition is a pellet of mercury fulminate weighing 0.57 gram with a thin layer of TNT weighing 0.04 gram on top. The capsule is inserted in the inertia pellet open end first, and secured by turning the end of the pellet over the base of the capsule and varnishing the join.

A felt disk is inserted between the base of the inertia pellet and the fuze body.

The ferrule is cylindrical with an external circumferential recess about its center.

Near its forward end are two holes, bored diametrically opposite, which partly accommodate the two steel balls. The ferrule surrounds the base end of the inertia pellet and is supported by the smaller of the two stirrup springs.

The stirrup spring is cylindrical; its lower edge has three external projections which fit under the ferrule and its upper edge has three internal projections which engage in the recess near the base of the inertia pellet.

The arming sleeve is cylindrical with a circumferential internal recess near its base edge. It surrounds the forward part of the ferrule and retains the two steel balls locking the inertia pellet in the safe position. The sleeve is supported by the larger stirrup spring.

The stirrup spring is cylindrical and split. Two lugs, cut diametrically opposite in its lower edge, project and fit under the arming sleeve.

ACTION

BEFORE FIRING. The inertia pellet is locked and held away from the striker by the two steel balls which are retained by the arming sleeve.

AFTER FIRING. On acceleration, the arming sleeve sets back and is retained by the larger stirrup spring which engages the circumferential groove, thereby freeing the two balls which move outwards under centrifugal action. Creep action is prevented by the smaller of the two stirrup springs.

On impact or graze, the inertia pellet moves forward onto the striker and detonates its filling.

BASE FUZE W. Z. 36

EMPLOYMENT: Mechanical Impact Base Fuze for Polish 3.7-mm A. P. shell. (See fig. 605.)

DATA:

Over-all length: 2.0 inches.

Maximum diameter: 1.0625 inches.

Threaded length: 0.5 inch.

Number of threads: 7 LH.

CONSTRUCTION: The upper body, which extends into the projectile, houses a fixed firing pin and a chamber into which is slipped a detonator pellet with a detonator on top of it. The lower body is threaded to engage the threads on the projectile. The detonator pellet has two indentations on the side to hold locking balls and a groove near the base which engages three vertical extensions of a spring which surrounds the pellet. Compressed composition explosive beneath the pellet acts as a booster. Surrounding the base of the detonator and the small spring is an iron ring, on the outside of which is fitted a stirrup spring. Near the top of this ring, are two holes for holding the locking balls. The two locking balls engage the indentations in the detonator pellet and are positioned by a brass ring which surrounds the whole assembly.

ACTION: Set-back causes the brass ring to bear against the stirrup spring located outside the iron ring. When set-back has been overcome, the brass ring has been driven to the base of the fuze creating a clearance into which the locking balls are thrown by centrifugal force. The detonator pellet is now held only by the three spring extensions at the base. On impact, inertia forces the detonator pellet to free itself from these spring extensions and to move forward against the fixed firing pin in the top of the fuze.

BASE FUZE M. 35

EMPLOYMENT: Base fuze used on German 4.7-cm A. P. ammunition. (See fig. 606.)

DATA:

Overall length: 2.656 inches.

Maximum diameter: 1.406 inches.

Threaded length: 0.688 inch.

Number of threads: 11 RH.

CONSTRUCTION: The body is threaded externally at the middle to engage the threads of the projectile. A detonator is screwed into the top of

GERMAN EXPLOSIVE ORDNANCE

the fuze and a tracer is crimped into a recess at the base.

A primer housing with a funnel-shaped hole through it and surrounded by a compressed spring is held in place by six steel balls. The collar which retains these balls increases in diameter towards the top.

ACTION: The primer housing is locked in place by the steel balls until the projectile strikes an object. Inertia causes the housing to move forward,

compressing its spring. The locking balls move forward also and are cammed out into the enlarged portion of the retaining ring. The primer then impinges upon the striker and the flash passes through the funnel-shaped hole firing the detonator.

BASE FUZE FOR 7.5-CM (SMALL CAVITY)

EMPLOYMENT: Base fuze used on German

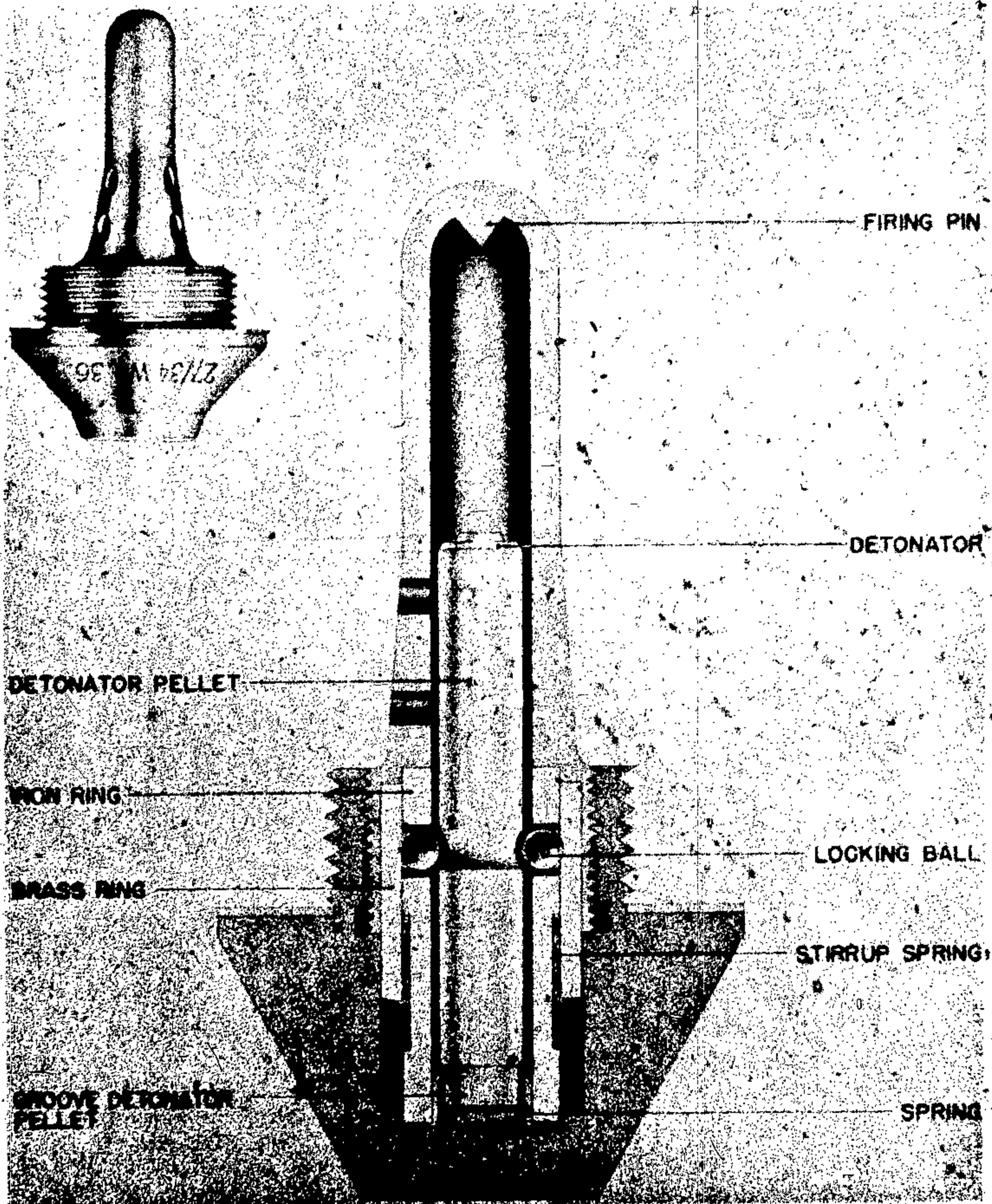

Figure 605—W. Z. 36

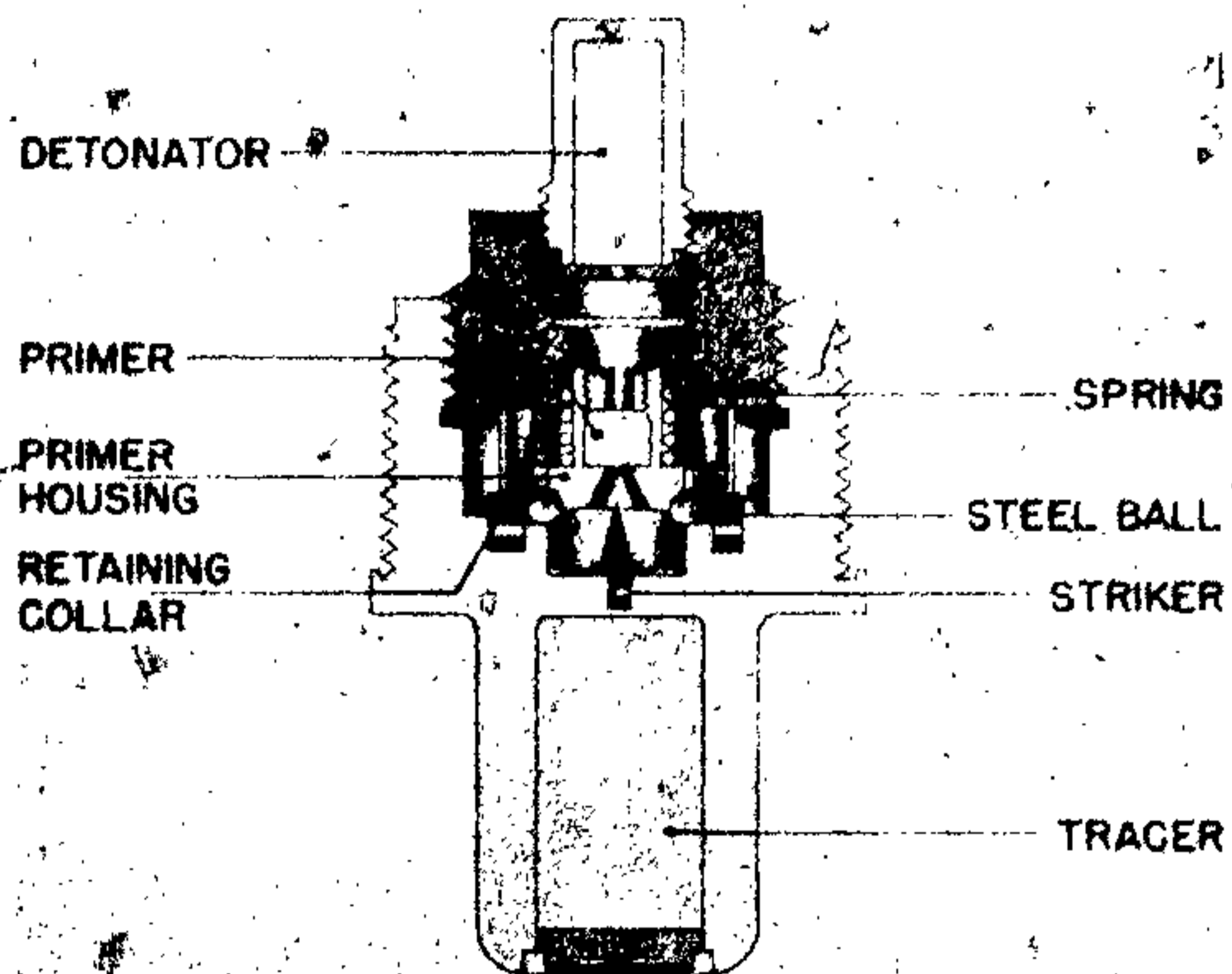

Figure 606—M. 35

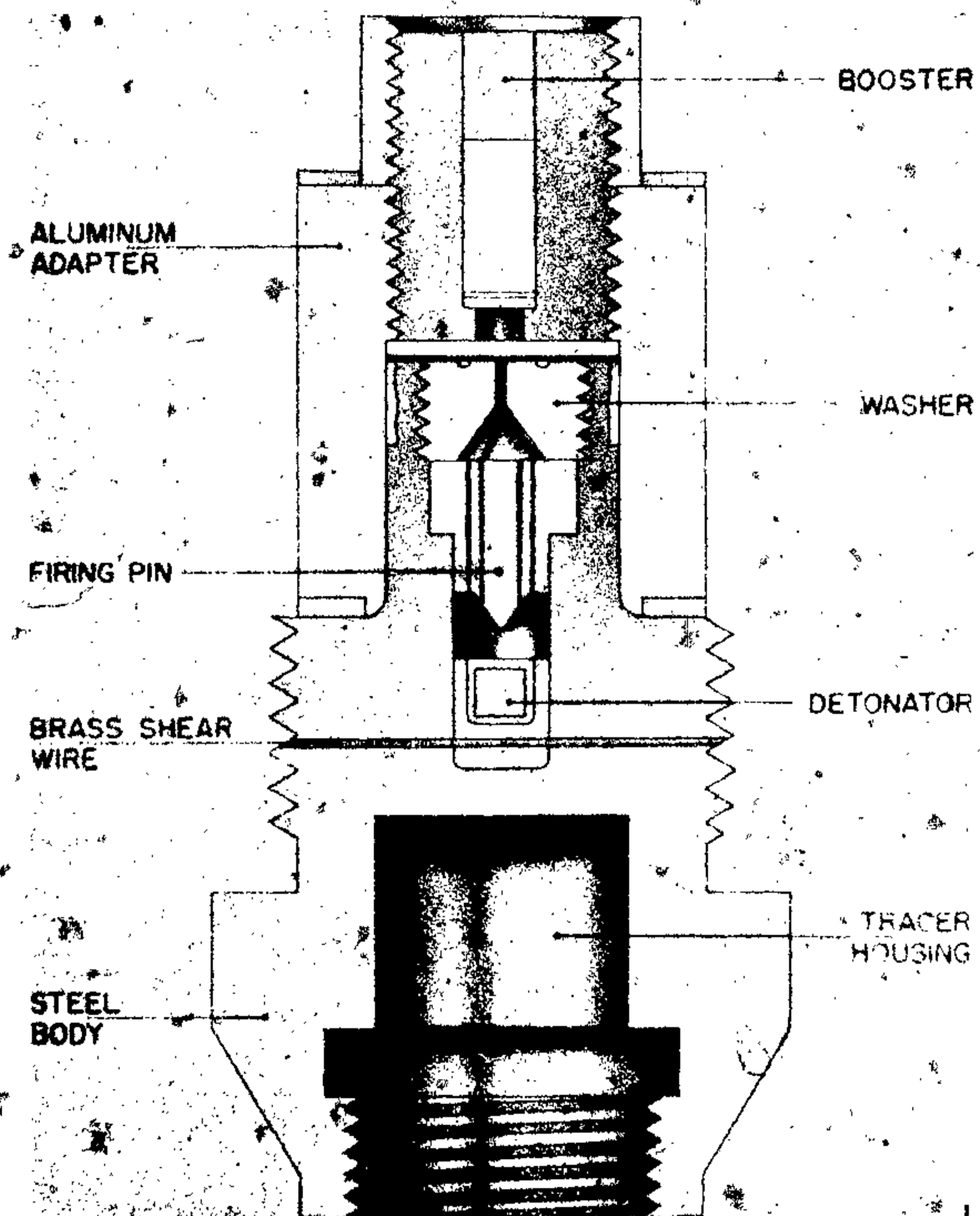

Figure 607—Fuze for 7.5-cm Projectiles (Small Cavity)

GERMAN EXPLOSIVE ORDNANCE

7.5-cm H. E. projectiles and 5-cm A. P. shells.
(See fig. 607.)

DATA:

Over-all length: 1.781 inches (with tracer).
Over-all length: 1.563 inches (without tracer).
Maximum diameter: 1.063 inches.
Threaded length: 0.438 inch.
Number of threads: 6 LH.

CONSTRUCTION: The base of the steel body is threaded internally to receive a brass tracer container. The center of the body is threaded externally to engage the threads on the projectile. An aluminum adapter is screwed over the top of the fuze body. A booster, containing either pellets of lead azide, calcium silicide, and PETN wax

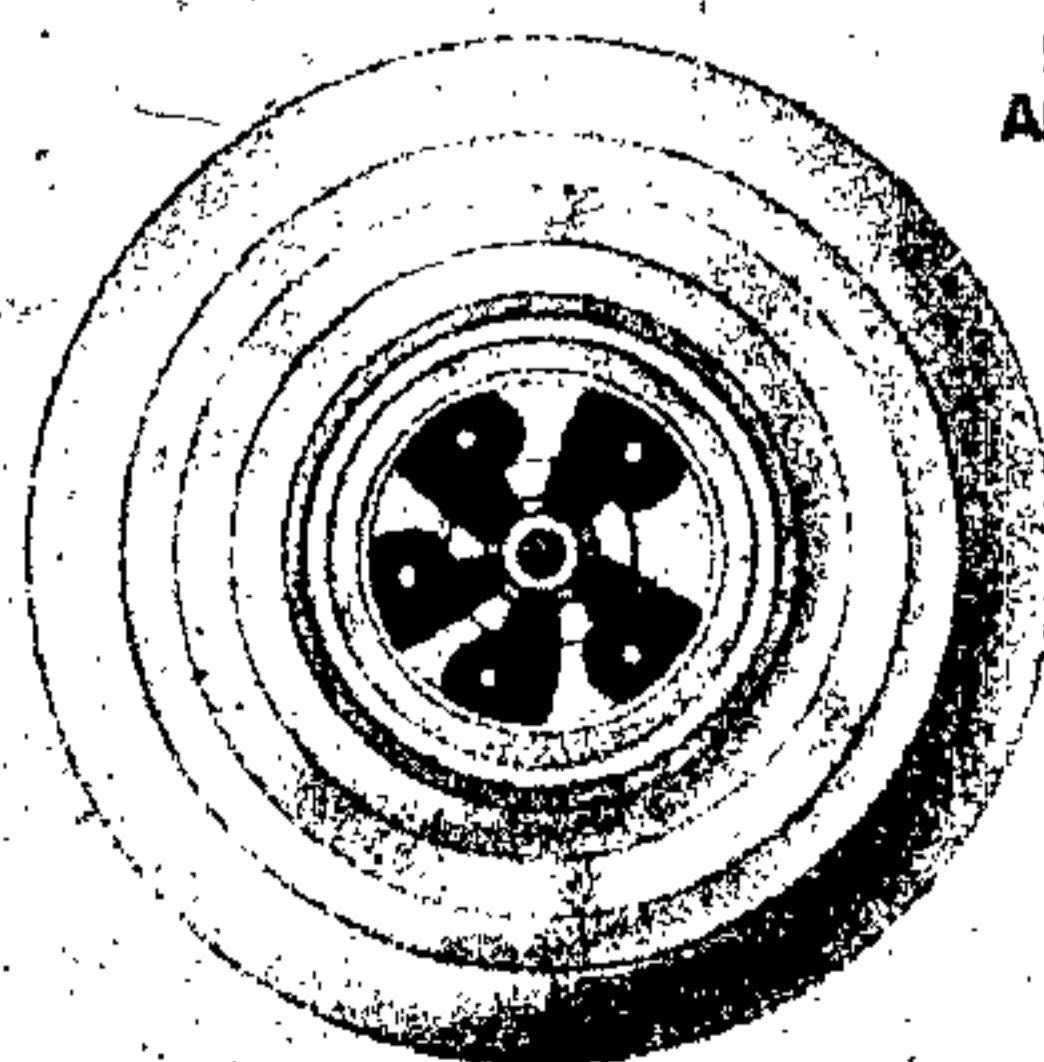
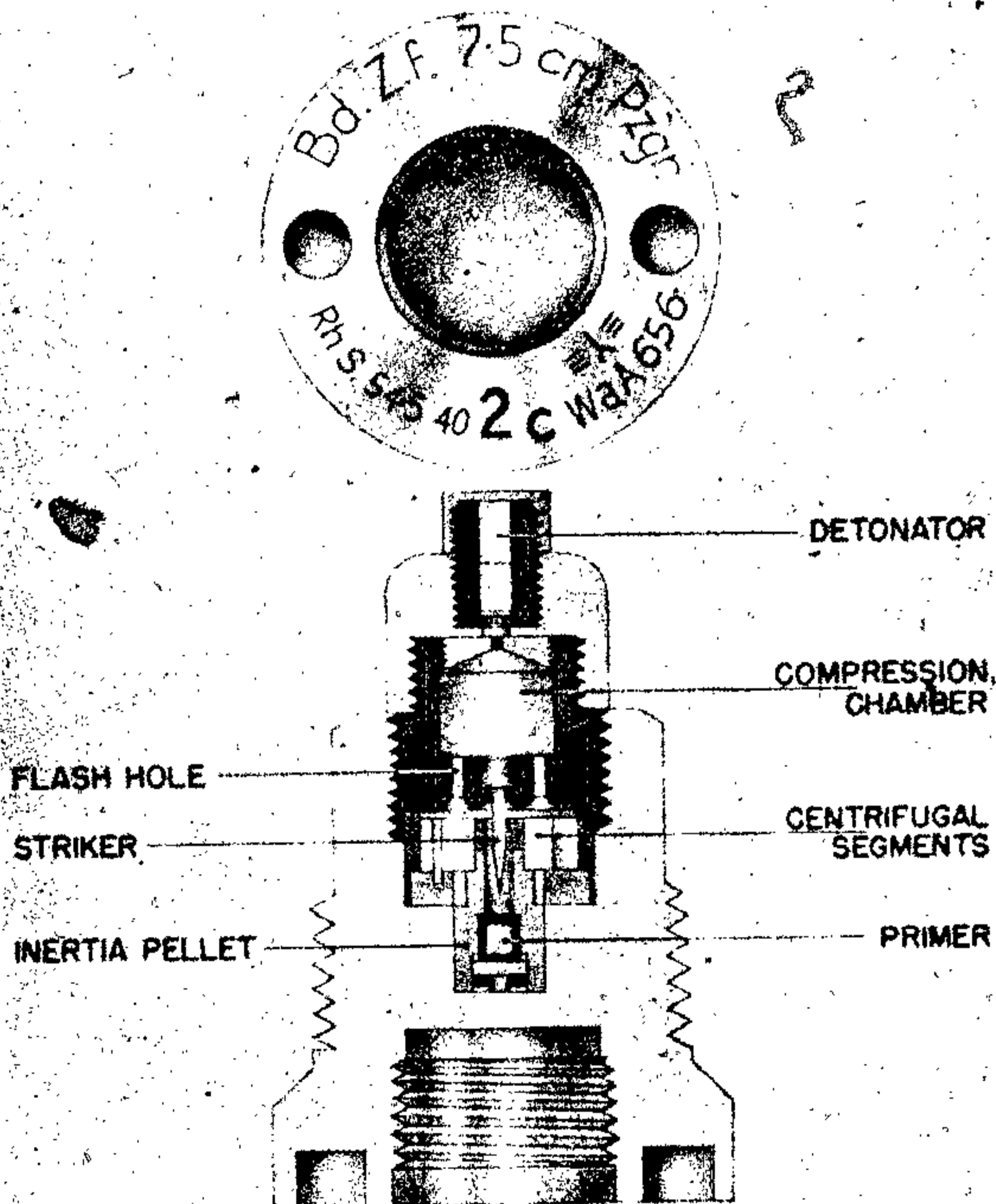

PLAN WITH GAIN
ADAPTER REMOVED
SHOWING
CENTRIFUGAL
SEGMENTS

Figure 608—Bd. Zf. 7.5 cm-Pzgr. (Large Cavity)

or tetryl, is screwed into this adapter and is sealed by an aluminum cap.

A funnel-shaped washer secures a firing pin in the body of the fuze. The flash from the primer passes through the washer and a channel in the firing pin. The washer is separated from the booster by a series of paper and gauze disks which delay the action of the fuze.

The primer holder is held away from the firing pin by a heavy brass shear wire.

ACTION: Upon impact, the primer holder moves forward shearing the shear wire and impinging the primer on the firing pin. The flash passes through the firing pin, the funnel washer, the paper and gauze disks, and into the booster. The booster then fires the shell.

BD. ZF. 7.5-CM PZGR. (LARGE CAVITY)

EMPLOYMENT: Mechanical Impact Base Fuze used in German 7.5-cm A. P. C. shells. (See fig. 608.)

DATA:

Over-all length: 3.875 inches.

Maximum diameter: 2.188 inches.

Threaded length: 0.875 inch.

Number of threads: 6 RH.

CONSTRUCTION: This fuze is similar in exterior construction to the 7.5-cm (small type) fuze. It has a fixed striker and an inertia pellet containing a primer in the top. It has the standard German centrifugal arming mechanism. Four flash holes around the striker lead to a compression chamber which is closed by a brass disk with a pin-point hole in the center. The top of the fuze closing plug is threaded externally to accept an aluminum cap which has a center hole lining up with the hole in the disk. This hole leads to another detonator composed of lead styphnate, lead azide, and PETN/wax.

ACTION: Centrifugal force causes the centrifugal segments to expand against the expanding spring ring thus releasing the inertia pellet. Upon impact the inertia pellet, containing the primer, goes forward impinging upon the fixed firing pin. The flash, after passing through the four holes around the striker, enters the compression chamber. When the pressure has been built up sufficiently, the flash passes through the pin-point hole in the closing disk firing the detonator.

REMARKS: The building up of pressure in the compression chamber determines the delay in the fuze.

BD. Z. FOR 8.8-CM. PZGR.

EMPLOYMENT: Small cavity fuze for 8.8-cm A. P. projectile. (See fig. 609.)

DATA:

Over-all length: 2.312 inches.

Maximum diameter: 0.812 inch.

Threaded length: 0.812 inch.

Number of threads: 14 RH.

CONSTRUCTION: This fuze contains a spring-loaded striker and is contained in a housing that fits into the base of the projectile. The detonator is fixed in the fuze. The firing pin is fitted with a spring under compression by two balls which are held stationary by a spring clip in a slight cannellure just forward of the collar.

ACTION: Upon impact the collar moves forward due to inertia forcing the spring clip out of position. The balls are free to move out of position, releasing the spring-loaded striker which is forced on to the primer.

REMARKS: Another version of this fuze has been identified in which there is no spring clip or cannellure but in their place, a shear wire restrains the collar until impact.

BD. ZF. 8.8-CM PZGR. (LARGE CAVITY)

EMPLOYMENT: Mechanical Impact Base Fuze used on German 8.8-cm A. P. projectiles. (See fig. 610.)

DATA:

Over-all length: 2.50 inches.

Maximum diameter: 2.563 inches.

Threaded length: 0.75 inch.

Number of threads: 6 RH.

CONSTRUCTION: This fuze is similar in construction to the fuze used on the 7.5-cm A. P. C. shell. The centrifugal segments of the customary arming device are of light alloy rather than brass and a steel detonator holder replaces the brass type. A light creep spring is incorporated as an added safety feature between the detonator holder and the fixed firing pin. The flash is transmitted through four holes surrounding the striker to a compression chamber closed by a coned brass disk with a pin-point hole leading to the booster.

GERMAN EXPLOSIVE ORDNANCE

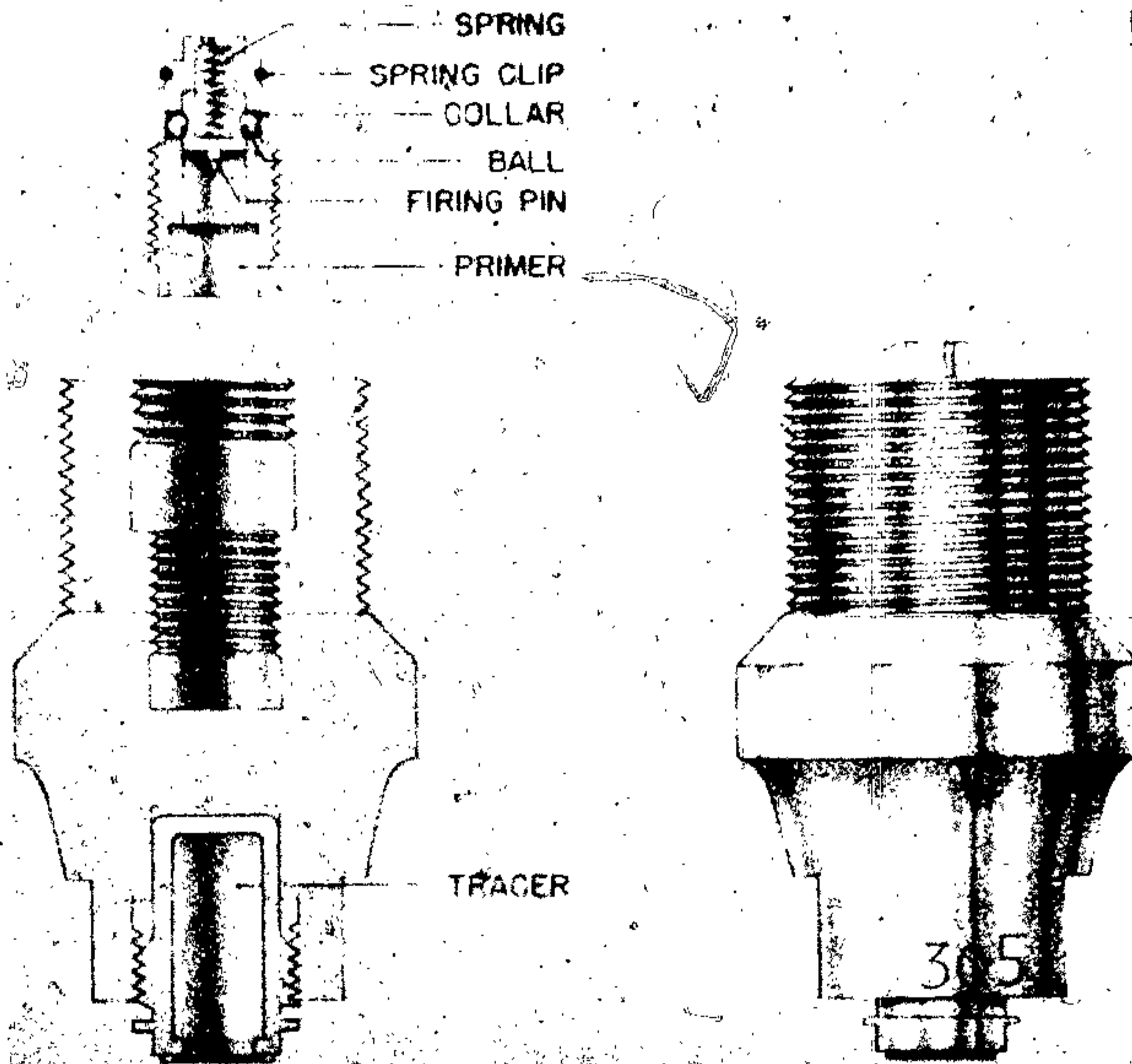

Figure 609—Bd. Z. for 8.8-cm Pzgr.

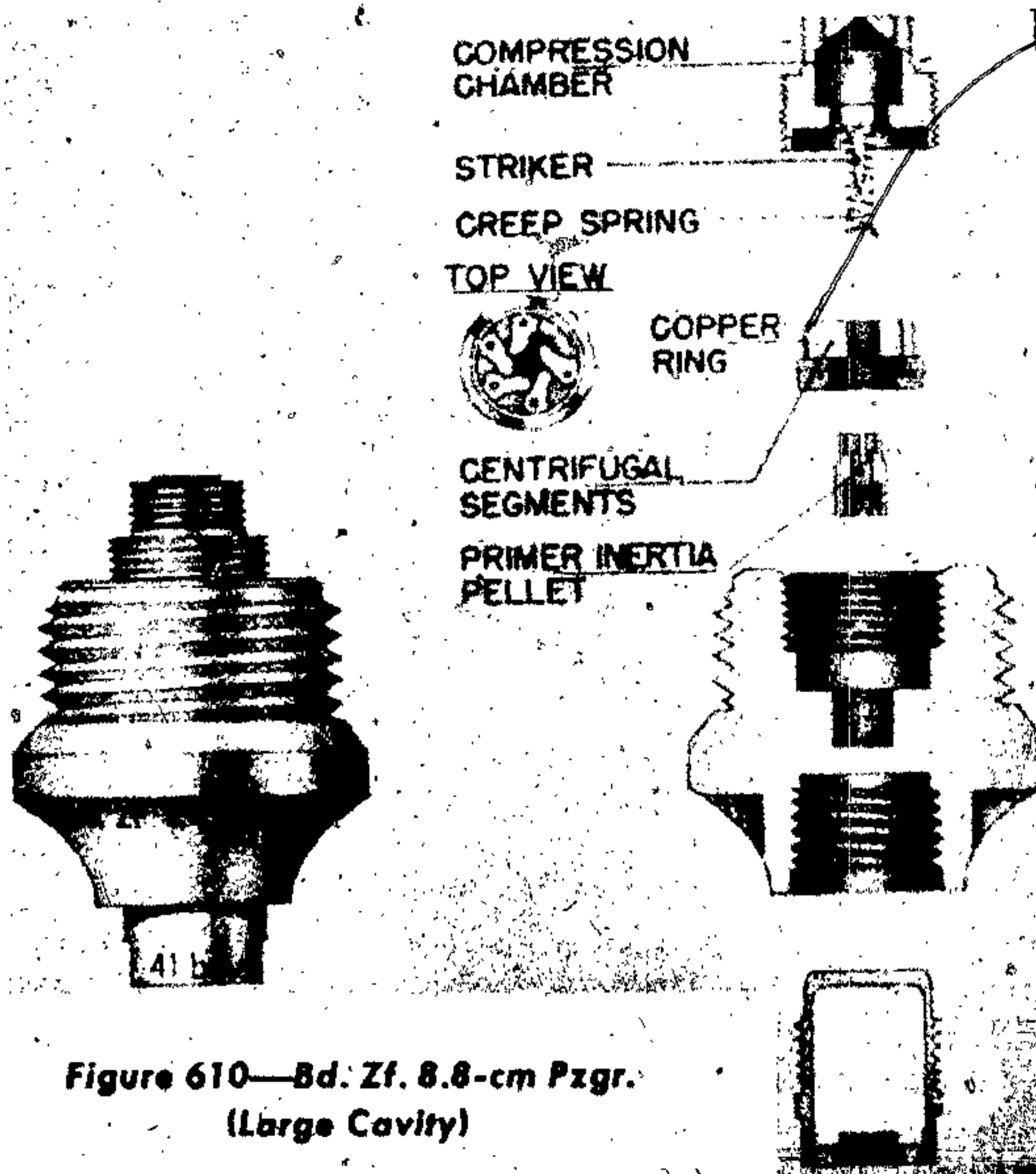

Figure 610—Bd. Zf. 8.8-cm Pzgr.
 (Large Cavity)

ACTION: Centrifugal force causes the centrifugal segments to expand the copper ring releasing the inertia pellet containing the primer. Upon impact, the primer overcomes the creep spring and impinges upon the fixed striker. The flash, after passing through the four holes below the striker, builds up a pressure in the compression chamber. When a great enough pressure is reached, it flashes through the pin-point hole in the coned disk firing the detonator.

REMARKS: The building up of pressure in the chamber apparently is what determines the delay in this fuze.

BASE FUZE BD. Z. (15-CM GR. 19- BE.)

EMPLOYMENT: Base fuze for 15-cm Granat 19 anticoncrete shell. (See fig. 611.)

DATA:

FUZE:

Over-all length: 8.0 inches.

Maximum diameter: 2.0 inches.

Threaded length: 1.0 inch.

Number of threads: 12 RH.

BOOSTER HOLDER:

Over-all length: 6.125 inches.

Maximum diameter: 3.0 inches.

Threaded length: 1.062 inches.

Number of threads: 8 RH.

CONSTRUCTION: This steel fuze threads into a large steel booster adapter. A notched setting disk which gives choice of two delays or instantaneous action is seated in the fuze head and held in the fuze by a locking ring on which are marked the setting indications G. V. (long delay), K. V. (short delay), O. V. (without delay). A second notch on the underside of the setting disk engages a ridged portion of the aluminum striker holder. This holder, to the bottom of which is affixed a felt disk, rides easily on an aluminum foil-covered steel plate towards the base of the fuze. Three

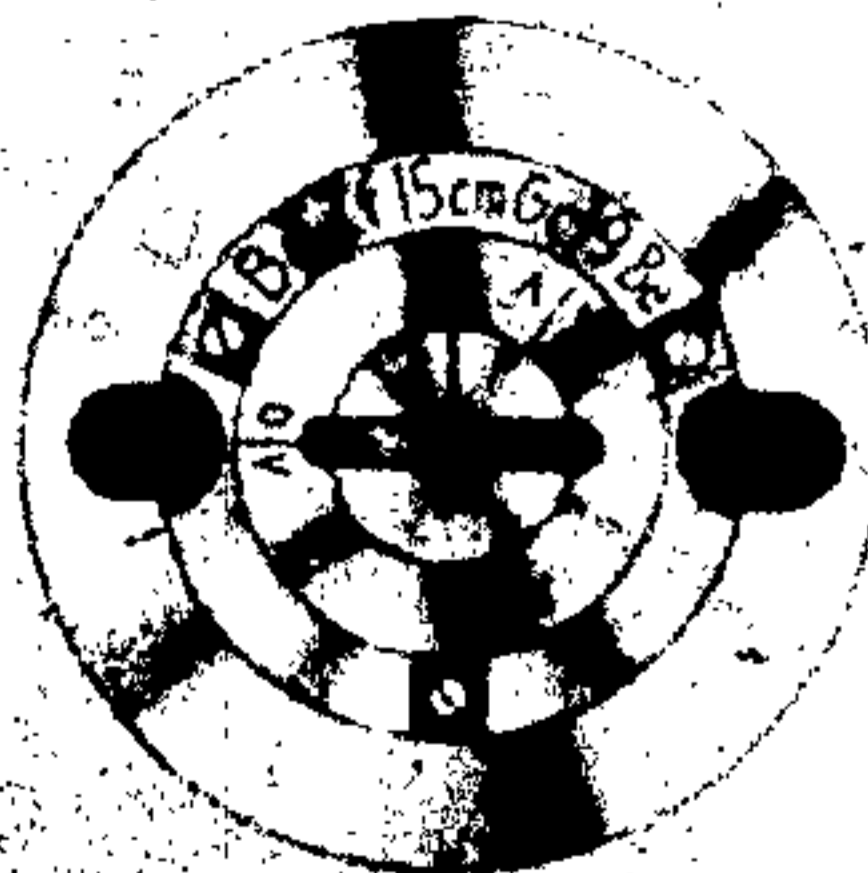
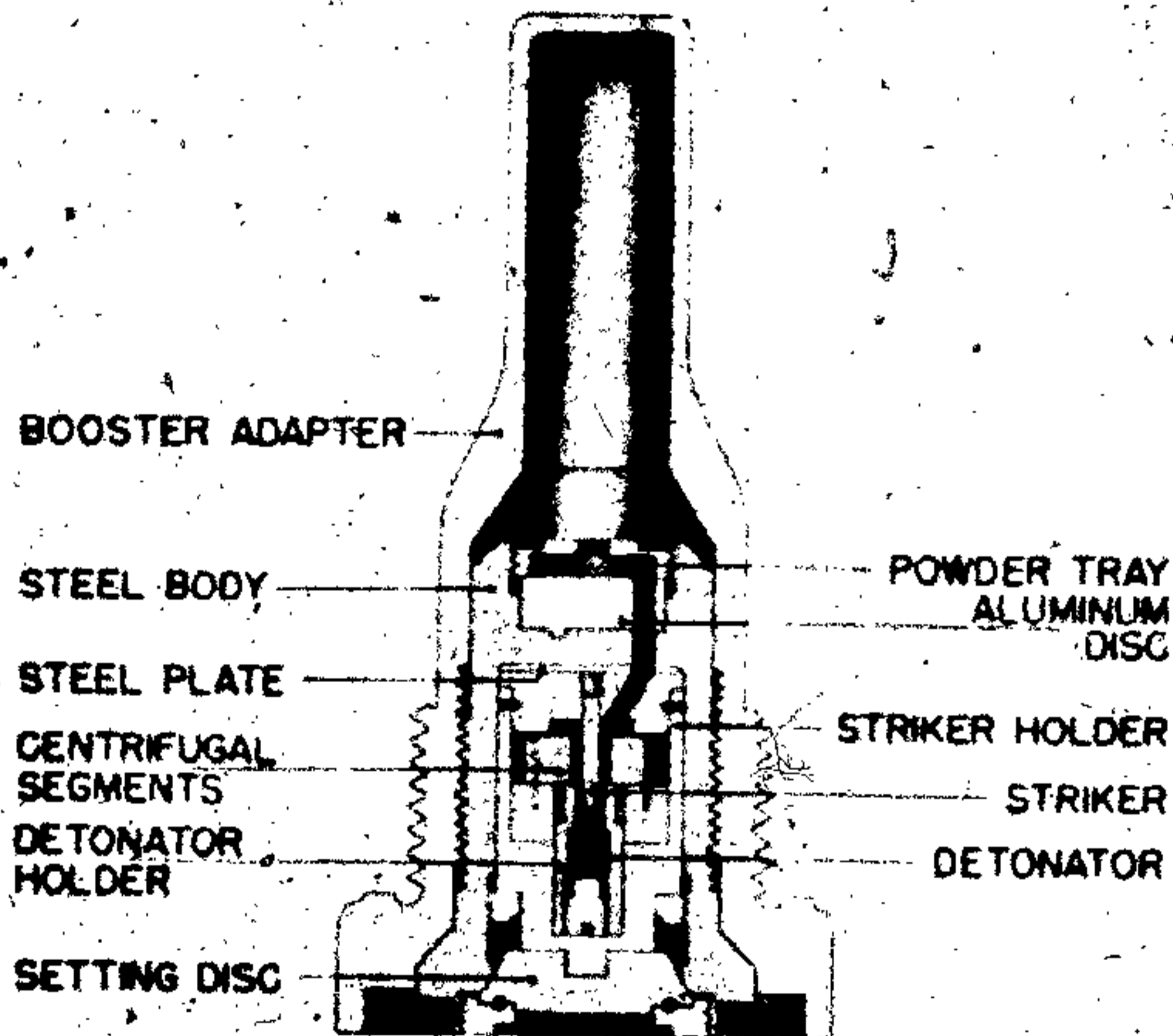

Figure 611—Bd. Z. (15-cm Gr. 19 Be.)

GERMAN EXPLOSIVE ORDNANCE

holes drilled in this plate give access to three holes in an aluminum disk below it. Two of these contain black powder delays while the third is empty. Thus, the turning of the holder which has a single flash hole, determines delay. A powder tray with one hole giving access to the gains screws into the fuze base.

The firing mechanism is standard and simple. The detonator in a brass holder is held from the fixed firing pin by means of five centrifugal detents in a spring ring.

ACTION: Rotation of the projectile causes the centrifugal detents to swing out against the spring, arming the fuze. On impact, the detonator impinges on the striker and flashes through a flash hole beside the striker, to the aluminum disk containing the delays.

FUZE, BASE, 'BD. Z. DOV

EMPLOYMENT: 15-cm Rakaten Oranate. (See fig. 612.)

DESCRIPTION: This is a direct action base fuze used in the 15-cm H. E. rocket. It may be identified by the stamping "Bd. Z. DOV" in the base. The over-all length of the fuze is 1.4 inches and its maximum diameter, over the threads, is 1.75 inches.

The fuze consists of a steel body, steel striker, five centrifugal segments of light alloy, expanding spring ring, creep spring, steel detonator holder, igniferous detonator and steel screwed plug. All steel components are rustproofed.

The body is screwthreaded externally with a left-hand thread for insertion in the base of the rocket, and the forward end is reduced in diameter

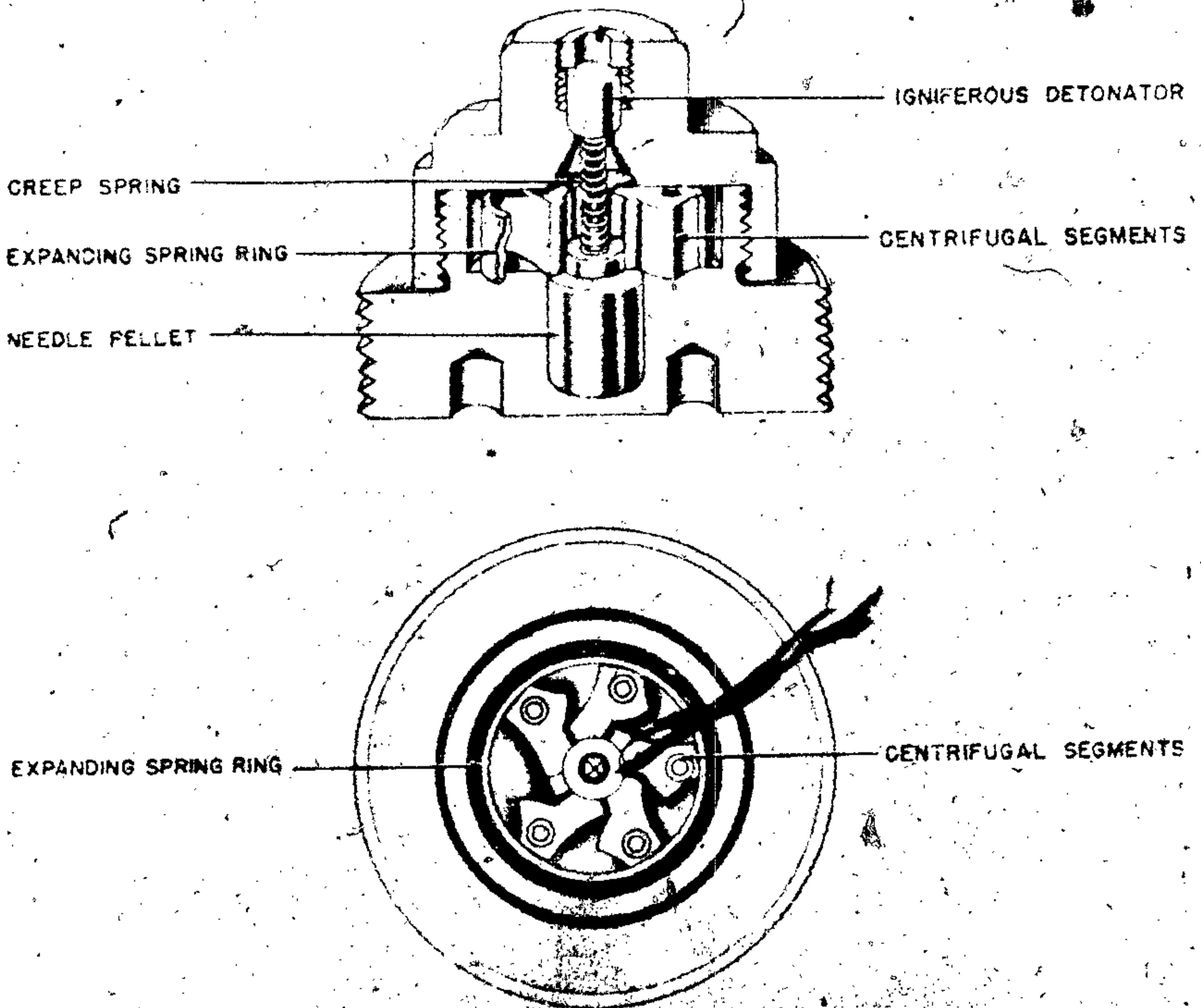

Figure 612—Bd. Z. DOV

and screwthreaded for the attachment of the detonator holder. It is bored centrally from the front in two diameters to form chambers to house the needle pellet and centrifugal segments.

The needle is integral with the inertia pellet. The pellet is housed in the base of the body, and provided with two shoulders below the needle, which is located centrally in the larger chamber.

The five centrifugal segments are pivoted on pins and are shaped so that one locks the other. In the unarmed position, the segments engage the larger shoulder of the striker pellet and hold the striker off the detonator. They are surrounded and retained in this position by an expanding spring ring.

The spiral creep spring surrounding the striker is held between the smaller shoulder of the striker pellet and a seating in the detonator holder.

The detonator holder is bored centrally to form two chambers, which are connected by a coned boring with a seating for one end of the creep spring. The larger chamber is screwthreaded to receive the forward end of the fuze body. The smaller chamber houses an igniferous detonator and is closed by a perforated screwed plug secured by stabbing.

ACTION

BEFORE FIRING. The striker is held off the detonator by the centrifugal segments which are retained in the closed position by the expanding spring ring.

DURING FLIGHT. On deceleration and when the necessary rotational velocity is reached, the segments, overcoming the spring ring, swing outwards under centrifugal force, clear of the striker pellet. Creep action by the striker pellet is prevented by the creep spring.

On impact or graze, the pellet moves forward, compressing the creep spring and carries the striker on to the detonator.

ELECTRIC FUZE ERZ 39

EMPLOYMENT: This base fuze fits into one of the venturi of the German 15-cm and 21-cm rockets. (See fig. 613.)

DATA:

Overall length: 1.438 inches.

Maximum diameter: 0.536 inch.

No threads.

CONSTRUCTION: The body is made of a black colored plastic with an aluminum band around the shoulder.

Within the body is a igniter bridge from which runs two wires. One wire is connected to the aluminum band around the shoulder and the other to a metal disk in the base of the fuze. A black powder charge is located just above the igniter bridge.

ACTION: An electric current is passed through the fuze firing the igniter bridge. This, in turn, fires the black powder charge which sets off the propellant.

REMARKS: This fuze is to be replaced by the type ERZ 39 (B) which is manufactured from heat resistant materials. The distinguishing feature of this new fuze is the grey color of the body.

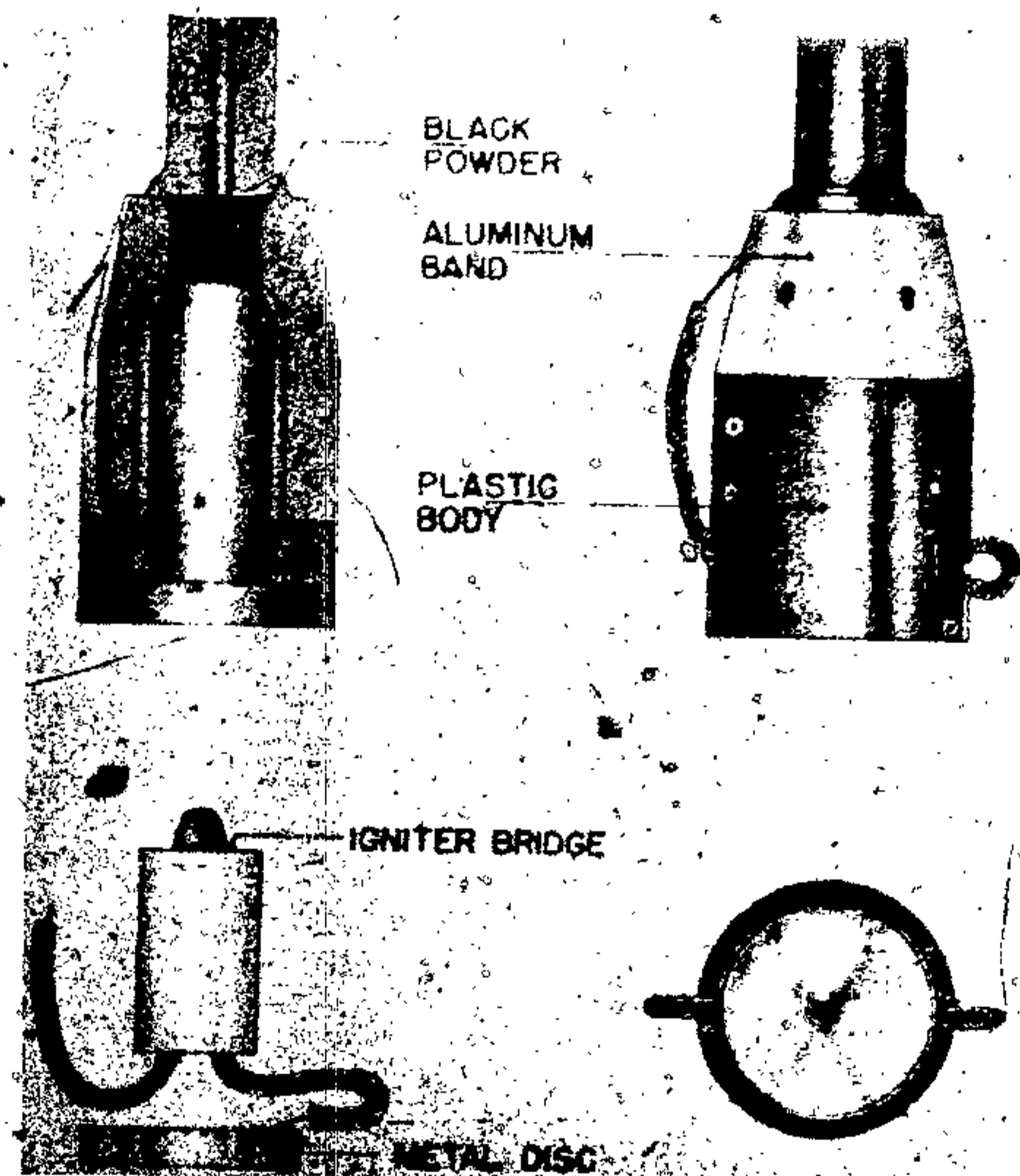

Figure 613—Electric Fuze ERZ 39