

MODULAR ELECTRONICS LEARNING (MODEL) PROJECT



ELECTRICAL SWITCHES

© 2020-2024 BY TONY R. KUPHALDT – UNDER THE TERMS AND CONDITIONS OF THE
CREATIVE COMMONS ATTRIBUTION 4.0 INTERNATIONAL PUBLIC LICENSE

LAST UPDATE = 25 AUGUST 2024

This is a copyrighted work, but licensed under the Creative Commons Attribution 4.0 International Public License. A copy of this license is found in the last Appendix of this document. Alternatively, you may visit <http://creativecommons.org/licenses/by/4.0/> or send a letter to Creative Commons: 171 Second Street, Suite 300, San Francisco, California, 94105, USA. The terms and conditions of this license allow for free copying, distribution, and/or modification of all licensed works by the general public.

Contents

1	Introduction	3
1.1	Recommendations for students	3
1.2	Challenging concepts related to switches	5
1.3	Recommendations for instructors	6
2	Case Tutorial	7
2.1	Example: potential in open and shorted circuits	8
3	Tutorial	15
3.1	Basic switch operation	16
3.2	Normal status	18
3.3	Poles and throws	19
3.4	Making and breaking order	20
3.5	Switch operators	20
3.5.1	Toggle switches	21
3.5.2	Key switches	21
3.5.3	Pushbutton switches	21
3.5.4	Selector switches	21
3.5.5	Joystick switches	22
3.5.6	Limit switches	22
3.5.7	Proximity switches	22
3.5.8	Optical switches	23
3.5.9	Speed switches	23
3.5.10	Process switches	24
3.6	Switch ratings and limitations	26
4	Derivations and Technical References	29
4.1	Occam’s Razor as a general diagnostic principle	30
5	Questions	35
5.1	Conceptual reasoning	39
5.1.1	Reading outline and reflections	40
5.1.2	Foundational concepts	41
5.1.3	Positive versus negative switch location	43

<i>CONTENTS</i>	1
5.1.4 Poles and throws	44
5.1.5 Three-way lamp circuit	44
5.1.6 Motor-reversing switch	45
5.1.7 Sketch a lamp control circuit	46
5.1.8 Switch states	47
5.2 Quantitative reasoning	48
5.2.1 Miscellaneous physical constants	49
5.2.2 Introduction to spreadsheets	50
5.2.3 Oven control switches	53
5.3 Diagnostic reasoning	54
5.3.1 Paralleled contacts	55
5.3.2 Testing a switch	55
A Problem-Solving Strategies	57
B Instructional philosophy	59
C Tools used	65
D Creative Commons License	69
E References	77
F Version history	79
Index	80

Chapter 1

Introduction

1.1 Recommendations for students

Switches are among the most elementary of electrical components in terms of their basic function: to make and break electrical connections at will. However, there are many details complicating the matter, which will be explored in this module.

Important concepts related to the topic of switches include **conductors** versus **insulators**, **making** versus **breaking** connections, **opens** versus **shorts**, **normally-open** versus **normally-closed** switch contacts, switch **poles**, switch **throws**, switch **operators**, **voltage ratings**, **current ratings**, and **wetting current**.

Here are some good questions to ask of yourself while studying this subject:

- How might an experiment be designed and conducted to test whether a switch was electrically open or closed? What hypothesis (i.e. prediction) might you pose for that experiment, and what result(s) would either support or disprove that hypothesis?
- How might an experiment be designed and conducted to test whether a multi-position switch was make-before-break or break-before-make? What hypothesis (i.e. prediction) might you pose for that experiment, and what result(s) would either support or disprove that hypothesis?
- What are some practical applications of electric switches?
- How could we fabricate an electrical switch using primitive components?
- What does the “normal” state of a switch represent?
- Where might we use a SPDT or DPDT switch instead of a SPST switch?
- How does a *make-before-break* switch differ from a *break-before-make* switch?
- What are some of the different types of actuating operators for switches?
- What factors influence the maximum voltage rating of a switch?

- What factors influence the maximum current rating of a switch?
- What special metal types are used to construct the contacts of switches?
- Why is a switch's "make" current rating often different than its "break" rating?
- Why is it easier to break an AC circuit than a DC circuit?

1.2 Challenging concepts related to switches

The following list cites concepts related to this module's topic that are easily misunderstood, along with suggestions for properly understanding them:

- **Shorts versus Opens** – these are two distinctly different types of electrical conditions, and are not generic labels for *any* problem that might occur in a circuit¹. Each of these conditions is characterized by a prohibition of some electrical measure: shorts prevent voltage from existing between the two points that are shorted together, and opens prevent current from passing through the conductors that used to be joined. A very common misconception is that shorts ensure current and opens ensure voltage, but it is more accurate to say that shorts prohibit voltage and opens prohibit current.
- **Normal status of a switch** – to say that a switch is “normally open” or “normally closed” refers to its electrical state *when at rest*, and not necessarily the state you will typically find the switch in. The root of the confusion here is the word *normal*, which most people take to mean “typical” or “ordinary”. In the case of switches, though, it refers to the zero-stimulation status of the switch as it has been manufactured.
- **Wetting current** – this switch rating is confusing because it specifies a certain *minimum* amount of current that a switch should periodically interrupt in order to maintain good contact health. Maximum switch current ratings are easier to comprehend because the damage mechanism is rather obvious: too much current overheats and pits the contact surfaces. Appreciating a wetting current (minimum) rating requires one to recognize the effects of oxidation and corrosion on contact surfaces, and how a small amount of interrupted current helps to clean the contact surfaces of these impurities.

The *Case Tutorial* chapter section called “Example: potential in open and shorted circuits” is very helpful in allowing students to understand the concept of electrical potential and therefore of voltage. Examining the different electrical (and hydraulic) circuits shown in this section, using colors to represent areas of different potential energy, shows how voltage is a quantity relative between two points, and how a gain or loss in potential energy relates to sources and loads, respectively.

¹It is common for new students of electricity to assume, for example, that “short” means any type of fault whatsoever!

1.3 Recommendations for instructors

This section lists realistic student learning outcomes supported by the content of the module as well as suggested means of assessing (measuring) student learning. The outcomes state what learners should be able to do, and the assessments are specific challenges to prove students have learned.

- **Outcome** – Demonstrate effective technical reading and writing
Assessment – Students present their outlines of this module’s instructional chapters (e.g. Case Tutorial, Tutorial, Historical References, etc.) ideally as an entry to a larger Journal document chronicling their learning. These outlines should exhibit good-faith effort at summarizing major concepts explained in the text.
- **Outcome** – Apply the concept of “normal” to switch contact statuses
Assessment – identify the actual state of a process switch given its stimulus quantity, and also given that switch’s “normal” classification.
Assessment – identify the proper stimulation required to maintain a process switch in a given state, and also given that switch’s “normal” classification; e.g. pose problems in the form of the “Switch states” Conceptual Reasoning question.
- **Outcome** – Design a switched-load circuit
Assessment – Sketch a schematic diagram of a circuit employing one or more switches to direct electrical power to one or more loads; e.g. pose problems in the form of the “Motor-reversing switch” or “Sketch a lamp control circuit” Conceptual Reasoning questions.
- **Outcome** – Prove the concept of switch contact status by experiment
Assessment – determine the location of the “COM” terminal for an unlabeled SPDT switch using a multimeter.
- **Outcome** – Independent research
Assessment – Locate switch datasheets and properly interpret some of the information contained in those documents including maximum current (closing, opening), maximum voltage, actuation life, etc.

Chapter 2

Case Tutorial

The idea behind a *Case Tutorial* is to explore new concepts by way of example. In this chapter you will read less presentation of theory compared to other Tutorial chapters, but by close observation and comparison of the given examples be able to discern patterns and principles much the same way as a scientific experimenter. Hopefully you will find these cases illuminating, and a good supplement to text-based tutorials.

These examples also serve well as challenges following your reading of the other Tutorial(s) in this module – can you explain *why* the circuits behave as they do?

2.1 Example: potential in open and shorted circuits

Here we will explore the concept of *potential* in both electric and hydraulic circuits. The following illustrations will be used, each circuit containing one *source* tasked with boosting the potential energy of the flow and two *loads* where that flow releases energy to do useful work:

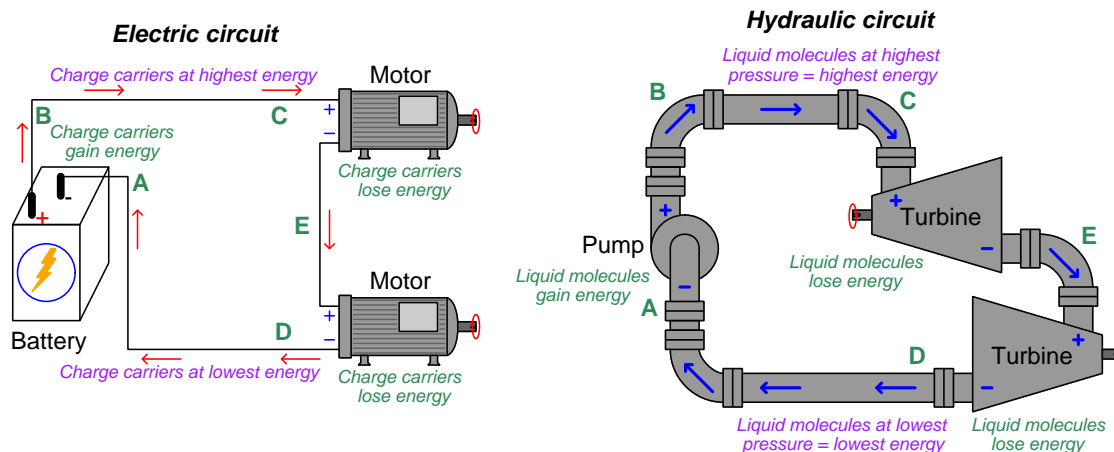

“Potential” may be thought of as *specific potential energy*, or the amount of potential energy possessed by a certain quantity of mobile fluid particles. In the case of electricity, electric potential is the number of Joules of potential energy carried by one Coulomb (6.2415×10^{18}) of charge carriers. In the case of hydraulic systems, fluid potential is better known as *pressure* and is the number of Joules of potential energy carried by one cubic meter of the fluid.

Differences of potential may be precisely quantified in any circuit, be it *voltage* for electric circuits or *pressure differential* for hydraulic circuits. The “+” and “-” symbol pairs shown in each illustration represent the high-potential and low-potential sides of each difference. Each component’s identity as either a source or a load is clear to see from a comparison of these “+” and “-” polarity marks in conjunction with the direction of flow. Note how each source takes in flow on the low-potential (-) side and outputs flow on the high-potential (+) side as it boosts the potential of the flowstream, while each load does just the opposite as energy is released by the flow.

Here we show the circuit illustrations with higher and lower potentials color-coded¹: red to signify high potential, orange to signify medium potential, and blue to signify low potential. Applying these colors to the original illustrations:

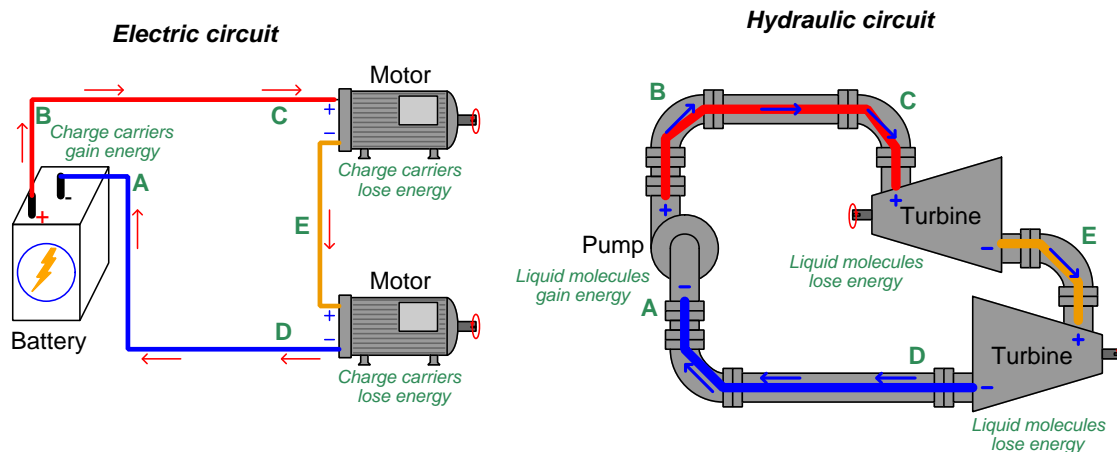

These color-coded potentials are all qualitative in nature. It is really impossible to precisely specify potential at any single location in a circuit, whether electrical or hydraulic, because potential energy depends on *two* conditions: a starting condition and an ending condition. We cannot say with any certainty how much energy is *potentially* released by any given fluid unless we know for certain what its end-state will be. This is why voltage in an electrical circuit is always relative between two points: an expression of how much potential was either gained or lost by charge carriers passing from one location to another. In a similar sense, hydraulic liquid pressure is also relative between two points: even a simple pressure gauge registering liquid pressure inside of a pipe is actually sensing the *difference* in pressure between the fluid within the pipe versus the atmospheric (air) pressure surrounding the pressure gauge. Thus, in both circuits the color-coding merely represents “greater” and “lesser” potential on a relative scale rather than absolute values of potential.

¹These same colors are often used to signify relative liquid pressures in hydraulic system illustrations.

Now we will place an “open” (i.e. a blockage to flow) on the upper portion of each circuit:

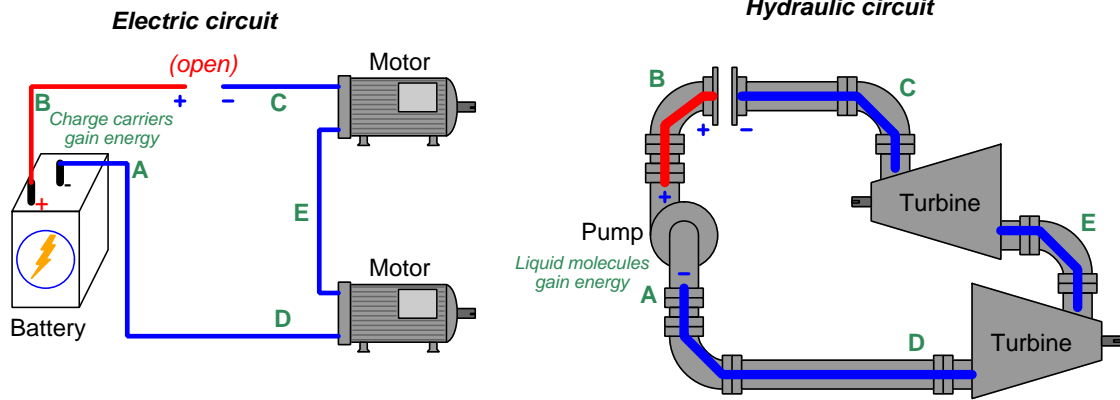

Note how the only portion with high potential lies between the “+” side of the source and the “opened” pathway. All other portions of each circuit immediately equalize in potential to be the same (low). No longer will a difference of potential develop across each load, since the flow ceases everywhere as a result of the “open”, but a potential difference does exist across the “open”.

Next we will place an “open” on the lower portion of each circuit:

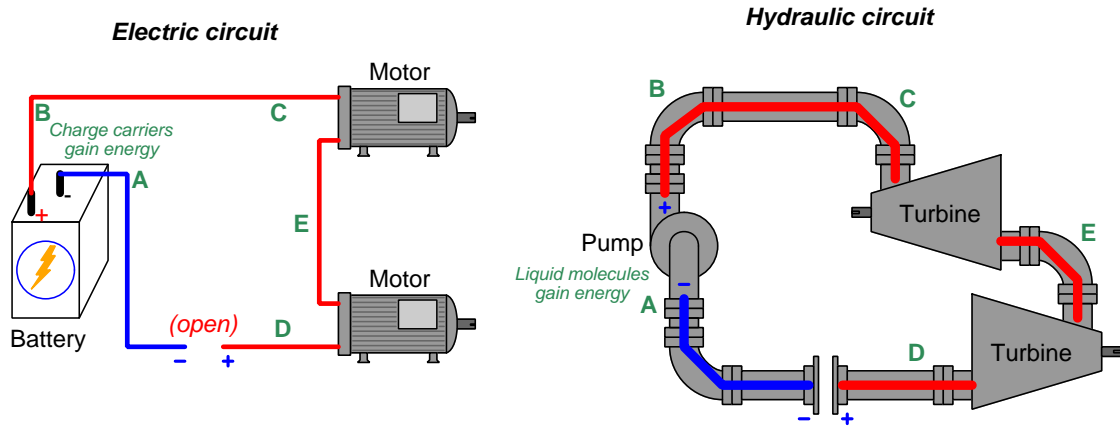

Note how the only portion with low potential lies between the “-” side of the source and the “opened” pathway. All other portions of each circuit immediately equalize in potential to be the same (high). Each load experiences zero difference of potential across it, since the flow ceases everywhere as a result of the “open”, but a potential difference does exist across the “open”.

Our last “open” will be placed between the two loads in each circuit:

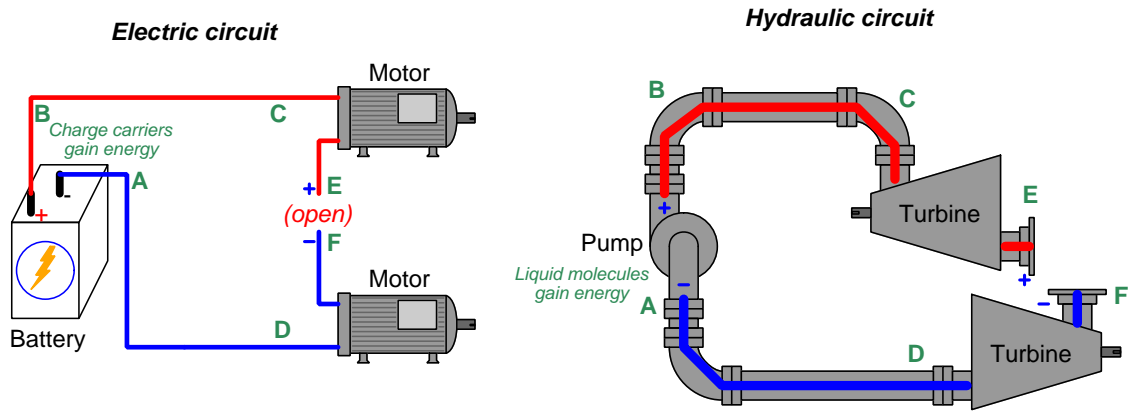

The “open” placed between the two loads creates a new distinct point which we label as **F**. Note how the lower load and its connection to the source maintains a low potential throughout, while the upper load and its connection to the source is at high potential throughout. Neither load has a difference of potential across it, but there is a difference of potential across the “open” in each circuit. The lack of flow, however, means no work is being done.

“Shorting” past loads in a circuit also affects the distribution of potential. Here we see the upper load shorted in each circuit:

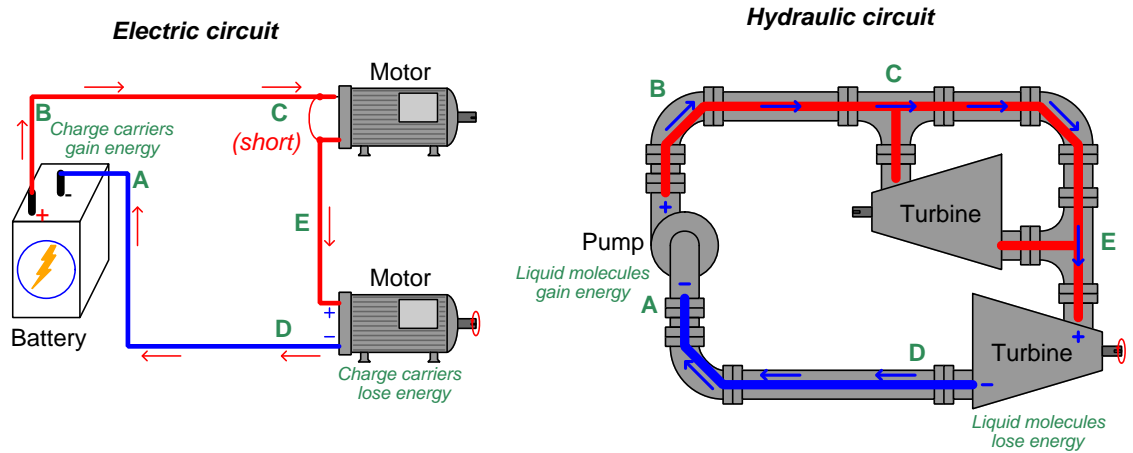

Making both ends of the upper load “common” to each other ensures equipotentiality, robbing the upper loads of any potential difference. This means the flow will not lose any energy going past the shorted load, and instead will deliver all its energy to the lower load which still provides resistance to the flow and is therefore able to extract energy from the flow.

Now we will short past the lower load in each circuit to see the effects:

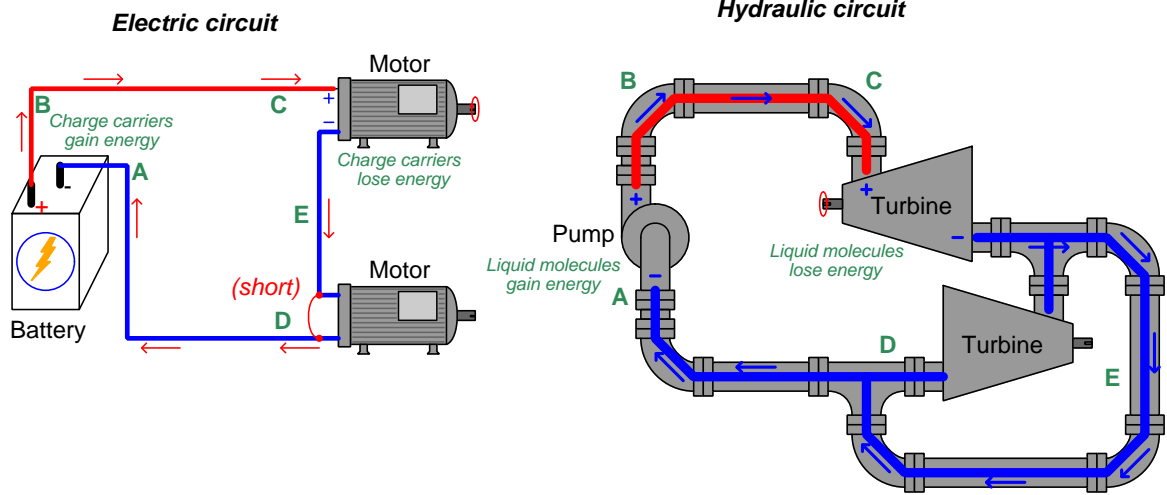

Making both ends of the lower load “common” to each other ensures equipotentiality, robbing the lower loads of any potential difference. This means the flow will not lose any energy going past the shorted load, and instead will deliver all its energy to the upper load which still provides resistance to the flow and is therefore able to extract energy from the flow.

Chapter 3

Tutorial

All *atoms* contains even smaller bits of matter called *particles*. Some of these particles experience a force when exposed to an electric field, with these “electrically-charged” particles found in two fundamental types: some of them *negative* and others *positive*. Electricity is the study of mobile electric charges, and the exchange of energy by those moving charges. Some substances easily permit electric charges to move within them, and we refer to these substances as *conductors* of electricity. Other substances lack mobile electric charges, and we call these substances *insulators* of electricity. The degree to which electric charges are drained of energy by moving through a substance is called *electrical resistance*.

The amount of energy either gained or lost by a mobile charge between two different locations is called *voltage*, measured in the unit of the *Volt* (one Volt being equal to one Joule of energy per Coulomb¹ of electric charges). The rate of charge carrier motion is called *current*, measured in the unit of the Ampere (one Ampere being equal to one Coulomb of electric charges passing by a point per second of time).

Metals are commonly used to construct electric circuits the outer-most electrons of metallic atoms are free to drift in the spaces between those atoms, making electrons the predominant form of *charge carrier*² within metals. Within some non-metallic conductors, such as liquids, both negatively charged electrons and positively charged atomic nuclei are free to drift through the bulk of the material which means there are two types of charge carriers (drifting in opposite directions when exposed to an electric field).

The particular type(s) of charge carrier(s) within any particular conductor is usually of little importance in the construction of an electric circuit. What matters for the existence of a complete circuit³ is that the conductive path is unbroken by any insulating gaps; i.e. a circuit demands a *continuous* path exist to support charge carrier motion.

¹A “Coulomb” is a rather large number of electric charges: 6.2415×10^{18} to be exact.

²A *charge carrier* is any bit of mobile matter possessing a net electrical charge. Electrically charged subatomic particles are charge carriers if they exist in a state where they may move when exposed to an electric field. Much larger pieces of matter may also serve as charge carriers if possessing a net electrical charge and free to move, such as a whole atom or molecule that is either missing electrons or in possession of extra electrons and in a liquid or gaseous state. Even macroscopic objects may serve as charge carriers provided they meet the criteria of possessing a net electrical charge as well as mobility. For example, a latex balloon that is rubbed against a wool shirt to give it an electrical charge is technically a charge carrier if it is then set aloft to float in a direction directed by an electric field!

³A *circuit* is defined as a loop through which charge carriers may travel endlessly.

3.1 Basic switch operation

The act of joining two or more conductors together so as to form a continuous path for charge carrier motion between them is called *making an electrical connection*. This consists of bringing the conductive materials together in direct contact with each other, so that no air gap exists between. Air, like most gases at room temperature and atmospheric pressure, is an electrical insulator. The electrically charged particles within each molecule of air are opposite in charge and equal in number so that each air molecule has zero net electrical charge. Unlike metals, where the constituent atoms and molecules are packed closely together and electrons may freely drift between, the molecules comprising gases are spaced far apart from each other and their electrons are rather tightly bound to the nuclei. Therefore, any air gap between metallic conductors will serve as an impassable⁴ chasm preventing charge carrier motion.

For example, an electrical connection may be made between two metal wires by simply touching the bare metal ends of each wire together. Once direct metal-to-metal contact is made between the two wires, electrons from one wire may cross over into the metal of the other wire. Separating those two metal wires creates an insulating air gap between them once more, thus *breaking* the connection. This is precisely how an electrical *switch* functions: a pair of metal “contact points” are brought into direct contact with each other to “close” or “make” or “short” the switch, and then separated from each other to “open” or “break” the switch:

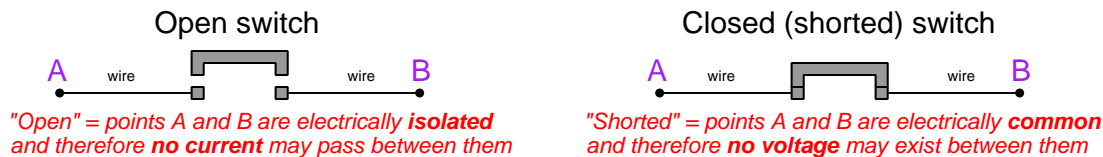

An elementary form of electrical switch is the *knife switch*, an example of which is shown in the photograph below:



The “blade” of this switch pivots on the left-hand side, and may be engaged or disengaged from the right-hand contact by moving it. A plastic insulating handle on the blade’s tip allow a person to move the blade with their hand without making direct contact with the metal itself.

⁴It should be noted that air may become *ionized* and therefore electrically conductive, but only by vastly elevating its temperature and/or exposing it to intense electric fields.

Electrical connections may also be made and broken between conductors of different substances by direct physical contact and separation, respectively, between those substances. For example, an electrical connection may be made between two metal wires by immersing their bare ends into a body of liquid mercury. Removing the wires from the mercury breaks the electrical connection between them. In fact, this is precisely how a *mercury tilt switch* works, by letting a drop of mercury make and break a connection between two metal electrodes inside a sealed glass tube depending on which way the tube is tilted:

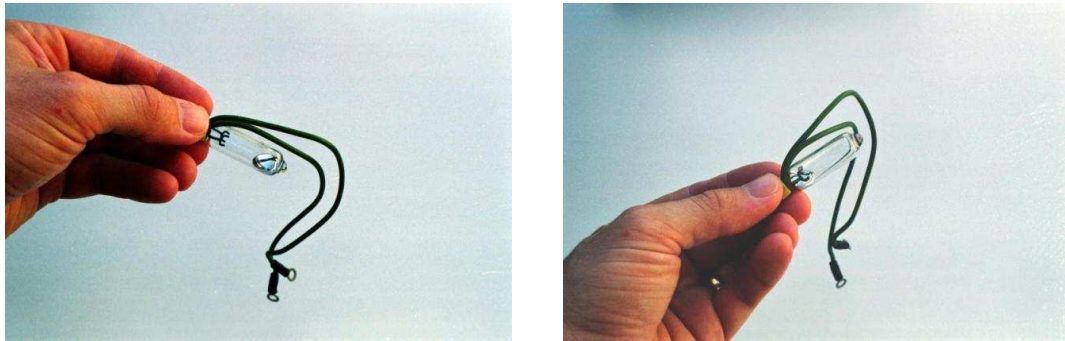

Likewise, substances other than air may separate two conductors from having direct contact with each other. Some electrical switches, for example, designed for high-power applications use contact points immersed in non-conductive oil which is a more effective⁵ electrical insulator than air.

Some switches like the simple knife switch shown previously rely solely on external force to move, and hold their place by friction. Other switches have internal springs to provide a default position, and may only be held in a different position by the constant application of an outside force. Spring-return switches are often called *momentary-contact* switches because their forced status does not hold after the force is removed.

A common form of momentary-contact switch is the *pushbutton* style, actuating with applied finger pressure to the “button” operator and returning to its resting state when released:

Pushbutton switch

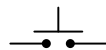

⁵These electrical oils have a greater *breakdown voltage* than air, which means a stronger electrical field is required to ionize the oil molecules and thus render it conductive than for air.

3.2 Normal status

Electrical switch contacts are typically classified as either *normally-open* or *normally-closed*, referring to the open or closed status of the contacts under “normal” conditions. The “normal” status for a momentary-contact switch is the status its electrical contacts are in *during a condition of no applied force*. Another way to think of the “normal” status is to think in terms of the switch being *at rest*. For a momentary-contact pushbutton switch, this would be the status of the switch contact when it is *not* being pressed. Electrical switches are always drawn in schematic diagrams in their “normal” statuses, regardless of their application.

The following schematic diagram shows a simple circuit consisting of a voltage source, a pushbutton switch, and a lamp:

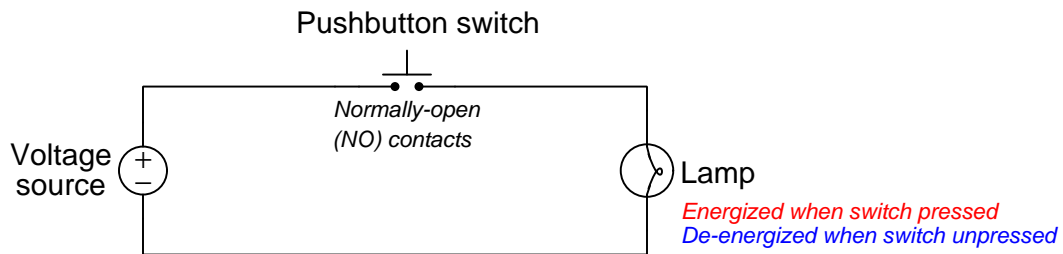

We can tell this switch is a normally-open (NO) switch because it is drawn in an open position. The lamp will energize only if someone presses the switch, holding its normally-open contacts in the “closed” position. Normally-open switch contacts are sometimes referred to in the electrical industry as *form-A* contacts. Normally-open pushbuttons are often referred to by the abbreviation *PBNO*.

If we had used a normally-closed pushbutton switch instead, the behavior would be exactly opposite. The lamp would energize if the switch was left alone, but it would turn off if anyone pressed it. Normally-closed switch contacts are sometimes referred to in the electrical industry as *form-B* contacts. Normally-closed pushbuttons are often referred to by the abbreviation *PBNC*:

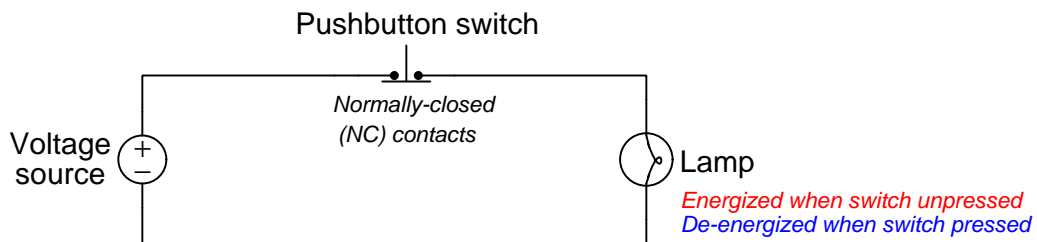

3.3 Poles and throws

The movable portion of a switch is called the *pole*, while a position of making contact is called a *throw*. Switches may be made with various combinations of poles and throws, the following photographs contrasting a *single-pole, single-throw* (SPST) knife switch on the left against a *single-pole, double-throw* (SPDT) knife switch on the right:

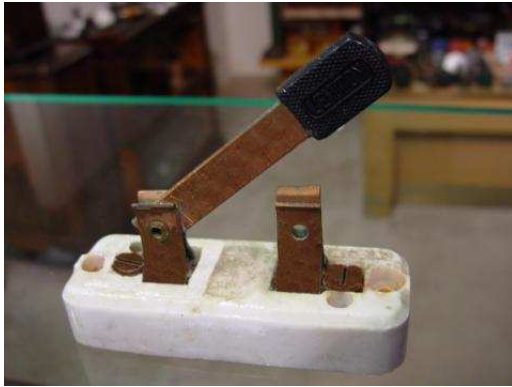

Their respective schematic symbols are shown below:

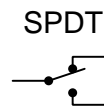
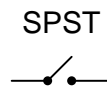

Other variations on this theme include *double-pole, single-throw* (DPST) switches where two moving poles actuated by the same mechanism make contact with respective stationary contacts, like two SPST switches mechanically linked. Similarly, we also have *double-pole, double-throw* (DPDT) switches which function as a pair of ganged SPDT switches. The schematic symbols for each of these switch configurations appear below:

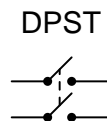

Of course, if it is possible to mechanically link a pair of switches, why not do so with three or more switch assemblies? This gives us possibilities such as *triple-pole* and *quadruple-pole* switches (e.g. 3PDT, 4PST).

3.4 Making and breaking order

With multiple-position selector switches, another design factor must be considered: that is, the sequence of breaking old connections and making new connections as the switch is moved from position to position, the moving contact touching several stationary contacts in sequence.

The following schematic symbol shows a single-pole, five-throw (SP5T) selector switch designed to make contact with no more than one of the five “throws” at a time:

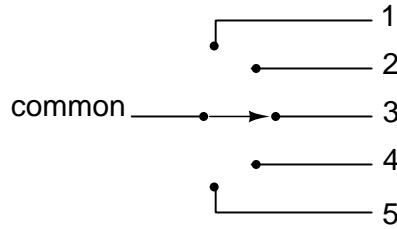

As this switch’s pole is moved from one throw to the next, it *breaks* contact with one pole before *making* contact with the next, giving it the name *break-before-make*. To give an example, if the switch were set at position number 3 and slowly turned clockwise, the contact lever would move off of the number 3 position, opening that circuit, move to a position between number 3 and number 4 (both circuit paths open), and then touch position number 4, closing that circuit.

There exist applications, however, where it is unacceptable to completely open the circuit attached to the “common” wire at any point in time. For such an application, a *make-before-break* switch design is best, in which the movable contact lever actually bridges between two positions of contact (between number 3 and number 4, in the above scenario) as it travels between positions. The compromise here is that the circuit must be able to tolerate switch closures between adjacent position contacts (1 and 2, 2 and 3, 3 and 4, 4 and 5) as the selector knob is turned from position to position. Such a switch is shown below:

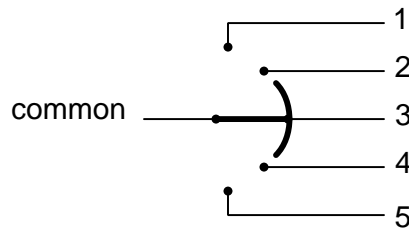

3.5 Switch operators

Various types of “operators” exist for mechanically actuating an electrical switch’s pole(s), as described in the following subsections.

3.5.1 Toggle switches

Toggle switches are actuated by a lever angled in one of two or more positions. The common light switch used in household wiring is an example of a toggle switch. Most toggle switches will come to rest in any of their lever positions, while others have an internal spring mechanism returning the lever to a certain *normal* position, allowing for what is called "momentary" operation.

Toggle switch

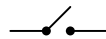

3.5.2 Key switches

For applications requiring some degree of security, a special form of toggle switch called a *key switch* may be employed, actuatable only by inserting and turning the correct key, like the lock on a door.

3.5.3 Pushbutton switches

Pushbutton switches are two-position devices actuated with a button that is pressed and released. Most pushbutton switches have an internal spring mechanism returning the button to its "out" or "unpressed" position, for momentary operation. Some pushbutton switches will latch alternately on or off with every push of the button. Other pushbutton switches will stay in their "in" or "pressed" position until the button is pulled back out. This last type of pushbutton switches usually have a mushroom-shaped button for easy push-pull action.

Pushbutton switch

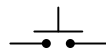

3.5.4 Selector switches

Selector switches are actuated with a rotary knob or lever of some sort to select one of two or more positions. Like the toggle switch, selector switches can either rest in any of their positions or contain spring-return mechanisms for momentary operation.

Selector switch



3.5.5 Joystick switches

A joystick switch is actuated by a lever free to move in more than one axis of motion. One or more of several switch contact mechanisms are actuated depending on which way the lever is pushed, and sometimes by how *far* it is pushed. The circle-and-dot notation on the switch symbol represents the direction of joystick lever motion required to actuate the contact. Joystick hand switches are commonly used for crane and robot control.

Joystick switch

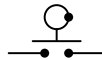

3.5.6 Limit switches

Some switches are specifically designed to be operated by the motion of a machine rather than by the hand of a human operator. These motion-operated switches are commonly called *limit switches*, because they are often used to limit the motion of a machine by turning off the actuating power to a component if it moves too far. As with hand switches, limit switches come in several varieties:

Lever actuator limit switch



These limit switches closely resemble rugged toggle or selector hand switches fitted with a lever pushed by the machine part. Often, the levers are tipped with a small roller bearing, preventing the lever from being worn off by repeated contact with the machine part.

3.5.7 Proximity switches

Proximity switches sense the approach of a metallic machine part either by a magnetic or high-frequency electromagnetic field. Simple proximity switches use a permanent magnet to actuate a sealed switch mechanism whenever the machine part gets close (typically 1 inch or less). More complex proximity switches work like a metal detector, energizing a coil of wire with a high-frequency current, and electronically monitoring the magnitude of that current. If a metallic part (not necessarily magnetic) gets close enough to the coil, the current will increase, and trip the monitoring circuit. The symbol shown here for the proximity switch is of the electronic variety, as indicated by the diamond-shaped box surrounding the switch. A non-electronic proximity switch would use the same symbol as the lever-actuated limit switch.

Proximity switch



3.5.8 Optical switches

Another form of proximity switch is the optical switch, comprised of a light source and photocell. Machine position is detected by either the interruption or reflection of a light beam. Optical switches are also useful in safety applications, where beams of light may be used to detect personnel entry into a dangerous area.

3.5.9 Speed switches

These switches sense the rotary speed of a shaft either by a centrifugal weight mechanism mounted on the shaft, or by some kind of non-contact detection of shaft motion such as optical or magnetic:

Speed switch

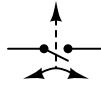

3.5.10 Process switches

In many industrial processes, it is necessary to monitor various physical quantities with switches. Such switches may be used to sound alarms, indicating that a process variable has exceeded normal parameters, or they may be used to shut down processes or equipment if those variables have reached dangerous or destructive levels. There are many different types of *process switches*.

Gas or liquid pressure may be used to actuate a switch mechanism if that pressure is applied to a piston, diaphragm, or bellows, which converts pressure to mechanical force. The result is called a **pressure switch**:

Pressure switch



A switch operated by changes in sensed temperature is called a **temperature switch**. An inexpensive temperature-sensing mechanism is the *bimetallic strip*: a thin strip of two metals, joined back-to-back, each metal having a different rate of thermal expansion. When the strip heats or cools, differing rates of thermal expansion between the two metals causes it to bend. The bending of the strip can then be used to actuate a switch contact mechanism. Other temperature switches use a brass bulb filled with either a liquid or gas, with a tiny tube connecting the bulb to a pressure-sensing switch. As the bulb is heated, the gas or liquid expands, generating a pressure increase which then actuates the switch mechanism:

Temperature switch



A floating object may be used to actuate a switch mechanism when the liquid level inside a vessel rises past a certain point, forming a **level switch**. If the liquid is electrically conductive, the liquid itself may be used as a conductor to bridge between two metal probes inserted into the vessel at the required depth. The conductivity technique is usually implemented with a special design of relay triggered by a small amount of current through the conductive liquid. In most cases it is impractical and dangerous to switch the full load current of the circuit through a liquid, and so we typically find some buoyant object used to mechanically actuate a conventional switch mechanism:

Liquid level switch

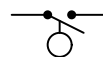

Level switches can also be designed to detect the level of solid materials such as wood chips, grain, coal, or animal feed in a storage silo, bin, or hopper. A common design for this application is a small paddle wheel, inserted into the bin at the desired height, which is slowly turned by a small electric motor. When the solid material fills the bin to that height, the material prevents the paddle wheel from turning. The torque response of the small motor then trips the switch mechanism. Another design uses a “tuning fork” shaped metal prong, inserted into the bin from the outside at the desired height. The fork is vibrated at its resonant frequency by an electronic circuit and magnet/electromagnet coil assembly. When the bin fills to that height, the solid material dampens the vibration of the fork, the change in vibration amplitude and/or frequency detected by the electronic circuit.

Inserted into a pipe, a **flow switch** will detect any gas or liquid flow rate in excess of a certain threshold, usually with a small paddle or vane which is pushed by the flow. Other flow switches are constructed as differential pressure switches, measuring the pressure drop across a restriction built into the pipe:

Liquid flow switch



3.6 Switch ratings and limitations

Switches, like many other electrical and electronic components, have limited operating ranges for both voltage and current. Grossly speaking, the current limit of a switch is a function of its contacting surface area while its voltage limit is a function of the distance of separation between its open contact points. In order to safely tolerate large amounts of electric current, a switch must present a low-resistance pathway when in its closed (shorted) state. The more overlapping contact area there is between the two contact points, the less electrical resistance there will be between them. In order for a switch to tolerate large amounts of voltage, there must be sufficient distance between the “open” contact points so that the air separating them does not become ionized and “arc” across⁶.

The next photograph shows a set of contacts on a pressure switch, the left-hand set damaged by arcing and the right-hand set in perfect working order:

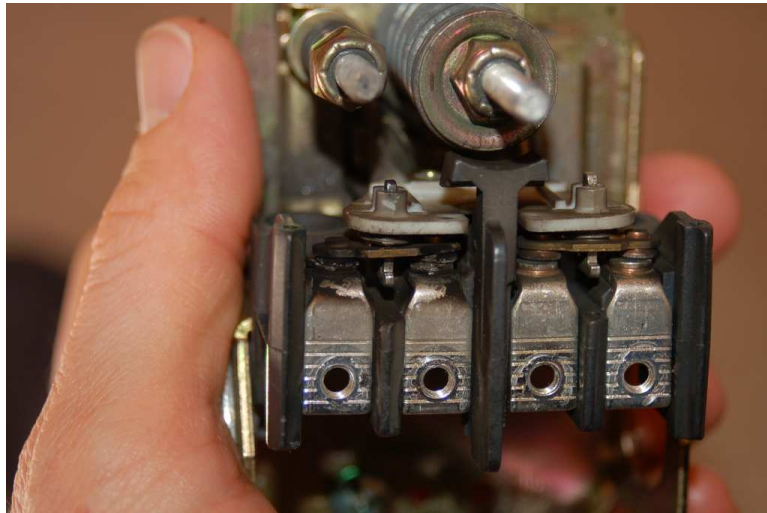

Evidence of physical distress from arcing (discoloration and pitting of the metal surfaces) is clearly evident here.

Another risk of under-sized switch contacts is the hazard of igniting surrounding materials or vapors in the air from switch arcing. A properly-sized switch with sufficient voltage and current ratings will not dissipate as much heat as an under-sized switch, all other factors being equal. Switch contacts having larger surface area experience a lower current density (Amperes per square millimeter of contact area) and present less resistance to the electric current, and switches with greater contact separation are more effective at extinguishing electric arcs.

⁶Clean and dry air is an excellent electrical insulator, but under conditions of intense electric fields it becomes possible for air to conduct electricity. High-strength electric fields have the ability to separate electrons from their parent atoms, and once an atom separates into positively- and negatively-charged pieces they will move in opposite directions with the applied electric field to constitute an electric current. If enough current passes through the ionized air it will become hot, which makes the air molecules even easier to ionize. The resulting “electric flame” is called an *arc*.

It is common to find general-purpose switch contact voltage and current ratings to be greater on any given switch or relay if the electric power being switched is AC instead of DC. The reason for this is the self-extinguishing tendency of an alternating-current arc across an air gap. Because 60 Hz power line current actually stops and reverses direction 120 times per second, there are many opportunities for the ionized air of an arc to lose enough temperature to stop conducting current, to the point where the arc will not re-start on the next voltage peak. DC, on the other hand, is a continuous, uninterrupted flow of electrons which tends to maintain an arc across an air gap much better. Therefore, switch contacts of any kind incur more wear when switching a given value of direct current than for the same value of alternating current. The problem of switching DC is exaggerated when the load possesses a significant amount of inductance⁷.

It is also common to encounter different current ratings for a switch when *making*, *breaking*, and *sustaining* closure. The lowest of these current ratings will be when the switch is breaking (opening) an established current, because as the switch transitions from a closed state to an open state its contacts must go from touching to having a small air gap which may ionize even with modest voltage between the opening contacts. An air gap that begins small and grows in length is more likely to sustain a hot electric arc than one that begins large and shrinks over time, because the small-to-large gap progression is ideal for *starting* an arc where there was none before. The “making” current rating of a switch will be greater than its “breaking” limit, and the highest limit of all will be when the switch is fully in the closed position and there is no opportunity for an air gap to form.

With all this discussion concerning the reduction of switch contact arcing, one might be led to think that less current is always better for a mechanical switch. This, however, is not necessarily so. It has been found that a small amount of periodic arcing can actually be good for the switch contacts because it disperses accumulating dirt and corrosion. If a mechanical switch contact is operated with *too little* current, the contacts will tend to accumulate excessive resistance and may fail prematurely! This minimum amount of electric current necessary to keep a mechanical switch contact in good health is called the *wetting current*.

Normally, a switch’s wetting current rating is far below its maximum current rating, and well below its normal operating current load in a properly designed system. However, there are applications where a mechanical switch contact may be required to routinely handle currents below normal wetting current limits (for instance, if a mechanical selector switch needs to open or close a digital logic or analog electronic circuit where the current value is extremely small). In these applications, it is highly recommended that gold-plated switch contacts be specified. Gold is a “noble” metal and as such gold-plated contacts have extremely low wetting current requirements. Conventional silver-alloy or copper-alloy contacts will not provide reliable operation if used in such low-current service!

⁷ *Inductance* is the storage of energy within a magnetic field caused by electric current passing through a conductor. An inductor’s stored energy cannot simply disappear, and so it will be released when the circuit breaks open (e.g. the switch opens) causing a high voltage to appear across the switch contacts and an arc forming through the air gap.

Chapter 4

Derivations and Technical References

This chapter is where you will find mathematical derivations too detailed to include in the tutorial, and/or tables and other technical reference material.

4.1 Occam's Razor as a general diagnostic principle

Sir William of Ockham was an English theologian who lived from 1287 to 1347, and whose name is attached (albeit often with different spellings) to a logical principle supremely useful in technical diagnostic work. Simply put, Occam's Razor states that the likeliest explanation for anything is that which employs the fewest assumptions. The word "razor" simply refers to the mental task of eliminating (i.e. shaving away) unnecessary assumptions until we are left with the most probable explanation for something.

Let's consider a common example everyone can surely relate to: misplacing something. Suppose you are leaving your home to go to work, school, or some other destination, and on your way out the door you realize you are missing some important item such as your keys, your wallet or purse, your hat, etc. Realizing this, you return inside your home to find this item, but to your dismay it is not where you usually leave it. Why is this item missing, and where may you find it? Multiple explanations are possible, just a few of them listed here:

1. You were distracted while previously handling this item, and set it somewhere you usually don't
2. Someone who lives with you borrowed this item
3. A thief broke into your house and stole this item
4. An interstellar species traveled light-years across space and decided to teleport your item to their spacecraft for research before returning to their home planet

How many independent assumptions are necessary for each of these explanations? For the first (distraction), there is only one assumption and that is your prior distraction. For the second there is the assumption that a house-mate would fail to notify you of their borrowing the item. For the third one must assume that the thief left no clue as to their entry and apparently were only motivated to steal this one item and none else you would have noticed. For the fourth rests on a host of assumptions: the existence of intelligent creatures far from Earth, their ability to travel here and scoop up your item unnoticed, their motive for doing so, etc., etc.

If you found yourself in the position of lacking this item on your way out the door of your home, you may very likely consider the first two explanations as possible, but not give any serious consideration to the third or fourth because they are so far-fetched. What makes them far-fetched is not their assured impossibility, but rather their *improbability* based on the number of assumptions necessary. You *might* be inclined to entertain explanation #3, but only after a thorough search of your house and inquiries of your house-mates failed to reveal the item's whereabouts. No one would seriously consider explanation #4. Of the first two explanations, the first is probably more likely than the second unless you happen to live with careless and inconsiderate people who would fail to let you know they needed to borrow this item from you.

Now let's consider how we might apply the principle of fewest (or least-unlikely) assumptions to electrical troubleshooting. Consider the following electric oven schematic, where three different heating elements are controlled by corresponding toggle switches:

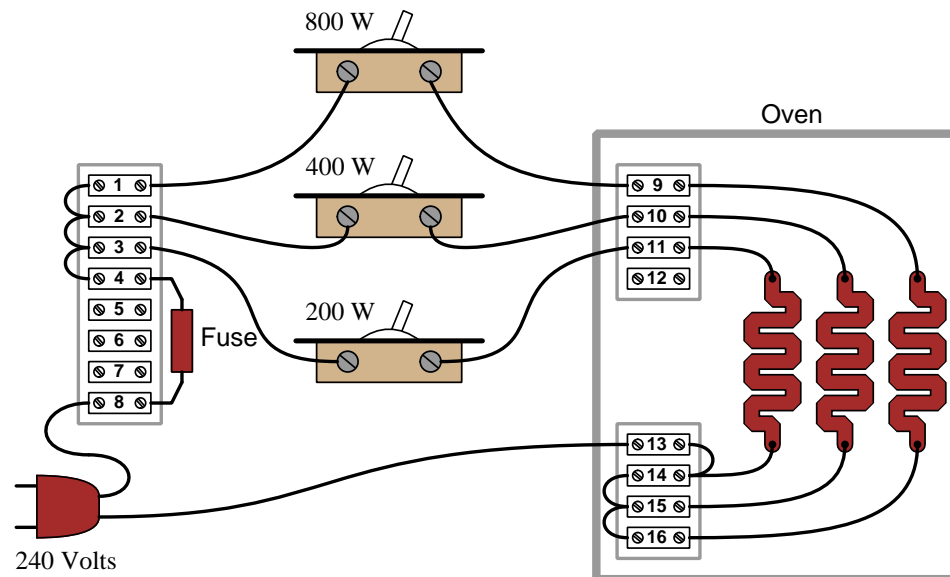

Suppose someone calls you over the telephone to request your diagnostic assistance with this oven. They tell you the 200-Watt switch didn't appear to work: when they turn on that switch by itself, the oven remains at room temperature. Based on this information, the following faults should immediately come to mind as possibilities:

- Failed-open 200-Watt toggle switch
- Failed-open 200-Watt heating element
- Dead 240 VAC power source
- Blown fuse
- Open terminal 3-4 wire
- Open terminal 3-switch wire
- Open terminal 13-plug wire
- Open terminal 13-14 wire
- Open terminal 14-element wire
- Open terminal 11-element wire
- Open terminal 11-switch wire

Now suppose while you're on your way to the oven to begin troubleshooting, you receive a second telephone call from the same person, this time informing you that they subsequently tried flipping every one of the toggle switches to find *none* of them work. Even with all three switches on, the oven remains at room temperature! Upon receiving this news, proper application of Occam's Razor would tell you that any of the previously-listed faults capable of incapacitating the whole oven are more likely than any fault that could only explain the 200-Watt element failing to heat up, since in order for such a specific fault to be true it must also be coincidentally accompanied by at least one more fault explaining why the other heating elements aren't working either. *Simply put, a single fault accounting for everything is more likely than multiple, coincidental faults where each one only accounts for part of the problem.*

By employing Occam's Razor in this way, we may "shave down" our list of likely faults to those single faults individually capable of preventing any of the heating elements from energizing:

- Dead 240 VAC power source
- Blown fuse
- Open terminal 3-4 wire
- Open terminal 3-switch wire
- Open terminal 13-plug wire
- Open terminal 13-14 wire

For example, it's far more likely that a single fault such as an open wire between terminals 3 and 4 is the cause of the trouble here, as opposed to multiple faults such as a failed-open 200-Watt heating element *and* a failed-open 400-Watt heating element *and* a failed-open 800-Watt heating element to account for none of the heating elements working. Mind you, it is not *impossible* that all three heating elements have failed open, just *less likely* than a single fault such as a loosened wire between terminals 3 and 4. Occam's Razor is all about *probability*, not certainty.

Note how much shorter this list is than the first one which we created when we only knew the 200-Watt element wasn't working! Shorter lists of possible faults are quicker to work through, and so by judiciously focusing on these most-probable faults we should be able to identify the problem in less time and with less effort. Limiting our search to the fewest faults capable of accounting for the most symptoms is key to efficient and timely diagnosis.

This is why, when troubleshooting a malfunctioning system, it is so important to collect data on the problem. With each test we perform, with each measurement we take, we learn new information helpful for "shaving" our list of possible causes to the fewest in number. This means it is wise for us to re-assess our list of possible causes with each new symptom and data point we collect.

A companion strategy when diagnosing faults in complex systems is to intentionally simplify the system (if possible), especially if the system in question is new (i.e. unproven) and therefore more likely to harbor multiple errors than a system that used to work just fine and suddenly stopped functioning. When I counsel students who find their breadboard-constructed circuits don't work when initially powered, I recommend the same: *build the simplest version of the circuit you can think of and get that simple version working before adding complexity to it.* Otherwise, if you build

the entire circuit from scratch in its full glory, it becomes more likely that you will have multiple, unrelated faults which will be more challenging to identify.

It's worth noting that the premise of Occam's Razor – that fewer faults are more likely than a multiplicity of faults – is true only when the multiple faults are unrelated to each other (i.e. coincidental). If, however, one form of fault subsequently leads to another fault, then it may be quite likely for a failed system to harbor those multiple faults. Considering our oven example, suppose the original failure was a *shorted* failure of the 200-Watt heating element. With the 200-Watt element failed-short, the fuse would immediately blow as soon as the 200-Watt toggle switch was flipped to its “on” position, leading to a non-functioning oven with *two* faults: a shorted 200-Watt heating element and a blown-open fuse. The blown fuse is not coincidental to the shorted 200-Watt element, but rather a direct consequence of it.

This leads to the concept of something called a *root cause*. A “root” cause is the source of subsequent failures, that will keep resulting in future failures if uncorrected. In the example just given of the shorted heating element and the blown fuse, the shorted element is the root cause and the blown fuse is a secondary cause: the shorted element explains why the fuse blew, but the blown fuse would explain why none of the other heating elements will energize despite their sub-circuits being in good condition.

Root causes may go even further than this simple example. Suppose after repairing the shorted 200-Watt heating element, we find it fails once more shortly thereafter. Now, our search for root cause becomes a search for the answer to why that one heating element keeps failing prematurely. Perhaps the oven is being used improperly, in such a way that causes physical damage to that 200-Watt element and makes it fail shorted. Perhaps our supplier of 200-Watt heating elements has an error in their manufacturing and/or quality-control processes such that we keep receiving defective heating elements. As you may well imagine, the search for root cause may extend far beyond the immediate scope of a malfunctioning oven, and may even involve entities beyond your responsibility or control. However, root causes being what they are, if uncorrected they will continue to spawn other failures.

Chapter 5

Questions

This learning module, along with all others in the ModEL collection, is designed to be used in an inverted instructional environment where students independently read¹ the tutorials and attempt to answer questions on their own *prior* to the instructor's interaction with them. In place of lecture², the instructor engages with students in Socratic-style dialogue, probing and challenging their understanding of the subject matter through inquiry.

Answers are not provided for questions within this chapter, and this is by design. Solved problems may be found in the Tutorial and Derivation chapters, instead. The goal here is *independence*, and this requires students to be challenged in ways where others cannot think for them. Remember that you always have the tools of *experimentation* and *computer simulation* (e.g. SPICE) to explore concepts!

The following lists contain ideas for Socratic-style questions and challenges. Upon inspection, one will notice a strong theme of *metacognition* within these statements: they are designed to foster a regular habit of examining one's own thoughts as a means toward clearer thinking. As such these sample questions are useful both for instructor-led discussions as well as for self-study.

¹Technical reading is an essential academic skill for any technical practitioner to possess for the simple reason that the most comprehensive, accurate, and useful information to be found for developing technical competence is in textual form. Technical careers in general are characterized by the need for continuous learning to remain current with standards and technology, and therefore any technical practitioner who cannot read well is handicapped in their professional development. An excellent resource for educators on improving students' reading prowess through intentional effort and strategy is the book *Reading For Understanding – How Reading Apprenticeship Improves Disciplinary Learning in Secondary and College Classrooms* by Ruth Schoenbach, Cynthia Greenleaf, and Lynn Murphy.

²Lecture is popular as a teaching method because it is easy to implement: any reasonably articulate subject matter expert can talk to students, even with little preparation. However, it is also quite problematic. A good lecture always makes complicated concepts seem easier than they are, which is bad for students because it instills a false sense of confidence in their own understanding; reading and re-articulation requires more cognitive effort and serves to verify comprehension. A culture of teaching-by-lecture fosters a debilitating dependence upon direct personal instruction, whereas the challenges of modern life demand independent and critical thought made possible only by gathering information and perspectives from afar. Information presented in a lecture is ephemeral, easily lost to failures of memory and dictation; text is forever, and may be referenced at any time.

GENERAL CHALLENGES FOLLOWING TUTORIAL READING

- Summarize as much of the text as you can in one paragraph of your own words. A helpful strategy is to explain ideas as you would for an intelligent child: as simple as you can without compromising too much accuracy.
- Simplify a particular section of the text, for example a paragraph or even a single sentence, so as to capture the same fundamental idea in fewer words.
- Where did the text make the most sense to you? What was it about the text's presentation that made it clear?
- Identify where it might be easy for someone to misunderstand the text, and explain why you think it could be confusing.
- Identify any new concept(s) presented in the text, and explain in your own words.
- Identify any familiar concept(s) such as physical laws or principles applied or referenced in the text.
- Devise a proof of concept experiment demonstrating an important principle, physical law, or technical innovation represented in the text.
- Devise an experiment to disprove a plausible misconception.
- Did the text reveal any misconceptions you might have harbored? If so, describe the misconception(s) and the reason(s) why you now know them to be incorrect.
- Describe any useful problem-solving strategies applied in the text.
- Devise a question of your own to challenge a reader's comprehension of the text.

GENERAL FOLLOW-UP CHALLENGES FOR ASSIGNED PROBLEMS

- Identify where any fundamental laws or principles apply to the solution of this problem, especially before applying any mathematical techniques.
- Devise a thought experiment to explore the characteristics of the problem scenario, applying known laws and principles to mentally model its behavior.
- Describe in detail your own strategy for solving this problem. How did you identify and organized the given information? Did you sketch any diagrams to help frame the problem?
- Is there more than one way to solve this problem? Which method seems best to you?
- Show the work you did in solving this problem, even if the solution is incomplete or incorrect.
- What would you say was the most challenging part of this problem, and why was it so?
- Was any important information missing from the problem which you had to research or recall?
- Was there any extraneous information presented within this problem? If so, what was it and why did it not matter?
- Examine someone else's solution to identify where they applied fundamental laws or principles.
- Simplify the problem from its given form and show how to solve this simpler version of it. Examples include eliminating certain variables or conditions, altering values to simpler (usually whole) numbers, applying a limiting case (i.e. altering a variable to some extreme or ultimate value).
- For quantitative problems, identify the real-world meaning of all intermediate calculations: their units of measurement, where they fit into the scenario at hand. Annotate any diagrams or illustrations with these calculated values.
- For quantitative problems, try approaching it qualitatively instead, thinking in terms of “increase” and “decrease” rather than definite values.
- For qualitative problems, try approaching it quantitatively instead, proposing simple numerical values for the variables.
- Were there any assumptions you made while solving this problem? Would your solution change if one of those assumptions were altered?
- Identify where it would be easy for someone to go astray in attempting to solve this problem.
- Formulate your own problem based on what you learned solving this one.

GENERAL FOLLOW-UP CHALLENGES FOR EXPERIMENTS OR PROJECTS

- In what way(s) was this experiment or project easy to complete?
- Identify some of the challenges you faced in completing this experiment or project.

- Show how thorough documentation assisted in the completion of this experiment or project.
- Which fundamental laws or principles are key to this system's function?
- Identify any way(s) in which one might obtain false or otherwise misleading measurements from test equipment in this system.
- What will happen if (component X) fails (open/shorted/etc.)?
- What would have to occur to make this system unsafe?

5.1 Conceptual reasoning

These questions are designed to stimulate your analytic and synthetic thinking³. In a Socratic discussion with your instructor, the goal is for these questions to prompt an extended dialogue where assumptions are revealed, conclusions are tested, and understanding is sharpened. Your instructor may also pose additional questions based on those assigned, in order to further probe and refine your conceptual understanding.

Questions that follow are presented to challenge and probe your understanding of various concepts presented in the tutorial. These questions are intended to serve as a guide for the Socratic dialogue between yourself and the instructor. Your instructor’s task is to ensure you have a sound grasp of these concepts, and the questions contained in this document are merely a means to this end. Your instructor may, at his or her discretion, alter or substitute questions for the benefit of tailoring the discussion to each student’s needs. The only absolute requirement is that each student is challenged and assessed at a level equal to or greater than that represented by the documented questions.

It is far more important that you convey your *reasoning* than it is to simply convey a correct answer. For this reason, you should refrain from researching other information sources to answer questions. What matters here is that *you* are doing the thinking. If the answer is incorrect, your instructor will work with you to correct it through proper reasoning. A correct answer without an adequate explanation of how you derived that answer is unacceptable, as it does not aid the learning or assessment process.

You will note a conspicuous lack of answers given for these conceptual questions. Unlike standard textbooks where answers to every other question are given somewhere toward the back of the book, here in these learning modules students must rely on other means to check their work. The best way by far is to debate the answers with fellow students and also with the instructor during the Socratic dialogue sessions intended to be used with these learning modules. Reasoning through challenging questions with other people is an excellent tool for developing strong reasoning skills.

Another means of checking your conceptual answers, where applicable, is to use circuit simulation software to explore the effects of changes made to circuits. For example, if one of these conceptual questions challenges you to predict the effects of altering some component parameter in a circuit, you may check the validity of your work by simulating that same parameter change within software and seeing if the results agree.

³*Analytical* thinking involves the “disassembly” of an idea into its constituent parts, analogous to dissection. *Synthetic* thinking involves the “assembly” of a new idea comprised of multiple concepts, analogous to construction. Both activities are high-level cognitive skills, extremely important for effective problem-solving, necessitating frequent challenge and regular practice to fully develop.

5.1.1 Reading outline and reflections

“Reading maketh a full man; conference a ready man; and writing an exact man” – Francis Bacon

Francis Bacon’s advice is a blueprint for effective education: reading provides the learner with knowledge, writing focuses the learner’s thoughts, and critical dialogue equips the learner to confidently communicate and apply their learning. Independent acquisition and application of knowledge is a powerful skill, well worth the effort to cultivate. To this end, students should read these educational resources closely, journal their own reflections on the reading, and discuss in detail their findings with classmates and instructor(s). You should be able to do all of the following after reading any instructional text:

☑ Briefly **SUMMARIZE THE TEXT** in the form of a journal entry documenting your learning as you progress through the course of study. Share this summary in dialogue with your classmates and instructor. Journaling is an excellent self-test of thorough reading because you cannot clearly express what you have not read or did not comprehend.

☑ Demonstrate **ACTIVE READING STRATEGIES**, including verbalizing your impressions as you read, simplifying long passages to convey the same ideas using fewer words, annotating text and illustrations with your own interpretations, working through mathematical examples shown in the text, cross-referencing passages with relevant illustrations and/or other passages, identifying problem-solving strategies applied by the author, etc. Technical reading is a special case of problem-solving, and so these strategies work precisely because they help solve any problem: paying attention to your own thoughts (metacognition), eliminating unnecessary complexities, identifying what makes sense, paying close attention to details, drawing connections between separated facts, and noting the successful strategies of others.

☑ Identify **IMPORTANT THEMES**, especially **GENERAL LAWS** and **PRINCIPLES**, expounded in the text and express them in the simplest of terms as though you were teaching an intelligent child. This emphasizes connections between related topics and develops your ability to communicate complex ideas to anyone.

☑ Form **YOUR OWN QUESTIONS** based on the reading, and then pose them to your instructor and classmates for their consideration. Anticipate both correct and incorrect answers, the incorrect answer(s) assuming one or more plausible misconceptions. This helps you view the subject from different perspectives to grasp it more fully.

☑ Devise **EXPERIMENTS** to test claims presented in the reading, or to disprove misconceptions. Predict possible outcomes of these experiments, and evaluate their meanings: what result(s) would confirm, and what would constitute disproof? Running mental simulations and evaluating results is essential to scientific and diagnostic reasoning.

☑ Specifically identify any points you found **CONFUSING**. The reason for doing this is to help diagnose misconceptions and overcome barriers to learning.

5.1.2 Foundational concepts

Correct analysis and diagnosis of electric circuits begins with a proper understanding of some basic concepts. The following is a list of some important concepts referenced in this module's full tutorial. Define each of them in your own words, and be prepared to illustrate each of these concepts with a description of a practical example and/or a live demonstration.

Energy

Conservation of Energy

Voltage

Conductors versus Insulators

Resistance

Current

Polarity

Electric circuit

Open

Short

Switch

Make

Break

Normal state of a switch

Form-A contacts

Form-B contacts

Pole

Throw

Break-before-make

Arc

Wetting current

5.1.3 Positive versus negative switch location

What difference will it make if the switch is located in either of these two alternate locations in the circuit?

Switch on negative side of circuit

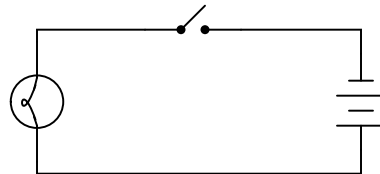

Switch on positive side of circuit

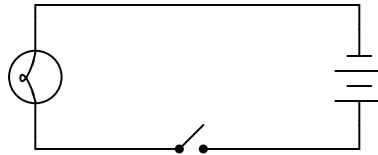

Challenges

- Suppose a student tells you they think of a switch's schematic symbol as being like a *drawbridge*. Do you think this is an accurate analogy?
- Does switch placement matter more, less, or the same for an AC circuit rather than a DC circuit?

5.1.4 Poles and throws

Identify the following types of switches, according to the number of “poles” and “throws” each switch has:

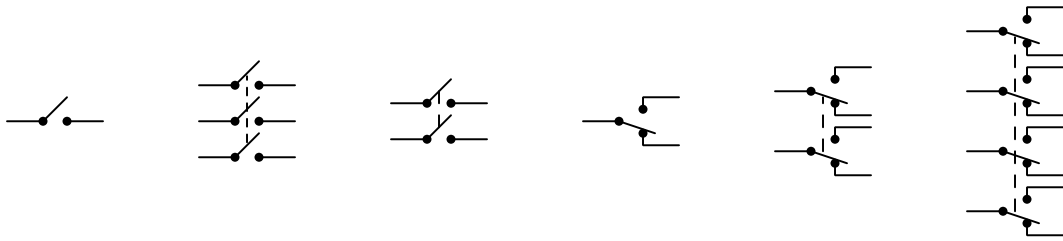

Challenges

- Identify a practical use for one of the more complex switches shown here.

5.1.5 Three-way lamp circuit

Which positions do the switches have to be in for the lamp to receive power?

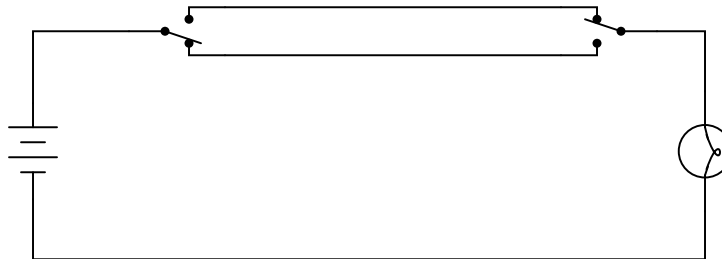

Challenges

- Where may you have encountered this form of lamp control in a residence?

5.1.6 Motor-reversing switch

Electric motors of the *permanent magnet* design are very simple to reverse: just switch the polarity of the DC power to the motor, and it will spin the other direction:

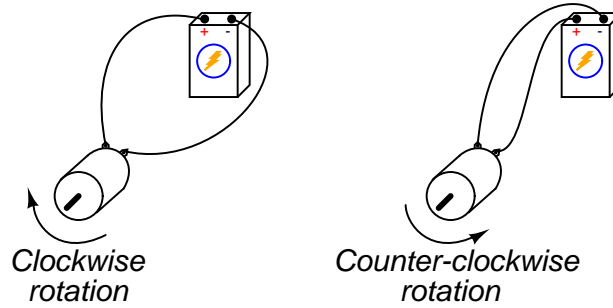

Complete this schematic diagram, showing how a DPDT switch may be placed in this circuit to reverse the motor's direction of rotation without the need to disconnect and re-connect wires:

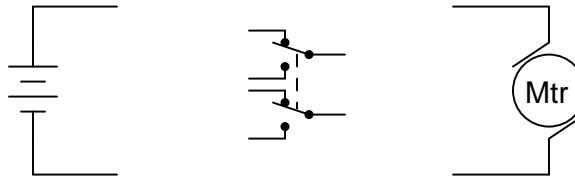

Challenges

- Trace the direction of current through the motor in both examples shown in the first illustration.

5.1.7 Sketch a lamp control circuit

Examine this schematic diagram:

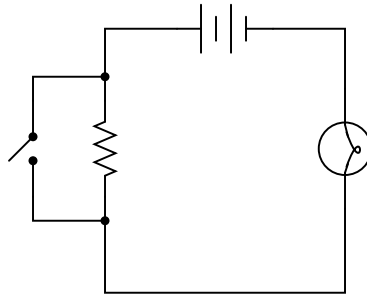

Now, without moving the following components, show how they may be connected together with wires to form the same circuit depicted in the schematic diagram above:

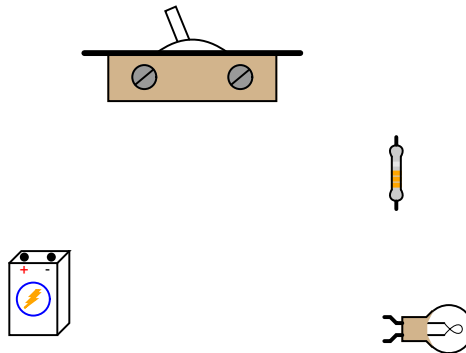

Lastly, use this circuit as an example to define the following concepts, explaining them in ways that would make sense to someone hearing them for the first time:

- Current
- Voltage
- Resistance
- Open versus closed
- Power

Challenges

- When finished, sketch an alternate wiring scheme to construct the same circuit (i.e. different wiring layout that faithful to the same schematic diagram).

- Explain what this circuit is supposed to do.
- Modify this circuit to use a single switch providing an “off” mode in addition to the modes provided by this circuit.
- One of the more difficult skills for students to develop is the ability to translate a nice, neat schematic diagram into a messy, real-world circuit, and vice-versa. Identify some strategies to assist you in this endeavor.

5.1.8 Switch states

Identify the “normal” status of each switch shown below, whether it is *normally-open* (NO) or *normally-closed* (NC). Then, identify what stimulation would be required to maintain each switch in the *closed* state.

Speed

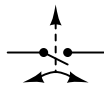

Limit



Pressure

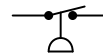

Flow



Level

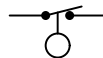

Pushbutton

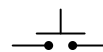

Challenges

- Suppose the speed switch was coupled to an electric motor shaft, turning a water pump that was necessary to supply water pressure to a town. This pump is critically important, and runs all the time. Would this switch, installed in this application, be called *normally-open* or *normally-closed*?

5.2 Quantitative reasoning

These questions are designed to stimulate your computational thinking. In a Socratic discussion with your instructor, the goal is for these questions to reveal your mathematical approach(es) to problem-solving so that good technique and sound reasoning may be reinforced. Your instructor may also pose additional questions based on those assigned, in order to observe your problem-solving firsthand.

Mental arithmetic and estimations are strongly encouraged for all calculations, because without these abilities you will be unable to readily detect errors caused by calculator misuse (e.g. keystroke errors).

You will note a conspicuous lack of answers given for these quantitative questions. Unlike standard textbooks where answers to every other question are given somewhere toward the back of the book, here in these learning modules students must rely on other means to check their work. My advice is to use circuit simulation software such as SPICE to check the correctness of quantitative answers. Refer to those learning modules within this collection focusing on SPICE to see worked examples which you may use directly as practice problems for your own study, and/or as templates you may modify to run your own analyses and generate your own practice problems.

Completely worked example problems found in the Tutorial may also serve as “test cases⁴” for gaining proficiency in the use of circuit simulation software, and then once that proficiency is gained you will never need to rely⁵ on an answer key!

⁴In other words, set up the circuit simulation software to analyze the same circuit examples found in the Tutorial. If the simulated results match the answers shown in the Tutorial, it confirms the simulation has properly run. If the simulated results disagree with the Tutorial’s answers, something has been set up incorrectly in the simulation software. Using every Tutorial as practice in this way will quickly develop proficiency in the use of circuit simulation software.

⁵This approach is perfectly in keeping with the instructional philosophy of these learning modules: *teaching students to be self-sufficient thinkers*. Answer keys can be useful, but it is even more useful to your long-term success to have a set of tools on hand for checking your own work, because once you have left school and are on your own, there will no longer be “answer keys” available for the problems you will have to solve.

5.2.1 Miscellaneous physical constants

Note: constants shown in **bold** type are *exact*, not approximations. Values inside of parentheses show one standard deviation (σ) of uncertainty in the final digits: for example, the magnetic permeability of free space value given as $1.25663706212(19) \times 10^{-6}$ H/m represents a center value (i.e. the location parameter) of $1.25663706212 \times 10^{-6}$ Henrys per meter with one standard deviation of uncertainty equal to $0.0000000000019 \times 10^{-6}$ Henrys per meter.

Avogadro's number (N_A) = **6.02214076** $\times 10^{23}$ **per mole** (mol⁻¹)

Boltzmann's constant (k) = **1.380649** $\times 10^{-23}$ **Joules per Kelvin** (J/K)

Electronic charge (e) = **1.602176634** $\times 10^{-19}$ **Coulomb** (C)

Faraday constant (F) = **96,485.33212...** $\times 10^4$ **Coulombs per mole** (C/mol)

Magnetic permeability of free space (μ_0) = **1.25663706212(19)** $\times 10^{-6}$ Henrys per meter (H/m)

Electric permittivity of free space (ϵ_0) = **8.8541878128(13)** $\times 10^{-12}$ Farads per meter (F/m)

Characteristic impedance of free space (Z_0) = **376.730313668(57)** Ohms (Ω)

Gravitational constant (G) = **6.67430(15)** $\times 10^{-11}$ cubic meters per kilogram-seconds squared (m³/kg-s²)

Molar gas constant (R) = **8.314462618...** **Joules per mole-Kelvin** (J/mol-K) = 0.08205746(14) liters-atmospheres per mole-Kelvin

Planck constant (h) = **6.62607015** $\times 10^{-34}$ **joule-seconds** (J-s)

Stefan-Boltzmann constant (σ) = **5.670374419...** $\times 10^{-8}$ **Watts per square meter-Kelvin⁴** (W/m²·K⁴)

Speed of light in a vacuum (c) = **299,792,458 meters per second** (m/s) = 186282.4 miles per second (mi/s)

Note: All constants taken from NIST data "Fundamental Physical Constants – Complete Listing", from <http://physics.nist.gov/constants>, National Institute of Standards and Technology (NIST), 2018 CODATA Adjustment.

5.2.2 Introduction to spreadsheets

A powerful computational tool you are encouraged to use in your work is a *spreadsheet*. Available on most personal computers (e.g. Microsoft Excel), *spreadsheet* software performs numerical calculations based on number values and formulae entered into cells of a grid. This grid is typically arranged as lettered columns and numbered rows, with each cell of the grid identified by its column/row coordinates (e.g. cell B3, cell A8). Each cell may contain a string of text, a number value, or a mathematical formula. The spreadsheet automatically updates the results of all mathematical formulae whenever the entered number values are changed. This means it is possible to set up a spreadsheet to perform a series of calculations on entered data, and those calculations will be re-done by the computer any time the data points are edited in any way.

For example, the following spreadsheet calculates average speed based on entered values of distance traveled and time elapsed:

	A	B	C	D
1	Distance traveled	46.9	Kilometers	
2	Time elapsed	1.18	Hours	
3	Average speed	= B1 / B2	km/h	
4				
5				

Text labels contained in cells A1 through A3 and cells C1 through C3 exist solely for readability and are not involved in any calculations. Cell B1 contains a sample distance value while cell B2 contains a sample time value. The formula for computing speed is contained in cell B3. Note how this formula begins with an “equals” symbol (=), references the values for distance and speed by lettered column and numbered row coordinates (B1 and B2), and uses a forward slash symbol for division (/). The coordinates B1 and B2 function as *variables*⁶ would in an algebraic formula.

When this spreadsheet is executed, the numerical value 39.74576 will appear in cell B3 rather than the formula = B1 / B2, because 39.74576 is the computed speed value given 46.9 kilometers traveled over a period of 1.18 hours. If a different numerical value for distance is entered into cell B1 or a different value for time is entered into cell B2, cell B3’s value will automatically update. All you need to do is set up the given values and any formulae into the spreadsheet, and the computer will do all the calculations for you.

Cell B3 may be referenced by other formulae in the spreadsheet if desired, since it is a variable just like the given values contained in B1 and B2. This means it is possible to set up an entire chain of calculations, one dependent on the result of another, in order to arrive at a final value. The arrangement of the given data and formulae need not follow any pattern on the grid, which means you may place them anywhere.

⁶Spreadsheets may also provide means to attach text labels to cells for use as variable names (Microsoft Excel simply calls these labels “names”), but for simple spreadsheets such as those shown here it’s usually easier just to use the standard coordinate naming for each cell.

Common⁷ arithmetic operations available for your use in a spreadsheet include the following:

- Addition (+)
- Subtraction (-)
- Multiplication (*)
- Division (/)
- Powers (^)
- Square roots (sqrt())
- Logarithms (ln() , log10())

Parentheses may be used to ensure⁸ proper order of operations within a complex formula. Consider this example of a spreadsheet implementing the *quadratic formula*, used to solve for roots of a polynomial expression in the form of $ax^2 + bx + c$:

$$x = \frac{-b \pm \sqrt{b^2 - 4ac}}{2a}$$

	A	B
1	x_1	= (-B4 + sqrt((B4^2) - (4*B3*B5))) / (2*B3)
2	x_2	= (-B4 - sqrt((B4^2) - (4*B3*B5))) / (2*B3)
3	a =	9
4	b =	5
5	c =	-2

This example is configured to compute roots⁹ of the polynomial $9x^2 + 5x - 2$ because the values of 9, 5, and -2 have been inserted into cells B3, B4, and B5, respectively. Once this spreadsheet has been built, though, it may be used to calculate the roots of *any* second-degree polynomial expression simply by entering the new a , b , and c coefficients into cells B3 through B5. The numerical values appearing in cells B1 and B2 will be automatically updated by the computer immediately following any changes made to the coefficients.

⁷Modern spreadsheet software offers a bewildering array of mathematical functions you may use in your computations. I recommend you consult the documentation for your particular spreadsheet for information on operations other than those listed here.

⁸Spreadsheet programs, like text-based programming languages, are designed to follow standard order of operations by default. However, my personal preference is to use parentheses even where strictly unnecessary just to make it clear to any other person viewing the formula what the intended order of operations is.

⁹Reviewing some algebra here, a *root* is a value for x that yields an overall value of zero for the polynomial. For this polynomial ($9x^2 + 5x - 2$) the two roots happen to be $x = 0.269381$ and $x = -0.82494$, with these values displayed in cells B1 and B2, respectively upon execution of the spreadsheet.

Alternatively, one could break up the long quadratic formula into smaller pieces like this:

$$y = \sqrt{b^2 - 4ac} \quad z = 2a$$

$$x = \frac{-b \pm y}{z}$$

	A	B	C
1	x_1	= (-B4 + C1) / C2	= sqrt((B4^2) - (4*B3*B5))
2	x_2	= (-B4 - C1) / C2	= 2*B3
3	a =	9	
4	b =	5	
5	c =	-2	

Note how the square-root term (y) is calculated in cell C1, and the denominator term (z) in cell C2. This makes the two final formulae (in cells B1 and B2) simpler to interpret. The positioning of all these cells on the grid is completely arbitrary¹⁰ – all that matters is that they properly reference each other in the formulae.

Spreadsheets are particularly useful for situations where the same set of calculations representing a circuit or other system must be repeated for different initial conditions. The power of a spreadsheet is that it automates what would otherwise be a tedious set of calculations. One specific application of this is to simulate the effects of various components within a circuit failing with abnormal values (e.g. a shorted resistor simulated by making its value nearly zero; an open resistor simulated by making its value extremely large). Another application is analyzing the behavior of a circuit design given new components that are out of specification, and/or aging components experiencing drift over time.

¹⁰My personal preference is to locate all the “given” data in the upper-left cells of the spreadsheet grid (each data point flanked by a sensible name in the cell to the left and units of measurement in the cell to the right as illustrated in the first distance/time spreadsheet example), sometimes coloring them in order to clearly distinguish which cells contain entered data versus which cells contain computed results from formulae. I like to place all formulae in cells below the given data, and try to arrange them in logical order so that anyone examining my spreadsheet will be able to figure out *how* I constructed a solution. This is a general principle I believe all computer programmers should follow: *document and arrange your code to make it easy for other people to learn from it.*

5.2.3 Oven control switches

This electric oven has three differently-rated heating elements (200 Watt, 400 Watt, and 800 Watt), each one controlled by its own toggle switch:

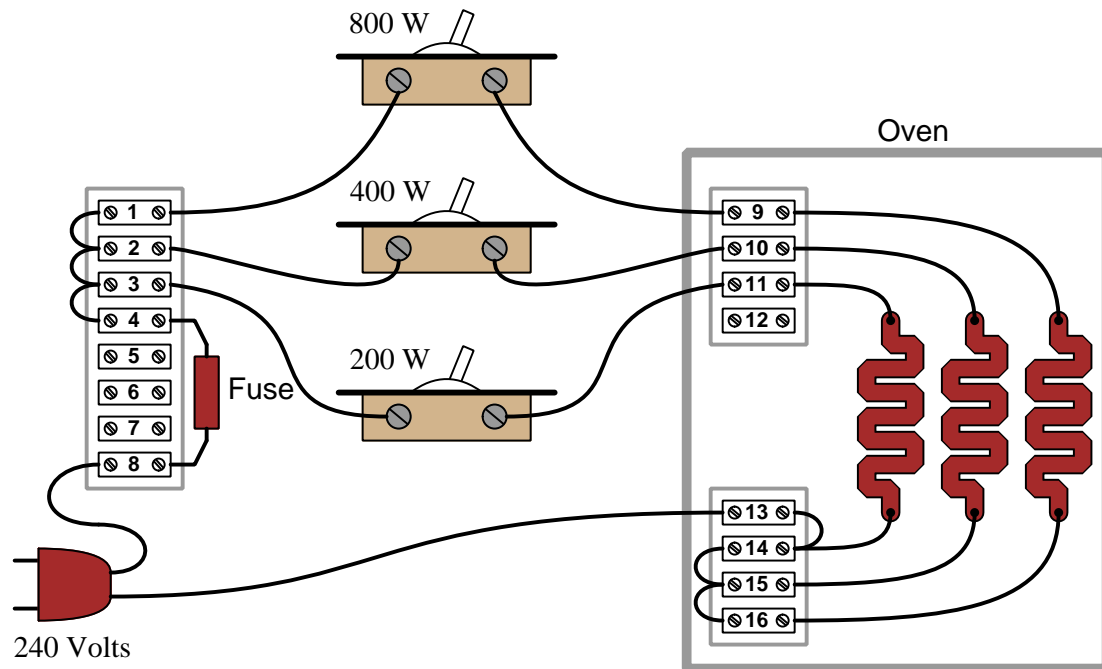

Identify how the total heating power of this oven may be modulated by these three switches on/off states. How many different total power settings are there with this system, and how much power is represented by each?

Finally, calculate the resistance in Ohms for each of the three heating elements.

Challenges

- Explain how you could estimate the resistor values without using an electronic calculator (i.e. using “mental math” and estimation techniques).
- Suppose we added a fourth heating element rated at 100 Watts, with its own switch connected like the other three elements. How many different power settings would the oven now have?
- Identify the consequence of the wire connecting terminals 1 and 2 together becoming loose and breaking contact with terminal #1.

5.3 Diagnostic reasoning

These questions are designed to stimulate your deductive and inductive thinking, where you must apply general principles to specific scenarios (deductive) and also derive conclusions about the failed circuit from specific details (inductive). In a Socratic discussion with your instructor, the goal is for these questions to reinforce your recall and use of general circuit principles and also challenge your ability to integrate multiple symptoms into a sensible explanation of what's wrong in a circuit. Your instructor may also pose additional questions based on those assigned, in order to further challenge and sharpen your diagnostic abilities.

As always, your goal is to fully *explain* your analysis of each problem. Simply obtaining a correct answer is not good enough – you must also demonstrate sound reasoning in order to successfully complete the assignment. Your instructor's responsibility is to probe and challenge your understanding of the relevant principles and analytical processes in order to ensure you have a strong foundation upon which to build further understanding.

You will note a conspicuous lack of answers given for these diagnostic questions. Unlike standard textbooks where answers to every other question are given somewhere toward the back of the book, here in these learning modules students must rely on other means to check their work. The best way by far is to debate the answers with fellow students and also with the instructor during the Socratic dialogue sessions intended to be used with these learning modules. Reasoning through challenging questions with other people is an excellent tool for developing strong reasoning skills.

Another means of checking your diagnostic answers, where applicable, is to use circuit simulation software to explore the effects of faults placed in circuits. For example, if one of these diagnostic questions requires that you predict the effect of an open or a short in a circuit, you may check the validity of your work by simulating that same fault (substituting a very high resistance in place of that component for an open, and substituting a very low resistance for a short) within software and seeing if the results agree.

5.3.1 Paralleled contacts

An electrician needs to turn an electric motor on and off using a simple switch. She selects a SPST toggle switch for the application, but subsequently discovers its contact current rating is insufficient for the motor's expected current. Looking through the inventory fails to yield a SPST switch with a greater current rating.

Another electrician suggests a solution: use a DPST switch having identically-rated contacts as the SPST switch, but connect the two sets of contacts in “parallel” to make motor's current divide between them. This way, each switch contact should only have to bear about 50% of the motor's current:

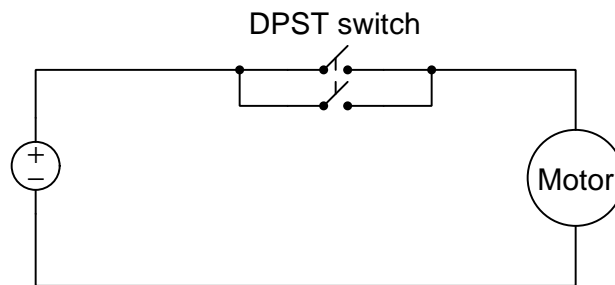

While this is a creative suggestion, it is ultimately unwise. Explain why.

Challenges

- Explain how the Conservation of Electric Charge applies to this DPST switch circuit.

5.3.2 Testing a switch

How might you use a meter (or a conductivity/continuity tester) to determine whether this electrical switch is in the *open* or *closed* state?

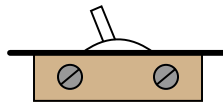

Challenges

- Identify a means of safely determining the switch's status without using a multimeter.

Appendix A

Problem-Solving Strategies

The ability to solve complex problems is arguably one of the most valuable skills one can possess, and this skill is particularly important in any science-based discipline.

- Study principles, not procedures. Don't be satisfied with merely knowing how to compute solutions – learn *why* those solutions work.
- Identify what it is you need to solve, identify all relevant data, identify all units of measurement, identify any general principles or formulae linking the given information to the solution, and then identify any “missing pieces” to a solution. Annotate all diagrams with this data.
- Sketch a diagram to help visualize the problem. When building a real system, always devise a plan for that system and analyze its function *before* constructing it.
- Follow the units of measurement and meaning of every calculation. If you are ever performing mathematical calculations as part of a problem-solving procedure, and you find yourself unable to apply each and every intermediate result to some aspect of the problem, it means you don't understand what you are doing. Properly done, every mathematical result should have practical meaning for the problem, and not just be an abstract number. You should be able to identify the proper units of measurement for each and every calculated result, and show where that result fits into the problem.
- Perform “thought experiments” to explore the effects of different conditions for theoretical problems. When troubleshooting real systems, perform *diagnostic tests* rather than visually inspecting for faults, the best diagnostic test being the one giving you the most information about the nature and/or location of the fault with the fewest steps.
- Simplify the problem until the solution becomes obvious, and then use that obvious case as a model to follow in solving the more complex version of the problem.
- Check for exceptions to see if your solution is incorrect or incomplete. A good solution will work for *all* known conditions and criteria. A good example of this is the process of testing scientific hypotheses: the task of a scientist is not to find support for a new idea, but rather to *challenge* that new idea to see if it holds up under a battery of tests. The philosophical

principle of *reductio ad absurdum* (i.e. disproving a general idea by finding a specific case where it fails) is useful here.

- Work “backward” from a hypothetical solution to a new set of given conditions.
- Add quantities to problems that are qualitative in nature, because sometimes a little math helps illuminate the scenario.
- Sketch graphs illustrating how variables relate to each other. These may be quantitative (i.e. with realistic number values) or qualitative (i.e. simply showing increases and decreases).
- Treat quantitative problems as qualitative in order to discern the relative magnitudes and/or directions of change of the relevant variables. For example, try determining what happens if a certain variable were to increase or decrease before attempting to precisely calculate quantities: how will each of the dependent variables respond, by increasing, decreasing, or remaining the same as before?
- Consider limiting cases. This works especially well for qualitative problems where you need to determine which direction a variable will change. Take the given condition and magnify that condition to an extreme degree as a way of simplifying the direction of the system’s response.
- Check your work. This means regularly testing your conclusions to see if they make sense. This does *not* mean repeating the same steps originally used to obtain the conclusion(s), but rather to use some other means to check validity. Simply repeating procedures often leads to *repeating the same errors* if any were made, which is why alternative paths are better.

Appendix B

Instructional philosophy

“The unexamined circuit is not worth energizing” – Socrates (if he had taught electricity)

These learning modules, although useful for self-study, were designed to be used in a formal learning environment where a subject-matter expert challenges students to digest the content and exercise their critical thinking abilities in the answering of questions and in the construction and testing of working circuits.

The following principles inform the instructional and assessment philosophies embodied in these learning modules:

- The first goal of education is to enhance clear and independent thought, in order that every student reach their fullest potential in a highly complex and inter-dependent world. Robust reasoning is *always* more important than particulars of any subject matter, because its application is universal.
- Literacy is fundamental to independent learning and thought because text continues to be the most efficient way to communicate complex ideas over space and time. Those who cannot read with ease are limited in their ability to acquire knowledge and perspective.
- Articulate communication is fundamental to work that is complex and interdisciplinary.
- Faulty assumptions and poor reasoning are best corrected through challenge, not presentation. The rhetorical technique of *reductio ad absurdum* (disproving an assertion by exposing an absurdity) works well to discipline student’s minds, not only to correct the problem at hand but also to learn how to detect and correct future errors.
- Important principles should be repeatedly explored and widely applied throughout a course of study, not only to reinforce their importance and help ensure their mastery, but also to showcase the interconnectedness and utility of knowledge.

These learning modules were expressly designed to be used in an “inverted” teaching environment¹ where students first read the introductory and tutorial chapters on their own, then individually attempt to answer the questions and construct working circuits according to the experiment and project guidelines. The instructor never lectures, but instead meets regularly with each individual student to review their progress, answer questions, identify misconceptions, and challenge the student to new depths of understanding through further questioning. Regular meetings between instructor and student should resemble a Socratic² dialogue, where questions serve as scalpels to dissect topics and expose assumptions. The student passes each module only after consistently demonstrating their ability to logically analyze and correctly apply all major concepts in each question or project/experiment. The instructor must be vigilant in probing each student’s understanding to ensure they are truly *reasoning* and not just *memorizing*. This is why “Challenge” points appear throughout, as prompts for students to think deeper about topics and as starting points for instructor queries. Sometimes these challenge points require additional knowledge that hasn’t been covered in the series to answer in full. This is okay, as the major purpose of the Challenges is to stimulate analysis and synthesis on the part of each student.

The instructor must possess enough mastery of the subject matter and awareness of students’ reasoning to generate their own follow-up questions to practically any student response. Even completely correct answers given by the student should be challenged by the instructor for the purpose of having students practice articulating their thoughts and defending their reasoning. Conceptual errors committed by the student should be exposed and corrected not by direct instruction, but rather by reducing the errors to an absurdity³ through well-chosen questions and thought experiments posed by the instructor. Becoming proficient at this style of instruction requires time and dedication, but the positive effects on critical thinking for both student and instructor are spectacular.

An inspection of these learning modules reveals certain unique characteristics. One of these is a bias toward thorough explanations in the tutorial chapters. Without a live instructor to explain concepts and applications to students, the text itself must fulfill this role. This philosophy results in lengthier explanations than what you might typically find in a textbook, each step of the reasoning process fully explained, including footnotes addressing common questions and concerns students raise while learning these concepts. Each tutorial seeks to not only explain each major concept in sufficient detail, but also to explain the logic of each concept and how each may be developed

¹In a traditional teaching environment, students first encounter new information via *lecture* from an expert, and then independently apply that information via *homework*. In an “inverted” course of study, students first encounter new information via *homework*, and then independently apply that information under the scrutiny of an expert. The expert’s role in lecture is to simply *explain*, but the expert’s role in an inverted session is to *challenge, critique*, and if necessary *explain* where gaps in understanding still exist.

²Socrates is a figure in ancient Greek philosophy famous for his unflinching style of questioning. Although he authored no texts, he appears as a character in Plato’s many writings. The essence of Socratic philosophy is to leave no question unexamined and no point of view unchallenged. While purists may argue a topic such as electric circuits is too narrow for a true Socratic-style dialogue, I would argue that the essential thought processes involved with scientific reasoning on *any* topic are not far removed from the Socratic ideal, and that students of electricity and electronics would do very well to challenge assumptions, pose thought experiments, identify fallacies, and otherwise employ the arsenal of critical thinking skills modeled by Socrates.

³This rhetorical technique is known by the Latin phrase *reductio ad absurdum*. The concept is to expose errors by counter-example, since only one solid counter-example is necessary to disprove a universal claim. As an example of this, consider the common misconception among beginning students of electricity that voltage cannot exist without current. One way to apply *reductio ad absurdum* to this statement is to ask how much current passes through a fully-charged battery connected to nothing (i.e. a clear example of voltage existing without current).

from “first principles”. Again, this reflects the goal of developing clear and independent thought in students’ minds, by showing how clear and logical thought was used to forge each concept. Students benefit from witnessing a model of clear thinking in action, and these tutorials strive to be just that.

Another characteristic of these learning modules is a lack of step-by-step instructions in the Project and Experiment chapters. Unlike many modern workbooks and laboratory guides where step-by-step instructions are prescribed for each experiment, these modules take the approach that students must learn to closely read the tutorials and apply their own reasoning to identify the appropriate experimental steps. Sometimes these steps are plainly declared in the text, just not as a set of enumerated points. At other times certain steps are implied, an example being assumed competence in test equipment use where the student should not need to be told *again* how to use their multimeter because that was thoroughly explained in previous lessons. In some circumstances no steps are given at all, leaving the entire procedure up to the student.

This lack of prescription is not a flaw, but rather a feature. Close reading and clear thinking are foundational principles of this learning series, and in keeping with this philosophy all activities are designed to *require* those behaviors. Some students may find the lack of prescription frustrating, because it demands more from them than what their previous educational experiences required. This frustration should be interpreted as an unfamiliarity with autonomous thinking, a problem which must be corrected if the student is ever to become a self-directed learner and effective problem-solver. Ultimately, the need for students to read closely and think clearly is more important both in the near-term and far-term than any specific facet of the subject matter at hand. If a student takes longer than expected to complete a module because they are forced to outline, digest, and reason on their own, so be it. The future gains enjoyed by developing this mental discipline will be well worth the additional effort and delay.

Another feature of these learning modules is that they do not treat topics in isolation. Rather, important concepts are introduced early in the series, and appear repeatedly as stepping-stones toward other concepts in subsequent modules. This helps to avoid the “compartmentalization” of knowledge, demonstrating the inter-connectedness of concepts and simultaneously reinforcing them. Each module is fairly complete in itself, reserving the beginning of its tutorial to a review of foundational concepts.

This methodology of assigning text-based modules to students for digestion and then using Socratic dialogue to assess progress and hone students’ thinking was developed over a period of several years by the author with his Electronics and Instrumentation students at the two-year college level. While decidedly unconventional and sometimes even unsettling for students accustomed to a more passive lecture environment, this instructional philosophy has proven its ability to convey conceptual mastery, foster careful analysis, and enhance employability so much better than lecture that the author refuses to ever teach by lecture again.

Problems which often go undiagnosed in a lecture environment are laid bare in this “inverted” format where students must articulate and logically defend their reasoning. This, too, may be unsettling for students accustomed to lecture sessions where the instructor cannot tell for sure who comprehends and who does not, and this vulnerability necessitates sensitivity on the part of the “inverted” session instructor in order that students never feel discouraged by having their errors exposed. *Everyone* makes mistakes from time to time, and learning is a lifelong process! Part of the instructor’s job is to build a culture of learning among the students where errors are not seen as shameful, but rather as opportunities for progress.

To this end, instructors managing courses based on these modules should adhere to the following principles:

- Student questions are always welcome and demand thorough, honest answers. The only type of question an instructor should refuse to answer is one the student should be able to easily answer on their own. Remember, *the fundamental goal of education is for each student to learn to think clearly and independently*. This requires hard work on the part of the student, which no instructor should ever circumvent. Anything done to bypass the student's responsibility to do that hard work ultimately limits that student's potential and thereby does real harm.
- It is not only permissible, but encouraged, to answer a student's question by asking questions in return, these follow-up questions designed to guide the student to reach a correct answer through their own reasoning.
- All student answers demand to be challenged by the instructor and/or by other students. This includes both correct and incorrect answers – the goal is to practice the articulation and defense of one's own reasoning.
- No reading assignment is deemed complete unless and until the student demonstrates their ability to accurately summarize the major points in their own terms. Recitation of the original text is unacceptable. This is why every module contains an "Outline and reflections" question as well as a "Foundational concepts" question in the Conceptual reasoning section, to prompt reflective reading.
- No assigned question is deemed answered unless and until the student demonstrates their ability to consistently and correctly apply the concepts to *variations* of that question. This is why module questions typically contain multiple "Challenges" suggesting different applications of the concept(s) as well as variations on the same theme(s). Instructors are encouraged to devise as many of their own "Challenges" as they are able, in order to have a multitude of ways ready to probe students' understanding.
- No assigned experiment or project is deemed complete unless and until the student demonstrates the task in action. If this cannot be done "live" before the instructor, video-recordings showing the demonstration are acceptable. All relevant safety precautions must be followed, all test equipment must be used correctly, and the student must be able to properly explain all results. The student must also successfully answer all Challenges presented by the instructor for that experiment or project.

Students learning from these modules would do well to abide by the following principles:

- No text should be considered fully and adequately read unless and until you can express every idea *in your own words, using your own examples*.
- You should always articulate your thoughts as you read the text, noting points of agreement, confusion, and epiphanies. Feel free to print the text on paper and then write your notes in the margins. Alternatively, keep a journal for your own reflections as you read. This is truly a helpful tool when digesting complicated concepts.
- Never take the easy path of highlighting or underlining important text. Instead, *summarize* and/or *comment* on the text using your own words. This actively engages your mind, allowing you to more clearly perceive points of confusion or misunderstanding on your own.
- A very helpful strategy when learning new concepts is to place yourself in the role of a teacher, if only as a mental exercise. Either explain what you have recently learned to someone else, or at least *imagine* yourself explaining what you have learned to someone else. The simple act of having to articulate new knowledge and skill forces you to take on a different perspective, and will help reveal weaknesses in your understanding.
- Perform each and every mathematical calculation and thought experiment shown in the text on your own, referring back to the text to see that your results agree. This may seem trivial and unnecessary, but it is critically important to ensuring you actually understand what is presented, especially when the concepts at hand are complicated and easy to misunderstand. Apply this same strategy to become proficient in the use of *circuit simulation software*, checking to see if your simulated results agree with the results shown in the text.
- Above all, recognize that learning is hard work, and that a certain level of frustration is unavoidable. There are times when you will struggle to grasp some of these concepts, and that struggle is a natural thing. Take heart that it will yield with persistent and varied⁴ effort, and never give up!

Students interested in using these modules for self-study will also find them beneficial, although the onus of responsibility for thoroughly reading and answering questions will of course lie with that individual alone. If a qualified instructor is not available to challenge students, a workable alternative is for students to form study groups where they challenge⁵ one another.

To high standards of education,

Tony R. Kuphaldt

⁴As the old saying goes, “Insanity is trying the same thing over and over again, expecting different results.” If you find yourself stumped by something in the text, you should attempt a different approach. Alter the thought experiment, change the mathematical parameters, do whatever you can to see the problem in a slightly different light, and then the solution will often present itself more readily.

⁵Avoid the temptation to simply share answers with study partners, as this is really counter-productive to learning. Always bear in mind that the answer to any question is far less important in the long run than the method(s) used to obtain that answer. The goal of education is to empower one’s life through the improvement of clear and independent thought, literacy, expression, and various practical skills.

Appendix C

Tools used

I am indebted to the developers of many open-source software applications in the creation of these learning modules. The following is a list of these applications with some commentary on each.

You will notice a theme common to many of these applications: a bias toward *code*. Although I am by no means an expert programmer in any computer language, I understand and appreciate the flexibility offered by code-based applications where the user (you) enters commands into a plain ASCII text file, which the software then reads and processes to create the final output. Code-based computer applications are by their very nature *extensible*, while WYSIWYG (What You See Is What You Get) applications are generally limited to whatever user interface the developer makes for you.

The GNU/Linux computer operating system

There is so much to be said about Linus Torvalds' `Linux` and Richard Stallman's `GNU` project. First, to credit just these two individuals is to fail to do justice to the *mob* of passionate volunteers who contributed to make this amazing software a reality. I first learned of `Linux` back in 1996, and have been using this operating system on my personal computers almost exclusively since then. It is *free*, it is completely *configurable*, and it permits the continued use of highly efficient `Unix` applications and scripting languages (e.g. shell scripts, Makefiles, `sed`, `awk`) developed over many decades. `Linux` not only provided me with a powerful computing platform, but its open design served to inspire my life's work of creating open-source educational resources.

Bram Moolenaar's Vim text editor

Writing code for any code-based computer application requires a *text editor*, which may be thought of as a word processor strictly limited to outputting plain-ASCII text files. Many good text editors exist, and one's choice of text editor seems to be a deeply personal matter within the programming world. I prefer `Vim` because it operates very similarly to `vi` which is ubiquitous on `Unix/Linux` operating systems, and because it may be entirely operated via keyboard (i.e. no mouse required) which makes it fast to use.

Donald Knuth's \TeX typesetting system

Developed in the late 1970's and early 1980's by computer scientist extraordinaire Donald Knuth to typeset his multi-volume magnum opus *The Art of Computer Programming*, this software allows the production of formatted text for screen-viewing or paper printing, all by writing plain-text code to describe how the formatted text is supposed to appear. \TeX is not just a markup language for documents, but it is also a Turing-complete programming language in and of itself, allowing useful algorithms to be created to control the production of documents. Simply put, *\TeX is a programmer's approach to word processing*. Since \TeX is controlled by code written in a plain-text file, this means anyone may read that plain-text file to see exactly how the document was created. This openness afforded by the code-based nature of \TeX makes it relatively easy to learn how other people have created their own \TeX documents. By contrast, examining a beautiful document created in a conventional WYSIWYG word processor such as Microsoft **Word** suggests nothing to the reader about *how* that document was created, or what the user might do to create something similar. As Mr. Knuth himself once quipped, conventional word processing applications should be called WYSIAYG (What You See Is *All* You Get).

Leslie Lamport's \LaTeX extensions to \TeX

Like all true programming languages, \TeX is inherently extensible. So, years after the release of \TeX to the public, Leslie Lamport decided to create a massive extension allowing easier compilation of book-length documents. The result was \LaTeX , which is the markup language used to create all ModEL module documents. You could say that \TeX is to \LaTeX as **C** is to **C++**. This means it is permissible to use any and all \TeX commands within \LaTeX source code, and it all still works. Some of the features offered by \LaTeX that would be challenging to implement in \TeX include automatic index and table-of-content creation.

Tim Edwards' **Xcircuit** drafting program

This wonderful program is what I use to create all the schematic diagrams and illustrations (but not photographic images or mathematical plots) throughout the ModEL project. It natively outputs PostScript format which is a true vector graphic format (this is why the images do not pixellate when you zoom in for a closer view), and it is so simple to use that I have never had to read the manual! Object libraries are easy to create for **Xcircuit**, being plain-text files using PostScript programming conventions. Over the years I have collected a large set of object libraries useful for drawing electrical and electronic schematics, pictorial diagrams, and other technical illustrations.

Gimp graphic image manipulation program

Essentially an open-source clone of Adobe's `PhotoShop`, I use `Gimp` to resize, crop, and convert file formats for all of the photographic images appearing in the `MODEL` modules. Although `Gimp` does offer its own scripting language (called `Script-Fu`), I have never had occasion to use it. Thus, my utilization of `Gimp` to merely crop, resize, and convert graphic images is akin to using a sword to slice bread.

SPICE circuit simulation program

`SPICE` is to circuit analysis as `TEX` is to document creation: it is a form of markup language designed to describe a certain object to be processed in plain-ASCII text. When the plain-text "source file" is compiled by the software, it outputs the final result. More modern circuit analysis tools certainly exist, but I prefer `SPICE` for the following reasons: it is *free*, it is *fast*, it is *reliable*, and it is a fantastic tool for *teaching* students of electricity and electronics how to write simple code. I happen to use rather old versions of `SPICE`, version 2g6 being my "go to" application when I only require text-based output. `NGSPICE` (version 26), which is based on Berkeley `SPICE` version 3f5, is used when I require graphical output for such things as time-domain waveforms and Bode plots. In all `SPICE` example netlists I strive to use coding conventions compatible with all `SPICE` versions.

Andrew D. Hwang's ePiX mathematical visualization programming library

This amazing project is a `C++` library you may link to any `C/C++` code for the purpose of generating PostScript graphic images of mathematical functions. As a completely free and open-source project, it does all the plotting I would otherwise use a Computer Algebra System (CAS) such as `Mathematica` or `Maple` to do. It should be said that `ePiX` is *not* a Computer Algebra System like `Mathematica` or `Maple`, but merely a mathematical *visualization* tool. In other words, it won't determine integrals for you (you'll have to implement that in your own `C/C++` code!), but it can graph the results, and it does so beautifully. What I really admire about `ePiX` is that it is a `C++` programming library, which means it builds on the existing power and toolset available with that programming language. Mr. Hwang could have probably developed his own stand-alone application for mathematical plotting, but by creating a `C++` library to do the same thing he accomplished something much greater.

gnuplot mathematical visualization software

Another open-source tool for mathematical visualization is `gnuplot`. Interestingly, this tool is *not* part of Richard Stallman’s GNU project, its name being a coincidence. For this reason the authors prefer “gnu” *not* be capitalized at all to avoid confusion. This is a much “lighter-weight” alternative to a spreadsheet for plotting tabular data, and the fact that it easily outputs directly to an X11 console or a file in a number of different graphical formats (including PostScript) is very helpful. I typically set my `gnuplot` output format to default (X11 on my Linux PC) for quick viewing while I’m developing a visualization, then switch to PostScript file export once the visual is ready to include in the document(s) I’m writing. As with my use of `Gimp` to do rudimentary image editing, my use of `gnuplot` only scratches the surface of its capabilities, but the important points are that it’s *free* and that it *works well*.

Python programming language

Both Python and C++ find extensive use in these modules as instructional aids and exercises, but I’m listing Python here as a *tool* for myself because I use it almost daily as a *calculator*. If you open a Python interpreter console and type `from math import *` you can type mathematical expressions and have it return results just as you would on a hand calculator. Complex-number (i.e. *phasor*) arithmetic is similarly supported if you include the complex-math library (`from cmath import *`). Examples of this are shown in the Programming References chapter (if included) in each module. Of course, being a fully-featured programming language, Python also supports conditionals, loops, and other structures useful for calculation of quantities. Also, running in a console environment where all entries and returned values show as text in a chronologically-ordered list makes it easy to copy-and-paste those calculations to document exactly how they were performed.

Appendix D

Creative Commons License

Creative Commons Attribution 4.0 International Public License

By exercising the Licensed Rights (defined below), You accept and agree to be bound by the terms and conditions of this Creative Commons Attribution 4.0 International Public License (“Public License”). To the extent this Public License may be interpreted as a contract, You are granted the Licensed Rights in consideration of Your acceptance of these terms and conditions, and the Licensor grants You such rights in consideration of benefits the Licensor receives from making the Licensed Material available under these terms and conditions.

Section 1 – Definitions.

a. **Adapted Material** means material subject to Copyright and Similar Rights that is derived from or based upon the Licensed Material and in which the Licensed Material is translated, altered, arranged, transformed, or otherwise modified in a manner requiring permission under the Copyright and Similar Rights held by the Licensor. For purposes of this Public License, where the Licensed Material is a musical work, performance, or sound recording, Adapted Material is always produced where the Licensed Material is synched in timed relation with a moving image.

b. **Adapter’s License** means the license You apply to Your Copyright and Similar Rights in Your contributions to Adapted Material in accordance with the terms and conditions of this Public License.

c. **Copyright and Similar Rights** means copyright and/or similar rights closely related to copyright including, without limitation, performance, broadcast, sound recording, and Sui Generis Database Rights, without regard to how the rights are labeled or categorized. For purposes of this Public License, the rights specified in Section 2(b)(1)-(2) are not Copyright and Similar Rights.

d. **Effective Technological Measures** means those measures that, in the absence of proper authority, may not be circumvented under laws fulfilling obligations under Article 11 of the WIPO Copyright Treaty adopted on December 20, 1996, and/or similar international agreements.

e. **Exceptions and Limitations** means fair use, fair dealing, and/or any other exception or

limitation to Copyright and Similar Rights that applies to Your use of the Licensed Material.

f. **Licensed Material** means the artistic or literary work, database, or other material to which the Licensor applied this Public License.

g. **Licensed Rights** means the rights granted to You subject to the terms and conditions of this Public License, which are limited to all Copyright and Similar Rights that apply to Your use of the Licensed Material and that the Licensor has authority to license.

h. **Licensor** means the individual(s) or entity(ies) granting rights under this Public License.

i. **Share** means to provide material to the public by any means or process that requires permission under the Licensed Rights, such as reproduction, public display, public performance, distribution, dissemination, communication, or importation, and to make material available to the public including in ways that members of the public may access the material from a place and at a time individually chosen by them.

j. **Sui Generis Database Rights** means rights other than copyright resulting from Directive 96/9/EC of the European Parliament and of the Council of 11 March 1996 on the legal protection of databases, as amended and/or succeeded, as well as other essentially equivalent rights anywhere in the world.

k. **You** means the individual or entity exercising the Licensed Rights under this Public License. **Your** has a corresponding meaning.

Section 2 – Scope.

a. License grant.

1. Subject to the terms and conditions of this Public License, the Licensor hereby grants You a worldwide, royalty-free, non-sublicensable, non-exclusive, irrevocable license to exercise the Licensed Rights in the Licensed Material to:

A. reproduce and Share the Licensed Material, in whole or in part; and

B. produce, reproduce, and Share Adapted Material.

2. Exceptions and Limitations. For the avoidance of doubt, where Exceptions and Limitations apply to Your use, this Public License does not apply, and You do not need to comply with its terms and conditions.

3. Term. The term of this Public License is specified in Section 6(a).

4. Media and formats; technical modifications allowed. The Licensor authorizes You to exercise the Licensed Rights in all media and formats whether now known or hereafter created, and to make technical modifications necessary to do so. The Licensor waives and/or agrees not to assert any right or authority to forbid You from making technical modifications necessary to exercise the Licensed Rights, including technical modifications necessary to circumvent Effective Technological Measures.

For purposes of this Public License, simply making modifications authorized by this Section 2(a)(4) never produces Adapted Material.

5. Downstream recipients.

A. Offer from the Licensor – Licensed Material. Every recipient of the Licensed Material automatically receives an offer from the Licensor to exercise the Licensed Rights under the terms and conditions of this Public License.

B. No downstream restrictions. You may not offer or impose any additional or different terms or conditions on, or apply any Effective Technological Measures to, the Licensed Material if doing so restricts exercise of the Licensed Rights by any recipient of the Licensed Material.

6. No endorsement. Nothing in this Public License constitutes or may be construed as permission to assert or imply that You are, or that Your use of the Licensed Material is, connected with, or sponsored, endorsed, or granted official status by, the Licensor or others designated to receive attribution as provided in Section 3(a)(1)(A)(i).

b. Other rights.

1. Moral rights, such as the right of integrity, are not licensed under this Public License, nor are publicity, privacy, and/or other similar personality rights; however, to the extent possible, the Licensor waives and/or agrees not to assert any such rights held by the Licensor to the limited extent necessary to allow You to exercise the Licensed Rights, but not otherwise.

2. Patent and trademark rights are not licensed under this Public License.

3. To the extent possible, the Licensor waives any right to collect royalties from You for the exercise of the Licensed Rights, whether directly or through a collecting society under any voluntary or waivable statutory or compulsory licensing scheme. In all other cases the Licensor expressly reserves any right to collect such royalties.

Section 3 – License Conditions.

Your exercise of the Licensed Rights is expressly made subject to the following conditions.

a. Attribution.

1. If You Share the Licensed Material (including in modified form), You must:

A. retain the following if it is supplied by the Licensor with the Licensed Material:

i. identification of the creator(s) of the Licensed Material and any others designated to receive attribution, in any reasonable manner requested by the Licensor (including by pseudonym if designated);

ii. a copyright notice;

- iii. a notice that refers to this Public License;
- iv. a notice that refers to the disclaimer of warranties;
- v. a URI or hyperlink to the Licensed Material to the extent reasonably practicable;

B. indicate if You modified the Licensed Material and retain an indication of any previous modifications; and

C. indicate the Licensed Material is licensed under this Public License, and include the text of, or the URI or hyperlink to, this Public License.

2. You may satisfy the conditions in Section 3(a)(1) in any reasonable manner based on the medium, means, and context in which You Share the Licensed Material. For example, it may be reasonable to satisfy the conditions by providing a URI or hyperlink to a resource that includes the required information.

3. If requested by the Licensor, You must remove any of the information required by Section 3(a)(1)(A) to the extent reasonably practicable.

4. If You Share Adapted Material You produce, the Adapter's License You apply must not prevent recipients of the Adapted Material from complying with this Public License.

Section 4 – Sui Generis Database Rights.

Where the Licensed Rights include Sui Generis Database Rights that apply to Your use of the Licensed Material:

- a. for the avoidance of doubt, Section 2(a)(1) grants You the right to extract, reuse, reproduce, and Share all or a substantial portion of the contents of the database;
- b. if You include all or a substantial portion of the database contents in a database in which You have Sui Generis Database Rights, then the database in which You have Sui Generis Database Rights (but not its individual contents) is Adapted Material; and
- c. You must comply with the conditions in Section 3(a) if You Share all or a substantial portion of the contents of the database.

For the avoidance of doubt, this Section 4 supplements and does not replace Your obligations under this Public License where the Licensed Rights include other Copyright and Similar Rights.

Section 5 – Disclaimer of Warranties and Limitation of Liability.

a. Unless otherwise separately undertaken by the Licensor, to the extent possible, the Licensor offers the Licensed Material as-is and as-available, and makes no representations or warranties of any kind concerning the Licensed Material, whether express, implied, statutory, or other. This includes, without limitation, warranties of title, merchantability, fitness for a particular purpose, non-infringement, absence of latent or other defects, accuracy, or the presence or absence of errors,

whether or not known or discoverable. Where disclaimers of warranties are not allowed in full or in part, this disclaimer may not apply to You.

b. To the extent possible, in no event will the Licensor be liable to You on any legal theory (including, without limitation, negligence) or otherwise for any direct, special, indirect, incidental, consequential, punitive, exemplary, or other losses, costs, expenses, or damages arising out of this Public License or use of the Licensed Material, even if the Licensor has been advised of the possibility of such losses, costs, expenses, or damages. Where a limitation of liability is not allowed in full or in part, this limitation may not apply to You.

c. The disclaimer of warranties and limitation of liability provided above shall be interpreted in a manner that, to the extent possible, most closely approximates an absolute disclaimer and waiver of all liability.

Section 6 – Term and Termination.

a. This Public License applies for the term of the Copyright and Similar Rights licensed here. However, if You fail to comply with this Public License, then Your rights under this Public License terminate automatically.

b. Where Your right to use the Licensed Material has terminated under Section 6(a), it reinstates:

1. automatically as of the date the violation is cured, provided it is cured within 30 days of Your discovery of the violation; or

2. upon express reinstatement by the Licensor.

For the avoidance of doubt, this Section 6(b) does not affect any right the Licensor may have to seek remedies for Your violations of this Public License.

c. For the avoidance of doubt, the Licensor may also offer the Licensed Material under separate terms or conditions or stop distributing the Licensed Material at any time; however, doing so will not terminate this Public License.

d. Sections 1, 5, 6, 7, and 8 survive termination of this Public License.

Section 7 – Other Terms and Conditions.

a. The Licensor shall not be bound by any additional or different terms or conditions communicated by You unless expressly agreed.

b. Any arrangements, understandings, or agreements regarding the Licensed Material not stated herein are separate from and independent of the terms and conditions of this Public License.

Section 8 – Interpretation.

a. For the avoidance of doubt, this Public License does not, and shall not be interpreted to, reduce, limit, restrict, or impose conditions on any use of the Licensed Material that could lawfully

be made without permission under this Public License.

b. To the extent possible, if any provision of this Public License is deemed unenforceable, it shall be automatically reformed to the minimum extent necessary to make it enforceable. If the provision cannot be reformed, it shall be severed from this Public License without affecting the enforceability of the remaining terms and conditions.

c. No term or condition of this Public License will be waived and no failure to comply consented to unless expressly agreed to by the Licensor.

d. Nothing in this Public License constitutes or may be interpreted as a limitation upon, or waiver of, any privileges and immunities that apply to the Licensor or You, including from the legal processes of any jurisdiction or authority.

Creative Commons is not a party to its public licenses. Notwithstanding, Creative Commons may elect to apply one of its public licenses to material it publishes and in those instances will be considered the “Licensor.” Except for the limited purpose of indicating that material is shared under a Creative Commons public license or as otherwise permitted by the Creative Commons policies published at creativecommons.org/policies, Creative Commons does not authorize the use of the trademark “Creative Commons” or any other trademark or logo of Creative Commons without its prior written consent including, without limitation, in connection with any unauthorized modifications to any of its public licenses or any other arrangements, understandings, or agreements concerning use of licensed material. For the avoidance of doubt, this paragraph does not form part of the public licenses.

Creative Commons may be contacted at creativecommons.org.

Appendix E

References

“Relay Contact Life” Application Note, Picker Components, Carrollton, TX.

Appendix F

Version history

This is a list showing all significant additions, corrections, and other edits made to this learning module. Each entry is referenced by calendar date in reverse chronological order (newest version first), which appears on the front cover of every learning module for easy reference. Any contributors to this open-source document are listed here as well.

25 August 2024 – divided the Introduction chapter into sections, one with recommendations for students, one with a listing of challenging concepts, and one with recommendations for instructors.

5 February 2024 – added a Derivations and Technical References chapter with a section on Occam’s Razor as a general troubleshooting principle.

3 February 2024 – added a Case Tutorial chapter with a section showing color-highlighting annotation of circuit potentials for open and shorted circuits.

27 November 2022 – placed questions at the top of the itemized list in the Introduction chapter prompting students to devise experiments related to the tutorial content.

7 February 2022 – added new Challenge question to “Oven control switches” Quantitative Reasoning problem.

2 February 2022 – added some Challenge questions.

18 July 2021 – added foundational concept review to the “Sketch a lamp control circuit” Conceptual Reasoning question.

8 May 2021 – commented out or deleted empty chapters.

9 September 2020 – added new Challenge questions to “Sketch a lamp control circuit” and “Oven control switches”.

29 August 2020 – significantly edited the Introduction chapter to make it more suitable as a pre-study guide and to provide cues useful to instructors leading “inverted” teaching sessions.

24 June 2020 – added Tutorial content as well as questions.

23 June 2020 – document first created.

Index

- AC versus DC switching, 27
- Adding quantities to a qualitative problem, 58
- Ampere, 15
- Annotating diagrams, 57
- Arc, 26
- Atom, 15

- Breakdown voltage, 17
- Breaking a connection, 16

- Cause, root, 33
- Charge carrier, 15
- Checking for exceptions, 58
- Checking your work, 58
- Circuit, 15
- Close, 16
- Code, computer, 65
- Conductors, 15
- Corrosion, 17
- Coulomb, 15
- Current, 15

- DC versus AC switching, 27
- Dimensional analysis, 57
- DPDT, 19
- DPST, 19

- Edwards, Tim, 66
- Electric field, 15
- Electrical resistance, 15
- Electrically common points, 16
- Electrically isolated points, 16
- Electricity, 15
- Energy, 15

- Flow switch, 25
- Form-A switch contact, 18
- Form-B switch contact, 18

- Graph values to solve a problem, 58
- Greenleaf, Cynthia, 35

- How to teach with these modules, 60
- Hwang, Andrew D., 67

- Identify given data, 57
- Identify relevant principles, 57
- Inductance, 27
- Instructions for projects and experiments, 61
- Insulators, 15
- Intermediate results, 57
- Inverted instruction, 60
- Ionization, 16
- Ionization of air, 26

- Joystick switch, 22

- Key switch, 21
- Knuth, Donald, 66

- Lamport, Leslie, 66
- Law of Energy Conservation, 27
- Level switch, 24
- Limit switch, 22
- Limiting cases, 58
- Load, 8

- Making a connection, 16
- Metacognition, 40
- Momentary contact, 17
- Moolenaar, Bram, 65
- Murphy, Lynn, 35

- Negative charge, 15
- Normal state of a switch, 18

- Occam's Razor, 30

- Ockham, Sir William of, 30
- Open, 10–12, 16
- Open-source, 65
- Optical switch, 23

- Particle, 15
- PBNO, 18
- Positive charge, 15
- Potential, 8
- Pressure, 8
- Pressure differential, 8
- Pressure switch, 24
- Problem-solving: annotate diagrams, 57
- Problem-solving: check for exceptions, 58
- Problem-solving: checking work, 58
- Problem-solving: dimensional analysis, 57
- Problem-solving: graph values, 58
- Problem-solving: identify given data, 57
- Problem-solving: identify relevant principles, 57
- Problem-solving: interpret intermediate results, 57
- Problem-solving: limiting cases, 58
- Problem-solving: qualitative to quantitative, 58
- Problem-solving: quantitative to qualitative, 58
- Problem-solving: reductio ad absurdum, 58
- Problem-solving: simplify the system, 57
- Problem-solving: thought experiment, 57
- Problem-solving: track units of measurement, 57
- Problem-solving: visually represent the system, 57
- Problem-solving: work in reverse, 58
- Process switch, 24
- Proximity switch, 22
- Pushbutton switch, 18, 21

- Qualitatively approaching a quantitative problem, 58

- Razor, Occam's, 30
- Reading Apprenticeship, 35
- Reductio ad absurdum, 58–60
- Resistance, 15
- Root cause, 33

- Schoenbach, Ruth, 35
- Scientific method, 40
- Selector switch, 21
- Short, 13, 16
- Simplifying a system, 57
- Socrates, 59
- Socratic dialogue, 60
- Source, 8
- SPDT, 19
- Speed switch, 23
- SPICE, 35
- SPST, 19
- Stallman, Richard, 65
- Switch, 16

- Temperature switch, 24
- Thought experiment, 57
- Toggle switch, 21
- Torvalds, Linus, 65

- Units of measurement, 57
- Visualizing a system, 57
- Volt, 15
- Voltage, 8, 15

- Wetting current, 27
- Work in reverse to solve a problem, 58
- WYSIWYG, 65, 66