

Recommended schedule

Day 1

Topics: *Basic concepts of AC and oscilloscope usage*
Questions: *1 through 20*
Lab Exercise: *Analog oscilloscope set-up (question 81)*

Day 2

Topics: *RMS quantities, phase shift, and phasor addition*
Questions: *21 through 40*
Lab Exercise: *RMS versus peak measurements (question 82) and measuring frequency (question 83)*

Day 3

Topics: *Inductive reactance and impedance, trigonometry for AC circuits*
Questions: *41 through 60*
Lab Exercise: *Inductive reactance and Ohm's Law for AC (question 84)*

Day 4

Topics: *Series and parallel LR circuits*
Questions: *61 through 80*
Lab Exercise: *Series LR circuit (question 85)*

Day 5

Exam 1: *includes Inductive reactance performance assessment*
Lab Exercise: *Oscilloscope probe ($\times 10$) compensation (question 86)*

Practice and challenge problems

Questions: *89 through the end of the worksheet*

Impending deadlines

Troubleshooting assessment (AC bridge circuit) due at end of ELTR110, Section 3
Question 87: Troubleshooting log
Question 88: Sample troubleshooting assessment grading criteria

Skill standards addressed by this course section

EIA Raising the Standard; Electronics Technician Skills for Today and Tomorrow, June 1994

C Technical Skills – AC circuits

- C.01 Demonstrate an understanding of sources of electricity in AC circuits.
- C.02 Demonstrate an understanding of the properties of an AC signal.
- C.03 Demonstrate an understanding of the principles of operation and characteristics of sinusoidal and non-sinusoidal wave forms.
- C.05 Demonstrate an understanding of measurement of power in AC circuits.
- C.11 Understand principles and operations of AC inductive circuits.
- C.12 Fabricate and demonstrate AC inductive circuits.
- C.13 Troubleshoot and repair AC inductive circuits.

B Basic and Practical Skills – Communicating on the Job

- B.01 Use effective written and other communication skills. *Met by group discussion and completion of labwork.*
- B.03 Employ appropriate skills for gathering and retaining information. *Met by research and preparation prior to group discussion.*
- B.04 Interpret written, graphic, and oral instructions. *Met by completion of labwork.*
- B.06 Use language appropriate to the situation. *Met by group discussion and in explaining completed labwork.*
- B.07 Participate in meetings in a positive and constructive manner. *Met by group discussion.*
- B.08 Use job-related terminology. *Met by group discussion and in explaining completed labwork.*
- B.10 Document work projects, procedures, tests, and equipment failures. *Met by project construction and/or troubleshooting assessments.*

C Basic and Practical Skills – Solving Problems and Critical Thinking

- C.01 Identify the problem. *Met by research and preparation prior to group discussion.*
- C.03 Identify available solutions and their impact including evaluating credibility of information, and locating information. *Met by research and preparation prior to group discussion.*
- C.07 Organize personal workloads. *Met by daily labwork, preparatory research, and project management.*
- C.08 Participate in brainstorming sessions to generate new ideas and solve problems. *Met by group discussion.*

D Basic and Practical Skills – Reading

- D.01 Read and apply various sources of technical information (e.g. manufacturer literature, codes, and regulations). *Met by research and preparation prior to group discussion.*

E Basic and Practical Skills – Proficiency in Mathematics

- E.01 Determine if a solution is reasonable.
- E.02 Demonstrate ability to use a simple electronic calculator.
- E.05 Solve problems and [sic] make applications involving integers, fractions, decimals, percentages, and ratios using order of operations.
- E.06 Translate written and/or verbal statements into mathematical expressions.
- E.09 Read scale on measurement device(s) and make interpolations where appropriate. *Met by oscilloscope usage.*
- E.12 Interpret and use tables, charts, maps, and/or graphs.
- E.13 Identify patterns, note trends, and/or draw conclusions from tables, charts, maps, and/or graphs.
- E.15 Simplify and solve algebraic expressions and formulas.
- E.16 Select and use formulas appropriately.
- E.17 Understand and use scientific notation.
- E.20 Graph functions.
- E.26 Apply Pythagorean theorem.
- E.27 Identify basic functions of sine, cosine, and tangent.
- E.28 Compute and solve problems using basic trigonometric functions.

Common areas of confusion for students

Difficult concept: *RMS versus peak and average measurements.*

The very idea of assigning a fixed number for AC voltage or current that (by definition) constantly changes magnitude and direction seems strange. Consequently, there is more than one way to do it. We may assign that value according to the *highest* magnitude reached in a cycle, in which case we call it the *peak* measurement. We may mathematically integrate the waveform over time to figure the mean magnitude, in which case we call it the *average* measurement. Or we may figure out what level of DC (voltage or current) causes the exact same amount of average power to be dissipated by a standard resistive load, in which case we call it the *RMS* measurement. One common mistake here is to think that the relationship between RMS, average, and peak measurements is a matter of fixed ratios. The number "0.707" is memorized by every beginning electronics student as the ratio between RMS and peak, but what is commonly overlooked is that this particular ratio holds true *for perfect sine-waves only!* A wave with a different shape will have a different mathematical relationship between peak and RMS values.

Difficult concept: *Resistance versus Reactance versus Impedance.*

These three terms represent different forms of opposition to electric current. Despite the fact that they are measured in the same unit (ohms: Ω), they are not the same. Resistance is best thought of as electrical *friction*, whereas reactance is best thought of as electrical *inertia*. Whereas resistance creates a voltage drop by dissipating energy, reactance creates a voltage drop by *storing* and *releasing* energy. Impedance is a term encompassing both resistance and reactance, usually a combination of both.

Difficult concept: *Phasors, used to represent AC amplitude and phase relations.*

A powerful tool used for understanding the operation of AC circuits is the *phasor diagram*, consisting of arrows pointing in different directions: the length of each arrow representing the amplitude of some AC quantity (voltage, current, or impedance), and the angle of each arrow representing the shift in phase relative to the other arrows. By representing each AC quantity thusly, we may more easily calculate their relationships to one another, with the phasors showing us how to apply trigonometry (Pythagorean Theorem, sine, cosine, and tangent functions) to the various calculations. An analytical parallel to the graphic tool of phasor diagrams is *complex numbers*, where we represent each phasor (arrow) by a pair of numbers: either a magnitude and angle (polar notation), or by "real" and "imaginary" magnitudes (rectangular notation). Where phasor diagrams are helpful is in applications where their respective AC quantities *add*: the resultant of two or more phasors stacked tip-to-tail being the mathematical sum of the phasors. Complex numbers, on the other hand, may be added, subtracted, multiplied, and divided; the last two operations being difficult to graphically represent with arrows.

Difficult concept: *Conductance, susceptance, and admittance.*

Conductance, symbolized by the letter G , is the mathematical reciprocal of resistance ($\frac{1}{R}$). Students typically encounter this quantity in their DC studies and quickly ignore it. In AC calculations, however, conductance and its AC counterparts (*susceptance*, the reciprocal of reactance $B = \frac{1}{X}$ and *admittance*, the reciprocal of impedance $Y = \frac{1}{Z}$) are very necessary in order to draw phasor diagrams for parallel networks.

Common mistake: *Common ground connections on oscilloscope inputs.*

Oscilloscopes having more than one input "channel" share common ground connections between these channels. That is to say, with two or more input cables plugged into an oscilloscope, the "ground" clip of each input cable is electrically common with the ground clip of every other input cable. This can easily cause problems, as points in a circuit connected by multiple input cable ground clips will be made common with each other (as well as common with the oscilloscope case, which itself is connected to earth ground). One way to avoid unintentional short-circuits through these ground connections is to only connect *one* ground clip of the oscilloscope to the circuit ground, removing or tying back all the other inputs' ground clips since they are redundant.

Questions

Question 1

What is the difference between *DC* and *AC* electricity? Identify some common sources of each type of electricity.

file 00028

Question 2

Alternating current produced by electromechanical generators (or *alternators* as they are sometimes designated) typically follows a sine-wave pattern over time. Plot a sine wave on the following graph, by tracing the height of a rotating vector inside the circle to the left of the graph:

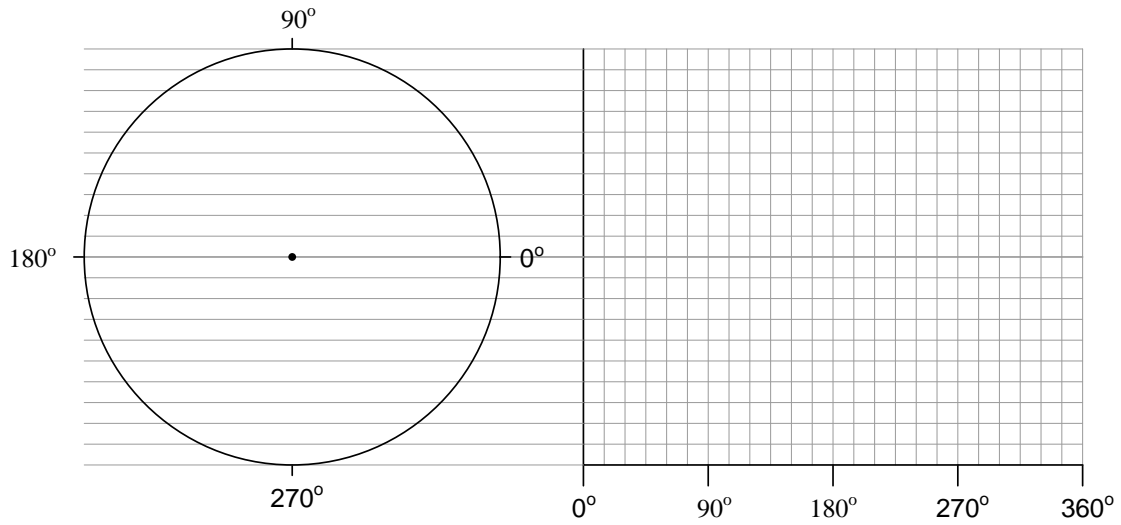

To illustrate the principle here, I will show how the point is plotted for a rotation of 45°:

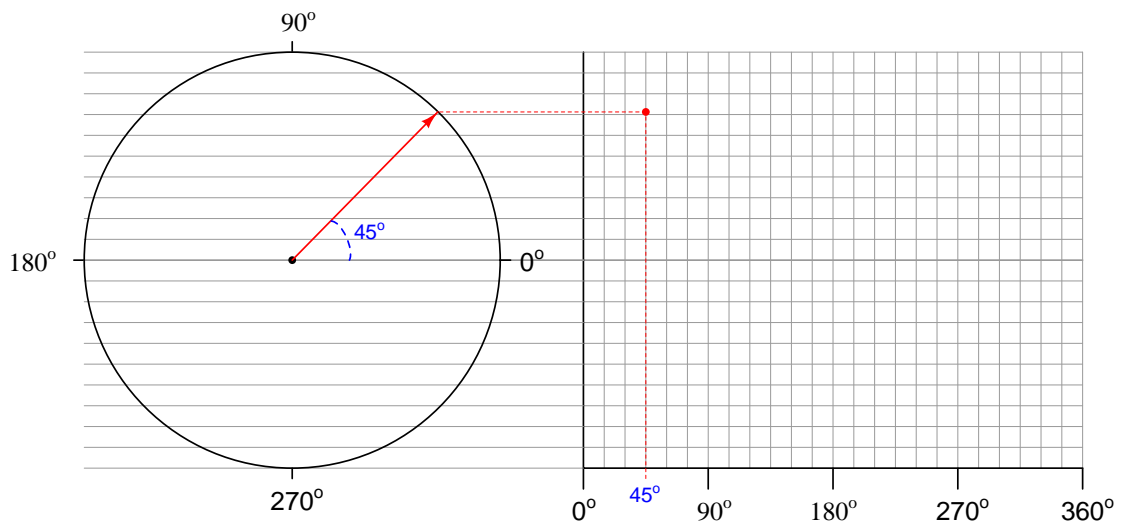

You may wish to use a *protractor* to precisely mark the angles along the rotation of the circle, in making your sine-wave plot.

[file 00093](#)

Question 3

All other factors being equal, which possesses a greater potential for inducing harmful electric shock, DC electricity or AC electricity at a frequency of 60 Hertz? Be sure to back up your answer with research data!

[file 03289](#)

Question 4

Apply the following terms to this graph of an AC voltage measured over time:

- Frequency
- Period
- Hertz
- Amplitude

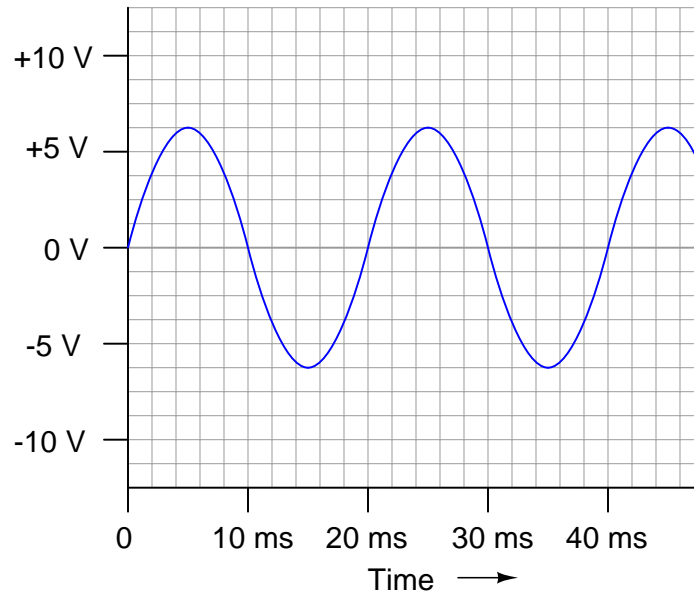

[file 00054](#)

Question 5

Frequency used to be expressed in units of *cycles per second*, abbreviated as *CPS*. Now, the standardized unit is *Hertz*. Explain the meaning of the obsolete frequency unit: what, exactly, does it mean for an AC voltage or current to have x number of "cycles per second?"

[file 00053](#)

Question 6

If an AC voltage has a frequency of 350 Hz, how long (in time) is its period?

[file 00055](#)

Question 7

Radio waves are comprised of oscillating electric and magnetic fields, which radiate away from sources of high-frequency AC at (nearly) the speed of light. An important measure of a radio wave is its *wavelength*, defined as the distance the wave travels in one complete cycle.

Suppose a radio transmitter operates at a fixed frequency of 950 kHz. Calculate the approximate wavelength (λ) of the radio waves emanating from the transmitter tower, in the metric distance unit of meters. Also, write the equation you used to solve for λ .

[file 01819](#)

Question 8

If the only instrument you had in your possession to detect AC voltage signals was an audio speaker, how could you use it to determine which of two AC voltage waveforms has the greatest period?

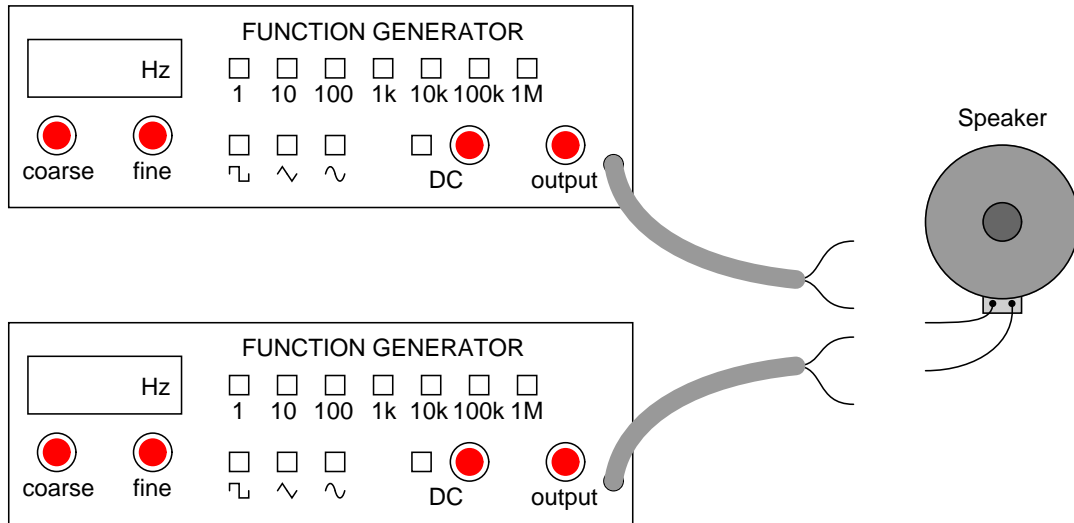

[file 00387](#)

Question 9

An *oscilloscope* is a very useful piece of electronic test equipment. Most everyone has seen an oscilloscope in use, in the form of a heart-rate monitor (electrocardiogram, or EKG) of the type seen in doctor's offices and hospitals.

When monitoring heart beats, what do the two axes (horizontal and vertical) of the oscilloscope screen represent?

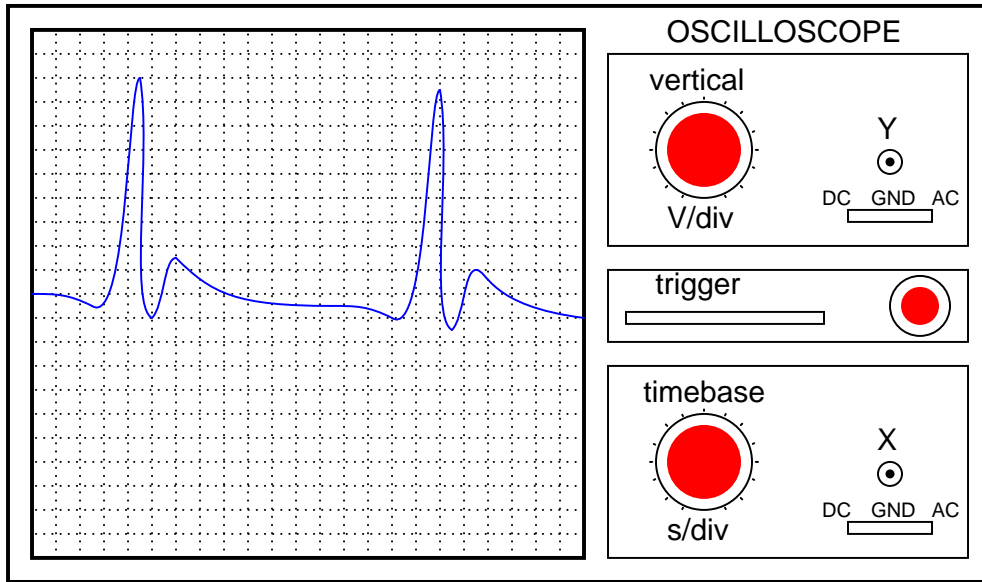

In general electronics use, when measuring AC voltage signals, what do the two axes (horizontal and vertical) of the oscilloscope screen represent?

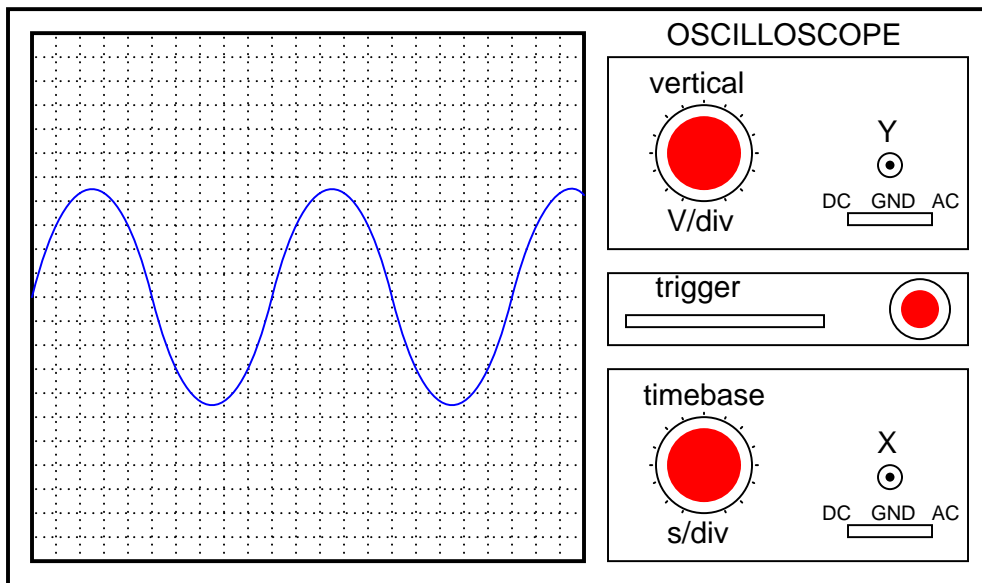

file 00530

Question 10

The core of an analog oscilloscope is a special type of vacuum tube known as a *Cathode Ray Tube*, or *CRT*. While similar in function to the CRT used in televisions, oscilloscope display tubes are specially built for the purpose of serving as a measuring instrument.

Explain how a CRT functions. What goes on inside the tube to produce waveform displays on the screen?

file 00536

Question 11

When the vertical ("Y") axis of an oscilloscope is shorted, the result should be a straight line in the middle of the screen:

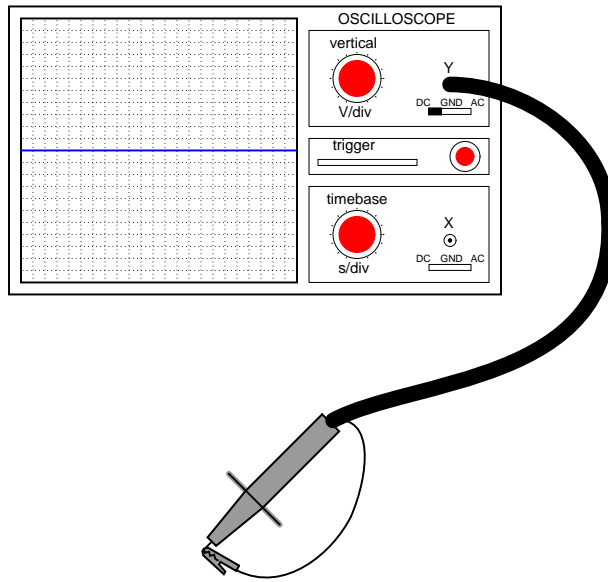

Determine the DC polarity of the voltage source, based on this illustration:

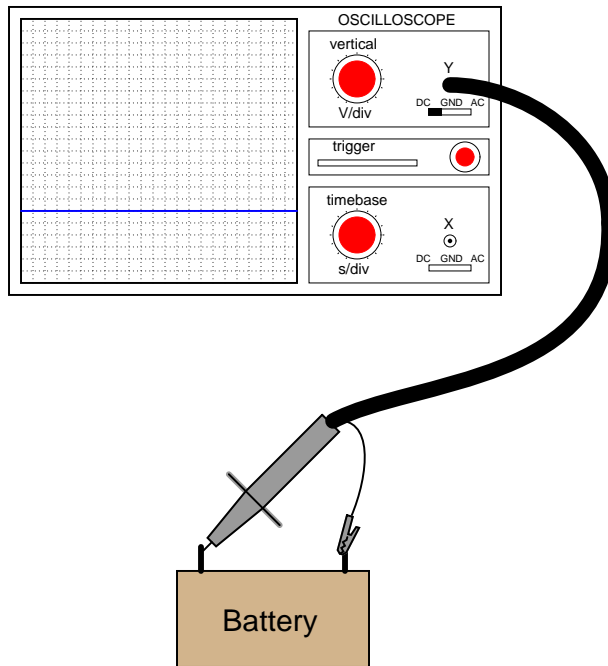

file 00531

Question 12

An oscilloscope is connected to a battery of unknown voltage. The result is a straight line on the display:

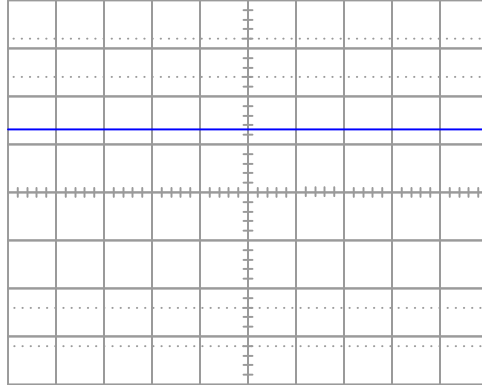

Assuming the oscilloscope display has been properly "zeroed" and the vertical sensitivity is set to 5 volts per division, determine the voltage of the battery.

file 01672

Question 13

A technician prepares to use an oscilloscope to display an AC voltage signal. After turning the oscilloscope on and connecting the Y input probe to the signal source test points, this display appears:

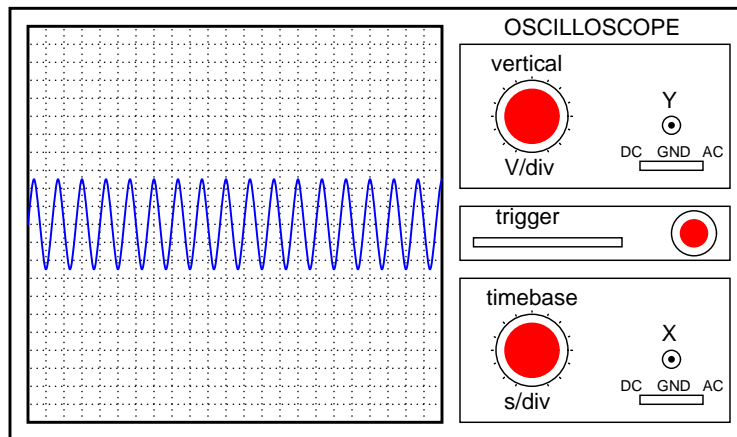

What display control(s) need to be adjusted on the oscilloscope in order to show fewer cycles of this signal on the screen, with a greater height (amplitude)?

file 00532

Question 14

A technician prepares to use an oscilloscope to display an AC voltage signal. After turning the oscilloscope on and connecting the Y input probe to the signal source test points, this display appears:

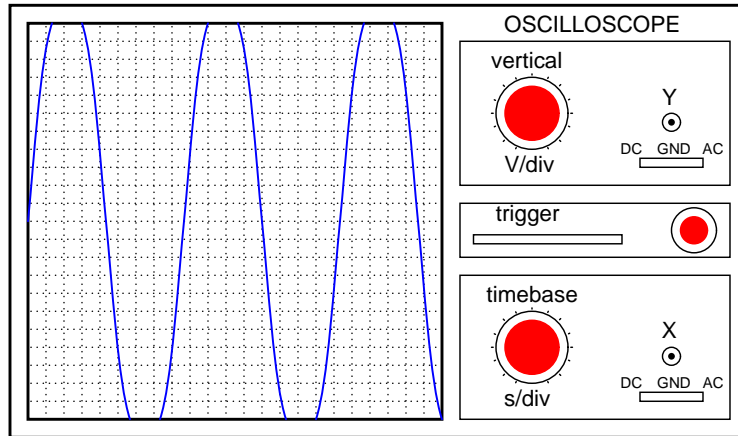

What display control(s) need to be adjusted on the oscilloscope in order to show a normal-looking wave on the screen?

[file 00534](#)

Question 15

A technician prepares to use an oscilloscope to display an AC voltage signal. After turning the oscilloscope on and connecting the Y input probe to the signal source test points, this display appears:

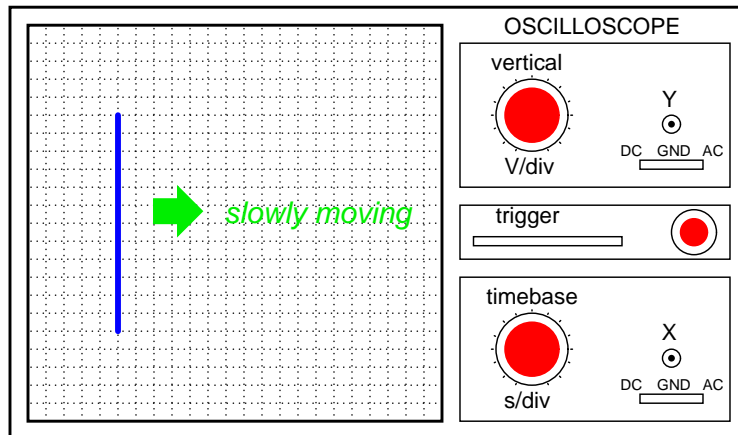

What appears on the oscilloscope screen is a vertical line that moves slowly from left to right. What display control(s) need to be adjusted on the oscilloscope in order to show a normal-looking wave on the screen?

[file 00533](#)

Question 16

A technician prepares to use an oscilloscope to display an AC voltage signal. After turning the oscilloscope on and connecting the Y input probe to the signal source test points, this display appears:

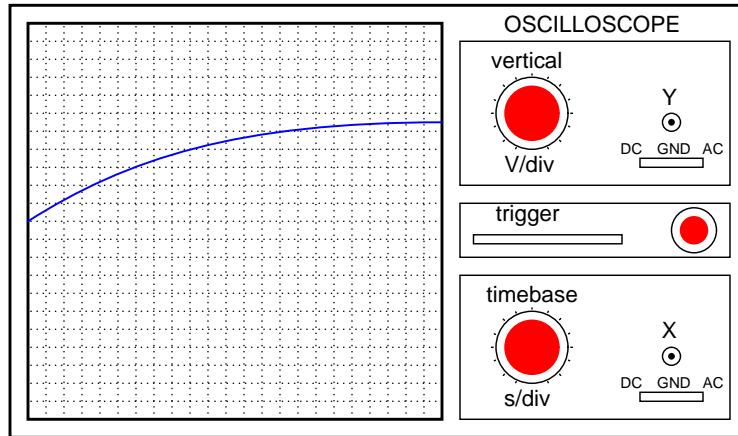

What display control(s) need to be adjusted on the oscilloscope in order to show a normal-looking wave on the screen?

[file 00535](#)

Question 17

Determine the frequency of this waveform, as displayed by an oscilloscope with a vertical sensitivity of 2 volts per division and a timebase of 0.5 milliseconds per division:

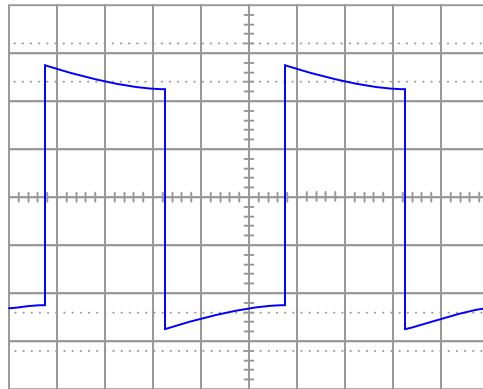

[file 01668](#)

Question 18

Assuming the vertical sensitivity control is set to 2 volts per division, and the timebase control is set to $10 \mu\text{s}$ per division, calculate the amplitude of this "sawtooth" wave (in volts peak and volts peak-to-peak) as well as its frequency.

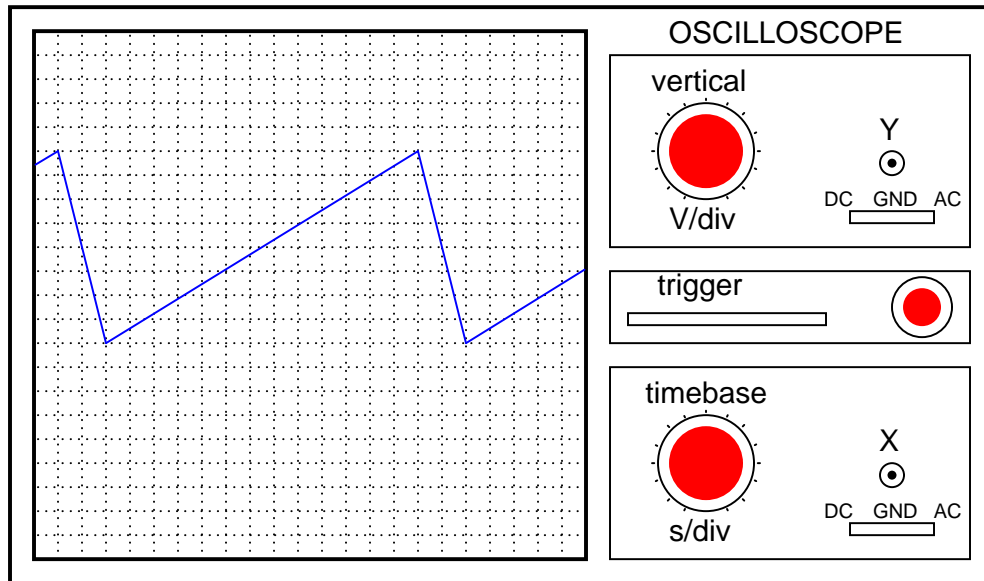

file 00541

Question 19

Most oscilloscopes can only directly measure voltage, not current. One way to measure AC current with an oscilloscope is to measure the voltage dropped across a *shunt resistor*. Since the voltage dropped across a resistor is proportional to the current through that resistor, whatever wave-shape the current is will be translated into a voltage drop with the exact same wave-shape.

However, one must be very careful when connecting an oscilloscope to any part of a grounded system, as many electric power systems are. Note what happens here when a technician attempts to connect the oscilloscope across a shunt resistor located on the "hot" side of a grounded 120 VAC motor circuit:

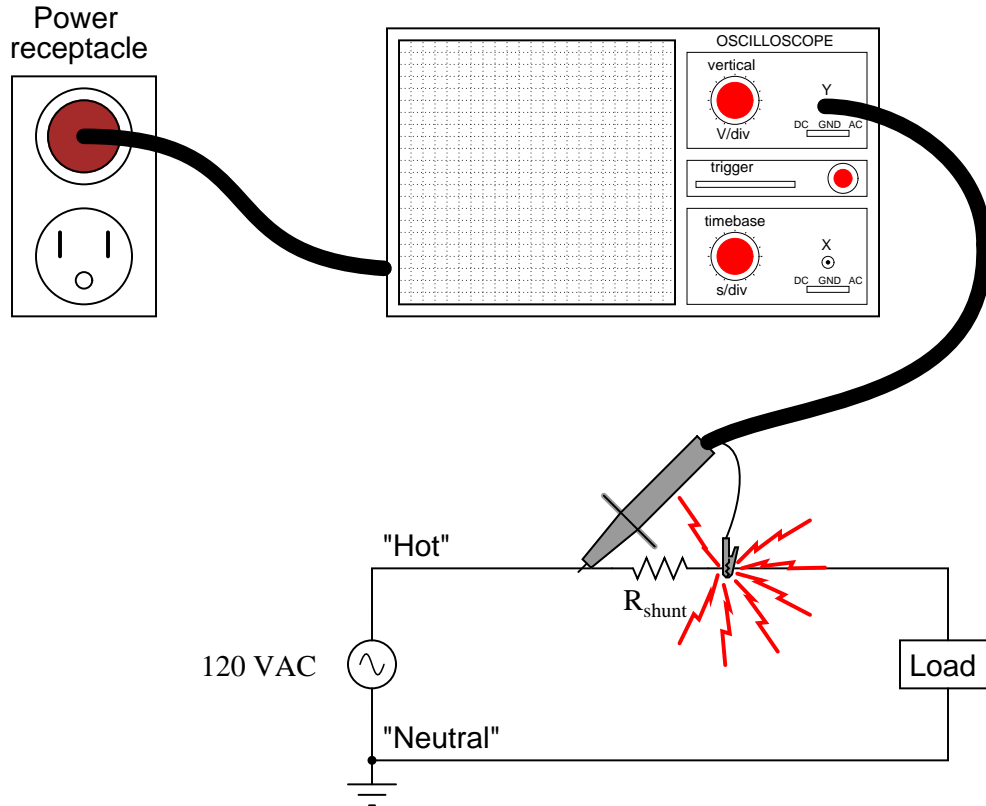

Here, the reference lead of the oscilloscope (the small alligator clip, not the sharp-tipped probe) creates a short-circuit in the power system. Explain why this happens.

[file 01820](#)

Question 20

Most oscilloscopes have at least two vertical inputs, used to display more than one waveform simultaneously:

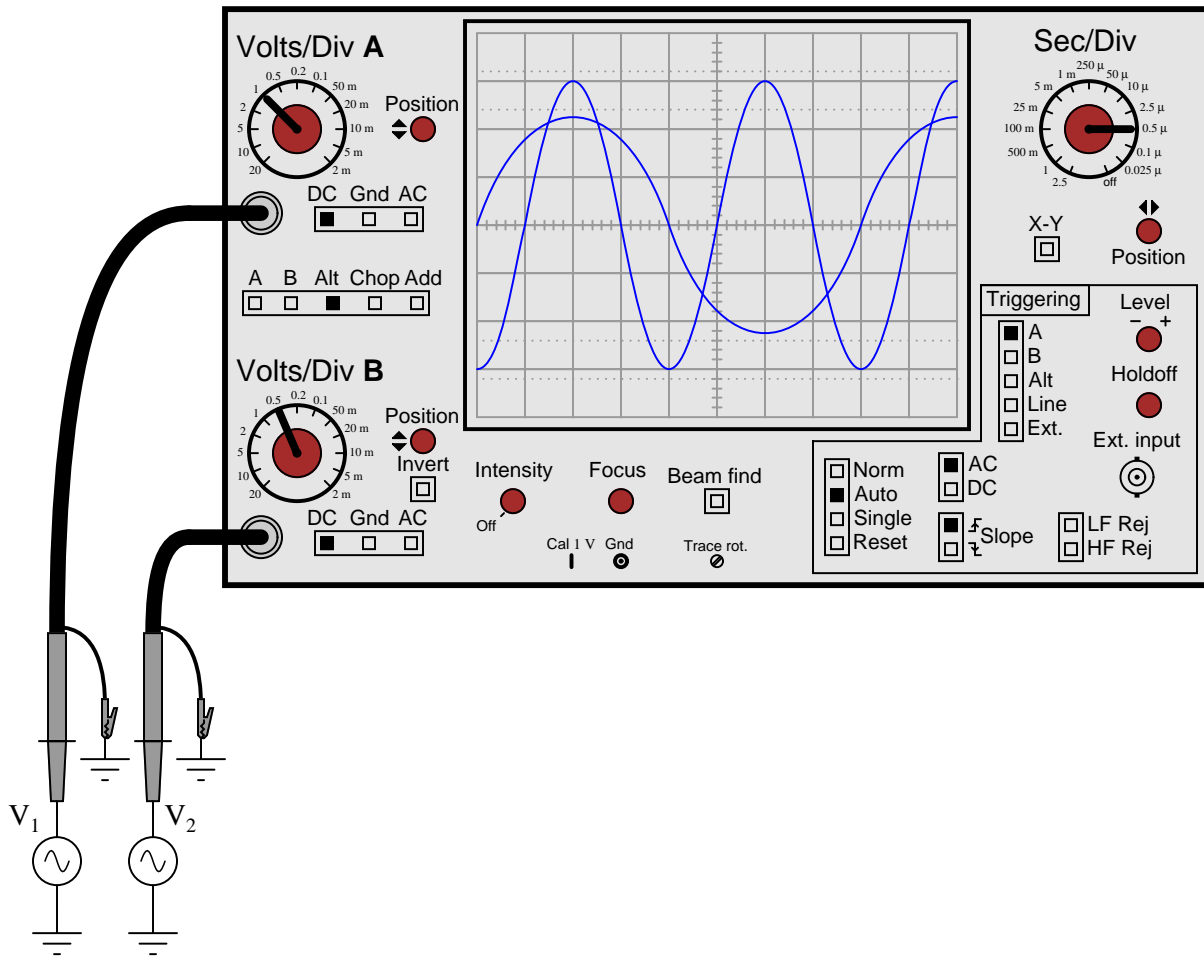

While this feature is extremely useful, one must be careful in connecting two sources of AC voltage to an oscilloscope. Since the "reference" or "ground" clips of *each* probe are electrically common with the oscilloscope's metal chassis, they are electrically common with each other as well.

Explain what sort of problem would be caused by connecting a dual-trace oscilloscope to a circuit in the following manner:

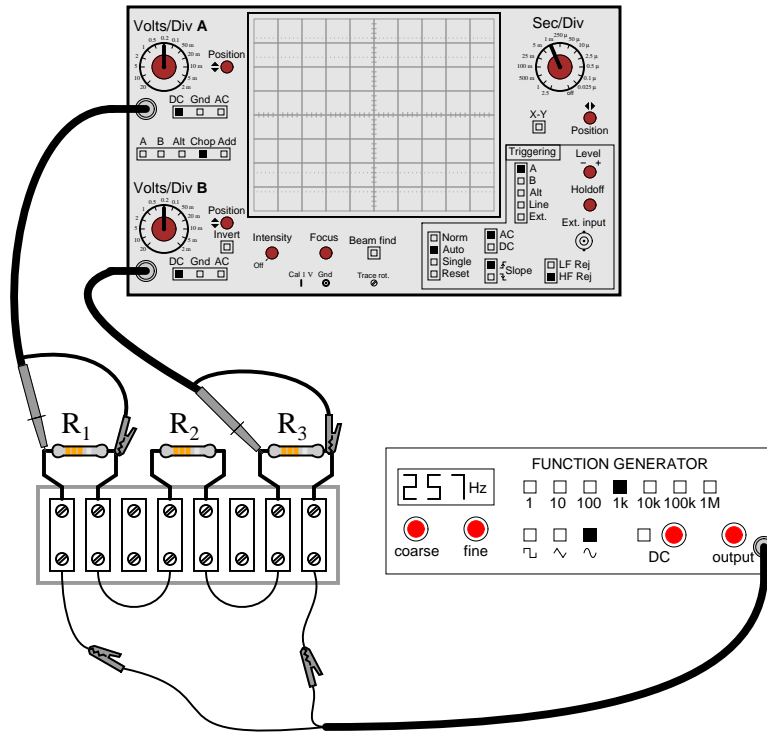

[file 01821](#)

Question 21

How is it possible to assign a fixed value of voltage or current (such as "120 volts") to an AC electrical quantity that is constantly changing, crossing 0 volts, and reversing polarity?

[file 00051](#)

Question 22

Suppose a DC power source with a voltage of 50 volts is connected to a 10Ω load. How much power will this load dissipate?

Now suppose the same 10Ω load is connected to a sinusoidal AC power source with a *peak* voltage of 50 volts. Will the load dissipate the same amount of power, more power, or less power? Explain your answer.

[file 00401](#)

Question 23

Suppose that a variable-voltage AC source is adjusted until it dissipates the exact same amount of power in a standard load resistance as a DC voltage source with an output of 120 volts:

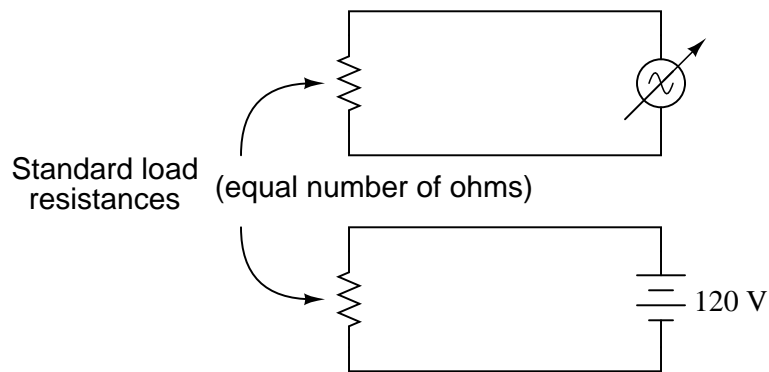

In this condition of equal power dissipation, how much voltage is the AC power supply outputting? Be as specific as you can in your answer.

file 00402

Question 24

Determine the RMS amplitude of this sinusoidal waveform, as displayed by an oscilloscope with a vertical sensitivity of 0.2 volts per division:

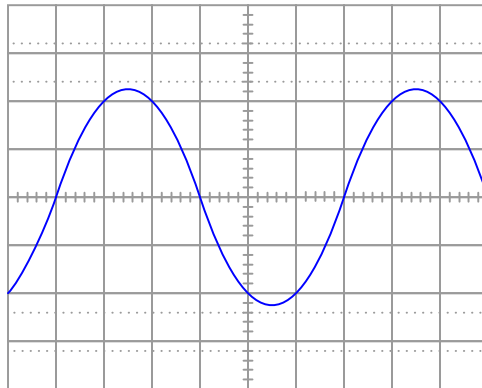

file 01818

Question 25

Determine the RMS voltage (amplitude) of this square-wave signal, as displayed by an oscilloscope with a vertical sensitivity of 0.5 volts per division:

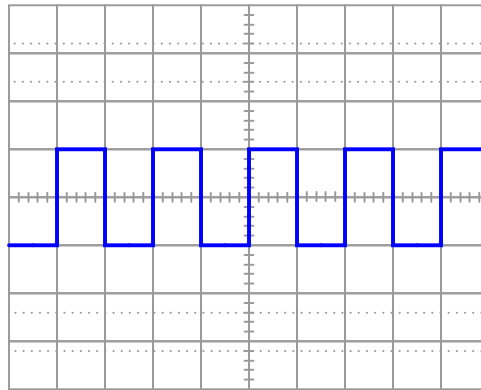

[file 01824](#)

Question 26

Suppose two voltmeters are connected to source of "mains" AC power in a residence, one meter is analog (D'Arsonval PMMC meter movement) while the other is true-RMS digital. They both register 117 volts while connected to this AC source.

Suddenly, a large electrical load is turned on somewhere in the system. This load both reduces the mains voltage and slightly distorts the shape of the waveform. The overall effect of this is average AC voltage has decreased by 4.5% from where it was, while RMS AC voltage has decreased by 6% from where it was. How much voltage does each voltmeter register now?

[file 02790](#)

Question 27

If we were to express the series-connected DC voltages as *phasors* (arrows pointing with a particular length and a particular direction, graphically expressing magnitude and polarity of an electrical signal), how would we draw them in such a way that the total (or *resultant*) phasors accurately expressed the total voltage of each series-connected pair?



If we were to assign angle values to each of these phasors, what would you suggest?

[file 00493](#)

Question 28

Calculate the total voltage of these series-connected voltage sources:

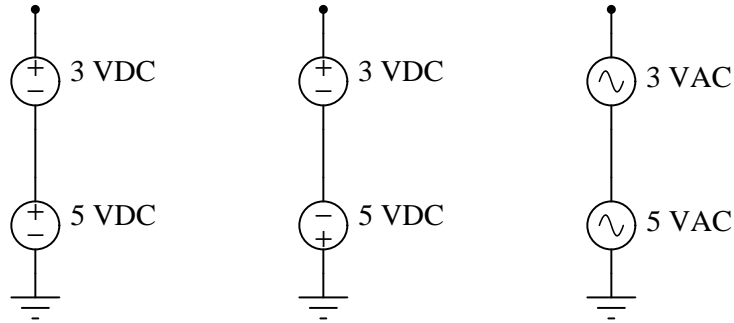

[file 00492](#)

Question 29

Using a computer or graphing calculator, plot the sum of these two sine waves:

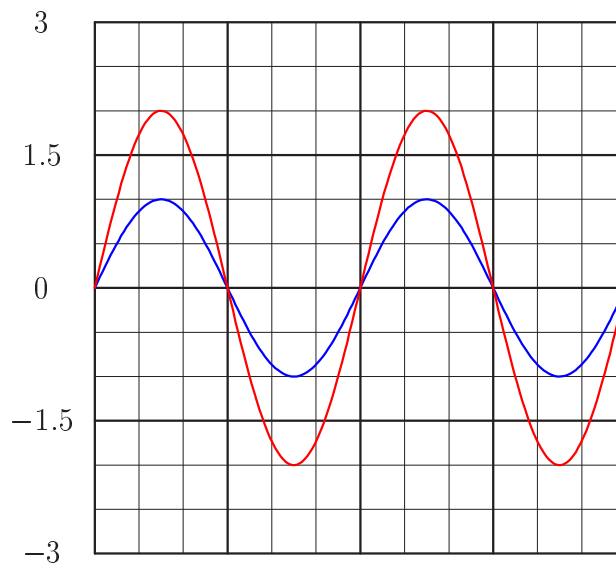

What do you suppose the sum of a 1-volt (peak) sine wave and a 2-volt (peak) sine wave will be, if both waves are perfectly in-phase with each other?

Hint: you will need to enter equations into your plotting device that look something like this:

$$y1 = \sin x$$

$$y2 = 2 * \sin x$$

$$y3 = y1 + y2$$

[file 01557](#)

Question 30

Using a computer or graphing calculator, plot the sum of these two sine waves:

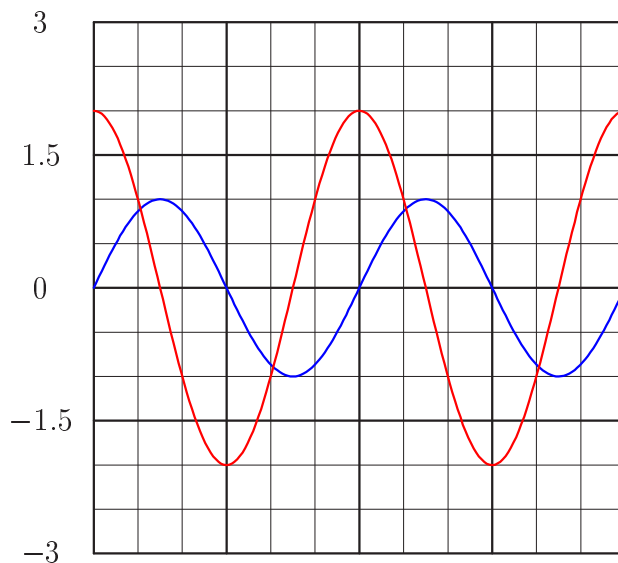

Hint: you will need to enter equations into your plotting device that look something like this:

$$y1 = \sin x$$

$$y2 = 2 * \sin (x + 90)$$

$$y3 = y1 + y2$$

Note: the second equation assumes your calculator has been set up to calculate trigonometric functions in angle units of *degrees* rather than *radians*. If you wish to plot these same waveforms (with the same phase shift shown) using radians as the unit of angle measurement, you must enter the second equation as follows:

$$y2 = 2 * \sin (x + 1.5708)$$

[file 01558](#)

Question 31

Special types of vectors called *phasors* are often used to depict the magnitude and phase-shifts of sinusoidal AC voltages and currents. Suppose that the following phasors represent the series summation of two AC voltages, one with a magnitude of 3 volts and the other with a magnitude of 4 volts:

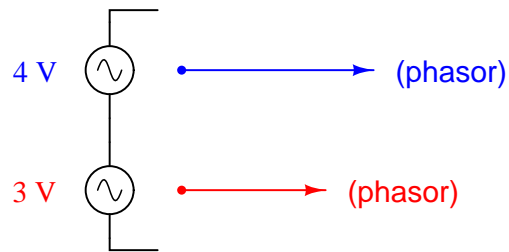

Explain what each of the following phasor diagrams represents, in electrical terms:

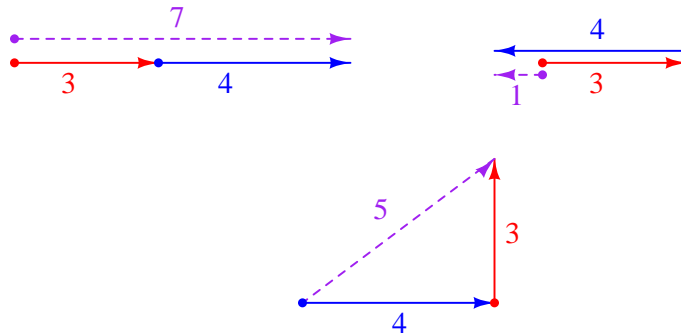

Also explain the significance of these sums: that we may obtain three *different* values of total voltage (7 volts, 1 volt, or 5 volts) from the same series-connected AC voltages. What does this mean for us as we prepare to analyze AC circuits using the rules we learned for DC circuits?

file 01559

Question 32

When drawing phasor diagrams, there is a standardized orientation for all angles used to ensure consistency between diagrams. This orientation is usually referenced to a set of perpendicular lines, like the x and y axes commonly seen when graphing algebraic functions:

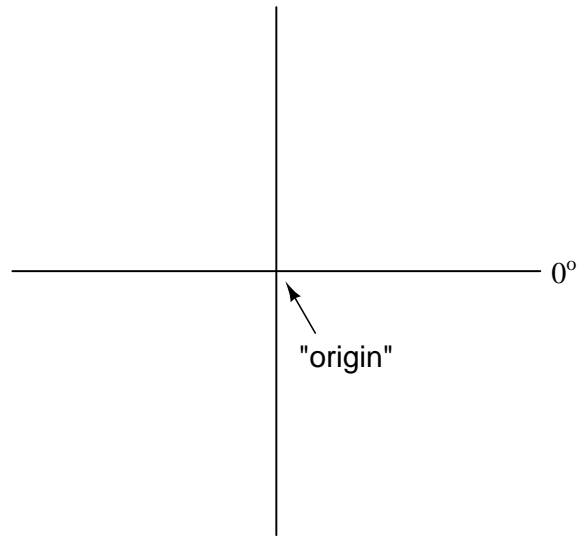

The intersection of the two axes is called the *origin*, and straight horizontal to the right is the definition of zero degrees (0°). Thus, a phasor with a magnitude of 6 and an angle of 0° would look like this on the diagram:

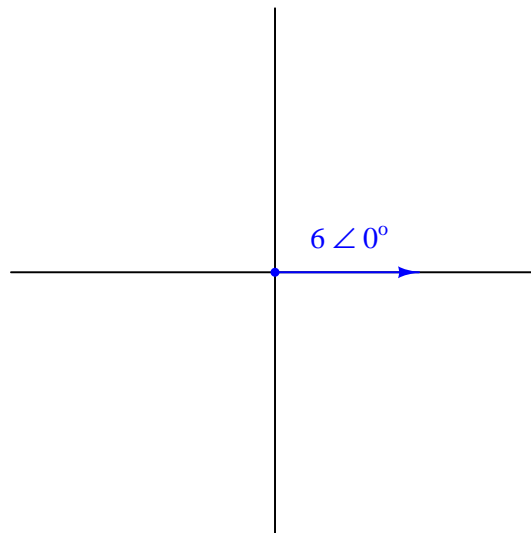

Draw a phasor with a magnitude of 10 and an angle of 100 degrees on the above diagram, as well as a phasor with a magnitude of 2 and an angle of -45° . Label what directions 90° , 180° , and 270° would indicate on the same diagram.

[file 02099](#)

Question 33

What does it mean to *add* two or more phasors together, in a geometric sense? How would one draw a phasor diagram showing the following two phasors added together?

How would you add these phasors together?

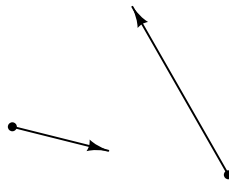

[file 02100](#)

Question 34

The *Pythagorean Theorem* is used to calculate the length of the hypotenuse of a right triangle given the lengths of the other two sides:

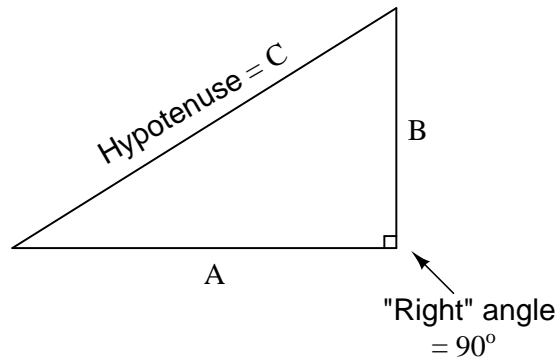

Write the standard form of the Pythagorean Theorem, and give an example of its use.

[file 02102](#)

Question 35

Determine the sum of these two phasors, and draw a phasor diagram showing their geometric addition:

$$(4 \angle 0^\circ) + (3 \angle 90^\circ)$$

How might a phasor arithmetic problem such as this relate to an AC circuit?

[file 00495](#)

Question 36

Phasors may be symbolically described in two different ways: *polar notation* and *rectangular notation*. Explain what each of these notations means, and why either one may adequately describe a phasor.

[file 02101](#)

Question 37

These two phasors are written in a form known as *polar notation*. Re-write them in *rectangular notation*:

$$4 \angle 0^\circ =$$

$$3 \angle 90^\circ =$$

file 00497

Question 38

In this graph of two AC voltages, which one is *leading* and which one is *lagging*?

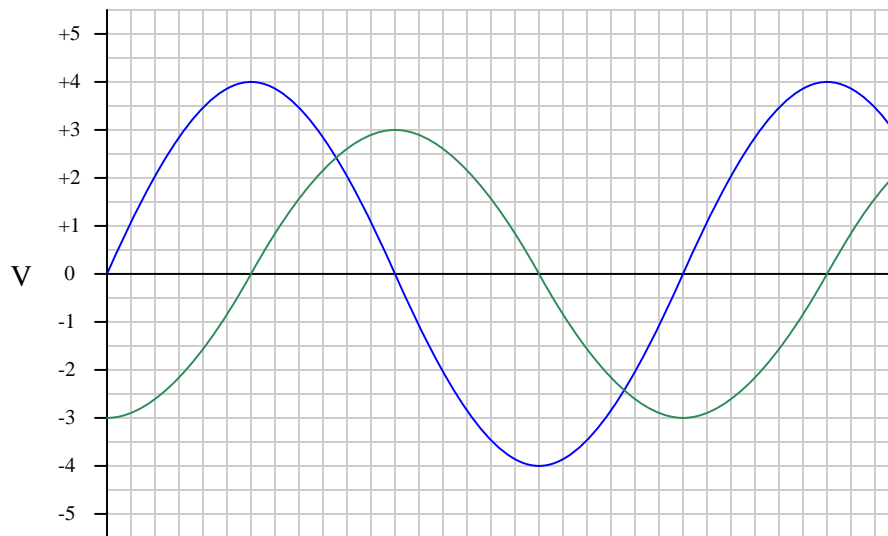

If the 4-volt (peak) sine wave is denoted in phasor notation as $4 \text{ V} \angle 0^\circ$, how should the 3-volt (peak) waveform be denoted? Express your answer in both polar and rectangular forms.

If the 4-volt (peak) sine wave is denoted in phasor notation as $4 \text{ V} \angle 90^\circ$, how should the 3-volt (peak) waveform be denoted? Express your answer in both polar and rectangular forms.

file 00499

Question 39

A common feature of oscilloscopes is the $X - Y$ mode, where the vertical and horizontal plot directions are driven by external signals, rather than only the vertical direction being driven by a measured signal and the horizontal being driven by the oscilloscope's internal sweep circuitry:

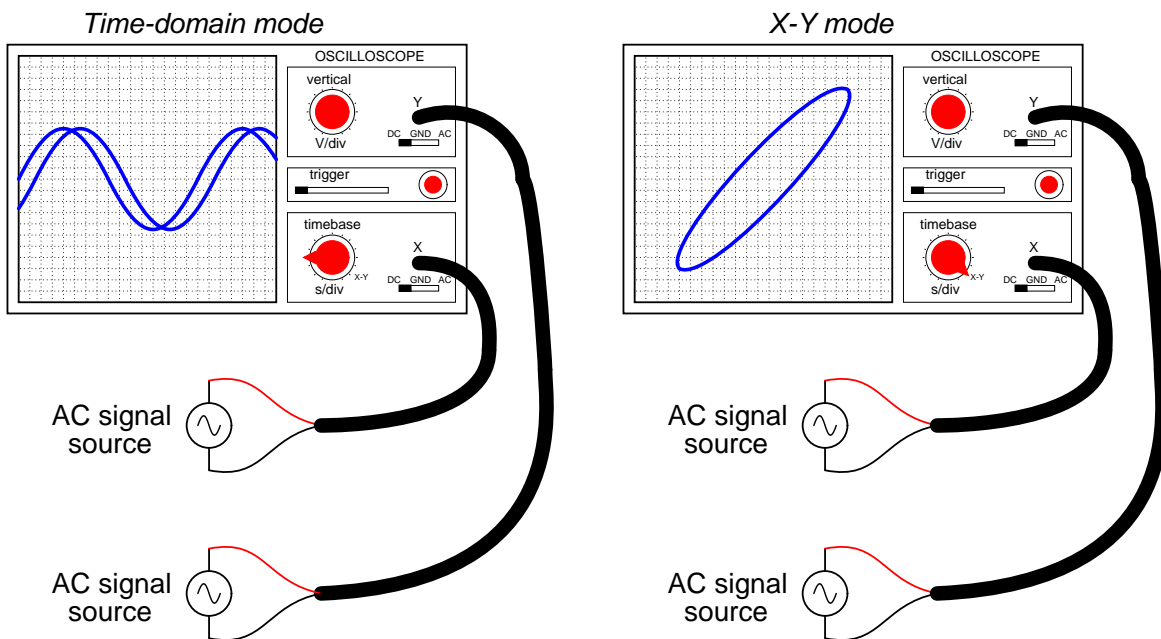

The oval pattern shown in the right-hand oscilloscope display of the above illustration is typical for two sinusoidal waveforms of the same frequency, but slightly out of phase with one another. The technical name for this type of $X - Y$ plot is a *Lissajous figure*.

What should the Lissajous figure look like for two sinusoidal waveforms that are at exactly the same frequency, and exactly the same phase (0 degrees phase shift between the two)? What should the Lissajous figure look like for two sinusoidal waveforms that are exactly 90 degrees out of phase?

A good way to answer each of these questions is to plot the specified waveforms over time on graph paper, then determine their instantaneous amplitudes at equal time intervals, and then determine where that would place the "dot" on the oscilloscope screen at those points in time, in $X - Y$ mode. To help you, I'll provide two blank oscilloscope displays for you to draw the Lissajous figures on:



Question 40

Lissajous figures, drawn by an oscilloscope, are a powerful tool for visualizing the phase relationship between two waveforms. In fact, there is a mathematical formula for calculating the amount of phase shift between two sinusoidal signals, given a couple of dimensional measurements of the figure on the oscilloscope screen.

The procedure begins with adjusting the vertical and horizontal amplitude controls so that the Lissajous figure is proportional: just as tall as it is wide on the screen (n). Then, we make sure the figure is centered on the screen and we take a measurement of the distance between the x-axis intercept points (m), as such:

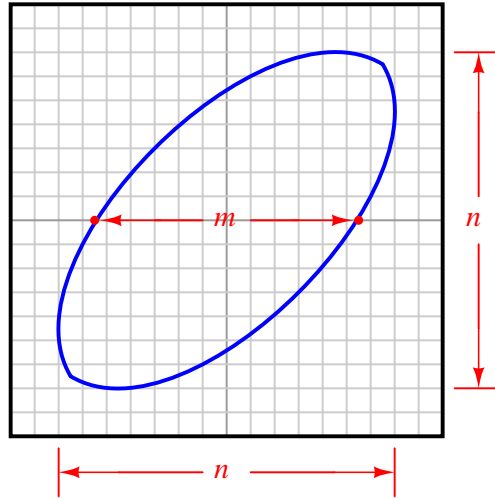

Determine what the formula is for calculating the phase shift angle for this circuit, given these dimensions. Hint: the formula is trigonometric! If you don't know where to begin, recall what the respective Lissajous figures look like for a 0° phase shift and for a 90° phase shift, and work from there.

[file 01481](#)

Question 41

As a general rule, inductors oppose change in (**choose:** voltage or current), and they do so by . . . (complete the sentence).

Based on this rule, determine how an inductor would react to a constant AC current that increases in frequency. Would an inductor drop more or less voltage, given a greater frequency? Explain your answer.

[file 00578](#)

Question 42

$\int f(x) dx$ *Calculus alert!*

We know that the formula relating instantaneous voltage and current in an inductor is this:

$$e = L \frac{di}{dt}$$

Knowing this, determine at what points on this sine wave plot for inductor current is the inductor voltage equal to zero, and where the voltage is at its positive and negative peaks. Then, connect these points to draw the waveform for inductor voltage:

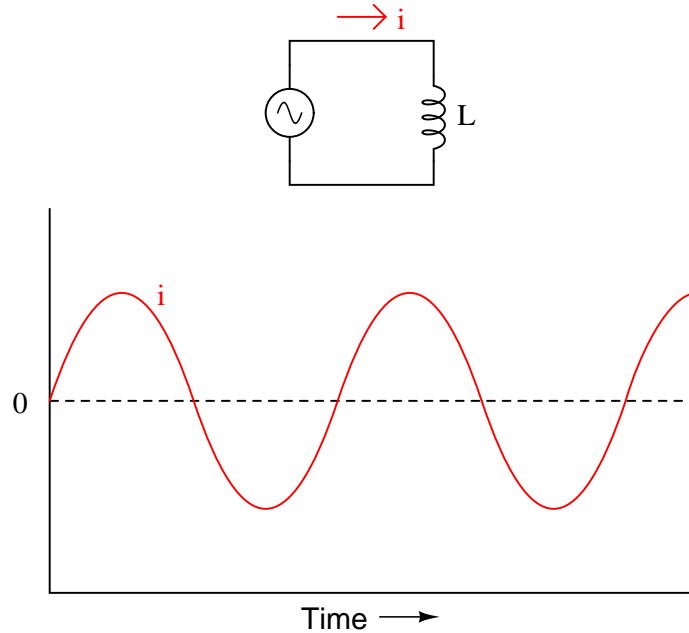

How much phase shift (in degrees) is there between the voltage and current waveforms? Which waveform is leading and which waveform is lagging?

[file 00576](#)

Question 43

Does an inductor's opposition to alternating current increase or decrease as the frequency of that current increases? Also, explain why we refer to this opposition of AC current in an inductor as *reactance* instead of *resistance*.

[file 00580](#)

Question 44

What will happen to the brightness of the light bulb as the iron core is moved away from the wire coil in this circuit? Explain why this happens.

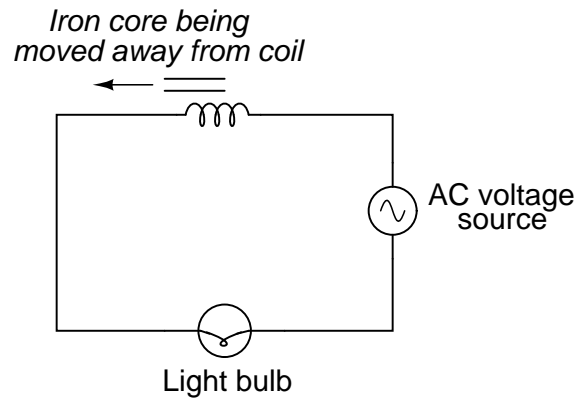

[file 00095](#)

Question 45

An inductor rated at 4 Henrys is subjected to a sinusoidal AC voltage of 24 volts RMS, at a frequency of 60 hertz. Write the formula for calculating inductive reactance (X_L), and solve for current through the inductor.

[file 00582](#)

Question 46

At what frequency does a 350 mH inductor have 4.7 k Ω of reactance? Write the formula for solving this, in addition to calculating the frequency.

[file 00586](#)

Question 47

How much inductance would an inductor have to possess in order to provide 540 Ω of reactance at a frequency of 400 Hz? Write the formula for solving this, in addition to calculating the frequency.

[file 03277](#)

Question 48

Explain all the steps necessary to calculate the amount of current in this inductive AC circuit:

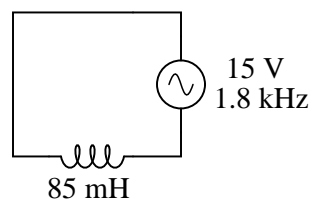

[file 01552](#)

Question 49

In this AC circuit, the resistor offers $300\ \Omega$ of resistance, and the inductor offers $400\ \Omega$ of reactance. Together, their series opposition to alternating current results in a current of $10\ \text{mA}$ from the $5\ \text{VAC}$ source:

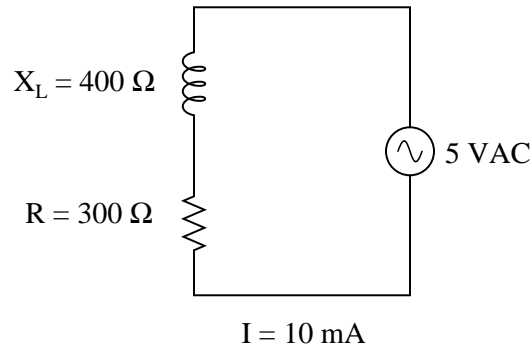

How many ohms of opposition does the series combination of resistor and inductor offer? What name do we give to this quantity, and how do we symbolize it, being that it is composed of both resistance (R) and reactance (X)?

[file 00584](#)

Question 50

While studying DC circuit theory, you learned that *resistance* was an expression of a component's opposition to electric current. Then, when studying AC circuit theory, you learned that *reactance* was another type of opposition to current. Now, a third term is introduced: *impedance*. Like resistance and reactance, impedance is also a form of opposition to electric current.

Explain the difference between these three quantities (resistance, reactance, and impedance) using your own words.

[file 01567](#)

Question 51

In DC circuits, we have Ohm's Law to relate voltage, current, and resistance together:

$$E = IR$$

In AC circuits, we similarly need a formula to relate voltage, current, and *impedance* together. Write three equations, one solving for each of these three variables: a set of Ohm's Law formulae for AC circuits. Be prepared to show how you may use algebra to manipulate one of these equations into the other two forms.

[file 00590](#)

Question 52

It is often necessary to represent AC circuit quantities as complex numbers rather than as scalar numbers, because both magnitude *and* phase angle are necessary to consider in certain calculations.

When representing AC voltages and currents in polar form, the angle given refers to the phase shift between the given voltage or current, and a "reference" voltage or current at the same frequency somewhere else in the circuit. So, a voltage of $3.5 \text{ V} \angle -45^\circ$ means a voltage of 3.5 volts magnitude, phase-shifted 45 degrees behind (lagging) the reference voltage (or current), which is defined to be at an angle of 0 degrees.

But what about *impedance* (Z)? Does impedance have a phase angle, too, or is it a simple scalar number like resistance or reactance?

Calculate the amount of current that would go through a 100 mH inductor with 36 volts RMS applied to it at a frequency of 400 Hz. Then, based on Ohm's Law for AC circuits and what you know of the phase relationship between voltage and current for an inductor, calculate the impedance of this inductor *in polar form*. Does a definite angle emerge from this calculation for the inductor's impedance? Explain why or why not.

[file 00588](#)

Question 53

If a sinusoidal voltage is applied to an impedance with a phase angle of 0° , the resulting voltage and current waveforms will look like this:

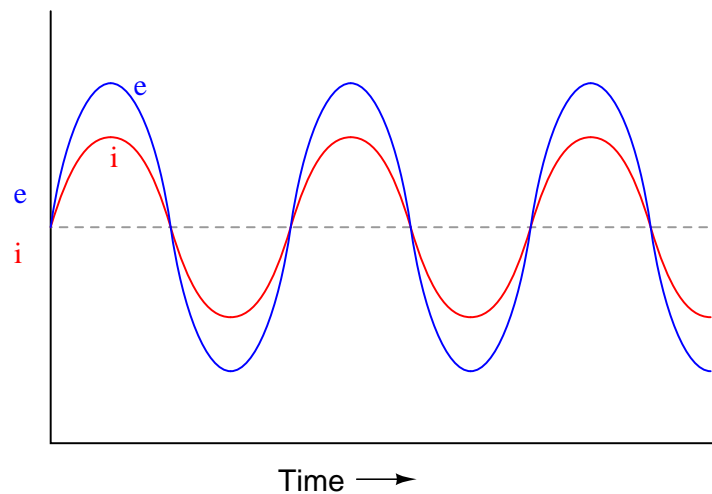

Given that power is the product of voltage and current ($p = ie$), plot the waveform for power in this circuit.

[file 00631](#)

Question 54

If a sinusoidal voltage is applied to an impedance with a phase angle of 90° , the resulting voltage and current waveforms will look like this:

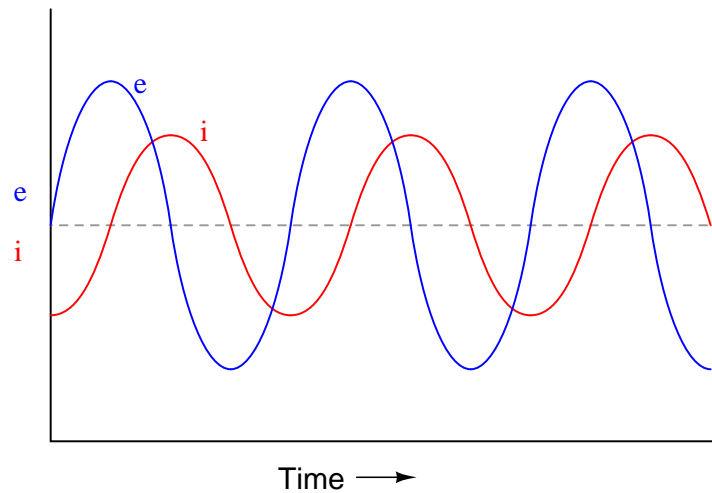

Given that power is the product of voltage and current ($p = ie$), plot the waveform for power in this circuit. Also, explain how the mnemonic phrase "*ELI the ICE man*" applies to these waveforms.

[file 00632](#)

Question 55

The *impedance triangle* is often used to graphically relate Z , R , and X in a series circuit:

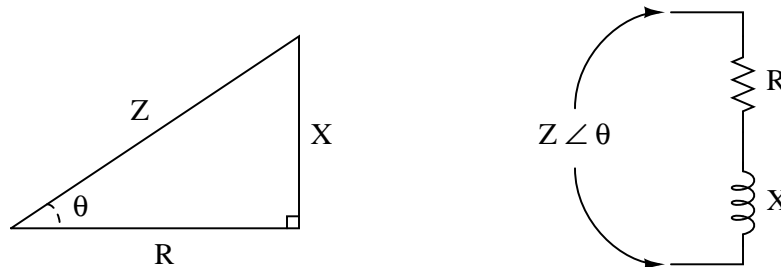

Unfortunately, many students do not grasp the significance of this triangle, but rather memorize it as a "trick" used to calculate one of the three variables given the other two. Explain *why* a right triangle is an appropriate form to relate these variables, and what each side of the triangle actually represents.

[file 02076](#)

Question 56

Use the "impedance triangle" to calculate the impedance of this series combination of resistance (R) and inductive reactance (X):

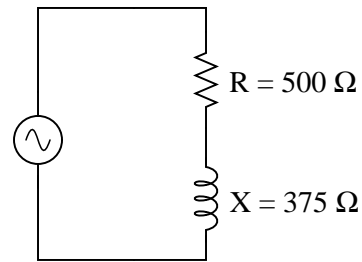
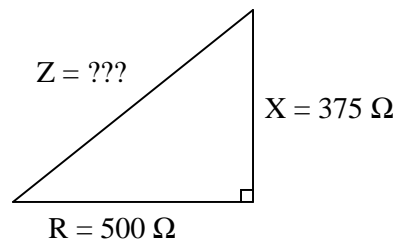

Explain what equation(s) you use to calculate Z .
[file 02081](#)

Question 57

Use the "impedance triangle" to calculate the necessary reactance of this series combination of resistance (R) and inductive reactance (X) to produce the desired total impedance of 145Ω :

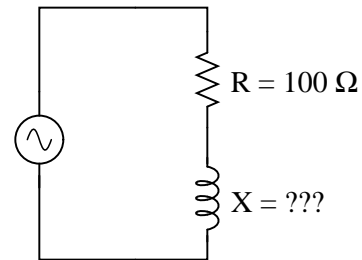
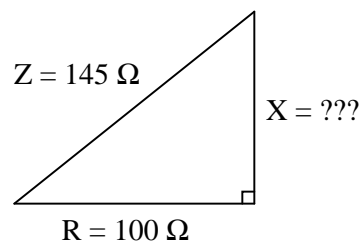

Explain what equation(s) you use to calculate X , and the algebra necessary to achieve this result from a more common formula.
[file 02083](#)

Question 58

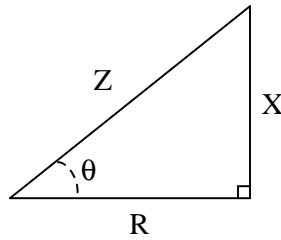

Identify which trigonometric functions (sine, cosine, or tangent) are represented by each of the following ratios, with reference to the angle labeled with the Greek letter "Theta" (Θ):

$$\frac{X}{R} =$$

$$\frac{X}{Z} =$$

$$\frac{R}{Z} =$$

[file 02084](#)

Question 59

Trigonometric functions such as *sine*, *cosine*, and *tangent* are useful for determining the ratio of right-triangle side lengths given the value of an angle. However, they are not very useful for doing the reverse: calculating an angle given the lengths of two sides.

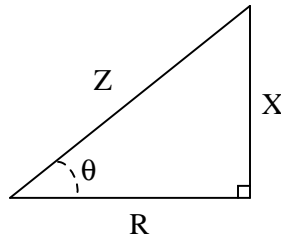

Suppose we wished to know the value of angle Θ , and we happened to know the values of Z and R in this impedance triangle. We could write the following equation, but in its present form we could not solve for Θ :

$$\cos \Theta = \frac{R}{Z}$$

The only way we can algebraically isolate the angle Θ in this equation is if we have some way to "undo" the cosine function. Once we know what function will "undo" cosine, we can apply it to both sides of the equation and have Θ by itself on the left-hand side.

There is a class of trigonometric functions known as *inverse* or "*arc*" functions which will do just that: "undo" a regular trigonometric function so as to leave the angle by itself. Explain how we could apply an "arc-function" to the equation shown above to isolate Θ .

[file 02086](#)

Question 60

A series AC circuit contains 1125 ohms of resistance and 1500 ohms of reactance for a total circuit impedance of 1875 ohms. This may be represented graphically in the form of an impedance triangle:

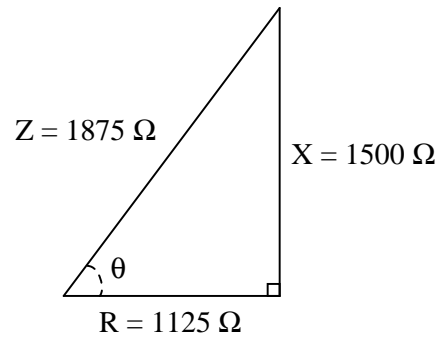

Since all side lengths on this triangle are known, there is no need to apply the Pythagorean Theorem. However, we may still calculate the two non-perpendicular angles in this triangle using "inverse" trigonometric functions, which are sometimes called *arcfunctions*.

Identify which arc-function should be used to calculate the angle Θ given the following pairs of sides:

R and Z

X and R

X and Z

Show how three different trigonometric arcfunctions may be used to calculate the same angle Θ .
[file 02085](#)

Question 61

Write an equation that solves for the impedance of this series circuit. The equation need not solve for the phase angle between voltage and current, but merely provide a scalar figure for impedance (in ohms):

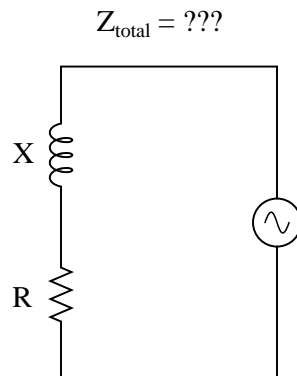

[file 00850](#)

Question 62

Draw a phasor diagram showing the trigonometric relationship between resistance, reactance, and impedance in this series circuit:

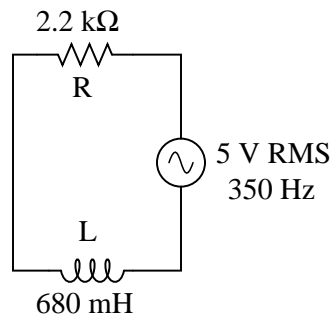

Show mathematically how the resistance and reactance combine in series to produce a total impedance (scalar quantities, all). Then, show how to analyze this same circuit using complex numbers: regarding component as having its own impedance, demonstrating mathematically how these impedances add up to comprise the total impedance (in both polar and rectangular forms).

[file 01827](#)

Question 63

Calculate the total impedance for these two 100 mH inductors at 2.3 kHz , and draw a phasor diagram showing circuit impedances (Z_{total} , R , and X):

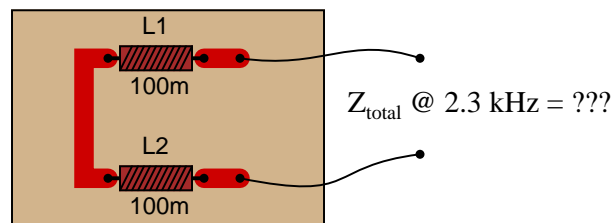

Now, re-calculate impedance and re-draw the phasor impedance diagram supposing the second inductor is replaced by a $1.5\text{ k}\Omega$ resistor:

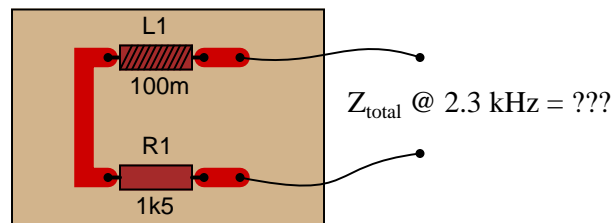

[file 02080](#)

Question 64

Calculate the total impedance of this series LR circuit and then calculate the total circuit current:

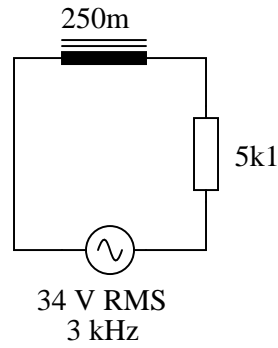

Also, draw a phasor diagram showing how the individual component impedances relate to the total impedance.

[file 02103](#)

Question 65

Calculate the magnitude and phase shift of the current through this inductor, taking into consideration its intrinsic winding resistance:

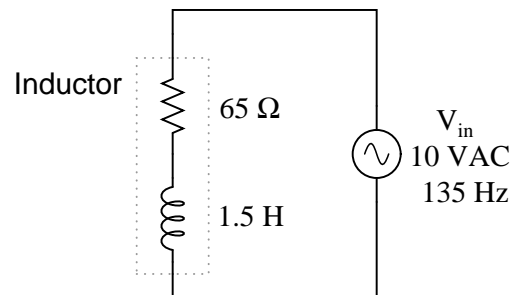

[file 00639](#)

Question 66

Solve for all voltages and currents in this series LR circuit:

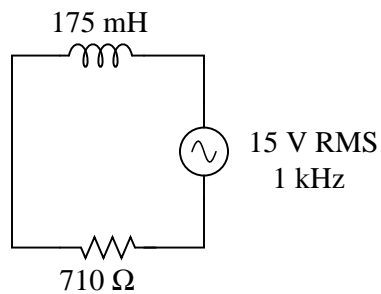

[file 01830](#)

Question 67

Solve for all voltages and currents in this series LR circuit, and also calculate the phase angle of the total impedance:

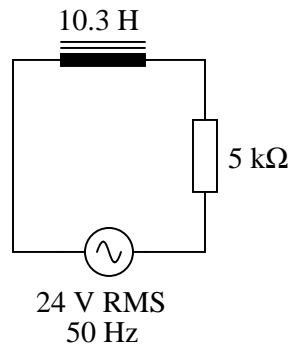

[file 01831](#)

Question 68

Determine the total current and all voltage drops in this circuit, stating your answers the way a multimeter would register them:

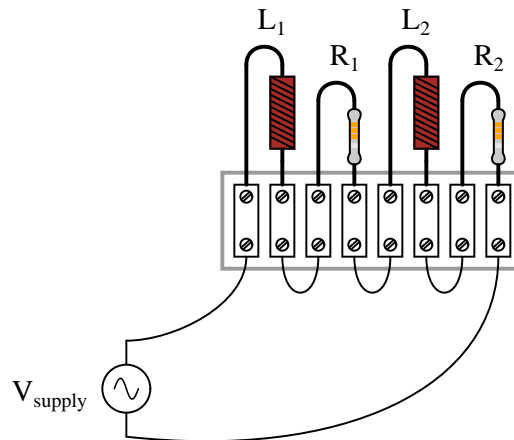

- $L_1 = 250 \text{ mH}$
- $L_2 = 60 \text{ mH}$
- $R_1 = 6.8 \text{ k}\Omega$
- $R_2 = 1.2 \text{ k}\Omega$
- $V_{supply} = 13.4 \text{ V RMS}$
- $f_{supply} = 6.5 \text{ kHz}$

Also, calculate the phase angle (Θ) between voltage and current in this circuit, and explain where and how you would connect an oscilloscope to measure that phase shift.

[file 01841](#)

Question 69

One way to vary the amount of power delivered to a resistive AC load is by varying another resistance connected in series:

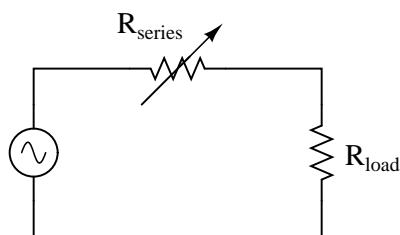

A problem with this power control strategy is that power is wasted in the series resistance ($I^2 R_{series}$). A different strategy for controlling power is shown here, using a series *inductance* rather than resistance:

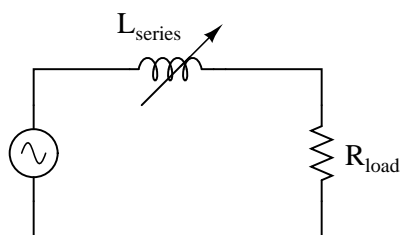

Explain why the latter circuit is more power-efficient than the former, and draw a phasor diagram showing how changes in L_{series} affect Z_{total} .

file 01829

Question 70

A quantity sometimes used in DC circuits is *conductance*, symbolized by the letter G . Conductance is the reciprocal of resistance ($G = \frac{1}{R}$), and it is measured in the unit of siemens.

Expressing the values of resistors in terms of conductance instead of resistance has certain benefits in parallel circuits. Whereas resistances (R) add in series and "diminish" in parallel (with a somewhat complex equation), conductances (G) add in parallel and "diminish" in series. Thus, doing the math for series circuits is easier using resistance and doing math for parallel circuits is easier using conductance:

$$R_{\text{total}} = R_1 + R_2 + R_3$$

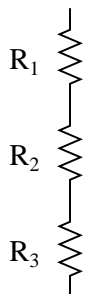

$$G_{\text{total}} = G_1 + G_2 + G_3$$

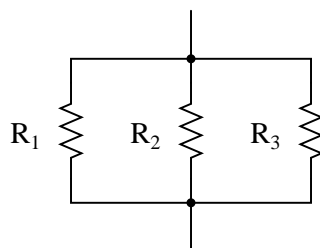

$$G_{\text{total}} = \frac{1}{\frac{1}{G_1} + \frac{1}{G_2} + \frac{1}{G_3}}$$

$$R_{\text{total}} = \frac{1}{\frac{1}{R_1} + \frac{1}{R_2} + \frac{1}{R_3}}$$

In AC circuits, we also have reciprocal quantities to reactance (X) and impedance (Z). The reciprocal of reactance is called *susceptance* ($B = \frac{1}{X}$), and the reciprocal of impedance is called *admittance* ($Y = \frac{1}{Z}$). Like conductance, both these reciprocal quantities are measured in units of siemens.

Write an equation that solves for the admittance (Y) of this parallel circuit. The equation need not solve for the phase angle between voltage and current, but merely provide a scalar figure for admittance (in siemens):

$$Y_{\text{total}} = ???$$

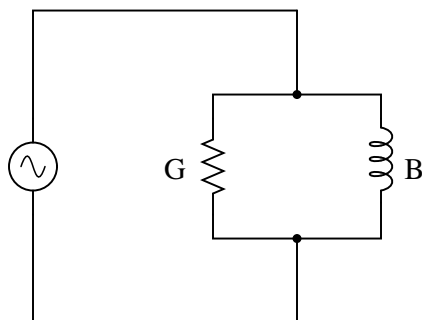

file 00853

Question 71

Students studying AC electrical theory become familiar with the *impedance triangle* very soon in their studies:

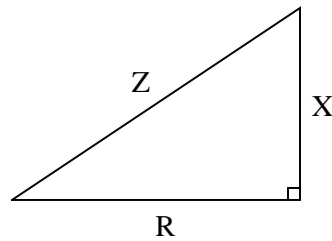

What these students might not ordinarily discover is that this triangle is also useful for calculating electrical quantities other than impedance. The purpose of this question is to get you to discover some of the triangle's other uses.

Fundamentally, this right triangle represents *phasor addition*, where two electrical quantities at right angles to each other (resistive versus reactive) are added together. In series AC circuits, it makes sense to use the impedance triangle to represent how resistance (R) and reactance (X) combine to form a total impedance (Z), since resistance and reactance are special forms of impedance themselves, and we know that impedances *add* in series.

List all of the electrical quantities you can think of that add (in series or in parallel) and then show how similar triangles may be drawn to relate those quantities together in AC circuits.

file 02077

Question 72

Explain why the "impedance triangle" is *not* proper to use for relating total impedance, resistance, and reactance in parallel circuits as it is for series circuits:

*This impedance triangle does **not** apply to parallel circuits, but only to series circuits!*

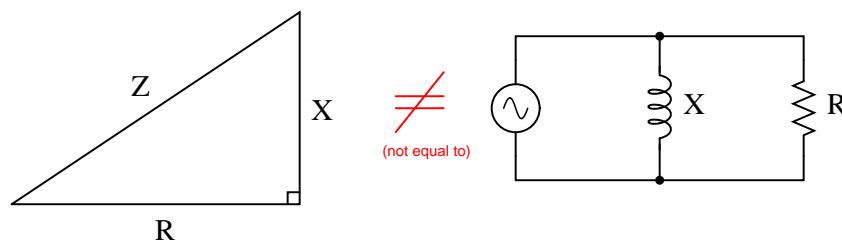

file 02078

Question 73

Calculate the total impedance for these two 100 mH inductors at 2.3 kHz, and draw a phasor diagram showing circuit admittances (Y_{total} , G , and B):

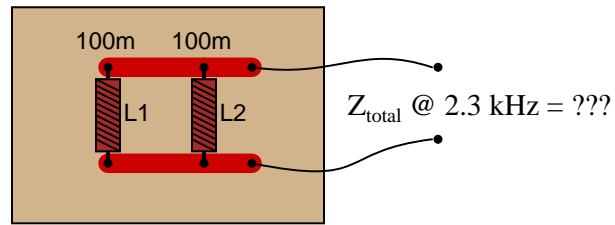

Now, re-calculate impedance and re-draw the phasor admittance diagram supposing the second inductor is replaced by a 1.5 k Ω resistor:

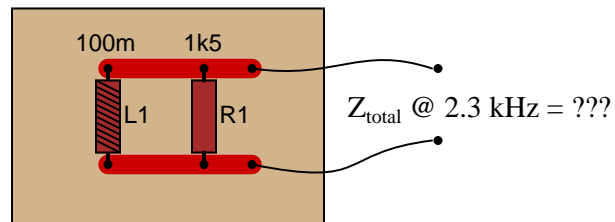

file 02079

Question 74

Calculate the individual currents through the inductor and through the resistor, the total current, and the total circuit impedance:

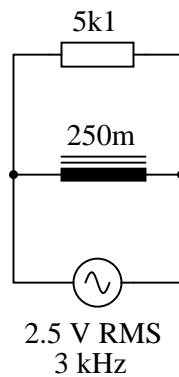

Also, draw a phasor diagram showing how the individual component currents relate to the total current.
file 02104

Question 75

A large AC electric motor under load can be considered as a parallel combination of resistance and inductance:

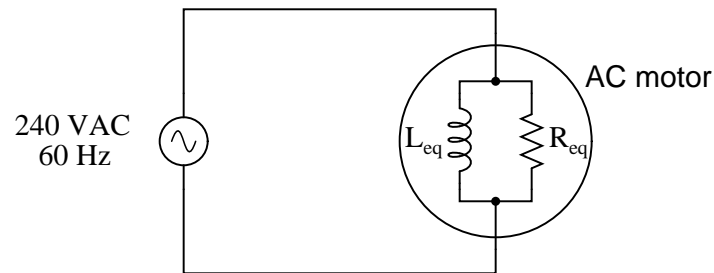

Calculate the current necessary to power this motor if the equivalent resistance and inductance is 20Ω and 238 mH , respectively.

[file 01839](#)

Question 76

A large AC electric motor under load can be considered as a parallel combination of resistance and inductance:

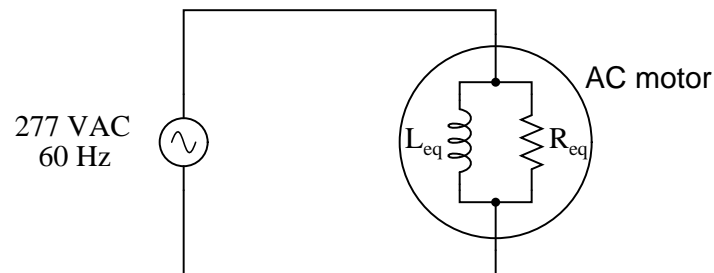

Calculate the equivalent inductance (L_{eq}) if the measured source current is 27.5 amps and the motor's equivalent resistance (R_{eq}) is 11.2Ω .

[file 01840](#)

Question 77

Determine the total current and all component currents in this circuit, stating your answers the way a multimeter would register them:

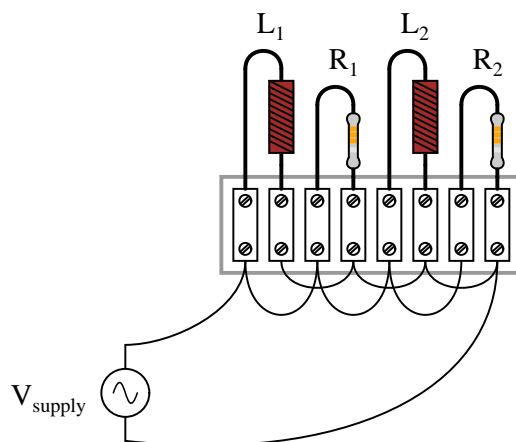

- $L_1 = 1.2 \text{ H}$
- $L_2 = 650 \text{ mH}$
- $R_1 = 33 \text{ k}\Omega$
- $R_2 = 27 \text{ k}\Omega$
- $V_{supply} = 19.7 \text{ V RMS}$
- $f_{supply} = 4.5 \text{ kHz}$

Also, calculate the phase angle (Θ) between voltage and current in this circuit, and explain where and how you would connect an oscilloscope to measure that phase shift.

file 01842

Question 78

Calculate the total impedances (complete with phase angles) for each of the following inductor-resistor circuits:

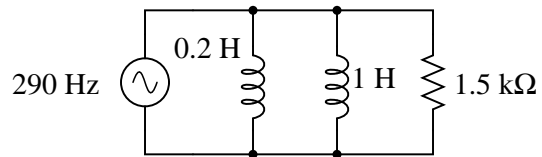
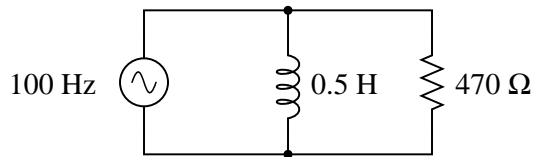
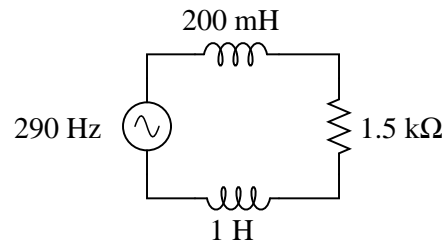
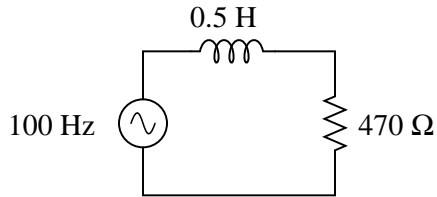

[file 02106](#)

Question 79

A doorbell ringer has a solenoid with an inductance of 63 mH connected in parallel with a lamp (for visual indication) having a resistance of 150 ohms:

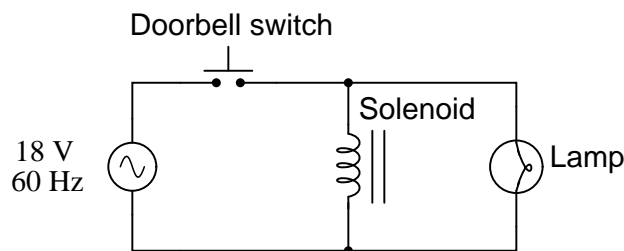

Calculate the phase shift of the total current (in units of degrees) in relation to the total supply voltage, when the doorbell switch is actuated.

[file 02105](#)

Question 80

An AC electric motor operating under loaded conditions draws a current of 11 amps (RMS) from the 120 volt (RMS) 60 Hz power lines. The measured phase shift between voltage and current for this motor is 34° , with voltage leading current.

Determine the equivalent parallel combination of resistance (R) and inductance (L) that is electrically equivalent to this operating motor.

[file 01542](#)

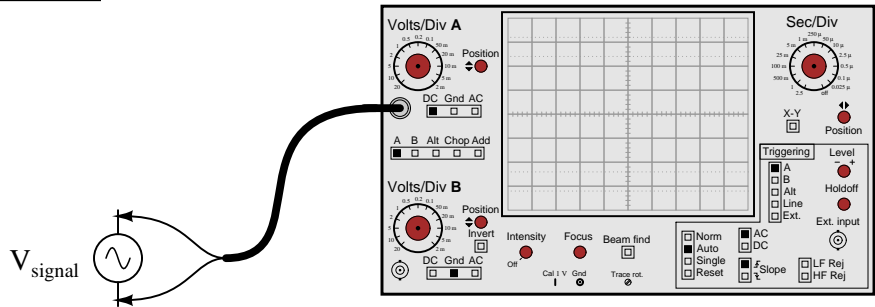
Competency: Analog oscilloscope set-up	Version:
Schematic	
	
Given conditions	
<p>V_{signal} = Set by instructor without student's knowledge</p> <p>f_{signal} = Set by instructor without student's knowledge</p>	
Parameters	
<p>Between two and five cycles of waveform displayed, without exceeding either top or bottom edge of screen.</p>	

file 01674

Competency: **RMS versus peak measurements** Version:

Schematic

Given conditions

V_{signal} = Set by instructor without student's knowledge

Parameters

		Measured	
	$V_{\text{signal(peak)}}$		(Measured with oscilloscope)
	Predicted	Measured	
$V_{\text{signal(RMS)}}$			(Measured with true-RMS multimeter)

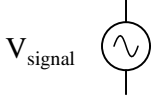
Competency: Measuring frequency	Version:
Schematic	
	
Given conditions	
$V_{\text{signal}} =$	
$f_{\text{signal}} =$ Set by instructor without student's knowledge	
Parameters	
Measured with oscilloscope	
t_{period} <input type="text"/>	
Measured with counter Measured with oscilloscope	
f_{signal} <input type="text"/> <input type="text"/>	

file 01660

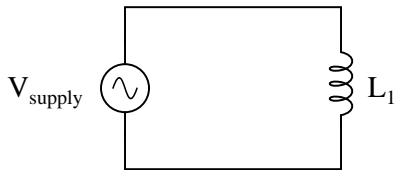
Competency: Inductive reactance and Ohm's Law for AC Version:				
Schematic				
				
Given conditions				
$V_{\text{supply}} =$	$L_1 =$			
$f_{\text{supply}} =$				
Parameters				
	<table style="margin-left: auto; margin-right: auto;"> <tr> <td style="padding: 5px;">Predicted</td> <td style="padding: 5px;">Measured</td> </tr> </table>	Predicted	Measured	
Predicted	Measured			
I_{total}	<table style="margin-left: auto; margin-right: auto;"> <tr> <td style="border: 1px solid black; width: 80px; height: 25px;"></td> <td style="border: 1px solid black; width: 80px; height: 25px;"></td> </tr> </table>			
V_{L1}	<table style="margin-left: auto; margin-right: auto;"> <tr> <td style="border: 1px solid black; width: 80px; height: 25px;"></td> <td style="border: 1px solid black; width: 80px; height: 25px;"></td> </tr> </table>			
<p><i>Qualitative answers only: Increase, decrease, or same</i></p>				
	<table style="margin-left: auto; margin-right: auto;"> <tr> <td style="padding: 5px;">Predicted</td> <td style="padding: 5px;">Measured</td> </tr> </table>	Predicted	Measured	
Predicted	Measured			
I_{total}	<table style="margin-left: auto; margin-right: auto;"> <tr> <td style="border: 1px solid black; width: 80px; height: 25px;"></td> <td style="border: 1px solid black; width: 80px; height: 25px;"></td> </tr> </table>			as frequency increases
I_{total}	<table style="margin-left: auto; margin-right: auto;"> <tr> <td style="border: 1px solid black; width: 80px; height: 25px;"></td> <td style="border: 1px solid black; width: 80px; height: 25px;"></td> </tr> </table>			as frequency decreases

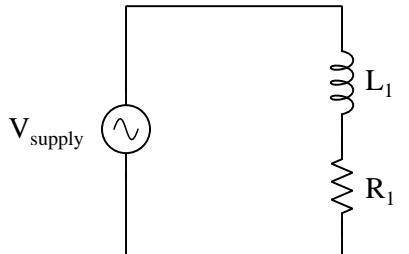
Competency: Series LR circuit	Version:		
Schematic			
			
Given conditions			
$V_{\text{supply}} =$	$L_1 =$	$R_1 =$	$f_{\text{supply}} =$
Parameters			
	Predicted	Measured	
V_{L1}	<input style="width: 80px; height: 20px;" type="text"/>	<input style="width: 80px; height: 20px;" type="text"/>	
V_{R1}	<input style="width: 80px; height: 20px;" type="text"/>	<input style="width: 80px; height: 20px;" type="text"/>	
I_{total}	<input style="width: 80px; height: 20px;" type="text"/>	<input style="width: 80px; height: 20px;" type="text"/>	
Calculations			
Fault analysis			
Suppose component <input style="width: 40px; height: 20px;" type="text"/> fails		<input type="checkbox"/> open <input type="checkbox"/> other _____ <input type="checkbox"/> shorted	
<i>What will happen in the circuit?</i>		<small>Write "increase", "decrease", or "no change" for each parameter:</small>	
V_{L1}	<input style="width: 80px; height: 20px;" type="text"/>	I_{L1}	<input style="width: 80px; height: 20px;" type="text"/>
V_{R1}	<input style="width: 80px; height: 20px;" type="text"/>	I_{R1}	<input style="width: 80px; height: 20px;" type="text"/>
I_{total}	<input style="width: 80px; height: 20px;" type="text"/>		

Competency: **Probe compensation adjustment** Version:

Schematic

Given conditions

(Use the built-in square wave signal source in your oscilloscope, and use a $\times 10$ probe to measure it)

Parameters

Between two and five cycles of waveform displayed, without exceeding either top or bottom edge of screen.

Measured

V_{signal}

f_{signal}

Properly compensated probe waveform

Overcompensated probe waveform

Undercompensated probe waveform

Troubleshooting log

Actions / Measurements / Observations <i>(i.e. What I did and/or noticed . . .)</i>	Conclusions <i>(i.e. What this tells me . . .)</i>

file 03933

Question 88

NAME: _____

Troubleshooting Grading Criteria

You will receive the highest score for which *all* criteria are met.

100 % (*Must meet or exceed all criteria listed*)

- A. Absolutely flawless procedure
- B. No unnecessary actions or measurements taken

90 % (*Must meet or exceed these criteria in addition to all criteria for 85% and below*)

- A. No reversals in procedure (i.e. changing mind without sufficient evidence)
- B. Every single action, measurement, and relevant observation properly documented

80 % (*Must meet or exceed these criteria in addition to all criteria for 75% and below*)

- A. No more than one unnecessary action or measurement
- B. No false conclusions or conceptual errors
- C. No missing conclusions (i.e. at least one documented conclusion for action / measurement / observation)

70 % (*Must meet or exceed these criteria in addition to all criteria for 65%*)

- A. No more than one false conclusion or conceptual error
- B. No more than one conclusion missing (i.e. an action, measurement, or relevant observation without a corresponding conclusion)

65 % (*Must meet or exceed these criteria in addition to all criteria for 60%*)

- A. No more than two false conclusions or conceptual errors
- B. No more than two unnecessary actions or measurements
- C. No more than one undocumented action, measurement, or relevant observation
- D. Proper use of all test equipment

60 % (*Must meet or exceed these criteria*)

- A. Fault accurately identified
- B. Safe procedures used at all times

50 % (*Only applicable where students performed significant development/design work – i.e. not a proven circuit provided with all component values*)

- A. Working prototype circuit built and demonstrated

0 % (*If any of the following conditions are true*)

- A. Unsafe procedure(s) used at any point

file 03932

Question 89

Determine the frequency of a waveform having a period of 1.4 milliseconds (1.4 ms).

file 03276

Question 90

Assuming the vertical sensitivity control is set to 0.5 volts per division, and the timebase control is set to 2.5 ms per division, calculate the amplitude of this sine wave (in volts peak, volts peak-to-peak, and volts RMS) as well as its frequency.

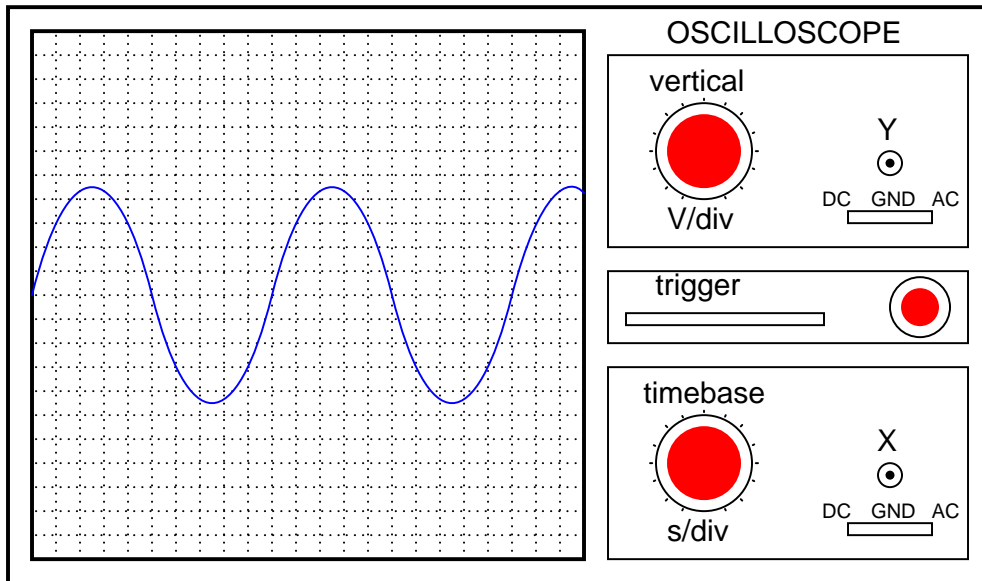

file 00540

Question 91

Something is wrong with this circuit. Based on the oscilloscope's display, determine whether the battery or the function generator is faulty:

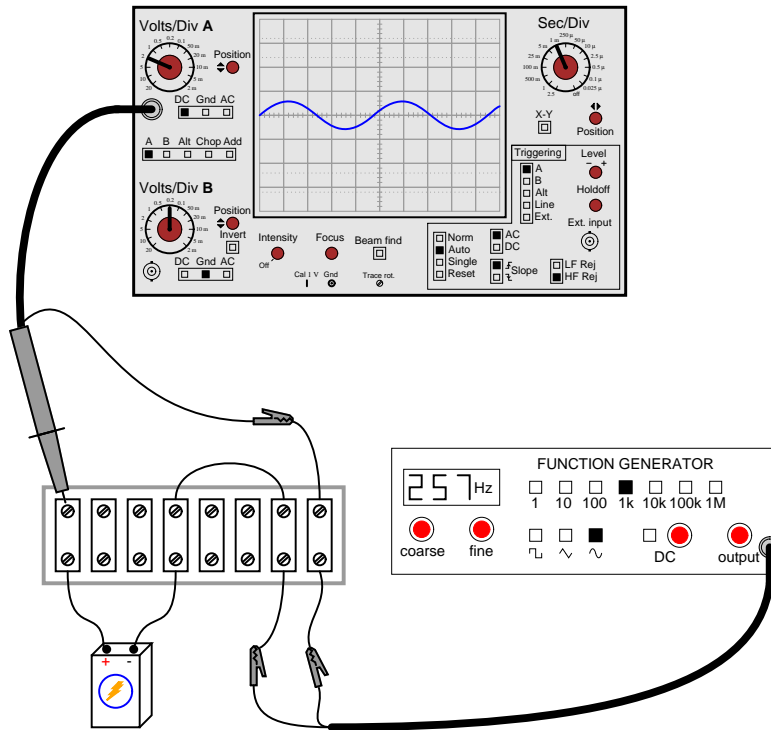

file 03448

Question 92

Something is wrong with this circuit. Based on the oscilloscope's display, determine whether the battery or the function generator is faulty:

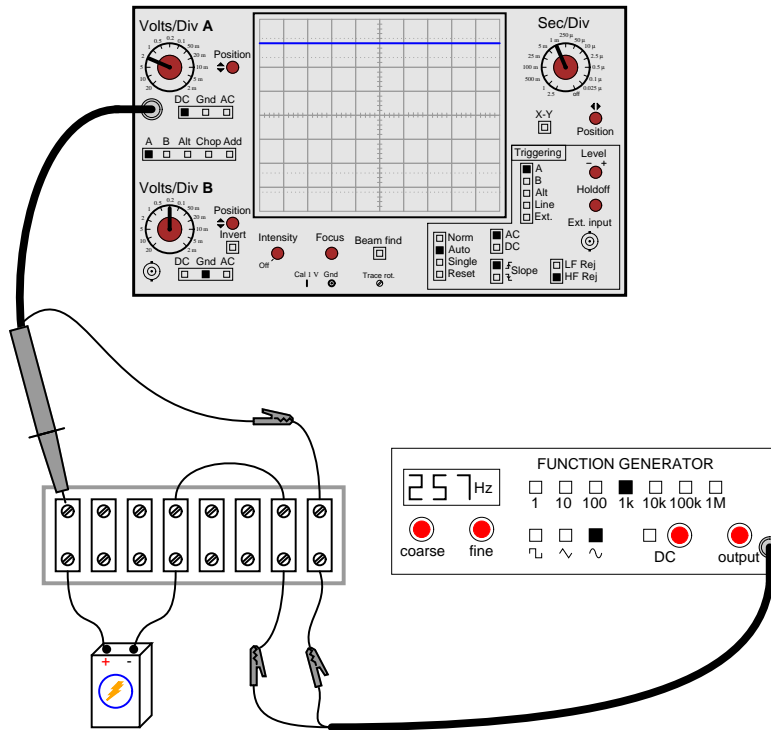

file 03449

Question 93

Shunt resistors are low-value, precision resistors used as current-measuring elements in high-current circuits. The idea is to measure the voltage dropped across this precision resistance and use Ohm's Law ($I = \frac{V}{R}$) to infer the amount of current in the circuit:

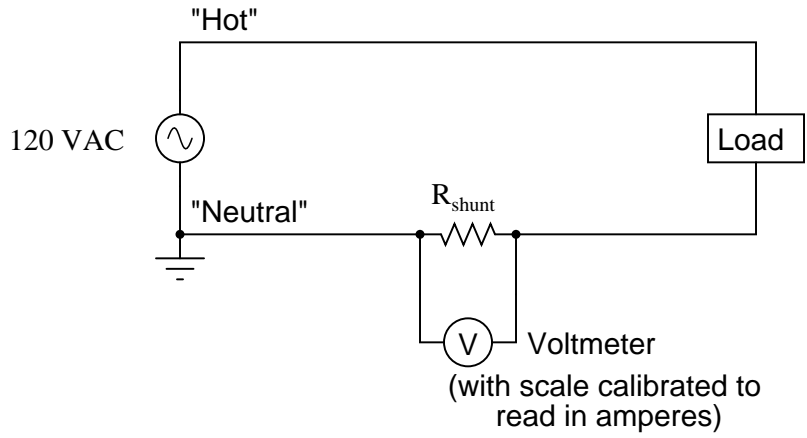

Since the schematic shows a shunt resistor being used to measure current in an AC circuit, it would be equally appropriate to use an oscilloscope instead of a voltmeter to measure the voltage drop produced by the shunt. However, we must be careful in connecting the oscilloscope to the shunt because of the inherent ground reference of the oscilloscope's metal case and probe assembly.

Explain why connecting an oscilloscope to the shunt as shown in this second diagram would be a bad idea:

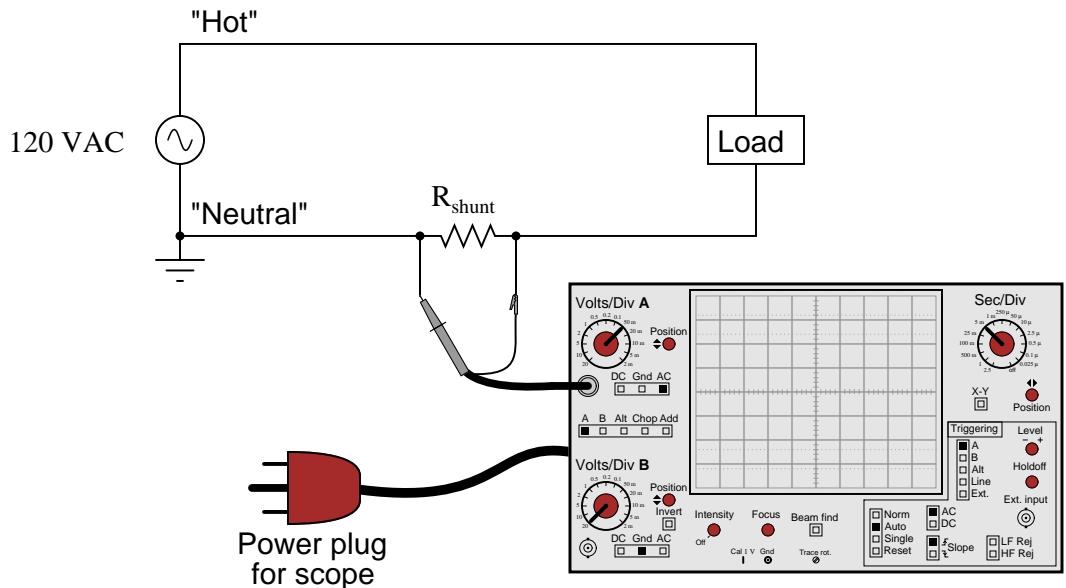

[file 03504](#)

Question 94

An electromechanical alternator (AC generator) and a DC-DC inverter both output the same RMS voltage, and deliver the same amount of electrical power to two identical loads:

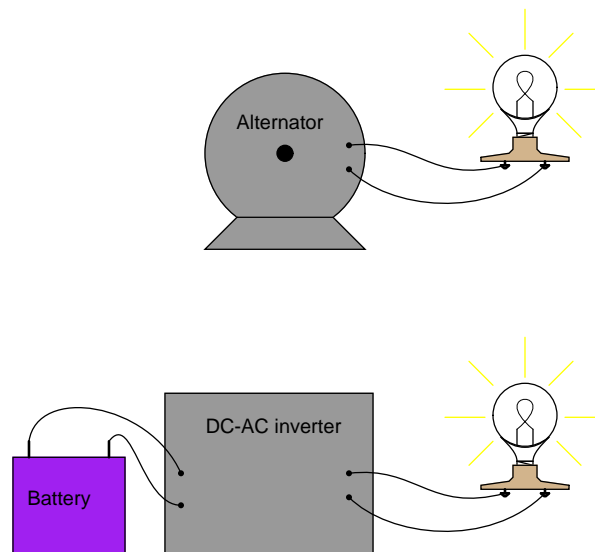

However, when measured by an analog voltmeter, the inverter's output voltage is slightly greater than the alternator's output voltage. Explain this discrepancy in measurements.

[file 00404](#)

Question 95

Is the deflection of an analog AC meter movement proportional to the peak, average, or RMS value of the waveform measured? Explain your answer.

[file 00403](#)

Question 96

In calculating the size of wire necessary to carry alternating current to a high-power load, which type of measurement is the best to use for current: peak, average, or RMS? Explain why.

[file 00162](#)

Question 97

In calculating the thickness of insulators for high-voltage AC power lines, which type of measurement is the best to use for voltage: peak, average, or RMS? Explain why.

[file 00163](#)

Question 98

Calculate the amount of phase shift indicated by this Lissajous figure:

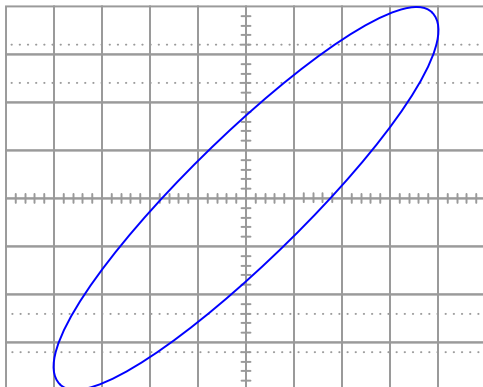

file 03578

Question 99

Calculate the amount of phase shift indicated by this Lissajous figure:

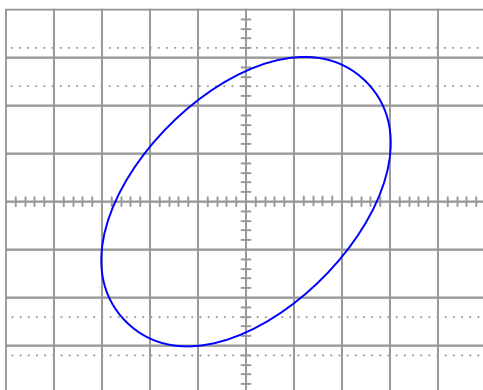

file 03575

Question 100

Calculate the amount of phase shift indicated by this Lissajous figure:

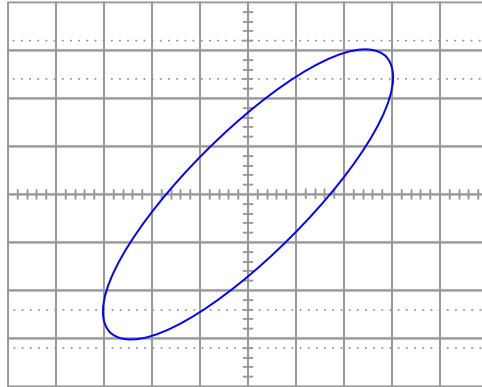

file 03577

Question 101

Calculate the amount of phase shift indicated by this Lissajous figure:

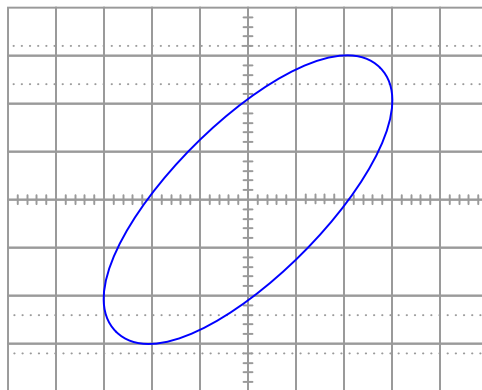

file 03576

Question 102

Determine which way the movable iron piece needs to go in order to *brighten* the light bulb in this circuit:

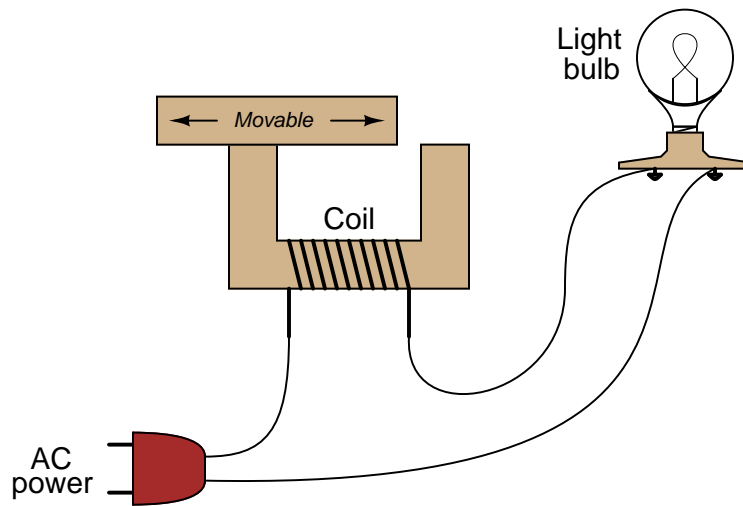

file 03446

Question 103

A *solenoid valve* is a mechanical shutoff device actuated by electricity. An electromagnet coil produces an attractive force on an iron "armature" which then either opens or closes a valve mechanism to control the flow of some fluid. Shown here are two different types of illustrations, both showing a solenoid valve:

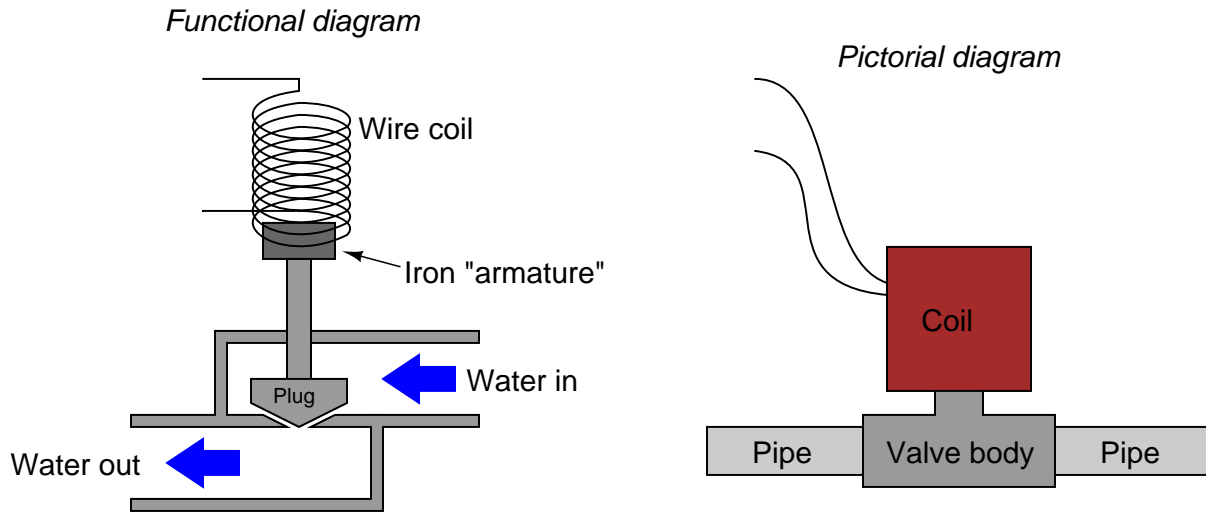

Some solenoid valves are constructed in such a way that the coil assembly may be removed from the valve body, separating these two pieces so that maintenance work may be done on one without interfering with the other. Of course, this means the valve mechanism will no longer be actuated by the magnetic field, but at least one piece may be worked upon without having to remove the other piece from whatever it may be connected to:

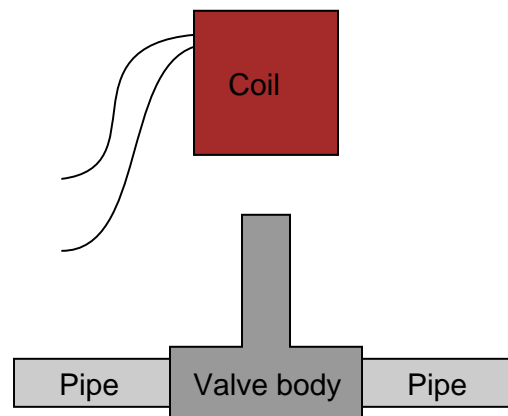

This is commonly done when replacement of the valve mechanism is needed. First, the coil is lifted off the valve mechanism, then the maintenance technician is free to remove the valve body from the pipes and replace it with a new valve body. Lastly, the coil is re-installed on the new valve body and the solenoid is once more ready for service, all without having to electrically disconnect the coil from its power source.

However, if this is done while the coil is energized, it will overheat and burn up in just a few minutes. To prevent this from happening, the maintenance technicians have learned to insert a steel screwdriver through the center hole of the coil while it is removed from the valve body, like this:

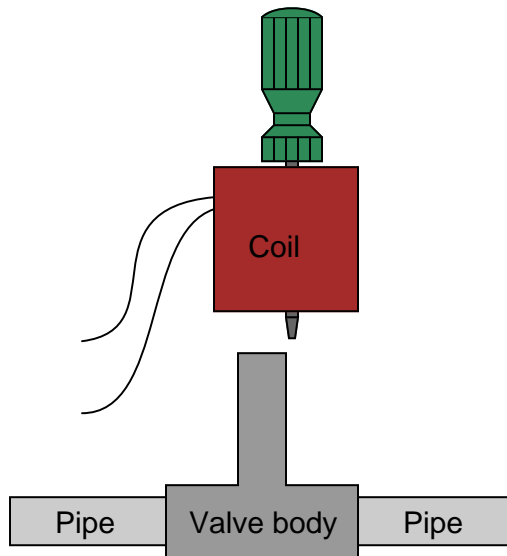

With the steel screwdriver shank taking the place of the iron armature inside the valve body, the coil will not overheat and burn up even if continually powered. Explain the nature of the problem (why the coil tends to burn up when separated from the valve body) and also why a screwdriver put in place of the iron armature works to prevent this from happening.

[file 03445](#)

Question 104

Doorbell circuits connect a small lamp in parallel with the doorbell pushbutton so that there is light at the button when it is *not* being pressed. The lamp's filament resistance is such that there is not enough current going through it to energize the solenoid coil when lit, which means the doorbell will ring only when the pushbutton switch shorts past the lamp:

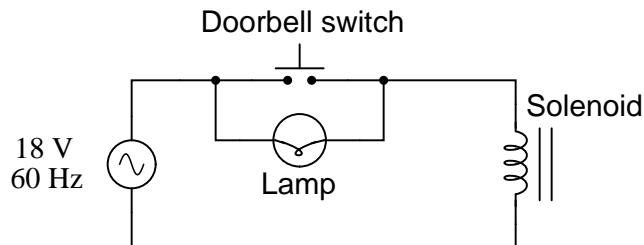

Suppose that such a doorbell circuit suddenly stops working one day, and the home owner assumes the power source has quit since the bell will not ring when the button is pressed and the lamp never lights. Although a dead power source is certainly possible, it is not the only possibility. Identify another possible failure in this circuit which would result in no doorbell action (no sound) and no light at the lamp.

[file 03447](#)

Question 105

Suppose someone were to ask you to differentiate electrical reactance (X) from electrical resistance (R). How would you distinguish these two similar concepts from one another, using your own words?

[file 03301](#)

Question 106

The *Pythagorean Theorem* is used to calculate the length of the hypotenuse of a right triangle given the lengths of the other two sides:

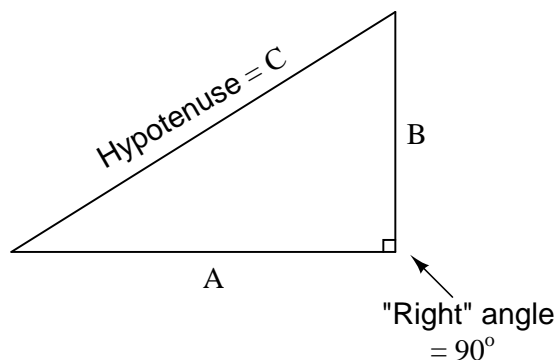

Manipulate the standard form of the Pythagorean Theorem to produce a version that solves for the length of A given B and C , and also write a version of the equation that solves for the length of B given A and C .

[file 03114](#)

Question 107

Suppose two people work together to slide a large box across the floor, one pushing with a force of 400 newtons and the other pulling with a force of 300 newtons:

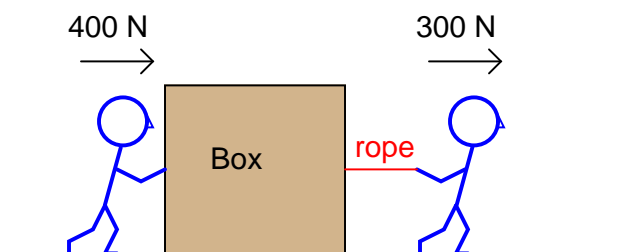

The resultant force from these two persons' efforts on the box will, quite obviously, be the sum of their forces: 700 newtons (to the right).

What if the person pulling decides to change position and push *sideways* on the box in relation to the first person, so the 400 newton force and the 300 newton force will be perpendicular to each other (the 300 newton force facing into the page, away from you)? What will the resultant force on the box be then?

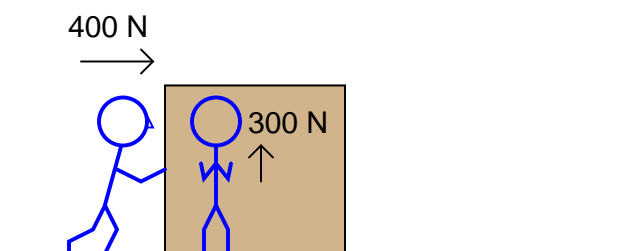

[file 03278](#)

Question 108

A rectangular building foundation with an area of 18,500 square feet measures 100 feet along one side. You need to lay in a diagonal run of conduit from one corner of the foundation to the other. Calculate how much conduit you will need to make the run:

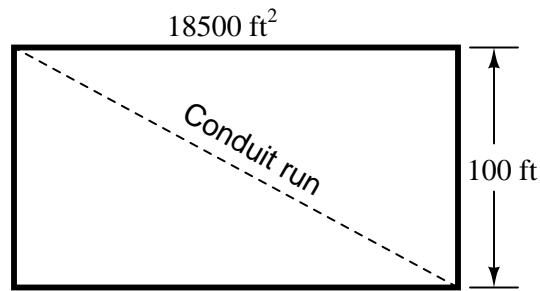

Also, write an equation for calculating this conduit run length (L) given the rectangular area (A) and the length of one side (x).

file 03275

Question 109

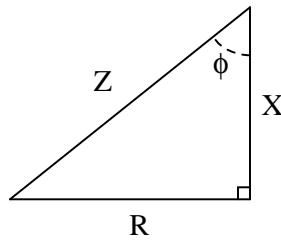

Identify which trigonometric functions (sine, cosine, or tangent) are represented by each of the following ratios, with reference to the angle labeled with the Greek letter "Phi" (ϕ):

$$\frac{R}{X} =$$

$$\frac{X}{Z} =$$

$$\frac{R}{Z} =$$

file 03113

Question 110

In this phasor diagram, determine which phasor is *leading* and which is *lagging* the other:

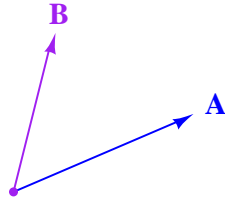

file 03286

Question 111

Is it appropriate to assign a phasor *angle* to a single AC voltage, all by itself in a circuit?

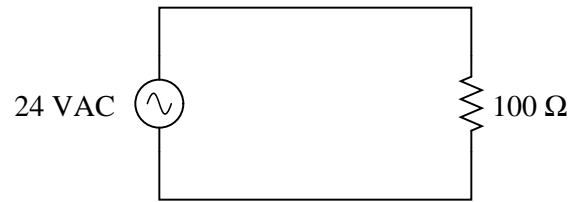

What if there is more than one AC voltage source in a circuit?

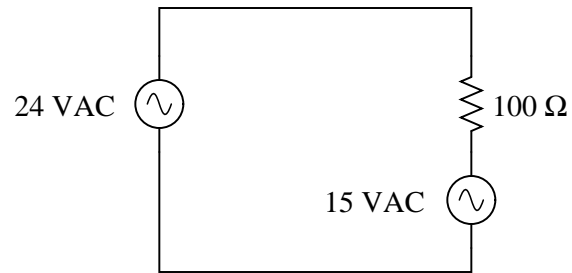

file 00496

Question 112

Determine the total voltage in each of these examples, drawing a phasor diagram to show how the total (resultant) voltage geometrically relates to the source voltages in each scenario:

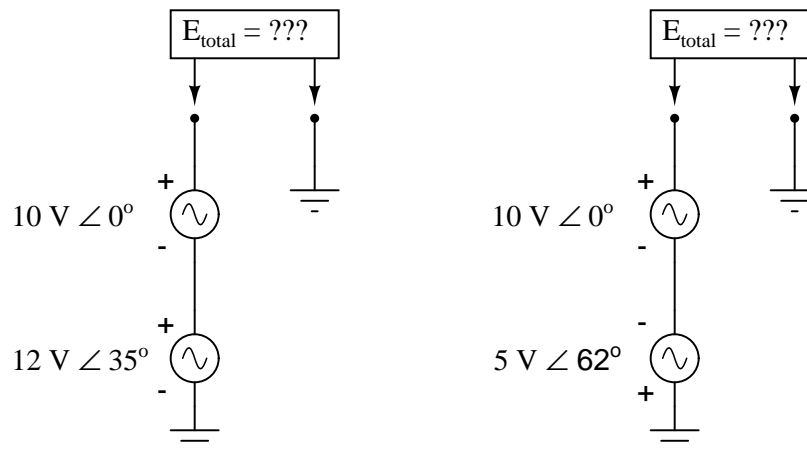

[file 00498](#)

Question 113

Before two or more operating alternators (AC generators) may be electrically coupled, they must be brought into synchronization with each other. If two alternators are out of "sync" (or out of *phase*) with each other, the result will be a large fault current when the disconnect switch is closed.

A simple and effective means of checking for "sync" prior to closing the disconnect switch for an alternator is to have light bulbs connected in parallel with the disconnect switch contacts, like this:

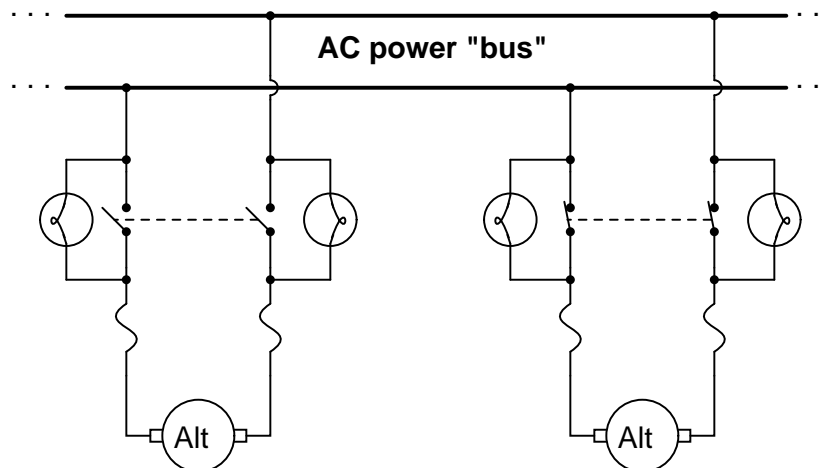

What should the alternator operator look for before closing the alternator switch? Do bright lights indicate a condition of being "in-phase" with the bus, or do dim lights indicate this? What does the operator have to do in order to bring an alternator into "phase" with the bus voltage?

Also, describe what the light bulbs would do if the two alternators were spinning at slightly different speeds.

[file 00491](#)

Question 114

Suppose a power plant operator was about to bring this alternator on-line (connect it to the AC bus), and happened to notice that neither one of the synchronizing lights was lit at all. Thinking this to be unusual, the operator calls you to determine if something is wrong with the system. Describe what you would do to troubleshoot this system.

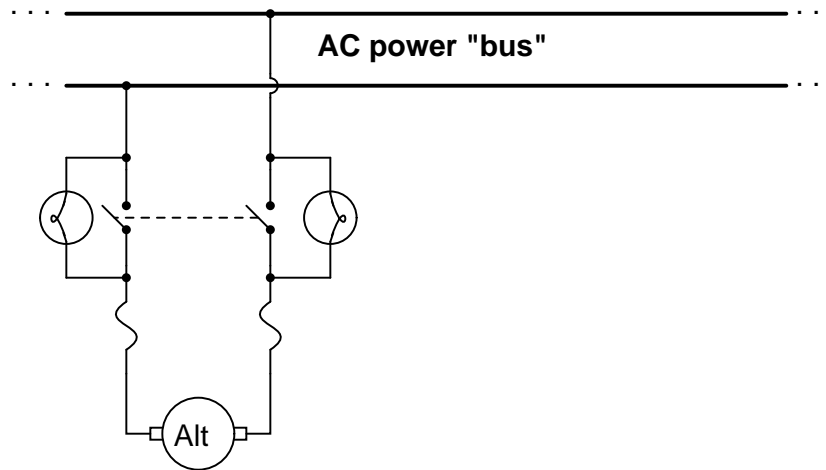

[file 00500](#)

Question 115

When AC power is initially applied to an electric motor (before the motor shaft has an opportunity to start moving), the motor "appears" to the AC power source to be a large inductor:

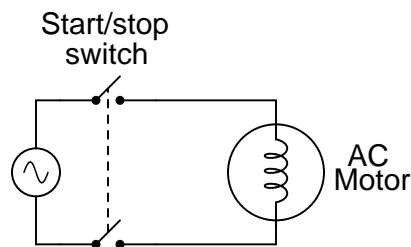

If the voltage of the 60 Hz AC power source is 480 volts RMS, and the motor initially draws 75 amps RMS when the double-pole single-throw switch closes, how much inductance (L) must the motor windings have? Ignore any wire resistance, and assume the motor's only opposition to current in a locked-rotor condition is inductive reactance (X_L).

[file 01826](#)

Question 116

In analyzing circuits with inductors, we often take the luxury of assuming the constituent inductors to be perfect; i.e., purely inductive, with no "stray" properties such as winding resistance or inter-winding capacitance.

Real life is not so generous. With real inductors, we have to consider these factors. One measure often used to express the "purity" of an inductor is its so-called *Q rating*, or *quality factor*.

Write the formula for calculating the quality factor (*Q*) of a coil, and describe some of the operational parameters that may affect this number.

[file 01389](#)

Question 117

Calculate the total impedance offered by these two inductors to a sinusoidal signal with a frequency of 60 Hz:

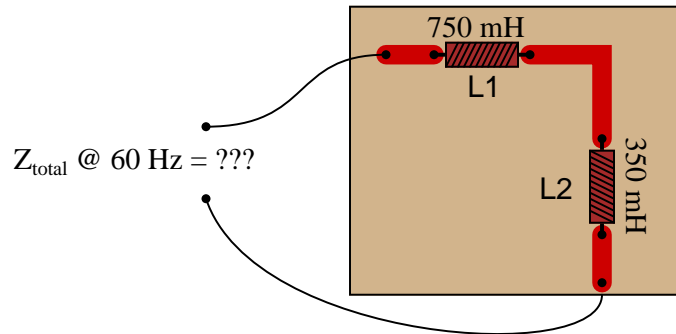

Show your work using two different problem-solving strategies:

- Calculating total inductance (L_{total}) first, then total impedance (Z_{total}).
- Calculating individual impedances first (Z_{L1} and Z_{L2}), then total impedance (Z_{total}).

Do these two strategies yield the same total impedance value? Why or why not?

[file 01832](#)

Question 118

Calculate the total impedance of this LR circuit, once using nothing but scalar numbers, and again using complex numbers:

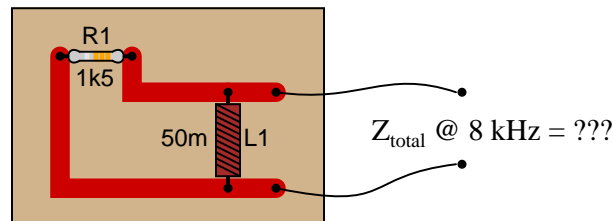

[file 01837](#)

Question 119

Calculate the total impedance offered by these two inductors to a sinusoidal signal with a frequency of 120 Hz:

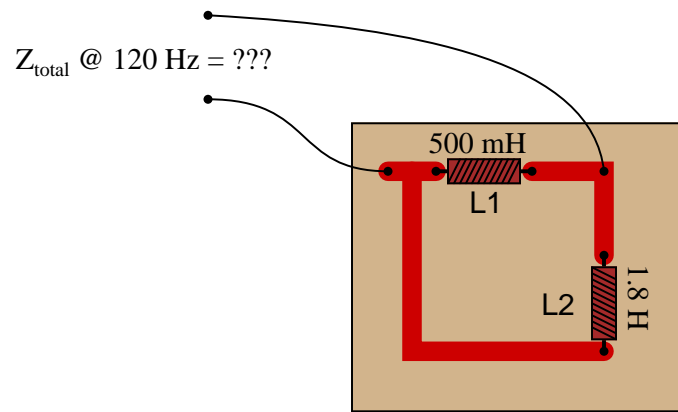

Show your work using three different problem-solving strategies:

- Calculating total inductance (L_{total}) first, then total impedance (Z_{total}).
- Calculating individual admittances first (Y_{L1} and Y_{L2}), then total admittance (Y_{total}), then total impedance (Z_{total}).
- Using complex numbers: calculating individual impedances first (Z_{L1} and Z_{L2}), then total impedance (Z_{total}).

Do these two strategies yield the same total impedance value? Why or why not?

[file 01833](#)

Question 120

Determine the input frequency necessary to give the output voltage a phase shift of 75° :

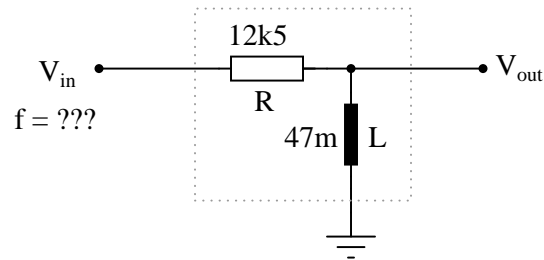

Also, write an equation that solves for frequency (f), given all the other variables (R , L , and phase angle θ).

[file 03282](#)

Question 121

Determine the necessary resistor value to give the output voltage a phase shift of 44° :

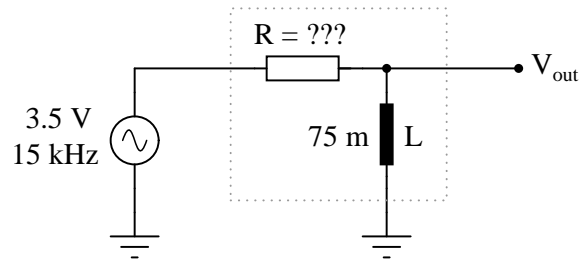

Also, write an equation that solves for this resistance value (R), given all the other variables (f , L , and phase angle θ).

[file 03283](#)

Question 122

Determine the input frequency necessary to give the output voltage a phase shift of -40° :

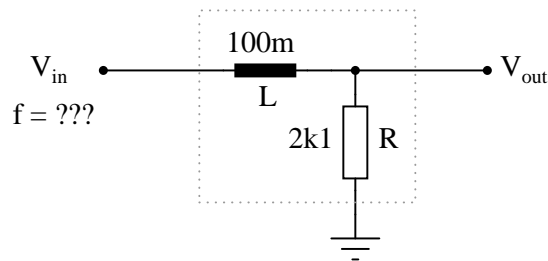

Also, write an equation that solves for frequency (f), given all the other variables (R , L , and phase angle θ).

[file 03280](#)

Question 123

Determine the necessary resistor value to give the output voltage a phase shift of -60° :

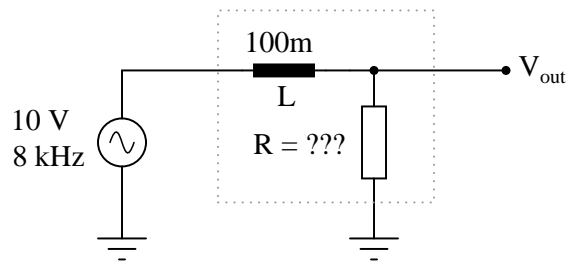

Also, write an equation that solves for this resistance value (R), given all the other variables (f , L , and phase angle θ).

[file 03281](#)

Answers

Answer 1

DC is an acronym meaning *Direct Current*: that is, electrical current that moves in one direction only. *AC* is an acronym meaning *Alternating Current*: that is, electrical current that periodically reverses direction ("alternates").

Electrochemical batteries generate DC, as do solar cells. Microphones generate AC when sensing sound waves (vibrations of air molecules). There are many, many other sources of DC and AC electricity than what I have mentioned here!

Answer 2

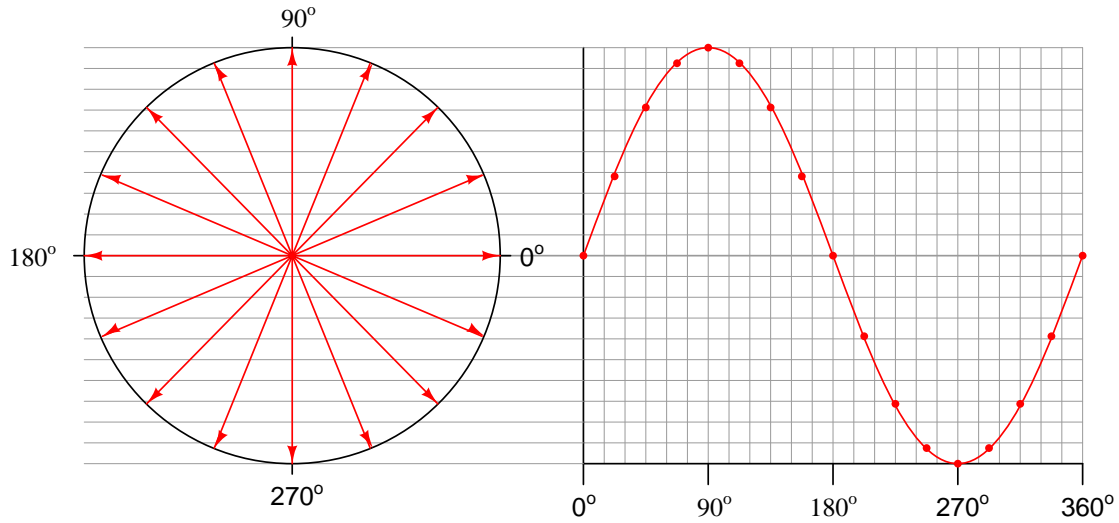

Answer 3

From a perspective of inducing electric shock, AC has been experimentally proven to possess greater hazard than DC (all other factors being equal). See the research of Charles Dalziel for supporting data.

Answer 4

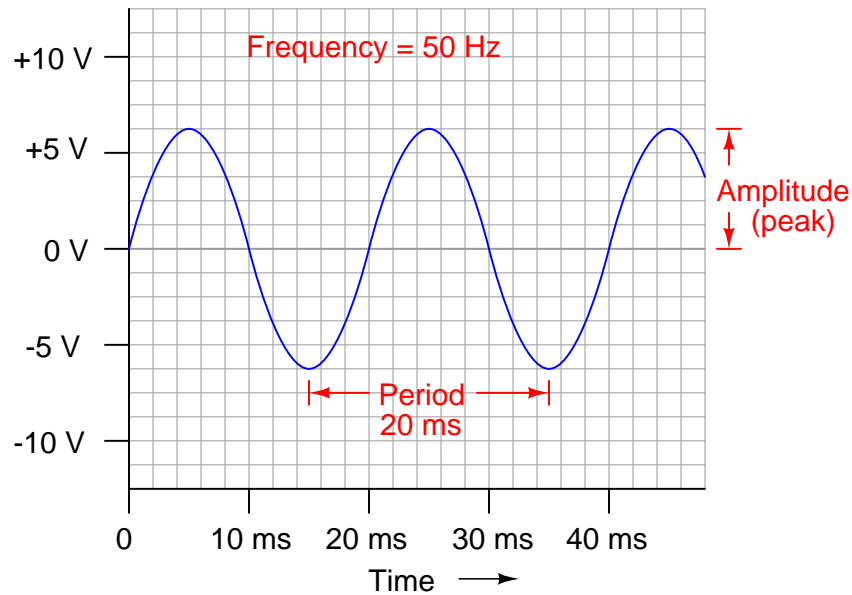

Answer 5

Each time an AC voltage or current repeats itself, that interval is called a *cycle*. Frequency, being the rate at which an AC voltage or current repeats itself over time, may be represented in terms of cycles (repetitions) per second.

Answer 6

Period = 2.8571 milliseconds

Answer 7

$\lambda \approx 316$ meters

I'll let you find the equation on your own!

Answer 8

Connecting the speaker to each AC voltage source, one at a time, will result in two different audio tones output by the speaker. Whichever tone is lower in pitch is the waveform with the greatest period.

Answer 9

EKG vertical = *heart muscle contraction* ; EKG horizontal = *time*
General-purpose vertical = *voltage* ; General-purpose horizontal = *time*

Answer 10

There are many tutorials and excellent reference books on CRT function – go read a few of them!

Answer 11

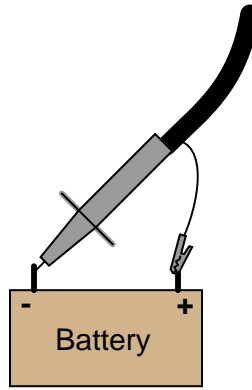

Answer 12

The battery voltage is slightly greater than 6.5 volts.

Answer 13

The "timebase" control needs to be adjusted for fewer seconds per division, while the "vertical" control needs to be adjusted for fewer volts per division.

Answer 14

The "vertical" control needs to be adjusted for a greater number of volts per division.

Answer 15

The "timebase" control needs to be adjusted for fewer seconds per division.

Answer 16

The "timebase" control needs to be adjusted for a greater number of seconds per division.

Answer 17

400 Hz

Answer 18

$$\begin{aligned}E_{peak} &= 8 \text{ V} \\E_{peak-to-peak} &= 16 \text{ V} \\f &= 6.67 \text{ kHz}\end{aligned}$$

Answer 19

The "ground" clip on an oscilloscope probe is electrically common with the metal chassis of the oscilloscope, which in turn is connected to earth ground by the three-prong (grounded) power plug.

Answer 20

The oscilloscope will create an earth-grounded short circuit in this series resistor circuit:

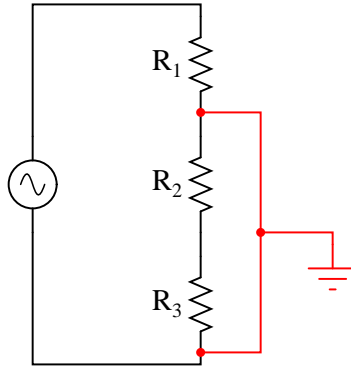

If the signal generator is earth-grounded through its power cord as well, the problem could even be worse:

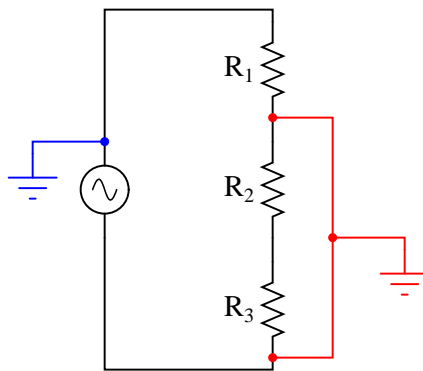

Follow-up question: explain why the second scenario is potentially more hazardous than the first.

Answer 21

We may express quantities of AC voltage and current in terms of *peak*, *peak-to-peak*, *average*, or *RMS*.

Answer 22

50 volts DC applied to a $10\ \Omega$ load will dissipate 250 watts of power. 50 volts (peak, sinusoidal) AC will deliver less than 250 watts to the same load.

Answer 23

120 volts AC RMS, *by definition*.

Answer 24

The RMS amplitude of this waveform is approximately 0.32 volts.

Answer 25

The RMS amplitude of this waveform is 0.5 volt.

Answer 26

Analog voltmeter now registers: 111.7 volts

True-RMS digital voltmeter now registers: 110 volts

Answer 27

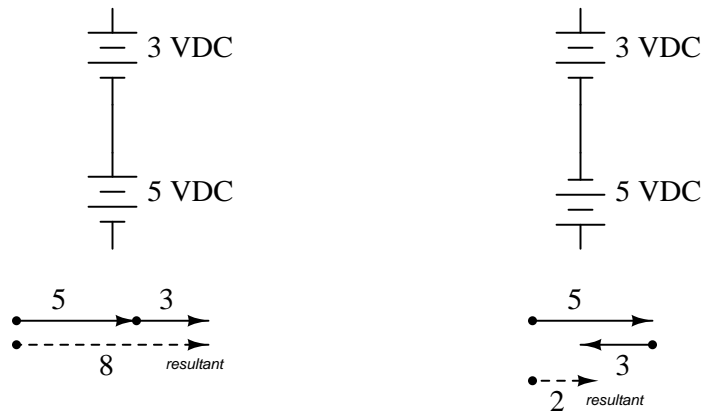

In the right-hand circuit, where the two voltage sources are opposing, one of the phasors will have an angle of 0° , while the other will have an angle of 180° .

Answer 28

This is a "trick" question, because only the total voltage of the DC sources may be predicted with certainty. There is insufficient information to calculate the total AC voltage for the two series-connected AC sources!

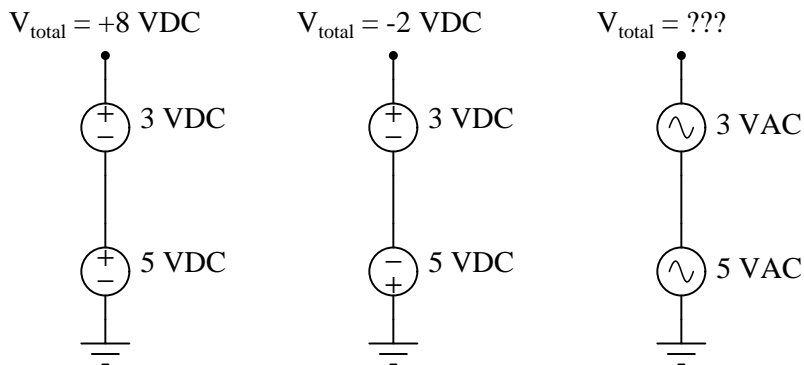

Answer 29

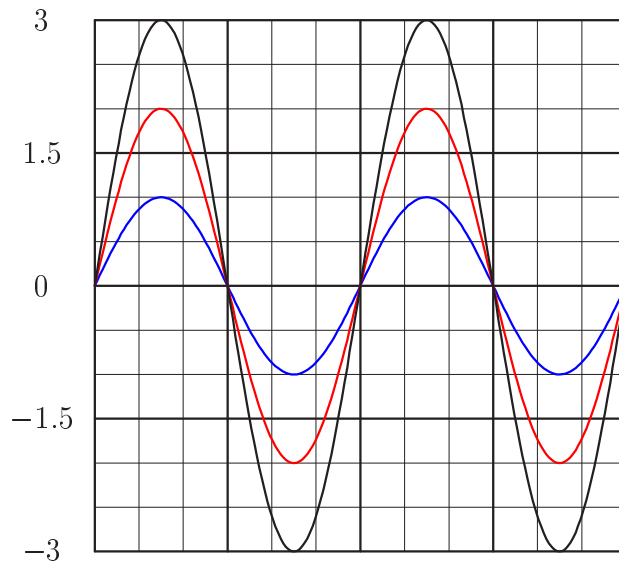

Answer 30

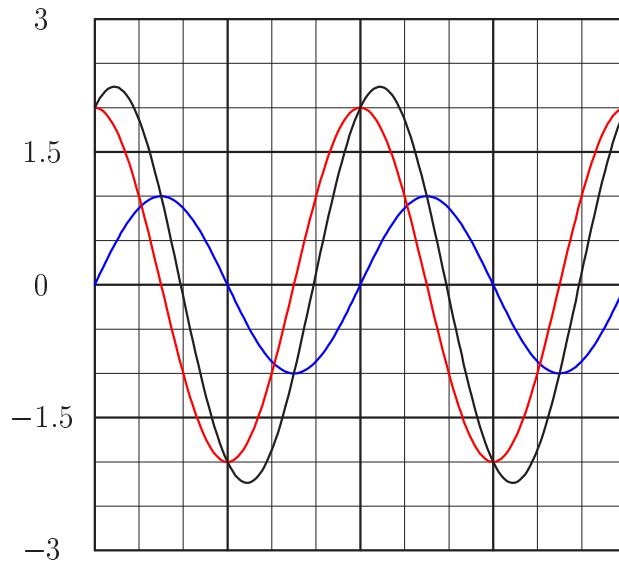

Follow-up question: note that the sum of the 1-volt wave and the 2-volt wave does *not* equate to a 3-volt wave! Explain why.

Answer 31

Each of the phasor diagrams represents two AC voltages being added together. The dotted phasor represents the sum of the 3-volt and 4-volt signals, for different conditions of phase shift between them.

Please note that these three possibilities are not exhaustive! There are a multitude of other possible total voltages that the series-connected 3 volt and 4 volt sources may create.

Follow-up question: in DC circuits, it is permissible to connect multiple voltage sources in parallel, so long as the voltages (magnitudes) and polarities are the same. Is this also true for AC? Why or why not?

Answer 32

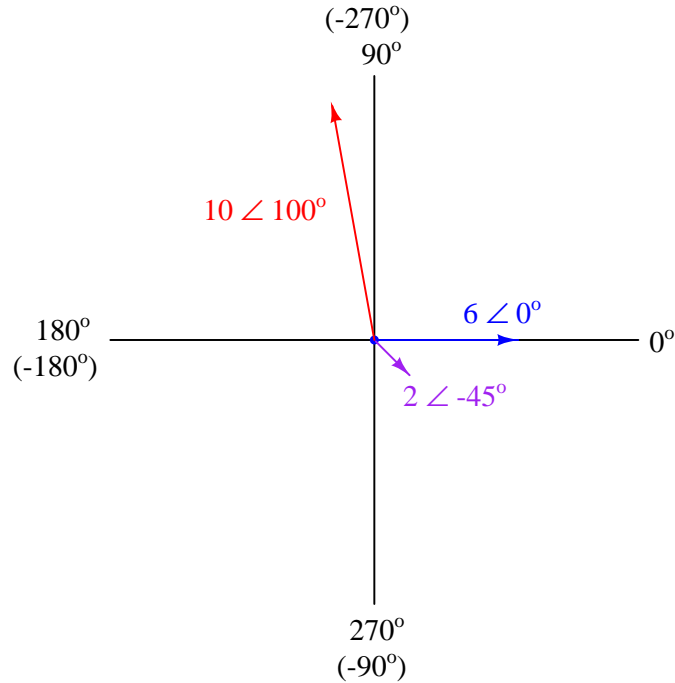

Answer 33

Here are two ways of showing the same addition:



Follow-up question: how would you verbally explain the process of phasor addition? If you were to describe to someone else how to add phasors together, what would you tell them?

Answer 34

I'll let you research this one on your own!

Follow-up question: identify an application in AC circuit analysis where the Pythagorean Theorem would be useful for calculating a circuit quantity such as voltage or current.

Answer 35

$$(4 \angle 0^\circ) + (3 \angle 90^\circ) = (5 \angle 36.87^\circ)$$

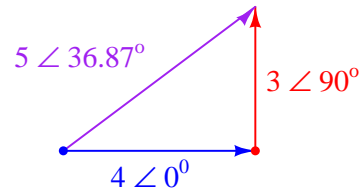

Polar notation describes a phasor in terms of magnitude (length) and angle:

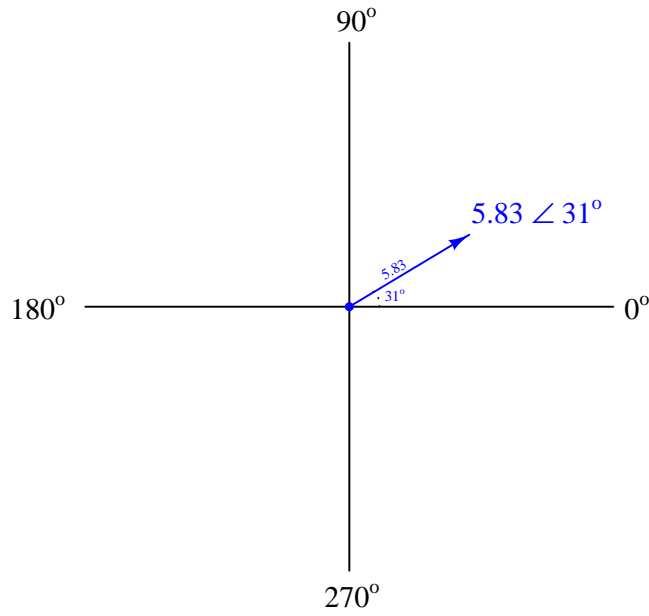

Rectangular notation describes a phasor in terms of horizontal and vertical displacement:

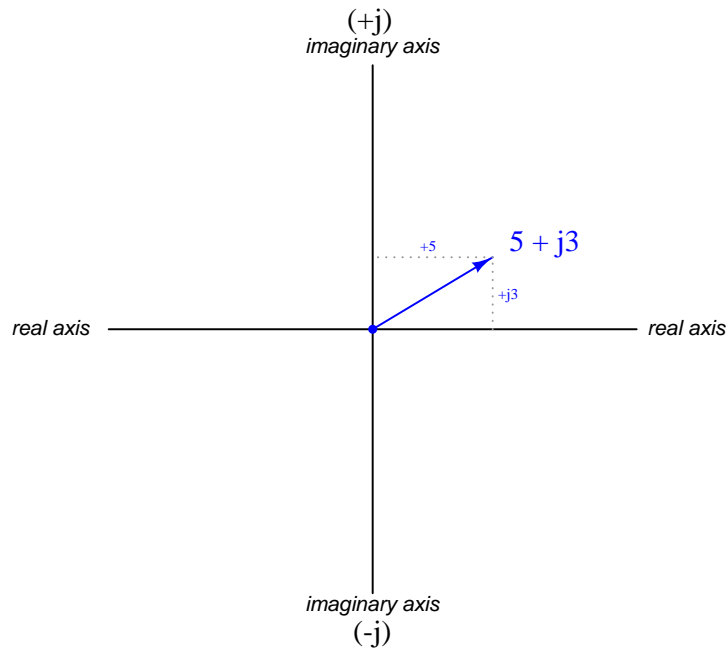

Follow-up question: why do we need the letter j in rectangular notation? What purpose does it serve, and what does it mean?

Answer 37

These two phasors, written in rectangular notation, would be $4 + j0$ and $0 + j3$, respectively, although a mathematician would probably write them as $4 + i0$ and $0 + i3$, respectively.

Challenge question: what does the lower-case j or i represent, in mathematical terms?

Answer 38

The 4-volt (peak) waveform *leads* the 3-volt (peak) waveform. Conversely, the 3-volt waveform *lags* behind the 4-volt waveform.

If the 4-volt waveform is denoted as $4 \text{ V} \angle 0^\circ$, then the 3-volt waveform should be denoted as $3 \text{ V} \angle -90^\circ$, or $0 - j3 \text{ V}$.

If the 4-volt waveform is denoted as $4 \text{ V} \angle 90^\circ$ ($0 + j4 \text{ V}$ in rectangular form), then the 3-volt waveform should be denoted as $3 \text{ V} \angle 0^\circ$, or $3 + j0 \text{ V}$.

Answer 39

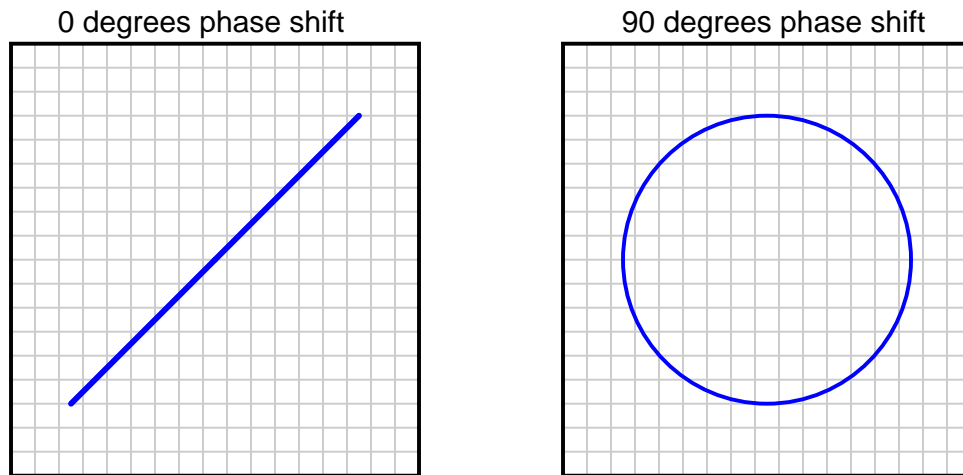

Challenge question: what kind of Lissajous figures would be plotted by the oscilloscope if the signals were non-sinusoidal? Perhaps the simplest example of this would be two square waves instead of two sine waves.

Answer 40

$$\Theta = \sin^{-1} \left(\frac{m}{n} \right)$$

Challenge question: what kind of Lissajous figure would be drawn by two sinusoidal waveforms at slightly different frequencies?

Answer 41

As a general rule, inductors oppose change in current, and they do so by producing a voltage.

An inductor will drop a greater amount of AC voltage, given the same AC current, at a greater frequency.

Answer 42

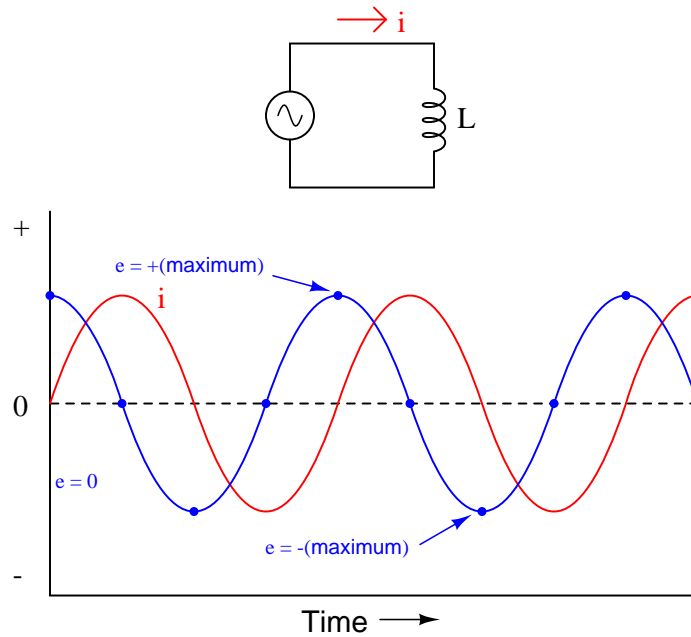

For an inductor, voltage is leading and current is lagging, by a phase shift of 90° .

Answer 43

The opposition to AC current ("reactance") of an inductor increases as frequency increases. We refer to this opposition as "reactance" rather than "resistance" because it is non-dissipative in nature. In other words, reactance causes no power to leave the circuit.

Answer 44

The light bulb will glow brighter when the iron core is moved away from the wire coil, due to the change in inductive reactance (X_L).

Follow-up question: what circuit failure(s) could cause the light bulb to glow brighter than it should?

Answer 45

$$X_L = 2\pi fL$$

The current through this inductor is 15.92 mA RMS.

Answer 46

$$f = 2.137 \text{ kHz}$$

Answer 47

$$L = 214.9 \text{ mH}$$

Answer 48

$$I = 15.6 \text{ mA}$$

Answer 49

$$Z_{total} = 500 \Omega.$$

Follow-up question: suppose that the inductor suffers a failure in its wire winding, causing it to "open." Explain what effect this would have on circuit current and voltage drops.

Answer 50

The fundamental distinction between these terms is one of abstraction: *impedance* is the most general term, encompassing both *resistance* and *reactance*. Here is an explanation given in terms of logical sets (using a *Venn diagram*), along with an analogy from animal taxonomy:

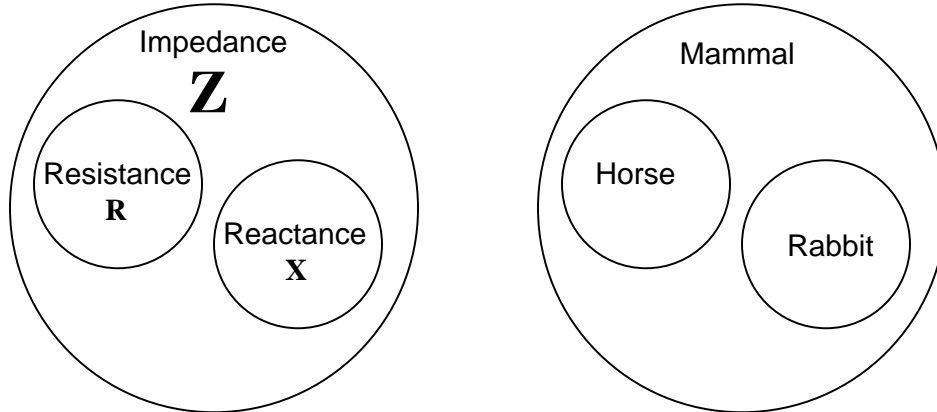

Resistance is a type of impedance, and so is reactance. The difference between the two has to do with *energy exchange*.

Answer 51

$$E = IZ$$

$$I = \frac{E}{Z}$$

$$Z = \frac{E}{I}$$

If using phasor quantities (complex numbers) for voltage, current, and impedance, the proper way to write these equations is as follows:

$$\mathbf{E} = \mathbf{I}\mathbf{Z}$$

$$\mathbf{I} = \frac{\mathbf{E}}{\mathbf{Z}}$$

$$\mathbf{Z} = \frac{\mathbf{E}}{\mathbf{I}}$$

Bold-faced type is a common way of denoting vector quantities in mathematics.

Answer 52

$$\mathbf{Z}_L = 251.33 \Omega \angle 90^\circ$$

Answer 53

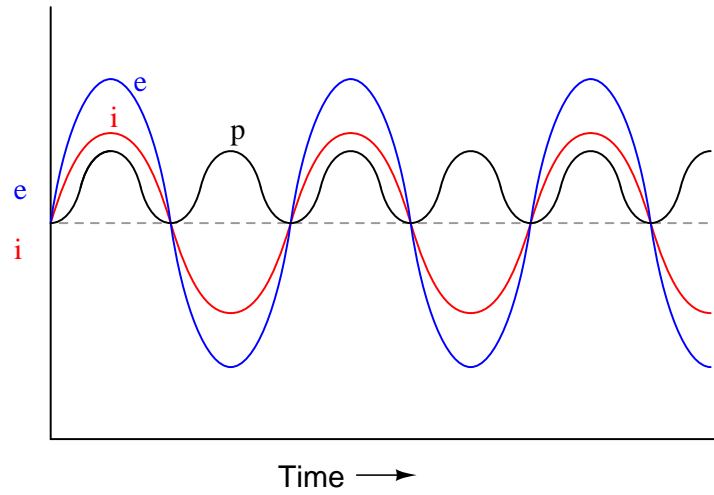

Answer 54

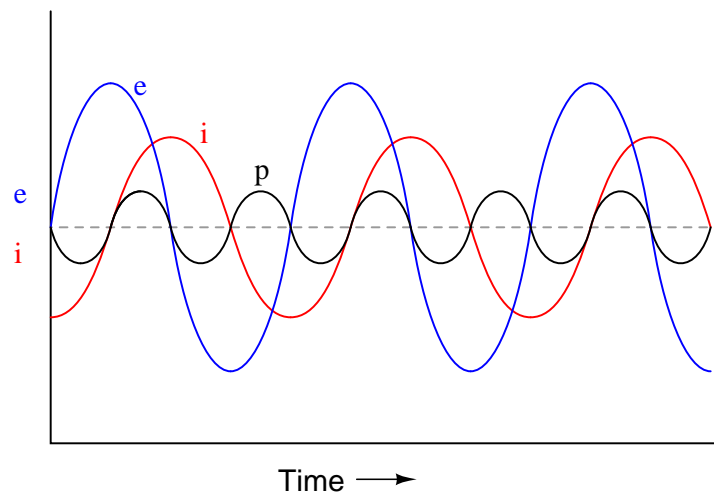

The mnemonic phrase, "ELI the ICE man" indicates that this phase shift is due to an inductance rather than a capacitance.

Answer 55

Each side of the impedance triangle is actually a *phasor* (a vector representing impedance with magnitude and direction):

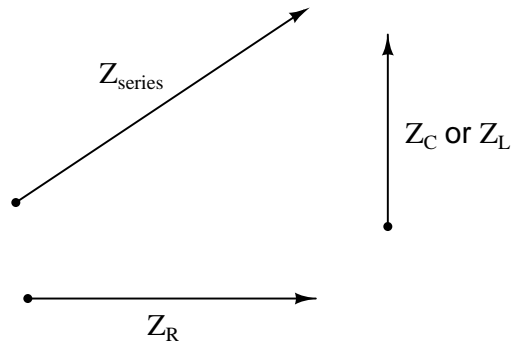

Since the phasor for resistive impedance (Z_R) has an angle of zero degrees and the phasor for reactive impedance (Z_C or Z_L) either has an angle of $+90$ or -90 degrees, the *phasor sum* representing total series impedance will form the hypotenuse of a right triangle when the first two phasors are added (tip-to-tail).

Follow-up question: as a review, explain why resistive impedance phasors always have an angle of zero degrees, and why reactive impedance phasors always have angles of either $+90$ degrees or -90 degrees.

Answer 56

$Z = 625 \Omega$, as calculated by the Pythagorean Theorem.

Answer 57

$X = 105 \Omega$, as calculated by an algebraically manipulated version of the Pythagorean Theorem.

Answer 58

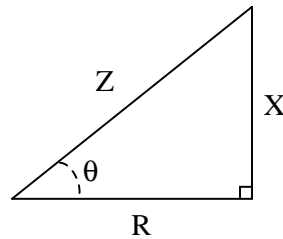

$$\frac{X}{R} = \tan \theta = \frac{\text{Opposite}}{\text{Adjacent}}$$

$$\frac{X}{Z} = \sin \theta = \frac{\text{Opposite}}{\text{Hypotenuse}}$$

$$\frac{R}{Z} = \cos \theta = \frac{\text{Adjacent}}{\text{Hypotenuse}}$$

$$\cos \Theta = \frac{R}{Z} \quad \text{Original equation}$$

. . . applying the "arc-cosine" function to both sides . . .

$$\arccos(\cos \Theta) = \arccos\left(\frac{R}{Z}\right)$$

$$\Theta = \arccos\left(\frac{R}{Z}\right)$$

$$\arccos \frac{R}{Z} = 53.13^\circ$$

$$\arctan \frac{X}{R} = 53.13^\circ$$

$$\arcsin \frac{X}{Z} = 53.13^\circ$$

Challenge question: identify three *more* arcfuctions which could be used to calculate the same angle Θ .

$$Z_{total} = \sqrt{R^2 + X^2}$$

Follow-up question: algebraically manipulate this equation to produce two more; one solving for R and the other solving for X .

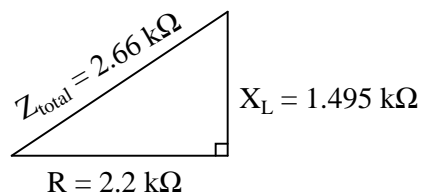

Scalar calculations

$$R = 2.2 \text{ k}\Omega \quad X_L = 1.495 \text{ k}\Omega$$

$$Z_{series} = \sqrt{R^2 + X_L^2}$$

$$Z_{series} = \sqrt{2200^2 + 1495^2} = 2660 \Omega$$

Complex number calculations

$$\mathbf{Z}_R = 2.2 \text{ k}\Omega \angle 0^\circ \quad \mathbf{Z}_L = 1.495 \text{ k}\Omega \angle 90^\circ \quad (\text{Polar form})$$

$$\mathbf{Z}_R = 2.2 \text{ k}\Omega + j0 \Omega \quad \mathbf{Z}_L = 0 \Omega + j1.495 \text{ k}\Omega \quad (\text{Rectangular form})$$

$$\mathbf{Z}_{\text{series}} = \mathbf{Z}_1 + \mathbf{Z}_2 + \dots + \mathbf{Z}_n \quad (\text{General rule of series impedances})$$

$$\mathbf{Z}_{\text{series}} = \mathbf{Z}_R + \mathbf{Z}_L \quad (\text{Specific application to this circuit})$$

$$\mathbf{Z}_{\text{series}} = 2.2 \text{ k}\Omega \angle 0^\circ + 1.495 \text{ k}\Omega \angle 90^\circ = 2.66 \text{ k}\Omega \angle 34.2^\circ$$

$$\mathbf{Z}_{\text{series}} = (2.2 \text{ k}\Omega + j0 \Omega) + (0 \Omega + j1.495 \text{ k}\Omega) = 2.2 \text{ k}\Omega + j1.495 \text{ k}\Omega$$

Answer 63

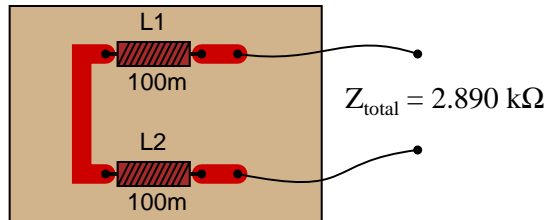

Phasor diagram

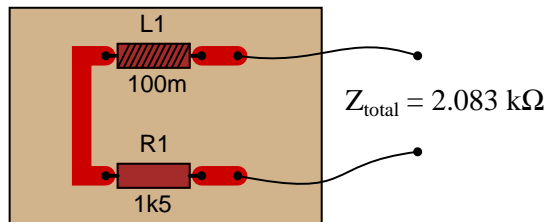
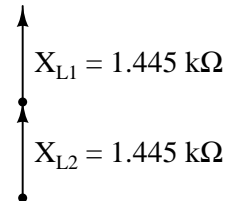

Phasor diagram

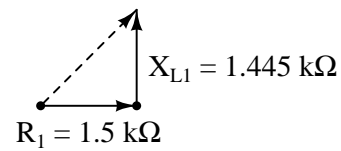

Answer 64

$$Z_{\text{total}} = 6.944 \text{ k}\Omega$$

$$I = 4.896 \text{ mA RMS}$$

Answer 65

$$\mathbf{I} = 7.849 \text{ mA} \angle -87.08^\circ$$

Answer 66

$$V_L = 12.60 \text{ volts RMS}$$

$$V_R = 8.137 \text{ volts RMS}$$

$$I = 11.46 \text{ milliamps RMS}$$

Answer 67

$$V_L = 13.04 \text{ volts RMS}$$

$$V_R = 20.15 \text{ volts RMS}$$

$$I = 4.030 \text{ milliamps RMS}$$

$$\Theta_Z = 32.91^\circ$$

Answer 68

- $I_{total} = 0.895$ mA
- $V_{L1} = 9.14$ V
- $V_{L2} = 2.19$ V
- $V_{R1} = 6.08$ V
- $V_{R2} = 1.07$ V
- $\Theta = 57.71^\circ$

I suggest using a dual-trace oscilloscope to measure total voltage (across the supply terminals) and voltage drop across resistor R_2 . Theoretically, measuring the voltage dropped by either resistor would be fine, but R_2 works better for practical reasons (oscilloscope input lead grounding). Phase shift then could be measured either in the time domain or by a Lissajous figure analysis.

Answer 69

Inductors are *reactive* rather than *resistive* components, and therefore do not dissipate power (ideally).

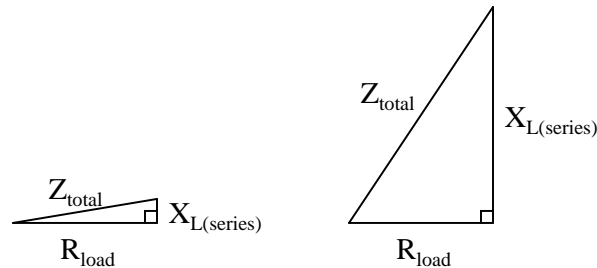

Follow-up question: the inductive circuit is not just more energy-efficient – it is safer as well. Identify a potential safety hazard that the resistive power-control circuit poses due to the energy dissipation of its variable resistor.

Answer 70

$$Y_{total} = \sqrt{G^2 + B^2}$$

Follow-up question #1: draw a phasor diagram showing how Y , G , and B relate.

Follow-up question #2: re-write this equation using quantities of resistance (R), reactance (X), and impedance (Z), instead of conductance (G), susceptance (B), and admittance (Y).

Answer 71

Electrical quantities that add:

- Series impedances
- Series voltages
- Parallel admittances
- Parallel currents
- Power dissipations

I will show you one graphical example of how a triangle may relate to electrical quantities other than series impedances:

Admittances add in parallel

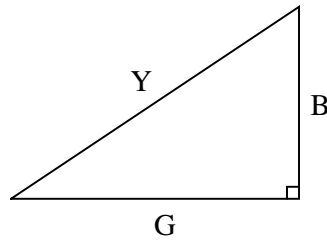

Answer 72

Impedances do not add in parallel.

Follow-up question: what kind of a triangle *could* be properly applied to a parallel AC circuit, and why?

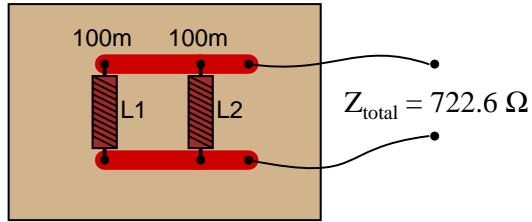

Phasor diagram

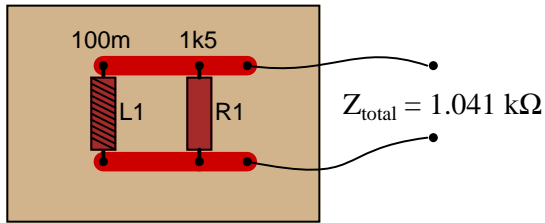
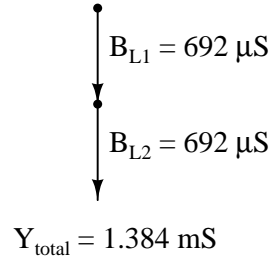

Phasor diagram

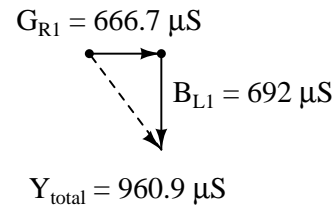

Challenge question: why are the susceptance vectors (B_{L1} and B_{L2}) pointed down instead of up as impedance vectors for inductances typically are?

Answer 74

$$I_L = 530.5 \mu\text{A RMS}$$

$$I_R = 490.2 \mu\text{A RMS}$$

$$I_{total} = 722.3 \mu\text{A RMS}$$

$$Z_{total} = 3.461 \text{ k}\Omega$$

Answer 75

$$I_{supply} = 12.29 \text{ A}$$

Answer 76

$$L_{eq} = 61.11 \text{ mH}$$

Answer 77

- $I_{total} = 2.12 \text{ mA}$
- $I_{L1} = 581 \mu\text{A}$
- $I_{L2} = 1.07 \text{ mA}$
- $I_{R1} = 597 \mu\text{A}$
- $I_{R2} = 730 \mu\text{A}$
- $\Theta = 51.24^\circ$

Measuring Θ with an oscilloscope requires the addition of a shunt resistor into this circuit, because oscilloscopes are (normally) only able to measure voltage, and there is no phase shift between any voltages in this circuit because all components are in parallel. I leave it to you to suggest where to insert the shunt resistor, what resistance value to select for the task, and how to connect the oscilloscope to the modified circuit.

Answer 78

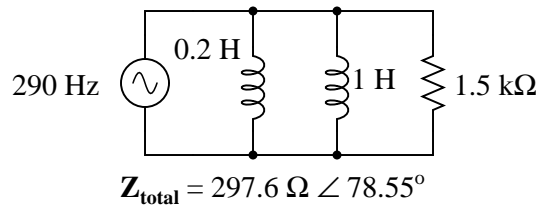
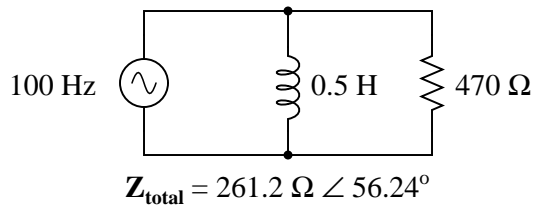
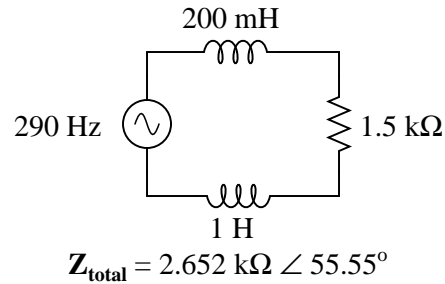
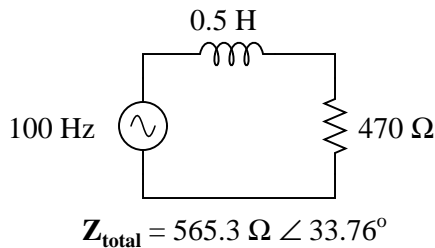

Answer 79

$$\Theta = 81 \text{ degrees}$$

Suppose the lamp turned on whenever the pushbutton switch was actuated, but the doorbell refused to ring. Identify what you think to be the most likely fault which could account for this problem.

Answer 80

$$R_{parallel} = 13.16 \Omega$$

$$L_{parallel} = 51.75 \text{ mH}$$

Challenge question: in the parallel LR circuit, the resistor will dissipate a lot of energy in the form of heat. Does this mean that the electric motor, which is electrically equivalent to the LR network, will dissipate the same amount of heat? Explain why or why not.

Answer 81

You may use circuit simulation software to set up similar oscilloscope display interpretation scenarios, for practice or for verification of what you see in this exercise.

Answer 82

You may use circuit simulation software to set up similar oscilloscope display interpretation scenarios, for practice or for verification of what you see in this exercise.

Answer 83

You may use circuit simulation software to set up similar oscilloscope display interpretation scenarios, for practice or for verification of what you see in this exercise.

Answer 84

Use circuit simulation software to verify your predicted and measured parameter values.

Answer 85

Use circuit simulation software to verify your predicted and measured parameter values.

Answer 86

There really isn't much you can do to verify your experimental results. That's okay, though, because the results are qualitative anyway.

Answer 87

I do not provide a grading rubric here, but elsewhere.

Answer 88

Be sure to document all steps taken and conclusions made in your troubleshooting!

Answer 89

$$f = 714.29 \text{ Hz}$$

Answer 90

$$\begin{aligned} E_{peak} &= 2.25 \text{ V} \\ E_{peak-to-peak} &= 4.50 \text{ V} \\ E_{RMS} &= 1.59 \text{ V} \\ f &= 40 \text{ Hz} \end{aligned}$$

Answer 91

The battery is faulty.

Follow-up question: discuss how accidentally setting the coupling control on the oscilloscope to "AC" instead of "DC" would also cause this waveform to show on the screen (even with a good battery).

Answer 92

The function generator is faulty.

Follow-up question: explain how this problem could be created simply by connecting the function generator to the circuit with the ground on the left-hand clip instead of the right-hand clip where it should be.

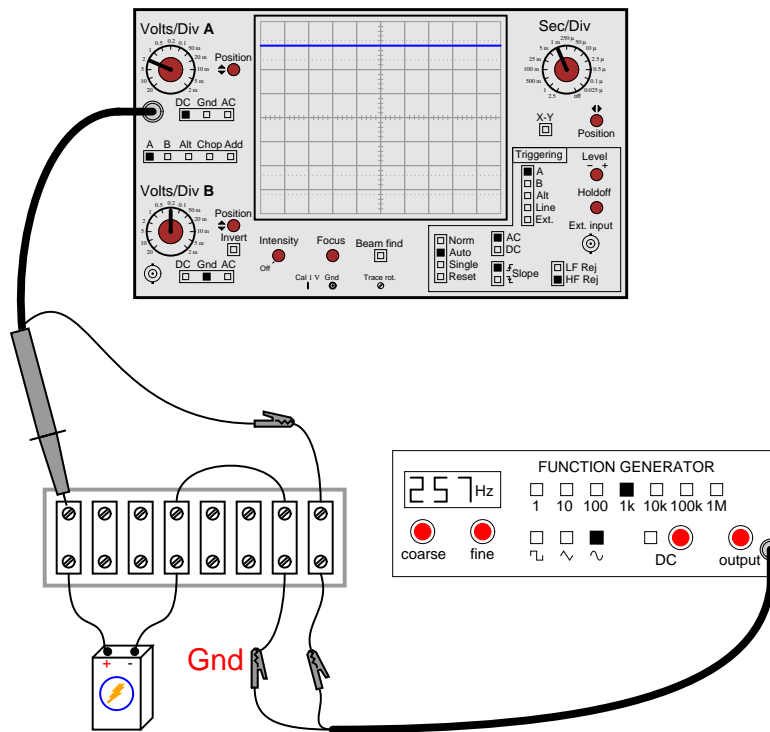

Answer 93

This would be a bad idea because the oscilloscope's ground clip would attempt to bypass current around the shunt resistor, through the oscilloscope's safety ground wire, and back to the grounded terminal of the AC source. Not only would this induce measurement errors, but it could damage the oscilloscope as well.

Follow-up question: identify a better way of connecting this oscilloscope to the shunt resistor.

Answer 94

Electromechanical alternators naturally output sinusoidal waveforms. Many DC-AC inverters do not.

Answer 95

Analog meter deflection is proportional to the *average* value of the AC waveform measured, for most AC meter movement types. There are some meter movement designs, however, that give indications proportional to the RMS value of the waveform: *hot-wire* and *electrodynamometer* movements are of this nature.

Follow-up question: does this mean an average-responding meter movement cannot be calibrated to indicate in RMS units?

Challenge question: why do hot-wire and electro-dynamometer meter movements provide true RMS indications, while most other movement designs indicate based on the signal's average value?

Answer 96

RMS current is the most appropriate type of measurement for calculating wire size.

Answer 97

Peak voltage is the most appropriate type of measurement for calculating insulator thickness. The reason why has to do with the time required for an insulator to "flash over."

Answer 98

$$\Theta \approx 25.9^\circ$$

Answer 99

$$\Theta \approx 64.2^\circ$$

Answer 100

$$\Theta \approx 34.5^\circ$$

Answer 101

$$\Theta \approx 44.4^\circ$$

Answer 102

The movable piece needs to move to the *left*, creating a larger air gap between the poles of the U-shaped inductor core.

Answer 103

With the iron armature no longer in the center of the solenoid coil, the coil's inductance – and therefore its inductive reactance to AC – dramatically diminishes unless the armature is replaced by something else ferromagnetic.

Answer 104

- Solenoid coil failed open
 - Wire broken anywhere in circuit
-

Answer 105

It is really important for you to frame this concept in your own words, so be sure to check with your instructor on the accuracy of your answer to this question! To give you a place to start, I offer this distinction: resistance is electrical *friction*, whereas reactance is electrical *energy storage*. Fundamentally, the difference between X and R is a matter of energy exchange, and it is understood most accurately in those terms.

Answer 106

Standard form of the Pythagorean Theorem:

$$C = \sqrt{A^2 + B^2}$$

Solving for A :

$$A = \sqrt{C^2 - B^2}$$

Solving for B :

$$B = \sqrt{C^2 - A^2}$$

Answer 107

The resultant force on the box will be 500 newtons.

Answer 108

Conduit run = 210 feet, 3.6 inches from corner to corner.

Note: the following equation is not the only form possible for calculating the diagonal length. Do not be worried if your equation does not look exactly like this!

$$L = \frac{\sqrt{x^4 + A^2}}{x}$$

Answer 109

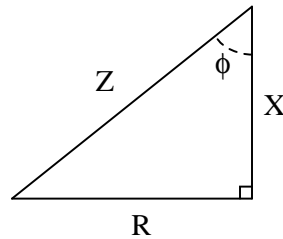

$$\frac{R}{X} = \tan \phi = \frac{\text{Opposite}}{\text{Adjacent}}$$

$$\frac{X}{Z} = \cos \phi = \frac{\text{Adjacent}}{\text{Hypotenuse}}$$

$$\frac{R}{Z} = \sin \phi = \frac{\text{Opposite}}{\text{Hypotenuse}}$$

Answer 110

In this diagram, phasor **B** is leading phasor **A**.

Follow-up question: using a protractor, estimate the amount of phase shift between these two phasors.

Answer 111

Phasor angles are *relative*, not *absolute*. They have meaning only where there is another phasor to compare against.

Angles may be associated with multiple AC voltage sources in the same circuit, but *only if those voltages are all at the same frequency*.

Answer 112

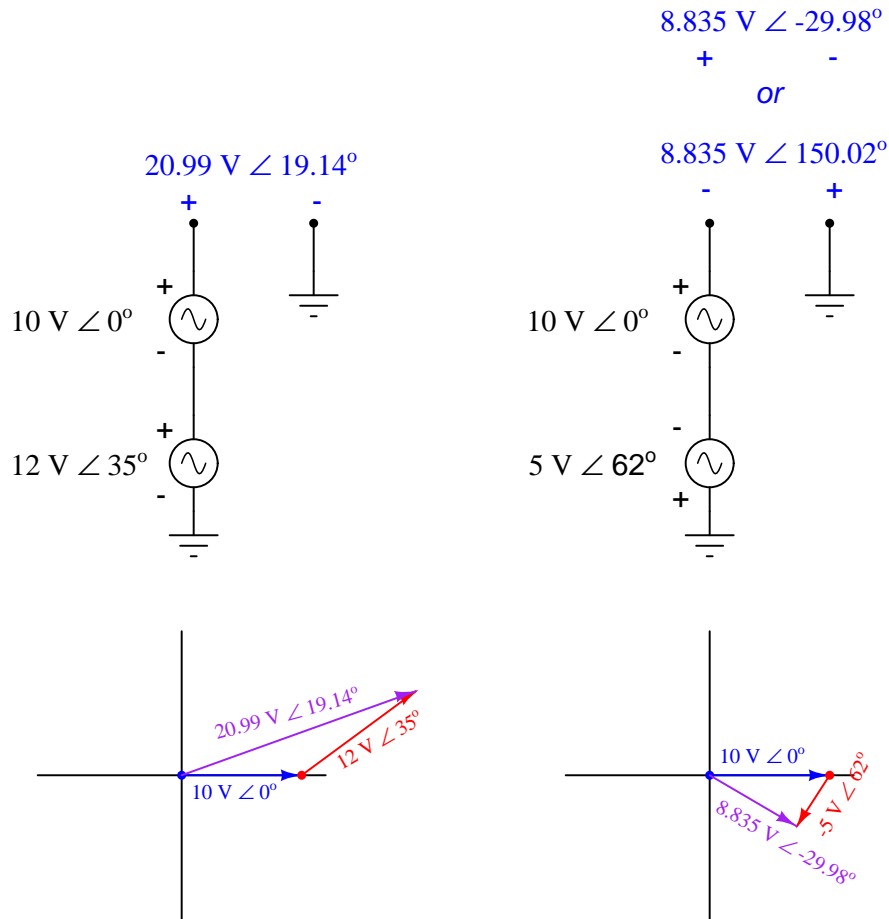

Answer 113

Dim lights indicate a condition of being "in-phase" with the bus. If the two alternators are spinning at slightly different speeds, there will be a *heterodyne* effect to the light bulbs' brightness: alternately growing brighter, then dimmer, then brighter again.

Answer 114

Before you proceed with troubleshooting steps, first try to determine if there is anything wrong with this system at all. Could it be that the operator is just overly cautious, or is their caution justified?

Answer 115

$$X_L = 16.98\text{ mH}$$

Answer 116

$$Q_{coil} = \frac{X_L}{R}$$

Answer 117

First strategy:

$$L_{total} = 1.1 \text{ H}$$

$$X_{total} = 414.7 \Omega$$

$$\mathbf{Z}_{total} = 414.7 \Omega \angle 90^\circ \text{ or } \mathbf{Z}_{total} = 0 + j414.7 \Omega$$

Second strategy:

$$X_{L1} = 282.7 \Omega \quad \mathbf{Z}_{L1} = 282.7 \Omega \angle 90^\circ$$

$$X_{L2} = 131.9 \Omega \quad \mathbf{Z}_{L2} = 131.9 \Omega \angle 90^\circ$$

$$\mathbf{Z}_{total} = 414.7 \Omega \angle 90^\circ \text{ or } \mathbf{Z}_{total} = 0 + j414.7 \Omega$$

Follow-up question: draw a phasor diagram showing how the two inductors' impedance phasors geometrically add to equal the total impedance.

Answer 118

Scalar calculations

$$R_1 = 1.5 \text{ k}\Omega \quad G_{R1} = 666.7 \mu\text{S}$$

$$X_{L1} = 2.513 \text{ k}\Omega \quad B_{L1} = 397.9 \mu\text{S}$$

$$Y_{total} = \sqrt{G^2 + B^2} = 776.4 \mu\text{S}$$

$$Z_{total} = \frac{1}{Y_{total}} = 1.288 \text{ k}\Omega$$

Complex number calculations

$$R_1 = 1.5 \text{ k}\Omega \quad \mathbf{Z}_{R1} = 1.5 \text{ k}\Omega \angle 0^\circ$$

$$X_{L1} = 2.513 \text{ k}\Omega \quad \mathbf{Z}_{L1} = 2.513 \text{ k}\Omega \angle 90^\circ$$

$$\mathbf{Z}_{total} = \frac{1}{\frac{1}{\mathbf{Z}_{R1}} + \frac{1}{\mathbf{Z}_{L1}}} = 1.288 \text{ k}\Omega \angle 30.83^\circ$$

Answer 119

First strategy:

$$L_{total} = 391.3 \text{ mH}$$

$$X_{total} = 295.0 \Omega$$

$$\mathbf{Z}_{total} = 295.0 \Omega \angle 90^\circ \text{ or } \mathbf{Z}_{total} = 0 + j295.0 \Omega$$

Second strategy:

$$Z_{L1} = X_{L1} = 377.0 \Omega$$

$$Y_{L1} = \frac{1}{Z_{L1}} = 2.653 \text{ mS}$$

$$Z_{L2} = X_{L2} = 1.357 \text{ k}\Omega$$

$$Y_{L2} = \frac{1}{Z_{L2}} = 736.8 \mu\text{S}$$

$$Y_{total} = 3.389 \text{ mS}$$

$$Z_{total} = \frac{1}{Y_{total}} = 295 \Omega$$

Third strategy: (using complex numbers)

$$X_{L1} = 377.0 \Omega \quad \mathbf{Z}_{L1} = 377.0 \Omega \angle 90^\circ$$

$$X_{L2} = 1.357 \text{ k}\Omega \quad \mathbf{Z}_{L2} = 1.357 \text{ k}\Omega \angle 90^\circ$$

$$\mathbf{Z}_{total} = 295.0 \Omega \angle 90^\circ \text{ or } \mathbf{Z}_{total} = 0 + j295.0 \Omega$$

Follow-up question: draw a phasor diagram showing how the two inductors' admittance phasors geometrically add to equal the total admittance.

Answer 120

$$f = 11.342 \text{ kHz}$$

$$f = \frac{R}{2\pi L \tan \theta}$$

Answer 121

$$R = 6.826 \text{ k}\Omega$$

$$R = 2\pi f L \tan \theta$$

Answer 122

$$f = 2.804 \text{ kHz}$$

$$f = -\frac{R \tan \theta}{2\pi L}$$

Answer 123

$$R = 2.902 \text{ k}\Omega$$

$$R = -\frac{2\pi f L}{\tan \theta}$$

Notes 1

Discuss a bit of the history of AC versus DC in early power systems. In the early days of electric power in the United States of America, there was a heated debate between the use of DC versus AC. Thomas Edison championed DC, while George Westinghouse and Nikola Tesla advocated AC.

It might be worthwhile to mention that almost all the electric power in the world is generated and distributed as AC (Alternating Current), and not as DC (in other words, Thomas Edison lost the AC/DC battle!). Depending on the level of the class you are teaching, this may or may not be a good time to explain *why* most power systems use AC. Either way, your students will probably ask why, so you should be prepared to address this question in some way (or have them report any findings of their own!).

Notes 2

For many students, this might be the first time they realize trigonometry functions have anything to do with electricity! That voltage and current in an AC circuit might alternate according to a mathematical function available in their calculators is something of a revelation. Be prepared to discuss *why* rotating electromagnetic machines naturally produce such waveforms. Also, encourage students to make the cognitive connection between the independent variable of a sine function (angle, expressed in units of degrees in this question) to actual shaft rotation in a real generator.

Notes 3

A common misconception is that DC is more capable of delivering a harmful electric shock than AC, all other factors being equal. In fact, this is something I used to teach myself (because I had heard it numerous times from others) before I discovered the research of Charles Dalziel. One of the explanations used to support the myth of DC being more dangerous is that DC has the ability to cause muscle tetanus more readily than AC. However, at 60 Hertz, the reversals of polarity occur so quickly that no human muscle could relax fast enough to enable a shock victim to release a "hot" wire anyway, so that fact that AC stops multiple times per second is of no benefit to the victim.

Do not be surprised if some students react unfavorably to the answer given here! The myth that DC is more dangerous than AC is so prevalent, especially among people who have a little background knowledge of the subject, that to counter it is to invite dispute. This is why I included the condition of supporting any answer by research data in the question.

This just goes to show that there are many misconceptions about electricity that are passed from person to person as "common knowledge" which have little or no grounding in fact (lightning never strikes twice in the same spot, electricity takes the least path of resistance, high current is more dangerous than high voltage, etc., etc.). The study of electricity and electronics is science, and in science experimental data is our sole authority. One of the most important lessons to be learned in science is that human beings have a propensity to believe things which are not true, and some will continue to defend false beliefs even in the face of conclusive evidence.

Notes 4

As always, it is more important to be able to apply a term to a real-life example than it is to memorize a definition for that term. In my experience, many students prefer to memorize definitions for terms rather than to go through the trouble of understanding how those terms apply to real life. Make sure students realize just how and why these AC terms apply to a waveform such as this.

Notes 5

Encourage your students to discuss the origins of the new unit (Hertz), and how it actually communicates less information about the thing being measured than the old unit (CPS).

Notes 6

It is important for students to realize the reciprocal relationship between frequency and period. One is *cycles per second* while the other is *seconds per cycle*.

Notes 7

I purposely omit the velocity of light, as well as the time/distance/velocity equation, so that students will have to do some simple research to calculate this value. Neither of these concepts is beyond high-school level science students, and should pose no difficulty at all for college-level students to find on their own.

Notes 8

An audio speaker is an outstanding instrument to use in teaching AC theory, because it makes use of a human sense that most instruments do not. I have constructed a simple headphone-based listening instrument for my own lab use, and have found it invaluable, especially in the absence of an oscilloscope. There is so much the trained ear may discern about an AC waveform based on volume and tone!

Notes 9

Oscilloscope function is often best learned through interaction. Be sure to have at least one oscilloscope operational in the classroom for student interaction during discussion time.

Notes 10

Some of your students may come across photographs and illustrations of CRTs for use in their presentation. If at all possible, provide a way for individual students to share their visual findings with their classmates, through the use of an overhead projector, computer monitor, or computer projector. Discuss in detail the operation of a CRT with your students, especially noting the electrostatic method of electron beam deflection used to "steer" the beam to specific areas on the screen.

Notes 11

This question challenges students to figure out both the polarization of the probe (and ground clip), as well as the orientation of the Y axis. It is very important, of course, that the coupling control be set on "DC" in order to successfully measure a DC signal.

Notes 12

Measuring voltage on an oscilloscope display is very similar to measuring voltage on an analog voltmeter. The mathematical relationship between scale divisions and range is much the same. This is one reason I encourage students to use analog multimeters occasionally in their labwork, if for no other reason than to preview the principles of oscilloscope scale interpretation.

Notes 13

Discuss the function of both these controls with your students. If possible, demonstrate this scenario using a real oscilloscope and function generator, and have students adjust the controls to get the waveform to display optimally. Challenge your students to think of ways the *signal source* (function generator) may be adjusted to produce the display, then have them think of ways the oscilloscope controls could be adjusted to fit.

Notes 14

Discuss the function of both these controls with your students. If possible, demonstrate this scenario using a real oscilloscope and function generator, and have students adjust the controls to get the waveform to display optimally. Challenge your students to think of ways the *signal source* (function generator) may be adjusted to produce the display, then have them think of ways the oscilloscope controls could be adjusted to fit.

Notes 15

Discuss the function of both these controls with your students. If possible, demonstrate this scenario using a real oscilloscope and function generator, and have students adjust the controls to get the waveform to display optimally.

Notes 16

Discuss the function of both these controls with your students. If possible, demonstrate this scenario using a real oscilloscope and function generator, and have students adjust the controls to get the waveform to display optimally. Challenge your students to think of ways the *signal source* (function generator) may be adjusted to produce the display, then have them think of ways the oscilloscope controls could be adjusted to fit.

Notes 17

This is just a straightforward exercise in determining period and translating that value into frequency.

Notes 18

This question is not only good for introducing basic oscilloscope principles, but it is also excellent for review of AC waveform measurements.

Notes 19

This is a very important lesson for students to learn about line-powered oscilloscopes. If necessary, discuss the wiring of the power system, drawing a schematic showing the complete short-circuit fault current path, from AC voltage source to "hot" lead to ground clip to chassis to ground prong to ground wire to neutral wire to AC voltage source.

Notes 20

Failing to consider that the "ground" leads on all probes are common to each other (as well as common to the safety ground conductor of the line power system) is a *very* common mistake among students first learning how to use oscilloscopes. Hopefully, discussing scenarios such as this will help students avoid this problem in their labwork.

Note to Socratic Electronics developers: the oscilloscope shown in figure 01821x01.eps is made up of individual lines, circles, text elements, etc., rather than a single object as is contained in the Xcircuit library file (scope.lps). If you wish to edit the features of this scope, start with the 01821x01.eps image file rather than the library object! Then you may save your modified oscilloscope as a complete object in your own image library for future use.

Notes 21

Before you discuss "RMS" values with your students, it is important to cover the basic idea of how to assign fixed values to quantities that change over time. Since AC waveforms are *cyclic* (repeating), this is not as difficult to do as one might think.

Notes 22

There are many analogies to explain this discrepancy between the two "50 volt" sources. One is to compare the physical effort of a person pushing with a constant force of 50 pounds, versus someone who pushes intermittently with only a *peak* force of 50 pounds.

Notes 23

Ask your students, "how much *peak* voltage is the AC power source outputting? More or less than 120 volts?"

If one of your students claims to have calculated the peak voltage as 169.7 volts, ask them how they arrived at that answer. Then ask if that answer depends on the shape of the waveform (it does!). Note that the question did not specify a "sinusoidal" wave shape. Realistically, an adjustable-voltage AC power supply of substantial power output will likely be sinusoidal, being powered from utility AC power, but it *could* be a different wave-shape, depending on the nature of the source!

Notes 24

Students must properly interpret the oscilloscope's display, then correctly convert to RMS units, in order to obtain the correct answer for this question.

Notes 25

Many electronics students I've talked to seem to think that the RMS value of a waveform is always $\frac{\sqrt{2}}{2}$, no matter what the waveshape. Not true, as evidenced by the answer for this question!

Students must properly interpret the oscilloscope's display in order to obtain the correct answer for this question. The "conversion" to RMS units is really non-existent, but I want students to be able to explain *why* it is and not just memorize this fact.

Notes 26

Students sometimes have difficulty grasping the significance of PMMC meter movements being "average-responding" rather than RMS-responding. Hopefully, the answer to this question will help illuminate this subject more.

Notes 27

Phasors are really nothing more than an extension of the familiar "number line" most students see during their primary education years. The important difference here is that phasors are two-dimensional magnitudes, not one-dimensional, as *scalar* numbers are.

The use of degrees to measure angles should be familiar as well, even to those students without a strong mathematics background. For example, what does it mean when a skateboarder or stunt bicyclist "does a 180°"? It means they turn around so as to face the opposite direction (180 degrees away from) their previous direction.

Notes 28

Discuss with your students exactly why the total voltage of the two series-connected AC sources cannot be determined, given the little information we have about them. Is it possible for their total voltage to be 8 VAC, just like the series-aiding DC sources? Is it possible for their total voltage to be 2 VAC, just like the series-opposing DC sources? Why or why not?

Notes 29

Graphing calculators are excellent tools to use for learning experiences such as this. In far less time than it would take to plot a third sine wave by hand, students may see the sinusoidal sum for themselves.

Notes 30

Graphing calculators are excellent tools to use for learning experiences such as this. In far less time than it would take to plot a third sine wave by hand, students may see the sinusoidal sum for themselves.

The point of this question is to get students thinking about how it is possible for sinusoidal voltages to not add up as one might expect. This is very important, because it indicates simple arithmetic processes like addition will not be as simple in AC circuits as it was in DC circuits, due to phase shift. Be sure to emphasize this point to your students.

Notes 31

Be sure to discuss with your students that these three conditions shown are not the only conditions possible! I simply chose 0° , 180° , and 90° because they all resulted in round sums for the given quantities.

The follow-up question previews an important subject concerning AC phase: the necessary *synchronization* or paralleled AC voltage sources.

Notes 32

Graph paper, a ruler, and a protractor may be helpful for your students as they begin to draw and interpret phasor diagrams. Even if they have no prior knowledge of trigonometry or phasors, they should still be able to graphically represent simple phasor systems and even solve for resultant phasors.

Notes 33

Discuss with your students that phasors may also be subtracted, multiplied, and divided. Subtraction is not too difficult to visualize, but addition and multiplication defies geometric understanding for many.

Notes 34

The Pythagorean Theorem is easy enough for students to find on their own that you should not need to show them. A memorable illustration of this theorem are the side lengths of a so-called *3-4-5* triangle. Don't be surprised if this is the example many students choose to give.

Notes 35

It is very helpful in a question such as this to graphically depict the phasors. Have one of your students draw a phasor diagram on the whiteboard for the whole class to observe and discuss.

The relation of this arithmetic problem to an AC circuit is a very important one for students to grasp. It is one thing for students to be able to mathematically manipulate and combine phasors, but quite another for them to smoothly transition between a phasor operation and comprehension of voltages and/or currents in an AC circuit. Ask your students to describe what the *magnitude* of a phasor means (in this example, the number 5), if that phasor represents an AC voltage. Ask your students to describe what the *angle* of an AC voltage phasor means, as well (in this case, 36.87°), for an AC voltage.

Notes 36

When discussing the meaning of *j*, it might be good to explain what *imaginary numbers* are. Whether or not you choose to do this depends on the mathematical aptitude and background of your students.

Notes 37

Discuss with your students the two notations commonly used with phasors: *polar* and *rectangular* form. They are merely two different ways of "saying" the same thing. A helpful "prop" for this discussion is the complex number *plane* (as opposed to a number *line* – a one-dimensional field), showing the "real" and "imaginary" axes, in addition to standard angles (right = 0° , left = 180° , up = 90° , down = 270°). Your students should be familiar with this from their research, so have one of them draw the number plane on the whiteboard for all to view.

The challenge question regards the origin of complex numbers, beginning with the distinction of "imaginary" numbers as being a separate set of quantities from "real" numbers. Electrical engineers, of course, avoid using the lower-case letter *i* to denote "imaginary" because it would be so easily be confused with the standard notation for instantaneous current *i*.

Notes 38

In my years of teaching, I have been surprised at how many students struggle with identifying the "leading" and "lagging" waveforms on a time-domain graph. Be sure to discuss this topic well with your students, identifying methods for correctly distinguishing "leading" waves from "lagging" waves.

This question also provides students with good practice expressing leading and lagging waves in phasor notation. One of the characteristics of phasors made evident in the answer is the relative nature of angles. Be sure to point this out to your students.

Notes 39

Many students seem to have trouble grasping how Lissajous figures are formed. One of the demonstrations I use to overcome this conceptual barrier is an analog oscilloscope and two signal generators set to very low frequencies, so students can see the "dot" being swept across the screen by both waveforms in slow-motion. Then, I speed up the signals and let them see how the Lissajous pattern becomes more "solid" with persistence of vision and the inherent phosphor delay of the screen.

Notes 40

This is a great exercise in teaching students how to derive an equation from physical measurements when the fundamental nature of that equation (trigonometric) is already known. They should already know what the Lissajous figures for both 0° and 90° look like, and should have no trouble figuring out what a and b values these two scenarios would yield if measured similarly on the oscilloscope display. The rest is just fitting the pieces together so that the trigonometric function yields the correct angle(s).

Notes 41

This question is an exercise in qualitative thinking: relating rates of change to other variables, without the use of numerical quantities. The general rule stated here is very, very important for students to master, and be able to apply to a variety of circumstances. If they learn nothing about inductors except for this rule, they will be able to grasp the function of a great many inductor circuits.

Notes 42

This question is an excellent application of the calculus concept of the *derivative*: relating one function (instantaneous voltage, e) with the instantaneous rate-of-change of another function (current, $\frac{di}{dt}$).

Notes 43

Ask your students to define the relationship between inductor reactance and frequency as either "directly proportional" or "inversely proportional". These are two phrases used often in science and engineering to describe whether one quantity increases or decreases as another quantity increases. Your students definitely need to be familiar with both these phrases, and be able to interpret and use them in their technical discussions.

Also, discuss the meaning of the word "non-dissipative" in this context. How could we prove that the opposition to current expressed by an inductor is non-dissipative? What would be the ultimate test of this?

Notes 44

One direction you might want to lead your students in with this question is how AC power may be controlled using this principle. Controlling AC power with a variable *reactance* has a definite advantage over controlling AC power with a variable *resistance*: less wasted energy in the form of heat.

Notes 45

I have consistently found that qualitative (greater than, less than, or equal) analysis is much more difficult for students to perform than quantitative (punch the numbers on a calculator) analysis. Yet, I have consistently found on the job that people lacking qualitative skills make more "silly" quantitative errors because they cannot validate their calculations by estimation.

In light of this, I always challenge my students to qualitatively analyze formulae when they are first introduced to them. Ask your students to identify what will happen to one term of an equation if another term were to either increase, or decrease (you choose the direction of change). Use up and down arrow symbols if necessary to communicate these changes graphically. Your students will greatly benefit in their conceptual understanding of applied mathematics from this kind of practice!

Notes 46

Be sure to ask your students to demonstrate the algebraic manipulation of the original formula, in providing the answer to this question. Algebraic manipulation of equations is a very important skill to have, and it comes only by study and practice.

Notes 47

Be sure to ask your students to demonstrate the algebraic manipulation of the original formula, in providing the answer to this question. Algebraic manipulation of equations is a very important skill to have, and it comes only by study and practice.

Notes 48

The current is not difficult to calculate, so obviously the most important aspect of this question is not the math. Rather, it is the *procedure* of calculation: what to do first, second, third, etc., in obtaining the final answer.

Notes 49

Students may experience difficulty arriving at the same quantity for impedance shown in the answer. If this is the case, help them problem-solve by suggesting they **simplify the problem**: short past one of the load components and calculate the new circuit current. Soon they will understand the relationship between total circuit opposition and total circuit current, and be able to apply this concept to the original problem.

Ask your students why the quantities of $300\ \Omega$ and $400\ \Omega$ do not add up to $700\ \Omega$ like they would if they were both resistors. Does this scenario remind them of another mathematical problem where $3 + 4 = 5$? Where have we seen this before, especially in the context of electric circuits?

Once your students make the cognitive connection to trigonometry, ask them the significance of these numbers' addition. Is it enough that we say a component has an opposition to AC of $400\ \Omega$, or is there more to this quantity than a single, scalar value? What type of number would be suitable for representing such a quantity, and how might it be written?

Notes 50

The given answer is far from complete. I've shown the semantic relationship between the terms resistance, reactance, and impedance, but I have only hinted at the conceptual distinctions between them. Be sure to discuss with your students what the fundamental difference is between resistance and reactance, in terms of electrical energy exchange.

Notes 51

Although the use of phasor quantities for voltage, current, and impedance in the AC form of Ohm's Law yields certain distinct advantages over scalar calculations, this does not mean one cannot use scalar quantities. Often it is appropriate to express an AC voltage, current, or impedance as a simple scalar number.

Notes 52

This is a challenging question, because it asks the student to defend the application of phase angles to a type of quantity that does not really possess a wave-shape like AC voltages and currents do. Conceptually, this is difficult to grasp. However, the answer is quite clear through the Ohm's Law calculation ($Z = \frac{E}{I}$).

Although it is natural to assign a phase angle of 0° to the 36 volt supply, making it the reference waveform, this is not actually necessary. Work through this calculation with your students, assuming different angles for the voltage in each instance. You should find that the impedance computes to be the same exact quantity every time.

Notes 53

Ask your students to observe the waveform shown in the answer closely, and determine what *sign* the power values always are. Note how the voltage and current waveforms alternate between positive and negative, but power does not. Of what significance is this to us? What does this indicate about the nature of a load with an impedance phase angle of 0° ?

Notes 54

Ask your students to observe the waveform shown in the answer closely, and determine what *sign* the power values are. Note how the power waveform alternates between positive and negative values, just as the voltage and current waveforms do. Ask your students to explain what *negative* power could possibly mean.

Of what significance is this to us? What does this indicate about the nature of a load with an impedance phase angle of 90° ?

The phrase, "ELI the ICE man" has been used by generations of technicians to remember the phase relationships between voltage and current for inductors and capacitors, respectively. One area of trouble I've noted with students, though, is being able to interpret which waveform is leading and which one is lagging, from a time-domain plot such as this.

Notes 55

The question is sufficiently open-ended that many students may not realize exactly what is being asked until they read the answer. This is okay, as it is difficult to phrase the question in a more specific manner without giving away the answer!

Notes 56

Be sure to have students show you the form of the Pythagorean Theorem, rather than showing them yourself, since it is so easy for students to research on their own.

Notes 57

Be sure to have students show you the form of the Pythagorean Theorem, rather than showing them yourself, since it is so easy for students to research on their own.

Notes 58

Ask your students to explain what the words "hypotenuse", "opposite", and "adjacent" refer to in a right triangle.

Notes 59

I like to show the purpose of trigonometric arcfunctions in this manner, using the cardinal rule of algebraic manipulation (do the same thing to both sides of an equation) that students are familiar with by now. This helps eliminate the mystery of arcfunctions for students new to trigonometry.

Notes 60

Some hand calculators identify arc-trig functions by the letter "A" prepending each trigonometric abbreviation (e.g. "ASIN" or "ATAN"). Other hand calculators use the inverse function notation of a -1 exponent, which is *not* actually an exponent at all (e.g. \sin^{-1} or \tan^{-1}). Be sure to discuss function notation on your students' calculators, so they know what to invoke when solving problems such as this.

Notes 61

Ask your students if this equation looks similar to any other mathematical equations they've seen before. If not, square both sides of the equation so it looks like $Z^2 = R^2 + X^2$ and ask them again.

Notes 62

I want students to see that there are two different ways of approaching a problem such as this: with *scalar* math and with *complex number* math. If students have access to calculators that can do complex-number arithmetic, the "complex" approach is actually simpler for series-parallel combination circuits, and it yields richer (more informative) results.

Ask your students to determine which of the approaches most resembles DC circuit calculations. Incidentally, this is why I tend to prefer complex-number AC circuit calculations over scalar calculations: because of the conceptual continuity between AC and DC. When you use complex numbers to represent AC voltages, currents, and impedances, almost all the rules of DC circuits still apply. The big exception, of course, is calculations involving *power*.

Notes 63

Phasor diagrams are powerful analytical tools, if one knows how to draw and interpret them. With hand calculators being so powerful and readily able to handle complex numbers in either polar or rectangular form, there is temptation to avoid phasor diagrams and let the calculator handle all the angle manipulation. However, students will have a much better understanding of phasors and complex numbers in AC circuits if you hold them accountable to representing quantities in that form.

Notes 64

This would be an excellent question to have students present methods of solution for. Sometimes I have students present nothing but their solution steps on the board in front of class (no arithmetic at all), in order to generate a discussion on problem-solving strategies. The important part of their education here is not to arrive at the correct answer or to memorize an algorithm for solving this type of problem, but rather how to *think* like a problem-solver, and how to methodically apply the math they know to the problem(s) at hand.

Notes 65

Inductors are the least "pure" of any reactive component, due to significant quantities of resistance in the windings. Discuss this fact with your students, and what it means with reference to choosing inductors versus capacitors in circuit designs that could use either.

Nothing special here – just a straightforward exercise in series AC circuit calculations.

Students often have difficulty formulating a method of solution: determining what steps to take to get from the given conditions to a final answer. While it is helpful at first for you (the instructor) to show them, it is bad for you to show them too often, lest they stop thinking for themselves and merely follow your lead. A teaching technique I have found very helpful is to have students come up to the board (alone or in teams) in front of class to write their problem-solving strategies for all the others to see. They don't have to actually do the math, but rather outline the steps they would take, in the order they would take them. The following is a sample of a written problem-solving strategy for analyzing a series resistive-reactive AC circuit:

Step 1: Calculate all reactances (X).

Step 2: Draw an impedance triangle ($Z ; R ; X$), solving for Z

Step 3: Calculate circuit current using Ohm's Law: $I = \frac{V}{Z}$

Step 4: Calculate series voltage drops using Ohm's Law: $V = IZ$

Step 5: Check work by drawing a voltage triangle ($V_{total} ; V_1 ; V_2$), solving for V_{total}

By having students outline their problem-solving strategies, everyone gets an opportunity to see multiple methods of solution, and you (the instructor) get to see how (and if!) your students are thinking. An especially good point to emphasize in these "open thinking" activities is how to check your work to see if any mistakes were made.

Nothing special here – just a straightforward exercise in series AC circuit calculations.

Students often have difficulty formulating a method of solution: determining what steps to take to get from the given conditions to a final answer. While it is helpful at first for you (the instructor) to show them, it is bad for you to show them too often, lest they stop thinking for themselves and merely follow your lead. A teaching technique I have found very helpful is to have students come up to the board (alone or in teams) in front of class to write their problem-solving strategies for all the others to see. They don't have to actually do the math, but rather outline the steps they would take, in the order they would take them. The following is a sample of a written problem-solving strategy for analyzing a series resistive-reactive AC circuit:

Step 1: Calculate all reactances (X).

Step 2: Draw an impedance triangle ($Z ; R ; X$), solving for Z

Step 3: Calculate circuit current using Ohm's Law: $I = \frac{V}{Z}$

Step 4: Calculate series voltage drops using Ohm's Law: $V = IZ$

Step 5: Check work by drawing a voltage triangle ($V_{total} ; V_1 ; V_2$), solving for V_{total}

By having students outline their problem-solving strategies, everyone gets an opportunity to see multiple methods of solution, and you (the instructor) get to see how (and if!) your students are thinking. An especially good point to emphasize in these "open thinking" activities is how to check your work to see if any mistakes were made.

Notes 68

Some students many wonder what type of numerical result best corresponds to a multimeter's readings, if they do their calculations using complex numbers ("do I use polar or rectangular form, and if rectangular do I use the real or the imaginary part?"). The answers given for this question should clarify that point.

It is very important that students know how to apply this knowledge of AC circuit analysis to real-world situations. Asking students to determine how they would connect an oscilloscope to the circuit to measure Θ is an exercise in developing their abstraction abilities between calculations and actual circuit scenarios.

Students often have difficulty formulating a method of solution: determining what steps to take to get from the given conditions to a final answer. While it is helpful at first for you (the instructor) to show them, it is bad for you to show them too often, lest they stop thinking for themselves and merely follow your lead. A teaching technique I have found very helpful is to have students come up to the board (alone or in teams) in front of class to write their problem-solving strategies for all the others to see. They don't have to actually do the math, but rather outline the steps they would take, in the order they would take them. The following is a sample of a written problem-solving strategy for analyzing a series resistive-reactive AC circuit:

Step 1: Calculate all reactances (X).

Step 2: Draw an impedance triangle ($Z ; R ; X$), solving for Z

Step 3: Calculate circuit current using Ohm's Law: $I = \frac{V}{Z}$

Step 4: Calculate series voltage drops using Ohm's Law: $V = IZ$

Step 5: Check work by drawing a voltage triangle ($V_{total} ; V_1 ; V_2$), solving for V_{total}

By having students outline their problem-solving strategies, everyone gets an opportunity to see multiple methods of solution, and you (the instructor) get to see how (and if!) your students are thinking. An especially good point to emphasize in these "open thinking" activities is how to check your work to see if any mistakes were made.

Notes 69

If appropriate, you may want to mention devices called *saturable reactors*, which are used to control power in AC circuits by the exact same principle: varying a series inductance.

Notes 70

Ask your students if this equation looks familiar to them. It should!

The answer to the second follow-up question is a matter of algebraic substitution. Work through this process with your students, and then ask them to compare the resulting equation with other equations they've seen before. Does its form look familiar to them in any way?

Notes 71

It is very important for students to understand that the triangle only works as an analysis tool when applied to quantities that *add*. Many times I have seen students try to apply the Z - R - X impedance triangle to parallel circuits and fail because *parallel impedances do not add*. The purpose of this question is to force students to think about where the triangle is applicable to AC circuit analysis, and not just to use it blindly.

The power triangle is an interesting application of trigonometry applied to electric circuits. You may not want to discuss power with your students in great detail if they are just beginning to study voltage and current in AC circuits, because power is a sufficiently confusing subject on its own.

Notes 72

Trying to apply the Z - R - X triangle directly to parallel AC circuits is a common mistake many new students make. Key to knowing when and how to use triangles to graphically depict AC quantities is understanding *why* the triangle works as an analysis tool and *what* its sides represent.

Notes 73

Phasor diagrams are powerful analytical tools, if one knows how to draw and interpret them. With hand calculators being so powerful and readily able to handle complex numbers in either polar or rectangular form, there is temptation to avoid phasor diagrams and let the calculator handle all the angle manipulation. However, students will have a much better understanding of phasors and complex numbers in AC circuits if you hold them accountable to representing quantities in that form.

Notes 74

This would be an excellent question to have students present methods of solution for. Sometimes I have students present nothing but their solution steps on the board in front of class (no arithmetic at all), in order to generate a discussion on problem-solving strategies. The important part of their education here is not to arrive at the correct answer or to memorize an algorithm for solving this type of problem, but rather how to *think* like a problem-solver, and how to methodically apply the math they know to the problem(s) at hand.

Notes 75

This is a practical example of a parallel LR circuit, as well as an example of how complex electrical devices may be "modeled" by collections of ideal components. To be honest, a loaded AC motor's characteristics are quite a bit more complex than what the parallel LR model would suggest, but at least it's a start!

Students often have difficulty formulating a method of solution: determining what steps to take to get from the given conditions to a final answer. While it is helpful at first for you (the instructor) to show them, it is bad for you to show them too often, lest they stop thinking for themselves and merely follow your lead. A teaching technique I have found very helpful is to have students come up to the board (alone or in teams) in front of class to write their problem-solving strategies for all the others to see. They don't have to actually do the math, but rather outline the steps they would take, in the order they would take them. The following is a sample of a written problem-solving strategy for analyzing a series resistive-reactive AC circuit:

Step 1: Calculate all reactances (X).

Step 2: Draw an impedance triangle ($Z ; R ; X$), solving for Z

Step 3: Calculate circuit current using Ohm's Law: $I = \frac{V}{Z}$

Step 4: Calculate series voltage drops using Ohm's Law: $V = IZ$

Step 5: Check work by drawing a voltage triangle ($V_{total} ; V_1 ; V_2$), solving for V_{total}

By having students outline their problem-solving strategies, everyone gets an opportunity to see multiple methods of solution, and you (the instructor) get to see how (and if!) your students are thinking. An especially good point to emphasize in these "open thinking" activities is how to check your work to see if any mistakes were made.

Here is a case where scalar calculations (R, G, X, B, Y) are *much* easier than complex number calculations (all Z) would be.

Students often have difficulty formulating a method of solution: determining what steps to take to get from the given conditions to a final answer. While it is helpful at first for you (the instructor) to show them, it is bad for you to show them too often, lest they stop thinking for themselves and merely follow your lead. A teaching technique I have found very helpful is to have students come up to the board (alone or in teams) in front of class to write their problem-solving strategies for all the others to see. They don't have to actually do the math, but rather outline the steps they would take, in the order they would take them. The following is a sample of a written problem-solving strategy for analyzing a series resistive-reactive AC circuit:

- Step 1:** Calculate all reactances (X).
- Step 2:** Draw an impedance triangle ($Z ; R ; X$), solving for Z
- Step 3:** Calculate circuit current using Ohm's Law: $I = \frac{V}{Z}$
- Step 4:** Calculate series voltage drops using Ohm's Law: $V = IZ$
- Step 5:** Check work by drawing a voltage triangle ($V_{total} ; V_1 ; V_2$), solving for V_{total}

By having students outline their problem-solving strategies, everyone gets an opportunity to see multiple methods of solution, and you (the instructor) get to see how (and if!) your students are thinking. An especially good point to emphasize in these "open thinking" activities is how to check your work to see if any mistakes were made.

Some students may wonder what type of numerical result best corresponds to a multimeter's readings, if they do their calculations using complex numbers ("do I use polar or rectangular form, and if rectangular do I use the real or the imaginary part?"). The answers given for this question should clarify that point.

It is very important that students know how to apply this knowledge of AC circuit analysis to real-world situations. Asking students to determine how they would connect an oscilloscope to the circuit to measure Θ is an exercise in developing their abstraction abilities between calculations and actual circuit scenarios.

Students often have difficulty formulating a method of solution: determining what steps to take to get from the given conditions to a final answer. While it is helpful at first for you (the instructor) to show them, it is bad for you to show them too often, lest they stop thinking for themselves and merely follow your lead. A teaching technique I have found very helpful is to have students come up to the board (alone or in teams) in front of class to write their problem-solving strategies for all the others to see. They don't have to actually do the math, but rather outline the steps they would take, in the order they would take them. The following is a sample of a written problem-solving strategy for analyzing a series resistive-reactive AC circuit:

- Step 1:** Calculate all reactances (X).
- Step 2:** Draw an impedance triangle ($Z ; R ; X$), solving for Z
- Step 3:** Calculate circuit current using Ohm's Law: $I = \frac{V}{Z}$
- Step 4:** Calculate series voltage drops using Ohm's Law: $V = IZ$
- Step 5:** Check work by drawing a voltage triangle ($V_{total} ; V_1 ; V_2$), solving for V_{total}

By having students outline their problem-solving strategies, everyone gets an opportunity to see multiple methods of solution, and you (the instructor) get to see how (and if!) your students are thinking. An especially good point to emphasize in these "open thinking" activities is how to check your work to see if any mistakes were made.

Notes 78

Have your students explain how they solved for each impedance, step by step. You may find different approaches to solving the same problem(s), and your students will benefit from seeing the diversity of solution techniques.

Notes 79

This would be an excellent question to have students present methods of solution for. Sometimes I have students present nothing but their solution steps on the board in front of class (no arithmetic at all), in order to generate a discussion on problem-solving strategies. The important part of their education here is not to arrive at the correct answer or to memorize an algorithm for solving this type of problem, but rather how to *think* like a problem-solver, and how to methodically apply the math they know to the problem(s) at hand.

Notes 80

If students get stuck on the challenge question, remind them that an electric motor does mechanical *work*, which requires energy.

Notes 81

An oscilloscope is nothing more than a graphical voltmeter, having the ability to represent fast-changing voltages over time in the form of a graph. It is very important for all students of electronics to learn how to use an oscilloscope well!

Use a sine-wave function generator for the AC voltage source, and be sure set the frequency to some reasonable value (well within the capability of both the oscilloscope and counter to measure).

If this is not the first time students have done this, be sure to “mess up” the oscilloscope controls prior to them making adjustments. Students *must* learn how to quickly configure an oscilloscope’s controls to display any arbitrary waveform, if they are to be proficient in using an oscilloscope as a diagnostic tool.

General concepts and principles to emphasize

- Basic oscilloscope operation (vertical sensitivity, coupling, timebase, triggering)
- Location of “ground” connections on both the oscilloscope and signal generator
- Relationship between the *period* of a wave and its *frequency*

Suggestions for Socratic discussion and experimentation

- What is the distinction between a waveform’s *peak* voltage value and its *peak-to-peak* voltage value?
- Demonstrate how to make the waveform appear taller (i.e. each cycle extending farther along the vertical axis) on the oscilloscope’s display.
- Demonstrate how to make the waveform appear longer (i.e. each cycle extending farther along the horizontal axis) on the oscilloscope’s display.
- Demonstrate how to set the *triggering* value for the oscilloscope, and what difference that makes in the displayed waveform.

Use a sine-wave function generator for the AC voltage source, and be sure set the frequency to some reasonable value (well within the capability of a multimeter to measure). It is very important that students learn to convert between peak and RMS measurements for sine waves, but you might want to mix things up a bit by having them do the same with triangle waves and square waves as well! It is vital that students realize the rule of $V_{RMS} = \frac{V_{peak}}{\sqrt{2}}$ only holds for *sinusoidal* signals.

An important point to note in this exercise is that the “variable” adjustment on the vertical sensitivity for the input channel must be turned fully so that the knob “clicks” into its calibrated position. If this fine-adjustment is not set in the calibrated position, your voltage measurements will be inaccurate!

If you do choose to challenge students with non-sinusoidal waveshapes, be very sure that they do their voltmeter measurements using *true-RMS* meters! This means no analog voltmeters, which are “miscalibrated” so their inherently average-responding movements register (sinusoidal) RMS accurately. Your students must use true-RMS digital voltmeters in order for their non-sinusoidal RMS measurements to correlate with their calculations.

Incidentally, this lab exercise also works well as a demonstration of the importance of true-RMS indicating meters, comparing the indications of analog, non-true-RMS digital, and true-RMS digital on the same non-sinusoidal waveform!

General concepts and principles to emphasize

- The concept of “Root-Mean-Square” (RMS) measurement
- Basic oscilloscope operation (vertical sensitivity, coupling, timebase, triggering)
- Location of “ground” connections on both the oscilloscope and signal generator

Suggestions for Socratic discussion and experimentation

- Explain what the “RMS” (Root-Mean-Square) value means for any AC waveform.
- If you change the *frequency* of the AC source, does this affect its RMS or peak voltage value? Why or why not?
- A common misconception among students is that the RMS value of any waveform is *always* equal to 0.707 times the waveform’s peak value. Refute this misconception with a demonstrated example!

Use a sine-wave function generator for the AC voltage source, and be sure set the frequency to some reasonable value (well within the capability of both the oscilloscope and counter to measure).

An important point to note in this exercise is that the “variable” adjustment on the horizontal timebase must be turned fully so that the knob “clicks” into its calibrated position. If this fine-adjustment is not set in the calibrated position, your time measurements (and therefore your frequency calculations) will be inaccurate!

General concepts and principles to emphasize

- Relationship between the *period* of a wave and its *frequency*
- Basic oscilloscope operation (vertical sensitivity, coupling, timebase, triggering)

Suggestions for Socratic discussion and experimentation

- The standard unit of measurement for period is *seconds* (s). The standard unit of measurement for frequency is *Hertz* (Hz), which means “cycles per second.” However, an alternate unit of measurement for frequency is *inverse seconds*, or s^{-1} . Explain why $\text{Hz} = s^{-1}$.
- If you change the *voltage* level of the AC source, does this affect its frequency? Why or why not?

In this exercise you will explore the concept of *reactance*, which is a form of opposition to the flow of electric current that is similar to but not identical to resistance. The distinction between reactance and resistance is a consequence of energy flow in an electrical component: components which *transfer* electrical energy out of the circuit and into some other form (such as heat in the case of a resistor or mechanical work in the case of an electric motor) exhibit *resistance*; components which have the ability to *absorb* energy from the circuit and *return* energy back into the circuit (e.g. inductors and capacitors) exhibit *reactance*.

In order to achieve results closely approximating ideal, you need to use an inductor that has very little wire resistance (the less, the better!). Your multimeter will be useful here to measure the DC resistance of the inductor – which is strictly a function of wire resistance and not inductance – and allow you to identify the most suitable inductor for this exercise. The problem with resistance is that it is a fundamentally different kind of opposition to electric current. If your inductor happens to possess a lot of resistance (in addition to inductive reactance), the results will be skewed by the presence of this resistance.

Use a sine-wave function generator for the AC voltage source. I recommend against using line-power AC because of strong harmonic frequencies which may be present (due to nonlinear loads operating on the same power circuit).

If students are to use a multimeter to make their current and voltage measurements, be sure it is capable of accurate measurement at the circuit frequency! Inexpensive digital multimeters often experience difficulty measuring AC voltage and current toward the high end of the audio-frequency range.

General concepts and principles to emphasize

- Self-induction (i.e. how a single coil is able to experience induction as a consequence of a changing current passing through it)
- The concept of *reactance*, and how it differs from *resistance*
- The relationship between inductance, frequency, and inductive reactance

Suggestions for Socratic discussion and experimentation

- Identify ways the inductor could be modified so as to possess more inductance.
- Explain how *reactance* differs from *resistance*, even though they are both quantified using the same unit of measurement: *ohms* (Ω).
- Explain why current changes as source frequency changes, despite voltage remaining the same.
- A technique used in making wire-wound resistors is something called a *bifilar winding*. Bifilar windings have nearly zero inductance. Research how a bifilar winding is made, and then explain how it works to minimize induction and also why this might be important for making resistors.

In order to achieve results closely approximating ideal, you need to use an inductor that has very little wire resistance (the less, the better!). Your multimeter will be useful here to measure the DC resistance of the inductor – which is strictly a function of wire resistance and not inductance – and allow you to identify the most suitable inductor for this exercise. The problem with resistance is that it is a fundamentally different kind of opposition to electric current. If your inductor happens to possess a lot of resistance (in addition to inductive reactance), the results will be skewed by the presence of this resistance.

Use a sine-wave function generator for the AC voltage source. I recommend against using line-power AC because of strong harmonic frequencies which may be present (due to nonlinear loads operating on the same power circuit). Specify standard resistor and inductor values.

If students are to use a multimeter to make their current and voltage measurements, be sure it is capable of accurate measurement at the circuit frequency! Inexpensive digital multimeters often experience difficulty measuring AC voltage and current toward the high end of the audio-frequency range.

An extension of this exercise is to incorporate troubleshooting questions. Whether using this exercise as a performance assessment or simply as a concept-building lab, you might want to follow up your students' results by asking them to predict the consequences of certain circuit faults.

General concepts and principles to emphasize

- The concept of *reactance*, and how it differs from *resistance*
- The concept of *impedance*, and how it relates to both *resistance* and *reactance*
- The relationship between inductance, frequency, and inductive reactance

Suggestions for Socratic discussion and experimentation

- Explain how *reactance* differs from *resistance*, even though they are both quantified using the same unit of measurement: *ohms* (Ω).
- What will happen to the amount of current in this circuit if the source frequency is increased (assuming a constant source voltage)?
- What will happen to the amount of current in this circuit if the inductor is replaced by another having greater inductance?
- What will happen to the amount of current in this circuit if the resistor is replaced by another having greater resistance?
- Explain why the sum of the resistor's voltage and the inductor's voltage does *not* equal the source voltage.

Notes 86

If the oscilloscope does not have its own internal square-wave signal source, use a function generator set up to output square waves at 1 volt peak-to-peak at a frequency of 1 kHz.

If this is not the first time students have done this, be sure to “mess up” the oscilloscope controls prior to them making adjustments. Students *must* learn how to quickly configure an oscilloscope’s controls to display any arbitrary waveform, if they are to be proficient in using an oscilloscope as a diagnostic tool.

General concepts and principles to emphasize

- Basic oscilloscope operation (vertical sensitivity, coupling, timebase, triggering)
- Relationship between the *period* of a wave and its *frequency*

Suggestions for Socratic discussion and experimentation

- Demonstrate how to make the waveform appear taller (i.e. each cycle extending farther along the vertical axis) on the oscilloscope’s display.
- Demonstrate how to make the waveform appear longer (i.e. each cycle extending farther along the horizontal axis) on the oscilloscope’s display.
- Explain why changes in the *triggering* level don’t seem to affect the displayed waveform at all.

Notes 87

The idea of a troubleshooting log is three-fold. First, it gets students in the habit of documenting their troubleshooting procedure and thought process. This is a valuable habit to get into, as it translates to more efficient (and easier-followed) troubleshooting on the job. Second, it provides a way to document student steps for the assessment process, making your job as an instructor easier. Third, it reinforces the notion that each and every measurement or action should be followed by reflection (conclusion), making the troubleshooting process more efficient.

Notes 88

The purpose of this assessment rubric is to act as a sort of “contract” between you (the instructor) and your student. This way, the expectations are all clearly known in advance, which goes a long way toward disarming problems later when it is time to grade.

Notes 89

It is important for students to realize the reciprocal relationship between frequency and period. One is *cycles per second* while the other is *seconds per cycle*.

Notes 90

This question is not only good for introducing basic oscilloscope principles, but it is also excellent for review of AC waveform measurements.

Notes 91

This question challenges students to apply their knowledge of AC+DC mixed signals to oscilloscope display patterns, in order to determine whether it is the battery or the function generator which has failed.

Notes 92

This question challenges students to apply their knowledge of AC+DC mixed signals to oscilloscope display patterns, in order to determine whether it is the battery or the function generator which has failed.

The ground-referenced clip on an oscilloscope probe is a constant source of potential trouble for those who do not fully understand it! Even in scenarios where there is little or no potential for equipment damage, placing an earth ground reference on a circuit via the probe clip can make for very strange circuit behavior and erroneous measurements. Problems like this frequently occur when new students attempt to connect their oscilloscopes to circuits powered by signal generators whose outputs are also earth-ground referenced.

In response to the follow-up question, the most obvious answer is to reverse the probe connections: ground clip on the left-hand terminal and probe tip on the right-hand terminal. However, even this might not be the best idea, since it creates a "ground loop" between the oscilloscope and the ground connection at the AC source:

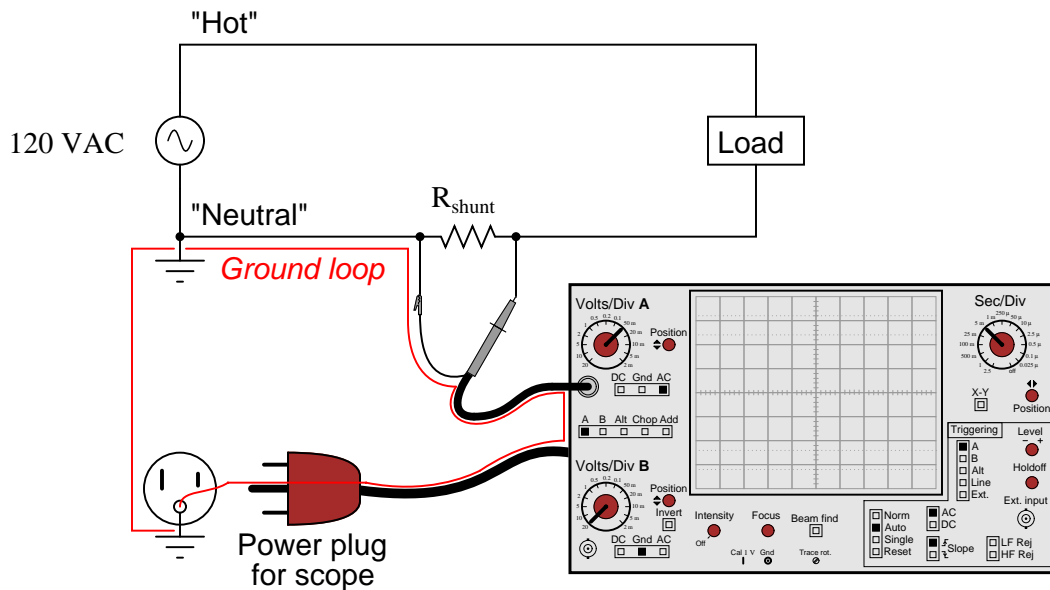

Ground loops are to be avoided in measurement circuits because they may be the source of some very strange effects, including the coupling of noise voltage from entirely unrelated circuits to the one being measured. To avoid this problem, the best solution for measuring the voltage dropped across the shunt resistor is to use two scope probes and set the scope up for *differential* voltage measurement:

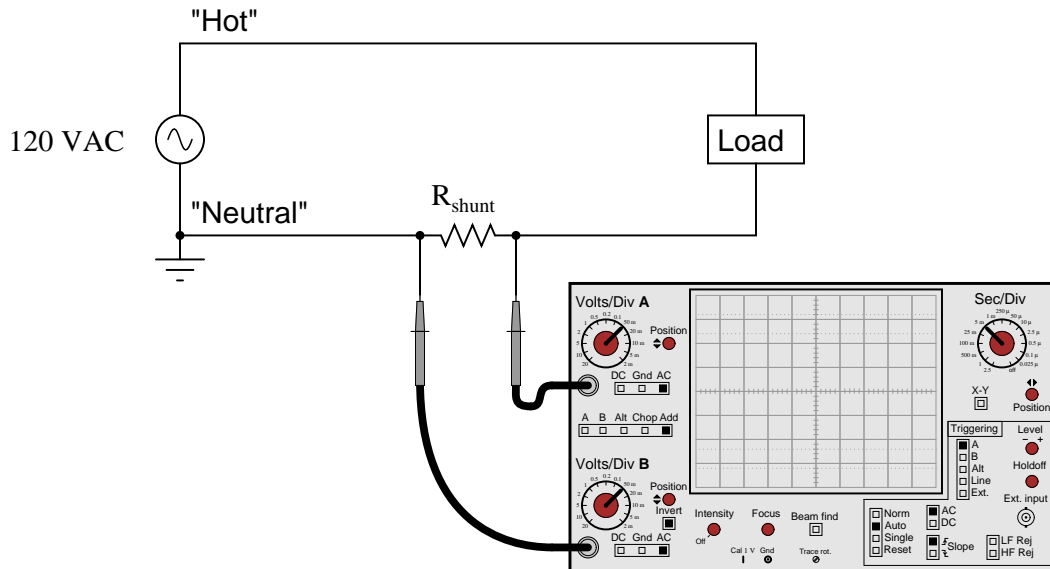

Notes 94

Remember, most analog meter movement designs respond to the average value of a waveform, not its RMS value. If the proportionality between a waveform's average and RMS values ever change, the relative indications of a true-RMS instrument and an average-based (calibrated to read RMS) instrument will change as well.

Notes 95

Students often confuse the terms "average" and "RMS", thinking they are interchangeable. Discuss the difference between these two terms, both mathematically and practically. While the concepts may seem similar at first, the details are actually quite different.

The question of whether an average-responding instrument can be calibrated to register in RMS units is very practical, since the vast majority of multimeters are calibrated this way. Because the proportionality between the average and RMS values of an AC waveform are dependent on the shape of the waveform, a certain wave-shape must be assumed in order to accurately calibrate an average-responding meter movement for RMS measurement. The assumed wave-shape, of course, is sinusoidal.

Notes 96

A clue to answering this question is this: what actually happens when the ampacity rating of a conductor is exceeded? Why, exactly, is overcurrent a bad thing for conductors in general?

It is important for students to recognize the value of RMS measurements: why do we use them, and in what applications are they the most appropriate type of measurement to use in certain calculations? Ask your students what other applications might best use RMS voltage and current measurements as opposed to peak or average.

Notes 97

A closely related subject is *insulator breakdown*, or *dielectric strength*. What actually happens when the dielectric strength rating of an insulator is exceeded?

Notes 98

This question is nothing more than an exercise in Lissajous figure interpretation.

Notes 99

This question is nothing more than an exercise in Lissajous figure interpretation.

Notes 100

This question is nothing more than an exercise in Lissajous figure interpretation.

Notes 101

This question is nothing more than an exercise in Lissajous figure interpretation.

Notes 102

This question is an exercise in applying practical electromagnetic theory (namely, reluctance of an iron/air flux path) to inductance and inductive reactance. Ask your students to explain their reasoning step-by-step as they give their answers to this question.

Notes 103

When I first saw this practice in action, I almost fell over laughing. It is both practical and ingenious, as well as being an excellent example of variable inductance (and inductive reactance) arising from varying reluctance.

Notes 104

After discussing alternative possibilities with your students, shift the discussion to one on how *likely* any of these failures are. For instance, how likely is it that the solenoid coil has developed an "open" fault compared to the likelihood of a regular wire connection going bad in the circuit? How do either of these possibilities compare with the likelihood of the source failing as a result of a tripped circuit breaker or other power outage?

Notes 105

This is an excellent point of crossover with your students' studies in elementary physics, if they are studying physics now or have studied physics in the past. The energy-storing actions of inductors and capacitors are quite analogous to the energy-storing actions of masses and springs (respectively, if you associate velocity with current and force with voltage). In the same vein, resistance is analogous to kinetic friction between a moving object and a stationary surface. The parallels are so accurate, in fact, that the electrical properties of R , L , and C have been exploited to model mechanical systems of friction, mass, and resilience in circuits known as *analog computers*.

Notes 106

The Pythagorean Theorem is easy enough for students to find on their own that you should not need to show them. A memorable illustration of this theorem are the side lengths of a so-called 3-4-5 triangle. Don't be surprised if this is the example many students choose to give.

Notes 107

This is a non-electrical application of vector summation, to prepare students for the concept of using vectors to add voltages that are out-of-phase. Note how I chose to use multiples of 3, 4, and 5 for the vector magnitudes.

Notes 108

Determining the necessary length of conduit for this question involves both the Pythagorean theorem and simple geometry.

Most students will probably arrive at this form for their diagonal length equation:

$$L = \sqrt{x^2 + \left(\frac{A}{x}\right)^2}$$

While this is perfectly correct, it is an interesting exercise to have students convert the equation from this (simple) form to that given in the answer. It is also a very practical question, as equations given in reference books do not always follow the most direct form, but rather are often written in such a way as to look more esthetically pleasing. The simple and direct form of the equation shown here (in the Notes section) looks "ugly" due to the fraction inside the radicand.

Notes 109

Ask your students to explain what the words "hypotenuse", "opposite", and "adjacent" refer to in a right triangle.

Notes 110

It may be helpful to your students to remind them of the standard orientation for phase angles in phasor diagrams (0 degrees to the right, 90 degrees up, etc.).

Notes 111

Discuss with your students the notion of "phase angle" in relation to AC quantities. What does it mean, exactly, if a voltage is "3 volts at an angle of 90 degrees"? You will find that such a description only makes sense where there is another voltage (i.e., "4 volts at 0 degrees") to compare to. Without a frame of reference, phasor angles are meaningless.

Also discuss with your students the nature of phase shifts between different AC voltage sources, if the sources are all at different frequencies. Would the phase angles be fixed, or vary over time? Why? In light of this, why do we not assign phase angles when different frequencies are involved?

Notes 112

At first it may confuse students to use polarity marks (+ and -) for AC voltages. After all, doesn't the polarity of AC *alternate* back and forth, so as to be continuously changing? However, when analyzing AC circuits, polarity marks are essential for giving a frame of reference to phasor voltages, which like all voltages are measured *between two points*, and thus may be measured two different ways.

Notes 113

Proper synchronization of alternators with bus voltage is a task that used to be performed exclusively by human operators, but may now be accomplished by automatic controls. It is still important, though, for students of electricity to understand the principles involved in alternator synchronization, and the simple light bulb technique of sync-indication is an excellent means of clarifying the concept.

Discuss with your students the *means* of bringing an alternator into phase with an AC bus. If the light bulbs are glowing brightly, what should the operator do to make them dim?

It might also be a good idea to discuss with your students what happens once two synchronized alternators become electrically coupled: the two machines become "locked" together as though they were mechanically coupled, thus maintaining synchronization from that point onward.

Notes 114

There may be some students who suggest there is nothing wrong at all with the system. Indeed, since dim (or dark) lights normally indicate synchronization, would not the presence of two dim lights indicate that perfect synchronization had already been achieved? Discuss the likelihood of this scenario with your students, that two independent alternators could be maintaining perfect synchronization without being coupled together.

In regard to troubleshooting, this scenario has great potential for group discussion. Despite there being a simple, single, probable condition that could cause this problem, there are several possible component failures that could have created the condition. Different students will undoubtedly have different methods of approaching the problem. Let each one share their views, and discuss together what would be the best approach.

Notes 115

In reality, motor winding resistance plays a substantial part in this sort of calculation, but I simplified things a bit just to give students a practical context for their introductory knowledge of inductive reactance.

Notes 116

Your students should be able to immediately understand that Q is not a static property of an inductor. Let them explain what makes Q vary, based on their knowledge of inductive reactance.

Notes 117

The purpose of this question is to get students to realize that *any* way they can calculate total impedance is correct, whether calculating total inductance and then calculating impedance from that, or by calculating the impedance of each inductor and then combining impedances to find a total impedance. This should be reassuring, because it means students have a way to check their work when analyzing circuits such as this!

Notes 118

Some electronics textbooks (and courses) tend to emphasize scalar impedance calculations, while others emphasize complex number calculations. While complex number calculations provide more informative results (a phase shift given in *every* variable!) and exhibit conceptual continuity with DC circuit analysis (same rules, similar formulae), the scalar approach lends itself better to conditions where students do not have access to calculators capable of performing complex number arithmetic. Yes, of course, you can do complex number arithmetic without a powerful calculator, but it's a *lot* more tedious and prone to errors than calculating with admittances, susceptances, and conductances (primarily because the phase shift angle is omitted for each of the variables).

Notes 119

The purpose of this question is to get students to realize that *any* way they can calculate total impedance is correct, whether calculating total inductance and then calculating impedance from that, or by calculating the impedance of each inductor and then combining impedances to find a total impedance. This should be reassuring, because it means students have a way to check their work when analyzing circuits such as this!

Notes 120

Discuss with your students what a good procedure might be for calculating the unknown values in this problem, and also how they might check their work.

Students often have difficulty formulating a method of solution: determining what steps to take to get from the given conditions to a final answer. While it is helpful at first for you (the instructor) to show them, it is bad for you to show them too often, lest they stop thinking for themselves and merely follow your lead. A teaching technique I have found very helpful is to have students come up to the board (alone or in teams) in front of class to write their problem-solving strategies for all the others to see. They don't have to actually do the math, but rather outline the steps they would take, in the order they would take them.

By having students outline their problem-solving strategies, everyone gets an opportunity to see multiple methods of solution, and you (the instructor) get to see how (and if!) your students are thinking. An especially good point to emphasize in these "open thinking" activities is how to check your work to see if any mistakes were made.

Notes 121

Discuss with your students what a good procedure might be for calculating the unknown values in this problem, and also how they might check their work.

Students often have difficulty formulating a method of solution: determining what steps to take to get from the given conditions to a final answer. While it is helpful at first for you (the instructor) to show them, it is bad for you to show them too often, lest they stop thinking for themselves and merely follow your lead. A teaching technique I have found very helpful is to have students come up to the board (alone or in teams) in front of class to write their problem-solving strategies for all the others to see. They don't have to actually do the math, but rather outline the steps they would take, in the order they would take them.

By having students outline their problem-solving strategies, everyone gets an opportunity to see multiple methods of solution, and you (the instructor) get to see how (and if!) your students are thinking. An especially good point to emphasize in these "open thinking" activities is how to check your work to see if any mistakes were made.

Notes 122

Discuss with your students what a good procedure might be for calculating the unknown values in this problem, and also how they might check their work.

Students often have difficulty formulating a method of solution: determining what steps to take to get from the given conditions to a final answer. While it is helpful at first for you (the instructor) to show them, it is bad for you to show them too often, lest they stop thinking for themselves and merely follow your lead. A teaching technique I have found very helpful is to have students come up to the board (alone or in teams) in front of class to write their problem-solving strategies for all the others to see. They don't have to actually do the math, but rather outline the steps they would take, in the order they would take them.

By having students outline their problem-solving strategies, everyone gets an opportunity to see multiple methods of solution, and you (the instructor) get to see how (and if!) your students are thinking. An especially good point to emphasize in these "open thinking" activities is how to check your work to see if any mistakes were made.

Discuss with your students what a good procedure might be for calculating the unknown values in this problem, and also how they might check their work.

Students often have difficulty formulating a method of solution: determining what steps to take to get from the given conditions to a final answer. While it is helpful at first for you (the instructor) to show them, it is bad for you to show them too often, lest they stop thinking for themselves and merely follow your lead. A teaching technique I have found very helpful is to have students come up to the board (alone or in teams) in front of class to write their problem-solving strategies for all the others to see. They don't have to actually do the math, but rather outline the steps they would take, in the order they would take them.

By having students outline their problem-solving strategies, everyone gets an opportunity to see multiple methods of solution, and you (the instructor) get to see how (and if!) your students are thinking. An especially good point to emphasize in these "open thinking" activities is how to check your work to see if any mistakes were made.