



This is a digital copy of a book that was preserved for generations on library shelves before it was carefully scanned by Google as part of a project to make the world's books discoverable online.

It has survived long enough for the copyright to expire and the book to enter the public domain. A public domain book is one that was never subject to copyright or whose legal copyright term has expired. Whether a book is in the public domain may vary country to country. Public domain books are our gateways to the past, representing a wealth of history, culture and knowledge that's often difficult to discover.

Marks, notations and other marginalia present in the original volume will appear in this file - a reminder of this book's long journey from the publisher to a library and finally to you.

### Usage guidelines

Google is proud to partner with libraries to digitize public domain materials and make them widely accessible. Public domain books belong to the public and we are merely their custodians. Nevertheless, this work is expensive, so in order to keep providing this resource, we have taken steps to prevent abuse by commercial parties, including placing technical restrictions on automated querying.

We also ask that you:

- + *Make non-commercial use of the files* We designed Google Book Search for use by individuals, and we request that you use these files for personal, non-commercial purposes.
- + *Refrain from automated querying* Do not send automated queries of any sort to Google's system: If you are conducting research on machine translation, optical character recognition or other areas where access to a large amount of text is helpful, please contact us. We encourage the use of public domain materials for these purposes and may be able to help.
- + *Maintain attribution* The Google "watermark" you see on each file is essential for informing people about this project and helping them find additional materials through Google Book Search. Please do not remove it.
- + *Keep it legal* Whatever your use, remember that you are responsible for ensuring that what you are doing is legal. Do not assume that just because we believe a book is in the public domain for users in the United States, that the work is also in the public domain for users in other countries. Whether a book is still in copyright varies from country to country, and we can't offer guidance on whether any specific use of any specific book is allowed. Please do not assume that a book's appearance in Google Book Search means it can be used in any manner anywhere in the world. Copyright infringement liability can be quite severe.

### About Google Book Search

Google's mission is to organize the world's information and to make it universally accessible and useful. Google Book Search helps readers discover the world's books while helping authors and publishers reach new audiences. You can search through the full text of this book on the web at <http://books.google.com/>



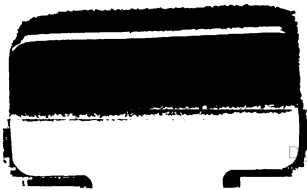
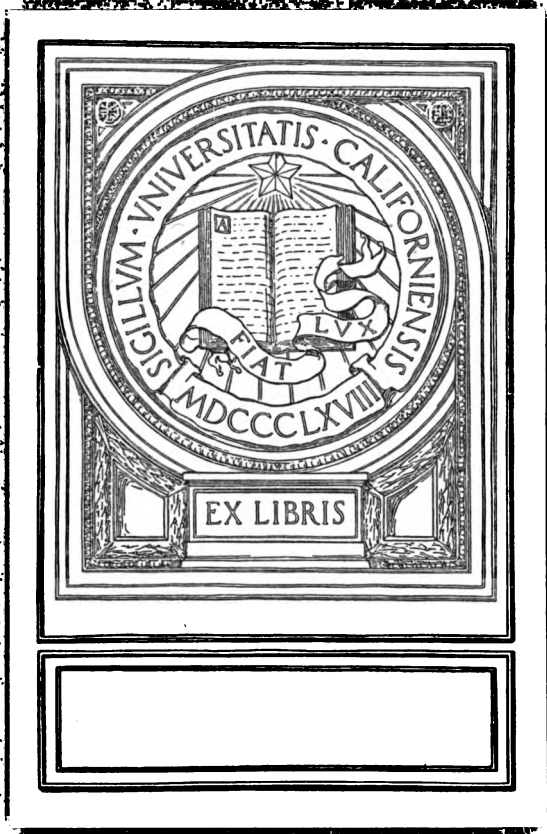









# FLOW AND MEASUREMENT OF AIR AND GASES.

BY

ALEC B. EASON, M.A.,

ASSOCIATE MEMBER OF THE INSTITUTE OF ELECTRICAL ENGINEERS.

With Folding Plate and other Illustrations.



UNIV. OF  
CALIFORNIA

LONDON:  
CHARLES GRIFFIN AND COMPANY, LIMITED,  
PHILADELPHIA: J. B. LIPPINCOTT COMPANY.

1919.



TJ1025  
E3

TO VBI  
SUBSTITUO

## PREFACE.

THE object of this book is to give information to engineers upon air and gas flow, and to indicate where more detailed information on the various subjects may be found: the references are purposely given fully, so that readers may consult the originals if they wish. An attempt is also made to co-ordinate the results of various tests and formulæ, so that the reason for variations may be appreciated. For instance, there are many references to the coefficient of friction in reports, but the extraordinary variations in its value may be seen in fig. 2'1 to 2'4 and in Tables 2'2 to 2'4: some authorities take it as constant.

For those who are ready to accept any formula without caring how it is arrived at or what values of the constants are included, this book will not perhaps be of much interest, as it is largely concerned with those very points. But for those who want to know upon what foundations graphs and formulæ are based it should be of value.

As regards subject-matter: Chapters II. and III. deal with the flow in pipes; Chapters IV. to VII. deal chiefly with pneumatic tube problems; Chapters VIII. to X. deal with the measurement of air and gas, about which little information is given in books on air compressors, and include a description of the recent development of hot-wire anemometers; Chapters XI. to XIV. deal shortly with some subsidiary questions relating to air flow.

Some of the graphs are plotted on logarithmically ruled paper, which deserves to be much better known in this country. A few abaci are included, these being a very convenient form of graphical chart.

The metric symbols cm, kg, m are printed without a full stop, as is customary in French and German journals.

The numbering of figures, equations, and tables is done consecutively for each chapter, not for the book as a whole. Use is made of the ' to differentiate between the chapter number and figure number, viz. 2'1, 3'1, etc.

I shall be glad if attention is drawn to any mistakes and errors which may have crept into the formulæ and tables: in this connection it may be stated that the constants in the formulæ have only been calculated upon a slide rule and may be  $\frac{1}{2}$  per cent. out. Such inaccuracy is immaterial in ordinary air and gas work, as the varying conditions of the atmosphere cause the specific volume of air to vary much more than  $\frac{1}{2}$  per cent. from day to day, or even from hour to hour.

Any suggestions as to the rearrangement of tables and graphs which would make them of more use will be welcomed.

A. B. EASON.

LONDON, August 1919.

415269



## LIST OF CONTENTS:

CHAP.	PAGE
I. PROBLEMS DEALT WITH, AND SOURCES OF INFORMATION . . . . .	1
II. COEFFICIENT OF FRICTION IN PIPES . . . . .	17
III. LOSS OF PRESSURE AT FITTINGS . . . . .	66
IV. PNEUMATIC TUBE PROBLEMS . . . . .	77
V. THEORIES OF AIR FLOW IN PIPES . . . . .	95
VI. TRANSIT TIME OF CARRIERS . . . . .	105
VII. INTERMITTENT FLOW OF AIR IN TUBES . . . . .	114
VIII. METERS FOR GAS AND AIR . . . . .	123
IX. MEASUREMENT OF AIR BY PITOT TUBES . . . . .	155
X. ELECTRIC VELOCITY METERS AND HOT-WIRE ANEMOMETRY . . . . .	177
XI. FLOW FROM ORIFICES . . . . .	198
XII. AIR FRICTION ON MOVING SURFACES . . . . .	221
XIII. GENERAL DESCRIPTION OF PNEUMATIC TUBES . . . . .	228
XIV. METHODS OF PRODUCING AIR CURRENTS . . . . .	236
NAME INDEX . . . . .	243
SUBJECT INDEX . . . . .	246



## LIST OF TABLES.

TABLE	PAGE
1'1. Critical Velocities of Air . . . . .	2
1'2. Gases : Molecular Weights, Specific Heats, etc. . . . .	6
1'3. Air : Densities of Dry and Moist Air, etc. . . . .	7
1'4. Conversion Factors for English and Metric Units . . . . .	8
1'5.       "       "       for Pressures . . . . .	9
2'1. Functions of Diameters and Coefficient of Friction, etc. . . . .	24
2'2. Coefficient of Friction, $\zeta$ : Fixed Values . . . . .	26
2'3.       "       "       Values dependent on D . . . . .	27
2'4.       "       "       "       "       on $m, u, D$ . . . . .	27
2'5. Viscosities of Air, Coal Gas, Steam . . . . .	54
2'6. Conversion Factors for Air, Coal Gas, Steam Flow ( $M/D\eta$ ) . . . . .	55
2'7. Correction Factors in Formulæ if $dP \neq Au^2$ . . . . .	62
3'1. Resistance of Pipe Fittings, $k$ . . . . .	71
3'2.       "       of Elbows and Globe Valves . . . . .	72
4'1. Quantities of Air circulating in Pneumatic Tubes . . . . .	82
4'2. Air : Work of Isothermal and Adiabatic Compression . . . . .	93
6'1. Transit-Time Functions . . . . .	113
7'1. Time taken to empty Tubes . . . . .	122
8'1. Particulars of Wet-drum Station Meters . . . . .	128
8'2. Pressure required to meter Various Quantities of Air . . . . .	138
8'3. Coefficients of Delivery from Orifices (Müller) . . . . .	140
8'4. Electrical Energy required to meter Various Quantities . . . . .	150
9'1. Velocity Distribution in Pipes, $R'$ and $U/U_c$ . . . . .	161
10'1. Conductivity of Air . . . . .	179
10'2. Radiation from Hot Bodies . . . . .	180
10'3. Metals : Specific Resistance, etc. . . . .	193
10'4. Convection Losses from Hot Tubes (Hughes) . . . . .	196
10'5.       "       "       from Platinum (Hartmann) . . . . .	196
11'1. Functions of $n$ for Air Flow . . . . .	201
11'2. Coefficients of Delivery from Orifices, $c$ . . . . .	207
12'1. Coefficient of Air Pressure on Surfaces, $K$ . . . . .	222







FIG.		PAGE
7'4.	Intermittent Working of Tubes : Time of Unsteady Flow . . . . .	121
8'1.	Venturi Meter : Theory . . . . .	129
8'2.	Orifice Flow : Coefficient of Delivery, <i>c</i> (Durley) . . . . .	134
8'3.	"    "    "    "    (Watson) . . . . .	136
8'4.	"    "    Correction for Pulsating Flow . . . . .	137
8'5.	"    "    Theory (Müller) . . . . .	139
8'6.	"    "    Coefficient of Delivery, <i>c</i> (Müller) . . . . .	140
8'7.	"    "    "    "    (Hickstein) . . . . .	142
8'8.	"    "    "    "    (Box) . . . . .	143
8'9.	"    "    "    "    of Contraction (Gaskell) . . . . .	144
8'10.	Electric Meters : Diagram of Connections (Thomas) . . . . .	149
9'1.	Velocity Distribution in Pipes : Theory . . . . .	157
9'2.	Various Forms of Pitot Tubes . . . . .	158
9'3.	Ratio of Mean to Maximum Velocity (Stanton) . . . . .	160
9'4.	Graphical Determination of Mean Velocity . . . . .	165
9'5.	Pitot Tube Tips (Anderson) . . . . .	166
9'6.	Multiplying Manometer : Theory . . . . .	170
10'1.	Electric Hot-wire Meter (King) . . . . .	190
11'1.	Orifice Flow : Theory . . . . .	198
11'2.	"    "    Function $\phi^{1.41} - \phi^{1.71}$ . . . . .	209
11'3.	Orifice used by Hartshorn . . . . .	210
11'4.	Loss of Pressure in Pneumatic Cocks . . . . .	220
14'1.	Aero-motive Force due to Wind, Hot Air, Fans . . . . .	236
14'2.	Blowers : Electrical Input for Various Outputs . . . . .	241

# FLOW AND MEASUREMENT OF AIR AND GASES.

## CHAPTER I.

### PROBLEMS DEALT WITH, AND SOURCES OF INFORMATION.

Purpose of book—States of flow—Specific problems investigated—Density of moist air—Conversion from one system of units to another—Conversion factors—Symbols used—Bibliography of books—Bibliography of reports, English, American, Continental, and Colonial.

THE purpose of the book is to investigate: (i.) the friction of gases and the coefficient of friction in pipes; (ii.) the question of suitable meters for gas and air; (iii.) the working of pneumatic tubes. The sources from which information has been obtained are the books and reports mentioned in Schedules 1 to 4, and experiments made on pneumatic tubes and air-compressing plants. We are chiefly concerned with the flow in pipes, and not with flow in unconfined space such as the atmosphere.

#### DIFFERENT STATES OF FLOW.

Any discussion upon the flow of gases may deal with one of three different states of flow, the boundaries between which are fairly definite. The first state covers the cases of flow at low velocities where the friction varies approximately as the velocity,  $u$ , and where the Poiseuille laws hold; these cases are chiefly of scientific interest and do not usually occur in commercial work. The second state covers cases of flow at medium velocities where the friction varies approximately as the square of the velocity,  $u^2$ . The critical velocity for air, which divides the first and second states, is given in Table 1'1.

The equation for the critical velocity (Hütte, p. 364) is

$$u_k = \frac{20000\eta}{dm}, \text{ in metric units.}$$

For a further discussion on this matter, see Chapter II., p. 48. The third state covers cases of flow at high velocities where the velocity is so high that it approximates to the velocity of sound in the gas, and the friction varies at a rate greater than the square of the velocity; this case is chiefly of scientific interest, but also occurs in the efflux of gases from orifices. The investigations in this book deal chiefly with the second type of flow.

TABLE I I.—CRITICAL VELOCITIES OF AIR.

Diam. of pipe . . . =	25	50	100	250	500 mm.
" " . . . =	1	2	4	10	20 inches.
Pressure in atmospheres.	Velocity : metres per second.				
0·2	6·00	3·00	1·50	0·60	0·30
1·0	1·20	0·60	0·30	0·12	0·06
10·0	0·12	0·06	0·03	0·012	0·006
	Velocity : in feet per second (approx.).				
0·2	20	10	5·0	2·0	1·0
1·0	4	2	1	0·4	0·2

## PROBLEMS INVESTIGATED.

Engineering works utilising moving gases comprise : pneumatic tubes, compressed-air systems, gas-lighting systems, ventilating systems. The problems arising in works of the first type differ considerably from those arising in the other types, because during flow in pneumatic-tube work the fluid undergoes a great change of density, whereas in the other cases the change of density is small. The term "pneumatic tubes" refers to tubes in which air is used to propel carriers containing goods or messages from one point to another: the best known are the tubes in large stores and mercantile houses where cash and bills are transmitted to a central cash office or to a central department. These tubes are also largely used in Post Office administrations to convey telegrams, letters, or parcels. In this work the object aimed at is to have the carriers travelling at the *greatest possible suitable speed* with the least expenditure of energy and upkeep. Some other problems arising are the relative advantages of high and low pressures, of big or small tubes, of working tubes both ways or one way only, etc.

In the other types of work, viz. compressed-air, gas-lighting, and ventilation systems, where the pipes are used as conductors of the fluid, the slower the air moves the better : in this case the problem is to transmit the greatest possible amount of air or gas for use at some distant point at the least possible expenditure of energy and cost of maintenance. The losses in the pipe lines are of great importance. Taking the case of a compressed-air installation where the pipe line acts in a similar fashion to the feeders in an electrical installation, it is economical as regards transmission loss to use a small pipe and a small volume of air at high pressure, and to transform to low pressure at the receiving end ; but, as the means for transforming down air pressures are not so economical as electrical transformers, the use of high air pressures is not relatively so economical as the use of high electrical pressures. The question of balancing the loss of pressure in the pipe line with that in the transformer arises. In this book only the loss in the pipe line is discussed.

In the case of service pipes from air-compressing plant leading from the place of storage to the apparatus which uses the air, the question of what size service pipe should be used arises. The bigger the pipe, the more

costly to instal, but the less will be the loss of pressure in the pipe. Local considerations as regards space may at once determine the size of pipe, but a method of finding the most economical pipe to use—if such a size is practicable—is given in Chapter IV.

In all air calculations one has to consider the quantities of air flowing. The metering of air is therefore dealt with in Chapters VIII., IX., X. Such meters are not nearly so common nor so well developed as meters for water; measurement of air is more difficult than measurement of water, because the forces available for working the mechanism of the meter in the case of air are much smaller than those available in the case of water. Difficulties also exist because of the alteration of the density of the air during flow, owing to the drop of pressure.

A scientific treatment of the flow of air is given by Shaw in his book on *Air Currents*; but his discussion only concerns air at atmospheric pressure, as used in ventilation work. He shows the analogy between air flow and currents in electrical circuits, thus:—

$$\begin{aligned} \text{Aero-Motive Force} &= \text{A.M.F.} = \text{resistance (quantity)}^2 \\ \text{Electro-Motive Force} &= \text{E.M.F.} = \text{resistance (quantity)}. \end{aligned}$$

The electric analogy is of use, but to get a complete analogy it is desirable to have a unit of resistance similar to the ohm. This is not possible in the case of air, as the resistance to flow depends upon the quantity flowing, while electrical resistance is independent of quantity. Shaw chooses as a unit for ventilation work an orifice 6 inches in diameter, which delivers unit quantity (1 cu. ft/sec) when unit aero-motive force exists between the two sides of the orifice. If the density is altered the flow will be altered, and therefore the unit is only useful with air at atmospheric pressure.

EQUATIONS FOR THE GAS CONSTANT AND DENSITY OF MOIST AIR.

We wish to have a ready means of finding the densities of gas mixtures, especially of moist air, and can proceed as follows:—We assume that the gases dealt with in this book, viz. air and coal gas, follow the laws of perfect gases; therefore the main equation holds:

$$Pv = CT = RT/\mu \quad . \quad . \quad . \quad (1\cdot10)$$

- P is the pressure per unit area.
- v ,, volume ,, weight.
- C ,, gas constant.
- T ,, absolute temperature.
- R ,, universal gas constant = 1530 Eng., = 848 metric (1'11)
- $\mu$  ,, molecular weight (see Table 1'2).

$$m = P/CT = P\mu/RT \quad . \quad . \quad . \quad (1\cdot12)$$

The density of various gases at atmospheric pressure and fixed temperature varies as  $\mu$ , so that we get equations for the density at standard temperature and pressures:—

In English units:

$$\text{At } 0^\circ \text{ C., } 32^\circ \text{ F., } \quad P = 2116, \quad p = 14\cdot7, \quad h = 760 \text{ mm,} \\ \text{Lb/ft}^3 = m = \cdot002788\mu, \quad v = 358\cdot7/\mu \quad . \quad (1\cdot13)$$

$$\text{At } 17^\circ \text{ C., } 62^\circ \text{ F., } \quad p = 14\cdot7, \quad m = \cdot002624\mu, \quad v = 380\cdot0/\mu \quad . \quad (1\cdot14)$$

In metric units :

$$\text{At } 0^\circ \text{ C., } 32^\circ \text{ F., } \quad h=760 \text{ mm, } p=1.03 \text{ kg/cm}^2, \\ \text{Kg/m}^3=m=0.446\mu, \quad v=22.4/\mu \quad . \quad . \quad (1.15)$$

$$\text{At } 15^\circ \text{ C., } 59^\circ \text{ F., } \quad h=735.5 \text{ mm, } p=1 \text{ kg/cm}^2, \\ m=0.410\mu, \quad v=24.4/\mu \quad . \quad . \quad . \quad (1.16)$$

For commercial work, a mean density of air may be chosen without reference to the actual amount of moisture which is present; but for scientific work this may not be accurate enough, and the density may have to be properly determined.

The moisture in the atmosphere is measured by comparing the amount actually present with the amount which would be present if the air were saturated. Assume the temperature is  $T$ ; at this temperature water vapour or steam exerts a pressure  $P'''$  which is independent of the existence of any pressure due to the presence of other gases. 1 cu. ft. of steam weighs  $m'''$  lb.; in moist air the pressure  $P''$  due to moisture is  $\phi P'''$ , where  $\phi$  is the fraction denoting how much steam is present; the weight of steam per cu. ft. of the mixture will be  $\phi m'''$ .

The humidity, wetness, or dryness of the air is denoted by  $\phi$ .

When  $\phi=1.0$  the air is perfectly wet and saturated with steam.

„  $\phi=0.0$  „ „ „ dry and no steam is present.

„  $\phi=0.50\sim 0.80$  the air is in a normal state.

The pressure of moist air  $P$ , as read on gauge, includes  $P'$  due to the air, and  $P''=\phi P'''$  due to the steam.

Now we can determine the density of moist air.

Unit volume of moist air contains  $m'$  air and  $m''$  steam.

$$\text{The density of moist air, } m=m'+m'' \quad . \quad . \quad (1.17)$$

$$\text{„ pressure „ „ } P=P'+P'' \quad . \quad . \quad (1.17a)$$

We have then unit volume filled with  $m'$  lb. of air at pressure  $P'$ , and  $m''$  lb. of steam at pressure  $P''$ ; or alternatively we can think of there being  $m'/(m'+m'')$  volume of air at a pressure  $P$  along with a volume  $m''/(m'+m'')$  of steam at pressure  $P$ : in either case we have unit volume filled with a mixture at pressure  $P$ . For air we have

$$C' = \frac{R}{\mu'} = \frac{848}{28.95} = 29.27 \text{ metric, } = \frac{1530}{28.95} = 52.7 \text{ Eng.} \quad . \quad (1.18)$$

For steam we have

$$C''' = \frac{R}{\mu'''} = \frac{848}{18.1} = 46.95 \text{ metric, } = \frac{1530}{18.1} = 84.5 \text{ Eng.} \quad . \quad (1.19)$$

$$C'/C''' = \mu'''/\mu' = 623 = e \quad . \quad . \quad . \quad (1.20)$$

$$\text{Then } m = m' + m'', \quad P = P' + P'' \quad . \quad . \quad . \quad (1.21)$$

$$= \frac{P'}{C'T} + \frac{P''}{C'''T}$$

$$= \frac{P - P''}{C'T} + \frac{P''C'}{C'TC'''}$$



TABLE 1'2.—PARTICULARS OF GASES.

	Air.		Oxygen.		Nitrogen.		Hydrogen.		Carbon monoxide.		Carbon dioxide.		Methane, Marsh gas.		Ethylene, Olefiant.		Acetylene.	
		O	N	H	CO	CO <sub>2</sub>	CH <sub>4</sub>	C <sub>2</sub> H <sub>4</sub>	C <sub>2</sub> H <sub>2</sub>									
1 Molecular weight	28.95	32.00	28.28	2.016	28.00	44.00	16.03	28.08	26.02									
1 lb. per cu. ft.	.0767	.0846	.0063	.0742	.1173	.0424	.0742	.0703										
1 Kg per cu. m.	1.227	1.356	1.190	.0855	1.185	1.964	1.187	1.100										
1 Specific gravity	1.000	1.105	.970	.0896	.968	0.554	.969	0.899										
2 Gas constant, Eng.	53.34	48.25	55.00	766.0	55.14	35.09	96.31	59.40										
2 " " metric	29.26	26.50	30.20	420.0	30.25	19.25	80.20	32.50										
3 Adiab. expansion, γ	1.405	1.400	1.408	1.405	1.410	1.280	1.250	1.280										
2 Specific heat, k <sub>p</sub>	.288	.217	.243	3.42	.242	.210	.590	.350										
2 " " k <sub>v</sub>	.170	.155	.176	2.42	.172	.160	.460	.270										
3 Viscosity, η, at 100°	2186	...	...	...	2047	1859	...	1244	These are									
4 " " at 0°	1678	...	...	...	1625	1383	...	922	η × 10 <sup>7</sup>									
5 Value of C in Eq. 2.78k	1720	1910	1670	8.40	1670	1450	...	990										
6 Conductivity, k, at 0°	113	127	84	...	100	277	...	272	These are									
6 " " at 100°	513	...	...	...	499	305	...	396	k × 10 <sup>7</sup>									
6 Temperature coef. of k	553	...	...	...	571.	466	...	636										
	.19	.20	.20	.175	...	.40	...	.75										
	.28	.30	.30	.275	...	.55	...	.78										

7 Percentages by volume of above gases in—		Specific heat = gm.-calories to raise 1 gm 1° C.		Viscosity in dyne/cm <sup>2</sup> .		Conductivity in gm.-calories per cm cube per 1° C.	
Coal gas	0-1	0-3	46-53	5-7	0-7	34-40	8-7
Water gas	0-1	1-5	26-40	25-30	0-5	16-27	10-16
Natural gas	0-1	1-6	0-1	0	0-1	70-97	0-16
Coal and water gas	0-1	0-4	37-52	7-21	0-2	80-40	5-9

Specific heat = gm.-calories to raise 1 gm 1° C.      Viscosity in dyne/cm<sup>2</sup>.      Conductivity in gm.-calories per cm cube per 1° C.

1 Hütte, p. 319.      2 Goodenough, *Thermodynamics*, p. 96.      3 Meyer, *Kinetic Theory of Gases*, p. 238.      4 *Ibid.*, p. 281.  
 5 *Ibid.*, p. 281.      6 *Ibid.*, p. 288.      7 Stone, *Practical Testing of Gas*, p. 316.

One should also remember that the densities of vapours are usually compared with that of air at the same temperature and pressure, and then become of the same nature as specific gravities, the density of air being taken as 1.00: in such a case the "density"

$$= \frac{\text{molecular weight of the gas}}{28.95 \sim 28.85} \quad (1.30)$$

The true density of vapours, or weight per unit volume, has been given in Eq. 1.12.

Rowse (*Trans. Amer. Soc. M.E.*, 35/687/1913) deals with this question also.

TABLE 1.3.—DENSITY OF AIR; PRESSURE OF WATER VAPOUR, ETC.

Degrees Cent.	Degrees Fahr.	735.5 mm Hg Dry air.		Water vapour.		Δ.	Δ'.
		Kg per cu. m.	Lb. per cu. ft.	Pressure, mm. Hg.	Density, kg.		
0	32.0	1.253	0.781	4.6	.0049	.003	.00064
2	35.6	1.244	.0775	5.3	.0056	.003	.00069
4	39.2	1.235	.0770	6.1	.0064	.004	.0008
6	42.8	1.226	.0765	7.0	.0073	.004	.0009
8	46.4	1.217	.0759	8.0	.0083	.005	.0010
10	50.0	1.208	.0754	9.2	.0094	.006	.0012
12	53.6	1.200	.0748	10.5	.0107	.007	.0013
14	57.2	1.192	.0743	12.0	.0121	.007	.0015
16	60.8	1.183	.0737	13.6	.0137	.008	.0017
18	64.4	1.175	.0732	15.5	.0154	.009	.0019
20	68.0	1.167	.0726	17.5	.0173	.011	.00215
22	71.6	1.159	.0721	19.8	.0194	.012	.0024
24	75.2	1.151	.0716	22.4	.0218	.013	.0027
26	78.8	1.144	.0712	25.3	.0243	.015	.0030
28	82.4	1.136	.0703	28.4	.0273	.017	.0034
30	86.0	1.128	.0703	31.8	.0304	.019	.0037

	Specific volumes of air: at			
	735.5 mm		and 760 mm	
	<i>m</i> <sub>0</sub>	<i>v</i> <sub>0</sub>	<i>m</i> <sub>0</sub>	<i>v</i> <sub>0</sub>
In metric units, dry at 0° C.	1.253	.798	1.293	.773
70% moist at 0° C.	1.251	.800	1.291	.774
dry at 15° C.	1.188	.843	1.225	.817
70% moist at 15° C.	1.182	.845	1.221	.819
In English units, dry at 0° C.	.0781	12.8	.0806	12.4
70% moist at 0° C.	.0780	12.8	.0805	12.4
dry at 15° C.	.0740	13.5	.0764	13.1
70% moist at 15° C.	.0736	13.5	.0761	13.14

CONVERSION OF FORMULÆ FROM ONE SYSTEM OF UNITS TO ANOTHER.

It often happens that an equation,

$$P^x = A m^y u^z \text{ in metric units,}$$

is required as

$$P_1^x = A_1 m_1^y u_1^z \text{ in English units:}$$

then

$$A_1 = A \frac{a^x}{b^y c^z}$$

89.6 - .36 47  
 93.2 - .36 42  
 96.1 - .36 28  
 100.4 - .36 0



where  $a$ ,  $b$ ,  $c$  are the multipliers to bring the factors  $P$ ,  $m$ ,  $u$  from the metric system to  $P_1$ ,  $m_1$ ,  $u_1$  in the English system. Values of  $a$ ,  $b$ ,  $c$ , etc., are given in Tables 1.4 and 1.5. For instance, suppose  $P$  is  $4 \text{ kg/m}^2$ ,  $P_1$  in  $\text{lb/ft}^2 = 4(2.048) = .820$ .

As an example, consider Petit's Eq. 2.67:

$$h = P_1 - P_2 = .000765 Lmu^{1.916}/D^{1.501}$$

$h$  is mm water;  $L$ ,  $u$ ,  $D$  are metres;  $m$  is  $\text{kg/m}^3$ ,  $P$  is  $\text{kg/m}^2$ .

This equation is to be brought to the form:

$$P_1 - P_2 = \frac{4\zeta u^2 m L}{D 2g} = A \frac{m L u^{1.916}}{D^{1.501}}$$

The conversion factors are: for  $P$ , 0.2048; for  $L$ ,  $u$ ,  $D$ , 3.28; for  $m$ , 0.0624; therefore

$$A' = \frac{.000765(.2048)(3.28)^{1.501}}{(.0624)(3.28)^{2.916}} = .000470$$

and

$$\zeta = \frac{2g(.000470)}{4D^{.503}u^{.081}} = \frac{.00756}{D^{.506}u^{.081}}$$

TABLE 1.4.—CONVERSION FACTORS FOR ENGLISH AND METRIC UNITS.

Lengths	. . . 1 Metre	=	3.2808	Feet.
		=	39.37	Inches.
Areas	. . . 1 Sq. metre	=	10.76	Sq. feet.
Volumes	. . . 1 Cu. metre	=	35.31	Cu. feet.
Weights	. . . 1 Kilogram	=	2.2046	Lb.
		=	9.81(10) <sup>5</sup>	Dynes.
	1 Dyne	=	2.25(10) <sup>-6</sup>	Lb.
Densities	. . . 1 Kg per cu. metre	=	.0624	Lb. per cu. ft.
	1 Gram per cu. cm	=	62.4	Lb. per cu. ft.
Quantities	. . . 1 Kg per hour	=	.00612	Lb. per sec.
	1 Cu. metre per hour	=	.00981	Cu. ft. per sec.
		=	.588	Cu. ft. per min.
Work	. . . 1 Erg = 1 Dyne-cm	=	73.8(10) <sup>-9</sup>	Ft.-lb.
	1 Kg-metre	=	7.238	Ft.-lb.
	1 Kilowatt-hour	=	2.65(10) <sup>6</sup>	Ft.-lb.
Heat	. . . 1 Kilogram-calorie	=	3088.0	Ft.-lb.
		=	427.0	Kg-metres.
		=	3.97	B.T.U.
		=	1.163	Watt-hour.
		=	4.186(10) <sup>10</sup>	Ergs.

TABLE 1'5.—MULTIPLY BY THE FACTORS GIVEN IN THE TABLE TO CONVERT PRESSURES GIVEN IN THE UNITS OF THE VERTICAL LIST TO PRESSURES IN THE UNITS AS SHOWN IN THE HORIZONTAL LIST.

Pressure.	Kg/m <sup>2</sup> .	Metric atm. Kg/cm <sup>2</sup> .	Feet of air.	Lb/ft <sup>2</sup> .	Lb/in <sup>2</sup> .	Mm of Water.		Inches of Water.	
						Mercury.	Water.	Mercury.	Water.
1 Kg per sq. metre =	1·0	·0001	2·68	·2048	·001422	·07355	1·0	·0029	·08987
1 Kg per sq. cm 1 metric atm. } =	10,000	1·0	26,800	2048	14·22	735·5	10,000	28·96	898·7
1 Atmosphere . =	10,333	1·0833	27,700	2116·8	14·70	760	10,333	29·95	404·8
1 Lb. per sq. ft. . =	4·882	·0004882	·0148	1·0	·00695	·3591	4·882	·01414	·192
1 Lb. per sq. in. . =	708·1	·07081	2·308	144	1·0	51·71	708·1	2·085	27·7
1 Mm mercury . =	13·6	·00136	38·4	2·786	·01934	1·0	13·6	·0394	·595
1 Mm water . =	1·0	·0001	2·68	·2048	·001422	·0735	1·0	·0029	·08987
1 Inch mercury . =	345·8	·08458	925	70·9	·4912	25·4	342·8	1·0	13·6
1 Inch water . =	25·4	·00254	68·5	5·2	·0881	1·87	25·4	·0786	1·0
1 Dyne per sq. cm =	·0102	1·02/10 <sup>6</sup>	·0278	·00209	·0000144	·000752	·0102	·000296	·00402
1 Poundal per sq. ft. =	·1518	1518	·767	·0311	·000216	·01116	·1518	·00440	·0596
1 Metre air . =	1·224	12,240	3·28	·2498	·00174	·0908	1·224	·00854	·0480
1 Foot air . =	·873	8730	1·0	·076	·000528	·0275	·873	·00108	·0146

## SYMBOLS USED.

The symbols which are commonly used are :—

Diameters	.	D	in feet	or in metres.
		<i>d</i>	„ inches	„ millimetres.
Lengths	.	L	„ feet	„ metres.
Velocities	.	<i>u, U</i>	„ feet per sec.	„ metres per sec.
Densities	.	<i>m</i>	„ lb. per cu. ft.	„ kg per cu. metre $\text{kg/m}^3$ or $\text{kg/cbm}$ .
Quantities	.	M	„ lb. per sec.	„ kg per sec.
		Q	„ cu. ft. per sec. at atmos. pressure	„ cu. m per sec. at atmos. pressure.
Pressures	.	P	„ lb. per sq. ft.	„ kg per sq. metre, $\text{kg/m}^2$ or $\text{kg/qm}$ .
		<i>p</i>	„ lb. per sq. in.	„ kg per sq. cm, $\text{kg/cm}^2$ .
Temperature	.	T	„ degrees absolute, Fahr. or Cent.	
		$\theta$	„ degrees	„ „
Time	.	<i>t</i>	„ seconds.	

On a double page at the end of each chapter will be found a list of the symbols used in that chapter, so that these may be visible at the same time as the text.

The question of suitable abbreviations gave food for thought. Should one use in. or ins. for inches, kg. or kgs. for kilograms, m. or ms. for metres? I have followed the practice recommended by a committee of the American Institutes of Electrical, Civil, Mechanical, and Mining Engineers, that the abbreviation should always be in the singular, viz. lb., in., amp., cm, kg; and have followed the French and German practice of using cm, m, kg for centimetres, metres, kilograms.

In the text, use is often made of the solidus / instead of the word “per,” so that “lb. per sq. in.” reads “ $\text{lb/in}^2$ ,” “kilograms per cu. metre” reads “ $\text{kg/m}^3$ ”; there is no ambiguity as to the meaning, and much space is saved. References to reports are also given in the form, *a/b/c*, instead of reading, vol. *a*, pg. *b*, year *c*, for the same reason.

CHAPTER I.—SYMBOLS USED.

Equation.	Symbol.	Meaning.
1'10	$C=R/\mu$	=particular gas constant.
1'18	$C'$	=gas constant for dry air.
1'19	$C'''$	= „ „ for steam.
..	$d$	=diameter.
1'20	$e=C'/C'''$	=ratio of gas constants.
1'25	$h''$	=pressure of steam at T, in mm mercury.
1'23	$h'''$	= „ „ at T, in in. „
1'17	$m$	=density.
1'17	$m'$	=weight of air in unit volume.
1'17	$m''$	= „ of steam in „ „
1'10	$P$	=pressure.
1'17a	$P'$	=partial pressure due to air.
1'17a	$P''=\varphi P'''$	= „ „ „ to steam.
1'16	$P'''$	=pressure of steam at T (see Table 1'3).
1'10	$R$	=universal gas constant.
1'10	$T$	=absolute temperature.
..	$u_k$	=critical velocity of air.
1'10	$v$	=volume.
1'24	$\Delta$	=a coefficient.
1'26	$\Delta'$	= „
..	$\eta$	=viscosity of gas.
1'10	$\mu$	=molecular weight of gases (see Table 1'2).
1'18	$\mu'=28.95$	= „ „ of dry air.
1'19	$\mu'''=18.1$	= „ „ of steam.
1'22	$\varphi =P''/P'''$	=wetness of air.



SCHEDULE 1.—BOOKS CONSULTED.

Title.	Author.	Publisher.	Date.
<i>Compressed Air Work.</i>			
Air Compressors and Blowing Engines . . . . .	Innes	Technical Publishing Co.	1906
Air Compression and Transmission . . . . .	Thorkelson	M'Graw Hill	1913
Compressed Air . . . . .	Harris	M'Graw Hill	1910
Compressed Air . . . . .	Hiscox	Constable	1905
Compressed Air . . . . .	Richards	Wiley	1907
Compressed Air . . . . .	Saunders	"Compressed Air"	1903
Pneumatic Transmission . . . . .	Culley, etc.	Clowes	1876
<i>Ventilation and Heating.</i>			
Air Currents, Laws of Ventilation . . . . .	Shaw	Cambridge Univ. Press	1907
Heating and Ventilation . . . . .	Barker	Coulton Press	1912
Heating and Ventilating Buildings . . . . .	Carpenter	Wiley	1915
Heating Systems . . . . .	Raynes	Longmans	1913
Hygiene . . . . .	Stevenson	Churchill	1892
Mechanics of Heating and Ventilation . . . . .	Meier	M'Graw Hill	1912
Mechanical Draft . . . . .	...	Sturtevant	1898
Mitteilungen Prüfungs Anstalten für Heizungs- und Lüftungseinrichtungen . . . . .	...	Oldenburg	1913
Modern Methods of Ventilation . . . . .	Grierson	Constable	1916
<i>Handbooks and Pocket-books.</i>			
Architectural Surveyors' Handbook . . . . .	Hurst	Spon	1908
Electrical Engineers' Handbook . . . . .	Fowler	Scientific Publishing Co.	...
Electrical Engineers' Formule . . . . .	Geipel & Kilgour	"Electrician"	...
Engineers' Year Book . . . . .	Kempe	Crosby Lockwood	1914
Engineers' Year Book . . . . .	"Hütte"	Berlin	1908
Handbook for Gas Engineers and Managers . . . . .	Newbigging	King	1913
Pocket-book for Mechanical Engineers . . . . .	Low	Longmans	1898
Pocket-book for Mechanical Engineers . . . . .	Molesworth	Spon	1906
Practical Engineers' Pocket-book . . . . .	...	...	1908
Standard Handbook for Electrical Engineers . . . . .	...	M'Graw Hill	1908
<i>General Subjects.</i>			
Development and Transmission of Power . . . . .	W. C. Unwin	Longmans	1893
Distribution of Gas . . . . .	W. Hole	Allan	1909
Evaporating, Condensing, Cooling Appliances . . . . .	E. Hausbrand	Scott-Greenwood	1900
The Fan . . . . .	C. H. Innes	Technical Publishing Co.	1904
Flow of Steam . . . . .	A. Rateau	Constable	1905
Le Gaz . . . . .	R. Masse	Béranger	1914
Hydraulics . . . . .	W. C. Unwin	Black	1907
Kinetic Theory of Gases . . . . .	O. E. Meyer	Longmans	1899
Measurement of Gas by Orifice Meter . . . . .	H. P. Westcott	Metric Metal Works, Erie, Pennsylvania	...
Mechanics of Engineering . . . . .	I. P. Church	Wiley	1890
Physics . . . . .	Ganot	Longmans	1906
Practical Testing of Gas and Gas Meters . . . . .	C. H. Stone	Wiley	1909
Principles of Thermodynamics . . . . .	G. A. Goodenough	Constable	1912
Pneumatic Tubes: Technical Instructions, X. . . . .	...	H. M. Stationery Office	1914
Resistance of the Air and Aviation . . . . .	G. Eiffel	Constable	1913
Smithsonian Tables of Physical Constants . . . . .	...	Smithsonian Inst.	1914
Steam Pipes and their Design . . . . .	W. H. Booth	Constable	1905
Steam Turbines . . . . .	A. Stodola	Constable	1906
Technical Thermodynamics (Vol. I.) . . . . .	G. A. Zeuner	Constable	1907
Treatise on Heat . . . . .	T. Box	Spon	1895
Treatise on Physics: Heat . . . . .	J. J. Thomson & Poynting	Griffin	1906
Pneumatic Despatch Tubes . . . . .	H. R. Kempe	} Inst. of Post Office Elec. Eng. }	1909
Post Office Installations . . . . .	H. O. Fleetwood		1910
Telegraph Traffic and Power Plant in Post Offices . . . . .	A. B. Eason		1913

The subjects in Schedules 2, 3, 4 are indicated by the following symbols:—

A,	anemometers.	M,	meters in general.
D,	disc or body friction, forces on planes.	Mo,	orifice meters.
F,	flow of air or gas in pipes and bends.	Mv,	Venturi meters.
Fk,	flow at critical velocities.	Mw,	hot-wire electric meters.
Fs,	steam flow in pipes.	O,	orifice and nozzle flow.
Fw,	flow of water in pipes.	P,	Pitot tubes.
Man,	manometers.	T,	pneumatic tubes generally.
		Vi,	question of viscosity.

SCHEDULE 2.—ENGLISH REPORTS CONSULTED.

Title.	Subject.	Vol.	Page.	Year.	Author.
Aeronautical Journal . . . . .	D	16-17	116	1912	Thurston
Cassier's Magazine . . . . .	Mv	15	411	1899	Herschel
Electrician . . . . .	Mw	69	1056	1912	Morris
	Mw	70	275	1912	Bordino
Engineer . . . . .	M	109	366	1910	—
	P	118	29	1914	Gibson
Engineering . . . . .	F	63	361	1897	Martin
	D	77	30	1903	Odell
	Mo	90	380	1910	Dalby
	D	91	299	1911	Johns
	F	94	703	1912	Gibson
	Mw	94	892	1912	Morris
	Mw	96	178	1913	Morris
	Man	96	343	1913	Pannell
	F	96	384	1913	Lander
	M	97	129	1914	—
	M	99	617	1915	Hackett
	O	99	643	1915	—
	O	101	91	1916	Morley
Jour. Gas Lighting . . . . .	F	109	357	1910	Chandler
	F	114	104	1911	Grebel
	P	120	670	1912	Griggs
	M	121	186	1913	Thomas
	F	126	1042	1914	Masse
Jour. Inst. Elec. Engineers . . . . .	P	33	28	1904	Threlfall
	P	52	563	1914	Teago
	A	57	293	1919	Barclay, Smith
Jour. Inst. Post Office Engr. . . . .	T	2	26	1909	Kennedy
	T	4	209	1911	Brown
	F	5	304	1912	Mansbridge
	T	7	189	1914	Walters
Jour. Sanitary Institute . . . . .	A	22	200	1901	Cowl Committee
Manchester Phil. Soc. Memoirs . . . . .	D	58	No. 7	1914	Cramp
Mechanical Engineer . . . . .	F	16	302	1905	Kinealy
	O	16	803	1905	Foster
	A	17	912	1906	Stokes
	O	18	574	1906	Foster
	Mo	21	493	1908	Muller
	M	24	70	1909	Orr
	P	27	635	1911	Anderson
	A	27	326	1911	—
	O	31	322	1913	Scanes

SCHEDULE 2.—ENGLISH REPORTS CONSULTED—*continued.*

Title.	Subject.	Vol.	Page.	Year.	Author.
Metallurgical and Chemical Engr.	M	15	250	1916	Northrup
Nat. Phys. Lab. Coll. Res.	D	1	247	1905	Stanton
	D	5	169	1909	Stanton
Nature	F	60	446	1899	Heleshaw
	D	86	60	1911	Chatley
Philosophical Magazine	D	1	530	1901	Zahm
	D	8	58	1904	Zahm
	D	8	66	1904	Rayleigh
	F	17	389	1909	Grindley
	Man	19	450	1910	Chattock
	Mw	20	591	1910	Russell
	P	21	348	1911	{ Fry
	Vi	21	697	1911	{ Tyndall
	Man	25	494	1913	{ Rayleigh
	D	28	728	1914	{ Fry
	Mw	29	556	1915	{ Shakespear
	Mw	31	118	1916	{ King
	Fk	31	322	1916	{ Hughes
	O	32	177	1916	{ King
					{ Rayleigh
Phil. Trans. (Royal Soc.)	A	169	797	1878	Robinson
	Fk	174	935	1883	Reynolds
	Mw	184	591	1893	Bottomley
	F	214	199	1914	{ Stanton
	Mw	214	373	1914	{ Pannell
					{ King
Proc. Inst. Civil Engineers	F	63	348	1880	Stockalper
	A	120	380	1895	Buchholtz
	P	123	272	1896	{ Heenan
					{ Gilbert
	P	133	464	1898	Parenty
	P	134	428	1898	Rateau
	M	139	446	1900	Krell
	D	156	78	1904	Stanton
	M	173	289	1908	Ashcroft
	F	192	371	1913	Kaplan
	F	193	437	1914	Banki
	F	193	438	1914	Archer
	Mv	199	391	1915	Gibson
	M	104	107	1918	Hodgson
Proc. Inst. Mech. Engineers	P	...	245	1904	Threlfall
	O	...	517	1912	{ Watson
					{ Schofield
	O	...	253	1913	Henderson
	O	...	927	1914	Fisher
	O	...	949	1914	Stewart
	O	...	53	1915	Callendar
Proc. Royal Society (All series A.)	D	48	233	1890	Dines
	F	76	205	1905	Morrow
	Man	78	410	1906	Roberts
	F	80	114	1908	{ Grindley
					{ Gibson
	F	85	366	1911	{ Stanton
					{ Pannell



SCHEDULE 2.—ENGLISH REPORTS CONSULTED—*continued.*

Title.	Subject.	Vol.	Page.	Year	Author.
Proc. Royal Society . . . . . (All series A.)	F	87	154	1912	Carothers
	O	89	91	1913	Davidson
	Mw	90	563	1914	King
	F	92	144	1915	Lees
	F	92	337	1916	Lander
	O	94	155	1918	Hartshorn
Proc. Royal Soc. Dublin . . . . .	Fk	13	375	1912	Dowling
Trans. Royal Soc. Edinburgh . . . . .	Mw	40	39	1900	Mitchell
Trans. Inst. Gas Engineers . . . . .	F	...	184	1904	Unwin .

## SCHEDULE 3.—AMERICAN REPORTS CONSULTED.

Title.	Subject.	Vol.	Page.	Year.	Author.
American Gas Journal . . . . .	F	82	648	1905	Shattuck
American Machinist . . . . .	F	22	636	1899	Johnson
	Mv	29	368	1906	Moss
	F	39	55	1913	Brown
Blast Furnace and Steel Plant . . . . .	M	...	...	1917	Estep
Compressed Air . . . . .	F	1	360	1898	Cox
	P	17	6636	1912	Crewson
	M	19	728	1914	—
Electrical Review . . . . .	M	63	238	1913	—
Electrical World . . . . .	M	68	866	1916	Phillips
Engineering Digest . . . . .	F	3	489	1908	Laschinger
	F	3	505	1908	Rix
	F	7	220	1910	Kent
	F	48	694	1915	Johnston
Engineering Magazine . . . . .	Vi	46	332	1901	Church
Engineering News . . . . .	P	51	318	1904	{ Boyd Judd
	P	54	660	1905	Burnham
	O	77	19	1917	Nelson
	F	62	384	1910	Chandler
	F	62	653	1910	Harris
Iron Age . . . . .	O	98	1049	1916	Estep
Jour. Amer. Soc. Mech. Engr. . . . .	F	36	258	1914	Dyer
	M	36	326	1914	Levin
	M	38	216	1916	Hickstein
	Vi	38	668	1916	Lewis
	O	38	775	1916	Bailey
	P	38	869	1916	Moss
	Vi	38	888	1916	Earhart
	O	38	953	1916	Reynolds
	O	39	221	1917	Upton
	O	39	250	1917	Reynolds
	P	27	34	1901	White
	M	172	411	1911	Thomas
	M	181	1	1916	King
	M	182	191	1916	King
Jour. Assoc. Engr. Societies . . . . .	Vi	183	115	1917	{ Worthington Malone
	Vi	183	783	1917	

SCHEDULE 3.—AMERICAN REPORTS CONSULTED—*continued.*

Title.	Subject.	Vol.	Page.	Year.	Author.
Jour. Indust. and Engr. Chem. . . . .	F	8	627	1916	Lewis
Physical Review . . . . .	F	12	372	1901	Barnes
	F	16	377	1903	Coker
	O	29	298	1909	Bradley
	M	34	401	1912	Langmuir
	Vi	1	124	1913	Gilchrist
	Mw	7	431	1916	Hartmann
	Vi	8	479	1916	Markwell
	Vi	8	738	1916	Harrington
Power . . . . .	M	32	918	1910	—
	P	37	156	1913	Busey
	P	37	302	1913	Loeb
	M	43	254	1916	Bailey
	O	44	58	1916	Anthes
	Fs	46	824	1917	Thies
Proc. Amer. Acad. Art and Sci. . . . .	D	43	380	1910	Hall
Proc. Amer. Gas Institute . . . . .	F	6	369	1911	Batten
	M	7	339	1912	Thomas
	P	9	615	1914	Spitzglass
	P	9	677	1914	Wing
Proc. Amer. Inst. Elec. Engr. . . . .	M	35	451	1916	Montsinger
Proc. Amer. Phil. Soc. . . . .	M	53	55	1914	{ Kennelly Sanborn
Proc. Amer. Soc. Heat. and Vent. Engr.	F	19	219	1913	Harding
	F	19	366	1913	Busey
	F	20	151	1914	Verner
	P	20	210	1914	—
Proc. Engr. Club, Philadelphia . . . . .	P	27	167	1910	Berry
Telephone Engineer . . . . .	F	14	295	1915	Scholtz
Trans. Amer. Inst. Elec. Engr. . . . .	M	28	363	1909	{ Wright Bylevelt Kennelly
	M	31	1229	1912	Langmuir
Trans. Amer. Soc. Civil Engr. . . . .	P	47	1	1902	{ Hubbell Williams Fenkel
	P	51	253	1903	{ Saph Schoder
	B	76	999	1913	Archer
Trans. Amer. Soc. Mech. Engr. . . . .	P	22	262	1901	Gregory
	P	25	184	1904	Gregory
	O	26	114	1905	Borsody
	M	27	193	1906	Durley
	P	28	483	1907	Coleman
	P	30	351	1908	Gregory
	P	31	601	1909	Gebhardt
	M	31	655	1909	Thomas
	F	33	1055	1911	{ Carrier Busey
	F	33	1137	1911	Kneeland

SCHEDULE 3.—AMERICAN REPORTS CONSULTED—*continued.*

Title.	Subject.	Vol.	Page.	Year.	Author.
Trans. Amer. Soc. Mech. Engr.	P	34	1019	1912	Treat
	F	34	1091	1912	Weymouth
	P	35	633	1913	Rowse
	M	36	239	1914	Levin
	M	36	707	1914	Hayes
	O	38	799	1916	Reynolds
Trans. Soc. Naval Arch. and Mar. Engr.	F	13	9	1905	Taylor

## SCHEDULE 4.—CONTINENTAL AND COLONIAL REPORTS CONSULTED.

Title.	Subject.	Vol.	Page.	Year.	Author.
Annales des Mines . . . . .	P	13	331	1898	Rateau
	F	2	541	1892	Ledoux
Comptes Rendus . . . . .	Man	155	1078	1912	Henry
	M	156	1831	1913	Carrière
	Mw	162	294	1916	Peczalski
Fort. der Physik . . . . .	Vi	52	442	1896	Houdaille
Gesundheits Ingenieur . . . . .	F	23	313	1905	Rietschel
Glückauf . . . . .	A	38	1141	1902	Stack
	A	39	1149	1903	Stack
Jour. New South Wales Royal Soc.	M	45	258	1911	Hebblewhite
Jour. Transvaal Inst. Mech. Engr.	F	7	154	1909	Laschinger
Mitt. über Forsch. Arb. des Ver. Deut. Ingr.	F	131	1	1913	Blasius
Motorwagen . . . . .	P	15	207	1912	Retschky
Phys. Zeit. . . . .	P	18	21	1917	Hagenbach
Stahl und Eisen . . . . .	M	33	1307	1913	Lütke
Verh. Deut. Phys. Gesch. . . . .	M	17	106	1898	Lummer
	D	16	695	1914	Kurlbaum
Wied. Annalen der Physik . . . . .	M	10	677	1880	Zenneck
	D	69	454	1899	Recknagel
	F	35	61	1911	Emden
	F	44	297	1914	Ziehendraht
	Vi	50	601	1916	Kohlrausch
	F	57	453	1905	Weinstein
Zeit. Öster. Ingr. Arkit.	D	30	489	1886	Brabbée
Zeit. Ver. Deut. Ingr. = Z. V. D. I.	F	36	621	1892	Recknagel
	F	52	81	1908	Lorenz
	F	52	285	1908	Fritzsche
	F	52	481	1908	Müller
	M	53	13	1909	Eberle
	F	56	1578	1912	Bendermann
	F	57	17	1913	Kaplan
	F	60	441	1916	Banki
	F	60	441	1916	Brabbée
	M	62	521	1918	Classen

## CHAPTER II.

### COEFFICIENT OF FRICTION IN PIPES.

List of authorities—Purpose of discussion—Types of formulæ—Method of correcting formula when other values of  $\zeta$  are used—Formulæ for quantities, volumes, velocities, losses of pressure—Various values of  $\zeta$ —Discussion on ventilation formulæ—Formulæ for flow of gas—Discussion on steam flow—Discussion on the flow of compressed air—Flow in pneumatic-tube distributor—Discussion on modern formulæ with fractional indices—Viscosity and its effect on critical velocities—Determination of critical velocities—Viscosity of air, gas, steam, and its alteration with temperature—Viscosity in turbulent flow and its relation to  $\zeta$ —Derivation of graphical charts—Discussion on flow in pneumatic tubes when fractional indices are included—Flow in telephone cables—Conclusions.

#### AUTHORITIES MENTIONED, AND THE RELATIVE EQUATION NUMBER.

Archer . . . . .	2'69c	Geipel . . . . .	2'43, 2'52	King's <i>Treatise</i> . . . . .	2'34
Arson . . . . .	2'23, 2'32	Gibson . . . . .	2'76	Kleint . . . . .	2'78j
Aubery . . . . .	2'75	Gilchrist . . . . .	2'78j	Kneeland . . . . .	2'75f
		Girard . . . . .	2'34	Kohlrausch . . . . .	2'78b
Babcox, Wilcox . . . . .	2'49	Grashof . . . . .	2'71		
Barker . . . . .	2'28	Grebel . . . . .	2'34	Lander . . . . .	2'85f
Barnes . . . . .	2'78	Grierson . . . . .	2'25	Laschinger . . . . .	2'59
Batcheller . . . . .	2'54	Grindley . . . . .	2'76	Ledoux . . . . .	2'62
Beardmore . . . . .	2'44	Gutermuth . . . . .	2'68	Lees . . . . .	2'84
Booth . . . . .	2'52			Lelong . . . . .	2'23
Box . . . . .	2'48	Hagen . . . . .	2'84	Lewis . . . . .	2'86
Brabbée . . . . .	2'28, 2'70	Harding . . . . .	2'21	Lindolt . . . . .	2'78j
Brown . . . . .	2'64	Harrington . . . . .	2'78j	Lorenz . . . . .	2'68, 2'71
		Harris . . . . .	2'64	Low . . . . .	2'54
Carothers . . . . .	2'69f	Hausbrand . . . . .	2'24	Lowe . . . . .	2'41
Carpenter . . . . .	2'22	Hawkesley . . . . .	2'34, 2'45		
Chandler . . . . .	2'44	Hazen . . . . .	2'69c	Mansbridge . . . . .	2'96b
Chapman Valve . . . . .	2'43	Hiscox . . . . .	2'55	Markowski . . . . .	2'78j
Church . . . . .	2'60, 2'67a	Hole . . . . .	2'44	Markwell . . . . .	2'78j
Coker . . . . .	2'78	Houdaille . . . . .	2'78j	Martin . . . . .	2'47
Cox . . . . .	2'40, 2'64	Hurst . . . . .	2'43	Masse . . . . .	2'33, 2'75
Cripps . . . . .	2'34	Hütte . . . . .	2'74a	Mayniel . . . . .	2'34
				Meier . . . . .	2'77
Darcy . . . . .	2'64	Innes . . . . .	2'23, 2'66	Meyer . . . . .	2'78k
Devillez . . . . .	2'71			Molesworth . . . . .	2'44
Dowling . . . . .	2'78j	Johnson . . . . .	2'61	Monnier . . . . .	2'34
Dyer . . . . .	2'89a	Johnston . . . . .	2'49		
				Newbigging . . . . .	2'44
Earhart . . . . .	2'78j	Kempe . . . . .	2'26, 2'56		
Eason . . . . .	2'66a	Kent . . . . .	2'57	Oliphant . . . . .	2'39
Eberle . . . . .	2'51	Kilgour . . . . .	2'43		
		Kinealy . . . . .	2'29	Pannell . . . . .	2'80
Fritzsche . . . . .	2'71	King . . . . .	2'78	Pecqueur . . . . .	2'71

AUTHORITIES MENTIONED, AND THE RELATIVE EQUATION NUMBER—*contd.*

Pedersen . . . . .	2'78j	Saph . . . . .	2'69	Thies . . . . .	2'49a
Pelzer . . . . .	2'70a	Saunders . . . . .	2'67	Thomas . . . . .	2'36
Petit . . . . .	2'67	Schilling . . . . .	2'34	Thorkelson . . . . .	2'31b
Pittsburg . . . . .	2'38	Schmidt . . . . .	2'24	Treat . . . . .	2'31
Pole . . . . .	2'34, 2'43	Scholz . . . . .	2'96b		
		Schroder . . . . .	2'69	Unwin . . . . .	2'37, 2'53, 2'84b
		Shattuck . . . . .	2'47		
Raynes . . . . .	2'50	Stanton . . . . .	2'79a, 2'80	Verner . . . . .	2'49a
Reynolds . . . . .	2'71, 2'78	Stockalper . . . . .	2'77		
Richards . . . . .	2'63	Sturtevant . . . . .	2'31c	Weinstein . . . . .	2'78k
Riedler . . . . .	2'53	Sutherland . . . . .	2'78k	Weisbach . . . . .	2'67a, 2'77, 2'84
Rietschel . . . . .	2'27			Western Elec. Co. . . . .	2'65
Rix . . . . .	2'57	Taylor . . . . .	2'30		

The investigations in this chapter were undertaken to determine the probable value of the coefficient of friction  $\zeta$  in pipes of various diameter. Information was therefore collected from papers upon the flow of air and from books dealing with compressed-air and ventilation work. As the formulæ were given in many different forms, with varying units, they were all reduced to standard forms, so that the constants were comparable.

It was then found that the variation in calculated results, using different formulæ, all depended on the value of  $\zeta$  which had been chosen by the originator of the formulæ. Our problem is to find the value of  $\zeta$  to use when a gas of any density,  $m$ , is flowing at any velocity,  $u$ , in a pipe of any diameter,  $D$ , made of any kind of material.  $\zeta$  depends upon all these quantities, though, if the variations in any of the quantities are limited—as, for instance, in ventilation work, where the density is practically constant—and the variations in velocity are also small,  $\zeta$  can then be expressed as a function of the diameter of the pipe only.

The material from which the pipe is made will determine whether the pipe is rough or smooth:  $\zeta$  can be approximately evaluated for either of these types of pipe.

$\zeta$  is defined by the hydraulic equation (see Eq. 2'07),

$$dH = \zeta \frac{u^2 dL}{2\gamma\mu}$$

$\zeta$  is not a true constant, but depends on  $m$ ,  $u$ ,  $D$ , or  $\mu$  the hydraulic mean depth.

The chapter is subdivided thus:—

(A) A discussion upon types of, and accuracy of, formulæ, followed by a series of useful formulæ giving quantities, velocities, loss of pressure of gases and air flowing in pipes, with both general and particular values of  $\zeta$ . These can be used in solving problems in air and gas work, and for comparison with other formulæ.

(B) Tables of the values of  $\zeta$ , the coefficient of friction, as given by various authorities, or as deduced from their formulæ.

(C) A *résumé* of, and observations on, the formulæ which contain the  $u^2$  term and a value of  $\zeta$  assumed to be independent of  $u$ : the derivation of these formulæ is discussed in Chapters IV. and V.

(D) A discussion of the formulæ which include fractional powers of the

velocity  $u$  and of the diameter  $D$ ; in which case the portion of  $\zeta$  dependent on  $m$ ,  $u$ ,  $D$  having been incorporated with the  $u^2/D$  term, the rest of the constant is independent of  $u$  and  $D$ .

(E) A discussion upon the work of Stanton, Lees, and others, who have shown that the coefficient of friction does not depend on diameter only, and that the  $u^2$  law is theoretically incorrect. For practical purposes, however, formulæ based on the  $u^2$  law are quite good enough if a proper value of friction is chosen.

(F) The explanation and derivation of graphical charts on logarithmic ruled paper, and reference to abaci, for solving ordinary air or gas transmission problems, using particular values of  $\zeta$ ; corrections to be made if other values of  $\zeta$  are to be used are also given.

(G) A discussion of air flow in telephone cables.

(H) General conclusions.

**A. Discussion on types of formulæ.**

Various expressions are used to give the loss of pressure in pipes, depending on the units included; but in all cases the loss of pressure is proportional to the length of the pipe. The general form of expression, based on velocities, is

$$dP = \beta \frac{mu^2 dL}{D} \quad (2'01)$$

$dP$  = the loss of pressure in length  $dL$ .

$m$  = the density of the gas.

$u$  = the velocity of the gas.

$D$  = the diameter of the pipe.

$\beta = 2\zeta/g = \zeta/(16 \cdot 1)$  English =  $\zeta/(4 \cdot 905)$  metric, when the lb., ft. or kg, metre units are employed.

$\beta$  is determined by experiment; it includes the coefficient of friction,  $\zeta$ , and the value of the force of gravitation,  $g$ ; it is approximately constant for any particular pipe if the variations in  $m$  and  $u$  are small.

The usual expressions for loss of pressure based on weights or volumes are

$$dP = \lambda_1 M^2 dL / (D^5 m) \quad (2'02)$$

$$dP = \lambda_2 Q^2 dL m / D^5 \quad (2'03)$$

$M$  = the weight of gas in lb/sec or kg/sec.

$Q$  = the volume of gas in cu. ft. or cu. metres per second.

$\lambda_1$ ,  $\lambda_2$  are coefficients similar to  $\beta$ : many authors give tables of values of  $\lambda_1/D^5$ ,  $\lambda_2/D^5$  for various diameters, to be used in solving problems in certain types of work, such as ventilation, gas, or compressed-air work, at particular pressures; in such cases  $\lambda_1$ ,  $\lambda_2$  may be considered functions of the diameter only.

In about half the references consulted, the authorities derive formulæ applicable to pipes in which the drop of pressure is negligible compared to the absolute pressure existing in the pipe, so mean values of the pressure, density, and velocity may be chosen without inaccuracy.

The more accurate formula for the drop of pressure in long pipes as deduced in Chapter IV., viz.

$$P_1^2 - P_2^2 = \frac{64\zeta}{\pi^2 g D^5} C T M^2 L = \frac{64\zeta}{\pi^2 g D^5} \frac{P_1 M^2 L}{m_1} \quad (2'04)$$

holds for pipes where the expansion is isothermal and allows for the alteration in density. The simpler equation results by the substitution,

$$\frac{P_1}{m_1} = \frac{P_2}{m_2} = \frac{P_1 + P_2}{2m} = C T \quad (2'05)$$

giving

$$P_1 - P_2 = \frac{32\zeta}{\pi^2 g D^5} \cdot \frac{M^2 L}{m} \quad (2'06)$$

Using the approximate formula, one obtains the same results as when using the more accurate formula, if the proper value for the density is chosen. In problems where the initial pressure  $P_1$  and the quantity  $M$  which is to be transmitted are known, but where the loss of pressure is required, a certain value for the density  $m$  must be chosen in order to determine the drop  $P_1 - P_2$  by the approximate formula; if the value of  $m$  chosen happens to be the actual mean density, the result would be quite accurate; the result obtained by choosing the density  $m_1$  at the beginning or  $m_2$  at the end is usually good enough, because the value of  $\zeta$  is not known accurately.

The standard formulæ used for comparison are based upon the hydraulic formula,

$$dH = \frac{u^2}{2g} \frac{dL\zeta}{\mu} \quad (2'07)$$

$H$  is measured in feet or metres of fluid of the density  $m$  at the point where the measurement is made. The hydraulic mean depth  $\mu = D/4$  for circular pipes, or for square ducts (side= $D$ ), when the fluid is a gas, because the fluid must fill the pipe completely. Some authors use the coefficient  $4\zeta$  or  $Z$  as the coefficient of friction, having incorporated the hydraulic mean depth factor with the true friction coefficient  $\zeta$ .

It is impracticable to give formulæ with suitable constants for all cases, and with the precise units required by commercial men and engineers; for instance,

$$\text{Quantity} = \text{a constant} \left[ \frac{(\text{fall of pressure})(\text{diameter in ft. or in.})^5}{(\text{length in ft. or yards or miles})} \right]^{\frac{1}{2}}$$

Engineers require pressures in inches of water ( $h$ ), in  $\text{lb}/\text{in}^2$  ( $p$ ), in atmospheres, in feet of head of the fluid ( $H$ ); they require quantities in  $\text{lb}/\text{min}$ , in  $\text{lb}/\text{hour}$ , in cu. ft. of free air or gas per minute or per hour, or in cu. ft. of compressed air at the pressure of delivery or at the working pressure per min. or per hour. And in each of these cases the metric units may be employed.

In order to avoid the multiplication of charts and graphs, etc., suitable for use when various types of units are used, it is necessary to have one standard unit for quantities, and to employ this in the charts; for instance, the charts and figures are based on  $\text{lb}/\text{sec}$  or  $\text{kg}/\text{sec}$  units. Fig. 2'13

gives the conversion factors necessary if quantities are in lb/min, lb/hr, kg/min, kg/hr, etc.

Similarly with regard to  $\zeta$ : a particular value of  $\zeta$  is chosen when drawing up the charts, fig. 2'8 to 2'11; if any reader prefers to use some other value—say  $\zeta'$ —the volumes, quantities, loss of pressure will be altered accordingly. To allow for this, the reader must multiply the result obtained from the chart by various factors, as follows (these are also in Table 2'1):—

Factors given or known.	Required factor obtained from chart.	To find the true value, if $\zeta'$ not $\zeta$ is used, multiply by
Density, quantity, loss of pressure . .	Diameter	$(\zeta'/\zeta)^5$
„ velocity „ . . .	„	„
„ diameter „ . . .	Quantity	$(\zeta'/\zeta)^4$
„ „ „ . . .	Velocity	„
„ „ quantity . . .	Loss of pressure	$(\zeta'/\zeta)$
„ „ velocity . . .	„	„

$\zeta$  is Unwin's value of the coefficient of friction (see fig. 2'1, Table 2'1);  $\zeta'$  is the reader's value of friction (see fig. 2'1, 2'2, 2'3). Some formulæ are given here, the unit of length of pipe being always feet or metres. To convert quantities given by weight to quantities by volume, see fig. 2'13. The numerical value of  $\zeta$  is purposely omitted from some formulæ, so that each individual can insert a suitable value for the problem in hand. Readers who are satisfied with the value of  $\zeta$  given by particular authors could use the tables to be found in the relative original paper. Martin, Kinealy, Richards, Cox, Laschinger, Lorenz, Fritzsche give such tables. Straight-line charts on logarithmic paper, using Unwin's  $\zeta$ , are given in fig. 2'8 to 2'11, for use instead of formulæ.

These formulæ are based on Eq. 2'02, 2'03, 2'04. The constants have been calculated by a slide-rule, so the accuracy is about 1 per cent.; the various factors are not usually known to this degree of accuracy. The value of  $g$  has been taken as 32.2 ft/sec<sup>2</sup>, or 9.81 metre/sec<sup>2</sup>, and the temperature  $T$  as 521° F. or 290° C. The suffix 1 in these expressions refers to factors at the beginning of the pipe, the point of greater pressure, and the suffix 2 to factors at the end of the pipe, the point of lesser pressure.

For meaning of symbols, see folder facing p. 64.

1st. General formulæ allowing for the variation of density of the gas flowing in the pipe line:—

$$\text{Loss of pressure, } P_1^2 - P_2^2 = \frac{64\zeta CT}{\pi^2 g D^5} M^2 L = c' M^2 L \quad . \quad . \quad . \quad (2'08)$$

$$c' = \left( \frac{64\zeta}{\pi^2 g D^5} \right) CT = D^n \frac{P_1}{m_1} \quad . \quad . \quad . \quad (2'08a)$$

$$64CT/(\pi^2 g) = 5580 \text{ (Eng. or metric).}$$



Quantity, 
$$M = \left[ \frac{(P_1^2 - P_2^2) D^5 \pi^2 g m_1}{L \zeta 64 P_1} \right]^{\frac{1}{2}} \quad \dots \quad (2'08b)$$

Velocity, at the point where the pressure is P,

$$u = \left[ \frac{(P_1^2 - P_2^2) D}{L} \frac{g}{4 \zeta P_m} \right]^{\frac{1}{2}}, \quad \frac{g}{P_m} = \frac{gCT}{P^2} \quad \dots \quad (2'08c)$$

Pressure, 
$$P = [P_1^2 - c'M^2L]^{\frac{1}{2}} \quad \dots \quad (2'08d)$$

where L is the distance from the beginning.

2nd. General formulæ assuming a mean density *m* :—

Loss of pressure, 
$$P_1 - P_2 = \frac{2\zeta mu^2L}{gD} = \beta \frac{mu^2L}{D} \quad \dots \quad (2'09)$$

$$= \frac{32\zeta M^2L}{\pi^2 g D^5 m} = \left( \frac{64\zeta}{\pi^2 g D^5} \right) \frac{M^2L}{2m} \quad \dots \quad (2'09a)$$

Values of  $\frac{64\zeta}{\pi^2 g D^5}$  are given in Table 2'1.

Quantity, 
$$M = \left[ \frac{(P_1 - P_2) D^5 \pi^2 g m}{L 32 \zeta} \right]^{\frac{1}{2}} \quad \dots \quad (2'09b)$$

Velocity, 
$$u = \left[ \frac{(P_1 - P_2) D}{L} \frac{g}{2 \zeta m} \right]^{\frac{1}{2}} \quad \dots \quad (2'09c)$$

Then we have particular formulæ with and without the value of  $\zeta$  inserted for the various factors.

3rd. Weight of gas transmitted :—

$$M = \left[ \frac{(P_1 - P_2) D^5}{L} \frac{m(9.95)}{\zeta} \right]^{\frac{1}{2}} \quad \dots \quad (2'10)$$

$$\text{Lb/sec} = \frac{.02105}{\sqrt{\zeta}} \left[ \frac{(p_1 - p_2) d^5}{L} \right]^{\frac{1}{2}}, \quad \text{for air at } p_0 \quad \dots \quad (2'10a)$$

$$= \frac{.02105}{\sqrt{\zeta}} \left[ \frac{(p_1 - p_2) d^5}{L} \frac{m}{.0764} \right]^{\frac{1}{2}}, \quad \text{for any gas} \quad \dots \quad (2'10b)$$

$$= \frac{.0758}{\sqrt{\zeta}} \left[ \frac{(p_1 - p_2) d^5 m}{L} \right]^{\frac{1}{2}} \quad \dots \quad (2'10c)$$

$$\text{Lb/hr} = 13.94 \left[ \frac{(p_1^2 - p_2^2) d^5 \rho}{L \zeta} \right]^{\frac{1}{2}} \quad \dots \quad (2'10d)$$

$$\text{Kg/sec} = \frac{1.74}{10^5 \sqrt{\zeta}} \left[ \frac{hd^5 m}{L} \right]^{\frac{1}{2}} \quad \dots \quad (2'10e)$$

$$= \frac{0.169}{10^5 \sqrt{\zeta}} \left[ \frac{(p_1 - p_2) d^5}{L} \right]^{\frac{1}{2}}, \quad \text{for air} \quad \dots \quad (2'10f)$$

$$\text{Kg/sec} = .000225 \left[ \frac{hd^5 m}{L} \right]^{\frac{1}{2}}, \text{ if } \zeta = .0060 \quad \dots \quad (2'10g)$$

$$= .000166 \left[ \frac{hd^5}{L} \right]^{\frac{1}{2}}, \text{ for gas if } m = 0.613, \text{ and } \zeta = 0.00673. \quad (2'10h)$$

$$\text{Kg/min} = \frac{1}{100} \left[ \frac{hd^5}{L} \right], \text{ for gas, as above.}$$

**4th. Volumes of gas transmitted at mean density  $m$  :—**

$$\text{Cu. ft. per sec.} = \frac{.076}{\sqrt{\zeta}} \left[ \frac{(p_1 - p_2)d^5}{Lm} \right]^{\frac{1}{2}} \quad \dots \quad (2'11)$$

$$\text{Cu. ft. per min.} = \frac{4.56}{\sqrt{\zeta}} \left[ \frac{(p_1 - p_2)d^5}{Lm} \right]^{\frac{1}{2}} \quad \dots \quad (2'11a)$$

$$= \frac{3.15}{\sqrt{\zeta}} \left[ \frac{hd^5}{L} \right]^{\frac{1}{2}}, \text{ for air at } p_0 \quad \dots \quad (2'11b)$$

$$\text{Cu. metres per sec.} = \left[ \frac{hD^5 \pi^2 (9.81)}{L 32 \zeta m} \right]^{\frac{1}{2}} \quad \dots \quad (2'11c)$$

$$= \frac{.55}{10^7 \sqrt{\zeta}} \left[ \frac{hd^5}{Lm} \right]^{\frac{1}{2}} \quad \dots \quad (2'11d)$$

$$= \frac{1.74}{10^5 \sqrt{\zeta}} \left[ \frac{hD'^5}{Lm} \right]^{\frac{1}{2}}, \text{ } D' \text{ in cm} \quad \dots \quad (2'11e)$$

$$= \frac{.493}{10^7 \sqrt{\zeta}} \left[ \frac{hd^5}{L} \right]^{\frac{1}{2}}, \text{ for air, } m_0 = 1.220 \quad \dots \quad (2'11f)$$

$$\text{Cu. metres per hour} = \frac{.000178}{\sqrt{\zeta}} \left[ \frac{hd^5}{L} \right]^{\frac{1}{2}}, \text{ for air at } p_0 \quad \dots \quad (2'11g)$$

$$= \frac{.0572}{\sqrt{(\zeta \rho)}} \left[ \frac{hD'^5}{L} \right]^{\frac{1}{2}}, \text{ for air or gas at } p_0 \quad \dots \quad (2'11h)$$

$$= 1.00 \left[ \frac{hD'^5}{L} \right]^{\frac{1}{2}}, \text{ when } \begin{array}{ll} \rho = .55, & \zeta = .0060 \\ & = .50, & = .00657 \\ & = .45, & = .0073. \end{array} \quad (2'11j)$$

$$\text{Cu. metres per min.} = \frac{8.3}{10^6 \sqrt{\zeta}} \left[ \frac{(p_1 - p_2)d^5}{L} \right]^{\frac{1}{2}}, \text{ for air at } p_0 \quad \dots \quad (2'12)$$

**5th. Velocities : velocity at mean density  $m$  :—**

$$\text{Feet per sec.} = \left[ \frac{(P_1 - P_2)D}{L} \frac{g}{2 \zeta m} \right]^{\frac{1}{2}} \quad \dots \quad (2'13)$$

$$= \frac{13.9}{\sqrt{(m \zeta)}} \left[ \frac{(p_1 - p_2)d^5}{L} \right]^{\frac{1}{2}}, \text{ for any gas} \quad \dots \quad (2'14)$$

$$\text{Feet per sec.} = \frac{50.2}{\sqrt{\zeta}} \left[ \frac{(p_1 - p_2)d}{L} \right]^{\frac{1}{2}}, \text{ for air at } p_0. \quad (2.15)$$

$$= \frac{9.54}{\sqrt{\zeta}} \left[ \frac{hd}{L} \right]^{\frac{1}{2}}, \text{ for air at } p_0 \quad (2.16)$$

$$\text{Metres per sec} = \left[ \frac{9.81 hD}{2\zeta_m L} \right]^{\frac{1}{2}} \quad (2.17)$$

$$= \frac{2.216}{\sqrt{(\zeta_m)}} \left[ \frac{hD}{L} \right]^{\frac{1}{2}} \quad (2.18)$$

$$= \frac{0.07}{\sqrt{(\zeta_m)}} \left[ \frac{hd}{L} \right]^{\frac{1}{2}} \quad (2.19)$$

$$= \frac{0.0635}{\sqrt{\zeta}} \left[ \frac{hd}{L} \right]^{\frac{1}{2}}, \text{ if } m=1.22 \quad (2.20)$$

TABLE 2'1.—FUNCTIONS OF DIAMETER AND COEFFICIENT OF FRICTION, USING UNWIN'S  $\zeta$ : ENGLISH UNITS.

D.	d.	Unwin's $\zeta$ .	$L_1 = \frac{D}{4\zeta}$	$\frac{4\zeta}{D} = \frac{\zeta}{\mu}$	$S = \frac{\pi D^2}{4}$	$(gL_1)^{\frac{1}{2}}$	$(D'')^{\frac{1}{2}} = \left( \frac{\pi^2 D^2 g}{64\zeta} \right)^{\frac{1}{2}}$	$\frac{(d+3.6)}{f(d)}$	$\frac{d^7}{5d+21.6}$ $1/f''(d)$	$\frac{\sqrt{2d+3.6}}{2d+7.2}$	
.0416	$\frac{1}{2}$	.0194	0.53	1.89	.00137	4.125	.00565	...	...	.526	
.0625	$\frac{1}{2}$	.0156	1.00	1.00	.00307	5.67	.01742	...	...	...	
.0823	1	.0124	1.66	.60	.00545	7.3	.0398	4.600	.0376	.545	
.1250	1 $\frac{1}{2}$	.00929	3.36	.296	.0123	10.4	.1255	.447	.5880	...	
.1666	2	.00757	5.51	.182	.0219	13.3	.291	.0875	4.0000	.573	
.1875	2 $\frac{1}{2}$	.00700	6.70	.149	.0277	14.68	.410	.0452	9.00	...	
.2083	2 $\frac{1}{2}$	.00658	7.93	.126	.0343	16.00	.548	.0252	17.80	.585	
.2500	3	.00594	10.4	.096	.0492	18.28	.900	.00908	60.00	.594	
.3333	4	.00513	16.2	.0617	.0875	22.80	2.00	.00183	394.0	.610	
.4166	5	.00464	22.5	.0445	.1370	26.86	3.68	.00050	1670.0	.620	
.5000	6	.00432	29.0	.0345	.1970	30.55	6.00	.000206	5400.0	.630	
.666	8	.00392	42.7	.0235	.350	37.0	13.0	...	34000.0	.644	
.833	10	.00367	57.0	.0176	.546	42.8	23.3	...	...	.654	
1.000	12	.00351	71	.0141	.785	47.7	37.3	...	...	.660	
1.333	16	.00330	100	.0100	1.400	56.7	79.3	For use in Eq. 4.30a.		For use in Eq. 4.29.	
1.500	18	.00324	116	.0086	1.778	61.0	103				
1.666	20	.00313	131	.0077	2.185	65.0	142				
2.000	24	.00311	158	.0063	3.142	71.4	224				
2.333	28	.00304	198	.0052	4.270	78.8	336				
2.666	32	.00300	223	.0045	5.520	84.7	467				
3.000	36	.00297	251	.0040	7.080	90.0	637				
Correc- tion factor	...	$\frac{\zeta'}{\zeta}$	$\frac{\zeta}{\zeta'}$	$\frac{\zeta'}{\zeta}$	...	$\left( \frac{\zeta}{\zeta'} \right)^{\frac{1}{2}}$	$\left( \frac{\zeta'}{\zeta} \right)^{\frac{1}{2}}$				

Multiply by correction factor, if  $\zeta$  is  $\zeta'$ .

TABLE 2'1—*continued*.—FUNCTIONS OF DIAMETER AND COEFFICIENT OF FRICTION, USING UNWIN'S  $\zeta$ : METRIC UNITS.

$d$ mm.	Unwin's $\zeta$ .	$L_1 = \frac{D}{4\zeta}$	$\frac{4\zeta}{D} = \frac{\zeta}{\mu}$ .	$S = \frac{\pi D^3}{4}$ .	$(gL_1)^{\frac{1}{2}}$ .	$D'' = \frac{\pi^2 D^{\frac{5}{2}} g}{64\zeta}$ .	$(D'')^{\frac{1}{2}}$ .
10	·0274	0·0914	10·96	·0000785	0·916	·0000741	·0086
20	·0150	0·333	3·00	·0003140	1·82	·0005710	·0239
30	·01093	0·686	1·46	·0007060	2·59	·0018400	·0428
40	·00885	1·13	·885	·0012550	3·33	·0041770	·0645
50	·00764	1·64	·611	·0018600	4·01	·0074500	·0861
60	·00681	2·2	·455	·0028250	4·64	·0131000	·1142
70	·00624	2·81	·357	·0038843	5·25	·0202	·142
80	·00577	3·47	·346	·005020	5·83	·0293	·171
90	·00545	4·13	·242	·006360	6·35	·0405	·201
100	·00517	4·83	·207	·007850	6·88	·0540	·232
120	·00475	6·31	·1586	·01130	7·87	·0790	·281
140	·00447	7·83	·1280	·01537	8·76	·1345	·366
160	·00424	9·45	·1060	·02010	9·62	·1930	·438
180	·00407	11·05	·0905	·0254	10·40	·264	·513
200	·00393	12·71	·0785	·0314	11·15	·350	·590
250	·00369	17·4	·0575	·0491	13·05	·641	·800
300	·00352	21·3	·0470	·0706	14·44	1·020	1·010
400	·00331	30·1	·0330	·1255	17·2	2·16	1·470
500	·00320	39·1	·0256	·1860	19·6	3·64	1·904
600	·00312	48·0	·0208	·2825	21·7	6·13	2·48
700	·00306	57·0	·0175	·3843	23·6	9·06	3·01
800	·00301	66·5	·0150	·502	25·6	12·3	3·57
900	·00298	75·5	·0132	·636	27·2	17·3	4·16
1000	·00295	84·6	·0118	·785	28·8	22·6	4·75
Correction factor	$\frac{\zeta'}{\zeta}$	$\frac{\zeta}{\zeta'}$	$\frac{\zeta'}{\zeta}$	...	$\left(\frac{\zeta'}{\zeta}\right)^{\frac{1}{2}}$	$\frac{\zeta}{\zeta'}$	$\left(\frac{\zeta}{\zeta'}\right)^{\frac{1}{2}}$

Multiply by correction factor, if  $\zeta$  is  $\zeta'$ .

**B. Values of  $\zeta$  for use with Eq. 2·04, etc.**

The following tables give approximate values of  $\zeta$  as used by different authorities. The values were obtained by slide-rule calculation, and may be inaccurate to 1 per cent. or so. Mean values of pressure, density, etc., were chosen in deducing  $\zeta$  from the various constants used in the original formulae.

$\zeta$  is independent of the system of units used: it represents the proportionate loss of velocity head in a length of pipe, and is merely a numerical factor. This can be seen at once by looking at the dimensions of units in Eq. 2'07.

In Table 2'2  $\zeta$  is independent of the diameter. The constant in Table 2'3 varies with the units used, as it is associated with diameter; in Table 2'4 it also varies with the units. Fig. 2'1, 2'2, 2'3 should be scrutinised along with these tables, so that the nature of variations of  $\zeta$  with diameter or quantity may be seen.

These values of  $\zeta$  are assembled together in order that anyone using a particular author's formula may know what value of  $\zeta$  is included, and for what ranges such a value may be correct.

TABLE 2.2.—VALUES OF THE COEFFICIENT OF FRICTION,  $\zeta$ , GIVEN AS BEING INDEPENDENT OF THE DIAMETER.

$\zeta$	Equation.	Authority.	$\zeta$	Equation.	Authority.		
Steam Flow.			For Air Flow in Mine Shafts.				
·00515	2·51	Eberle	·01520	*	Atkinson		
·00702	*	Gutermuth	·01070	}	Wabner		
·008075	*	Geipel	·01600				
·00830	2·52	Geipel, Booth	Gas Flow.				
Compressed Air Flow.			·00415	*	Robinson		
·00300	2·56	Kempe	·00431	2·34	Hawkesley		
·00400 } ·00500 }	2·60	Church	·00453 } ·00530 }	2·40	Oliphant		
·00415			*			Norwalk Iron Co.	
·00435	2·54	Batcheller	·00467	2·38	Pittsburg		
·00450	2·62	Ledoux	·00518 } ·00740 }	2·42	Lowe		
·00460	2·57	Kent					
·00550	2·61	Johnson	·00552	*	Hurst		
·00550	*	Laidlaw-Dunn	·00640 } ·01170 }	2·43	Hurst		
·00555	2·57	Rix					
·00570	2·40 <sub>a</sub>	Cox	·01920 } ·00608 }	}	Pole		
Air Flow, Ventilation.			·00735			2·34	
·00275	2·34	Girard, <i>via</i> Masse	·00640	2·43	{ Chapman Valve Co., Pole, Geipel, Kilgour		
·00330 } ·00440 } ·00870 }	2·70	Brabbée	·00644	2·34		Schilling	
·00370 } ·00460 }			2·21	Harding	·00650	2·44	Beardmore
·00440 } ·00600 }					2·31	Treat	·00655
·00575	2·65 <sub>b</sub>	Eason	·00663 } ·01540 }	2·34			Cripps
·00606	2·23	Innes, Lelong	·00543 } ·00815 }		2·34	Masse	
·00600	*	Buffalo Forge Co.	·00687	2·34			Monnier
·00631	*	Sturtevant	·00920	2·58	Rix		
·00633	2·31 <sub>c</sub>	Sturtevant	·01170	2·43	Molesworth		
·00633	2·29	Kinealy					
·00633	2·31 <sub>b</sub>	Thorkelson					
·00644	2·30 <sub>a</sub>	Taylor					
·00645	2·26	Kempe					
·00647	*	Martin					
·00700	2·45	Hawkesley					
·00755	2·79	Stanton					

The values marked \* are those given by Laschinger in the *Journal of the Transvaal Mining Engineers*, 7/154/1909.

TABLE 2.3.—COEFFICIENT OF FRICTION,  $\zeta$ , GIVEN AS DEPENDING ON DIAMETER. See Fig. 2.1.

$\zeta$	English.	Metric.	Equation.	Authority.
·00270	$(1 + \cdot3/D)$ ,	$(1 + \cdot0915/D)$	$\left. \begin{array}{l} 2\cdot49 \\ 2\cdot54 \\ 2\cdot63 \end{array} \right\}$	Babcox, Wilcox, Johnston Unwin Richards
·00223	$(1 + \cdot3/D)$ ,	$(1 + \cdot0915/D)$		
·00260	$(1 + \cdot3/D)$ ,	$(1 + \cdot0915/D)$		
·00295	$(1 + \cdot3/D)$ ,	$(1 + \cdot0915/D)$	$\left. \begin{array}{l} 2\cdot47 \\ 2\cdot54 \end{array} \right\}$	Martin Low
·00500	$(1 + \cdot3/D)$ ,	$(1 + \cdot0915/D)$		
·00655	—·00302D,	—·00990D	2·28	Arson, <i>via</i> Carpenter
·00440	$(1 + 1/7D)$ ,	$(1 + \cdot0436/D)$	2·64	Harris
·00193	$(1 + \cdot656/D)$ ,	$(1 + \cdot2/D)$	2·53	Riedler, <i>via</i> Unwin
·00125	$+ \cdot00217/D^{\cdot5}$ ,	$+ \cdot00120/D^{\cdot5}$	2·24	Hausbrand, Schmidt, Meier, Stockalper
·00368	$D^{300}$ ,	$\cdot00143/D^{300}$	2·59a	Laschinger
·00650	$+ \frac{\cdot0604}{2\cdot54Y - 48}$ ,	$+ \frac{\cdot0604}{8\cdot3Y - 48}$	2·68	Lorenz
			2·28	Barker, Rietschel, Brabbée

TABLE 2.4.—COEFFICIENT OF FRICTION,  $\zeta$ , GIVEN AS DEPENDING UPON VARIOUS FACTORS,  $m$ ,  $u$ ,  $D$ .

$\zeta$	Equation.	Authority.
·00368		Box
$\frac{\cdot0542}{u^{50}}$	2·67a	Weisbach, <i>via</i> Church
$\frac{\cdot217}{u^{50}}$	2·77	Weisbach, <i>via</i> Meier
$\cdot0036 + \frac{\cdot00429}{u^{50}}$	*	Weisbach, <i>via</i> Laschinger
$\frac{\cdot00745}{u^{25}}$	2·75d	Kneeland
$\cdot0039$	*	Laschinger
$D^{\cdot5} u^{10}$		
·00367	2·70a	Pelzer, <i>via</i> Brabbée
$D^{\cdot375} m^{338}$		
·0080	2·77a	Meier
$D^{180} \cdot 10$		
·00756	2·67	Saunders
$D^{306} u^{1084}$		
$\cdot0185 + \frac{\cdot001235 + \cdot01d}{du^{50}}$	...	Meier
$\frac{\cdot01236}{D^{280}} \left( \frac{T}{pu} \right)^{148}$	2·73b	Fritzsche
$\cdot00309 + \frac{\cdot0068}{u} + \frac{\cdot00035}{D} + \frac{\cdot00300}{uD}$	2·27	Rietschel
·0018 + $\cdot0153(\nu/uD)^{35}$	2·85	Stanton, <i>via</i> Lees

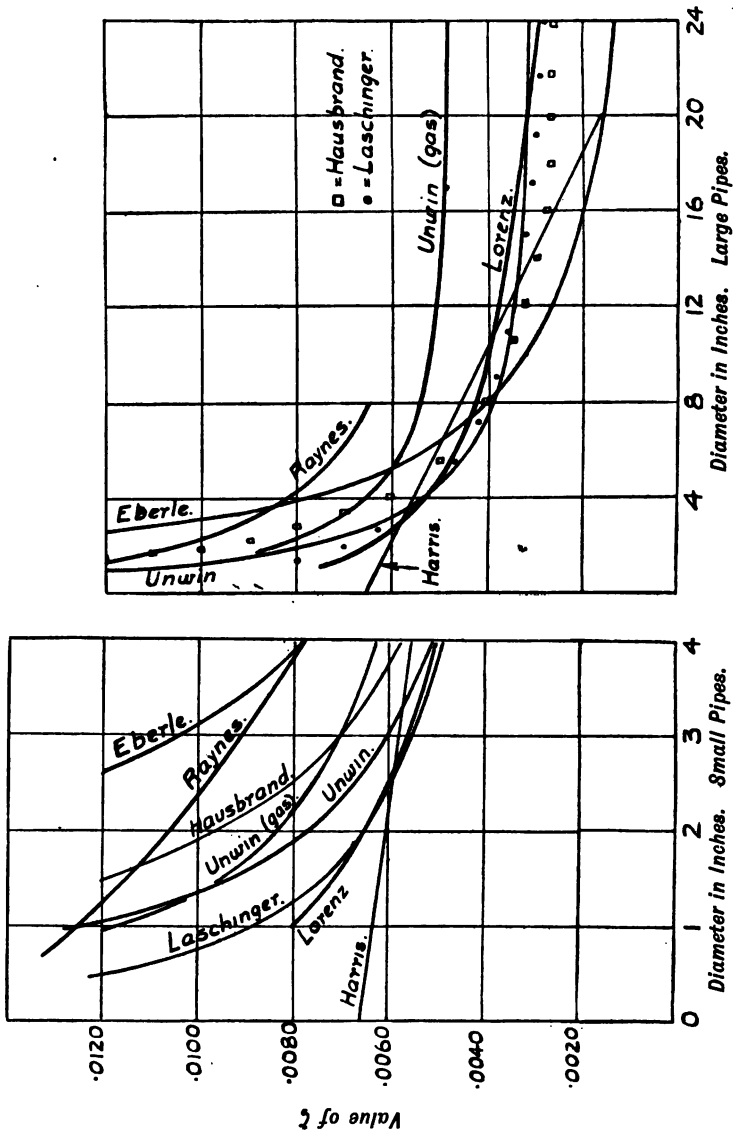

FIG. 2'1.—Coefficient of friction, various authorities. See Table 2'3 for the equations to various curves.

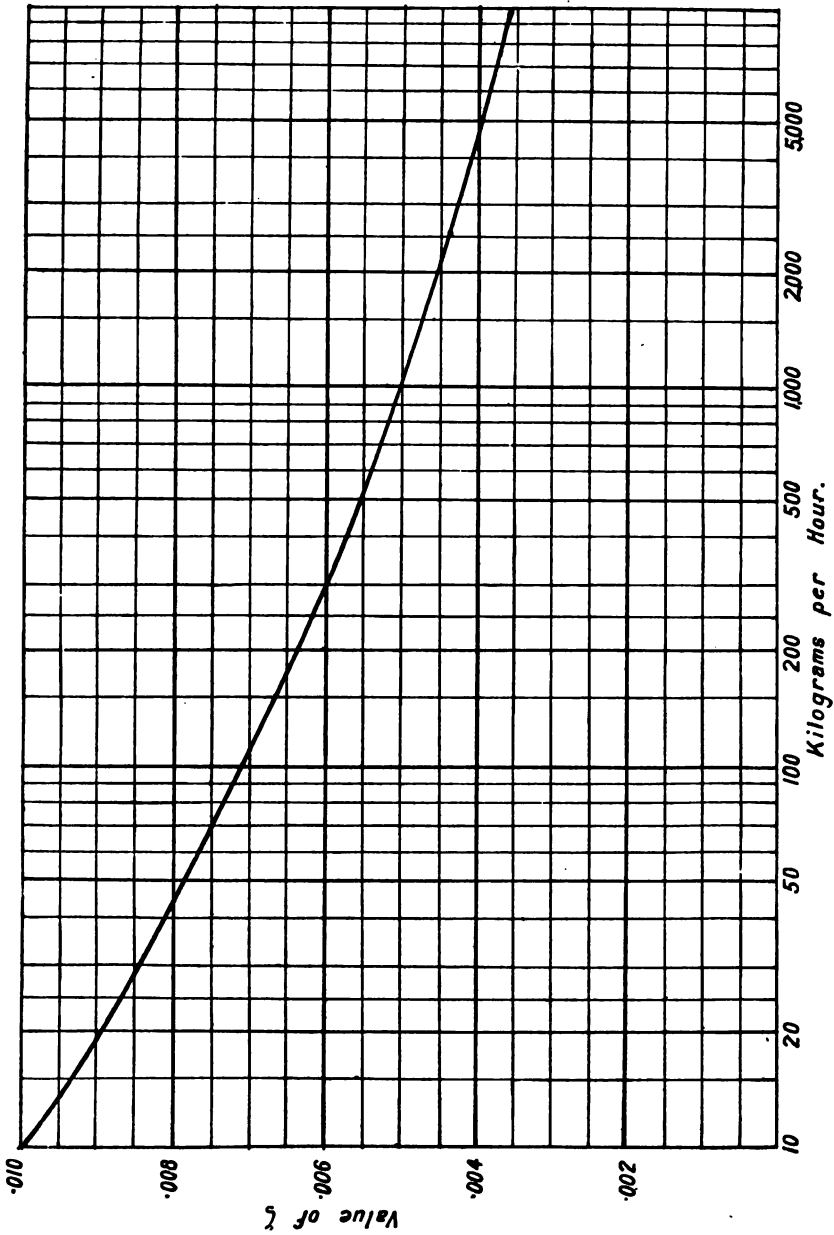

FIG. 22.—Coefficient of friction,  $\zeta$ , depending upon quantity. Given by Hütte.



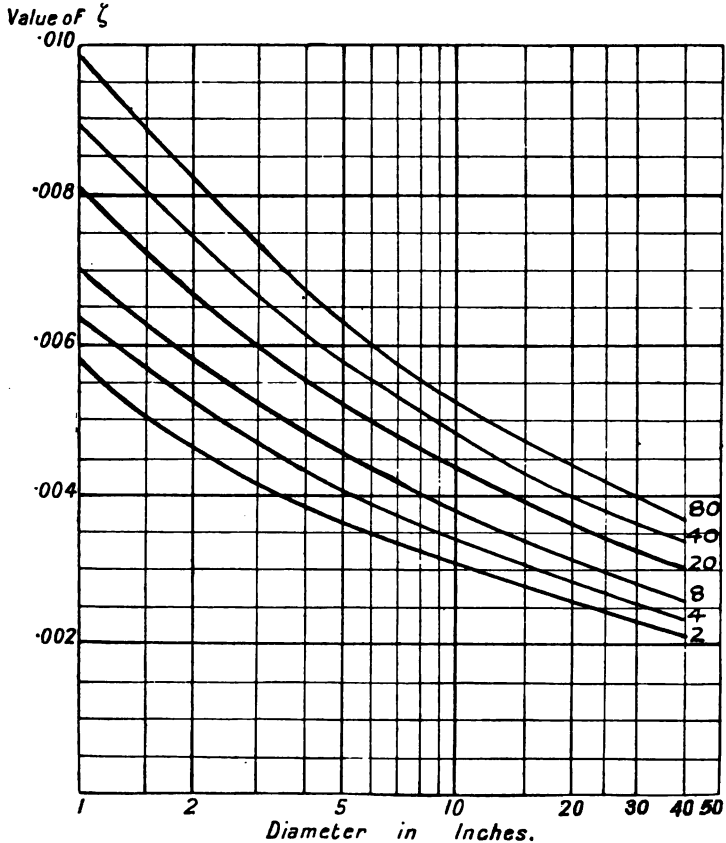

FIG. 23.—Coefficient of friction,  $\zeta$ , depending on  $\frac{T}{\rho u}$ , or  $\frac{144S}{MC}$ , and on diameter. Given by Fritzsche. The numbers against the curves are values of  $T/(\rho u)$  in metric units. When using English units, viz.  $T$  absolute Fahrenheit,  $p$  lb/in<sup>2</sup>,  $u$  ft/sec, multiply the value of  $T/(\rho u)$  by 26 to bring to the metric value.

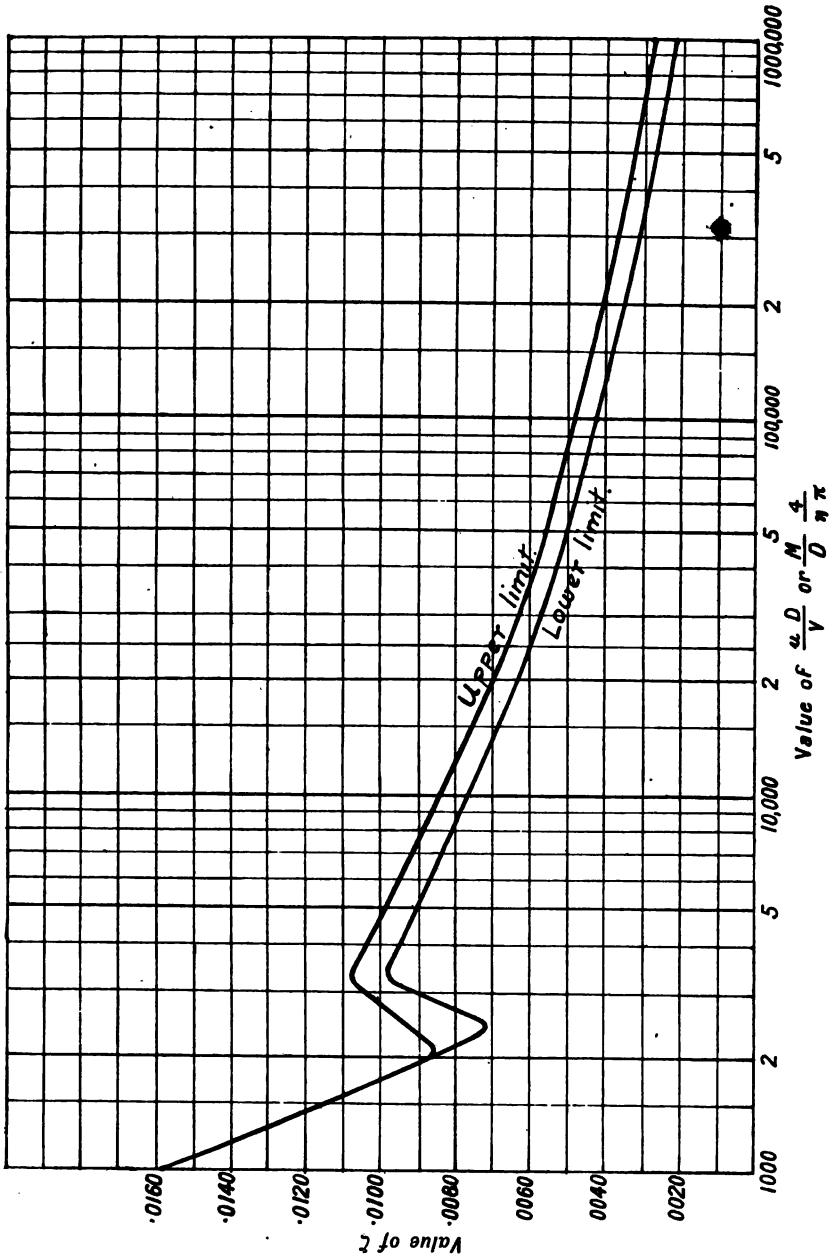

FIG. 2'4.—Coefficient of friction depending on  $\frac{uD}{\nu}$  or  $\frac{M}{D} \frac{4}{\pi}$ . Given by Stanton. For converting ordinary units in gas, air, and steam work to  $\frac{uD}{\nu}$  in C.G.S. units, see p. 55.

### C. Discussion upon various authors' formulæ.

Harding (*Amer. Soc. Heat. and Vent. Engr.*, 19/219/1913),<sup>1</sup> in calculating the sizes of ducts in ventilating systems, gives,

$$\frac{P_1 - P_2}{m} = H = \frac{\zeta u^2 LY}{2gS} = \frac{u^2 \zeta L}{2g\mu} \quad (2\cdot21)$$

Y is the perimeter, S the section. In his tests the velocity varied from 25 to 42 f.p.s. Eq. 2·21 gives  $\zeta = \cdot0037$  for smooth sheet steel ducts 12 in. to 48 in. in diameter; he suggests that 25 per cent. should be added in practice to allow for bad alignment and roughness.

Carpenter (*Heat. and Vent.*, p. 140), from experiments made with steam flow, found that

$$\zeta = (\cdot00223 \sim \cdot00260)(1 + \cdot3/D) \quad (2\cdot22)$$

and also stated that Arson had given friction as,

$$\zeta = (\cdot0050)(1 + \cdot3/D) \quad (2\cdot23)$$

This gives too big a value for  $\zeta$ : it is possible that the factor including D has been added to  $\cdot0050$  in error.

Innes (*Fan*, p. 5) says that Long gives  $\zeta = \cdot0060$  for ventilating ducts. Hausbrand (*Condensing Apparatus*, p. 161) quotes Schmidt's formula,

$$h = \frac{785u^2mL}{10^{10}D} \left(5 + \frac{1}{D}\right) \text{ (metric units).} \quad (2\cdot24)$$

The formula is supposed to hold for tubes 150 to 200 mm (6 in. to 8 in. in diameter, and gives  $\zeta = \cdot00193(1 + \cdot656/D)$ , D being in feet. See also Eq. 2·77.

Grierson (*Modern Methods of Ventilation*, p. 37) gives for the flow of air in galvanised iron ducts (English units),

$$h = 1\cdot73(\cdot00012) \frac{u^2(\pi DL)}{144} \left(\frac{4}{\pi D^2}\right) \quad (2\cdot25)$$

For air ducts of brick and plaster,  $\cdot00022$  replaces  $\cdot00012$ ;  $\zeta$  becomes  $\cdot00630$  and  $\cdot01150$  respectively.

Kempe (*Year Book*, p. 1575) gives the formula for the loss of pressure in ventilating ducts as,

$$h = \frac{u^2 L}{14450d}, \text{ giving } \zeta = \cdot00645 \quad (2\cdot26)$$

Rietschel (*Gesundheits Ingr.*, 28/315/1905), in making tests upon air flow in ventilation channels, found a formula for the coefficient of friction for tubes 32 to 370 mm in diameter, in metric units,

$$\zeta = \cdot00309 + \frac{\cdot00209}{u} + \frac{\cdot000337}{Y} + \frac{\cdot000878}{uY} \quad (2\cdot27)$$

<sup>1</sup> The reference 19/219/1913 stands for vol. 19, p. 219, year 1913.

This can be put in the form with  $D$  and  $u$  for round pipes,

$$\zeta = .00309 + \frac{.00209}{u} + \frac{.000107}{D} + \frac{.00028}{uD} \quad (2.27a)$$

Barker (*Heat. and Vent.*, p. 89) quotes this work of Rietschel, and also mentions a formula for the friction in rough chimneys about 20 in. in circumference,

$$\zeta = .0065 + \frac{.0604}{2.54Y - 48} \quad (2.28)$$

Eq. 2.27 and 2.28 are given by Brabbée (*Z.V.D.I.*, 60/441, etc./1916).

Values of  $\zeta$  as calculated from Eq. 2.27a are given in fig. 8a of Barker's book. The interesting point is that the coefficient decreases as the velocity increases. This is due to the fact that this coefficient is associated with  $u^2$ . Fritzsche, Meier, and others have found that the loss of pressure varies at a less rate, viz.  $u^{1.852}$ ,  $u^{1.9}$  instead of  $u^{2.0}$ ; the factors  $u^{-1.48}$ ,  $u^{-1.00}$  are partly allowed for then by the terms in which  $u$  is in the denominator. The variations in  $\zeta$  (using Eq. 2.27a) are only large when the value of  $u$  is low; thus  $\zeta$  varies from .0040 to .0035 while the velocity varies from 10 to 50 ft/sec. Barker's derivation of the equation for loss of pressure in pipes follows that of Harris, but is hardly so clearly expressed; Barker's constant is merely  $\zeta$ .

Kinealy (*Mech. Engr.*, 16/302/1905) states that the loss of pressure for air at atmospheric pressure flowing in pipes is,

$$F(\text{oz/in}^2) = \left(\frac{60u}{5200}\right)^2 \cdot \frac{3L}{12D} \quad (2.29)$$

Then, if  $m_0 = .0764$ ,  $\zeta = .00633$ .

Working from this equation, he gets,

$$\text{for round pipes, } 60Q = 60M/m_0 = 5.15(dF/L)^{\frac{1}{2}} \quad (2.29a)$$

$$\text{for square pipes, } 60Q = \quad ,, \quad = 6.54(dF/L)^{\frac{1}{2}} \quad (2.29b)$$

He says that the constant should be reduced to 4.4 and 5.5 respectively to allow for the roughness of pipes in ordinary use; then  $\zeta = .0087$  instead of .00633. .0087 seems unnecessarily high, I think.

Taylor (*Trans. Amer. Nav. Arch. and Mar. Engr.*, 13/9/1905), in describing experiments upon ventilating fans for warships, states that the head of air required to drive air through ducts is,

$$H = (P_1 - P_2)/m_0 = fu^2L\pi D/S \quad (2.30)$$

or 
$$H = \frac{f2g\pi D}{S} \frac{u^2L}{2g}, \text{ then } f = \zeta/(2g) = \beta/4 \quad (2.30a)$$

His tests were made to determine  $f$ —where  $fm_0$  is the force in lb. required to move 1 cu. ft. of air at atmospheric pressure over 1 sq. ft. of surface at a velocity of 1 ft/sec—and showed that  $f$  varied from .000075 to .000103 for pipes 6 in. to 27 in. in diameter; but the value was greatest for the largest pipe, the difference being due to some local variation in the make-up of the pipes. Most of the tests gave  $f$  about .000080, and Taylor says this is a suitable value for pipes more than 6 in. in diameter when well laid.

general use he recommends  $f = .000100$ , making  $\zeta = .00644$ .  $f$  was found to be independent of the velocity. On p. 31 of his paper are given conclusions as to the best sizes of branch pipes and the most suitable angles at which to take these from main pipes in ventilating systems.

Treat (*Trans. Amer. Soc. C.E.*, 34/1019/1912) says that for round galvanised iron pipes the head in inches of water is,

$$h = h''L / (40D) \quad \dots \quad (2'31)$$

where  $h'' =$  velocity inches  $= u^2 / (2g)$  in inches of water.

For smooth, straight pipes the divisor is 60 instead of 40; this gives  $\zeta = .0041$  for smooth pipes,  $\zeta = .00612$  for rough pipes.

Thorkelson (*Air Compression*, p. 48) gives the loss of pressure in square galvanised iron ducts as,

$$16(p_1 - p_2) = \frac{\text{perimeter } u^2 L}{\text{area } 10^5} = \frac{u^2 L}{\mu 10^5} \quad \dots \quad (2'31b)$$

For circular ducts,

$$16(p_1 - p_2) = u^2 L / (25000d), \text{ giving } \zeta = .00633 \quad \dots \quad (2'31c)$$

Eq. 2'31c is given on p. 155 of Sturtevant's *Mechanical Draft*. These formulæ are based on Weisbach's work.

The next batch of formulæ refer to gas flow.

Masse (*Le Gaz*, vol. iii. p. 622) quotes various formulæ for the loss of pressure in mains, but considers that Monnier's are the most convenient for use. He mentions three types of formulæ existing:

- In type 1 the loss of pressure varies as the quantity.
- "    2    "    "    "    "    as  $au + bu^2$ .
- "    3    "    "    "    "    as the (quantity)<sup>2</sup>.

The first type only holds when the motion is not turbulent, that is, when the velocity is less than the critical velocity; the second type is Arson's, whose values of  $a$  and  $b$  are given by Masse:

$$\left. \begin{array}{l} \text{When } d \text{ varies from 50 mm to 500 mm} \\ \text{then } \left\{ \begin{array}{ll} a & \text{, , } .000702 \text{ to } .000125 \\ b & \text{, , } .000593 \text{ to } .000510 \end{array} \right\} \dots \quad (2'32) \end{array} \right.$$

The third type of equation is ordinarily used by engineers, and is,

$$P_1 - P_2 = \frac{(3600Q)^2}{K^2} \frac{L\rho}{D^5} = h \text{ (metric)} \quad \dots \quad (2'33)$$

$$3600Q = K \left[ \frac{D^5 h}{\rho L} \right]^{\frac{1}{2}} = K' \left[ \frac{D^5 h}{L} \right]^{\frac{1}{2}} \quad \dots \quad (2'33a)$$

In the second form, with  $K'$  a value has been inserted for the specific gravity  $\rho$  of the gas: Masse chooses  $\rho = 0.40$ , but it varies, and may be as high as 0.60.

Values of K and K' are found by comparison with the expressions,

$$\text{Cu. metres per sec.} = \left[ \frac{h(\text{in mm})}{L\rho m} \frac{D^5 \pi^2 9 \cdot 81}{\zeta \cdot 32} \right]^{\frac{1}{2}} \quad (2\cdot33b)$$

$$\text{Cu. metres per hour} = 3600 \left[ \frac{3\cdot03hD^5}{1\cdot2\zeta L\rho} \right]^{\frac{1}{2}} \quad (2\cdot33c)$$

If the diameter is expressed in cm,

$$3600Q = \frac{5710}{(10)^5} \left[ \frac{h(D')^5}{\zeta L\rho} \right] = K \left[ \frac{h(D')^5}{L\rho} \right] = K' \left[ \frac{h(D')^5}{L} \right] \quad (2\cdot34)$$

The relations between K, K', ρ, and ζ from Eq. 2·34 are,

$$K' = K/(\rho)^{\frac{1}{2}} = \cdot0571/(\zeta\rho)^{\frac{1}{2}} \quad (2\cdot34a)$$

$$\zeta = \frac{(\cdot0571)^2}{\rho(K')^2} = \left[ \frac{\cdot0571}{K} \right]^{\frac{1}{2}} = \frac{\cdot00327}{\rho(K')^2} \quad (2\cdot34b)$$

If K' = 1·0 and ρ = ·40, then ζ = ·00815  
 ρ = ·50, ,, ζ = ·00653  
 ρ = ·60, ,, ζ = ·00543.

Masse (p. 626) mentions the following values of the constants from which ζ is deduced :—

	K'.	K.	ζ if ρ = ·40.
Girard, for air . . . . .		1·09	·00275
Hawkesley, for gas . . . . .		·087	·00431
The ordinary formula . . . . .		1·045	·00300
Monnier, in 1876 . . . . .	1·09	·69	·00687
Pole . . . . .	1·04	·6659	·00735
Schilling . . . . .	1·123	·7106	·00644
<i>Ingenieur Metallurgistes</i> handbook . . . . .	1·04	·6658	·00735
Cripps ( <i>Flow of Gases</i> ) . . . . .		·7010	·00663
„ (small pipes) . . . . .		·4600	·01540

Grebel's abacus is discussed in *Jour. Gas Lighting*, 114/104/1911. It is said that the formulæ for gas flow in use previously were of the form,

$$3600Q = K'[h(D')^5/L]^{\frac{1}{2}} \quad (2\cdot35)$$

where Girard gave K' = ·845, giving ζ = ·0082, if ρ = ·5  
 Mayniel „ = ·860, „ = ·0079, „  
 Schilling „ = 1·091, „ = ·00532, „  
 Monnier „ = 1·091, „ = ·00532, „  
 King's *Treatise* „ = 1·120, „ = ·00587, „

The writer of the article states that tests on a 3-in. (7·6-cm) gas main 4 miles (6·44 km) long gave K' = 1·00, with m<sub>g</sub> = ·613 kg/m<sup>3</sup>, ρ = ·50, ζ = ·00675.

Thomas (*Jour. Franklin Inst.*, 172/411/1911) mentions the following formulæ for gas flow, starting with Pole's formula of the year 1851, viz.

$$3600Q = 1350 \left[ \frac{hd^5}{\rho L/3} \right]^{\frac{1}{2}}, \text{ giving } \zeta = \cdot 00655 \quad (2\cdot36)$$

Unwin's formula for the flow of gas down inclined mains is,

$$u = 4\cdot 012 [DH/(\zeta L)]^{\frac{1}{2}} \quad (2\cdot37)$$

where 
$$H = \frac{780(P_1 - P_2)m_g}{62\cdot 5m_g} + (z_1 - z_2) \left( 1 - \frac{m_0}{m_g} \right) \quad (2\cdot37a)$$

$z_1$  and  $z_2$  being the heights of the ends of the line above the arbitrary datum level. A fuller discussion on this matter is given in Eq. 5'60, etc.

The Pittsburg formula is,

$$3600Q = 3600M/m_g = 3450[(p_1^2 - p_2^2)d^5/L]^{\frac{1}{2}} \quad (2\cdot38)$$

$m_g$  = density of the gas =  $\cdot 0458$ ,  $\rho = 0\cdot 60$ ,  $\zeta = \cdot 00467$ .

Oliphant's formula is,

$$3600Q = 42E[(p_1^2 - p_2^2)5280/L]^{\frac{1}{2}} \quad (2\cdot39)$$

where  $E = 16\cdot 5$  for a 3-in. pipe,  $E = 2055$  for a 20-in. pipe, then  
 $\rho\zeta = \cdot 00320$  ,, ,,  $\rho\zeta = \cdot 00273$  ,, ,,

if  $\rho = 0\cdot 6$ ,  $\zeta = \cdot 0053$  and  $\cdot 00453$  respectively.

Cox's formula is similar to Oliphant's, but  $\rho = 0\cdot 65$  and the constant is 41·3 (5280)<sup>1/2</sup>, giving  $\zeta = \cdot 0057$ . (2'40a)

Lowe's formula is,

$$\frac{60M}{m_g} = Q = \text{constant} \left[ \frac{(p_1 - p_2)d^5}{Lm_g} \frac{(p_1 + p_0)}{p_0} \right]^{\frac{1}{2}} \quad (2\cdot41)$$

which has to be compared with the standard formula,

$$Q = \frac{60}{m_g} \left[ \frac{(p_1 - p_2)d^5}{L(12)^3\zeta} \frac{\pi^2 2g}{64} \frac{(P_1 + P_2)m_g}{2P_0} \right]^{\frac{1}{2}} \quad (2\cdot41a)$$

The factor  $(P_1 + P_2)m_g/(2P_0)$  = the density = Lowe's  $(p_1 + p_0)m/p_0$ , because Lowe uses  $p_1$  as the gauge pressure, not the absolute pressure. Eq. 2'41a becomes,

$$Q = \frac{4\cdot 55}{\sqrt{\zeta}} \left[ \frac{(p_1 - p_2)}{L} \frac{d^5}{m_g} \right]^{\frac{1}{2}} \quad (2\cdot42)$$

Lowe's constants are 52·7 for 2-in., and 63·2 for 24-in. pipes, giving  $\zeta = \cdot 0074$  and  $\cdot 00518$  respectively.

Hurst (*Arch. Surv. Handbook*, p. 113) gives the expression,

$$Q_{60} = \lambda \left[ \frac{d^5 h}{\rho L/3} \right]^{\frac{1}{2}} \quad (2\cdot43)$$

and says that

$$\begin{aligned} \lambda = 780 & \text{ for branch pipes, } & \zeta = \cdot 01920 \\ \lambda = 1000 & \text{ for main pipes, } & \zeta = \cdot 0117 \\ \lambda = 1350 & \text{ for ideally good pipes, } & \zeta = \cdot 0064. \end{aligned}$$

The last value is given by Pole, by the Chapman Valve Co., and by Geipel and Kilgour (*Elec. Engr. Form.*, p. 294). Hurst's  $\zeta$  for branch pipes seems big unless it is assumed that these are of very small diameter.

Molesworth (*Handbook*, p. 552) gives the same formula with the constant as 1000,  $\zeta = \cdot 0117$ .

Martin (*Engineering*, 63/361/1897) quotes Beardmore's formula,

$$P_1 - P_2 = \frac{M^2 L (144)(3600)}{3192 m d^5}, \text{ giving } \zeta = \cdot 0065 \quad (2'44)$$

Chandler (*Jour. Gas Lighting*, 109/357/1910; and *Eng. Record*, 62/384/1910) gave a paper concerning the flow of gases in small pipes. The discussion which followed was lengthy; both the author and those who criticised the paper seemed to have been surprised that Dr Pole's formula (Eq. 2'36) did not hold for small pipes. The speakers apparently did not realise that the coefficient of friction depends upon the diameter, and, though the variation with diameter may be neglected when pipes of large diameter are being used, yet the alteration of  $\zeta$  with diameter is very great when  $D$  is small. Chandler discussed Pole's formula and found it did not hold for small pipes. He made tests to determine the flow in  $\frac{1}{4}$ -in.,  $\frac{3}{8}$ -in., and  $\frac{1}{2}$ -in. compo. gas pipes; the quantity delivered through lengths from 12 ft. to 59 ft. long at definite heads was measured. The velocities of the gas were very low, viz. 0.25 to 15 ft. per sec. (0.076 to 4.5 metres per sec.): some of these are below the critical velocities for the pipes, which explains why the quantities delivered varied as  $P_1 - P_2$  not  $(P_1 - P_2)^{\frac{1}{2}}$ .

In the discussion one writer suggests that tables concerning gas flow should use yards as the unit of length. This is a backward step, because the English unit of length is the foot, and velocities are measured in feet per second; it is quite easy for an engineer to multiply or divide by three if the records are in yards not feet. Standard units only should be used in formulæ.

Hole (*Distribution of Gas*, p. 14) determines the loss of pressure in pipe lines from Dr Pole's formula, but mentions the later tests of Unwin and others. Newbigging (*Handbook for Gas Engr.*, p. 277) on this same question takes up a peculiar standpoint: he quotes and uses Pole's formula (King's *Treatise*, vol. ii. p. 374), but mentions that the formula is inaccurate in many cases; then he states that "he uses Pole's formula because no theoretical calculations can be accurate under the varying conditions of gas supply." To adopt such a position is unsatisfactory; to use old formulæ based on a few tests in preference to new formulæ based on many tests and on increased knowledge shows a lack of adaptability and energy. Even though no formula will be perfectly accurate, it is best to use the most accurate formula available. Pole's formula holds when the coefficient of friction is  $\cdot 0060$ ; most of the later formulæ take into account the effect of the diameter, and therefore give better results than Pole's formula in most cases. The real dislike to accurate formulæ is based upon the extra work involved in using them, as they are complicated; but there is no reason why tables based on the more accurate formula should not be drawn up, once it has been decided which of the complicated formulæ best suits the conditions.

Hawkesley's formula, as quoted by Molesworth (*Handbook*, p. 554), is,

$$u = 396(hD/L)^{\frac{1}{2}} \quad (2'45)$$



giving  $\zeta = .0070$ , if  $m_0 = .0764$ ; Martin gives the formula as,

$$u = 48 \left[ \frac{(P_1 - P_2)D}{mL} \right]^{\frac{1}{2}}, \quad \zeta = .0070 \quad . \quad . \quad (2'46)$$

The formula which Martin himself recommends (*Engineering*, 63/361/1897) is,

$$p_1 - p_2 = \frac{(60M)^2 L (1 + .3/D)}{7000 m d^5} \quad . \quad . \quad . \quad (2'47)$$

giving  $\zeta = .00295(1 + .3/D)$ ; this formula he chooses after discussing many of the existing ones for gas, air, and steam. He gives charts for finding loss of pressure, quantities, diameters, etc., for various conditions of flow.

Shattuck (*Amer. Gas Journal*, 82/648/1905) quotes a number of formulæ for gas flow and compares them for particular cases; like Martin and others, he failed to make the general comparison of the friction coefficient.

Box (*Treatise on Heat*, p. 116) gives the expression,

$$h = \frac{(60Q)^2 L}{(3.7d)^5 3} \quad . \quad . \quad . \quad (2'48)$$

for the flow of air, gas, or steam. This gives  $\zeta = .000363/m$ , if  $m = .0764$  as for free air,  $\zeta = .00476$ . Why the number 3.7 is associated with  $d$  is not stated.

The next series of references deal with steam flow.

Johnston (*Eng. Mag.*, 48/694/1915) discusses the design of steam-pipe installations, having regard to the loss of pressure in the pipes, to the loss of heat by radiation, the capital cost of the present systems and future extensions. He uses Babcox and Wilcox's formula for steam flow,

$$p_1 - p_2 = .000131(1 + .3/D) \frac{(60M)^2 L}{m d^5} \quad . \quad . \quad . \quad (2'49)$$

and draws up charts for the loss of pressure in pipes on that basis :

$$\zeta = .0027(1 + .3/D).$$

Verner (*Amer. Soc. Heat. and Vent. Engr.*, 20/151/1914) deals with the question of steam heating systems and gives an equation,

$$p_1 - p_2 = \frac{.00987L(3600M)^2}{(10d)^5 m} \text{ (Eng. units)} \quad . \quad . \quad (2'49a)$$

giving  $\zeta = .0074$ .

Thies (*Power*, 46/824/1917) gives charts for steam flow in pipes 2½ in. to 16 in. diameter at pressures 50 to 250 lb/in<sup>2</sup> gauge. He gives no hint as to how they are drawn up, and it is not clear to which of the lines the numbers against the scales refer.

Raynes (*Heating Systems*, p. 269) gives a formula for the quantity of heat which can be transmitted by steam in various sizes of pipes; it includes the latent heat of steam. By dividing by this term we get,

$$3600M = c_2 [16(p_1 - p_2)d^2 m/L]^{\frac{1}{2}}, \quad \zeta = 4660/c_2^2 \quad . \quad . \quad (2'50)$$

Raynes'  $\zeta$  is given in fig. 2'1; as these values include the resistance of bends and fittings, they are greater than most of the values for straight pipes.

Eberle (*Z.V.D.I.*, 52/664/1908) gives the formula for steam flow,

$$P_1 - P_2 = \frac{10.5}{10^8} \cdot \frac{\mu u^2 L}{D} \quad (2.51)$$

The value of the constant which he gives as 10.5 varied between 10.0 and 11.0; 10.5 gives  $\zeta = .00515$ . In *Eng. Dig.*, 5/164/1909, the formula is quoted in English units incorrectly as,

$$p_1 - p_2 = \frac{222.2}{10^8} \frac{\mu u^2 L}{D^2}, \quad \zeta = \frac{.00515}{D} \quad (2.51a)$$

The term  $D^2$  is incorrect, and should be  $D$ ; the formula holds for steam flow in pipes 50 mm (2 in.) to 300 mm (6 in.) in diameter, with velocities 7 to 74 m/sec (23 to 243 ft/sec), when the steam is saturated or superheated up to 100° C. superheat.

Geipel's formula (*Elec. Engr. Form.*, p. 513) for steam flow, which is also used by Booth (*Steam Pipes*, p. 16), is,

$$3600M = 3000[(p_1 - p_2)d^5 m/L]^{\frac{1}{2}}, \quad \text{giving } \zeta = .0083 \quad (2.52)$$

The next batch of formulæ refer to compressed-air flow.

Unwin (*Hydraulics*, p. 225; and *Trans. Gas Engr.*, —/184/1904) gives

$$\zeta = .0044[1 + 1/(7D)] \quad (2.53)$$

as a result of tests made on gas mains. From Riedler's tests made on air mains in Paris 11½ in. in diameter and up to 10 miles in length, he had previously deduced the expression,

$$\zeta = .0027(1 + .3/D) \quad (2.54)$$

This is given in *Proc. Inst. C.E.*, 63/348/1880, and on p. 230 of Unwin's *Hydraulics*. Riedler's tests on the gas mains of Paris are reported fully in *Development and Transmission of Power*, p. 218. Eq. 2.54 is the formula called Unwin's by various authorities, and is very commonly used. Low (*Pocket-book*, p. 698) uses it with Martin's value of the constant—i.e. .00295—in quoting compressed-air formulæ. Batcheller says that  $\zeta = .00435$  for the 6½-in. air mains of New York.

Hiscox (*Compressed Air*, p. 216) mentions tests made in the Mont Cenis Tunnel which gave as a result  $h = .0078u^2 L/D$ ; but the units are not stated, and the value of  $\zeta$  has not been deduced. He gives tables for use with air at 80 lb/in<sup>2</sup> pressure based on Cox's formula,

$$\text{Cu. ft. delivered at } p_2 = c[(p_1 - p_2)D^5/(m_1 L)]^{\frac{1}{2}} \quad (2.55)$$

Kempe (*Engr. Year Book*, p. 782) gives the ratio of initial to final pressure, from which one can deduce,

$$P_1^2 - P_2^2 = \frac{u_1^2 L P_1^2}{D(74.3)(10)^6}, \quad \text{giving } \zeta = .0030 \quad (2.56)$$

Rix (*Eng. Dig.*, 3/305/1908), in a paper dealing with compressing machinery and calculations for air at 100 lb/in<sup>2</sup> pressure, determines the loss of pressure from the Johnson formula,

$$p_1^2 - p_2^2 = .0006(60M/m_0)^2 L/d^5, \text{ giving } \zeta = .00555 \quad (2.57)$$

Kent (*Eng. Dig.*, 7/220/1910) says the constant should be .0005, which makes  $\zeta = .0046$ . For gas, Rix gives the same formula, but with the constant .0005 $\rho$ , giving  $\zeta = .0046$ .

Laschinger (*Eng. Dig.*, 3/489/1908) deals with the work of air compressors and tools in the Rand mines, and gives,

$$M = \left[ \frac{\pi^2 g D^5 (P_1^2 - P_2^2)}{16 Z C T L} \right]^{\frac{1}{2}} = (.0881) \left[ \frac{(p_1^2 - p_2^2) d^5}{T L \zeta} \right]^{\frac{1}{2}} \quad (2.58)$$

The coefficient Z contains the hydraulic mean depth factor and = 4 $\zeta$ ; he gives  $\zeta = .00125 + .00217/D^{\frac{1}{2}}$ , values of which are given in fig. 27. For air work on the Rand, where the temperature is about 80° F., he gives constants for use with the formula,

$$\text{Lb/min} = (60M) = \text{const.} [(p_1 - p_2)^{\frac{1}{2}} (p_1 + p_2)]^{\frac{1}{2}} \quad (2.59)$$

where  $p_1 - p_2$  is the loss of pressure per 1000 ft.

It is stated in *Ind. Eng. and Eng. Dig.*, 7/220/1910, that Church, in *Mechanics of Engineering*, develops a formula for the flow in pneumatic tubes, on the assumption of uniform decrease of density and isothermal expansion, as,

$$P_1^2 - P_2^2 = \frac{(32)4\zeta M^2 L P_1}{2g\pi^2 D^5 m_1} \quad (2.60)$$

This is Eq. 2'04: Church says  $\zeta = .0040$  to .0050.

Johnson (*Amer. Mach.*, 22/686/1899) endeavours to find an equation to allow for the variation of density in air flowing down long pipes. He says it is reasonable to assume that the friction varies with the square of the quantity, and depends on some function of the diameter, and thus puts,

$$dp = \text{const. } Q^2 m^n dL/d^5 \quad (2.61)$$

$n$  is to be found by experiment. In reading the article, one might think Johnson has found a new formula, but he takes  $n=1$ , and then gets the standard form,

$$p_1^2 - p_2^2 = .0006(60Mv_0)^2 L/d^5 \quad (2.61a)$$

giving  $\zeta = .0055$ .

Ledoux (*Annales des Mines*, 2/595/1892) gives the formula,

$$P_2^2 = P_1^2 \left( 1 - .0001012 \frac{Q_1^2 T L}{T_1^2 D^5} \right), \text{ giving } \zeta = .0045 \quad (2.62)$$

Richards (*Compressed Air*, p. 112) gives a formula for the flow of air at 75 lb/in<sup>2</sup>, and states that the formula is only approximate; yet in his tables  $p_1 - p_2$  is given to 1 in 10,000, e.g. 20.412 lb/in<sup>2</sup> and so on. His formula is,

$$P_1^2 - P_2^2 = \frac{M^2 L}{m D^5} \frac{2}{4800c} \quad (2.63)$$

Values of  $c$  are given in a table; he uses Unwin's  $\zeta$ .

Harris (*Compressed Air*, p. 33; and *Eng. Record*, 62/653/1910) deduces his own formula, assuming that the force necessary to move air at atmospheric pressure over each sq. ft. of surface at the rate of 1 ft/sec is  $k$  lb.  $k$  he finds by experiment. The friction on the surface of a pipe per sq. ft. is  $ku^2x$ , where  $x=p/p_0$ , making the total pipe friction  $\pi DL(ku^2x)$ , and the work done on friction  $\pi DLku^2x$ : this must equal the work done by the air, which is,

$$(P_1 - P_2)Su = (P_1 - P_2)\pi D^2u/4 = \pi DLku^2x \quad (2'64)$$

$$\therefore (P_1 - P_2) = 4Lku^2x/D \quad (2'64a)$$

$$k = m_0\zeta/(2g) = m_0f \quad (2'64b)$$

where  $f$  is Taylor's coefficient; see Eq. 2'30a. We also have,

$$P_1 - P_2 = cM^2Lm_0/(D^5m) \quad (2'64c)$$

Values of the coefficient  $c$  are given by Harris:  $c = .0866 - .040D$ ;  $\zeta = .0755c = .00655 - .00302D$ ; this seems to give rather a low value to  $\zeta$ . Harris' tests covered the ranges  $d$  from  $\frac{1}{2}$  in. to 12 in., and  $u$  from 5 to 100 ft/sec.

Cox (*Compressed Air*, 2/358/1898 and 3/1/1898) deals with compressed-air flow and uses the ordinary hydraulic formula with Unwin's or Darcy's coefficient of friction; he finds the drop of pressure on the assumption that the drop is negligible as compared with the absolute pressure, and that the density of the air is constant. Hiscox in his book follows Cox precisely.

Brown (*Amer. Mach.*, 39/55/1913) gives a chart for finding quantities, loss of pressure, diameter of pipes for compressed-air flow in pipe lines. The ordinary formulæ of Unwin and Church, including Unwin's value of  $\zeta$ , are used. The method of plotting the chart on logarithmic paper is explained in Eq. 2'90, etc.

The Western Electric Company, in describing their pneumatic ticket distributor—which is a tube system in which paper tickets are transmitted along tubes by means of an air current,—state that the pressure required to get a ticket speed of 35 ft/sec (10.7 m/sec) in rectangular tubes 2.75 in. by 0.375 in. (70 mm by 9.5 mm) is,

$$\text{Hg}'' \text{ (inches of mercury)} = 0.01L + 0.10 \quad (2'65)$$

The velocity of the air is not stated, but it will be slightly greater than 35 ft/sec, on account of the slip past the tickets.  $0.10''$  is the pressure required to create the velocity, but it corresponds to a velocity of only 30 ft/sec. The other portion of the equation is for the friction and can be compared with Eq. 2'09, and gives  $\zeta = 0.0600$ , if the velocity is taken as 40 ft/sec (12.2 m/sec).  $\mu = 0.165$  for this tube; a pipe 0.66 in. diameter gives the same value of  $\mu$ , and gives a coefficient of friction 0.0175 by Unwin's formula. The Western Electric Company quotes Eq. 2'09c for velocity, and Thorkelson's Eq. 2'31c for the loss of pressure in exhaust pipes.

My own experiments on brass pneumatic tube  $2\frac{1}{4}$  in. in diameter gave,

$$h = 10.7 \frac{L}{100} \left( \frac{Q}{100} \right)^2 \quad (2'65a)$$

$L$  varied from 200 to 400 ft. (60 to 120 metres), and included a large

proportion of bends. If we assume that the effect of the bent tube was to increase the loss of pressure by 7 per cent., the equation for straight tube becomes,

$$h = \frac{L}{10} \left( \frac{Q}{100} \right)^2, \text{ giving } \zeta = \cdot 00575 \quad . \quad . \quad (2'65b)$$

**D. Formulæ with fractional indices.**

Now we come to the formulæ in which the factors are given with fractional indices ; this arises because the value of the coefficient of friction  $\zeta$  depends not only upon D but also on  $m$  and  $u$ . In the previous formulæ  $\zeta$  is a coefficient which is different for each diameter of pipe ; in these formulæ a constant is used which is independent of all the quantities.

Innes (*The Fan*, p. 92) quotes a formula for air flow which seems to be based on Pelzer's (Eq. 2'70a), though the values of the indices are slightly altered ; the formula is,

$$dP = (\text{const.}) u^2 m^{2/3} / D^{1\cdot375} \quad . \quad . \quad . \quad (2'66)$$

Innes does not give the value of the constant.

Saunders (*Compressed Air*, p. 282) quotes Petit's formula for the loss of pressure in pipes of greater diameter than 13 in., but the units are not stated ; if they are metric units, we get,

$$h = \frac{\cdot 000765 L m u^{1\cdot916}}{D^{1\cdot506}}, \quad \zeta = \frac{\cdot 00386}{D^{.506} u^{.081}} \quad . \quad . \quad (2'67)$$

Church (*Mechanics*, p. 788) quotes Weisbach's value of the coefficient of friction as  $\zeta = \cdot 0060$  for a 1-in. pipe ; but also says that for high velocities, when  $u$  exceeds 80 ft/sec,

$$u = \cdot 0542 / (u)^{\frac{1}{2}} \quad . \quad . \quad . \quad (2'67a)$$

Lorenz (*Z.V.D.I.*, 36/628/1892) deduces a formula for air flow from the results of Stockalper's, Riedler's, and Gutermuth's tests, and confirms it by experiments of his own carried out at Offenbach, as mentioned on p. 835 of the same volume. The equation is,

$$\frac{dp}{\text{mean pressure}} = \beta \frac{T_0 L u^2}{T} \quad . \quad . \quad . \quad (2'68)$$

L is in kilometres ;  $\beta$  includes three factors,  $1/D$ ,  $\zeta$ , and a constant. According to Lorenz, when L is in metres,

$$\beta = \cdot 52 / d^{1\cdot309} = \cdot 000292 / D^{1\cdot309} \quad . \quad . \quad . \quad (2'68a)$$

The formula converted to English units gives,

$$\frac{2(P_1 - P_2)}{P_1 + P_2} = \frac{\beta T_0 L u^2}{T 35400}, \text{ but } \frac{P}{T} = C m = \frac{P_1 + P_2}{2T}$$

$$P_1 - P_2 = \beta C m T_0 L u^2 / (35400) \quad . \quad . \quad . \quad (2'68b)$$

$$\frac{\beta C T_0}{35400} = \frac{2\zeta}{gD} = \frac{\cdot 000292}{D^{1\cdot309}} \cdot \frac{27700}{35400}$$

$$\zeta = 12\cdot6 D \beta = \cdot 00368 / D^{.309} \quad . \quad . \quad . \quad (2'68c)$$

Saph and Schroder (*Trans. Amer. Soc. C.E.*, 51/252/1903) describe experiments on the flow of water in small pipes at low velocities from  $\frac{1}{2}$  to 12 ft/sec (0.15 to 3.6 m/sec). They made tests to ascertain if the equation of flow could be put in the form,  $H=(\text{const.})u^n$ , where  $n$  was not 2.0. The experiments were made with very smooth brass tube and ordinary galvanised iron pipes. The authors plotted the results of previous experiments on log paper, and were thus able to determine the limits of the variations in the variable values given to  $n$ .

In the case of brass tube the authors found  $n=1.75$ ; for galvanised iron pipes  $n$  varied between 1.82 and 1.95; and for rubber hose pipe  $n$  varied from 1.78 to 1.91. They then drew up the following equations from all previous tests:—

For water flow in smooth pipes under ideal conditions,

$$H = .000296u^{1.75}(.93 - 1.07)/D^{1.25} \quad (2'69)$$

For water flow in very rough pipes,

$$H = .000687u^{1.82-1.99}/D^{1.25} \quad (2'69a)$$

For water flow in ordinary moderately smooth pipes,

$$H = (.000296 \text{ to } .000469)u^{1.74-2.0}/D^{1.25} \quad (2'69b)$$

The refinement in values, 296, 1.99, 469, seems unnecessary, considering the range of variation existing. Variations in the temperature of the water affected the resistance slightly.

Archer (*Trans. Amer. Soc. C.E.*, 76/1016/1913) mentions Hazen's formula,

$$(\text{Ft. of water})^{.54} = \frac{uL}{1.32(135-145)\mu^{.63}}$$

which gives

$$\frac{P_1 - P_2}{m} = \frac{u^{1.85}(5.03)L}{(25400-33400)D^{1.185}}$$

giving

$$\zeta = \frac{.0032-.00243}{u^{.15}D^{.165}} \quad (2'69c)$$

Carothers (*Proc. Roy. Soc.*, 87A/154/1912) describes tests on the flow of oil in pipes from 2 in. to 10 in. in diameter; he found that the flow could be expressed approximately by the equation,

$$H = (\text{const.}) \frac{v^{.75}u^{1.5}L}{D^{1.20}} = (\text{const.}) \left(\frac{v}{uD}\right)^{.75} \frac{u^2 \cdot 25L}{D^{.45}} \quad (2'69d)$$

Unfortunately, he does not state what his symbols mean; he refers to Prof. Orr's paper on this subject in *Proc. Roy. Irish Acad.*, 27/—/1907.

Brabbée (*Zeit. Öster. Ingr. u. Arch. Ver.*, 57/453/1905) describes tests carried out on air flow in pipes 300 mm (1 ft.) to 800 mm (2½ ft.) in diameter and 300 to 600 metres long. He found that the ratio of the maximum velocity at the centre to the mean velocity was constant and independent of the velocity and size of pipe. Velocities were measured by means of a special anemometer. The coefficient of friction was constant for 500, 700,

800-mm pipes, the value being  $0.0175 = 4\zeta$ , when the velocities varied from 4 m (13 ft.) to 17 m (55 ft.) per second. For a 300-mm pipe the value was  $0.035$  ( $\zeta = 0.0087$ ); for the larger pipes, when the air was saturated with oil, the value was reduced to  $0.0132$ ; these suit the expression for the loss of pressure,

$$h \text{ (mm water)} = ZmLu^2 / (2gD) \quad \dots \quad (2.70)$$

We get  $\zeta = 0.0033$  and  $0.0044$  respectively for the above pipes.

Brabbée mentions Pelzer's formula, and says it is quite good, viz.

$$h = 0.00748m^{2/3}u^2L/D^{1.373} \quad \dots \quad (2.70a)$$

Putting this into the form comparable with previous ones,

$$h = P_1 - P_2 = \frac{748(19.62)mu^2L}{10^6m^{1/3}D^{.373}2gD} \quad \dots \quad (2.70b)$$

Then

$$\zeta = \frac{.187(19.62)}{10^3m^{1/3}D^{.373}} \quad \dots \quad (2.70c)$$

In order to find  $\zeta$  we must choose some value of the density; this we do for air,  $m_0 = 1.200$ , and for gas with  $\rho = .50$ , and then we get for Pelzer's value of  $\zeta$ ,

$$\zeta = .00345/(D)^{.373} \text{ (metric), for air, } m_0^{1/3} = 1.08 \quad \dots \quad (2.70d)$$

$$= .00538/(D)^{.373} \text{ (English)}$$

$$= .00435/D^{.373}, \text{ for gas, } m_g^{1/3} = 0.854 \quad \dots \quad (2.70e)$$

$$= .00680/D^{.373} \text{ (English).}$$

Brabbée (*Z.V.D.I.*, 60/509/1916) deduces from the results of previous experiments on air flow a formula for the loss of pressure in cast-iron and relatively rough pipes, when transmitting air at atmospheric pressure, the density being  $1.20 \text{ kg/m}^3$ ,

$$h \text{ (in mm water)} = 6.61u^{1.924}L/d^{1.281} \quad \dots \quad (2.70f)$$

The previous experiments on smooth brass and copper tubes were not taken into account in making up this equation. It can be compared with Fritzsche's Eq. 2.73,

$$dp = .0864 \left( \frac{p}{T} \right)^{.852} u^{1.852} dL / d^{1.289}$$

$p$  is in atmospheres, so that this, choosing  $T = 291$ , becomes,

$$h = 864(1/291)^{.852}(u^{1.852}/d^{1.289})L \quad \dots \quad (2.70g)$$

The constant becomes 6.85, which compares favourably with Brabbée's constant 6.61.

$$\text{Brabbée's } \zeta = \frac{.027}{d^{.281}u^{.119}} = \frac{.00386}{D^{.281}u^{.119}} \text{ (metric)} \quad \dots \quad (2.70h)$$

$$= \frac{.00234}{D^{.281}m^{.119}} \text{ (English).}$$

Fritzsche (*Z.V.D.I.*, 52/81/1908) mentions previous tests on air flow and describes his tests made on air flow in two pieces of gas tube 64 ft. long,





Fritzsche determines from previous tests that  $A=0.08642$  ; but the value in different tests varied widely.

In these formulæ  $p$  stands for atmospheres or kg per sq. cm.

$$dp = \frac{.0864(p)^{.852}}{d^{1.269} (T)^{.852}} u^{1.852} dL \quad (2.73)$$

$$\frac{dp}{p} = \frac{.0864(T)^{.148} u^2 dL}{d^{.269} (pu)} \frac{dL}{dT} \quad (2.73a)$$

$$\frac{P_1 - P_2}{\text{Mean } P} = \left[ \frac{.0864(T)^{.148}}{d^{.269} (pu)} \right] \frac{u^2 L}{dT} = \Phi \frac{u^2 L}{dT} \quad (2.73b)$$

$$\frac{\text{Loss of pressure}}{\text{Mean pressure}} = \frac{\Phi}{1000} \frac{u^2 L}{DT}, \quad D \text{ in metres} \quad (2.73c)$$

$$P_1 - P_2 = \frac{\Phi c}{1000} \frac{mu^2 L}{D} = \beta \frac{mu^2 L}{D} \quad (2.73d)$$

$$\zeta = \frac{2g}{4} \frac{\Phi C}{1000} = .1435\Phi \quad (2.73e)$$

Fritzsche also gives for superheated steam, where  $C=47.0$ ,

$$dp = \Phi' mu^2 L/d, \quad \text{where } \Phi' = .00315\Phi \quad (2.73f)$$

Fritzsche on p. 90 gives a table of values of  $\Phi$  for various values of  $.0864T^{.148}d^{.269}/(pu)^{.148}$  and for pipes 10 to 1000 mm in diameter ; he says that the values will be correct to within 10 per cent., the uncertainty arising because of the difficulty in determining the constant A. From Fritzsche's table for  $\Phi$  I have found  $\zeta$  as shown in fig. 2.3. The curves are for values of  $T/(pu)$ ,  $p$  (metric) being in atmospheres, (English) being in lb/in<sup>2</sup>; with  $T, p, u$  in English units, multiply the value by 26 to bring it to metric units, and then use the curves in fig. 2.3, which include the metric value. The following table gives those values for certain common velocities and pressures existing in certain types of work:—

VALUE OF  $T/(pu)$  IN METRIC UNITS.

$u, \text{ ft/sec} =$	20	40	60	80	100	
When $p = \frac{1}{2}$	92	46	31	23	18.4	(vacuum)
„ $p = 1$	46	23	15.5	11.5	9.2	(ventilation)
„ $p = 6$	7.7	3.8	2.55	1.9	1.53	(comp. air)

Keeping note of this, and looking at fig. 2.3, we see that for ventilation work, where  $p=1$ , and  $u$  varies from 20 to 100 ft/sec,  $\zeta$  varies from .0050 to .0064 for a 3½-in. pipe, and from .0028 to .0036 for a 30-in. pipe. For compressed air at 6 atmospheres, for a 6-in. pipe, and for these velocities,  $\zeta$  varies from .0035 to .0045. For any particular pipe the coefficient  $\zeta$  varies very appreciably with the various values of  $T/(pu)$ ; for 2¼-in. pneu-

matic tubes, with pressures varying from  $\frac{1}{2}$  to 2 atmospheres,  $\zeta$  varies from .0055 to .0072, which corresponds fairly well to facts.

Hütte (*Ingr. Tasch.*, p. 365) quotes Fritzsche's work and gives,

$$P_1 - P_2 = \beta \mu^2 L / d \text{ (metric)} \quad \dots \quad (2'74)$$

If we have  $\beta'$  with English units,  $\beta' = .000305\beta = 4f$ , where  $f$  is Taylor's coefficient (see Eq. 2'30a). Hütte gives a table of values of  $\beta$ , from which I have calculated  $\beta'$  and  $\zeta$ , but the table is drawn up with reference to quantities flowing, not on the basis of the diameter of pipe, and on the assumption that the diameter is 4 in. or 100 mm; this is a satisfactory basis, as shown in Chapter V.; but values of  $\zeta$  deduced from  $\beta$  cannot be compared with the values based on diameter. Values of  $\zeta$  are plotted to a quantity base in fig. 2'2.

Masse (*Jour. Gas Lighting*, 126/1042/1914) describes the slide-rule devised by Aubery to determine factors in problems of gas transmission. The slide-rule is based on the formula,

$$h = \frac{1.625Q^{1.85}L}{d^{4.92}} \quad \dots \quad (2'75)$$

The units in this I cannot recognise; those used on the rule are cu. metres per hour,  $d$  in mm,  $h$  in mm of water per metre of pipe. The slide-rule is based on the equation,

$$\log (h/L) + 4.92 \log d = \log 1.625 + 1.85 \log Q \quad \dots \quad (2'75a)$$

In English units, if  $Q$  is in cu. metres per second, we get

$$P_1 - P_2 = .0000458 \mu u^{1.85} L / D^{1.22} \quad \dots \quad (2'75b)$$

giving 
$$\zeta = \frac{.000739}{D^{.22} u^{.15}} \quad \dots \quad (2'75c)$$

Something is wrong in this formula.

Kneeland (*Trans. Amer. Soc. Mech. Engr.*, 33/1151/1911) gives figures for the loss of pressure in a 24-in. pipe where the air was flowing at very high velocities to convey coal. These results, when plotted, give,

$$16(p_1 - p_2) = (60u/2500)^{2.25} = .578h \quad \dots \quad (2'75d)$$

Then  $\zeta = .000745u^{.25}$ ,  $u$  being from 60 to 140 ft/sec; the loss of pressure is less than that given by the Sturtevant formula which was used by Kneeland at first.

Grindley and Gibson (*Proc. Roy. Soc.*, 80A/114/1908) tested the flow of air at atmospheric pressure in  $\frac{1}{8}$ -in. lead pipe which was wound 29 times round a drum 1.18 ft. in diameter, giving a test length of 108 ft. The experiments were made to determine air viscosity and the critical velocity. They found

$$dP = \text{const. } u^{1.25} \quad \dots \quad (2'76)$$

independent of the density of the air, but the pressure was approximately atmospheric; the small alteration in density would not affect the resistance. For use with the  $u^2$  law putting  $u^{-.75}$  in  $\zeta$  gives,

$\zeta$ .	cm/sec.	$p$ in inches of mercury.	Unwin's value of $\zeta$ would be ·0805 for a ·125-in. pipe.
·0837	3·12	29·92	
·0529	4·07	37·55	
·0467	6·09	30·58	
·0272	10·90	35·43	
·0194	19·40	32·61	

The same authors (*Engineering*, 94/703/1912; and *Phil. Mag.*, 17/389/1909) give,

$$dp = \cdot 00000125 \frac{p^n - 1 u^n L}{(6 \cdot 6)^n d^{3-n}} \dots \dots \dots (2\cdot76a)$$

and give the value of  $n$  for various diameters as,

$n = 1\cdot83,$	$1\cdot81,$	$1\cdot79,$	$1\cdot78,$	$1\cdot77$
$3 - n = q = 1\cdot17,$	$1\cdot19,$	$1\cdot21,$	$1\cdot22,$	$1\cdot23$
$d = 3,$	$5,$	$7,$	$9,$	$12$ inches.

Meier (*Heat. and Vent.*, p. 100) quotes Stockalper's formula, Eq. 2·24, but deduces Eq. 2·77 after he had plotted the results of other experimenters:

$$P_1 - P_2 = \frac{5\cdot13 Z m u^{1\cdot9} L}{2gD^{1\cdot18}} \dots \dots \dots (2\cdot77)$$

where  $Z = \cdot 00624$ ,  $5\cdot13 = 4^{1\cdot18}$ , so that

$$\zeta = \frac{\cdot 0080}{D^{1\cdot18} u^{1\cdot10}} \dots \dots \dots (2\cdot77a)$$

For pipes of any shape he gives,

$$P_1 - P_2 = \frac{Z' m u^{1\cdot9} L}{2g\mu^{1\cdot18}} \dots \dots \dots (2\cdot77b)$$

where  $Z' = \cdot 032/(4)^{1\cdot18} = \cdot 00624$ .

Meier says Weisbach gives  $\zeta = \cdot 217/u^{.50}$  for very small tubes when the velocity is high.

**E. Viscosity and critical velocities.**

This division deals with (i.) the critical velocity in pipes, (ii.) viscosity, and (iii.) the velocity distribution in pipes; further information on this last point will be found in Chap. IX. All these qualities are related, and deserve study as they help us to know the value of the coefficient of friction  $\zeta$ . It will be shown that the ordinary equation,

$$dP = \text{const. } u^n$$

is only an approximation, which nevertheless is accurate enough for commercial work.

It is difficult to express the thoughts in this division in a consecutive manner, as the various ideas are so intermingled with each other, but the scheme follows these lines:—We consider (a) critical velocity and its determination, (b) viscosity and its determination, (c) the way in which friction in turbulent flow depends upon the  $(uD/\nu)$  factor.

The *critical velocity*,  $u_c$ , is such that with velocities less than  $u_c$  the friction varies approximately as the (velocity)<sup>1.0</sup>, whereas with velocities greater than  $u_c$  the friction varies approximately as (velocity)<sup>2.0</sup>.

Viscosity of a fluid is the force exerted between adjacent layers of the fluid moving at different velocities. Suppose we have an infinite layer of fluid, at a distance  $r$  from an infinite datum plane, and moving at velocity  $u$  parallel to the datum plane, and another parallel infinite layer at a distance  $r+dr$  from the datum plane and moving at a velocity  $u+du$ , then viscosity  $-\eta$ —is defined by the equation,

$$\eta(du/dr) = \text{force per unit area} \quad \dots \quad (2'78)$$

$\eta$  is usually given in dynes-sec. per sq. cm.

The kinematical viscosity is denoted in this book by  $\nu$ , and is the value of  $\eta/m$ ;  $m$  is the density in gm/cm<sup>3</sup>. Stanton uses the term “mechanical viscosity”— $\mu'$ —to represent the equivalent of viscosity in the case of fluids moving with turbulent or non-stream-line flow.

(a) *Critical velocity*.—Reynolds found that the critical velocity for water flowing in small pipes occurred when  $uD/\nu=2500$ .  $u$ =velocity in cm/sec,  $D$ =diam. in cm.

King (*Phil. Mag.*, 31/322/1916) calls the function,  $uD/\nu$ , “Reynolds’ constant”—denoted by  $K$ —when the value of the velocity inserted in  $uD/\nu$  is  $u_c$ , the critical velocity. King gives, on p. 338 of the original article, a list of values of  $K$  which have been found by different experimenters; for air and gases, they range from 2080 to 2500. Now consider some of the methods used to determine the critical velocity. Prof. Osborne Reynolds introduced bands of colouring-matter into the fluid, and noticed at what velocity the single stream of colour broke and mingled with the whole of the fluid. This showed when the stream-line flow became turbulent. As long as the velocity is less than the critical, the quantity of fluid delivered through a pipe is proportional to the difference of pressure at the ends of the pipe: the viscosity can be evaluated if the quantity and the pressures are noted. The equation is,

$$\eta = \frac{\pi D^4 (P_1 - P_2)}{128 QL} \quad \dots \quad (2'78a)$$

when the fluid is delivered through a pipe under pressure at velocities below  $u_c$ ;  $\eta$  is in gm-sec/cm<sup>2</sup> or dyne-sec/cm<sup>2</sup> units, depending in which units  $P_1 - P_2$  is measured.

Barnes and Coker (*Phys. Rev.*, 12/372/1901) determined the point at which stream-line flow gave way to eddying flow by noting temperature effects on a thermometer. If stream-line flow exists, and the walls of the pipe in which the flow occurs are heated, only a very small layer by the walls is affected, and the portion of the fluid in the centre of the pipe is entirely unaffected. A thermometer placed at the centre will remain at the same temperature whether there is heating at the walls or not. But if the flow is eddying the whole mass becomes heated and the thermometer is affected. They used a small mercury-bulb thermometer, and easily saw when the type of flow changed from stream-line to turbulency. The tubes were of glass, and the point of critical velocity was also noted by colouring-matter in the fluid, as used by Reynolds. They also (*Phys. Rev.*, 16/377/1903) carried

out the tests with fluids flowing in metal tubes, to see how the laws as regards critical flow were followed in such cases.

King (*Phil. Mag.*, 31/332/1916) says that the point at which stream-line flow alters to turbulent depends upon the chance of sound vibrations occurring in the gas. His paper deals with the mathematical theories of distribution of velocity in stream-line flow in various channels, and includes a number of references to previous mathematical work. If the flow follows stream-lines the distribution of velocity should be parabolic, and the mean velocity would be just half of the maximum velocity, which is at the centre; such a condition hardly ever exists in commercial work. King also refers to tests on gas flow in capillary tubes.

Kohlrausch (*Ann. der Phys.*, 44/319/1914) reports very complete tests upon air flow at velocities 0-200 cm/sec in tubes 240 cm long, varying from 0.76 to 3.58 cm in diameter. His value of Reynolds' constant was 2080. He found that the resistance or coefficient of friction was independent of  $u$ , and gives conclusions :—

For stream-line flow, when  $u < u_k$ ,

$$u_k = \frac{2080\eta}{mD} \quad \dots \quad (2.78b)$$

$$Q = \frac{\pi D^4 (P_1 - P_2)}{128 \eta L} = Q_p \quad \dots \quad (2.78c)$$

$$u = (P_1 - P_2)(R^2 - r^2)/(4\eta L) \text{ at any point,} \quad \dots \quad (2.78d)$$

For turbulent flow, when  $u > u_k$ ,

$$Q = \frac{k_1 \pi \eta D}{2m} + \frac{k_2 \pi (P_1 - P_2) D^4}{16 \eta L} \quad \dots \quad (2.78e)$$

$$= \frac{3\pi D^4 u_k}{16} + \frac{1}{4} Q_p \quad \dots \quad (2.78f)$$

$\eta$  is in dyne-sec/cm<sup>2</sup> units. The difference of pressure must be in dynes/cm<sup>2</sup>.

$$M = mQ = \frac{k_1 \pi \eta D}{2} + \frac{k_2 \pi m (P_1 - P_2) D^4}{16 \eta L} \quad \dots \quad (2.78g)$$

and again, for the velocity at any point,

$$u = \frac{2\eta(2080)}{mD} \left[ \frac{R^2 - r^2}{R^2} - \frac{4}{K_2} \right] + \frac{K_2 (P_1 - P_2) D^2}{4\eta L} \quad \dots \quad (2.78h)$$

In Kohlrausch's tests,  $k_1 = 780$ ,  $k_2 = 1/(32) = K_2$ .

The above equation for  $M$  does not bear much resemblance to that ordinarily used, viz. Eq. 2.09b.

(b) *Viscosity*.—The usual method of evaluating  $\eta$  is from Eq. 2.78a; other methods have been employed, as mentioned below. We are interested in the value of  $\eta$ , in order that we may find  $\nu$  and then  $uD/\nu$ .

Dowling (*Proc. Roy. Soc. Dub.*, 13/375/1913) measured the air viscosity

by electric methods, and found the critical velocity of air in small glass and copper tubes. He gives

$$K=3030 \text{ for copper tubes, } D=1.90 \text{ cm.}$$

$$K=2720 \text{ for glass tubes, } D=2.03 \text{ cm.}$$

After these tests he measured the force exerted on a tube by air in motion; the tube was hung from a sensitive balance, and the force to balance the air friction was noted;  $\eta$  was found from the equation,  $\text{force}=8\pi\eta UL$ .

Markwell (*Phys. Rev.*, 8/479/1916) tested the viscosity of air by the capillary tube method (using Eq. 2.78a) and found  $\eta=.0001827$  at  $23^\circ \text{ C.}$ , giving  $\eta=.0001713$  at  $0^\circ \text{ C.}$

Harrington (*Phys. Rev.*, 8/738/1916) tested air viscosity by means of a suspended cylinder set in motion by air flow induced by the coaxial rotation of another cylinder round the first one. The value of  $\eta$  at  $23^\circ \text{ C.}$  was  $.00018226$ , correct to within 0.1 per cent.

Gilchrist (*Phys. Rev.*, 1/124/1913) found that the presence of moisture in air had no effect upon its viscosity, which he gives as  $.0001776 \sim .0001780$ . On p. 140 he gives a very complete list of papers concerning viscosity.

Pedersen (*Phys. Rev.*, 25/249/1907) gives a complete bibliography of papers concerning viscosity. In his report he quotes  $\eta$ , for air:

His own tests	.	.	.0001932 at	21.4° Centigrade.	}	(2.78j)
			2246	„ 100.0°		
Lindolt	.	.	1784	„ 15.0°		
Markowski	.	.	1814	„ 16.0°		
Kleint	.	.	1808	„ 14.5°		
Reynolds	.	.	1870	„ 20.7°		

In no reports of tests could I find any mention of the viscosity of coal gas till 1916—in the French table of physical constants:  $\eta=.000135$  at  $11^\circ \text{ C.}$ ; with  $m=.000614$  this gives  $\nu=0.220$ .

Earhart (*Jour. Amer. Soc. M.E.*, 38/888/1916) gives values of the viscosity  $\eta$ , of the specific gravity  $\rho$ , and of the index of adiabatic expansion  $n$ , for ten samples of natural gas; some of these are quoted here, along with the mean values.

	$\rho$ .	$n$ .	$\eta \times 10^6$ .
Air	1.000	1.404	178
	.585	1.209	126
Various samples of gas	.660	..	133
	.682	..	137
	.755	..	135
	.770	1.293	147
Mean of the ten values in the original paper	.690	1.244	135

Houdaille (*Fort. der Physik*, 52/442/1896) gives the viscosity of steam at  $0^\circ \text{ C.}$  as  $.0000975$ ; this value is apparently deduced from the value at  $100^\circ \text{ C.}$ , which latter value is not stated. The *Smithsonian Physical Tables*, p. 136, give values of  $\eta$  for water vapour, which are used in Table 2.5.

The alteration of viscosity due to temperature changes is considerable. Meyer (*Kin. Theory*, p. 219) gives Sutherland's formula as,

$$\frac{\eta}{\eta_0} = \left( \frac{1+aC}{1+C/T} \right) (1+a\theta)^{\frac{1}{2}} \quad \dots \quad (2.78k)$$

For air,  $C=113$ ;  $a$  is the coefficient of expansion of the gas = .00367;  $\theta = T - T_0$ . Meyer (p. 220) then gives for air,  $\eta/\eta_0$ :

$\theta$ .	$\eta/\eta_0$ .	$\theta$ .	$\eta/\eta_0$ .		
0	1.000	0	1.000	giving $\eta =$	.000172
14	1.038	16	1.045	„	.000180
43	1.118	30	1.080	„	.000186
67	1.185	50	1.150	„	.000198
99	1.270	100	1.283	„	.000221

Values of the constant  $C$  for other gases are given in Table 1'2; and of  $\eta$  and  $\nu$  for air depending on temperature in fig. 2'5.

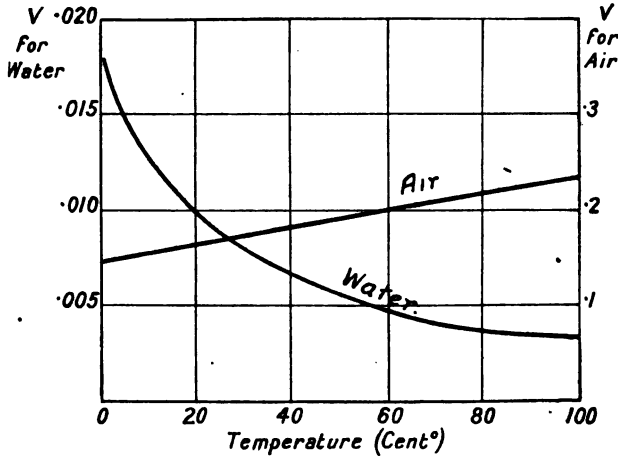

FIG. 2'5.—Variation of kinematical viscosity with temperature.  $\nu = \eta/m$ , in  $\text{cm}^2/\text{sec}^2$ . From Blasius (*Mitt. über Forsch. Ver. Deut. Ingr.*, 131/35/1913).

Weinstein (*Ann. d. Phys.*, 50/601, 796/1916); *Sci. Abs.*, Dec. 1916) investigates the equations giving the variation of viscosity with temperature; the matter is too advanced for inclusion here.

(c) *Turbulent flow*.—Now consider the question of turbulent flow as discussed by Stanton, Reynolds, Pannell, Lees, Lander, Lewis.

Stanton (*Proc. Roy. Soc.*, 85A/366/1911) discusses the question of the apparent viscosity of liquids when the flow is turbulent, in which case the formula (Eq. 2'78a) for finding viscosity when the flow is stream-line does not hold. The tests were made with air in order to determine the "mechanical viscosity"  $\mu'$ , where

$$F = \mu' du/dr \quad \dots \quad (2.79)$$

F is the average stress in dynes/cm<sup>2</sup> on the surface of the circular ring whose radius is *r*, where the velocity is *u*; the maximum velocity is *U<sub>c</sub>* at the centre.

Tests were carried out on two pipes, length 61 cm, diameters 7.35 and 5.08 cm; the interior surface of each pipe was roughened by being cut with double screw-threads of such pitch and depth that the principle of dynamical similarity was maintained. As the pipes were rough, the force of friction varied as *u*<sup>2</sup>, and the amount per unit area was 4.6*u*<sup>2</sup>/(10)<sup>6</sup> dynes, giving ζ = .00755.

Stanton found that the velocity distribution was parabolic, so that

$$u = U_c - Ar^2, \quad du/dr = -2Ar \quad . \quad . \quad . \quad (2.79a)$$

When the velocities at the centre were made proportional to the diameters of the pipes, he found that the velocity distribution was exactly the same in each case, that is, *du/dr* was the same.

The conclusions to which he came are :—

(a) For turbulent flow, the mechanical viscosity μ' is constant across the pipe, except for the region close to the sides where the effect of the boundary is felt.

(b) As  $F \propto U_c^2, \quad F = \mu' du/dr, \quad du/dr \propto U_c \quad . \quad . \quad . \quad (2.79b)$

then

$$\mu' \propto U_c.$$

In similar pipes, when *U<sub>c</sub>/D* was constant, *du/dr* had the same value at points where *r/D* was the same; but as *du/dr* ∝ *U<sub>c</sub>*, μ' must vary as *D*; therefore, for pipes in which the roughness is such that *F* ∝ *u*<sup>2</sup>, and in which it is similar for each pipe,

$$\mu' = (\text{constant})U_c D.$$

In the case of smooth pipes, where *F* varies more nearly as *u*<sup>1.75</sup>, the parabolic law of velocity distribution still held, but only between the limits *r*=0 up to *r*=0.8*R*; for this central region of the pipe the shearing stress per unit area, *F* / rate of change of distortion, *du/dr* was constant as long as *U<sub>c</sub>* was constant, but beyond the central area the value of μ' altered rapidly, until, when *r*=*R* and the boundary was reached, μ' = η, which value holds when the flow is stream-line.

Stanton and Pannell (*Phil. Trans.*, 214A/199/1914) describe tests made to determine what similarity exists in the states of flow of different fluids in pipes. They found that *F/(μ*u*<sup>2</sup>)* was the same for all fluids when *uD/ν* was the same, within the range *uD/ν* from 2500 up to 470,000; *F* is the resistance per unit area of surface of contact between the fluid and the pipe.

Reynolds had found that for geometrically similar pipes  $\frac{mD^3 dP}{\eta^2 dL}$  was a function of  $\frac{uD}{\nu}$ ; now, as  $dP \pi D^2 = 4\pi DF dL$ ,

$$\frac{mD^3 dP}{\eta^2 dL} = \frac{m^2 D^3 u^2 dP D}{\eta^2 dL \mu u^2} = \left(\frac{uD}{\nu}\right)^2 \frac{4F}{\mu u^2} \quad . \quad . \quad . \quad (2.80)$$

One can therefore expect that *F/(μ*u*<sup>2</sup>)* will be a function of *uD/ν* or of



$uDm/\eta$ , which is what Stanton and Pannell proved. Reynolds thought that the function was of the form  $(uD/\nu)^n$ , where  $n=1.0$  when  $u < u_k$ , and  $n=1.75 \sim 2.00$  when  $u > u_k$ , and the roughness of the pipe varied. Stanton and Pannell found that this was not so; their tests covered ranges  $D=0.3$  to 10 cm,  $u=30$  to 6000 cm/sec, and showed how  $F/(mu^2)$  varied with  $uD/\nu$  for rough pipes (see fig. 2'4). The function is independent of the type of fluid used.

The interest of Stanton's work on, and curve for,  $F/mu^2$  lies in the fact that this function is  $\frac{1}{2}\zeta$ ; because,

$$g(P_1 - P_2)\pi D^2/4 = FL\pi D \quad \dots \quad (2'81)$$

The  $g$  is added because  $F$  is in absolute units: also, from Eq. 2'9,

$$(P_1 - P_2) = \frac{mu^2}{2g} \frac{\zeta L}{\mu} = \frac{FL}{g} \frac{4}{D} \quad \dots \quad (2'81a)$$

$$\therefore 2F/mu^2 = \zeta \quad \dots \quad (2'81b)$$

Taylor's coefficient  $f$  in Eq. 2'30a,  $f = \frac{\zeta}{2g} = \frac{F}{mu^2 g}$ , so that  $fg$  should equal  $F/mu^2$ .

In any particular problem in which  $u$ ,  $D$ ,  $\nu$  are known, the value of  $\zeta$  can be found from Stanton's curve, fig. 2'4; but the use of  $u$ ,  $D$  is not convenient, as  $u$  is not usually known; but  $uD/\nu$  can be altered by using,

$$\frac{uD}{\nu} = \frac{muD}{\eta} = \frac{muS}{\eta} \frac{4}{\pi D} = \frac{M}{D} \frac{4}{\eta\pi} = f(M, D) \quad \dots \quad (2'82)$$

Consider the use of this in practical problems: for any given pipe transmitting a known quantity of fluid  $M$ , we are able to find  $\zeta$ ; this value can be compared with the one in Table 2'1 for the same diameter pipe. As  $M/D$  increases, the value of  $\zeta$  does not decrease greatly; this can be seen from fig. 2'4, which is plotted on a long basis. Assuming that the coefficient of friction found from fig. 2'4 is  $\zeta'$  instead of being Unwin's  $\zeta$ , the loss of pressure in the pipe can be determined from fig. 2'9 or 2'10, and can be corrected by multiplying it by  $(\zeta'/\zeta)$ . For ordinary problems we must know the values of the viscosity  $\eta$  or  $\nu$  of gas, air, and steam, before we can use fig. 2'4; reasonable values are given here:—

TABLE 2-5.—APPROXIMATE VALUES OF VISCOSITIES FOR GENERAL USE.

Cent. °	Air.		Natural or coal gas.		Steam.	
	$\eta$	$\nu$	$\eta$	$\nu$	$\eta$	$\nu$
At 0°	·000172	·133	·000131	·146	·0000904	18·50
„ 16	·000180	·147	·000136	·161	·000097	7·07
„ 100	·000221	·235	...	...	·000132	·217

$M$ ,  $m$ ,  $D$ , and  $\nu$  are in C.G.S. units, which are quite unsuitable for use in ordinary problems; so we transform the expression  $\frac{M}{D} \frac{4}{\eta\pi}$  into one using lb., ft., and g-metres. The conversion factors are:

$$K_1 = \frac{1}{\eta} \frac{4}{\pi} \frac{1000}{100} = \frac{12.75}{\eta}, \text{ for metric, kg-metres units} \quad (2.83)$$

$$K_2 = \frac{1}{\eta} \frac{12.75}{2.204} \frac{(3.28)}{1} = \frac{19}{\eta}, \text{ for English, lb.-feet units} \quad (2.83a)$$

Then the function  $\frac{M}{D} \cdot \frac{4}{\eta\pi}$  becomes  $K_1(M/D)$  in practical problems,

M and D being in the ordinary units. Values of  $K_1$  and  $K_2$  for the various conditions are as below :—

TABLE 2.6.—CONSTANTS FOR CONVERTING M/D FUNCTIONS TO C.G.S. UNITS.

Units being	Air.		Natural or coal gas.		Steam.	
	Metric.	Eng.	Metric.	Eng.	Metric.	Eng.
At 0° C., 32° F.	74,000	110,000	97,400	145,000	141,200	210,000
„ 16 „ 60 „	70,900	105,000	93,800	140,000	132,000	196,000
„ 100 „ 212 „	57,600	85,500	...	...	96,600	144,000

Generally M/D in metric units will range from 0.10 to 20.0, so that the function  $K_1(M/D) = 7400-148,000$ , and the log varies from 3.8 to 6.2. Fig. 2.4 gives the values of  $\zeta$  for various values of  $K(M/D)$ ; fig. 2.13 gives graphs for converting quantities of flow into kg or lb/sec.

Lees (*Proc. Roy. Soc.*, 91A/46/1915), in discussing the flow of viscous liquids through circular pipes, mentions that Hagen (*Math. Abh. Berlin. Akad.*, —/17/1854) gives,

$$P_1 - P_2 = fLu^{1.75}/D^{1.25} \quad (2.84)$$

and that Weisbach gives,

$$P_1 - P_2 = (\text{const.})[u^2 + (7/6)u^{1.5}] \quad (2.84a)$$

Reynolds (*Phil. Trans.*, 174/935/1883) has shown that the frictional resistance should be expressed by,

$$f\left(\frac{\eta}{m}\right)^{2-n} \frac{u^n}{D^{3-n}} = \frac{fv^{2-n}u^n}{D^{3-n}} = \frac{fv^2(uD)^n}{D^3\left(\frac{v}{u}\right)^n} \quad (2.84b)$$

where  $f$  and  $n$  are constants. From Darcy's work Reynolds found,

$$\begin{aligned} n &= 1.79 \text{ for glass, } 1.88 \text{ for lead, } 2.0 \text{ for cast-iron pipes.} \\ 3-n &= q = 1.21 \quad \text{,,} \quad 1.12 \quad \text{,,} \quad 1.0 \quad \text{,,} \quad \text{,,} \end{aligned}$$

Unwin found that the friction varied as  $fu^n/D^q$ , with

$$\begin{aligned} n &= 1.72, \quad q = 1.10 \text{ for tinplate pipes.} \\ &= 1.72, \quad = 1.39 \text{ for wrought-iron pipes,} \\ &= 1.95, \quad = 1.16 \text{ for new cast-iron pipes,} \\ &= 2.00, \quad = 1.16 \text{ for old cast-iron pipes.} \end{aligned}$$

Lees says that the velocity distribution in a pipe is the same as long as the function  $uD/\nu$  is the same;  $F/(mu^2)$  will also have the same value for such pipes. From Stanton's curve in fig. 2'4, showing the relation between the functions  $uD/\nu$  and  $F/(mu^2)$ , Lees worked out the equation giving this relation, viz.

$$F/(mu^2) = f(uD/\nu) \quad . \quad . \quad . \quad (2'84c)$$

The function of  $uD/\nu$  is not a simple one, so that  $F$  cannot be expressed as a single power of  $u$ : Lees found the function as,

$$F = m[.0765(\nu/D)^{.35}u^{1.65} + .0009u^2] \quad . \quad . \quad . \quad (2'85)$$

for pipes 0.3 to 12 cm in diameter; all units are C.G.S. As  $\nu$  for air is 0.137 at 15° C., we get for atmospheric air,

$$F = .0000468u^{1.65}/D^{.35} + .00000110u^2 \quad . \quad . \quad . \quad (2'85a)$$

$$P_1 - P_2 = L[.0001872u^{1.65}/D^{1.35} + .00000440u^2/D] \quad . \quad (2'85b)$$

as  $F\pi DL = \pi D^2(P_1 - P_2)/4 \quad . \quad . \quad . \quad (2'85c)$

As  $u$  or  $D$  increases,  $F$  varies more nearly as  $u^2$ , the index of  $u$  being

	1.72	1.77	1.82	1.92
when	$u = 58$	$258$	$900$	$2250$ cm/sec.
or	$u = 1.91$	$8.50$	$29.5$	$74$ ft/sec.

The effect of temperature on  $F$  decreases as  $u$  or  $D$  increases and as  $\nu$  decreases. Finally, the form in which  $F$  should be put is,

$$P_1 - P_2 = \frac{mu^2L}{D} \left[ a + b \left( \frac{\nu}{uD} \right)^n \right] \quad . \quad . \quad . \quad (2'85d)$$

and for bodies in which the principle of dynamical similarity holds,

$$a = 0.0036, \quad b = 0.306, \quad n = 0.35 \quad . \quad . \quad . \quad (2'85e)$$

These are absolute constants, and we have the values in Eq. 2'85d in practice as follows:—

Since	$\frac{\nu}{uD} = \frac{1}{K(M/D)}$
and	$K(M/D)$ varies from 7400–1,480,000
then	$K(M/D)^{.35}$ „ 22.4–142.8
and	$b(\nu/uD)^{.35}$ „ .01368–.002145

Lander (*Proc. Roy. Soc.*, 92A/337/1916) describes similar tests made with steam flowing in iron pipes 1.07 and 3.30 cm in diameter. The maximum value of  $uD/\nu$  was 500,000 C.G.S. units, and the velocities went up to 4000 cm/sec (130 ft/sec). The tests gave the same type of results as Stanton's, viz.

$$\zeta = .0020 + .1410(uD/\nu)^{.44} \quad . \quad . \quad . \quad (2'85f)$$

Lander's value for  $\zeta$  is about .0002 to .0004 greater than Lee's at small and large values of  $\log(uD/\nu)$  respectively.

Lewis (*Jour. Indust. and Eng. Chem.*, 8/627/1916) discusses the flow of oil and such viscous liquids in pipes, and finds the equation of flow to be,

$$p = 1.15\eta + .000114u^{1.85}/D^{1.22} \quad (2'86)$$

$\eta$  is the viscosity in poundals/in<sup>2</sup>. Putting this in a form using  $\eta$  in dynes/cm<sup>2</sup>, as 1 dyne/cm<sup>2</sup> = .000466 poundal/in<sup>2</sup>,

$$p = .000537\eta + .000000533u^{1.85}/D^{1.22} \quad (2'87)$$

$$P = .0773\eta = .0000765u^{1.85}/D^{1.22} \quad (2'88)$$

Lewis states further that for oil flow in pipes up to 2 inches in diameter one may use for approximate purposes a coefficient of friction  $\zeta'$ , where  $\zeta'$  is related to  $\zeta$  for water in similar circumstances, as follows:—

$$\zeta' = \zeta[0.955 + .045(\eta' \text{ for oil})/(n \text{ for water})] \quad (2'89)$$

$\eta$  for water is .00000467 poundals/in<sup>2</sup>; Lewis verified Eq. 2'89 for values of the ratio  $\eta'/\eta$  up to 20.

Dyer (*Jour. Amer. Soc. M.E.*, 36/258/1914) discusses the flow of oil in pipe lines and gives a tentative formula,

$$H = \frac{Q^2L}{327D^5}(0.001075E - 1) \quad (2'89a)$$

where E is the viscosity in seconds, *i.e.* the time taken for a standard quantity to flow out of a standard viscometer. In the cases under consideration E always exceeds 930.

### F. Derivation of graphical charts.

There are three methods of drawing up graphical charts for solving problems in ventilation, compressed-air, or gas work, where the approximate equations 2'09, etc., hold.

The first method is to plot the quantities on arithmetically squared paper, as is done by Martin (*Engineering*, 63/361/1897).

The second is to plot the quantities on logarithmic ruled paper, as described in detail below.

The third method is to plot the quantities on an abacus, as explained in the *Electrician*, 81/339/1918.

In every case some value for the constant part of the coefficient of friction,  $\zeta$ , must be chosen as representing accurately enough the friction in the pipes in question, before the charts can be drawn up. The variations of  $\zeta$  with  $m$ ,  $u$ ,  $d$ , as shown in Table 2'4, are taken into account in drawing up the charts on the third method.

The first type of chart is unsatisfactory because with arithmetically squared paper the accuracy of the curves varies greatly at small and big values owing to the formula including the squared terms of M and  $u$ ; therefore this type is not discussed here, but some graphs illustrating it are shown in fig. 2'6.

The second type of chart, being on log paper, allows the quantities to be represented by straight lines (see fig. 2'8 to 2'11), but there are many lines on the chart, tending to make it confusing.

The third type of chart (see fig. 2'7) is very simple in form, but requires one or two straight lines to be drawn on it when solving problems.

Fig. 2'8, 2'9 are drawn up from Eq. 2'09,

$$\frac{P_1 - P_2}{m} = \frac{4\zeta u^2 L}{2gD} = v(P_1 - P_2) \quad (2'90)$$

$$\begin{aligned} v(h/L)(5.2) &= (4\zeta/2gD)u^2, \text{ Eng.} \\ v/h &= (4\zeta/2gD)u^2, \text{ metric.} \end{aligned} \quad (2'90a)$$

Then

$$\log v + \log (h/L) + \log 5.2 = \log (4\zeta/D) - \log 2g + 2 \log u \quad (2'90b)$$

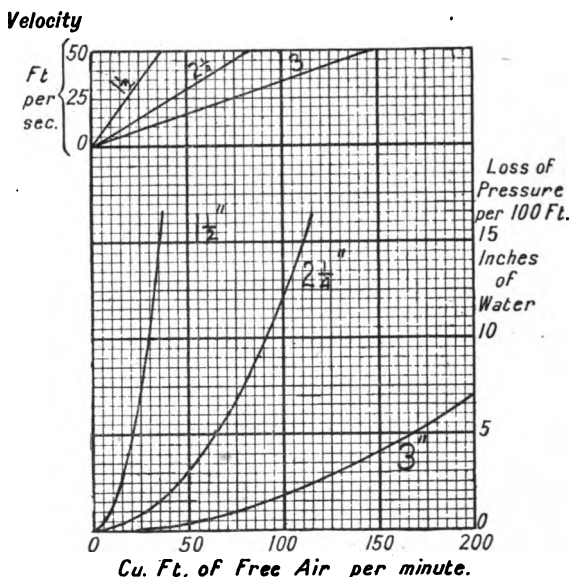

FIG. 2'6.—Loss of pressure and velocities in short brass tubes when various quantities of air are flowing. Unwin's  $\zeta$  has been used.

We take as abscissæ on the log scale values of  $h/L$ ; by adding  $\log 5.2 + \log v$  to the values of  $\log h/L$  we get straight lines representing the left-hand side of Eq. 2'90b for each type of gas required;  $v$  being the specific volume for gas of various densities. Lines are drawn, for coal gas of densities  $\rho = .4$ ,  $\rho = .6$ , for air at atmospheric pressure, and for compressed air at various pressures; these lines associate *loss of pressure* with types of *gas* of various *density*. Similarly, values of  $\log (4\zeta/D) - \log 2g$  are added to  $2 \log u$ , and straight lines representing the right-hand side of Eq. 2'90b for pipes of various diameters are obtained. These lines associate *velocities* with *sizes of pipe*. Given any three factors, we are now able to find the fourth by simple inspection of the chart. Consider the following example.

What is the velocity of air in a ventilating duct 4 in. diameter if the loss of pressure is 0.2 in. of water per 100 ft.? One runs the eye along the "air" line to where  $h/L = 2$ ; then pass horizontally to the 4 in. diameter

line; drop vertically to the bottom scale and read off the velocity, viz. 12.1 ft/sec.

What is the loss of pressure per 100 ft. for an 8-in. gas main when the velocity is 20 ft/sec, the density of the gas being 0.60? Run the eye along

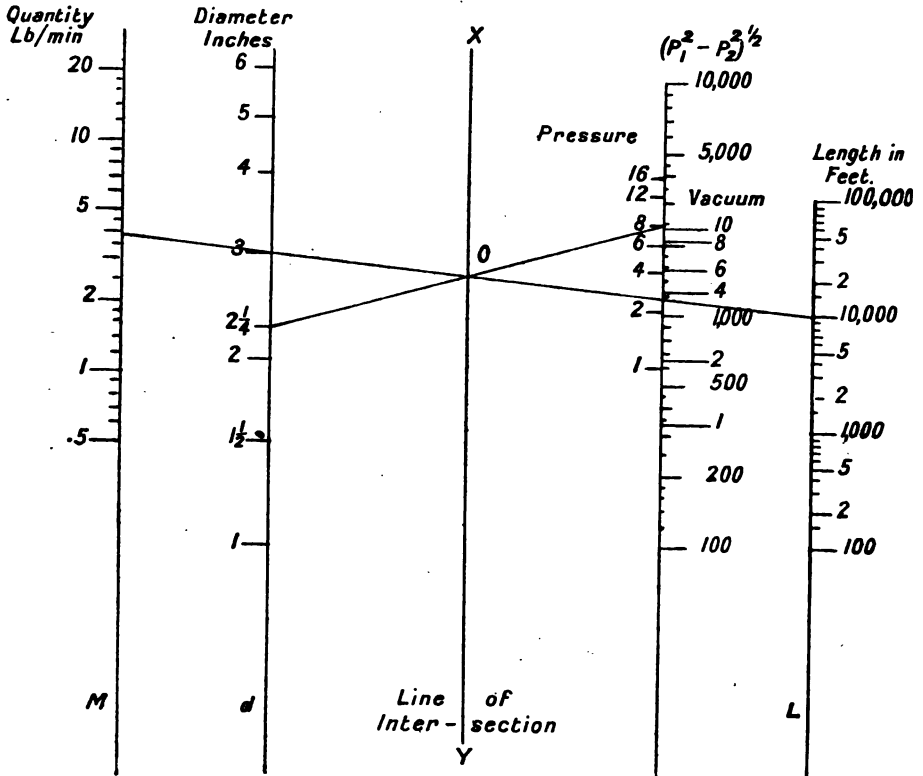

FIG. 27.—Typical abacus, for giving the quantity of flow in pneumatic tubes, 100 to 100,000 ft. long, 1 in. to 6 in. diam., when working at various pressures or vacuum. To find the quantity of air used per minute, join the given diameter to the given pressure, intersecting the XY line at O. Join the given length to O, and produce this line to meet the quantity line; where this cuts the quantity line gives the quantity flowing in lb/min. The figures under pressure and vacuum are gauge pressures in lb/in<sup>2</sup>. The fig. is drawn up from the equation  $(P_1^2 - P_2^2)^{1/2} D^{2.654} = 4.52ML^{1/2}$ . Lorenz's value of friction is used. P is lb/ft<sup>2</sup>, D is diam. in ft., M is quantity in lb/sec, L is length in ft.

an assumed 8-in. line to where  $u=20$  ft/sec, and pass horizontally to the line for gas, 0.6, and read the loss of pressure on the bottom scale, = 0.13 in.

What size of pipe will be necessary if the loss of pressure in a ventilation duct is to be  $\frac{1}{4}$  in. per 500 ft. and the velocity is not to exceed 15 ft/sec? One runs along the dotted line for "air" to the point where  $h/L=0.50$ , and then goes horizontally to where  $u=15$  ft/sec; this point lies about one-third of the way between the 12-in. and 24-in. lines, so a 16-in. pipe would be required.

To draw up fig. 2'10, 2'11 for quantities in kg or lb/sec, we proceed on precisely similar lines, using Eq. 2'09b,

$$M^2 = \frac{(P_1 - P_2)}{L} \frac{2D''}{v} = \frac{(P_1 - P_2)}{Lv} \left( \frac{\pi^2 g D}{64 \zeta} \right)^2 \quad (2'91)$$

putting  $L=100$  and using mm or inches of water,

$$M^2 v = (P_1 - P_2)(2D'') = (h/L)(5.2)2D'' \quad (2'91a)$$

Then,

$$2 \log M - \log 2D'' = \log h + \log 5.2 - \log v \quad (2'91b)$$

Consider one example. What diameter pipe 3 miles long will transmit 50,000 cu. ft. of free air per hour at 100 lb/in<sup>2</sup> at a loss of pressure of 10 lb/in<sup>2</sup>? Lb/sec = 1.061,  $h=277$ ,  $L=15,800$ ,  $h$  per 100 ft. = 0.185. Then on fig. 2'10 run up a line from  $h=0.185$  to a point slightly above the 102 lb/in<sup>2</sup> line, as the mean pressure is 95 lb/in<sup>2</sup>; run horizontally to where  $M=1.061$ ; a 5-in. pipe will do.

We draw lines of greater slope for quantities flowing in pipes of particular diameters, and lines of lesser slope for the loss of pressure for various types of gas. One must remember that in fig. 2'8 to 2'11 the factors associated are:

Quantities }  
or } and diameters of pipes: greater slope lines.  
Velocities }  
Loss of pressure, and types of gas: lesser slope lines.

These figures include Unwin's  $\zeta$ ; if another value  $\zeta'$  is preferable, either redraw the charts with that value of  $\zeta'$ , or use fig. 2'8 to 2'11 and multiply the quantities and velocities by  $(\zeta/\zeta')$ , etc. See Table 2'1.

To use the charts even when  $dP = (\text{const.})^n$  instead of  $(\text{const.})^2$ , we can proceed thus:

$$\begin{aligned} P_1 - P_2 &= ALu^2 \text{ in the first case} \quad \dots \quad (2'92) \\ P_1' - P_2' &= BLu^n \text{ in the second case,} \end{aligned}$$

where  $n$  may have any value between 1.75 and 2.0.

Then, as regards loss of pressure for a fixed velocity  $u$ , the ratio of the true loss to the loss found by the first equation is,

$$\frac{P_1' - P_2'}{P_1 - P_2} = \frac{Bu^n}{Au^2} = \frac{B}{Au^{2-n}} = \frac{B}{A} \frac{1}{f_1(u)} \quad (2'93)$$

Values of  $u^{2-n}$  are given in Table 2'7 below. If, therefore,  $u$  is given and  $A$  and  $B$  are known and assumed equal,  $P_1 - P_2$  may be found from fig. 2'8 or 2'9, and the true  $P_1' - P_2'$  deduced by dividing by the proper factor in Table 2'7.

If  $P_1' - P_2'$  is given and  $u$  is required, use a process of trial and error: find  $u$  from fig. 2'8 or 2'9: find what  $P_1' - P_2'$  would be with the correction factor: find  $u$  again from this new value, and so on until a value of  $u$  is found which gives  $P_1' - P_2'$  when the correction factor is divided into  $P_1 - P_2$ , as found from fig. 2'8.







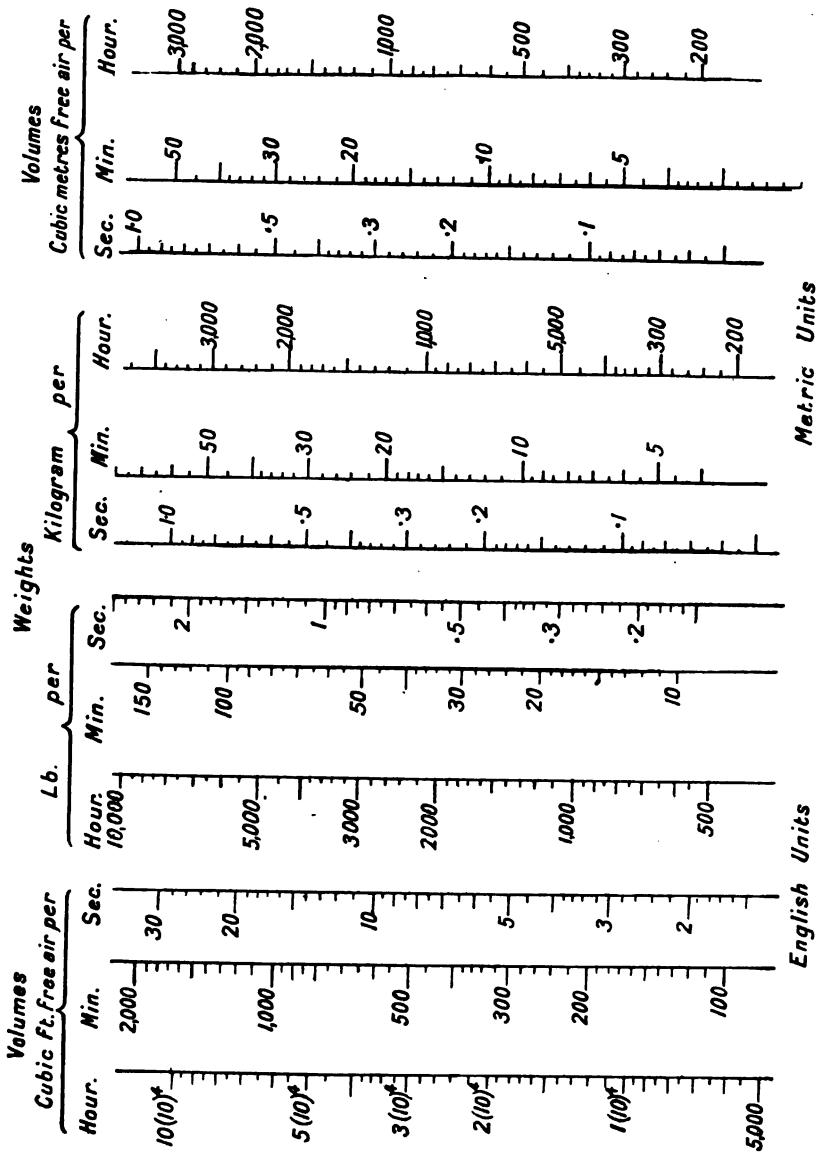

FIG. 2-12.—Abacus for converting quantities from one system of units to another.

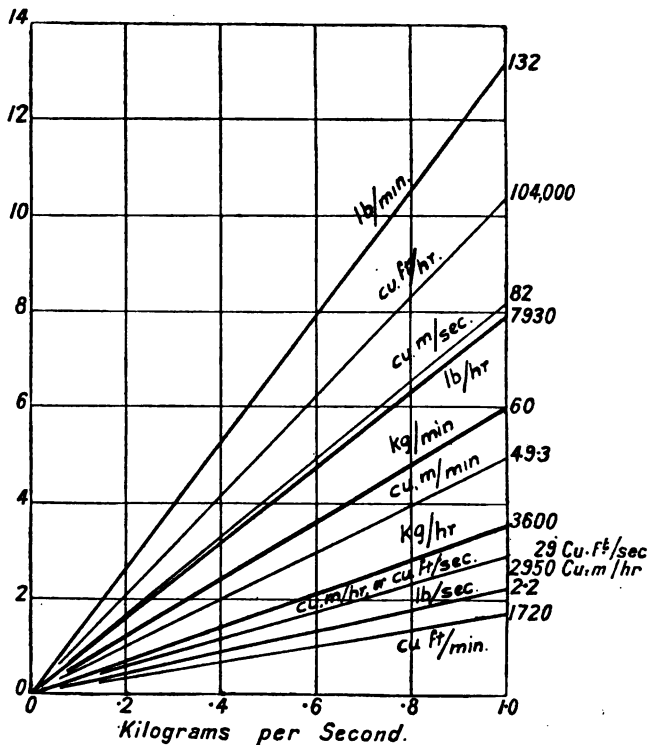

FIG. 2-13.—Chart for converting quantities of flow in various units to flow in kilograms per second. The numbers at the right hand show the flow equivalent to 1 kg/sec.

TABLE 2-7.—CORRECTION FACTORS, IF  $n$  DOES NOT EQUAL 2.0.

$u =$ $n$	5	10	20	30	40	50
$f_1(u) = u^{2-n}$ , $P_1' - P_2' = [(P_1 - P_2)/f_1(u)](B/A)$ .						
1.75	1.50	1.78	2.12	2.35	2.52	2.66
1.80	1.38	1.59	1.82	1.98	2.09	2.19
1.90	1.17	1.26	1.35	1.40	1.44	1.47
$f_2(u) = u^{(2-n)/n}$ , $M' = f_2(u)M$ .						
1.75	1.26	1.38	1.53	1.62	1.70	1.75
1.80	1.19	1.29	1.39	1.45	1.50	1.64
1.90	1.09	1.13	1.17	1.20	1.22	1.23

$M$  and  $u$  are found from charts or graphs, using  $n = 2$ .

As regards *quantities delivered*, if the loss of pressure is fixed, we have,

$$M' = mS[(P_1' - P_2')/(BL)]^{1/n} \quad (2'94)$$

$$\frac{M'}{M} = \left[ \frac{(P_1' - P_2')}{BL} \right]^{1/n} \left[ \frac{AL}{(P_1 - P_2)} \right]^{\frac{1}{2}} = \frac{u'}{u} \quad (2'94a)$$

If the drop of pressure is fixed, and  $A = B$ ,

$$\frac{M'}{M} = \left[ \frac{(P_1 - P_2)}{AL} \right]^{\frac{2-n}{2n}} = u^{(2-n)/n} = u'{}^{(2-n)/2} = f_2(u) \quad (2'94b)$$

If  $P_1 - P_2$  is given and we want to find  $M'$ , knowing that the true formula for drop of pressure is  $dP/dL = Au^n$ , we find by calculation or from graphs  $M$  the quantity and  $u$  the velocity which would exist if the law was  $dP/dL = Au^2$ . The true quantity flowing will be  $f_2(u)M$ . Similarly, if we want to know what pressure will give a velocity  $u'$ , the necessary pressure is  $(P_1 - P_2)/f_1(u)$ , where  $P_1 - P_2 = ALu^2$ , and can be found from charts or tables. The charts are based on the velocity-square law.

For pneumatic tubes the equations are more complex, if the fundamental equation is of the form,

$$dP/dL = Bm^{n'}u^n \quad (2'95)$$

This seems likely from Fritzsche's work;  $m$  and  $u$  are not independent, as  $u$  increases as  $P$  falls and  $m$  decreases, so

$$\frac{dP}{dL} = B \left( \frac{P}{CT} \right)^{n'} \left( \frac{MCT}{S} \right)^n \frac{1}{P^n} \quad (2'95a)$$

Assuming that  $T$  is constant,

$$dP P^{n-n'} = B(M/S)^n (CT)^{n-n'} dL \quad (2'95b)$$

which when integrated gives the general equation,

$$\frac{P_1^{n-n'+1} - P_2^{n-n'+1}}{n-n'+1} = LB \left( \frac{M}{S} \right)^n (CT)^{n-n'} \quad (2'95c)$$

putting  $n - n' + 1 = a$ ; if  $n' = 1$ , then  $a = n$ .

$$\frac{P_1^a - P_2^a}{a} = BL \left( \frac{M}{S} \right)^n (CT)^{a-1} \quad (2'95d)$$

It is known that  $n$  is about 2.0, Fritzsche says = 1.852  
 $n'$  ,, 1.0, ,, = 0.852  
 $a$  ,, 2.0, ,, = 2.000.

If we now test pneumatic tubes, when working at high pressures, say  $p = 30$  or  $45$  lb/in<sup>2</sup> absolute, and work the other end of the tube at a very high vacuum, say  $10.7$  lb/in<sup>2</sup>, then the variations in the high vacuum will be negligible, as  $P_2^a$  will be very small in comparison with  $P_1^a$ .

If  $P_1$  is made so large that  $P_2^a$  may be neglected, then

$$\frac{P_1^a}{M^n} = \frac{aBL(CT)^{n-n'}}{S^n} \quad (2'96)$$

Observations of  $M$  with  $P_1 = 15, 20, 30, 45$  lb/in<sup>2</sup> on one particular tube

should enable one to determine how closely  $n$  and  $a$  correspond;  $n$  could be determined by working different tubes at the same terminal pressures, if we can assume that we know the coefficient of friction for each tube accurately, because we would get,

$$\frac{P_1^a - P_2^a}{M^n} = (\text{constant}) \frac{\zeta L}{S^n} \quad (2'96a)$$

$\zeta$  would have to be measured by noting  $P_1 - P_2$  for a small length of tube when the velocities  $u$  were known.

At the moment I cannot say certainly what are the values of  $n$  and  $n'$ : for a short portion of tube  $n$  would quite probably be about 1.85 or so, as the tube is of the smooth type; but for a long tube with many joints, and with apparatus, etc., it may be that the tube as a whole becomes of the rough type and  $n$  becomes = 2.0.

$n'$ , again, evidently varies from .852 up to 1.0, the usual value which is taken. Further tests could give more light upon these matters.

As regards quantities, if  $n$  does not = 2.0, comparisons between the quantity found by the usual formula and the true quantity  $M'$  can be made thus:

$$\frac{M'}{M} = \frac{(1 - \phi^n)^{1/n} \cdot 2^{\frac{1}{2}} (CT)^{1/n - \frac{1}{2}}}{(1 - \phi^2)^{\frac{1}{2}} n^{1/n} (LB)} \quad (2'97)$$

For particular cases when the value of  $n$  is known this can easily be worked out; it is not worth working out in general, because the values of  $\phi$  and  $n$  both vary. The value of the ratio  $M'/M$  will be somewhat similar to the values given in Table 2'7.

### G. Telephone cables.

The flow of air for desiccating telephone cables must follow the general laws of air flow, but few experiments have been made, and the types of cables vary so much that a great many tests would be required in order to get full results. Scholz (*Telephone Engr.*, 14/295/1915) has given a translation of a German article concerning tests which were made upon certain lengths of cable. It is not easy to follow the equations which he gives, owing to printers' errors and the absence of statements as to what all the symbols mean. He gives a few results of tests, but the laws of flow do not seem to be regular.

Mansbridge (*Jour. Post Office Engr.*, 5/304/1912) tested the flow of air in a 7-pair telephone cable, 2520 ft. long. He took as the unit of resistance, a resistance such that, with a gauge pressure of 1 lb/in<sup>2</sup> at one end and with atmospheric pressure at the other, a flow of 1 cu. ft. of atmospheric air *per hour* was delivered. In the calculations he seems to have only used gauge pressures, which is not altogether satisfactory, because the flow of air will not only depend upon the gauge pressure at the one end, but will be dependent upon the absolute pressures at both ends, and the function which connects the flow with these pressures may not be a function of  $(p_1 - p_0)$  = gauge pressure. The flows for the 7-pair cable were as follows:—

Cu. ft/hr	.0193	.0422	.0682	.0950	.1390	.1770
$p_1 - p_0$	10	20	30	40	50	60
$p_1$	24.7	34.7	44.7	54.7	64.7	74.7

## CHAPTER II.—SYMBOLS USED.

Equation.	Symbol.	Meaning.
2'79a, 2'92	A	= a coefficient.
2'92	B	= "
2'32, 2'85d	a	= "
2'32, 2'85d	b	= "
2'05	C	= air or gas constant.
2'64c	c	= a coefficient.
2'01	D	= diameter in ft. or metres.
2'34	D'	= " in cm.
2'36	d	= " in in. or mm.
2'08a	$D'' = \frac{64\zeta}{g\pi^2 D^5}$	= coefficient depending on size of pipe
2'79	F	= shearing force of friction.
2'29	F	= pressure in oz./in <sup>2</sup> .
2'30a	f = $\zeta/(2g)$	= the frictional force.
2'04	g	= gravitational constant.
2'31	h	= pressure in in. or mm. water.
2'07	H	= " in ft. of fluid.
2'31	$h'' = u^2/(2g)$	= velocity, in. of water.
2'64	k = $m_0 f$	= frictional force.
2'33	K	= a coefficient.
2'33a	K'	= "
2'83	K <sub>1</sub> , K <sub>2</sub>	= "
2'01	L	= length of pipe.
2'02	M	= weight of gas flowing per sec.
2'01	m <sub>v</sub>	= density of gas.
2'29	m <sub>0</sub> = 0.764 lb.	= density of air at 60° F. and P <sub>0</sub> .
2'38	m <sub>0v</sub> = $\rho m_0$	= " of gas.
2'71c	n	= index of u in Fritzsche's equation.
2'71c	n'	= " of p in " "
2'01	P	= pressure in lb/ft <sup>2</sup> or in kg/m <sup>2</sup> .
2'10a	p	= " in lb/in <sup>2</sup> or in kg/cm <sup>2</sup> .
2'03	Q	= volume in cu. ft. or in cu. metres per sec.
2'71f	q	= index of D giving friction.
2'79	r	= radius of pipe.
2'21	S	= area of pipe.
2'04	T	= absolute temperature.
2'01	u	= velocity.
2'79a	U <sub>c</sub>	= " at axis of pipe.
2'78b	u <sub>k</sub>	= critical velocity.
2'90	v	= volume.
2'64	x = P/P <sub>0</sub>	= ratio of pressure to atmosphere.
2'21	Y	= perimeter of pipe.
2'59	Z = 4 $\zeta$	= coefficient of friction as used by some writers.
2'37a	z <sub>1</sub> , z <sub>2</sub>	= height above datum level.
2'01	$\beta$	= a coefficient.
2'79	$\beta'$	= "
2'04	$\zeta$	= the coefficient of friction.
2'78	$\eta$	= " " of viscosity.
2'02	$\lambda_1, \lambda_2$	= a coefficient.
2'73b	$\phi$	= "
2'73f	$\phi'$	= "
2'79	$\mu'$	= "
2'07	$\mu = S/Y$	= hydraulic mean depth.
2'80	$\nu = \eta/m$	= kinematical viscosity.
2'33	$\rho = m_0/m_0$	= specific gravity of a gas, when $\rho = 1$ for air.



Mansbridge shows how the flow in the telephone cables follows entirely different laws to the flow in pneumatic tubes, and the reason is simply that in telephone cables the flow is so slow that it follows the Possieule laws, in which the resistance varies only as the velocity and not as the (velocity)<sup>2</sup>. The critical velocity dividing the two states depends upon  $1/md$ : for a telephone cable the effective diameter  $d$  must be very small, so the critical velocity is high.

**Conclusions.**

When one sees Tables 2'2, 2'3, 2'4, it seems rather hopeless to come to any conclusions; such an attempt will, however, be made.

*Conclusion 1.*—For approximate use, if the variation of  $\zeta$  with diameter, etc., is to be neglected, and Eq. 2'09 is to be used, we can choose,

- $\zeta = \cdot 0080$  for steam flow.
- $= \cdot 0060$  for ventilation work.
- $= \cdot 0050$  for compressed-air work.

*Conclusion 2.*—Using Eq. 2'09, but wishing to use a value of  $\zeta$  dependent upon diameter, Unwin's formula is reasonably satisfactory. Fig. 2'8 to 2'11 are then of use in solving any problem in transmission.

*Conclusion 3.*—In pneumatic-tube work, when using Unwin's theory on which Eq. 2'08, etc., are based, suitable values are,

- $\zeta = \cdot 0085$  for  $1\frac{1}{2}$ -in. tubes.
- $= \cdot 0070$  ,,  $2\frac{1}{4}$ -in. ,,
- $= \cdot 0060$  ,, 3-in. ,,

If scientific experiments with accurate instruments could be made on such tubes, the values could be more accurately determined and, for clean tubes, would be found to be somewhat less than the above.

*Conclusion 4.*—The later formulæ showing that  $\zeta$  varies with  $u$ ,  $D$ ,  $m$  (see Table 2'4), or showing that  $dP$  varies as  $m^{n'}$ ,  $u^n$ , where  $n'$  is not 1.0 and  $n$  is not 2.0, are to be preferred as being more accurate than the older formulæ, Eq. 2'09, etc.

Further tests are necessary to determine what are the best values of  $n'$  and  $n$ , and to find how these indices vary under different conditions, if they do vary. It should be remembered, however, that the value of  $u^{15}$ ,  $u^{10}$  which appears in the denominator of the expressions for  $\zeta$  lies between 1.0 and 1.5 in practical cases, as long as  $u$  does not exceed 50 ft/sec, and therefore tends to neutralise the variations in  $\zeta$  due to alteration in  $D$ .

*Conclusion 5.*—In the equation,

$$dP = \frac{\zeta'(m)^{n'}(u)^n L}{2g(D)^q}$$

$\zeta'$  is a coefficient which can only be constant for perfectly smooth pipes. If a pipe is rough or has been in use a long time and has become dirty, the value of  $\zeta'$  must alter, and the values of  $n'$ ,  $n$ ,  $q$  also alter, as these differ for smooth and rough pipes.



## CHAPTER III.

### LOSS OF PRESSURE AT FITTINGS.

Methods of specifying loss of pressure—Determination of length equivalent to fitting—Loss of head at a fitting—Table for velocity head lost at fitting—Loss at bends of various curvature—Solution of problems—Theoretical basis for finding the loss at fittings—Notes on the references consulted.

THE purpose of this chapter is to enable the reader to allow for the loss of pressure in pipe fittings, such as elbows, bends, globe valves, etc., when solving problems of air flow. The loss of pressure at any fitting—for instance, at a bend—is taken as  $=H_1 + H_2$ , where  $H_1$  is due to the length of the fitting and  $H_2$  to its type.

Writers on this subject choose four methods of specifying the loss of pressure in fittings:—

(i.) They give the length of straight pipe,  $L'$ , whose resistance is equal to that of the fitting; this requires a table of "lengths of pipe" for each "type of fitting" for each "diameter."

(ii.) They give the "number of diameters,"  $k_1$ , which must be added to the length of the fitting to allow for its resistance. This requires a table of "number of diameters" for each "type of fitting."

(iii.) They give the "percentage loss of velocity head,"  $k$ , at the fitting. This requires a table of "percentages" for "each type of fitting." In both (ii.) and (iii.)  $k_1$  and  $k$  are assumed to be independent of the velocity and diameter.

(iv.) They give the actual loss of pressure in lb/in<sup>2</sup>, or some other units, at the fitting. This requires tables giving "loss of pressure" for each "type of fitting" for each "diameter," and in each case the table would have to be given for each velocity, say 10, 20, 30 ft/sec, etc.

To enable the reader to understand the matter more clearly, a schedule showing the kind of tables required in each case is attached.

For (i.).		For (ii.).		For (iii.).	
Equivalent lengths.		No. of diameters to be added.		Per cent. of velocity head lost.	
Diam.	Elbow, Tee, etc.	Elbow, Tee, etc.		Elbow, Tee, etc.	
1 in.	$a_1$ $a_2$ etc.				
2 "	$b_1$ $b_2$ "				
3 "	.   .   .				
4 "	.   .   .				
etc.	.   .   .				
		For } any } diam. }	$x_1$ $x_2$ etc.	For } any } diam. }	$y_1$ $y_2$ etc.

For method (iv.) it would be necessary to have tables similar to (i.), giving the loss in lb/in<sup>2</sup> instead of equivalent lengths, and to have the table for every possible velocity, say for  $u=10, 20, 30$ , etc. Method (iv.) then becomes unwieldy: if the tables for various velocities are not given, then the method is inaccurate.

In the case of (i.), a rather big table is required if a great many types of fittings and bends are included.

The usual problem for engineers to solve is to find the quantity of fluid transmitted for a given loss of pressure down a pipe  $L_0$  feet long containing various bends, valves, elbows, etc.; or alternatively the problem is to find the loss of pressure when a given quantity is flowing in the pipe. Assume that the equivalent length of each bend is  $L'$ , of each elbow is  $L''$ , and of each valve is  $L'''$ , the equivalent total length of straight pipe is then,

$$L_0 + \Sigma L' + \Sigma L'' + \Sigma L''' + \text{etc.} = \Sigma L \quad (3'01)$$

This length  $L$  can be used in the formulæ given in Chapter II.

We want to determine  $L'$ ,  $L''$ ,  $L'''$  for each fitting and for every sort of bend, of every sort of curvature, for any diameter of pipe. The loss of pressure at the fitting, say a 6-in. sluice-valve, will consist of  $H_1$  due to the length of the valve, say 1 ft., and  $H_2$  due to the valve itself, that is, due to the edges and openings and corners, which will cause eddy currents in the fluid. The first loss is taken into account if  $L_0$  includes the length of the fittings in the pipe. The second loss,  $H_2$ , is taken into account by adding the length  $L''$  to the measured length of pipe. The length  $L'''$  will differ for the valve for each size of pipe, being say 7 ft. for a 6-in. pipe and 0.6 ft. for a 1-in. pipe. This second loss of pressure,  $H_2$ , we shall speak of as the loss of pressure at the fitting.

#### Definition of $L_1$ .

To assist in obtaining  $L'''$ , it is useful to employ the length of pipe of diameter  $D$  in which the loss of pressure is just equal to the velocity head, thus,  $H = u^2/(2g)$ . From Eq. 2'07 we have,

$$H = \frac{4\zeta}{D} \frac{u^2}{2g} L \quad (3'02)$$

If  $4\zeta L/D = 1$ , then  $H = u^2/(2g) \quad (3'03)$

The length of pipe in which the whole velocity is lost is then  $D/(4\zeta)$ , and this length we call  $L_1$ . Values of  $L_1$  are given in Table 2'1 and in fig. 3'1. Many authors state that the whole velocity head is lost in a length = 60 diameters; this gives  $\zeta = .00417$ , as  $60D = D/(4\zeta)$ .

#### Assumption that $k$ is independent of $u$ and $D$ .

We now assume that for any velocity,

$$\frac{\text{loss of pressure in a fitting}}{\text{loss of pressure in the length } L_1} = k = \text{a constant}$$

and that this is also independent of the diameter; but we have agreed that

the loss of pressure in the fitting shall be the loss of pressure in  $L'$  ft. of pipe, so that we get,

$$L'/L_1 = k, \text{ and } L' = kL_1 \quad \dots \quad (3'04)$$

By knowing  $k$  for each fitting, and by finding  $L_1$ , we can arrive at the

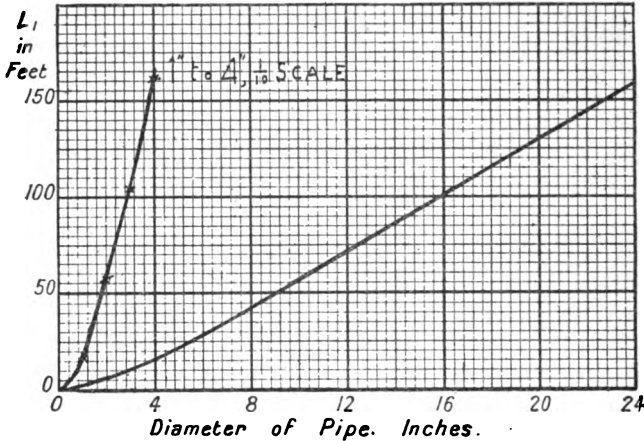

FIG. 3'1.—Length of pipe in which the velocity head is lost.  
Length =  $L_1 = D/(4\zeta)$ , using Unwin's  $\zeta$ .

equivalent lengths of pipe,  $L'$ ,  $L''$ , etc. Then we can make up a table as in (i.) if we wish. The actual loss of pressure at the fitting becomes,

$$H_2 = \frac{4\zeta}{D} \frac{u^2}{2g} L' \quad \dots \quad (3'05)$$

**Proportionate loss of pressure at a fitting.**

Consider now method (iii.), where the percentage or proportionate loss of head at the fitting is given : let this be  $y$  : the table then shows that the fitting causes a loss of pressure,

$$yu^2/(2g), \text{ i.e. } H = yu^2/(g) \quad \dots \quad (3'06)$$

Comparing this with Eq. 3'05, we get,

$$\frac{4\zeta}{D} \frac{u^2}{2g} L' = y \frac{u^2}{2g} \quad \dots \quad (3'07)$$

but  $L' = kL_1 = kD/(4\zeta)$ , therefore

$$\frac{4\zeta}{D} \frac{u^2}{2g} \frac{kD}{4\zeta} = y \frac{u^2}{2g} \quad \dots \quad (3'08)$$

giving  $k = y$  ; so that the proportionate loss of velocity head is the value  $k$  which we seek.

*Numerical Value of  $L_1$ .*

$L_1 = D/(4\zeta)$ ;  $D$  is known, but  $\zeta$  depends on the predilection of the person who uses it. In Table 2'1 are given values of  $L_1$  based on Unwin's  $\zeta$ ,  $\cdot 0027(1 + \cdot 3/D)$ . If other values are used,  $L_1$  will have to be suitably altered. This ambiguity in the value of  $\zeta$  causes the equivalent lengths given by various authorities to differ among themselves. Working backwards from equivalent lengths, as given by any authority, we can divide such lengths by  $L_1$ , and so for each diameter find what  $k$  appears to be;  $k$  will not be constant unless the original authority and our  $L_1$  each include the same value of  $\zeta$  for any diameter.

*Method (ii.).—Number of Diameters to be added.*

In this case the equivalent length of pipe is given as being equal to so many diameters, say  $k_1$ ; thus

$$L' = k_1 D \quad \dots \quad (3'09)$$

In the previous method,  $L' = kL_1 = kD/(4\zeta)$ .

Equating these values,

$$k_1 = k'/(4\zeta) \quad \dots \quad (3'10)$$

Some writers give  $k$  for each fitting independent of the diameter; other writers give  $k_1$  for each fitting independent of the diameter; but  $\zeta$  is dependent on the diameter, therefore both methods (ii.) and (iii.) cannot be correct. The amount of incorrectness in using either one or the other may be small, but the fact remains that both cannot be right. Writers using method (iii.) assume that a fixed value of  $\zeta$  for any diameter pipe may be chosen. For practical work, when  $D = 0\cdot 5$ , or  $d = 6$  in., the alteration of  $\zeta$  with diameter may perhaps be neglected, and  $\zeta$  may be taken as  $0\cdot 0040$  say; then both  $k$  and  $k_1$  may be relatively correct.

*Comparison of  $k$  and  $k_1$ .*

For our work in comparing these two factors, we take  $\zeta = 0\cdot 0040$  and multiply  $k_1$  by  $0\cdot 0160$  in order to get a  $k'$ , which is comparable with  $k$ ; in this way we can arrive at fig. 3'2. This sort of comparison is preferable to an attempt to compare a series of tables like (i.): such tables could be drawn up for each authority by multiplying  $k_1$  by  $D$ , but the law underlying variations would not be recognisable. Of course, for any particular fitting in a particular pipe, there is no trouble in finding the equivalent lengths as given by each writer, and seeing how they compare.

*Loss of Pressure due to (1) Length, (2) Type of Fitting.*

Returning to the question of the loss of pressure being made up of  $H_1$ , due to its length, and  $H_2$ , due to its type, and considering bends.

An example may make this clearer. Take a pipe 300 ft. long containing 20 bends, each 1 ft. long: the loss of pressure due to 280 ft. of straight pipe and to 20 bends will be given by,

$$P_1 - P_2 = \frac{4\zeta}{D} \frac{mu^2}{2g} (300 + 20kL_1) \quad \dots \quad (3'11)$$

if  $k$  refers to the excess loss of pressure due to the fitting,  $H_2$ . On the other hand,

$$P_1 - P_2 = \frac{4\zeta}{D} \frac{mu^2}{2g} (280 + 20k'L_1) \quad (3.12)$$

if  $k''$  refers to the whole loss of pressure at the bend, viz.  $H_1 + H_2$ . The former equation is the proper one to use.

**Procedure for solving practical problems.**

To obtain the equivalent length of pipe for an ordinary pipe with various fittings, one measures the total length of the pipe =  $L_0$  say, and notes what

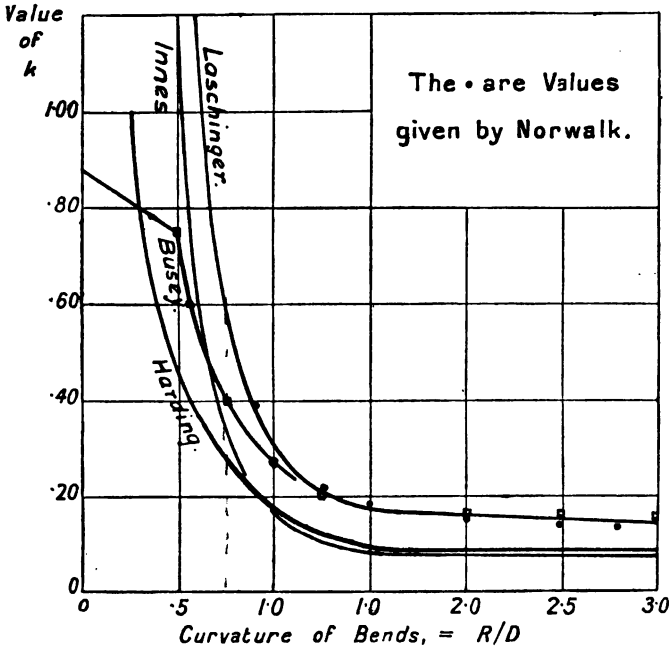

Fig. 3.2.—Coefficient  $k$  for the resistance of bends of various curvature.

fittings are included. From Table 3.1 one obtains values for  $k$  for each type of fitting; for bends of various curvature one can use fig. 3.2 if necessary. One finds  $L_1$  from Table 2.1 or fig. 3.1. The equivalent length of pipe for each fitting is then  $kL_1$ .

The length of straight pipe equivalent to the actual pipe and fittings is,  $L = L_0 + \sum kL_1$ ; this length  $L$  can be used in all the formulæ and graphs in Chapter II., for the various calculations of flow.

TABLE 3'1.—RESISTANCE OF FITTINGS, *k*.

	Harding, <i>A.S.H.</i> , <i>V.E.</i> , 19/219.	Verner, <i>A.S.H.</i> , <i>V.E.</i> , 20/151.	Barker, Rietschel.		Brabbée, <i>Z.V.D.I.</i> , 60/511.	Laschinger (Weisbach), <i>Ind. Dig.</i> , 7/493.	Raynes, p. 310.	
			P. 97.	Table XII.				
Leaving boiler	...	} 2·5 {	...	...	...	1·5	} 2 <i>a</i>	2·5
Entering boiler	...		1·0	...	...	1·0		
Elbow in round pipe	·90		1·0	1·5	1·5	...		
Elbow in square pipe	1·30	...	...	...	2·0	...	...	...
Sharp elbow .	...	...	...	...	...	2·0	$\frac{1}{2}a$	·63
Round elbow .	...	...	...	...	...	1·0	...	...
Short elbow .	...	·67	...	...	...	...	...	...
Long elbow .	...	·42	...	...	...	...	...	...
Tee, through .	...	...	...	...	1·1	...	...	...
„ crosswise	1·33	...	...	1·1	1·5	2·0	$\frac{1}{2}a$	1·87
„ opposing	...	...	...	...	3·0	...	...	...
„ square .	...	...	...	...	...	...	2 <i>a</i>	2·5
Valves, globe.	...	2·0	·5~1·0	...	2·0	4·0	$\frac{1}{2}a$	1·87
„ sluice	...	·25	0	0	·5	·2	...	...
„ angle	...	...	...	...	4·0	2·5	$\frac{3}{4}a$	·83
Plug cock .	...	...	·1~·3	...	...	·5	...	...
Bend, 135° .	...	...	·6	...	·2	...	...	...
Sharp angle, 135°	·30	...	...	...	...	...	...	...
Return bend .	...	1·0	·8	...	...	...	$\frac{3}{4}a$	·94
Bend, R = $\frac{1}{2}D$	...	...	...	1·0	...	2·0	...	...
= 1D	...	·33	...	·25	·30	·29	...	...
= $1\frac{1}{2}D$	...	...	...	·15	...	·17	...	...
= 2D	...	...	...	...	...	·15	...	...
Double bend, R = 3D .	...	...	·4	...	...	...	...	...
R/D = 4~8	...	...	·25	...	...	...	...	...
= 9~12	...	...	·10	...	...	...	...	...
> 12 .	...	...	nil	...	...	...	...	...

For Raynes' "a," see notes on his work.

A report upon the loss of head occurring when water flows through gate and angle valves, etc., will be found in the *University of Illinois Engineering Expt. Station, Bulletin No. 105, May 1918.*

**Resistance of bends.**

Bends must be defined by stating (*a*) their curvature, (*b*) their angle. In fig. 3'4, (*a*) shows an ordinary 90° bend ; when R is nearly equal to D, it is often called an elbow : (*d*) and (*e*) show true elbows for which the throat radius *r*=0 and the centre of the bend lies at the inner corner.

A right angle or 90° bend subtends an angle of 90° at the centre of the arc.

The radius of the bend, R, is measured to the centre line of the pipe.

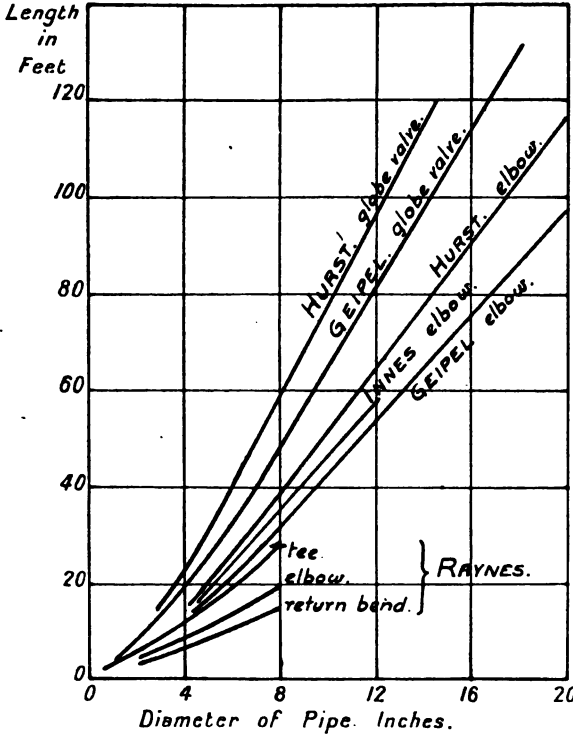

FIG. 3'3.—Resistance of fittings. The length of straight pipe equivalent to the fitting is given.

TABLE 3'2.—RESISTANCE OF ELBOWS AND GLOBE VALVES.

Values of  $k$  for elbows and globe valves: most authorities say that  $H_2$  for elbows =  $\frac{3}{4}H_2$  for globe valves, or  $H_2$  for globe valves =  $1\frac{1}{3}H_2$  for elbows.

	Elbow.	Globe valve.
† Kempe ( <i>Year Book</i> , —/1043/1916) . . . . .	} .84	1 23
Booth ( <i>Steam Pipes</i> , p. 16) . . . . .		
Hatch ( <i>Elec. World</i> , 68/1143/1916) . . . . .		
* Martin ( <i>Engng.</i> 67/366/1897 . . . . .	} .98	1'50
Hurst and Trautwine . . . . .		
* Geipel and Kilgour ( <i>Elec. Eng. Form.</i> , p. 514) . . . . .	.75	1'12
* Innes ( <i>The Fan</i> , p. 7) . . . . .	.81	...
* Harding ( <i>A. S. H. V. E.</i> , 19/222/1913) . . . . .	.90	...
Brabbee ( <i>Z. V. D. I.</i> , 60/511/1916) . . . . .	1'50	2'00
Johnston ( <i>Eng. Mag.</i> , 48/694/1915) . . . . .	$k_1 = 40$	$k_1 = 60$
If $\zeta = .0060$ . . . . .	.96	1'44
If $\zeta = .0040$ . . . . .	.64	.96

\* These values were obtained by dividing equivalent lengths, as given for various sizes of pipe, by Unwin's  $L_1$  (see Table 2'1).

† These were obtained directly from the formula for equivalent lengths which includes Unwin's value of  $\zeta$ .

The throat radius,  $r$ , is measured to the inner edge of the pipe; it is not such a convenient quantity to use as  $R$ .

The radius of curvature is  $R/D$ .

Fig. 3'4 (g) shows a 45° elbow; a 45° bend would subtend an angle of 45° at the centre of the arc, though some writers call it a 135° bend. It seems as if the loss of pressure in a 45° bend should be just half what the loss is in a 90° bend, and therefore 45° fittings need not be considered as separate fittings; they can be considered as half bends of the same curvature, and  $k$  for a 45° bend =  $\frac{1}{2}k$  for the 90° bend.

The loss of pressure in a bend depends on its curvature, which should

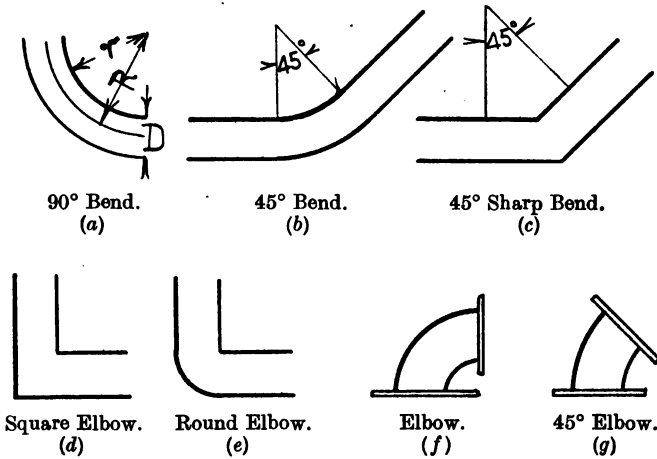

FIG. 3'4.—Bends of various types.

always be stated, unless it exceeds 5; when the curvature = 0.5 to 1.0, the bend may be considered an elbow.

The term "return bend" is ambiguous, because the curvature is unknown; either a close or an open return bend might be meant.

For bends the value of  $k$  is given in fig. 3'2 as dependent on  $R/D$ .

It can now be seen why the loss of pressure at a fitting is taken as  $H_1 + H_2$ : for a bend where  $R/D = 5.0$ ,  $k = 0$ , so  $H_2$  becomes 0; but  $H_1$  remains as the loss of pressure in the bend due to its length, which length must be included in measuring up the pipe.

### Theoretical basis for finding $k$ .

It is well to consider the theoretical basis upon which the value of  $k$  for fittings may be determined.

Consider what happens when air flows out of a container, or receiver, or boiler; the initial velocity must be given at the expense of some pressure head. If the entrance is rounded, there will be no eddy loss, and the pressure will be merely used in creating the velocity, or  $u^2/(2g)$ ; but in most cases the air leaves the container through a plain pipe, and the eddy loss due to flow through a sharp-edged orifice also exists. This amounts to about half



the velocity head, so that the total pressure required is  $(1+0.5)u^2/(2g)$ , and  $k=1.5$ .

In flowing into a container there would be no loss of pressure if the pipe gradually expanded with a diverging cone, so that the velocity gradually became zero; but usually the pipe finishes with a plain end, and the whole velocity head is lost in eddy motion at the point of entry. Thus  $k=1.0$  for an entrance.

For a receiver or container as a whole both of these losses will usually exist, so that, if  $k$  refers to both entries and exits, the value will be 2.5.

In the case of an elbow the velocity of the air in one direction is suddenly destroyed and the air is given a velocity in another direction, so that one expects a loss of pressure more than the velocity head: the value of  $k$  is doubtful, and will no doubt depend considerably upon what sort of surface exists at the outer side. From an inspection of fig. 3'2 it appears that for an elbow, or when  $R/D$  for a bend is less than 0.5,  $k$  should be greater than 1.0; Busey's curve, which goes sharply to the value of 1.0, seems to be incorrect.

Fig. 3'3 shows equivalent lengths of elbows and globe valves as given by various authors; the variation between authors' values is very apparent.

### References.

The remainder of the chapter deals in detail with the references consulted.

Peclet (Stevenson, *Hygiene*, p. 67) states that for sharp bends  $k = \sin^2 \theta u^2/(2g)$ , which, for  $\theta=90^\circ$ , gives  $k=1.0$ : what is meant by a sharp bend is not stated.

Harding (*Amer. Soc. Heat. and Vent. Engr.*, 19/219/1913) and the Norwalk Compressor Co. (quoted by Thorkelson, p. 176) give tables of  $k_1$  for round or square ducts.

Busey (*Amer. Soc. Heat. and Vent. Engr.*, 19/366/1913) gives a curve for  $k$  for bends of various curvature; it is given in fig. 3'2.

Raynes (*Steam Heating*, p. 310) and Innes (*The Fan*, p. 6) give tables of "equivalent lengths" for various fittings: I have divided these by Unwin's  $L_1$  and put the mean value in Table 3'1.

Martin (*Engineering*, 63/361/1897) quotes Hurst's or Trautwine's table of equivalent lengths for globe valves and elbows: I have divided these by Unwin's  $L_1$  and put the value of  $k$  in Table 3'1.

Johnston (*Eng. Mag.*, 48/694/1915) states for globe valves or the exit from a boiler,  $k_1=60$ , and for an elbow,  $k_1=40$ . He assumes that the length to be added for a 6-in. pipe is  $60 \times \frac{1}{2} = 30$  ft.

Kinealy (*Mech. Engr.*, 16/302/1905) gives a table of values of  $k_1$ , but in his case the diameter is in inches; so for a 6-in. pipe he gives  $k=5$  and assumes that the diameters are to be in inches. This means that Kinealy's and Johnston's figures for  $k_1$  are entirely different, and one must notice whether they are to be associated with diameters in feet or inches.

Raynes (*Heating Systems*, p. 310) gives equivalent lengths for various fittings; some of these are plotted in fig. 3'3. The values are lower than those ordinarily quoted and appear to be quite arbitrary: the value of  $k$ , viz.  $L'/L$ , is not at all constant, varying from 2.26 for the  $\frac{1}{2}$ -in. pipe down to 0.42 for an 8-in. pipe: it seems that the equivalent lengths are too big

for small sizes of pipes and too small for the large sizes. I deduced the relative resistance of fittings for each size of pipe; these are fairly constant, and are given in Table 3'1: if we assume that the value of  $k$  for boiler connections should be 2.5, then  $a=1.25$ , and the other values of  $k$  are as shown in the table.

The ambiguity in description of fittings is well shown in Raynes' table when it is compared with others. Raynes mentions:

Sharp elbow or quick-curved tee, with  $k=a$ .  
 Tee (with no amplification), ,,  $k=1\frac{1}{2}a$ .  
 Radiator connection or square tee, ,,  $k=2a$ .

It is perfectly obvious that investigators should describe distinctly and give drawings of the various fittings which are included under the various terms. Raynes' angle valve must be of quite a different type to that used by Rietschel, the resistance relative to elbows and boiler connections being so different in his figures.

Hatch (*Elec. World*, 68/1143/1916) gives the formula for  $L'$  for globe valves, elbows, and square entrances to boilers as,

$$L = \frac{114d}{(1+3.6/d)12} \text{ for globe valves; } L' = \frac{2}{3} \text{ ditto for elbows.}$$

These are given in *Mechanical Equipment of Buildings* by Harding and Willard (1916) and by Kempe (*Year Book*, 1043/1916), and also by Booth (*Steam Pipes*, p. 16). Obviously they include Unwin's value of  $\zeta$ , and therefore by equating this to Unwin's  $kD/(4\zeta)$  one finds  $k$ : this has been put in Table 3'1.

Innes quotes Weisbach's equation for the loss of pressure at bends, as,

$$H = \left\{ 0.131 + 1.847 \left( \frac{D}{2R} \right)^{3.5} \right\} \frac{\theta}{180} \cdot \frac{u^2}{2g} \quad (3'13)$$

where  $\theta$  is the angle of the bend. The values for right-angle bends I have plotted in fig. 3'2: this equation is also quoted by Unwin (*Hydraulics*, p. 171) as being in Weisbach's *Hydraulik*, p. 150.

Geipel and Kilgour (*Elec. Engr. Form.*, p. 514) give equivalent lengths for elbows and globe valves: these are given in fig. 3'3.

Brabbée (*Z. V.D.I.*, 60/441, 511, /1916) explains fully the principles underlying the design of pipework systems for water and air flow. Tables for the loss of pressure at various fittings for water and air are given. Values for air flow have been inserted in Table 3'1.

Barker (*Heating and Ventilation*, p. 97 and Table XII.) gives values of  $k$  for various fittings: these are taken from Rietschel's work, but the names of the fittings as translated from the German are not very clear.

Laschinger (*Eng. Dig.*, 3/489/1908) follows Weisbach in stating his values of  $k$  for fittings and bends.

Archer (*Trans. Amer. Soc. C.E.*, 76/999/1913; and *Proc. Inst. C.E.*, 193/438/1914) gives the loss of head at a sudden enlargement from area  $S_2$  to large area  $S_1$  as,

$$H = \frac{1.098u^{1.919}}{2g(1 - S_2/S_1)^{1.919}} \quad (3'14)$$

The tests were made with water flowing in brass pipes 1 in. to 3 in. in diameter, 4 ft. long; the velocities  $u_2$  ranged from 3.82 to 31.6 f.p.s.,  $u_1$  from 0.07 to 11 f.p.s.,  $S_1/S_2$  from 1.45 to 9.32. Archer found that the distance from the enlargement to the position where the pressure was a maximum after the enlargement was,

$$L = 1.45(d_2 - d_1)^4 \quad \dots \quad (3'15)$$

For evaluating friction in the pipe he used Eq. 2'71.

Taylor (*Jour. Amer. Nav. Arch.*, 13/9/1905) discusses the effect of tapering and diverging pipes: he says that a 9-in. pipe expanding to a 15-in. pipe in a 6-ft. length gives a loss of pressure the same as in  $14\frac{1}{2}$  ft. of 9-in. pipe, and that if the taper lasts for only 2 ft. the loss is the same as in  $17\frac{1}{2}$  ft. of pipe. In the case of converging pipes he found no extra loss due to the convergence. He quotes experiments with elbows, but the results were not consistent.

The loss of pressure at receivers, including both the entrances and exits, was measured by Riedler in the compressed-air mains in Paris, as mentioned by Unwin (*Development and Transmission of Power*, p. 219): it came out as  $.00003pu^2$ ,  $p$  being 100 lb/in<sup>2</sup>.

Banki (*Z. V.D.I.*, 57/17/1913) deals both theoretically and experimentally with the question of the distribution of pressure and velocity in water flowing round bends: the paper is well illustrated with photos showing the currents in the water.

#### AUTHORITIES MENTIONED.

Archer, Banki, Barker, Booth, Busey, Geipel, Harding, Harris, Hatch, Hurst, Innes, Johnston, Kempe, Kilgour, Kinealy, Laschinger, Martin, Norwalk Co., Peplet, Raynes, Riedler, Rietschel, Stevenson, Taylor, Thorkelson, Trautwine, Unwin, Weisbach.

## CHAPTER III.—SYMBOLS USED.

Equation.	Symbol.	Meaning.
3'02	D	=diameter in feet or metres.
..	<i>d</i>	= „ „ in inches or mm.
3'02	<i>g</i>	=gravitational constant.
3'02	H	=loss of pressure in feet or metres of fluid.
..	H <sub>1</sub>	= „ „ in fitting due to length.
3'05	H <sub>2</sub>	= „ „ „ „ to type.
3'04	<i>k</i>	=proportion of velocity head lost at the fitting, due to its type.
3'12	<i>k'</i>	=proportion of velocity head lost at the fitting, due to its type and its length.
3'09	<i>k</i> <sub>1</sub> = L'/D	=number of diameters in equivalent length
3'10	<i>k'</i> = 4ζ <i>k</i> <sub>1</sub>	=a coefficient like <i>k</i> deduced from <i>k</i> <sub>1</sub> .
3'01	L	=total equivalent length of straight pipe.
3'01	L <sub>0</sub>	=the measured length of the pipe.
3'03	L <sub>1</sub> = D/(4ζ)	=the length of straight pipe in which all the velocity head is lost.
3'04	L', L'' = <i>k</i> L <sub>1</sub>	=equivalent length of fittings.
3'11	<i>m</i>	=density.
..	R	=radius of bend to centre line.
..	<i>r</i>	= „ „ „ to inner edge.
3'14	S <sub>1</sub>	=area of the large pipe.
3'14	S <sub>2</sub>	= „ „ „ small „
3'02	<i>u</i>	=velocity.
3'07	<i>y</i>	=proportion of velocity head loss at the fitting
3'02	ζ	=coefficient of friction.
3'13	θ	=angle of bend, at centre of the arc.



## CHAPTER IV.

### PNEUMATIC TUBE PROBLEMS.

Unwin's equations of flow—Summary of formulæ for quantities, etc.—Derivation of graphs—Effect of altering amount of working pressure—Method of increasing carrier speed—Looping tubes—Use of extra blowers—Increase in transit time—Graphs to use in problems—Effect of inaccurate observations—Quantities flowing in house tubes—Loss of pressure in service pipes—Use of two pipes instead of one of equal area—Determination of the most economical service pipe—Table 4'2, work done in compressing air.

#### A. Unwin's equations of flow.

THESE equations include the assumption that the flow is isothermal: in practice this is slightly incorrect, but isothermal expansion gives the best conditions for pneumatic tubes, where flow at a high velocity is wanted. If the expansion of air in the tube is not isothermal the velocity will be reduced, the transit time increased, and the quantity of flow reduced. The equations when the flow follows other laws are given in Chapter V.

The effects of altering the conditions of working can be studied from the curves in fig. 4'1, which refer to isothermal flow. Fig. 5'1 gives the curves of non-isothermal flow.

The theory is as follows (Unwin, *Hydraulics*, p. 222). It is also given by Church, Innes, and Johnson.

At any point in the pipe line the fall of pressure,  $dP$ , in the length  $dL$ , must counterbalance the friction of the air in the length  $dL$ , and also account for the acceleration of the air. Consider now a unit quantity of air, 1 lb., which is flowing, the kinetic energy of which is  $u^2/(2g)$ .

The equation of flow is,

$$-v dP = \frac{u du}{2g} + \frac{u^2 4\zeta}{2gD} dL \quad (4'01)$$

$Mv = Su$  as the flow is constant and steady.

$Pv = CT$  as the flow is isothermal.

$Pu = (CT/S)M$ , which is a constant.

∴  $P du = -u dP$ .

$$\frac{CT du}{u} = \frac{u du}{2g} + \frac{u^2 4\zeta}{2gD} dL \quad (4'02)$$

$$\frac{2gCT du}{u^3} - \frac{du}{u} = \frac{4\zeta}{D} dL = \frac{\zeta dL}{\mu} = \frac{dL}{L_1} \quad (4'03)$$

$L_1 = D/(4\zeta)$  is given in Table 2'1 and fig. 3'1.

$$\text{Integrating Eq. 4'03, } -\frac{gCT}{u^2} - \log_e u = \frac{L}{L_1} + A \quad (4'04)$$

Bringing this into the form with pressures, and putting  $P = P_1$ , when  $L = 0$  we get the equation,

$$\frac{gCTS^2(P_1^2 - P^2)}{(CTM)^2} - \log_e \frac{P_1}{P} = \frac{L}{L_1} \quad (4'05)$$

This equation does not give us pressures at once, as it includes the term  $M$ , the quantity which is yet unknown, but which is,

$$M = \left[ \frac{(P_1^2 - P_2^2)gS^2}{CT \{L_0/L_1 + \log_e (P_1/P_2)\}} \right]^{\frac{1}{2}} \quad (4'06)$$

Neglecting the log term, which is less than 1 per cent. of  $L/L_1$ , we get,

$$M^2 = \frac{(P_1^2 - P_2^2)gS^2}{L_0CT} \frac{D}{4\zeta} = \frac{\pi^2 g D^5}{64\zeta} P_1^2 \frac{(1 - \phi^2)}{L_0CT} \quad (4'07)$$

We can insert the value of  $M$  in the general equation and get for the pressure at any point in the tube,

$$\frac{(P_1^2 - P^2)}{(P_1^2 - P_2^2)} = \frac{L}{L_0} \quad (4'08)$$

This means that the square of the pressure falls in accordance with a straight-line law from one end of the tube to the other. For velocities we have,

$$u^2 = \frac{gCTL_1}{L_0} \frac{(P_1^2 - P^2)}{P^2} \quad (4'09)$$

To find the transit time we integrate  $dL/u$  having the equation,

$$A + \frac{gCT}{u^2} + \log_e u = -\frac{L}{L_1}$$

in which we neglect the log term and get  $2gCTdu/u^3 = dL/L_1$ .

$$\int \frac{dL}{u} = \int \frac{2gCTL_1 du}{u^4} = -\frac{2gCTL_1}{3u^3} \quad (4'10)$$

The transit time is,

$$t = \frac{2gCTL_1}{3} \left[ \frac{1}{u_1^3} - \frac{1}{u_2^3} \right] = \frac{\sqrt{8}(4\zeta)^{\frac{1}{2}}}{3} \frac{L_0^{3/2}}{(D)} \frac{(P_1^3 - P_2^3)}{(2gCT)^{\frac{1}{2}} (P_1^2 - P_2^2)^{3/2}} \quad (4'11)$$

$$= \frac{L_0^{3/2} F4}{(2gCTL_1)^{\frac{1}{2}}}; \text{ see Eq. 6'09} \quad (4'12)$$

Values of  $F4$  are given in fig. 5'2, and of  $L_0^{3/2}$  in fig. 4'4, and of  $L_1$  in fig. 3'1:  $(2gCT)^{\frac{1}{2}} = 1335$ ;  $(gCT)^{\frac{1}{2}} = 945$ , for air at  $P_0$ ,  $T_0 = 60^\circ \text{ F}$ .

Before discussing the different conditions of working, it is well to notice the assumptions which have been made.

1. We assume that the temperature is constant, which is not quite true. At any one point in the tube, when the flow is steady the temperature will be constant and the same as that of the tube, pipe, and ground at that point;

otherwise heat would be flowing continually into or out of the surrounding ground or fittings from the tube. But generally in pneumatic tubes the temperature at the inlet will be higher than the temperature at the outlet, the inlet temperature being, say, 60° F. to 80° F. (15°–27° C.), while the outlet temperature may be 40° F. to 60° F. (10°–15° C.). The variation in the specific volume of the air due to a 20° F. (11° C.) difference will be 4 per cent.; therefore the velocities may be this much too big or too small.

In the case of compressed-air lines, where high-pressure air is transmitted at a slow velocity through long lengths of pipe without much loss of pressure, the range of temperature variation will be very small, and may be exceeded by the difference of atmospheric temperature at the ends of the pipe.

2. We assume that the log term is negligible: the physical reason of this is that the pressure required to accelerate the air is a few inches of water gauge only, whereas the pressure required to overcome the friction of the tube amounts to some lb/in<sup>2</sup>. The velocity head when  $u=20$  ft/sec is only 0.10 in. water (2.5 mm), and even with a velocity of 60 ft/sec this head is only 0.90 in. for air at atmospheric pressure.

3. We assume that the initial and final pressures are constant: this is quite unlike the conditions in ordinary practice, where the pressures in the connection boxes and containers vary continually.

4. We assume that the coefficient of friction,  $\zeta$ , depends upon the diameter of the tube only. This is not quite true, as has already been shown in Chapter II.; but the variation due to velocity and to density has been neglected for the sake of simplification.

### B. Summary of general equations and derivation of graphs.

We now summarise the equations in a form convenient for calculation; see Table 2'1.  $L_1=D/(4\zeta)$ ; see fig. 3'1.

$$M = \left[ \frac{D^5 \pi^2 g}{4\zeta} \frac{(P_1^2 - P_2^2)}{L_0 CT} \right]^{\frac{1}{2}} \left[ \frac{D f_1(P_1, P_2)}{(CTL_0)} \right]^{\frac{1}{2}} \quad (4'13)$$

$$u = \left[ \frac{gCTL_1}{L_0} \frac{(P_1^2 - P_2^2)}{P^2} \right]^{\frac{1}{2}} \quad (4'14)$$

Initial velocity,  $u_1 = (gCT L_1/L_0)^{\frac{1}{2}}(1 - \phi_0^2)^{\frac{1}{2}} = (gCT L_1/L_0)^{\frac{1}{2}} f_2(\phi)$  . . . . . (4'15)

Final velocity,  $u_2 = (gCT L_1/L_0)^{\frac{1}{2}}(\chi^2 - 1)^{\frac{1}{2}} = (gCT L_1/L_0)^{\frac{1}{2}} f_3(\phi)$  . . . . . (4'16)

$$P = P_1 [1 - (L_1/L_0)(1 - \phi_0^2)]^{\frac{1}{2}} \quad (4'17)$$

$$t = \frac{L_0^{3/2} 2^{3/2} (P_1^3 - P_2^3)}{3(gCTL_1)^{\frac{1}{2}} (P_1^2 - P_2^2)^{3/2}} = \frac{L_0^{3/2}}{(gCTL_1)^{\frac{1}{2}}} f_4(\phi) \quad (4'18)$$

Minimum transit time when  $\phi=0$  is,

$$0.941 L_0^{3/2} (gCTL_1)^{-\frac{1}{2}} \quad (4'19)$$

Values of the functions will be found in Table 2'1 and in fig. 3'1 and 4'4.

The functions of the pressures which enter into the equations for ordinary pneumatic-tube working where one end of the tube is at atmospheric pressure, 14.7 lb/in<sup>2</sup>, are shown in fig. 4'1 and 4'2.

In order to make comparisons of pressure and vacuum working, and to



make calculations easily, using gauge pressures instead of absolute pressures, we make the substitutions,

$$p_1 = p_0(1+a) \text{ for pressure}$$

$$p_2 = p_0(1-b) \text{ for vacuum.}$$

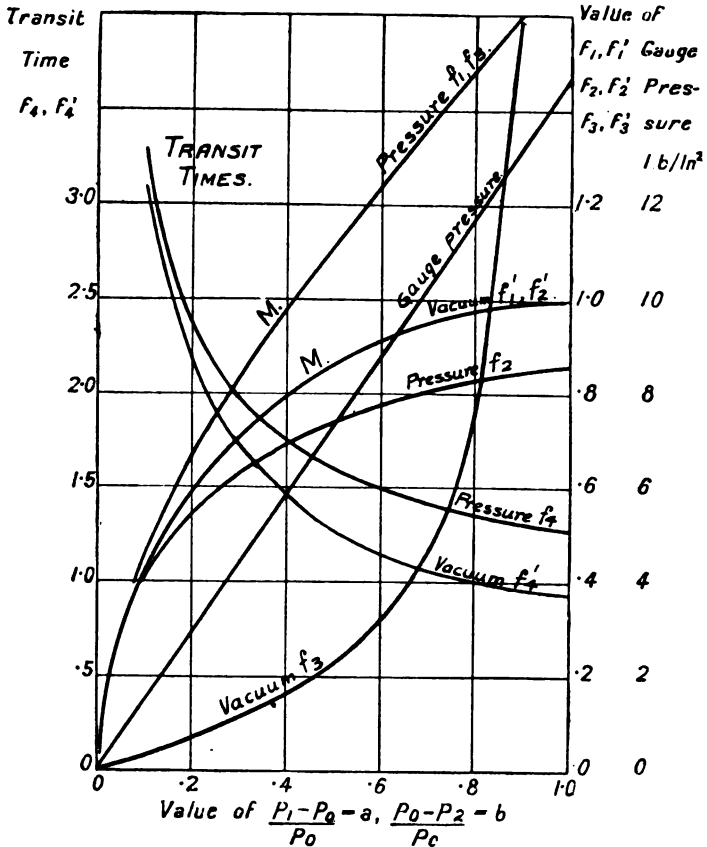

FIG. 4'1.—Pneumatic tubes: functions giving the quantities of air used, velocities of air, and transit times.  $f_1$  gives quantity;  $f_2$  gives initial velocity;  $f_3$  gives final velocity;  $f_4$  gives transit time.

$a$  and  $b$  are the ratios of the working gauge pressure to atmospheric pressure. We then find in terms of  $a$  and  $b$ ,

- The quantity function,  $f_1$ .
- The velocity functions,  $f_2$  and  $f_3$ .
- The transit time functions,  $f_4$ .

When the function has a dash ', it refers to vacuum.

The values are given in fig. 4'1 with  $a$  or  $b$  as abscissæ; the straight line is the line of gauge pressures. Suppose one is working at 7.5 lb/in<sup>2</sup> and

requires  $f_1, f_2$ , etc., take 7.5 on the left-hand scale and see where the 7.5 line cuts the thick black line; the vertical through this gives the various functions where it cuts  $f_1, f_2$ , etc. Fig. 4.1 is not so much for use in particular cases as for general comparisons: one sees how the quantity used increases indefinitely with the pressure curve  $f_1$ ; how it rises to a maximum for vacuum, curve  $f_1'$ ; how slowly transit time decreases as the pressure is increased when  $a$  exceeds 0.50, curve  $f_4$ ; and so on. The general comparisons shown in fig. 4.1 will hold even if the laws of flow are slightly modified, that is, if Fritzsche's or some other equations more nearly

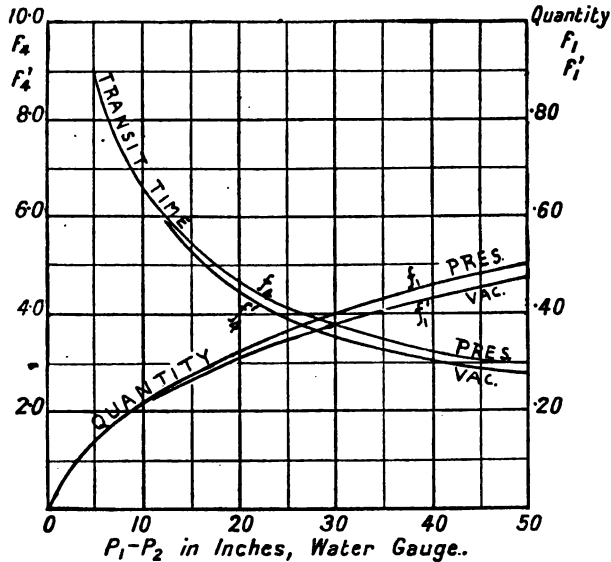

FIG. 4.2.—Pneumatic tubes: transit times and quantities of air used, for tubes worked at low pressures.

Transit time function is  $F_4$  of Eq. 6'09 =  $f_4, f_4'$ .  
Quantity function is from Eq. 4'13 =  $f_1, f_1'$ .

represent the truth. Until such a law is definitely established, the curves in fig. 4.1 will prove useful.

The functions of  $P_1, P_2$  or of  $\phi = P_2/P_1$ , in terms of  $a$  and  $b$ , the ratio of the gauge pressures to atmosphere, are:

Function.	Pressure working.	Vacuum working.	}	(4.20)		
	$P_1 = P_0 + aP_0$	$P_1 = P_0$				
	$P_2 = P_0$	$P_2 = P_0 - bP_0$				
$f_1(\phi),$	$(P_1^2 - P_2^2)^{1/2} = P_0[(2+a)a]^{1/2}$	$f_1' = P_0[(2-b)b]^{1/2}$				
$f_2(\phi),$	$1 - (P_2/P_1)^2 = [(2+a)a]^{1/2}/(1+a)$	$f_2' = [(2-b)b]^{1/2}$				
$f_3(\phi),$	$(P_1/P_2)^2 - 1 = [(2+a)a]^{1/2}$	$f_3' = [(2-b)b]^{1/2}/(1-b)$				
$f_4(\phi),$	$\frac{P_1^3 - P_2^3}{(P_1^2 - P_2^2)^{3/2}} = \frac{\sqrt{8}(3+3a+a^2)}{3[a(2+a)]^{3/2}}$	$f_4' = \frac{\sqrt{8}(3-3b+b^2)}{3[b(2-b)]^{3/2}}$				

Using the graphs in fig. 4'1, the theoretical values of quantities can be obtained when the coefficient of friction, lengths, and temperatures are chosen. The quantities of air flowing in tubes when the initial pressure is 10 lb/in<sup>2</sup> and the final pressure is atmospheric are given here for general information, so that the reader may realise the amount of air involved in tube work.

TABLE 4'1.

For 2½-in. tubes worked at 10 lb/in<sup>2</sup> we have :

L, length in feet . . . . .	1000	2000	3000	6000	9000
M, lb/sec . . . . .	·225	·159	·130	·092	·0752
60Q, cu. ft/min . . . . .	177	125	102	72	59

For 2½-in. hoses worked at 1 lb/in<sup>2</sup> we have :

L, lb/sec . . . . .	300	400	500	600	700
M, lb/sec . . . . .	·114	·097	·087	·079	·073
60Q, cu. ft/min . . . . .	89	76	68	62	57

For a 60-mm tube,  $\zeta = \cdot 00681$ , worked at 0·7 kg/cm<sup>2</sup> :

L, length in metres . . . . .	300	600	1000	2000	4000
M, kg/sec . . . . .	·113	·080	·062	·0438	·031
60Q, cu. metres/sec . . . . .	5·63	4·0	3·1	2·19	1·55

For a 60-mm tube, worked at 0·070 kg/cm<sup>2</sup> :

L . . . . .	100	150	200	250	300
M . . . . .	·054	·0442	·0384	·0342	·0313
60Q . . . . .	2·7	2·21	1·92	1·71	1·57

### C. Effect of altering conditions.

We shall now consider various conditions of working, using the graphs in fig. 4'1. As regards transit time, it will be seen that this is always less with vacuum than with pressure for the same effective difference of pressure,  $P_1 - P_2$ , in the tube. One can also see what pressure gives the same transit time as any particular vacuum, by comparing curves  $f_4$  and  $f_4'$ .

The minimum possible transit time is found when a tube is worked at absolute vacuum,  $P_2 = 0$ , or by using infinite pressure,  $P_1 = \text{infinity}$ . This minimum time is,

$$\frac{(2L)^{3/2} \left[ \frac{1}{gCTD} \right]^{1/2}}{3} = \frac{0.941}{945} \frac{L^{3/2}}{L_1^{1/2}} \quad (4'21)$$

This becomes 45 sec. for a tube 3000 ft. long, the average velocity in the tube being 67 ft. per sec.

As regards quantities, using curves  $f_1$  and  $f_1'$ , it will be seen that there is a limit to the quantity of air which can be used when working with vacuum. The quantity used with vacuum is always less than that used when working with the same amount of pressure. With pressure the quantity of air used can be increased indefinitely as the pressure is increased.

As regards the cost of working under the various conditions, with different tubes the question of the pressures or vacuum maintained in the common connection boxes and in the tubes arises; this is dealt with in Chapter XIII. When working continuously at one particular pressure, the quantities circulating in the same length of 1½-in., 2½-in., 3-in. tubes will be as 1, 2½, 5½ approximately. In practice, the loads due to the various-sized tubes

will not be quite in this ratio, because the shorter tubes are usually of smaller diameter than the long tubes; and the quantity function includes the factor  $(1/L)^{1/2}$ , which is smallest for the longest tubes.

**D. Methods of increasing the speed of carriers.**

Considering two tubes of the same length, one worked "Down" and one worked "Up," both of which require to be speeded up, so as to carry more traffic. It has often been suggested that the working would be improved if the ends of the tube at the out-office were connected: by doing

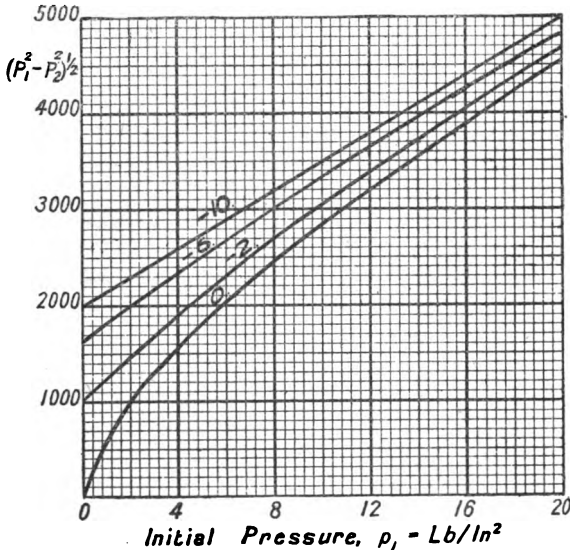

FIG. 4'3.—Function for giving the quantities of air circulating in looped tubes: using English units. The figures on the curves give the final pressure in lb/in<sup>2</sup> gauge. The function is  $(P_1^2 - P_2^2)^{1/2}$ , P in lb/ft<sup>2</sup>.

this the kinetic energy of the air (say  $M'$  lb.) flowing out of the "Down" tube is used to create the kinetic energy of the air (say  $M''$  lb.) entering the "Up" tube; but the kinetic energy is so small that it may easily be less than the energy required to overcome the friction of the pipes and fittings which are necessary to loop the tubes.

We shall investigate the effect of looping, because it does speed up the "Up" tube. Consider the quantities  $M'$  and  $M''$ ,

The quantity flowing in the "Down" tube is,  $M' = f_1$  (constant)

The quantity flowing in the "Up" tube is,  $M'' = f_1'$  (constant).

If the tubes are looped,  $M' = M''$ ; if the working pressure on the "Down" tube exceeds 6 lb/in<sup>2</sup>,  $f_1$  exceeds 1.0; but under no circumstances can  $f_1'$  for vacuum exceed 1.0; see fig. 4'1. Thus the quantity of air circulating in the "Down" tube when the working pressure  $p_1 - p_0 > 6$  lb/in<sup>2</sup> always

exceeds the quantity circulating in the similar "Up" tube, as long as the tubes are not looped. In the British Post Office tube systems the working pressure for "Down" tubes is about 6 to 10 lb/in<sup>2</sup>; therefore, when the tubes are looped, the quantity flowing in the "Down" tube is reduced and the quantity in the "Up" tube is increased; the speed of the one is reduced

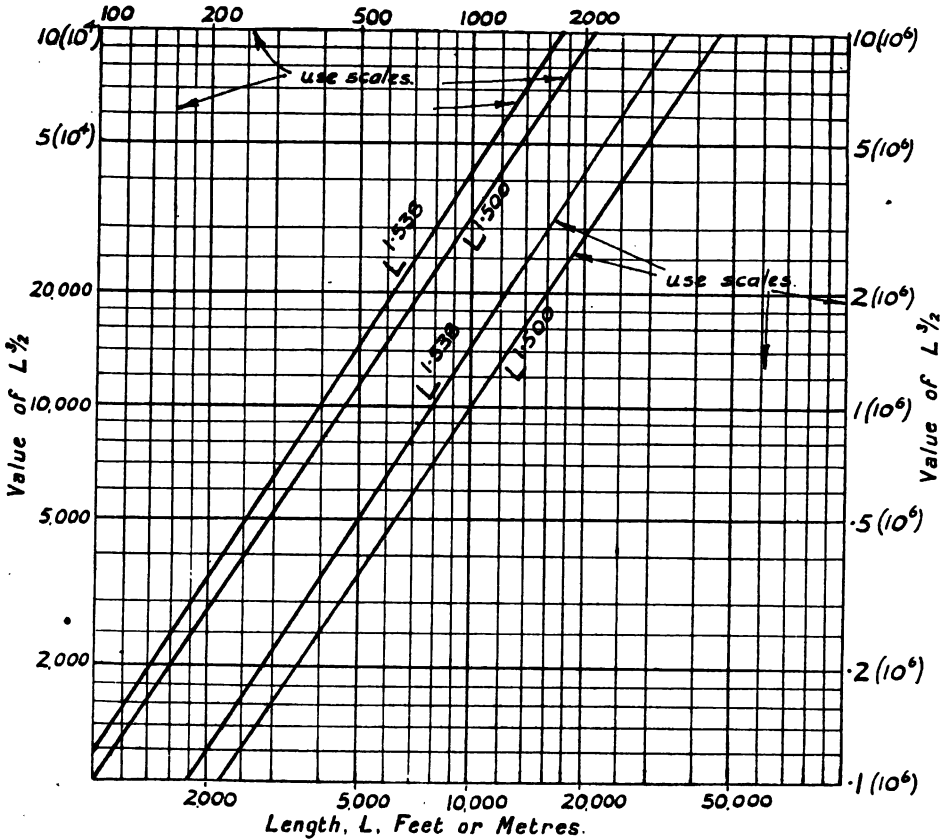

FIG. 4.4.—Functions of L for use in finding transit time.

and the speed of the other is increased. Looping tubes thus gives increased speed on the "Up" tube at the expense of the "Down" tube.

It may be possible to get this increased speed on the "Up" tube without any disadvantage to the "Down" tube, by increasing the vacuum at the Head Office. There is a real gain in speed for increases in the vacuum until the vacuum reaches 10 lb/in<sup>2</sup>; after that the gain in speed is inappreciable: the transit time factors depending on the vacuum are:

$f'_4$	=	1.07	1.14	1.195	1.28	1.38	1.52
lb/in <sup>2</sup> , vac.		11	10	9	8	7	6

The velocity in the "Down" tube may be increased along with that in

the "Up" tube when the tubes are looped if the pressure of working is increased. But it is useless to increase the pressure  $p_1$  beyond the point where the ratio of the initial to final pressure,  $p_1/p_0$  or  $\chi$ , exceeds 4 or 5, or  $\phi$  goes below 0.25-0.20, as the increase in transit time then becomes inappreciable.

To increase the speed on the "Down" tube one has to increase the ratio of the initial to final pressure: this may be done by reducing the absolute pressure  $p_0$  at the out-office. Supposing the initial pressure at the Head Office is 12 lb/in<sup>2</sup>, but that a blower giving a vacuum of 1 or 2 lb/in<sup>2</sup> is placed at the out-office, the transit-time factor  $f_4$  becomes 1.31 instead of 1.42. This same improvement could have been obtained by increasing the pressure at the Head Office to 16 lb/in<sup>2</sup>. The cost of increasing the pressure to 16 lb/in<sup>2</sup> for all the tubes at the Head Office may exceed the cost of blowers for the long tubes only: so that, if there are only one or two long tubes requiring speeding up, it is quite likely that the most economical way of increasing the speed will be to place a blower in the out-office at the end of the "Down" tube. A much greater improvement of speed would be obtained by placing a vacuum pump giving 7 lb/in<sup>2</sup> at the out-office, but the cost would usually be prohibitive.

The same amount of improvement cannot be gained on "Up" tubes by using a blower to give pressure 2 lb/in<sup>2</sup> at the out-office, because the increase in  $\chi$  gives only a slight decrease in the transit-time factor; thus:

		Transit function, $f_4$ .	Increase in $f_4$ .
"Down" tubes @ 10 lb/in <sup>2</sup>	Ordinary working, $\chi = \frac{p_1}{p_0} = \frac{24.7}{14.7} = 1.68$	1.54	
	With blower at out-office } $\chi = \frac{p_1}{p_0 - 2} = \frac{24.7}{12.7} = 1.95$	1.37	12%
"Up" tubes @ 7 lb/in <sup>2</sup>	Ordinary working, $\chi = \frac{p_0}{p_0 - q} = \frac{14.7}{7.7} = 1.92$	1.38	
	With blower at out-office } $\chi = \frac{p_0 + 2}{p_0 - q} = \frac{16.7}{7.7} = 2.17$	1.30	6%

The increase in speed is obviously better in the case of the "Down" tubes.

**E. Question of looping tubes: Increase in total transit time.**

Considering two similar tubes, length L, worked at pressure  $p$  and vacuum  $-q$ . It will be shown that when these tubes are looped so as to form one tube of length 2L, worked with  $p$  and  $-q$ , then the sum of the new transit times is greater than the sum of the former transit times; so that the gain on the "Up" tube is more than counterbalanced by the loss on the "Down" tube: provided that the pressure  $p$  is greater than 6 lb/in<sup>2</sup>. The reason is easily explicable (see fig. 4.5).

The transit times in the first case are,

$$t = f_4 L^{3/2}, \text{ and } t' = f_4' L^{3/2}.$$

The effect of looping the tubes is to shift the point of atmospheric pressure

beyond half way, say to a distance  $a$  feet beyond the middle point, so that the new lengths are  $L+a$  and  $L-a$ , in each of which lengths the same terminal pressures exist as did previously, therefore  $f_4$  and  $f_4'$  are the same as before. The total tube transit time under the new conditions becomes,

$$t+t' = f_4(L+a)^{3/2} + f_4'(L-a)^{3/2} \quad (4.22)$$

This function is a minimum when  $a=0$ , as long as  $f_4$  is equal to or greater than  $f_4'$ . If  $f_4$  is less than  $f_4'$ , then the minimum occurs when

$$\left(\frac{L-a}{L+a}\right)^{\frac{3}{2}} = \frac{f_4}{f_4'} \quad (4.23)$$

The question arises as to whether it is worth while increasing the pressure of working at the Head Office after looping the tubes: it is worth while until a pressure of about 15 lb/in<sup>2</sup> is reached; after that, a more satis-

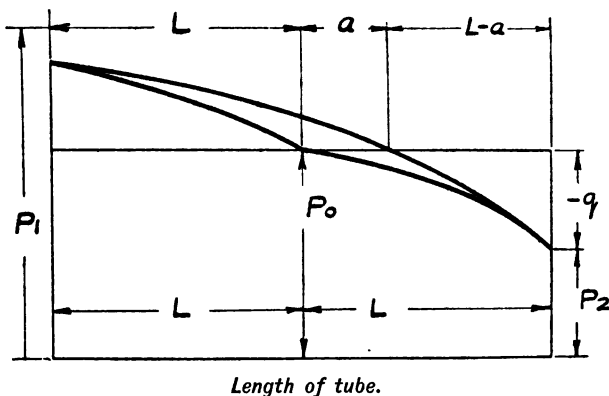

Fig. 4.5.—Theory of looped tubes.  $P_0$ =atmospheric pressure.

factory procedure is to increase the vacuum. If the vacuum at first was 6 lb/in<sup>2</sup> ( $p_2=8.7$ ), and the pressure 15 lb/in<sup>2</sup>, the transit factor would be 1.52: by increasing the vacuum to 8 or to 9 lb/in<sup>2</sup> this factor falls to 1.28 and 1.20 respectively; to get the same diminution by increasing pressure, it would have to be increased to 20.9 and 24.7 lb/in<sup>2</sup> respectively, with 6 lb/in<sup>2</sup> vacuum at the other end. High pressures are disadvantageous, because the tubes tend to become filled with water and oil from the pumps, during the cooling of the hot air.

The point at which the pressure in a looped tube should be atmospheric is easily found. The quantity circulating in the tube depends upon  $[(P_1^2 - P_0^2)/L]^{\frac{1}{2}}$ : we must have then,

$$\frac{L+a}{L-a} = \frac{P_1^2 - P_0^2}{P_0^2 - P_2^2}, \text{ and } P_1, P_0, P_2 \text{ are known} \quad (4.24)$$

Tubes may be speeded up by placing extra plant at an intermediate point and so boost up the tube. Consider a simple case, when such plant provides the same pressure as exists at the Head Office, so that in the new conditions we have pressure  $p$ , working on two lengths  $\frac{1}{2}L$ , instead of

working on length  $L$ ; the other ends being open to atmosphere. The total transit time in the new conditions would be 71 per cent. of the former transit time: the actual gain will be less, because the transshipment of the carriers from one tube to another at the intermediate office will take time. The quantity of energy used in the second case will be  $2\sqrt{2}$  times that used in the first case. The proof is as follows:—The quantity of air circulating is  $\text{const.}/L^{\frac{1}{2}}$  in the first case, and is  $2(\text{const.})/(\frac{1}{2}L)^{\frac{1}{2}}$  in the second case; the constant is the same in both cases, as the terminal pressures are not altered.

In the case of transit times, the transit time at first is  $f_4 L^{3/2} = t_1$ ; in the second case the time for each half of the tube is  $f_4 (\frac{1}{2}L)^{3/2} = t_2$ , and the total time becomes  $2t_2$ : the ratio of these is  $1/(2)^{\frac{3}{2}} = 0.71$ .

**Curves to use in calculations.**—When solving tube problems one should carefully notice the factors which are given, in order to see which are the most suitable formulæ and graphs to use.

Working with open ends, where the pressure is atmospheric—or 14.7 lb/in<sup>2</sup>,—the graphs in fig. 4.1 and 4.2 are suitable: these are also useful in comparing vacuum with pressure working.

If one is working with a tube neither end of which is at atmospheric pressure, then fig. 4.3, 5.1, and 5.2 will be useful. The factors entering into the equations are functions of  $\phi = P_2/P_1$ : fig. 5.2 gives the factor entering into the transit time equation; it is worth noticing how little this factor decreases when  $\phi$  becomes less than 0.20. The quantity function for looped pneumatic tubes can be found at once from fig. 4.3, without calculating the value of  $\phi$ .

**Effect of inaccurate observations, etc.**—The effect of using values of temperature, coefficient of friction, diameter, inaccurate to an extent  $z$  per cent., is to alter transit times generally by  $\frac{1}{2}z$  per cent., as the factors enter into the transit equation as  $[\zeta/(TD)]^{\frac{1}{2}}$ .

The alterations to the transit time are in the direction one would expect, namely, if the temperature is increased, the velocity of flow will increase; if the friction is increased, the velocity will be reduced; if the diameter is increased, the velocity will be increased.

The quantity flowing contains a  $[D^5/(T\zeta)]^{\frac{1}{2}}$  factor; this decreases as the temperature rises, or the friction increases. If the diameter increases, the quantity increases at a greater rate than  $D^2$ . If a tube is much greater than the supposed or nominal diameter, it will take a much greater quantity of air than is expected. If a  $2\frac{1}{2}$ -in. tube is actually  $\frac{1}{32}$  in. more than  $2\frac{1}{2}$ -in. in diameter, 2 per cent. more air will be used than in a true  $2\frac{1}{2}$ -in. tube.

The length of the tube,  $L$ , is the factor which is most likely to be inaccurate, and this enters into the transit function as  $L^{3/2}$ .

**Question of theory and practice.**—It is little use testing the transit time of carriers to prove if the theory concerning the flow of air in tubes is correct, because there is slip between the carriers and the air; theory gives the air transit time. In order to make really satisfactory tests, the quantity should be measured, and also the pressures along the tube, if this is practicable. But, even then, one has to assume a value for the coefficient of friction, and this is known to a much less degree of accuracy than the other factors.

A modification to the air transit formula will usually give an equation for the transit times of carriers which will be true for new carriers, but the



percentage accuracy obtainable will not be much above 5 per cent. This question is dealt with in more detail in Chapter VI.

**F. Some common problems in tube work.**

**Quantities of air flowing in pneumatic house tubes.**—For continuous flow of air in tubes where the variation in density may be neglected, the approximate flow equations can be used. Taking Unwin's value of  $\zeta$ , the flow in 1½-in., 2¼-in., 3-in. tubes is as shown in fig. 2'6: the cubic feet of air are measured at 60° F. and atmospheric pressure. The quantities are

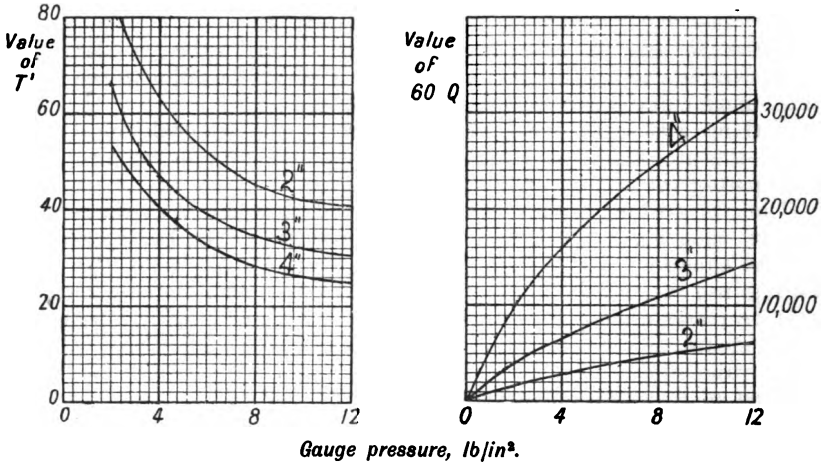

FIG. 4'6.—Comparison of transit times and quantities flowing in pneumatic tubes, 2 in., 3 in., 4 in. in diameter.

$$\text{Transit time} = T'L^{3/2}(10)^{-5}, L \text{ being in ft.}$$

only approximate, but serve to show the size of blowers required to work the tubes. These curves are obtained from Eq. 4'25,

$$h = \frac{u^2 m (1 + \cdot 3/D) 100}{784000D}, \text{ or } h = \frac{m u^2 4\zeta}{2g D} 100 \quad (4'25)$$

Fig. 4'6 shows some comparisons for 2-in., 3-in., 4-in. tubes.

We find the *loss of pressure in service pipes* thus:

Eq. 2'09a gives, 
$$p_1 - p_2 = \frac{32\zeta M^2 L 1728}{\pi^2 g m d^5} \quad (4'26)$$

If  $\zeta = 0\cdot 00295(1 + \cdot 3/D)$ , Martin's value, then

$$p_1 - p_2 = \frac{0\cdot 513M^2 L}{m} \frac{(d + 3\cdot 6)}{d^6} = \frac{0\cdot 513M^2 L f(d)}{m} \quad (4'27)$$

We get for pneumatic-tube work when moderate pressures are used:

- with  $p = 12 \text{ lb/in}^2$  gauge pressure and  $T = 60^\circ \text{ F.}$ ,  $m = 0\cdot 1335$
- with  $p = 7 \text{ lb/in}^2$  gauge vacuum and  $T = 60^\circ \text{ F.}$ ,  $m = 0\cdot 0356$
- with pressure working: per 100 ft. straight pipe,  $p_1 - p_2 = 384 M^2 f(d)$
- with vacuum working: per 100 ft. straight pipe,  $p_1 - p_2 = 1440 M^2 f(d)$ .

Values of  $f(d)$  are given in Table 2·1. The size of the service depends upon the number of tubes to be served: as an example we can assume there are six 2½-in. tubes being worked continuously, and that they each take 4 lb. of air a minute when worked by vacuum ( $M^2=0·16$ ), or 6 lb. of air per minute when worked by pressure ( $M^2=0·36$ ), and that in either case a 4-in. pipe serves them. The loss of pressure in the pipe will be,

$$\frac{384 \cdot (·36) \cdot 1·88}{1000} \text{ pressure,}$$

$$\frac{1440 \cdot (·16) \cdot 1·88}{1000} \text{ vacuum,}$$

giving 0·256 and 0·433 lb/in<sup>2</sup> per 100 ft. It will be seen that the loss is much greater with the vacuum, even though the quantity is much less.

**Effect of two pipes instead of one of equivalent area.**—We assume that the combined area of the two pipes is  $S' = \frac{1}{2}\pi d^2 = \frac{1}{2}\pi (d')^2$ ,  $d'$  being the diameter of the single large pipe, and  $d$  being the diameter of the two small pipes; then  $d' = \sqrt{2}d$ . We want to evaluate the ratio of the loss of pressure in these two cases, viz.,

$$\frac{(p_1 - p_2), \text{ for sending } \frac{1}{2}M \text{ down a pipe } d}{(p_1' - p_2'), \text{ for sending } M \text{ down a pipe } d'}$$

$$p_1 - p_2 = \frac{0·513M^2}{m^4} \frac{(d+3·6)}{d^5} \quad \dots \quad (4·28)$$

$$p_1' - p_2' = \frac{0·513M^2}{m} \frac{(\sqrt{2}d+3·6)}{(\sqrt{2}d)^5}$$

The ratio becomes 
$$\frac{2d+7·2}{(1·414d+3·6)} \quad \dots \quad (4·29)$$

This varies from 0·50 to 0·660 as the diameter of the small pipe  $d$  increases from 0 up to 12 inches: values of the ratio based on Martin's or Unwin's value of  $\zeta$  are given in Table 2·1; this is the loss for a single pipe as compared with the loss for the two pipes; obviously it is much better to use a *single pipe* where possible, rather than two pipes of equivalent area. In general terms, the ratio is  $L_1'/L_1$ , where

$L_1$  is the "equivalent length of pipe" for the diameter  $d$ , and  
 $L_1'$  " " " " " "  $d'$ .

Values of  $L_1$  are given in Table 2·1, so that the ratio can easily be found when Unwin's value of  $\zeta$  is to be used.

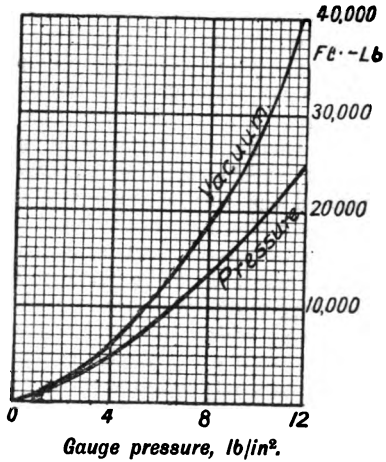

FIG. 4·7—Pneumatic tubes: work required when using various pressures; function  $f_1W$ .

### G. Determination of the size of service pipe.

The question of what size of service should be used to connect the receiver or container and the apparatus requiring the supply of air may be decided by rule of thumb or by existing practice ; but it deserves scientific treatment. The problem is to instal a pipe which will deliver the required amount of air or gas without excessive loss of pressure and without excessive cost. The bigger the service pipe, the less will be the loss of pressure therein, and the smaller will be the pressure in the container to produce the required pressure at the apparatus ; but as the diameter of the service pipe is increased the cost of the installation and the annual charges thereon are increased : the most economical size of pipe to instal is one for which these two effects balance and least cost is obtained. The condition underlying the problem is that the pressure at the end of the service pipe is constant, depending upon what use is made of the air. If a small pipe is used, the pressure at which the air is delivered by the compressor will have to be greater than if a big service is used, and the whole quantity of air used will have to be compressed to this greater pressure. Whether the extra cost for higher compression is less than the extra cost for a larger pipe has to be investigated.

The factors which are known before one proceeds to tackle the problem are :

$M$  = the lb. of air, or gas, per second : averaged over a year.

$M'$  = the lb. of air used by the apparatus, including leakage, per year.

The connection between  $M$  and  $M'$  depends upon how long each day the apparatus is worked.

$m$  = the density of the air, lb/ft<sup>3</sup>, in the service pipe.

$f$  = the overall efficiency of the pump  

$$= \frac{\text{work of isothermal compression per lb. of air}}{\text{watts input to the motors per lb. of air}}$$

$W$  = isothermal work per lb. of air to compress air to the container pressure,  $p$ , in ft.-lb. See Table 4'2, fig. 4'8.

$dW/dp$  = the increase in  $W$  for a 1-lb. rise of pressure, to  $p+1$ .

$a'$  = the cost of current in pence per unit, or per  $2.65 \times 10^6$  ft.-lb.

$L$  = the length of the service pipe in feet.

$d$  = the diameter of the pipe in inches : which is to be determined.

As regards the cost of the installation, the cost of supplying and erecting the various sizes of pipes which might be suitable must be known to the person dealing with the problem, and will be, say,  $B + Ad$  per ft. run : the variation in cost as the diameter is increased must therefore be known. The difference in cost of a pipe of diameter  $d$  and one of diameter  $d+1$  is then known, and is taken as  $A$  : for instance, assuming that the cost of a 4-in. pipe will be 5s. per ft. run, and the cost of a 5-in. pipe will be 6s. 6d., then the value of  $A$  is 18 pence.<sup>1</sup> The cost of interest on capital and depreciation must be known : this is called  $r$ , which will be about  $5\% + 5\% = 0.10$ . The capital charges per year on any pipe per unit length then become,

$$C'' = r(B + Ad) \quad . \quad . \quad . \quad (4.29a)$$

<sup>1</sup> The costs have altered since this was written : these figures are only given as an example.

Now taking an example: if a vacuum of 6 lb/in<sup>2</sup> must be maintained in the connection box to work the tubes, with one size of service pipe there might be a drop of 1 lb/in<sup>2</sup> along the service pipe, and the vacuum maintained in the container would have to be 7 lb/in<sup>2</sup>; whereas with a larger pipe the drop might be only ½ lb/in<sup>2</sup>, and the vacuum maintained in the container would only need to be 6½ lb/in<sup>2</sup>: this latter vacuum could be maintained at less cost than the former vacuum. The equation giving the

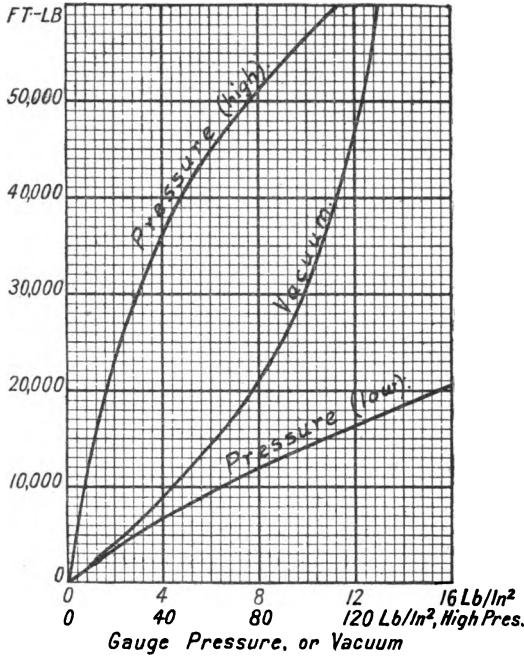

FIG. 4.8.—Work done in isothermal compression per lb. of air, when compressing from atmospheric pressure, 14.7 lb/in<sup>2</sup>, and 60° F.

most economical size of pipe to use, taking into account the above-mentioned factors, is,

$$rA = \frac{M'a'}{f \cdot 2.65(10)^6} \frac{M^2(dW)}{m} \left( \frac{dW}{dp} \right) 0.513 \frac{\partial f(d)}{\partial d} \quad (4.30)$$

This is on the assumption that Martin's value of  $\zeta$  is right.

$$f(d) = \frac{d+3.6}{d^6}, \quad \frac{\partial f(d)}{\partial d} = f'(d) = - \left\{ \frac{5d+21.6}{d^7} \right\}$$

Values of  $1/f'(d)$  are given in Table 2.1.  $dW/dp$  is the increase in isothermal work for a 1 lb/in<sup>2</sup> increase in pressure, and can be obtained from Table 4.2 or fig. 4.8 by noticing the increase in work of compression for the pressure under consideration. Eq. 4.30 is deduced thus:—

The loss of pressure in the pipe line, from Eq. 4.27, is,  $p_1 - p_2 = 0.513 (M^2/m)Lf(d)$ ; the pressure of delivery from the pump is  $p_1$ , while that of

the connection box from which the apparatus is worked is  $p_2$ . The work done in compression to cover the loss in the service pipe is  $W_1 - W_2 = dW = (p_1 - p_2)(dW/dp)$ ; this portion of the work of compression can be reduced if the service pipe is increased in diameter and the friction reduced: the latter portion of the expression, viz.  $dW/dp$ , is fixed, as it depends upon the pressure  $p_2$ , which is the pressure at which the air is to be delivered to the apparatus, which is a constant. The cost of current for compressing  $M'$  lb. of air annually at the extra expenditure of work  $(p_1 - p_2)(dW/dp)$  ft.-lb. is,

$$\frac{M'a'(p_1 - p_2)}{f2650000} \frac{dW}{dp} \text{ pence,} = C' \quad (4\ 31)$$

We want the total annual cost for capital charges,  $C''$ , and air charges,  $C'$ , to be a minimum, therefore  $\frac{\partial C''}{\partial d} = -\frac{\partial C'}{\partial d}$ .

But  $\frac{\partial C''}{\partial d} = rAL \quad (4\ 32)$

$$\frac{\partial C'}{\partial d} = \frac{M'a'}{f2650000} \left(\frac{dW}{dp}\right) \frac{M^2}{m} L(0.513)f'(d) \quad (4\ 33)$$

Combining these two equations, we get Eq. 4.30, which may be put,

$$\frac{1}{f'(d)} = \left(\frac{a'}{rA}\right) M^2 M' \left\{ \left(\frac{dW}{dp}\right) \frac{0.513}{f m 2650000} \right\} \quad (4\ 34)$$

= (money)(load)(pressure) factors.

For pneumatic tubes, when working at 8 lb/in<sup>2</sup> vacuum,  $m=0.0356$ ,  $f$  the overall efficiency may be taken as 50.9 per cent., and the pressure factor becomes 0.048 = K1. For pressure working at 12 lb/in<sup>2</sup>,  $m=0.1335$ ,  $f=51.1$  per cent., pressure factor = 0.034 = K2. For compressed-air work at 80 lb/in<sup>2</sup>,  $m=0.491$ ,  $f=50.5$  per cent., the pressure factor = 0.024 = K3. Then the equation becomes,

$$\frac{1}{f'(d)} = \left(\frac{a'}{rA}\right) M^2 M' [K1, \text{ or } K2 \text{ or } K3,] \text{ for these cases} \quad (4\ 35)$$

Taking an example where there are 8-2 1/4-in. house tubes, each 200 ft. long, or the equivalent of that, worked at about 3/4 lb/in<sup>2</sup>, each using 0.039 lb. of air per second: assuming that they are worked for 4 hours daily on 300 days a year, and that  $r=10$  per cent.,  $a'=2$  pence.

- $M = 8(.038) = 0.300$  lb. a second approximately.
- $M' = 0.3(3600)1200 = 1,300,000$  lb. a year.
- $dW/dp$  at 1 lb/in<sup>2</sup> is approximately 1800 ft.-lb.
- $f$ , the overall efficiency, we shall take as 50 per cent.
- A we shall choose later.

Then we get the equation,

$$\frac{1}{f'(d)} = \frac{2}{(0.10A)} \frac{(3)^2 \cdot 1.3 \cdot 1800 (0.513)}{(0.0764) 50\% (2.65)} = \frac{21300}{A} \quad (4\ 36)$$

Taking A as 12 pence,  $d$  would be about 5 in. If the load were bigger, or if  $f$  were less, a pipe larger than 5 in. might be more suitable.

Taking another example where there are 6-2½-in. tubes to be worked by a vacuum of 8 lb/in<sup>2</sup> for 12 hours a day continuously on 300 days a year, each taking 4 lb. a minute, M=0.4, M'=5,184,000 lb., dW/dp=4450, and assuming r=10 per cent., a=1 penny, A=18 pence, then using the factor K1,

$$\frac{1}{f'(d)} = 22100, \text{ and a 7-in. pipe should be used for the service.}$$

TABLE 4.2.—WORK DONE IN COMPRESSING AIR FROM ATMOSPHERIC PRESSURE (14.7 lb/in<sup>2</sup>, 1.031 kg/cm<sup>2</sup>) AND ORDINARY TEMPERATURE, 60° F. OR 15.6° C., TO VARIOUS PRESSURES.

Gauge pressure.	Theoretical work per lb.			Gauge pressure.	Theoretical work per kg.			
	Isothermal.		Adiabatic.		Metric atmos.	Isothermal.		Adiabatic.
$\frac{p_1}{p_0}$ Lb/in <sup>2</sup> .	Ft.-lb.	Watt-hr.	Ft.-lb.	Lb/in <sup>2</sup> .		Kg/cm <sup>2</sup> .	Kg-m.	Watt-hr.
1	1,830	.69	1,910	1.42	.1	347	.95	354
2	3,530	1.33	3,630	2.84	.2	691	1.86	700
3	5,130	1.94	5,250	4.26	.3	980	2.77	1,020
4	6,660	2.51	6,840	5.69	.4	1,260	3.44	1,340
5	8,130	3.07	8,450	7.11	.5	1,510	4.12	1,600
6	9,550	3.60	10,000	8.53	.6	1,750	4.80	1,870
7	10,650	4.02	11,430	9.95	.7	1,990	5.43	2,150
8	12,020	4.55	12,880	11.37	.8	2,200	6.00	2,400
9	13,040	4.90	14,200	12.80	.9	2,400	6.55	2,640
10	14,500	5.48	15,540	14.22	1.0	2,600	7.07	2,860
12	16,570	6.23	18,000	17.10	1.2	2,950	8.03	3,300
14	18,580	7.00	20,410	19.90	1.4	3,320	9.08	3,760
16	20,500	7.70	23,000	22.80	1.6	3,690	9.80	4,110
18	22,200	8.40	24,700	25.60	1.8	3,860	10.50	4,480
20	23,800	8.94	27,000	28.44	2.0	4,130	11.27	4,850
30	30,840	11.60	36,350	42.66	3.0	5,230	14.27	6,400
40	36,500	13.77	44,410	56.90	4.0	6,050	16.53	7,420
50	41,100	15.50	51,500	71.10	5.0	6,740	18.40	8,310
60	45,000	16.93	57,500	85.30	6.0	7,320	20.10	9,800
80	51,700	19.50	68,100	99.50	7.0	7,850	21.50	10,780

CT=27,700 ft.-lb., T=60° F. or 15.6° C., 1 ft.-lb.=0.0003736 watt-hr.

CT= 3,820 kg-metre, 1 kg-metre=0.002724 watt-hr.

1 atmosphere = 14.7 lb/in<sup>2</sup>=1.031 kg/cm<sup>2</sup>=p<sub>0</sub>.

Isothermal work = CT log<sub>e</sub> (p<sub>1</sub>/p<sub>0</sub>).

Adiabatic work = CT  $\left(\frac{1.408}{0.408}\right) \left[ \left(\frac{p_1}{p_0}\right)^{.29} - 1 \right]$ .

Absolute pressure = [gauge pressure + 1.031] kg/cm<sup>2</sup>.  
 = [ „ „ + 14.70] lb/in<sup>2</sup>.

**Cooling of air at rest in pneumatic tubes.**

Suppose one is testing a tube for leakage, and fills a tube with compressed air at about 95° F. (35° C.). How long will it take for the air to

attain the temperature of the lead, and what will be the loss of pressure through cooling? No appreciable temperature difference is likely to last for more than a few seconds. The weight of air per cm of tube, diam.  $d$  inches, the air being at  $1\frac{1}{2}$  atmos. pressure, is  $.0093d^2$  grams. The gm-cal. given up by the air in falling  $\theta_1$  C. are  $0.237(.0093)d^2\theta_1$ . Assuming that the lead tube is only  $\frac{1}{8}$  in. thick, the volume of lead per cm length is  $\pi(6.46)d(\frac{1}{8})$  cm<sup>3</sup>: the weight is  $28.2d$  gm: the specific heat of lead is 0.035; assume that the rise of temperature of the lead is  $\theta_2$  C.; then  $\theta_2(.035)28.2d = \theta_1(.00218)d^2 = 0.3$  gm-cal. = 1.26 watts, if the fall of air temperature is 15° C. and  $d$  is 3 in. Assuming the surface thermal resistivity of lead and air = 500° C. per watt emitted per cm<sup>2</sup> per sec., the watts absorbed by the lead tube =  $(.002)\pi(2.54)3$  (temp. diff.) = 0.0486 per sec. Suppose that the average temperature difference between the lead and the air is 5°, it will take  $(1.26/0.24) = 5$  seconds for the air to come to the temperature of the lead. Even if the surface thermal resistivity is much greater than 500°, one can see that the time will be small in any case.

The loss of pressure due to cooling from 308° abs. to 293° abs. will be 5 per cent., which is quite appreciable if the absolute pressure in the first case is 22 lb/in<sup>2</sup>.

CHAPTER IV.—SYMBOLS USED.

Equation.	Symbol	Meaning.
4'20	$a'$	=(gauge pressure)/(atmospheric pressure).
4'30	$a'$	=cost of current per unit in pence.
4'30	A	=a constant.
4'20	$b$	=(gauge vacuum)/(atmospheric pressure).
4'02	$C = 53.18$	=gas constant for moist air.
4'29a	$C''$	=capital charges on cost of a pipe line.
4'31	$C'$	=annual charges for current.
4'02	D	=diameter of pipe or tube in feet or metres.
4'13	$D'' = \pi^2 g D^5 / (64 \zeta)$	=a function of the pipe diameter.
4'26	$d$	=diameter in inches or in mm.
4'27	$f(d) = (d + 3.6) / d^6$	=function for loss of pressure.
4'33	$f'(d)$	=differential of $f(d) = -(5d + 21.6) / d^7$ .
4'30	$f$	=overall efficiency of pump.
4'20	$f_1, f_1'$	=quantity function, pressure and vacuum.
4'20	$f_2, f_2'$	=initial velocity function, pressure and vacuum.
4'20	$f_3, f_3'$	=final " " " "
4'20	$f_4, f_4'$	=transit-time function, " " " "
4'01	$g = 32.2$	=acceleration due to gravity.
4'07	L	=lengths, $L_0$ = length of tube.
4'03	$L_1 = D / (4 \zeta)$	= $\mu / \zeta$ = a function of diameter.
4'07	M	=quantity flowing, lb/sec or kg/sec.
4'30	$M'$	= " of air used per year.
4'25	$m$	=density of the air.
4'01	P	=absolute pressure at any point of the tube.
4'07	$P_1, P_2$	= " " at beginning and end of tube.
4'20	$P_0$	=atmospheric pressure.
4'20	$p$	=gauge pressure at which a tube is worked.
4'20	$-q$	= " vacuum " " " "
4'29a	$r$	=interest on capital and depreciation.
4'02	S	=area of tube in sq. feet or sq. metres =0.01225, 0.0276, 0.0491 for $1\frac{1}{2}$ -, $2\frac{1}{4}$ -, 3-in. tubes.
4'02	T	=absolute temperature.
4'22	$t, t'$	=transit times.
4'01	$u$	=velocity, ft/sec or metre/sec.
4'01	$v$	=specific volume.
4'30	W	=isothermal work of compression per lb. of air.
4'01	$\zeta$	=coefficient of friction of pipe.
4'03	$\mu$	=hydraulic mean depth.
4'07	$\varphi = P_2 / P_1$	=ratio of final to initial pressure in pipe.
4'16	$\chi = P_1 / P_2$	= " of initial to final pressure in tube.





## CHAPTER V.

### THEORIES OF AIR FLOW IN PIPES.

Theories of Culley and Sabine—Zeuner—Innes—Hütte and Fritzsche—Harris—  
Equations for the flow in sloping pipes.

At the present time it is not practicable to say which theory is the most correct. Harris' theory is very approximate. Hütte's and Fritzsche's appear to be satisfactory if the value of the constant could be determined accurately for all cases. Innes' is practically the same as Unwin's, which has been given in Chapter IV.

The equations give quantities, pressures, and transit times; they are for use in pneumatic-tube work rather than in ventilation or gas work, where the variation in density during flow is negligible. They are unnecessarily complicated for use when the approximate equation is good enough. Nevertheless, the theories are worth looking at, so as to understand the problems involved.

#### A. Culley and Sabine.

One of the earliest discussions on the subject of flow of air in tubes is the paper given by Messrs Culley and Sabine in 1875, which is reprinted in the book *Pneumatic Transmission*; it is given here, but only briefly because it is theoretically incorrect. The author assumes that expansion is adiabatic (which is not the case), so that  $pv^n = \text{constant}$ ,  $n = 1.408$ . The work done by 1 cu. ft. of compressed air at  $p$  in expanding from  $p_1$  to  $p_2$  is,

$$W = \frac{144p_1}{(n-1)} \left\{ 1 - \left( \frac{p_2}{p_1} \right)^{1-1/n} \right\} \quad \dots \quad (5.01)$$

The velocities in the tube are such that  $\frac{u_1}{u_2} = \frac{v_1}{v_2} = \left( \frac{p_2}{p_1} \right)^{1/n}$ .

The mean velocity in the tube,  $u'$ ,  $= \frac{\text{length}}{\text{transit time}}$ , is assumed to exist where the pressure is a mean of the initial and final pressures, *i.e.* where  $p' = \frac{1}{2}(p_1 + p_2)$ ; hence

$$u' = u_1 \left\{ \frac{2p_1}{p_1 + p_2} \right\}^{1/n} \quad \dots \quad (5.02)$$

The author then states that the volume of compressed air which enters the tube during transit time is  $V_0(p'/p_1)^{1/n}$ , where  $V_0$  is the volume of the

tube : the reason for this statement is not clear. The work done during transit is then,

$$WV_0 \left( \frac{p'}{p_1} \right)^{1/n} = WV_0 \left[ \frac{(p_1 + p_2)}{2p_1} \right]^{1/n} \quad (5'02a)$$

This work overcomes the friction of the air in the tube, accelerates the air, accelerates the carrier, and overcomes carrier friction ; these last three factors are treated as negligible in Culley's final formula and are quite negligible in practice, so in this discussion they are left out of account at once. Culley states that the air friction in ft.-lb. is  $\frac{ZLu'^2}{D 2g} m'V$ , where  $m' = \frac{1}{2}(m_1 + m_2)$ . The value of the coefficient  $Z$ ,  $=4\zeta$ , is taken as 0.0280 for iron pipes and 0.0200 for brass tubes. The reason for the statement as to friction work is not given. Equating work done to friction work, we get,

$$WV_0 \left( \frac{p'}{p_1} \right)^{1/n} = \frac{L 4\zeta u'^2}{D 2g} m'V_0 \quad (5'03)$$

which gives

$$u' = \left[ \frac{2gD}{4\zeta} - \frac{1}{L} \frac{W}{m'} \left( \frac{p_1 + p_2}{2p_1} \right)^{1/n} \right]^{\frac{1}{2}} \quad (5'04)$$

and the transit time,  $=L_0/u' = t$ .

$$t = \frac{L_0^{3/2}}{D^{\frac{1}{2}}} \left[ \frac{4\zeta}{2g} \frac{m'}{W} \left( \frac{2p_1}{p_1 + p_2} \right)^{1/n} \right]^{\frac{1}{2}} \quad (5'05)$$

with values inserted,  $n=1.408$ ,  $\frac{1}{2n} = .357$ ,

$$t = \frac{L^{1.5}}{D^{.5}} (.0176) \left( \frac{m_1 + m_2}{2W} \right)^{.5} \left( \frac{2p_1}{p_1 + p_2} \right)^{.357} \quad (5'05a)$$

$=$ (dimension factor)(pressure and constant factor).

Putting this into the form with  $\phi$  we get,

$$t = \frac{L^{3/2}}{D^{\frac{1}{2}}} \left[ \frac{4\zeta}{2g} \left( \frac{P_1}{CT_1} + \frac{P_2}{CT_2} \right) \frac{1}{2W} \left( \frac{2P_1}{P_1 + P_2} \right)^{1/n} \right]^{\frac{1}{2}} \quad (5'05b)$$

but 
$$W = \frac{P_1}{n-1} \{1 - \phi^{1-1/n}\} \quad (5'05c)$$

and also 
$$\frac{T_1}{T_2} = \left( \frac{P_1}{P_2} \right)^{1-1/n} \quad (5'05d)$$

$$t = \frac{L^{3/2}}{D^{\frac{1}{2}}} \left\{ \frac{4\zeta}{2gCT_1} \right\}^{\frac{1}{2}} \left[ \frac{(1 + \phi^{1/n})(n-1)}{(1 - \phi^{1-1/n})} \left( \frac{2}{1 + \phi} \right)^{1/n} \right]^{\frac{1}{2}} \quad (5'05e)$$

The transit time will be incorrect in so far as  $4\zeta$  does not equal 0.0200 for the three sizes,  $1\frac{1}{2}$ -in.,  $2\frac{1}{4}$ -in., 3-in. tubes. The values of the two parts of the above equation are given in the original paper for various pressures and for three sizes of tubes ; they are also found in Tables IX. and X. of the British Post Office Technical Instructions on pneumatic tubes. The values of the pressure function, which are suitable for comparing Culley's

transit times with those of other authors, are given in fig. 5'2 : these are obtained by dividing his values by,

$$\left[ \frac{4\zeta}{2\gamma CT} \right]^{\frac{1}{2}} = \left[ \frac{0.020}{(64.4) 27700} \right]^{\frac{1}{2}} = .0001057.$$

Then we can say that the transit time is,

$$t = \frac{L^{1.5}}{D^{.5}} \left( \frac{4\zeta}{2\gamma CT} \right)^{.5} \left( \begin{array}{c} \text{Culley's function} \\ \text{in fig. 5'2} \end{array} \right) \quad . \quad . \quad (5'05f)$$

**B. Zeuner.**

The thermodynamic equations upon which discussions on the flow of gases in tubes are based are,

$$J dq = d(Pv) + dU + dH + dz \quad . \quad . \quad . \quad (5'06)$$

$$J dq = -dW + dU + P dv \quad (\text{Stodola, p. 48}) \quad . \quad . \quad (5'07)$$

Subtracting Eq. 5'07 from Eq. 5'06, we get,

$$0 = dW + v dP + dH + dz. \quad . \quad . \quad . \quad (5'08)$$

and when  $dz=0$ ,  $-v dP = dW + dH$ .

The symbols used are :

$J$  = coefficient to bring heat units (calories) to work units (kg-metre).

$dq$  = the heat added from outside.

$dU$  = change in internal energy =  $d[Pv/(\gamma-1)]$  for gases.

$dH = u du/g$  = alteration in velocity head.

$dz$  = alteration in level = 0 in this discussion.

$dW$  = work done by the gas in friction in tubes.

The derivation of the equations is given in Chapter XI., Eq. 11'01. When  $dq=0$ ,  $dW = dU + P dv$ , which gives Zeuner's equations. When  $Pv^n = \text{constant}$ ,  $nP dv = dW + dH$ , which gives Innes' equation. If  $J dq = dH$ , we get isothermal expansion, as  $d(Pv) = -dU = -d[Pv/(\gamma-1)]$ , i.e.  $d(Pv)$  must be = 0; then

$$P dv + dU = dW + dH \quad . \quad . \quad . \quad (5'09)$$

It becomes Unwin's equation when  $dU=0$ , that is, when  $T = \text{constant}$ . Innes' equations as quoted by him are incorrect, because he left out the  $n$  before  $P dv$ ; his equation only holds when  $n=1$ , but then his assumption that  $Pv^n = \text{constant}$  is incorrect.

The equations for the flow in tubes, on the assumptions and with the equations given by Zeuner, are,

$$dW = \frac{\zeta dL H}{\mu} = \frac{v dP + \gamma P dv}{\gamma - 1}, \text{ from 5'07} \quad . \quad . \quad (5'10)$$

but 
$$H = \frac{u^2}{2g} = \frac{M^2 v^2}{S^2 2g} \quad . \quad . \quad . \quad (5'10a)$$

and 
$$Pv^n = \lambda, \quad v dP = -nP dv \quad . \quad . \quad . \quad (5'10b)$$

Then 
$$\frac{(\gamma-1)\zeta M^2 dL}{2g\mu S^2} v^2 = v dP + \gamma P dv = P dv(\gamma-n) \quad . \quad . \quad (5'11)$$

As long as there is friction  $n$  can never =  $\gamma$ : when there is little friction  $\zeta$  is small and  $n$  approximates  $\gamma$ .

Putting B for the constant in the first term,

$$BdL = - \frac{(\gamma - n)}{n} \frac{dP}{v} = - \frac{(\gamma - n)}{n} dP \left( \frac{P}{\lambda} \right)^{1/n} \quad (5.11a)$$

Integrating,

$$BL + A = - \frac{(\gamma - n)}{n} \frac{P^{1+1/n} n}{\lambda^{1/n} (n+1)} = \frac{(\gamma - n)}{(n+1)} P m \quad (5.11b)$$

$$A = - \frac{(\gamma - n)}{(n+1)} P_1 m_1$$

$$BL = \frac{(\gamma - n)}{(n+1)} (P_1 m_1 - P m) \quad (5.12)$$

$$\frac{(\gamma - 1) \zeta M^2 L}{2g \mu S^2} = \frac{(\gamma - n)}{(n+1)} P_1 m_1 (1 - \phi^{1+1/n}) \quad (5.12a)$$

which shows how  $\phi$  or P falls with the distance L from the beginning of the pipe.

The quantity is given by,

$$M^2 = \frac{(\gamma - n)}{(\gamma - 1)} \frac{2\gamma P_1 m_1 S^2 L_1}{(n+1)L} (1 - \phi^{1+1/n}) \quad (5.13)$$

The transit time from Zeuner's equation 5.11 is found from,

$$dL v^2 \left( \frac{M}{S} \right)^2 = P dv \frac{(\gamma - n)}{(\gamma - 1)} \left( \frac{2\gamma D}{4\zeta} \right) \quad (5.14)$$

which is like Innes' equation 5.21, only  $(\gamma - n)/(\gamma - 1)$  replaces  $n$ . Zeuner's transit time is given in Chapter VI., Eq. 6.07.

### C. Innes.

Innes (*Air Compressors*, p. 28) discusses the flow in tubes for an expansion law,  $Pv^n = \text{constant}$ . The loss of head per length dL is  $dZ$

$$= \frac{\zeta dL u^2}{\mu 2g} = \frac{\zeta dL H}{\mu}$$

We then get the energy equation, from Eq. 5.08,

$$n P dv = dZ + dH = \frac{\zeta dL u^2}{\mu 2g} + \frac{u du}{g} \quad (5.15)$$

and can deduce 
$$\frac{n 2g S^2}{(n+1) M^2} (P_1 m_1 - P m) = \frac{2}{n} \log_e \frac{P_1}{P} + \frac{\zeta L}{\mu} \quad (5.16)$$

Neglecting the log term, we get, for quantities,

$$M^2 = \frac{2g \mu S^2}{\zeta L} \left( \frac{n}{n+1} \right) (P_1 m_1 - P_2 m_2) = \left( \frac{\pi^2 g D^5}{64 \zeta} \right) \frac{2 P_1}{CT} \frac{(1 - \phi^{1+1/n}) n}{L(n+1)} \quad (5.17)$$

$$\begin{aligned}
 M &= SP_1 \left[ \frac{L_1 2g}{LCT_1} \right]^{\frac{1}{2}} \left[ \frac{n(1-\phi^{1+1/n})}{n+1} \right]^{\frac{1}{2}} \\
 &= m_1 \left[ \frac{2gCT_1 L_1}{L} \right]^{\frac{1}{2}} f(n, \phi) \quad \dots \quad (5.18)
 \end{aligned}$$

Values of  $f(n, \phi)$  are given in fig. 5.1, and of  $L_1$  in fig. 3.1. The temperature of the air at the far end can be found from,

$$T = T_1 \phi^{1+1/n}, \quad T_2 = T_1 \phi_0^{1+1/n}; \quad \text{see fig. 5.1} \quad \dots \quad (5.19)$$

The equation giving the pressure at any point is,

$$\frac{P_1^{1+1/n} - P^{1+1/n}}{P_1^{1+1/n} - P_2^{1+1/n}} = \frac{L}{L_0} = \frac{1 - \phi^{1+1/n}}{1 - \phi_0^{1+1/n}} \quad \dots \quad (5.20)$$

Values of  $\phi^{1+1/n}$  are to be found in fig. 5.1; the value of  $n$  will usually lie

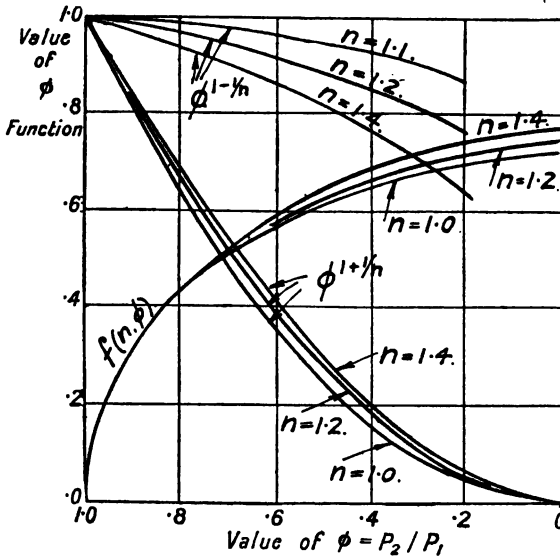

FIG. 5.1.—Quantity, temperature, pressure, functions depending upon  $\phi$ , the ratio of final to initial pressure,  $P_2/P_1$ . See Eq. 5.18, etc.

between 1.0 and 1.2, but the functions are given for values up to 1.4, the index for adiabatic expansion.

The transit time is found from Innes' equations, by using Eq. 5.15 and neglecting the term  $u du/g$ ; then we get,

$$t = \frac{L_0^{3/2}}{D^{\frac{5}{2}}} \left( \frac{4\zeta}{2gCT} \right)^{\frac{1}{2}} \frac{(n+1)^{3/2}}{(n+2)n^{\frac{1}{2}}} \frac{(1-\phi^{1+2/n})}{(1-\phi^{1+1/n})^{3/2}} \quad \dots \quad (5.21)$$

The resemblance of these formulæ to those of Unwin may be seen at once; they become the same when  $n=1$ . In practice one has to determine which value of  $n$  best suits the results of tests: the variation in quantities and transit times due to varying  $n$  and  $\phi$  can be seen in fig. 5.1: the effect of varying  $n$  is very small.

The effect of neglecting the log term in finding quantities gives a value greater than the true one, as the log term would increase the denominator slightly: for instance, if  $p_1/p_2=5=\chi$ , which is a very high value, and the tube is only 3000 ft. long, the log term is about 3, and the friction term is 440: usually the log term will be less and the friction term greater, which shows that there is practically no error in neglecting it.

It is quite conceivable that the law of expansion and the value of  $n$  are not independent of the pressures or the ratio of pressures: in the case of short tubes with rapid flow, the expansion may follow a different law than in long tubes when the flow is relatively slow.

#### D. Hütte and Fritzsche.

Hütte (*Engr. Handbook*, vol. i. p. 363) gives the main equation for flow of gases in tubes,

$$u \, du/g + v \, dP + dZ + dz = 0 \quad (\text{Eq. 5'07}) \quad (5'22)$$

$dZ$  is the friction term,  $dz$  is the difference in level in  $dL$ . If  $u$  is less than the critical velocity of air, then the friction

$$dZ = \text{const.} \frac{\eta u \, dL}{mD} \quad (5'23)$$

but if  $u$  is greater than the critical velocity, then friction

$$dZ = \frac{\beta u^2 dL}{D} \quad (5'24)$$

The value of the critical velocity is given in Chapter I. In commercial practice the velocities exceed the critical velocities.

If we take a pipe line all at one level,  $dz=0$ : assume that the gas follows the law of expansion  $Pv^n = \lambda$ , also  $Mv = Su$ , then

$$\frac{u \, du}{g} + v \, dP + \frac{\beta u^2 dL}{D} = 0 \quad (5'25)$$

$$\text{or} \quad dP \left\{ 1 - \frac{u^2}{gnPv} \right\} + \frac{m\beta u^2 dL}{D} = 0 \quad (5'25a)$$

Putting the velocity of sound in the gas  $u_s = (g\gamma Pv)^{\frac{1}{2}}$ ,

$$dP \left\{ 1 - \frac{\gamma u^2}{nu_s^2} \right\} + \frac{m\beta u^2 dL}{D} = 0 \quad (5'25b)$$

In ordinary cases  $u$  is much smaller than  $u_s$ , so that the formula can be written as  $-dP = \beta mu^2 dL/D$ , which gives the loss of pressure at each point along the tube for the length  $dL$ . Then with a long tube, where  $m$  and  $u$  can be considered constant, this can be at once integrated so that it becomes,

$$P_1 - P_2 = \frac{\beta mu^2 L}{D}$$

This formula converted into one with quantities becomes,

$$P_1 - P_2 = \frac{16\beta M^2 L}{\pi^2 dm} \quad (5'26)$$

Fritzsche used this formula when he deduced the empirical value of  $\beta$  from various tests as,

$$\beta = 6.02(d)^{-2.69}(mu)^{-1.48} \quad (5.27)$$

$d$  is in mm,  $m$  is in  $\text{kg/m}^3$ ,  $u$  is in metres,  $M$  in  $\text{kg/sec}$ . The value of  $\beta$  can also be expressed in a form including  $M'$ , the quantity in  $\text{kg/hour}$ , thus,

$$\beta = 2.526d^{.027}(M')^{-1.48} \quad (5.28)$$

As the variation of the term  $(d)^{.027}$  is only slight as  $d$  itself varies, we

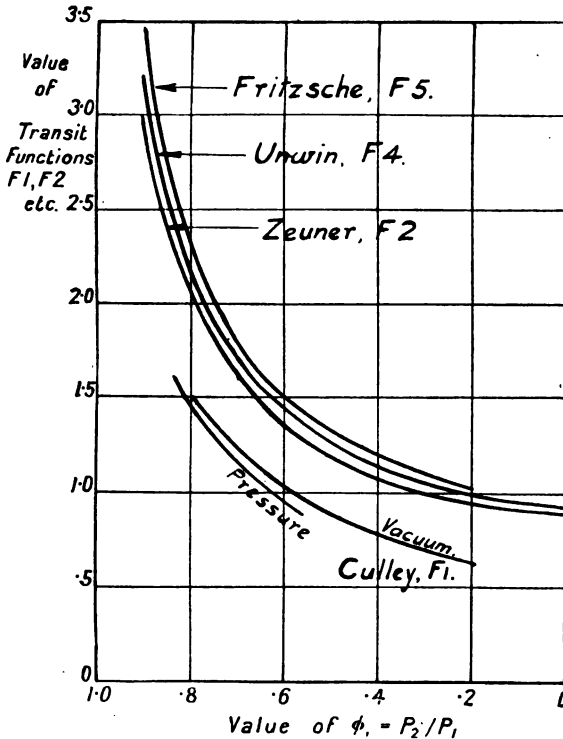

FIG. 5.2.—Transit time functions based on values of  $\phi$ , the ratio of final to initial pressure. For the values of  $F1, F2$ , etc., see Eq. 6.06, etc. The values of the function according to Innes lie between Fritzsche's and Unwin's.

choose a value when  $d=100 \text{ mm}=3.94 \text{ in.}$ , and

$$\beta = 2.86(M')^{-1.48} \quad (5.29)$$

This gives a coefficient  $\beta$  depending on the quantity flowing (see fig. 2.2), not upon the diameter.

Working from Hütte's equation for the loss of pressure, we get,

$$dP = \beta \frac{mu^2 dL}{d} = \frac{6.02(m)^{0.852}(u)^{1.852}dL}{(d)^{1.269}} \quad (5.30)$$



which is the value given in *Eng. Dig.*, 5/164/1909. The constant 6.02 becomes 0.000315 =  $\alpha$  when English units are used.

We have equations as follows, on the assumption that the expansion is isothermal,  $Pv = CT$  :

$$\frac{SuP}{CT} = Sum = M, \quad (\mu u)^n = \left(\frac{M}{S}\right)^n$$

$$dP = \frac{\alpha(\mu u)^n u dL}{D^{\alpha}} = \alpha \left(\frac{M}{S}\right)^n \frac{u dL}{D^{\alpha}}, \quad \text{where } n = .852 \quad (5.31)$$

giving 
$$M = \left(\frac{D^{\alpha}}{\alpha CT}\right)^{.54} S \left(\frac{P_1^2 - P_2^2}{2} \frac{1}{L}\right)^{.54} \quad (5.32)$$

$$M = \frac{\pi}{4} \frac{1}{(\alpha CT)^{.54} D^{.015}} \left\{ \frac{(P_1^2 - P_2^2) D^5}{2 L} \right\}^{.54} \quad (5.33)$$

$$M = (\text{constant})(\text{pressure, length function}) \quad (5.34)$$

Now, for transit times, from Eq. 5.31,  $n = 1.852$ ,  $q = 1.269$ ,  $\alpha = 0.000315$ .

$$t = \int \frac{dL}{u} = \int \frac{D^{\alpha}}{\alpha} \frac{dP}{(M/S)^n u^2} = \int \frac{D^{\alpha} dP (S/M)^{n+2}}{\alpha v^2} \quad (5.35)$$

$$= \int \frac{D^{\alpha} dP P^2}{\alpha (CT)^2} \left(\frac{S}{M}\right)^{n+2} \quad (5.36)$$

$$= \frac{0.000116 L^{1.538}}{P_1^{.076} D^{.685}} \left(\frac{2}{1-\phi^2}\right)^{1.538} \left(\frac{1-\phi^3}{3}\right) \quad (5.37)$$

For finding values of  $t$ , see Chapter VI.

### E. Harris.

Harris deduces an equation for flow in tubes, which he says is good enough for ordinary use : afterwards he proceeds to discuss the more exact equation. The former equation is found as follows :—

Fluid friction is assumed to be  $ku^2x$  per sq. ft. of surface :  $k$  being the force necessary to move air at atmospheric pressure at the rate of 1 ft. per second over 1 sq. ft. of surface. The thought in the author's mind is that the tube or pipe is full of a mass of air which for the moment may be considered like a solid block, and this solid block has to be moved along the tube by means of the force at the end of the tube.

The total pipe friction,  $F$ , is  $\pi DLku^2x$  : this must equal the force moving the mass of air, which is the net pressure multiplied by the area of the pipe,

$$= (P_1 - P_2)S = \pi DLku^2x \quad (5.38)$$

The mean values of pressures, densities, velocity are taken, and the Eq. 2.64, etc., are obtained.

### F. Equations when the pipe is not level.

So far we have only dealt with the flow in pipes which are all at one level, but now we shall give the equation allowing for alteration in level. But

in order to make it soluble the temperature is assumed constant, that is, Unwin's equations are followed.

From Eq. 5'08 we get,

$$dW + v dP + dH + dz = 0 \quad (5'39)$$

and we assume that the pipe falls continuously in such a way that  $dz = \psi dL$ , so that,

$$\zeta H/\mu dL + v dP + dH + \psi dL = 0 \quad (5'40)$$

We neglect  $dH$ , which accounts for the difference in velocity and which is always small, and get,

$$dL = \frac{-v dP}{(\zeta/\mu)H + \psi} \quad (5'41)$$

Now

$$H = \frac{v^2}{2g} = \left(\frac{CTM}{S}\right)^2 \frac{1}{P^2 2g}, \quad v = \frac{CT}{P}$$

$$dL = \frac{-CT dP/P}{\frac{\zeta}{2g\mu} \left(\frac{CTM}{S}\right)^2 \frac{1}{P^2} + \psi} \quad (5'42)$$

We assume that  $T$  is constant, and then this is easily integrable,

$$dL = \frac{-P dP}{\frac{\zeta}{\mu 2g CT} \left(\frac{CTM}{S}\right)^2 + \frac{\psi P^2}{CT}} = \frac{-P dP}{a + \frac{\psi P^2}{CT}} \quad (5'43)$$

giving

$$L = -\frac{CT}{2\psi} \log_e \left( a + \frac{\psi}{CT} P^2 \right) \quad (5'44)$$

The full solution is then,

$$\frac{1 + \frac{\psi}{aCT} P_1^2}{1 + \frac{\psi}{aCT} P^2} = e^{\frac{2\psi L}{CT}} = e^{\frac{2(z_1 - z_2)}{CT}} = e^{\frac{2h}{h_a}} \quad (5'45)$$

$$(1 + bP^2) = (1 + bP_1^2)e^{-2aLb} \quad (5'46)$$

where  $b = \psi/(aCT)$ ,  $h = z_1 - z_2$ ,  $h_a = CT = 27,700$ ;

then  $P^2 = (P_1^2 - 2aL) - 2aLb(P_1^2 - aL) + 2a^2L^2b^2\left(P_1^2 - \frac{4}{3}aL\right) + \text{etc.}$

$$= (P_1^2 - 2aL) - 2(h/h_a)(P_1^2 - aL) + 2(h/h_a)^2\left(P_1^2 - \frac{4}{3}aL\right) + \text{etc.} \quad (5'47)$$

When  $z_1 - z_2 = h = 0$ , this is exactly Unwin's formula, Eq. 4'14, as  $a$  stands for  $4\zeta CTM^2/(2gDS^2)$ .

This means that, when we have a sloping pipe, the pressure  $P_2'$  existing at the end is less than the pressure  $P_2$  which would exist if the pipe was not sloping, by the amount,

$$\frac{2(\text{difference in height})}{(\text{atmospheric height})} (P_1^2 - aL) \quad (5'48)$$

The correction is quite a small one, as the atmospheric height is about 27,700 ft., and the difference in level will usually be less than 1 per cent. of this.

Laschinger's discussion (*Eng. Dig.*, 3/491/1908) concerning the flow in pipes which are not level is:

$$\begin{aligned} P_t &= \text{pressure at the top of the pipe,} \\ P_b &= \text{,, ,, bottom of the pipe.} \end{aligned}$$

$$\text{Then} \quad P_b = P_t e^{(\rho_1 - \rho_2)(CT)} \quad (5.49)$$

$$\text{because} \quad dP = m dz = P dz / (CT).$$

Then for any problem, if we want to find out how much air will flow down a pipe, we have got  $P_t$  the top pressure =  $P_1$ ;  $P_b$  the bottom static pressure, and we assume that the actual bottom pressure will be  $P_2 = P_b - (\text{loss of head in friction.})$  The mean pressure is  $\frac{1}{2}(P_1 + P_2)$ ; but until this is known the loss of pressure is undetermined. One could well enough take  $\frac{1}{2}(P_b + P_t)$  as the mean pressure, however.

## CHAPTER V.—SYMBOLS USED.

Equation.	Symbol.	Meaning.
5'11	A	=a constant.
5'43	a	= "
5'11	B	= "
5'46	b	= "
5'18	C	=the gas constant.
5'04	D	=diameters.
5'26	d	= "
5'04	g	=force of gravity.
5'06	H = $u^2/(2g)$	=head due to velocity.
5'38	k = $m_0 \zeta/(2g)$	=frictional force.
5'18	$L_1 = D/(4\zeta)$	= $\mu/\zeta$ , a function of the pipe diameter.
..	L	=lengths.
5'20	$L_0$	=the length of the pipe.
5'10a	M	=weight of gas flowing per sec.
..	m	=densities.
5'03	$m' = \frac{1}{2}(m_1 + m_2)$	=mean density.
5'01	n	=index of polytropic, or adiabatic expansion.
5'31	n = 0.852	=index of m in flow equation.
..	p, P	=pressures.
5'02	$p' = \frac{1}{2}(p_1 + p_2)$	=mean pressure in pipe.
5'31	q = 1.269	=index of D in flow equation.
5'10a	S = $\pi D^2/4$	=section of pipe.
5'21	T	=absolute temperatures.
5'05	t	=transit time.
5'25b	u	=velocities.
5'02	$u' = L_0/t$	=mean velocity.
5'25b	$u_s = (g\gamma Pv)^{\frac{1}{2}}$	=velocity of sound in gas.
5'06	U	=internal energy of gas.
5'01	v	=volumes.
5'03	$V_0 = L_0 S$	=volume of the pipe.
5'01	W	=work done by air.
5'07	W	=external work done by gas in pipe.
5'38	x = $P/P_0$	=ratio of pressure to atmosphere.
5'22	Z	=work done in pipe friction.
5'39	z	=height above datum line.
5'31	$\alpha$	=a constant.
5'24	$\beta$	= "
5'10	$\gamma = 1.408$	=index of adiabatic expansion.
5'13	$\varphi = P_2/P_1$	=ratio of pressures.
..	$\chi = P_1/P_2$	= " " "
5'10b	$\lambda = Pv^n$	=a constant.
5'10	$\mu = D/4$	=hydraulic mean depth.
5'03	$\zeta$	=coefficient of friction.
5'40	$\psi = dz/dL$	=slope of pipe.



## CHAPTER VI.

### TRANSIT TIME OF CARRIERS.

Transit time as affected by: Length of tube—Diameter of tube—Physical condition of the tube—Pressure at which the tube is worked—Type and condition of the carrier—Methods of working, whether continuous or intermittent—Existence of leaks—Equations for transit time.

THIS chapter deals with the time of transit of carriers in pneumatic tubes, both during ordinary conditions of working and during special tests made under special conditions. The factors which influence transit time for any particular tube are :—

- (A) The length of the tube.
- (B) The diameter of the tube.
- (C) The material and physical condition of the tube.
- (D) The pressure at which the tube is worked.
- (E) The type and condition of the carrier used.
- (F) The methods of working, whether continuous or intermittent.
- (G) The existence of leaks.

#### A. Effect of length.

As shown in Chapter IV., Eq. 4'11, the length of the tube,  $L$ , enters into the transit-time formula as  $L^{3/2}$ : this is reasonably certain, and the only question is to know the true length of the tube, which is not a simple matter. In commercial businesses the length of the tubes will be only known approximately, as a knowledge of the length is unimportant for ordinary working. The length of tubes laid specially for test purposes can be measured accurately. In the case of the British Post Office the lengths of tubes are recorded just as all plant is recorded, but one can never be certain that every slight alteration to the length of a tube is entered on the records. An exhaust pipe may be added at the end of a tube, or the position of some apparatus may be shifted, and the alterations in the length may be so slight as to be not worth recording. For instance, the records of a street tube might show :

Length in head office . . . . .	60 ft.
„ „ street . . . . .	3000 „
„ „ out-office . . . . .	30 „
	<hr/>
Total . . . . .	3090 ft.

An alteration to the apparatus at the out-office, which increased the length by 20 or 30 ft., would be negligible as regards effects on the working ; but, if one tried to compare theory and practice, the addition of 1 per cent. to the length would produce errors of  $\frac{1}{2}$  per cent. in the quantities and transit times to be expected.

We have seen it stated that a particular formula for transit time gives results correct to within 1 per cent. : such accuracy is unrealisable in practice, because the observations of length, pressure, diameter are not made to such a degree of accuracy. Results of tests may agree to within 1 per cent. of results computed from a formula, but, unless each of the quantities in the formula is known accurately, the percentage accuracy of the formula is not determinable ; and it is merely a chance that the small inaccuracies in the quantities cancel out and give a result agreeing so closely with practice. It is satisfactory if the actual transit time for a particular tube worked at a particular pressure is within 5 per cent. of the theoretical time computed from the formula.

In the case of a tube laid in the street, unless the length has been carefully measured when it is being laid, it cannot be known accurately. In the case of tubes in buildings, as the whole tube may be within reach, the length can be measured at any time ; but to get the accurate length of such a tube when there are a good many bends and sets is not easy, and one may have to be content with the approximate mean length.

### B. Effect of the diameter.

As regards diameter, one should remember that there are three different measurements which can be called the "diameter" of the pipe or tube, these being (i.) the *actual* diameter at any point, which would have to be measured in hundredths or thousandths of an inch ; (ii.) the *standard* diameter of the tube as drawn by the makers ; (iii.) the *nominal* diameter of the tube, by which it is usually known. Considering the *nominal* diameter : in America, a pipe known as  $1\frac{1}{2}$ -in. is less than  $1\frac{1}{2}$  in. in internal diameter. In England,  $2\frac{1}{4}$ -in. tube may measure  $2\frac{1}{4}$  in. either outside or inside : Culley mentions in his paper on pneumatic transmission that the tubes called  $2\frac{1}{4}$ -in. were actually only  $2\frac{3}{16}$  internally. This is about the size of the tubes used by Messrs Reid Bros. in their house tube installations.

The standard diameter of the tube in this case is  $2\frac{3}{16}$  in., which is the diameter of the mandril fitting into the tube. The actual diameter of this tube at any place would vary to the extent of some thousandths of an inch above and below the standard, *i.e.* it might be 2.190 in., 2.170 in., instead of 2.1875 in. These variations are always small, and will tend to be both positive and negative. For use in formulæ the *standard* diameter would be used.

The variation likely to exist in practice will be less than  $1\frac{1}{2}$  per cent., which is  $\frac{1}{32}$  in. in a  $2\frac{1}{4}$ -in. tube. Greater variations, if negative, would be noticeable, as new carriers would be very liable to become wedged in the tube. The variations from the standard diameter will have little effect on the computed transit time : even if the tube was everywhere as much as 1 per cent. too big or too small, the error in the computed transit time would be only  $\frac{1}{2}$  per cent. from this cause.

### C. Effect of the physical condition of the tube.

I know of no experiments made to determine the effect of the lie of the tube upon the transit time. Taking the case of a street tube: if it had many twists and turns, the carrier would inevitably travel slower than in a perfectly straight tube; if the tube was laid on a great slope, carriers would travel in a downward direction at a greater rate than they would travel upwards. The effect of these factors, however, could only be measured properly if the lengths of the tubes were known very accurately and the condition of carriers used in the tests were perfect; otherwise the variations in transit time as between carriers moving in level as opposed to sloping tubes, or in straight as opposed to curved tubes, might be due to variations in the condition of the carriers, or to imperfect readings of the tube lengths and pressures.

The material of the tube affects transit time very slightly, because the surface of the tube must be very smooth if carriers are to travel freely, and the friction depends upon the smoothness of the surface, not upon its material. The rubbing of the carriers upon the walls of the tube keeps the surface smooth, and gives a high polish to lead tubes. The effect of the material on the flow of air, in the case of pipes for transmitting gas or compressed air, is quite different, because the surface may be rough without the flow being stopped, and the method of manufacture and the treatment to prevent corrosion will considerably affect the smoothness of the pipes, whether of iron, steel, brass, or other material.

The existence of foreign material in the tube, such as oil, dirt, or water, affects the speed of carriers. Dust will only collect in tubes when they are not being used; but oil, water, and grit may find access to the tube during ordinary working conditions. Moisture is always liable to be present, because the air expands and falls in temperature as it flows along the tube. Oil from the pumps may be carried over to the tubes when these are worked at relatively high pressures and temperatures. The water collects in the dips in tubes, and resists the motion of carriers: this is especially noticeable in the case of old and worn carriers, as the air flows past them and leaves them stationary in the pool of water until a new carrier arrives at the spot and fills the tube, thus preventing the flow of air past the carrier. The pressure then rises behind the new carrier and drives both carriers through the water. Every tube between two offices, which is laid in a street, must have a dip somewhere in its length, as the tube always rises to the terminating instruments in the offices. If the office in one case was in a basement below the level of the street, it might be possible to get a tube with a falling gradient over the whole length, but such a case would have to be specially arranged for.

The quantitative effect of these factors upon the transit time is indeterminable.

### D. Effect of pressure.

The effect of the pressure of working upon transit time has been discussed in theory in Chapters IV. and V.: it has been seen that the important factor is not the absolute pressures at the ends of the tube, but the ratio of the sending pressure to the receiving pressure. Practice agrees



well with theory, except when the tubes are being worked at a very high vacuum, when the air is so rarefied that it leaks past carriers, and has not the same power of driving them along the tube as when denser air is used. Both Culley and Kempe give equations for the *approximate* transit time which include the pressure function  $1/(p_1 - p_2)^{\frac{1}{2}}$ : this is only a rough approximation, because the transit time depends upon the value of the mean pressure. The same difference of pressure when driving compressed air through the pipe line will not give the same time of transit as when driving rarefied air.

Culley's equation (*Pneumatic Transmission*, p. 54) is practically the same as Kempe's, and is,

$$t = 0.000482 \left[ \frac{L^3}{D(p_1 - p_2)} \right]^{\frac{1}{2}} \quad (6.01)$$

An equation of this form can be deduced by using Eq. 2.09c and assuming a constant air velocity.

$$\text{The constant } 0.000482 \text{ stands for } \left[ \frac{2\zeta m}{144g} \right]^{\frac{1}{2}} \quad (6.01a)$$

giving  $\zeta m = 0.00054$ ; if  $m = 0.0764$ ,  $\zeta = 0.0070$ .

### E. Effect of type of carrier.

The variation of the type or condition of carriers used makes a considerable difference to the transit time, but practically no difference to the consumption of energy in working the tube if the tube is being worked continuously, and a very slight difference if the tube is being worked intermittently. As regards energy used, this is due to the air friction on the whole length of the tube, and to carrier friction on a very small portion of the tube: the carrier friction on a 6000-ft. (1.8-km) tube may amount to that from six carriers, taking up a length of 3 to 5 ft. (90 to 150 cm) in all; this latter friction is negligible whether the carriers are new or old. If the tube is being worked intermittently, *i.e.* power is only turned on while the carriers are being sent, the power will have to be kept on for a longer period if worn carriers are being used, as their speed of travelling is less than that of new carriers; but the extra power used is not determinable in practice, because the power is never turned off immediately the carrier arrives at its destination. A tube attendant has more than one tube to attend to, and some time elapses between the receipt of a signal acknowledging the arrival of a carrier and the turning off of the power; and the signal itself may not be given immediately the carrier has reached its destination. The extra energy consumption due to the use of carriers in various conditions of wear cannot be separated from the extra energy used owing to lax attendance.

The speed of different types of carriers will be the same as long as the buffer fits the tube closely; but if the buffer is worn the speed is only approximately determinable, as there is no really satisfactory criterion of the amount of wear on the buffer. I am thinking now of carriers about  $1\frac{1}{2}$  in.,  $2\frac{1}{4}$  in., and 3 in. in diameter; with carriers 6 in. and 8 in. diameter, no doubt, it might be possible to measure the speed for carriers whose buffers differed

by  $\frac{1}{4}$  in.,  $\frac{1}{2}$  in. from the standard. In most of the routine tests made on British Post Office tubes to find transit times, new carriers are used ; these show the best time possible, and show if the tube is in good order. In the tests which I made, both new and old carriers were usually employed, so as to find the ordinary transit time as well as the best time. The results of these tests showed a difference of carrier speed as between new and old carriers of 0 to 10 per cent. normally. By far the greater proportion of cases showed a difference less than 5 per cent. : it was only in the case of the longer tubes that it amounted to 10 per cent. If a carrier with no buffer is used, the speed may become nil and the carrier may cease to travel ; but such a case would not occur in practice, as carriers worn down to such an extent would be withdrawn from use and replaced by good ones. For ordinary use, it may be taken that the difference in speed between good and worn carriers will be less than 10 per cent. A further difference in speed due to varying the pressure also occurs, so that to cover all possibilities of speed variation an amount of 20 per cent. should be allowed for, if it is desired to prevent one carrier overtaking another.

#### F. Method of working.

The transit time of carriers in a tube worked intermittently will, in theory, differ from that of carriers in a tube worked continuously ; but in practice the difference is immaterial, because tubes worked intermittently are always short, and the slight alteration in time is of no moment. The difference, according to Culley's theory, amounts to 10 per cent. working with vacuum of 12 lb/in<sup>2</sup> (8.5 kg/cm<sup>2</sup>), and to smaller amounts with lower vacua. The basis of Culley's theory does not appear to be at all sound, nor is it very intelligible, and the 10 per cent. may be greater than what actually exists ; but the question as a whole is dealt with more fully in Chapter VII. The reason for the difference between transit times for continuously or intermittently worked tubes is that, with vacuum working, if an attendant inserts the carrier at the out-office and the vacuum is then turned on by the attendant at the head office, it will be some seconds before the continuous state of flow is reached, and during this period the carrier is travelling at something less than the full speed.

With pressure working, on the other hand, if an attendant at the head office inserts a carrier in the tube and then turns on pressure, there is a rush of air into the tube where the pressure is atmospheric, and the carrier travels faster than if the state of continuous flow had been existing from the beginning.

#### G. Effect of leaks.

The effect of a leak upon the transit time is not obvious : one would ordinarily think that a leak would be a disadvantage in every way, but this is not borne out by theory. The existence of a leak can increase the speed and reduce the transit time. The point is investigated on the assumption that Unwin's formulæ, as given in Chapter IV., hold for pneumatic tubes. For pressure tubes, the pressure  $P$  at any point along the length can be found from the curves in fig. 6'2, which give the value of  $\chi = P_1/P$  at all points of the tube for values of  $\chi_0 = P_1/P_2$  from 2.0 to 1.0. If there

is a leak at any point, the pressure will be less than  $P$ ; assume it to be  $P'$ , and the values of  $\chi_1 = \frac{P_1}{P}$  and  $\chi_2 = \frac{P}{P_2}$  now become  $\chi_1' = \frac{P_1}{P'}$  and  $\chi_2' = \frac{P'}{P_2}$ , but  $\chi_1' \chi_2' = \chi_0 = \frac{P_1}{P_2}$ . It can be readily seen that the speed on the first part,  $L_1$ , will be increased, and on the latter part,  $L_2$ , will be decreased; but the increase in  $L_1$  may be more than the decrease in  $L_2$ , and the total transit time may thus be decreased. In order to determine the effect

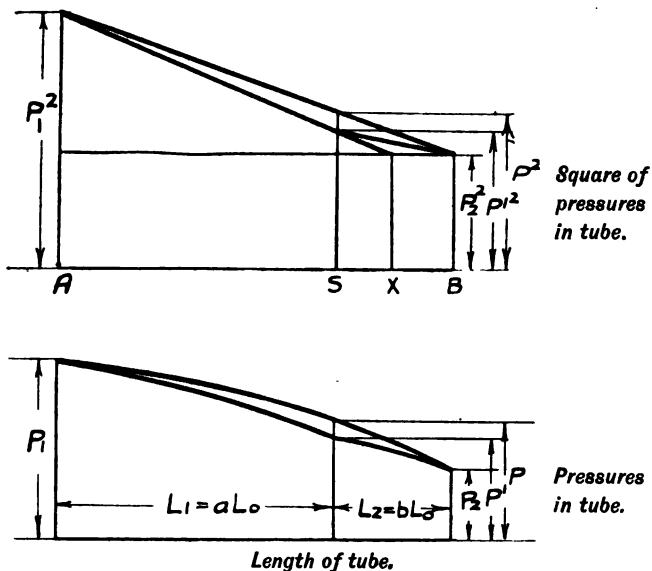

FIG. 6'1.—Theory of the effect of leaks in tubes.

in any particular case, we assume that the leak is equivalent to a length of tube  $zL_2$ ; the squares of the pressures along the tube and the pressures are then as shown in fig. 6'1. The distance  $SX$  is  $zL_2/(z+1)$ , and is found by using the quantity equation,

$$M^2 = \frac{(P_1^2 - P'^2)D^5}{L_1 c_1} = \frac{(P'^2 - P_2^2)D^5}{L_2 c_1} + \frac{(P'^2 - P_2^2)D^5}{zL_2 c_1} \quad (6'02)$$

giving,

$$\frac{(P_1^2 - P'^2)}{L_1} = \frac{(P'^2 - P_2^2)}{L_2} \left[ \frac{1}{z} + 1 \right] \quad (6'03)$$

The transit time for the tube is,

$$L_1^{3/2} f_4(\chi_1) + L_2^{3/2} f_4(\chi_2) \quad (6'04)$$

where

$$\chi_1 = P_1/P', \quad \chi_2 = P'/P_2$$

and if this is to be a minimum,

$$\left( \frac{L_1}{L_2} \right)^{3/2} = - \frac{\partial f_4(\chi_2)}{\partial f_4(\chi_1)} \quad (6'05)$$

Values of  $\partial f_4(\chi)$  and of  $(L_1/L_2)^{3/2}$  are given in fig. 6'2.

The ratio  $P_1/P$  is given in the lines marked 2.0, etc., in fig. 6'2. If we assume that there is a leak at any particular point, we know what value of the differentials would make the transit time a minimum, and we can also see what the value of the pressure would be if there were no leak. Then we can scrutinise the values of the differentials for values of  $\chi_1$  and  $\chi_2$  for lower pressures, and see if there appears to be any lower pressure which will give the minimum. For instance, if  $L_1=0.8L_0$ ,  $L_2=0.2L_0$ , and the ratio of differentials must be 8 to give a minimum; this occurs

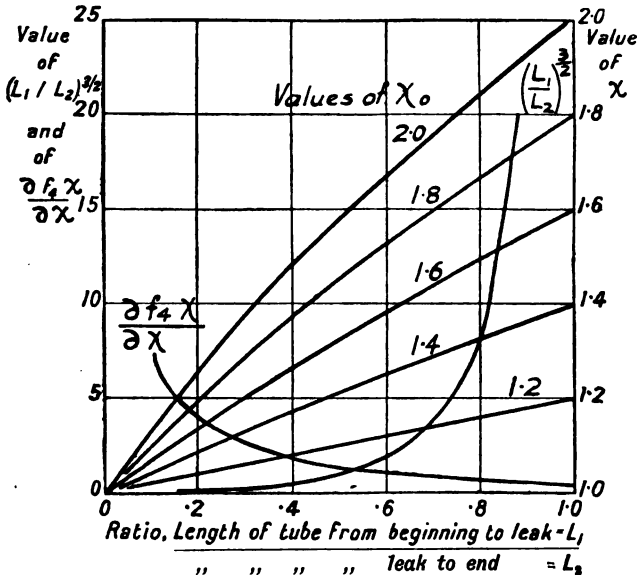

FIG. 6'2.—Effect of leaks on transit time. The lines marked 2.0, 1.8, etc., give the ratio of initial pressure to the pressure at points along the tube, viz.  $\chi = P_1/P$ , when the ratio  $P_1/P_2 = 2.0, 1.8$ , etc.

when there is no leak. But on a tube where  $\chi_0 = 2$ , and a leak is introduced at a point  $L_1 = 0.6L_0$  such that the pressure falls to  $P = P_1/1.54$ , instead of being  $P_1/1.66$ , as it would be if there were no leak, then the transit time becomes reduced in the proportion 1.350 to 1.310, or by 3 per cent.

### H. Various equations for transit time.

What equation gives the transit time most accurately is not known. It must be remembered the equations are for *air* transit times, and do not take into account the slip of the air past the carrier. In making tests there are five points which can be investigated :

1. Time of transit in practice.
2. Effect of pressure.
3. „ types of carriers.
4. „ length and diameter.
5. „ friction.

In order to get the transit time, new and old carriers can be sent and timed under working conditions: the pressure should always be recorded; but, as it is usually variable, only a mean value can be chosen. To test the effect of pressure, new carriers can be sent in any existing tube at various pressures, which should be kept constant, and which must be read on accurate standard gauges. To test the effect of different carriers, various sorts of carriers can be sent down any tube at one or more definite constant pressures. To test the effect of dimensions is almost impossible, because one would require to have many different tubes of accurately known dimensions down which new carriers at constant pressures could be sent. The point is not very important, if we assume Eq. 2'08*b* is true, as there is then no doubt about the correctness of the functions  $L^{3/2}$  and  $1/(D)^{1/2}$  which appear in the formula: these functions are altered if the equation for loss of pressure includes fractional indices. To test the effect of friction, one could investigate the loss of pressure due to passing known quantities of air down short lengths of tube. Pneumatic tubes, after being laid, are so smooth that the friction will be the same as that of the tubes as manufactured; or it may even be less, due to the polishing effect which carriers have on tubes in use.

To find the probable transit times of carriers in pneumatic tubes, we have equations deduced from formulæ given by five authorities:

Culley, from Eq. 5'05*e*,

$$t = \frac{L^{3/2} \left( \frac{4\zeta}{2gCT_1} \right)^{1/2} (n-1)^{1/2} \left[ \frac{1 + \phi^{1/n}}{(1 - \phi^{1-1/n})} \left( \frac{2}{1 + \phi} \right)^{1/n} \right]^{1/2}}{D^{1/2}} \quad (6'06)$$

Zeuner, deduced from Eq. 5'14,

$$t = \frac{L^{3/2} \left( \frac{4\zeta}{2gCT_1} \right)^{1/2} (n+1)^{3/2} \left( \frac{1}{n} \right)^{3/2} \left\{ \frac{\gamma - n}{\gamma - 1} \right\} \frac{(1 - \phi^{1+2/n})}{(1 - \phi^{1+1/n})^{3/2}}}{D^{1/2}} \quad (6'07)$$

Innes, from Eq. 5'21,

$$t = \frac{L^{3/2} \left\{ \frac{4\zeta}{2gCT_1} \right\}^{1/2} (n+1)^{3/2} \left( \frac{1}{n} \right)^{1/2} (1 - \phi^{1+2/n})}{D^{1/2} (1 - \phi^{1+1/n})^{3/2}} \quad (6'08)$$

Unwin, from Eq. 4'18,

$$t = \frac{L^{1.5} \left\{ \frac{4\zeta}{2gCT_1} \right\}^{1/2} (1 - \phi^3) \left\{ \frac{2}{(1 - \phi^2)} \right\}^{3/2}}{D^{1.5}} \quad (6'09)$$

Fritzsche, from Eq. 5'35,

$$t = \frac{L^{1.538} (\alpha CT)^{.54}}{D^{.685} CTP_1^{.076}} \left\{ \frac{2}{1 - \phi^2} \right\}^{1.538} \left( \frac{1 - \phi^3}{3} \right) \quad (6'10)$$

In Eq. 6'06 to 6'09 the value of  $\zeta$  varies with each size of pipe, and therefore the value of the constant will differ for each size. In Eq. 6'10 the variation of  $\zeta$  with diameter is incorporated in the index of  $D$ . Culley's tables in his book, and those in the Technical Instructions of the British Post Office Department, include a fixed value for  $\zeta$ , and therefore are only correct for one particular size of tube: they seem to be best for  $2\frac{1}{2}$ -in. tube.

For use in getting transit times, the pressure functions are given in graphical form in fig. 5'2: these are called F1, F2, etc.

## CHAPTER VI.—SYMBOLS USED.

Equation.	Symbol.	Meaning.
6'05	$a = L_1/L_0$	=a ratio.
6'05	$b = L_2/L_0$	= „
6'06	C	=the gas constant.
6'02	$c_1$	=a coefficient.
6'01	D	=diameters.
6'07-6'10	F1, F2, etc.	=pressure functions in transit-time formula.
6'06	$g$	=force of gravity.
6'01	$L_0$	=length of tube under consideration.
6'04	$L_1$	=length of tube from beginning to leak.
6'04	$L_2$	= „ „ from leak to end.
6'01a	$m$	=density of gas.
6'02	M	=quantity of gas flowing.
6'06	$n$	=index of polytropic expansion.
6'01	$p, P$	=pressures.
6'01	$t$	=transit time.
6'02	$z$	=a ratio, $zL_2$ =equivalent of leak.
6'10	$\alpha = .000315$	=a coefficient.
6'07	$\gamma = 1.408$	=index of adiabatic expansion.
6'06	$\zeta$	=coefficient of friction.
6'06	$\varphi = P_2/P_1$	=ratio of pressures.
6'02	$\chi_1 = P_1/P$	= „ „
6'02	$\chi_2 = P/P_2$	= „ „
6'02	$\chi_1' = P_1/P'$	= „ „ when leak exists.
6'02	$\chi_2' = P'/P_2$	= „ „ „ „
6'02	$\chi_0 = P_1/P_2$	= „ „



$$F1 = \left[ \left( \frac{m_1 + m_2}{2W} \right) \left( \frac{2P_1}{P_1 + P_2} \right)^{1/n} \right]^{\frac{1}{2}} \quad (6.11)$$

and the values are found by dividing Culley's values by 1.76, which is  $100,000(4\zeta/2gCT)^{\frac{1}{2}}$ .

- F2 is the function of  $n, \phi$ , in Eq. 6.07, when  $n=1.0$ .
- F3 " " "  $n, \phi$ , " 6.08, when  $n=1.4$ .
- F4 " " "  $\phi$ , " 6.09,  $n$  being 1.0.
- F5 " " "  $P, \phi$ , " 6.10.

The dimension functions,  $L^{1.5}$ ,  $L^{1.538}$ , are given in fig. 4.4. The transit time for any tube then becomes,

$$t = \left( \frac{\text{dimension}}{\text{function}} \right) \left( \frac{\text{friction, temp.}}{\text{gas function}} \right) \left( \frac{\text{pressure}}{\text{function}} \right) \quad (6.12)$$

of which the middle function is ordinarily constant, and the first function is constant for any tube, while the third function is variable. We then get as follows :

Culley's transit times,

$$f(L, D)(.0176)F1 \text{ for } 2\frac{1}{2}\text{-in. tubes.}$$

Unwin's transit times,

$$f(L, D)(\text{const.})F4.$$

Fritzsche,

$$f(L, D) \left( \frac{1.16}{10000} \right) F5.$$

Table 6.1 shows the values of the constants for air flow when  $T=60^\circ \text{ F}$ . and  $CT=27,700$ .

TABLE 6.1.

Internal diameter of tube . . .	1½ in.	2½ in.	3 in.
Assumed value of $\zeta$ . . .	.00805	.00580	.00605
10,000 $[4\zeta/(2gCT_1)]^{\frac{1}{2}}$ (Unwin) . . .	1.45	1.322	1.26
10,000 Fritzsche's constant . . .	1.16	1.16	1.16
Fritzsche's, divided by $D^{.685}$ . . .	4.80	3.65	3.00
Unwin's, divided by $D^5$ . . .	4.10	3.09	2.52

As the function of L in the case of pneumatic tubes usually lies between 200,000 and 1,000,000, the first portion varies from 80 to 400, which has to be multiplied by the pressure function, F2, F3, etc., these being from 0.50 to 2.0 and onwards. The transit times then work out as from 50 seconds up to about 600 seconds. For the above sizes of tube, Fritzsche's  $1/(D)^{.685}$  and Unwin's  $(\zeta/D)^5$  do not differ much.

As regards the variation in transit time due to pressure variations, Fritzsche's F5 appears to be most near the truth ; Unwin's value of F4 gives results which are too low when working with high vacuum, and which are too high when working with high pressure.

Many more experiments, made under good conditions and with accurate readings of the lengths and pressures, are required before the best formula can be determined.



## CHAPTER VII.

### INTERMITTENT FLOW OF AIR IN TUBES.

Unsteady flow in general—Results of tests—Consideration of flow when working with pressure—Determination of weight of air used—Flow when working with vacuum—Determination of the time taken to empty the tube of compressed air, or to fill it with air at atmospheric pressure—Probable times in practice—Variations of pressure immediately after a cock is turned on.

THIS question arises in determining the quantities of air used when working pneumatic tubes intermittently, or when working "Up" and "Down."

#### A. General question of unsteady flow.

With tubes worked intermittently, in practice it is difficult to predict accurately what amount of air will be used or what the transit times will be, because the conditions at the beginning and end of flow are variable. The cock controlling the tube may be turned on when the air in the tube is in motion, and when the pressure is not atmospheric; and the cock may not be turned off by the attendant immediately the carrier reaches the end of its journey.

Considering first the normal case, in which the air in the tube is at rest and at atmospheric pressure when the cock is turned on.

Working with pressure, immediately the cock is turned on there is a big rush of air into the tube, and the rate of flow through the cock is much in excess of the rate of continuous flow, because the pressure gradient is big: until the state of continuous flow is attained the pressure near the cock rises continuously. The time taken before this state of continuous flow is reached varies widely according to the length and diameter of tube, and the pressure of working, etc., but it is about 5–20 seconds for 2½-in. tubes up to 2000 yd. or metres long. Graphs showing the rise and fall of pressure at the cock are given in fig. 73.

As is easily understood, since the rate of intermittent flow in pressure working is greater than the continuous rate, the transit time of carriers will be less for intermittent working than for continuous working; but the reduction of transit time is fairly slight, because the time during which the greater rate of flow acts is only a small proportion of the total time.

In the case of vacuum working, the opposite effects are noticeable: when the cock is turned on, air flows in at a slow rate to the open end of the tube where the carrier lies, and thus at the beginning of its travel the carrier goes slowly; the total time of transit is increased, therefore. At the

cock the rate of flow at first is big, because of the large pressure gradient : the flow decreases as the vacuum rises.

**B. Results of tests.**

The tests made at various times showed that the rise of pressure or vacuum at the cock was very rapid when the cock was opened, unless there was some definite throttling in the service pipe, in which case the final pressure reached during steady motion was of course about 1 to 3 lb/in<sup>2</sup> below the tube pressure which would have existed if there had been no throttling. When the cock was shut the rate of the fall of pressure was always much smaller, because the source of power—which is the atmosphere—was at the open end of the tube. The general form of pressure-

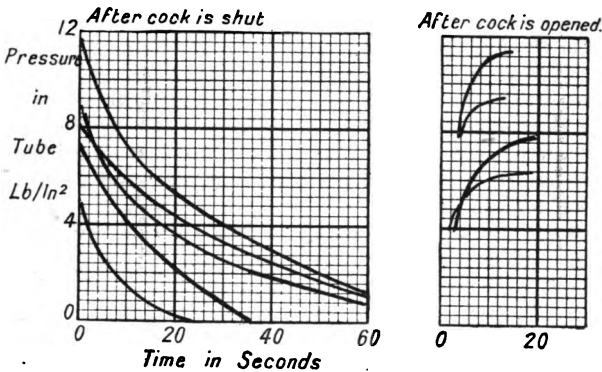

FIG. 71.—Intermittent working of pneumatic tubes. Rise and fall of pressure in the tube by the cock when power is turned on or off. The time is reckoned from the moment when the cock is operated.

time curve can be seen in fig. 71: that the results of tests agree with theory to some extent is shown in Table 7'1.

Bontemps (*Pneu. Trans.*, p. 56) describes tests made on the Paris pneumatic tubes, which are 2.52 in. diameter. The carriers struck indicators in the tubes at various points, and the times of striking were recorded electrically at the Central Office, so that the velocity was deducible. Bontemps states that the velocity was constant over the middle section of the tube length: the working was intermittent, and at a pressure of 19.7 in. mercury (10 lb/in<sup>2</sup>), so that the velocity in the first section was much greater than the velocity in the middle section. The velocity in the final section was greater than in the middle section because the air was rarefied. He states that the air was at a constant density in the tube, but this cannot have been true, and the constancy of the velocity over the middle section is hard to believe.

**C. Pressure working.**

We want to determine what quantity of air will be used when sending carriers intermittently: this quantity is more than one would anticipate,

so that intermittent working does not save much air, but it enables a tube to be worked in both directions, and thus avoids the laying of two tubes in place of one.

Though it is impossible to know exactly the consumption of air, it is possible to find the limits between which such quantity will probably lie.

The difficulty of treating the question theoretically arises because, during a portion of the time of transit, the quantities flowing are variable : all previous equations of flow have included the constant,  $M$ , for the quantity per second. In this problem, during the earlier part of the time,  $M$  is a variable with regard to both time and place ; just after  $t=0$ ,  $M$  is enormous for a fraction of a second.

We shall first think of the various periods of time into which the total time may be divided.

$t_1$  = time from opening the cock till the steady state is attained, say 5 to 20 sec.

$t_2$  = the time during which the steady state exists, until the carrier arrives at its destination.

$t_3$  = the time during which the cock is left on after the carrier reaches its destination, which may be from 3 sec. up to any time if the attendant does not receive the notification of the carrier's arrival, or if he overlooks such a signal, and then leaves the cock on indefinitely.

$t_4$  = the time for the pressure to sink to atmospheric pressure.

$t_5$  = the transit time for intermittent working.

$t_6$  = the transit time for continuous working.

Now we shall find the weight of air used : for this purpose fig. 7'2 has been drawn. The ordinates of the curve OBCDE show the rate of flow out of the tube at the open end, and the ordinates of the curve ABCD show the rate of flow into the tube at the cock : the integral of OBCDEO or of ABCDD'O is the quantity we are out to find. The amount of air which has flowed out of the container cannot be determined until it is known how AB should actually be drawn, and the solution for that portion of the curve is not yet found. The approximate total flow we can know.

$W_1 = OBB'$  = the weight of air leaving the tube during  $t_1$ . During this time air is flowing into the tube and filling it with compressed air. The area ABO just equals this amount = area DD'E.

$W_2$  = the amount of air used during  $t_2$  : it goes into and comes out of the tube.

$W_3$  = the amount of air used during  $t_3$ .

$W_4$  = the amount of air which comes out of the tube after the cock has been turned off. This equals the difference between the weight of compressed and uncompressed air in the tube.

$W_5$  = the amount of compressed air in the tube.

$W_6$  = the amount of air at atmospheric pressure in the tube.

$W_2$  is known if we know  $t_2$  :  $W_2 = M t_2$ .  $W_3$  is known when we assume some value for  $t_3$ , the time during which the cock is left on unnecessarily. The actual value of  $W_1$  I am unable to determine by theory at present.

W5, the amount of compressed air in the tube, is easily evaluated; this weight of air fills the tube at any instant during the time of continuous flow, and exists in the tube immediately the cock is turned off.

The amount of air W5 - W6 flows out of the tube during the time t4, which varies from a few seconds, up to a minute in the case of long tubes. A knowledge of this time is of no direct importance, except as giving assistance in knowing the laws of variable flow, and so in helping to determine t1.

$$W5 = \int S \, dL \, m = \int S \, dL \, M/(uS) = M \int dL/u = M t6 \quad (7'01)$$

One can see from this that in the case of continuous working the amount of compressed air in the tube is just the amount which leaves the container during the transit of one carrier.

We are now in a position to determine the total weight of air used.

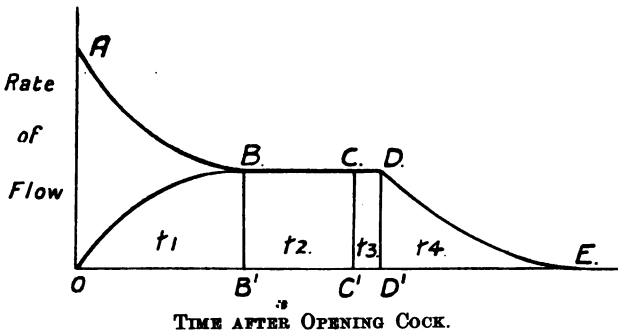

- At A the cock is opened; flow variable during t1.
- At B the cock is still open; flow is steady during t2.
- At C the carrier arrives at its destination.
- At D the attendant shuts off the cock, and the flow is variable.
- At E the air in the tube is at rest at atmospheric pressure.

FIG. 7'2.—Intermittent working of tubes; theory. Rate of flow at the open end of the tube is given by OBCDE, to atmosphere (pressure), from atmosphere (vacuum). Rate of flow out of, or into, reservoir is ABCD.

Supposing one is at the open end of the tube: air flows out during t1, t2, t3, t4, and the total amount is,

$$W = W1 + W2 + W3 + W4 \quad (7'02)$$

The factors which require special investigation are W1, t1, t2. We see at once that the area DD'E will be about as big as BCC'B' if t4 approximates t6: the total quantity of air used will therefore be considerable.

W1 is the area OBB': assume that OB is a straight line, and that we have found by experiment the ratio t1/t6 = a; we also assume that t1 + t2 + t3 = t6, which we can do by allowing t3 to be just such an amount as to make the equation true; the intermittent transit time t1 + t2 is less than t6. The air used is,

$$W = W1 + (M t2 + M t3) + W5 - W6 \quad (7'03)$$

$$= \frac{1}{2} M t1 + (M t6 - M t1) + M t6 - W6 \quad (7'04)$$

$$= M t6 (2 - \frac{1}{2} a) - W6 \quad (7'05)$$

$$= W6 [f(n, \phi) (2 - \frac{1}{2} a) - 1] \quad (7'06)$$

M t6 from Eq. 5'21 and 5'18 becomes,

$$M t6 = SLm_1 \frac{(n+1)(1-\phi^{1+2/n})}{(n+2)(1-\phi^{1+1/n})} \dots \dots \dots (7'07)$$

$$= SLm_0 \frac{(n+1) P_1 (1-\phi^{1+2/n})}{(n+2) P_0 (1-\phi^{1+1/n})} \dots \dots \dots (7'08)$$

$$= W6 \frac{2}{3} \frac{1}{\phi} \frac{(1-\phi^3)}{(1-\phi^2)} = W6 f(n, \phi), \text{ when } n=1 \dots \dots \dots (7'09)$$

The errors which have crept in because of the assumptions arise because,

- (i.) OB is not a straight line.
- (ii.)  $t1+t2+t3$  may be less or more than  $t6$ , depending upon the way in which the attendant works the tube.

None of these, however, are serious objections, as the way in which OB rises must be as shown ; almost certainly the true area of OBB' will be greater than the triangular area ; and the time the cock is left on is quite likely to be sufficient to make  $t1+t2+t3=t6$ .

**D. Vacuum working.**

The conditions are somewhat similar to pressure working, but the quantity of air used is far less, because,

- (i.) The mean pressure in the tube is less.
- (ii.) The attendant can see the carrier arrive, and turns off the cock at once, so  $t3$  becomes small. \*

In this problem OBB' is again unknown, and  $t2$  and  $t3$  are also unknown. The amount of air which has flowed into the container during  $t1$  must be equal to  $W6-W5$ , with the addition of whatever has flowed in at the open end during  $t1$ . We have times  $t1, t2, t3, t4$  during which the flow from atmosphere into the open end is  $W1, W2, W3, W4$ ; during  $t1$ , the air flowing into the reservoir is  $W6-W5+W1$ . The total amount used, W,

$$W = W1 + W2 + W3 + (W6 - M t6) \dots \dots \dots (7'10)$$

$$= (W6 - M t6 + \frac{1}{2} M a t6) + M t2 + M t3 \dots \dots \dots (7'11)$$

Now if  $t2+t3=t6$ , and because  $M t6 = W6 f'(n, \phi)$ ,

$$W = W6 \{ 1 + \frac{1}{2} a f'(n, \phi) \} \dots \dots \dots (7'12)$$

The air used is therefore equal to the weight of air in the tube plus a small percentage depending on  $a$  and  $f'(n, \phi)$ ,

$$f'(n, \phi) = \frac{2 W6 (1-\phi^3)}{3 (1-\phi^2)} \dots \dots \dots (7'13)$$

This is obtained from Eq. 7'07 by putting  $m_1=m_0$ ; values are given in fig. 5'1.

The amount of air which flows into the tube from atmosphere is,

$$W4 = W6 - M t6 \text{ (see fig. 7'3)} \dots \dots \dots (7'14)$$

whereas for pressure the amount of air which flowed out was,

$$W4 = M t6 - W6 \dots \dots \dots (7'15)$$

If one is working "Up" and "Down," and no time is allowed for the air in the tube to fall or rise to atmospheric pressure each time a carrier is sent, this amount  $W_4$  will partly find its way into or out of the container, and will increase the amount of air used accordingly. Suppose we have been working by pressure, and that the point of time is as represented by  $D'$ , and that we then turn on the vacuum cock so as to bring a carrier up to the head office, then the compressed air in the tube will partly find its

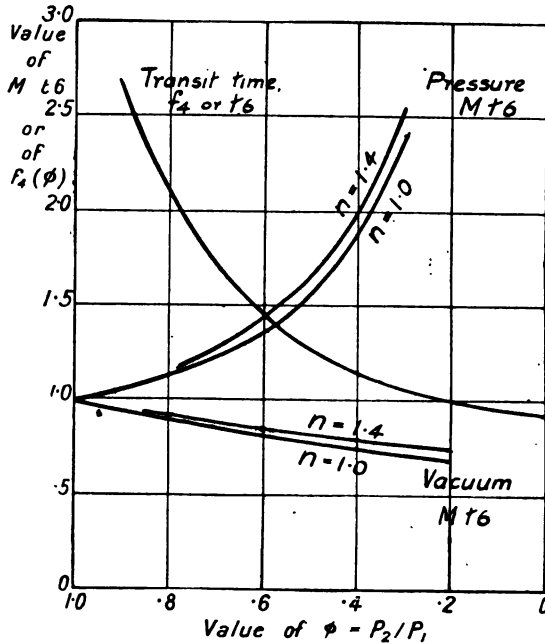

FIG. 73.—Intermittent working of pneumatic tubes. Functions giving the quantities of air involved; see Eq. 7'05, and Eq. 7'07 for  $M t_6$ .

way out of the open end of the tube, and will partly find its way into the vacuum reservoir. How much will go each way is quite indeterminate, depending as it does upon the resistance of the cock and services relative to that of the open end of the tube. The only point to notice is that  $W$  must be increased in such a case: a suitable proportion of  $W_4$  to take would be  $\frac{1}{2}$  to  $\frac{2}{3}$ , and add this to  $W$  as found previously.

There is a way of finding  $t_4$  approximately when we assume that the expansion is isothermal, and when we neglect the change in kinetic energy, as follows:—

When the cock is shut off, the air in the tube is  $W_5$ ; this decreases or increases by an amount  $M$  lb. per second, where,

$$M = \alpha f_1(\phi), \text{ pressure working (see Eq. 4'13)} \quad (7'16)$$

$$M = \alpha f_1'(\phi), \text{ vacuum working} \quad (7'17)$$

From Eq. 4'13,

$$\alpha = m_0 S (gCT L_1/L_0)^{\frac{1}{2}} \quad (7\cdot18)$$

$$f_1(\phi) = (1/\phi^2 - 1)^{\frac{1}{2}} \quad (7\cdot19)$$

$$f_1'(\phi) = (1 - \phi^2)^{\frac{1}{2}} \quad (7\cdot20)$$

We also know that  $W_5 = M(t/6)$ , and from Eq. 4'19,

$$t/6 = L_0 \frac{2}{3} \left( \frac{L_0}{L_1 gCT} \right)^{\frac{1}{2}} \frac{(1 - \phi^3)}{(1 - \phi^2)^{3/2}} = B f_4(\phi) \quad (7\cdot21)$$

giving  $W_5 = \alpha B f_1(\phi) f_4(\phi) = \alpha B f_5(\phi) \quad (7\cdot22)$

But  $\alpha B = 2/3 W_6$ ,  $f_5(\phi) = \frac{(1 - \phi^3)}{\phi(1 - \phi^2)}$  pressure  $(7\cdot23)$

$$f_5'(\phi) = \frac{(1 - \phi^3)}{(1 - \phi^2)} \text{ vacuum} \quad (7\cdot24)$$

Then we have

$$M dt = d(W_5) = d[\alpha B f_5(\phi)] \quad (7\cdot25)$$

and when the values are inserted we get,

$$\frac{(1 - \phi^2)^{\frac{1}{2}}}{\phi} dt = \alpha B \frac{1 - 3\phi^2 + 2\phi^3}{\phi^2(1 - \phi^2)^2} d\phi \text{ pressure} \quad (7\cdot26)$$

$$(1 - \phi^2)^{\frac{1}{2}} dt = \alpha B \frac{2\phi - 3\phi^2 + \phi^4}{(1 - \phi^2)^2} d\phi \text{ vacuum} \quad (7\cdot27)$$

The equations take the form,

$$B f(\phi) = dt \quad (7\cdot28)$$

and are integrable, using  $\phi = \sin x$ ,  $d\phi = \cos x dx$ .

Let the solution be  $F(x, \phi)$ , which is,

Pressure,  $F(x, \phi) = \frac{2 \sin^3 x - 1}{\cos^3 x} + \frac{1}{\cos x} + \log_e \tan \frac{x}{2} \quad (7\cdot29)$

Vacuum,  $F'(x, \phi) = \frac{2/3 + 1/3 \phi^3 - \phi}{\cos^3 x} + x \quad (7\cdot30)$

In the case of pressure the values of the function are negative ; the values in both cases are given in fig. 7'4. For pressure working,  $\phi = P_0/P_1$  and is about 0.5 to begin with, and decreases till  $P_1 = P_0$ , and  $\phi = 1$ .

For vacuum,  $P_2$  increases as the time goes on until  $P_2 = P_0$ . We get,

$$B F(x, \phi) = t/4 + \text{constant} \quad (7\cdot31)$$

For pressure, the constant is  $B F(x_1, \phi_1)$ , and the general equation is,

$$B F(x, \phi) = t/4 + B F(x_1, \phi_1) \quad (7\cdot32)$$

Now  $F(x, \phi) = 0$  when  $t = t_4$  and  $\phi = 1.0$ ; so that,

$$t_4 = -B F(x_1, \phi_1) \quad (7\cdot33)$$

For vacuum,  $F'(x, \phi) = \pi/2$  when  $\phi = 1.0$ , and we get,

$$t4 = B\{\pi/2 - F'(x, \phi)\} = F_1'(x, \phi) \quad (7.34)$$

Values of this latter function are given in fig. 7.4.

If we wish to compare  $t4$  with the transit time  $t6$ ,

$$t4 = B F(x, \phi), \quad t6 = B f_4(\phi) \quad (7.35)$$

we get  $t4/t6 = F(x, \phi)/f_4(\phi)$ , which can be evaluated from fig. 7.4 and 5.1.

Here it should be noticed that as  $P_1$  increases  $t6$  decreases, while  $t4$

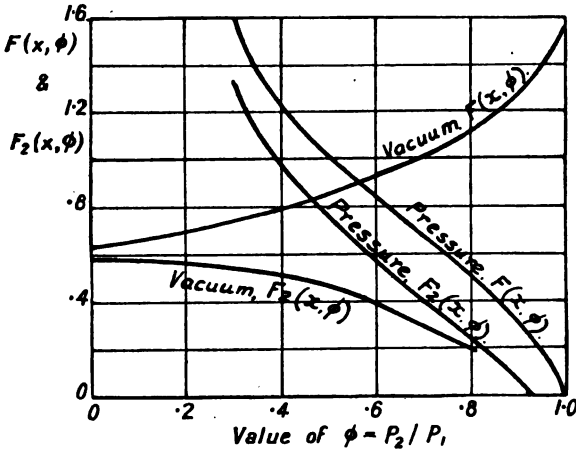

FIG. 7.4.—Functions giving the time for unsteady flow after the cock is turned off.  $F(x, \phi)$  assists in determining  $t4$ ; see Eq. 7.29, 7.30.  $F_2(x, \phi)$  is the time taken for the pressure in the tube to reach 1 lb/in<sup>2</sup> above or below atmospheric pressure. See Eq. 7.40, 7.41.

increases; working with high pressure, the time for the pressure to fall to zero is longer than when working with low pressures.

One may now ask, what are the numerical values of B?

$$1/B \text{ stands for } \left(\frac{g D S^2 P_0^2}{4\zeta C T L_0}\right)^{\frac{1}{2}} \frac{3}{2 m_0 S L} \quad (7.36)$$

$$= \frac{D^{\frac{1}{2}} (g C T)^{\frac{1}{2}} 3}{L_0^{3/2} (4\zeta)^{\frac{1}{2}} 2} = \frac{3 (g C T)^{\frac{1}{2}}}{2 L_0^{3/2}} L_1^{\frac{1}{2}} \quad (7.37)$$

which is the reciprocal of the dimension function in Eq. 6.09.

$$\text{In this, } 1.5(g C T)^{\frac{1}{2}} = 1.5[(32.2)(27700)]^{\frac{1}{2}} = 1412 \text{ approx.} \quad (7.38)$$

$(D/4\zeta)^{\frac{1}{2}}$  varies from 1.29–5.35 for 1-in. to 6-in. pipes, and = 2.75 and 3.35 for 2½-in. and 3-in. tubes.

$L_0^{3/2} = 164100, 302000, 465000$  for 3000, 4500, 6000-ft. tubes.

$$\text{Therefore } B = \frac{302000}{(2.75-3.35)1412} = 77.8 \text{ or } 64.0 \quad (7.39)$$



For ordinary pneumatic tubes B will then vary from 40 to 100. I have also given  $F_2(x, \phi)$ , which is the function giving the time  $t''4$  for the pressure to fall to 1 lb/in<sup>2</sup>, which is a more definite point than the atmospheric pressure: it is not easy to determine just when the pressure reaches  $P_0$ , as, theoretically, the time is infinite and the curve of the fall of pressure lies so near the zero line (see fig. 7'1). The values of  $F_2(x, \phi)$  for pressure and vacuum are obtained from,

$$F(x, \phi) - F(P=15.7, \phi=0.933) = t''4 \quad . \quad . \quad (7'40)$$

$$F(\pi/2, 1) - F'(x, \phi) = t'''4 \quad . \quad . \quad (7'41)$$

The results of tests gave:—

TABLE 7'1.

$t''4$ observed	8, 13	23, 16	17	28, 22	60	60	60	60	110
$t''4$ calculated	9, 11	23, 19	21	30, 25	66	70	77	73	130
L in feet	1900	2790	3070	3900	5430	5660	6920	7050	12,540
d inches	2½	3	2½	2½	1½	1½	2½	2½	3

This shows that theory will give some indication of the time  $t4$ . The small value in practice is probably due to the neglect of the effect of the velocity; 10 per cent. of  $t4$  might be deducted to allow for this.

The way in which the pressure in the tube just after the cock varies with the time is shown in fig. 7'3: it seems to rise to its full value almost instantaneously, the reason being that the inertia of the air in the tube forms a buffer and the air in front of the cock is merely compressed, and not given a motion of translation for some moments. Certainly no motion occurs at the outer end of the tube for about 5 seconds, while the pressure at the cock may have risen to almost full pressure in 2-3 seconds.

No expression for  $t1$  can be given, but it will vary from 3 to 20 seconds in tubes up to 5000 ft. long.

Unfortunately, the greater number of the tests were made before the theory as to what the times  $t1$ ,  $t4$ , etc., were likely to be had been deduced; and so some of the points which might have been carefully noticed were overlooked. It would be desirable to have for such tests a water or mercury gauge which could be put in connection with the tube when the pressure was nearly at zero: by this means one could more accurately determine the point of atmospheric pressure.

It was noticed in tests that immediately the cock was shut off the pressure in the tube dropped very suddenly when working with pressure, because of the relative rarefaction produced at the cock as the moving air continued its motion instantaneously at the same speed as before, in virtue of its inertia: shortly afterwards the motion became such that the pressure dropped steadily in accordance with the theoretical law.

CHAPTER VII.—SYMBOLS USED.

Equation.	Symbol.	Meaning.
7'05	$a$	=ratio of unsteady time $t_1$ to transit time $t_6$ .
7'22	$B$	=a coefficient.
7'01	$L$	=length of tube.
7'16	$M$	=lb/sec during steady motion.
7'01	$m$	=density of air; which is $m_0$ at $P_0$ .
7'07	$n$	=index of polytropic expansion.
7'01	$S$	=area of tube.
7'04	$t_1$	=time of unsteady flow at the beginning.
7'03	$t_2$	= ,, of steady motion while carrier travels.
7'03	$t_3$	= ,, ,, ,, ,, ,, is at rest.
7'33	$t_4$	= ,, of unsteady motion at the end.
..	$t_5$	=transit time for intermittent working.
7'05	$t_6$	= ,, ,, for continuous ,,
7'01	$u$	=velocity.
7'02	$W_1$	=air used during $t_1$ .
7'02	$W_2$	= ,, ,, ,, $t_2$ .
7'02	$W_3$	= ,, ,, ,, $t_3$ .
7'02	$W_4$	= ,, ,, ,, $t_4 = W_5 - W_6$ .
7'05	$W_5$	=compressed air in the tube = $M t_6$ .
7'06	$W_6$	=uncompressed air in the tube = $m_0 S L_0$ .
7'29	$x$	= $\sin^{-1} \varphi$ .
7'18	$\alpha$	=a coefficient.
7'09	$\varphi$	= $P_2/P_1$ .



## CHAPTER VIII.

### METERS FOR GAS AND AIR.\*

Necessity of metering gases in commercial work—Various types of meter—Methods of calibration—Direct and indirect methods of measurement and relative costs—Measurement by gas-holders—Measurement by containers—Measurement by displacement meters—Measurement by Venturi meters—Theory of Venturi meter—Friction loss in cones—Measurement by orifice meters when small pressure difference is used—Formula for quantities in such cases—Shaw's unit of resistance for air flow—Various orifice tests—Orifice in pipe line—Amount of pressure required for metering various quantities—Müller's tests and theory—Tests on orifice in pipe lines—Commercial orifice meters—Sentinel meter—Kent meter—Measurement of quantity by electrical methods—Thomas meter—Equations for quantities of gas heated by electrical energy—Anemometers—Necessity for calibration *in situ*—Miscellaneous types of meters.

THE subject-matter in these three chapters, VIII., IX., X., is arranged generally as follows: there is a discussion upon the need for meters and the types of meter in use, followed by investigations into the various types of meter. On account of the length of such investigation in the case of Pitot tube and hot-wire meters, these discussions are retained for Chapters IX. and X. Nine methods of metering gas flow are summarised on the next page, and then follow the remarks and investigation on each in detail.

The quantity of air or gas flowing in circuits or systems must be known in order to deal with the laws concerning the flow: the knowledge is also required in working with practical problems which can occur, for example:

(a) In a compressed-air installation when it is required to know the air consumption of tools.

(b) In pneumatic-tube installations where it is desired to know the air consumption of each tube.

(c) In gas-engine work when one is investigating the question of obtaining the maximum efficiency, which depends upon the proportions of gas and air present; the same question arises with oil engines.

(d) In ordinary household gas supplies, where it is necessary to meter the gas used in each installation; similar metering should be done on the mains if practicable.

(e) In ventilation work when the contractors and engineers require to know how much air is being circulated among the various rooms.

(f) In aerial navigation where a knowledge of the velocity of air currents is required. In such cases it is the velocity at a point which is required, and the velocity meters are to be preferred to the quantity meters.

\* An illustrated description of some types of meter discussed here is given in *Engineering*, vol. 107, pp. 261, 295, etc., Feb. 28 to Mar. 28, 1919.

In the first five cases it is desirable to know the costs of working the plant in terms which admit of the *overall efficiency* of the plant being determined. If a certain quantity of air is wanted at a certain pressure, then the minimum quantity of work which must be done is the work required to compress or rarefy the specified quantity of air by means of isothermal compression or rarefaction to the specified absolute pressure: the actual work done will be much greater than this, on account of the losses in the machinery and in the various transformations of energy which are required in the various processes to produce the air at the requisite place and pressure.

The greater **the overall efficiency**, which is the ratio  $\frac{\text{isothermal work necessary}}{\text{actual work done}}$ , the less will be the cost of working the plant, provided the maintenance charges are kept constant.

In all the above problems it is best to deal with **the weight** of air or gas, and not with **the volume**; and to reduce the weight to volume when the volume at a specified temperature and pressure is required. The weight of gas flowing is the only thing which is constant about the flow of gases in circuits as usually dealt with. The volume of flow is only approximately constant in any case, and is variable if the density changes much.

There are many different methods of measuring quantities, and different sorts of meters can be used according to what sort of flow is to be measured: the methods can be roughly divided into the following nine types:—

- (A) Measurement by gas-holders.
- (B) Measurement in containers or receivers.
- (C) Displacement meters.
- (D) Venturi meters.
- (E) Orifice, float, or valve meters.
- (F) Electrical meters for quantities.
- (G) Anemometers: and miscellaneous meters.
- (H) Pitot tubes: dealt with in Chapter IX.
- (J) Electrical meters for velocities: dealt with in Chapter X.

The last three types of meters measure *velocity* directly: all the others register *quantities*.

One of the first questions which arises is that of *calibration*. Assuming ideal conditions and perfect instruments, the measurement of gas in gas-holders or in containers is absolutely correct; such methods form the usual standards in calibrating meters. Displacement meters form another ready means of calibration, but are more complicated in form, and are not convenient for ordinary investigators to have at hand. The Thomas electrical meter, the Venturi meter, and the Pitot tubes usually require a small correction coefficient, the need for which prevents them being used as primary standards; but they are quite satisfactory for rough work without being calibrated and without the actual coefficient being known. Float and valve meters, ordinary commercial meters, and anemometers are quite useless unless the calibration is known.

Velocity meters can be approximately calibrated by passing them through still air at known velocities, which is the common method of calibrating Pitot tubes, for water and air.

Another method used by Threlfall was to inject smoke into a current

of air and to watch the travel of the smoke and assume that it travelled at the same speed as the air.

In order to determine the velocity of air currents absolutely, Stanton (*Nat. Phys. Lab. Res.*, 1/247/1905) used a specially made anemometer, which consisted of four very light vanes of aluminium placed at approximately  $45^\circ$  to the direction of air flow. The vanes could be rotated horizontally, and were suspended upon rollers which could travel up and down at an angle of  $45^\circ$  to the horizontal. An air current flowing vertically downwards tended to drive the vanes and rollers down the plane on which the rollers rested; but if, at the same time, the vanes were rotated horizontally at the same speed as the air current, there was no force tending to move the vanes and rollers. The velocity of the air current was therefore given directly by the rate of rotation of the vanes. The force of the vanes due to gravity was counterbalanced by weights. The actual shape of the aluminium vanes was such that the intersections between cylinders coaxial with the direction of air flow and the vanes were helices at  $45^\circ$  to the horizontal.

As regards accuracy, in scientific work, if the readings and observations are made to less than 1 per cent. accuracy, the humidity of the air must be considered (see Chapter I.); such refinement is unnecessary for commercial work.

The only definite quantity which remains constant when gas or fluid is flowing in a circuit and through a meter is the weight, and even this will only remain constant as long as there are no leaks and no condensation on the walls of the circuit. In all gas meters, the pressures, velocities, specific volumes, or temperatures differ—perhaps inappreciably—at the two sides of the meter, even if the area of the circuit remains constant: this difference is due to the loss of pressure in the meter: therefore velocities or volumes as read by the meter can properly only apply to the circuit at one or other side of the meter.

Meters of the following types may be required:—(a) Indicating, (b) integrating, (c) recording, which measure respectively:—

(a) The instantaneous quantity, or velocity, of air or gas: which will be given directly by orifice, Venturi, electrical meters or static anemometers.

(b) The total quantity of air or gas which passes in a day or any other period of time, which will be given directly by gas-holders, displacement meters, and anemometers.

(c) The approximate quantity of flow at each moment over a long period, which will be given by any of the above meters when associated with suitable recording devices, on the assumption that the pressure and temperature of the gas or air in the pipe at the meter is constant.

(d) The accurate quantity at each moment over a long period, which will be given by any of the above, when in addition to the recording devices there are also devices for compensating for variations in the pressure and temperature.

Wing (*Proc. Amer. Gas. Eng.*, 9/677/1914) describes methods of measuring large quantities of gas and discusses the *direct methods* of measurement, which include the use of diaphragm meters, gas-holders, wet-drum meters, calibrated exhausters; and the *indirect methods* by use of inferential meters, such as velocity meters, shunt meters, calorimeters. He mentions the Wylie shunt meter, where a portion of the gas is shunted through the meter.

He quotes Weymouth's formulæ for flow, but omits to state the units in which the quantities are measured; and states that the Pitot tube meters may be as much as 10 per cent. to 20 per cent. out. There are many comparisons of flow as measured by different methods. He gives the comparative initial costs of different types of meters, for main stations, as:—

Wet station meters . . .	100 per cent.	See Division C.
Rotary or blower meters . . .	50    "	"    "    C.
Electric (Thomas)    " . . .	38    "	"    "    F.
Proportional    " . . .	30    "	"    "    E.
Venturi    " . . .	12    "	"    "    D.
Pitot    " . . .	$\frac{1}{2}$ "	"    Chapter IX.

and in his fig. 12 shows the comparative costs of maintaining the wet meter and the electrical meter: the latter meter is more economical when the flow to be measured exceeds 25,000 cu. ft/hr. If the above figures are true, one would expect the Venturi meter to be used mostly, as it is on the whole quite accurate.

Bendermann (*Zeit. Ver. Deut. Ingr.*, 53/13 & 142/1909) describes many types of commercial meters for steam: many of these are also mentioned by Orr (*Mech. Engr.*, 24/70 & 94/1909), but in this latter case they are considered from the point of suitability for compressed-air work also. Orr states that the Kennedy displacement meter will give readings to within 1 per cent. accuracy when used for air: he mentions the Worthington and Kent positive meters, but gives no description of them. Lindenheim of Berlin in 1896 introduced the inferential meter, consisting of vanes rotating in the pipe: in this meter a coned pulley transmitted the revolutions of the vanes to the dial, and the position of the dial pulley relative to the coned pulley was determined by the pressure in the main, so that readings were automatically compensated for pressure variations. Other meters depend upon the float principle, in which the displacement of the float is controlled either by the weight of the float or by a spring; these meters work either with a varying cross section and a constant control or with a constant cross section and varying control: such meters are orifice meters. Bendermann's and Baeyer's meters of this type are given in fig. 10 in Orr's paper, and are also illustrated in Bendermann's paper. Orr also mentions the American St John, and the Sergeant meters, but does not describe them.

Phillips (*Elec. World*, 68/866/1916) discusses shortly the question of the incorrectness of steam meters when used to measure pulsating flow: his tests showed that the reading needed a large correction factor, but the exact type of meter used by him is not stated.

### A. Measurement by gas-holders.

This is a perfectly accurate method if the mean temperature of the gas or air in the holder is known, as well as the pressure and volume: there is no difficulty in knowing these latter, while there is serious difficulty in determining the mean temperature: the holder is usually relatively large and the temperature may vary from one side to another, or from the bottom to the top, and a good many temperature readings at different points are necessary to determine the true mean. The temperature may vary also in

the time during which the readings are taken. The quantity of gas flowing into or out of such gas-holders is,

$$M = V'm' - V''m'' = \frac{V'P'}{CT'} - \frac{V''P''}{CT''} \quad (8'01)$$

where the suffix ' refers to quantities at the beginning of the test or experiment and the suffix '' refers to the quantities at the end.

### B. Measurement by containers.

This is a common method for determining the output of compressors, but is likely to be exceedingly inaccurate if the temperatures are inaccurately known. The size of the containers is usually small, and there is no ready means usually available for inserting thermometers in the interior of the container, and the variations which go on in the gas or air do not communicate themselves quickly to the outside of the plates forming the container. The method is satisfactory for use as a standard if one employs high pressures with accurate gauges, so that the range of pressure is great, and if one allows the temperature to attain the normal, or attain a fixed temperature when readings are taken: this can only be done if a relatively long time elapses after each time that air has flowed out of the container to the instruments under test, during which period of rest the air in the container can regain heat after it has been cooled by the expansion during test. This method has been employed by Durley when calibrating orifices.

The equation for weight of gas is,

$$M = V'm' - V''m'' = \frac{V'}{C} \left\{ \frac{P'}{T'} - \frac{P''}{T''} \right\}, \text{ as } V' \text{ is constant} \quad (8'01a)$$

### C. Displacement meters.

These meters possess a drum or a piston which passes through a definite space at each revolution and displaces whatever fluid may be in that space: the quantity displaced is accurately known if there is no leakage past the moving parts. Such a meter is employed by George Kent & Co. in the Rand Mines Calibration Plant, and is illustrated in their catalogue dealing with air meters. The ordinary household gas meters are worked on the same principle, but they are generally only useful for work at or about atmospheric pressure. Fritzsche used such a meter as his standard in his experiments.

The Kennedy meter, which is described by Kempe (*Year Book*, p. 775) is a well-known displacement meter for use with water: it can also be used for air.

The ordinary gas meter used for household work includes two compartments, each made in the form of a bellows: these are filled alternately with the gas, and the number of times each is filled determines the quantity of gas passing through the meter: as soon as one compartment is full of gas, the mechanism is so arranged as to turn the gas into the empty compartment and to actuate the dials on the meter. These meters are on the whole very accurate, but the rate of flow through them is relatively slow as compared to the size of the meter, and, for accuracy, the meter must not be worked at a high speed.



About 1 to 2 per cent. of commercial meters in use are found to be inaccurate by more than 2 per cent. when tested by Public Departments.

The disadvantages of displacement meters, except for calibration purposes, is the low rate at which any fluid can pass through them. The faster they work the more friction there is and the greater chance of leakage past the moving parts. The mechanism in the case of the reciprocating meters is also complicated.

Root's blowers and other similar blowers can be used readily for roughly metering large quantities of air or gas, once they have been calibrated under the conditions in which they will work. But the quantity  $M$  displaced by blowers depends upon three variables, namely, the inlet and the outlet pressures  $P_1$  and  $P_2$ , and the speed of the blower  $n$ . With any two of these factors fixed, quantities vary as the other factor varies.

Displacement meters are of considerable weight, as can be seen from the following table of particulars of wet-drum meters for gas works which is given by Wing (*Proc. Amer. Gas. Inst.*, 9/677/1914):—

TABLE 8'1.—WET STATION METERS.

Cu. ft. per hr.	Lb. per sec.	Size of meter.	Usual pipe connections.	Weight of meter.	Total weight (lb.) of meter with water.
		ft.	in.		
8,000	·087	4	8	3,800	6,000
21,750	·23	6	10	8,750	16,100
40,000	·43	8	12	16,600	33,800
92,000	1·0	12	16	44,500	102,000
200,000	2·15	16	24	95,000	231,000

In *Comp. Air*, 19/728/1914, a description is given of a volumetric meter for measuring the consumption of air by rock drills: no reports of tests of the meter in use are given.

#### D. Venturi meters.

The principle of this type of meter is so well known that a description is almost superfluous: the general nature of the meter is shown in fig. 8'1. A converging pipe and diverging pipe, between which is the throat, are placed in the pipe-line carrying the gas or air to be measured: owing to the increased velocity, the pressure at the throat falls and the quantity can be determined by noting the pressures at the inlet and at the throat.

This type of meter is perhaps the most satisfactory for permanent use in pipe lines where large quantities are to be measured: the meter causes a very small loss of pressure and is accurate: whereas Pitot tubes may cause a smaller loss of pressure, but are not so accurate. But the long converging and diverging cones take up a considerable space; and the manufacture of the cones and of the throat, which must be very smooth, makes the whole affair expensive.

The formulæ and theory governing the flow in such meters are as follows:—

The pipe in which the fluid is flowing is contracted gradually, so that the velocity of the fluid is increased without any abrupt changes, and the pressure gradually falls; the work which the fluid can do in virtue of the fall of pressure is spent in creating the increased kinetic energy of the fluid, neglecting that amount of work which is done in friction. The length of a Venturi meter is so small that the extra work done in friction due to decrease in diameter, though not negligible, is immaterial in commercial work.

Assuming that the factors with the suffix 1 refer to the fluid at the

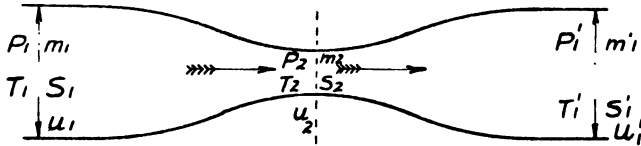

$P_1 - P_1'$  is the pressure lost in the meter.  
 $u_1' - u_1$  is the increase in velocity due to the decreased pressure.  
 $S_1 = S_1'$ ,  $T_1 = T_1'$  usually.

FIG. 8'1.—Venturi meter: theory.

entrance or the exit of the meter, and that the factors with the suffix 2 refer to the fluid when it is passing through the contracted portion of the pipe, we get the following equations for adiabatic frictionless flow:—

Work done = increase in kinetic energy.

$$M \frac{\gamma}{\gamma - 1} (P_1 v_1 - P_2 v_2) = \frac{M P_1 v_1 \gamma}{(\gamma - 1)} \left\{ 1 - \left( \frac{P_2}{P_1} \right)^{\frac{\gamma - 1}{\gamma}} \right\} = \frac{M(u_2^2 - u_1^2)}{2g} \quad (8'02)$$

$$M = u_1 S_1 m_1 = \frac{u_1 S_1 P_1}{C T_1} = u_2 S_2 m_2 = \frac{u_2 S_2 P_2}{C T_2}, \text{ and } \frac{T_2}{T_1} = \left( \frac{P_2}{P_1} \right)^{\frac{\gamma - 1}{\gamma}}. \quad (8'03)$$

$$\therefore u_1 = \frac{S_2}{S_1} \left( \frac{P_2}{P_1} \right)^{\frac{1}{\gamma}} u_2; \quad m_1 = m_2 \left( \frac{P_1}{P_2} \right)^{\frac{1}{\gamma}} \quad (8'04)$$

Then from the first equation we get the velocity  $u_2$  at once,

$$u_2^2 \left\{ 1 - \left( \frac{S_2}{S_1} \right)^2 \left( \frac{P_2}{P_1} \right)^{\frac{2}{\gamma}} \right\} = 2g \frac{\gamma}{\gamma - 1} \frac{P_1}{m_1} \left\{ 1 - \left( \frac{P_2}{P_1} \right)^{\frac{\gamma - 1}{\gamma}} \right\} \quad (8'05)$$

Some American writers deduce the quantity in cubic feet at once, which appears to be unsatisfactory, as the correction for temperature and pressure has to be made. The better way is to find the quantity by weight at once, and then to determine the volume at the desired pressure and temperature. However, the equations in both ways are,

$$\text{Cu. ft. per sec. at } T_2 = Q_2 = S_2 u_2$$

$$\text{Cu. ft. per sec. at } T_0 = Q_0 = S_2 u_2 \frac{T_0 P_2}{T_2 P_0} = S_2 u_2 \frac{(P_1^{1 - \frac{1}{\gamma}} P_2^{\frac{1}{\gamma}})}{T_1} \frac{T_0}{P_0} \quad (8'06)$$

$$\begin{aligned} \text{Lb/sec} = M &= S_2 u_2 m_2 = S_2 u_2^{1/\gamma} \left( \frac{P_2}{P_1} \right)^{\frac{1}{\gamma}} = S_2 u_2 \frac{P_1}{CT_1} \left( \frac{P_2}{P_1} \right)^{\frac{1}{\gamma}} \\ M &= S_2 \left( \frac{P_2}{P_1} \right)^{\frac{1}{\gamma}} \frac{P_1}{\sqrt{CT_1}} \left[ \frac{2\gamma}{(\gamma-1)} \frac{\left\{ 1 - \left( \frac{P_2}{P_1} \right)^{\frac{\gamma-1}{\gamma}} \right\}}{\left\{ 1 - \left( \frac{S_2}{S_1} \right)^2 \left( \frac{P_2}{P_1} \right)^2 \right\}} \right]^{\frac{1}{2}} \end{aligned} \quad (8'07)$$

This can be made simpler if we put  $\frac{P_2}{P_1} = \frac{1}{\chi} = \phi$ , and then we get an equation consisting of terms,

Quantity = area, initial conditions, qualities of fluid, ratio of pressures,

being

$$M = S_2 \frac{P_1}{\sqrt{T_1}} \left[ \left( \frac{2\gamma}{C(\gamma-1)} \right) \frac{\left( 1 - \left( \frac{1}{\chi} \right)^{\frac{\gamma-1}{\gamma}} \right)}{\left( \chi^2 - \left( \frac{S_2}{S_1} \right)^2 \right)} \right]^{\frac{1}{2}} \quad (8'07a)$$

Now the volume at  $P_0, T_0$  in cubic feet is  $M/m_0$ , where  $m_0$  stands for the density at the standard temperature and pressure: there is no need, therefore, to bring in the factors  $P_0$  and  $T_0$  as is done in Weymouth's formula.

In actual practice, as there is friction, some of the work done is lost, and the velocity  $u_2$  is less than that given by the formula, so that the quantity for any particular reading  $p_2$  is less than that given by the formula: the difference being about 5 per cent. or less.

The formula is not convenient because of the fractional powers of the ratios of the pressures; and if the ratio of pressures is large, the area of the throat must be correspondingly reduced, which creates a relatively large friction loss owing to high velocity of the fluid.

In these formulæ the value of  $C$  refers to the fluid, and if one is dealing with gases  $C = (C \text{ for air})/\rho$ , where  $\rho$  is the specific gravity as compared with air.

Weymouth's formula for the cubic feet of fluid flowing per hour is then deduced as,

$$\text{Cu. ft/hr} = 210840 S_2 \frac{T_0}{P_0} \frac{P_1}{\sqrt{T_1}} \left( \frac{P_2}{P_1} \right)^{1/\gamma} \left( \frac{\gamma}{\gamma-1} \right)^{\frac{1}{2}} \left[ \frac{1 - \phi^{1-1/\gamma}}{1 - (S_2/S_1)^2 \phi^{2/\gamma}} \right]^{\frac{1}{2}} \quad (8'08)$$

In these formulæ, no account has been taken of the friction and the contraction of the jet as it goes through the cone. The contraction is very slight and the friction is almost negligible, but the combined effects of the two, cause the actual quantity delivered to be about 0.94 to 0.97 of the quantity registered by the formula. This coefficient must therefore be incorporated in the equations for quantity. Taking this coefficient as  $c = 0.95$ , we get,

$$M = \frac{c S_2 P_1}{(CT_1)^{\frac{1}{2}}} \left[ \left( \frac{2\gamma}{\gamma-1} \right) \frac{1 - \phi^{1-1/\gamma}}{\chi^{2/\gamma} - (S_2/S_1)^2} \right]^{\frac{1}{2}} \quad (8'09)$$

$$Q = \frac{c S_2 P_1 T_0}{P_0 T_1} \left[ \left( \frac{2\gamma}{\gamma-1} \right) \frac{1 - \phi^{1-1/\gamma}}{\chi^{2/\gamma} - (S_2/S_1)^2} \right]^{\frac{1}{2}} \quad (8'09a)$$

$\chi = P_1/P_2 = 1 + a$ , where, if  $a$  is small,  $a = (P_1 - P_2)/P_1 = (P_1 - P_2)/P_2$ ,  $\beta = S_2/S_1$ .

If we expand the expression in brackets, we get,

$$\left[ 1 + 2a/\gamma + (4 - 2\gamma)/\gamma^2 a^2 - \beta^2 \right]^{\frac{1}{2}} \quad (8'10)$$

If now we neglect both  $a$  and  $\beta$  as compared with 1, we get,

$$M = cS_2 \left[ \frac{P_1}{CT_1} 2g(P_1 - P_2) \right]^{\frac{1}{2}} = cS_2 [2g(P_1 - P_2)m_1]^{\frac{1}{2}} \quad (8'11)$$

which is the orifice formula or the Pitot tube formula, if  $S_2$  is left out.

In *Cassier's Mag.*, 15/411/1899, Herschel gives a good description of Venturi meters used for water, and in the article are illustrations of some meters in large pipe lines. Coleman (*Trans. Amer. Soc. Mech. Engr.*, 28/483/1907) describes fully some experiments made on the flow of air as measured by Pitot tubes and Venturi meters. Coleman states that the probable velocity of the air in the throat is 100 to 300 ft. per second, and that the coefficient of contraction amounts to 0.94 to 0.99.

Gibson (*Proc. Inst. C.E.*, 199/391/1914) deals with the causes for variation in the Venturi meter constant  $c$ , for use with water, and says: (1) Friction will not affect  $c$  by more than 2 per cent. as long as the diameter of the pipe exceeds 2 in. (2) With low velocities the destruction of the eddies and the steadying of the motion at the throat causes an increase in the apparent kinetic energy at the throat. (3) The constant is lower measuring pulsating than steady flow, and is increased when there is a whirl in the water approaching the meter.

### E. Orifice meters.

In this section we only deal with orifices in which the pressure lost is a small fraction of the pressures existing at either side of the orifice: there are three different cases to be dealt with.

(a) The first concerns a circular orifice at either side of which the pressure is atmospheric: (b) the second is when the orifice plate is placed in a pipe line and the pressures are not atmospheric: (c) the third is the case of ordinary commercial meters using the orifice principle, but in which the shape of the orifice is not always circular.

**Case a.**—An orifice meter with one of the sides open to the atmosphere can be made with very little expense, and if properly made is accurate enough for commercial purposes. All that is required is a well-constructed wooden or metal box, which will not leak at small water gauges up to about 6 in., at one end of which is an orifice plate, preferably with sharp edges, but this is immaterial if the plate is thin. At the other end is placed the connection for the entry or exit of the air or gas. A thermometer and a U-tube water gauge are also required. The coefficient of delivery for the orifice is 0.6 to within 5 per cent. if the area of the box is greater than 20 times the area of the orifice, and the length of the box is sufficient to prevent the velocity of the air approaching the orifice having an appreciable effect upon the pressure behind the orifice.

The deduction of the various formulæ for the flow from such orifices follows here. We assume that the air is at atmospheric pressure, and that the pressure at the back of the orifice is only a few inches of water, and that

air is flowing out of the orifice : the formulæ hold equally well if the air is flowing from the atmosphere into the orifice.

The theoretical velocity of efflux is,  $u = [2g(P_1 - P_2)/m_1]^{\frac{1}{2}}$  . . . (8'12)

The actual velocity of efflux is,  $c_1 u = c_1 [2g(P_1 - P_2)/m_1]^{\frac{1}{2}}$  . . . (8'13)

where  $c_1$  is the coefficient of velocity. Then there is also the coefficient of contraction, as the velocity  $u$  is measured at the centre of the jet and the jet does not fill the whole area of the orifice : the effective area of the jet is taken as  $c_2 S$ , and the two coefficients may be combined into one which is called the coefficient of delivery,  $c = c_1 c_2$ . The delivery from an orifice becomes, in lb/sec,

$$M = \frac{1}{4} \pi D^2 m_1 c [2g(P_1 - P_2)/m_1]^{\frac{1}{2}} \quad \dots \quad (8'14)$$

$$= 0.785 D^2 c [2g(P_1 - P_2) m_1]^{\frac{1}{2}} \quad \text{using } c = .6 \quad \dots \quad (8'14a)$$

$$= S c [2g(P_1 - P_2) m_1]^{\frac{1}{2}} = 4.81 S [(P_1 - P_2) m_1]^{\frac{1}{2}} \quad \dots \quad (8'14b)$$

$$= S c [2g m' h' m_1]^{\frac{1}{2}} = 0.0334 s (m' h' m_1)^{\frac{1}{2}} \quad \dots \quad (8'14c)$$

$$= S c \left[ \frac{2g m' h' P_1}{CT_1} \right]^{\frac{1}{2}} = 0.55 s \left[ \frac{m' h' p_1 \rho}{T_1} \right]^{\frac{1}{2}} \quad \dots \quad (8'14d)$$

$m'$  is the density of the liquid in the U-tube, and  $h'$  is the height of the liquid in feet. If we now measure the orifice pressure in inches of water, and use the pressure in lb/in<sup>2</sup> and take the diameter in inches, then

$$M = \frac{0.785 d^2 c}{144} \left[ 2g \frac{62.4 h''}{12} \frac{144 p_1 \rho}{CT_1} \right] = 0.1 d^2 c \left[ \frac{h'' p_1 \rho}{CT_1} \right]^{\frac{1}{2}} \quad \dots \quad (8'14e)$$

$$= 0.10 d^2 c (h'' m_1)^{\frac{1}{2}} = 0.1645 d^2 c \left[ \frac{h'' p_1 \rho}{T_1} \right]^{\frac{1}{2}} \quad \dots \quad (8'14f)$$

$$= 0.0986 d^2 \left[ \frac{h'' p_1 \rho}{T_1} \right]^{\frac{1}{2}} = 2.51 S c \left[ \frac{h'' P_1 \rho}{T_1} \right]^{\frac{1}{2}} \quad \dots \quad (8'14g)$$

The quantity of air at  $p_0 = 14.7$ ;  $\rho = 1.0$ .

$$M = 0.378 d^2 \left[ \frac{h''}{T_1} \right]^{\frac{1}{2}} \overset{K, \rho_2}{=} 0.478 s \left[ \frac{h''}{T_1} \right]^{\frac{1}{2}} = 68.7 S \left[ \frac{h''}{T_1} \right]^{\frac{1}{2}} \quad \dots \quad (8'14h)$$

The quantity at normal temperature,  $T = 521$  abs., is,

$$M = 0.01655 d^2 (h'')^{\frac{1}{2}} \quad \dots \quad (8'14j)$$

The quantity of air or gas in cubic feet at  $P_0, T_0$  is,

$$Q = 0.10 d^2 c \left[ \frac{h'' CT_1}{P_1 \rho} \right]^{\frac{1}{2}} \quad \dots \quad (8'15)$$

$$= 0.438 d^2 \left[ \frac{h'' T_1}{P_1 \rho} \right]^{\frac{1}{2}} = 0.0365 d^2 \left[ \frac{h'' T_1}{p_1 \rho} \right]^{\frac{1}{2}} \quad \dots \quad (8'15a)$$

$$= 0.217 d^2 (h'')^{\frac{1}{2}} \text{ (Air)} = 0.362 c d^2 (h'')^{\frac{1}{2}} \text{ (Air)} \quad \dots \quad (8'15b)$$

The volume of free air passing through orifices 1 in. to 5 in. in diameter at water gauges  $h''$  is as follows :—

Diameter of orifice	1 in.	2 in.	3 in.	4 in.	5 in.
Quantity, cu. ft./min	$13\sqrt{h''}$	$52\sqrt{h''}$	$117\sqrt{h''}$	$209\sqrt{h''}$	$326\sqrt{h''}$

The above formulæ are for rough use only, as they include the coefficient of delivery as 0.60, which is only an approximation. If accurate figures are required it is necessary to use more accurate values of  $c$ : Durley (*Trans. Amer. Soc. Mech. Engrs.*, 27/193/1906) gives a table of values of  $c$  for small orifices. A full report of air flow under small pressures is there given. He says that Weisbach's equation for orifice flow gives a coefficient  $c=0.555$  to  $0.589$ , when the head producing the flow varied from 22 in. to 37 in.: he also quotes Fliegner's equation for the flow from containers to atmosphere, when the absolute pressure at the back of the orifice is less than two atmospheres, as,

$$M=1.060(144)S[p_0(p_1-p_0)/T_1]^{\frac{1}{2}} \text{ (Eng. units) . . . (8'16)}$$

Durley gives the equations for theoretical discharge—neglecting  $c$ —as,

$$M=2.51 S \left[ \frac{h'' P_1}{T_1} \right]^{\frac{1}{2}} = 0.0137 d^2 \left[ \frac{h'' P_1}{T_1} \right]^{\frac{1}{2}} = 0.63 d^2 \left[ \frac{h''}{T_1} \right]^{\frac{1}{2}} \text{ . . . (8'17)}$$

for the flow when the pressure is atmospheric. Up to about 20 in. water gauge these equations give the same results as the more exact adiabatic flow equation. In Durley's tests the actual flow was compared with that given by the above equation, and thus the value of  $c$  was measured. Quantities of air were measured by Pitot tubes, and the results of the tests gave values of  $c$  as shown in fig. 8'2. Durley's conclusions concerning orifice flow are :—

- (i.)  $c$  increases as  $h''$  increases for small orifices less than 2 in. in diameter.  $c=0.60$  for an orifice 2 in. in diameter, and is independent of the head causing the flow.
  - $c$  decreases as the head  $h''$  increases for large orifices, greater than 2 in. in diameter.
- (ii.) When the head is kept constant,  $c$  decreases as the diameter increases; this means that relatively less air will flow out of a big orifice than out of a small orifice.
- (iii.)  $c$  is independent of the temperature between  $40^\circ$  and  $100^\circ$  F.
- (iv.)  $c$  is independent of the ratio of the area of the box and the orifice if this ratio is greater than 20; that is, the ratio of box area  $S_1$  to orifice area  $S_2$  must exceed 20.

These results were for orifices in a plate 0.0571 in. thick with square edges, not bevelled in any way. But the interior of the edges of the box behind the orifice plate was rounded off, which would, I think, tend to give a higher coefficient of discharge than with the orifice plate placed directly in the wall of the box.

Ashcroft (*Proc. Inst. C.E.*, 173/289/1908) describes the use of an orifice for measuring the supply of gas to a gas engine.

Dalby (*Engng.*, 90/380/1910) describes some tests made on gas engines

in which the quantity of air and gas consumed by the engine was read by an orifice meter. The box area was 2.66 sq. ft. and the orifice was  $\frac{5}{8}$  in. in diameter,  $S_2=0.00214$ . In these tests  $c$  varied from 0.58 to 0.62: Dalby states that 0.60 is a suitable value for general use. His approximate formula was,

$$M = \frac{1}{4}s(\rho'h'm)^{\frac{1}{2}} \quad \dots \quad (8.18)$$

where  $\rho'$  is the specific gravity of the liquid in the U-tube.

The above formula is accurate if  $c=0.57$ , and is obtained from,

$$M = cSm_1[2g(P_1 - P_2)/m_1]^{\frac{1}{2}} = c(s/144)[2g \cdot 62.4 \rho'h'm_1]^{\frac{1}{2}} \quad \dots \quad (8.19)$$

Now, if  $c=0.60$  and  $g=32.2$ ,  $M=0.264s[\rho'h'm_1]^{\frac{1}{2}}$ .

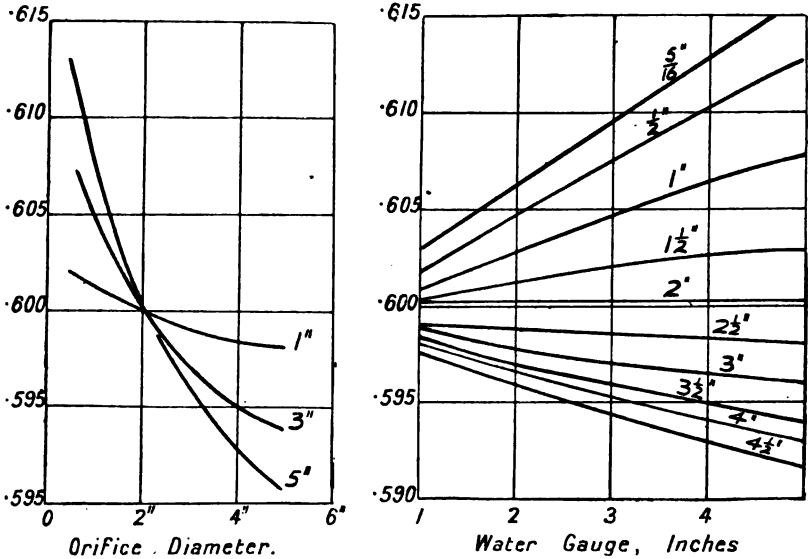

Figures on curves give orifice diameter.

Figures on curves give water gauge.

FIG. 8'2.—Coefficients of delivery from pure orifices at low pressures. (Durley.)

Harris (*Compressed Air*, p. 29) also mentions orifice flow, and gives the equation for velocity,  $u = [2gh''(5.2)/m_1]^{\frac{1}{2}}$ , and deduces the ordinary equations.

Shaw (*Ventilation*, p. 12) states that a circular orifice approximately 6 in. in diameter will deliver 1 cu. ft. of air per second when the water gauge is 0.015 in., which equals one foot of air. Then he chooses such an orifice as the unit of resistance for air currents: so that unit aero-motive force (=1 ft. of air) produces unit current of air (=1 cu. ft./sec) through unit resistance (=6-in. orifice). This unit of resistance depends upon the coefficient of contraction for the 6-in. orifice. Shaw makes two statements: first, that 1/27 ft. of air (=H) drives 1 cu. ft. of air through an orifice 1 cu. ft. in area: this gives,

$$Q = 1 = cSu = cS[2g/27]^{\frac{1}{2}} \quad \dots \quad (8.20)$$

therefore  $c=0.647$ .

Now he deduces the unit of resistance from,

$$\begin{aligned} (\text{unit head}) \times (\text{unit area})^2 &= (\text{unit vol.})^2 \\ (1/27) \times (\text{unit area})^2 &= 1 \end{aligned}$$

$$\begin{aligned} \text{Unit area} &= [1/27]^{\frac{1}{2}} = 0.1925 = 0.785D^2, & D &= 0.495 \text{ ft.} \\ & & d &= 5.94 \text{ in.} \end{aligned}$$

Then on p. 12 he states that unit head, or 1 ft. of air, gives unit flow through a 6-in. orifice, in this case  $c=0.626$ .

Watson and Schofield (*Proc. Inst. M.E.*, —/517/1912) describe tests on the quantity of air delivered through orifices  $\frac{1}{2}$  in. to 2 in. in diameter at pressures of  $\frac{1}{2}$  in. to 2 in. of water, the pressures being both steady and pulsating. Most of the orifices were made with sharp edges in a 0.4-mm tin plate; but some tests were made with the edges slightly rounded, in which case the coefficient of discharge was increased as follows :—

Orifice diameter.	Per cent. increase in delivery.	Pressure (approx.).
2 in.	1.7	1 in.
1 "	0.2 ~ 1.8	1 "
$\frac{1}{2}$ "	4.8 ~ 5.1	1 "

If orifices are placed in a box in parallel, a disturbance in the coefficient of delivery will arise unless the distance between the centres exceeds  $2\frac{1}{2}$  times the diameter of the orifices.

Three different sizes of orifice box were used, viz.  $57'' \times 25'' \times 25''$ ,  $38'' \times 17'' \times 17''$ , and  $28'' \times 13'' \times 13''$ . It was found that the coefficient of delivery,  $c$ , varied with the same orifice in different boxes; this is contrary to Durley's result, where  $c$  was invariable if the ratio of box area to orifice area exceeded 20. The values of  $c$  varied between 0.59 and 0.62 for different conditions, as is shown in fig. 8.3: the results may be summarised thus :—

- (a)  $c$  for a fixed orifice decreases as the pressure increases.
- (b)  $c$  increased as orifice diam. increased for the  $13 \times 13$  box.  
 $c$  was constant " " " for the  $17 \times 17$  "  
 $c$  decreased " " " for the  $25 \times 25$  "
- (c) For commercial work  $c$  may be taken as 0.60 without serious error.

Watson and Schofield used the orifice and box to measure the quantity of air supplied to an internal combustion engine; owing to the pulsating flow the pressure in the box underwent cyclic variations, represented by  $h = h_0(1 + a \sin \omega t)$ , where  $h_0$  was the mean pressure registered on the gauge and  $ah_0$  was the amplitude of the variations: the coefficient of delivery is reduced in such a case, the value for use with the ordinary formulæ being found from the value of  $c$  when the pressure is steady, by multiplying by a correction factor,  $1 - \frac{a^2}{16} - \frac{15a^4}{1024}$ , as given in fig. 8.4. The correction is small for the values which would ordinarily be experienced.

**Orifice flow: case b: orifice in pipe line.**—An orifice plate may be inserted in a pipe and the drop of pressure at the orifice noted, but in this case the connection between the loss of pressure  $P_1 - P_2$  and the quantity



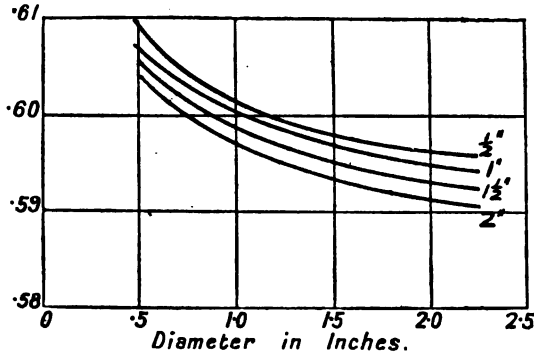

FIG. 8'3A.—Coefficient of delivery from orifices; giving the variation with size of orifice at various pressures measured in inches of water. Given by Watson, p. 532.

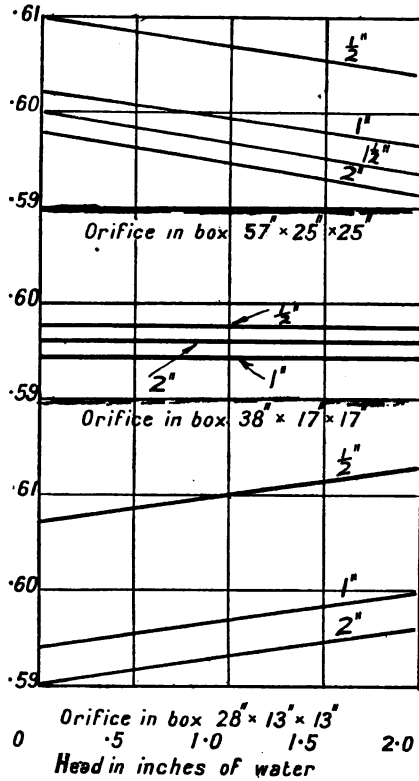

FIG. 8'3B.—Coefficient of delivery from pure orifices in different orifice boxes; depending upon pressure. Figures on curves give orifice diameter.

M is not theoretically determinable, because the coefficient of contraction depends upon the ratio of orifice area to pipe area, to ratio  $S_2/S_1$ . One cannot make this ratio very small, say  $20 S_2=S_1$ , without producing a relatively large loss of pressure in the pipe line at the orifice. The coefficient of contraction  $c$  has therefore to be determined by experiment.  $c$  will vary from 1.0 when the orifice area=pipe area, to a value 0.60 when the orifice is quite a small portion of the pipe. According to the table of constants which George Kent & Co., Ltd., give with their orifice meters,  $M = \text{constant} [(P_1 - P_2)P_1/T_1]^{\frac{1}{2}}$ , where the constant is fixed for any particular size of orifice in any particular sized pipe. The coefficient depends only upon  $D_1$  the diameter of the pipe, and  $D_2$  the diameter of the orifice. If now a series of tests were made and the results were published, showing how  $c$  varies with the ratio  $D_2/D_1$  for various sizes of pipes, it would be

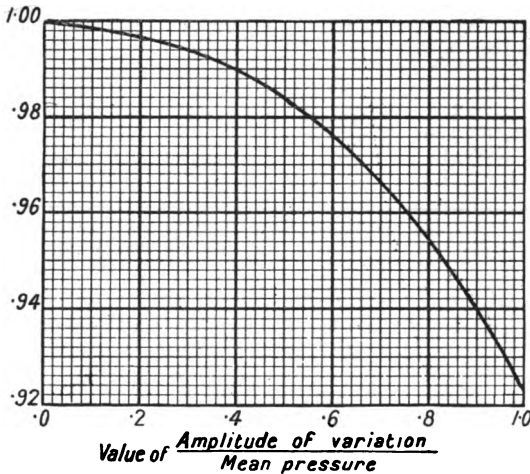

FIG. 84.—Factor with which to multiply the coefficient of delivery from orifices, when the pressure at the back of the orifice is variable. Given by Watson, p. 537.

possible to know the coefficient of contraction approximately when an orifice plate of any particular size is inserted in any pipe.

The loss of pressure which occurs at the meter is,

$$P_1 - P_2 = \frac{M^2}{S_2^2 c^2 g m_1} = \frac{Q^2 m_1}{S_2^2 c^2 2g} = \frac{u^2 m_1}{c^2 2g} \quad (8.21)$$

For various types of work we find the quantities which can be metered for any loss of pressure :—

[TABLE.

TABLE 8'2.—LOSS OF PRESSURE IN METERING VARIOUS QUANTITIES.

	Type of circuit.			
	Vacuum at $\frac{1}{2}P_0$	Ventilation at $P_0$	Compressed air at 70 lb/in <sup>2</sup> gauge.	
Loss of pressure at the orifice, inches water.	2	$\frac{1}{2}$	10	} English units.
Density, lb/ft <sup>3</sup>	·0382	·0764	·458	
Lb/sec, M	·0221d <sup>2</sup>	·0156d <sup>2</sup>	·172d <sup>2</sup>	
$d =$ orifice diam. inches }				
Cu. ft. per min. } Free air = 60Mv <sub>0</sub> }	17·4d <sup>2</sup>	12·3d <sup>2</sup>	135d <sup>2</sup>	
Pressure in pipe line	$\frac{1}{2}$ atmos.	atmos.	5 kg/cm <sup>2</sup> gauge	} Metric units.
Loss of pressure at the orifice, mm water.	50	10	250	
Density, kg/m <sup>3</sup>	0·61	1·22	6·0	
Kg/sec $\times (10)^2$ }	15·4d <sup>2</sup>	9·7d <sup>2</sup>	108d <sup>2</sup>	
$d =$ orifice diam., mm }				
Cu. metres/min $\times (1000)$ } Free air = 60Mv <sub>0</sub> }	0·760d <sup>2</sup>	0·478d <sup>2</sup>	5·30d <sup>2</sup>	

The metric quantities are obtained from  $M = 0·8 S (19·62mh)^{\frac{1}{2}}$ .  
 The English " " " "  $M = 0·8d^2(h''m)^{\frac{1}{2}}$ .

Moss (*Amer. Mach.*, 19/368/1906) gives a great number of formulæ for orifice flow for air and gas : his formulæ cover the three conditions of flow,

$$\begin{aligned} &\text{when } P_1 - P_2 < 0·01 P_1 \\ &\text{when } P_1 - P_2 > 0·01 P_1 \text{ and } < 0·10 P_1 \\ &\text{when } P_1 - P_2 > 0·10 P_1 \text{ and } < 0·50 P_1. \end{aligned}$$

The orifice flows we have been considering lie in the first two groups, or at least partly in the second one. But the third type of flow, when the loss of pressure in the orifice is a big fraction of the pressure at the back of the orifice, is dealt with in Chapter XI. Such a type of orifice is not ordinarily used for meters, as it is much too costly, except when the orifice is also used as a load in testing compressors. If one is running a compressor which is to deliver, say, 91 cu. ft. or 7 lb. of air a minute at 60 lb. pressure, then a definite orifice may be used which will just deliver that quantity at the specified pressure. Moss calls attention to the fact that the fractional expression

$$1/[1 - (P_2/P_1)^{2/\gamma} (S_2/S_1)^2]^{\frac{1}{2}} \quad (8·22)$$

which occurs in the Venturi meter formula, is an integral part of all orifice formulæ, but that it usually differs from 1 by so little that it is neglected. This occurs when the ratio of  $S_1/S_2$  is greater than 20.

Müller (*Z.V.D.I.*, 52/285/1908) describes tests upon the coefficient of contraction for pure orifices used in four different positions, namely, (i.) in a container, (ii.) for a container with a short pipe outside, (iii.) for a short pipe ending in an orifice, (iv.) for an orifice in a pipe line. He measured quantities of air by means of containers : the air was taken as having 60

per cent. moisture, as the percentage varied from 50 to 70 ; the density was calculated from  $m = 13.6 P'(\text{mm mercury}) / (CT) = P / (CT)$ .

For a pure orifice in an infinite plate, which is equivalent to the orifice in the side of a container, in which case the velocity  $u_1 = 0$ , Müller puts,

$$H = \frac{P_1}{m_1} - \frac{P_0}{m_0} = \frac{u_0^2}{2g} (1 + \xi) \quad (8.23)$$

where  $\xi$  is introduced to cover friction, and H is the feet of head of fluid causing the flow.

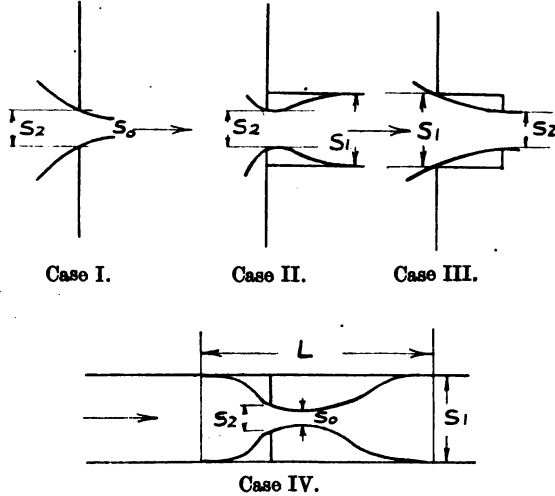

FIG. 8.5.—Orifice flow : Müller's theory.

Also we have  $S_0 = \text{vena contracta} = c_2 S_2$ .

$$u_0^2 (1 + \xi) = 2gH \quad (8.24)$$

$$u_0 = c_1 (2gH)^{\frac{1}{2}} = c_1 [2g(P_1/m_1 - P_0/m_0)]^{\frac{1}{2}} \quad (8.24a)$$

Therefore,

$$c_1 = 1 / (1 + \xi) \quad (8.25)$$

and the volume delivered is,

$$S_0 u_0 = c_2 S_2 c_1 (2gH)^{\frac{1}{2}} = c S_2 (2gH)^{\frac{1}{2}} \quad (8.26)$$

For a pure orifice, delivering air to an open atmosphere,  $c$  becomes approximately 0.597, and is independent of  $S_2$ .

Müller also tested the flow for three other conditions, viz. :—

- (ii.) Flow from a container with an orifice and short pipe outlet.
- (iii.) " " " " " " at the end of the short pipe.
- (iv.) " through an orifice in a pipe line.

The value of  $c$  for each of these cases is given in Table 8.3.

The value of  $c$  for an orifice in a pipe line is not the same as for the same orifice in the side of a container : further, assuming that we have a head H

delivering a quantity of fluid  $Q$  through the orifice in the case of the pipe line, this quantity is not  $cS_2(2gH)^{\frac{1}{2}}$ , but is  $kS_2(2gH)^{\frac{1}{2}}$ , and  $k$  does not equal  $c$ . In each case Müller compared the actual quantity  $Q$  which flowed with the theoretical quantity  $Q'$  obtained from the equation,

$$Q' = S_2(2gH)^{\frac{1}{2}}$$

The value of  $k$  depends upon the coefficient of contraction in the orifice and also upon the ratio of the orifice area to the pipe area, when it is associated with a pipe: this ratio  $S_2/S_1=r$ . The equations for the flow in the case of an orifice in the pipe line, which is the one in which we are chiefly interested as regards metering quantities, are as follows (see fig. 8'5):—

$Q = u_0S_0 = u_1S_1 = u_0cS_2$ ; when the alteration of density is neglected, owing to the small difference between the two sides of the orifice.

$$\frac{P_1}{m_1} + \frac{u_1^2}{2g} = \frac{P'}{m'} + \frac{u_1^2}{2g} + fL \frac{u_1^2}{2g} + \frac{(u_0 - u_1)^2}{2g} \quad (8\cdot27)$$

where  $f$  stands for the friction in the pipe,  $= 4\zeta m/D_1$ .

$$2g \left[ \frac{P_1}{m_1} - \frac{P'}{m'} \right] = fL \frac{Q^2}{S_1^2} + \left\{ \frac{Q}{cS_2} - \frac{Q}{S_1} \right\}^2 = \frac{Q^2}{k^2 S_2^2} \quad (8\cdot28)$$

and 
$$\frac{S_2^2 fL}{S_1^2} + \left\{ \frac{1}{c} - \frac{S_2}{S_1} \right\}^2 = \frac{1}{k^2} = r^2 fL + \left\{ \frac{1}{c} - r \right\}^2 \quad (8\cdot29)$$

therefore 
$$1/c = r + [1/k^2 - r^2 fL]^{\frac{1}{2}} \quad (8\cdot30)$$

Müller's values for  $k$  and  $c$  in various cases are given herewith (see fig. 8'6):—

TABLE 8'3.—VALUES OF  $k$  AND  $c$  (MÜLLER).

	$d_2=23\cdot4$ $r= \cdot0816$	$36\cdot0$ $\cdot193$	$43\cdot9$ $\cdot2875$	$52\cdot2$ $\cdot406$	$62\cdot25$ mm. $\cdot578$	$D_1=81\cdot9$ mm.
i.	$c = \cdot597$	...	$\cdot598$	...	$\cdot596$	Pure orifice.
ii.	$k = \cdot632$	...	$\cdot685$	...	$\cdot764$	
	$c = \cdot602$	...	$\cdot582$	...	$\cdot571$	Short cylinder ending in orifice.
iii.	$k = \cdot603$	...	$\cdot644$	...	$\cdot757$	
	$c = \cdot602$	...	$\cdot633$	...	$\cdot691$	
iv.	$k = \cdot641$	$\cdot689$	$\cdot750$	$\cdot854$	$1\cdot084$	
	$c = \cdot609$	$\cdot610$	$\cdot621$	$\cdot644$	$\cdot697$	

The reason for the value of  $k$  which is greater than 1, is the fact that the pressure rises between the orifice and the point  $P'$ , and the velocity falls: the head available for driving the air or gas through the orifice is really much more than  $P - P'$ .

If we can assume that  $c$  is constant for each particular ratio of  $D_2/D_1$ ,  $=r^{\cdot5}$ , then one can determine  $k$  for any orifice in any pipe when particular values of  $\zeta$  and  $m$  are chosen. If the friction term  $r^2 fL$  is neglected, then

$$r + 1/k = 1/c, \text{ and } k = c/(1 - cr) \quad (8\cdot31)$$

The way in which  $c$  varies with  $r$  is not fully determined in Müller's tests, and therefore it is not possible to draw up a complete table for the values of  $k$  to cover general cases. The friction will usually be negligible unless highly compressed air is being metered.

$k$  will usually be less than 1, so that  $1/k^2$  is greater than 1.

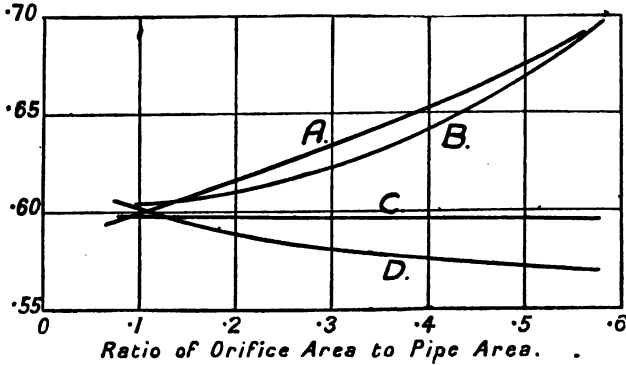

A, for orifice at the end of short pipe. C, for orifice in a plate, pure orifice.  
 B, " in a pipe line. D, " at entrance to the pipe.

FIG. 8'6.—Coefficient of delivery from various types of orifice depending upon the ratio of the orifice area to the area of the pipe. Given by Müller. See fig. 8'5 for the different types.

The question of whether the friction term,  $r^2 f L = r^2 4 \zeta_m L/D$ , is negligible can be approximately determined, because usually,

$$r < \frac{1}{2}, \quad r^2 < \frac{1}{4}, \quad L < 4 \text{ ft.}$$

so that

$$r^2 f L < f < \frac{4 \zeta_m}{D}.$$

Values of  $4 \zeta/D$  are given in Table 2'1, and are always less than 1, and when  $D > 3$  in. become less than 0.10, so that  $r^2 f L$  will be very small unless the air is very highly compressed.

For the case in which the orifice is at the entrance to the pipe, the equations connecting  $c$  and  $k$  are,

$$\frac{1}{k^2} = r^2 + \left(\frac{1}{c} - r\right)^2, \quad \frac{1}{c} = r + \left[\frac{1}{k^2} - r^2\right]^{\frac{1}{2}} \quad (8'32)$$

and if friction is allowed for,

$$\frac{1}{k^2} = r^2(1 + fL) + \left[\frac{1}{c} - r\right]^2 \quad (8'33)$$

Müller's value of  $f$  was 0.407.

Hickstein (*Jour. Amer. Soc. M.E.*, 38/216/1916) describes tests upon orifice meters 8 in. and 10 in. in diameter: he measured the quantities of air directly by gas-holders. The discs were made from  $\frac{1}{4}$ -in. plate, and had  $\frac{1}{32}$  in. flat surface and the remainder bevelled at 45°, the bevel facing downstream.

The pressure upstream,  $P_1$ , was read at a distance  $2\frac{1}{2} D$  before the disc.  
 " " downstream,  $P_2$ , " "  $8 D$  after the disc.  
 He found that the usual equation,  $Q = K(\frac{1}{2}P)^{\frac{1}{2}}$ , held, values of  $K$  varying from 0.52 up to 1.8; in his figure on p. 217 he plots values of  $c_v$ , which he says =  $11.55 K/D^2$ , but he does not explain what  $c_v$  is nor how the equation is got. Fig. 8.7 is drawn from his figure: the curve is only approximate; the abscissæ are the ratio  $\frac{\text{disc diam.}}{\text{pipe diam.}}$ , not *vice versa* as given in his figure.

Westcott, in *Measurement of Gas by Orifice Meter*, has given tables of correcting factors for use with the formulæ concerning orifice flow when the pressure and density differ from the standard values. Full reports are given of Hickstein's tests at the Erie works, and of similar tests made at Joplin. The book is primarily for the use of men who are maintaining orifice flow meters made by the particular company who produce the book:

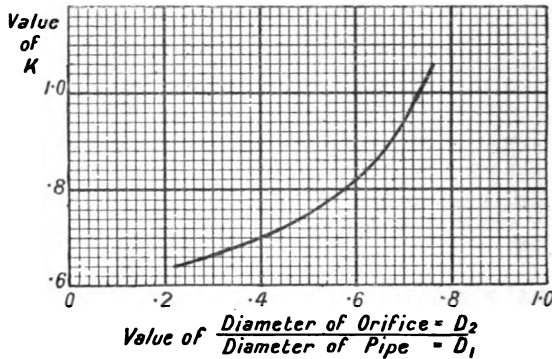

FIG. 8.7.—Coefficient of delivery for orifices in a pipe line.  
 Given by Hickstein, p. 217.

not much information is given on the general question of measurement with other types of meter.

Box's values of  $c$  are given in fig. 8.8 (see Table 11.2).

Gaskell (*Proc. Inst. C.E.*, 197/243/1914) discusses the use of orifices in pipe lines to measure air flow. He found that round-edged orifices gave variable results, and therefore abandoned them in favour of square-edged orifices in  $\frac{1}{16}$ -in. plate. One test orifice was made in  $\frac{1}{16}$ -in. plate with  $\frac{1}{16}$ th in. plain and the remaining  $\frac{1}{16}$ ths on a  $45^\circ$  bevel; the pressure holes were bored in the plate itself, one facing upstream and one downstream. He found that the holes for taking pressure readings should be placed close to the orifice. His formula for the discharge is,

$$M = c \frac{S_1}{\gamma^{\frac{1}{2}}} \left[ \frac{2g dP}{(S_1^2/S_2^2) - 1} \right]^{\frac{1}{2}} \left[ 1 - a \frac{dP}{P} \right] \quad \dots \quad (8.33a)$$

where  $P_1 - P_2 = dP = \text{loss of pressure across the orifice.}$

$$a = \frac{3}{4\gamma} \left[ 1 - \frac{3 dP}{8\gamma P_1} + \text{etc.} \right] \quad \dots \quad (8.33b)$$

= 0.531(1 - 0.265 dP/P<sub>1</sub> + ) for gases  
 = 0.656(1 - 0.328 dP/P<sub>1</sub> + ) ,, steam.

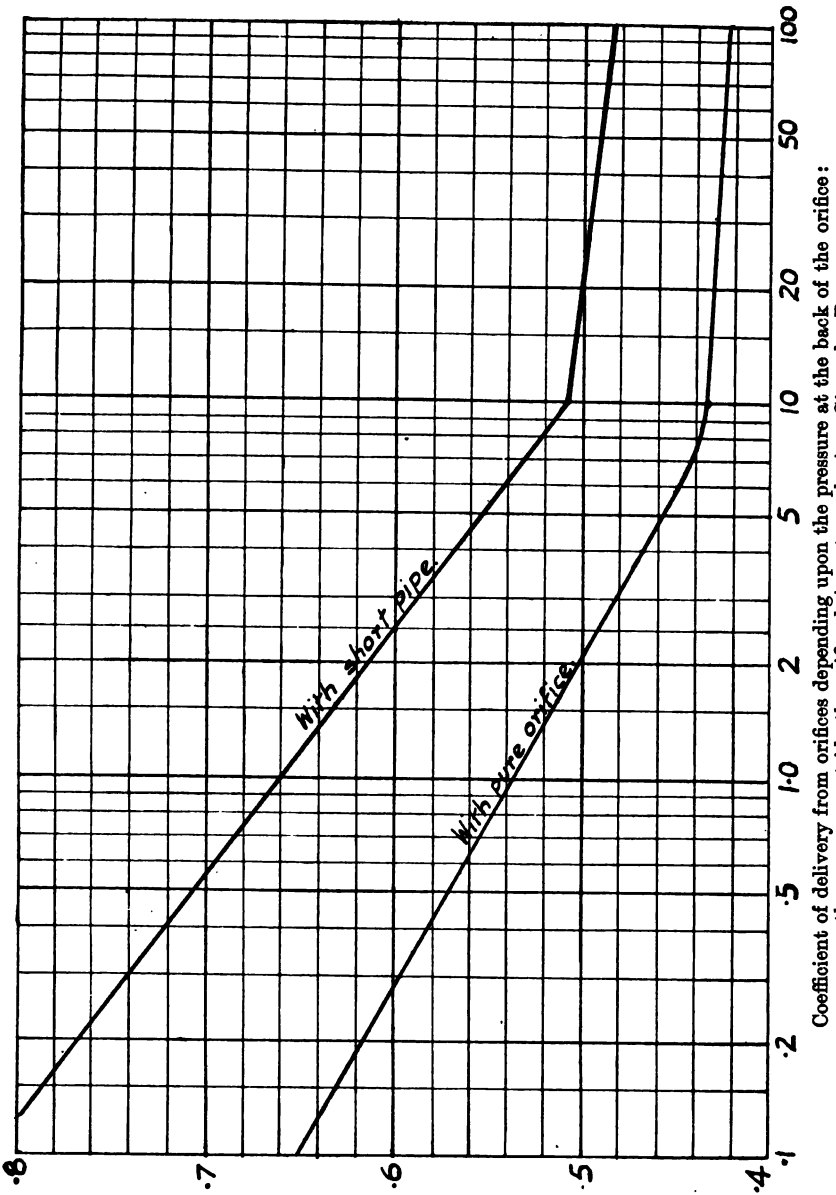

Fig. 8'8.—Difference of pressures in atmospheres.



Usually  $dP/P$  will be small, so  $a$  becomes nearly 0.52 for gases and 0.65 for steam. Gaskell's tests with water gave approximately for the coefficient of contraction,

$$\begin{aligned} \text{For orifices in 8-in. pipe, } c_c &= 0.61 \text{ (0.1) } (S_2/S_1). \\ \text{,, ,, 6-in. ,, } c_c &= 0.616(0.08)(S_2/S_1). \end{aligned}$$

An interesting comparison between Weisbach's figures and the test figures is given in his figure on p. 260, the general result of which is to give a coefficient of contraction as shown in fig. 8'9.

Bailey (*Jour. Amer. Soc. M.E.*, 38/775/1916) discusses the use of orifices in pipe lines as steam meters. He states that in Venturi meters 15 per cent. of the available head is lost, while in orifice meters 25 per cent. may be

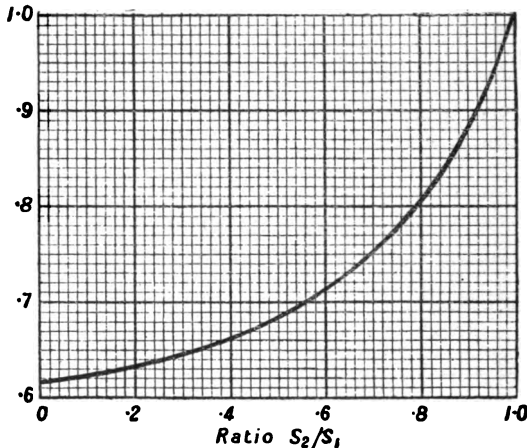

FIG. 8'9.—Coefficient of contraction as given by Gaskell.

lost. Regarding the coefficient of discharge, which is unknown, he says: "The coefficient did not appear to be as constant for different values of the ratio orifice diameter to pipe diameter, as it had been hoped that it would"; and further on: "The coefficient increased as the ratio of orifice area  $S_2$  to pipe area  $S_1$  increased with no obvious reason why it should." The fact of the increase and its reason should be obvious to any engineer, because when the ratio becomes unity the coefficient = 1.0, and presumably—as shown by Hickstein and Müller (see fig. 8'7)—the coefficient will increase from the value 0.6 up to 1.0 gradually as  $S_2/S_1$  varies from, say,  $\frac{1}{2}$ th up to 1.0.

Bailey found that the type of Pitot tube he experimented with gave very unreliable results when placed with the hole at the centre of the pipe: the form of tube was apparently that of a hollow tube divided down the middle by a partition with single openings at the back and front; so that the tube was to some extent a "Stauscheibe." Such a form of tube is known to be unreliable: Bailey found it reading 15 per cent. low because the whirls in the steam created high velocities at the boundaries of the pipe and left the velocity at the centre relatively low. For steam work he also found that the multiple form of Pitot tube became unsatis-

factory in use because the holes became stopped up with sediment and then ceased to act, thus altering the constant of the tube.

Nelson (*Engng. News*, 77/19/1917) states: "There is little data available as to the amount of air flowing through an orifice against a back pressure," which is quite incorrect, as there is a large amount of such data in existence; see the various references in Chapters VIII. and XI., most of which are prior to 1917. Nelson made tests on  $\frac{2}{84}$ ,  $\frac{3}{84}$ ,  $\frac{4}{84}$ -in. orifices, placed in a  $\frac{1}{2}$ -in. main consisting of various valves and tees. The quantity of air flowing was found by discharging it through a nozzle at the end of the pipe to atmosphere and using the formula  $M=0.53(144 S)p/T$ : there is a printer's error in this: T should be  $T^{\frac{1}{2}}$ ; see Eq. 11'34*m*. He found that, for the orifice in the pipe line,

$$Mv=33(p_1-p_2)^{\frac{1}{2}}p_1^{\frac{1}{2}}(144 S),$$

$p_1-p_2$  varied from 2-10 lb/in<sup>2</sup>, and  $p_1$  from 45-90 lb/in<sup>2</sup>; T was 60° F., and was constant, as the quantities of flow only ranged from  $\frac{1}{2}$  to 4 ft<sup>3</sup>/min. When compared with Eq. 11'34, his equation gives  $c=0.90$ .

**Orifice meters: case c: commercial meters.**—Many commercial meters which act on the orifice principle are made. Some of these employ a "pure" orifice, by which is meant a circular orifice in a thin plate: others employ an "impure" orifice, by which is meant a hole of any shape and section, which may sometimes be the ring-shaped area formed between two cones, one fitting inside another; the area may be indeterminable, and then the flow is indeterminable by theory. A good example of such a meter is a globe valve which will transmit various quantities, according to how much it is opened.

The laws of flow in commercial meters with the pure orifice in the pipe line have just been dealt with: the laws of flow in meters with impure orifices cannot be stated in the same way, because very often the area  $S_s$  is a varying quantity.

As a good typical case of such a meter, consider the "Sentinel" meter valves as made by Alley M'Lellan, Ltd., to Gibbs' Patent 27042/08. In this meter the difference of pressure which exists between the two sides of an accurately made sluice valve is adjusted to a fixed value when transmitting varying quantities of fluids, by varying the amount of the opening: the amount of the opening is read on a scale placed near the handle, and the quantity being transmitted is then read from the calibration curve.

A few paragraphs taken from the catalogue description may explain the meter more clearly: "As meters, the valves have an enormous range through which accurate readings may be obtained; they will measure from quite a small dribble up to the full amount the pipe will carry. The action is so simple that anyone can take readings accurate well within commercial requirements. For instance, the 6-in. valve towards one end of its range plainly indicates the difference between 500 and 501 gallons of water per minute, and all valves will measure rates of flow smaller than 1 per cent. of their maximum capacity."

"Taking a reading with a 'Sentinel' meter is a simple matter occupying a minimum of time. The main valve is gradually closed down until the small manometer interposed between its inlet and outlet just indicates.

Then there is (1) a definite pressure driving (2) a fluid of known density through (3) an area of definite section, the result being, as all know, a perfectly definite rate of flow. This measurement should always be made by closing the valve slowly down so as to take up the necessary small amount of backlash, and is accurate well within  $2\frac{1}{2}$  per cent., not only once in a while, but always."

"The main valve is one of our parallel-slide steam stop valves. The wedging gear is omitted to permit of accurate measurement of the opening of the gates. The seats are bored and the gates are turned to limit gauges, so that the area past the valve with a definite opening is the same for all valves of the same size."

"The manometer consists of a plunger, which is a free but practically fluid-tight fit in its cylinder. Pressure is led to its under side from the inlet, and from the outlet pressure is led to the top side. When the standard pressure difference is reached the plunger floats, and this movement is easily seen through the glass tube. The friction is negligible, and this manometer, while a very sensitive instrument, cannot easily be damaged. Cocks are provided to shut off the manometer from the tube."

Some criticisms can be made upon these claims. As the metering depends upon a constant pressure difference, which equals the weight of the plunger less any friction, the quantity registered depends upon  $cS$ ; if, therefore, it reads 1 per cent. of the maximum accurately, this quantity  $cS$  must be 0.01 of the maximum  $cS$ ; when the valve is at the maximum opening,  $c$  may be 0.8 and  $S$  for a 7-in. valve 36 sq. in.;  $cS$  then = 28.8. In order to read 0.01 of the quantity, the opening will be small and the coefficient  $c$  will be about 0.6, so that the area of the opening will have to be 0.48 sq. in. The valve will be thus nearly on the bottom seat, the distance from the bottom edge being about 0.10 in. to 0.05 in. This amount can probably be measured reasonably well as claimed by the makers, provided there is no backlash error. But unless the two edges and surfaces of the orifice are quite clean, errors will arise owing to the altered value of the effective area  $S$ . Dirtiness of the edges will not seriously affect the readings at the maximum value, but will cause serious errors at the minimum values. To try and get a very accurate reading at 1 per cent. of the maximum quantity is unnecessary.

Friction of the plunger in its cylinder will introduce a constant error in all the readings, and can be allowed for: it will not affect the percentage error at all. And the question of its importance depends entirely on the weight of the plunger, which is not stated. The loss of pressure in the valves of various sizes is not stated.

This type of meter is not very satisfactory for a circuit when the flow to be metered varies widely from moment to moment, though for metering such flow all meters are at a disadvantage.

With an ordinary orifice meter and water gauge, however, the sort of variations in the flow are apparent in the fluctuations of the liquid in the U-tube gauge; but in this meter the range of the variations cannot be gauged. Suppose the valve has been screwed down till the plunger just floats, and during the next moment the flow increases, the plunger will immediately rise and will remain up until the flow decreases again. If after a momentary equilibrium the flow is reduced and the plunger falls, the valve can be

screwed down a little until the plunger rises again. The difficulty of finding the proper mean position arises from backlash, because, if the plunger is up and the valve is opened, it must be opened so far that the plunger falls properly, and then the valve can be slowly brought down again. The position of the valve required is one such that the plunger is either always flowing, or is up for the same length of time as it is down. Throttling the supply to the plunger will have no effect, as there is no flow of fluid between the two sides of the plunger.

The great advantage of the meter is that it takes no extra space in the pipe line, and that there is no loss of pressure, except when readings are being taken.

Orifice meters, in which an orifice plate is inserted in the pipe line and the drop of pressure is read upon a water or oil gauge, reveal variations of the flow at once. There is no trouble with backlash, as the area remains constant; but they suffer from the disadvantage that unless an orifice plate is inserted, big enough to take the maximum flow when giving the maximum gauge reading, the variations in the flow may drive the liquid in the U-tube beyond the scale. Further, as the size of the orifice is constant,  $cS$  is constant, and the flow then depends upon  $(P - P_2)^{\frac{1}{2}}$  or  $(h'')^{\frac{1}{2}}$ : the quantities therefore vary as the square root of the water gauges, and the readings at low values will not be of much value. George Kent & Sons have partly overcome this disadvantage by making the U-tube of a parabolic shape, the tangent of the parabola being horizontal. The linear reading along the tube varies approximately as  $\sqrt{h''}$ , and the height of any point above the tangent varies exactly as  $\sqrt{h''}$ . By this means relatively accurate readings of small quantities of the maximum flow can be obtained.

Hebblewhite (*Jour. N.S. Wales Roy. Soc.*, 45/258/1911) describes a recording air meter. Air flowed into a chamber floating in water and flowed out of the chamber *via* small holes; the number of holes available depended upon the height of the float outside the water, which depended upon the pressure of air in the float. The meter was calibrated from standard meter tanks. An additional spring-borne float was used to damp the pulsating effect, because the air was being received from a steam-engine condensing plant.

The "Rhenania" steam meter is described in *Engng.*, 97/129/1914. In this recording meter the flowing steam acts on a mechanism which opens two rectangular ports to an amount depending upon the quantity flowing. Commercial sizes of the meter are made for pipes 25–200 mm diam., to register flows from 300 to 20,000 kg/hr (11 to 740 lb/min).

Claasen (*Z.V.D.I.*, 62/521/1918) describes the perfections of the Claasen recording steam meter, which works on the float principle similar to the St John meter; he claims that his shape of float is so superior that the accuracy of the meter is increased: the tests made by the Charlottenburg calibration plant showed 2 per cent. accuracy with saturated steam, and 3.5 per cent. accuracy for superheated steam. The meter will measure quantities between 1000–22,000 kg/hr with good accuracy.

Good illustrations of various steam and water meters and some particulars of their sizes and methods of operation will be found in the *Electrician*, 82/721/1919.

### F. Electrical meters for quantities.

Thomas (*Jour. Franklin Inst.*, 172/411/1911) describes an electrical method of measuring quantities of air or gas, by using an electric heater in the pipe line, and by noting the electrical energy imparted to the gas and the rise of temperature of the gas: when the specific heat of the gas is known, the quantity will be deducible. One very great advantage of this type of meter is that the specific heat is practically independent of small variations of the pressure and temperature, and for commercial work is quite independent of such variations: at any rate the variations in the specific heat from day to day due to the quality of the gas will be greater than those due to variations in temperatures and pressures during the day.

The heater is placed in some convenient spot in the pipe line in a special housing of its own, to avoid losses by radiation. Two electrical resistances are introduced at each side of the heater and form two arms of a Wheatstone bridge: when the resistance of the second resistance unit rises as the temperature rises, the bridge will become unbalanced and the galvanometer needle will be deflected. It could be arranged that this deflection would measure the quantity flowing in the pipe.

Thomas in his experiments compared quantities registered by his meter against quantities registered with Pitot tubes and Venturi meters, and found good agreement. A detailed description of a commercial form of the instrument is given in *Proc. Amer. Gas Engr.*, 7/339/1912. In this instrument the deflections of the galvanometer needle are used to control the amount of energy imparted to the heater, so that the energy is varied as the quantity varies, the temperature difference between the resistances being kept as constant as possible: this is done instead of keeping the power constant and allowing the temperature difference to vary with the varying quantities.

Fig. 8'9 shows the meter in diagrammatic form: illustrations of the actual meter are given on pages 342 and 350 of the original article.

The heater, which is a grid of wire, is placed between two nickel wire resistances: these are kept at temperatures  $T_1$  and  $T_2$  such that  $T_2 - T_1$  is fairly constant and about  $1^\circ\text{C}$ . A resistance  $R_1$  can be inserted to make up for the increased resistance of  $r_2$  when hot, and is such that, when  $T_2 - T_1$  is the correct amount, the needle of the galvanometer will be in its central position. Now suppose that there is equilibrium and the energy imparted to the gas is just sufficient to heat it from  $T_1$  to  $T_2$ , but that then the quantity of gas or air flowing is reduced. With the same energy imparted to the heater, the temperature  $T_2$  will rise and the galvanometer needle will be deflected. An  $\frac{1}{3}$ th H.P. motor is running continuously and rotates the drum contacts  $b$  continuously, and also moves toggle arms provided with magnets, over the rheostat in the main energy circuit. If the galvanometer needle is displaced, the rotating drum makes contact with  $a$  and  $c$ , and the magnets on the toggle arms are energised: the magnets drop pawls into the teeth of the rheostat controller, and the toggle arms move the rheostat arm so that more resistance is introduced into the main circuit and less energy is imparted to it. Then the rise of temperature of the reduced quantity of gas becomes less, so that the galvanometer needle goes back towards zero. The amount of resistance added depends upon the number of contacts moved over by the rheostat arm; this depends upon when the

magnets  $d_1, d_2$  are energised, which depends upon the position of the needle  $a$ . If  $T_2 - T_1$  is much in excess of the proper amount,  $a$  makes contact with  $b_3$  and three additional units of resistance are cut in; if  $T_2 - T_1$  is only slightly in excess of the proper amount, then  $a$  makes contact with  $b_1$  and only one additional unit of resistance is inserted. The wattmeter in the circuit will then register the integral of the quantity of gas flowing, when suitably calibrated.

The galvanometer needle is clamped for a short time during each revolution of the contact drum, while contact is being made.

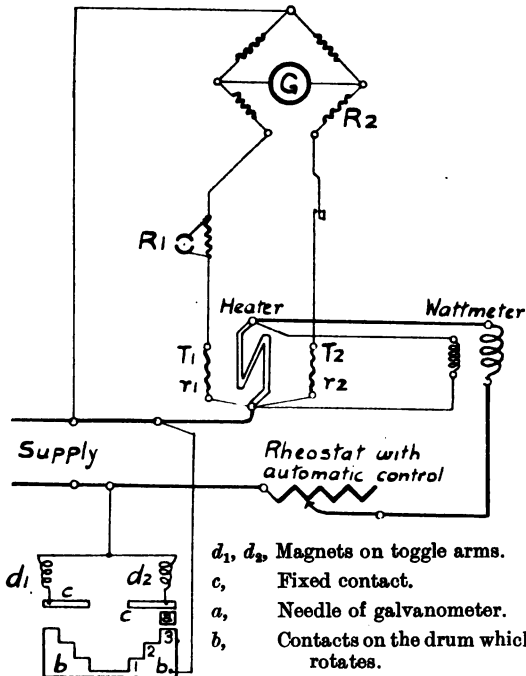

Fig. 810.—Thomas electrical meter; electrical connections.

This meter is also mentioned in *Jour. Gas Lighting*, 12/186/1913, and in *Trans. Amer. Soc. Mech. Engr.*, 31/655/1909.

Two sorts of equations are desirable, one giving the units required to heat a given quantity of gas or air, and the other giving the quantity of flow which can be metered by any input, so that one can see at a glance what is the cost of current for the meter, and what voltage and current are required to meter a certain flow per second. For this we require to know the specific heat of gas,  $\sigma$ , which the author has seen stated as lying between 0.2068 and 0.2182, with usual values 0.209 to 0.211.

The derivation of the equation is as follows:—

Let  $\sigma$  = specific heat = 0.2375 for air, = 0.211 for gas.  $\sigma$  calories heat 1 kg of fluid  $1^\circ$  C. or  $1.8^\circ$  F.

1 calorie=4190 watts ; 1 B.T.U.=1055 watts ; let the rise of temperature be  $\theta=1^\circ \text{C. or } 1.8^\circ \text{F.}$

The watts generated =  $W = (\text{constant})(\text{quantity of air})(\text{temp. rise})$  in metric units.

$$\frac{W}{4190} \frac{1}{\sigma} \frac{1}{\theta} = \text{kg heated} = Mt, \text{ where } t \text{ is the time.}$$

Introducing kw-hr., viz. 3600000 watts-sec.,

$$Mt = \frac{3600000}{4190\sigma\theta} = 4070 \text{ kg gas, } = 3620 \text{ kg air} \quad . \quad . \quad (8.34)$$

In English units,

$$\frac{W}{1055} \frac{1}{\sigma} \frac{1}{\theta} = Mt = \frac{3600000}{1055\sigma\theta}, = 9000 \text{ lb. gas, } = 8000 \text{ lb. air} \quad . \quad (8.34a)$$

TABLE 8.4.—ELECTRICAL ENERGY REQUIRED TO HEAT VARIOUS QUANTITIES.

Eng. units.	Metric units.
1 Kw-hr heats—	1 Kw hr heats—
i. 8000 lb. of air.	3620 kg of air.
ii. 105,000 cu. ft. free air.	2970 cu. metres free air.
iii. Flow at the rate 2.2 lb/sec.	Flow at rate 1 kg/sec.
iv. 9000 lb. of gas.	4070 kg of gas.
v. 236,000 cu. ft. of gas at $p_0$ .	6680 cu. metres of gas at $p_0$ .
vi. Flow at the rate 2.5 lb/sec.	Flow at rate 1.13 kg/sec.
If the flow is :—M lb/sec.	M kg/sec.
Watts required = 0.455M, air.	Watts = 1.00M, air.
= 0.400M, gas.	= 0.885M, gas.

The cost of energy used in the heater is therefore not a serious item in the cost of upkeep, as it only amounts to  $4\frac{1}{2}$ d. per million cubic feet, if the cost of current is 1d. per unit.

### G. Anemometers.

Perhaps the most common form of meter in general use for measuring the flow of air at atmospheric pressure, as in ventilation work, is the anemometer, which registers the velocity of the air currents. The instrument is well known, and consists of vanes placed at an angle of about  $45^\circ$  to the axis of flow and a dial which registers the number of revolutions of the vanes. The ordinary anemometer is an integrating instrument, and records the total flow in any length of time : the reading must be associated with readings of time if the velocity per second is required. A full discussion upon these instruments is given in the report of the Cowl Committee of the Sanitary Institute in the *Journal* of that Institute, 22/200/1901.

Before one can determine quantities, the readings of pressure, temperature, and the area of the pipe and calibration of the anemometer must be

known. But, apart from this, the anemometer is a very handy instrument for measuring *velocities* of winds and air currents where the area across which the air is blowing,  $S_1$ , is free space and therefore indefinitely greater than the area of the anemometer,  $S_2$ . For ventilation work, where air is flowing in ducts of, say, 3 ft. diameter, small anemometers are also suitable, as the introduction of the meter will have no appreciable effect upon the current of air in the duct. This is not so when the area of the meter is large in comparison to the area of the pipe, or when all the air entering the circuit must flow through the meter. In the latter cases the meter must be calibrated in position if the readings are to be accurate. When the velocity of air in open spaces is being metered, the conditions are those which usually exist under calibration.

The usual method of calibration consists in rotating the anemometer at a definite speed in still air, and noting the revolutions of the dial hand and the speed of rotation. The only inaccuracies which arise will be due to the existence of local currents set up by centrifugal force. Calibration by moving the meter in a straight line would be preferable, but is difficult to obtain on account of the length of travel which would be necessary, and the difficulty of obtaining sufficient velocity.

Hackett (*Engineering*, 99/617/1915) describes a method of calibrating anemometers by means of a secondary standard, as used by him in Siemens' works, Stafford. Ordinary anemometers read velocities up to 60 f.p.s. or 20 metres per sec., are accurate in the hands of careful observers, but require recalibrating regularly, and it is troublesome to send them away to the maker's works each time. Hackett therefore used a fan coupled to a variable-speed motor as the secondary standard: the quantity of air delivered by a fan is approximately proportional to its speed. This law he verified for the particular fan used, up to 120 m/sec peripheral speed, and to outlet velocities up to 27 m/sec, using a Pitot tube as the primary standard.

Stack (*Glückauf*, 38/1141/1902 and 39/1149/1905) describes the calibration of anemometers for use in mine ventilation work.

Rietschel (*Mitteilungen Prüfungs Heiz. Anstalt*, p. 40) states that the calibration of anemometers by whirling may differ by as much as 13 per cent. from the calibration by volumetric methods: these latter are preferable. For measuring large quantities of flow in large pipes by means of anemometers, Rietschel used a bank of 14 anemometers placed in various positions across a pipe, and found that an accurate result of the quantity flowing could then be obtained; but to use such a quantity of meters in one pipe is not ordinarily very practicable. The above-mentioned tests were carried out at the experimenting rooms of the Königliche Technische Hochschule, Berlin, where specially elaborate arrangements have been made for such work; a full description is given in the above-mentioned volume. Gas-holders and wet Brabbée meters are employed as the primary standards.

When a meter is set up in a pipe line, the existing distribution of velocity is upset, and the velocity of air through the meter will be greater than the velocity previously existing in the space taken up by the meter, owing to the reduced total effective area of pipe. The meter will tend to register a velocity  $u'$ , which will exist over the area  $S'$ , instead of registering the



velocity  $U$ , which exists over the area  $S$ . The amount of reduction in area due to the meter cannot be determined by theory, and either this must be allowed for arbitrarily or the meter calibrated in position.

If the meter is small relative to the pipe area, the readings will be accurate enough, and then the only correction required will be for the ratio of the velocity where the meter is placed to the mean velocity in the pipe: the velocity distribution must be taken as known or experimentally found.

The anemometer is convenient in being an integrating meter, but its great disadvantage is its inaccuracy. A restraining force exists in the friction of the pivot of the vanes and of the wheels of the dial: this force is not constant, but depends upon the state of the instrument; and if the flow varies from moment to moment, the vanes will not be able to respond to such variations owing to their moment of inertia.

Then the meter is of no use apart from its calibration: the scale registers correctly only at one particular velocity: the magnitude of the inaccuracies varies immensely: some writers put it as high as 10 per cent. to 20 per cent.

Barclay and Smith (*Jour. I.E.E.*, 57/293/1919) describe the use of anemometers in measuring the volumes of cooling air used for turbo-alternators. They were satisfied that the anemometers were as accurate as the Venturi meters, and that readings could be taken more conveniently than with the Pitot tubes, because there was no liquid pressure gauge to be manipulated. In the discussion upon the paper some authorities cast doubt upon the accuracy of the anemometer.

Beardmore (*Mech. Engr.*, 17/912/1906) describes an anemometer which can be placed in a gas main to register the total flow of gas and also to measure the fluctuations of flow. An ordinary anemometer is used, and no mention is made of the correction factor which would be necessary on account of the velocity distribution not being uniform: it would be necessary, therefore, to calibrate the meter in position.

Robinson (*Phil. Trans.*, 152/797/1878) has dealt with the question of the forces on cup anemometers due to winds: as such types of anemometers are not ordinarily used in measuring the flow of air in channels, no extracts from his work are given here.

**Deflecting or indicating anemometers.**—So far only the ordinary type of anemometer with revolving vanes has been under discussion, but there is another type, in which the revolution of the vanes is prevented by a spring or some other type of control, or where some other form of surface can be deflected against some controlling force. These forms of anemometer are indicating meters, as opposed to the integrating meters, and only show the pressure due to air currents: the velocity is known once the meter has been calibrated.

This calibration will partly depend upon the laws concerning the pressure of moving air on plane surfaces, or on curved surfaces. Such an indicating meter can be made extremely sensitive, if very light vanes are pivoted very freely: Shaw used mica flaps in experiments in some of the lecture rooms at Cambridge University, and was able to detect convection currents due to the warmth of a person's hand by this means.

Stanton (*Proc. Inst. C.E.*, 156/79/1904) describes experiments made upon the air pressure on discs placed at right angles to a flow of air. It

was found that the form of distribution of air velocity across a pipe or tube was greatly altered if a disc of appreciable size in comparison to the area of the pipe were introduced in the pipe. The effect became noticeable in a 2-ft. pipe, when a disc of more than 2 in. diameter was introduced, i.e. when the area was diminished by 0.7 per cent.

In measuring the pressure on discs, it must be remembered that the pressure read in the ordinary way is a resultant pressure due to the positive pressure on the front of the disc and a negative pressure, or suction, acting on the back of the disc. The amount of this resultant pressure is given by various authorities in Chapter XII., Table 12'1. Stanton found that the shielding effect of two planes placed one behind the other is greatest when the distance apart of the planes is 1.5 times the smallest width if the planes are rectangular, or 1.5 times the diameter if the planes are circular. The effect of such shielding he has fully investigated in connection with the determination of wind pressure on braced structures, girders, etc.

Buchholz (*Proc. Inst. C.E.*, 120/380/1895) describes Bornstein's wind meter: this meter consists of a ball fixed on the end of a pivoted rod, whose lower extremity carries a pencil which registered graphically the wind pressure.

The indicating vane type of meter could be made use of as an indicating meter in a pipe line, if calibrated in position and if the position of the flap or vane was visible from the outside, through a glass window. If the motion of the flap was transmitted to the outside of the pipe through a bearing and a rod or extended axis, the friction of the rod in its bearing would make the readings quite unreliable. But a freely pivoted vane should give very accurate readings, as the pivot friction can be made negligible.

**Miscellaneous meters.**—Levin (*Trans. Amer. Soc. M.E.*, 36/237/1914) describes a meter for measuring flow using the principle that the pressure differences existing in a fluid passing round a bend are known: thus, if the pressures at the inside and at the outside of the bend are measured, the mean velocity of the fluid in the bend will be known, and thus the quantity flowing can be determined. The formula giving the quantity is similar to that for the Pitot tubes, but the factor  $(R/2D)^{\frac{1}{2}}$  is included with  $(2gH)^{\frac{1}{2}}$ . A special type of bend with holes for tapping the pressure connections is required: it seems doubtful if such a meter would prove any better in practice than an orifice meter.  $R$  is the mean radius of the bend, and  $D$  is the diameter of the pipe.

Hayes (*Trans. Amer. Soc. M.E.*, 36/707/1914) describes a new type of meter for measuring the amount of feed-water supplied to a boiler: it is supposed to be useful for measuring pulsating flow, but it is not clear why the meter should be so much better than other types in this respect.

The meter works on the principle that the difference of pressure between the outside and the centre of a fluid vortex is a definite known quantity depending upon the velocities existing in the vortex; and conversely, if the difference of pressure is measured, the velocities in the vortex will be known. The fluid to be measured enters at the circumference of the vortex and flows away at the centre: the pressure at the centre is measured through a pipe suspended in the centre of the vortex, and the pressure at the side of the vessel is measured like the static pressure in a pipe line. Hayes proved with the meters he made that the law between difference of pressure and

velocity was quite good enough in practice for the meters to be used with confidence in their accuracy.

A form of gas meter using Pitot tubes has been designed by Threlfall; see Chapter IX.

Lütke (*Stahl und Eisen*, 33/1307/1913) describes a meter for recording ordinary air pressures and differential pressures obtained when measuring air and gas flow by orifices. He takes two vessels containing mercury or other suitable liquid, one being fixed and open to the atmosphere, the other being movable and connected to the pressure reservoir. An inverted U-tube connects the two vessels: the movable vessel is hung from a balance and balanced against a weight: on the other end of the balance arm is a pencil pressing on a chart. When the pressure in the reservoir alters, the liquid in one vessel is driven into the other, and the balance is upset: the balance arm and weight move until equilibrium is again obtained, and the pencil records the relative pressure on the recording chart.

Carrière (*Comptes Rendus*, 156/1831/1913) describes the measurement of air velocities by blowing steam into the air current and allowing the deflection of the steam jet to be made visible by a beam of light: this beam of light falls on a rotating mirror, and the movements of the steam can be recorded on a photographic plate. The amount of deflection of the steam jet is a measure of the air velocity.

For other optical methods of measuring air currents qualitatively, see *Phys. Zeit.*, 18/22/1917.

Hodgson (*Proc. Inst. C.E.*, 104/107/1918) has given a most excellent paper on commercial metering of air, gas, and steam by means of meters developed by himself. There are relatively few references to the works of other investigators. The meters were primarily for use in connection with the supply of compressed air at 100 lb/in<sup>2</sup> to various customers by the Victoria Falls and Transvaal Power Scheme. Meters reading to  $\pm 3$  per cent. accuracy were required: a Venturi meter belonging to the Power Company, and a gate meter belonging to the consumer, were installed in the supply to each customer: the charge for power was to be based on the average reading of the two meters. The meters registered in air units, equivalent to kilowatt-hours. In the paper are described (a) Venturi and gate meters with elaborate recording mechanism; (b) limit and cut-out valves to prevent any consumer taking more than his maximum allowable load; (c) orifice meters, pulsating flow meters, fan proportional meters, and a steam meter: a full description of the calibration plant for meters on the Rand mines is also given. For this plant, see also *Times Engineering Supplement*, 23rd Feb. 1917.

#### AUTHORITIES MENTIONED.

Alley M'Lellan, Ashcroft, Bailey, Barclay, Bayer, Beardmore, Bendermann, Buchholz, Carrière, Coleman, Dalby, Durley, Fliegner, Gaskell, Gibson, Hackett, Harris, Hayes, Herschel, Hickstein, Hodgson, Kempe, Kennedy, Kent, Levin, Lindenheim, Lütke, Moss, Müller, Nelson, Orr, Phillips, Rietschel, Robinson, St John, Sentinel, Sergeant, Shaw, Smith, Stack, Stanton, Thomas, Weymouth, Wing, Worthington.

## CHAPTER VIII.—SYMBOLS USED.

Equation.	Symbol.	Meaning.
8'01	C	=gas constant.
8'14	$c = c_1 c_2$	=coefficient of delivery.
8'13	$c_1$	= " of velocity.
8'13	$c_2$	= " of contraction.
8'30	$D_1$	=diameter of pipe.
8'30	$D_2$	= " of orifice.
8'14	$d, D_1$	=diameters.
8'27	$f = 4\zeta m/D_1$	=loss of head in friction.
8'02	$g$	=force of gravity.
8'24	$H = u^2/2g$	=feet of head of fluid.
8'14c	$h'$	= " of liquid, density $m'$ , in U-tube.
8'14f	$h''$	=inches of water in U-tube.
8'29	$k$	=coefficient of delivery, Müller's.
8'02	M	=quantities.
8'02	$m$	=densities.
8'14d	$m'$	=density of liquid in U-tube.
8'01	$m', m''$	=densities of gas in gas-holder.
8'01	$P', P''$	=pressures " " "
8'02	P	=pressures.
8'09a	Q	=volume flowing per second.
8'29	$r = S_2/S_1$	=ratio of orifice area to pipe area.
8'03	$S_1$	=area of pipe.
8'03	$S_2$	= " of orifice in sq. ft.
8'14b	S	= " " "
8'14c	$s$	= " " in inches.
8'03	T	=temperatures.
8'01	$T', T''$	= " in gas-holder.
8'03	$u$	=velocities.
8'02	$v$	=volumes.
8'01	$V', V''$	=volume of gas-holders.
8'10	$\alpha = \chi - 1$	=ratio of pressures less unity.
8'10	$\beta = S_2/S_1$	= " of throat area to pipe area.
8'02	$\gamma = 1.408$	=index of adiabatic expansion.
8'27 ff.	$\zeta =$	=coefficient of friction in pipe.
8'23	$\xi = 1 - 1/c_1$	= " " in jets.
8'14f	$\rho$	=specific gravity of gas.
8'19	$\rho'$	= " " of liquid in U-tube.
8'32	$\sigma$	= " heat of gas.
8'07a	$\chi = P_1/P_2$	=ratio of pressures.



## CHAPTER IX.

### MEASUREMENT OF AIR BY PITOT TUBES.

Theory of tube—Derivation of formula—Velocity distribution in pipe—Ratio of mean to maximum velocity—Correction factors when Pitot tube readings are taken at various points—Graphical solution for the mean velocity—Various forms of tips used—Equations for quantities obtained from Pitot tube readings.

THE great number of reports dealing with this subject, and its general interest, make it desirable to allot a whole chapter to it. The various points which come under investigation are:—

- (a) The theories on which this method of measurement is based.
- (b) The theories concerning the distribution of velocity in the pipe, which distribution is generally measured across a diameter: finding this distribution is called “making a velocity traverse of the pipe.”
- (c) The various forms of mouthpiece used to obtain the static pressure in the pipe.
- (d) The various forms of mouthpiece used to get the velocity pressure, or dynamic pressure: this pressure is called “velocity inches” by some writers, when measured in inches of water gauge.

We have not been able to keep all these factors separate, as they are intermingled with each other, and in the various papers they are not kept separate; but the conclusions, which are practically agreed upon, are:—

1. The velocity,  $u = (2gH)^{\frac{1}{2}}$ .
2. The velocity distribution curve tends to be elliptical.
3. A small opening in the side of the pipe gives the static pressure correctly.
4. A small opening of any form, placed facing the flow along the axis of flow, will give the dynamic pressure correctly.

#### A. Theories.

One should have clearly in one’s mind the different velocities under discussion, and the pressure produced by them in a Pitot tube. We have:—

	Feet of fluid.	Inches of water.
$U$ = mean velocity in the pipe . . . . .	$H$	$h''$
$U_m$ = maximum velocity in the pipe . . . . .	$H_m$	$h''_m$
$U_c$ = velocity at the centre of the pipe; this is usually taken as $U_m$ .	$H_c$	..
$U'$ = the apparent velocity as given by a multiple tube.	$H'$	$h'''$
$u$ = the velocity at any point at any time	$H$	$h''$
$u_0$ = the mean velocity at a point over a period of time.	..	..

The theoretical pressure due to the velocity, which should be given by the Pitot tubes, is denoted by the H symbols.

The ordinary formula for Pitot tubes giving the velocity of the fluid impinging on the mouth is  $u=(2gH)^{\frac{1}{2}}$ : one proof of this is simple. Consider the flow of the fluid into or out of the tube. If a head  $H_1$  exists in the tube, the velocity of efflux out of the mouthpiece would be,

$$u_1=(2gH_1)^{\frac{1}{2}} \quad \dots \quad (9\cdot01)$$

Now, if the fluid is flowing towards the tube with a velocity  $u$ , the relative motion into the mouthpiece is  $u-u_1$ , and the fluid will flow into the mouth at this rate until the pressure in the tube has been increased to give a velocity of efflux= $u$ : this occurs when  $H=u^2/(2g)$ . Therefore the head will be as given in the usual formula.

Taylor (*Trans. Amer. Soc. Nav. and Mar. Engr.*, 13/9/1905) deduces the formula from the theory concerning the adiabatic flow of gases in orifices. We have,

$$\begin{aligned} \text{if } P_1 &= \text{pressure at the back of the tube, where } u=0, \\ P_2 &= \text{,, in the pipe where the flow is } u=u_2. \end{aligned}$$

The work done by the gas in expanding from  $P_1$  to  $P_2$  creates the velocity, and

$$\frac{u^2}{2g} = \frac{n}{n-1} P_1 v_1 \left\{ 1 - \left( \frac{P_2}{P_1} \right)^{\frac{n-1}{n}} \right\} = \frac{n}{n-1} P_2 v_2 \left\{ \left( \frac{P_1}{P_2} \right)^{\frac{n-1}{n}} - 1 \right\} \quad (9\cdot02)$$

In the Pitot tube case we assume that the process is reversed, and that air flowing at a velocity  $u$  impinges on the mouthpiece and creates the pressure  $P_1=P_2(1+k)$ . Then

$$u^2 = 2g \frac{P_2}{m_2} \frac{n}{n-1} \left\{ (1+k)^{\frac{n-1}{n}} - 1 \right\} \quad \dots \quad (9\cdot03)$$

in which  $k$  is a small fraction.

Expanding the term in brackets to three terms, we get,

$$u^2 = \frac{2gP_2}{m_2} \left\{ k + \frac{1k^2}{2n} - \frac{k^3(n+1)}{6n^2} \right\} \quad \dots \quad (9\cdot04)$$

but 
$$\frac{P_2 k}{m_2} = \frac{P_1 - P_2}{m_2} = H \quad \dots \quad (9\cdot05)$$

giving 
$$u^2 = 2gH(1 + 0\cdot355k - 0\cdot203k^2) \quad \dots \quad (9\cdot06)$$

when  $n=1\cdot404$ , for adiabatic flow.

Then  $u = \sqrt{2gH(1\cdot152, 1\cdot017, 1\cdot0035)}$ , when  $k=0\cdot1, 0\cdot05, 0\cdot01$ .

For air work, if  $h'=5''$ ,  $k=0\cdot0125$ , and the correction for  $k$  becomes negligible.

One of the very early theories was that the pressure in the Pitot tube was due to the destruction of the momentum of the flowing fluid, and it

was assumed that the fluid impinging on the mouthpiece was brought to rest there. If all the momentum were destroyed,

$$(u) \frac{(mu)(\text{area})}{g} = (P_1 - P_2)(\text{area}) \quad (9'07)$$

giving 
$$\frac{u^2}{g} = \frac{P_1 - P_2}{m} = H \quad (9'07a)$$

This formula has been conclusively proved to be wrong.

Threlfall (*Proc. Inst. Mech. Engr.*, —/245/1904) deals with this question. As it is obvious that the air striking the tube is not brought to rest, but is diverted and flows past the tube, one can think of the existence of a cone-shaped mass of air in front of the mouth against which the flowing air strikes. Lord Rayleigh and Kirchoff investigated the pressure due to the impact of a fluid on a long thin lamina, the length of which may be neglected, and showed that an amount 0.440 of the total momentum of the fluid was destroyed at the lamina. In this case the proper formula for the velocity as given by the impact tube would be,

$$u = f(u)(2gH)^{\frac{1}{2}} = K(2gh)^{\frac{1}{2}} \quad (9'08)$$

where  $f(u)$  is some function of the velocity, which in ordinary practice becomes unity, or something very near unity.

**B. Distribution of velocity.**

This section of the chapter deals with the distribution of the velocity across the tube, and the relations between the maximum, mean, and minimum velocities. It is assumed that the velocity curve found by making a traverse across the pipe is elliptical (see fig. 9'1), and that the velocity at the surface of the pipe is  $B$  ft/sec, and at the centre is  $B + A = B(1 + z)$  ft. per sec. Of course, when the traverse is made near a bend this distribution is altered, and the maximum velocity will probably occur away from the centre, the actual position depending upon how far the traverse is taken from the bend.

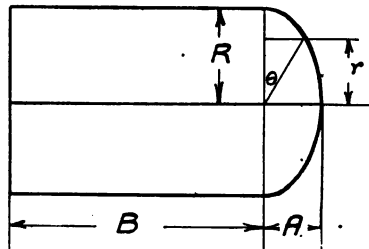

FIG. 9'1.—Theory of velocity distribution in a pipe

The velocity at a point  $r$  is  $u = B + A \sin \theta \quad (9'09)$

also  $r = R \cos \theta, \quad dr = -R \sin \theta \, d\theta \quad (9'09a)$

$$(\text{mean vel.}) \times (\text{area}) = \text{quantity} = US = \int u \, dr \, 2\pi r \quad (9'09b)$$

Now the mean ordinate of an ellipsoid is  $(2/3)A$ , so that the mean velocity becomes  $U = B + (2/3)A$ . The distance of the mean ordinate from the centre is fixed, and equals  $0.745 R$ : so that, if the distribution is *elliptical*, the *position of the mean velocity is known*.



To obtain the mean velocity in a pipe by means of Pitot tubes, various methods of taking readings may be used. One may use a single Pitot tube, which will give a reading  $h$ , for the velocity at the particular point where the tube is placed; and then use a factor to give the mean velocity when the ratio  $u/U$  is known. One may take a number of readings,  $h$ ,

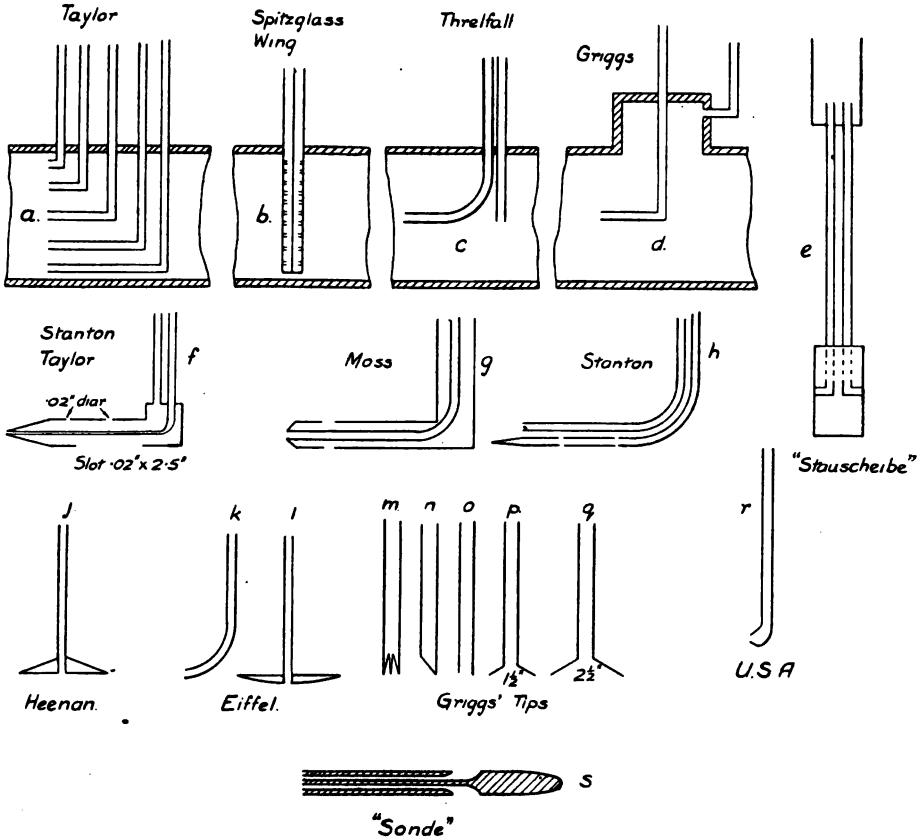

FIG. 9'2.—Forms of Pitot tubes.

all across a diameter, and take the mean reading as giving  $U$ , or one may take the mean of the square roots of the readings to get  $U$ .

One may use a "multiple" Pitot tube, by which is meant either a small pipe placed across the main pipe, at right angles to the flow, with a number of small openings facing the flow (see fig. 9'2: Wing); or a series of Pitot tubes may be placed at various distances from the centre of the tube, and the impact tubes of these may all be led to one chamber, where a mean pressure will be registered (see fig. 9'2: Taylor). In all these cases the velocity as found from the pressure reading will be different from the true mean velocity; the amount of this difference is now investigated.

For a multiple Pitot tube with openings all across it; the mean pressure registered is given by,

$$(U')^2 = 2\int_0^R \frac{u^2 dr}{R} = \int \frac{B^2 dr}{R} + \int \frac{2BA \sin \theta dr}{R} + \int \frac{A^2 \sin^2 \theta dr}{R} \quad (9'10)$$

$$= B^2 + \frac{2AB\pi}{4} - \frac{2}{3} A^2 = (U')^2 \quad (9'10a)$$

$$= B \left[ \cos \theta \right]_{\pi/2}^{\theta'} + 2AB \left[ \frac{\sin 2\theta}{4} - \frac{\theta}{2} \right]_{\pi/2}^{\theta'} + \left[ \frac{1}{3} \cos^3 \theta - \cos \theta \right]_{\pi/2}^{\theta'} A^2 \quad (9'10b)$$

Equation 9'10b shows the value of the velocity when the multiple tube does not extend all the way across the pipe;  $\theta' = \cos^{-1} r/R$ . The true mean velocity,  $U$ , gives,

$$U^2 = B^2 + \frac{4}{3} AB + \frac{4}{9} A^2. \quad (9'11)$$

The ratio of the velocity as read by the multiple tube to the mean velocity is,

$$\frac{U'}{U} = \frac{[B + (\pi/2)AB - (2/3)A^2]^{\frac{1}{2}}}{B + (2/3)A} = \frac{(1 + 1.57z - 0.666z^2)^{\frac{1}{2}}}{1 + 0.666z} \quad (9'12)$$

values of which are given below :—

$z$	$= .1$	$.2$	$.3$	$.4$	$.5$	$.6$	$.7$	$.8$	$.9$	$1.0$
$U'/U$	$= 1.000$	$1.000$	$.990$	$.975$	$.955$	$.932$	$.910$	$.880$	$.857$	$.829$
$c = U/U_m$	$= .970$	$.946$	$.924$	$.904$	$.890$	$.875$	$.864$	$.854$	$.842$	$.833$
$c = U/U_m$	$= .955$	$.918$	$.885$	$.858$	$.835$	$.813$	$.795$	$.778$	$.762$	$.750$

$U'$  = by Pitot tube,  $U$  = mean,  $U_m$  = max.

The second set of ratios is for a parabolic distribution of velocity. Supposing that the ratio of the mean velocity to the maximum velocity is known, then the value of  $z$  is known, if elliptical distribution is assumed;  $z$  and  $U/U_m$  are related thus :—

$z$	$= 0$	$0.429$	$0.815$	$1.49$	$2.98$	$8.84$	infinity
$U/U_m$	$= 1.0$	$0.90$	$0.85$	$0.80$	$0.75$	$0.70$	$0.6666$

The multiple tube which has been mentioned could just as well be a plain pipe cut lengthways, with the hollow side facing the flow, instead of having a number of openings all along it. In this latter case there must be currents of air flowing through the openings and up and down the hollow pipe. If the connections from all the openings were taken up to one chamber where a mean pressure  $p$  exists, air would flow up the tubes from the openings near the centre of the pipe, and would flow down the tubes out of the openings near the surface of the pipe. The flow of air will be perhaps small if the resistance of the tubes is made considerable, but there will be a tendency for it to exist.

Another method of taking readings is to take a series of them, with the Pitot tube placed in positions on the circumference of circles, the areas of which are 0.1, 0.3, 0.5, 0.7, 0.9 of the total area of the pipe. This method is used by Gregory and others.

In this method we get readings,

$$\begin{aligned} 2gh_1 &= (U + a_1), \\ 2gh_2 &= (U + a_2), \\ 2gh_3 &= (U + a_3), \text{ etc.} \end{aligned}$$

The mean of  $\Sigma(2gh_1)^{\frac{1}{2}}$  will give the true mean velocity if a sufficient number of readings are taken. If, however, we take the square root of the mean of the readings, we get,

$$(\text{vel.})^2 = \frac{2g\Sigma h_1}{n} = U^2 + \frac{2U\Sigma a_1}{n} + \frac{\Sigma a_1^2}{n} \quad (9.14)$$

where  $n$  is the number of readings taken. If ten are taken on the circles mentioned above, and the distribution is elliptical, then the values of  $a_1, a_2, a_3$ , etc., are:—

$$0.282A, 0.171A, 0.041A, -0.118A, -0.350A,$$

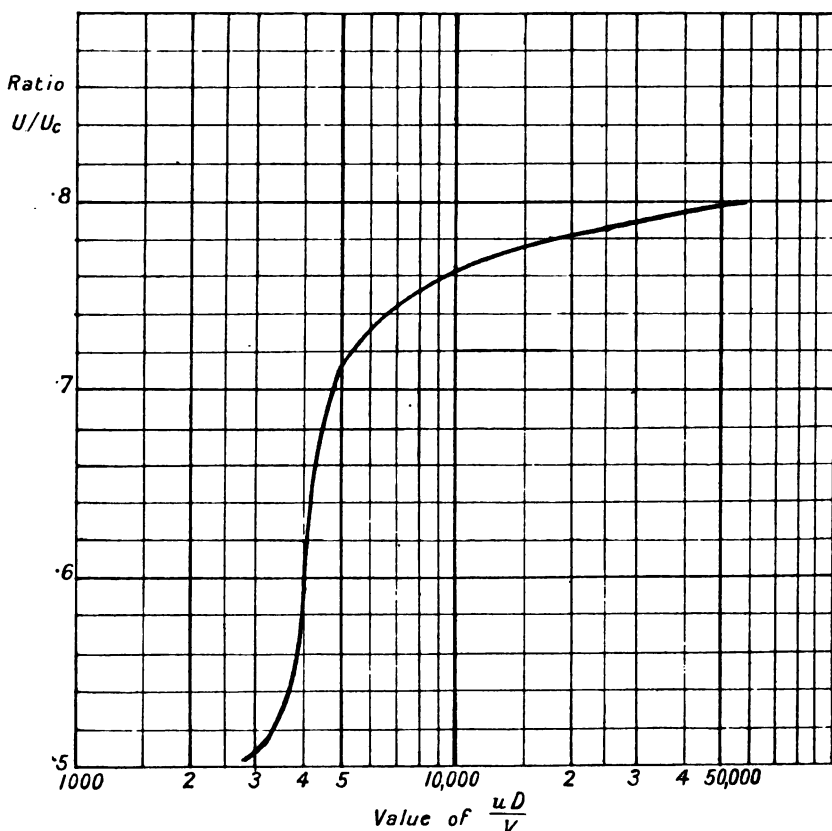

FIG. 9'3.—Ratio of mean velocity,  $U$ , to the velocity at the centre of the pipe,  $U_c$ , for various values of  $uD/\nu$ ;  $u$  in cm/sec,  $D$  in cm,  $\nu$  is the kinematical viscosity in dyne/cm<sup>2</sup>. Given by Stanton.

and these values are repeated on both sides of the centre line, so that

$$\Sigma a_1 = 0.052, \quad \Sigma a_1^2 = 0.500,$$

and then, 
$$\frac{\Sigma 2gh_1}{n} = U^2 + UA(0.0104) + 0.050A^2. \quad (9.14a)$$

If we take  $A=B$ , then  $A=0.6U$  (see Eq. 9.09b). From Eq. 9.14a,

$$(\text{vel.})^2 = \frac{2g\Sigma h_1}{10} = U^2(1.024).$$

The mean of the readings will then give a figure for the dynamic pressure which is approximately correct, and it is unnecessary to go to the trouble of finding the square roots of the readings and then to take the mean.

Burnham's method is to take readings at equidistant points along a diameter and to find the mean velocity by a graphical construction, as explained by Eq. 9.18 and fig. 9.4.

Both the last-named methods are good, but they involve taking a number of readings for each particular state of flow. If it is known that the distribution and flow are reasonably constant, one reading at a particular point will be sufficient. It would be advantageous if in all cases, when a number of readings are taken, the experimenters would obtain and state the two ratios, (a) mean to max. velocity, and (b) the position of the mean velocity in relation to the centre.

Some authors have suggested that the distribution is parabolic, in which case the mean velocity is  $U=B+A/2$ . The position of this mean velocity is at a point  $R'=0.706R$ . This occurs when the velocities are less than the critical.

A circular distribution is merely an elliptical distribution plotted to particular scales, so that the line representing the radius is equal to the line representing the velocity  $A$ .

Stanton and Pannell (*Phil. Trans.*, 214A/199/1914) investigated the value of  $U/U_c$ , which for stream-line motion should be  $\frac{1}{2}$ , and found that this varied from about 0.50 up to 0.81 as the values of  $uD/v$  varied from 2000 up to 70,000. The sort of variation is given in fig. 9.3. Obviously when  $D$  is large the value will become about 0.81. Here follows a table of values for  $U/U_c$  and for the position of the mean velocity:—

TABLE 9.1.—VELOCITY DISTRIBUTION IN PIPES.

Mean velocity  $U$  exists at a distance  $R'$  from the centre.

	Value of $R'/R$ .
Anderson . . . . .	.800
Darcy . . . . .	.689
Burnham . . . . .	.700
Elliptical distribution . . . . .	.745
Griggs . . . . .	.650
Innes . . . . .	.660
Moss . . . . .	.700
Threlfall . . . . .	$\left. \begin{array}{l} .775 \\ .750 \\ .770 \end{array} \right\}$

TABLE 9'1.—VELOCITY DISTRIBUTION IN PIPES—*continued*.*Ratio of mean velocity U to velocity U<sub>c</sub> at axis.*

	Value of U/U <sub>c</sub> .
Busey . . . . .	.950
Cramp . . . . .	.800 – .900
Kneeland . . . . .	.753
Loeb . . . . .	.930 – .910
Pannell, Stanton . . . . .	.500 – .810
Rowse . . . . .	.900
Spitzglass . . . . .	.910
Teago (special) . . . . .	.940
Threlfall . . . . .	.873
Weymouth . . . . .	.853

**C, D. Notes on various tests and forms of tip used.**

The rest of the chapter contains a discussion on various articles on this question: repetition has been avoided as much as possible.

Innes (*Fan*, p. 84) states that the Prussian Mining Commission, in their tests at Breslau in 1884, found that the mean velocity, U, in a pipe, existed at a distance 0.66R from the centre, when the velocity distribution was measured by means of anemometers. On p. 73 he gives the theory of the Pitot tube, and includes a good description of Heenan's tests upon the various forms of tip used for static pressures.

Busey (*Power*, 37/156/1913) has given a short paper on Pitot tubes, and refers to Kneeland's work. Busey says that it is usual to take,

$$\text{mean velocity, } U = (0.87-0.91)U_c,$$

but that one should take  $U = 0.95U_c$

$$\begin{aligned} \text{or mean } h &= 0.89h_c \text{ at the axis for square ducts.} \\ &= 0.90h_c \quad \text{,,} \quad \text{,,} \quad \text{round} \quad \text{,,} \end{aligned}$$

White (*Jour. Assoc. Eng. Soc.*, 27/34/1901) deals with Pitot tubes used for measuring the flow of water; he found that the dynamic head was practically  $u^2/(2g)$  in all cases, and that, if the constant of the tube, K, differed from unity to a small extent, the constant as found by any method of rating was the same, so that it was immaterial what method was employed. He made some experiments to determine the manner in which a falling jet of water spread out upon a flat plate, and also tested the normal pressure of a jet falling vertically upon a plate, the pressure being measured by Pitot tubes associated with small openings placed diametrically across the plate. In no case did the pressure rise above the value as given by  $u^2/(2g)$ : this proved conclusively that the equation of impact  $u = (gH)^{\frac{1}{2}}$  could not be true.

Williams, Hubbell, and Fenkel (*Trans. Amer. Soc. C.E.*, 47/1/1902) deal very fully with the flow of water, and on p. 64 came to the conclusion that the ratio  $U/U_m = 0.84$ . The traverse made by Pitot tubes showed elliptical distribution, and also gave the velocity at the centre as twice the velocity at the surface of the pipe, or  $A = B$ . Anyone interested specially in the flow of water would find the whole of vol. 47 interesting.

Boyd and Judd (*Eng. News*, 51/318/1904) made a series of experiment to determine the value of the coefficient  $K$  for Pitot tubes of various forms ; they found that  $K$  was the same, no matter what the shape and size of the impact tube were, as long as the orifice was placed along the axis of flow. In these tests there was no trouble with the static pressure, as the measurements were taken in water issuing from an orifice : the static pressure outside the vessel was read. The velocity was found to be constant all across the jet, except close to the surface ; even there it was uncertain if the apparently lower velocities were not due to the Pitot tube mouthpiece not being wholly immersed in the fluid. References are made to Robinson's and Freeman's experiments made in 1886 and in 1889.

Berry (*Proc. Engr. Club, Phil.*, 27/167/1910) deals with the rating of Pitot tubes for use in water. He found that the constant was not always unity, but that it is found accurately by any method of rating. His experiments were carried out with velocities of flow 4 to 8 ft/sec ; he rated tubes by dragging them at known rates through water, and by noting the velocities of floats in streams.

Gregory (*Trans. Amer. Soc. Mech. Engr.*, var. ref.) gives various papers concerning Pitot tubes. In 22/262/1901 he deals with centrifugal pumps and finds the quantities delivered by this method. In 25/184/1904 he gives a *résumé* of Pitot tube tests, and gives drawings of tubes for which the constant is unity. In 30/350/1908 he gives curves showing the velocity distribution, and also showing the pressure distribution for water flowing round bends. He found the same value for  $z=A/B=1.00$ , as White had found. Gregory explains his method of taking readings thus. To determine where these shall be taken, the pipe is divided up into circular areas containing 0.1, 0.3, 0.5, 0.7, 0.9 of the total area : readings are taken on the circumferences of these circles, whose radii are 0.316R, 0.548R, 0.707R, 0.837R, 0.949R. The areas of the first circle and the last concentric ring are each 0.10S, and the areas of the other rings are all 0.20S. Batten and Treat use the same method.

Burnham (*Eng. News*, 54/660/1905) describes tests made to determine the tube constant  $K$ . The *theoretical* velocity of the fluid striking the tube is given by,

$$u = 18.23(h'/m)^{\frac{1}{2}} \dots \dots \dots (9'15)$$

and the *actual* velocity is  $=K(2gh'/m)^{\frac{1}{2}}$ .

He found that  $K$  was practically unity, and comes to the conclusion that wherever it is found to be very different from 1.0, this has been due to a faulty reading of the static pressure. The mean velocity in the pipe occurred at a distance 0.70R from the centre. The static pressure was measured by means of a slit  $1\frac{1}{4}$  in. long and  $\frac{1}{16}$  in. wide on the under side of the impact tube.

Threlfall (*Proc. Inst. Mech. Engr.*, —/245/1904) mentions tests made upon a Pitot tube in which the static pressure was taken from a thin-walled tube projecting into the pipe : in this case there was a large suction effect, and the relation between the velocity and the difference between the static and dynamic pressures was of the form  $H=k(u)^n$ , where  $n$  was greater than 2, but the difference between that curve and the curve  $H=k(u)^2$  was not very great, and at one point the two curves cut. Of course, if a

tube with the suction effect is employed, the amount of suction will vary with the velocity, and it is not certain that the amount of suction is always equivalent to  $u^2/(2g)$ . Threlfall determined the true velocity of the air by injecting smoke into the air current, and noting the time taken for the smoke to reach the open end of the pipe, which was about 110 ft. long. The first appearance of the smoke was a measure of the maximum velocity, and following this appearance there was a smoky cloud, after which the cloud trailed off and hung about the surface of the pipe, where the velocity was a minimum. The mean velocity was taken as the mean of the velocities given by the first appearance of the smoke and by the time when it vanished. Threlfall found that the shape of the velocity curve varied considerably. Darcy says that for water the mean velocity occurs on the circle whose radius is  $0.689R$ ; but in no case did Threlfall find this for air. He found that the mean occurred where  $R' = 0.775R$ , while in one test where the readings were taken 10 yd. from a bend the mean occurred where  $R' = 0.90R$ . The ratio of the mean to maximum velocity was fairly consistently  $0.873$ ; but he considered that if only one reading was to be taken it was best to take this at  $R' = 0.775R$ , and assume that this gave the mean velocity, rather than to take the reading at the centre and deduce the mean by multiplying by the factor  $0.873$ . It is better to take the reading at the centre, according to Loeb.

Threlfall describes a gas meter which embodies the Pitot tube principle: this consists of a small gas-holder immersed partly in oil; the gas on the outside is in communication with the impact opening of a Pitot tube, and the gas in the inside is in communication with the static pressure. When there is any flow in the pipe, the bell-shaped holder tends to sink in the oil, and this tendency is balanced partly by a weight and partly by an electro-magnet. The force of the magnet depends on the (current)<sup>2</sup>, and the force on the holder on the (velocity)<sup>2</sup>, or (quantity)<sup>2</sup>, so that the current in the magnet will represent the quantity flowing if the gas-holder is in equilibrium, and the temperature and pressure in the pipe are kept constant. If the current in the magnet is not sufficient to balance the air pressure on the holder, the holder will move downwards and, by means of a long arm, will make an electric contact, which controls the supply of water to a cistern: in this water is a float attached to the arm of a rheostat in the electro-magnet circuit. The moment the gas-holder makes the first contact, the current in the electro-magnet is increased, and this will tend to attract the holder and break the contact. If at first the electro-magnet is too strong, owing to a decrease in the quantity flowing and to a reduction in the pressure on the top of the holder, then the arm makes a contact which causes a reduction in the current strength in the magnet.

Threlfall (*Jour. Inst. Elec. Engrs.*, 33/31/1903) deals with the measurement of air used to cool electrical machinery, and discusses the use of Pitot tubes in a 21-in. diam. pipe. He states that a small hole bored in the side of the pipe gives the static pressure correctly, but that a hole bored in the flat base of a very flat cone is equally good: this was used by Heenan (see fig. 9'2), but the disadvantage of using it lies in the difficulty of introducing it into the pipe. The formula for Pitot tubes if half the momentum is destroyed is,

$$p = \frac{1}{2} \rho u^2, \text{ giving } u = 1.414 (p/\rho)^{\frac{1}{2}}. \quad (9'16)$$

but Threlfall found that in practice

$$u = 1.377(p/m)^{\frac{1}{2}} \dots \dots \dots (9'17)$$

giving  $K = 0.975$ .  $u$  is in cm,  $p$  is in dyne/cm<sup>2</sup>,  $m$  is in gm/cm<sup>3</sup>,  $h'$  is in mm of water, and then  $u = 11.93(h')^{\frac{1}{2}}$ . The distribution of the velocity is not uniform, and it may be taken generally that the mean velocity exists at a distance  $0.750R$  from the centre. Threlfall also says that the distribution is not affected by any alterations in the mean velocity, and is therefore independent of the quantity flowing.

On p. 37 he gives a table showing how the position of the mean velocity varied from  $0.721R$  to  $0.863R$  in various tests; and concludes that the mean value  $0.77R$  is a reasonable one to choose.

Taylor (*Amer. Nav. Arch. and Mar. Engr.*, 13/9/1905) gives a long description of the flow of air in ventilating ducts in warships, and describes minutely the use of Pitot tubes and the various formulæ for use with them. His Pitot tube is shown in his Plate 7, and consists of a long tube with a slot in the side to give the static pressure (see fig. 9'2). He tested this opening for static pressure by placing it in a jet of air flowing from an orifice into the atmosphere, and states that the pressure as read by the static opening was always greater than the atmospheric pressure, but that this pressure decreased gradually as the tube was moved away from the orifice: he states that if there had been a suction effect in the static opening the pressure registered would have been less than atmosphere: this is not quite certain, because the pressure in the jet was evidently not constant, and might have been higher than was registered if there had been no suction effect at all. When testing the flow in pipes, he read the mean pressure as given by ten tubes placed at various distances from the centre of the pipe: all the dynamic mouthpieces were connected to one side of the U gauge. The corrections required when the velocity is read in this way have already been discussed.

Thomas (*Jour. Franklin Inst.*, 172/411/1911), in describing his electric meter, deals with the comparison of his meter with readings taken with the Pitot tube and with a Venturi meter: he employs a graphical method to determine the mean velocity as follows (see fig. 9'4):—

Draw a base line  $OC$  to represent the radius of the pipe: take a Pitot tube reading at a distance  $r = OA$  from the centre, and let the reading be  $h$ . Erect a perpendicular  $CQ$  from  $C$ , and mark off  $CQ' = (h')^{\frac{1}{2}}$ ; join  $Q'$  and  $O$ : erect a perpendicular from  $A$ , which cuts  $OQ'$  at  $P$ :  $P$  is a point on a curve which represents the total flow. Draw a line  $OC'$  so that the triangle  $OCC'$  = area under the curve

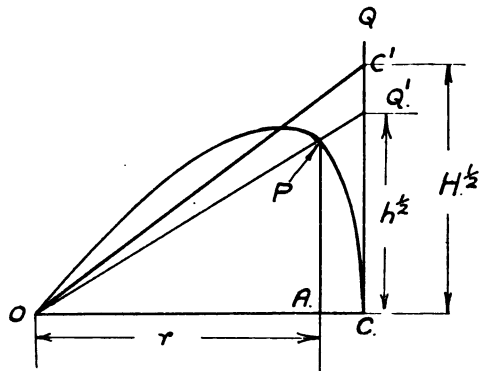

FIG. 9'4.—Method of finding the mean velocity in a pipe from Pitot tube readings taken at various points in the pipe.



OPC; CC' then represents the head H due to the mean velocity in the same units as h. The proof is as follows:—

The mean velocity U is such that

$$\pi R^2 U = \int (2\pi r) dr u \quad . \quad . \quad . \quad (9\cdot18)$$

$$AP = y = \frac{r}{R} CQ' = \frac{r}{R} h^{\frac{1}{2}} = \frac{ru}{R(2g)^{\frac{1}{2}}} \quad . \quad . \quad (9\cdot19)$$

$$2\pi \int y dr = \int \frac{2\pi ru dr}{R(2g)^{\frac{1}{2}}} = 2\pi \text{ area OPC} = 2\pi \Delta OCC' \quad . \quad . \quad (9\cdot20)$$

$$2\pi \Delta OCC' = \pi R H^{\frac{1}{2}} = \frac{\pi R^2 U}{R(2g)^{\frac{1}{2}}}$$

Therefore  $U = (2gH)^{\frac{1}{2}}$ , so that H gives the mean velocity.

Anderson (*Mech. Engr.*, 27/635/1911) describes tests made by rotating

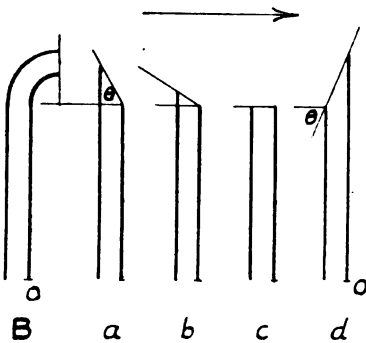

FIG. 9'5.—Pitot tubes as used by Anderson.

Pitot tubes in air, the tubes having various forms of tips: the tests were made to determine the best angle at which to place the vanes of blowers. He states that a Pitot tube placed in front of an air duct from which air is flowing will give a reading  $h = u^2/(2g)$ , but makes no statement as to where the tube should be placed relative to the centre of the duct; it is probable that the reading would vary with the position. If a tube is rotated about an axis through O (fig. 9'5), the suction head due to the centrifugal force is  $u^2/g$ , if the velocity of A is  $u$ : Anderson found that the head read on the gauge

$$= \frac{u^2}{g} \quad \text{when } \theta = 0^\circ \text{ or had negative values}$$

$$< \frac{u^2}{g} > \frac{u^2}{2g} \quad \text{when } \theta > 0^\circ < 30^\circ$$

$$= \frac{u^2}{2g} \quad \text{when } \theta = 30^\circ \text{ or } > 30^\circ.$$

This would confirm Gebhardt's statement that bevelling the end of the static tube does away with the suction effect: but the exact amount of bevelling is perhaps doubtful. Anderson's experiments tend to show that the suction effect will always overbalance the impact effect, and therefore, if a tube is rotated about O (fig. 9'5), air will flow out of the mouthpiece in a forward direction, due to the centrifugal force overcoming the impact force.

In testing the output from blowers, Anderson determined the quantities by means of tube readings taken where  $R' = 0\cdot8R$  from the centre, assuming that the mean velocity existed there: in his fig. 9, p. 637, it appears that

this velocity might easily have been more than the mean velocity, and that the quantities calculated from the Pitot tube readings would be perhaps greater than those actually delivered.

Batten (*Proc. Amer. Gas Inst.*, 6/369/1911) describes a method of regulating the flow in large gas mains supplying a town, where the terminal pressure is to be constant, whatever quantity of gas is being transmitted down the main: incidentally he mentions the determination of quantities by means of Pitot tubes, where the velocity is only 5 to 20 ft/sec. He used a U-gauge with one leg on a small slope, to measure the very small pressures which were to be registered. The tube he first used was made suitable for inserting in the mains through a 1-in. hole drilled in the gas main: this tube is shown in his Plate 8. The static end was quite straight and projected into the pipe, and had a large suction effect; this was afterwards discarded in favour of a separate 1-in. pipe let into the side of the pipe, which gave the static pressure correctly to within 1 per cent.

Griggs (*Jour. Gas Lighting*, 120/670/1912) deals with the measurement of gas flow by means of Pitot tubes, and states that there is little information published on the subject; but his paper seems to be based upon Batten's paper: as mentioned by the editor of the journal in a later issue. He first used a static tube projecting into the tube, and found a large suction effect (fig. 9'2); then he used a tube with a coned mouthpiece, which overcame the suction effect; later on he used as the static mouthpiece an opening in the side of the pipe where the dynamic mouthpiece entered the pipe, and this he found quite satisfactory. He also found that a combination mouthpiece in which the static pressure was taken from small holes less than 0.04 in. in diameter gave a tube constant = unity  $\pm$  1 per cent. In his tests, which were made on gas flowing at velocities up to 35 ft/sec, he used a U-gauge with one sloping limb, and found that the mean velocity occurred where  $R' = 0.65R$ . He says that the readings should be taken in concentric areas, but makes no mention of how the mean velocity should be obtained, and is not clear as to what concentric areas should be chosen. His results as to the amount of suction experienced with different kinds of tips are interesting. The tip with a bevel of 60° gave a suction effect just about equal to the velocity head. The other forms gave a smaller suction.

Kneeland (*Trans. Amer. Soc. Mech. Engr.*, 37/1137/1911) describes tests made upon a 24-in. pipe line, which was to be used for the transmission of coal by means of a current of air; this current was produced by a Roots blower exhausting the pipe line, and the coal was carried in a finely divided state with the air along the pipe. He gives a good deal of information concerning the various forms of Pitot tubes.

In his tests he used (1) the Gebhardt tube, which was first produced by Burnham, the static opening of which is made with a bevel; (2) the Taylor tube (fig. 9'2); (3) the United States tube, which consists of a tube of seamless cold-drawn steel with one end bent towards the current of air, the static pressure being measured from a hole drilled in the pipe line. Kneeland comes to the conclusion that this last form of tube is the best for use with air flowing at high velocities, such as he used, *i.e.* from 50 to 400 ft/sec, whereas the other types are satisfactory for low velocities, but they require careful handling, being much more delicate instruments.

Gebhardt (*Trans. Amer. Soc. Mech. Engr.*, 31/601/1909) describes

various forms of Pitot tube which were in use at the Armour Technological Institute for the measurement of steam flow. Besides the ordinary indicating flow meters, integrating flow meters with electrical and mechanical control are described: the latter suggest the forms of the British Thomson-Houston meters for steam and air. He states that the bevelling of the end of the static tube opening will do away with the suction effect.

Crewson (*Comp. Air*, 17/6636/1912), when using Pitot tubes for measuring flow, began his testing with a static tube projecting from the walls of the tube, and soon found it incorrect. If he had been aware of previous work on the subject, this fact could have been known, and the time during which incorrect results were obtained might have been saved.

Treat (*Trans. Amer. Soc. Mech. Engr.*, 34/1019/1912) describes tests made upon centrifugal fans, and mentions Pitot tubes: he does not altogether agree with other experimenters as to what tubes are suitable. He found that two .02-in. holes bored in a  $\frac{1}{4}$ -in. brass tube  $\frac{1}{32}$  in. thick gave correct readings, but that if the holes were  $\frac{1}{16}$  in. in diameter the Pitot readings were faulty: a slot  $2\frac{1}{2}$  in. long and  $\frac{1}{16}$  in. wide gave readings as much as 14 per cent. wrong: this last tube was the type of tube used by Taylor. A slot  $\frac{5}{8}$  in. long and .01 in. wide gave fairly true results. He calibrated the tubes by rotating them in air at a known speed. He suggests dividing up the area into half as many circles as there are to be readings, to get the mean velocity in a pipe, and then taking readings on the circumference of circles which divide the concentric areas equally.

Spitzglass (*Proc. Amer. Gas Inst.*, 9/615/1914) gives the particulars which are required in drawing up specifications for blowers, and describes the methods of testing them. He says that when using the Taylor tube the mean velocity is 0.91 of the velocity read at the centre of the pipe; but why this should depend upon the type of tube used is not stated.

The Pitot tube equation is,

$$u = (2gh' \cdot 5.2/m)^{\frac{1}{2}} \quad \dots \quad (9.22)$$

if water is the liquid in the U-gauge. The mean velocity in ft/min is,

$$60U = 1100 cK (h'/m)^{\frac{1}{2}} \quad \dots \quad (9.23)$$

where the reading  $h'$  is taken at the centre and  $c = U/U_m$ . Spitzglass also uses the ratio of the mean velocity to the velocity as read by a multiple Pitot tube,  $c_1 = U/U'$ . He first used a pair of tubes whose mouthpieces were turned towards and away from the flow respectively; this gave  $cK = 0.73$ : later he used the multiple tube with the openings all across the pipe, and in this case  $c_1K = 0.75$ . This type of tube is used by the British Thomson-Houston Company in their meters. The coefficients in his equations include two unknown factors, one the tube constant  $K$ , which would include the suction effect of the static tube, and the factor  $U/M_m$  depending upon the distribution, which is not known accurately.

In *Power*, 32/918/1910, and *Electrical Review* (Amer.), 63/238/1913, is given a description of recording and indicating steam meters made by the General Electric Company in America: a multiple Pitot tube is placed in the steam pipe: the difference of pressure controls the mechanism by depressing or elevating mercury in cups. The steam meters made by the English British Thomson-Houston Company are of the same type.

Raynes (*Heat. and Vent.*, p. 299) says that the velocity of gases in chimney flues is,

$$u = 18.3(h''/m)^{\frac{1}{2}} \quad (9.24)$$

where  $m$  is the density of the gases, and  $h''$  is the water gauge given by a Pitot tube. He says nothing about the position in which the tube should be placed, and the velocity will therefore be only the velocity at a particular point in the chimney.

Eiffel (*Resistance of the Air*, p. 3), in making experiments on air resistance, tried various forms of Pitot tubes for measuring velocities, and used as the standard to find the velocity, calibrated anemometers obtained from Recknagel, Hamburg, and from Casartelli, London. The ordinary form with a small hole in the side of the tube he found to be incorrect by 1 per cent.; but with a tube similar to that used by Heenan he got readings 12 per cent. wrong. This seems to have been due to the rounded form which he gave to the surface at the mouthpiece, and to the proximity of the dynamic mouthpiece (fig. 9'2).

Loeb (*Power*, 37/302/1913) describes tests made in a 12½-in. duct at the U.S.A. naval experimenting station with a Taylor Pitot tube. An elbow at a distance of 8 diameters from the point where readings were taken caused disturbance in the velocity distribution. He found the ratio  $U/U_c$ , with  $u$  from 20 to 60 ft/sec, to be about 0.93 at  $u=20$ , and 0.91 at  $u=60$ ; between these values it decreased regularly as the velocity increased. He states that it is best to put the Pitot tube at the centre of the pipe, and to use the value of the ratio  $U/U_c$ , rather than to attempt to find the point of mean velocity, which is very uncertain; the velocity round about the centre point does not vary much.

Teago (*Jour. Inst. Elec. Engr.*, 52/563/1915) describes the measurement of air for cooling transformers. The quantity was measured by a Brabbée tube used in a portion of the pipe where the velocity was made as uniform as possible by means of baffling: he found that gauze placed across the pipe produced a distribution which gave a constant velocity all across the pipe, except at the surface; this is shown in fig. 5 and 6, p. 565, of his paper. The ratio of the mean velocity to the velocity at the centre came out as 0.920, 0.940, 0.942, and was constant while the mean velocity varied from 13.5 to 21 ft/sec. He found that when a large Brabbée tube was used, where the area taken by the tube was 3.16 per cent. of the pipe area, the velocities registered were 6 per cent. to 9 per cent. greater than when the small Brabbée tube, occupying only 0.163 of the pipe area, was used. The tube constant was taken as being 1.0.

Teago also mentions in detail the theory of the differential multiplying manometer, for measuring pressures of hundredths of an inch of water. The principle of the instrument is as follows. Instead of a plain U-tube of constant bore throughout, a U-tube of very small bore connects two vessels of large capacity and area. Liquids differing in density are placed in the vessels, and the surface dividing them lies somewhere in the small tube connecting the vessels. When there is any alteration in the difference in pressure between the two vessels, one liquid is depressed and the other rises: consequently there is a flow in the U-tube, and the position of the surface of division is altered. The displacement of this surface is great compared with the alteration in level of the liquids in the vessels.

If the area of each of the vessels is  $A$ , =say, 5 sq. in., and the area of the U-tube is  $a$ , =.01 sq. in., then if the excess pressure causes the difference in levels of the liquids in the vessels to alter by 0.02 in., the surface of division must move up the U-tube to the extent of 5 in., to allow of the change in height of 0.01 in. in each vessel.

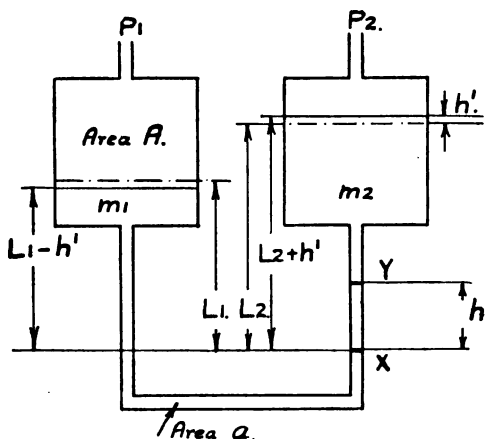

FIG. 9'6.—Theory of the differential multiplying manometer.

The equations of the process are as follows (the symbols here used are not mentioned at the end of the chapter):—

As shown in fig. 9'6, let  $L_1$  and  $L_2$  be the heights in inches of the liquids in the vessels above the dividing surface X when the pressures in the two vessels are equal, and let  $m_1$  and  $m_2$  be the densities of the liquids; then  $L_1 m_1 = L_2 m_2$ . Now let  $P_1 - P_2 = H$  inches of water (density of water =  $m_0$ ); the liquids in the vessels move

up and down  $h'$  inches, and the dividing surface moves up  $h$  inches to Y, where  $ah = Ah'$ .

The equation of equilibrium, with the liquids subjected to pressure, is,

$$m_0 H + (L_1 - h - h') m_1 = m_2 (L_2 - h + h'), \quad (9'25)$$

giving

$$m_0 H = (h + h') m_1 - m_2 (h - h') \quad (9'26)$$

Now, if one liquid is water, then  $m_0 = m_1$ , and

$$H = h \left[ \left( 1 - \frac{m_2}{m_0} \right) + \frac{a}{A} \left( 1 + \frac{m_2}{m_0} \right) \right] \quad (9'27)$$

$$= h (\text{const.}), \text{ when } m_1, m_2, a, A \text{ are fixed.}$$

Now, if  $m_2 = .80$ , as for paraffin oil,

$$H = h \left( \frac{1}{5} + \frac{a \cdot 1 \cdot 8}{A} \right) \quad (9'28)$$

If  $a$  is only  $A/500$ , then the latter part may be neglected, and the movement of the surface of division will be five times the difference of water gauge existing between the bulbs. The constant is fixed for any particular manometer as long as the specific gravities of the liquids are kept constant. The greater the size of the vessels, the smaller the pressure which can be accurately read. This manometer is described in *Engineer*, 109/366/1910.

Thurston (*Aero. Jour.*, 15/65/1911) describes tests made upon the air pressure upon rods, wires, and bars of various section. Very precise measuring instruments were employed, and the fittings were arranged so that the distribution of velocity over the air passage was uniform.

For measuring velocities a Pitot tube with a constant 1.03 was used,  $u^2 = 1.03(2gH)^{\frac{1}{2}}$ . To read small differences of pressures as given by the Pitot tube a tilting manometer was used. This manometer consisted of two tubes of relatively large section connected by a small tube: when a difference of pressure existed the liquid in one vessel was depressed, and then the tubes were tilted until the level of the liquids in the two vessels was horizontal again: a telescope was placed so that the coincidence of the two surfaces could easily be determined. The tilting was done by a levelling screw, a complete turn of which altered the level of the bottom of the tube by 1 mm, and the head of the screw was divided into 100 parts, so that an alteration in level of 0.01 mm could be detected.

Gibson (*Engr.*, 118/29/1914) discusses the theory of the Pitot tube and of the intensity of pressure over a plane area due to an impinging fluid. He gives photos of the stream-lines obtained with certain Pitot tube tips inserted in moving water.

Henry (*Comptes Rendus*, 155/1078/1912) describes a micromanometer consisting of two large glass bulbs connected by a small tube in the middle of which is a bubble of air. Carbon tetrachloride is the liquid used in the bulbs: a pressure of 0.005 mm of water is sufficient to give a movement to the bubble.

Pannell (*Engineering*, 96/343/1913) describes in detail a suitable tilting manometer for measuring water gauges of 0.00006 in., or pressures of 0.000002 lb. per sq. in.: the manometer was designed by A. P. Chattock, of Bristol University, and is described in *Phil. Mag.*, 19/450/1910.

Retschky (*Motorwagen*, 15/207/1912) reports tests upon air pressure upon surfaces when air is moving at the velocities ordinarily experienced in flying. In discussing the effect of variations of the air velocity with time upon the velocity measurements, and dealing specially with Pitot tube measurements, he shows how the ordinary reading will give too high a mean velocity.

Supposing that the velocity, at the point where the Pitot tube is placed, is constantly varying with the time, then the surface of the liquid of the manometer showing the difference of pressure will be constantly shifting if the variations are able to transmit themselves to the liquid. If these variations are throttled so as to get a steady reading, then the manometer will give a mean reading.

Suppose that the velocity at any instant,  $u = u_0(1 \pm \lambda)$ , where  $u_0$  is the mean velocity over the period of time during which the reading is being taken, then  $\int u_0 \lambda dt = 0$ , because  $u_0$  is the mean velocity.

The Pitot tube reading measures  $u^2/(2g)$ , and therefore the manometer reading will be a measure of

$$\int \frac{u_0^2(1 \pm \lambda)^2}{2g} dt \quad \dots \quad (9.29)$$

The value of this is always greater than  $\frac{u_0^2}{2g}$  by  $\int \frac{\lambda^2 dt}{2g}$ , and the reading will be this much in excess of the true value.

Fry and Tyndall (*Phil. Mag.*, 21/348/1911) describe very careful tests made to determine the Pitot tube constant. The value was first found by

rotating the tube in still air, and came out as 1.002 for velocities 600–2000 cm/sec (20–65 ft/sec), but became 1.01 at about 10 ft/sec.

They show how the method of finding the constant from readings taken over a pipe give an artificial value to  $k$ , if it varies with the velocity, because

$$Q = \int k \left[ \frac{2g(P_1 - P_2)}{m} \right]^{\frac{1}{2}} 2\pi r dr \quad . \quad . \quad . \quad (9.29a)$$

If  $k$  depends upon the velocity, it is not correct to treat it as a constant and put it outside the integral. That point is immaterial in commercial work. The experiments upon the distribution of velocity in a pipe were made on a 2-in. tube 18 in. long; quantities were measured by a gas-holder: the distribution did not follow the parabolic law even when the flow was stream-line.

They tested Pitot tubes with exceedingly small mouthpieces, and found that these gave a value of  $k$  1.10, etc., several per cent. above 1.00; this was due to the effect of the very small edges of the tube. Tubes tested had a  $0.2 \times 2$  mm orifice, with walls 0.05 mm. Such small tubes would not be used in commercial work, but are necessary if the distribution of velocity is to be measured very close to the walls of the pipe.

They state that the constant cannot be obtained accurately by deduction from the quantity when the velocities in the pipe are low.

Fry (*Phil. Mag.*, 25/494/1913) describes a form of micromanometer in which an animal membrane ("Badische," supplied by Ferris & Co., Bristol) is fixed to a ring of metal. The membrane deflects when subjected to very small pressures, and causes a mirror to rotate. Fry states that the smallest detectable pressure is 0.001 dyne/cm<sup>2</sup>. He gives a table of references to other forms<sup>1</sup> of micromanometers in which the smallest detectable pressures ranged from 0.68 to 0.01 dyne/cm<sup>2</sup>.

Cramp (*Manch. Phil. Soc.*, 58/memoir 7/1914) describes tests made on the following forms of Pitot tube: the Nipper, the Brabbée tube, which is like Taylor's, and the ordinary form with the static mouthpiece in the wall of the pipe. He mentions Krell and Prandtl's "Pneumometer," which is the Stauscheibe. His tests gave  $U/U_0$  varying from 0.8 to 0.9 with velocities 6.7 to 9.42 m/sec.

Rowse (*Trans. Amer. Soc. Mech. Engr.*, 35/633/1913) has given a full report of experiments carried out upon many forms of Pitot tubes, and has determined the constants for these tubes accurately. The tests were made at the Wisconsin University, in order to form an idea of the reliability of the Pitot tube of various forms. To measure the quantity of air he used the Thomas electrical meter, using the formula,

$$M = \frac{0.00948 \text{ (watts per min.)}}{\text{(rise of temp.) (sp. heat of air)}} \quad . \quad . \quad . \quad (9.30)$$

The quantities compared in the tests were: (i.) the quantity as measured by the Thomas meter; (ii.) the mean velocity as obtained from readings taken at ten points across a diameter by Pitot tubes, using the velocity head as shown between the two openings of the Pitot tube in use; (iii.)

<sup>1</sup> Rayleigh, *Phil. Trans.*, 196A/205/1901. Morley, *Amer. Jour. Sci.*, 13/455/1902. Hering, *Ann. d. Phys.*, 21/319/1906. Scheel, *Deut. Phys. Ges.*, 11/1/1909.

the mean velocity as obtained from Pitot tube readings taken at ten points, the static pressure being taken from a series of small holes bored in the side of the pipe—that is, by means of a piezometer. As is well known, this method is the best for obtaining static pressure. The following quantities were then deduced :

$C_1$	=	quantity as given by the Thomas meter	=	correct quantity,
$C_2$	=	”	”	” Pitot tube, using its openings,
$C_3$	=	”	”	” Pitot tube and piezometer,

and the relation between the mean velocity and the velocity at the centre of the pipe as given in methods (ii.) and (iii.). The ratio  $C_1/C_2$  varied from 1.0987 to 0.9861 for the various forms of tube ; the ratio  $C_1/C_3$  varied from 0.992 to 1.0175, the mean value being 1.0033. The ratio of the squares of the mean velocity to the squares of the velocities at the centre when the Pitot tube openings were used varied approximately thus :

0.77, 0.80, 0.80, 0.81, 0.79, 0.78, 0.77, 0.81, 0.79, 0.80,

and 0.76, 0.75 for the Pitot tube with bevelled ends. When the Pitot tube dynamic mouthpiece and the piezometer were used the variation was remarkably small, the value of the ratio being 0.79 approximately in all but two cases, when it was 0.80 and 0.81, this latter occurring with the bevelled-ended tube. Certainly for general purposes or commercial use the value 0.80 would be satisfactory. Rowse's conclusions are :—

1. The Pitot tube is correct to within 1 per cent. if the dynamic opening is used, the static pressure being read on a piezometer : both readings being taken at least 20 to 38 diameters from the last preceding bend or irregularity in the pipe direction.

2. Any form of dynamic mouthpiece is correct.

3. The piezometer method of finding static pressure is correct.

4. If the static pressure is to be measured by the Pitot tube, two holes 0.02 in. diameter, bored in the smooth sides of the leg pointing along the axis of flow, will give it correctly.

5. Bevelled tubes are decidedly unreliable, because one can never be certain that the bevelling is precisely at right angles to the axis of flow : a very small angle of divergence from its true position will produce serious errors.

6. The German form of tube, the Stauscheibe, is reliable when its own constant, 0.854, is used.

7. For approximations one may take the reading of the Pitot tube at the centre of the pipe, and use the formula  $U = [2g(0.80)H_c]^{\frac{1}{2}}$ , where  $H_c$  is the velocity head at the centre.

In *Amer. Soc. Heat. and Vent. Engr.*, 20/210/1914, there is a report of a committee appointed to consider the best methods in which to use Pitot tubes. They recommend that the tube should be placed at a distance 10D from the outlet of the fluid, and suggest the use of Stanton's form of tube (fig. 9'2). For approximate work they state that the reading of the *water gauge* at the centre should be multiplied by 0.81 to give the mean velocity, or the *velocity* at the centre should be multiplied by 0.91 to give the mean velocity.

A form of tube frequently mentioned in German reports is the



Stauscheibe (fig. 9'2), which consists of a solid drum, in which are the orifices for measuring pressure. This form of tube was introduced by Recknagel (*Z. V.D.I.*, 30/489/1886), who found that the pressures registered in the front and back orifices were,

$$P + u^2m/(2g) \text{ and } P - 0.37u^2m/(2g). \quad (9'31)$$

where P was the static pressure in the pipe. Then,

$$P_1 - P_2 = 1.37mu^2/2g \quad (9'32)$$

Müller (*Z. V.D.I.*, 52/285/1908) tested the ratio of the max. to mean velocity in a pipe, using the Stauscheibe to measure the velocity at the centre and taking 1.37 as the constant. The mean velocity was deduced from the quantity, which was measured by containers. Müller found then that

$$\frac{\text{mean vel.}}{\text{max. vel.}} = \sqrt{\frac{1.37}{2.428}} = 0.753 \quad (9'32a)$$

with velocities varying from 10 to 33 ft/sec.

Rietschel (*Gesundheits Ingr.*, 28/313 Fest. p. 10/1905) states that a Stauscheibe is correct as long as its diameter is not more than  $\frac{1}{10}$ th the diameter of the pipe in which it is placed. The same writer (*Mitteilungen P. für H. und L.A.*, p. 62) made exhaustive tests in 1912 upon this instrument, and found that Recknagel's constant, 1.37, did not hold: the tests showed that the constants varied from 1.30 to 1.48, and Berlowitz found a value 1.50. The whole of the inaccuracy arose in the suction opening constant, which depends upon the distance between the front and back openings. In these tests special measures were taken to ensure an even distribution of flow over the pipe.

Recknagel (*Ann. der Phys.*, 10/677/1880) describes experiments made upon the air pressures set up in holes in the faces of planes, when the planes were rotated upon a whirling table in air: from these he later on deduced his theory of the Pitot tube and the Stauscheibe.

A description of an instrument for measuring wind pressure, using the principle of the Stauscheibe, is given in *Proc. Inst. C.E.*, 139/446/1900. The resultant pressure  $h = 1.37mu^2/2g$  (metric). The instrument was made by Krell of Nuremberg.

Weymouth (*Trans. Amer. Soc. Mech. Engr.*, 34/1091/1912) has given a paper dealing with the measurement of natural gas flowing from wells, and mentions various types of meters. In one case he used Pitot tubes, and in order to get a consistent variation in velocity of the gas across the pipe, he inserted a specially smooth length of pipe, from 2 in. to 5 in. in diameter, in the pipe line, and then placed the dynamic mouthpiece of the Pitot tube in the centre of the pipe, so that he felt certain that the maximum velocity was registered. He found by experiment that the ratio of the maximum velocity to the mean velocity was, on the average, 0.853.

Weymouth's equation for quantity, as found by Pitot tubes, is,

$$\text{Cu. ft./sec} = Q = 0.0608E (=0.853) d^2 \frac{T_0}{p_0} \left[ \frac{h' p_1}{\rho T_1} \right]^{\frac{1}{2}} \quad (9'33)$$

$p_1$  and  $T_1$  referring to the pipe, and  $p_0$  and  $T_0$  to the standard temperature

and pressure at which volume is measured.  $h''$  is the velocity head read at the centre of the pipe.

Moss (*Jour. Amer. Soc., M.E.*, 38/869/1916) describes the use of the impact portion of Pitot tubes—which he calls “the impact tube”—when testing the output of blowers and fans at the Lynn steam turbine works of the General Electric Company of America. Moss says that in the case of a converging nozzle, with a straight portion following the smallest part, placed at the end of a pipe, the pressure in the issuing jet is constant all across the jet, except close to the edges; and further states that the velocity distribution in a pipe is elliptical, and the position of mean velocity exists at a point 0.7R from the centre.

Convergent nozzles should be finished off with a cylindrical pipe to ensure that the gas completely fills the whole of the orifice area, thus making the coefficient of contraction  $c_c=1.00$ ; the length of this pipe should be about  $\frac{1}{2}D_2$ , where  $D_2$  is the diameter of the orifice or pipe. He examined by means of a  $\frac{3}{8}$ -in. impact tube the velocity distribution across jets from 4-in. orifices, and found that the velocity was constant till within  $\frac{1}{4}$  in. of the edge.

When obtaining static pressures it is desirable to have large holes in the pipe walls—say  $\frac{1}{4}$  in. to  $\frac{1}{2}$  in.—so as to reduce the errors arising from the leakage in the pipes leading from the static holes to the pressure indicator.

Zichendraht (*Ann. der Phys.*, 340/61/1911) mentions a type of Pitot tube, a “Sonde,” which gives the static pressure correctly independently of its position in an air current (fig. 9'2).

Stodola (*Z.V.D.I.*, 63/31, 96/1919) gives curves of velocity distribution in pipes as found by Pitot tubes.

**E. Formulæ for quantities and velocities of fluids as measured by Pitot tubes.**

$h''$  = head in inches of water due to the mean velocity.

$\rho$  = specific gravity of the gas.

$$u = [2gH]^{\frac{1}{2}} = \left[ 2g \frac{(P_1 - P_2)}{m} \right]^{\frac{1}{2}} = 18.23 \left[ \frac{h''}{m} \right]^{\frac{1}{2}} = 18.23 \left[ \frac{h''CT}{\rho P} \right]^{\frac{1}{2}} \quad (9.34)$$

$m$  the density can be measured at either  $P_1$  or  $P_2$ .

$$\text{Cu. ft/sec at } P_1, T_1 = 14.32D^2 \left[ \frac{h''CT_1}{\rho P_1} \right]^{\frac{1}{2}} \quad (9.35)$$

$$= 0.10 i^2 \left[ \frac{h''CT_1}{\rho P_1} \right]^{\frac{1}{2}} \quad (9.36)$$

$$\text{Cu. ft/sec at } P_0, T_0 = 0.725 \frac{d^2 T_0}{P_0} \left[ \frac{h''P_1}{\rho T_1} \right]^{\frac{1}{2}} \text{ using lb/ft}^2 \quad (9.37)$$

$$= 0.0604 \frac{d^2 T_0}{p_0} \left[ \frac{h''p_1}{\rho T_1} \right]^{\frac{1}{2}} \text{ using lb/in}^2 \quad (9.38)$$

$$\text{Cu. ft/hour at } P_0, T_0 = 218 \frac{d^2 T_0}{P_0} \left[ \frac{h''P_1}{\rho T_1} \right]^{\frac{1}{2}} \quad (9.39)$$

$$\text{Lb/hour} = 632d^2[h''p_1\rho/T_1]^{\frac{1}{2}} \quad (9'40)$$

$$\text{Lb/sec} = 14\cdot32D^2(h''m)^{\frac{1}{2}} = 14\cdot32\left[\frac{h''P_1\rho}{CT_1}\right]^{\frac{1}{2}} \quad (9'41)$$

$$= 0\cdot10d^2\left[\frac{h''P_1\rho}{CT_1}\right] = 0\cdot001135d^2\left[\frac{h''P_1\rho}{T_1}\right]^{\frac{1}{2}}$$

The max. velocity =  $U_m$ , and gives a pressure of  $h''_m$ .

The mean velocity =  $U$ , and gives a pressure of  $h''$ .

Also  $U = cU_m$  and  $h'' = jh''_m$ ,  $c = j^{\frac{1}{2}}$ .

Experimenters give values of either  $c$  or  $j$ : the best way to use the formulæ is to use  $h''$  due to the mean velocity, obtaining this by the use of the correction factor  $j$ , after taking the reading  $h''_m$  at the centre of the pipe.

The formulæ in metric units are as follows;  $h$  = mm of water:

$$u = [2gH]^{\frac{1}{2}} = [2g(P_1 - P_2)/m_1]^{\frac{1}{2}} = 4\cdot43(h/m_1)^{\frac{1}{2}} \quad (9'42)$$

$$= 4\cdot43[hCT_1/\rho P_1]^{\frac{1}{2}} = 24\cdot1[hT_1/\rho P_1]^{\frac{1}{2}} \quad (9'43)$$

Kilograms per second,

$$M = \text{Sum}_1 = 3\cdot47D^2(hm_1)^{\frac{1}{2}} = 3\cdot47(10)^{-6}d^2(hm_1)^{\frac{1}{2}} \quad (9'44)$$

$$= 3\cdot84(10)^{-6}d^2(h)^{\frac{1}{2}} \text{ for air} \quad (9'45)$$

$$= \frac{3\cdot47d^2}{10^6} \left[\frac{hP_1\rho}{CT_1}\right]^{\frac{1}{2}} = 0\cdot00638d^2 \left[\frac{hp_1\rho}{T_1}\right]^{\frac{1}{2}} \quad (9'46)$$

Cubic metres per second,  $Q$  at  $P_0$ ,  $T_0$ ,

$$Q = \frac{SuP_1T_0}{P_0T_1} = \frac{3\cdot47D^2T_0P_1}{T_1P_0} \left[\frac{h}{m}\right]^{\frac{1}{2}} = \frac{3\cdot47D^2m_1}{m_0} \left[\frac{h}{m}\right]^{\frac{1}{2}} \\ = \frac{3\cdot47d^2}{10^3} \frac{T_0}{P_0} \left[\frac{hP_1C\rho}{T_1}\right] \quad (9'47)$$

#### AUTHORITIES MENTIONED.

Anderson, Batten, Berlowitz, Berry, Boyd, Chattock, Cramp, Crewson, Darcy, Burnham, Busey, Eiffel, Fry, Gebhardt, Gibson, Gregory, Griggs, Heenan, Henry, Innes, Kirchoff, Krell, Kneeland, Loeb, Moss, Müller, Pannell, Rayleigh, Raynes, Recknagel, Retschky, Rietschel, Robinson, Rowse, Spitzglass, Stanton, Taylor, Teago, Thomas, Threlfall, Thurston, Treat, Tyndall, Weymouth, White, Williams.

## CHAPTER IX.—SYMBOLS USED.

Equation.	Symbol.	Meaning.
9'14	$a = u - U$	=difference between velocity at a point and the mean velocity.
9'09	A	=difference between maximum and minimum velocity.
9'09	B	=the minimum velocity at the surface of the pipe.
9'10	$A + B = U_m$	=maximum velocity.
9'12	$c = U/U_m$	=ratio mean to maximum velocity.
9'35	$d, D$	=diameters.
9'01	$g$	=force of gravity.
..	$H, h''$	=head due to mean velocity.
..	$H_m, h''_m$	= ,, ,, to maximum velocity.
..	$H', h'''$	= ,, given by multiple tube.
9'14	$h_1, h_2$	= ,, at particular points in pipe.
9'34	$j = (U/U_m)^2$	=ratio of head due to mean velocity to head due to maximum velocity.
9'03	$k = P_1/P_2 - 1$	=excess pressure in Pitot tube.
9'08	$k, K = u/(2gH)^{1/2}$	=coefficient for use with Pitot tube formula.
9'44	M	=weight of gas flowing per second.
9'03	$m$	=densities.
9'03	$n$	=index of polytropic expansion.
9'14	$n$	=number of Pitot tube readings taken.
9'02	$P_2$	=pressure in the pipe, or static Pitot tube.
9'02	$P_1$	= ,, in dynamic mouthpiece of tube.
9'17	$p$	= ,, ,, ,, ,,
9'33	Q	=volume per second flowing in pipe.
9'09b	$R = \frac{1}{2}D$	=radius of pipe.
..	$R'$	=position of mean velocity from centre.
9'09	$r = R \sin \theta$	=distance of any point from centre of pipe.
9'09b	S	=area of pipe.
9'34	T	=temperatures.
9'09	$U = Q/S$	=mean velocity.
9'09	$U_m = A + B$	=maximum velocity in the pipe.
..	$U_c$	=velocity at the centre of the pipe.
9'10	$U'$	= ,, as given by the multiple tube.
..	$u$	= ,, at any point.
..	$u_0$	=mean velocity over a period of time.
..	$u_1$	=velocity at a particular point.
..	$v$	=volume.
9'19	$y = (r/R)h^2$	=mathematical expression.
9'12	$z = A/B$	=coefficient defining distribution of velocity.
9'09	$\theta$	=angle defining point in pipe.
9'29	$\lambda = u/u_0 - 1$	=variation in velocity over a period of time.
9'33	$\rho$	=specific gravity of the gas.



## CHAPTER X.

### ELECTRIC VELOCITY METERS AND HOT-WIRE ANEMOMETRY.

Hot-wire meter—Principles employed—Conductivity of gases—Radiation from hot bodies—Temperature gradient in hot wires—Laws of convection—Convectivity of wires,  $\lambda$ —Currents required in hot wires—Values of  $\lambda$ —Convection laws for elliptical bodies—Equation for total heat loss, including conduction and radiation—King's hot-wire meter—Convection from spongy platinum—Convection from hot nickel—Convection from wires in water.

IN dealing with this subject a number of physical problems arise, and a knowledge of the values of many physical constants is required. Some of the questions which concern us are :—

Conductivity of gases.

Laws of radiation and radiation constants of wires of various metals.

Laws of convection currents round wires.

Specific heat of gases and of the metals used for wires.

Specific resistance of wires and the temperature coefficients of electrical resistance.

No special knowledge of these questions is necessary to use hot-wire meters, but for a discussion of the meters such knowledge is desirable.

#### A. General principles of the meter.

This type of measuring instrument is a recent development, and so far the author has seen no commercial meter of this type. The meter consists of a wire of very small diameter, usually of platinum, kept at a definite temperature by means of an electrical current: the magnitude of the current is varied as the air currents vary, so that the temperature of the wire and its electrical resistance shall be constant.

The chief use of such a meter is to determine the distribution of velocity in air currents, and also to determine the direction of the velocities. Quantities of air are not so readily measured, as the ratio of the mean velocity of the air over the area considered to the velocity measured by the meter would have to be known.

The principle underlying the working of the meter is that, given any wire at temperature  $T_1$ , and air flowing past it at velocity  $u$ , there is a convection of  $Q_c$  units of heat, and a radiation of  $Q_r$  heat units per unit area of surface.  $Q_c$  depends upon the velocity of the air, and  $Q_r$  is independent

of the velocity. We should like to be able to determine the values of  $Q_c$  and  $Q_r$  for any wire at any temperature, and for any velocity of any type of gas.

There are two different sets of problems to be dealt with here: the first concerns the values of radiation  $Q_r$  and conduction  $Q'$  in still air, both of which are questions dealt with by physicists. The second concerns the values of the convection  $Q_c$ , which depends upon the velocity  $u$ , and which is dealt with chiefly by those concerned in anemometry: this latter factor is independent of the radiation, and greatly exceeds it in hot-wire anemometry work.

$Q_r$ , the radiation per sq. cm, is independent of the pressure, and can be determined in a vacuum by noting the loss of heat in a hot body.

$Q'$ , the conduction, can be determined at low pressures when there is little convection, and can also be determined by heating the gas from above, so that the convection currents are prevented.

$Q_c$ , the convection, can be determined by noting the loss of heat of hot bodies placed in currents of air.

The question of the radiation losses is dealt with in section C: the radiation loss is negligible except when great accuracy is required, or when the hot body is at a temperature above  $500^\circ\text{C}$ .; the radiation loss cannot be neglected, however, if one is dealing with hot covered wires and cables in still air.

### B. Conductivity of gases.

The value of the conductivity of various gases is required: the value at  $0^\circ\text{C}$ . is usually given, and is denoted by  $k$ . We also want to know how this varies with pressure and temperature.

Meyer (*Kinetic Theory*, p. 281) shows how

$$k = (\text{constant})\eta k_v = \text{calories per sq. cm per } 1^\circ\text{C.}$$

$\eta$  = coefficient of viscosity.

$k_v$  = specific heat at constant volume.

The value of the constant is not quite certain.

Now  $k_v$  and  $\eta$  are independent of the pressure.

Therefore  $k$  is           "           "           "  
and for simple gases,

while  $k_v$  is independent of the temperature,

yet  $\eta$  increases with the temperature;

therefore  $k$  increases with the temperature, in the same ratio

as  $\eta$            "           "           "

The values of the temperature coefficient of conductivity, and viscosity, and for the conductivity at  $0^\circ\text{C}$ ., for various gases, are given in Table 1.2: for air the values of  $k$  as given by various authorities are quoted herewith. A reasonable value to choose for ordinary use appears to be 0.0000555, and for the temperature coefficient, 0.0027 per  $1^\circ\text{C}$ .: this would give  $k=0.000130$  for air at  $500^\circ\text{C}$ .

TABLE 10'1.—CONDUCTIVITY OF AIR.

Values of  $(10)^{5k}$ =calories/cm<sup>2</sup> per 1° C., for air at 0° C.

Eckerlein . . . . .	4·677	} Compan, <i>Ann. de Chim. et Phys.</i> , 26/550/1902.
Compan . . . . .	4·790	
Clausius . . . . .	4·840	
Grätz . . . . .	4·844	
Kundt and Warburg	4·800	
Winkelmann . . . . .	5·200	
Maxwell . . . . .	5·500	
Müller . . . . .	5·572	
Stefan . . . . .	5·600	
Schleiermacher . . . . .	5·620	
Stefan . . . . .	5·550	Meyer, p. 289.
.. . . .	5·580	Ganot's <i>Physics</i> , p. 409.
Stefan . . . . .	5·580	Thomson, <i>Heat</i> , p. 106.
Maxwell . . . . .	5·40	" " "
.. . . .	5·58	Langmuir.
Hercus, Laby . . . . .	5·22	in <i>Proc. Roy. Soc.</i> , 95/190/1919.

**C. Radiation from hot bodies.**

The absolute radiation from bodies depends upon the fourth power of the absolute temperature and upon the type of the surface of the body, and is independent of the surroundings: but the net radiation depends also upon the existence and temperature of other bodies in relation to the first body.

Poynting and Thomson (*Heat*, p. 250) state that the absolute radiation from a full radiator is,

$$5\cdot32 \times 10^{-12} T_1^4, \text{ watts per sq. cm. . . . . (10'01)}$$

Langmuir (*Trans. Amer. Inst. Elec. Engr.*, 32/301/1913) states that the net radiation from black bodies into air is,

$$\text{Watts per sq. cm} = \left( \frac{\text{relative}}{\text{emissivity}} \right) 5\cdot7 [(\cdot001 T_1)^4 - (\cdot001 T_2)^4] \quad (10'02)$$

- where relative emissivity = 0·02 to 0·30 for bright surfaces.  
 = 0·74 (·74) for oxidised copper at a red heat.  
 = 0·25 (·20) for cast-iron, fresh.  
 = 0·65 (·60) ,, ,, oxidised.  
 = 0·47 (·57) ,, ,, with aluminium paint.

The figures in brackets are quoted from *Proc. A.I.E.E.*, 35/454/1916.

The absolute emissivity of a body, by which is meant the calories lost per sq. cm per 1° C. difference in temperature between the hot body and the cold surroundings, would seem to include conduction, radiation, and convection if that exists.

Kennelly (*Trans. A.I.E.E.*, 28/363/1909) quotes the formula for radiation from wires as,  $\sigma'(T_1^4 - T_2^4)$ , with

$$\sigma' = 5\cdot3 \times 10^{-5} \text{ absolute watts per sq. cm . . . . . (10'03)}$$

The value of the constant is not perfectly certain, but we shall assume



that the hot wires of velocity meters are equivalent to  $\frac{3}{4}$  of a full radiator, and that  $\sigma' = 5.32$ . The absolute radiation is then determinable from Table 10.2.

Montsinger (*Proc. Amer. Inst. Elec. Engr.*, 35/452/1916), quoting Langmuir (*Trans. A.I.E.E.*, 32/309/1913), gives values of  $\sigma'(10)^{12}$  :—

- (10)<sup>12</sup> $\sigma' = 5.32$  Kurlbaum (*Wied. Ann.*, 65/746/1899).
- $= 6.30$  Fery.
- $= 5.90$  Paschen and Gerlach (*Ann. d. Physik*, 38/30/1912).
- $= 5.67$  Shakespear (*Proc. Roy. Soc.*, 86A/180/1911).
- $= 5.70$  a suitable value for general use.

Coblentz (*Elec.*, 77/38/1916) is quoted as giving the value  $\sigma' = 5.75(10)^{-12}$  in a paper published by the Bureau of Standards. Peczalski (*Comptes Rendus*, 162/294/1916) found that the law of radiation from tantalum wire was  $Q_r = \sigma' T^{4.2}$ .

TABLE 10.2.—RADIATION FROM HOT BODIES.

C.	T.	(.001 T) <sup>4</sup> .	Q <sub>r</sub> .	Q' <sub>r</sub> = $\pi$ Q <sub>r</sub> .
0	273	.00558	.0223	.070
17	290	.00710	.0284	.089
27	300	.00810	.0324	.102
40	313	.00960	.0384	.120
80	353	.0156	.0624	.196
100	373	.0195	.0775	.244
120	393	.0239	.0956	.301
160	433	.0354	.1416	.445
200	473	.0502	.2008	.631
300	573	.1030	.4320	1.310
400	673	.2060	.8240	2.590
500	773	.3580	1.4320	4.580

Q<sub>r</sub> is the radiation in watts/cm<sup>2</sup> = 0.75(5.32)(.001 T)<sup>4</sup>.

Q'<sub>r</sub> when multiplied by diam. in cm gives the radiation per cm length.

#### D. Rate of cooling of hot bodies.

The determination of the heat losses is usually made by noting the fall of temperature of hot bodies under specified condition.

Supposing the body is a sphere of radius R,

the heat lost by radiation is Q<sub>r</sub>4 $\pi$ R<sup>2</sup>,

„ „ conduction is Q<sub>c</sub>4 $\pi$ R<sup>2</sup>,

and the rate of fall of temperature is dT/dt.

Then 
$$\frac{4}{3}\pi R^3 \beta c \frac{dT}{dt} = \left( \frac{dQ_r}{dt} + \frac{dQ_c}{dt} \right) 4\pi R^2 \quad \dots \quad (10.04)$$

Knowing R, c, dT/dt, Q<sub>r</sub>, one finds Q<sub>c</sub>.

For a sphere, then, 
$$\frac{dT}{dt} = \left\{ \frac{dQ_r}{dt} + \frac{dQ_c}{dt} \right\} \frac{3}{cR\beta} \quad \dots \quad (10.05)$$

For a wire, 
$$\frac{dT}{dt} = \left\{ \frac{dQ_r}{dt} + \frac{dQ_c}{dt} \right\} \frac{1}{cR\beta} \quad (10'06)$$

In the above we assume that no heat leaks into the body through the supports; if heat is leaking in or is being generated and  $dT/dt=0$ , then the heat generated equals the heat lost, which in the case of wires heated by electric currents = (volts per cm)(current).

Ayrton and Kilgour (*Phil. Trans.*, 183/371/1892) conducted experiments upon the emissivity of platinum wires heated by electric currents, and found for emissivity,

$$\begin{aligned} \text{When } \theta = 100^\circ \text{ C. } \quad \epsilon &= \cdot 001036 + \cdot 012078/d \text{ (mils).} \quad \dots (10'07) \\ &\quad \cdot 0000306/d \text{ (cm)} \\ \theta = 200^\circ \text{ C. } \quad \epsilon &= \cdot 001111 + \cdot 014303/d \\ &\quad \cdot 0000360/d \text{ (cm)} \\ \theta = 300^\circ \text{ C. } \quad \epsilon &= \cdot 001135 + \cdot 016084/d \\ &\quad \cdot 00004074/d \text{ (cm)} \end{aligned}$$

In general he found that  $\epsilon$  increased as the diameter decreased when  $\theta$  was kept constant; and again  $\epsilon$  increased with temperature, but the rate of increase of  $\epsilon$  with temperature became greatly increased as the diameter of the wires decreased.

The equation used for emissivity was,

$$\epsilon = \left( \frac{1 + 15\gamma'}{1 + \theta\gamma'} \right)^2 \cdot \frac{239 E_i}{Ld\theta\pi} \text{ calories/cm}^2 \text{ per } 1^\circ \text{ C.} \quad (10'08)$$

where  $\gamma'$  is the coefficient of linear expansion for platinum.

The radiation of heat from platinum and other metals is fully dealt with by Lummer and Kurlbaum in *Ver. Deut. Phys. Gesch.*, 17/106/1898, and also by Bottomley in *Phil. Trans.*, pt. i, 184/591/1893.

Mitchell (*Trans. Roy. Soc. Edin.*, 40/39/1900) made tests upon the rate of cooling of a copper ball 2 in. in diameter, placed in a current of air, in order to find the effect of convection. The ball was heated in a furnace to about  $400^\circ \text{ C.}$ , and the temperature while cooling was read by means of a thermo-electric junction at the centre. Mitchell proved that the difference between the internal temperature and the temperature at the surface did not vary greatly as long as the temperature at the centre was not greater than  $600^\circ \text{ C.}$  The velocity distribution of the air in the flue in which the ball was placed was noticed by means of smoke in the air, and the actual velocity of the air was measured by an anemometer made by Richard Frères of Paris. He found that the rate of cooling by convection varied as the temperature elevation of the ball above that of the air.

Compan (*Ann. de Chim. et Phys.*, 26/488/1902) gives a very full discussion upon the rate of cooling of bodies in air. The results of his own experiments upon the rate of cooling of spheres placed at the centre of a spherical enclosure were:

For a 16-cm sphere, 
$$\frac{dT}{dt} = 0\cdot 00014723 h \cdot 45 \theta^{1\cdot 232} + u'' \quad (10'09)$$

as long as  $h$  exceeded 16 mm mercury both the indices increased as the pressure was lowered.

For an 8.3-cm sphere,  $\frac{dT}{dt} = 0.0002470 h^{.30} \theta^{1.154} + u''$  . . . . . (10.10)

where  $u''$  is the rate of cooling due to radiation, a small quantity.

For a metal sphere 1.45 cm,  $\frac{dT}{dt} = 0.00015842 h^{.45} \theta^{1.231} + u''$  . . . . . (10.11)

while  $h$  varied from 50–4480 mm mercury.

He found, as usual, that the loss from convection varied as  $\theta$ .

**E. Temperature gradient in hot wires.**

Retschky (*Motorwagen*, 15/463/1912), in discussing the use of hot-wire anemometry, determines the fall of temperature from the centre to the circumference of the hot wire, in order to see if the temperature is fairly constant all over the section of the wire.

Considering a small cylindrical element of the wire, of which the radius is  $r$ , length  $dx$ , in which an amount of heat  $dQ$  is developed per second; all this heat must flow out of the cylinder each second, and traverse the surface  $2\pi r dx$  at the heat gradient of  $d\theta/dr$ .

Therefore,  $dQ/dt = -2\pi r k' dx d\theta/dr$  . . . . . (10.13)

Now let the ohmic resistance of the wire per cm cube be  $\sigma$ . The total current  $i$  will be equally spaced all over the section of the wire, as the resistance of each section is approximately the same, so we have for the heat generated,

$$\frac{dQ}{dt} = \left(\frac{i^2 r^4}{R^4}\right) \left(\frac{\sigma dx}{\pi r^2}\right) 0.239 . . . . . (10.14)$$

$R$  is the radius of the wire:  $t$  refers to time.

From Eq. 10.13 and 10.14,  $\frac{d\theta}{dr} (-2\pi r k') = i^2 \frac{r^2 \sigma}{R^4 \pi} (0.239)$  . . . . . (10.15)

$$\frac{d\theta}{dr} = \frac{0.239 i^2 \sigma r}{2\pi^2 k' R^4} . . . . . (10.16)$$

The difference between the temperatures at the centre and the

circumference =  $\int_0^R d\theta/dr = \frac{0.239 i^2 \sigma}{4\pi^2 k' R^2}$ .

This can be put in the form using current density,  $i/S$ , as

$$\text{Temp. diff.} = \frac{0.239 i (\text{density}) \sigma}{4\pi k'} = \frac{30.4 (\text{density}) i^2}{10^8} . . . . . (10.17)$$

when we use copper,  $\sigma = .0000016$ , and  $k' = 1.04$ .

**F. Laws of convection.**

Langmuir's formula for the convection of heat from flat surfaces (*Proc. A.I.E.E.*, 35/455/1916) is,

$$\text{Watts/cm}^2 = \frac{F(T_1) - F(T_2)}{B} . . . . . (10.18)$$

where  $B$  is the thickness of the film of gas adhering to the surface.

$$F(T) = 0.000193(1 + 0.0012T) \left[ \frac{2}{3}T^3 - 248T^{\frac{1}{2}} + 2760 \tan^{-1} \left( \frac{T}{124} \right)^{\frac{1}{2}} \right] \quad (10.18a)$$

$$B = 0.45 \text{ cm when } T_1 \text{ exceeds } 100^\circ \text{ C.} \\ = 0.45 - 0.58 \text{ cm when } T_1 - T_2 = 25^\circ \text{ C. to } 75^\circ \text{ C.}$$

Lorenz (*Ann. d. Phys.*, 13/582/1881) derived a formula for the convection losses from vertical planes as,

$$\text{Watts/cm}^2 = 0.548 \left[ \frac{k_p g k^3}{\eta H_1 \theta_1} \right]^{\frac{1}{2}} m^{\frac{1}{2}} (T_1 - T_2)^{1.25} \quad (10.18b)$$

$H_1$  is the height of the surface,  $\theta_1$  is the average temperature of the surface in deg. C. Montsinger, repeating Langmuir (32/403/1913), says that the function  $(H)^{-1}$  is much too large, and that the effect of height is negligible. Montsinger (*Proc. A.I.E.E.*, 35/458/1916) found that the loss of heat from self-cooled transformers could be represented by

$$W_c = K_1 \theta^{1.2.5}, \quad W_c = K_2 \theta^{1.27}, \quad W_c = K_3 \theta^{1.15}$$

for the three transformers which he tested;  $\theta = T_1 - T_2$ ; the values of  $K$  depended upon the type of cooling surface adopted, the different types giving different ratios for watts lost in radiation and in convection.

Kennelly (*Trans. A.I.E.E.*, 28/363/1909) discusses the question of hot-wire anemometry very fully. For radiation from copper wires he uses Stefan's formula—which Compan (p. 574) says is the best of all radiation formulæ,

$$\text{Radiation, abwatts per sq. cm} = \sigma'(T_1^4 - T_2^4) \quad (10.19)$$

$\sigma' = 5.3(10)^{-5}$  for black bodies, according to Lummer; if measured in watts the  $(10)^{-5}$  becomes  $(10)^{-12}$ . Then for linear free convection from copper wires, which was determined by subtracting the loss by radiation from the total heat loss, this latter being equal to the heat generated in the wire when the steady state had been obtained, Kennelly gives,

$$\text{Abwatts per cm} = (4000 + 64000 D')(T_1 - T_2)p^{.5d^{\frac{1}{2}}} \quad (10.20)$$

$D'$  is in cm,  $p$  is in megabars, 1 megabar = 750.09 mm mercury.

The value of the constant for free convection for wires is,

$$5300, 5600, 8500 \text{ when } D' = 0.01143, 0.02616, 0.06907 \text{ cm.}$$

For forced convection—the velocity of the air current being  $u$  cm—Kennelly found that,

$$\text{Abwatts per cm} = (300 + 58000 D')(T_1 - T_2)(u + 25)^{\frac{1}{2}} \quad (10.21)$$

Using Eq. 10.21, and putting  $T_1 - T_2 = 200^\circ \text{ C.}$ ,  $D' = 0.1 \text{ cm}$ , one gets,

$$\text{Watts/cm length} = 0.122(u + 25)^{\frac{1}{2}} \quad (10.22)$$

For a wire at one particular temperature and of one particular diameter, say, a copper wire at temperature  $T$ , diam. = 0.1 cm, there will be only one current and voltage suitable for any particular velocity, because

$$Ei = 0.122(u + 25)^{\frac{1}{2}} = \frac{i^2 4\sigma(1 + \alpha\theta_1)}{\pi d^2} \quad (10.23)$$

In the above case, taking  $\alpha=0.004$ ,  $\sigma=1.6(10)^{-6}$ ,  
 $\theta_1=200$ ,  $d=0.10$ ,

$$0.122(u+25)^{\frac{1}{2}}=i^2(0.000367) \quad \dots \quad (10'23a)$$

So that even when the velocity is nil, the current to be carried in the wire would be 41 amp. ; this would not fuse the wire, as on the supposition the temperature is only 200° C.

In any case, for wires used as anemometers the change in the air velocity or its cessation may cause the wires to be burnt out. To avoid the use of large currents it is desirable that the resistance of the wire should be relatively large.

Kennelly and Sanborn (*Amer. Phil. Soc.*, 53/55/1914) tested the effect of forced convection upon hot wires rotated in air. In order to find out how the convection loss varied with the pressure of the air, the wire forming the meter was rotated in a closed container, and the velocity was deduced from the E.M.F. given by a generator fixed upon the same shaft : it was possible to compress or rarefy the air in the container. The authors' conclusions were :—

1. Watts lost varied as  $(pu)^{\frac{1}{2}}$ , between  $p > \frac{1}{2}p_0$ ,  $< 3p_0$ .

2. This law did not hold accurately when  $p < \frac{1}{2}p_0$ ,  $> 3p_0$ .

3. The effect of moisture upon convection is not very great. No difference was noticeable when the air in the container was saturated with moisture : any difference there may have been was outside the range of accuracy of the instruments used.

4. Watts lost varied as  $(mu)^{\frac{1}{2}}$ .

5. When the pressure was kept constant,

$$(\text{Watts})=[\text{const.}(u)+\text{const.}]^{\frac{1}{2}}(T_1-T_2) \quad \dots \quad (10'24)$$

6. A platinum wire can be used as an anemometer.

The tests were made with a 0.114-mm platinum wire (No. 36, B. & S.) ; copper being no use because the surface conditions of copper wires vary too much as they oxidise. Kennelly gives the resistance of the platinum wire as 0.0001306, and the temperature coefficient 0.002575. He deduced the temperature of the wire from the electrical resistance, and made the tests at temperatures of 410° and 558° C. For the range of velocities 0.517 to 21.6 ft/sec the absolute watts, or ergs per second lost per 1° C. difference, were 52,400 to 90,750, when the pressure was atmospheric. He recorded pressures in megabars, where

$$\begin{aligned} 1 \text{ bar} &= 1 \text{ dyne/cm}^2, \\ 1 \text{ megabar} &= 10^3 \text{ ,, ,, } = 750.09 \text{ mm mercury.} \end{aligned}$$

He then found that the law of convection which the figures 52,400 and 90,750 followed was,

$$\frac{\text{Absolute watts per cm}}{(T_1-T_2)\sqrt{(u+30)}}=1930 \quad \dots \quad (10'24a)$$

where 30 is the constant introduced to compensate for the loss in convection when the air round the wire is quite still. The radiation, he says, amounts to only 1 per cent. of the total when there is an air current and it has been neglected.

For the convection in rarefied air, when the pressure was only 0.44 and 0.66 megabars, =330 and 495 mm mercury.

$$\frac{\text{Abwatts per cm}}{(T_1 - T_2)} = (\text{const.})(u + 30)^4 \quad (10\cdot24b)$$

This is the main equation for convection, and may be put,

$$\begin{aligned} 10^7 Q_c &= (\text{const.})f(u)(T_1 - T_2) \\ &= 1930 (u + 30)^4 (T_1 - T_2) \\ &= \lambda f(u)(T_1 - T_2) \end{aligned} \quad (10\cdot24c)$$

We shall call  $\lambda$  the *convectivity* of the wire: we want to know how it varies with diameters, and with the qualities of the gas in which the wire is rotated. For various sizes of wire and pressures we also want to know how  $f(u)$  varies.

It appears from Russell's and King's equations that

$$\lambda = \left[ \frac{k_p m k d}{2\pi} \right]^{\frac{1}{2}}, \quad d \text{ in cm} \quad (10\cdot25)$$

Now the question arises as to the magnitude of the currents which are likely to be met with in wires of ordinary gauge, say about 1 mm diam. We can proceed thus:—

Watts generated in the wire,

$$\text{Watts} = i^2 = \frac{i^2 \sigma (1 + a\theta')}{0.785 d^2} \quad (10\cdot26)$$

$$\text{Abwatts per cm imparted to the air} = \lambda (T_1 - T_2) f(u), \quad (10\cdot27)$$

$$\begin{aligned} \text{If } f(u) &= (u + 30)^{\frac{1}{2}}, \quad u \text{ in cm/sec.} \\ &= (30.5u + 30)^{\frac{1}{2}}, \quad u \text{ in ft/sec,} \\ \text{then when } u &= 0 \text{ f.p.s., } f(u) = 5.5 \\ &= 10 \quad \text{,,} \quad = 18.3 \\ &= 20 \quad \text{,,} \quad = 25.2 \\ &= 30 \quad \text{,,} \quad = 30.4. \end{aligned}$$

Therefore  $f(u)$  varies from 5.5 to 30.4 in ordinary cases. The resistance of wires which could be used will be about,

$$\begin{aligned} \sigma &= 1.6 \text{ microhms for copper,} \\ \sigma &= 10.0 \quad \text{,,} \quad \text{,,} \quad \text{platinum,} \\ \sigma &= 42.0 \quad \text{,,} \quad \text{,,} \quad \text{manganin,} \end{aligned}$$

and assuming that the increase of resistance, viz.  $a\theta'$ , varies from 0 to 0.40,

$$\text{Watts generated in wire} = \frac{i^2 (1.6 \sim 42) (1.00 \sim 1.40)}{0.785 d^2 10^6} \quad (10\cdot27a)$$

Again, as  $\lambda$  varies from about 2000 to 5000, we get an expression for the current  $i$  by combining Eq. 10.26, 10.27,

$$i^2 \frac{(1.6 \sim 42) (1.00 \sim 1.40)}{0.785 d^2 10^6} = \frac{(2 \sim 5) (T_1 - T_2) (5.5 \sim 30.4)}{10^4} \quad (10\cdot28)$$

Choosing values, 1.6 ; 1.4 ; const. = 3 ;  $T_1 - T_2 = 100$  ;  $f(u) = 25.2$ ,

$$i = d \ 515 ; i = 51.5 \text{ (diam. in mm)}. \quad (10\cdot29)$$

The general equation connecting  $i$ ,  $d$ ,  $\sigma$ ,  $u$  is,

$$i^2 = \frac{d^2(0.785)\lambda(T_1 - T_2)f(u)}{10^7[1 + a(T_1 - T_2)]\sigma} \quad (10.29a)$$

Then, if we have a velocity  $u$  to measure, the bigger  $\sigma$  is the smaller will be the current: currents also increase proportionately to  $d^{1.25}$  as  $\lambda$  varies as  $d^{\frac{1}{2}}$ ; see Eq. 10.33b. The higher we allow  $T_1 - T_2$  to be, the less will be the current  $i$  for any fixed value of the velocity  $u$ . On the other hand, if we wish to convey heat to the air we should make  $d$ ,  $T_1 - T_2$ , and  $u$  all large.

Langmuir (*Proc. A.I.E.E.*, 32/409/1913) quotes Kennelly's formula for convection as being proportional to  $(u+25)^{\frac{1}{2}}$ : Langmuir says that the 25 should be 33. If now the velocity of the air becomes about 1000 cm/sec, the small term 25 or 33 may be neglected, and the convection will vary as  $u^{\frac{1}{2}}$ , agreeing with King's results. Boussinesq's equation, given by Russell, viz.,

$$\text{Watt/cm per sec.} = K(T_1 - T_2)(k_p m k u r / \pi)^{\frac{1}{2}} \quad (10.30)$$

is quoted, and values of the constant  $K$  are stated to be,

$$\begin{aligned} K &= 7-8 \text{ for wires from 2 cm to 10 cm diam.} \\ &5-6 \text{ ,, ,, ,, 0.01 cm to 2 cm diam.} \end{aligned}$$

For forced convection Eq. 10.30 becomes,

$$\text{Watts/cm} = .000180(5 \text{ to } 8)(T_1 - T_2)(2ru)^{\frac{1}{2}} \quad (10.31)$$

Eq. 10.30 enables us to find how  $\lambda$  and  $K$  are related,

$$\text{Abwatts lost} = \lambda(T_1 - T_2)f(u) \quad (10.32)$$

$$\text{Watts lost} = \frac{\lambda}{10^7}(T_1 - T_2)f(u) \quad (10.32a)$$

$$= K(T_1 - T_2) \left[ \frac{k_p m k d}{2\pi} \right]^{\frac{1}{2}} u^{\frac{1}{2}} \quad (10.32b)$$

Now assuming  $u^{\frac{1}{2}} = f(u)$ ,

$$\frac{\lambda}{10^7} = K \left[ \frac{(.237)(.001293)(.000055)}{(.239) 2\pi (.239)} \right]^{\frac{1}{2}} d^{\frac{1}{2}} \quad (10.33)$$

$$= (5 \sim 6)(.000218)d^{\frac{1}{2}} \quad (10.34)$$

$$\lambda = (10900 \sim 13080)d^{\frac{1}{2}} \quad (10.35)$$

Then we get the following values of  $\lambda$  for air at atmospheric pressure when  $K=5$  or  $6$ :

$K=5.$	$K=6.$	$d.$
$\lambda=1090$	1308	.01 cm.
=2440	2950	.05 ,,
=3440	4130	.10 ,,
=4210	5050	.15 ,,

Russell, in the same article, deals with the mathematical equations expressing the flow of heat in fluids flowing past hot bodies, these being

wires, or rods, or flat strips, and gives references to the previous mathematical work of Fourier, Poisson, Oberbeck, L. Lorenz, Graetz, Wilson, Boussinesq.

For deriving the equations, the following assumptions are made :—

1. The fluid is opaque to heat rays ; or radiation is nil.
2. The fluid has no viscosity.
3. The fluid is incompressible.
4. Thermal conductivity is very small.
5. Any variation in density will not alter the trajectory of the flow, as compared with what it would be for isothermal flow.
6. The surface of the hot body is isothermal, at  $T_1$ .
7. The fluid touching the hot body is also at temperature  $T_1$ .
8. The fluid before it reaches the hot body is at  $T_2$ .

We shall only give the results which Russell obtains after he has solved the equations : these should only apply to convection from the hot body into fluids with a stream-line flow, that is, for rates of flow which are less than the critical velocity (see Table 1-1).

The total flow of heat from a circular wire *per unit length* per second then becomes,

$$F = 8(T_1 - T_2)(k_p m k u r / \pi)^{\frac{1}{2}} = \text{Eq. 10'30.}$$

The heat carried off by convection, *per unit area of surface*, is,

$$F = \frac{4(T_1 - T_2)}{\pi \sqrt{\pi}} \sqrt{\frac{k_p m k u}{r}} \quad \dots \quad (10'36)$$

It is seen, therefore, that this depends upon the radius of the wire, and is greater per sq. cm for a small wire than for a large wire.

The heat flow per unit length for elliptical wires becomes,

$$F = 4(T_1 - T_2)[k_p m k u (2(a+b)/\pi)]^{\frac{1}{2}} \quad \dots \quad (10'37)$$

This holds independent of the direction in which the ellipsoid is turned relative to the current, except when the ellipsoid is very elongated, and the ratio of the minor axis  $b$  to the major axis  $a$  becomes very small ; it then only holds if the major axis is parallel to the direction of flow, and the minor axis is perpendicular to that direction.

For the convection from a flat strip with the thin edge placed facing the flow and the surface parallel to the direction of flow, the above equation holds, with  $b=0$ .

$$F = 4(T_1 - T_2)[k_p m k u (2a)/\pi]^{\frac{1}{2}} \quad \dots \quad (10'38)$$

where  $2a$  is the breadth of the strip.

The convection of heat per second per sq. cm of area is,

$$F = 2(T_1 - T_2)[k_p m k u / (2a\pi)]^{\frac{1}{2}} \quad \dots \quad (10'39)$$

These equations seem to hold fairly well with the results of tests, even though the flow in practice must usually be turbulent, and not in accordance with stream-lines. For turbulent motion we should have the convection,

$$F = A(T_1 - T_2) + Bmu(T_1 - T_2) \quad \dots \quad (10'40)$$



where A and B are constants and A is small, so that the convection would be proportional to the velocity.

From Eq. 10·30 we have an approximate method of determining the rise of temperature of a wire when traversed by an electric current: when the steady state is attained,

$$0.239 \frac{i^2 \sigma}{\pi r^2} = 8(T_1 - T_2) \left[ \frac{k_p m k u r}{\pi} \right]^{\frac{1}{2}} \quad (10.41)$$

as 1 watt = 0.239 calories:  $\sigma$  is resistance per unit vol. at  $T_1$ .

This gives the value of the current,

$$i = 7.7 r^{1.25} (k_p m k u)^{.25} \left( \frac{T_1 - T_2}{\sigma} \right)^{.5} \quad (10.42)$$

Now, using  $i$  as the fusing current of the wire, we find that for any particular material the fusing current should vary with the diameter as  $r^{1.25}$ ; this does not hold absolutely because radiation has been neglected, and is appreciable at the fusing temperatures: but on this matter of fusing currents one can refer to *Electrician*, 80/77/1917. Schwartz and James (*Jour. I.E.E.*, 33/364/1905), in experiments upon fusing currents, gave results in fair agreement with such a law. For the rise of temperature in a wire, when the current is  $i$  and the velocity of the air is  $u$ , and the coefficient for the rise of resistance with temperature is  $\alpha$ , we have

$$\sigma = \sigma_0 [1 + \alpha(T_1 - T_2)],$$

and then,

$$\sigma \left\{ \frac{1}{T_1 - T_2} + \alpha \right\} = 59.5 r^{2.5} \frac{(k_p m k u)}{i^2} \quad (10.43)$$

Assuming that the rise of temperature  $T_1 - T_2$  is fixed, then the current  $i$  for bare wires should vary as  $r^{1.25}$ , or as (section)<sup>.825</sup>. The wiring rules of the Inst. Elec. Engr. give the allowable current varying as (section)<sup>.82</sup>.

As the convection from wires is  $8(T_1 - T_2) [k_p m k u r / \pi]^{\frac{1}{2}}$ , it is best to have a small wire for use as an electrical velocity meter, if one wishes to expend the least energy. For the same convection loss the type of material used is immaterial, but the determination of the constancy of temperature, or of the temperature of the wire from the measured electrical resistance, is best obtained by using a metal with a fairly high temperature coefficient.

King (*Proc. Roy. Soc.*, 90A/563/1914), for hot-wire anemometry, used a 3-mil platinum wire, heated to about 1000° C., which made the resistance about four times that at normal temperatures: then in still air a current  $i_0$  was required to keep the wire at  $T_1$ : as soon as an air current was sent past the wire, more current was needed to keep the temperature at  $T_1$ , and it was found that,

$$i^2 = i_0^2 + (\text{const.})(u)^{\frac{1}{2}}.$$

King found that the angle subtended between the axis of the wire and the direction of the air current made an appreciable difference in the amount of current required in the wire. Taking

$$i^2 \sigma = i_0^2 \sigma + (\text{const.})(u)^{\frac{1}{2}} = \text{watts} \quad (10.44)$$

it was found that, as regards variations in T and the radius of the wire R,

$$\text{watts} = f_1(T, R) + f(T, R)(u)^{\frac{1}{2}} \quad (10.45)$$

The function of T and R associated with velocity was found to be,

$$f(T, R) = \lambda_0 [1 + 0.0008(T_1 - T_2)](T_1 - T_2) \quad (10\cdot46)$$

Then from theory it was known that  $\lambda_0$  should vary inversely as the square root of the radius of the wire, and it was found,

$$\lambda_0 = 0.001432/(R)^{\frac{1}{2}} \quad (10\cdot47)$$

This held good for platinum wires from 1 to 6 mils in diameter, when rotated in air at known velocities. Theory would make

$$\frac{\lambda_0}{D^{\frac{1}{2}}} = \left[ \frac{k_p m k}{2\pi} \right]^{\frac{1}{2}} = 0.00166 \text{ cal.} \quad (10\cdot48)$$

The value 0.00166 is given, when  $k_p = 0.171$  cal.

$$m = 0.001293 \text{ gm, } k = 5.66(10)^{-5} \text{ cal.}$$

The other function of T, R depends upon the radiation. King chooses Lummer and Kurlbaum's value (*Ver. Deut. Phys. Ges.*, 17/106/1898),

$$\text{watts/cm}^2 = 0.514(0.001T_1)^{5.2} = Q_r \quad (10\cdot49)$$

The radiation from the wire per unit length =  $2\pi R Q_r$ . Since  $f_1(T, R)$  includes the radiation loss, the function of the convection loss which is independent of  $u$ , or the convection loss in still air, becomes  $f_1(T, R) - Q_r$ . When this was evaluated, it became,

$$Q_c \text{ in still air} = \gamma_0(T_1 - T_2)[1 + 0.00114(T_1 - T_2)] \quad (10\cdot50)$$

$$\gamma_0 = 0.000250(1 + 70R).$$

We can now put for the watts emitted per cm length of hot wire,

$$\sigma i^2 = \text{watts} = 2\pi R(0.514)[(0.001T_1)^{5.2} - (0.001T_2)^{5.2}] + [\gamma + \lambda(u)^{\frac{1}{2}}](T_1 - T_2) \quad (10\cdot51)$$

$\gamma = \gamma_0[1 + 0.00114(T_1 - T_2)]$ , which covers conduction,

$\lambda = \lambda_0[1 + 0.0008(T_1 - T_2)]$ , this covers convection,

$$\lambda_0 = 2(\pi m k_p k R)^{\frac{1}{2}} = 2\pi \left[ \frac{k_p m k d}{2\pi} \right]^{\frac{1}{2}} \quad (10\cdot52)$$

From Eq. 10.30 this gives  $K = 2\pi$ , instead of from 5 to 8. For commercial work one would put

$$\sigma i^2 = \lambda(u)^{\frac{1}{2}}(T_1 - T_2) \quad (10\cdot53)$$

King (*Phil. Mag.*, 29/556/1915) gives a full description of a suitable electrical velocity meter, the electrical connections for which are given in fig. 10.1. The calibration of such meters should, he says, be done by means of whirling them in air, and, if necessary, correcting them for the "swirl," as mentioned in *Phil. Trans.*, 214A/388-428/1914, for the ranges of velocities 60-800 cm/sec. For very low velocities, say less than 10 cm/sec, the free convection currents will affect the general law,  $i^2 = i_0^2 + K'(u)^{\frac{1}{2}}$ , and it would be necessary to take into account the current due to free convection, which, in the case of a 3-mil platinum wire at 1000° C., amounts to 15 cm/sec, and only falls to 8 cm/sec when the temperature falls to 200° C.

However, an electrical meter will register down to velocities of about 15 cm/sec with 10 per cent. accuracy.

The linear relation

$$i^2 = i_0^2 + K'\sqrt{u} \quad \dots \quad (10\cdot54)$$

holds good theoretically to within  $2\frac{1}{2}$  per cent. for velocities down to a value given by  $ud=0\cdot0187$ , where  $u$  and  $d$  are in cm.

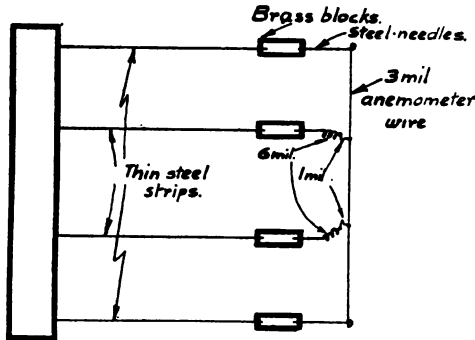
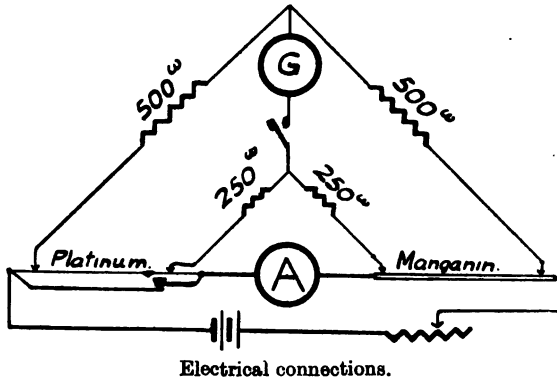

FIG. 10'1.—Hot-wire anemometer.

For calibration of low velocities he suggests moving the meter horizontally or vertically backwards and forwards in a straight-line motion, using, perhaps, Trowbridge and Truesdell's Table, which is described in *Phys. Rev.*, 4/290/1914.

He then discusses what sort of differences in velocity can be detected on the meter, working from the equation for the constants of the  $2\frac{1}{2}$ -mil wire,

$$u = \frac{(i^2 - 564)^2}{276 \cdot 4} = \frac{(i^2 - i_0^2)^2}{(K')^2} \quad \dots \quad (10\cdot55)$$

$$du = 4(i^2 - i_0^2) i \, di / (K')^2$$

and therefore,

$$\frac{u}{du} = \frac{1}{4} \frac{i}{di} \left( 1 - \frac{i_0^2}{i^2} \right),$$

which shows what difference in velocities can be measured. In the

tests King made he could detect a difference of 0.002 ampere in his instrument, and thus detected differences of 1, 5½, 15 cm/sec at velocities 752, 785, 3260 cm/sec.

In an exploration of the distribution of velocity over spaces outside an orifice, or a slit, he placed the wire at points distant 0.05 mm from each other in series, and could easily read the velocities from point to point, though they varied considerably one from another.

In order to get accurate readings the position of the wire and the position of the potential terminals on the wire, and the way of leading the potential wires to the anemometer wire should all have the same relative position to the air currents in the tests as they had when the wire was being calibrated.

King discusses the variations due to alteration in pressure and to variations in temperature of the atmosphere, but the corrections are so minute that they would not be needed in commercial work.

King (*Jour. Frank. Inst.*, 181/1/1916) describes further tests of his meter and gives photographs and drawings of the actual hot wire used. In his mathematical discussion is given Boussinesq's Eq. 10.30 for heat loss, and also his own equation,

$$\text{Cal. per cm} = 4\pi k_p m r u / \int_0^{r'} e^{-u} K_0(u) du \quad (10.56)$$

where  $K_0(u)$  is a solution of Bessel's equation. King states,

$$\text{Cal/cm for high velocities} = k\theta + 2\theta(k_p k m r u)^{\frac{1}{2}} \quad (10.57)$$

$$,, \quad ,, \quad \text{low} \quad ,, \quad = 2\pi k\theta / [\log(ke^{-1.2}) / (mk_p u r)] \quad (10.58)$$

The report is largely a reproduction of the one in *Phil. Mag.*

King (*Jour. Franklin Inst.*, 18/191/1916) describes how his hot-wire anemometer can be associated with an integrating watt-meter in order to read the quantity of gas flowing in a pipe. When the quantity is such that the velocity in the throat of the Venturi cone exceeds 90 ft/sec (28 m/sec) the hot-wire meter becomes rather insensible to changes of velocity: in such cases he arranges the hot-wire meter in a shunt channel in parallel with the Venturi cones: the difference of pressure created by the cones produces a flow through the shunt: the meter in the shunt can then be calibrated to measure the whole flow; this must be done with some standard form of meter, as there is no theory to show how much would circulate in the shunt and how much in the main channel.

In *Jour. Franklin Inst.*, 183/783/1917, is described a method of compensating the bridge arms of such an anemometer to allow for variations in the temperature of the fluid. The four arms of the Wheatstone bridge are made of tungsten or nickel, and are all placed in the air current: in the one mentioned nickel wires 0.155 mm diameter were used; this required a current of 0.74 amp. to maintain balance in still air, and of 2.18 amp. to maintain balance when the air velocity was 17.5 m/sec.

### G. Results of and notes of tests.

Gerdien (*Verh. Deut. Phys. Ges.*, 15/961/1913) describes a hot-wire anemometer as made by Siemens and Halske: in this the principles under-

lying the velocity and quantity meters are combined. Two wires are used, and both are heated by electric currents: they are placed after one another in the pipe line, and the difference of temperature is noted: by suitable calibration the quantity of air flowing can be determined.

Morris (*Electrician*, 69/1056/1912) describes tests made upon the measurement of air velocity by means of a hot-wire anemometer at the East London College, in a duct 1 sq. ft. in area, the flow being measured by a Pitot tube, and by the pressure of air upon the round surface of a brass tube  $\frac{1}{2}$  in. in diameter. Another report is given in *Engineering*, 94/892/1913, where the advantages of the electrical velocity meter are fully portrayed. He had used as hot wires, tinned iron, tinned copper, nickel, platinum, tantalum; but of these platinum was the metal finally decided upon, because it does not oxidise readily and has a high melting-point. To make the other arms of the Wheatstone bridge he used 6-in. lengths of manganin wire. A current of from 2-5 amp. at about 4 volts provided all the energy removed by convection. Some of his test figures are:—

Rea. at 0°.	Diam., mm.	Diam., inches.	Length, inches.	Material and size of wire.	T <sub>1</sub> -T <sub>2</sub> C°.	Current i <sub>0</sub> when $\alpha = 0$ .
·394	·1219	·0048	2·00	Platinum, 40 S.W.G.	43	0·84
·540	"	"	2·75	" "	71	1·23
·492	"	"	2·50	" "	100	1·55
·540	·1930	·0076	6·90	" 36 S.W.G.	...	1·80

He gives particulars as to the qualities of various metals; suitable values for general use are:—

Metal.	Resistance per cm cube, microhms.	Melting point, Cent.	Resistance coefficient per 1° C.
Iron . . .	9·70	1300-1400	·00620
Copper . . .	1·60	1100	·00400
Nickel . . .	12·40	1450	·00270
Platinum . . .	10·00	1800	·00370

Table 10'3 gives fuller particulars concerning wires.

Morris found that,

$$(m.p.h. + 1.8) = \text{const. (watts)}^2 . . . (10'59)$$

which gives  $u$  in ft.  $(u + 2.63) = .. .. . (10'60)$

" "  $u$  in cm  $(u + 45) = .. .. .$

in which case the constant differs materially from that found by Kennelly. Morris found that the speed of the fan delivering the air varied directly as the speed of air in the duct, which confirms Hackett's work and theory that anemometers can be well calibrated by running a fan at various speeds.

TABLE 10'3.—SPECIFIC RESISTANCE OF WIRES.

$\sigma$  = Microhms per cm. cube at 0° C.  
 $\alpha'$  = Temperature coefficient per 1° C. multiplied by 1000=1000  $\alpha$ .

Metal.	Geipel, p. 56, also Ayrton.		Glover, <i>Vade Mecum</i> , p. 359.		Standard Handbook, p. 131.		Melts at C°.		Hütte, vol. ii. p. 819.		Everett, <i>C. C. S. System of Units</i> , p. 176.		Morris.		Melts at C°.		Suitable values to choose.	
	$\sigma$	$\alpha'$	$\sigma$	$\alpha'$	$\sigma$	$\alpha'$	$\sigma$	$\alpha'$	$\sigma$	$\alpha'$	$\sigma$	$\alpha'$	$\sigma$	$\alpha'$	$\sigma$	$\alpha'$	Resist- ance.	Temp. coef.
Aluminium	2'900	3'90	4'85	2'665	2'906	...	625	{ 2'8 } { 4'6 }	$\sigma$	$\alpha'$	$\sigma$	$\alpha'$	...	...	...	...	$\sigma$	$\alpha$
Copper, annealed	1'584	3'88	4'28	1'561	1'584	3'88	1100	1'58	3'70	3'88	1'580	1'600	4'28	1070	1'60	0'040	1'60	0'040
„ hard-drawn	1'621	..	...	...	1'619	...	...	1'66	...	...	1'616	...	...	...	1'60	0'040	...	...
Iron	9'700	...	6'25	9'065	9'693	...	1630	{ 9'5 } { 11'0 }	4'50	...	9'611	9'690	6'20	1300	9'70	0'062	...	...
Nickel	12'36	4'87	6'22	12'32	12'43	...	1500	13'9	3'7	...	12'32	12'40	2'70	1450	12'4	...	...	...
Platinum	8'982	2'47	3'69	10'92	9'035	...	1900	{ 11'0 } { 15'0 }	2'4 3'5	...	8'957	9'04	3'80	1780	10'0	0'030	...	...
Platinoid	32'5	...	...	...	...	...	...	...	...	{ 29'0 } { 37'0 }	...	...	...	...	33'0	0'000	...	...
Manganin	42'0	...	...	...	...	...	...	42'0	0'1	...	...	...	...	...	42'0	0'000	...	...

Ayrton and Kilgour . . . for platinum,  $\sigma$  = 10'50  $\alpha$  = 3'60.  
 „ quoted by Sewell . . . = 9'04 = 3'80.  
 „ *Mechanical Engineer's Handbook* . . . = 10'40 = 3'70.

Professor MacGregor-Morris kindly gave the author the privilege of seeing the anemometer which he uses at the East London College. About 2 amp. is used for heating the wires of the bridge, which consist of four nickel, tungsten, or platinum wires 0.15 mm in diameter, which are at about 100° C. when in still air. Two of the wires are in thin copper tubes, so that the air current affects them to a slight extent; the other two wires of the bridge are in the current. Calibration is performed with a Pitot tube for high velocities, the static mouthpiece being in the wall of the wind tunnel, the air-pressure difference being read on a Hicks manometer, the vessels of which are connected by a small-bore horizontal tube: the liquid is xylol, and an air bubble is introduced in the small tube. For a description of such a manometer, see Roberts (*Proc. Roy. Soc.*, 78A/410/1906). A commercial anemometer of this form is being produced by the Cambridge Scientific Instrument Company.

Morris (*Engineering*, 96/178/1913) used the same type of meter to investigate the distribution of velocity of air currents round a circular rod placed in an air current. The rod, 21 mm (0.825 in.) in diameter, was provided with fittings holding two small platinum wires which acted as the meters, these wires being parallel to the axis of the rod: the distance of the wires from the rod could be altered, and the rod could be rotated about its axis so that the wires could be placed anywhere in the space round the rod: the charts of the velocity are given in the original paper, and show the very small velocity which exists where the rod faces the flow, and the high velocity which exists where the flow is tangential to the rod.

Hughes (*Phil. Mag.*, 31/118/1916) made experiments upon the convection losses from bodies of relatively large diameter as compared to the wires used by other observers. Hughes made use of hollow copper tubes about 1 metre long, with diameters varying from 0.43 to 15.5 cm; the tubes were heated by steam at atmospheric pressure, and the loss of heat was determined by the quantity of steam condensed. The air velocity was measured by means of a Pitot tube, and varied from 10 to 45 ft/sec.

For the radiation losses from tarnished copper, Hughes took the equation,

$$Q_r = 63 \times 10^{-12}(T_1^4 - T_2^4), \text{ calories per sq. cm} \quad . \quad (10'61)$$

Using  $\sigma' = 5.32$ , this gives relative emissivity .495. Hughes found that the heat loss was related to the velocity according to law,  $Q = K v^n$ , where  $n$  had different values depending upon the diameter, and that as regards diameter the loss for the same velocity varied as  $d^{.57}$ . He states that Reynolds, Nicholson, and Williams, for large bodies, have stated that the heat loss by convection varies as the velocity, but Hughes does not quote the references. Tests were also made upon a tube of stream-line section, placed (a) with the taper end, (b) with the butt end, facing the air current. In these tests he found for (a)  $n = 0.67$ , and for (b)  $n = 0.62$ , and also found that the convection from such a tube was much greater than that from circular tubes of the same area per cm length when projected on a plane perpendicular to the air current, or the diameter of the circular tube = smallest diameter of stream-line section: the constant  $Kb$  when the butt end faces the current is about  $1\frac{1}{2}$  times  $Ka$  for the tube in the other position.

Hughes' results are somewhat different to those of Russell and King, with which they shall now be compared.

Hughes gives,  $Watts = K1 u^n$ , with  $d$  constant . . . . (10'62)

$= K' d^{.57}$ , ,,  $u$  ,, . . . . (10'63)

but the index  $n$  is given as varying with the diameter, so that we get,

$Watts = K1 u^{\frac{1}{2}} f(u, d)$ .

Russell, Eq. 10'30,

$Watts \text{ per sec.} = K \left[ \frac{k_p m k}{2\pi} \right]^{\frac{1}{2}} (T_1 - T_2) d^{\frac{1}{2}} f(u)$ .

We shall bring Hughes' formula to the same form : he gives,

$Q1 = \text{watts per cm per 600 sec. for } T_1 = 100, T_2 = 16.3$ ,

from which we deduce watts per sec. per 1° = Q2, and so continue, until we get a similar expression to Russell's. In making the comparison, I have chosen the figures for  $u = 1000$  from Hughes' table, and have drawn up Table 10'4, in which :

- Column 1 and 2 are diameters and the index  $n$  from Hughes.
- „ 3,  $Q_r$  gives the radiation loss.
- „ 4,  $Q1$  are the watts lost in 600 sec.,  $u = 1000$ .
- „ 5,  $u^n$  is  $u^{.50}$ , as per Hughes.
- „ 6,  $Q2$  watts per sec. per 1°, found from  $Q1 / (600)(100 - 16.3)$ .
- „ 7,  $K3$  is found from  $Q2 / (d)^{\frac{1}{2}}$ .
- „ 8,  $K4$  is found from  $K3 / (31.6)$ , where  $31.6 = (1000)^{\frac{1}{2}}$ .
- „ 9,  $K5$  is found from  $K4 / (.000218)$ ; this latter figure is the constant in Russell's Eq. 10'33a.
- „ 10 is the value of  $(d)^{.07}$ .
- „ 11,  $K6$  is found from  $K5 / (d)^{.07}$ .

Then we see that Hughes'  $Q2 = K4 d^{\frac{1}{2}} u^{\frac{1}{2}}$  . . . . (10'64)

and should equal  $= (5 \sim 6) (.00218) d^{\frac{1}{2}} u^{\frac{1}{2}}$  . . . . (10'65)

The values of  $K5$  in column 9 show how Hughes' constants compare with Russell's ; and a further comparison is made by assuming that Hughes' function of  $d^{.57}$  is the correct one, instead of  $d^{\frac{1}{2}}$ , and then the value of the constant becomes as in column 11.

Hughes' results for the watts lost from the wire through the convection currents, when the velocity is 1000 cm/sec, then become,

$Watts \text{ per sec.} = K6 d^{.07} \left[ \frac{k_p m k d}{2\pi} \right] (T_1 - T_2) u^{\frac{1}{2}}$  . . . . (10'66)

$K6$  varying from 5.05 to 4.88 for diameters from about  $\frac{1}{2}$  to 5 cm. There is certainly room for many more tests, so as to find out how the constant  $K$  varies round about 5, or 6, or  $2\pi$ .

For other velocities the value of  $K$  may be different : from Hughes' general equations one would expect them to vary as

$K6 (u)^{n-.5}$  : in the case where  $n = 0.70$ .

This would make an appreciable difference to  $K$ .



TABLE 10'4.—CONVECTION FROM COPPER TUBES (HUGHES).

1 <i>d.</i>	2 <i>n.</i>	3 <i>Q<sub>r</sub>.</i>	4 <i>Q<sub>l</sub>.</i>	5 <i>w<sup>2</sup>.</i>	6 <i>Q<sub>2</sub>.</i>	7 <i>K<sub>3</sub>.</i>	8 <i>K<sub>4</sub>.</i>	9 <i>K<sub>5</sub>.</i>	10 <i>d.</i>	11 <i>K<sub>6</sub>.</i>
0·43	·50	6·3	1050	31·6	·0210	·0321	·00102	4·76	0·945	5·05
0·81	·60	11·9	1440	63·1	·0288	·0321	·00102	4·76	0·985	4·80
1·93	·65	28·3	2390	89·1	·0478	·0345	·00109	5·00	1·045	4·78
5·06	·70	73·8	4200	126·0	·0840	·0374	·00118	5·46	1·120	4·88

L. W. Hartmann (*Phys. Rev.*, 7/431/1916) describes tests upon the quantity of heat emitted from incandescent spongy platinum wires 0·2 to 0·7 mm in diameter at temperatures 900 to 1700 degrees absolute. In order to determine temperatures the hot wire was placed in front of an electric furnace containing at the centre magnesium oxide. The temperature of the furnace was measured by a thermo-electric couple and by a Wanner pyrometer. The platinum wire was heated until its incandescence was equal to that of the furnace, the fact of equality being determined by the hot wire becoming invisible when looking towards the incandescent magnesium oxide: when the temperatures differed the wire at once became visible. The energy imparted to the wire was noted in the ordinary way from voltage and current readings.

Readings of the watts lost per cm were plotted against the absolute temperature: an amount for radiation, using Coblentz's value of the radiation constant—viz.  $5·61 \times (10)^{-12}$ ,—was then calculated and deducted, leaving the remainder of the loss for conduction and convection. The energy loss per cm for the range 900 to 1700 degrees absolute was found to be nearly proportional to the temperature, viz.,

$$Q_c = k_1 T \quad \dots \quad (10'67)$$

The values of  $k_1$  are shown below. One may write approximately,

$$Q_c = \cdot 0010 T \quad \dots \quad (10'68)$$

for the heat loss of spongy platinum wires in still air, the wire being at 900° to 1700° abs., and from 0·07 to 0·03 cm in diam.

Hartmann also quotes Lorenz's law (*Wied. Annal.*, 13/582/1881) for the energy absorbed by a wire when heated in air, viz.,

$$\text{Watts} = A(T_1^4 - T_0^4) + B(T_1 - T_0)^{5/4} \quad \dots \quad (10'69)$$

and finds the values of A and B from his test figures: the values of the constant A then approximate those calculated from  $\sigma \pi d$  for radiation, as shown here.

TABLE 10'5.—HEAT LOSSES FROM WIRES (HARTMANN).

<i>d</i> (cm).	$k_1 = \frac{\text{abwatts}}{\text{cm. T}}$	$\sigma \pi d = 5'61 \pi d$ .	$A \times (10)^{-12}$ .	$B \times (10)^{-4}$ .
·0690	10,920	1·22	1·120	3·035
·0420	10,830	0·74	0·682	2·820
·0275	9,760	0·485	0·447	2·500
·0194	8,540	0·342	0·315	2·100

## CHAPTER X.—SYMBOLS USED.

Equation.	Symbol.	Meaning.
10'40	A	=a constant.
10'37	$a$	=major axis of ellipse.
10'37	$b$	=minor " "
10'40	B	=a constant.
10'04	$c$	=specific heat of metal, of hot body.
10'08	$d$	=diameter of wire in cm, or as mentioned.
10'08	E	=voltage at ends of length L of wire.
10'09	$h$	=pressure in mm of mercury.
10'08	$i$	=current in amperes.
10'44	$i_0$	= " to heat wire to T when $u=0$ .
10'30	$k$	=specific conductivity.
..	$k^v$	= " heat at constant volume.
10'30	$k_p$	= " " " " pressure.
10'13	$k'$	= " conductivity of the metal body.
10'30	K	=a constant.
10'54	K'	= " "
..	L	=length of wire.
10'30	$m$	=density of the gas.
10'20	$p$	=pressure in megabars (750 mm mercury).
10'04	$Q_c$	=watts lost by convection and conduction.
10'04	$Q_r$	= " " by radiation, per sq. cm.
10'04	R	=radius of wire in cm.
10'13	$r$	=any radius.
10'26	$s$	=resistance of particular wire per length L cm.
10'17	S	=section of wire.
10'01	$T_1$	=absolute temperature of the wire or hot body.
10'01	$T_2$	= " " of the gas or cold body.
10'04	$t$	=time in seconds.
10'22	$u$	=velocity of gas.
10'09	$u^r$	=rate of cooling due to radiation.
10'13	$dx$	=small length of wire.
10'23	$\alpha$	=temperature coefficient of electrical resistance.
10'04	$\beta$	=density of the wire or hot body.
10'08	$\gamma$	=coefficient of expansion of platinum.
10'50	$\gamma_0$	=a constant.
10'07	$\epsilon$	=emissivity=calories per sq. cm per 1° C.
..	$\eta$	=coefficient of viscosity.
10'23	$\theta_1, \theta_2$	=temperatures in degrees Centigrade.
10'26	$\theta'$	=temperature elevation of hot body above cold body.
10'24c	$\lambda$	=convectivity.
10'14	$\sigma$	=specific resistance of the metal.
10'03	$\sigma'$	=Stefan's radiation constant.



The value of  $k_1$  is nearly 100, as mentioned above in Eq. 10'67. It should also be similar to  $\lambda$  (see Eq. 10'33), but is much greater than  $\lambda$ : presumably this is because with such high temperatures the free convection current will be large, and so the term  $u$ , for velocity, in Eq. 10'24c must be introduced. One must also remember that  $\lambda$  is associated with  $T - T_0$ , whereas  $k_1$  is associated with  $T$  only.

Northrup (*Metal. and Chem. Eng.*, 15/250/1916) describes tests made on nickel wires to determine their elasticity and the amount of heat emitted when at the melting-point. To the centre of the wire was attached a spring which broke the wire at the fusing temperature, and which measured the tension and elongation in the wire at the moment of breaking. The heat radiated at melting-point, 1725° abs. C., was found to be :—

D.	Watts/cm <sup>2</sup> .	Watts/cm length.	Watts/D <sup>1</sup> .
·0246	67·5	5·21	33·2
·0510	56·5	9·08	40·3
·0775	52·4	12·70	46·7
·1990	32·5	20·30	45·5

The expansion in length was found to be 3·28 per cent.: regarding the heat loss no mention is made of how much, if any, would be imparted to the spring, but this might affect the results. Radiation must be subtracted from the above figures if the convection loss is required.

Worthington and Malone (*Jour. Franklin Inst.*, 183/115/1917) state that the convection of heat from a 0·256-mm platinum wire in water follows the same laws as convection in air, and is represented by

$$\text{Watts per cm} = 0\cdot031(T_1 - T_2)(u + 1\cdot15)^{\frac{1}{2}}, \text{ where } T_1 \text{ is wire temperature.}$$

,,  $T_2$  is water            ,,  
 ,,  $u$  is velocity of the wire  
    in water in cm/sec.

#### AUTHORITIES MENTIONED.

Ayrton, Bottomley, Coblentz, Compan, Fery, Gerlach, Gerdien, Hartmann, Hughes, James, Kennelly, Kilgour, King, Kurlbaum, Langmuir, Lorenz, Lummer, Malone, Maxwell, Meyer, Mitchell, Montsinger, Morris, Northrup, Paschen, Peczalski, Poynting, Retschky, Russell, Sanborn, Schwartz, Shakespear, Stefan, Thomson, Worthington.

## CHAPTER XI.

### FLOW FROM ORIFICES.

Fundamental thermodynamic equations—Zeuner's equations—Equation for maximum delivery—Table for functions of  $n$ , index of polytropic expansion—Zeuner's theory as to the throat pressure—Formulae for delivery from orifices—Flow when the external pressure exceeds the critical pressure—Orifice profiles—Coefficients of velocity and delivery—Throat pressure—Effect of friction—Equations for throttling, and the work lost therein—Pressure lost in cocks.

THIS chapter deals partially with the subject of flow from orifices. Those who wish to study the subject fully will find it dealt with in all books on thermodynamics: Goodenough (*Thermodynamics*, p. 267) and Henderson (*Proc. Inst. Mech. Engr.*, —/253/1913) give a list of papers in scientific journals dealing with the subject.

#### A. Fundamental thermodynamic equations.

The following assumptions are made in deriving the theoretical equations:—

1. The particles of the fluid follow stream-lines, which are treated as being normal to the sections across the nozzle: there is no flow across the orifice from one side to the other in the direction  $ab$ ; see fig. 11'1.

2. The fluid completely fills the pipe, so that the equation of continuity holds, *i.e.*  $Su = Mv$ .

3. The motion is steady, so that the element of time does not enter the equations: the various factors, pressure, velocity, temperature, depend only upon the position of the point to which they refer, and are constant for that point.

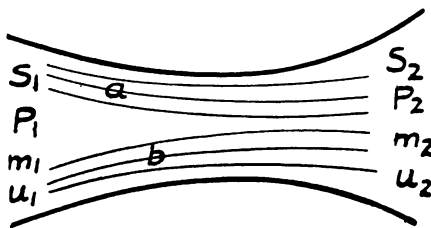

FIG. 11'1.—Theory of orifice flow.

In order to determine the flow, we use two different fundamental thermo-dynamic equations.

The first refers to the whole of the fluid flowing between the sections  $S_1$  and  $S_2$ , and is based upon the principle of conservation of energy for this fluid.

Now, considering the factors relating to unit mass of fluid, 1 lb. or 1 kg, and using the symbols:—

$S_1$  and  $S_2$  for the areas of the sections.

$P_1$  „  $P_2$  for the pressures at these sections, assumed constant over the whole section.

- $u_1$  and  $u_2$  for the velocities at  $S_1$  and  $S_2$ .
- $U_1$  ,,  $U_2$  represent the internal energy at  $S_1$  and  $S_2$ .
- $z_1$  ,,  $z_2$  are the heights of the sections above the datum level.
- $M$  mass of fluid flowing per second.
- $q$  is the heat introduced from outside between  $S_1$  and  $S_2$ .
- $Z$  is the work done in overcoming friction.
- $J=1/A$  the divisor to bring ft.-lb. to heat units = 778.

Then we have,

$$\text{the energy at } S_1 = \frac{u_1^2}{2g} + z_1 + U_1$$

$$\text{,, ,, } S_2 = \frac{u_2^2}{2g} + z_2 + U_2.$$

External work done on system at  $S_1 = P_1 v_1$ .

,, ,, by the system at  $S_2 = P_2 v_2$ .

Internal work done by the system in friction =  $Z$  ft.-lb.

Heat added to the system =  $(q + Z)J$ .

Then the energy at  $S_2$  must be the energy at  $S_1$  together with the heat added, less the work done, giving,

$$\frac{u_1^2}{2g} + z_1 + U_1 + P_1 v_1 + Jq + JZ = \frac{u_2^2}{2g} + z_2 + U_2 + P_2 v_2 + ZJ \quad (11'01)$$

The terms  $z_1$  and  $z_2$  are neglected, as the difference in level between the two sides of an orifice is negligible, so,

$$\frac{u_2^2 - u_1^2}{2g} = Jq + (U_1 + P_1 v_1) - (U_2 + P_2 v_2) \quad (11'02)$$

Differentiating this, and dropping the suffix 2, and taking the conditions at  $S_1$  as constant, we get a differential,

$$u \, du/g = J \, dq - d(Pv) - dU \quad (11'03)$$

Now we can also consider what is happening to a small element of the fluid while travelling along the orifice; it will be receiving heat, expanding and doing external work of expansion, so that for the element we have,

$$\text{Heat absorbed by element, } J \, dq + dZ = dU + P \, dv \quad (11'04)$$

This is the equation as given by Goodenough (*Thermodynamics*, p. 246).  $dZ$  is the head due to friction; see also Eq. 11'13. Combining this with Eq. 11'03, we get, using  $H = u^2/(2g)$ ,

$$dH = \frac{u \, du}{g} = P \, dv - dZ - P \, dv - v \, dP \quad (11'05)$$

which on integration gives,

$$\frac{u^2 - u_1^2}{2g} = - \int_{P_1}^P v \, dP - Z \quad (11'06)$$

$dP$  is a negative quantity for the flow from pure orifices; and the final

velocity  $u$  is smaller when there is friction than when there is no friction by the amount due to  $2gZ$ .

The expression  $U + Pv =$  internal energy + work done

$$= \text{heat content} = JI \quad \dots \quad (11\cdot07)$$

Then, if there is no heat gained from the outside,  $q=0$ , and from Eq. 11\cdot02,

$$\frac{u^2 - u_1^2}{2g} = J(I_1 - I) \quad \dots \quad (11\cdot08)$$

This equation holds whether the flow is *frictionless or not*. The theoretical velocities of flow of fluids can be determined from this equation when the heat contents of the fluid in the two states are known: for simple gases,  $I = \frac{\gamma Pv}{\gamma - 1}$ .

**B. Zeuner's equations.**

The main thermodynamic equations according to Zeuner are,

$$J dq = d(Pv) + dU + dH - dz, \text{ 1st equation} \quad \dots \quad (11\cdot09)$$

$$J dq = -dZ + dU + P dv, \text{ 2nd main equation} \quad \dots \quad (11\cdot10)$$

$$dH = u du/g = dz - dZ - v dP, \text{ as per Eq. 11\cdot03.}$$

These equations are independent of values of  $q, Z, z$ , etc.

For gases,  $U = U_0 + \frac{Pv}{\gamma - 1}, \quad dU = \frac{d(Pv)}{\gamma - 1} \quad \dots \quad (11\cdot11)$

From first equation,  $dH = J dq - d(Pv)\gamma/(\gamma - 1) \quad \dots \quad (11\cdot12)$

From second ,,  $J dq + dZ = \frac{v dP + \gamma P dv}{\gamma - 1} \quad \dots \quad (11\cdot13)$

For efflux from orifices, if  $dz$ , difference in height between inlet and outlet = 0, and  $dq = 0$ ; if *no heat is added from, or lost to, the outside*; then

$$dH = -\frac{\gamma d(Pv)}{\gamma - 1} \quad \dots \quad (11\cdot14)$$

$$dZ = \frac{1}{\gamma - 1} (v dP + \gamma P dv) \quad \dots \quad (11\cdot15)$$

$$H = \frac{\gamma}{\gamma - 1} (P_1 v_1 - P_2 v_2) = \frac{u_2^2}{2g} \text{ if } u_1 = 0 \quad \dots \quad (11\cdot16)$$

$$u_2 = \sqrt{\frac{2g\gamma(P_1 v_1 - P_2 v_2)}{\gamma - 1}} \quad \dots \quad (11\cdot17)$$

$$M = S_2 \sqrt{\frac{2g\gamma}{\gamma - 1} \frac{(P_1 v_1 - P_2 v_2)}{v_2^2}} \quad \dots \quad (11\cdot18)$$

TABLE 11'1.—AIR FLOW: FUNCTIONS OF  $n$ .

Equation.	Quantity.	Function of $n$ .	Values of the $n$ function.					
			1'00	1'1	1'2	1'3	1'4	1'408
...	...	$n$	1'00	1'1	1'2	1'3	1'4	1'408
...	...	$2/(n+1)$	1'00	'952	'910	'870	'834	'830
...	...	$n/(n-1)$	$\infty$	11'00	6'00	4'34	3'50	3'45
11'21	$P_2/P_1$	$2/(n+1)^{n/(n-1)}$	1'00	'588	'560	'544	'527	'524
11'24	M	$\left[ \frac{2g\gamma}{\gamma-1} \frac{(n-1)}{(n+1)} \right]^{\frac{1}{2}} \left[ \frac{2}{(n+1)} \right]^{1/(n-1)}$	0	2'00	2'78	3'34	3'83	...
11'25	$u$	$\left[ \frac{2g\gamma}{\gamma-1} \frac{(n-1)}{(n+1)} \right]^{\frac{1}{2}}$	0	3'25	4'50	5'35	6'08	6'13
11'28	$P_2/P_1$	$[2/(\gamma+1)]^{n/(n-1)}$	...	'1286	'3266	'4457	'5266	'5240
11'28	$v_2/v_1$	$[(\gamma+1)/2]^{1/(n-1)}$	...	6'455	2'547	1'862	1'576	...
11'29	M	$\left[ \left( \frac{2}{\gamma+1} \right)^{2/(n-1)} \left( \frac{\gamma}{\gamma+1} \right) \right]^{\frac{1}{2}}$	...	'119	'300	'411	'480	...
11'29	M	$2g$ (ditto), English units.	...	'953	2'410	3'300	3'840	...
6'08	$t_0$	$\left[ \frac{(n+1)}{n} \right]^{3/2} \frac{n}{n+2}$	'942	'936	'930	'925	'922	...
6'07	$t_0$	$\left[ \frac{(n+1)}{n} \right]^{3/2} \frac{n}{(n+2)} \frac{(\gamma-n)}{(\gamma-1)n}$	'942	'641	'396	'189	...	...
11'46 and 11'48	$c_v$	when = 1'4	...	'564	'765	'900	1'000	...
	$c_v$	when = 1'408	...	'560	'759	'893	'993	1'000

Now if  $P_1 v_1^\gamma = P_2 v_2^\gamma$ , then

$$M = S_2 \sqrt{\frac{2g\gamma}{\gamma-1} \frac{P_1}{v_1} \left\{ \left( \frac{P_2}{P_1} \right)^{2/\gamma} - \left( \frac{P_2}{P_1} \right)^{(\gamma+1)/\gamma} \right\}} \quad (11'19)$$

and if  $P_1 v_1^n = P_2 v_2^n$ , then

$$M = S_2 \sqrt{\frac{2g\gamma}{\gamma-1} \frac{P_1}{v_1} \left\{ \left( \frac{P_2}{P_1} \right)^{2/n} - \left( \frac{P_2}{P_1} \right)^{(n+1)/n} \right\}} \quad (11'20)$$

For the maximum delivery, the pressure in the throat must be such that

$$\frac{P_2}{P_1} = \left( \frac{2}{n+1} \right)^{n/(n-1)} = n' \quad (11'21)$$

$$\frac{v_2}{v_1} = \left( \frac{n+1}{2} \right)^{1/(n-1)} \quad (11'22)$$

$$\frac{T_2}{T_1} = \frac{2}{n+1} \quad (11'23)$$



and 
$$M' = S_2 \sqrt{\frac{2g\gamma}{\gamma-1} \left(\frac{2}{n+1}\right)^{2/(n-1)} \left(\frac{n-1}{n+1}\right) P_1 m_1} \quad (11\cdot24)$$

and 
$$u = \sqrt{\frac{2g\gamma}{\gamma-1} P_1 v_1 \left(\frac{n-1}{n+1}\right)} \quad (11\cdot25)$$

This becomes equal to the velocity of sound in air at  $P_2, v_2$  when  $n = \gamma$ .  
 For any value of the outside pressure  $P_2$  which is less than the *critical pressure*, at which the flow is a maximum, the flow will be the same as the maximum,  $M'$ . The critical pressure bears a certain relationship to the initial pressure  $P_1$ : we call the ratio of (critical/initial) pressure =  $P_2/P_1 = n'$ . The value of this ratio should not be put as 0.528, as is usually done, without some further discussion, for which see division H.

**C. Zeuner's theory for  $P_2/P_1$ .**

Zeuner finds an entirely different value for  $P_2/P_1$ , by making use of the hypothesis that the velocity of the air in the throat, even when the expansion is  $Pv^n = \text{constant}$ , is equal to the velocity of sound. Zeuner states this hypothesis thus: "That the air flows into vacuum with the acoustic velocity,  $u = \sqrt{(gP_2 v_2 \gamma)}$ , corresponding to the state of air in the orifice, no matter what resistances exist during the flow toward the orifice."

On this assumption, that the velocity of efflux is equal to that of sound, we have,

$$u_2 = (g\gamma P_2 v_2)^{\frac{1}{2}} = \left\{ \frac{2g\gamma}{\gamma-1} (P_1 v_1 - P_2 v_2) \right\}^{\frac{1}{2}} \quad (11\cdot26)$$

$$(\gamma-1)P_2 v_2 = 2(P_1 v_1 - P_2 v_2).$$

Therefore 
$$P_2 v_2 = \frac{2P_1 v_1}{\gamma+1}, \quad \frac{P_2}{P_1} = \left(\frac{2}{\gamma+1}\right) \frac{v_1}{v_2} \quad (11\cdot27)$$

and also, 
$$P_1 v_1^n = P_2 v_2^n;$$

therefore the ratio of the pressure  $P_2$  in the throat to  $P_1$  is,

$$\frac{P_2}{P_1} = \left(\frac{2}{\gamma+1}\right)^{n/(n-1)}, \quad \frac{v_2}{v_1} = \left(\frac{\gamma+1}{2}\right)^{1/(n-1)} \quad (11\cdot28)$$

$$\text{Velocity} = \left[ \frac{2g\gamma P_1 v_1}{\gamma+1} \right]^{\frac{1}{2}} \quad (11\cdot29)$$

$$M'' = S_2 \left[ \frac{2}{\gamma+1} \right]^{1/(n-1)} \left[ \frac{2g\gamma P_1 m_1}{\gamma+1} \right]^{\frac{1}{2}} \\ = S_2 f(n, \gamma) (P_1, m_1)^{\frac{1}{2}}.$$

Consider Eq. 11.20, giving the quantity delivered.

$$M = S_2 \sqrt{\frac{2g\gamma}{\gamma-1} \frac{P_1}{v_1} \left\{ \left(\frac{P_2}{P_1}\right)^{2/n} - \left(\frac{P_2}{P_1}\right)^{(n-1)/n} \right\}}.$$

The variables in this equation are  $P_2$  and  $n$ ;  $n$  may vary with the values of  $P_1$  and  $P_2$ , but for the purpose of determining the maximum

quantity which can be delivered we shall assume that the value of  $n$  is independent of the value of  $P_2$ , the pressure in the throat, and we also assume that the expansion will follow the same law no matter what  $P_1$  is. The maximum quantity flows out, then, if there is a fixed relation between  $P_2$  and  $P_1$ , which is given by

$$\frac{P_2}{P_1} = \left\{ \frac{2}{n+1} \right\}^{n/(n-1)}$$

The *maximum quantity* which can be delivered and the *quantity* delivered on *Zeuner's theory* are :

Maximum quantity, 
$$M' = \left[ \frac{2g\gamma}{\gamma-1} \frac{(n-1)}{(n+1)} \left( \frac{2}{n+1} \right)^{2/(n-1)} P_1 m_1 \right]^{\frac{1}{2}} \quad (11.30)$$

Quantity when  $u_2 = u_3$ , 
$$M'' = \left[ \frac{2g\gamma}{\gamma-1} \frac{(\gamma-1)}{(\gamma+1)} \left( \frac{2}{\gamma+1} \right)^{2/(n-1)} P_1 m_1 \right]^{\frac{1}{2}} \quad (11.30a)$$

Ratio, 
$$\frac{M''}{M'} = \left[ \frac{(\gamma-1)}{(n-1)} \left( \frac{n+1}{\gamma+1} \right)^{(n+1)/(n-1)} \right]^{\frac{1}{2}} \quad (11.31)$$

If  $P_3$ , the pressure in the space outside the orifice, is less than  $P_2$ , the pressure in the throat, the quantity delivered will depend only upon the pressure in the vessel,  $P_1$ , and the equation for quantity is of the form,

$$M = cS_1 f(P_1) f(n) \quad \text{if Eq. 11.21 is true} \quad (11.32)$$

$$= cS_1 f(P_1) f(n, \gamma) \quad \text{if Eq. 11.28 is true.}$$

$f(P_1) = \sqrt{(P_1 m_1)}$ , which is a function containing  $P_1$  only for those fluids where the density depends upon the pressure. Whichever hypothesis is true, it is seen that the *velocity* of efflux is constant so long as  $T_1$  and  $n$  are fixed—that is, it is independent of the *pressure* existing in the vessel; but the **quantity** delivered depends upon this **pressure**, owing to the increase of density of the fluid. For steam flow the value of  $n$ , the index for the polytropic expansion, depends upon the pressure and the quality of the steam, and therefore both the quantity and the velocity vary with  $P_1$  as well as with  $T_1$ . For air, if we assume that  $n$  is independent of  $P_1$ , the pressure in the reservoir can be increased indefinitely without affecting the velocity. In practice, however, the tendency would be for the actual velocity to be reduced through friction to a greater extent when the pressure was high than when it was low, as friction increases with increased density.

The velocity of sound in air at 60° F.  $= (gCT\gamma)^{\frac{1}{2}} = 1120$  ft/sec, and the throat velocity, Eq. 11.29, is  $[2gCT_1\gamma/(\gamma+1)]^{\frac{1}{2}}$ ,

which becomes	1000	1020	1040	1150 ft/sec
for temperatures, T,	40°	60°	80°	200° F. degrees.

#### D. Formulæ for steam and air flow.

In order to find the quantity delivered for any fluid, we want to have the density,  $m_1$ , given in terms of  $P_1$ , and then the expression for the mass delivered can be written in terms of  $P_1$  and  $n$ .

For dry air we have,  $m = P/(CT)$ ,  $C = 53.34$  Eng., 29.27 metric.

For moist air,  $m = P/(CT)$ ,  $C = 53.18$  Eng., 28.43 metric.

For saturated steam,  $m = 0.587 p^{.94}$  (Zœuner) . . . . . (11.33)

For saturated steam  
(Stodola),  $m = \frac{p^{.94}}{438}$  (Eng.) =  $\frac{p^{.94}}{1.604}$  (metric)

For superheated steam,  $\frac{1}{m} = \frac{46.1 T}{p} - 0.0084$  (metric) . . . . . (11.34)

$\frac{1}{m} = \frac{0.591 T}{p} - 0.1345$  (Eng.) . . . . . (11.34a)

The quantity of air delivered becomes,

$$M = f(n) \sqrt{P_1 m} = 0.53 p_1 / (T_1)^{\frac{1}{2}}, \text{ when } n = 1.4 \quad . \quad . \quad (11.34b)$$

The quantity of saturated steam delivered is given by Grashof, as quoted by Goodenough (*Thermodynamics*, p. 256), as,

$$M = 0.01911 P^{.97} = 2.38 p^{.97} \text{ (Eng. units)} \quad . \quad . \quad (11.34c)$$

Rateau's formula, as quoted by Goodenough, is,

$$M = 2.357 p_1 - 0.1387 \log p_1 \text{ (Eng.)} \quad . \quad . \quad (11.34d)$$

Napier's formula, as quoted by Goodenough, p. 256, is,

$$M = \frac{p_1}{70} \quad \text{if } p_2 < 0.60 p_1 \quad . \quad . \quad . \quad (11.34e)$$

$$= \frac{p_2}{42} \left[ \frac{3(p_1 - p_2)}{2p_2} \right]^{\frac{1}{2}} \quad \text{if } p_2 > 0.60 p_1 \quad . \quad . \quad . \quad (11.34f)$$

$$= 0.0292 p_1 [(1 - \phi)\phi]^{\frac{1}{2}} \text{ if } p_2 > 0.60 p_1, \text{ where } \phi = p_2/p_1.$$

Rateau (*Flow of Steam*, p. 15) gives his own and Grashof's formulæ :

$$\text{Rateau, } M = (15.20 \sim 15.32) p_1 - 0.96 \log_e p_1 \text{ (metric)} \quad . \quad (11.34g)$$

$$= (15.20 \sim 15.32) p_1^{.9725} \quad . \quad . \quad . \quad , ,$$

$p$  varied from 1 to 12 kg/cm<sup>2</sup>.

$$\text{Grashof, } M = 15.26 p_1^{.9725} \quad . \quad . \quad . \quad (11.34h)$$

$$\text{Hütte, p. 262, gives, } M = 15.3 c_v p_1^{.97} \quad . \quad . \quad . \quad (11.34i)$$

Geipel (*Elec. Engr. Form.*, p. 515) gives,

$$M = 0.63 p_1 (.01428), \text{ for a pure orifice, if } p_2 = \text{or } < 0.6 p_1 \quad . \quad (11.34j)$$

$$= 0.93 p_1 (.01428), \text{ for an orifice and pipe, if } p_2 = \text{or } < 0.6 p_1 \quad . \quad (11.34k)$$

$$= 0.63 p_1 (.0292) [(1 - \phi)\phi]^{\frac{1}{2}}, \text{ pure orifice, } p_2 > 0.60 p_1 \quad . \quad (11.34l)$$

$$= 0.93 p_1 (.0292) [(1 - \phi)\phi]^{\frac{1}{2}}, \text{ for an orifice and pipe, } p_2 > 0.60 p_1.$$

These are Napier's formulæ as mentioned above, with delivery coefficients added.

Thorkelson (*Comp. Air*, p. 166) gives for the two cases,

$$M = 0.535 p_1 / (T_1)^{\frac{1}{2}} \quad \text{if } p_2 < 0.50 p_1 \quad . \quad . \quad . \quad (11.34m)$$

$$= 1.060 p_1 [(1 - \phi)\phi / T_1]^{\frac{1}{2}} \text{ if } p_2 > 0.50 p_1 \quad . \quad . \quad . \quad (11.34n)$$

Kempe (*Engr. Year Book*, p. 772) quotes Leblanc as giving for the quantity of air flowing from atmosphere into a vacuum,

$$M = 1090/(T)^{\frac{1}{2}} = \frac{20330(144)}{3600 T^{\frac{1}{2}}} \quad (11'34p)$$

In this the value of  $f(n) = 376$ , and therefore  $n = 1.30$ .

The second expression is given by Scanes (*Mech. Engr.*, 31/322/1913).

Carpenter (*Heating and Vent.*, p. 133) gives the velocity of air flowing from an orifice into the atmosphere as,

$$u^2 = 2g \cdot 183 \cdot 6 T_1 (1 - \phi^{2.29}) \quad (11'35)$$

which is the equivalent of Eq. 11'36 with the constants inserted.

**E. Flow when external pressure is above critical pressure.**

The equations which must be used when the pressure outside the reservoir is above the critical pressure are:

$$\text{Velocity, } u = \left[ \frac{2gP_1 v_1 \gamma}{\gamma - 1} (1 - \phi^{1-1/n}) \right]^{\frac{1}{2}} \quad (11'36)$$

$$\text{Quantity, } M = \left[ \frac{2gP_1 m_1 \gamma}{\gamma - 1} (\phi^{2/n} - \phi^{1+1/n}) \right]^{\frac{1}{2}} \quad (11'36a)$$

$\phi = P_2/P_1$  varies from about 0.60 up to 0.99. This is the equation which is quoted by Durley (*Trans. Amer. Soc. Mech. Engr.*, 27/176/1906), but which he found could be replaced by the simpler orifice equation for the low values of  $\phi$  which he used in his tests.

We have other equations: from Eq. 11'17,

$$H = \frac{u^2}{2g} = \frac{\gamma P_1 v_1}{\gamma - 1} \left\{ 1 - \left( \frac{P_2}{P_1} \right)^{(n-1)/n} \right\} \quad (11'36b)$$

but as  $P_1 - P_2$  is small,

$$\begin{aligned} H &= \frac{\gamma}{(\gamma - 1)} P_1 v_1 \frac{(n-1)(P_1 - P_2)}{n P_1} \quad (11'36c) \\ &= \frac{v_1(P_1 - P_2)}{1 + \xi}, \text{ from Eq. 11'48.} \end{aligned}$$

Therefore

$$u^2 = \frac{2g v_1 (P_1 - P_2)}{(1 + \xi)} \quad (11'36d)$$

$$M^2 = \frac{2g v_1 (P_1 - P_2)}{(1 + \xi) v_2^2} (c_2 S_2)^2 \quad (11'37)$$

but as  $P_1 - P_2$  is small we take  $v_1 = v_2$ ,  $T_1 = T_2$ ,  $P_2 v_2 = CT_1$ , and then

$$M^2 = \frac{2g P_2 (P_1 - P_2)}{(1 + \xi) CT_1} (c_2 S_2)^2 \quad (11'37a)$$

and as  $P_2$  is the same as  $P_1$  approximately, this can also be put as,

$$M^2 = \frac{2g P_1 (P_1 - P_2)}{(1 + \xi) CT_1} (c_2 S_2)^2 \quad (11'37b)$$

The pressure and temperature can be read at either side of the orifice in this case, and the difference read upon a water or oil gauge of some sort.

### F. Orifice profiles.

In order to get the maximum quantity of fluid out of the reservoir in practice when  $P_3 < 0.60 P_1$ , it is desirable to terminate the orifice with an expanding nozzle, so that the velocity and pressure of the fluid can be gradually altered from  $u_2$ ,  $P_2$  to  $u_3$  and  $P_3$ . If this is not done, the jet expands suddenly with a large friction loss while the pressure falls from  $P_2$  to  $P_3$ . The whole orifice should be designed so that the pressure can fall gradually to the final pressure, and the shape of orifice necessary can be determined from the thermodynamic equations,

$$u^2/(2g) = J(I_1 - I), \quad S = Mv/u \quad . \quad . \quad . \quad (11'38)$$

Goodenough (*Thermodynamics*, p. 262) states that friction can be allowed for by assuming that there is a proportion of the total energy lost, say from 8 per cent. to 20 per cent. =  $\lambda$ , and then

$$\frac{u^2}{2g} = J(1 - \lambda)(I_1 - I_2) = \frac{J(1 - \lambda)\gamma}{\gamma - 1} (P_1 v_1 - P_2 v_2) \text{ for air} \quad . \quad (11'38a)$$

For a full discussion on the shapes of orifices, see books on turbines.

### G. Coefficients of velocity and delivery.

So far no mention has been made of the value of the area  $S_2$ , minimum area of the jet, in discussing the flow from a pure orifice. The area is much less than that of the orifice,  $S_1$ , and the combined coefficient of velocity and contraction will give a delivery of the fluid of about 0.60 to 0.95 of the theoretical amount which would be delivered if the theoretical velocity existed all over the orifice.

Probably it is best to find the coefficient of delivery by comparison of the actual amount delivered with the theoretical amount which would be delivered if the flow were frictionless and adiabatic. This coefficient will vary greatly with the different forms of orifice, being about 0.97 with orifices with rounded edges on the inside. The values of this coefficient as given by various authors are given in Table 11'2. One must be careful to note that  $c$  here represents the ratio of actual flow to that due to a particular kind of theoretical flow.

Considering the flow from a rounded orifice, area  $S_1$ , with a diverging nozzle, there are three quantities of delivery which may be considered :—

- $M_1$ , the quantity calculated for frictionless adiabatic flow.
- $M_2$ , the quantity calculated when friction is allowed for.
- $M_3$ , the actual quantity delivered.

It is conceivable that the form of the orifice might be incorrect, so that the fluid did not completely fill the smallest section and did not follow the lines of the diverging cone. In designing the nozzle, the friction  $Z$  should be allowed for, and if the actual friction is  $Z$ , the flow will fill the nozzle

exactly, but if the friction varies from  $Z$ , then it may be possible that the fluid does not fill the nozzle completely.

In the case of a pure orifice, we may calculate the delivery as  $c'S_1u'm'$ , where  $u'$  and  $m'$  are calculated after allowing for friction  $Z$ , and  $c'$  is the assumed coefficient, giving the ratio of the throat area  $S_2$  to the orifice area  $S_1$ .  $c'$  the coefficient should be independent of the friction.

Or we may calculate the delivery as  $c''S_1u_2m_2$ , where  $u_2$  and  $m_2$  are the theoretical quantities for adiabatic frictionless flow, and  $c''$  includes  $c_v$ , which allows for the loss of velocity due to friction.

Zeuner's derivation of the coefficient of velocity  $c_v$  will be found in Eq. 11'46.

TABLE 11'2.—COEFFICIENTS OF DELIVERY,  $c$ .

Authority.	Pure orifice.	With pipe.	Diverging cones.	With rounded outlet.	
Box, p. 115 (Daubisson)	.65	.93	...	...	...
Hiscox, p. 97 (Poncelet)	.65	.834	...	...	.01 atmosphere.
Box, p. 115	.423	.487	...	...	100 "
Church, p. 784 (Weisbach)	.55	...	...	...	.05 "
	.78	...	...	...	2.0 "
Unwin (for water)	.64	.81	.97	...	...
	...	.83	...	...	...
Carpenter, p. 133	.788	.81	.90	.93	Up to 1 atmosphere.
	.563	.84	.97	.92	...
Stewart, p. 955	.64	...	...	...	...
	.76	...	...	...	...
Geipel, p. 515	.63	...	...	.93	...
	.64	.815	...	.97	...
Hütte, p. 361	...	.813	...	...	$P_2 = .925 P_1$
	...	.831	...	...	$= .710 P_1$
Müller, p. 285	.597	...	...	...	$= .589 P_1$
	...	...	...	...	...
Values for general use	.60	.81	.97	.93	Small pressures.
	.64	.83	.97	.93	Large pressures.

Hütte, p. 361, gives the following table of  $c$ ,  $c_v$ ,  $n$ , etc. :—

	$c$ .	$c_v$ .	$c_v$ .	$\xi$ .	$n$ .	$p_2/p_1$ .
For circular orifice	.64	.65	.981	.04	1.388	...
With cylindrical pipe, 14 mm diam.	.815	1.0	.821	.490	1.243	.925
	.813	1.0	.838	.444	1.252	.710
	.831	1.0	.866	.362	1.271	.589
Rounded orifice, 10 mm diam.	.97	1.0	.974	.034	1.392	...

**H. Experimental values of  $c$ .**

Reynolds (*Jour. Amer. Soc. M.E.*, 38/953/1916) describes tests upon the flow of air through orifices, quantities being measured by a Venturi meter and by a Pitot tube and by gas-holders as the standard.

The orifices were from  $\frac{1}{8}$  in. to  $\frac{1}{2}$  in. in diameter, bored in  $\frac{1}{16}$ -in. plate, and were placed in a 2-in. pipe line: the size of orifice seemed to have no effect upon the coefficient of delivery, but then the area of the largest orifice was only  $\frac{1}{16}$ th of the area of the pipe, so that such a result might be anticipated. The pressure at the back of the orifice varied from 10 to 100 lb/in<sup>2</sup>, and was atmospheric at the front. Weymouth's formulæ were used for evaluating the quantities as measured by the Pitot tube—of the Taylor form—and Venturi meter: Reynolds found that the constants were reliable or otherwise, as follows:—

	Unreliable.	Reliable.
Pitot tube in 2-in. pipe . . . .	when $u < 30$	when $u > 60$
„ „ in $1\frac{1}{2}$ -in. pipe . . . .	„ $u < 41$	„ $u > 45$
Venturi in 2-in. pipe . . . .	„ $u < 19$	„ $u > 20$

The Venturi constant was 0.95;  $u$  is ft/sec.

For determining the theoretical flow from orifices he used Hirschfeld's formula, taken from *Heat Power Engineering*, viz.,

$$Q = \frac{254 P_1 S_2}{T_1^{1.5}} \left[ \left( \frac{P_2}{P_1} \right)^{1.42} - \left( \frac{P_2}{P_1} \right)^{1.71} \right]^{.5} \quad (11.39)$$

which can be compared with the formula in Eq. 11.36a.

$$M = S_2 \left[ \frac{2g(1.408)}{0.408} \right]^{.5} \left[ \left( \frac{P_1^2}{CT_1} \right) \left( \phi^{1.408} - \phi^{1.71} \right) \right]^{.5}$$

$$Q = 26.8 \frac{P_1 S_2}{T_1^{1.5}} (\phi^{1.42} - \phi^{1.71})^{.5} \text{ at } P_0, T_0.$$

Unless other than English units are being used, the constants do not agree. Values of the  $\phi$  function are given in fig. 11.2, so that the theoretical discharge can be found by multiplying the constant by  $P_1 S_2$ , or (lb/in<sup>2</sup>)(area in sq. in.). To find the actual discharge, the amount found thus has to be multiplied by the coefficient of discharge, which Reynolds' results give as  $c = 0.94 - 0.40\phi$ .

This has been calculated from fig. 7 in the original paper, where the coefficient of discharge,  $c$ , is given as a straight line.  $c$  becomes 0.6 when  $\phi = 0.85$ ,  $p_1$  being 17.3 lb/in<sup>2</sup> abs.

Reynolds proceeds to find an equation for the discharge in terms of  $P_1$  and  $P_2$  without the use of any coefficient, thus incorporating  $c$  in the  $P_1, P_2$  function; and states the actual discharge is,

$$60 Q = 405(144 S_2)(p_1^2 - p_2^2)^{.48} / (T_1)^{.5} \quad (11.39a)$$

$$Q = 6.75(144) S_2 \frac{[(p_1/T_1)(p_1 - p_2)(1 + \phi)]^{.50}}{(p_1^2 - p_2^2)^{.02}}$$

The value of  $c$  in Eq. 8.14a is then  $(0.47)(1 + \phi)^{.5} / (p_1^2 - p_2^2)^{.02} \quad (11.39b)$

Upton (*Jour. Amer. Soc. M.E.*, 39/221/1917) discusses Reynolds' paper, and shows how the ordinary formula for orifice flow produces a similar curve to that given by Reynolds' formula: in Reynolds' tests the ratio of orifice area to pipe area is  $(3/32)^2$ : assuming that there is a coefficient of contraction of 0.7 the ratio  $c(S_2/S_1)^2$  becomes = 0.00043, which is negligible: in that case Upton shows that the ordinary Venturi formula gives,  $(P_1 - P_2)^{1/2}(-0.072 P_1 + 1.072 P_2)^{1/2}$ , which is to be compared with Reynolds'

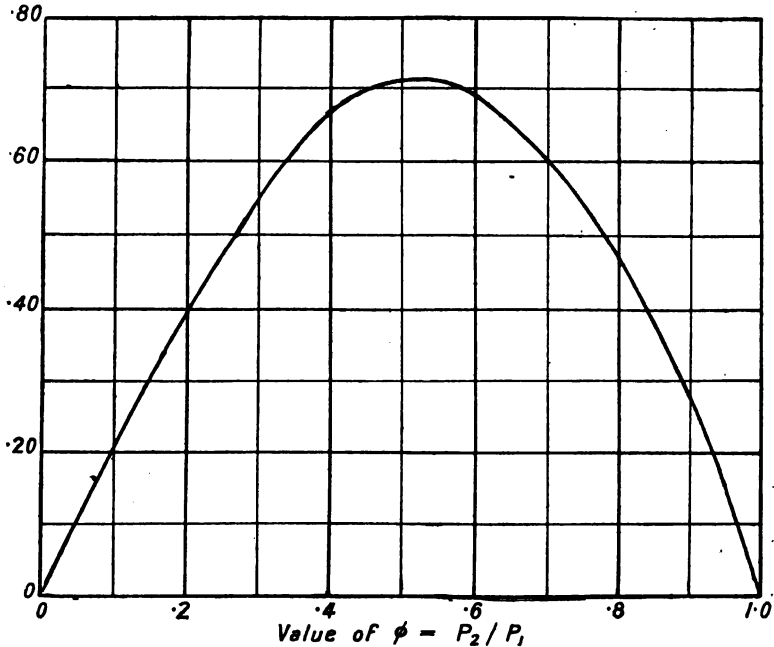

FIG. 11.2.—Value of the function  $\phi^{1.41} - \phi^{1.71}$  for use in orifice flow.

$0.655(P_1^2 - P_2^2)^{.48}$ : these agree numerically up to the point where  $(P_1^2 - P_2^2)^{.48} = 0.40$ .

Reynolds and Ling (*Jour. Amer. Soc. M.E.*, 39/250/1917) state that the most probable values of the coefficient of discharge for various orifices are:—

- For a thin plate orifice, pressures 1 to 12 in. water,  $c = .60$
- „ 15 to 50 lb/in<sup>2</sup>, 1 to 3.8 kg/cm . . . = .63
- „ 50 to 150 lb/in<sup>2</sup>, 3.8 to 11.4 kg/cm . . . = .65
- „ short cylindrical pipe . . . . . = .75
- „ rounded convergent nozzle . . . . . = .98
- „ straight convergent nozzle, 6° to 10° . . . = .90

L. Hartshorn (*Proc. Roy. Soc.*, 94A/155/1918) gives the results of tests on the discharge of air under atmospheric pressure from orifices 0.8 to 2.4 mm in diameter into a receiver wherein the pressure varied from 30 mm to 64 mm mercury. St Venant and Wantzel had stated that the discharge increases as  $p_2/p_1$  decreases until  $p_2/p_1 = 0.3$  to 0.4:



In 1885 Osborne Reynolds gave the critical value of  $p_2/p_1=0.50$  to  $0.53$ .

In Hartshorn's report the actual quantities of air delivered are not stated: the figures and graphs are given only for the discharge compared with the maximum discharge. They show that the value of the critical pressure in the receiving vessel is about:—

- $P_2=0.2 P_1$ : for pure and convergent orifices and straight cylindrical pipes.  
 $=0.4 P_1$ : for orifices ending in divergent cones of  $16.6^\circ$  and  $2.5^\circ$  respectively.  
 $=0.5 P_1$ : for orifice with divergent cone of  $7.8^\circ$ .  
 $=0.8 P_1$ : „ „ „ „ „ „  $4.4^\circ$  and  $2.5^\circ$ .

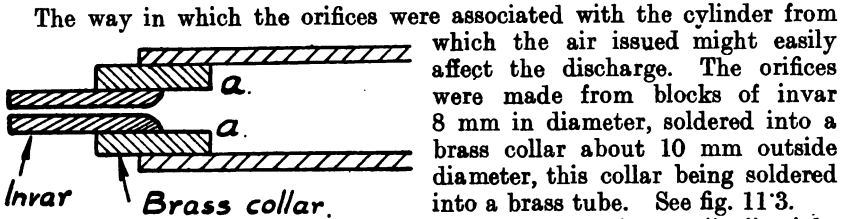

FIG. 11'3.—Hartshorn's orifice.

which the air issued might easily affect the discharge. The orifices were made from blocks of invar 8 mm in diameter, soldered into a brass collar about 10 mm outside diameter, this collar being soldered into a brass tube. See fig. 11'3.

The contraction at "a" might have an effect on the discharge.

Hodgson (*Proc. Inst. C.E.*, 204/129/1917) discusses the relation between water and gaseous flow in orifices: his conclusions are:—

1. There is ordinarily no fixed relation between the coefficient of delivery for gas and for water.
2. If, for water,  $M=\text{constant} (P_1 - P_2)^{\frac{1}{2}}$ , then when  $\phi=0.98$  to  $1.0$ ,  $c$  is the same for air and water.
3. For air, with shaped nozzles,  $c$  varies down to  $0.85$ , but approaches  $1.0$  when  $\phi=0.527$ .
4. For air, when  $\phi=\text{or} < 0.527$ ,  $c=0.97$  to  $1.0$ .

As regards the effect of the size of the orifice in a pipe line, he says:—

5. For water,  $c=0.608$ , when  $S_2/S_1=0$  up to  $0.49$ .
6. For water,  $c$  decreases when  $S_2/S_1=0.49$  to  $1.0$ .

It seems that the word "decrease" should be "increase," as the discharge coefficient must be  $1.0$  when the orifice is the full size of the pipe and ceases to be an orifice proper: unless  $P_1$  becomes so much greater than the pressure in the pipe that  $c$  must be reduced.

Hodgson measured his pressures,  $P_1$  and  $P_2$ , in the plane of the orifice. The value of  $P_1$  increases considerably just before the orifice if  $S_2$  nearly equals  $S_1$ ; and  $P_2$  decreases suddenly after the orifice and then increases. This method of reading  $P_1 - P_2$  does not give the loss of pressure at the orifice as a whole, as  $\frac{1}{2}(P_1 - P_2)$  is soon recovered after the orifice:  $P_2$  is therefore rather the throat pressure than the pressure after the orifice,  $P_3$ , which exceeds  $P_2$  in the case of a pipe line.

One can think of a piece of pipe, say 5 ft. long: assume the fall of pressure is  $P_1 - P_3$  when no orifice exists, and  $=P_1 - P_2'$  with an orifice, and that

$P_2$  is the throat pressure with the orifice in place: the discharge can be considered relative to either  $P_1 - P_3'$ , or to  $P_1 - P_2$  if  $P_2$  is measurable, or to  $P_1'' - P_2''$  where  $P_1''$  and  $P_2''$  are measured in the plane of the orifice: according to Hodgson,  $P_1'' > P_1$ , and  $P_2'' < P_2$ .

Hodgson's tests with the flow of air through square-edged orifices, with  $d_1 = 6$  in., and  $d_2 = 0.67, 1.0, 1.57$  in., gave  $c = 0.914 - 0.306\phi$ : this equation also held for steam flow in a 6-in. main at 50-70 lb/in<sup>2</sup>, at 50° F. superheat. With this formula one might compare Reynolds', viz.  $c = 0.94 - 0.40\phi$ . It is suggested that square-edged orifices get corroded, and that then the value of  $c$  varies. The amount of the variation must, I think, be only a small proportion of the total. One would imagine that the effect of dirt and corrosion upon the edges of an orifice plate whose thickness is a fiftieth of the diameter of the orifice would not be serious, and that it would not matter seriously whether the orifice had a slight bevel or not in such a case. Hodgson, however, goes to such a fine degree of accuracy that any slight alteration in the coefficient would be noticeable, though commercially it might be negligible. One notices Hodgson's equation used on p. 153 for  $W$ , viz.  $= 2.6998 p_1 / T_1$ : for all practical purposes this might just as well be put as  $2.70 p_1 / T_1$  as neither  $p_1$  nor  $T_1$  will ordinarily be read to 1 part in 10,000.

On p. 155 a summary of the values of  $c$  is given, thus:—

When $\varphi = 1.0$ to 0.98.	When $\varphi < 0.98$ .	
Nozzle 1. $c = 0.75 - 0.95$ . $c$ varies with $M$ . $c$ varies with nozzle.	$c = 0.97 - 1.0$ when $\phi < n'$ .	
Nozzle 2. $c = 0.94$ , small nozzles. $c = 0.99$ , large nozzles, and is constant for any one nozzle.		
Nozzle 3. $c = 0.82$ with $d_2 = 0.25$ in. and $d_1 =$ or $> 1.0$ in. $c = 0.62$ with $d_2 = 7.0$ in. and $d_1 \leq 9.0$ in.		$c = 0.97 - 1.0$ when $\phi < n'$ .
Nozzle 4. $c = 0.608$ for $d_2/d_1 < 0.7$ for all values of $d_2$ .		$c = 0.92 - 0.30\phi$ .
	$c = 0.914 - 0.306\phi$ .	

On p. 185 it is stated that the discharge from squared-edged orifice may be put, when  $\phi > 0.88$  and  $S_1/S_2 > 6$ ,

$$M = 0.665(144) S_1 \left[ \frac{(p_1 - p_2) p_1}{(S_1^2/S_2^2 - 1) T_1} \right]^{\frac{1}{2}} = \frac{96 S_2}{[1 - (S_2/S_1)]^{\frac{1}{2}}} \left[ \frac{(p_1 - p_2) p_1}{T_1} \right]^{\frac{1}{2}} \quad (11.40)$$

Estep (*Iron Age*, 98/1049/1916) gives a chart for calculating lb. of air delivered by well-rounded orifices: he does not mention what particular shape or size of orifice is to be used. He puts  $c = 0.98$ , which is perhaps reasonable; but the reader may use any coefficient he likes. Estep's curve shows

$$2g(53.18) \frac{\gamma}{\gamma - 1} \left( 1 - \phi^{\frac{\gamma}{\gamma - 1}} \right) = K$$

for various values of  $\phi$ . Another curve shows  $1000 v_2/v_1 = r$  (it would be

as simple to show  $v_2/v_1$  and leave out the 1000), so that the discharge is readily found from

$$M = \frac{cS(KT)^{\frac{1}{2}}}{rv_1} \quad \dots \quad (11'40a)$$

K and  $r$  being read from the curves. The K curve might equally well have shown  $K^{\frac{1}{2}}$ , thus simplifying the calculation.

Rateau, when comparing and discussing the results of tests on the flow of steam from convergent nozzles when the back pressure is relatively large, that is, when  $P_3$  is greater than  $n'P_1$ , took the values of the ratio,

$$\frac{\text{theoretical delivery for } P_3 \text{ and } P_1}{\text{theoretical max. delivery for } P_3 \cdot (58 P) \text{ and } P_1} = \frac{M}{M'}$$

where  $M'$  is the maximum delivery.

The quantities can be determined theoretically from the temperature entropy curve. He also plotted the curve giving the ratio of the actual delivery,  $M$ , to the theoretical maximum delivery, and then found the coefficient of delivery to vary from 0.94 up to 1.00. Values of  $M/M'$  plotted against values of  $P_3/P_1$  show elliptical curves similar to Hartshorn's,  $M/M'$  increasing as  $P_3/P_1$  falls from 1.00 to about 0.5.

With a thin plate orifice the results were different. The coefficient of delivery varied from 0.61 up to 0.87. He then found the values of the ratio,  $\frac{\text{delivery from orifice plate}}{\text{delivery from convergent nozzles}}$ , and found that the coefficient  $c$  followed a straight-line law,  $c = 1 - 0.356(P_3/P_1)$ , giving  $c = 0.64$  when  $P_3 = P_1$ ,  $c = 0.80$  when  $P_3 = 0.55 P_1$ .

Hirn (Rateau's *Flow of Steam*, p. 46) is stated to have found  $c = 0.633$  for air flowing from orifices under small pressure differences.

Morley (*Engineering*, 101/91/1916) discusses the flow of air from nozzles when  $P_1$  is 25 to 70 lb/in<sup>2</sup>, the tests being made to determine the most efficient type of nozzle for use in gas-turbine work. Six nozzles were used, and five of them were reduced in length from time to time during the tests, so that altogether eighteen different nozzles were tested. The quantities were measured by means of a 6 ft. by 3 ft. container and pressure gauges. The velocities were measured (a) by noting the force of impact of the jet upon a flat disc placed at right angles to it; (b) by noting the force of reaction of the jet when it delivered air direct into the atmosphere, the nozzle being connected by a flexible tube to the container, and resting on one end of a balance; by placing weights on the other end of the balance the force of reaction when air was flowing could readily be measured. Morley found that measurement by reaction was better than measurement by impact: the latter method gave readings 12 per cent. higher than the former, the reason being that the issuing jet sucked the surrounding air into itself and gave it a forward motion, so that the quantity of air impinging on the disc was in excess of the air being discharged through the nozzle. The force of impact was a maximum when the disc was placed at about 8 inches from the end of the nozzle.

The coefficient of discharge was found to vary from 0.95 to 0.98; the throat areas of the nozzles varied from 0.0294 to 0.0302 sq. in. The best delivery was given by nozzles with a rounded entrance—though the type of

rounding appears to make no difference—and with no diverging cone, or at least with only a very small cone of very small divergence. Long diverging cones, or cones with divergence of more than 1 in 64, gave a reduced discharge and a lower velocity. The coefficient of velocity was found to be unity with the first type nozzle, this also giving the maximum velocity. Morley also tested the flow through an orifice plate 0.196 in. in diameter at pressures 25 to 50 lb/in<sup>2</sup>; the velocity of discharge was practically the same as for the best short nozzles.

Anthes (*Power*, 44/58/1916) has given the coefficients for the discharge of oil from orifices 0.0232 in. to 0.0807 in. (approx. 0.60 to 2 mm) in diameter at pressures varying from 10 to 350 lb/in<sup>2</sup>. The coefficient of discharge decreased from 0.70 to 0.63 at 10 lb/in<sup>2</sup> pressure as the orifice increased in size: the coefficient decreased also—for any particular orifice—as the pressure was increased, the range of variation being about 0.73 to 0.66.

Davidson (*Proc. Roy. Soc.*, 89A/91/1913) describes tests made on the flow of oil through drowned orifices 40, 20, 5 mm in diameter, at pressures up to 1000 mm of the oil. The temperature varied from 11° C. to 110° C., and  $\nu$  the kinematical viscosity varied from 200 to 0.14; the coefficient of discharge varied with both  $\nu$  and the head, but the maximum value obtained was 0.70. It is pointed out that the laws of capillary flow based on the assumption that the stress varies with the rate of distortion would not hold, as that assumption proved wrong for the oil.

Bradley (*Phys. Rev.*, 29/258/1909) discusses the flow of air from orifices at very low temperatures and high pressures, the initial temperatures being 20° to -120° C., and the pressures from 68 to 204 atmospheres.

With regard to the use of orifices for measuring the quantity of air delivered by pumps or compressors, if the pressure is quite low, then a pure orifice should be used, and the coefficient  $c$  taken as 0.60; if the pressure of delivery is high, one should use a rounded outlet and choose  $c$  as being approximately 0.93; in both cases the orifice should preferably be in the wall of a container or box, and not directly at the end of a pipe of small diameter.

Fig. 8.6 and Table 11.2 show generally how  $c$  varies as the conditions vary, but much more information seems to be necessary before definite values of  $c$  can be known for all cases.

### I. Pressure $P_2$ in the throat.

The question arises as to whether the delivery from orifices does actually follow the law,

$$M = f(P_1), f(n),$$

when the pressure outside the orifice is below the critical pressure,  $n'P_1$ . Experiments confirm the law generally, but the value of  $n'$  varies.

Rateau (*Flow of Steam*, p. 46) says that for steam  $n' = 0.58$ , while for air  $n' = 0.52$ .

Fisher (*Proc. Inst. Mech. Engr.*, —/927/1914) tested the steam flow from  $\frac{1}{4}$ -in. nozzles of various types, and found the value of  $n' = 0.38$  and also 0.465 for a pure orifice: this, of course, is much smaller than the value to expect if  $n = 1.4$ .

Stewart (*Proc. Inst. Mech. Engr.*, —/949/1914), in dealing with the flow of air from nozzles, suggests that the cause of the low values may be due to the value of  $\gamma$  for air being 1.66 instead of 1.4, as ordinarily taken, assuming that the molecules of air have five degrees of freedom. He found  $n'=0.35$ , and found that this ratio was lower for a pure orifice than for one with a rounded edge. He mentions that Grindley (*Proc. Roy. Soc.*, 66/79/1900) found for steam  $n'=0.33$ .

Another cause to account for the low values, i.e. those which are less than about 0.52, is obtained if we assume that the kinetic energy of gases is due to two kinds of motion, one being the motion of individual molecules around its own centre of inertia, and the other due to the motion of translation of the whole of the molecule. Stewart suggests that, in the case of the flow from orifices, only the energy of the translation velocity is altered, and that the motion of rotation remains the same during the first portion of the flow. Later on this energy can be gradually altered to translational energy. With such a theory the value of the adiabatic flow index becomes 1.66, so that  $P_2/P_1$  is reduced from 0.527 to 0.484, and, since  $P_1 - P_2$  is now increased beyond what it is if  $P_2/P_1=0.52$ , the total flow is increased. For the further discussion about the theory of  $\gamma=1.40$  or 1.66, see Poynting and Thomson (*Heat*, p. 130) and Meyer (*Kinetic Theory*, p. 140 ff.).

The discussions on friction also have a bearing on the ratio of  $P_2/P_1$ .

### J. Effect of friction.

Here we shall discuss the theoretical investigations concerning the effect of friction upon the flow.

Stewart (*Proc. Inst. Mech. Engr.*, —/949/1914) gives the following theory. The energy lost in friction is assumed to be a constant proportion of the difference of pressure at the two sides of the orifice, and he therefore takes the energy lost in eddies as

$$aP_1(1-\phi) \quad \dots \quad (11'41)$$

Then, from Eq. 11'05,  $\frac{u_2^2}{2g} = \frac{nCT_1}{n-1}(1-\phi^{\frac{n-1}{n}}) - aP_1(1-\phi) \quad \dots \quad (11'42)$

$$\begin{aligned} M &= \frac{cS_1 u_2}{v_2} = \frac{cS_1 u_2 \phi^{1/n}}{v_1} \\ &= \frac{cS_1}{v_1} \sqrt{\frac{2gP_1 v_1}{n-1} \left( \phi^{2/n} - \phi^{\frac{n+1}{n}} \right) - aP_1 \left( \phi^{2/n} - \phi^{\frac{n+2}{n}} \right)} \quad \dots \quad (11'43) \end{aligned}$$

We get the maximum quantity when the differential of this in respect to  $\phi$  is equal to 0, which occurs when,

$$\frac{a(n-1)}{v_1 n} = \frac{2/\phi - (n+1)(1/\phi)^{1/n}}{2/\phi - (n+2)} = f(Z) \quad \dots \quad (11'44)$$

Stewart gives a graph showing how  $\phi$  and  $n$  vary for various values of the above function for  $f(Z)$ , between 0 and 0.25 (see his fig. 9, p. 955). In any problem, we choose a value for  $a$  the friction, and for  $n$  the polytropic index: we are given  $P_1$ , and know  $v_1$ , so we determine the value of the first

factor,  $a(n-1)/(v_1n)$ , and from the graph we find what the value of  $\phi$  will be. The actual value of  $P_2$  at the throat will be in accordance with the calculated value if the friction does vary as  $P_1 - P_2$ , and if the right value for  $a$  has been assumed. If the law is true, we can determine the value of  $a$  which will suit the particular case or test, when  $P_2$  has been found by experiment.

Goodenough's suggestion for dealing with friction is to assume that the friction

$$= \lambda(I_1 - I_2) \dots \dots \dots (11.45)$$

This will not alter the value of the ratio  $P_2/P_1$  or  $\phi$  for the maximum delivery, whereas in Stewart's case the value of  $P_2/P_1$  alters as different values are taken for  $a$ .

Stodola found the amount of energy lost in friction when steam was flowing through nozzles by actual tests, and gives (*Steam Turbine*, p. 63) :

$$\begin{aligned} \text{Total energy lost in friction, } Z &= (5-8 \text{ per cent.})(I_1 - I_2) \\ \text{or } &= (10-15 \text{ per cent.})(I_1 - I_2), \end{aligned}$$

the first value being for nozzles less than 50 mm long, and the latter value being for nozzles 100-150 mm long; the smallest diameter at the throat being 6-10 mm (=0.24 in. to 0.39 in.).

He also found what the value of the friction was, by determining the loss of head,  $= A\zeta \int \frac{u^2 Y dL}{2gS}$ ,  $Y$  = perimeter, and found that  $\zeta = 0.039$ . Using

Unwin's value for friction in pipes of 0.25 in. and 0.36 in. in diameter, we find  $\zeta = 0.0415$  and 0.0297, so the agreement is fairly good, considering the method by which it is found.

Zeuner's theory concerning friction flow is based on the assumption that the head lost in friction is  $\xi u^2/(2g)$ : he finds how  $\xi$  is related to the index of expansion  $n$ . Assuming that the pressure at the back of the orifice is  $P_1$ , and  $u_1 = 0$ , which may also be taken as  $H$  feet of fluid, of density  $m_1$ ,

The theoretical velocity of efflux	=	$u_2$ .
,, actual	=	$c_v u_2$ .
,, energy of flow for velocity	=	$H = u_2^2/(2g)$ .
,, ,, lost in friction	=	$c_v u_2 = H' = (c_v u_2)^2/(2g)$ .
	=	$\xi H'$ .

Now, the total head,  $H$ , makes up  $H' + \xi H'$ .

Therefore the relation between  $\xi$  and  $c_v$  is,

$$(c_v)^2 = \frac{1}{1 + \xi^2} \quad \xi = \frac{1}{(c_v)^2} - 1 \dots \dots \dots (11.46)$$

Then we also have to determine the coefficient of contraction for the various types of orifice, and thus get the coefficient of delivery, or of efflux,  $c = c_v c_c$ .

In order to determine the polytropic index for flow with friction such as always exists in any kind of orifice, we commence with the case of simple orifices, that is, either a pure orifice, or a well-rounded orifice, or one in which

there is a short cylindrical pipe as an outlet. In all these cases the coefficients are well known for water, and we shall assume that the coefficient in the case of air, and the loss of head,  $\xi$ , is constant for any particular orifice.

The friction work  $Z$  then =  $\xi u^2 / (2g) = \xi H'$ .

$$dZ = \xi dH' = \frac{-\xi \gamma d(Pv)}{\gamma - 1} \text{ from Eq. 11'14}$$

$$= \frac{(v dP + P \gamma dv)}{\gamma - 1} \text{ from Eq. 11'15.}$$

Therefore  $\xi \gamma (P dv + v dP) + v dP + P \gamma dv = 0$  . . . (11'47)

$$v dP(1 + \xi \gamma) + P dv \gamma(1 + \xi) = 0.$$

Putting  $n = \frac{\gamma(1 + \xi)}{1 + \xi \gamma}$  or  $(1 + \xi) = \frac{n(\gamma - 1)}{\gamma(n - 1)}$  . . . (11'48)

we have  $Pv^n = \text{constant}$ , and  $\xi = \frac{\gamma - n}{\gamma(n - 1)}$  . . . (11'49)

If either  $\xi$  or  $n$  is chosen, the other is thus determined. The values are given in Table 11'2.

According to Weisbach,  $\xi = 0.063$  for a well-rounded orifice  
 = 0.063 for a pure orifice  
 = 0.505 for a short pipe.

Rayleigh (*Phil. Mag.*, 32/177/1916) discusses the motion of gases discharged through orifices at high pressure, especially in regard to what occurs to the jet after it has left the orifice: he mentions Emden's work, where it is shown that the jet does not simply expand quietly in the receiver, but has a series of contractions and expansions produced from stationary sound waves. This type of motion occurs when the velocity of the jet exceeds the velocity of sound in the gas.

**K. Equations for throttling.**

With regard to the flow of air through orifices in pipe lines or through valves where throttling exists, all such obstructions cause a loss of work, and should be avoided where possible, unless one wants to waste energy for some particular purpose.

Considering a pipe line with an orifice ( $u_3 = \text{vel. after orifice}$ ), Goodenough (*Thermodynamics*, p. 268) says that,

$$(u_3^2 - u_1^2) / (2g) = J(I_1 - I_3)$$
 . . . (11'50)

and that ultimately  $u_3$  becomes equal to  $u_1$ , in which case  $I_1 = I_3$ , and the equation for a throttling process is that of a constant heat content. But it seems questionable if the velocity before and after throttling is the same. For simple gases it can only be so if  $v_3 = v_1$ , and  $P_3$  and  $T_3$  are such as to make the volumes equal. In any case  $P_3$  must be less than  $P_1$  for the flow to

exist at all, and the work per lb. which can be got from the fluid in expanding from  $P_3$  to the final pressure  $P''$  after leaving the pipe is,

$$P_1 v_1 \left\{ \frac{1 - (P''/P_1)^{\frac{n-1}{n}}}{n-1} \right\} \dots \dots \dots (11\cdot51)$$

The work which the fluid can do after the throttling is,

$$P_3 v_3 \left\{ \frac{1 - (P''/P_3)^{\frac{n-1}{n}}}{n-1} \right\} \dots \dots \dots (11\cdot52)$$

Using the fundamental Eq. 11'02,

$$\frac{u_3^2 - u_1^2}{2g} = J \{ q + I_1 - I_3 \} \dots \dots \dots (11\cdot53)$$

and taking  $q=0$ , that is, assuming that no heat leaks into or out of the system at the throttling constriction, then if

$$I_1 = I_3 = a \text{ constant} = \text{for gases } \frac{P_1 v_1 \gamma}{J(\gamma-1)}, = \frac{CT_1 \gamma}{J(\gamma-1)},$$

therefore  $T_3$  must equal  $T_1$ .

For actual gas flow, with  $q=0$ , we have,

$$I_1 = \frac{P_1 v_1 \gamma}{J(\gamma-1)} = I_3 + \frac{u_3^2 - u_1^2}{2gJ} \dots \dots \dots (11\cdot54)$$

$$u_1 = MCT_1/S \left( \frac{P_1}{P_1} \right) \quad \text{and} \quad u_3 = MCT_3/S \left( \frac{P_3}{P_3} \right); \quad ?$$

so that we get from Eq. 11'54,

$$\frac{C\gamma(T_1 - T_3)}{J(\gamma-1)} = \left( \frac{MC}{S} \right)^2 \left\{ \left( \frac{T_3}{P_3} \right)^2 - \left( \frac{T_1}{P_1} \right)^2 \right\} \dots \dots \dots (11\cdot55)$$

which means that for perfect gases, with  $P_1, T_1$  at one side, and  $P_3$  being known at the other side,  $T_3$  must be defined, and can have only one particular value.

If, now, the heat content is constant, we see that  $T_3 = T_1$  and  $P_3 = P_1$ , so that  $v_3 = v_1$  and  $u_3 = u_1$ . This is an impossible case for perfect gases, as it would mean there was a flow without any pressure difference causing it.

Eq. 11'55 can be solved by trial and error, when  $P_3$  is read upon a gauge. As  $P_3 < P_1$  and  $I_3 < I_1$ ,  $T_3$  must be less than  $T_1$ , and the gas is cooled in flowing through the orifice.

The amount of work lost by throttling is,

$$\frac{CT_1}{n-1} \left\{ 1 - \left( \frac{P''}{P_1} \right)^{1-1/n} \right\} - \frac{CT_3}{n-1} \left\{ 1 - \left( \frac{P''}{P_3} \right)^{1-1/n} \right\} \dots \dots \dots (11\cdot56)$$

assuming that the law of expansion will be the same from  $P_3$  to  $P''$  as from  $P_1$  to  $P''$ . In order to simplify this expression, we neglect the difference between  $T_3$  and  $T_1$ , and then we know that we have put a lower value upon the loss of work than the actual loss is, as  $T_3$  is less than  $T_1$  really. The work lost therefore must exceed that given by,

$$\frac{P_1 v_1}{n-1} \left\{ \left( \frac{P''}{P_3} \right)^{1-1/n} - \left( \frac{P''}{P_1} \right)^{1-1/n} \right\}$$



and using the symbols  $P_3 = P_1(1-a)$ , where  $a$  may be a small or large quantity, depending upon circumstances,

this is, 
$$\frac{P_1 v_1 (P'')^{1-1/n}}{n-1 (P_3)} \left\{ 1 - (1-a)^{1-1/n} \right\} \dots \dots \dots (11\cdot57)$$

which can be put in the simpler form,

$$P_1 v_1 \text{ (or } CT_1) \left( \frac{P''}{P_3} \right)^{1-1/n} \left\{ \frac{a}{n} + \frac{a^2}{2n^2} + \frac{(n+1)a^3}{6n^3} \right\} \dots \dots \dots (11\cdot58)$$

This shows how much work is lost as  $a, P, n$  vary. If  $a$  is to be a fixed proportion of  $P_1$ , and the expansion of the fluid follows the same law no matter what  $P_1$  is, then the work lost decreases rapidly as  $P_1$  is increased, because  $P''$  is about atmospheric pressure and  $P_3 = P_1$  approximately if  $a$  is small.

This problem is of interest in connection with air and gas meters, as the different types of meter differ considerably in the drop of pressure which they require to give readable deflections. If a meter needs 8 in. water to give a full-scale deflection, and the pressure  $P_1$  is large, only a small proportion of the work is lost ; but if the fluid is at low pressure, and the meter requires a pressure 3 in. of mercury (34 in. water), the lost work may become considerable.

Assuming that  $n=1$ , we have a different equation :

$$\begin{aligned} \text{Work which could be done} &= CT_1 (\log_e P_1 - \log_e P'') \\ \text{Work lost} &= CT_1 (\log_e P_1 - \log_e P_3) \end{aligned}$$

$$\text{Ratio } \frac{\text{work lost}}{\text{work possible}} = \frac{\log_e P_1 - \log_e P_3}{\log_e P_1 - \log_e P''}$$

which must be calculated out for the values of  $P_1$  and  $P_3$  found in any particular tests.

If  $n$  is not 1, and the expansion follows a polytropic curve, we can find the value of the function of  $a, n$  for various values of  $a$  and  $n$ .

Putting  $(P''/P_1)^{1-1/n} = b$ , and  $\{1/(1-a)\}^{1-1/n} = y \dots \dots \dots (11\cdot59)$

the work possible from  $P_1 = CT_1(1-b) \dots \dots \dots (11\cdot60)$

„ „ „  $P_3 = CT_3(1-by) \dots \dots \dots (11\cdot61)$

Assuming that  $T_3 = T_1$  and  $a$  is small,

$$\text{the ratio, } \frac{\text{lost work}}{\text{possible work}} = \frac{1-b-1+by}{1-b} = -\frac{b(1-y)}{(1-b)}$$

Now,  $(y-1) = (n-1) f(a, n) \dots \dots \dots (11\cdot62)$

where  $f(a, n) = \frac{a}{n} + \frac{1}{2} \left( \frac{a}{n} \right)^2 + \frac{n+1}{6} \left( \frac{a}{n} \right)^3$

and the value of the ratio becomes,

$$\frac{(n-1) f(a, n)}{(P_1/P'')^{1-1/n} - 1} \dots \dots \dots (11\cdot63)$$

We can evaluate this for values of  $a/n=0.10, 0.05, 0.01$ , etc., and for values of  $n$  from 1.01 to 1.40: the numerator of the fraction is always small, but the denominator may become small also, and then the ratio can reach a relatively appreciable magnitude.

$$\begin{array}{l} \text{When } a/n=0.10, \quad 0.05, \quad 0.01, \\ f(a, n)=0.1052, \quad 0.05127, \quad 0.01005. \end{array}$$

Now, when  $n$  is nearly 1,  $(P_1/P'')^{1-1/n}$  becomes only slightly greater than 1,

$$\begin{array}{l} \text{say, } (P_1/P'') = 2, \quad 5, \quad 10, \quad \text{and } n=1.1 \\ (P_1/P'')^{1/11}=1.065, \quad 1.15, \quad 1.23. \end{array}$$

Taking an extreme case, where  $P_1/P''=2$  and  $a/n=0.10$ ,  $n=1.1$ , the percentage of work lost in throttling is,

$$\frac{0.10(0.1052)}{0.065} = 16.3 \text{ per cent.}$$

The question deserves attention when manufacturers are offering meters for the measurement of air or gas at atmospheric, or below atmospheric, pressure; some makes of meter might consume in the throttling appreciable amounts of the total available energy.

#### L. Throttling in cocks.

The amount of throttling of air at low pressures in cocks is more than one would expect. Tests made at various times upon apparatus controlling pneumatic tubes showed a much more serious drop of pressure at the cocks than was anticipated. It must be remembered that in pneumatic-tube work the pressures are relatively low, and any loss becomes a large proportion of the total available pressure.

The tests were made chiefly on old  $1\frac{1}{4}$ -in. three-way cocks of the British Post Office, as illustrated in both the old and new editions of the *Technical Instructions*, X.: this type of cock has been in use a considerable number of years. At one time the object of the cocks was definitely to reduce the pressure in the reservoir from, say, 15 to 18 lb/in<sup>2</sup> to 8 to 10 lb/in<sup>2</sup> for use in the tubes: then the pressure of air in the reservoir was reduced to about 8 to 12 lb/in<sup>2</sup>, and the cocks reduced this to about 6 to 7 lb/in<sup>2</sup> in the tubes. Existing practice is to have the air delivered at about 5 to 12 lb/in<sup>2</sup>, and to use it at about the same pressure, the controlling cocks being made of full bore and causing a loss of about  $\frac{1}{2}$  lb/in<sup>2</sup>. The values of the pressures quoted above give a general idea of the trend of practice, and do not apply to any particular place.

Fig. 11'4 shows the effect of throttling; the straight line gives the pressure existing in the reservoir or container, the curved lines show the pressure which existed in the tubes: the throttling was, of course, greater at the higher values of the pressure on account of the greater quantity flowing. It is obvious that, to get the same pressure in the tube, the reservoir pressure might be reduced by about 1 to 3 lb/in<sup>2</sup> if there were no loss of pressure in the cocks.

The general conclusion on this matter is that in services from a reservoir

practically no throttling should take place in the cocks supplying those services which have the maximum load, because then the pressure in the reservoir may be kept at the lowest value consistent with working the apparatus at the end of the service ; every increase in the reservoir pressure

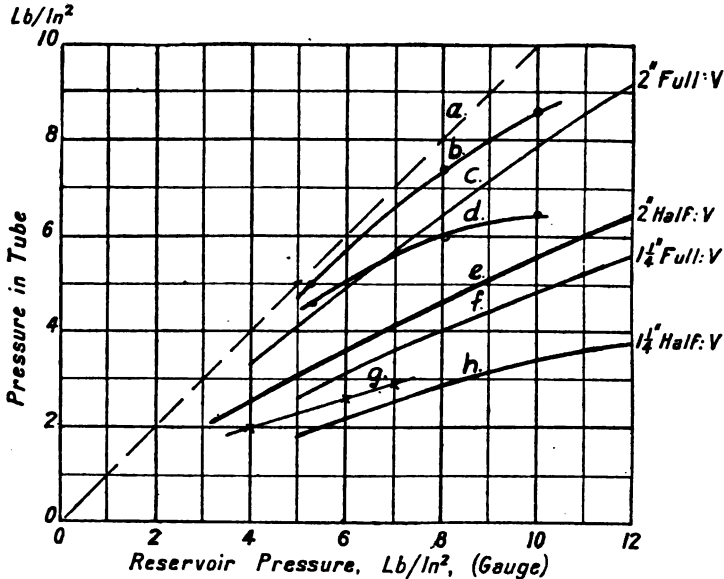

- a, Pressure in reservoir, no cock in circuit.
- b, Pressure working, 2-in. cock, full on.
- c, Vacuum " 2-in. " "
- d, Pressure " 1 1/2-in. " "
- e, Vacuum " 2-in. " half on.
- f, " " 1 1/2-in. " full on.
- g, " " 1 1/4-in. " "
- h, " " 1 1/4-in. " half on.

Fig. 11'4.—Loss of pressure between the reservoir and the tubes due to the throttle cocks.

causes a proportionate increase in the amount of work which has to be done on all the air passing through such reservoir. On the services where the load is less and where it will not be necessary to have the maximum pressure, it may be desirable to have throttling simply to reduce the pressure at the apparatus.

AUTHORITIES MENTIONED.

Anthes, Bradley, Carpenter, Davidson, Estep, Fisher, Geipel, Good-enough, Grashof, Grindley, Hartshorn, Henderson, Hirn, Hirschfeld, Hodgson, Hütte, Kempe, Leblanc, Ling, Morley, Napier, Rayleigh, Rateau, Reynolds, Scanes, Stewart, Stodola, Thorkelson, Upton, Weisbach, Zeuner.

CHAPTER XI.—SYMBOLS USED.

Equation.	Symbol.	Meaning.
..	$A = 1/J$	=multiplier to bring work units to heat units.
11'57	$a = \frac{P_1 - P_2}{P_1}$	=proportionate loss of pressure in throttling.
11'59	$b = (P'/P_1)^{(n-1)/n}$	=a function of pressures.
11'33	$C$	=air constant.
..	$c = c_e, c_r$	=coefficient of efflux, or delivery.
11'46	$c_v$	= " of velocity.
..	$c_c$	= " of contraction.
11'24	$f(n) = \sqrt{\frac{2g\gamma}{\gamma-1} \left(\frac{n-1}{n+1}\right) \left(\frac{2}{n+1}\right)^{2/(n-1)}}$	
11'29	$f(n, \gamma) = \sqrt{\frac{2g\gamma}{\gamma+1} \left(\frac{2}{\gamma+1}\right)^{2/(n-1)}}$	
11'62	$f(a, n) = \frac{a}{n} + \frac{1}{2} \left(\frac{a}{n}\right)^2 + \frac{n+1}{6} \left(\frac{a}{n}\right)^3$	
..	$g = 32.2, (9.81)$	=acceleration due to gravity.
11'05	$H = u^2/2g$	=head of fluid.
11'08	$I = U + Pv$	=total heat, or heat content of fluid.
11'02	$J = 1/A$	=multiplier to bring heat units to work units.
..	$L$	=length of orifice.
..	$M$	=quantity of fluid delivered per second.
..	$n$	=index of polytropic expansion.
11'21	$n'$	=ratio of throat critical pressure to initial pressure.
..	$P, p$	=pressures.
..	$P_0$	=atmospheric pressure.
..	$P_1$	=initial pressure.
..	$P_2$	=throat pressure.
..	$P_3$	=pressure after throttling or outside orifice.
11'51	$P'$	=final available pressure.
..	$q$	=heat added to fluid.
..	$S_1$	=section of orifice or nozzle.
..	$S_2$	= " " at throat.
..	$T$	=absolute temperature.
..	$U$	=internal energy = $Pv/(\gamma-1)$ for simple gases.
..	$u$	=velocity.
..	$u_s = (g\gamma Pv)^{1/2}$	= " of sound in air at $P, v$ .
..	$v$	=volume.
11'59	$y = 1/(1-a)^{(n-1)/n}$	
11'01	$z$	=height of fluid above datum line.
11'01	$Z$	=work done in friction.
..	$\gamma$	=index for adiabatic expansion.
..	$\varphi = P_2/P_1$	=ratio of pressures.
11'38a	$\lambda$	=proportion of work lost in friction.





Stanton (*Nat. Phys. Lab. Res.*, 5/169/1909) found that the intensity of wind-pressure on large plates was slightly greater than on small plates, because of the greater suction effect existing with large plates; in his tests,  $P$  for large plates = 1.11  $P$  for small plates, the positive pressure being  $\frac{1}{2}\rho u^2$  in either case. The formula for pressure  $P$  holds for plane surfaces moving perpendicular to still air at a velocity  $u$ , as well as for the pressure of moving air on fixed surfaces.

The variation in  $K$  which might arise because of the variation in density will lie between -11 per cent. and +16 per cent.: suppose that the air is at 60° F. and at 14.7 lb/in<sup>2</sup> when the value of the constant is obtained. But the pressure may fall to 13.8 lb/in<sup>2</sup> or rise to 15.1 lb/in<sup>2</sup>, and the temperature may vary from 32° to 90° F.; the density would then vary.

$$m(0.94 \sim 1.03)(0.948 \sim 1.13) = m(0.891 \sim 1.16). \quad (12.03)$$

These are, of course, maximum variations; ordinarily the density will be nearly the normal; but the fact of the possibility of variation in density should be remembered when using  $K$ .

TABLE 12.1.—PRESSURE OF MOVING AIR ON PLANE SURFACES.

Pressure =  $Ku^2$ . The table gives values of 1000  $K$ , which give pressures in (1) lb/ft<sup>2</sup>, (2) kg/metre<sup>2</sup>, when the velocity is given in miles/hr, ft/sec, km/hr, metre/sec.

Pressures will be in . . . . .	lb/ft <sup>2</sup> .		kg/metre <sup>2</sup> .	
	miles/hr.	ft/sec.	km/hr.	metre/sec.
Velocity being given in . . . . .				
Conversion factors . . . . .	K = A.	K = 0.465 A.	K = 1.9 A.	K = 24.4 A.
Stanton, p. 94 . . . . .	2.70	1.26	5.12	65.8
"    Froude (carriage) . . . . .	3.66	...	6.95	89.3
"    Dines (whirling table) . . . . .	2.80	...	5.50	70.6
"    Langley (whirling table) . . . . .	3.26	...	6.20	79.5
"    Langley . . . . .	3.90	...	7.40	95.0
Shaw, p. 91, quoting Dines . . . . .	3.00	1.40	5.70	73.2
"    Stephenson . . . . .	5.00	2.32	9.50	122.0
Keimpe (p. 771) . . . . .	{ 2.86	1.33	5.43	69.6
	{ 3.27	1.52	6.20	80.0
Krell, <i>Proc. I.C.E.</i> , 139/446 . . . . .	3.50	1.63	6.70	85.5
Grashof ( <i>Hütte</i> , p. 386) . . . . .	5.00	2.32	9.50	122.0
Stanton, plate 25 ft. <sup>2</sup> . . . . .	3.20			
"    "    50 " . . . . .	3.18			
"    "    100 " . . . . .	3.22			
Thurston, round wires . . . . .	{ 2.55			
	{ 2.80			

Box (p. 288) quotes Hutton as giving,  $P_1 - P_2 = .001487u^{2.04}$ . Grashof's value is for thin plates less than 3 sq. ft.; Dines' is for 1 sq. ft. plates. Löfsl (*Hütte*, p. 386) found that  $K$  was independent of the area of the plate. The Beaufort international scale of wind-pressure is based upon Grashof's values. The references are given in the chapter.

Further valuable information on this question is given in Matthews' *Aviation Pocket Book*, published by Crosby Lockwood.

Johns (*Engineering*, 91/299/1911) has given a table of 51 values of  $K$

for square, rectangular, and circular plates, compiled from various sources (unfortunately, the original references are not given), and criticises the values fully. Evidently the value 0.003 is quite a reasonable one to use generally.

**B. Pressure on inclined surfaces.**

Thurston (*Aero. Jour.*, 14/152/1910) treats of this subject and gives photos showing the flow round about the edges of inclined planes. Zenneck (*Ver. Deut. Phys. Ges.*, 16/695/1914) describes apparatus for photographing the eddies in water impinging upon plates and rods, and gives photos of such eddying motion.

Thurston (*Aero. Jour.*, 16/116/1912) tested the resistance offered to the flow of air by bars of various sections—round, diamond-shaped, egg-shaped, elliptical, etc. All the bars were  $\frac{1}{8}$  in. wide—that is, their diametral plane at right angles to the flow of air was  $\frac{1}{8}$  in. wide: the length of the bars was either 12, 18, or 30 inches. The resistance offered was,

$$P \text{ (lb.)} = KLt \text{ (m.p.h.)}^2 - 0.0073t \text{ (m.p.h.)}^2 \quad . \quad . \quad (12'04)$$

L=length of bar in feet; t=width in inches.

K=(.00441 ~ .00100), depending upon the section of the bar.

For bars of stream-line section, when the pointed end of the bar faced the air current the resistance was less than when the blunt end of the bar faced the current (p. 123): this is not the ordinarily accepted idea. On p. 176 of the same volume are given formulæ for the pressure of air on round wires:

$$P = 263 KLDu^2 \text{ (metric units)} \quad . \quad . \quad . \quad (12'05)$$

$$= KLD \text{ (m.p.h.)}^2 \text{ (Eng.)} \quad . \quad . \quad . \quad (12'06)$$

$$K = 0.00535, 0.00339, 0.00268, 0.00261 \text{ when}$$

$$d = 0.014, 0.0475, 0.1020, 0.610$$

For large wires, where  $d = 0.10$  to 1.75 in.,  $K = 0.00255$  to 0.00280: the shielding effect of wires is dealt with on p. 184 of the same volume. The above formula can be compared with that mentioned by Hütte (p. 387) for the pressure on cylindrical surfaces.

$$P = 0.667 DLKu^2, \quad K \text{ is given in Table 12'1} \quad . \quad (12'07)$$

$$\text{or } P = 0.785 DLKu^2 \quad . \quad . \quad . \quad (12'08)$$

according as to whether the pressure upon inclined surfaces depends upon the sin of the angle or upon the square of the sin of the angle between the plane and the air current. These formulæ do not agree well with one another.

Shakespear (*Phil. Mag.*, 28/728/1914) deals with the resistance offered by air to falling spheres. The experiments were made at Birmingham with celluloid spheres filled with shot; the spheres were dropped from the top of a tower, and the time for falling certain distances was noted. Three sets of tests were made:—

- (i.) To find the relation between the air resistance and the velocity for a sphere 3.70 cm in diameter falling at velocities up to 1.3 metres per second.



- (ii.) To find the relation between the diameters and masses of the spheres which fell at the same velocities.
- (iii.) To find the relation between the air resistance and the velocity when the diameter of the spheres varied between 2 and 7 cm, but the velocity was constant and equal to 1030 cm/sec.

He found that for a 3.70-cm sphere,

$$P \text{ in dynes} = 0.000277 Su^2 + 216, \text{ S in cm, } u \text{ cm/sec} \quad (12'09)$$

$$P \text{ in lb} = 0.0537(10)^{-6} Su^2 + 0.000485, \text{ Eng.} \quad (12'10)$$

$$P \text{ in kg} = (0.0282) Su^2 + 0.000220, \text{ metric} \quad (12'11)$$

This should be compared with a formula given by Hütte, p. 388,

$$P = 0.33 KSu^2, \quad K = 0.08 \text{ to } 0.12 \quad (12'12) \\ = (0.0264 \sim 0.0396) Su^2.$$

Shakespear also found that  $P$  increased with  $S$  and  $u$ ; and that  $K$  had a value about equal to  $\frac{1}{4}$ th the density of the spheres, while the diameter varied from 2 to 7 cm, and the velocity from 0.5 to 20 metres per second.

Hall (*Proc. Amer. Acad. Art and Sci.*, 45/380/1910) let a bronze ball 1 in. diameter fall a distance of 2285 cm in 2.176 seconds, and deduced that the skin friction  $k = 0.00154$  dyne/cm<sup>2</sup> where the accelerating force =  $mg - kv^2$ .

Chatley (*Nature*, 86/60/1911) discusses the skin friction on dirigible airships, and quotes values of  $f$  (in lb-ft units) obtained by previous investigators as varying from  $(10 \text{ to } 17)10^{-6}$ .

Zahm (*Phil. Mag.*, 1/530/1901) measured the resistance of the air to spherical bullets 3.985 in. diameter, travelling at velocities 200 to 1000 ft/sec, and found that it could be put,

$$F = 0.000008u^2 + 0.00000049u^3 \quad (12'13)$$

$7F = \frac{1}{2}m(u_1^2 - u_2^2)$ ,  $u_1$  and  $u_2$  being the average velocities in the first and second 7 ft. respectively. The velocities were measured by noting the times from  $t = 0$  at which the bullets cut through three beams of light placed 7 ft. apart; the beams were reflected by mirrors on to a sensitised moving photographic plate, and the points of time when the bullet passed the beams were visible by a discontinuity in each of the three lines formed on the plate by the beams. The equation does not seem to agree altogether well with that of Shakespear, but then the velocities were very high.

Emden (*Ann. der Physik*, 69/454/1899) states that the resistance of air to the movement of bullets at high velocities is,

$$F = \lambda m Su^2 f(u) \quad (12'14)$$

where  $f(u)$  has a value 0.14 while the velocity is relatively low, and that it suddenly increases as the velocity approaches that of sound, until it attains a value 0.39 when the velocity is equal to that of sound. For higher velocities  $f(u)$  remains at 0.39.

### C. Friction on discs.

Odell (*Engineering*, 77/33/1904) describes tests made upon the power required to rotate discs in air. Paper discs 15, 22, 27, 48 in. in diameter were used; for a disc with diameter  $d$ ,

$$\text{Torque varied as } (\omega)^{2.5} \quad \dots \quad (12'15)$$

$$\text{Power } \quad \quad \quad (\omega)^{3.5} \quad \dots \quad (12'16)$$

but the law broke down at a critical speed of 18000/d. For a fixed speed,  $\omega$ , but with diameter varying, the torque was such,

$$\text{Torque varied as } (d)^{5.6} \quad \dots \quad (12'17)$$

which Odell explains thus: air flows to the centre of the disc and out towards the edge, and the loss of kinetic energy in friction per lb. of air is  $\frac{kLu^2}{\mu 2g}$ , where L is the mean length of path which the air has to travel. Odell says that both L and  $\mu$  will be proportional to the radius of the disc, so that the loss of kinetic energy will vary as  $ku^2/(2g)$ . Further, the quantity of air set in motion will be  $k'ur^2$ , and the total work done will be therefore  $kk'u^3r^2 = kk'\omega^3r^5$ , so that the power would vary as  $d^5$  for a constant speed.

This question of disc friction can be dealt with in another way. A disc moving at a velocity  $u$  in still air will experience a retarding force on both surfaces: assuming that unit area of surface moving at unit velocity in atmospheric air experiences a retarding force  $k$ , or assuming that to move atmospheric air over unit surface of an infinite plane at unit velocity requires a force  $k$ ; already from Eq. 2'64b we know that  $k = m_0\zeta/(2g)$ , where  $\zeta$  is the coefficient of friction in the pipe. Now  $\zeta$  varies with the contiguity of other surfaces;  $k$  will also depend upon whether the surface has other surfaces near it or not. For a disc rotating in still air we have,

$$\text{Force} = ku^2 \text{ per sq. ft.} \quad \dots \quad (12'18)$$

$$\text{Torque} = k'k \int r^3 \omega^2 (2\pi r dr) = k'k\omega^2 2\pi \int r^4 dr \quad \dots \quad (12'19)$$

$$\text{Power} = \omega \text{ torque} = k'k\omega^3 2\pi r^5/5 \quad \dots \quad (12'20)$$

$k$  varies with the existence of other surfaces near the rotating disc, so that two discs near together should experience more resistance to motion than the same two discs placed far apart, because each disc sets up its own eddies, and the two sets of eddies resist each other. If a series of discs were placed on a shaft and the whole series were rotated, and if fixed discs were placed between each of the rotating ones, by altering the number of the discs we should get a good measure of the friction and should be able to find the value of  $k$ . If this arrangement is air-tight, so that the pressure of the air in which the vanes rotate can be varied, we could get the value of  $k$  for various pressures: it should vary nearly as the pressure. The value of  $k$  found for a single disc rotating in free air should coincide with the value for  $k$  as deduced from  $\zeta$  for pipes of large diameter, about 0.003.

Though  $k$  is a very small quantity, it has been directly measured; for atmospheric air,

$$k = 0.0764(0.003)/64.4 = 3.56(10)^{-6} \text{ approximately.}$$

Direct measurement involves placing a very thin long plane of large surface in a uniform current of air, and noting the force tending to displace it along its length: allowance has to be made for the effect of the impact of the air upon the edge facing the current of air. Such experiments have

been carried out by Zahm (*Phil. Mag.*, 8/58/1904). He used flat wooden plates 1 in. thick,  $25\frac{1}{2}$  in. deep, and from 2 to 16 ft. long; special hemispherical ends were attached to the ends, and the effect of the ends alone was also determined and deducted from the total friction. The skin friction  $F$  was found to be,

$$F = au^{1.85}, \text{ when } u \text{ varied from 5 to 40 ft/sec, and}$$

$F = .000524,$	$\zeta = .00288,$	for	2-ft. board,	$u = 10$	ft/sec.
$.000500$	$.00276$	„	4 „	„	„
$.000475$	$.00262$	„	8 „	„	„
$.000467$	$.00258$	„	12 „	„	„
$.000457$	$.00252$	„	16 „	„	„

From Eq. 2'30, 2'64 we get  $\zeta = \frac{2g}{m_0} \left( \frac{F}{10^{1.85}} \right) = 5.5 F$  . . . . . (12'21)

The above values show that  $F$  or  $\zeta$  varies with  $L$ , as  $L^{.07}$ ,  
 Finally, the force of skin friction on a plane 1 ft wide becomes,

$$F = 0.00000778 L^{.93} u^{1.85} . . . . . (12'22)$$

Zahm covered the planes with varnish, cambric, zinc, rough drawing-paper, but found that  $F$  remained constant; but when fine wire gauze was placed against the wood he found that  $F$  varied as  $u^{2.06}$ . This agrees with other experimenters, where,

$F$	for smooth surfaces	varies as	$u^{1.85}$
$F$	„ rough	„	$u^{2.00}$

Lord Rayleigh (*Phil. Mag.*, 8/66/1904) adds a note to Zahm's paper, concerning the laws which hold if the principle of dynamical similarity holds. Suppose the tangential frictional force or skin friction is  $F$ , this will be such that,

$$F = mu^2 f(Lu/\nu) . . . . . (12'23)$$

where  $L$  is a linear dimension of the solid body,  
 $\nu$  is the kinematical viscosity.

If now  $F$  is independent of  $\nu$ , then the function of  $(Lu/\nu)$  must be constant, and  $F \propto mu^2$  . . . . . (12'24)

but if the function of  $(Lu/\nu)$  is not constant, then  $F \propto mu^2 f(Lu/\nu)$  . . . . . (12'25)

Even in this latter case, if  $L$  varies inversely as  $u$ , then  $F \propto mu^2$  . . . . . (12'26)

Or, again, if the fluid is such that  $\nu \propto u$ , then  $F \propto mu^2$ .

Lees (*Proc. Roy. Soc.*, 92A/144/1915) gives a mathematical discussion upon the resistance of elongated bodies flowing in viscous fluids. He states that the resistance per unit area of a flat lamina of width  $2D$  and of contour  $4D$ —that is, a lamina of infinitely small thickness—is equal to

CHAPTER XII.—SYMBOLS USED.

Equation.	Symbol.	Meaning.
12'29	$a$	=a constant.
12'29	$b$	= "
12'05	$D$	=diameter of bar.
..	$d$	= " "
12'21	$F$	=force of friction in lb/ft <sup>2</sup> .
12'02	$g$	=gravitational constant.
12'20	$k'$	=a coefficient.
12'18	$k$	= "
12'01	$K$	= "
12'05	$L$	=length of bar or plane disc.
12'02	$m$	=density of air.
12'01	$P$	=intensity of pressure on surfaces.
12'19	$r$	=radius of disc.
12'09	$S$	=area of diametral plane of sphere.
12'04	$t$	=thickness of bar.
12'01	$u$	=velocity of air current.
12'21	$\zeta$	=coefficient of friction.
12'27	$\eta$	=viscosity.
12'17	$\mu$	=hydraulic mean depth.
12'23	$\nu$	=kinematical viscosity.
12'02	$\psi$	=a coefficient.
12'15	$\omega$	=angular velocity of disc.



that of a circular rod of diameter  $D$  and contour  $\pi D$ . If the skin resistance of turbulent flow follows the same laws as when the flow follows stream-lines, then the resistance of a lamina of depth  $2D$  as measured by Zahn would equal that of circular rods of diameter  $D$ .

Lees states that the resistance per unit area for circular pipes is  $8\eta U/D$ , for stream-line flow, where  $\eta$  is the viscosity: this would give the resistance per unit length,

$$\pi D 8\eta U/D = 8\pi\eta U \quad . \quad . \quad . \quad (12\cdot27)$$

The velocity of flow would then vary inversely as the length and would be independent of the pressure as long as the difference of pressure between the ends was kept constant.

Rayleigh (*Phil. Mag.*, 21/698/1911) discusses the mathematical laws of solid bodies moving in viscous fluids: he states that for very thin laminæ, breadth  $b$ , moving at velocity  $u$ , Lanchester gives the force per unit length as,

$$F = cm\nu^{\frac{1}{2}}Lbu^{3/2} \quad . \quad . \quad . \quad (12\cdot28)$$

Rayleigh shows that  $c = 2/(\pi)^{\frac{1}{2}}$  if  $\nu$  is small enough.

Pannetti (*Accad. Sci. Torino, Atti*, 50/483/1915) and F. Burzio (*ibid.*, 50/697/1915) (*Science Abs.*, 19 $\Delta$ /3/1916) determined the coefficient of air resistance for rectangular vanes rotated in air with the current blowing perpendicularly to the face of the vane: they found that the coefficient of resistance was,

$$K = 0\cdot305 \frac{(a-b)}{(a+b)} + 0\cdot0806 \quad . \quad . \quad . \quad (12\cdot29)$$

where  $a$  is the distance of the outer edge of the plate from the axis,  
 $b$  ,, ,, ,, inner ,, ,, ,, ,,

Frank (*Z.V.D.I.*, 52/1522/1908) gives a report upon the resistance offered by air to a pendulum made of flat lead plates, whose planes were parallel to the direction of motion of the pendulum. The lead plates were 300 mm deep by 500 mm long: the thickness was such that the end surface at right angles to the air currents was constant, that is, (thickness)  $\times$  (number of plates) was a constant. The distance between the plates was varied from 0 to 3, 6, 9, 12 mm, and the relation between the frictional force of the air on the moving plates,  $k$ , and the distance between them,  $\beta$ , was found to be,

$$\begin{aligned} \text{when } \beta > 0\cdot0121 \text{ metres, } k &= 0\cdot00244/\beta \quad . \quad . \quad . \quad (12\cdot30) \\ \text{,, } \beta < 0\cdot0121 \text{ ,, } k &= 0\cdot575 - 44\beta + 1084\beta^2. \end{aligned}$$

Unfortunately, I am unable to trace the connection between the value of  $k$  and Taylor's  $f$ , or  $\zeta$ , as the units with which  $k$  is associated are unknown.

**AUTHORITIES MENTIONED.**

Box, Chatley, Dines, Emden, Frank, Froude, Grashof, Hall, Johns, Kempe, Krell, Langley, Lees, Odell, Pannetti, Rayleigh, Shakespear, Shaw, Stanton, Stephenson, Thurston, Zahn, Zenneck.

## CHAPTER XIII.

### GENERAL DESCRIPTION OF PNEUMATIC TUBES.

Merits of big *versus* small tubes—Relative amounts of energy required and cost of working—Types and amount of leakage in systems—Purposes for which tubes are used—Carriers—Radiating *versus* loop systems—Cost of power for tubes—Faults in tubes—References to information.

#### A. Merits of big and small tubes.

WHEN one is asked to provide a tube between two points or offices, the question as to its diameter at once arises. The pressure of air necessary, quantity of air to be circulated, and the capacity of the tube for taking message traffic all are involved in the question of tube diameter.

The type of message form to be inserted in the carrier may be such as to determine at once the tube diameter; but, assuming that it does not—as, for instance, telegraph forms which can be put in carriers for tubes of  $1\frac{1}{2}$  in. diameter and upwards,—we could use, say, a 2-in. tube having carriers taking 30 forms each, or a 3-in. tube having carriers taking 70 forms each. The 3-in. tube would give greater capacity and greater speed at a greater cost than the 2-in. tube. The first comparison will now be made for 2-in., 3-in., 4-in. tubes, to see how (i.) speed, (ii.) quantities of air circulated, vary for such tubes. It is useless to treat of the capacity for message forms, because this depends entirely on what sort of forms are being used. As regards speed and quantities, see fig. 4'6; the upper chart shows the relative transit times for various pressures. For the moment we are only concerned with the comparison of times for any particular pressure, say 8 lb/in<sup>2</sup>, giving relative transit time  $T' = 28, 35, 46$ , for 4-in., 3-in., 2-in. tubes.

The actual time of transit depends upon the length of the tube. If we use a 4-in. tube we get many more messages in each carrier, and can send carriers more often, say every 30 instead of 46 seconds in a busy period of the day, than if we used a 2-in. tube.

But now look at the size of the pumps and pipework which would be necessary for the 4-in. tube: the relative amounts will be 25,000 cu. ft. and 5000 cu. ft., a very considerable difference.

It is better to compare the quantities, having fixed upon a *definite transit time* and having decided to vary the pressure so as to give the definite speed. Taking a transit time of 50, we see from the upper chart of fig. 4'6 that the necessary pressures would be 2.3, 3.6, 6.4, in 4-in., 3-in., 2-in. tubes; from the lower chart we see that the quantities would be as 11,000, 6000, 4000. This shows clearly that the larger-sized tubes do not take so very

much more air if the pressure can be reduced to just the amount which is necessary to give the proper speed.

If only one tube is under consideration, the plant to give the larger quantity of air at low pressure may be cheaper than the plant to give the smaller quantity of air at the high pressure.

The values in fig. 4.6 have been obtained from :

$$\text{Transit time} = L^{3/2} \left( \frac{4\zeta}{D} \right)^{1/2} \left( \frac{1}{2gCT} \right)^{1/2} f_4(\phi) \quad . \quad . \quad (13.01)$$

$(4\zeta/D)^{1/2}$  is in Table 2.1 ;  $f_4(\phi)$  is in fig. 5.2.

The cu. ft. of free air per min. = 60 Q

$$= (13.1)60 (D'')^{1/2} (P_1^2 - P_2^2)^{1/2} / (CTL)^{1/2} \quad . \quad . \quad (13.02)$$

$D''$  is in Table 2.1 ;  $(P_1^2 - P_2^2)^{1/2}$  is in fig. 4.3.

The second comparison will now be made : this concerns *work done on the air* for the various sized tubes.

This comparison cannot be made fully until it is known whether a definite speed or a definite pressure is the basis. For any particular tube the work factor depends upon (i.) how many lb. of air are used at any pressure ; (ii.) how much work is necessary to compress or rarefy each lb. of air to the relative pressure. The variable portion of (i.) due to pressure is represented by  $f_1(\phi)$ , and is given in fig. 4.1 ; the work of compression or rarefaction,  $W$ , is given in fig. 4.8 ; the multiplication of these,  $= Wf_1(\phi)$  = work factor, is given in fig. 4.7. This shows how the work factor varies with the pressure of working for a given tube, and is not to be confused with  $W$ , the work per lb. of air. The factor shown in fig. 4.7 has to be multiplied by a dimension factor when the complete amount of work done for various sized tubes is being considered. This amount of work is,

$$D''^{1/2} \frac{f_1(\phi)}{(CTL)^{1/2}} W = \frac{D''^{1/2}}{(CTL)^{1/2}} W f_1(\phi) \quad . \quad . \quad (13.03)$$

For  $D''$ , see Table 2.1 ; for  $Wf_1(\phi)$ , see fig. 4.7.

I have made the comparison for 1½-in., 2¼-in., 3-in. tubes 3000, 6000, 9000 ft. long, converting the ft.-lb. into electrical units or kw-hr. used per hour : these figures give the approximate number of units consumed per hour in working the tubes continuously at either 10 lb/in<sup>2</sup> pressure or 8 lb/in<sup>2</sup> vacuum. The figures in brackets are for vacuum working.

Diam.		L=	3000	6000	9000 ft.
cm.	in.				
3.8	1½		1.88 (1.36)	1.4 (1.0)	1.1 (0.84)
5.7	2¼		5.20 (4.00)	3.7 (2.9)	3.0 (2.30)
7.6	3		12.30 (9.50)	8.8 (6.8)	7.1 (5.50)

These figures are obtained from Eq. 4.13.

$$Wf_1(\phi) \frac{D''^{1/2} P_0 3600}{(CTL)^{1/2} 2650000} \cdot \frac{1}{f\%} = \frac{W'D''^{1/2}}{L^{1/2}} (0.002263) \quad . \quad (13.04)$$

$W$  is the isothermal work of compression from  $p_0$  to  $p_1$ , or  $p_2$  to  $p_0$ .  $Wf_1(\phi) = W'$  depends on  $P$ , and is given in fig. 4.7.



$f\%$  is the overall efficiency of the pump, and is taken as 60 per cent.

3600 brings sec. to hours; 2650000 brings kw-hr. to ft.-lb.

$D''P_0/(CT)^{\frac{1}{2}}$  for  $1\frac{1}{2}$ -in.,  $2\frac{1}{2}$ -in., 3-in. tubes = 1.600, 5.21, 11.45 when using the values of  $\zeta$  given in Table 2'1.

The probable cost for electrical power used in working tubes can be determined readily from Eq. 13'04: the relative costs for small and big tubes should probably be reduced as mentioned previously, because a lower pressure would be used with the larger tubes. The table also shows how working by vacuum is less costly than working by pressure.

### B. Leaks in systems.

Leakage from systems will vary somewhat as the flow from orifices, for leaks are simply orifices of very small dimensions: so when the pressure of the system  $P_1$  exceeds  $2P_0$ , the leakage will vary approximately as  $P_1$  for systems of the same make and tightness of joints (see Eq. 11'34, etc.). For ventilation work, where the pressure is only a few inches above atmospheric, the leakage will vary as  $[p_1(p_1 - p_0)]^{\frac{1}{2}}$ ; as  $p_1 = p_0$  approx., the leakage would vary as  $h''$ , where  $h''$  is the mean water gauge in the system. As each joint in any system will be liable to leak all round the joint, it is reasonable to expect the leakage to increase with the diameter of the pipes used, so that finally we find,

$$\begin{aligned} \text{Leakage} &= aP_1D, && \text{if } P_1 \text{ exceeds } 2P_0 \\ &= b(h'')^{\frac{1}{2}}D, && \text{if } P_1 \text{ is nearly } P_0 \\ &= c[(P_1 - P_0)P_1]^{\frac{1}{2}}D, && \text{if } P_1 > P_0 < 2P_0. \end{aligned}$$

where  $a, b, c$  are constants.

Unwin (*Trans. Inst. Gas Engr.*, —/202/1904) states that in general leakage from bad joints will vary as  $D(\frac{1}{2}p)^{\frac{1}{2}}$ .

For compressed-air systems, where, owing to the high pressure, the leakage may be well worth taking into account, there are three types of leakage to be considered:—

- (i.) Leakage from containers and reservoirs.
- (ii.) „ „ pipes and distributing systems.
- (iii.) „ „ apparatus, drills, hammers, etc.

Leaks of the first type should not be allowed to remain for a long time, as there is no great difficulty in getting reservoirs air-tight.

Leaks on the mains must always exist, because one can never have all the joints air-tight: the quantity of leakage from mains will ordinarily have no relation to the quantity of air transmitted, but only to the extent of the distributing system and its mean pressure.

Leaks on apparatus always exist, as the moving parts and valves are bound to get loose in handling, and it is not worth repairing tools continually.

In any investigation upon leakage the different types of leaks should be kept separate, because—

- (i.) should be nil.
- (ii.) should vary as  $LD$ .
- (iii.) should vary as  $n(Ap)$ , where  $n$  is the number of each type of tool,

and  $A_p$  is the leakage from each tool of that type over the whole day. If now the tools are in continuous use, this leakage will be proportional to the load on the system; and one could add to the amount of air consumed by each tool when in use the amount of the leakage, which exists even when it is not in use.

Whereas in electrical systems the leakage is watched carefully and observed on delicate electrical instruments, the leakage from air systems is not observed to anything like the same extent; chiefly, no doubt, because the instruments for air are not fully developed yet, and because the air leakage does no harm to any of the neighbouring property, while electrical leakage may cause serious damage to such property.

The leakage into vacuum systems is naturally much less than leakage from pressure systems, because the holes become filled up with dirt and dust from the atmosphere, so the entry of air from outside is checked.

Tests made on street tubes in London in 1913, to determine the amount of leakage from pneumatic tubes, gave the following results:—9 tubes worked continuously by pressure gave leakage 4.65 lb/min; 21 tubes worked continuously by vacuum gave a leakage 3.60 lb/min; 6 tubes worked both ways intermittently gave leakage at the rate 1.48 lb/min; 6 similar tubes with very old apparatus gave a leakage 5.40 lb/min. This leakage included the air lost from the terminal apparatus and from any leaks in the lead tube, which occur mostly at bad joints or from old joints which have become broken through age; the greater part was undoubtedly from the apparatus. The plant working the tubes was dealing with about 120 lb. of air per min., so that the leakage load was from 3 per cent. to 5 per cent. of the total.

The amount of air lost in terminal apparatus by means of which carriers are inserted in and abstracted from  $2\frac{1}{4}$ -in. tubes may be expected to be about 0.10 to 0.20 lb/min when the tubes are worked at 10 lb/in<sup>2</sup> pressure, and from 0.03 to 0.15 lb/min when worked by 7 lb/in<sup>2</sup> vacuum. These values are a very rough guide as to what may be expected when the apparatus is kept in reasonable repair.

### C. Notes on pneumatic tubes.

Pneumatic tubes are used to transmit (a) parcels, (b) letters, (c) telegrams, (d) cash and bills, (e) messages, notes, dockets. By far the greater number of tubes in use, however, are for the uses (c), (d), (e).

The material of which the tubes are made may be steel, wrought iron, lead, brass, or copper. The tubes of the British Post Office laid in streets are of lead laid in cast-iron pipes. On the Continent it seems that iron is more usually employed. To reduce air friction and to prevent the carriers from sticking the tubes have to be made very smooth; for this reason steel, which rusts easily, is not so suitable as brass or lead, though these latter metals are more expensive: for small-sized tubes, where the cost of installation is large compared with the cost of the material, the use of brass is economical.

Carriers for the reception of messages, cash, or dockets consist of tubular receptacles of less diameter than the tube: the body of the carrier is made of leather, fibre, aluminium, iron, steel, or gutta-percha covered with felt;

one end is always closed, the other end is sometimes left open. A common method of closing the open end consists in having an elastic tape or leather band across it, which is moved to one side when messages are being inserted: the band covers the end while the carrier is in the tube, thus preventing the messages or docketts from dropping out during transit: in practice, however, messages do sometimes fall out even though the band is apparently placed across the open end.

The manufacture and production of carriers which will endure the hard usage they receive is no easy matter. Carriers (i.) travel at velocities up to 40 miles per hour; (ii.) they travel in tubes which are liable to be damp, and which are often quite wet, so that the carrier body becomes soaked with water; (iii.) they are brought to a dead stop at the terminal apparatus when travelling at full speed; (iv.) they are likely to be handled roughly when being loaded with messages. The two weakest parts are the buffer and the band or cap used to close the open end.

To provide buffers which will not wear quickly, and of approximately the same diameter as the tube, is also difficult. In tubes in England carriers are sent as single units, and each carrier is provided with its own buffer to prevent air leaking past; a single carrier can travel quite well. In Berlin and Vienna tube systems the carriers have no buffers, and a special buffer carrier to drive a train of from 3 to 5 message carriers is used. This special buffer carrier wears out much more quickly than the message carriers.

The carriers used by the British Post Office administration are of leather or gutta-percha; those used by private firms are often of fibre, brass, or leather. On the Continent carriers of iron and leather are used; the iron tube fits tightly into the leather tube and a closed carrier is formed.

Carriers for holding cash must be made so that there is no chance of the coins falling out; so provision must be made for totally enclosing the interior: one manufacturer arranges for this by making the body of an outer and an inner tube, in both of which are apertures. These apertures can be made to coincide, and money can be inserted; then, by rotating the outer tube a half turn, the hole in the outer tube is brought opposite the solid part of the inner tube, and *vice versa*, so that the interior of the carrier becomes completely closed.

When a system of tubes is to be installed, one of two main types of system, viz. the radiating system or the loop system, may be employed. In the loop system a train of carriers or individual carriers are sent round the whole loop on which are various stations, say 5 to 10; at each station the train or the carriers are stopped and the messages for that station withdrawn, and the other carriers of the train are sent on their journey. At various stations on the loop there will be engines and pumps for working the tube.

With the radiating system a separate tube is taken from each outstation to a central station, where all the power plant working the tubes is concentrated: it may happen that on certain tubes two stations are placed and a small loop formed, but the fact of all the plant being in one place makes the system a radiating one.

Tubes can also be divided into "house" and "street" tubes: the latter connect stations in different buildings and are laid mostly in public thoroughfares, while the former only connect the stations in a particular

building. House tubes will, therefore, be relatively short, and street tubes will be relatively long.

The power plant, or engines and pumps required to compress or rarefy the air for the tubes, consisting of compressors, motors, reservoirs, and the necessary pipework, will always be placed at the Central station in radiating systems, but is scattered about among various offices in the loop system.

The factor which should decide the type of system to be adopted is whether the traffic is mostly for the offices in the town or for offices in other towns. In the latter case, as the traffic must be transmitted by other means than tubes to other towns, and such transmission can best be done from one centre, the radiating system will be the better: in the former case, when the traffic is mostly internal and will not necessarily need retransmission, the loop system will save time in the delivery of the majority of the messages.

Instructions and information as to the working of tubes can be found in the British Post Office Technical Instructions, X., which also describes the apparatus used for introducing and ejecting carriers from the tubes.

As regards the air work done in the tubes, this is mostly consumed in overcoming the air friction and not in moving the carrier along the surface of the tube. Some inventors suggest the use of carriers with wheels, but no advantage would be gained thereby. While a carrier is travelling in a tube the carrier friction exists over about 6 in. to 3 ft. of tube, while the air friction exists over the whole length of the tube, which may be from 300 to 6000 ft. long. There is no way of avoiding the air friction: the only way in which it can be reduced is to use rarefied air. The friction varies roughly as the density, so that working by vacuum with rarefied air is preferable to working by pressure with compressed air. This has just been dealt with, but it may be emphasised that to obtain a mean speed of 30 ft/sec on a  $2\frac{1}{4}$ -in. tube 6000 ft. long a pressure of 10 lb/in<sup>2</sup> or a vacuum of  $6\frac{1}{2}$  lb/in<sup>2</sup> would be required, the pressure at the other end being atmospheric.

The cost of working radiating tubes continuously while air is delivered at a *fixed pressure* is less for long tubes than for short tubes, but the *speed* of carriers varies in tubes of different length, and is much less in long tubes than in short tubes. The cost of working long tubes continuously is much greater than the cost of working short tubes if the same *speed* is maintained on them all and the *pressure* is varied to suit the length.

The cost of work done on the air used in working pneumatic tubes at 10 lb/in<sup>2</sup> pressure or 8 lb/in<sup>2</sup> vacuum per hour, if the cost of a Board of Trade unit (kw-hr.) is 2d., will be approximately:—

Length of tube in feet .	3000	6000	9000
Cost for $2\frac{1}{4}$ -in. tube .	10½d. (8d.)	7½d. (6d.)	6d. (4½d.)
Cost for 3-in. tube .	2s. (1s. 7d.)	1s. 6d. (1s. 2d.)	1s. 2d. (11d.)

The figures in brackets give the cost for vacuum working. The cost is for the current consumed by the electric motors driving the air-pumps delivering the air at the requisite pressure: the cost of maintaining the plant is not included.

Tubes are economical for transmitting telegraph messages, because relatively unskilled attendants can place the messages in carriers and send

them to the central offices for retransmission by wire to their destination, whereas only highly skilled officers could send the messages by wire to the central offices. Saving in labour costs can also be made by certain private firms which send large quantities of telegrams: if these telegrams are sent by messenger to the telegraph office the cost of the messenger service may be heavy: in such cases it may pay the firm to have a tube laid to the telegraph office and pay rental for the use of the tube. Such a tube will in any case give the firm a quicker service: whether this is of any advantage depends entirely upon the importance of the traffic handled.

Regarding the question of faults which occur in tubes when carriers become fixed in them something may be said here. When they become fixed because of obstructions, dents, displaced joints, etc., they can sometimes be removed by reversing the pressure. Suppose that the carrier has been travelling under pressure and strikes a large obstruction which simply stops it; by turning on vacuum it can be brought back to its starting-point. By noting the time between the turning on of vacuum and the arrival of the carrier some idea is gained of where the obstruction exists. Suppose now that the carrier strikes a dent in the tube, but that its impetus drives it under the dent and it becomes wedged; now a mere reversal of the pressure will fail to dislodge it, but the application of extra high pressure may possibly do so. If this fails, the position of the obstruction must be located, the street opened, and the tube cut. Such a fault is of rare occurrence, because there is ordinarily nothing to cause a dent except external damage. The usual damage to tubes is caused by workmen digging up the road when laying gas pipes or electric mains, and driving their picks through the pipes: in one known case the man actually transixed a carrier just as it was passing the pick. These faults are easily found by sending someone along the route of the tube in the streets and noticing where men have been at work.

Unusual obstructions are caused by pencils, papers, penknives, steel springs, parts of carriers, and other materials finding their way into the tube: these articles may take up a position so that carriers become wedged in the tube and a block is formed: at other times the article is driven forward by the carrier and delivered into the receiving apparatus. The position of such obstructions cannot be determined by inspection, but is usually located by cutting the tube at some point and inserting sweep-rods, which are pushed along until they touch the blocked carrier. Faults have been caused by electric cables going to earth on the tube and fusing the lead, which then formed an obstruction and stopped the carriers. Such faults can be located by finding where workmen are repairing the electric mains.

For those who are anxious to find further information on this subject of pneumatic tubes, the following papers and reports may be of interest:—

*Post Office Engineers' Journal*:—

2/26/1909. D. H. Kennedy gives a general description of tubes.

4/209/1911. H. P. Brown describes the system of rectangular tubes for paper docketts at the Trunk Exchange, London.

6/378/1913. A. B. Eason gives particulars of tubes worked by hand-pumps.

7/189/1914. E. H. Walters describes the house-tube system in the Central Telegraph Office, London.

Institute of Post Office Engineers, printed papers :

No. 32. "Pneumatic Despatch Tubes" : H. R. Kempe gives a general historical sketch of the subject.

No. 36. "Post Office Installations" : H. O. Fleetwood describes various systems in use in S.W. England and Wales.

No. 55. "Telegraph Traffic and Power Plant of Tubes" : A. B. Eason gives the theory and reasons for various systems.

The Technical Instructions of the various Post Office governments would probably also have valuable information.

In the *Electrical Review*, 69/1006/1916, a general description of the 8-in. pneumatic tubes used in New York for the transmission of letters is given. The pressure used is about 10 lb/in<sup>2</sup> : no details as regards transit times and other scientific facts are given.

Kasten describes the tube system of Berlin in *Archiv. Post. Teleg.*, 22/657/1911.

## CHAPTER XIV.

### METHODS OF PRODUCING AIR CURRENTS.

Units for specifying air pressures—Forces due to air currents and wind—Aeromotive force due to temperature differences—Various formulæ for velocities of chimney gases—Fans and blowers.

THIS chapter deals with the methods by which pressures can be obtained to produce air flow, viz. :—

- (a) The force of wind blowing directly on the end of an opening.
- (b) Wind blowing across an opening, which creates a suction effect.
- (c) The difference of temperature in columns of air.
- (d) Fans and rotary blowers.
- (e) Turbo-blowers and air-compressors.

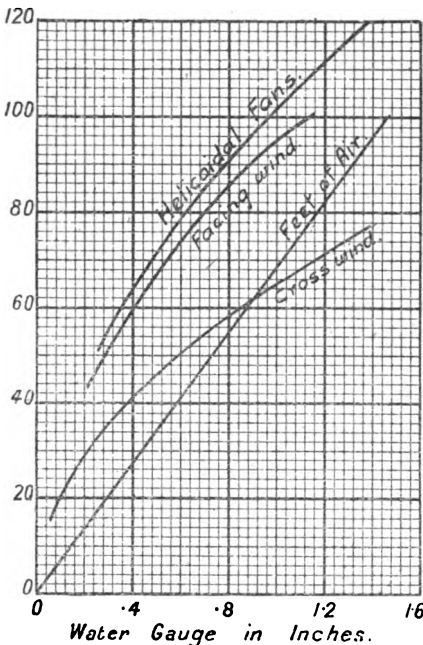

FIG. 14'1.—Aeromotive force of winds and fans. (Given by Shaw.)

Four common units are used to specify the amount of aero-motive force or pressure producing the flow, namely :—

- (i.) Feet of head of fluid under discussion.
- (ii.) Height of the water or mercury gauge.
- (iii.) Pressure in lb/ft<sup>2</sup>, lb/in<sup>2</sup>, kg/m<sup>2</sup>.
- (iv.) Pressure in atmospheres.

Feet of fluid is only used in calculations, as it is not measurable directly; water-gauge readings are practically always used for ventilation work; atmospheres or lb/in<sup>2</sup> are practically always used in compressed-air work.

Shaw (*Ventilation*, p. 9) has given a table of the comparative values of pressure produced by the methods (a), (b), (c), (d), but as he deals only with ventilation work the pressures are only small; some of the values are shown in fig. 14'1.

Any of the methods are used in ventilation work, but for gas, pneumatic-tube, compressed-air work, only methods (d) or (e) can be used to any extent.

The dividing line between the blowers and compressors is not at all distinct, but practically compressors would not be used to give pressures under about 2 lb/in<sup>2</sup>, nor would blowers be used to give pressures above about 5 to 6 lb/in<sup>2</sup> or so. I should think the large majority of blowers manufactured are for delivering air up to 27 in. water gauge, or about 1 lb/in<sup>2</sup>.

### Forces due to air currents.

We want to discuss the pressure caused in a ventilating duct or chimney or similar opening if an air-current blows either across the opening or directly upon it: Shaw's values in fig. 14'1 were found from the equations,

$$\text{Direct blowing, lb/ft}^2 = 0.003 (\text{mile/hr})^2 = 1.17u^2/(2g) \quad (14'01)$$

$$\text{Cross ,, ft. of head} = u^2/(2g) \quad (14'02)$$

For Pitot tubes we have already found that,

$$P = \frac{u^2 \cdot n}{2g} = \frac{m \cdot (\text{mile/hr})^2 (88)^2}{2g} = 0.00256 (\text{mile/hr})^2 \quad (14'03)$$

The increase in the value of the impact pressure in the case of wind blowing directly on an opening will be due to the fact that more of the momentum of the air is destroyed than when air blows on the small area of the Pitot tube mouthpiece.

The effect of wind blowing at right angles across an opening, such as a chimney, will be to cause the air to come out of the opening and create a pressure below the outside pressure just inside the opening. This suction effect vanishes when the opening is very small, say for an opening of  $\frac{1}{80}$ th in. in diameter, and again vanishes or becomes positive when the opening is made infinitely large. In between the two limits there must be some size of opening which with a certain velocity will give the maximum effect. The suction effect is therefore dependent both on the nature of the opening and upon the velocity of the air.

In practice a further disturbing effect arises because both the direction and velocity of air currents vary from moment to moment, and therefore the current may not always be parallel to the plane of the opening, but can be blowing either upwards away from the opening or downwards towards the opening: these variations will cause disturbances. The subject is one that affects ventilation chiefly, as the forces involved are very small.

It would be interesting to observe the effects of air currents flowing in the direction of the axis of the opening, and then flowing at various angles to the opening. In the case when the angle was 0° and the air current directly faced the opening, we know from the investigations with Pitot tubes that the impact pressure will be  $u^2/(2g)$  approximately. When the angle is 180°, as happens in the Stauscheibe, the effect will be a suction head of about  $0.38u^2/(2g)$ ; but probably, if the air were flowing past the sides of a thin tube, the effect would be greater. Such tests would be of scientific interest only, as in practice the air currents of the wind are perfectly variable as regards direction and velocity.

### Aeromotive force due to temperature differences.

Considering the simple case of a chimney, height  $H$ , in which the mean temperature of the gases is  $T_g$ , while the mean temperature of the air out-



side is  $T_a$ . Then, comparing the pressures of the columns of gas outside and inside the chimney, we get,

$$\begin{aligned} \text{Pressure at foot due to gas in chimney} &= Hm_c = HP_0/CT_c \\ \text{,, ,, ,, air outside} &= Hm_a = HP_0/CT_a, \end{aligned}$$

so that the effective pressure available for creating a draught is,

$$\frac{HP_0}{C} \left\{ \frac{1}{T_a} - \frac{1}{T_c} \right\} = 39.8 H \left( \frac{T_c - T_a}{T_c T_a} \right) \quad (14.04)$$

Now, if we take  $T_a = T_0 = 521$  abs.,

$$P_1 - P_2 = Hm_0 \left( \frac{T_c - T_a}{T_c} \right) = \frac{HP_0}{CT_0} \left( 1 - \frac{T_a}{T_c} \right) \quad (14.05)$$

$$= 0.0764 H(T_c - T_a)/T_c \quad (14.06)$$

$$h = 0.0147 H(1 - T_a/T_c) \text{ inches of water} \quad (14.07)$$

$$h = 0.00735 H \text{ if } T_c = 2T_a, \text{ as per Molesworth} \quad (14.08)$$

The pressure can be expressed in feet of gas at the temperature of either the atmosphere or in the chimney ; on the whole, it is better to put it in feet of hot gas, as follows,

$$P_1 - P_2 = H \left\{ \frac{T_c - T_a}{T_a} \right\} m_c = H'' m_c \quad (14.09)$$

The determination of the velocity of the gases in the chimney depends upon the assumptions made ; we shall assume that the pressure drives  $M$  lb. of gas per second, at mean velocity  $u$ , along the chimney of diameter  $D$ . Actually, the velocity of the gases might be varying as they went up the chimney, due to variations in the temperature. We also suppose that the length of the path at diameter  $D$ , or the equivalent length for that diameter if the real path has various obstructions in it, is  $L$ . Then the friction work in the chimney is,

$$\frac{u^2}{2g} \frac{\zeta L}{\mu} \quad (14.10)$$

where  $\mu$  is the hydraulic mean depth,  $\mu = D/4$  for a round chimney. The pressure has to create a velocity  $u$  as well as to overcome friction, so that the main equation for velocity is,

$$\frac{P_1}{m_1} - \frac{P_2}{m_2} = \frac{u^2}{2g} + \frac{u^2 \zeta L}{2g\mu} \quad (14.11)$$

Now taking  $m_1 = m_2 = m_c$  and  $P_1 - P_2 = H'' m_c$ ,

$$\text{we get} \quad \frac{u^2}{2g} = \frac{H''}{1 + \zeta L/\mu} = \frac{H''}{1 + \psi} \quad (14.12)$$

The equation for velocity is,

$$u^2 = 2g \frac{H(T_c - T_a)}{T_a} \frac{1}{1 + \zeta L/\mu} = \frac{2gT_c}{T_a(1 + 4\zeta L/D)} \frac{H(T_c - T_a)}{T_c} \quad (14.13)$$

We can only put  $u^2 = 2gH''$  if  $\psi$  is negligible as compared with unity. For chimneys over 1 ft. in diameter, for which

$$\mu = D/4 > 1/4, \quad \zeta = 0.0040 \text{ when clean, } \zeta = 0.0080 \text{ when dirty,}$$

and assuming that the least value which  $L$  is likely to have is 50 ft., then

$$\zeta L/\mu \text{ does not exceed } 4(0.0080)50, \text{ or is } < 1.6:$$

the quantity  $\psi$  is not negligible.

Kempe (*Year Book*, p. 1574) gives the approximate equation,

$$u^2 = 2gH'' \quad . \quad . \quad . \quad . \quad . \quad (14.14)$$

but the equations usually given include the friction term.

Hurst (*Arch. Surv. Hand.*, p. 210) quotes Montgolfier's equation for the velocity in chimneys, as,

$$u = 8.025[H\alpha'(T_c - T_a)]^{1/2} \quad . \quad . \quad . \quad . \quad (14.15)$$

where  $\alpha'$  = coefficient of expansion of air = 0.002 approx.

= the reciprocal of the absolute temperature = 1/491;

therefore

$$u^2 = 2gH(T_c - T_a)/T_a \quad . \quad . \quad . \quad . \quad (14.16)$$

which is the main equation when the friction is negligible.

Then Hurst gives an equation including the friction term,

$$u^2 = \frac{0.13 DH(T_c - T_a)}{D + NL} \quad . \quad . \quad . \quad . \quad (14.17)$$

$N$  being a constant with various values, *i.e.*,

For glazed earthenware chimneys,	$N = 0.02,$	$\zeta = 0.0050$
„ wooden flues	$= 0.03,$	$= 0.0075$
„ sooty flues	$= 0.06,$	$= 0.0150.$

The above formula can be transformed into the form,

$$u^2 = \frac{(64.4/495)T_a H''}{1 + N(L/D)} \quad . \quad . \quad . \quad . \quad (14.18)$$

which gives values for  $\zeta$  as above mentioned when

$$T_a = 495 \quad \text{or} \quad \theta = 34^\circ \text{ F.}$$

Geipel (*Elec. Engr. Form.*, p. 324) gives for the velocity of chimney gases, in chimneys less than 3 ft. in diameter,

$$u^2 = 2gH \frac{(T_c - T_a)}{T_a} \frac{1}{13 + 0.6 L/12 D} \quad . \quad . \quad . \quad (14.19)$$

or

$$u^2 = \frac{2gH''}{13 + (0.125)4 L/D} \quad . \quad . \quad . \quad . \quad (14.20)$$

In this the appearance of 13 instead of 1 is unintelligible, and Geipel does not state why it should be there. In the case of chimneys over 3 ft. in diameter, he gives the approximate formula,

$$u^2 = 4.6 H'' ,$$

in which the factor  $2g$  has been divided by 14.

The *Standard Handbook for Elec. Engr.*, p. 567, gives,

$$h = 0.52 H p_0 \left( \frac{1}{T_a} - \frac{1}{T_c} \right) = \frac{7.61 H}{T_a} \left( 1 - \frac{T_a}{T_c} \right), \text{ as Eq. 14.07.} \quad (14.21)$$

The *Practical Engineer's Pocket Book*, p. 89, gives,

$$h = \frac{H(T_c - T_a)}{0.13 T_c T_a} = \frac{1}{0.13 T_a} H \left( 1 - \frac{T_a}{T_c} \right) \quad (14.22)$$

This is Eq. 14.07, when the air temperature is 522 abs.

Fowler (*Elec. Engr. Hand.*, p. 451) gives the formula,

$$h = H \left( \frac{7.6}{T_a} - \frac{7.9}{T_c} \right) = \frac{7.6 H}{T_a} \left\{ 1 - \frac{T_a}{T_c} (1.04) \right\} \quad (14.23)$$

which is Eq. 14.07, except for the addition of the 4 per cent. to the last term; the reason for such addition is not known.

Molesworth (*Eng. Form.*, p. 438/1907) quotes for the velocity of chimney draught,

$$u^2 = \frac{(2.42)^2 (\theta_c - \theta_a) H}{\theta_c^2} = \frac{5.88 (T_c - T_a) H T_a}{(T_c - 461) T_a} \quad (14.24)$$

Comparing this with Eq. 14.09, we get,

$$\frac{2g}{1 + \psi} = \frac{5.88 T_a}{\theta_c^2} \quad (14.25)$$

If  $\psi = 1.13$  and  $T_a = 521$ ,  $\theta_c^2 = 10$ , which is wrong.

There is some fault in the formula; if the 2.42 reads 24.2, and  $\theta_c$  is put under the root, then  $\theta_c = 0.913(1 + \psi)T_a$ , which is possible for ordinary cases.

Hutton's formula (*Prac. Engr.*, p. 605) is,

$$u^2 = \frac{2gH(T_c - T_a)}{3.3 T_c} = \frac{2gH''T_a}{3.3 T_c} \quad (14.26)$$

What the 3.3 represents, and how it is arrived at, is unknown.

### Fans and blowers.

The dividing line between fans, rotary blowers, blowing engines, and compressors is not defined; but in general fans deliver relatively large quantities of air at very low pressures; rotary blowers and blowing engines deliver medium quantities of air at medium pressures; compressors deliver small quantities of air at relatively high pressures.

Of these, only rotary blowers are dealt with here.

There are books dealing with fans, and others dealing with air compressors, but few deal with rotary blowers and with the laws upon which they work. A report of tests made upon Root's blowers used for working pneumatic tubes may be of interest: the results are not highly accurate, as the tests were made for commercial purposes, without any special instruments.

The chief difference between the performance of rotary blowers and air compressors is that the quantity of air displaced by blowers depends

upon (i.) size, (ii.) speed, (iii.) pressure of delivery ; whereas for reciprocating compressors it depends upon (i.) and (ii.), but is roughly independent of (iii.). This is only approximately true ; but the lb. of air delivered by an air compressor if the pressure is 80 lb/in<sup>2</sup> instead of 60 lb/in<sup>2</sup> will not be materially decreased—if the compressor is well made,—whereas with blowers the quantity delivered at 6 in. water gauge will be much greater than the quantity delivered at 8 in.

We shall consider the question of blowers working pneumatic tubes. Given a tube of a certain length L and of diameter D, what size blower will be required to work it at a definite carrier speed ? What will the revolutions of the blower be per minute, and what electrical energy will be required to drive it ?

Considering a real example, what blower would it be best to use to work a 2½-in. tube 300 yards long if the air speed is to be 30 ft/sec, giving a transit time of about 30 seconds. The question at once arises whether a large blower running at a slow speed will do the work more efficiently than a small blower running at a high speed. Roughly, any convenient size of blower does the work equally well, because for any fixed speed of transit the water gauge and the quantity of air flowing are constant. The air work necessary is therefore fixed, and the only comparison is between a small blower revolving quickly and a large blower revolving slowly : the friction will be similar in either case if the displacement is the same.

To solve the problem adequately, one requires, first, a series of curves giving the electrical energy necessary to drive blowers delivering 20, 30, 40, 50 cu. ft. of free air at 2, 3, 4, 5, 10, 20 in. water gauge for various types of blowers ; and then a series of curves showing what water gauges are necessary to drive 20, 30, 40, 50 cu. ft. of air through tubes of various diameters. We have not had the opportunity of making complete tests on this matter, but have got some results showing the electrical input required for particular blowers to deliver certain quantities of air.

Tests were made with blowers working—

1. Actual length of tubes.
2. Through orifice plates.
3. Through a made-up length of pipe, orifice meter, and throttle cock.

As regards input and speed, the tests showed that one could put the speed, *n*, and the watts input, *W*, in the form,

$$W = a + bQ + ch,$$

$$n = a' + b'Q + c'h,$$

where *Q*=cu. ft. of free air per min., *h*=water gauge at blower. *a*, *b*, *c*, *a'*, *b'*, *c'*, are constants depending upon the actual blower tested. The general results are shown in fig. 14'2, which

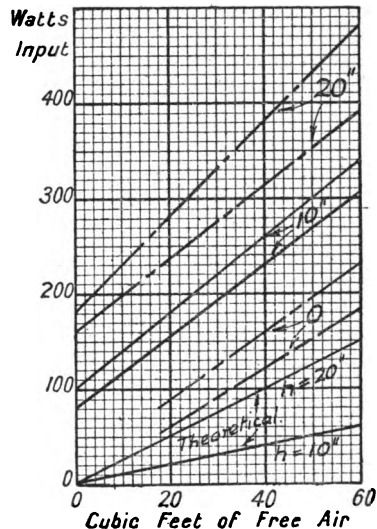

FIG. 14'2.—Electrical energy required to deliver air at various pressures. The energy will lie between the upper and lower lines, depending on the type of blower used.

gives the watts input required for delivering various quantities at 0, 10, 20 in. of water gauge. This enables one to form some idea of the cost of working small tubes continuously. The watts required theoretically to compress the air isothermally to 10 in. and 20 in. =  $0.125Qh$  approximately, as shown in fig. 14'2.

There is difficulty in determining at a maker's works whether a blower is an economical one to use for tubes: in pneumatic-tube work the resistance placed in the blower circuit is a long length of tube. Such a resistance cannot be reproduced by the manufacturer, who usually employs an orifice plate to determine the quantity displaced by the blower. Take, for instance, a blower running at 400 rev. per min., which has the outlet blocked by a flange in which is a  $\frac{1}{2}$ -in. diameter hole, and at the back of which the blower maintains a pressure of 1 or 2 lb/in<sup>2</sup>. There is no plain formula for the discharge in such a case, because the velocity of the air at the back of the orifice is not zero. Such an orifice is not perfectly equivalent to a tube, because the resistance of a tube does not vary absolutely as (velocity)<sup>2</sup>; but one can use an orifice plate of a certain size as the rough equivalent of a tube of a certain length: in one test an orifice  $1\frac{3}{8}$  in. diameter appeared to be equivalent to 60 ft. of  $2\frac{1}{2}$ -in. tube, as the water gauge was the same for the tube and for the orifice, which were placed one before and one after the blower.

Tests made with a blower run at various speeds working a particular tube are of no use for general comparisons, because the quantities and water gauges vary together. For general comparisons one must know the watts input for any quantity  $Q$  at any water gauge  $h$ , and this can only be obtained by running a blower at various speeds and working tubes of various lengths, say 100, 200, 500, 1000 ft. long.

#### AUTHORITIES MENTIONED.

Fowler, Geipel, Hurst, Hutton, Kempe, Molesworth, Shaw.

CHAPTER XIV.—SYMBOLS USED.

Equation.	Symbol.	Meaning.
14'04	C	=gas constant.
14'13	D	=diameter.
14'01	$g$	=gravitational constant.
14'04	H	=height of chimney.
14'09	$H' = H(1 - T_a/T_c)$	=pressure in ft. of hot gases.
14'01	$m$	=density.
14'17	N	=a coefficient.
14'05	P	=pressure.
14'04	$T_c$	=mean temperature of gases in chimney.
14'04	$T_a$	= „ „ of air.
14'01	$u$	=velocity.
14'15	$\alpha'$	=coefficient of expansion of air.
14'10	$\zeta$	= „ „ of friction.
14'24	$\theta$	=temperature in degrees.
14'10	$\mu = D/4$	=hydraulic mean depth.
14'12	$\psi = \zeta L/\mu$	=a function of the length and diameter.



## NAME INDEX.

ALLEY M'LELLAN, 145.

Anderson, 166.

Anthes, 213.

Archer, 43, 75.

Arson, 34.

Ashcroft, 133.

Aubery, 47.

Ayrton, 181.

BABCOX, 38.

Baeyer, 126.

Bailey, 144.

Banki, 76.

Barclay, 152.

Barker, 33, 75.

Barnes, 49.

Batcheller, 39.

Batten, 167.

Beardmore, 37, 152.

Bendermann, 126.

Berlowitz, 150.

Berry, 163.

Bontemps, 115.

Booth, 39, 75.

Box, 38, 142, 222.

Boyd, 163.

Brabbée, 43, 75.

Bradley, 213.

British Thomson-Houston Co., 168.

Brown, 41.

Brown, H. P., 234.

Buchholz, 153.

Burnham, 161.

Busey, 74, 162.

CAROTHERS, 43.

Carpenter, 32, 205.

Carrière, 154.

Chandler, 37.

Chapman Valve Co., 36.

Chatley, 224.

Church, 40, 77.

Claassen, 147.

Coblentz, 180.

Coker, 49.

Coleman, 131.

Compan, 181.

Cox, 36, 41.

Cramp, 172.

Crewson, 168.

Cripps, 35.

Culley, 95, 112.

DALBY, 133.

Darcy, 55, 164.

Devillez, 45.

Dines, 222.

Dowling, 50.

Durley, 133.

Dyer, 57.

EARHART, 51.

Eberle, 39.

Eiffel, 169.

Emden, 224.

Estep, 211.

FENKEL, 162.

Fisher, 213.

Fleetwood, 234.

Fowler, 240.

Frank, 227.

Fritzsche, 45, 100.

Froude, 222.

Fry, 171.

GASKELL, 142.

Gebhardt, 167.

Geipel, 36, 39, 75, 204.

Gerdien, 191.

Gerlach, 180.

Gibson, 47, 131, 171.

Gilchrist, 51.

Girard, 34.

Goodenough, 204, 215.

Grashof, 45, 204.

Grebel, 35.

Gregory, 163.

Grierson, 32.

Griggs, 167.

Grindley, 47, 214.

Gutermuth, 42.

HACKETT, 151.

Hagen, 55.

Hall, 224.

Harding, 32, 74.

Harrington, 51.



Harris, 41, 102, 134.  
 Hartmann, 196.  
 Hartshorn, 209.  
 Hatch, 75.  
 Hausbrand, 32.  
 Hawkesley, 34, 37.  
 Hayes, 153.  
 Hazen, 43.  
 Hebblewhite, 147.  
 Heenan, 162.  
 Henderson, 198.  
 Henry, 171.  
 Herschel, 131.  
 Hickstein, 141.  
 Hirn, 212.  
 Hirschfeld, 208.  
 Hiscox, 39.  
 Hodgson, 154, 210.  
 Hole, 37.  
 Houdaille, 51.  
 Hughes, 194.  
 Hurst, 36, 239.  
 Hutton, 222, 240.  
 Hütte, 47, 100.

INNES, 32, 42, 75, 98, 162.

JOHNS, 222.  
 Johnson, 40, 77.  
 Johnston, 38, 74.  
 Judd, 163.

KEMPE, 32, 39, 75, 205, 239.  
 Kennedy, 127, 234.  
 Kennelly, 179, 184.  
 Kent, 40.  
 Kilgour, 36, 75, 181.  
 Kinealy, 33, 74.  
 King, 49, 188.  
 King's *Treatise*, 35.  
 Kirchoff, 157.  
 Kleint, 51.  
 Kneeland, 47, 167.  
 Kohlrausch, 50.  
 Krell, 172.  
 Kurlbaum, 189.

LANDER, 56.  
 Langley, 222.  
 Langmuir, 179, 186.  
 Laschinger, 40, 75, 104.  
 Ledoux, 40.  
 Lees, 55, 226.  
 Lelong, 32.  
 Levin, 153.  
 Lewis, 57.  
 Lindenheim, 126.  
 Lindolt, 51.  
 Ling, 209.  
 Loeb, 169.  
 Lorenz, 42, 45, 183.

Lowe, 35.  
 Lummer, 189.  
 Lütke, 154.

MALONE, 197.  
 Mansbridge, 64.  
 Markowski, 51.  
 Markwell, 51.  
 Martin, 37, 38, 74.  
 Masse, 35, 47.  
 Mayniel, 35.  
 Meier, 48.  
 Meyer, 52, 178.  
 Mitchell, 181.  
 Molesworth, 37, 240.  
 Monnier, 35.  
 Montsinger, 180.  
 Morley, 212.  
 Morris, 192, 194.  
 Moss, 138, 175.  
 Müller, 138, 174.

NAPIER, 204.  
 Nelson, 145.  
 Newbigging, 37.  
 Northrup, 197.  
 Norwalk Compressor Co., 74.

ODELL, 224.  
 Oliphant, 36.  
 Orr, 126.

PANNELL, 53, 171.  
 Pannetti, 227.  
 Paschen, 180.  
 Peclet, 74.  
 Pecqueur, 45.  
 Peczalski, 180.  
 Pedersen, 51.  
 Pelzer, 42, 44.  
 Petit, 42.  
 Phillips, 126.  
 Pittsburg, 36.  
 Pole, 35, 37.  
 Possieule, 1.  
 Poynting, 179.

RATEAU, 204, 212.  
 Rayleigh, 216, 226.  
 Raynes, 38, 74, 169.  
 Recknagel, 174.  
 Retschky, 171, 182.  
 Reynolds, H., 208.  
 Reynolds, O., 45, 49, 55.  
 "Rhenania," 147.  
 Richards, 40.  
 Riedler, 39, 76.  
 Rietschel, 32, 151, 174.  
 Rix, 40.  
 Robinson, 152.  
 Rowse, 172.  
 Russell, 186.

SABINE, 95.  
Sanborn, 184.  
Saph, 43.  
Saunders, 42.  
Scanes, 205.  
Schilling, 35.  
Schmidt, 32.  
Schofield, 135.  
Scholz, 64.  
Schroder, 43.  
Schwartz, 188.  
Sentinel, 145.  
Sergeant, 126.  
Shakespear, 223.  
Shattuck, 38.  
Shaw, 3, 134, 236.  
Smith, 152.  
Spitzglass, 168.  
Stack, 151.  
Stanton, 53, 125, 152, 161, 222.  
Stefan, 179.  
Stewart, 214.  
Stockalper, 48.  
Stodola, 175, 215.  
Sturtevant, 34.  
Sutherland, 52.  
  
TAYLOR, 33, 76, 156, 165.  
Teago, 169.  
Thies, 38.

Thomas, 35, 148, 165.  
Thomson, 179.  
Thorkelson, 34, 204.  
Threlfall, 124, 157, 163.  
Thurston, 170, 223.  
Treat, 34, 168.  
Tyndall, 171.  
  
UNWIN, 36, 39, 55, 75, 77.  
Upton, 209.

## VERNER, 38.

WALTERS, 234.  
Watson, 135.  
Weinstein, 52.  
Weisbach, 42, 48, 55, 75, 216.  
Westcott, 142.  
Western Electric Co., 41.  
Weymouth, 174.  
White, 162.  
Wilcox, 38.  
Williams, 162.  
Wing, 125, 128.  
Worthington, 197.

ZAHM, 224, 226.  
Zenneck, 223.  
Zeuner, 97, 200, 215.  
Zichendraht, 175.

## SUBJECT INDEX.

- ABACUS**, derivation of, 57.  
 — for gas-flow problems, 35.  
 — for pneumatic tubes, 59.  
**Abbreviations**, symbols, 10  
 — in reference to reports, 32.  
**Absolute measurement of velocity**, 125.  
 — unit of air resistance, 3.  
**Accuracy** :  
   depending on air humidity, 125.  
   in recording pipe lengths, 126.  
   Pitot tube readings for, 160.  
   of anemometers, 152.  
   of formulæ, 21.  
   of gas meters, 128.  
   of hot-wire meter, 191.  
   of Pitot tubes, 173.  
   of Sentinel meter, 146.  
**Adiabatic compression**, work done, 93.  
 — expansion, index of, 95.  
**Aero-motive force**, definition, 3.  
 — — — produced by fans, blowers, 240.  
 — — — by temperature difference, 237.  
 — — — by wind, 237.  
**A.I.E.E.** = *Amer. Inst. Elec. Engr.*  
**Air** : conduction, convection, density, flow, humidity, viscosity, volume, weight.  
   *See* relative quality.  
 — meters, Chapter VIII.  
 — pressure on discs, rods. *See* Impact of air.  
 — — in pipes, orifices, tubes. *See* Pressure.  
**Allowance for resistance of bends**, etc., 67.  
**Amount of air used.** *See* Quantity.  
**Analogy between air transmission and electrical transmission**, 2.  
 — between air flow and electric current flow, 3.  
**Anemometers** :  
   calibration of, 151.  
   description, 150.  
   disc, 152.  
   hot-wire. *See* Hot-wire meter.  
   inaccuracy of, 151.  
   used as standards, 152, 169, 181.  
**Angles suitable for branching pipes**, 34.  
**Area**, ratio of throat, orifice, pipe areas.  
   *See* Ratio.  
**Atmosphere**, humidity of, 4.  
**Atmospheric pressure** :  
   in looped tubes, 86.  
   usual value chosen, 5.  
   variation in, 222.  
**BEND**, loss of pressure at, 72.  
 — specify kind and radius, 71.  
 — types of, 73.  
**Bibliography of books and references**, 11.  
**Blowers** :  
   energy used in driving, 241.  
   output tested by Pitot tubes, 166.  
   pressure of delivery, 241.  
   used as meters, 128.  
   used for pneumatic tubes, 85.  
   used to calibrate anemometer, 151.  
**Books consulted**, 11.  
**Branching pipes**, 34, 36.  
**Brick ducts**, friction, 32.  
**CALIBRATION** :  
   of anemometers, 151.  
   of hot-wire meter, 190.  
   of meters, 124.  
   of Pitot tubes. *See* Pitot tubes.  
**Carriers** :  
   condition affects transit time, 108.  
   difficulty of manufacture, 232.  
   friction *versus* air friction, 233.  
   increasing the speed of, 83.  
   materials for, 233.  
**Charts**, logarithmic, for solving problems, 60.  
**Chimneys**, flow of gas in, 33.  
**Coal gas**, constituents, 6.  
 — specific heat, 149.  
 — viscosity, 51, 54.  
**Cocks**, pneumatic, loss of pressure in, 220.  
**Coefficient of air pressure on surfaces.** *See* Impact of air.  
 — of convection,  $\lambda$ , 185.  
 — —  $k$  (Hartmann), 196.  
**Coefficient of contraction in and discharge from orifices** :  
   definition of, 132.  
   general discussion, 133-144, 206-213.  
   in meter valve, 146.  
   related to coefficient of velocity, 215.  
   table of values, 207.

- Coefficient of friction in pipes and tubes :  
 conclusions concerning, 65.  
 definition of, 18.  
 dependent on density, Table 2'4, 27.  
 — on diameter, Table 2'3, 27.  
 — on pressure,  $T/(pu)$ , 30, 46.  
 — on quantity,  $M$ , 29, 47.  
 —  $M/D\eta$ , 31, 54.  
 — on velocity, Table 2'4, 27.  
 independent of diameter, Table 2'2, 26.  
 $K$ ,  $K'$  for gas flow, 35.  
 reduced by oil, 44.  
 related to surface friction  $k$ ,  $f$ , 41, 225.  
 — to viscosity, 54.  
 values for pipes,  $\frac{1}{4}$  to 36 inches (Unwin), 24.  
 — — 10 to 1000 mm. (Unwin), 25.  
 Coefficient of impact,  $K$ , of air on discs, 222.  
 — — — on rods, 223.  
 — of Pitot tubes. *See* Pitot tubes.  
 — of resistance at bends, fittings, definition, 67.  
 — — — *See also* Loss of pressure.  
 — of velocity,  $c_v$ , 215.  
 Comparison :  
 capital and maintenance costs, 90.  
 cost of various types of meter, 126.  
 energy required for big and small tubes, 229.  
 friction formulæ, 27.  
 loss of pressure in one or two pipes, 89.  
 pressure *versus* vacuum working, 233.  
 speeds in looped and unlooped tubes, 86.  
 — of old and new carriers, 108.  
 transit-time formulæ, 112.  
 Compression, adiabatic, work done, 93.  
 — isothermal, work done, 93.  
 Conduction, conductivity, of heat in air, 178.  
 Conductivity of various gases, 6.  
 — of metals, electrical, 193.  
 Constituents of mixed gases, 6.  
 Containers :  
 leakage from, 230.  
 loss of pressure at entrance, 73.  
 — at exit, 74.  
 measurement by, 127.  
 Continuous working of pneumatic tubes, 79, 109, 233.  
 Contractions used, 10.  
 Convection :  
 cooling by, 180.  
 effect of moisture, 184.  
 — of pressure, 184.  
 from flat surfaces and laminae, 183.  
 from hot wires, Hartmann, 196.  
 — — Kennelly, 184.  
 — — King, 188.  
 — — Morris, 192.  
 from hot wires, Northrup, 197.  
 — — Russell, 186.  
 from tubes, 194.  
 in compressed or rarefied air, 183.  
 in water, 197.  
 Convectivity,  $\lambda$ , defined, 185.  
 Converging nozzles, 212.  
 — pipes, loss of pressure in, 76.  
 — — for Venturi meter, 129.  
 Conversion of units from one system to another, 7.  
 — — English to metric, 8.  
 — of quantities, 61, 62.  
 — factors if  $\zeta'$  not  $\zeta$  is used, 21.  
 Cooling of air in tubes, 94.  
 — of copper ball, 181.  
 Copper :  
 melting-point, 193.  
 radiation from, 179.  
 resistance, 193.  
 tubes, heat loss, 194.  
 Corrections for inaccurate data, 87.  
 — for the  $u^3$  law instead of  $u^2$  law, 62.  
 Cost of air meters, relative, 126.  
 — of working pneumatic tubes, 233.  
 Costs, saving in, by using pneumatic tubes, 234.  
 Critical pressure in orifice flow, 213.  
 Critical velocity :  
 definition, 1, 49.  
 determination of, 49.  
 equations for, 1.  
 theories concerning, 49.  
 values for air flow in pipes, 2.  
 Cup anemometer, 152.  
 Currents :  
 for fusing wires, 188.  
 for heating air flow, 150.  
 for hot-wire meter, 192.  
 for maintaining wire at temp.  $T$ , 185.  
 Curvature of bends, effect on resistance, 70.  
 Curves to use in solving problems, 87.  
 DEFLECTING anemometer, 152.  
 Delivery from orifices. *See* Orifice flow.  
 Density affects coefficient of friction, 42.  
 — — convection, 185.  
 — — pressure on surfaces, 222.  
 — does not affect viscosity, 178.  
 — of air, dry and moist, 4.  
 — of coal gas, 5.  
 — of gases, 5.  
 — of steam, 4.  
 Derivation of graphical charts, 58, 79.  
 Desiccating of telephone cables, 64.  
 Diameter of pipe, actual, 106.  
 — — determining factors, 228.  
 — — functions of, 24.  
 — — nominal, and standard, 106.  
 Differential multiplying manometer, 169.  
 Disc, air pressure on. *See* Impact of air.

Disc, air friction on, 225.  
 Discharge from orifices. *See* Orifice flow.  
 — coefficient. *See* Coefficient of contraction.  
 Displacement meters, 127.  
 Distribution of velocity across a pipe.  
   *See* Velocity distribution.  
 — of pressure at bends, 76, 153.  
 Distributor, pneumatic, 41.  
 Diverging orifice, 212.  
 — pipes, loss of pressure in, 76.  
 Dryness of air, 4.  
 Dynamical similarity, 53.  
 Dynamic head or pressure, 155.

**EFFICIENCY** of blowers, 241.  
 — overall, definition, 90, 124.  
 Elbow, loss of pressure at, 72.  
 Electric heater in pipe line, 149.  
 — hot-wire meter for velocity. *See* Hot-wire meter.  
 — meter for quantity (Thomas), 148.  
 Emissivity of bodies, 179.

**Energy used :**  
 in driving blowers, 241.  
 in electric quantity meters, 149.  
 in electric velocity meters, 194.  
 in orifice meters, 218.  
 in service pipes, 90.

Enlargement of pipe, loss of pressure, 75.  
 Equations for velocity, etc. *See* relative item.  
 Equivalent length of pipe,  $L_1$ , definition, 67.

**FAN**, used to calibrate anemometer, 151.  
 Faults in pneumatic tubes, 234.  
 Fittings, loss in pressure in, 69.  
 Flat surface, air pressure on, 222.  
 — convection from, 183.

Float meters, 147.

**Flow of air, gas, steam :**  
 equations of, 20, 22.  
 — thermodynamic, 200.  
 — derivation, Chap. IV., V.  
 from orifices. *See* Orifice flow.  
 in chimneys and flues, 33, 238.  
 in pipes and pneumatic tubes, Chap. II., IV., VI.  
 in sloping pipes, 36, 103.  
 in telephone cables, 64.  
 of air at atmospheric pressure, 32.  
 of air round rods and other bodies.  
   *See* Impact of air.  
 of coal gas, 34.  
 of compressed air, 39.  
 of steam, 38.  
 quantities, functions for. *See* Quantity.  
 resistance to. *See* Coefficient of friction.  
 stream-line and turbulent, 49.  
 various states of flow, 1.

Flow of oil, 43.  
 Flues, flow equations in, 33.  
 Formulae for flow, with fractional indices, 42.  
 — for humidity, pressure, quantity, etc.  
   *See* relative item.  
 — percentage accuracy, 21.  
 — useful even when not perfect, 37.

**Friction coefficient. See** Coefficient of friction.  
 — in chimneys, 33, 238.  
 — in orifices, 200, 214.  
 — in pipes. *See* Coefficient of friction.  
 — of air on discs and plates, 221.  
 — of carriers in tubes, 96, 108, 233.  
 Functions of diameter,  $D$ , 24.  
 — of index of expansion,  $n$ , 201.  
 — of length,  $L$ , 84.  
 — of pressure,  $\phi$ , 99.

Fusing currents of wires, 188.

**Gas constants**, of gases and air, 4, 5, 6  
 — flow, generally, 21, 34.  
 — holders, measurement by, 126.

**Gas meter :**  
 electric, 148.  
 household, 127.  
 on Pitot-tube principle, 164.  
 station meter, 126.

**Graphical solutions :**  
 for pressure, 60.  
 for quantities in short tubes, 58.  
 — in pneumatic tubes, 80.  
 for velocities, 60.  
 mean velocity in pipe, 157.

**HEAT** content, 200.  
 — constant in throttling, 216.  
 Heating of wires by electric currents, 188.  
 Hot-wire meter or electric velocity meter :

calibration of, 190.  
 choice of metals, 192.  
 current required, 185, 191.  
 details of instrument, 190.  
 principle of, 177.

**House tubes :**  
 definition, 232.  
 energy used in, 229.  
 materials for, 231.  
 quantity of air used, 88, 229.  
 size of blowers for, 241.  
 velocity of carriers, Chap. VI.

Humidity of air, 4.  
 Hydraulic equation or formula, 20.

**IMPACT** of air :  
 coefficient  $K$ , 222.  
 on bullets, 224.  
 on cylinders, 194, 223.  
 on discs, 153, 212.  
 on discs and planes, 221.  
 on inclined planes, 223.

- Impact of air :  
 on lamina, 157.  
 on large and small plates, 222.  
 on rods and bars, 222.  
 on spheres, 224.
- Impact of wind on openings, 237.  
 — pressure affected by thickness of body, 221.
- Inclined mains and pipes, flow in, 36, 103.
- Increasing the speed of carriers :  
 by auxiliary blowers, 85.  
 by boosting up pressure, 85.  
 by increasing the diameter of the tube, 112, 228.  
 by increasing the pressure, 86.  
 by reducing carrier friction, 108, 233.
- Index of adiabatic expansion, 6.
- Information, sources of, bibliography, 11-16.
- Intermittent working of tubes, 114.  
 — — time to reach steady state, 116, 122.  
 — — quantity of air used, 119.
- Isothermal expansion of tubes, 78.  
 — compression, 91, 124.
- JETS, pressure in, 162, 175.
- K, K', VALUES of, for gas flow, 35.
- Kent meter, 147.
- Kinematical viscosity, definition, 49.
- LEAKS :  
 amount of air lost in, 231.  
 effect on transit time, 111.  
 in containers, 230.  
 in pipes, 110, 231.  
 in systems, 230.
- Length, equivalent,  $L_1$ , defined, 67.  
 — functions  $L^{1.588}$ ,  $L^{1.588}$ , 84.
- Limit of useful air pressure to use, 85, 108.  
 — to quantity of air used in vacuum working, 82.
- Logarithmic charts, 57.  
 — term for acceleration, 78.
- Looping of tubes, 85.
- Loss of pressure in or at :  
 bends, 71.  
 cocks, 71, 219.  
 containers, 74.  
 crosses, 71.  
 diverging nozzles, 76, 212.  
 elbows, 72.  
 enlargement of pipe, 73, 76.  
 entering containers, 73.  
 fittings, 68.  
 formulæ for, in various units, 21.  
 globe valves, 72.  
 house tubes, 58.  
 hydraulic formulæ for, 20.  
 measuring quantities, 138, 218.  
 orifices, 133, 204.
- Loss of pressure in or at :  
 pipes, formulæ, 20.  
 — graphs, 60.  
 — general discussion, Chap. II.  
 receivers, 76.  
 service pipes, 89.  
 tees, 71.  
 tubes,  $1\frac{1}{2}$ -in.,  $2\frac{1}{2}$ -in., 3-in. diameter, 58.  
 valves, 71.
- MANGANIN, resistance, 193.
- Manometer, differential multiplying, 169.  
 — tilting, 171.
- Maximum quantity delivered from orifices, 202.  
 — and mean velocity. *See* Velocity.
- Measurement of flow, quantities and velocities. *See* Meters.  
 — — direct and indirect methods, 125.  
 — of pressure, dynamic, 153.  
 — — static, 155.  
 — — very small, 170, 172.  
 — of transit time, 112.  
 — of velocity, very small, 170.
- Mechanical viscosity, 49.
- Megabar, definition, 184.
- Melting-points of metals, 193.
- Metals, choice of, for hot-wire meter, 192.  
 — qualities, 192.
- Meters and metering :  
 calibration of, 124, 151.  
 costs, relative, 126.  
 displacement, 127.  
 electric, for quantity, 148.  
 — for velocity. *See* Hot-wire meter.  
 float, 147.  
 gas, ordinary, 127.  
 — Threlfall, 164.  
 indicating and integrating, 125.  
 on the Rand, 154.  
 orifice, 131, 145, 211.  
 Pitot tube. *See* Pitot tube.  
 recording, 154.  
 types of, 124.  
 valve (Sentinel), 145.  
 Venturi, 128.  
 vortex, 153.  
 wet station, 128.
- Methods of finding mean velocity, 161.  
 — of measuring air and gas flow, Chap. VIII.  
 — of producing aero-motive force, Chap. XIV.  
 — of referring to reports, 12/7/1916 = vol. 12, p. 7, 1916.  
 — of taking Pitot-tube readings, 158.
- Micromanometers, 171, 172.
- Minimum transit time, 82.
- Moisture in atmosphere, 4.  
 — in tubes, 107.
- Molecular weights, 6.

**Multiple Pitot tube :**

- British Thomson-Houston, 168.
- definition, 158.
- types, 165, 169.

**Multiplying manometer, 169.****NATURAL gas, qualities, 6.**

Nickel, heat losses from, 197.

Nominal diameter of tube, 106.

Nozzle, diverging, and various types, 206-212.

**OIL causing carrier friction, 107.**

— flow in orifices, 213.

— in pipes, 43, 57.

— reducing air friction, 44.

**Optical methods of measurement, 154.**

Orifice, absolute unit of resistance, 134.

— best shape for, 212.

— coefficient of contraction and discharge. *See* Coefficient of contraction.

**Orifice flow :**

delivery coefficient, 206-212.

effects outside orifice, 212.

equations for, 200.

formulae for quantity, 132, 203, 204.

friction in, 214.

maximum delivery, 203.

small pressure difference, 132, 205.

velocity distribution, 191.

**Orifice in pipe line, 136.**

— meters, 131, 211.

— commercial, 145, 208.

— formulae, 132.

— plates, 142, 211.

— size, for measuring quantities, 132, 138.

— for accurate result, 131.

— used for testing blowers, 242.

Overall efficiency,  $f$ , definition, 90, 124.

**PARABOLIC distribution, 161.****Pipe, areas, 24, 25.**

— loss of pressure in, Chap. II.

— pressure at any point, 78.

— service, determination of size, 90.

**Pitot tubes :**

accuracy, 124, 173.

calibration, 124, 169, 173.

constant or coefficient,  $K$ , 157, 163, 167.

formulae, general, 175.

— proof, 156.

—  $u = (gH)^{1/2}$ , incorrect, 157.

multiple, 158, 165, 168.

rating of, 163, 168.

reading across a pipe, 163.

for static pressure. *See* Static pressure.

theory, 156.

— of very small dimensions, 172.

Platinum as hot-wire meter, 184, 188, 194.

— emissivity, 181, 196, 197.

Platinum, melting-point, 192.

— resistance and temperature coefficient, 193.

Pneumatic cocks, loss of pressure in, 219.

— ticket distributor, 41.

**Pneumatic tubes :**

blowers for, 241.

carriers for, 232.

cost of working, 233.

definition, 231.

energy used in, 229.

faults, 234.

leaks, amount of, 231.

— theory concerning, 110.

looped tubes, quantities, 83.

materials for, 231.

moisture in, 107.

problems generally considered, Chap. IV.

— purpose of, 228, 234.

quantities found by graphs, 60, 88.

— generally, 82.

— in 2-in., 3-in., 4-in. tubes, 88, 228.

sources of information, 235.

street tubes, quantities, 80-83.

systems of, 232.

transit times. *See* Transit times.

Pneumometer=Stauscheibe, 172.

Position of mean velocity in pipe, 161.

Possieule laws, 1.

**Pressure :**

at intermediate point in tube, 78.

conversion factors for units, 9.

critical, in orifice, 213.

distribution in bends, 76, 153, 163.

— over a plate, 171.

effect on conduction, 178.

— on friction. *See* Coefficient of friction.

— on velocity of efflux, 203.

— on viscosity, 178.

in bends, 153, 163.

in throat of orifice, 213.

in tubes, varies parabolically, 78.

loss of. *See* Loss of pressure.

of air on discs, plates, etc. *See*

Impact of air.

of water vapour, steam, 7.

produced by blowers, fans, 240.

— by temperature difference, 238.

— by wind, 237.

static. *See* Static pressure.

variation at cock, intermittent flow, 115.

Problems dealt with, 1, 2.

Pulsating flow, 171.

Pure orifice definition, 145.

**QUANTITY of flow :**

graphs, 58, 60, 80.

formulae in various units, 22.

functions for, 20, 78, 81.

in compressed-air lines, 39, 40.

- Quantity of flow :  
 in house tubes, 82, 89.  
 in orifices, 132, 201-203.  
 in pipes, Chap. II.  
 in service pipes, 90.  
 in street tubes, 82.  
 knowledge desirable, 2, 123.  
 measured directly and indirectly, 123.  
 — by orifice in pipe line, 135.  
 — by electrical methods, 148.  
 — by Pitot tubes, Chap. IX.  
 with continuous working, 80.  
 with intermittent working, pressure,  
 111, 117.  
 — — vacuum, 111, 119.
- RADIATION constant,  $\sigma'$ , various values,  
 179.  
 — depends on temperature, 179.  
 — from hot wires, 180-189, 196.  
 Radius of bend and throat defined, 73.  
 Rate of cooling of spheres, 181.  
 — of air at rest in tubes, 93.  
 Ratio of areas :  
 anemometer to pipe, 151.  
 disc to pipe, 153.  
 orifice to pipe, 137.  
 Pitot tube to pipe, 137.  
 Venturi meter areas, 128.  
 Ratio of mean to maximum velocity, 162.  
 — of throat pressure to initial pressure,  
 213.  
 Receiver, fall of pressure due to leaks, 230.  
 — loss of pressure in, 74, 76.  
 References to reports, form of, 32.  
 — — 7/12/1916=vol. 7, p. 12, 1916.  
 Reports consulted, 12-16.  
 Resistance, absolute unit of air resistance,  
 3.  
 — of bends, fittings, etc. *See* Loss of  
 pressure.  
 Root's blowers, 241.  
 Roughness in pipes, arbitrarily made, 53.  
 — allowance for, 32, 33, 34.  
 — of plates, 226.
- SERVICE pipes, best size to use, 90.  
 — — loss of pressure in, 88.  
 — — problems of, 2.  
 Shielding effect of discs and plates, 153.  
 Shunt meter, 125.  
 Slide rule for gas flow, 47.  
 Sloping pipes, flow in, 36, 103.  
 Sonde (Zichendraht's), 175.  
 Sources of information, 1, 11.  
 Specific heat, volume, and gravities of  
 gases, 6.  
 Speed, increase of. *See* Increasing the  
 speed.  
 — of air in pipes. *See* Velocity.  
 — of carriers. *See* Transit time.  
 — required in pneumatic tubes, 2.
- Standard unit for quantity=lb/sec, or  
 kg/sec, 20.  
 States of flow, 1.  
 Static pressure, measurement of, 155, 163,  
 167, 173.  
 Station meter, 127.  
 Stauscheibe, 173, 174.  
 Steady motion, general equation, 198.  
 — — *versus* turbulent motion, 1, 53.  
 Steam flow in pipes, 38, 57.  
 — — in orifices, 204, 212.  
 — meters, 147, 168.  
 — viscosity of, 51, 54.  
 Stream-line flow, 1, 53.  
 Street tubes. *See* Pneumatic tubes.  
 Suction effect :  
 depends upon size of opening, 237.  
 in air impact, 221.  
 in Pitot tubes, 163, 167.  
 in Stauscheibe, 174.  
 of cross winds, 237.  
 of jet, 212.  
 of various tips, 167.  
 removed by bevelling, 166.  
 — by use of cone, 164.  
 — by use of small holes, 155, 173.
- Symbols used in equations and formulæ,  
 10.  
 Systems of pneumatic tubes, 232.  
 — of units, 8.
- TELEPHONE cables, air flow in, 64.  
 Temperature coefficient :  
 of electrical resistance, 193.  
 of heat conductivity, 6, 178.  
 of viscosity, 52, 178.  
 Temperature difference creating air  
 pressure, 238.  
 — in hot-wire meter, 184, 189.  
 — in pipes, 79.  
 — melting-point of metals, 192.  
 — standard chosen, 5.  
 Theory of air flow in pipes :  
 Culley and Sabine, 95.  
 Fritzsche, Hütte, 100.  
 Harris, 102.  
 Innes, 98.  
 Unwin, 77.  
 Zeuner, 97.
- Theories of orifice flow, Chap. XI.  
 Thermodynamic equations, 199.  
 Throat pressure, 202, 213.  
 — radius defined, 73.  
 Throttling in cocks, 219.  
 — in orifices, 216.  
 — loss of energy in, 219.  
 Ticket distributor, 41.  
 Tilting manometer, 171.  
 Time to empty tube, 122.  
 Tips for Pitot tubes, 158.  
 — — very small, 172.



## Transit time of carriers in tubes :

- effect of condition of carriers, 108.
  - of tube, 107.
  - of diameter, 106.
  - of leaks, 109.
  - of length of tube, 105.
  - of method of working, 109.
  - of pressure of working, 107, 229.
  - equations for, Unwin, 79.
  - various authorities, 112.
  - functions  $f_p, f_s$ , 80, 101.
  - F1, F2, etc., 101.
  - increased by looping tubes, 84, 86.
  - in intermittent working, 114.
  - measurement of, 114.
  - minimum possible, 79.
  - of new *versus* old carriers, 108.
  - reduction of. *See* Increasing the speed.
  - tests in practice, 112.
  - to check theory, little use, 106.
- Tubes, pneumatic. *See* Pneumatic tubes.
- Turbulent flow, 1, 53.

## UNIT of quantity, weight preferable to volume, 124.

— of resistance, 3.

## Units, factors for conversion :

- densities, 8.
- pressures, 9.
- quantities, 61.
- volumes, 62.

Units, formula for converting constants, 7.

Unsteady flow, 114.

U.S.A. Pitot tube, 167.

## VACUUM working, 82.

## Velocity across a pipe and at boundary.

*See* Velocity distribution.

— at centre of pipe, 110.

— critical, 1, 2, 49.

## Velocity distribution :

- across pipes (Stanton), 58, 175.
- (Lees), 56, 181.
- across plates, 162.
- altered by meter in pipe, 151, 169.
- around wires, 194.
- at edge of pipe, 53, 172.
- elliptical, 155, 159, 163.
- found by Pitot tubes, Chap. IX.
- by hot-wire meter, Chap. X.
- general discussion, 157.
- independent of quantity, 165.
- in orifices, 191.
- in water jets, 162.
- made uniform by baffling, 169, 174.
- parabolic, 169.
- position of mean velocity, 161.
- uncertain, 169.
- theory, 157.

## Velocity :

- formulae in various units, 23.
  - initial, 80.
  - in house and street tubes. *See* Transit times.
  - in throat of orifice, 200.
  - maximum and mean, 155.
  - mean, 155.
  - determination by multiple Pitot tube, 159.
  - determined graphically, 165.
  - position in pipe, 161.
- Velocity meters, 124, and Chap. X.
- measurement, 124.
  - absolutely, 125.
  - by anemometers, 150.
  - by light, 154.
  - by smoke, 164.
  - of efflux. *See* Orifice flow.
  - of sound, 1, 202.
  - ratio of mean to maximum, 160, 162.
  - traverse definition, 155.
  - varying with the time, 171.
- Ventilation formulae, 32.
- Venturi meter, 129.
- Viscosity :
- affected by temperature, 52.
  - generally considered, 50.
  - kinematical =  $\eta/m$ .
  - not affected by pressure, 178.
  - of air, 6, 51, 54.
  - of coal gas, 51, 54.
  - of steam, 51, 54.
  - of various gases, 6.
  - related to  $\zeta$ , 54.
- Viscous liquids, flow in pipes, 57.
- Volume of flow, formulae in various units, 23.
- *versus* weight as unit, 124.
- Vortex meter, 153.

## WATER flow in pipes, 43.

— gas, qualities, 6.

Watts emitted by hot wire. *See* Convection.

— required to heat air or gas, 150.

Weight of air, 7.

— of fluid as unit quantity, 124.

Wet station meters, 128.

Wind pressure. *See* Impact of air.

— aero-motive force produced by, 237.

Wires, convection from. *See* Convection.

— fusing currents, 188.

— radiation from, 180.

Work of air compression, 93.

Z.V.D.I. stands for <sup>28</sup> *Zeitschrift des Ver.  
Deutscher Ingr.*







THIS BOOK IS DUE ON THE LAST DATE  
STAMPED BELOW

**AN INITIAL FINE OF 25 CENTS**  
WILL BE ASSESSED FOR FAILURE TO RETURN  
THIS BOOK ON THE DATE DUE. THE PENALTY  
WILL INCREASE TO 50 CENTS ON THE FOURTH  
DAY AND TO \$1.00 ON THE SEVENTH DAY  
OVERDUE.

DEC 11 1939

APR 16 1941

MAR 26 1942 P

OCT 2 1942

MAY 29 1944

OCT 7 1944

~~20 Nov 48 AF~~

18 Feb 56 NW

MAY 1 - 1956 TW

LD 21-100m-7,'39 (402s)

YC 20088

415269 TJ1025  
E3

**THE UNIVERSITY OF CALIFORNIA LIBRARY**

