

NASA CR-92124

Final Report

PART II

RTCC REQUIREMENTS FOR MISSION G:
LANDING SITE DETERMINATION USING ON-BOARD OBSERVATIONS

George A. Austin
Analytical Mechanics Associates, Inc.

Paul F. Flanagan
NASA Manned Spacecraft Center

GPO PRICE \$ _____

CFSTI PRICE(S) \$ _____

Hard copy (HC) 3.00

Microfiche (MF) 1.65

Report No. 68-5
Contract NAS 9-4036
April 1968

ff 653 July 65

FACILITY FORM 602

~~N 68-24311~~ (THRU) _____

30 (PAGES) 1 (CODE)

NASA-CR-92124 (NASA CR OR TMX OR AD NUMBER) 07 (CATEGORY)

ANALYTICAL MECHANICS ASSOCIATES, INC.
57 OLD COUNTRY ROAD
WESTBURY, N. Y. 11500

NASA CR 92124

TABLE OF CONTENTS

<u>Section</u>	<u>Page</u>
SUMMARY AND INTRODUCTION	1
GENERAL PROCEDURE FOR PROCESSING OF ONBOARD OBSERVATIONS	1
PREPROCESSOR	2
LANDING SITE DETERMINATION PROCESSOR	3
Formulation of Pseudo Observations	3
Storage Data Batch Format	4
Initialization	6
Working Data Batch Format	7
State Vector	8
State Weights	9
Observation Weights	9
Observation Computations	10
Equations for Processing Onboard Observations	11
Partials for Onboard Data Processing	13
Landmark Start Routine	15
Offset Landsite Routine	16
MANUAL CONTROLS	17
FLOW CHARTS	
1 Onboard Observation Preprocessor	19
2 Onboard Supervisor Logic	21
3 Onboard Data Convergence Processor	24
REFERENCES	29

RTCC REQUIREMENTS FOR MISSION G: LANDING SITE

DETERMINATION USING ONBOARD OBSERVATIONS

By Paul F. Flanagan and George A. Austin

SUMMARY AND INTRODUCTION

During the lunar landing mission, the ground Real-Time Computer Complex (RTCC) will locate the landing site relative to the command module (CM) orbit through the use of telemetered CM optical sightings. Also, the lunar module (LM) position after landing will be found by using telemetered LM rendezvous radar (RR) tracking of the orbiting CM.

This note presents the formulation (basic requirements) for the RTCC programs. This processor is separate from the Manned Space Flight Network (MSFN) data processor used for orbit determination.

Two programs are described, a preprocessor which collects and prepares the telemetered data and the landing site determination program. The description of the latter includes a discussion of the batch initialization, differential correction, and convergence processor modules.

The same predictor module used for the MSFN orbit determination processor (ref. 1) will be used to determine the CM ephemeris over the landing site.

The computation of LM position requires the use of the libration matrix which relates the mean of the nearest Besselian year (MNB) system to the geocentric coordinate system. The following formulation supersedes the corresponding formulation of reference 1.

GENERAL PROCEDURE FOR PROCESSING OF ONBOARD OBSERVATIONS

Onboard data processing is a manual procedure. The batch to be processed, as well as the CM ephemeris start vector, are manually selected.

The predictor is used to find the CM position and velocity at the time of the first observation. Then a CM ephemeris is generated across the time span of the batch of data.

The estimate of the landing site or lunar module position is updated with the assumption that the CM position is well known. A 3×3 covariance matrix for LM position is selected and used in the process.

A sequential batch solution may be obtained by selecting the LM start vector, R_{LM} , and covariance matrix, B , from a previous batch solution.

The basic equation solved is

$$\Delta R_{G_i} = \left(\sum A^T W A + B_o^{-1} \right)^{-1} \left(\sum A^T W \Delta y - B_o^{-1} \sum \Delta R_{G_{i-1}} \right)$$

where

R_G	landmark or LM position expressed in ϕ , λ , and r (selenographic)
ΔR_G	correction to the landmark or lunar module position
$A = \frac{\partial Y}{\partial R_G}$	partials of the observations with respect to the state
W	observation weight matrix
B_o	covariance matrix in $(\text{rad})^2$ and $(\text{e.r.})^2$ for landmark or lunar module position
Δy	observation residual.

PREPROCESSOR

A preprocessor is required to handle the telemetered data since this data will not be handled by the pre-O.D. program used for ground tracking. This routine multiplies the incoming telemetered LM rendezvous radar data and CM sextant or telescope data by the correct granularity constants and stores the data into batches suitable for subsequent use by the convergence processor. The appropriate granularity constants are obtained from a table different from the station characteristics table used for ground-based trackers.

This preprocessor will be able to store five batches of RR data. As currently planned, the raw observation rate is at least one every 6 seconds, and the batch size will be large enough to accommodate all the data accumulated in a complete pass of the CM over the landing site.

The preprocessor will store in each frame shaft, trunnion, gimbal angles, range, and Doppler observations, as shown in the format example for storage data batches.

The Doppler data obtained from telemetry will be in the form of a binary data word, S_{RR} , which is the count in the RR. This count will be divided by the counting interval to yield a frequency comprised of the Doppler frequency and a bias frequency.

The range data is obtained as a binary word, R_{RR} , which is multiplied in the preprocessor by the bit weight, J_R , to obtain the range from the LM to the CM in earth radii.

The time associated with the Doppler observable is the time associated with the observation on the telemetered downlink.

In addition, five batches of sextant or telescope observations having a maximum of 5 observations per batch may be accumulated. Sextant and telescope observations may be included in a single batch. The preprocessor will store shaft, trunnion, and gimbal angles in each observation frame (see storage data batch format on following page).

The controller may tag any of the observations invalid over any interval of time. This is done by N_1 N_2 edit MED for the specified observation type. If angular data are tagged invalid, both hour angle and declination will be tagged invalid in the working batch.

LANDING SITE DETERMINATION PROCESSOR

The landing site processor constructs observed values for hour angle and declination from the original telemetered shaft, trunnion, and gimbal angle data set up by the preprocessor. In processing the data, the convergence processor computes estimated values for these elements based on the estimated values for the LS or LM position and the CM ephemeris.

Formulation of Pseudo Observations

The raw angular data will be converted to a unit vector which will be rotated by REFSMMAT and converted to pseudo hour angle and declination. The angles will be scaled from 0° to 360° for hour angle, from 0° to 90° and 270° to 360° for declination. The formulation used to convert the raw observations to pseudo hour angle and declination along the CSM line of sight from the LM is given below.

Storage Data Batch Format

(a) Radar

	Batch ID	LS ID	Radar ID	
	No. Obs. Frames	Range Obs. Flag	Doppler Obs. Flag	
Obs. Frame 1	Time			
	Range			
	Shaft		Trunnion	
	Inner Gimbal		Middle Gimbal	
	Outer Gimbal			
	Doppler			
Obs. Frame 2				

(b) Optics

	Batch ID	LS ID ^a	Optics ID	
	No. Obs. Frames	0	0	
Obs. Frame 1	Time			
	Offset Obs. Flag			
	Shaft		Trunnion	
	Inner Gimbal		Middle Gimbal	
	Outer Gimbal			

^aTwo-digit code tagged by astronaut from landmark-landsite table.

The LM rendezvous radar rotates about two axes, the shaft axis and the trunnion axis. When the radar is locked on the CSM transponder, the antenna can rotate about either or both simultaneously to maintain a line of sight to the CSM.

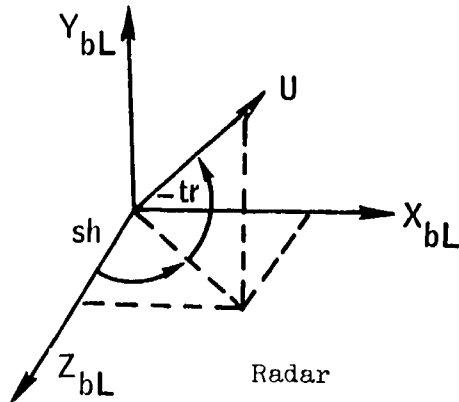

$$x_{bL} = \sin sh \cos tr$$

$$y_{bL} = -\sin tr$$

$$z_{bL} = \cos sh \cos tr$$

where sh is the shaft angle and tr is the trunnion angle.

The sextant or telescope shaft and trunnion angles are also converted to a unit vector, U, along the CSM line of sight from the landmark or LM position on the moon in local optical (opC) system.

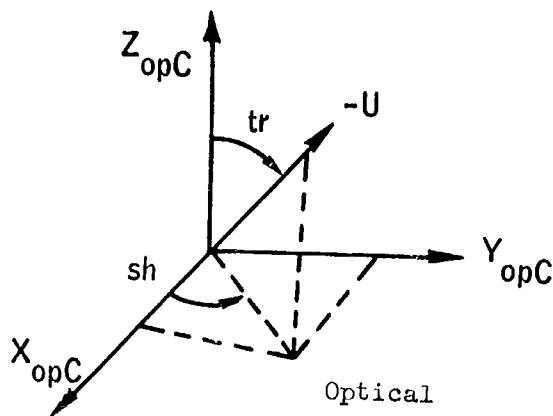

$$x_{opC} = -\cos sh \sin tr$$

$$y_{opC} = -\sin sh \sin tr$$

$$z_{opC} = -\cos tr$$

The local optical system is offset from the navigation base system by a negative rotation, $\xi = 32^{\circ}31'23.19''$, about the Y axis.

$$\begin{bmatrix} X_{bC} \\ Y_{bC} \\ Z_{bC} \end{bmatrix} = \begin{bmatrix} \cos \xi & 0 & \sin \xi \\ 0 & 1 & 0 \\ -\sin \xi & 0 & \cos \xi \end{bmatrix} \begin{bmatrix} X_{opC} \\ Y_{opC} \\ Z_{opC} \end{bmatrix}$$

To transform a unit vector in the local navigation base coordinate system to the platform (stable member) coordinate system, the following transformation is used.

$$\begin{bmatrix} x_p \\ y_p \\ z_p \end{bmatrix} = \begin{bmatrix} \cos \alpha & 0 & \sin \alpha \\ 0 & 1 & 0 \\ -\sin \alpha & 0 & \cos \alpha \end{bmatrix} \begin{bmatrix} \cos \beta & -\sin \beta & 0 \\ \sin \beta & \cos \beta & 0 \\ 0 & 0 & 1 \end{bmatrix} \begin{bmatrix} 1 & 0 & 0 \\ 0 & \cos \gamma & -\sin \gamma \\ 0 & \sin \gamma & \cos \gamma \end{bmatrix} \begin{bmatrix} x_b \\ y_b \\ z_b \end{bmatrix}$$

where α , β , and γ are the inner, middle, and outer gimbal angles, respectively, of either the CSM or LM inertial measuring units. The subscripts b and p refer to the navigation base and platform coordinate systems, respectively, of the CM or the LM.

A REFSMMAT matrix is used to transfer from MNBY to platform coordinates. The transformation from the platform to the MNBY selenocentric system is the transpose of REFSMMAT:

$$U_{\text{MNBY}} = (\text{REFSMMAT})^T U_p$$

Once the unit vector is available in the MNBY system with an origin at the LM or landmark position, hour angle and declination are computed as follows.

$$\text{HA} = \tan^{-1} \left(\frac{y}{x} \right)$$

$$D = \sin^{-1} \left(\frac{z}{\rho} \right)$$

where $\rho = 1$ since x, y, and z are components of a unit vector.

Initialization

In setting up onboard data for processing, the operator specifies the following.

1. Batch I.D. to be processed.
2. CSM vector used to generate ephemeris:
 - (a) I.D. of previously determined CSM vector (DC ephemeris).
 - (b) Current CSM anchor vector.

Working Data Batch Format

(a) Radar

Batch ID	LS ID	Radar ID	
No. Obs. Frames	Range Obs. Flag	Doppler Obs. Flag	
Obs. Frame 1	Time		
	Range		
	HA	DEC	
	Doppler		
Obs. Frame 2			

(b) Optics

Batch ID	LS ID	Optics ID	
No. Obs. Frames	0	0	
Obs. Frame 1	Time		
	Offset Obs. Flag		
	HA	DEC	
Obs. Frame 2			

3. Initial landmark or LM position:
 - (a) Computed estimate from previous batch.
 - (b) Table entry referenced by data flag.
 - (c) PNGS vector.
 - (d) AGS vector.
 - (e) Unknown landmark start routine.
 - (f) MED direct-input vector.
4. Initial covariance (3 x 3) associated with landmark:
 - (a) $B^{-1} = 0$ (set flag for onboard convergence processor).
 - (b) Manually entered value.
 - (c) I.D. of previously determined covariance matrix, B.
 - (d) Hard-coded nominal.
5. REFSMMAT
6. OFFSET - Specifies use of offset landsite routine.

State Vector

The landmark position may be manually entered as a latitude, longitude, and radius in degrees and n. mi., respectively. These will be converted to internal units of radians and earth radii. Any previously solved-for value may be chosen. Also a stored value for the nominal landing site may be used from an internal table of landmarks and offset landsites (illustrated below).

Landmark ID	$\Delta\phi$	$\Delta\lambda$	ΔR	ϕ	λ	R	Landsite ID

The landmark start routine may be used if estimates are not available.

State Weights

The covariance matrix associated with the lunar module position or landmark may be eliminated by setting ($B^{-1} = 0$), resulting in a single-batch solution. Also any covariance matrices left after previous batches have been processed may be manually selected along with the corresponding position vector, in processing a current batch of data, which results in a sequential batch solution.

A covariance matrix for landmark or lunar module position may be entered manually. This is done by inserting selenographic radial, latitudinal, and longitudinal standard deviations in yards. The program will construct the corresponding deviation in ϕ and λ in radians as

$$\sigma_{\phi}(\text{rad}) = \frac{\sigma_{\phi}(\text{yd})}{r_o(\text{yd})}, \quad \sigma_{\lambda}(\text{rad}) = \frac{\sigma_{\lambda}(\text{yd})}{r_o \cos \phi(\text{yd})}$$

A hard-coded nominal covariance matrix associated with the nominal landsite may be specified by the controller.

Observation Weights

A different weight is given to each type of observation. For range and range rate, the weight is expressed as a function of the variance. The variance (ref. 2) is a function of the computed observation. A different weight is used for each type of angular observation, radar or optics. Hour angle and declination have the same relative weights since they are functions of both angular observables, shaft and trunnion. Expressions for computing weights are given below.

Type	Optical	Radar
Angular weights	$\frac{K_{O\zeta}}{\text{var } O_{\zeta}}$	$\frac{K_{RR\zeta}}{\text{var } R_{\zeta}}$
Range weight		$\frac{K_{RR\rho}}{\rho^2 \text{var } \rho}$
Range rate weight		$\frac{K_{RR\dot{\rho}}}{\max\left(\frac{\rho_b - \rho_e}{\tau_{RR}} \text{var } \dot{\rho}, \text{var } \dot{\rho} \text{ min}\right)}$

K_{α} , a four-element manual entry, allows the operator to adjust the observations relative to each other. This is required to process radar observed from the lunar surface since the quality of the angles in this phase is undetermined.

All the elements in the K_{α} table are initially unity but may be changed in real time by the K_{α} MED.

The variances on each observation are functions of the noise and bias on the observation instrument and will be determined and loaded prior to the mission.

Observation Computations

Rendezvous radar observations - The following equations are used to compute values to compare with RR observations. This requires the availability of the ephemeris of the CM in MNBY coordinates. The nominal selenographic coordinates may be used, or the telemetered touchdown position vector from either the primary or the abort guidance-navigation systems may be converted from inertial coordinates to selenographic coordinates by interpolating the libration matrix, L, from the stored JPL ephemeris tape elements. Then the inertial position of the LM is computed using the libration matrix evaluated at the time of each observation.

The RR angles are processed as pseudo hour angle (HA) and declination (D). These are formed from shaft and trunnion angles, gimbal angles, and REFSMMAT.

Declination is measured from a plane through the LM, parallel to the earth's equatorial plane to the line of sight of the vehicle. It varies from 0° to 90° when measured to a line parallel to the earth's spin axis and toward the North, and from 360° to 270° when measured toward the South.

Hour angle is measured from the LM meridian in a plane parallel to the earth's equatorial plane to the projected line of sight of the vehicle. It varies counterclockwise from 0° to 360° when viewed from the North pole.

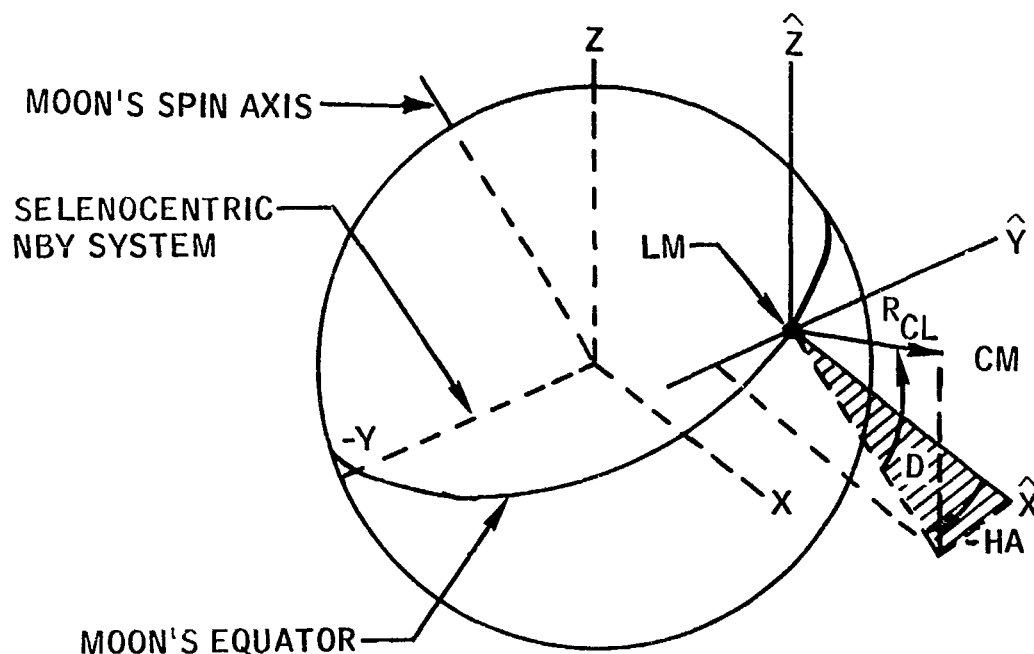

Optics observations - The equations used to process optics data taken from the CM are the same as for the RR angles taken from the LM. The reason for this is that pseudo hour angle and declination are constructed from shaft and trunnion angles, gimbal angles, and the REFSMMAT associated with the CM sextant sightings. The unit vector from the CM to the LM in the MNBY system whose origin is at the CM is in the opposite direction to that for the LM. The sextant or telescope pseudo hour angle and declination are made to look just like the LM RR hour angle and declination. However, it is necessary that the CM sight on the intended landing site position before the LM has landed. For this case, the intended landing site position is used instead of the actual.

Equations for Processing Onboard Observations

The selenographic latitude, longitude, and radius of the landing site define the selenographic Cartesian coordinates as follows.

$$R_G = \begin{bmatrix} r \cos \phi \cos \lambda \\ r \cos \phi \sin \lambda \\ r \sin \phi \end{bmatrix}$$

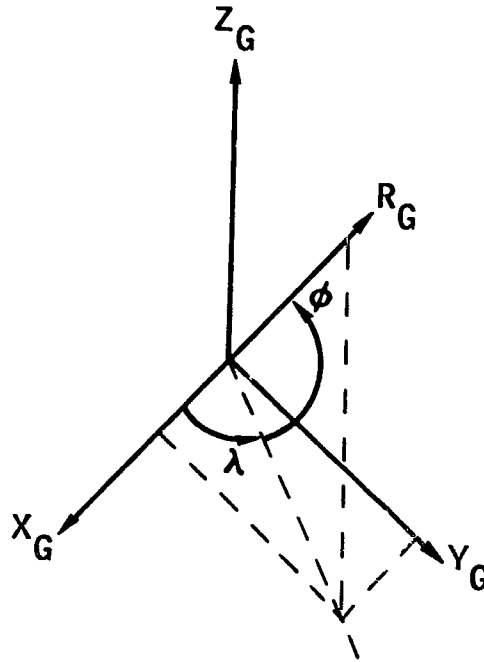

The Cartesian selenographic position (R_L) is transformed to the MNBV system by utilizing the libration matrix (L), which is available in the planetary ephemeris.

$$R_L = L^T R_G$$

The computed observations are formed from the MNBV state vectors. R_{CL} is the MNBV vector from the LM to the CM, that is

$$\rho = R_{CL} = R_C - R_L$$

$$D = \sin^{-1} \left(\frac{Z_{CL}}{\rho} \right)$$

$$HA = \tan^{-1} \left(\frac{Y_{CL}}{X_{CL}} \right)$$

The time associated with range and angles is $t_{ob} + KT$, where KT is a constant time interval between these observations and t_{ob} .

For optics angles, $KT = 0$.

t_{ob} is the time tag associated with the incoming data and is the time associated with the midpoint of the Doppler interval.

$$DF = \frac{2 \text{ KER } (\rho_e - \rho_b)}{\tau_{RR}} + F_{RR}$$

KER is a conversion factor for converting earth radii to counts

τ_{RR} is the count interval in seconds

F_{RR} is the Doppler bias in cycles per second

ρ_e is the LM-CM range at the end of the count interval t_e (infinite speed of light)

ρ_b is the LM-CM range at the beginning of the count interval t_b

$$t_b = t_{ob} - \frac{\tau_{RR}}{2}$$

$$t_e = t_{ob} + \frac{\tau_{RR}}{2}$$

Partials for Onboard Data Processing

To solve for latitude, longitude, and radius of the landing site directly, the partials of the observation, y , with respect to the selenographic state are required.

$$\begin{pmatrix} \frac{\partial y}{\partial \phi} & \frac{\partial y}{\partial \lambda} & \frac{\partial y}{\partial r} \end{pmatrix}_{4 \times 3} = \begin{pmatrix} \frac{\partial y}{\partial R_L} \end{pmatrix}_{4 \times 3} \begin{pmatrix} \frac{\partial R_L}{\partial R_G} \end{pmatrix}_{3 \times 3} \begin{pmatrix} \frac{\partial R_G}{\partial \phi} & \frac{\partial R_G}{\partial \lambda} & \frac{\partial R_G}{\partial r} \end{pmatrix}_{3 \times 3}$$

The following are the partials of the observations with respect to the MNBY state.

$$\frac{\partial D}{\partial R_L} = \frac{-Z_{CL}}{\rho^2 \sqrt{\rho^2 - Z^2}} \left(X_{CL}, Y_{CL}, \frac{Z_{CL}^2 - \rho^2}{Z_{CL}} \right)$$

$$\frac{\partial HA}{\partial R_L} = \frac{1}{\rho^2 - Z_{CL}^2} \begin{pmatrix} -Y_{CL} & X_{CL} & 0 \end{pmatrix}$$

$$\frac{\partial \rho}{\partial R_L} = \begin{pmatrix} \frac{X_L - X_C}{\rho} & \frac{Y_L - Y_C}{\rho} & \frac{Z_L - Z_C}{\rho} \end{pmatrix}$$

$$\frac{\partial DF}{\partial R_L} = \frac{2 \text{KER}}{\tau_{RR}} \begin{pmatrix} \overline{\rho_b} & \overline{\rho_e} \\ \overline{\rho_b} & \overline{\rho_e} \end{pmatrix}$$

$$\bar{\rho} = R_C - R_L = (X_C - X_L, Y_C - Y_L, Z_C - Z_L)$$

$$\rho = |R| = \left(\bar{\rho} \cdot \bar{\rho} \right)^{\frac{1}{2}}$$

The following is the partial of the MNBY state with respect to the selenographic state.

$$\frac{\partial R_L}{\partial R_G} = L^T$$

The following are the partials of the Cartesian selenographic coordinates with respect to the latitude, longitude, and radius.

$$\frac{\partial R_G}{\partial \phi} = (-r \cos \lambda \sin \phi, -r \sin \lambda \sin \phi, r \cos \phi)$$

$$\frac{\partial R_G}{\partial \lambda} = (-r \cos \phi \sin \lambda, r \cos \phi \cos \lambda, 0)$$

$$\frac{\partial R_G}{\partial r} = (\cos \phi \cos \lambda, \cos \phi \sin \lambda, \sin \phi)$$

Landmark Start Routine

The astronaut may not be able to choose a suitable landmark at the expected landing site. In this event, the astronaut will take one sighting on the landing site area, the offset observation, and the remaining sightings on a suitable nearby landmark. The first landmark sighting is used to obtain an estimate of the landmark position, and the remaining sightings are processed to determine the landmark position. The landsite offset is then applied to the landmark vector.

If the landmark is not tagged by the astronaut as a known landmark stored in a fixed memory, an initial landmark position vector (R_L) will be estimated from the first sighting by

$$R_L = R_C - r_C \left[\cos A - \left(\frac{r_O^2}{r_C^2} - \sin^2 A \right)^{\frac{1}{2}} \right] U$$

where

R_C = MNBY position of the CM

r_O = mean lunar radius

$r = |R|$

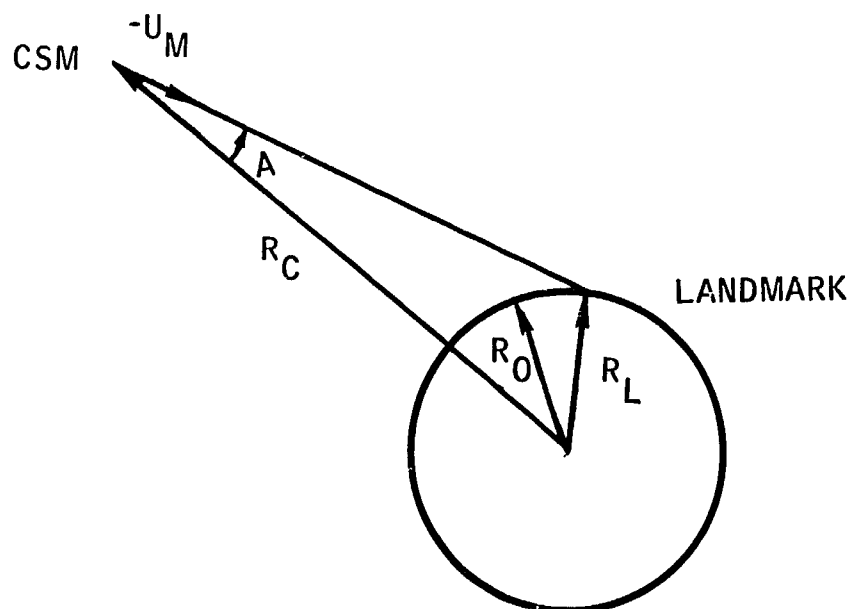

Offset Landsite Routine

The landing site estimate is calculated by the following equations, where U is the vector in the line of sight from the landing site to the CM.

$$R_{LS} = R_C - r_C \left[\cos A - \left(\frac{r_L^2}{r_C^2} - \sin^2 A \right)^{\frac{1}{2}} \right] U$$

$$\cos A = \frac{R_C}{r_C} \cdot U_m$$

where

R_{LS} = MNBV position of the landing site

R_L = MNBV position of the landmark

U_m = observation unit vector in MNBV coordinates

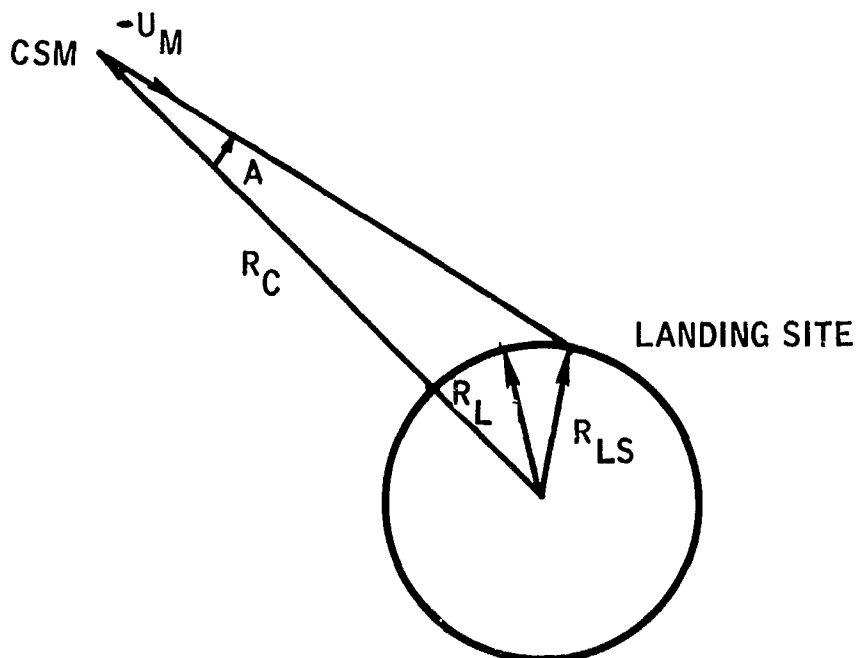

MANUAL CONTROLS^a

1. Initiate Processing

This entry initializes the necessary parameters for solution of landing site (batch ID, initial LM vector ID, or an indication for the landmark start routine, initial LM covariance ID to be used, option to be able to specify which REFSMMAT to be used, option to consider telemetered offset observation to determine landsite).

2. LM Covariance Matrix

Defines the initial covariance as the given diagonal.

3. Data Batch Residuals

Displays residuals for a specified batch using a previously determined or input LM position and a specified REFSMMAT.

4. Time Pre-Edit

Indicated observation types (angles, range, Doppler) may be tagged invalid in specified batches. Entry of this MED places a flag which is always checked when a data batch is copied into the working area. N_1 and N_2 , normalized time intervals for the time of the i th and j th data points, are specified. Observations that were invalid for a particular batch may be tagged valid by MED control.

5. Data Residual Summary

Upon specifying a normal solution vector ID or a landsite identification, this MED displays residuals for all pertinent optical or radar data batches. The controller may specify which type (optical or radar) will be displayed and may input any landsite position.

6. LM Position Vector Table

The controller may enter any LM solution vector or a LM position vector and tag the vector as the best available vector, AGS vector, PNGS vector, or a MED vector to be used for further processing.

^aReference 3 should be consulted for details on the above general description.

7. Alpha Coefficients Table

The controller may modify the nominal weights on the observations by specifying the observation type (optics or radar) and the range, Doppler, and angle weight multipliers. These multipliers are initialized to unity and once changed, remain changed until another MED is entered.

8. Eliminate Batches

This MED clears any specified processed batch to allow the next batch to be displayed in the cleared location. Nominally, after five batches are processed, the location of the batch processed first will be cleared to allow display of the next current batch.

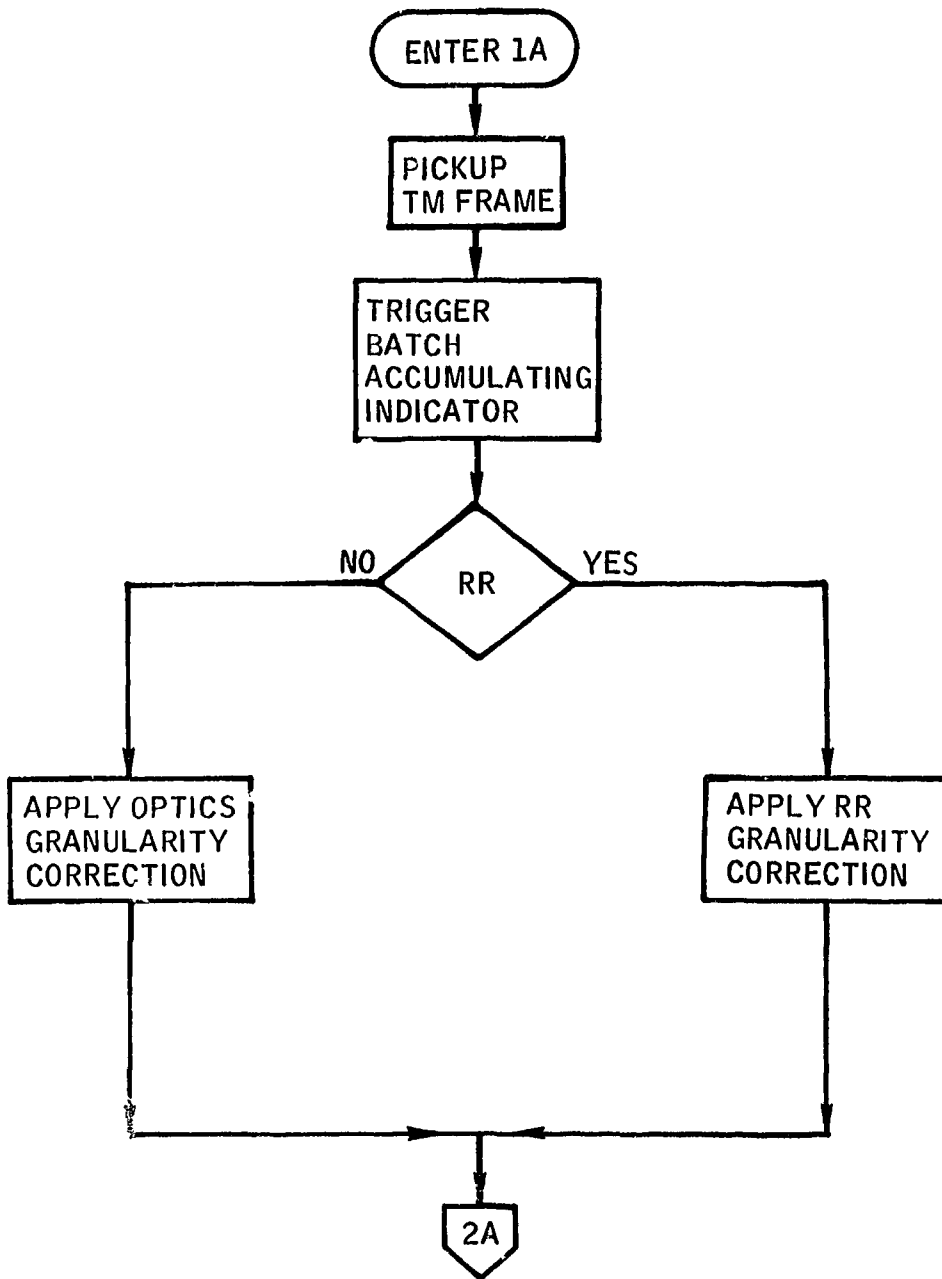

Flow chart 1.- Onboard observation preprocessor.

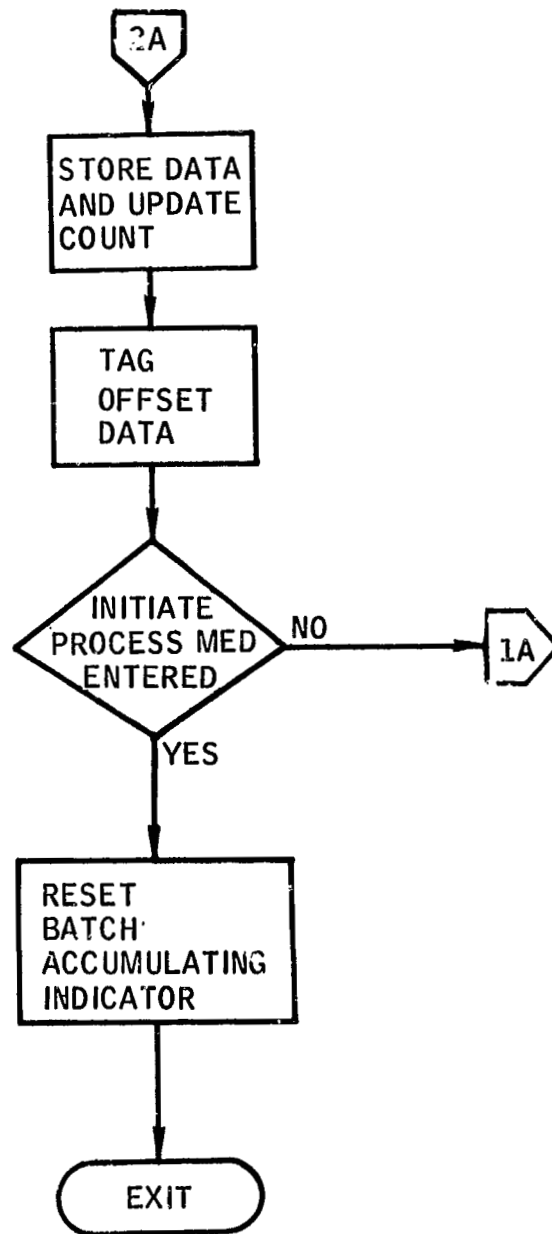

Flow chart 1.- Onboard observation preprocessor - Concluded.

21

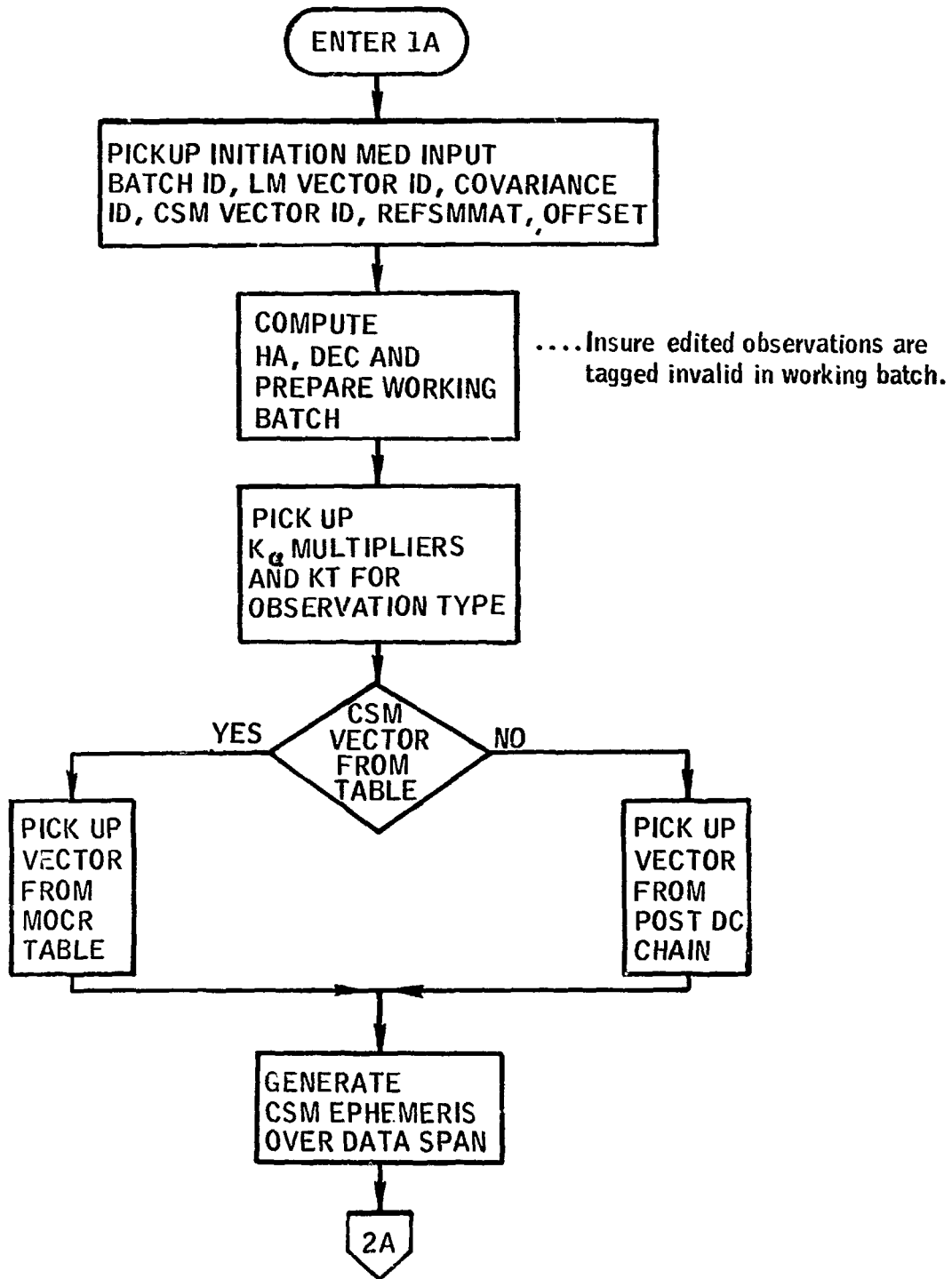

Flow chart 2. - Onboard supervisor logic.

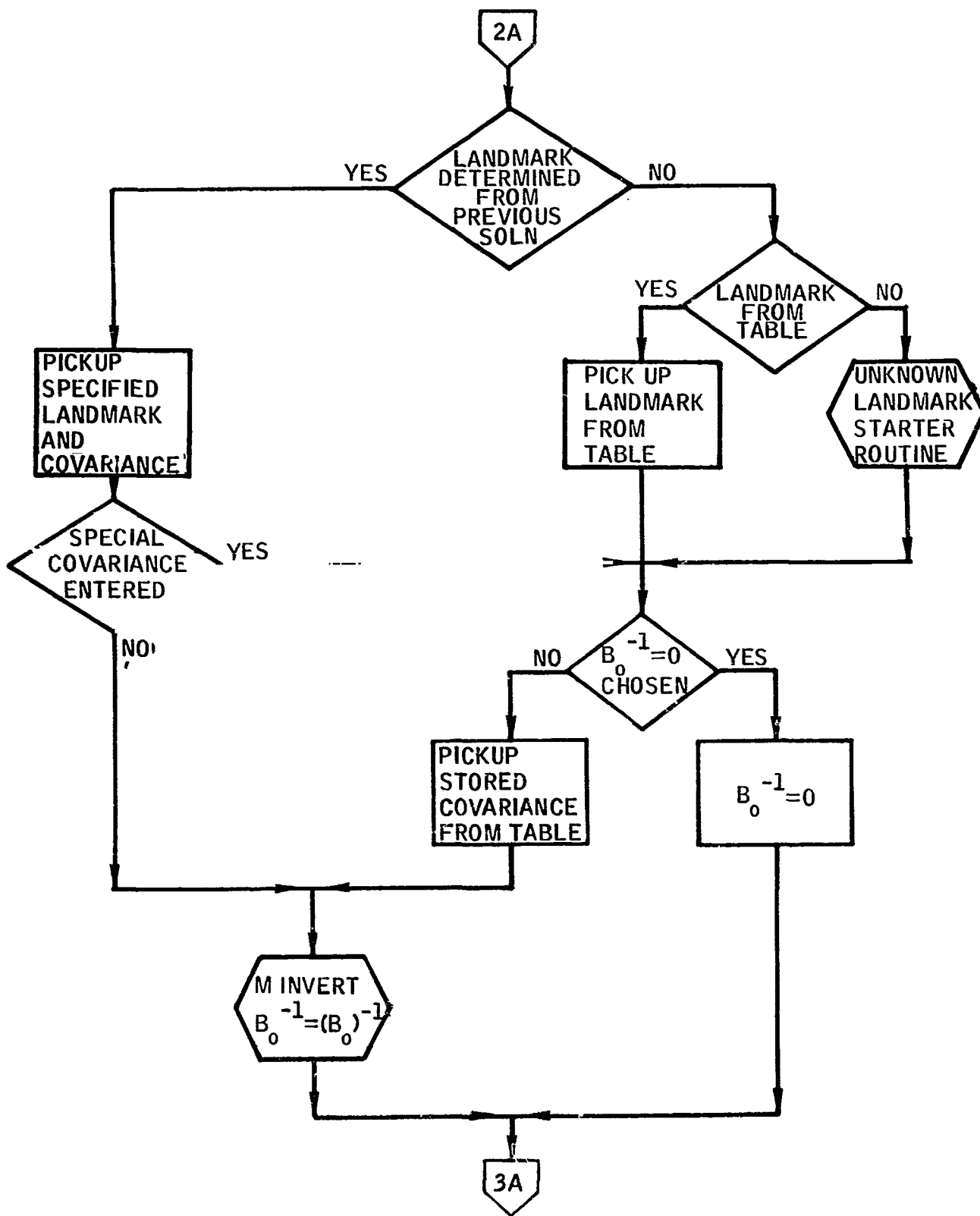

Flow chart 2. - Onboard supervisor logic - Continued.

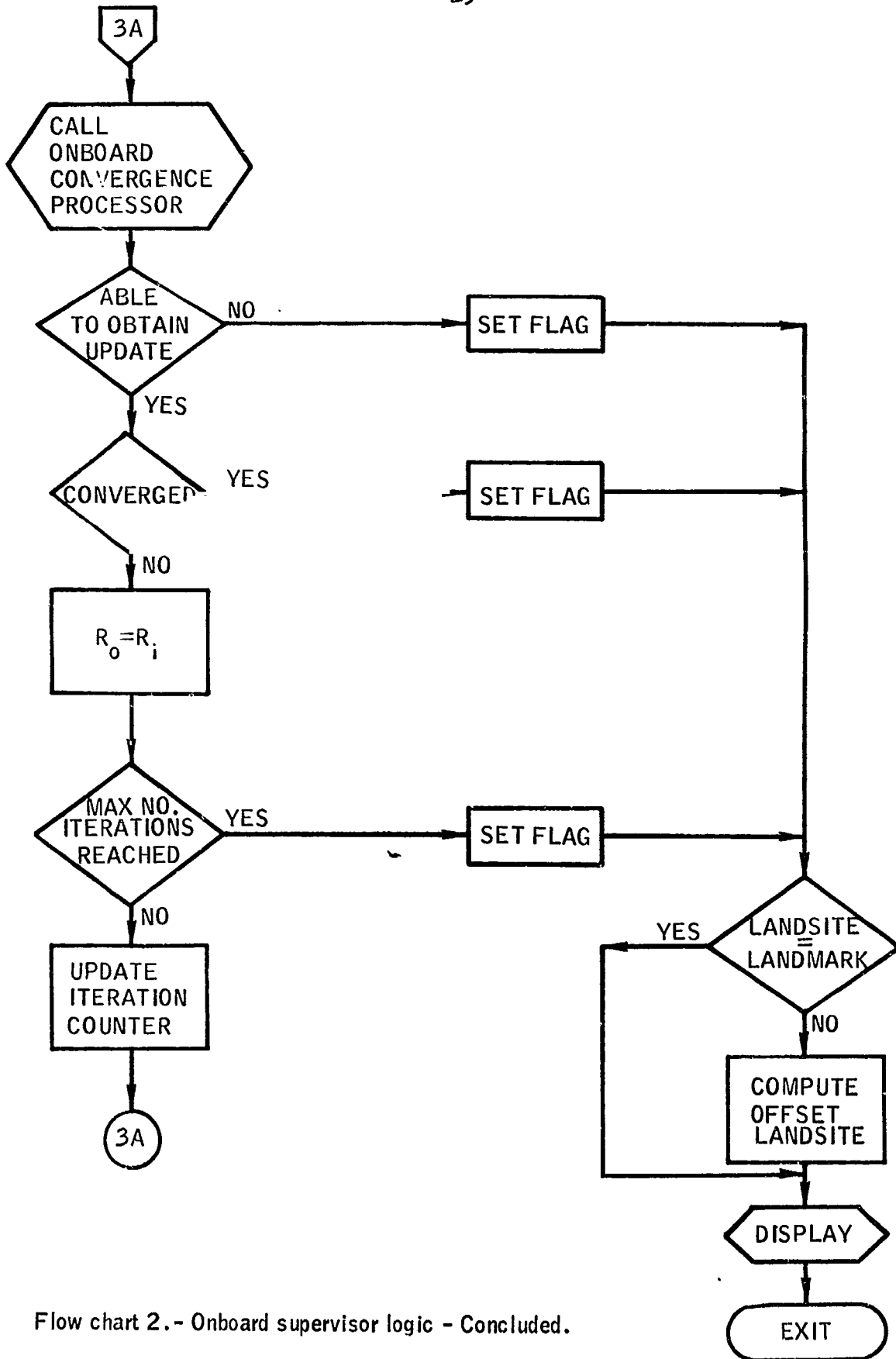

Flow chart 2.- Onboard supervisor logic - Concluded.

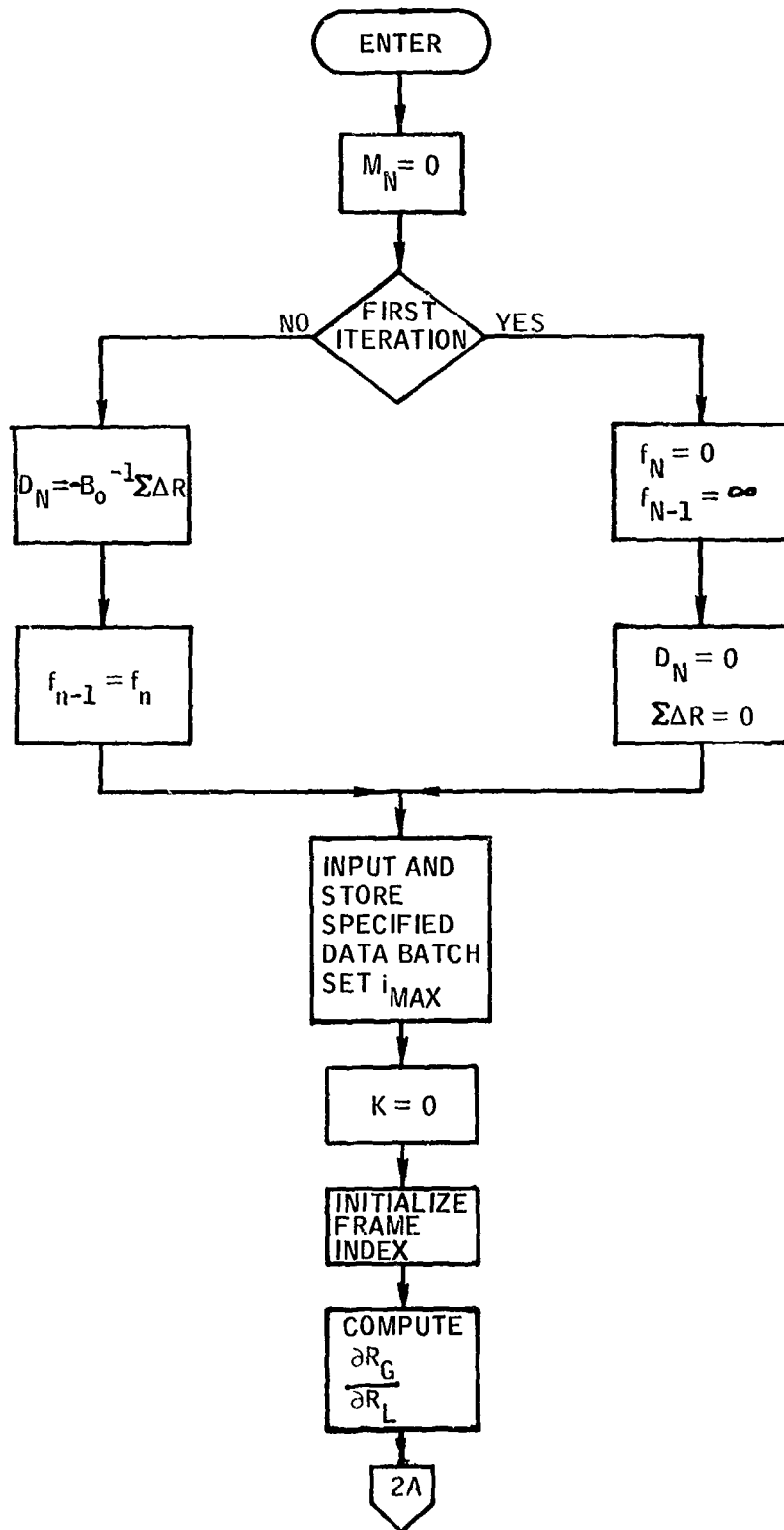

Flow chart 3.- Onboard data convergence processor.

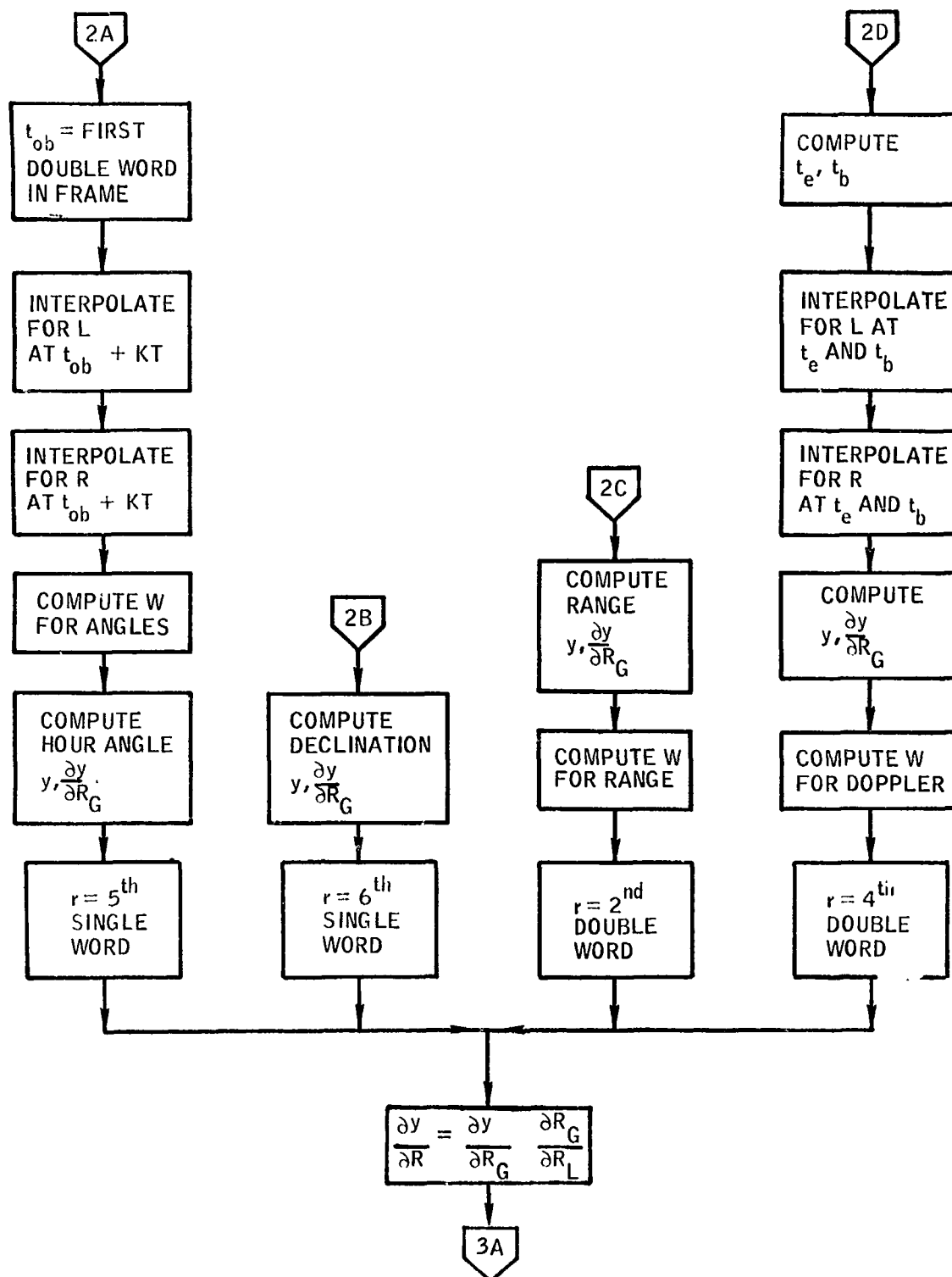

Flow chart 3. - Onboard data convergence processor - Continued.

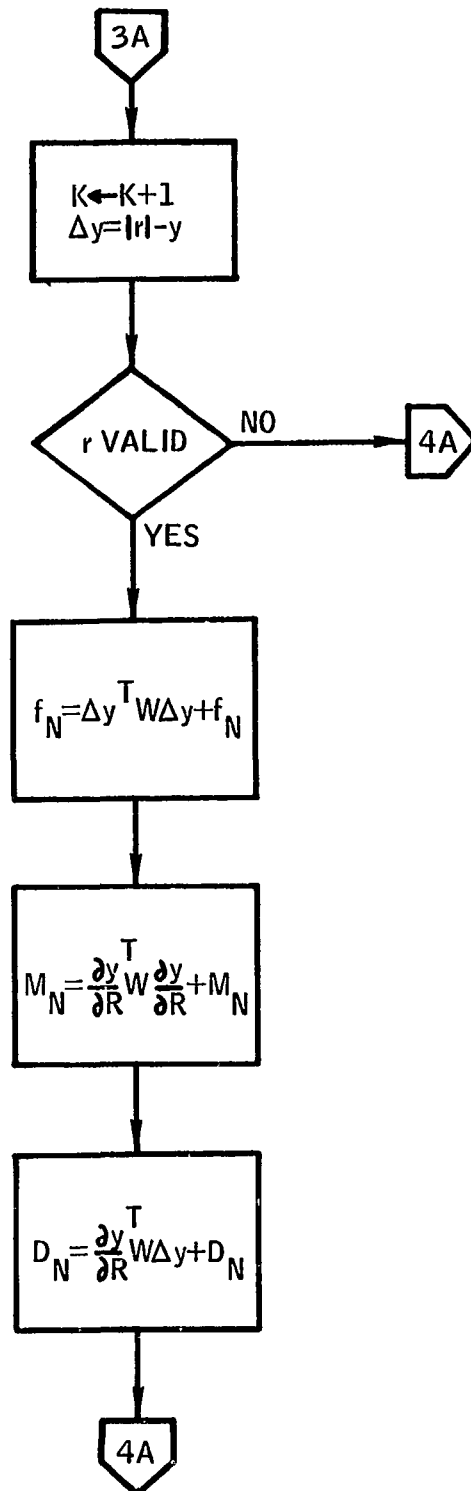

Flow chart 3. - Onboard data convergence processor - Continued.

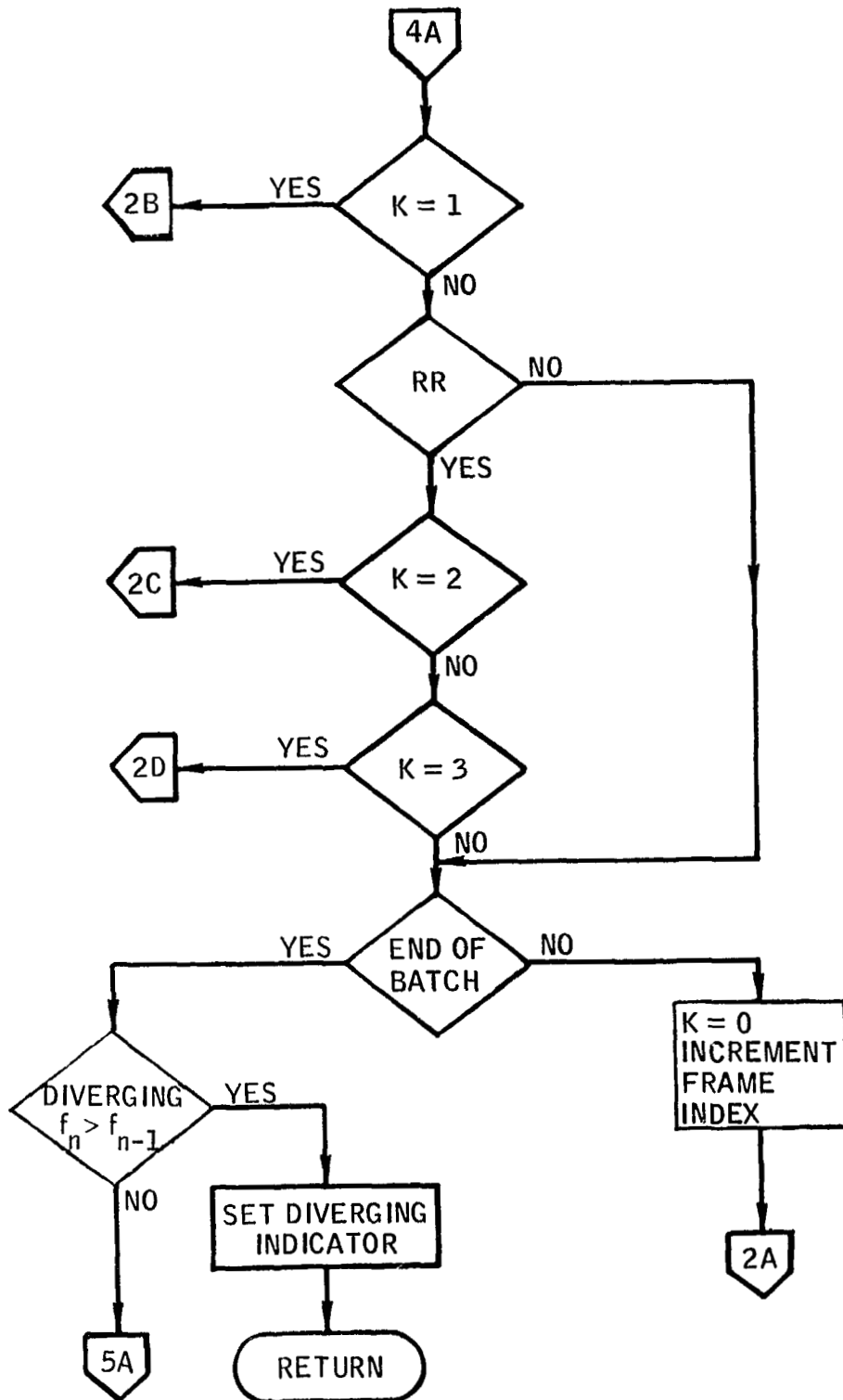

Flow chart 3.- Onboard data convergence processor - Continued.

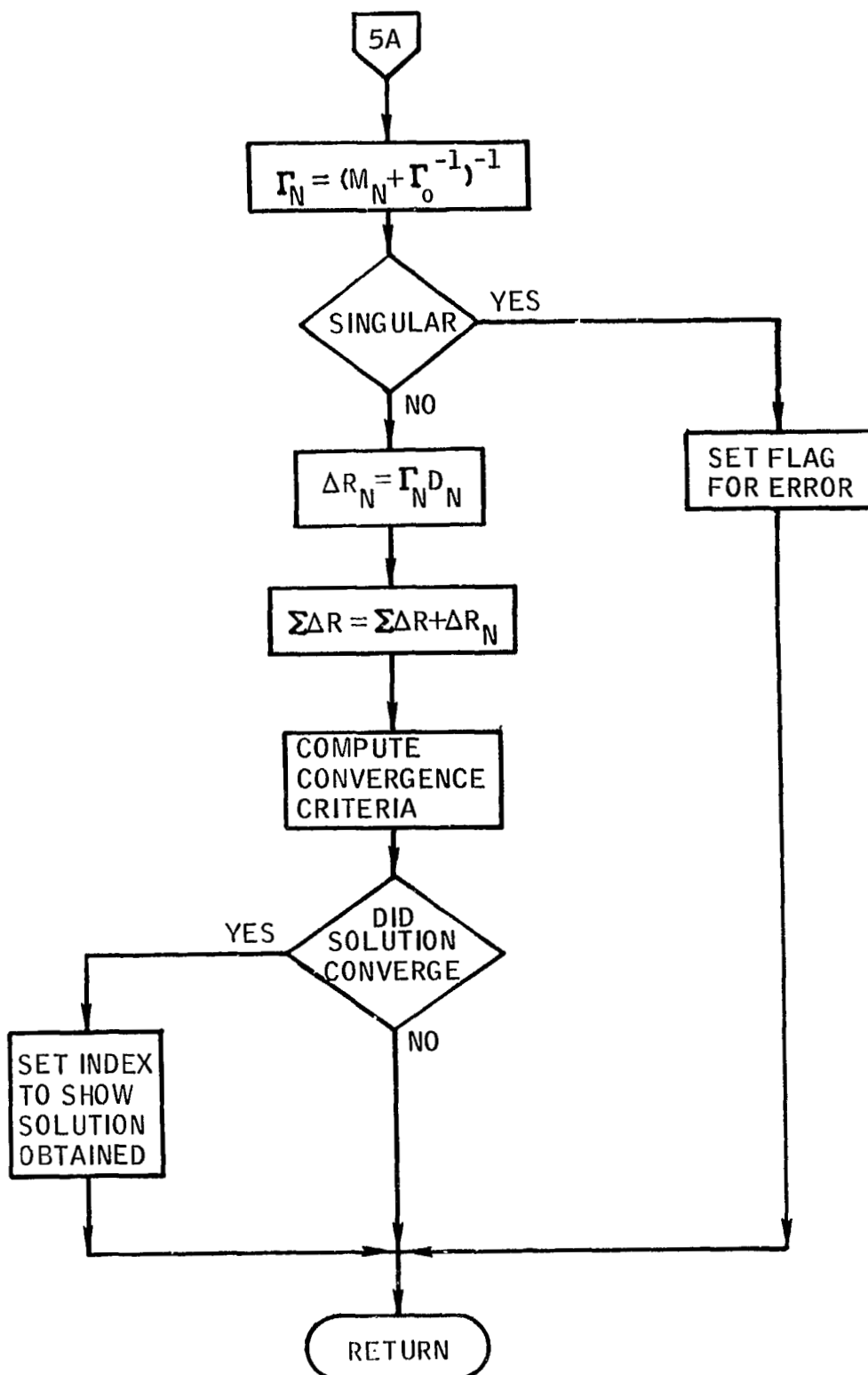

Flow chart 3. - Onboard data convergence processor - Concluded.

REFERENCES

1. Schiesser, Emil R.; Savely, Robert T.; deVezin, Howard G.; and Oles, Michael J.: Basic Equations and Logic for the Real-Time Ground Navigation Program for the Apollo Lunar Landing Mission. MSC IN 67-FM-51, May 31, 1967.
2. Apollo Navigation Working Group: Apollo Missions and Navigation Systems Characteristics. ANWG Technical Report AN-1.3, December 15, 1967.
3. Real-Time Computer Program Requirements for Apollo C-V. NASA PHO-TR170A, March 17, 1967.