

# Flight Plan

## STS-130/20A

(FDO 12+1+2 FRR Trajectory)

**Mission Operations Directorate  
Operations Division**

**Final  
December 18, 2009**

**Launch Date: Thursday, February 4, 2010  
Launch Time: 035/10:45:04 GMT  
February 4, 04:45:04 EDT**

For the latest working copy of the Flight Plan, visit  
[http://modspops.jsc.nasa.gov/mod/DO/DO4/Joint/130\\_20A/default.aspx](http://modspops.jsc.nasa.gov/mod/DO/DO4/Joint/130_20A/default.aspx)

National Aeronautics and  
Space Administration

**Lyndon B. Johnson Space Center**  
Houston, Texas



**Verify this is the correct version for the pending operation (training, simulation or flight).**  
Electronic copies of FDF books are available. URL: <http://mod.jsc.nasa.gov/do3/FDF/index.html>



FLIGHT PLAN STS-130

FINAL (Dec 18, 2009)

## PCN-1 (January 21, 2010) Sheet 1 of 1

List of Implemented Change Requests (482s):

FLT PLN-02114A

Incorporate the following:

1. Replace iii and iv
2. Replace 1-3 and 1-4
3. Replace 2-3 thru 2-14
4. Replace 3-1 thru 3-42

Prepared by:

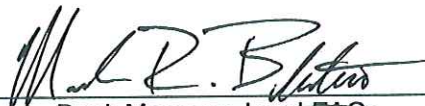

Book Manager, Lead FAO

Approved by:



Chief, Flight Planning Branch

Encl: 58 pages

**File this PCN immediately behind the front cover as a permanent record**



MISSION OPERATIONS DIRECTORATE

**FLIGHT PLAN  
STS-130**

FINAL  
December 18, 2009

PREPARED BY:

  
Mark Blanton  
Book Manager, Lead FAO

  
Gail Hansen  
Lead Timeliner

  
Sarah Toschlog  
Lead Ops Planner

  
Chris Rasnick  
Lead RPE

  
Alex Rigas  
Lead Pointer

APPROVED BY:

  
Douglas Bristol  
Flight Planning Group

  
Scott A. Curtis  
Chief, Flight Planning Branch

  
Peter J. Beauregard  
Chief, Operations Division

  
Paul S. Hill  
Director of Operations

This document is under the configuration control of the Crew Procedures Control Board (CPCB). All proposed changes must be submitted via Change Request Workflow (CRW) to DO3/FDF Manager.

Additional distribution of this book, for official use only, may be requested in writing to DO3/PMO Administrator. The request must include justification and requester's name, organization, position, and phone number. Contractor requests are made through the NASA or DOD organization supported. Deletions, reduction in quantity, or change of address may be submitted to DO3/FDF Management Office, 281-244-1184.

|                             |
|-----------------------------|
| Incorporates the following: |
| 482#: FLT PLN-02083         |

AREAS OF TECHNICAL RESPONSIBILITY

|                       |                 |              |
|-----------------------|-----------------|--------------|
| Book Manager/Lead FAO | DO4/M. Blanton  | 281-483-7728 |
| Lead Timeliner        | DO4/G. Hansen   | 281-483-3817 |
| Lead Pointer          | DO4/A. Rigas    | 281-483-2596 |
| Lead Ops Planner      | DO4/S. Toschlog | 281-483-7475 |
| Lead RPE              | DO4/C. Rasnick  | 281-244-5716 |

FLIGHT PLAN  
STS-130

**LIST OF EFFECTIVE PAGES**

|                | FINAL<br>PCN-1 | 12/18/09<br>01/21/10 |            |           |
|----------------|----------------|----------------------|------------|-----------|
| Sign Off ..... | *              | 130/FIN              | 2-39 ..... | 130/FIN   |
| ii.....        | *              | 130/FIN              | 2-40 ..... | 130/FIN   |
| iii.....       | *              | 130/FIN 1            | 2-41 ..... | 130/FIN   |
| iv.....        | *              | 130/FIN 1            | 2-42 ..... | 130/FIN   |
| v .....        | *              | 130/FIN              | 2-43 ..... | 130/FIN   |
| vi.....        | *              | 130/FIN              | 2-44 ..... | 130/FIN   |
| 1-1 .....      |                | 130/FIN              | 2-45 ..... | 130/FIN   |
| 1-2 .....      |                | 130/FIN              | 2-46 ..... | 130/FIN   |
| 1-3 .....      |                | 130/FIN 1            | 2-47 ..... | 130/FIN   |
| 1-4 .....      |                | 130/FIN              | 2-48 ..... | 130/FIN   |
| 2-1 .....      |                | 130/FIN              | 3-1 .....  | 130/FIN   |
| 2-2 .....      |                | 130/FIN              | 3-2 .....  | 130/FIN 1 |
| 2-3 .....      |                | 130/FIN 1            | 3-3 .....  | 130/FIN 1 |
| 2-4 .....      |                | 130/FIN 1            | 3-4 .....  | 130/FIN 1 |
| 2-5 .....      |                | 130/FIN 1            | 3-5 .....  | 130/FIN 1 |
| 2-6 .....      |                | 130/FIN 1            | 3-6 .....  | 130/FIN 1 |
| 2-7 .....      |                | 130/FIN 1            | 3-7 .....  | 130/FIN 1 |
| 2-8 .....      |                | 130/FIN 1            | 3-8 .....  | 130/FIN 1 |
| 2-9 .....      |                | 130/FIN 1            | 3-9 .....  | 130/FIN 1 |
| 2-10 .....     |                | 130/FIN 1            | 3-10 ..... | 130/FIN 1 |
| 2-11 .....     |                | 130/FIN 1            | 3-11 ..... | 130/FIN 1 |
| 2-12 .....     |                | 130/FIN 1            | 3-12 ..... | 130/FIN 1 |
| 2-13 .....     |                | 130/FIN 1            | 3-13 ..... | 130/FIN 1 |
| 2-14 .....     |                | 130/FIN              | 3-14 ..... | 130/FIN 1 |
| 2-15 .....     |                | 130/FIN              | 3-15 ..... | 130/FIN 1 |
| 2-16 .....     |                | 130/FIN              | 3-16 ..... | 130/FIN 1 |
| 2-17 .....     |                | 130/FIN              | 3-17 ..... | 130/FIN 1 |
| 2-18 .....     |                | 130/FIN              | 3-18 ..... | 130/FIN 1 |
| 2-19 .....     |                | 130/FIN              | 3-19 ..... | 130/FIN 1 |
| 2-20 .....     |                | 130/FIN              | 3-20 ..... | 130/FIN 1 |
| 2-21 .....     |                | 130/FIN              | 3-21 ..... | 130/FIN 1 |
| 2-22 .....     |                | 130/FIN              | 3-22 ..... | 130/FIN 1 |
| 2-23 .....     |                | 130/FIN              | 3-23 ..... | 130/FIN 1 |
| 2-24 .....     |                | 130/FIN              | 3-24 ..... | 130/FIN 1 |
| 2-25 .....     |                | 130/FIN              | 3-25 ..... | 130/FIN 1 |
| 2-26 .....     |                | 130/FIN              | 3-26 ..... | 130/FIN 1 |
| 2-27 .....     |                | 130/FIN              | 3-27 ..... | 130/FIN 1 |
| 2-28 .....     |                | 130/FIN              | 3-28 ..... | 130/FIN 1 |
| 2-29 .....     |                | 130/FIN              | 3-29 ..... | 130/FIN 1 |
| 2-30 .....     |                | 130/FIN              | 3-30 ..... | 130/FIN 1 |
| 2-31 .....     |                | 130/FIN              | 3-31 ..... | 130/FIN 1 |
| 2-32 .....     |                | 130/FIN              | 3-32 ..... | 130/FIN 1 |
| 2-33 .....     |                | 130/FIN              | 3-33 ..... | 130/FIN 1 |
| 2-34 .....     |                | 130/FIN              | 3-34 ..... | 130/FIN 1 |
| 2-35 .....     |                | 130/FIN              | 3-35 ..... | 130/FIN 1 |
| 2-36 .....     |                | 130/FIN              | 3-36 ..... | 130/FIN 1 |
| 2-37 .....     |                | 130/FIN              | 3-37 ..... | 130/FIN 1 |
| 2-38 .....     |                | 130/FIN              | 3-38 ..... | 130/FIN 1 |

\* – Omit from flight book

|      |           |       |         |
|------|-----------|-------|---------|
| 3-39 | 130/FIN 1 | 3-95  | 130/FIN |
| 3-40 | 130/FIN 1 | 3-96  | 130/FIN |
| 3-41 | 130/FIN 1 | 3-97  | 130/FIN |
| 3-42 | 130/FIN   | 3-98  | 130/FIN |
| 3-43 | 130/FIN   | 3-99  | 130/FIN |
| 3-44 | 130/FIN   | 3-100 | 130/FIN |
| 3-45 | 130/FIN   | 3-101 | 130/FIN |
| 3-46 | 130/FIN   | 3-102 | 130/FIN |
| 3-47 | 130/FIN   | 3-103 | 130/FIN |
| 3-48 | 130/FIN   | 3-104 | 130/FIN |
| 3-49 | 130/FIN   | 3-105 | 130/FIN |
| 3-50 | 130/FIN   | 3-106 | 130/FIN |
| 3-51 | 130/FIN   | 3-107 | 130/FIN |
| 3-52 | 130/FIN   | 3-108 | 130/FIN |
| 3-53 | 130/FIN   | 3-109 | 130/FIN |
| 3-54 | 130/FIN   | 3-110 | 130/FIN |
| 3-55 | 130/FIN   | 3-111 | 130/FIN |
| 3-56 | 130/FIN   | 3-112 | 130/FIN |
| 3-57 | 130/FIN   | 3-113 | 130/FIN |
| 3-58 | 130/FIN   | 3-114 | 130/FIN |
| 3-59 | 130/FIN   | 3-115 | 130/FIN |
| 3-60 | 130/FIN   | 3-116 | 130/FIN |
| 3-61 | 130/FIN   | 3-117 | 130/FIN |
| 3-62 | 130/FIN   | 3-118 | 130/FIN |
| 3-63 | 130/FIN   | 3-119 | 130/FIN |
| 3-64 | 130/FIN   | 3-120 | 130/FIN |
| 3-65 | 130/FIN   | 3-121 | 130/FIN |
| 3-66 | 130/FIN   | 3-122 | 130/FIN |
| 3-67 | 130/FIN   | 3-123 | 130/FIN |
| 3-68 | 130/FIN   | 3-124 | 130/FIN |
| 3-69 | 130/FIN   | 3-125 | 130/FIN |
| 3-70 | 130/FIN   | 3-126 | 130/FIN |
| 3-71 | 130/FIN   | 3-127 | 130/FIN |
| 3-72 | 130/FIN   | 3-128 | 130/FIN |
| 3-73 | 130/FIN   | 3-129 | 130/FIN |
| 3-74 | 130/FIN   | 3-130 | 130/FIN |
| 3-75 | 130/FIN   | 3-131 | 130/FIN |
| 3-76 | 130/FIN   | 3-132 | 130/FIN |
| 3-77 | 130/FIN   | 3-133 | 130/FIN |
| 3-78 | 130/FIN   | 3-134 | 130/FIN |
| 3-79 | 130/FIN   | 3-135 | 130/FIN |
| 3-80 | 130/FIN   | 3-136 | 130/FIN |
| 3-81 | 130/FIN   | 3-137 | 130/FIN |
| 3-82 | 130/FIN   | 3-138 | 130/FIN |
| 3-83 | 130/FIN   | 3-139 | 130/FIN |
| 3-84 | 130/FIN   | 3-140 | 130/FIN |
| 3-85 | 130/FIN   | 3-141 | 130/FIN |
| 3-86 | 130/FIN   | 3-142 | 130/FIN |
| 3-87 | 130/FIN   | 3-143 | 130/FIN |
| 3-88 | 130/FIN   | 3-144 | 130/FIN |
| 3-89 | 130/FIN   | 3-145 | 130/FIN |
| 3-90 | 130/FIN   | 3-146 | 130/FIN |
| 3-91 | 130/FIN   | 3-147 | 130/FIN |
| 3-92 | 130/FIN   | 3-148 | 130/FIN |
| 3-93 | 130/FIN   | 3-149 | 130/FIN |
| 3-94 | 130/FIN   | 3-150 | 130/FIN |
|      |           | 3-151 | 130/FIN |
|      |           | 3-152 | 130/FIN |
|      |           | 3-153 | 130/FIN |
|      |           | 3-154 | 130/FIN |



CONTENTS

PAGE

INTRODUCTION ..... vi

OVERVIEW TIMELINE ..... 1-1

SUMMARY TIMELINE ..... 2-1

DETAILED TIMELINE..... 3-1

## INTRODUCTION

The STS-130 Flight Plan is the Flight Data File article that contains the on-orbit timeline. It does not contain the detailed timelines that are covered in the Ascent, Post Insertion, Deorbit Prep, and Entry Checklists. The detailed rendezvous and undocking timelines and procedures are contained in the Rendezvous Checklist. The detailed EVA task timelines and procedures are contained in the EVA Checklist.

This Flight Plan satisfies the mission requirements specified in the following documents:

- NSTS-07700 Vol III, Flight Definition and Requirements Document
- NSTS-17462-130, STS-130 Flight Requirements Document
- NSTS-37326, Shuttle Crew Scheduling Constraints
- NSTS-21549, ISS-20A Mission Integration Plan

The timeline formats used in this Flight Plan are based on JSC-19933, Timeline Format Definitions and Standard Notes, Rev C, May 1990.

The STS-130 Flight Plan is based on a launch date of February 4, 2010, at 10:45:04 GMT (04:45:04 AM CDT). The trajectory products support a 12+1+2 mission duration, however, flight products were directed to be built with a 13+1+2 mission duration. Trajectory related items diverge starting with FD12 and extend through EOM. Subsequent trajectory deliveries will correct the timeline disconnects. Orbiter inertial attitudes are expressed relative to a mean of 1950 (M50) reference frame.

The following SCSC Exceptions have been submitted in order to meet Category 1 objectives:

None

The Flight Plan and previously published, non-flown sections listed below are available on the following Space Shuttle Flight Planning web site:

[http://modspops.jsc.nasa.gov/mod/DO/DO4/Joint/130\\_20A/default.aspx](http://modspops.jsc.nasa.gov/mod/DO/DO4/Joint/130_20A/default.aspx)

Non-flown sections that are no longer published:

- ISS Commanding Pages
- Attitude Timeline
- Ku-Band Antenna Masking Plan
- Flight Plan Notes
- Flight Plan Walkthrough

OVERVIEW TIMELINE

This Page Intentionally Blank

## STS-130/20A Overview Timeline 13+1+2 (3 EVAs)

### GMTLO 038/09:39:39 Feb 7th, 2010

|       |         | GMT        | 22 | 23        | 38/0 | 1           | 2 | 3    | 4                     | 5                  | 6        | 7         | 8            | 9        | 10          | 11        | 12 | 13 | 14 | 15 | 16 | 17 | 18 | 19 | 20 | 21 |
|-------|---------|------------|----|-----------|------|-------------|---|------|-----------------------|--------------------|----------|-----------|--------------|----------|-------------|-----------|----|----|----|----|----|----|----|----|----|----|
|       |         | MET        |    |           |      |             |   |      |                       |                    |          |           |              |          | 00/0        | 1         | 2  | 3  | 4  | 5  | 6  | 7  | 8  | 9  | 10 | 11 |
| FD 01 | STS     |            |    |           |      |             |   |      |                       |                    |          |           | ASC          | PI       | P TV / PGSC | RMS C/O   |    |    |    |    |    |    |    |    |    |    |
|       | Orb Att |            |    |           |      |             |   |      |                       |                    |          |           | -ZLV -YVV    |          | NC1         | -ZLV -XVV |    |    |    |    |    |    |    |    |    |    |
|       |         | ^NC1 03:34 |    |           |      |             |   |      |                       |                    |          |           |              |          |             |           |    |    |    |    |    |    |    |    |    |    |
| FD 02 | STS     | -ZLV -XVV  |    | NC2       |      | Inspections |   | Meal | Inspections & EMU C/O | Docking Prep       |          |           |              |          |             |           |    |    |    |    |    |    |    |    |    |    |
|       | Orb Att | -ZLV -XVV  |    | NC2       |      | BIASED -XSI |   |      |                       | NC3                |          | -ZLV -XVV |              |          |             |           |    |    |    |    |    |    |    |    |    |    |
|       |         | ^NC2 01:55 |    |           |      |             |   |      |                       |                    |          |           | ^NC3 1/01:50 |          |             |           |    |    |    |    |    |    |    |    |    |    |
| FD 03 | STS     | -ZLV -XVV  |    | -ZLV +YVV |      | RNDZ        |   | Meal | Dock                  | Hatch Hello Safety | OBSS H/O |           |              |          |             |           |    |    |    |    |    |    |    |    |    |    |
|       | Orb Att | -ZLV -XVV  |    | -ZLV +YVV |      | RNDZ        |   |      |                       | EVA Xfer           |          | D         |              | LVLH TEA |             |           |    |    |    |    |    |    |    |    |    |    |
|       |         | WS4/Node 2 |    |           |      |             |   |      |                       |                    |          |           |              |          |             |           |    |    |    |    |    |    |    |    |    |    |
| FD 04 | STS     | -ZLV -XVV  |    | -ZLV +YVV |      | RNDZ        |   | Meal | Dock                  | Hatch Hello Safety | OBSS H/O |           |              |          |             |           |    |    |    |    |    |    |    |    |    |    |
|       | Orb Att | -ZLV -XVV  |    | -ZLV +YVV |      | RNDZ        |   |      |                       | EVA Xfer           |          | D         |              | LVLH TEA |             |           |    |    |    |    |    |    |    |    |    |    |
|       |         | WS4/Node 2 |    |           |      |             |   |      |                       |                    |          |           |              |          |             |           |    |    |    |    |    |    |    |    |    |    |
| FD 04 | STS     | -ZLV -XVV  |    | -ZLV +YVV |      | RNDZ        |   | Meal | Dock                  | Hatch Hello Safety | OBSS H/O |           |              |          |             |           |    |    |    |    |    |    |    |    |    |    |
|       | Orb Att | -ZLV -XVV  |    | -ZLV +YVV |      | RNDZ        |   |      |                       | EVA Xfer           |          | D         |              | LVLH TEA |             |           |    |    |    |    |    |    |    |    |    |    |
|       |         | WS4/Node 2 |    |           |      |             |   |      |                       |                    |          |           |              |          |             |           |    |    |    |    |    |    |    |    |    |    |
| FD 05 | STS     | -ZLV -XVV  |    | -ZLV +YVV |      | RNDZ        |   | Meal | Dock                  | Hatch Hello Safety | OBSS H/O |           |              |          |             |           |    |    |    |    |    |    |    |    |    |    |
|       | Orb Att | -ZLV -XVV  |    | -ZLV +YVV |      | RNDZ        |   |      |                       | EVA Xfer           |          | D         |              | LVLH TEA |             |           |    |    |    |    |    |    |    |    |    |    |
|       |         | WS4/Node 2 |    |           |      |             |   |      |                       |                    |          |           |              |          |             |           |    |    |    |    |    |    |    |    |    |    |
| FD 05 | STS     | -ZLV -XVV  |    | -ZLV +YVV |      | RNDZ        |   | Meal | Dock                  | Hatch Hello Safety | OBSS H/O |           |              |          |             |           |    |    |    |    |    |    |    |    |    |    |
|       | Orb Att | -ZLV -XVV  |    | -ZLV +YVV |      | RNDZ        |   |      |                       | EVA Xfer           |          | D         |              | LVLH TEA |             |           |    |    |    |    |    |    |    |    |    |    |
|       |         | WS4/Node 2 |    |           |      |             |   |      |                       |                    |          |           |              |          |             |           |    |    |    |    |    |    |    |    |    |    |
| FD 06 | STS     | -ZLV -XVV  |    | -ZLV +YVV |      | RNDZ        |   | Meal | Dock                  | Hatch Hello Safety | OBSS H/O |           |              |          |             |           |    |    |    |    |    |    |    |    |    |    |
|       | Orb Att | -ZLV -XVV  |    | -ZLV +YVV |      | RNDZ        |   |      |                       | EVA Xfer           |          | D         |              | LVLH TEA |             |           |    |    |    |    |    |    |    |    |    |    |
|       |         | WS4/Node 2 |    |           |      |             |   |      |                       |                    |          |           |              |          |             |           |    |    |    |    |    |    |    |    |    |    |
| FD 06 | STS     | -ZLV -XVV  |    | -ZLV +YVV |      | RNDZ        |   | Meal | Dock                  | Hatch Hello Safety | OBSS H/O |           |              |          |             |           |    |    |    |    |    |    |    |    |    |    |
|       | Orb Att | -ZLV -XVV  |    | -ZLV +YVV |      | RNDZ        |   |      |                       | EVA Xfer           |          | D         |              | LVLH TEA |             |           |    |    |    |    |    |    |    |    |    |    |
|       |         | WS4/Node 2 |    |           |      |             |   |      |                       |                    |          |           |              |          |             |           |    |    |    |    |    |    |    |    |    |    |
| FD 07 | STS     | -ZLV -XVV  |    | -ZLV +YVV |      | RNDZ        |   | Meal | Dock                  | Hatch Hello Safety | OBSS H/O |           |              |          |             |           |    |    |    |    |    |    |    |    |    |    |
|       | Orb Att | -ZLV -XVV  |    | -ZLV +YVV |      | RNDZ        |   |      |                       | EVA Xfer           |          | D         |              | LVLH TEA |             |           |    |    |    |    |    |    |    |    |    |    |
|       |         | WS4/Node 2 |    |           |      |             |   |      |                       |                    |          |           |              |          |             |           |    |    |    |    |    |    |    |    |    |    |
| FD 07 | STS     | -ZLV -XVV  |    | -ZLV +YVV |      | RNDZ        |   | Meal | Dock                  | Hatch Hello Safety | OBSS H/O |           |              |          |             |           |    |    |    |    |    |    |    |    |    |    |
|       | Orb Att | -ZLV -XVV  |    | -ZLV +YVV |      | RNDZ        |   |      |                       | EVA Xfer           |          | D         |              | LVLH TEA |             |           |    |    |    |    |    |    |    |    |    |    |
|       |         | WS4/Node 2 |    |           |      |             |   |      |                       |                    |          |           |              |          |             |           |    |    |    |    |    |    |    |    |    |    |
| FD 08 | STS     | -ZLV -XVV  |    | -ZLV +YVV |      | RNDZ        |   | Meal | Dock                  | Hatch Hello Safety | OBSS H/O |           |              |          |             |           |    |    |    |    |    |    |    |    |    |    |
|       | Orb Att | -ZLV -XVV  |    | -ZLV +YVV |      | RNDZ        |   |      |                       | EVA Xfer           |          | D         |              | LVLH TEA |             |           |    |    |    |    |    |    |    |    |    |    |
|       |         | WS4/Node 2 |    |           |      |             |   |      |                       |                    |          |           |              |          |             |           |    |    |    |    |    |    |    |    |    |    |
| FD 08 | STS     | -ZLV -XVV  |    | -ZLV +YVV |      | RNDZ        |   | Meal | Dock                  | Hatch Hello Safety | OBSS H/O |           |              |          |             |           |    |    |    |    |    |    |    |    |    |    |
|       | Orb Att | -ZLV -XVV  |    | -ZLV +YVV |      | RNDZ        |   |      |                       | EVA Xfer           |          | D         |              | LVLH TEA |             |           |    |    |    |    |    |    |    |    |    |    |
|       |         | WS4/Node 2 |    |           |      |             |   |      |                       |                    |          |           |              |          |             |           |    |    |    |    |    |    |    |    |    |    |
| FD 09 | STS     | -ZLV -XVV  |    | -ZLV +YVV |      | RNDZ        |   | Meal | Dock                  | Hatch Hello Safety | OBSS H/O |           |              |          |             |           |    |    |    |    |    |    |    |    |    |    |
|       | Orb Att | -ZLV -XVV  |    | -ZLV +YVV |      | RNDZ        |   |      |                       | EVA Xfer           |          | D         |              | LVLH TEA |             |           |    |    |    |    |    |    |    |    |    |    |
|       |         | WS4/Node 2 |    |           |      |             |   |      |                       |                    |          |           |              |          |             |           |    |    |    |    |    |    |    |    |    |    |
| FD 09 | STS     | -ZLV -XVV  |    | -ZLV +YVV |      | RNDZ        |   | Meal | Dock                  | Hatch Hello Safety | OBSS H/O |           |              |          |             |           |    |    |    |    |    |    |    |    |    |    |
|       | Orb Att | -ZLV -XVV  |    | -ZLV +YVV |      | RNDZ        |   |      |                       | EVA Xfer           |          | D         |              | LVLH TEA |             |           |    |    |    |    |    |    |    |    |    |    |
|       |         | WS4/Node 2 |    |           |      |             |   |      |                       |                    |          |           |              |          |             |           |    |    |    |    |    |    |    |    |    |    |
| FD 10 | STS     | -ZLV -XVV  |    | -ZLV +YVV |      | RNDZ        |   | Meal | Dock                  | Hatch Hello Safety | OBSS H/O |           |              |          |             |           |    |    |    |    |    |    |    |    |    |    |
|       | Orb Att | -ZLV -XVV  |    | -ZLV +YVV |      | RNDZ        |   |      |                       | EVA Xfer           |          | D         |              | LVLH TEA |             |           |    |    |    |    |    |    |    |    |    |    |
|       |         | WS4/Node 2 |    |           |      |             |   |      |                       |                    |          |           |              |          |             |           |    |    |    |    |    |    |    |    |    |    |
| FD 10 | STS     | -ZLV -XVV  |    | -ZLV +YVV |      | RNDZ        |   | Meal | Dock                  | Hatch Hello Safety | OBSS H/O |           |              |          |             |           |    |    |    |    |    |    |    |    |    |    |
|       | Orb Att | -ZLV -XVV  |    | -ZLV +YVV |      | RNDZ        |   |      |                       | EVA Xfer           |          | D         |              | LVLH TEA |             |           |    |    |    |    |    |    |    |    |    |    |
|       |         | WS4/Node 2 |    |           |      |             |   |      |                       |                    |          |           |              |          |             |           |    |    |    |    |    |    |    |    |    |    |
| FD 11 | STS     | -ZLV -XVV  |    | -ZLV +YVV |      | RNDZ        |   | Meal | Dock                  | Hatch Hello Safety | OBSS H/O |           |              |          |             |           |    |    |    |    |    |    |    |    |    |    |
|       | Orb Att | -ZLV -XVV  |    | -ZLV +YVV |      | RNDZ        |   |      |                       | EVA Xfer           |          | D         |              | LVLH TEA |             |           |    |    |    |    |    |    |    |    |    |    |
|       |         | WS4/Node 2 |    |           |      |             |   |      |                       |                    |          |           |              |          |             |           |    |    |    |    |    |    |    |    |    |    |
| FD 11 | STS     | -ZLV -XVV  |    | -ZLV +YVV |      | RNDZ        |   | Meal | Dock                  | Hatch Hello Safety | OBSS H/O |           |              |          |             |           |    |    |    |    |    |    |    |    |    |    |
|       | Orb Att | -ZLV -XVV  |    | -ZLV +YVV |      | RNDZ        |   |      |                       | EVA Xfer           |          | D         |              | LVLH TEA |             |           |    |    |    |    |    |    |    |    |    |    |
|       |         | WS4/Node 2 |    |           |      |             |   |      |                       |                    |          |           |              |          |             |           |    |    |    |    |    |    |    |    |    |    |
| FD 12 | STS     | -ZLV -XVV  |    | -ZLV +YVV |      | RNDZ        |   | Meal | Dock                  | Hatch Hello Safety | OBSS H/O |           |              |          |             |           |    |    |    |    |    |    |    |    |    |    |
|       | Orb Att | -ZLV -XVV  |    | -ZLV +YVV |      | RNDZ        |   |      |                       | EVA Xfer           |          | D         |              | LVLH TEA |             |           |    |    |    |    |    |    |    |    |    |    |
|       |         | WS4/Node 2 |    |           |      |             |   |      |                       |                    |          |           |              |          |             |           |    |    |    |    |    |    |    |    |    |    |
| FD 12 | STS     | -ZLV -XVV  |    | -ZLV +YVV |      | RNDZ        |   | Meal | Dock                  | Hatch Hello Safety | OBSS H/O |           |              |          |             |           |    |    |    |    |    |    |    |    |    |    |
|       | Orb Att | -ZLV -XVV  |    | -ZLV +YVV |      | RNDZ        |   |      |                       | EVA Xfer           |          | D         |              | LVLH TEA |             |           |    |    |    |    |    |    |    |    |    |    |
|       |         | WS4/Node 2 |    |           |      |             |   |      |                       |                    |          |           |              |          |             |           |    |    |    |    |    |    |    |    |    |    |
| FD 13 | STS     | -ZLV -XVV  |    | -ZLV +YVV |      | RNDZ        |   | Meal | Dock                  | Hatch Hello Safety | OBSS H/O |           |              |          |             |           |    |    |    |    |    |    |    |    |    |    |
|       | Orb Att | -ZLV -XVV  |    | -ZLV +YVV |      | RNDZ        |   |      |                       | EVA Xfer           |          | D         |              | LVLH TEA |             |           |    |    |    |    |    |    |    |    |    |    |
|       |         | WS4/Node 2 |    |           |      |             |   |      |                       |                    |          |           |              |          |             |           |    |    |    |    |    |    |    |    |    |    |
| FD 13 | STS     | -ZLV -XVV  |    | -ZLV +YVV |      | RNDZ        |   | Meal | Dock                  | Hatch Hello Safety | OBSS H/O |           |              |          |             |           |    |    |    |    |    |    |    |    |    |    |
|       | Orb Att | -ZLV -XVV  |    | -ZLV +YVV |      | RNDZ        |   |      |                       | EVA Xfer           |          | D         |              | LVLH TEA |             |           |    |    |    |    |    |    |    |    |    |    |
|       |         | WS4/Node 2 |    |           |      |             |   |      |                       |                    |          |           |              |          |             |           |    |    |    |    |    |    |    |    |    |    |
| FD 14 | STS     | -ZLV -XVV  |    | -ZLV +YVV |      | RNDZ        |   | Meal | Dock                  | Hatch Hello Safety | OBSS H/O |           |              |          |             |           |    |    |    |    |    |    |    |    |    |    |
|       | Orb Att | -ZLV -XVV  |    | -ZLV +YVV |      | RNDZ        |   |      |                       | EVA Xfer           |          | D         |              | LVLH TEA |             |           |    |    |    |    |    |    |    |    |    |    |
|       |         | WS4/Node 2 |    |           |      |             |   |      |                       |                    |          |           |              |          |             |           |    |    |    |    |    |    |    |    |    |    |
| FD 14 | STS     | -ZLV -XVV  |    | -ZLV +YVV |      | RNDZ        |   | Meal | Dock                  | Hatch Hello Safety | OBSS H/O |           |              |          |             |           |    |    |    |    |    |    |    |    |    |    |
|       | Orb Att | -ZLV -XVV  |    | -ZLV +YVV |      | RNDZ        |   |      |                       | EVA Xfer           |          | D         |              | LVLH TEA |             |           |    |    |    |    |    |    |    |    |    |    |
|       |         | WS4/Node 2 |    |           |      |             |   |      |                       |                    |          |           |              |          |             |           |    |    |    |    |    |    |    |    |    |    |

^KSC 202 12/17:34

This Page Intentionally Blank

SUMMARY TIMELINE

This Page Intentionally Blank



**FD01**

GMT 02/07/10 (038)

MET Day 000 10 01 02 03 04 05 06 07 08 09 10 11 12

|           |  |             |                |                                  |                  |                  |                        |           |                      |       |   |      |
|-----------|--|-------------|----------------|----------------------------------|------------------|------------------|------------------------|-----------|----------------------|-------|---|------|
| STS-130   | CDR ZAMKA  | ASCENT      | POST INSERTION | RMS*<br>LDAPS<br>ELVPRK          | NC1A<br>OMS BURN | -ZLVV<br>GPRDN   | AFTC/O<br>BAPUE*       | PRE SLEEP | CPMCA/G<br>PRE SLEEP | WATCH | <p><b>ASSUMPTIONS:</b></p> <p>1. SSRMS Pre-launch C/O @ L-48hrs (MT @ WS4 with SSRMS on NODE 2 in Docking Position)</p> <p>2. ISS SAFER C/Os completed.</p> <p>3. ISS EMUs temp stowed in Node.</p> <p>4. CBCS installed on NODE 1 Port Hatch Window to prepare for NODE 3 INSTL.</p> |      |
|           | PLT VIRTIS   | ASCENT      | POST INSERTION | P/TV01 VIDEO SETUP               | OMS BURN         | PS/TV01<br>GPRDN | AAPCTU<br>EVD/HEO      | PRE SLEEP | WATCH                |       |   |      |
|           | MS1 HIRE   | ASCENT      | POST INSERTION | P/TV01 VIDEO SETUP               |                  | RPOWERUP         | RMS C/O                | PRE SLEEP | SLEEP                |       |   |      |
|           | MS2 ROBINSON   | ASCENT      | POST INSERTION | PGSC SETUP                       |                  |                  | WLESWELLACT<br>UMB D/L | PRE SLEEP | SLEEP                |       |   |      |
|           | MS3 PATRICK  | ASCENT      | POST INSERTION | RMS*<br>OSCEATUP<br>GIRA INSTALL |                  | RPOWERUP         | RMS C/O                | PRE SLEEP | WATCH                |       |   |      |
|           | MS4 BEHNKEN  | ASCENT      | POST INSERTION | PGSC SETUP                       |                  |                  | TEPCON<br>SEE SETUP    | PRE SLEEP | SLEEP                |       |   |      |
| DAY/NIGHT | ORBIT  |             |                |                                  |                  |                  |                        |           |                      |       |   |      |
| STS       | TDRS   | W<br>E<br>Z |                |                                  |                  |                  |                        |           |                      |       |   |      |
|           | ORB ATT  | ASC         | OMS2           | -ZLV                             | -XVV             | NC1              |                        |           |                      |       | -ZLV  | -XVV |
| NOTES     | <p>*ON-ORBIT INIT #FILTER CK</p> <p>*RECONFIG #POWERDOWN</p> |             |                |                                  |                  |                  |                        |           |                      |       |   |      |

**FD02**

GMT 02/07/10 (038)

MET Day 000

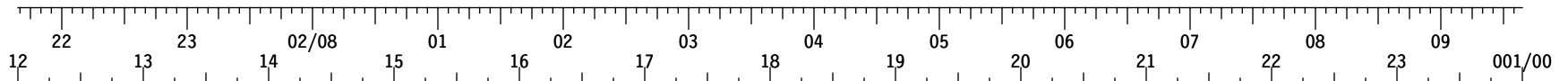

|         |   |  |            |                    |                          |                          |                      |              |                                  |                               |                       |             |                      |                       |                       |                       |                              |
|---------|---|--|------------|--------------------|--------------------------|--------------------------|----------------------|--------------|----------------------------------|-------------------------------|-----------------------|-------------|----------------------|-----------------------|-----------------------|-----------------------|------------------------------|
| STS-130 | CDR ZAMKA   | SLEEP  | POST SLEEP | LOG                | MGICR P<br>MIM UP<br>UL# | NC2A<br>OMS BURN         | -ZLVV                | GPWR<br>PRDN | PO2<br>S2-BT                     | MSNT<br>VBRD                  | STBD WING SURVEY (R3) | MNOV<br>SRE | NOSE CAP SURVEY (R1) | PW<br>ORTG<br>(R3)    | MEAL                  | -ZLVV                 | EXERCISE                     |
|         | PLT VIRTS   | SLEEP  | POST SLEEP | LOG                | AGP<br>CUP<br>2#         | OMS BURN                 | PSL<br>SET           | GPWR<br>PRDN | FC<br>PRG                        | CRYO<br>O2<br>SNSR<br>CK      | MIDDECK XFER PREP     | MEAL        | NOSE CAP SURVEY (R3) | MP<br>NO<br>VRT       | PORT WING SURVEY (R1) |                       | OB<br>BE<br>SR<br>SH<br>(R1) |
|         | MS1 HIRE  | SLEEP  | POST SLEEP | MINI<br>CAM<br>D/L | POST SLEEP               | P/TV01<br>VIDEO<br>SETUP | OBSS UNBERTH         |              |                                  |                               | STBD WING SURVEY (R1) | MEAL        |                      | PORT WING SURVEY (R2) |                       |                       | OB<br>BE<br>SR<br>SH<br>(R2) |
|         | MS2 ROBINSON  | SLEEP  | POST SLEEP |                    |                          |                          | PGSC SETUP (PART II) |              |                                  |                               | EXERCISE              | MEAL        | NOSE CAP SURVEY (R2) | PORT WING SURVEY (R3) | EMU*                  | PORT WING SURVEY (R3) | EVA PREP FOR XFER            |
|         | MS3 PATRICK   | SLEEP  | POST SLEEP | FRED<br>SETUP      | ERG<br>SETUP             |                          | OBSS UNBERTH         |              | EMU<br>DRK<br>BAG<br>FIL         |                               | STBD WING SURVEY (R2) | MEAL        | EMU<br>C/O<br>PREP   | EMU C/O               |                       | EVA PREP FOR XFER     |                              |
|         | MS4 BEHNKEN   | SLEEP  | POST SLEEP |                    | ERG<br>SETUP             |                          | H2O<br>CWC<br>SETUP  |              | GA<br>EMU<br>DRNK<br>BAG<br>FILL | GA<br>NLP<br>VAC<br>ACT<br>#1 | EXERCISE              | MEAL        | EMU<br>C/O<br>PREP   | EMU C/O               |                       | EVA PREP FOR XFER     |                              |
| STS     | DAY/NIGHT ORBIT   | [Timeline with day/night shading]                              |            |                    |                          |                          |                      |              |                                  |                               |                       |             |                      |                       |                       |                       |                              |
|         | TDRS W E Z  | [Timeline with TDRS activity bars]                             |            |                    |                          |                          |                      |              |                                  |                               |                       |             |                      |                       |                       |                       |                              |
|         | ORB ATT   | -ZLV -XVV -NC2 -ZLV -XVV STBD SURVEY -NOSE SURVEY -PORT SURVEY |            |                    |                          |                          |                      |              |                                  |                               |                       |             |                      |                       |                       |                       |                              |
| NOTES   | #FILTER CK @CNTLR SWAP #MORNING CONFIG *POWERUP & COMM CHECK<br>*A POD HTR RCNFG<br>^MANUAL *OVERNIGHT CONFIG<br>*DISABLE PWR TO OBSS |  |            |                    |                          |                          |                      |              |                                  |                               |                       |             |                      |                       |                       |                       |                              |

**FD02**

GMT 02/08/10 (039)

MET Day 001 10 01 11 02 12 03 13 04 14 05 15 16 07 17 18 09 19 10 20 11 21 12

|         |   |                   |                 |                        |                         |           |                   |           |       |       |  |           |  |       |  |       |  |       |  |
|---------|---|-------------------|-----------------|------------------------|-------------------------|-----------|-------------------|-----------|-------|-------|--|-----------|--|-------|--|-------|--|-------|--|
| STS-130 | CDR ZAMKA   | EXERCISE          | PRE SLEEP       | APCU *2<br>+X RCS BURN | NC3Δ<br>-ZLVV<br>FUTMVR | PRE SLEEP | FD CON<br>PMC A/G | PRE SLEEP | SLEEP |       |  |           |  |       |  |       |  |       |  |
|         | PLT VIRTS   | OBSS BERTH (R1)   | FILTER CLEANING | +X RCS BURN            | OMS POD SURV            | PRE SLEEP |                   | PRE SLEEP | SLEEP |       |  |           |  |       |  |       |  |       |  |
|         | MS1 HIRE  | OBSS BERTH (R2)   | FCMS OPS        | PRE SLEEP              | RNDZ TOOLS C/O          | PRE SLEEP |                   | PRE SLEEP | SLEEP |       |  |           |  |       |  |       |  |       |  |
|         | MS2 ROBINSON  | EVA PREP FOR XFER | LDRI D/L        | WLES                   | RNDZ TOOLS C/O          | OCAA*     | PRE SLEEP         |           | SLEEP |       |  |           |  |       |  |       |  |       |  |
|         | MS3 PATRICK   | EVA PREP FOR XFER | C/L CMR INSTL   | DRE OIX CNT KG IN G    |                         | PRE SLEEP |                   | PRE SLEEP | SLEEP |       |  |           |  |       |  |       |  |       |  |
|         | MS4 BEHNKEN   | EVA PREP FOR XFER | C/L CMR INSTL   | DRE OIX CNT KG IN G    |                         | PRE SLEEP |                   | PRE SLEEP | SLEEP |       |  |           |  |       |  |       |  |       |  |
| STS     | DAY/NIGHT ORBIT   | 17                |                 | 18                     |                         | 19        |                   | 20        |       | 21    |  | 22        |  | 23    |  | 24    |  | 25    |  |
|         | TDRS W E Z  | [Bar]             |                 | [Bar]                  |                         | [Bar]     |                   | [Bar]     |       | [Bar] |  | [Bar]     |  | [Bar] |  | [Bar] |  | [Bar] |  |
|         | ORB ATT   | -ZLV -XVV         |                 | -NC3                   |                         |           |                   |           |       |       |  | -ZLV -XVV |  |       |  |       |  |       |  |
| NOTES   | *REACT FOR N3 HTRS *D/L RATE 48M PL MAX (AFTER CREW CHOICE D/L) |                   |                 |                        |                         |           |                   |           |       |       |  |           |  |       |  |       |  |       |  |

**NO EXERCISE  
[DURING DEADBAND COLLAPSE]**

**FD03**

GMT 02/08/10 (039)

MET Day 001

|                 |              | 12   | 13         | 14           | 15           | 16           | 17           | 18           | 19           | 20           | 21           | 22            | 23                  | 09                  | 002/00             |           |                    |                    |          |
|-----------------|--------------|--|------------|--------------|--------------|--------------|--------------|--------------|--------------|--------------|--------------|---------------|---------------------|---------------------|--------------------|-----------|--------------------|--------------------|----------|
| STS-130         | CDR ZAMKA    | SLEEP  | POST SLEEP | ISS RNDZ OPS |              | ISS RNDZ OPS |              | ISS RNDZ OPS |              | APPROACH T/L | MNVR TEA     | HATCH OPEN    | WELLCOME            | SBARFIETY           | POST DOCK EVA XFER | XOFPESR   |                    |                    |          |
|                 | PLT VIRTIS   | SLEEP  | POST SLEEP | ISS RNDZ OPS |              | ISS RNDZ OPS |              | ISS RNDZ OPS |              | APPROACH T/L | DAUCIO       | HATCH OPEN    | WELLCOME            | SBARFIETY           | SMRNVSR            | OPRRLS    |                    |                    |          |
|                 | MS1 HIRE     | SLEEP  | POST SLEEP | XFER UPDATE  | ISS RNDZ OPS |              | ISS RNDZ OPS |              | ISS RNDZ OPS |              | APPROACH T/L | HATCH LEAK CK | HATCH OPEN          | WELLCOME            | SBARFIETY          | SMRNVSR   |                    |                    |          |
|                 | MS2 ROBINSON | SLEEP  | POST SLEEP | SIMO INIT    | POST SLEEP   | SIMO TERM    | EXERCISE     | ISS RNDZ OPS |              | ISS RNDZ OPS |              | APPROACH T/L  | HATCH LEAK CK       | POST RNDZ PGSC CNFG | PCS S/U            | WELLCOME  | SBARFIETY          | POST DOCK EVA XFER | GLCTRV09 |
|                 | MS3 PATRICK  | SLEEP  | POST SLEEP | EXERCISE     |              | EXERCISE     |              | EXERCISE     |              | P/TV02 S/U   | P/TV02 DOCK  | HATCH LEAK CK | ODS PREP FOR INGR   | P/TV04 OPS INGR/EGR | WELLCOME           | SBARFIETY | PS/TTVUOP5         | OBSS GRPL          |          |
|                 | MS4 BEHNKEN  | SLEEP  | POST SLEEP | EXERCISE     |              | EXERCISE     |              | EXERCISE     |              | EXERCISE     |              | APPROACH T/L  | POST RNDZ PGSC CNFG | PCS S/U             | WELLCOME           | SBARFIETY | POST DOCK EVA XFER | SMP XFR RVW        |          |
| DAY/NIGHT ORBIT |              | 25   | 26         | 27           | 28           | 29           | 30           | 31           | 32           | 33           |              |               |                     |                     |                    |           |                    |                    |          |
| STS             | TDRS WEZ     | [Timeline bars for TDRS WEZ]   |            |              |              |              |              |              |              |              |              |               |                     |                     |                    |           |                    |                    |          |
|                 | ORB ATT      | [Timeline bars for ORB ATT]  |            |              |              |              |              |              |              |              |              |               |                     |                     |                    |           |                    |                    |          |
| ISS             | TDRS AVAIL   | [Timeline bars for TDRS AVAIL]   |            |              |              |              |              |              |              |              |              |               |                     |                     |                    |           |                    |                    |          |
| ISS             | SSRMS POS    | [Timeline bars for SSRMS POS]  |            |              |              |              |              |              |              |              |              |               |                     |                     |                    |           |                    |                    |          |
| NOTES           |              | #FILTER CK *D/L RATE 2M<br>*B POD HTR RCNFG<br>*DOCKING 01/20:44<br>*TO ISS ^RECONFIG #ACT |            |              |              |              |              |              |              |              |              |               |                     |                     |                    |           |                    |                    |          |

NO EXERCISE  
[DURING DEADBAND COLLAPSE]

FD03

GMT 02/08/10 (039)

MET Day 001

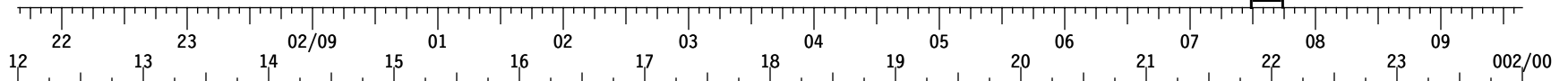

|              |                  |  |            |       |       |       |                   |                   |           |           |                     |                 |                 |                 |                 |             |                 |  |  |  |  |  |  |  |  |
|--------------|------------------|--|------------|-------|-------|-------|-------------------|-------------------|-----------|-----------|---------------------|-----------------|-----------------|-----------------|-----------------|-------------|-----------------|--|--|--|--|--|--|--|--|
| ISS          | TDRS AVAIL       | ΔRPM   |            |       |       |       |                   |                   |           |           |                     |                 |                 |                 |                 |             |                 |  |  |  |  |  |  |  |  |
|              | DAY/NIGHT        | 13 14 15 1 2 3 4 5 6   |            |       |       |       |                   |                   |           |           |                     |                 |                 |                 |                 |             |                 |  |  |  |  |  |  |  |  |
| S            | DAILY ORBIT      | 122 142 112  |            |       |       |       |                   |                   |           |           |                     |                 |                 |                 |                 |             |                 |  |  |  |  |  |  |  |  |
|              | TLM FORMAT       | +XVV +ZLV TEA +XVV +ZLV -XVV +ZLV  |            |       |       |       |                   |                   |           |           |                     |                 |                 |                 |                 |             |                 |  |  |  |  |  |  |  |  |
| EXP22        | ATTITUDE         |  |            |       |       |       |                   |                   |           |           |                     |                 |                 |                 |                 |             |                 |  |  |  |  |  |  |  |  |
|              | ALL VHF          |  |            |       |       |       |                   |                   |           |           |                     |                 |                 |                 |                 |             |                 |  |  |  |  |  |  |  |  |
|              | ISS CDR WILLIAMS | SLEEP  | POST SLEEP | PWDPC | CEVIS | ARED  | P/TV RPM VRFY S/U | MEAL              | PHOOTO M  | R P M D L | DA O U C K I O      | HATCH OPEN      | W E L L C O M E | S A F E T Y     | S M P X F R R W |             |                 |  |  |  |  |  |  |  |  |
|              | FE-1 SURAEV      | SLEEP  | POST SLEEP | PWDPC | PW    | TVIS  | HYG               | VELO              | MEAL      | RS OPS    |                     |                 | W E L L C O M E | S A F E T Y     | R S O P S       |             |                 |  |  |  |  |  |  |  |  |
|              | FE-4 KOTOV       | SLEEP  | POST SLEEP | PWDPC | PW    | VELO  | RS OPS            | P/TV RPM VRFY S/U | MEAL      | PHOOTO M  |                     |                 | W E L L C O M E | S A F E T Y     | T V I S         |             |                 |  |  |  |  |  |  |  |  |
| FE-5 NOGUCHI | SLEEP            | POST SLEEP   | PWDPC      | PW    | CEVIS | T2    | MEAL              | T I M E R         | D V I C E | ®         | HATCH OPEN          | W E L L C O M E | S A F E T Y     | S S C R         |                 |             |                 |  |  |  |  |  |  |  |  |
| FE-6 CREAMER | SLEEP            | POST SLEEP   | PWDPC      | PW    | T2    | CEVIS | MEAL              | A R P V X W C     |           |           | HATCH LEAK CK - ISS | C A M D         | HATCH OPEN      | W E L L C O M E | S A F E T Y     | P V A I O D | O B S S G R P L |  |  |  |  |  |  |  |  |
| TDRS         | W E Z            | [Timeline bars]  |            |       |       |       |                   |                   |           |           |                     |                 |                 |                 |                 |             |                 |  |  |  |  |  |  |  |  |
| ISS          | SSRMS POS        | -ZLV -XVV -ZLV +YVV RNDZ -DK +BIAS -XLV -ZVV   |            |       |       |       |                   |                   |           |           |                     |                 |                 |                 |                 |             |                 |  |  |  |  |  |  |  |  |
| STS          | ORB ATT          | ♦JPM/LAB-SHUTTER-CL *CABLE CONNECT ^SALIVA SETUP ♦Q&T-DK SM IIA 3-CNFG @N2 XFER INIT @ACS-PM42-ARVL-THRSTR |            |       |       |       |                   |                   |           |           |                     |                 |                 |                 |                 |             |                 |  |  |  |  |  |  |  |  |
| NOTES        |                  |  |            |       |       |       |                   |                   |           |           |                     |                 |                 |                 |                 |             |                 |  |  |  |  |  |  |  |  |

\*DOCKING 01/20:44

**NO EXERCISE  
[WHILE DOUBLE GRAPPLED]**

**FD03**

GMT 02/09/10 (040)

MET Day 002

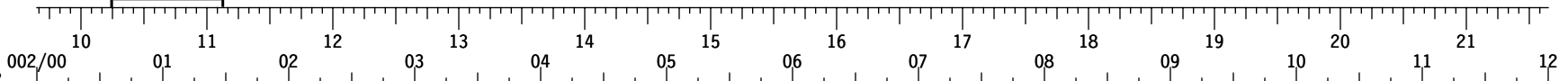

|           |  |                                  |                  |                    |             |                    |              |           |       |
|-----------|--|----------------------------------|------------------|--------------------|-------------|--------------------|--------------|-----------|-------|
| STS-130   | CDR ZAMKA                                    | XFER OPS                         | N2 XFER INIT     | EXERCISE           | PRE SLEEP   | FD CONF<br>PMC A/G | PRE SLEEP    | SLEEP     |       |
|           | PLT VIRTIS                                   | GRPL                             |                  | MN3 VIRTIS<br>INIT | EXERCISE    |                    | PRE SLEEP    | SLEEP     |       |
|           | MS1 HIRE                                     | GRPL                             |                  | MN3 VIRTIS<br>INIT | XFER OPS    | XTFA<br>EGRUP      | XBFR<br>EIRF | PRE SLEEP | SLEEP |
|           | MS2 ROBINSON                                 | *SODF XFER                       | PLAY BACK        | XFER OPS           |             |                    | PRE SLEEP    | SLEEP     |       |
|           | MS3 PATRICK                                  | SOUN<br>RSB<br>MSE<br>S<br>RTH   | UNGRPL &<br>MNVR | E_LK PREP          | REBA<br>C/O |                    | PRE SLEEP    | SLEEP     |       |
|           | MS4 BEHNKEN                                  | GLCR<br>MLF<br>20A<br>SMP<br>XFR | GLCR*            | MDDK<br>E_LK PREP  | REBA<br>C/O |                    | PRE SLEEP    | SLEEP     |       |
| DAY/NIGHT | ORBIT  |                                  |                  |                    |             |                    |              |           |       |
| STS       | TDRS   | W<br>E<br>Z                      |                  |                    |             |                    |              |           |       |
|           | ORB ATT                                      | BIAS -XLV -ZVV                   |                  |                    |             |                    |              |           |       |
| ISS       | TDRS AVAIL                                   |                                  |                  |                    |             |                    |              |           |       |
|           | SSRMS POS                                    |                                  |                  |                    |             |                    |              |           |       |
| NOTES     | *GLCR P/TV09 *INSTALL<br>*CONFIG FOR DESCENT |                                  |                  |                    |             |                    |              |           |       |

**NO EXERCISE  
[WHILE DOUBLE GRAPPLED]**

**FD03**

GMT 02/09/10 (040)

MET Day 002

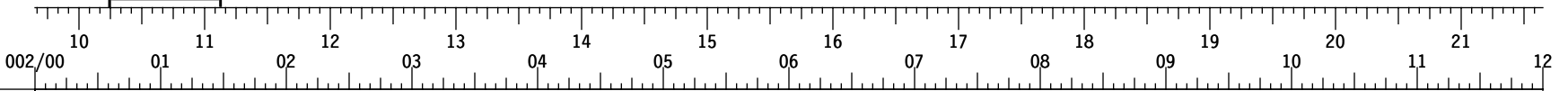

|         |             |                                     |   |   |   |    |    |     |    |  |  |  |  |
|---------|-------------|-------------------------------------|---|---|---|----|----|-----|----|--|--|--|--|
| ISS     | TDRS AVAIL  | [Bar chart showing availability]    |   |   |   |    |    |     |    |  |  |  |  |
|         | DAY/NIGHT   | [Bar chart showing day/night cycle] |   |   |   |    |    |     |    |  |  |  |  |
|         | DAILY ORBIT | 6                                   | 7 | 8 | 9 | 10 | 11 | 12  | 13 |  |  |  |  |
|         | TLM FORMAT  | 112                                 |   |   |   |    |    | 122 |    |  |  |  |  |
|         | ATTITUDE    | -XVV +ZLV                           |   |   |   |    |    |     |    |  |  |  |  |
| ALL VHF |             | -                                   |   |   |   |    |    |     |    |  |  |  |  |

|       |                  |   |               |           |                                |               |       |       |
|-------|------------------|---|---------------|-----------|--------------------------------|---------------|-------|-------|
| EXP22 | ISS CDR WILLIAMS | GLCR MLF 20A SMP XFR                        | N2 XFER INIT  | E_LK PREP | PW                             | PRE SLEEP-ISS | REACT | SLEEP |
|       | FE-1 SURAEV      | RS OPS                                      |               | PW DPC    | PW                             | PRE SLEEP-ISS |       | SLEEP |
|       | FE-4 KOTOV       | T V I S<br>HYG                              |               | PW DPC    | PW                             | PRE SLEEP-ISS |       | SLEEP |
|       | FE-5 NOGUCHI     |   |               | PW DPC    | G C / D M S *<br>DCB APCX UNPK | PRE SLEEP-ISS | REACT | SLEEP |
|       | FE-6 CREAMER     | S O U<br>S B N<br>R S B<br>M S E<br>R T H I | UNGRPL & MNVR | DPC       | PW                             | PRE SLEEP-ISS | REACT | SLEEP |



|     |           |                |  |  |  |  |  |  |  |  |  |  |  |
|-----|-----------|----------------|--|--|--|--|--|--|--|--|--|--|--|
| ISS | SSRMS POS |                |  |  |  |  |  |  |  |  |  |  |  |
| STS | ORB ATT   | *PRE SLEEP-ISS |  |  |  |  |  |  |  |  |  |  |  |

BIAS -XLV -ZVV

NOTES





**FD04**

GMT 02/09/10 (040)

MET Day 002

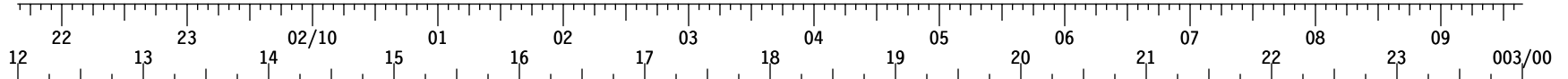

|     |             |                                     |    |    |   |   |   |   |   |  |  |  |  |  |  |  |  |  |  |  |  |  |  |  |  |  |
|-----|-------------|-------------------------------------|----|----|---|---|---|---|---|--|--|--|--|--|--|--|--|--|--|--|--|--|--|--|--|--|
| ISS | TDRS AVAIL  | [Bar chart showing availability]    |    |    |   |   |   |   |   |  |  |  |  |  |  |  |  |  |  |  |  |  |  |  |  |  |
|     | DAY/NIGHT   | [Bar chart showing day/night cycle] |    |    |   |   |   |   |   |  |  |  |  |  |  |  |  |  |  |  |  |  |  |  |  |  |
|     | DAILY ORBIT | 14                                  | 15 | 16 | 1 | 2 | 3 | 4 | 5 |  |  |  |  |  |  |  |  |  |  |  |  |  |  |  |  |  |
|     | TLM FORMAT  | 122                                 |    |    |   |   |   |   |   |  |  |  |  |  |  |  |  |  |  |  |  |  |  |  |  |  |
|     | ATTITUDE    | -XVV +ZLV                           |    |    |   |   |   |   |   |  |  |  |  |  |  |  |  |  |  |  |  |  |  |  |  |  |

|           |                  |       |            |    |     |    |             |                 |                    |          |                      |                |          |          |                    |      |          |          |      |          |    |
|-----------|------------------|-------|------------|----|-----|----|-------------|-----------------|--------------------|----------|----------------------|----------------|----------|----------|--------------------|------|----------|----------|------|----------|----|
| EXP<br>22 | ISS CDR WILLIAMS | SLEEP | POST SLEEP | PW | DPC | PW | SPINAL S/U  | STAND*          | STS 02 P/B CONFIG  | STAND    | SPINAL               | WRS-DA-INSTALL | HD SU    | PAO      | PAO                | MEAL | OFF DUTY | T2       | ARED |          |    |
|           | FE-1 SURAEV      | SLEEP | POST SLEEP | PW | DPC | PW | RS OPS      |                 |                    | TVIS     | HYG                  | MEAL           | OFF DUTY |          |                    |      |          |          |      | VELO     |    |
|           | FE-4 KOTOV       | SLEEP | POST SLEEP | PW | DPC | PW | RS OPS      |                 |                    |          | VELO                 | MEAL           | OFF DUTY |          |                    |      |          |          |      | TVIS     |    |
|           | FE-5 NOGUCHI     | SLEEP | POST SLEEP | PW | DPC | PW | ARED        | EVA CAMERA CNFG | SPNL DATA CLCT OPR | STAND    | SPINAL               | SHS P/T W/O W  | MEAL     | OFF DUTY |                    |      |          |          |      |          | T2 |
|           | FE-6 CREAMER     | SLEEP | POST SLEEP | PW | DPC |    | ABRS REINIT | MWASU           | PHOTO              | TRAEPLNT | CAMBIUM LOOP REPLNT2 | T2             | STAND    | SPINAL   | SPNL DATA CLCT OPR | PAO  | MEAL     | OFF DUTY | ARED | OFF DUTY |    |



|     |           |                |  |  |  |  |  |  |  |  |  |  |  |  |  |  |  |  |  |  |  |  |  |  |  |
|-----|-----------|----------------|--|--|--|--|--|--|--|--|--|--|--|--|--|--|--|--|--|--|--|--|--|--|--|
| ISS | SSRMS POS | BIAS -XLV -ZVV |  |  |  |  |  |  |  |  |  |  |  |  |  |  |  |  |  |  |  |  |  |  |  |
| STS | ORB ATT   | *S/U           |  |  |  |  |  |  |  |  |  |  |  |  |  |  |  |  |  |  |  |  |  |  |  |

NOTES

**FD04**

GMT 02/10/10 (041)

MET Day 003 003/00 10 01 02 03 04 05 06 07 08 09 10 11 12

|                 |              |                                 |                   |           |           |           |       |    |  |    |  |    |  |    |  |    |  |
|-----------------|--------------|---------------------------------|-------------------|-----------|-----------|-----------|-------|----|--|----|--|----|--|----|--|----|--|
| STS-130         | CDR ZAMKA    | OFF DUTY                        | EVA 1 PROC REVIEW | PRE SLEEP | PRE SLEEP | PRE SLEEP | SLEEP |    |  |    |  |    |  |    |  |    |  |
|                 | PLT VIRTS    | OFF DUTY                        | EVA 1 PROC REVIEW | PRE SLEEP | PRE SLEEP | PRE SLEEP | SLEEP |    |  |    |  |    |  |    |  |    |  |
|                 | MS1 HIRE     | OFF DUTY                        | EVA 1 PROC REVIEW | PRE SLEEP | PRE SLEEP | PRE SLEEP | SLEEP |    |  |    |  |    |  |    |  |    |  |
|                 | MS2 ROBINSON | OFF DUTY                        | EVA 1 PROC REVIEW | PRE SLEEP | PRE SLEEP | PRE SLEEP | SLEEP |    |  |    |  |    |  |    |  |    |  |
|                 | MS3 PATRICK  | OFF DUTY                        | EVA 1 PROC REVIEW | PRE SLEEP | PRE SLEEP | PRE SLEEP | SLEEP |    |  |    |  |    |  |    |  |    |  |
|                 | MS4 BEHNKEN  | OFF DUTY                        | EVA 1 PROC REVIEW | PRE SLEEP | PRE SLEEP | PRE SLEEP | SLEEP |    |  |    |  |    |  |    |  |    |  |
| DAY/NIGHT ORBIT |              | 49                              |                   | 50        |           | 51        |       | 52 |  | 53 |  | 54 |  | 55 |  | 56 |  |
| STS             | TDRS WEZ     | [Timeline of TDRS operations]   |                   |           |           |           |       |    |  |    |  |    |  |    |  |    |  |
|                 | ORB ATT      | [Timeline of Orbital Attitude]  |                   |           |           |           |       |    |  |    |  |    |  |    |  |    |  |
| ISS             | TDRS AVAIL   | [Timeline of TDRS Availability] |                   |           |           |           |       |    |  |    |  |    |  |    |  |    |  |
|                 | SSRMS POS    | [Timeline of SSRMS Position]    |                   |           |           |           |       |    |  |    |  |    |  |    |  |    |  |
| NOTES           |              | *READINGS                       |                   |           |           |           |       |    |  |    |  |    |  |    |  |    |  |

**FD04**

GMT 02/10/10 (041)

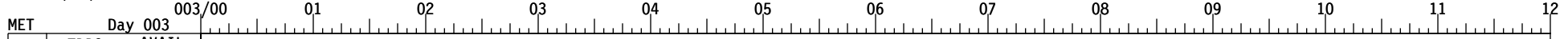

|             |             |                                     |   |   |   |   |    |     |    |    |  |  |  |
|-------------|-------------|-------------------------------------|---|---|---|---|----|-----|----|----|--|--|--|
| I<br>S<br>S | TDRS AVAIL  | [Bar chart showing availability]    |   |   |   |   |    |     |    |    |  |  |  |
|             | DAY/NIGHT   | [Bar chart showing day/night cycle] |   |   |   |   |    |     |    |    |  |  |  |
|             | DAILY ORBIT | 5                                   | 6 | 7 | 8 | 9 | 10 | 11  | 12 | 13 |  |  |  |
|             | TLM FORMAT  | 122                                 |   |   |   |   |    | 111 |    |    |  |  |  |
|             | ATTITUDE    | -XVV +ZLV                           |   |   |   |   |    |     |    |    |  |  |  |
| ALL VHF     |             | [Bar chart showing VHF usage]       |   |   |   |   |    |     |    |    |  |  |  |

|                       |                  |          |                   |                   |              |               |     |               |   |               |               |       |
|-----------------------|------------------|----------|-------------------|-------------------|--------------|---------------|-----|---------------|---|---------------|---------------|-------|
| E<br>X<br>P<br>2<br>2 | ISS CDR WILLIAMS | ARED     | EVA 1 PROC REVIEW | DPC               | UPA FILL     | *             | PFC | ⊕             | ◆ | PRE SLEEP-ISS | SLEEP         |       |
|                       | FE-1 SURAEV      | VELO     | EVA 1 PROC REVIEW | DPC               | PW           |               |     |               |   | PRE SLEEP-ISS | SLEEP         |       |
|                       | FE-4 KOTOV       | TVIS     | HYG               | EVA 1 PROC REVIEW | DPC          | PW            |     |               |   |               | PRE SLEEP-ISS | SLEEP |
|                       | FE-5 NOGUCHI     | T2       | EVA 1 PROC REVIEW | DPC               | PW           | PRE SLEEP-ISS | PFC | PRE SLEEP-ISS |   |               |               | SLEEP |
|                       | FE-6 CREAMER     | OFF DUTY | EVA 1 PROC REVIEW | DPC               | H<br>M<br>PW | PRE SLEEP-ISS | PFC | ⊕             |   |               |               | SLEEP |

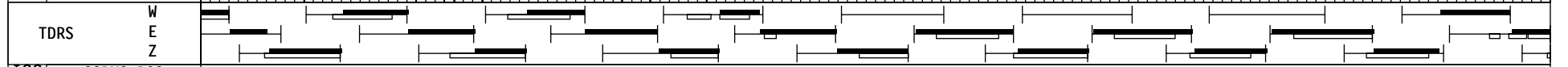

|     |           |                |  |  |  |  |  |  |  |  |  |  |  |
|-----|-----------|----------------|--|--|--|--|--|--|--|--|--|--|--|
| ISS | SSRMS POS | BIAS -XLV -ZVV |  |  |  |  |  |  |  |  |  |  |  |
| STS | ORB ATT   |                |  |  |  |  |  |  |  |  |  |  |  |

|       |  |  |  |  |  |  |  |  |  |  |  |  |
|-------|--|--|--|--|--|--|--|--|--|--|--|--|
| NOTES | *PRE SLEEP-ISS    ⊕PRE SLEEP-ISS<br>⊕PRE SLEEP-ISS<br>◆MASK P/B CONFIG |  |  |  |  |  |  |  |  |  |  |  |
|-------|--|--|--|--|--|--|--|--|--|--|--|--|

NO EXERCISE  
[FROM PRE-INSTL UNTIL A-BOLTS COMPLETE]

NO UNISOLATED EXERCISE  
[DURING OTP REMOVAL]

FD05

GMT 02/07/10 (038)

MET Day 003

|         |                 | 12  | 13         | 14            | 15                | 16        | 17             | 18             | 19                                 | 20                  | 21                   | 22                 | 23                   | 10             | 004/00 |
|---------|-----------------|---|------------|---------------|-------------------|-----------|----------------|----------------|------------------------------------|---------------------|----------------------|--------------------|----------------------|----------------|--------|
| STS-130 | CDR ZAMKA       | SLEEP   | POST SLEEP | PMC A/G       | HYG BRK/HATCH CLS | EVA-PREP  | EMURGE         | EMU PREBREATHE | C_LK DPRS                          | P/TV07 EVA OPS      | P/TV07 EVA OPS       | MEAL               | P/TV07 EVA OPS       | P/TV07 EVA OPS |        |
|         | PLT VIRTS       | SLEEP   | POST SLEEP |               |                   | INADMBT   | PE/TAVS/07     | ARED           | NODE 3 GRPL                        | XFER OPS            | NODE 3 MNVR PREINSTL | NODE 3 MNVR TO RTL | MEAL                 | CHWFFP         | XOFP   |
|         | MS1 HIRE        | SLEEP   | POST SLEEP |               |                   | XUFEDRATE | EXERCISE       | NODE 3 GRPL    | CBCS*3                             | NVAOESCETS          | NODE 3 LKCK S/U      | XFER OPS           | NODE 3 MNVR PREINSTL | MEAL           | CBXOPS |
|         | MS2 ROBINSON    | SLEEP   | POST SLEEP |               |                   | EXERCISE  | EVA TOOL CHECK | XFER OPS       | IVA SUPPORT<br><b>EVA 1 (6:30)</b> |                     |                      |                    |                      |                |        |
|         | MS3 PATRICK EV2 | SLEEP   | POST SLEEP | HYGIENE BREAK | EVA-PREP          | EMURGE    | EMU PREBREATHE | C_LK DPRS      | EVA EGRS/SETUP                     | NODE 3 PREP UNBERTH | NH3 BAG OPS          | OTP REMOVAL        | LTA CABLE INSTL      | GET AHEAD      |        |
|         | MS4 BEHNKEN EV1 | SLEEP   | POST SLEEP | HYGIENE BREAK | EVA-PREP          | EMURGE    | EMU PREBREATHE | C_LK DPRS      | EVA EGRS/SETUP                     | NODE 3 PREP UNBERTH | NH3 BAG OPS          | OTP REMOVAL        | AVIONICS CABLE INSTL | GET AHEAD      |        |
| STS     | DAY/NIGHT ORBIT | 56  | 57         | 58            | 59                | 60        | 61             | 62             | 63                                 | 64                  |                      |                    |                      |                |        |
| STS     | TDRS W E Z      | [Timeline bars for TDRS W, E, Z]                            |            |               |                   |           |                |                |                                    |                     |                      |                    |                      |                |        |
| STS     | ORB ATT         | BIAS -XLV -ZVV  |            |               |                   |           |                |                |                                    |                     |                      |                    |                      |                |        |
| ISS     | TDRS AVAIL      | [Timeline bars for TDRS AVAIL]                              |            |               |                   |           |                |                |                                    |                     |                      |                    |                      |                |        |
| ISS     | SSRMS POS       | [Timeline bars for SSRMS POS]                               |            |               |                   |           |                |                |                                    |                     |                      |                    |                      |                |        |
|         | NOTES           | *POWER UP @OPEN ^POWERDOWN #CLNUP & I @CLNUP & I #TEMP STOW |            |               |                   |           |                |                |                                    |                     |                      |                    |                      |                |        |

NO EXERCISE  
[FROM PRE-INSTL UNTIL A-BOLTS COMPLETE]

NO UNISOLATED EXERCISE  
[DURING OTP REMOVAL]

FD05

GMT 02/07/10 (038)

MET Day 003

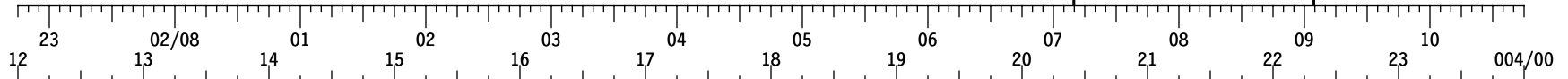

|             |             |                    |    |    |   |   |   |   |   |   |  |  |  |     |  |  |  |  |  |  |  |  |  |  |  |     |  |  |  |  |  |  |  |  |  |  |  |     |  |  |  |  |  |  |  |  |  |  |  |
|-------------|-------------|--------------------|----|----|---|---|---|---|---|---|--|--|--|-----|--|--|--|--|--|--|--|--|--|--|--|-----|--|--|--|--|--|--|--|--|--|--|--|-----|--|--|--|--|--|--|--|--|--|--|--|
| I<br>S<br>S | TDRS AVAIL  | [Color-coded bars] |    |    |   |   |   |   |   |   |  |  |  |     |  |  |  |  |  |  |  |  |  |  |  |     |  |  |  |  |  |  |  |  |  |  |  |     |  |  |  |  |  |  |  |  |  |  |  |
|             | DAY/NIGHT   | [Color-coded bars] |    |    |   |   |   |   |   |   |  |  |  |     |  |  |  |  |  |  |  |  |  |  |  |     |  |  |  |  |  |  |  |  |  |  |  |     |  |  |  |  |  |  |  |  |  |  |  |
|             | DAILY ORBIT | 14                 | 15 | 16 | 1 | 2 | 3 | 4 | 5 | 6 |  |  |  |     |  |  |  |  |  |  |  |  |  |  |  |     |  |  |  |  |  |  |  |  |  |  |  |     |  |  |  |  |  |  |  |  |  |  |  |
|             | TLM FORMAT  | 111                |    |    |   |   |   |   |   |   |  |  |  | 141 |  |  |  |  |  |  |  |  |  |  |  | 141 |  |  |  |  |  |  |  |  |  |  |  | 111 |  |  |  |  |  |  |  |  |  |  |  |
|             | ATTITUDE    | -XVV +ZLV          |    |    |   |   |   |   |   |   |  |  |  |     |  |  |  |  |  |  |  |  |  |  |  |     |  |  |  |  |  |  |  |  |  |  |  |     |  |  |  |  |  |  |  |  |  |  |  |
| ALL VHF     |             |                    |    |    |   |   |   |   |   |   |  |  |  |     |  |  |  |  |  |  |  |  |  |  |  |     |  |  |  |  |  |  |  |  |  |  |  |     |  |  |  |  |  |  |  |  |  |  |  |

|                       |                  |       |                  |               |          |          |                |           |         |        |         |      |          |             |             |      |          |
|-----------------------|------------------|-------|------------------|---------------|----------|----------|----------------|-----------|---------|--------|---------|------|----------|-------------|-------------|------|----------|
| E<br>X<br>P<br>2<br>2 | ISS CDR WILLIAMS | SLEEP | POST SLEEP       | HYGIENE BREAK | EVA-PREP | EMURGE   | EMU PREBREATHE | C LK DPRS | P D P S | *      | CEVIS   | MEAL | VELOCITY | 1ST STG CAP | 2ND STG CAP | ARED |          |
|                       | FE-1 SURAEV      | SLEEP | POST SLEEP       | PW DPC PW     | RS OPS   | TVIS     | HYG            | VELO      | MEAL    | RS OPS |         |      |          |             |             |      |          |
|                       | FE-4 KOTOV       | SLEEP | POST SLEEP       | PW DPC PW     | RS OPS   | VELO     | TVIS           | HYG       | MEAL    | RS OPS |         |      |          |             |             |      |          |
|                       | FE-5 NOGUCHI     | SLEEP | POST SLEEP       | TEST DPC PW   | ARED     | XFER OPS |                |           |         |        |         | MEAL | NSIBNCK  | XFER OPS    |             | TEST | XFER OPS |
|                       | FE-6 CREAMER     | SLEEP | SALVA POST SLEEP | HYGIENE BREAK | EVA-PREP | EMURGE   | EMU PREBREATHE | C LK DPRS | P D P S | ARED   | INSPECT | MEAL |          |             |             |      | CEVIS    |

|      |     |                 |  |  |  |  |  |  |  |  |  |  |  |  |  |  |  |  |  |  |  |  |  |  |  |
|------|-----|-----------------|--|--|--|--|--|--|--|--|--|--|--|--|--|--|--|--|--|--|--|--|--|--|--|
| TDRS | WEZ | [Timeline bars] |  |  |  |  |  |  |  |  |  |  |  |  |  |  |  |  |  |  |  |  |  |  |  |
|------|-----|-----------------|--|--|--|--|--|--|--|--|--|--|--|--|--|--|--|--|--|--|--|--|--|--|--|

|     |           |                |  |  |  |  |  |  |  |  |  |  |  |  |  |  |  |  |  |  |  |  |  |  |  |
|-----|-----------|----------------|--|--|--|--|--|--|--|--|--|--|--|--|--|--|--|--|--|--|--|--|--|--|--|
| ISS | SSRMS POS |                |  |  |  |  |  |  |  |  |  |  |  |  |  |  |  |  |  |  |  |  |  |  |  |
| STS | ORB ATT   | BIAS -XLV -ZVV |  |  |  |  |  |  |  |  |  |  |  |  |  |  |  |  |  |  |  |  |  |  |  |

|       |   |  |  |  |  |  |  |  |  |  |  |  |  |  |  |  |  |  |  |  |  |  |  |  |
|-------|---|--|--|--|--|--|--|--|--|--|--|--|--|--|--|--|--|--|--|--|--|--|--|--|
| NOTES | ⊕JPM/LAB-SHUTTER-CL<br>♦C&T-CUCU-INH<br>*UPA FILL<br>^MELFI |  |  |  |  |  |  |  |  |  |  |  |  |  |  |  |  |  |  |  |  |  |  |  |
|-------|---|--|--|--|--|--|--|--|--|--|--|--|--|--|--|--|--|--|--|--|--|--|--|--|

**FD05**

GMT 02/08/10 (039)

MET Day 004

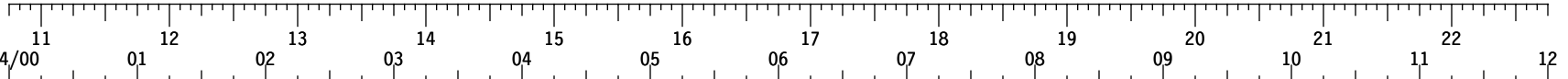

|         |                         |   |                         |                       |               |              |                               |           |       |           |       |
|---------|-------------------------|---|-------------------------|-----------------------|---------------|--------------|-------------------------------|-----------|-------|-----------|-------|
| STS-130 | CDR ZAMKA               | PEVA OPS<br>TA VOPS                           | PCRP<br>RTRKS           | POST EVA W/H20        | BSA INIT      | PS           | FD<br>C<br>P<br>M<br>C<br>A/G | PRE SLEEP | SLEEP |           |       |
|         | PLT VIRTS               | XFER OPS                                      | DEAD<br>PIT             | FLTR CLN<br>- INSPECT |               |              |                               | PRE SLEEP | SLEEP |           |       |
|         | MS1 HIRE                | XFER OPS                                      | N3 VEST<br>LK CK<br>PT1 | N3 LK<br>CK<br>PT2    | XTFA<br>EGRUP | XBFR<br>EIEF |                               |           |       | PRE SLEEP | SLEEP |
|         | MS2 ROBINSON            | ISUP<br>APPORT                                | PCRP<br>RTRKS           | XFER OPS              | KCKKDDM       |              |                               | PRE SLEEP | SLEEP |           |       |
|         | MS3 PATRICK<br>EV2      | CILN<br>GURPS<br>&                            | PCRP<br>RTRKS           | POST EVA W/H20        |               |              |                               | PRE SLEEP | SLEEP |           |       |
|         | MS4 BEHNKEN<br>EV1      | CILN<br>GURPS<br>&                            | PCRP<br>RTRKS           | POST EVA W/H20        |               |              |                               | PRE SLEEP | SLEEP |           |       |
| STS     | DAY/NIGHT ORBIT         | 64 65 66 67 68 69 70 71 72                    |                         |                       |               |              |                               |           |       |           |       |
|         | TDRS WEZ                | [Timeline of TDRS WEZ events]                 |                         |                       |               |              |                               |           |       |           |       |
| ISS     | ORB ATT                 | BIAS -XLV -ZVV                                |                         |                       |               |              |                               |           |       |           |       |
|         | TDRS AVAIL<br>SSRMS POS | [Timeline of TDRS AVAIL and SSRMS POS events] |                         |                       |               |              |                               |           |       |           |       |
| NOTES   |                         |   |                         |                       |               |              |                               |           |       |           |       |

**FD05**

GMT 02/08/10 (039)



MET Day 004

|     |             |                                 |   |   |   |    |    |     |    |  |     |  |  |
|-----|-------------|---------------------------------|---|---|---|----|----|-----|----|--|-----|--|--|
| ISS | TDRS AVAIL  | [Color-coded availability bars] |   |   |   |    |    |     |    |  |     |  |  |
|     | DAY/NIGHT   | [Day/Night cycle bars]          |   |   |   |    |    |     |    |  |     |  |  |
|     | DAILY ORBIT | 6                               | 7 | 8 | 9 | 10 | 11 | 12  | 13 |  |     |  |  |
|     | TLM FORMAT  | 111                             |   |   |   |    |    | 122 |    |  | 112 |  |  |
|     | ATTITUDE    | -XVV +ZLV                       |   |   |   |    |    |     |    |  |     |  |  |

|           |                  |                   |               |                |               |               |       |
|-----------|------------------|-------------------|---------------|----------------|---------------|---------------|-------|
| EXP<br>22 | ISS CDR WILLIAMS | N3 VEST LK CK PT1 | DWN LK CK PT2 | DPC            | PRE SLEEP-ISS | SLEEP         |       |
|           | FE-1 SURAEV      | RS OPS            | PW            | DPC            | PRE SLEEP-ISS | SLEEP         |       |
|           | FE-4 KOTOV       | RS OPS            | PW            | DPC            | PRE SLEEP-ISS | SLEEP         |       |
|           | FE-5 NOGUCHI     | * CEVIS           | PW            | EVA*           | DPC           | PRE SLEEP-ISS | SLEEP |
|           | FE-6 CREAMER     | CEVIS             | PCRPERS       | POST EVA W/H2O |               | PRE SLEEP-ISS | SLEEP |

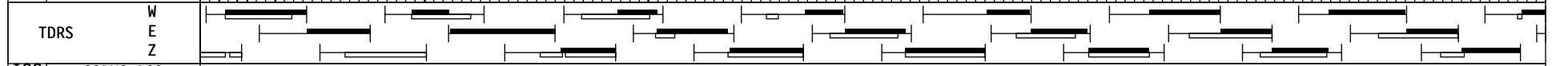

|     |           |                |
|-----|-----------|----------------|
| ISS | SSRMS POS |                |
| STS | ORB ATT   | BIAS -XLV -ZVV |

|       |           |      |
|-------|-----------|------|
| NOTES | *XFER OPS | *D/L |
|-------|-----------|------|

**NO EXERCISE  
[DURING LCS IMAGING]**

**FD06**

GMT 02/08/10 (039)

MET Day 004

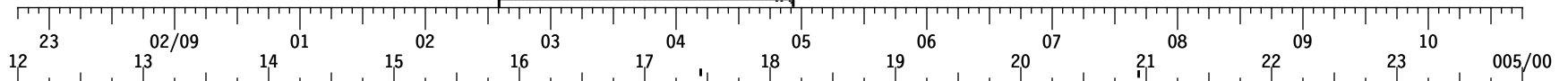

|         |                      |  |            |                  |                           |                  |            |                  |                 |                 |                 |                    |                     |           |             |             |             |             |
|---------|----------------------|--|------------|------------------|---------------------------|------------------|------------|------------------|-----------------|-----------------|-----------------|--------------------|---------------------|-----------|-------------|-------------|-------------|-------------|
| STS-130 | CDR ZAMKA            | SLEEP LOG  | POST SLEEP | FOCUS INSPECTION | EXERCISE                  | NODE 3 VO PART 2 | MEAL       | NODE 3 VO PART 2 |                 |                 |                 |                    |                     |           |             |             |             |             |
|         | PLT VIRTIS           | SLEEP LOG  | POST SLEEP | FOCUS INSPECTION | SWT SAO R L M K A S O F F | VAJ FIT CHK      | MEAL       | N2 RLS & MNVR*   | N3 PORT IMV CAP | N3 PORT IMV CAP | ARE RACK XFER   | ARS RACK XFER      |                     |           |             |             |             |             |
|         | MS1 HIRE             | SLEEP  | POST SLEEP | FOCUS INSPECTION | SWT SAO R L M K A S O F F | VAJ FIT CHK      | MEAL       | N2 RLS & MNVR*   | N3 PORT IMV CAP | N3 PORT IMV CAP | N3 OVHD IMV CAP | N3 VAP CAP REMOVAL | NODE 3 PPRV CAP RMV |           |             |             |             |             |
|         | MS2 ROBINSON         | SLEEP  | POST SLEEP | NODE 3 VO PART 1 | EVA TOOL CONFIG           | NODE 3 VO PART 2 | MEAL       | NODE 3 VO PART 2 |                 |                 |                 |                    |                     |           |             |             |             |             |
|         | MS3 PATRICK          | SLEEP ASPL IORGIN  | POST SLEEP | PS/TU 06         | PSOL STEP                 | EVA TOOL CONFIG  | TOOL AUDIT | QD FAM OPS       | PLAYBACK OPS    | NPA C K         | CGBA SWAP       | MEAL               | PAO                 | EXERCISE  | E_LK PREP   |             |             |             |
|         | MS4 BEHNKEN          | SLEEP ASPL IORGIN  | POST SLEEP | MDCK             | EVA TOOL CONFIG           | TOOL AUDIT       | QD FAM OPS | CIN CIT #3       | EXERCISE        | CTE CRM         | MEAL            | PAO                | B S A - T           | E M U - I | I N S T L ^ | PWR FILL #1 | P X W F E R | C X W F E R |
| STS     | DAY/NIGHT ORBIT      | 72   | 73         | 74               | 75                        | 76               | 77         | 78               | 79              | 80              |                 |                    |                     |           |             |             |             |             |
| STS     | TDRS W E Z           | [TDRS W E Z activity bars]   |            |                  |                           |                  |            |                  |                 |                 |                 |                    |                     |           |             |             |             |             |
| ISS     | TDRS AVAIL SSRMS POS | [TDRS AVAIL SSRMS POS activity bars]   |            |                  |                           |                  |            |                  |                 |                 |                 |                    |                     |           |             |             |             |             |
| ISS     | NOTES                | *FILTER CK<br>BIAS -XLV -ZVV<br>*TO OVERNIGHT PARK ^LIOH & BATTERY<br>NODE 3 HATCH OPEN SSRMS BASE CHANGE<br>NODE 3 TO CUPOLA HATCH OPEN |            |                  |                           |                  |            |                  |                 |                 |                 |                    |                     |           |             |             |             |             |



**NO EXERCISE  
[DURING LCS IMAGING]**

**FD06**

GMT 02/08/10 (039)

MET Day 004

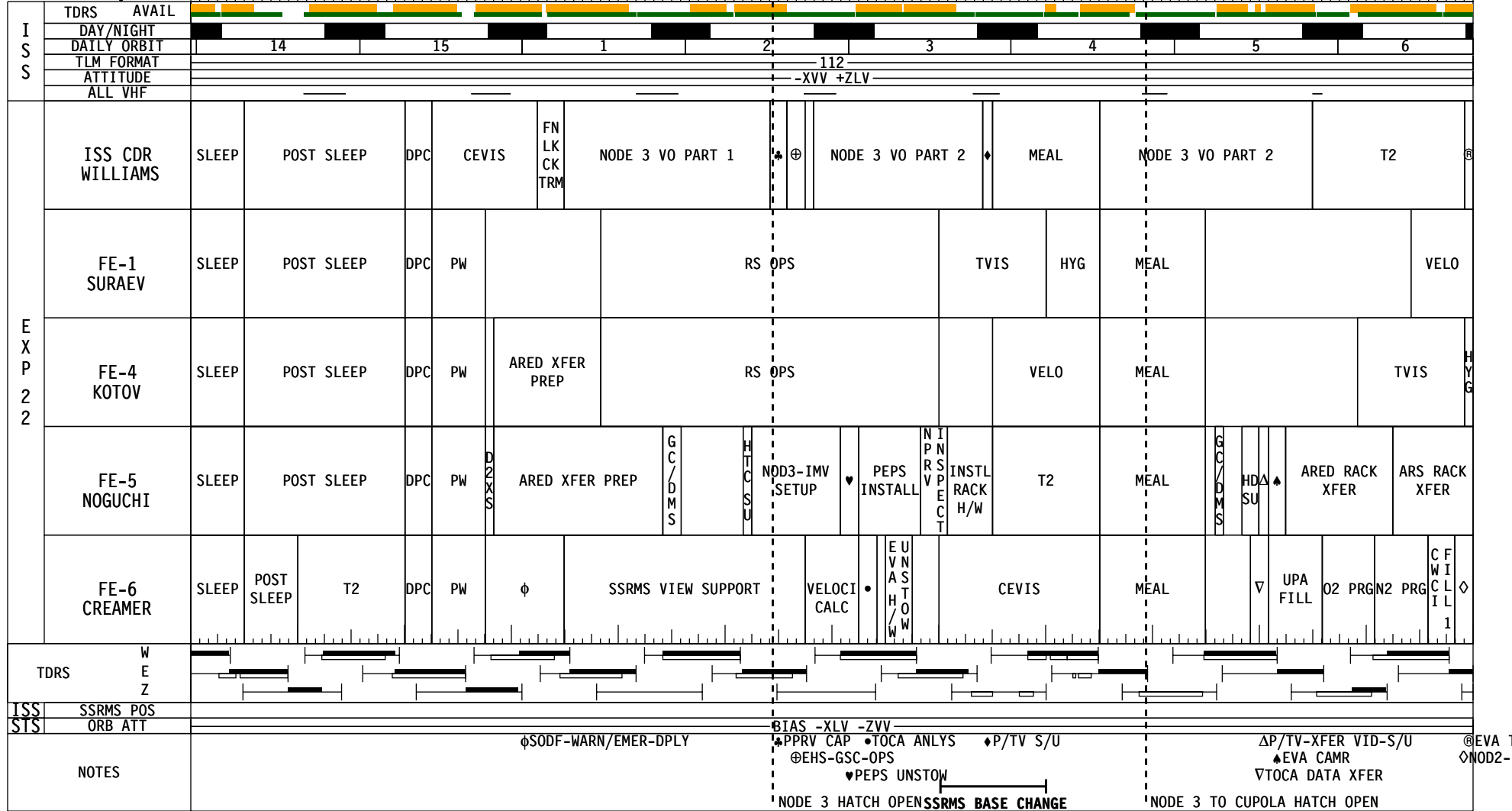

**FD06**

GMT 02/09/10 (040)

MET Day 005

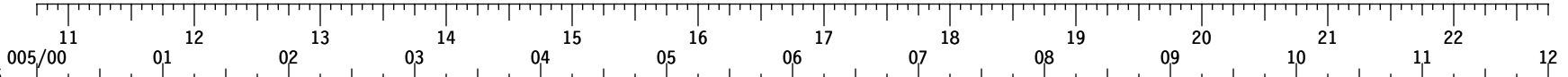

|         |                 |  |                   |           |                 |                 |           |       |  |
|---------|-----------------|--|-------------------|-----------|-----------------|-----------------|-----------|-------|--|
| STS-130 | CDR ZAMKA       | NODE 3 VO PART 2                       | EVA 2 PROC REVIEW | PRE SLEEP | FD CPMC QA/G    | MASK P/B CONFIG | PRE SLEEP | SLEEP |  |
|         | PLT VIRTIS      | ILUM-I                                 | EVA 2 PROC REVIEW | PA0       | PRE SLEEP       |                 | SLEEP     |       |  |
|         | MS1 HIRE        | ⊕                                      | EVA 2 PROC REVIEW | PA0       | PRE SLEEP       |                 | SLEEP     |       |  |
|         | MS2 ROBINSON    | NODE 3 VO PART 2                       | EVA 2 PROC REVIEW | EXERCISE  | PRE SLEEP       |                 | SLEEP     |       |  |
|         | MS3 PATRICK     | E_LK PREP                              | EVA 2 PROC REVIEW | PRE SLEEP | MASK P/B CONFIG | PRE SLEEP       | SLEEP     |       |  |
|         | MS4 BEHNKEN     | E_LK PREP                              | EVA 2 PROC REVIEW | PRE SLEEP | MASK P/B CONFIG | PRE SLEEP       | SLEEP     |       |  |
|         | DAY/NIGHT ORBIT | 80 81 82 83 84 85 86 87 88             |                   |           |                 |                 |           |       |  |
| STS     | TDRS W E Z      | [Timeline of TDRS events]              |                   |           |                 |                 |           |       |  |
|         | ORB ATT         | BIAS -XLV -ZVV                         |                   |           |                 |                 |           |       |  |
| ISS     | TDRS AVAIL      | [Timeline of TDRS availability]        |                   |           |                 |                 |           |       |  |
|         | SSRMS POS       | [Timeline of SSRMS positions]          |                   |           |                 |                 |           |       |  |
|         | NOTES           | *ARS RACK XFER<br>⊕NODE 3 PPRV CAP RMV |                   |           |                 |                 |           |       |  |

**FD06**

GMT 02/09/10 (040)

MET Day 005

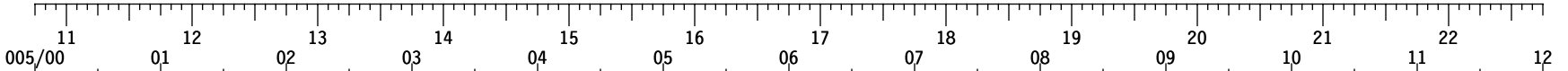

|     |             |  |   |   |   |    |    |     |    |    |  |  |  |
|-----|-------------|--|---|---|---|----|----|-----|----|----|--|--|--|
| ISS | TDRS AVAIL  | [Color-coded bars: orange, green, black] |   |   |   |    |    |     |    |    |  |  |  |
|     | DAY/NIGHT   | [Color-coded bars: black, white]         |   |   |   |    |    |     |    |    |  |  |  |
|     | DAILY ORBIT | 6  | 7 | 8 | 9 | 10 | 11 | 12  | 13 | 14 |  |  |  |
|     | TLM FORMAT  | 112                                      |   |   |   |    |    | 122 |    |    |  |  |  |
|     | ATTITUDE    | -XVV +ZLV                                |   |   |   |    |    |     |    |    |  |  |  |

|       |                  |               |                   |                   |            |     |               |               |                     |
|-------|------------------|---------------|-------------------|-------------------|------------|-----|---------------|---------------|---------------------|
| EXP22 | ISS CDR WILLIAMS | EVA TOOL STOW | EVA 2 PROC REVIEW | *PW               | ⊕          | DPC | PRE SLEEP-ISS | SLEEP         | ISS EXTERNAL SURVEY |
|       | FE-1 SURAEV      | VELO          | EVA 2 PROC REVIEW | PW                | ⊕          | DPC | PRE SLEEP-ISS | SLEEP         |                     |
|       | FE-4 KOTOV       | HYG           | EVA 2 PROC REVIEW | PW                | ⊕          | DPC | PRE SLEEP-ISS | SLEEP         |                     |
|       | FE-5 NOGUCHI     | ♦             | CEVIS             |                   | ⊕          | DPC | PRE SLEEP-ISS | SLEEP         |                     |
|       | FE-6 CREAMER     | ♥             | CFWICLIL2         | EVA 2 PROC REVIEW | DHWANPWMLD | ⊕   | DPC           | PRE SLEEP-ISS | SLEEP               |

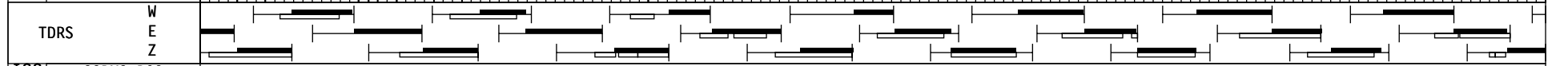

|     |           |                |  |  |  |  |  |  |  |  |  |  |  |
|-----|-----------|----------------|--|--|--|--|--|--|--|--|--|--|--|
| ISS | SSRMS POS |                |  |  |  |  |  |  |  |  |  |  |  |
| STS | ORB ATT   | BIAS -XLV -ZVV |  |  |  |  |  |  |  |  |  |  |  |

|       |  |  |  |  |  |  |  |  |  |  |  |  |  |
|-------|--|--|--|--|--|--|--|--|--|--|--|--|--|
| NOTES | ♦ARS RACK XFER *P/TV STOW<br>♥NOD2-IMV DUCT S/U ⊕PRE SLEEP-ISS<br>⊙PRE SLEEP-ISS |  |  |  |  |  |  |  |  |  |  |  |  |
|-------|--|--|--|--|--|--|--|--|--|--|--|--|--|

**NO UNISOLATED EXERCISE**  
**[NH3 JUMPER INSTALL & OPEN LOOP A QDS]**

**FD07**

GMT 02/09/10 (040)

MET Day 005

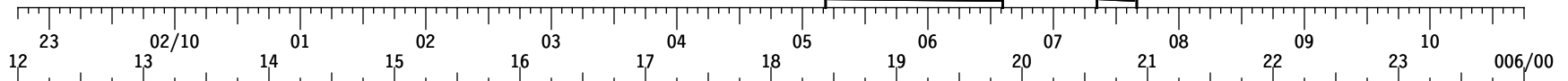

|                 |                 |            |               |               |                   |            |                |                     |                      |                    |                     |                     |                      |                     |                    |                   |                      |          |          |       |
|-----------------|-----------------|------------|---------------|---------------|-------------------|------------|----------------|---------------------|----------------------|--------------------|---------------------|---------------------|----------------------|---------------------|--------------------|-------------------|----------------------|----------|----------|-------|
| STS-130         | CDR ZAMKA       | SLEEP      | POST SLEEP    | PMC A/G       | HYG BRK/HATCH CLS | EVA-PREP   | EMURGE         | EMU PREBREATHE      | C_LK DPRS            | PPC RLI DLOM PASSE | P/TV07 EVA OPS      | CINICIT #4          | MEAL                 | CTWRM               | P/TV07 EVA OPS     | P-RPS             |                      |          |          |       |
|                 | PLT VIRTS       | SLEEP      | POST SLEEP    |               |                   | ILINLUM-O  | EXERCISE       | LIQH TRANSFER       |                      |                    | ISP STOWAGE XFER    |                     | MEAL                 |                     | ISP 1 RMV          | ISP 2 RMV         | N3 AVIONICS RK OUTFT |          |          |       |
|                 | MS1 HIRE        | SLEEP      | POST SLEEP    |               |                   | XUFEDRATE  | PEV/TAVS/U     | STBD DECK IMV INSTL | STBD OVRHD IMV INSTL |                    | NODE 3 H2O BUS FILL |                     | MEAL                 | STBD DECK IMV C/O   | STBD OVRHD IMV C/O | CXWFER            | EXERCISE             | CBCS S/U | XTFAGRUP |       |
|                 | MS2 ROBINSON    | SLEEP      | POST SLEEP    |               |                   | MDDKCK     | EVA TOOL CHECK | XFER OPS            |                      |                    |                     | IVA SUPPORT         |                      |                     |                    |                   |                      |          |          | P-RPS |
|                 |                 |            |               |               |                   |            |                |                     |                      |                    |                     | <b>EVA 2 (6:30)</b> |                      |                     |                    |                   |                      |          |          |       |
|                 | MS3 PATRICK EV2 | SLEEP      | POST SLEEP    | HYGIENE BREAK |                   | EVA-PREP   | EMURGE         | EMU PREBREATHE      | C_LK DPRS            | EVA EGRS/SETUP     | NML OLA DIY OUT 3   | NH3 JUMPER INSTALL  | NH3 MLI INSTALL      | OPEN LAB LOOP A QDS | NCHL30SUMLRE       | NODE 3 OUTFITTING | CLNUP & INGRS        |          |          |       |
| MS4 BEHNKEN EV1 | SLEEP           | POST SLEEP | HYGIENE BREAK |               | EVA-PREP          | EMURGE     | EMU PREBREATHE | C_LK DPRS           | EVA EGRS/SETUP       | NML OLA DIY OUT 3  | NH3 JUMPER INSTALL  | NH3 MLI INSTALL     | OPEN NOD3 LOOP A QDS | NH3 MLI CLOSURE     | NODE 3 OUTFITTING  | CLNUP & INGRS     |                      |          |          |       |
| DAY/NIGHT ORBIT |                 | 88         | 89            | 90            | 91                | 92         | 93             | 94                  | 95                   | 96                 |                     |                     |                      |                     |                    |                   |                      |          |          |       |
| TDRS WEZ        |                 |            |               |               |                   |            |                |                     |                      |                    |                     |                     |                      |                     |                    |                   |                      |          |          |       |
| ORB ATT         |                 |            |               |               |                   |            |                |                     |                      |                    |                     |                     |                      |                     |                    |                   |                      |          |          |       |
| ISS TDRS AVAIL  |                 |            |               |               |                   |            |                |                     |                      |                    |                     |                     |                      |                     |                    |                   |                      |          |          |       |
| SSRMS POS       |                 |            |               |               |                   |            |                |                     |                      |                    |                     |                     |                      |                     |                    |                   |                      |          |          |       |
| NOTES           |                 |            |               |               |                   | *FILTER CK |                |                     |                      |                    | NODE 3 GROUND ACT   |                     |                      |                     |                    |                   |                      |          |          |       |

\*C\_LK RPRS  
 ⊕XFER BRIE  
 ◆C\_LK RPRS  
 ⊗C\_LK RPRS

**NO UNISOLATED EXERCISE**  
 [NH3 JUMPER INSTALL & OPEN LOOP A QDS]

**FD07**

GMT 02/09/10 (040)

MET Day 005

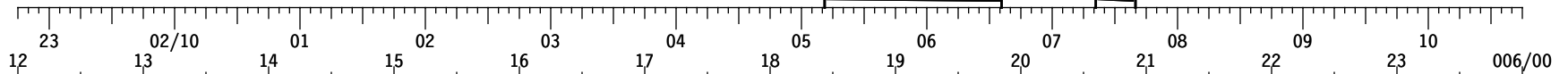

|            |             |  |    |    |   |   |   |   |   |   |  |  |  |     |  |  |  |  |  |  |  |  |  |  |  |     |  |  |  |  |  |  |  |  |  |
|------------|-------------|--|----|----|---|---|---|---|---|---|--|--|--|-----|--|--|--|--|--|--|--|--|--|--|--|-----|--|--|--|--|--|--|--|--|--|
| ISS<br>STS | TDRS AVAIL  | [Color-coded bars: orange, green, black] |    |    |   |   |   |   |   |   |  |  |  |     |  |  |  |  |  |  |  |  |  |  |  |     |  |  |  |  |  |  |  |  |  |
|            | DAY/NIGHT   | [Color-coded bars: black, white]         |    |    |   |   |   |   |   |   |  |  |  |     |  |  |  |  |  |  |  |  |  |  |  |     |  |  |  |  |  |  |  |  |  |
|            | DAILY ORBIT | 14                                       | 15 | 16 | 1 | 2 | 3 | 4 | 5 | 6 |  |  |  |     |  |  |  |  |  |  |  |  |  |  |  |     |  |  |  |  |  |  |  |  |  |
|            | TLM FORMAT  | 122                                      |    |    |   |   |   |   |   |   |  |  |  | 142 |  |  |  |  |  |  |  |  |  |  |  | 144 |  |  |  |  |  |  |  |  |  |
|            | ATTITUDE    | -XVV +ZLV                                |    |    |   |   |   |   |   |   |  |  |  |     |  |  |  |  |  |  |  |  |  |  |  |     |  |  |  |  |  |  |  |  |  |
| ALL VHF    |             |  |    |    |   |   |   |   |   |   |  |  |  |     |  |  |  |  |  |  |  |  |  |  |  |     |  |  |  |  |  |  |  |  |  |

|           |                  |       |            |            |               |                     |                      |                      |           |                  |              |       |            |           |            |                   |
|-----------|------------------|-------|------------|------------|---------------|---------------------|----------------------|----------------------|-----------|------------------|--------------|-------|------------|-----------|------------|-------------------|
| EXP<br>22 | ISS CDR WILLIAMS | SLEEP | REACT      | POST SLEEP | DPC           | NODE 3 1553 CONNECT | NODE 3 IMV RTRN INST | STBD DECK IMV INSTL  | HOPA      | ISP STOWAGE XFER | H2 VNT DCNCT | MEAL  | ⊕ LL CC KK | CEVIS     | T2         |                   |
|           | FE-1 SURAEV      | SLEEP | POST SLEEP | DPC        | PW            | TVIS                | HYG                  | VELO                 | RS OPS    |                  |              | MEAL  | RS OPS     |           |            |                   |
|           | FE-4 KOTOV       | SLEEP | POST SLEEP | DPC        | PW            | VELO                | TVIS                 | HYG                  | RS OPS    |                  |              | MEAL  | RS OPS     |           |            |                   |
|           | FE-5 NOGUCHI     | SLEEP | REACT      | POST SLEEP | ⊕ DPC         | IT FE T             | NOD3-IMV SETUP       | NODE 3 IMV RTRN INST | T2        | ARED INSTALL     |              | CEVIS | MEAL       | ISP 1 RMV | ISP 2 RMV  | NOD2 IMV DUCT S/U |
|           | FE-6 CREAMER     | SLEEP | REACT      | POST SLEEP | HYGIENE BREAK | EVA-PREP            | EP MURGE             | EMU PREBREATHE       | C_LK DPRS | DPS              | CEVIS        | T2    | ⊕          | MEAL      | ♥ UPA FILL | GL OAVE           |



|     |           |                |  |  |  |  |  |  |  |  |  |  |  |  |  |  |  |  |  |  |  |  |  |  |  |
|-----|-----------|----------------|--|--|--|--|--|--|--|--|--|--|--|--|--|--|--|--|--|--|--|--|--|--|--|
| ISS | SSRMS POS |                |  |  |  |  |  |  |  |  |  |  |  |  |  |  |  |  |  |  |  |  |  |  |  |
| STS | ORB ATT   | BIAS -XLV -ZVV |  |  |  |  |  |  |  |  |  |  |  |  |  |  |  |  |  |  |  |  |  |  |  |

|       |                                      |  |  |  |  |  |  |  |  |  |  |  |                  |  |  |  |  |  |   |  |  |  |  |  |
|-------|--------------------------------------|--|--|--|--|--|--|--|--|--|--|--|------------------|--|--|--|--|--|---|--|--|--|--|--|
| NOTES | *JPM/LAB-SHUTTER-CL<br>♦C&T-CUCU-INH |  |  |  |  |  |  |  |  |  |  |  | ⊕CMS-T2 MNTH-MNT |  |  |  |  |  | ⊕P/TV-NODE 3-CAM-INST<br>♥UPA FILL<br>ΔN3-C&W PANEL-C/O |  |  |  |  |  |
|-------|--------------------------------------|--|--|--|--|--|--|--|--|--|--|--|------------------|--|--|--|--|--|---|--|--|--|--|--|

**NODE 3 GROUND ACT**

**FD07**

GMT 02/10/10 (041)

MET Day 006

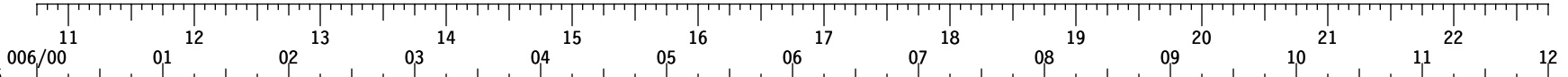

|         |                      |   |  |           |             |                          |                     |           |           |       |  |
|---------|----------------------|---|--|-----------|-------------|--------------------------|---------------------|-----------|-----------|-------|--|
| STS-130 | CDR ZAMKA            | ✱ | POST EVA W/H20   | BSA INIT  | EMU - T     | PRE SLEEP                | FD CPM CON A/G      | PRE SLEEP | SLEEP     |       |  |
|         | PLT VIRTS            | ⊕ | CUPOLA DEPRESS PART1   | NOR DEF 4 | D PRS P 2   | CDP UEA PPR ORT LE3 AS S | MNVR TO CPLA & GRPL | ILLUM - I | PRE SLEEP | SLEEP |  |
|         | MS1 HIRE             | ◆ | CUPOLA DEPRESS PART1   |           | D PRS P 2   | CDP UEA PPR ORT LE3 AS S | MNVR TO CPLA & GRPL |           | PRE SLEEP | SLEEP |  |
|         | MS2 ROBINSON         |   | EXERCISE   |           | M D D K C K |                          |                     |           | PRE SLEEP | SLEEP |  |
|         | MS3 PATRICK EV2      | ⊗ | POST EVA W/H20   |           |             |                          |                     |           | PRE SLEEP | SLEEP |  |
|         | MS4 BEHNKEN EV1      | ▼ | POST EVA W/H20   |           |             |                          |                     |           | PRE SLEEP | SLEEP |  |
| STS     | DAY/NIGHT ORBIT      |   | 96   | 97        | 98          | 99                       | 100                 | 101       | 102       | 103   |  |
|         | TDRS W E Z           |   | [Timeline bars for TDRS W E Z]   |           |             |                          |                     |           |           |       |  |
| ISS     | ORB ATT              |   | BIAS -XLV -ZVV   |           |             |                          |                     |           |           |       |  |
|         | TDRS AVAIL SSRMS POS |   | [Timeline bars for TDRS AVAIL SSRMS POS]                                       |           |             |                          |                     |           |           |       |  |
| NOTES   |                      |   | ✱C LK RPRS<br>⊕N3 AVIONICS RK OUTFT<br>◆XFER BRIEF<br>⊗C LK RPRS<br>▼C LK RPRS |           |             |                          |                     |           |           |       |  |

**FD07**

GMT 02/10/10 (041)

MET Day 006

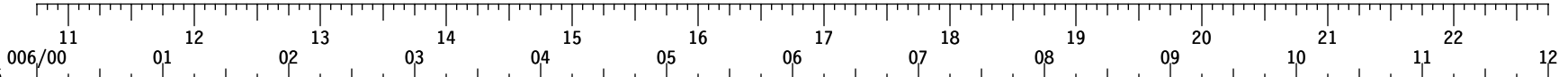

|     |             |  |   |   |   |    |    |    |    |    |  |  |  |  |  |  |
|-----|-------------|--|---|---|---|----|----|----|----|----|--|--|--|--|--|--|
| ISS | TDRS AVAIL  | [Color-coded bars: green, orange, black] |   |   |   |    |    |    |    |    |  |  |  |  |  |  |
|     | DAY/NIGHT   | [Color-coded bars: black, white]         |   |   |   |    |    |    |    |    |  |  |  |  |  |  |
|     | DAILY ORBIT | 6  | 7 | 8 | 9 | 10 | 11 | 12 | 13 | 14 |  |  |  |  |  |  |
|     | TLM FORMAT  | 112                                      |   |   |   |    |    |    |    |    |  |  |  |  |  |  |
|     | ATTITUDE    | -XVV +ZLV                                |   |   |   |    |    |    |    |    |  |  |  |  |  |  |

|           |                  |                     |    |            |               |               |       |                     |  |  |  |  |  |  |
|-----------|------------------|---------------------|----|------------|---------------|---------------|-------|---------------------|--|--|--|--|--|--|
| EXP<br>22 | ISS CDR WILLIAMS | T2                  | PW | DPC        | PRE SLEEP-ISS | REACT         | SLEEP | ISS EXTERNAL SURVEY |  |  |  |  |  |  |
|           | FE-1 SURAEV      | RS OPS              | PW | DPC        | PRE SLEEP-ISS |               | SLEEP |                     |  |  |  |  |  |  |
|           | FE-4 KOTOV       | RS OPS              | PW | DPC        | PRE SLEEP-ISS |               | SLEEP |                     |  |  |  |  |  |  |
|           | FE-5 NOGUCHI     | * SODF-N3 BOOK-DPLY | PW | DEWNA<br>D | DPC           | PRE SLEEP-ISS | REACT | SLEEP               |  |  |  |  |  |  |
|           | FE-6 CREAMER     | ⊕ POST EVA W/H2O    | PW | DPC        | PRE SLEEP-ISS | REACT         | SLEEP |                     |  |  |  |  |  |  |



|     |           |                |  |  |  |  |  |  |  |  |  |  |  |  |  |
|-----|-----------|----------------|--|--|--|--|--|--|--|--|--|--|--|--|--|
| ISS | SSRMS POS |                |  |  |  |  |  |  |  |  |  |  |  |  |  |
| STS | ORB ATT   | BIAS -XLV -ZVV |  |  |  |  |  |  |  |  |  |  |  |  |  |

|       |                                       |  |  |  |  |  |  |  |  |  |  |  |  |  |
|-------|---------------------------------------|--|--|--|--|--|--|--|--|--|--|--|--|--|
| NOTES | *NOD2 IMV DUCT S/U *D/L<br>⊕C_LK RPRS |  |  |  |  |  |  |  |  |  |  |  |  |  |
|-------|---------------------------------------|--|--|--|--|--|--|--|--|--|--|--|--|--|

**NO EXERCISE**  
**[FROM 3RD SET OF BOLTS RELEASED UNTIL A-BOLTS COMPLETE]**

**FD08**

GMT 02/10/10 (041)

MET Day 006

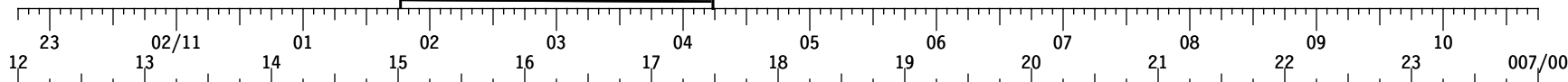

|         |                      |                                      |          |            |                   |                      |                 |                       |                 |           |                      |                 |                     |                     |          |         |          |          |        |         |                                    |  |  |  |  |
|---------|----------------------|--------------------------------------|----------|------------|-------------------|----------------------|-----------------|-----------------------|-----------------|-----------|----------------------|-----------------|---------------------|---------------------|----------|---------|----------|----------|--------|---------|------------------------------------|--|--|--|--|
| STS-130 | CDR ZAMKA            | SLEEP                                | LOG      | POST SLEEP | INMUT #5          | CINWIC               | CTWCRM          | CINWIC #6             | WRS 1 RACK XFER | CTWCRM    | MEAL                 | WRS 2 RACK XFER | N2                  | ATTN/O*             | MNUM/VPY | SINPLYT | EXERCISE | STPENLYM | MTENVA | ATTN/O* | DAP                                |  |  |  |  |
|         | PLT VIRTS            | SLEEP                                | LOG      | POST SLEEP | ILUM-O            | CUPOLA UNBTH & RELOC | RELOC           | LIMP                  | BRKAKE          | ENLPA3    | CBSCMOVE N3N         | MEAL            | PAO                 | CUP VEST OUTFIT PT1 |          |         |          |          |        |         |                                    |  |  |  |  |
|         | MS1 HIRE             | SLEEP                                | LOG      | POST SLEEP | CUPOLA CBM DEMATE | CUPOLA UNBTH & RELOC | RELOC           | 1ST STG CAP           | 2ND STG CAP     | BRKAKE    | EXERCISE             | MEAL            | PAO                 | CUP VEST OUTFIT PT1 |          |         |          |          |        |         |                                    |  |  |  |  |
|         | MS2 ROBINSON         | SLEEP                                | LOG      | POST SLEEP | TOCARMV           | WRS DEMATES          | WRS 1 RACK XFER | WRS 1 RACK UMBIL MATE | EVA TOOL CONFIG | MEAL      | N3 NAD MPEV INSTL    | OGS RACK XFER   | OGS RACK UMBIL MATE | WREHABC             | ILLNACE  |         |          |          |        |         |                                    |  |  |  |  |
|         | MS3 PATRICK          | SLEEP                                | ASPLIORG | POST SLEEP | PS/TUV 06         | P/TV06 ROBO OPS      | EVA TOOL CONFIG | MEAL                  | TOOL AUDIT      | E_LK PREP | GPL/CTV 09           | STAND           | SPINAL              |                     |          |         |          |          |        |         |                                    |  |  |  |  |
|         | MS4 BEHNKEN          | SLEEP                                | ASPLIORG | POST SLEEP | MDDKCK            | CXWFER               | EVA TOOL CONFIG | MEAL                  | TOOL AUDIT      | E_LK PREP | MLF GLCR 20A SMP XFR | CXWFER          | BSA-T               | EMUSWP              | STAND    | SPINAL  | EXERCISE |          |        |         |                                    |  |  |  |  |
| STS     | DAY/NIGHT ORBIT      | [Bar chart showing day/night cycle]  |          |            |                   |                      |                 |                       |                 |           |                      |                 |                     |                     |          |         |          |          |        |         |                                    |  |  |  |  |
|         | TDRS WEZ             | [Bar chart showing TDRS operations]  |          |            |                   |                      |                 |                       |                 |           |                      |                 |                     |                     |          |         |          |          |        |         |                                    |  |  |  |  |
| ISS     | ORB ATT              | BIAS -XLV -ZVV                       |          |            |                   |                      |                 |                       |                 |           |                      |                 |                     |                     |          |         |          |          |        |         |                                    |  |  |  |  |
|         | TDRS AVAIL SSRMS POS | [Bar chart showing ISS availability] |          |            |                   |                      |                 |                       |                 |           |                      |                 |                     |                     |          |         |          |          |        |         |                                    |  |  |  |  |
| NOTES   | *VERIFY              |                                      |          |            |                   |                      |                 |                       |                 |           | GROUND BOLTING       |                 |                     |                     |          | *TO STS |          |          |        |         | @RECONFIG *TO ISS #METOX & BATTERY |  |  |  |  |



**NO EXERCISE**  
 [FROM 3RD SET OF BOLTS RELEASED UNTIL A-BOLTS COMPLETE]

**FD08**

GMT 02/10/10 (041)

MET Day 006

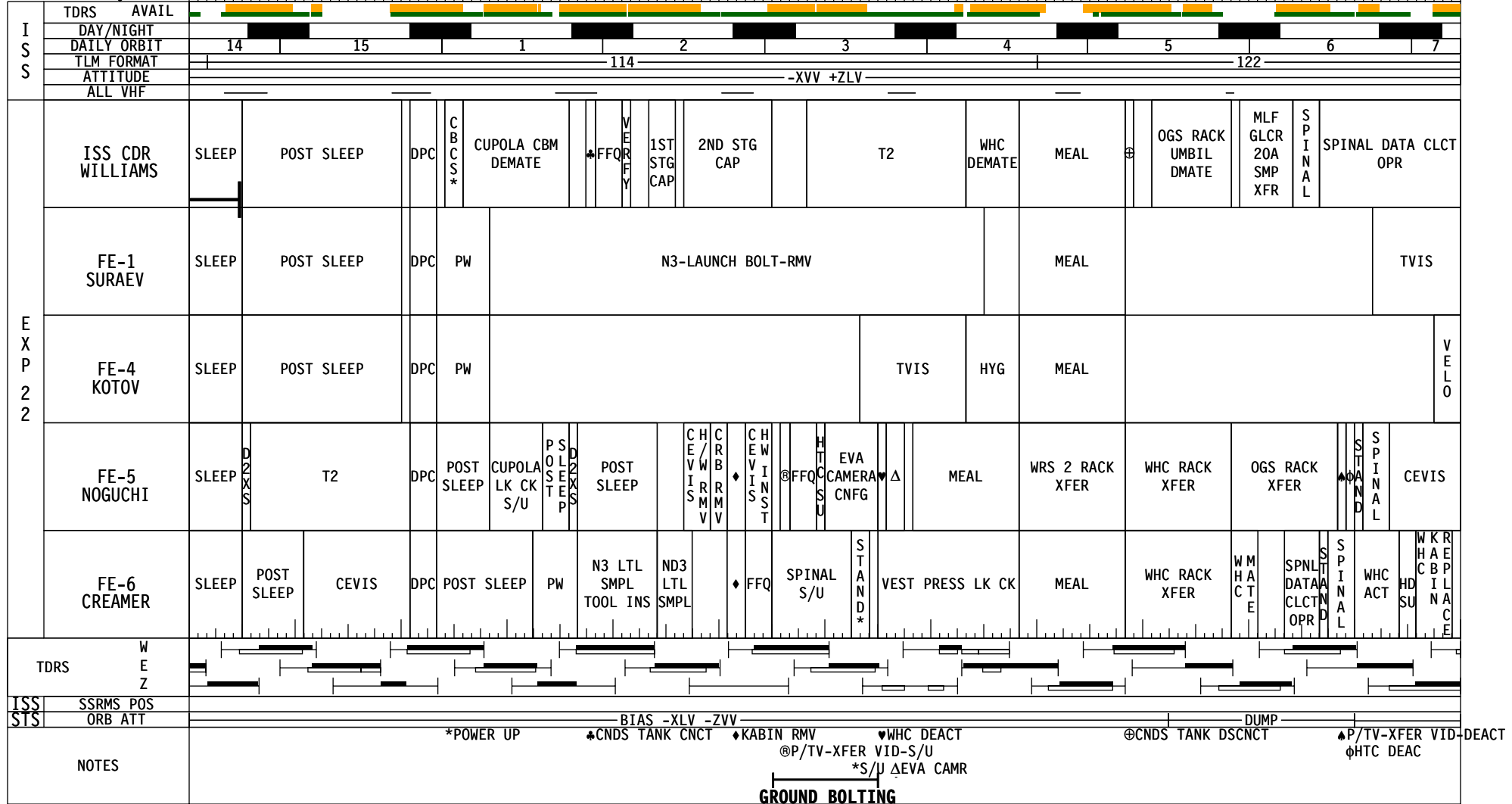

FD08

GMT 02/11/10 (042)

MET Day 007

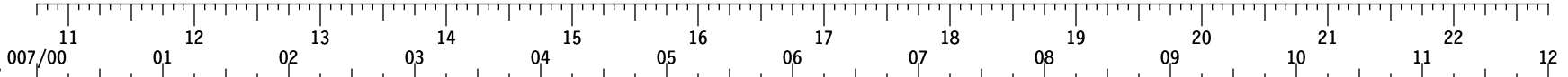

|         |                 |           |                    |                      |           |           |       |                            |  |
|---------|-----------------|-----------|--------------------|----------------------|-----------|-----------|-------|----------------------------|--|
| STS-130 | CDR ZAMKA       |           | FLTR CLN - INSPECT | PMC OCA              | PRE SLEEP | SLEEP     |       |                            |  |
|         | PLT VIRTS       |           | ILLUM-I            | EXERCISE             | PAO       | PRE SLEEP | SLEEP | <b>ISS EXTERNAL SURVEY</b> |  |
|         | MS1 HIRE        | STAND     | SPI                | CUPOLA FN LK CK INIT | MYCO*     | PRE SLEEP | SLEEP |                            |  |
|         | MS2 ROBINSON    | STAND     | SPI                | WRS 2 RK UMBIL MATE  | EXERCISE  | PRE SLEEP | SLEEP |                            |  |
|         | MS3 PATRICK     |           | EXERCISE           | PMA3 GRPL            | PAO       | PRE SLEEP | SLEEP |                            |  |
|         | MS4 BEHNKEN     | EXER CISE | KKKKK              | PMA3 GRPL            | PAO       | PRE SLEEP | SLEEP |                            |  |
| STS     | DAY/NIGHT ORBIT |           |                    |                      |           |           |       |                            |  |
|         | TDRS W E Z      |           |                    |                      |           |           |       |                            |  |
|         | ORB ATT         |           |                    |                      |           |           |       |                            |  |
| ISS     | TDRS AVAIL      |           |                    |                      |           |           |       |                            |  |
|         | SSRMS POS       |           |                    |                      |           |           |       |                            |  |
| NOTES   | *REVIEW         |           |                    |                      |           |           |       |                            |  |

**FD08**

GMT 02/11/10 (042)

MET Day 007

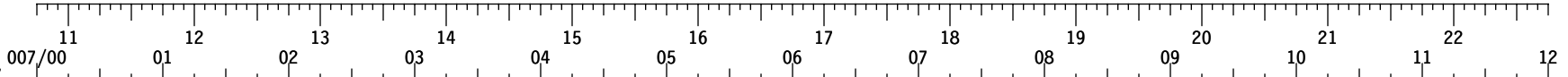

|     |             |  |   |   |    |    |     |    |    |    |  |     |  |  |  |  |
|-----|-------------|--|---|---|----|----|-----|----|----|----|--|-----|--|--|--|--|
| ISS | TDRS AVAIL  | [Color-coded bars: orange, green, black]   |   |   |    |    |     |    |    |    |  |     |  |  |  |  |
|     | DAY/NIGHT   | [Color-coded bars: black, white, black, white, black, white, black, white, black, white, black, white, black, white, black, white] |   |   |    |    |     |    |    |    |  |     |  |  |  |  |
|     | DAILY ORBIT | 7  | 8 | 9 | 10 | 11 | 12  | 13 | 14 | 15 |  |     |  |  |  |  |
|     | TLM FORMAT  | 112  |   |   |    |    | 114 |    |    |    |  | 112 |  |  |  |  |
|     | ATTITUDE    | -XVV +ZLV  |   |   |    |    |     |    |    |    |  |     |  |  |  |  |

|       |                  |                      |       |                 |               |               |                     |       |  |  |  |  |  |  |  |       |       |       |
|-------|------------------|----------------------|-------|-----------------|---------------|---------------|---------------------|-------|--|--|--|--|--|--|--|-------|-------|-------|
| EXP22 | ISS CDR WILLIAMS | SPINAL DATA CLCT OPR | CEVIS | DW N DPC        | PRE SLEEP-ISS | REACT         | ISS EXTERNAL SURVEY |       |  |  |  |  |  |  |  | SLEEP |       |       |
|       | FE-1 SURAEV      | TVIS                 | HYG   | PW              | DPC           | PRE SLEEP-ISS |                     |       |  |  |  |  |  |  |  |       | SLEEP |       |
|       | FE-4 KOTOV       | VELO                 |       | PW              | DPC           | PRE SLEEP-ISS |                     |       |  |  |  |  |  |  |  |       | SLEEP |       |
|       | FE-5 NOGUCHI     | CEVIS                | *     | SPINAL H/W STOW | PAO           | DPC           | PRE SLEEP-ISS       | REACT |  |  |  |  |  |  |  |       |       | SLEEP |
|       | FE-6 CREAMER     | T2                   |       |                 | H A DPC       | M             | PRE SLEEP-ISS       | REACT |  |  |  |  |  |  |  |       |       | SLEEP |

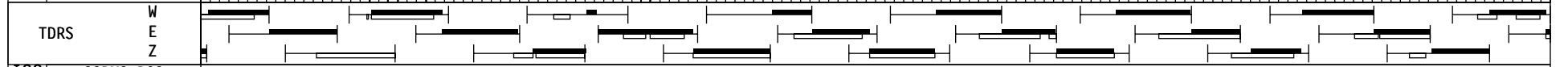

|     |           |                |  |  |  |  |  |  |  |  |  |  |  |  |  |  |
|-----|-----------|----------------|--|--|--|--|--|--|--|--|--|--|--|--|--|--|
| ISS | SSRMS POS |                |  |  |  |  |  |  |  |  |  |  |  |  |  |  |
| STS | ORB ATT   | BIAS -XLV -ZVV |  |  |  |  |  |  |  |  |  |  |  |  |  |  |

\*MYCO-PREP @MYCO-ISS CREW-REVIEW

NOTES

**NO EXERCISE      NO EXERCISE**  
**[DURING PMA3 CBM DEMATE] [FROM PMA3 INSTL UNTIL A-BOLTS COMPLTE]**

**FD09**

GMT 02/11/10 (042)

MET Day 007

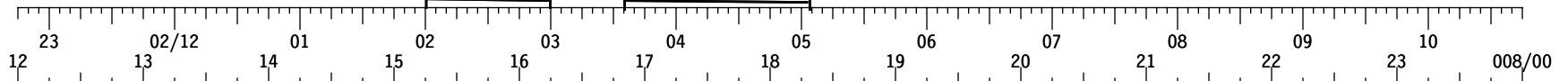

|         |  |   |           |            |                  |                   |                     |                 |                    |          |                 |                         |          |          |           |          |
|---------|--|---|-----------|------------|------------------|-------------------|---------------------|-----------------|--------------------|----------|-----------------|-------------------------|----------|----------|-----------|----------|
| STS-130 | CDR ZAMKA  | SLEEP                                   | LOG       | POST SLEEP |                  | IM XFER OPS       |                     | P/TV06 ROBO OPS |                    | MEAL     | PFC OCA         | OFF DUTY                | EXERCISE | OFF DUTY |           |          |
|         | PLT VIRTIS   | SLEEP                                   | LOG       | POST SLEEP |                  | ILLUM-06          | CUP VEST OUTFIT PT2 | XFER OPS        | CUPOLA UOP INSTALL | MEAL     | OFF DUTY        | PFC OCA                 | EXERCISE | OFF DUTY |           |          |
|         | MS1 HIRE   | SLEEP                                   | MC YLCCOT | POST SLEEP |                  | XUPFE R A T E     | CUP VEST OUTFIT PT2 | CUP PNL RMV     | CUPOLA ATU INSTALL | MEAL     | CBCS STOW       | OFF DUTY                | PFC OCA  | OFF DUTY | EXER CISE |          |
|         | MS2 ROBINSON   | SLEEP                                   |           | POST SLEEP | CUP FN LK CK TRM | PMA 3 PRESS CHECK | PS O L S E E P *    | LT-PPA LR-RMV   | ⊕                  | XFER OPS | MEAL            | OFF DUTY                | PFC OCA  | EXERCISE | OFF DUTY  |          |
|         | MS3 PATRICK EV2                                      | SLEEP                                   | LOG       | POST SLEEP |                  |                   |                     | PMA3 MNVR       | P I M N A S T L    | L I M P  | B U N G R P L S | W T A O L P K D O G F F | MEAL     | OFF DUTY | PFC OCA   | EXERCISE |
|         | MS4 BEHNKEN EV1                                      | SLEEP                                   |           | POST SLEEP |                  |                   |                     | PMA3 MNVR       | P I M N A S T L    | L I M P  | B U N G R P L S | W T A O L P K D O G F F | MEAL     | OFF DUTY | EXERCISE  | OFF DUTY |
| STS     | DAY/NIGHT ORBIT                                      | [Timeline bars for Day/Night and Orbit] |           |            |                  |                   |                     |                 |                    |          |                 |                         |          |          |           |          |
|         | TDRS WEZ   | [Timeline bars for TDRS WEZ]            |           |            |                  |                   |                     |                 |                    |          |                 |                         |          |          |           |          |
|         | ORB ATT  | BIAS -XLV -ZVV                          |           |            |                  |                   |                     |                 |                    |          |                 |                         |          |          |           |          |
| ISS     | TDRS AVAIL   | [Timeline bars for TDRS AVAIL]          |           |            |                  |                   |                     |                 |                    |          |                 |                         |          |          |           |          |
|         | SSRMS POS  | [Timeline bars for SSRMS POS]           |           |            |                  |                   |                     |                 |                    |          |                 |                         |          |          |           |          |
| NOTES   | *NOD3D1 STWG RMV      ⊕NOD301 STWG RMV<br>^POWERDOWN |   |           |            |                  |                   |                     |                 |                    |          |                 |                         |          |          |           |          |

**NO EXERCISE**      **NO EXERCISE**  
 [DURING PMA3 CBM DEMATE] [FROM PMA3 INSTL UNTIL A-BOLTS COMPLTE]

**FD09**

GMT 02/11/10 (042)

MET Day 007

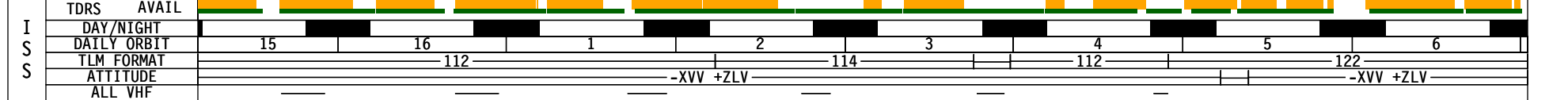

|                       |                  |       |            |     |          |                   |                  |             |                             |              |                    |          |          |          |          |      |
|-----------------------|------------------|-------|------------|-----|----------|-------------------|------------------|-------------|-----------------------------|--------------|--------------------|----------|----------|----------|----------|------|
| E<br>X<br>P<br>2<br>2 | ISS CDR WILLIAMS | SLEEP | POST SLEEP | DPC | CEVIS    | PMA3 CBM DEMATE   | CF W I C L I L 1 | V E R I F   | CF W I C L I L 2            | 1ST STG CAP  | 2ND STG CAP /ABOLT | MEAL     | OFF DUTY | PMC      | OFF DUTY | ARED |
|                       | FE-1 SURAEV      | SLEEP | POST SLEEP | DPC | TVIS     | HYG               | PW               | RS OPS      |                             |              | MEAL               | OFF DUTY |          |          | VELO     |      |
|                       | FE-4 KOTOV       | SLEEP | POST SLEEP | DPC | VELO     | PW                | RS OPS           |             |                             | MEAL         | OFF DUTY           |          |          | TVIS     |          |      |
|                       | FE-5 NOGUCHI     | SLEEP | POST SLEEP | DPC | CB C S * | PMA3 CBM DEMATE   | V E R I F        | 1ST STG CAP | 2ND STG CAP /ABOLT          | MEAL         | OFF DUTY           | ARED     | OFF DUTY | PMC      | OFF DUTY |      |
|                       | FE-6 CREAMER     | SLEEP | POST SLEEP | DPC | T2       | P S O L S E T E P | PW               | QD CNCT     | B I U N S M S P T E A R L L | H2 SNSR CNCT | MEAL               | OFF DUTY | PMC      | OFF DUTY | CEVIS    |      |

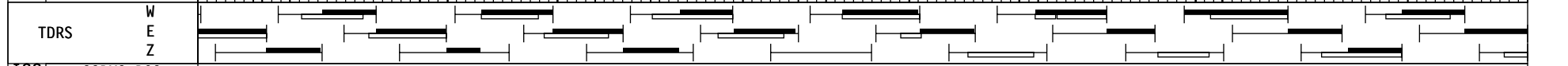

ISS SSRMS POS      STS ORB ATT      BIAS -XLV -ZVV      ϕP/TV S/U

NOTES  
 \*POST SLEEP      ϕPOST SLEEP  
 ♦MYCO-ISS SAMPLE-CLCT      ♡P/TV S/U  
 @MYCO-20A-MELFI INS      ΔCMS-ARED UNMAND-ACO  
    ▲CMS-TVIS WKLY-MNT  
    \*POWER UP

**FD09**

GMT 02/12/10 (043)

MET Day 008

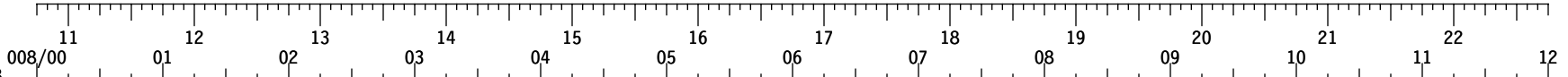

|                 |                 |                                |                   |                 |                      |                 |           |       |     |     |
|-----------------|-----------------|--------------------------------|-------------------|-----------------|----------------------|-----------------|-----------|-------|-----|-----|
| STS-130         | CDR ZAMKA       | OFF DUTY                       | EVA 3 PROC REVIEW | PRE SLEEP       | FD<br>CPMC<br>QA/G   | MASK P/B CONFIG | PRE SLEEP | SLEEP |     |     |
|                 | PLT VIRTS       | OFF DUTY                       | EVA 3 PROC REVIEW | PRE SLEEP       |                      |                 | SLEEP     |       |     |     |
|                 | MS1 HIRE        | EXERCISE                       | EVA 3 PROC REVIEW | PS<br>RL<br>EEP | XT<br>FA<br>RUR<br>P | XB<br>FR<br>EIF | PRE SLEEP | SLEEP |     |     |
|                 | MS2 ROBINSON    | OFF DUTY                       | EVA 3 PROC REVIEW | MD<br>DK<br>CK  | PRE SLEEP            |                 |           | SLEEP |     |     |
|                 | MS3 PATRICK EV2 | *<br>OD<br>FU<br>TY            | EVA 3 PROC REVIEW | PRE SLEEP       | MASK P/B CONFIG      | PRE SLEEP       | SLEEP     |       |     |     |
|                 | MS4 BEHNKEN EV1 | ⊕<br>PFC<br>OCA                | EVA 3 PROC REVIEW | PRE SLEEP       | MASK P/B CONFIG      | PRE SLEEP       | SLEEP     |       |     |     |
| DAY/NIGHT ORBIT |                 | 127                            | 128               | 129             | 130                  | 131             | 132       | 133   | 134 | 135 |
| STS             | TDRS W E Z      | [Timeline bars for TDRS W E Z] |                   |                 |                      |                 |           |       |     |     |
|                 | ORB ATT         | BIAS -XLV -ZVV                 |                   |                 |                      |                 |           |       |     |     |
| ISS             | TDRS AVAIL      | [Timeline bars for TDRS AVAIL] |                   |                 |                      |                 |           |       |     |     |
|                 | SSRMS POS       | [Timeline bars for SSRMS POS]  |                   |                 |                      |                 |           |       |     |     |
| NOTES           |                 | *EXERCISE<br>⊕OFF DUTY         |                   |                 | SPDM RELOCATE        |                 |           |       |     |     |

**FD09**

GMT 02/12/10 (043)



|     |             |  |       |   |    |    |    |    |    |  |  |  |       |
|-----|-------------|--|-------|---|----|----|----|----|----|--|--|--|-------|
| ISS | TDRS AVAIL  | [Color-coded bars: orange, green, black] |       |   |    |    |    |    |    |  |  |  |       |
|     | DAY/NIGHT   | 7  | 8     | 9 | 10 | 11 | 12 | 13 | 14 |  |  |  |       |
|     | DAILY ORBIT | [Black bars]                             |       |   |    |    |    |    |    |  |  |  |       |
|     | TLM FORMAT  | -122-                                    | -122- |   |    |    |    |    |    |  |  |  | -142- |
|     | ATTITUDE    | -XVV +ZLV                                |       |   |    |    |    |    |    |  |  |  |       |

|       |                  |          |                   |       |     |               |               |       |
|-------|------------------|----------|-------------------|-------|-----|---------------|---------------|-------|
| EXP22 | ISS CDR WILLIAMS | ARED     | EVA 3 PROC REVIEW | PW    | DPC | PRE SLEEP-ISS | SLEEP         |       |
|       | FE-1 SURAEV      |          | EVA 3 PROC REVIEW | PW    | DPC | PRE SLEEP-ISS | SLEEP         |       |
|       | FE-4 KOTOV       | HYG      | EVA 3 PROC REVIEW | PW    | DPC | PRE SLEEP-ISS | SLEEP         |       |
|       | FE-5 NOGUCHI     | OFF DUTY | CEVIS             | DWNLD | PW  | DPC           | PRE SLEEP-ISS | SLEEP |
|       | FE-6 CREAMER     | CEVIS    | EVA 3 PROC REVIEW | PW    | DPC | PRE SLEEP-ISS | SLEEP         |       |

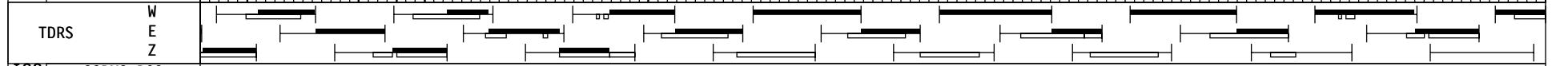

|     |           |                |
|-----|-----------|----------------|
| ISS | SSRMS POS |                |
| STS | ORB ATT   | BIAS -XLV -ZVV |

NOTES \*P/TV STW

**FD10**

GMT 02/12/10 (043)

MET Day 008

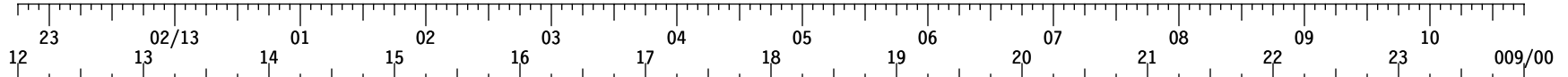

|                 |                                    |                     |               |               |                   |            |                   |                     |                           |                           |                      |                      |                    |                             |                    |                      |                      |               |                    |               |         |
|-----------------|------------------------------------|---------------------|---------------|---------------|-------------------|------------|-------------------|---------------------|---------------------------|---------------------------|----------------------|----------------------|--------------------|-----------------------------|--------------------|----------------------|----------------------|---------------|--------------------|---------------|---------|
| STS-130         | CDR ZAMKA                          | SLEEP               | POST SLEEP    | PMC A/G       | HYG BRK/HATCH CLS | EVA-PREP   | EMURGE            | EMU PREBREATHE      | C_LK DPRS                 | P DM PUS                  | P/TV07 EVA OPS       | ARED                 | C I W N C I T # 7  | MEAL                        | C T W E R C M      | PWR FILL #2          | P/TV07 EVA OPS       | P R P S       |                    |               |         |
|                 | PLT VIRTS                          | SLEEP               | POST SLEEP    |               |                   |            | W C S #           | I P N A H D         | P E / T A V S / U         |                           | CUPOLA PANEL INSTALL | MT-PPA LR-RMV        | MEAL               | C W C U I / P N O D L O A W |                    | RWS CUP RELOC        | ARED                 |               |                    |               |         |
|                 | MS1 HIRE                           | SLEEP               | POST SLEEP    |               |                   |            | M C H U * X F E R | U P F E D R A T E   |                           | XFER OPS                  | CUPOLA FSS FILL      | MTL SMPL TOOL INSTL  | MEAL               |                             | NODE 1 FSS FILL    |                      | XFER OPS             |               |                    |               |         |
|                 | MS2 ROBINSON                       | SLEEP               | POST SLEEP    |               |                   |            | M D D K C K       | A F T P C S X F E R | EVA TOOL CHECK            | EXERCISE                  |                      |                      |                    |                             | IVA SUPPORT        |                      |                      |               | P R P S            |               |         |
|                 |                                    | <b>EVA 3 (6:30)</b> |               |               |                   |            |                   |                     |                           |                           |                      |                      |                    |                             |                    |                      |                      |               |                    |               |         |
|                 | MS3 PATRICK                        | SLEEP               | POST SLEEP    | HYGIENE BREAK |                   | EVA-PREP   | EMURGE            | EMU PREBREATHE      | C_LK DPRS                 | P D E G R S / P S E T U P | EVA                  | PMA3 H/D CABLE INSTL | CUPOLA MLI REMOVAL | CUPOLA LL RELEASE           | A R P E F L R O C  | VSC VIDEO CABLE INST | P1 P-CLAMP RELEASE   | CLNUP & INGRS | P R P S            |               |         |
| MS4 BEHNKEN     | SLEEP                              | POST SLEEP          | HYGIENE BREAK |               | EVA-PREP          | EMURGE     | EMU PREBREATHE    | C_LK DPRS           | P D E G R S / P S E T U P | EVA                       | OPEN LOOP B QDS      | N C 3 A B L E        | CUP MLI BAG S/U    |                             | CUPOLA MLI REMOVAL | NOD3 OIH/OI WIF INST | VSC VIDEO CABLE INST | N2 CBM OPS    | P1 P-CLAMP RELEASE | CLNUP & INGRS | P R P S |
| DAY/NIGHT ORBIT | 135                                | 136                 | 137           | 138           | 139               | 140        | 141               | 142                 | 143                       |                           |                      |                      |                    |                             |                    |                      |                      |               |                    |               |         |
| TDRS W E Z      | [Timeline bars for TDRS W E Z]     |                     |               |               |                   |            |                   |                     |                           |                           |                      |                      |                    |                             |                    |                      |                      |               |                    |               |         |
| ORB ATT         | BIAS -XLV -ZVV                     |                     |               |               |                   |            |                   |                     |                           |                           |                      |                      |                    |                             |                    |                      |                      |               |                    |               |         |
| ISS TDRS AVAIL  | [Timeline bars for ISS TDRS AVAIL] |                     |               |               |                   |            |                   |                     |                           |                           |                      |                      |                    |                             |                    |                      |                      |               |                    |               |         |
| SSRMS POS       | [Timeline bars for SSRMS POS]      |                     |               |               |                   |            |                   |                     |                           |                           |                      |                      |                    |                             |                    |                      |                      |               |                    |               |         |
| NOTES           |                                    |                     |               |               | #COMPACT          | *FILTER CK |                   |                     |                           |                           |                      |                      |                    |                             |                    |                      |                      |               |                    |               |         |

\*C\_LK RPRS  
 ⊕XFER OPS  
 ◆C\_LK RPRS  
 ⊙C\_LK RPRS



**FD10**

GMT 02/12/10 (043)

MET Day 008

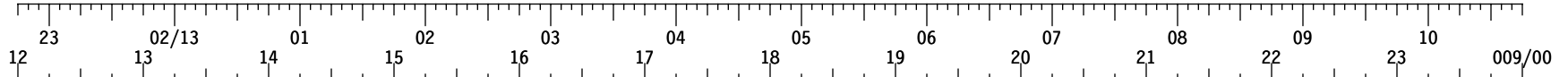

|     |             |                    |   |   |   |   |   |   |   |  |  |  |  |  |  |     |  |  |  |  |  |  |     |  |  |
|-----|-------------|--------------------|---|---|---|---|---|---|---|--|--|--|--|--|--|-----|--|--|--|--|--|--|-----|--|--|
| ISS | TDRS AVAIL  | [Color-coded bars] |   |   |   |   |   |   |   |  |  |  |  |  |  |     |  |  |  |  |  |  |     |  |  |
|     | DAY/NIGHT   | [Color-coded bars] |   |   |   |   |   |   |   |  |  |  |  |  |  |     |  |  |  |  |  |  |     |  |  |
|     | DAILY ORBIT | 15                 | 1 | 2 | 3 | 4 | 5 | 6 | 7 |  |  |  |  |  |  |     |  |  |  |  |  |  |     |  |  |
|     | TLM FORMAT  | 142                |   |   |   |   |   |   |   |  |  |  |  |  |  | 142 |  |  |  |  |  |  | 112 |  |  |
|     | ATTITUDE    | -XVV +ZLV          |   |   |   |   |   |   |   |  |  |  |  |  |  |     |  |  |  |  |  |  |     |  |  |

|       |                  |       |            |               |          |                    |                 |           |              |                    |               |                     |                 |         |              |
|-------|------------------|-------|------------|---------------|----------|--------------------|-----------------|-----------|--------------|--------------------|---------------|---------------------|-----------------|---------|--------------|
| EXP22 | ISS CDR WILLIAMS | SLEEP | POST SLEEP | PW            | DPC      | T2                 | CUPOLA FSS FILL |           |              | N3 STBD GUIDE RING | MEAL          | N3 NADIR GUIDE RING | NODE 1 FSS FILL |         | CEVIS        |
|       | FE-1 SURAEV      | SLEEP | POST SLEEP | PW            | DPC      | VELO               | TVIS            | HYG       |              |                    |               | MEAL                |                 |         | RS OPS       |
|       | FE-4 KOTOV       | SLEEP | POST SLEEP | PW            | DPC      | RS OPS             |                 | VELO      | TVIS         | HYG                | MEAL          | RS OPS              |                 |         |              |
|       | FE-5 NOGUCHI     | SLEEP | POST SLEEP | PW            | DPC      | CCAA-AV MOUNT-RMWL | CEVIS           | T2        | BOOT INSTALL | MEAL               | PMA 3 REPRESS | RWS CUP RELOC       |                 | RWS C/O | UL OAB 1 S 5 |
|       | FE-6 CREAMER     | SLEEP | POST SLEEP | HYGIENE BREAK | EVA-PREP | EMURGE             | EMU PREBREATHE  | C_LK DPRS | CEVIS        | MEAL               | PMA 3 REPRESS | GLOVE               | T2              | P-RPS   |              |

|      |     |                 |  |  |  |  |  |  |  |  |  |  |  |  |  |  |  |  |  |  |  |  |  |  |
|------|-----|-----------------|--|--|--|--|--|--|--|--|--|--|--|--|--|--|--|--|--|--|--|--|--|--|
| TDRS | WEZ | [Timeline bars] |  |  |  |  |  |  |  |  |  |  |  |  |  |  |  |  |  |  |  |  |  |  |
|------|-----|-----------------|--|--|--|--|--|--|--|--|--|--|--|--|--|--|--|--|--|--|--|--|--|--|

|     |           |                |  |  |  |  |  |  |  |  |  |  |  |  |  |  |  |  |  |  |  |  |  |  |
|-----|-----------|----------------|--|--|--|--|--|--|--|--|--|--|--|--|--|--|--|--|--|--|--|--|--|--|
| ISS | SSRMS POS |                |  |  |  |  |  |  |  |  |  |  |  |  |  |  |  |  |  |  |  |  |  |  |
| STS | ORB ATT   | BIAS -XLV -ZVV |  |  |  |  |  |  |  |  |  |  |  |  |  |  |  |  |  |  |  |  |  |  |

|       |  |  |  |  |  |  |  |  |  |  |  |  |  |  |  |  |  |  |  |  |  |  |  |
|-------|--|--|--|--|--|--|--|--|--|--|--|--|--|--|--|--|--|--|--|--|--|--|--|
| NOTES | *JPM/LAB-SHUTTER-CL<br>@C&T-CUCU-INH<br>◆LAB-RWS-F<br>@C_LK RPRS |  |  |  |  |  |  |  |  |  |  |  |  |  |  |  |  |  |  |  |  |  |  |
|-------|--|--|--|--|--|--|--|--|--|--|--|--|--|--|--|--|--|--|--|--|--|--|--|

**FD10**

GMT 02/13/10 (044)

MET Day 009

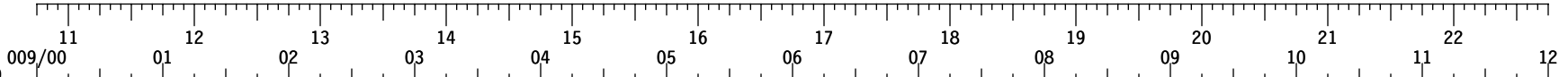

|         |  |                  |  |                    |           |       |
|---------|--|------------------|--|--------------------|-----------|-------|
| STS-130 | CDR ZAMKA  | * POST EVA W/H2O | PRE SLEEP                                | FD CPMCA/G<br>CONF | PRE SLEEP | SLEEP |
|         | PLT VIRTIS   | ARED             | 02 CONFIG TO XFER                        | 02 INIT            | PRE SLEEP | SLEEP |
|         | MS1 HIRE   | EXERCISE         | X T X B<br>F A F R<br>E G E I<br>R U R P |                    | PRE SLEEP | SLEEP |
|         | MS2 ROBINSON   | XFER OPS         | C X P M<br>W F W D<br>C E R R<br>R R C K |                    | PRE SLEEP | SLEEP |
|         | MS3 PATRICK  | ⊕ POST EVA W/H2O |  |                    | PRE SLEEP | SLEEP |
|         | MS4 BEHNKEN  | ◆ POST EVA W/H2O |  |                    | PRE SLEEP | SLEEP |
| STS     | DAY/NIGHT ORBIT  |                  |  |                    |           |       |
|         | TDRS WEZ   |                  |  |                    |           |       |
| ISS     | ORB ATT  |                  |  |                    |           |       |
|         | TDRS AVAIL<br>SSRMS POS  |                  |  |                    |           |       |
| NOTES   | *C_LK RPRS<br>⊕C_LK RPRS<br>◆C_LK RPRS<br><div style="text-align: right; margin-top: 10px;"><b>SPDM RELOCATE</b></div> |                  |  |                    |           |       |

**FD10**

GMT 02/13/10 (044)

MET Day 009

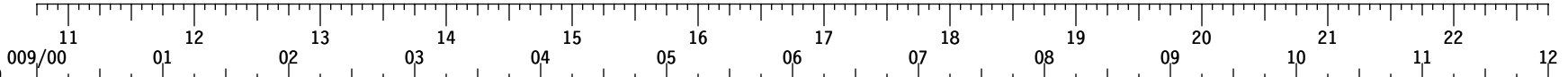

|     |             |                   |   |   |    |    |    |    |    |    |  |  |  |  |  |  |
|-----|-------------|-------------------|---|---|----|----|----|----|----|----|--|--|--|--|--|--|
| ISS | TDRS AVAIL  | [Color-coded bar] |   |   |    |    |    |    |    |    |  |  |  |  |  |  |
|     | DAY/NIGHT   | [Color-coded bar] |   |   |    |    |    |    |    |    |  |  |  |  |  |  |
|     | DAILY ORBIT | 7                 | 8 | 9 | 10 | 11 | 12 | 13 | 14 | 15 |  |  |  |  |  |  |
|     | TLM FORMAT  | 112               |   |   |    |    |    |    |    |    |  |  |  |  |  |  |
|     | ATTITUDE    | -XVV +ZLV         |   |   |    |    |    |    |    |    |  |  |  |  |  |  |

|       |                  |                               |                   |      |               |               |               |       |
|-------|------------------|-------------------------------|-------------------|------|---------------|---------------|---------------|-------|
| EXP22 | ISS CDR WILLIAMS | CEVIS                         | 02 CONFIG TO XFER |      |               | 02 INIT       | PRE SLEEP-ISS | SLEEP |
|       | FE-1 SURAEV      | RS OPS                        | PW                | DPC  | PW            | PRE SLEEP-ISS | SLEEP         |       |
|       | FE-4 KOTOV       | RS OPS                        | PW                | DPC  | PW            | PRE SLEEP-ISS | SLEEP         |       |
|       | FE-5 NOGUCHI     | UL<br>OA<br>PB<br>1<br>P<br>5 | ⊕                 | NDPC | CAMR<br>RCNFG | PRE SLEEP-ISS | SLEEP         |       |
|       | FE-6 CREAMER     | ◆                             | POST EVA W/H20    |      |               | PRE SLEEP-ISS | SLEEP         |       |

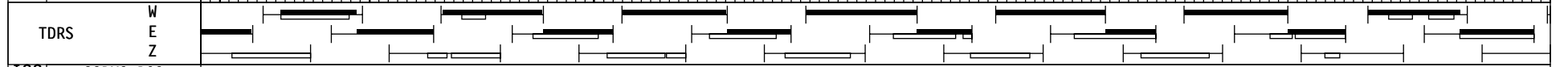

|      |           |                   |  |  |  |  |  |  |  |  |  |  |  |  |  |  |
|------|-----------|-------------------|--|--|--|--|--|--|--|--|--|--|--|--|--|--|
| TDRS | WEZ       | [Color-coded bar] |  |  |  |  |  |  |  |  |  |  |  |  |  |  |
| ISS  | SSRMS POS | BIAS -XLV -ZVV    |  |  |  |  |  |  |  |  |  |  |  |  |  |  |
| STS  | ORB ATT   |                   |  |  |  |  |  |  |  |  |  |  |  |  |  |  |

|       |  |  |  |  |  |  |  |  |  |  |  |  |  |  |  |
|-------|--|--|--|--|--|--|--|--|--|--|--|--|--|--|--|
| NOTES | ◆LAB-RWS-POWERDOWN<br>⊕LAB-RWS-POWERUP<br>◆C_LK RPRS |  |  |  |  |  |  |  |  |  |  |  |  |  |  |
|-------|--|--|--|--|--|--|--|--|--|--|--|--|--|--|--|

FD11

GMT 02/13/10 (044)

MET Day 009

|         |                      | 12  | 13 | 14         | 15          | 16               | 17                  | 18                  | 19              | 20           | 21          | 22         | 23        | 10                | 010/00         |             |                |                   |                |           |
|---------|----------------------|---|----|------------|-------------|------------------|---------------------|---------------------|-----------------|--------------|-------------|------------|-----------|-------------------|----------------|-------------|----------------|-------------------|----------------|-----------|
| STS-130 | CDR ZAMKA            | POST SLEEP  |    |            | PWR FILL #3 | PWR FILL #4      | PWR XFER (2)        | CINWICIT #8         | ARED            | CTWECRM      | CXFER       | CPHREO WTO | CREW CONF | MEAL              | FWAERREL       | HATCH CLOSE | ATHRO/0*       | MREBROOST         | RC3 EOBNFOISGT |           |
|         | PLT VIRTS            | POST SLEEP  | N2 | POST SLEEP | NCONMFG     | CHONG/O          | ARED                | O2 T ERM            | 02 SYS TEARDOWN | N2 XFER TERM | CPHREO WTO  | CREW CONF  | MEAL      | NOMLHES#          | RNDZ TOOLS C/O | P/TV 04 S/U | FWAERREL       | HATCH CLOSE       | ODS LEAK CHECK |           |
|         | MS1 HIRE             | POST SLEEP  |    |            | XUPEDRATE   | XFER OPS         |                     |                     |                 | PDEAVOC5T    | CPHREO WTO  | CREW CONF  | MEAL      | XTFAEGRUP         | XBFIEF         | OBBSIS#     | RNDZ TOOLS C/O | FWAERREL          | HATCH CLOSE    | EXERCISE  |
|         | MS2 ROBINSON         | POST SLEEP  |    |            | XFER OPS    |                  |                     |                     | N2              | XFER OPS     | CPHREO WTO  | CREW CONF  | MEAL      | EXERCISE          |                |             | FWAERREL       | HATCH CLOSE       | ODS LEAK CHECK |           |
|         | MS3 PATRICK          | POST SLEEP  |    |            | PS//TV08    | P/TV08 EXT SRVY  | EVA RECONFIG & XFER |                     |                 | EIMNUS TALL  | CPHREO WTO  | CREW CONF  | MEAL      | ISS A/L TOOL STOW |                |             | FWAERREL       | C/L CAM INST UNDK | FD MPLY        | EXER CISE |
|         | MS4 BEHNKEN          | POST SLEEP  |    |            | MDDCKK      | SAFER C/O & SWAP | SAFER XFER          | EVA RECONFIG & XFER |                 |              | EIMNUS TALL | CPHREO WTO | CREW CONF | MEAL              | EXERCISE       |             |                | FWAERREL          |                |           |
| STS     | DAY/NIGHT ORBIT      | 151 152 153 154 155 156 157 158   |    |            |             |                  |                     |                     |                 |              |             |            |           |                   |                |             |                |                   |                |           |
|         | TDRS WEZ             | [Gantt chart showing TDRS WEZ activity across orbits 151-158]             |    |            |             |                  |                     |                     |                 |              |             |            |           |                   |                |             |                |                   |                |           |
| ISS     | ORB ATT              | BIAS -XLV -ZVV  |    |            |             |                  |                     |                     |                 |              |             |            |           |                   |                |             |                |                   |                |           |
|         | TDRS AVAIL SSRMS POS | [Gantt chart showing TDRS AVAIL SSRMS POS activity across orbits 151-158] |    |            |             |                  |                     |                     |                 |              |             |            |           |                   |                |             |                |                   |                |           |
| NOTES   |                      | *FILTER CK  |    |            |             |                  | #MNVR TO UNDOCK     |                     |                 |              |             | *TO STS    |           |                   |                |             |                |                   |                |           |

**FD11**

GMT 02/13/10 (044)

MET Day 009

|         |                  | 12   | 13       | 14     | 15     | 16         | 17  | 18         | 19     | 20          | 21        | 22              | 23           | 010/00       |           |      |                   |           |             |           |             |            |            |
|---------|------------------|--|----------|--------|--------|------------|-----|------------|--------|-------------|-----------|-----------------|--------------|--------------|-----------|------|-------------------|-----------|-------------|-----------|-------------|------------|------------|
| ISS     | TDRS AVAIL       | [Color-coded bars]                         |          |        |        |            |     |            |        |             |           |                 |              |              |           |      |                   |           |             |           |             |            |            |
|         | DAY/NIGHT        | 15   | 1        |        | 2      |            | 3   |            | 4      |             | 5         |                 | 6            |              | 7         |      | 8                 |           |             |           |             |            |            |
|         | DAILY ORBIT      | [Color-coded bars]                         |          |        |        |            |     |            |        |             |           |                 |              |              |           |      |                   |           |             |           |             |            |            |
|         | TLM FORMAT       | -112                                       |          |        |        |            | 122 |            |        |             |           |                 |              |              | 122       |      |                   |           |             |           |             |            |            |
|         | ATTITUDE         | -XVV +ZLV                                  |          |        |        |            |     |            |        |             |           |                 |              |              |           |      |                   |           |             |           |             |            |            |
| ALL VHF |                  |  |          |        |        |            |     |            |        |             |           |                 |              |              |           |      |                   |           |             |           |             |            |            |
| EXP22   | ISS CDR WILLIAMS | REACT                                      | PSOLSTEP | BLDOPR | BLDSTW | POST SLEEP | DPC | CEVIS      |        | T2          |           | O2 SYS TEARDOWN | N2 XFER TERM | CPHREO W T O | CREW CONF | MEAL | ISS A/L TOOL STOW | FWAREL EL | HATCH CLOSE |           | DWNLD       | PW         |            |
|         | FE-1 SURAEV      |  |          |        |        | POST SLEEP | DPC | PW         | RS OPS | TVIS        | HYG       | VELO            |              | CPHREO W T O | CREW CONF | MEAL |                   |           | FWAREL EL   |           |             |            | PW         |
|         | FE-4 KOTOV       |  |          |        |        | POST SLEEP | DPC | PW         | RS OPS | VELO        | TVIS      | HYG             |              | CPHREO W T O | CREW CONF | MEAL |                   |           | FWAREL EL   |           |             |            | PW         |
|         | FE-5 NOGUCHI     | REACT                                      |          |        |        | POST SLEEP | DPC | PW         | T2     |             | RAM INSTL |                 | ⊕            | CPHREO W T O | CREW CONF | MEAL | DCB RVW           | DCB PACK  | DCB XFER    | FWAREL EL | PALO        | CEVIS      | PW         |
|         | FE-6 CREAMER     | SRALVC AT                                  | BLD SU   | BLOOD  | SLVSTW | POST SLEEP | DPC | POST SLEEP | CEVIS  | IMAK UNPACK | T2        |                 | HD SU        | CPHREO W T O | CREW CONF | MEAL | DCB RVW           | DCB PACK  |             | FWAREL EL | HATCH CLOSE | CFWICL I 1 | CFWICL I 2 |
| TDRS    | WEZ              | [Color-coded bars]                         |          |        |        |            |     |            |        |             |           |                 |              |              |           |      |                   |           |             |           |             |            |            |
| ISS     | SSRMS POS        |  |          |        |        |            |     |            |        |             |           |                 |              |              |           |      |                   |           |             |           |             |            |            |
| STS     | ORB ATT          | BIAS -XLV -ZVV                             |          |        |        |            |     |            |        |             |           |                 |              |              |           |      |                   |           |             |           |             |            |            |
|         |                  | REBOOST                                    |          |        |        |            |     |            |        |             |           |                 |              |              |           |      |                   |           |             |           |             |            |            |
| NOTES   |                  | ♦POST SLEEP *POST SLEEP ⊕JPM1F3-POST MAINT |          |        |        |            |     |            |        |             |           |                 |              |              |           |      |                   |           |             |           |             |            |            |

**FD11**

GMT 02/14/10 (045)

MET Day 010

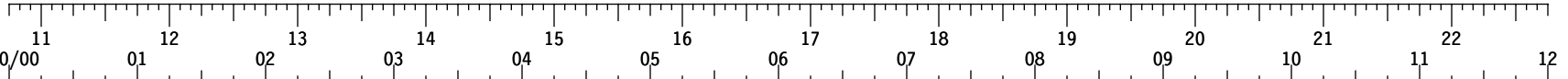

| STS-130 | Crew Member   |           | Activity  |  | Log        |
|---------|---|-----------|-----------|--|------------|
|         | Name  | Initials  | Activity  | Time                                   |            |
| STS-130 | CDR ZAMKA   | M N V A   | PRE SLEEP | 11:00 - 18:00                          | POST SLEEP |
|         | PLT VIRTS   | ⊕         | PRE SLEEP | 11:00 - 18:00                          | POST SLEEP |
|         | MS1 HIRE  |           | PRE SLEEP | 11:00 - 18:00                          | POST SLEEP |
|         | MS2 ROBINSON  | ♦         | PRE SLEEP | 11:00 - 18:00                          | POST SLEEP |
|         | MS3 PATRICK   | EXER CISE | PRE SLEEP | 11:00 - 18:00                          | POST SLEEP |
|         | MS4 BEHNKEN   | ⓧ         | PRE SLEEP | 11:00 - 18:00                          | POST SLEEP |
| STS     | DAY/NIGHT ORBIT   |           |           | 159, 160, 161, 162, 163, 164, 165, 166 |            |
|         | TDRS W E Z  |           |           | 159, 160, 161, 162, 163, 164, 165, 166 |            |
|         | ORB ATT   |           |           | BIAS -XLV -ZVV                         |            |
| NOTES   | *REBOOST CONFIG 3<br>⊕ODS LEAK CHECK<br>♦ODS LEAK CHECK<br>ⓧRECONFIG<br>*TO ISS<br><b>SPDM RELOCATE</b> |           |           |  |            |

**FD11**

GMT 02/14/10 (045)

MET Day 010

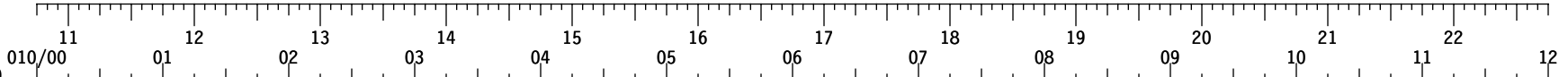

|         |             |                                 |   |    |    |    |    |    |    |     |  |  |  |  |  |  |  |     |
|---------|-------------|---------------------------------|---|----|----|----|----|----|----|-----|--|--|--|--|--|--|--|-----|
| ISS     | TDRS AVAIL  | [Color-coded availability bars] |   |    |    |    |    |    |    |     |  |  |  |  |  |  |  |     |
|         | DAY/NIGHT   | [Day/Night cycle bars]          |   |    |    |    |    |    |    |     |  |  |  |  |  |  |  |     |
|         | DAILY ORBIT | 8                               | 9 | 10 | 11 | 12 | 13 | 14 | 15 | 16  |  |  |  |  |  |  |  |     |
|         | TLM FORMAT  | 122                             |   |    |    |    |    |    |    | 122 |  |  |  |  |  |  |  | 132 |
|         | ATTITUDE    | -XVV +ZLV                       |   |    |    |    |    |    |    |     |  |  |  |  |  |  |  |     |
| ALL VHF |             |                                 |   |    |    |    |    |    |    |     |  |  |  |  |  |  |  |     |

|           |                  |    |     |    |               |       |       |            |
|-----------|------------------|----|-----|----|---------------|-------|-------|------------|
| EXP<br>22 | ISS CDR WILLIAMS | PW | DPC | PW | PRE SLEEP-ISS | REACT | SLEEP | POST SLEEP |
|           | FE-1 SURAEV      | PW | DPC | PW | PRE SLEEP-ISS |       | SLEEP | POST SLEEP |
|           | FE-4 KOTOV       | PW | DPC | PW | PRE SLEEP-ISS |       | SLEEP | POST SLEEP |
|           | FE-5 NOGUCHI     | PW | DPC | PW | PRE SLEEP-ISS | REACT | SLEEP | POST SLEEP |
|           | FE-6 CREAMER     | PW | DPC | PW | PRE SLEEP-ISS | REACT | SLEEP | POST SLEEP |

|      |           |                         |  |  |  |  |  |  |  |  |  |  |  |  |  |  |  |
|------|-----------|-------------------------|--|--|--|--|--|--|--|--|--|--|--|--|--|--|--|
| TDRS | WEZ       | [Timeline bars for WEZ] |  |  |  |  |  |  |  |  |  |  |  |  |  |  |  |
| ISS  | SSRMS POS |                         |  |  |  |  |  |  |  |  |  |  |  |  |  |  |  |
| STS  | ORB ATT   | BIAS -XLV -ZVV          |  |  |  |  |  |  |  |  |  |  |  |  |  |  |  |

NOTES

**FD12**

GMT 02/14/10 (045)

MET Day 010

|                 |              | 012 23 02/15 01 02 03 04 05 06 07 08 09 10 011/00  |  |  |                   |                   |               |  |      |                |          |                       |                       |                      |                       |                      |                       |                 |         |                 |  |  |  |  |  |
|-----------------|--------------|--|--|--|-------------------|-------------------|---------------|--|------|----------------|----------|-----------------------|-----------------------|----------------------|-----------------------|----------------------|-----------------------|-----------------|---------|-----------------|--|--|--|--|--|
| STS-130         | CDR ZAMKA    | POST SLEEP   |  |  | MNVR UNDOCK       | UNDOCK OPS        | FLYAROUND/SEP |  |      | MEAL           | EXERCISE |                       |                       | NOSE CAP SURVEY (R3) | PORT WING SURVEY (R3) |                      |                       | ZLVV            | PS LEEP |                 |  |  |  |  |  |
|                 | PLT VIRTS    | POST SLEEP   |  |  | POST SLEEP        | UNDOCK OPS        | FLYAROUND/SEP |  |      | UNDK PLAY BACK | EXERCISE |                       |                       | NOSE CAP SURVEY (R2) | PORT WING SURVEY (R1) |                      |                       | OBSS BERTH (R2) |         |                 |  |  |  |  |  |
|                 | MS1 HIRE     | POST SLEEP   |  |  | POST SLEEP        | UNDOCK OPS        | FLYAROUND/SEP |  |      | MEAL           |          |                       | STBD WING SURVEY (R2) |                      |                       | NOSE CAP SURVEY (R1) | EXERCISE              |                 |         | LDRI D/L        |  |  |  |  |  |
|                 | MS2 ROBINSON | POST SLEEP   |  |  | POST SLEEP        | UNDOCK OPS        | FLYAROUND/SEP |  |      | MEAL           |          |                       | STBD WING SURVEY (R3) |                      |                       | EXERCISE             | PORT WING SURVEY (R2) |                 |         | OBSS BERTH (R1) |  |  |  |  |  |
|                 | MS3 PATRICK  | POST SLEEP   |  |  | P/TV03 UNDOCK S/U | P/TV03 UNDOCK OPS |               |  | MEAL |                |          | STBD WING SURVEY (R1) |                       |                      | EVA UNPACK & STOW     | POST EVA ENT PREP    |                       | EXERCISE        |         |                 |  |  |  |  |  |
|                 | MS4 BEHNKEN  | POST SLEEP   |  |  | UNDOCK OPS        | FLYAROUND/SEP     |               |  | MEAL |                |          | STBD WING SURVEY (R1) |                       |                      | EVA UNPACK & STOW     | POST EVA ENT PREP    |                       | EXERCISE        |         |                 |  |  |  |  |  |
| DAY/NIGHT ORBIT |              | 167 168 169 170 171 172 173 174  |  |  |                   |                   |               |  |      |                |          |                       |                       |                      |                       |                      |                       |                 |         |                 |  |  |  |  |  |
| STS             | TDRS WEZ     | [Timeline bars for TDRS WEZ]   |  |  |                   |                   |               |  |      |                |          |                       |                       |                      |                       |                      |                       |                 |         |                 |  |  |  |  |  |
|                 | ORB ATT      | BIAS -XLV -ZVV UNDOCK FLYAROUND/SEP DUMP STBD SURVEY NOSE PORT SURVEY                            |  |  |                   |                   |               |  |      |                |          |                       |                       |                      |                       |                      |                       |                 |         |                 |  |  |  |  |  |
| ISS             | TDRS AVAIL   | [Timeline bars for TDRS AVAIL]   |  |  |                   |                   |               |  |      |                |          |                       |                       |                      |                       |                      |                       |                 |         |                 |  |  |  |  |  |
|                 | SSRMS POS    | [Timeline bars for SSRMS POS]  |  |  |                   |                   |               |  |      |                |          |                       |                       |                      |                       |                      |                       |                 |         |                 |  |  |  |  |  |
| NOTES           |              | <p>*TO STS #FILTER CK ^DEACT</p> <p><b>*UNDOCK 10/15:07</b></p> <p>*REG RCNFG #CNTL RECONFIG</p> |  |  |                   |                   |               |  |      |                |          |                       |                       |                      |                       |                      |                       |                 |         |                 |  |  |  |  |  |



**FD12**

GMT 02/14/10 (045)

MET Day 010

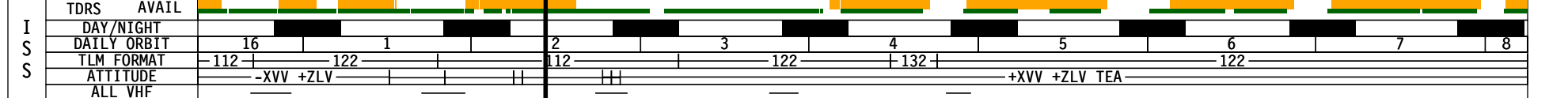

|                       |                  |            |     |             |   |                                |                            |  |             |      |                       |                       |       |    |
|-----------------------|------------------|------------|-----|-------------|---|--------------------------------|----------------------------|--|-------------|------|-----------------------|-----------------------|-------|----|
| E<br>X<br>P<br>2<br>2 | ISS CDR WILLIAMS | POST SLEEP | DPC | FSS CLEANUP | ♦ | PDC MEON<br>2 A P N<br>R I T G | PM2-DEPRS                  | L<br>K<br>-<br>C<br>K                          | PMA2<br>PT3 | MEAL | ISP 3 STOWAGE XFER    | T2                    | CEVIS |    |
|                       | FE-1 SURAEV      | POST SLEEP | DPC | RS OPS      |   |                                |                            |  |             | MEAL | A<br>U<br>D<br>I<br>O |                       |       |    |
|                       | FE-4 KOTOV       | POST SLEEP | DPC | RS OPS      |   |                                |                            |  |             | MEAL |                       |                       |       |    |
|                       | FE-5 NOGUCHI     | POST SLEEP | DPC | ⊕           |   |                                | U<br>N<br>D<br>O<br>C<br>K | *<br>B<br>S<br>P<br>T<br>S<br>O<br>M<br>W<br>U |             | T2   | MEAL                  | V<br>I<br>D<br>E<br>O | CEVIS |    |
|                       | FE-6 CREAMER     | POST SLEEP | DPC | FSS CLEANUP | ♦ | PDC MEON<br>2 A P N<br>R I T G | NOD3 UNPACK PART 2         |  |             | MEAL | ISP 3 STOWAGE XFER    |                       | CEVIS | T2 |



|     |           |                |  |                      |  |      |  |             |  |      |  |             |  |
|-----|-----------|----------------|--|----------------------|--|------|--|-------------|--|------|--|-------------|--|
| ISS | SSRMS POS |                |  |                      |  |      |  |             |  |      |  |             |  |
| STS | ORB ATT   | BIAS -XLV -ZVV |  | UNDOCK FLYAROUND/SEP |  | DUMP |  | STBD SURVEY |  | NOSE |  | PORT SURVEY |  |

NOTES  
 ⊕PH-FOREST-CULT  
 ♦PEPS-RELOCATE  
 \*PBA RELOCATE  
**\*UNDOCK 10/15:07**

**FD12**

GMT 02/15/10 (046)

MET Day 011

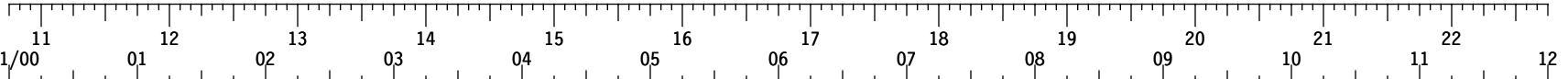

|            |   |             |              |         |    |          |           |       |            |
|------------|---|-------------|--------------|---------|----|----------|-----------|-------|------------|
| STS-130    | CDR ZAMKA   | PRE SLEEP   | RPMSRDN (R2) | PSL EEP | FD | CPMC A/G | PRE SLEEP | SLEEP | POST SLEEP |
|            | PLT VIRTS   | OBSS BERTH  |              |         |    |          | PRE SLEEP | SLEEP | POST SLEEP |
|            | MS1 HIRE  | PRE SLEEP   | RPMSRDN (R1) |         |    |          | PRE SLEEP | SLEEP | POST SLEEP |
|            | MS2 ROBINSON  | OBSS BERTH* |              |         |    |          | PRE SLEEP | SLEEP | POST SLEEP |
|            | MS3 PATRICK   |             |              |         |    |          | PRE SLEEP | SLEEP | POST SLEEP |
|            | MS4 BEHNKEN   |             |              |         |    |          | PRE SLEEP | SLEEP | POST SLEEP |
|            | DAY/NIGHT ORBIT   |             |              |         |    |          |           |       |            |
| TDRS W E Z |   |             |              |         |    |          |           |       |            |
| ORB ATT    |   |             |              |         |    |          |           |       |            |
| NOTES      | <p>*D/L RATE 48M PL MAX (AFTER CREW CHOICE D/L)</p> <p style="text-align: right;">-ZLV -XVV</p> |             |              |         |    |          |           |       |            |

**FD13**

GMT 02/15/10 (046)

MET Day 011

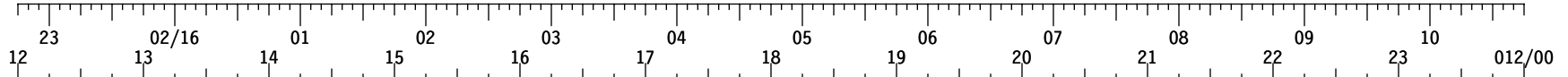

|            |                          |                   |            |            |                 |                 |                      |                             |                      |            |                     |                                 |                     |                     |                            |           |
|------------|--------------------------|-------------------|------------|------------|-----------------|-----------------|----------------------|-----------------------------|----------------------|------------|---------------------|---------------------------------|---------------------|---------------------|----------------------------|-----------|
| STS<br>130 | CDR ZAMKA                | POST SLEEP        | EXERCISE   | CABIN STOW | FILTER CLEANING | FCS C/O         | RFCS<br>HOT          | D/O<br>PREP<br>BRIEF        | PAO                  | MEAL       | L-1<br>COMMS<br>CHK | PILOT OPS                       | L-1<br>COMMS<br>CHK | CABIN STOW          | RFCS<br>HOT                | PRE SLEEP |
|            | PLT VIRTIS               | POST SLEEP        | EXERCISE   | CABIN STOW | COMM 2          | CABIN STOW      | FCS C/O              | RFCS<br>HOT                 | D/O<br>PREP<br>BRIEF | PAO        | MEAL                | SE<br>VACT                      | PILOT OPS           | CABIN STOW          | RFCS<br>HOT                | PRE SLEEP |
|            | MS1 HIRE                 | POST SLEEP        | EXERCISE   | CABIN STOW |                 | FCS C/O<br>P/TV | CABIN STOW           | PSD<br>AETG<br>OUIPT<br>-AL | D/O<br>PREP<br>BRIEF | PAO        | MEAL                | EVS<br>NIE<br>TDT<br>REU<br>YOP | CABIN STOW          |                     |                            | PRE SLEEP |
|            | MS2 ROBINSON             | POST SLEEP        | CABIN STOW | EXERCISE   | CABIN STOW      | FCS C/O         | RFCS<br>HOT          | D/O<br>PREP<br>BRIEF        | PAO                  | MEAL       | CABIN STOW          | PILOT OPS                       | CABIN STOW          | WDL<br>EACT<br>STOW | PGSC<br>STOW<br>PART<br>I  | PRE SLEEP |
|            | MS3 PATRICK              | POST SLEEP        | FRED STOW  | EXERCISE   | CABIN STOW      | ERG STOW        | CABIN STOW           | D/O<br>PREP<br>BRIEF        | PAO                  | MEAL       | CABIN STOW          |                                 |                     |                     |                            | PRE SLEEP |
|            | MS4 BEHNKEN              | POST SLEEP        | CABIN STOW | EXERCISE   | ERG STOW        | CABIN STOW      | D/O<br>PREP<br>BRIEF | PAO                         | MEAL                 | CABIN STOW |                     |                                 |                     |                     | PRE SLEEP                  |           |
| STS        | DAY/NIGHT                | [Day/Night Cycle] |            |            |                 |                 |                      |                             |                      |            |                     |                                 |                     |                     |                            |           |
|            | ORBIT                    | [Orbit Cycle]     |            |            |                 |                 |                      |                             |                      |            |                     |                                 |                     |                     |                            |           |
|            | TDRS                     | [TDRS Cycle]      |            |            |                 |                 |                      |                             |                      |            |                     |                                 |                     |                     |                            |           |
|            | GND                      | [Ground Cycle]    |            |            |                 |                 |                      |                             |                      |            |                     |                                 |                     |                     |                            |           |
| ATTITUDE   | -ZLV -XVV                |                   |            |            |                 |                 |                      |                             |                      |            |                     |                                 |                     |                     |                            |           |
| NOTES      | ^HTR ACT<br>*D/L RATE 2M |                   |            |            |                 |                 |                      |                             |                      |            |                     |                                 |                     |                     | #COOLING CNFG<br>*POWER ON |           |

**FD13**

GMT 02/16/10 (047)

MET Day 012

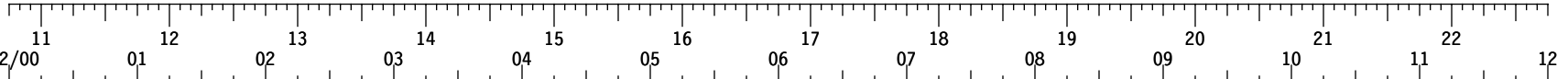

|                                 |           |           |           |       |            |         |     |     |     |     |  |
|---------------------------------|-----------|-----------|-----------|-------|------------|---------|-----|-----|-----|-----|--|
| S<br>T<br>S<br>-<br>1<br>3<br>0 | CDR       | PRE SLEEP | PRE SLEEP | SLEEP | POST SLEEP | PMC A/G |     |     |     |     |  |
|                                 | PLT       |           | PRE SLEEP | SLEEP | POST SLEEP |         |     |     |     |     |  |
|                                 | MS1       |           | PRE SLEEP | SLEEP | POST SLEEP |         |     |     |     |     |  |
|                                 | MS2       |           | PRE SLEEP | SLEEP | POST SLEEP |         |     |     |     |     |  |
|                                 | MS3       |           | PRE SLEEP | SLEEP | POST SLEEP |         |     |     |     |     |  |
|                                 | MS4       |           | PRE SLEEP | SLEEP | POST SLEEP |         |     |     |     |     |  |
| S<br>T<br>S                     | DAY/NIGHT |           |           |       |            |         |     |     |     |     |  |
|                                 | ORBIT     | 190       | 191       | 192   | 193        | 194     | 195 | 196 | 197 | 198 |  |
|                                 | TDRS      |           |           |       |            |         |     |     |     |     |  |
|                                 | ORB ATT   | -ZLV -XVV |           |       |            |         |     |     |     |     |  |
|                                 | NOTES     |           |           |       |            |         |     |     |     |     |  |

**FD14**

GMT 02/16/10 (047)

MET Day 012

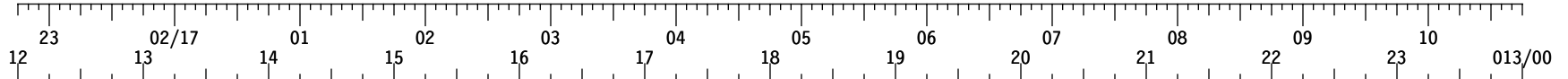

|         |              |                                     |                       |                                 |  |   |                        |   |  |  |
|---------|--------------|-------------------------------------|-----------------------|---------------------------------|--|---|------------------------|---|--|--|
| STS-130 | CDR ZAMKA    | POST SLEEP                          | WGR<br>AR<br>TP<br>CH | P<br>PR<br>UP                   | IMU<br>ALIGN<br>&<br>VERIF   | T<br>R<br>X<br>S<br>I   | DEORBIT PREP           | D<br>E<br>O<br>R<br>B<br>I<br>T<br><br>B<br>U<br>R<br>N | K<br>S<br>C<br><br>L<br>A<br>N<br>D<br>I<br>N<br>G |  |
|         | PLT VIRTS    | POST SLEEP                          | G<br>R<br>P<br>B      | M<br>W<br>P<br>U<br>S<br>P<br>* | A<br>A<br>A<br>D<br>M<br>T<br>S<br>P<br>C<br>L<br>H                |   | DEORBIT PREP           |   |  |  |
|         | MS1 HIRE     | POST SLEEP                          |                       |                                 |  |   | DEORBIT PREP           |   |  |  |
|         | MS2 ROBINSON | POST SLEEP                          |                       |                                 | P<br>G<br>S<br>C<br>S<br>T<br>O<br>W<br>P<br>A<br>R<br>T<br>I<br>I |   | DEORBIT PREP           |   |  |  |
|         | MS3 PATRICK  | POST SLEEP                          |                       |                                 | O<br>S<br>T<br>A<br>O<br>C<br>W<br>A                               | G<br>S<br>I<br>T<br>R<br>O<br>C<br>H<br>W<br>A<br>I<br>T<br>I<br>N<br>G | DEORBIT PREP           |   |  |  |
|         | MS4 BEHNKEN  | POST SLEEP                          |                       |                                 | M<br>D<br>E<br>W<br>K<br>C<br>K<br>C<br>K<br>N                     | T<br>P<br>P<br>R<br>C<br>D<br>N   | DEORBIT PREP           |   |  |  |
| STS     | DAY/NIGHT    |                                     |                       |                                 |  |   |                        |   |  |  |
|         | ORBIT        | 198 199 200 201 202 203 204 205 206 |                       |                                 |  |   |                        |   |  |  |
|         | TDRS         |                                     |                       |                                 |  |   |                        |   |  |  |
| ORB ATT |              |                                     |                       |                                 |  |   |                        |   |  |  |
| NOTES   | *POWER ON    |                                     |                       |                                 |  |   | DEORBIT TIG (12/18:09) | LANDING (12/19:14)                                      |  |  |

This Page Intentionally Blank

DETAILED TIMELINE

DETAILED  
TIMELINE





# STS-130 FD01

| GMT              | TDRS<br>W E Z | MET<br>Day 000 | S<br>T<br>S<br>A<br>T<br>T | MS2<br>ROBINSON  | MS3<br>PATRICK   | MS4<br>BEHNKEN   | Notes |
|------------------|---------------|----------------|----------------------------|--|--|--|-------|
| Date 02/07 (038) |               | 00:00          |                            |  |  |  |       |
|                  |               | 10:00          | ASC                        | ASCENT   | ASCENT   | ASCENT   |       |
|                  |               | 11:00          | OMS                        |  |  |  |       |
|                  |               | 12:00          | ZLV                        | POST INSERTION   | POST INSERTION   | POST INSERTION   |       |
|                  |               | 13:00          | XVV                        |  |  |  |       |
|                  |               | 03:00          |                            | <u>PGSC ACT</u><br><u>PGSC NETWORK (A. SETUP)</u><br><u>PGSC HARD DISK LATE UPDATE</u><br><u>WINDECOM OPS (A. ACT)</u><br><u>WORLDMAP INITIALIZATION</u><br><u>COLOR PRINTER UNSTOW &amp; ASSEMBLE</u><br><u>COLOR PRINTER WARMUP &amp; SELF-TEST</u><br>(ORB OPS, PGSC) | <u>ON-ORBIT INITIALIZATION</u><br>(PDRS, ON-ORBIT INIT)<br><br><u>OCAC SETUP</u><br>(ORB OPS, CREW SYS)<br><br><u>GIRA INSTALLATION</u><br>(ORB OPS, ECLS) | <u>PGSC ACT</u><br><u>PGSC NETWORK (A. SETUP)</u><br><u>PGSC HARD DISK LATE UPDATE</u><br><u>WINDECOM OPS (A. ACT)</u><br><u>WORLDMAP INITIALIZATION</u><br><u>COLOR PRINTER UNSTOW &amp; ASSEMBLE</u><br><u>COLOR PRINTER WARMUP &amp; SELF-TEST</u><br>(ORB OPS, PGSC) |       |
|                  |               | 04:00          | NC1                        |  | <u>RMS POWERUP</u><br>(PDRS, RMS POWERUP)  |  |       |

# STS-130 FD01

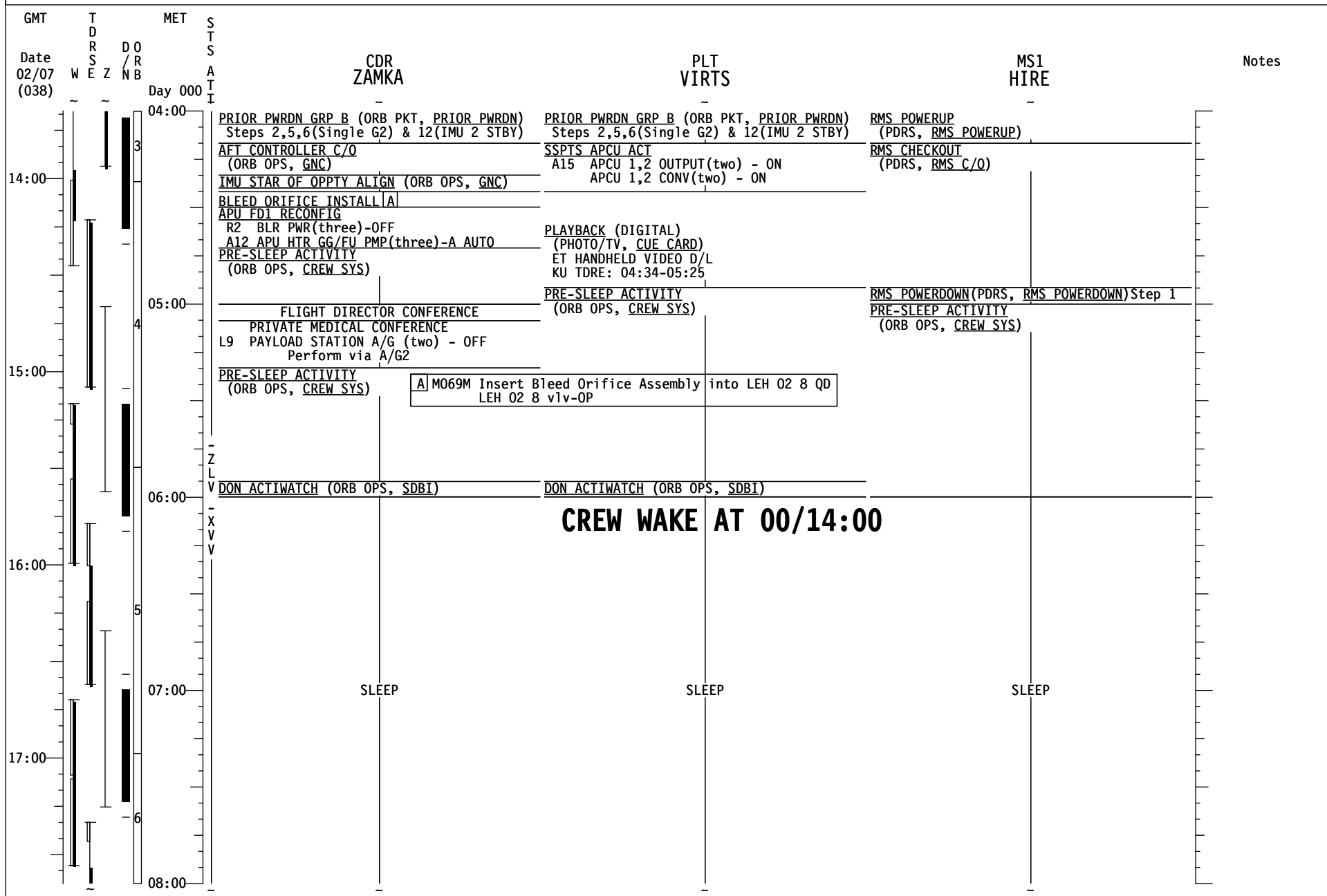

# STS-130 FD01

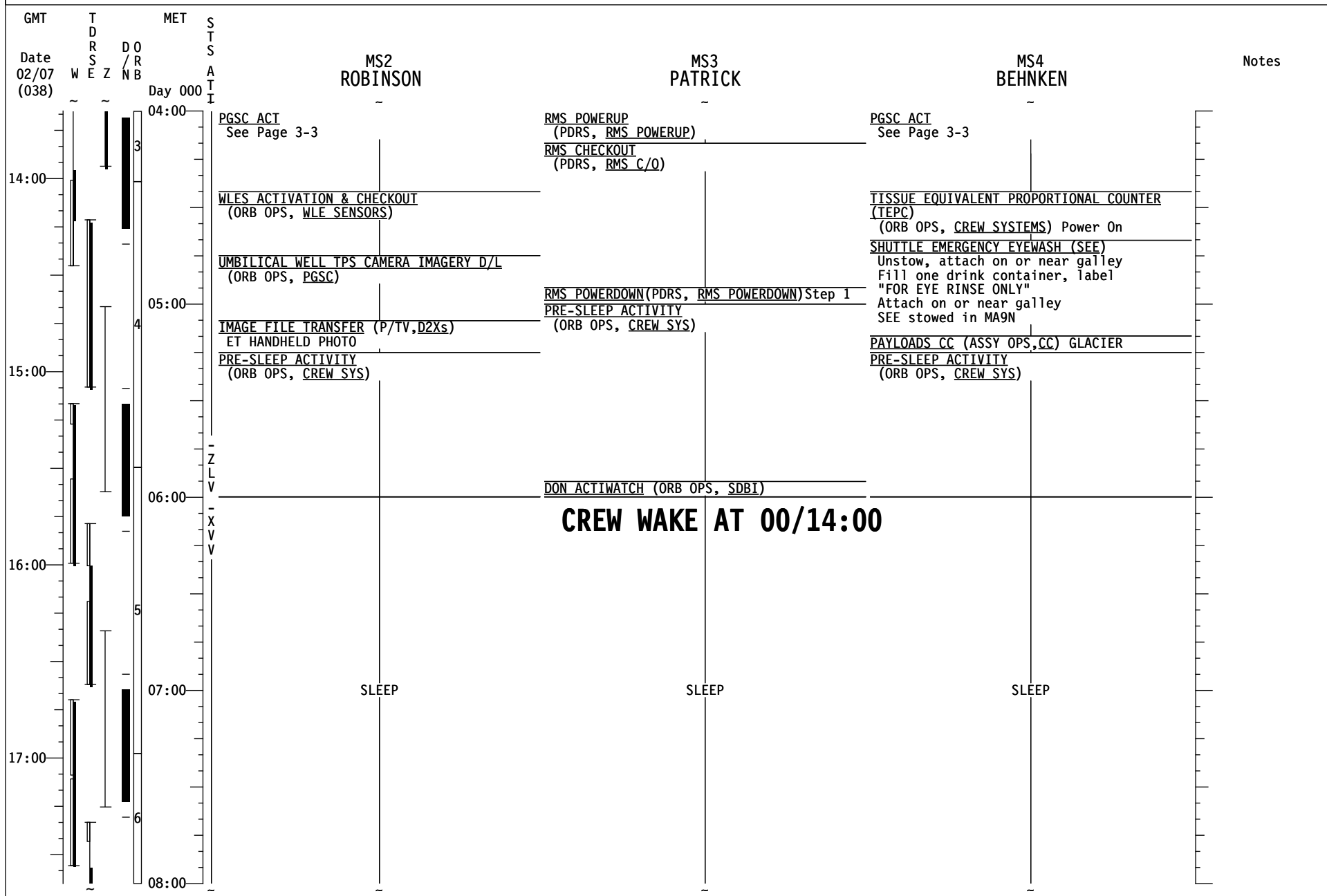

# STS-130 FD01

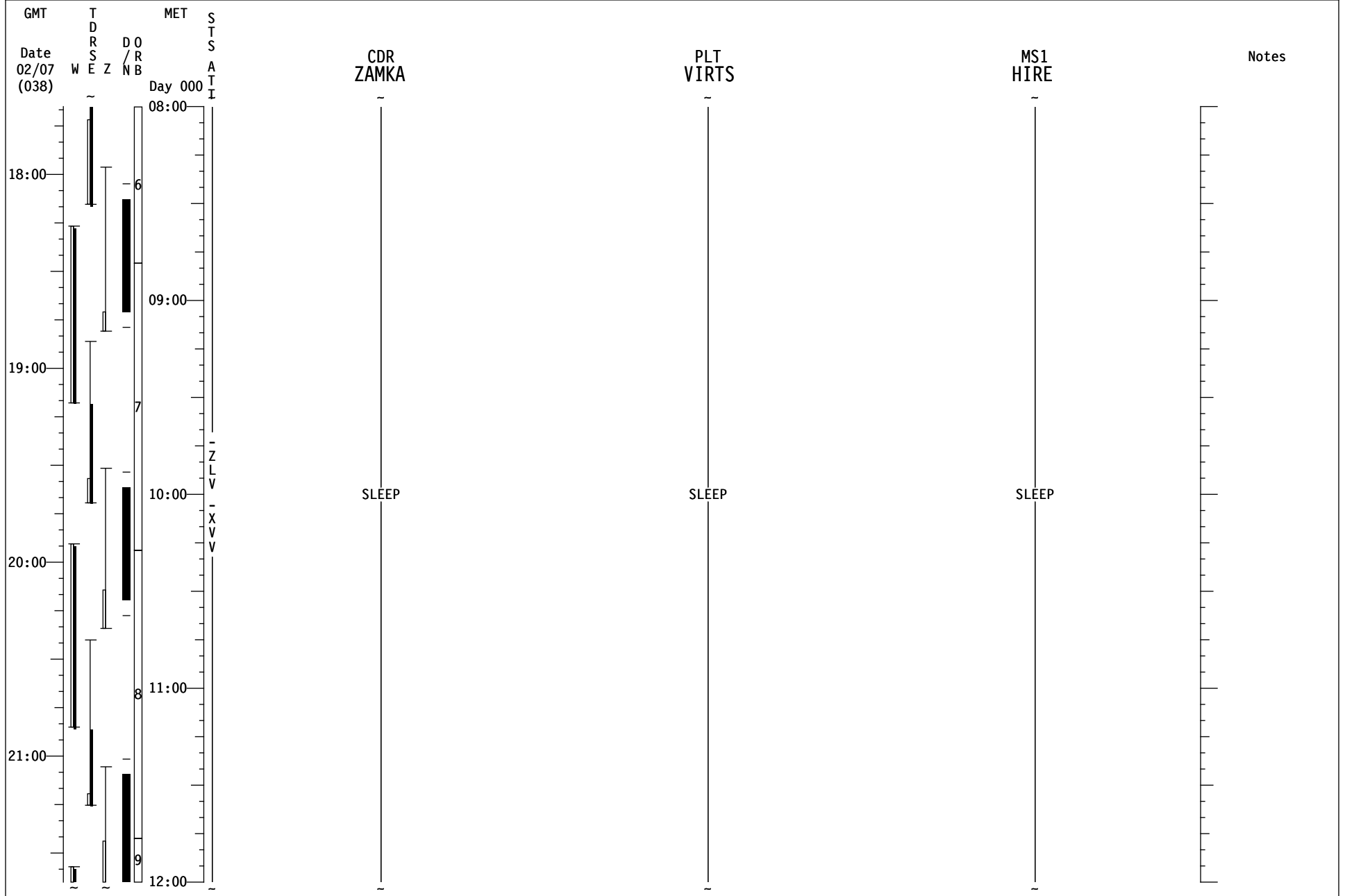

# STS-130 FD01

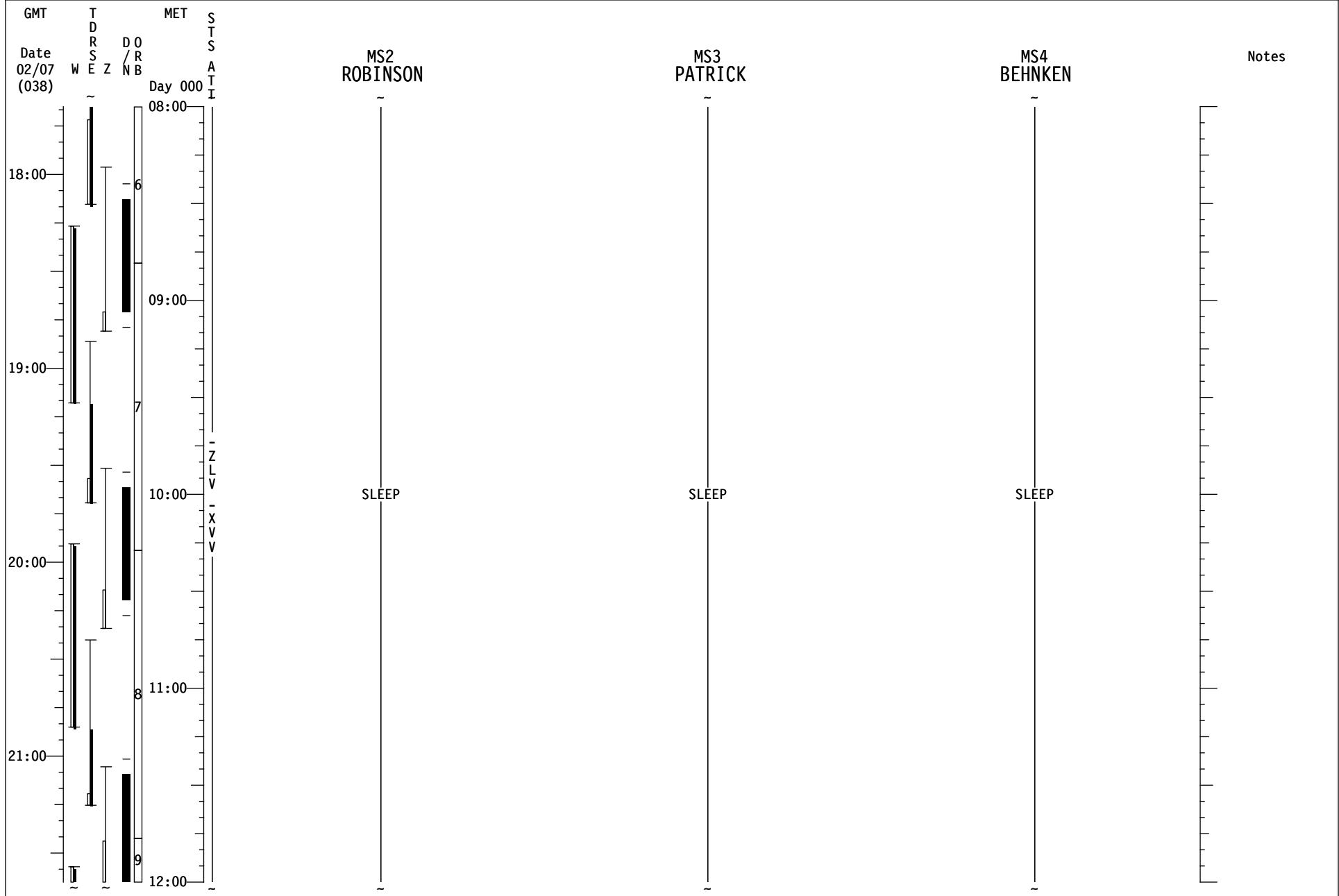

# STS-130 FD02

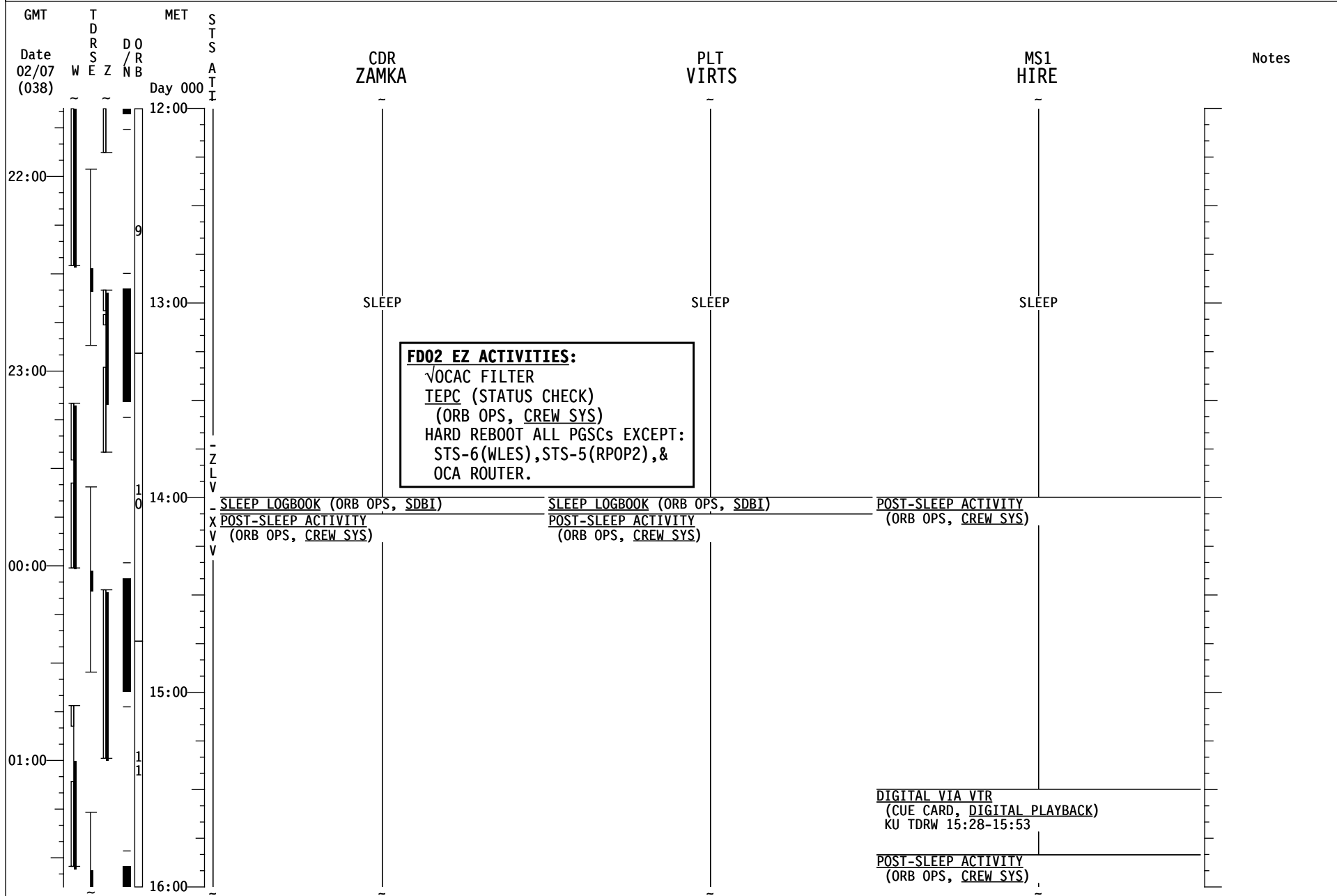

# STS-130 FD02

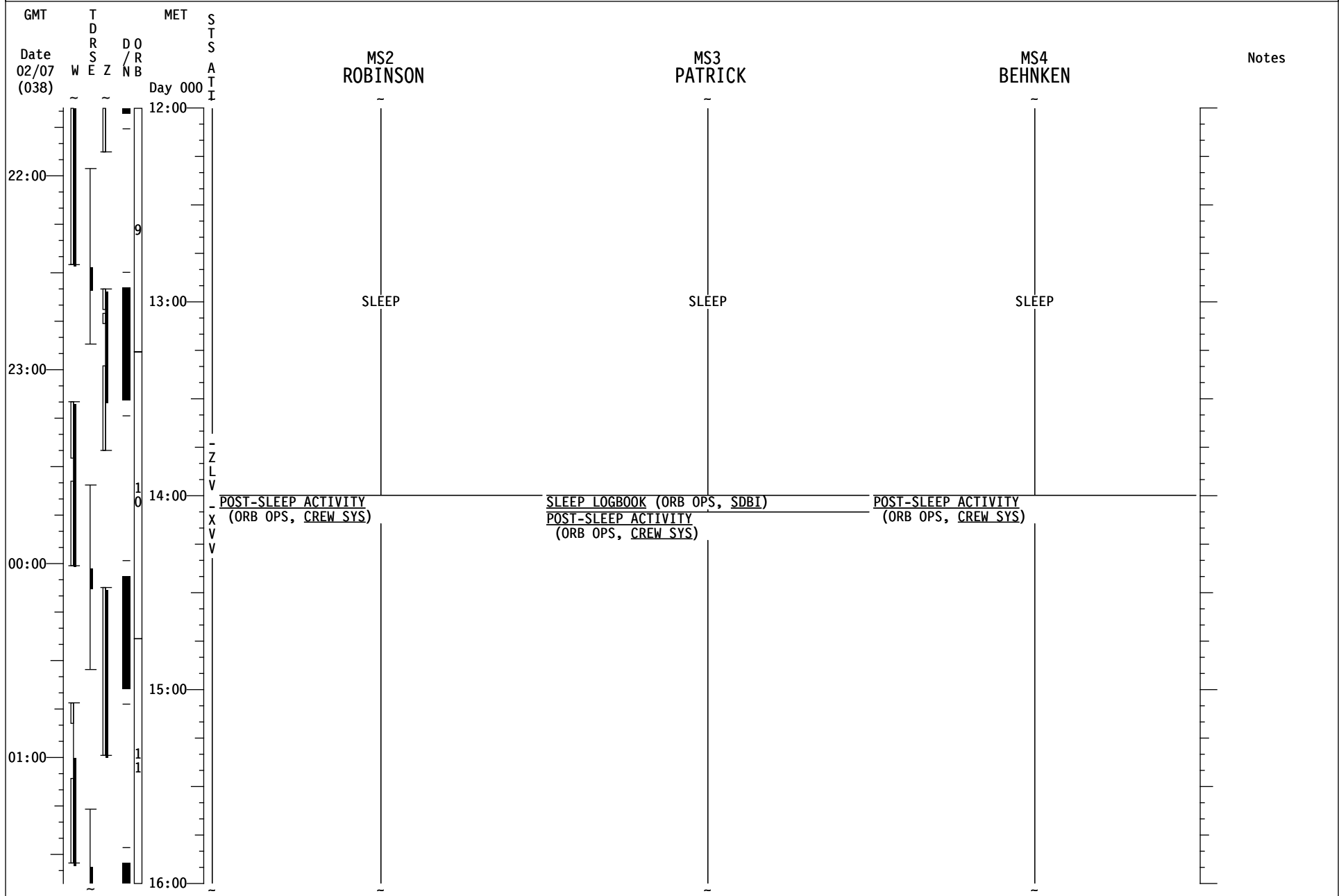

# STS-130 FD02

| GMT              | TDRSEZ | MET     | SATS | CDR ZAMKA   | PLT VIRTS   | MS1 HIRE   | Notes                   |
|------------------|--------|---------|------|---|---|--|-------------------------|
| Date 02/08 (039) | W E Z  | Day 000 | 1    |   |   |  |                         |
| 16:00            |        |         | 1    | POST-SLEEP ACTIVITY -<br>(ORB OPS, CREW SYS)<br>IMU STAR OF OPPTY ALIGN (ORB OPS, GNC)<br>L17 Check MCIU filter screen<br>PRIOR PWRUP GRP B (ORB PKT, PRIOR PWRDN)<br>Steps 12 (IMU 2), 6 (Dual G2) & 5 | POST-SLEEP ACTIVITY -<br>(ORB OPS, CREW SYS)<br>APCU 2: Disable Power to OBSS<br>A15 APCU 2 CONV - OFF<br>PRIOR PWRUP GRP B (ORB PKT, PRIOR PWRDN)<br>Steps 12 (IMU 2), 6 (Dual G2) & 5 | POST-SLEEP ACTIVITY -<br>(ORB OPS, CREW SYS)           |                         |
| 02:00            |        |         |      | ON-ORBIT OMS BURN<br>(ORB OPS, OMS)   | ON-ORBIT OMS BURN<br>(ORB OPS, OMS)   | P/TV01 VIDEO SETUP<br>(PHOTO/TV, SCENES)               | UPDATE ORBITAL MNVR PAD |
|                  |        |         | 2    | < NC2 TIG (16:55)   | < NC2 TIG (16:55)   |  |                         |
| 03:00            |        |         | 2    | MNVR (TRK) -ZLV -XVV<br>TGT=2 BV=3 OM=0<br>A1/AUTO/VERN, Init TRK<br>PRIOR PWRDN GRP B (ORB PKT, PRIOR PWRDN)<br>Steps 5,6(Single G2) & 12(IMU 2 STBY)  | POST-SLEEP ACTIVITY -<br>(ORB OPS, CREW SYS)<br>PRIOR PWRDN GRP B (ORB PKT, PRIOR PWRDN)<br>Steps 5,6(Single G2) & 12(IMU 2 STBY)   | OBSS UNBERTH<br>(PDRS, OBSS OPERATIONS)                |                         |
|                  |        |         |      | RCS/OMS POD HTR RECONFIG A<br>02 REPRESS INIT B<br>R2 BLR CNTLR/HTR (three) - B<br>02 REPRESS TERM C  | FC PURGE - MANUAL<br>(ORB OPS, EPS)<br>CRYO 02 TANK HEATER SENSOR CHECK<br>(ORB OPS, EPS)   |  |                         |
| 04:00            |        |         | 3    | MNVR (TRK) BIAS +YSI (STBD SURVEY)<br>TGT=4 BV=5 P=0 Y=43 OM=48<br>A14/AUTO/VERN, Init TRK<br>OBSS LDRI RCC SURVEY - STBD<br>(PDRS, OBSS OPERATIONS)  | MIDDECK TRANSFER PREP<br>Ref. MSG XXX   | OBSS LDRI RCC SURVEY - STBD<br>(PDRS, OBSS OPERATIONS) |                         |
|                  |        |         |      | <b>R3</b>   |   | <b>R1</b>  |                         |
|                  |        |         |      | A A14 RCS/OMS HTR L POD A - OFF<br>B - AUTO<br>R POD A - OFF<br>B - AUTO  |   |  |                         |
|                  |        |         |      | B 02 REPRESS INIT<br>OCAC PWR - OFF<br>C5 DIRECT 02 v1v - OP  |   |  |                         |
|                  |        |         |      | C On MCC GO 02 REPRESS TERM:<br>C5 DIRECT 02 v1v - CL<br>OCAC PWR - ON  |   |  |                         |
| 05:00            |        |         | 4    |   |   |  |                         |
| 19:00            |        |         |      |   |   |  |                         |
| 20:00            |        |         |      |   |   |  |                         |



# STS-130 FD02

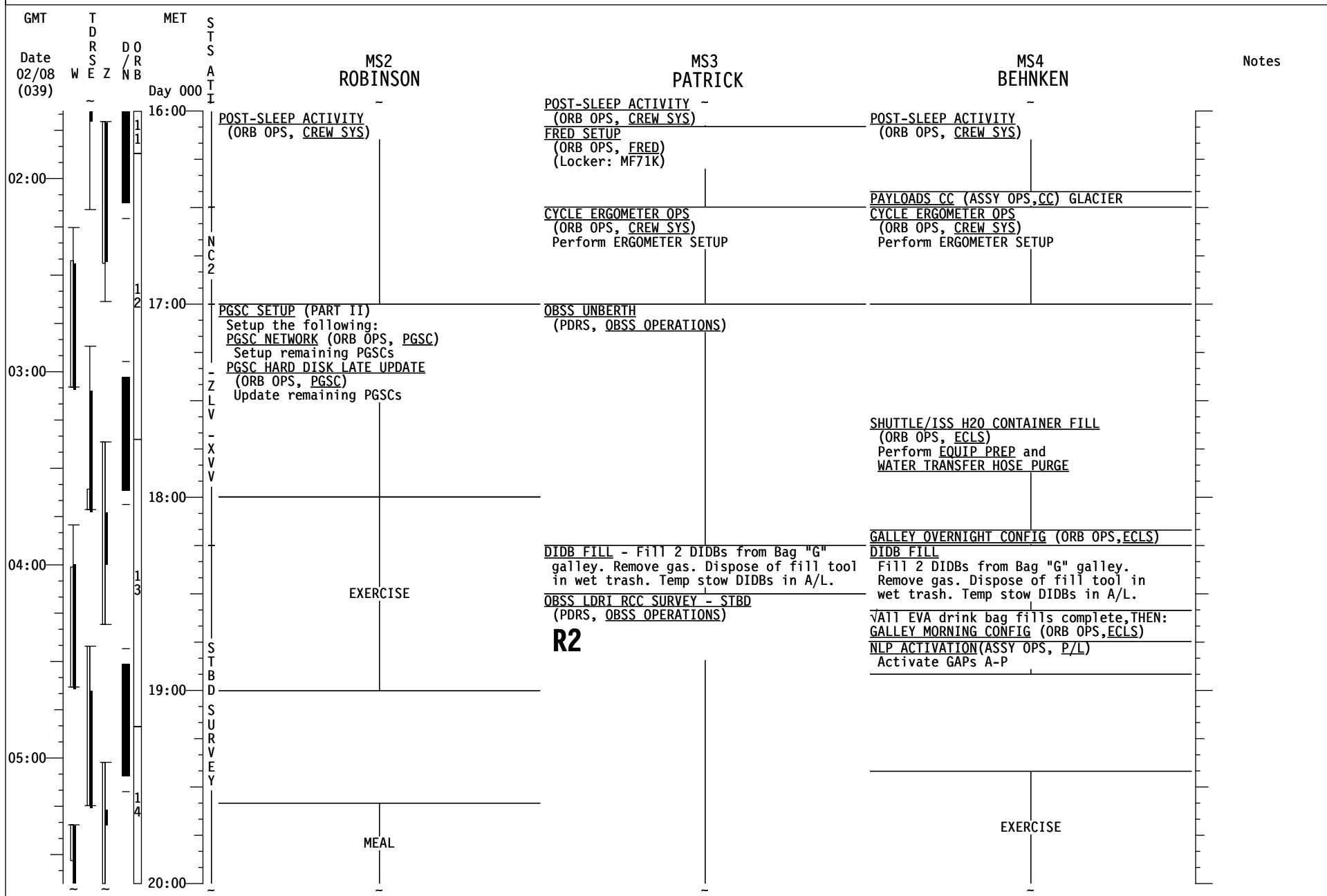

# STS-130 FD02

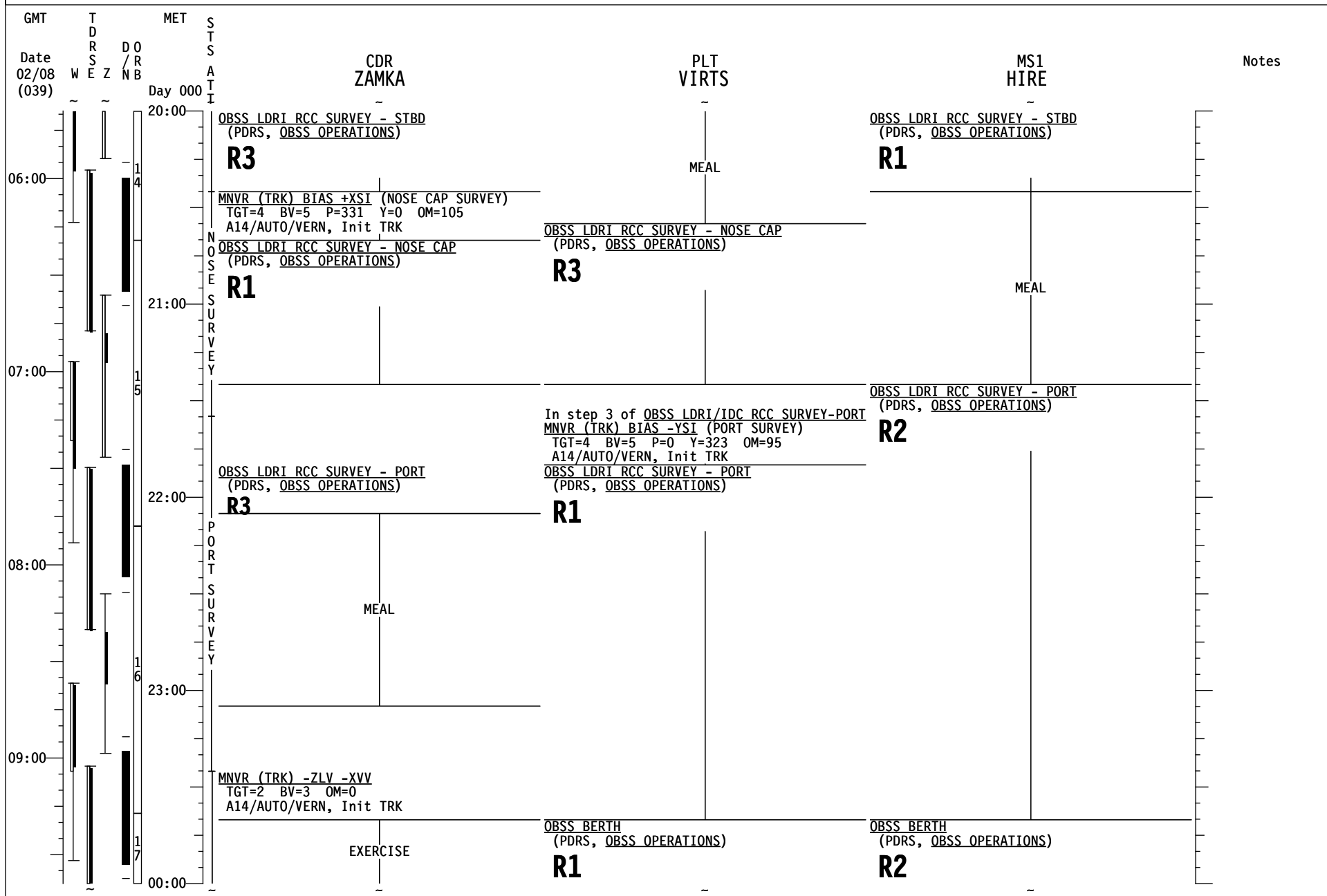

# STS-130 FD02

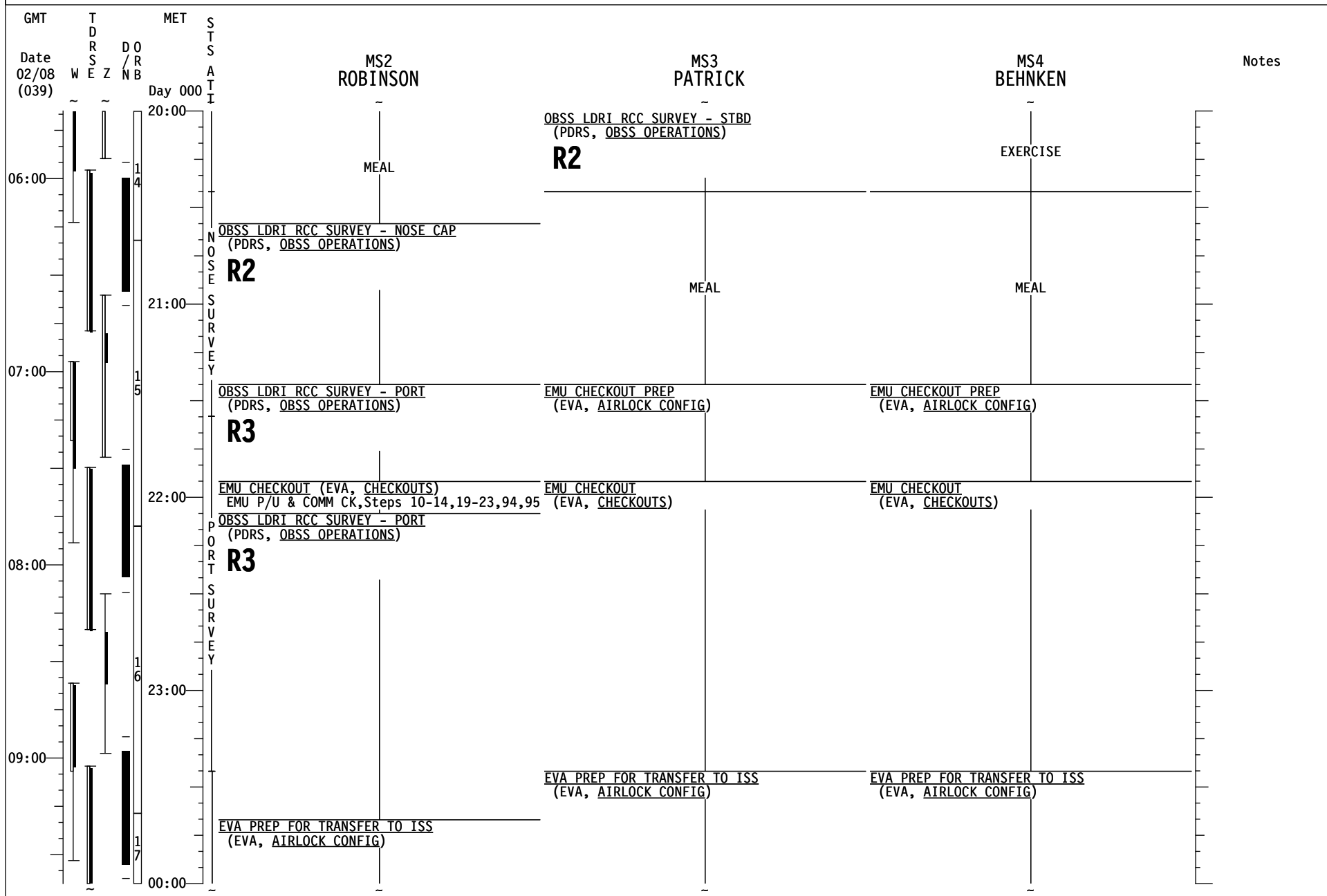

# STS-130 FD02

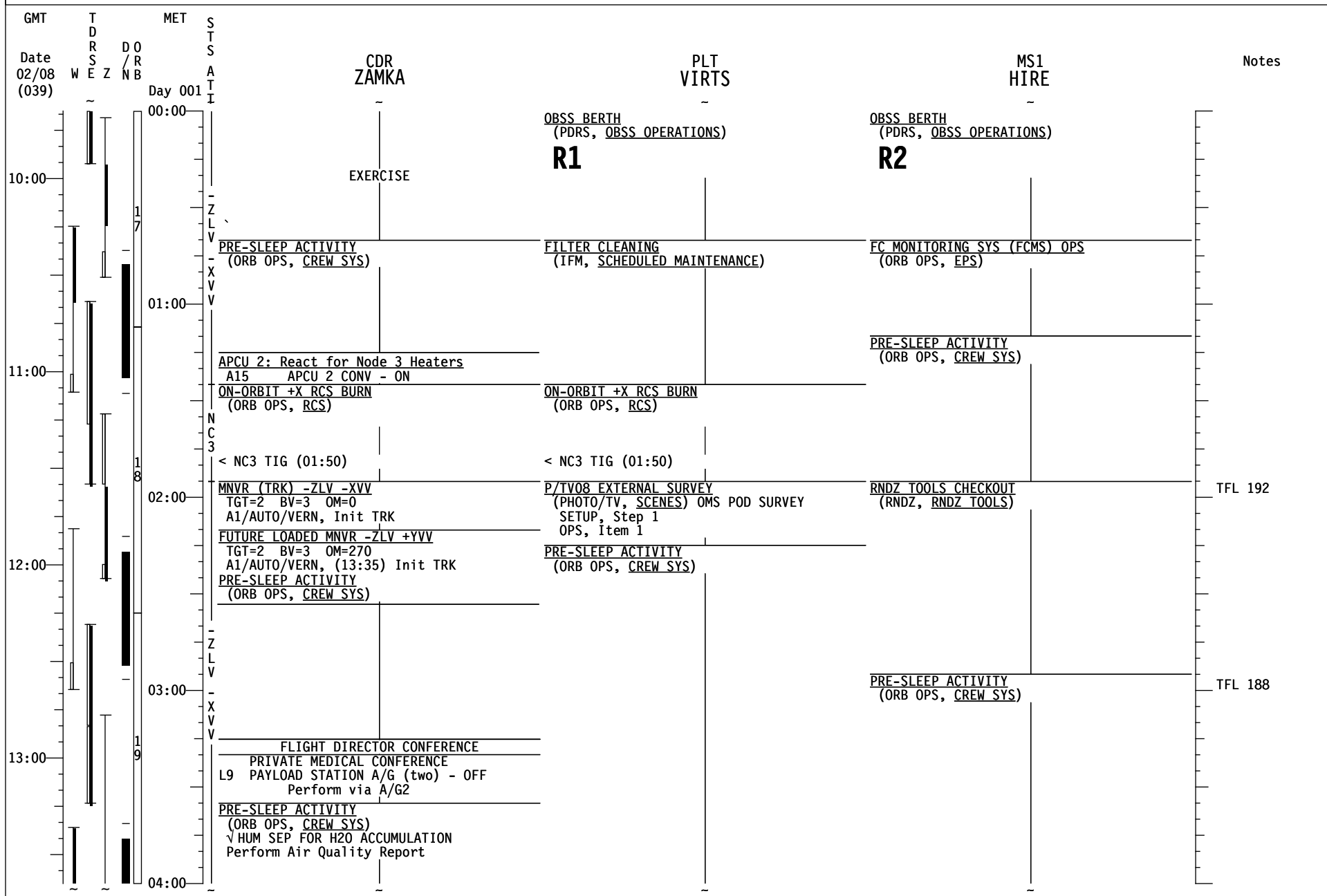

# STS-130 FD02

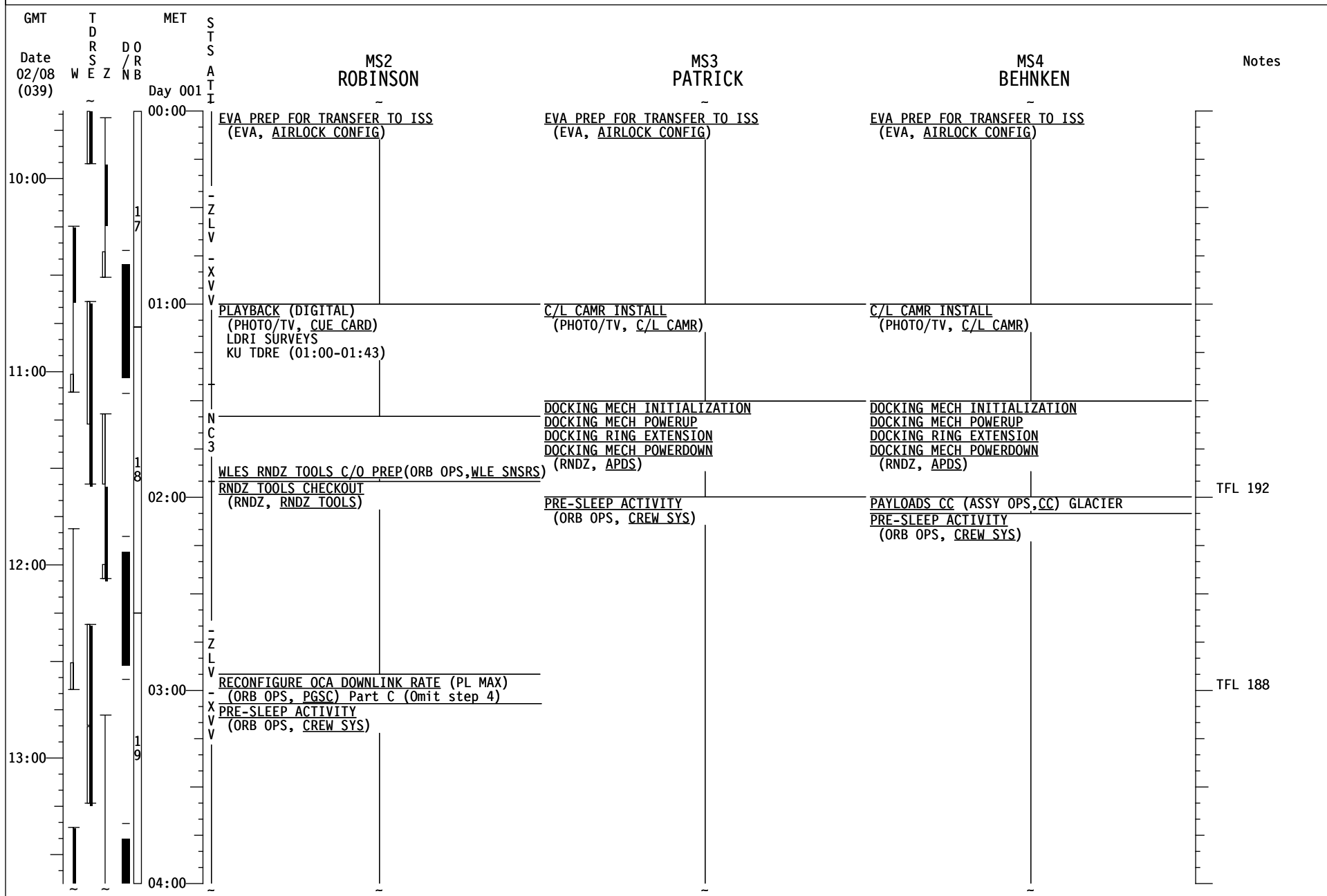

# STS-130 FD02

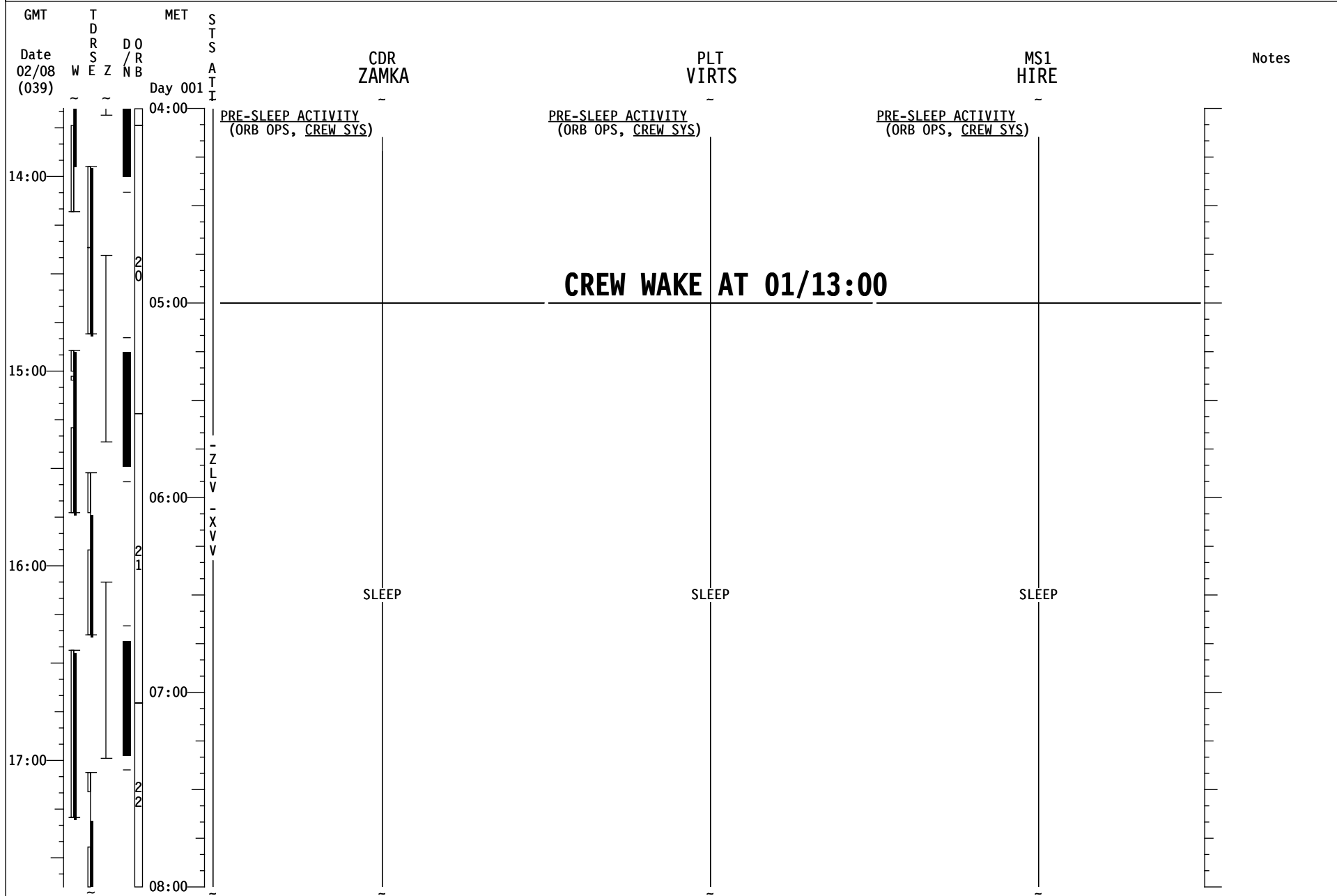

# STS-130 FD02

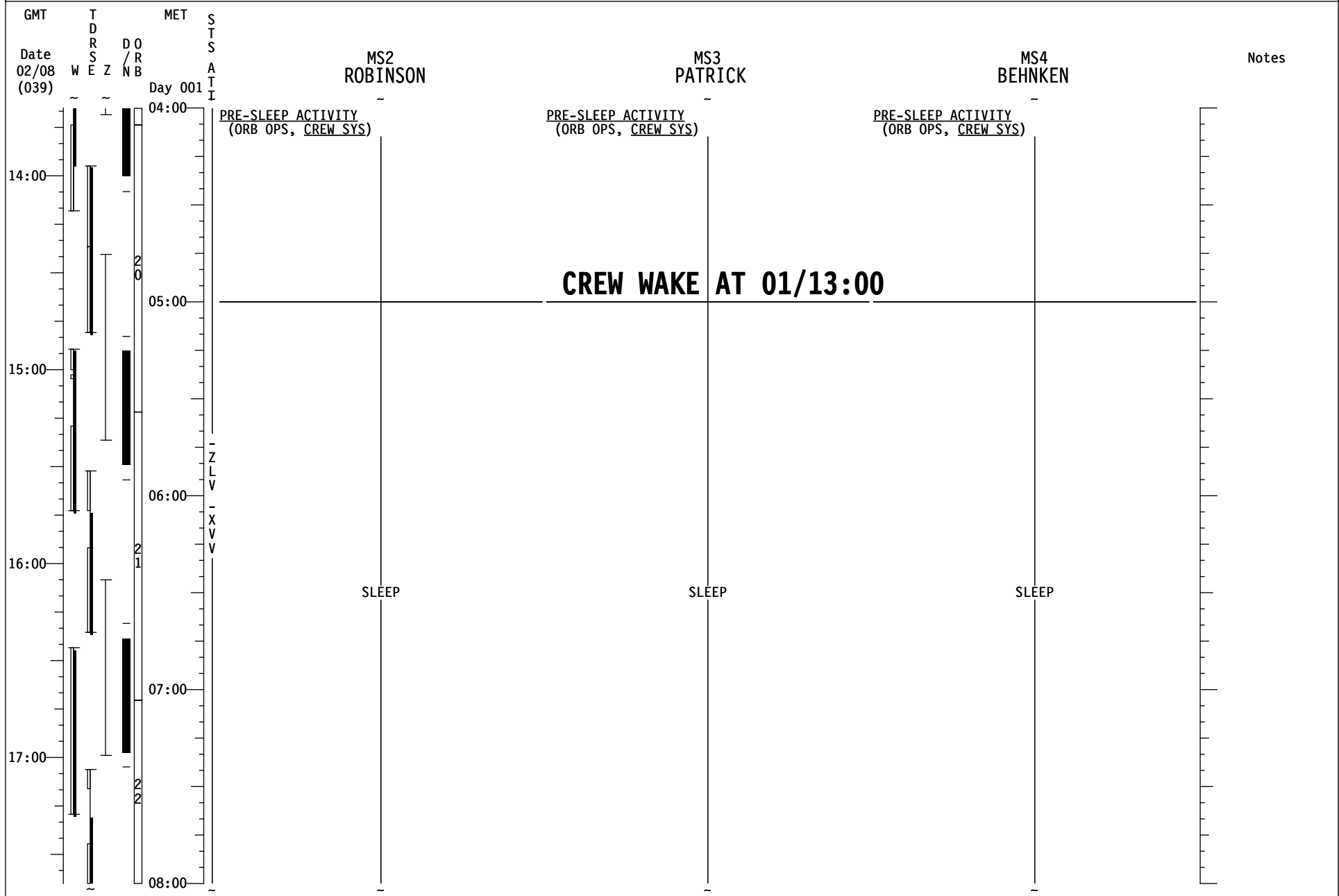

# STS-130 FD02

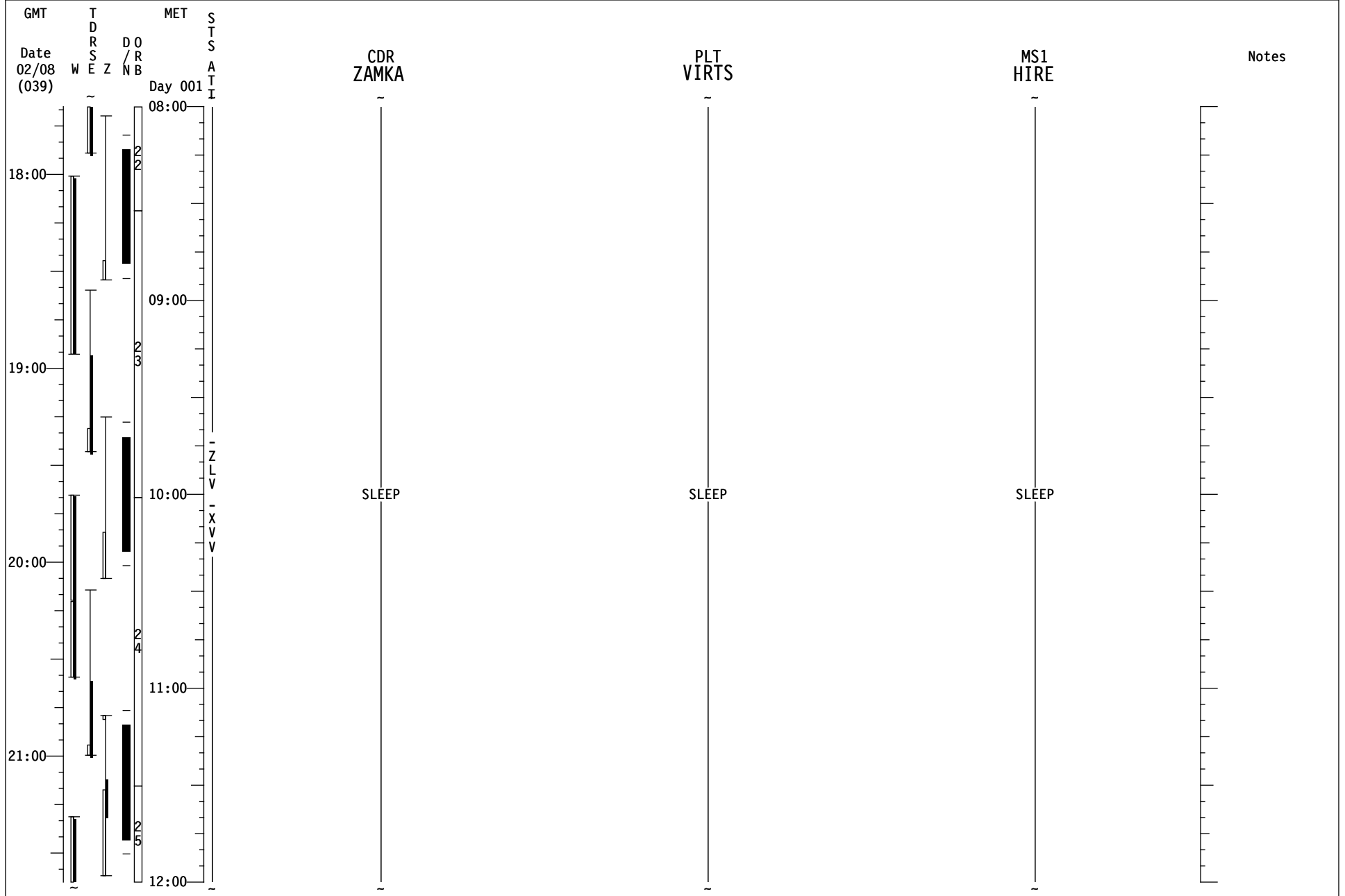



# STS-130 FD02

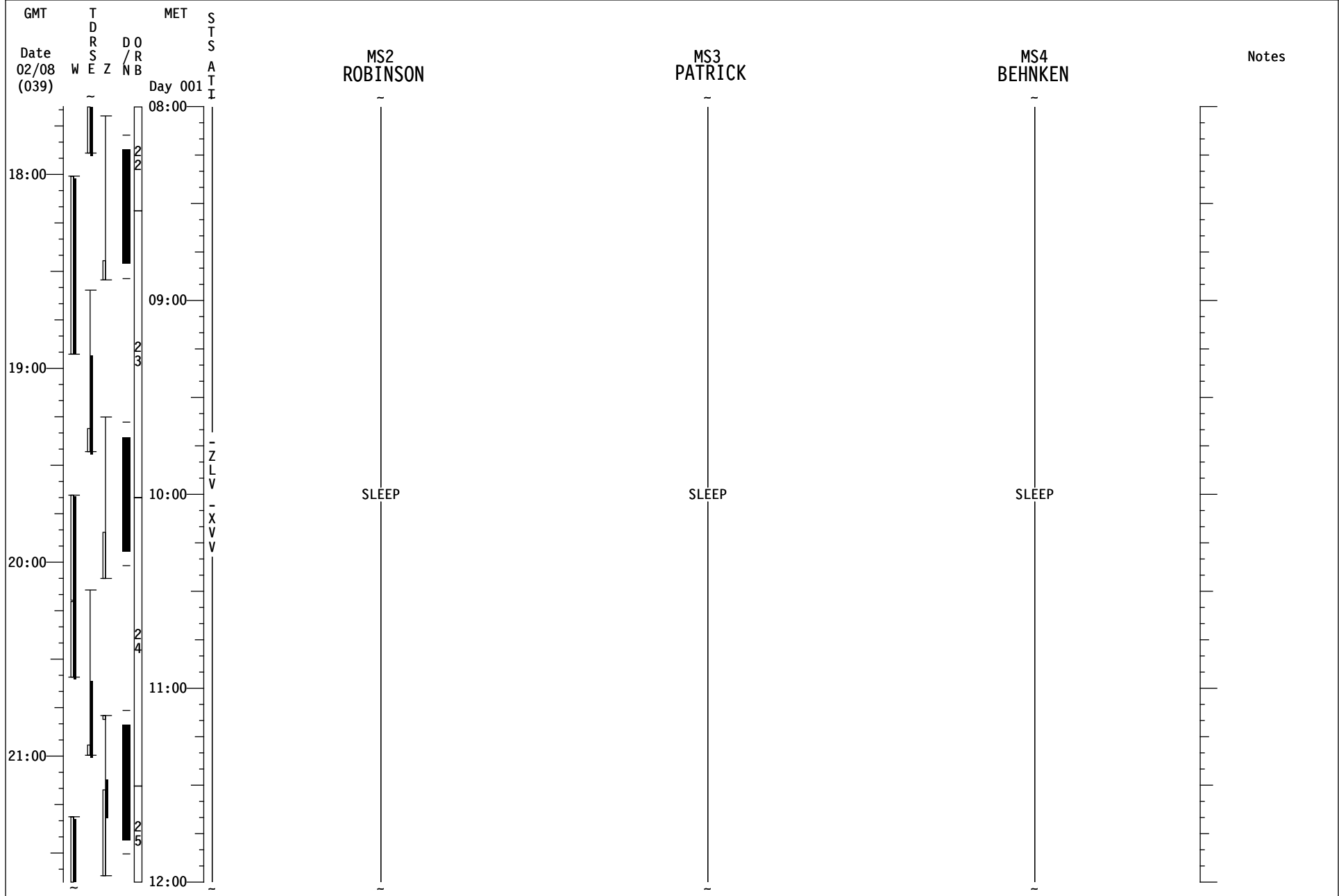

# STS-130 FD03

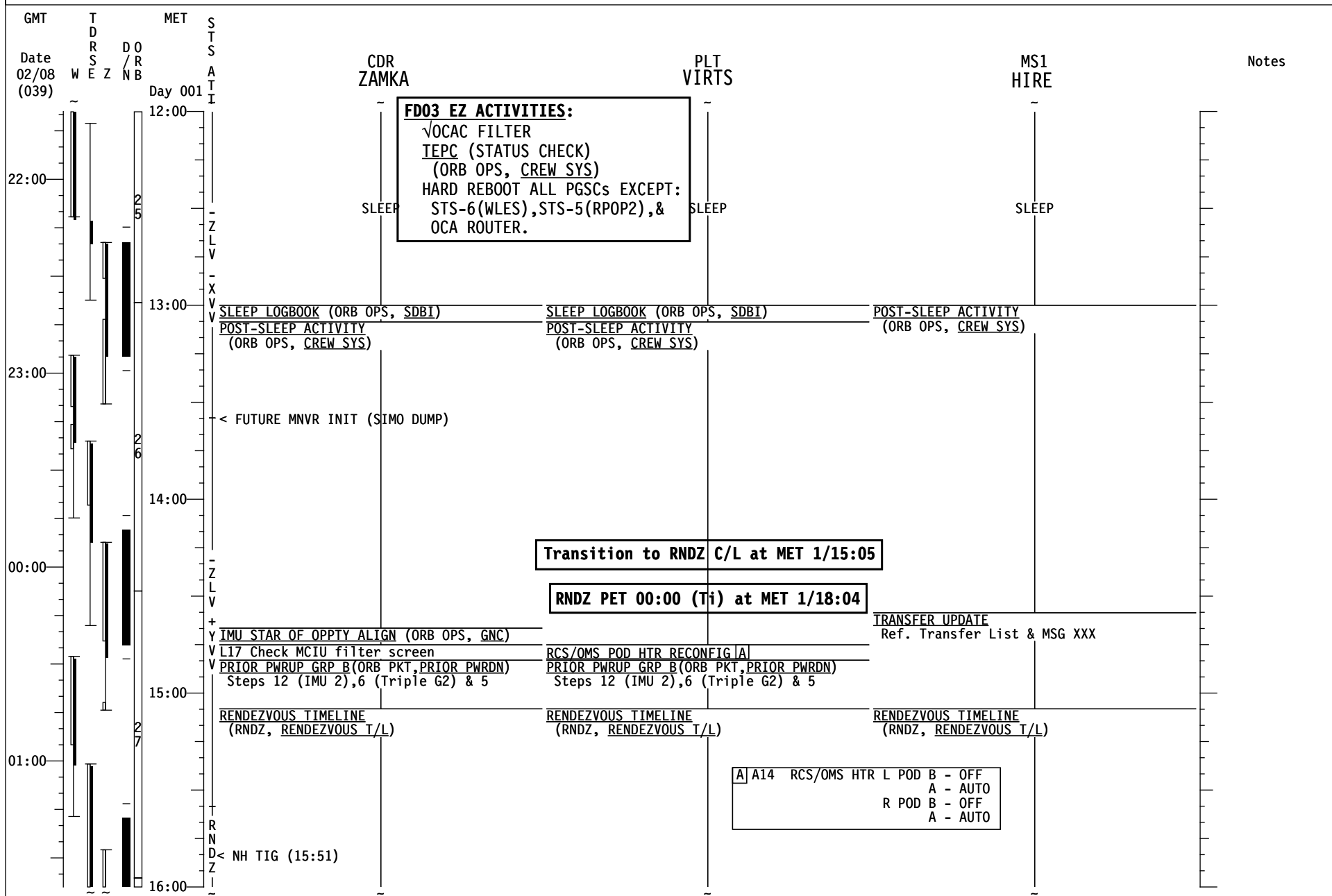

# STS-130 FD03

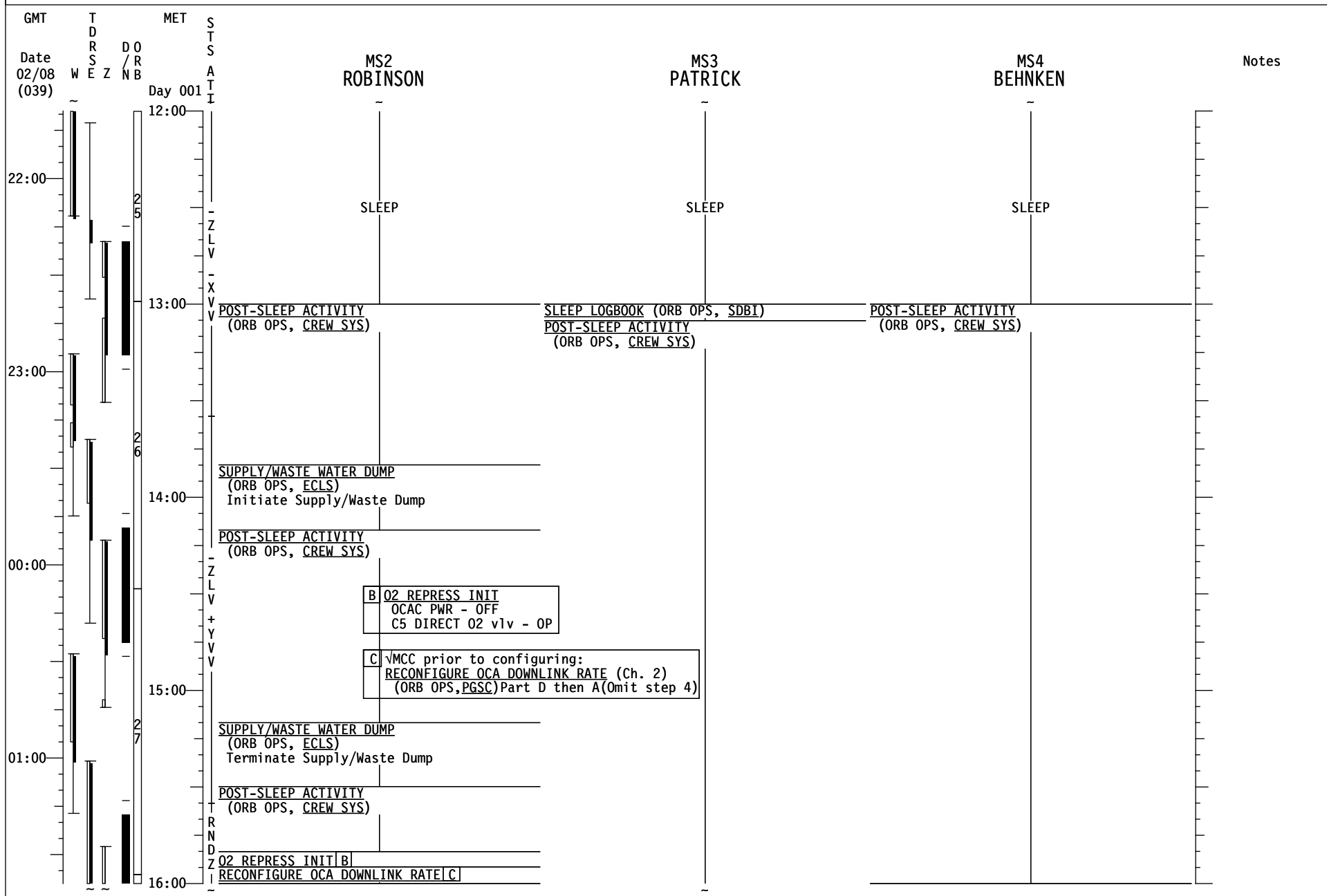

# STS-130 FD03

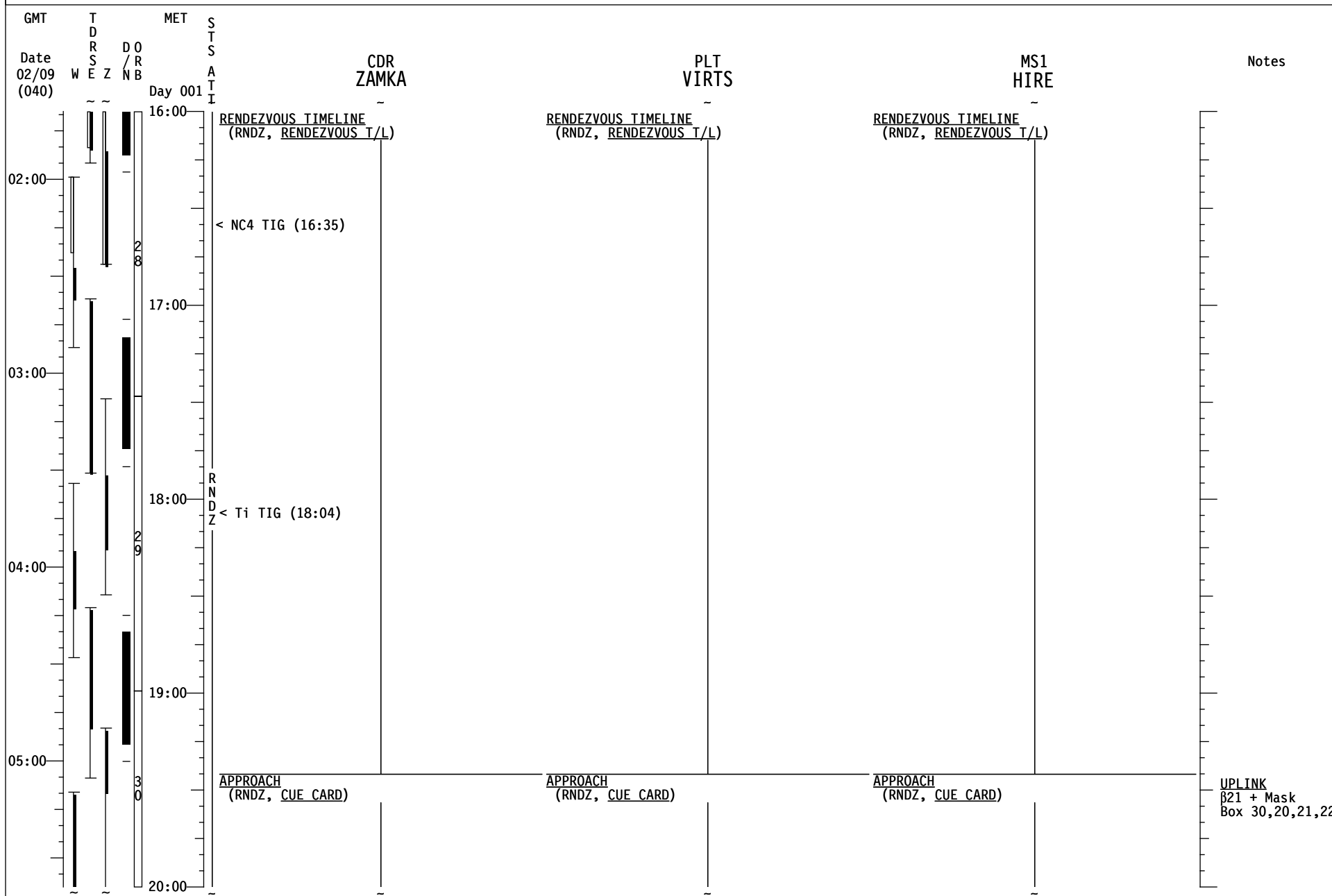

# STS-130 FD03

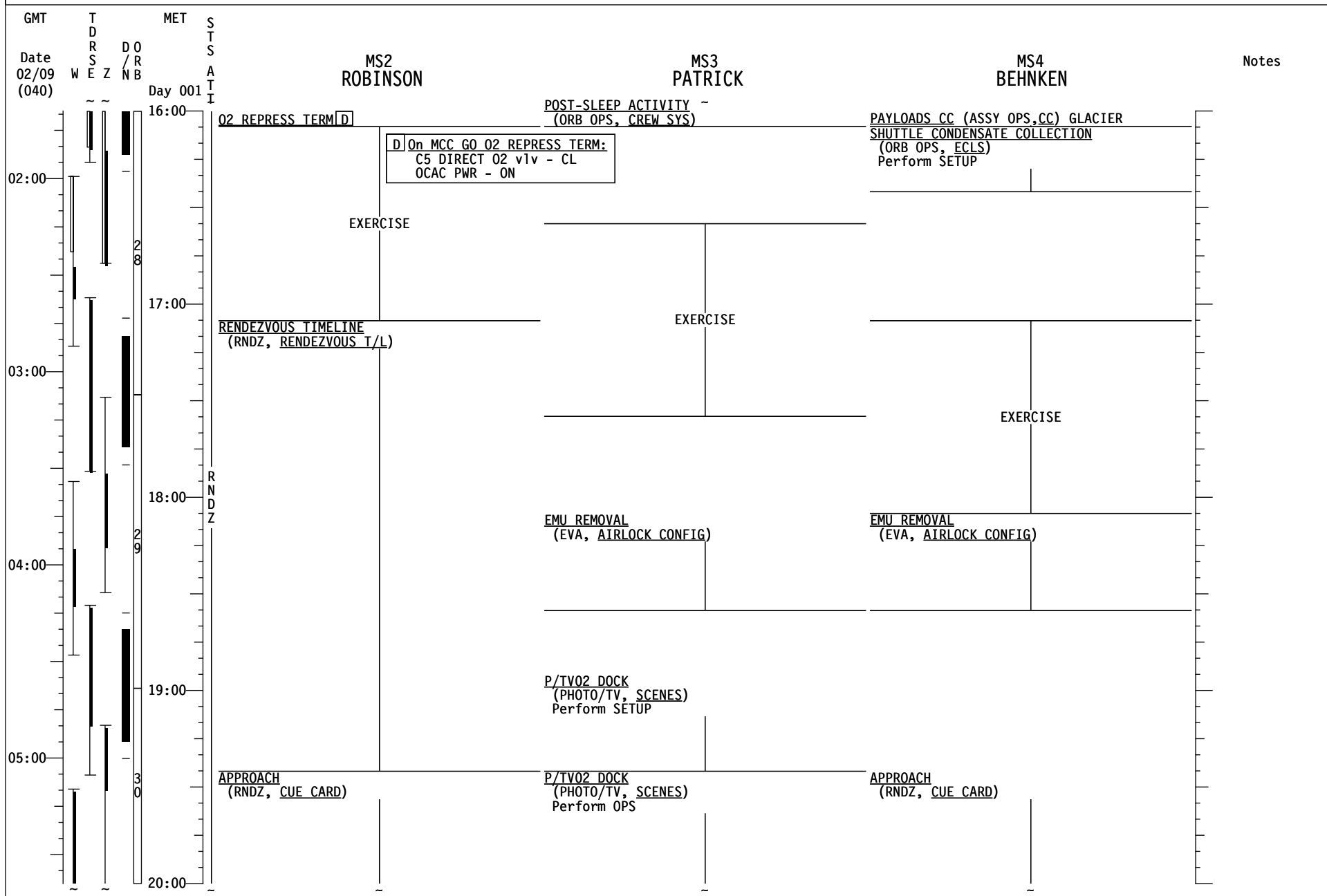

# STS-130 FD03

| GMT              | TDRSEZ | MET     | S<br>T<br>S<br>A<br>T<br>I | CDR<br>ZAMKA   | PLT<br>VIRTS  | MS1<br>HIRE   | Notes   |
|------------------|--------|---------|----------------------------|--|---|---|---|
| Date 02/09 (040) | W E Z  | Day 001 | D O R B / N B              |  |   |   |   |
| 20:00            |        |         | RNDZ                       | APPROACH (RNDZ, CUE_CARD)  | APPROACH (RNDZ, CUE_CARD)   | APPROACH (RNDZ, CUE_CARD)   |   |
| 06:00            |        |         |                            |  |   |   |   |
|                  |        |         |                            | <b>RETURN TO FLIGHT PLAN</b>   |   |   |   |
|                  |        |         |                            | <b>&lt; DOCKING(1/20:44)</b>   |   |   |   |
|                  |        |         | D K                        | <div style="border: 1px solid black; padding: 2px;">                     E Single G2 - after MNVR complete<br/>                     Step 3: √MCC or pause - 3 min (DAP settling)<br/>                     DAP: as req'd                 </div> |   |   |   |
| 21:00            |        |         |                            | MNVR (TRK) BIAS -XLV -ZVU<br>TGT=2 BV=5 P=163 Y=0 OM=167<br>Init TRK, DAP:FREE > 2 sec, then<br>DAP: A12/AUTO/VERN   | JOINT OPS: 6.109 HARDLINE ICOM AUDIO<br>Steps 1,5,6   | POST DOCKING HATCH LEAK CHECK<br>(RNDZ, APDS)   |   |
| 07:00            |        |         |                            | PRIOR PWRDN GRP B (ORB PKT, PRIOR PWRDN)<br>Steps 5,6([E]) & 12 (IMU 2 STBY)<br>06 S TRK PWR -Z - OFF  | PRIOR PWRDN GRP B (ORB PKT, PRIOR PWRDN)<br>Steps 5,6([E]) & 12 (IMU 2 STBY)<br>06 S TRK PWR -Z - OFF   | AIRLOCK PREP FOR INGRESS - AIRLOCK FAN<br>ACTIVE<br>(RNDZ, APDS)  | UPLINK<br>β21 + Mask<br>Box 20,21,22            |
|                  |        |         |                            | SSV OUTFATE - 2  | When ISS is GO for deadband collapse, DAP:B13   |   |   |
| 22:00            |        |         | B I A S                    | JOINT OPS: 2.104 HATCH OPENING AND SHUTTLE/ISS DUCT INSTALL<br>Perform steps 2-11, 14, & 15<br>√MCC-H complete with step 1   | DAP RECONFIG [F]  | JOINT OPS: 2.104 HATCH OPENING AND SHUTTLE/ISS DUCT INSTALL<br>Perform steps 2-11, 14, & 15<br>√MCC-H complete with step 1  | TFL 184<br>NO EXERCISE DURING DEADBAND COLLAPSE |
| 08:00            |        |         | - X L V                    |  | <div style="border: 1px solid black; padding: 2px;">                     F When ISS is GO for att, control, DAP: FREE<br/>                     Then return to DAP A, √A12/FREE/VERN<br/>                     Reconfig DAP B to B12                 </div> |   |   |
|                  |        |         | - Z V V                    | WELCOME  | WELCOME   | WELCOME   |   |
| 23:00            |        |         |                            | SAFETY BRIEFING  | SAFETY BRIEFING   | SAFETY BRIEFING   |   |
| 09:00            |        |         |                            | POST-DOCKING EVA TRANSFER & RECONFIG (EVA, AIRLOCK CONFIG)   | OBSS GRAPPLE FROM SSRMS (PDRS, OBSS NOMINAL) Steps 1-2  | OBSS GRAPPLE FROM SSRMS (PDRS, OBSS NOMINAL) Steps 1-2  |   |
|                  |        |         |                            |  | SSPTS ODS CONNECTOR VERIF<br>A15 ODS MATE X1,X2 (two) - ON<br>√MCC then - OFF   |   |   |
|                  |        |         |                            | TRANSFER OPS<br>Ref. Transfer List   | SSPTS OPCU ACT [G]  | <div style="border: 1px solid black; padding: 2px;">                     G SSPTS OPCU ACT<br/>                     On MCC GO:A15 OPCU 1,2 CONV(two) - ON<br/>                     R1 MN BUS TIE B - ON(tb-ON)<br/>                     C - ON(tb-ON)                 </div> |   |
| 00:00            |        |         |                            |  | OBSS GRAPPLE FROM SSRMS (PDRS, OBSS NOMINAL) Steps 3-5  | OBSS GRAPPLE FROM SSRMS (PDRS, OBSS NOMINAL) Steps 3-5  |   |

# STS-130 FD03

| GMT            | TDRS<br>W E Z | MET<br>Day 001 | S<br>T<br>S<br>A<br>T<br>I | MS2<br>ROBINSON  | MS3<br>PATRICK  | MS4<br>BEHNKEN  | Notes   |
|----------------|---------------|----------------|----------------------------|--|---|---|---|
| 02/09<br>(040) |               |                |                            |  |   |   |   |
| 06:00          |               |                | RNDZ                       | APPROACH<br>(RNDZ, CUE_CARD)   | P/TV02 DOCK<br>(PHOTO/TV, SCENES)<br>Perform OPS  | APPROACH<br>(RNDZ, CUE_CARD)  |   |
|                |               |                |                            | <b>RETURN TO FLIGHT PLAN</b>   |   |   |   |
| 07:00          |               |                | DK                         | POST DOCKING HATCH LEAK CHECK<br>(RNDZ, APDS)                                      | P/TV04 INGRESS/EGRESS (PHOTO/TV, SCENES)<br>P/TV02 Deact Step 2 FD steps only<br>Airlock Prep steps as shown<br>P/TV02 Deact Step 2 ODS steps<br>P/TV04 Setup | POST RNDZ PGSC CONFIG<br>Configure PGSCs per usage chart                            |   |
|                |               |                |                            | POST RNDZ PGSC CONFIG<br>Configure PGSCs per usage chart                           | AIRLOCK PREP FOR INGRESS - AIRLOCK FAN<br>ACTIVE<br>(RNDZ, APDS)  | POST RNDZ PGSC CONFIG<br>Configure PGSCs per usage chart                            |   |
| 08:00          |               |                | IAS                        | WLES DOCK/UNDK RECOVERY (ORB OPS, WLE SNSRS)<br>JOINT OPS: 6.107 PCS SETUP-SHUTTLE | P/TV04 INGRESS/EGRESS (PHOTO/TV, SCENES)<br>Perform OPS   | JOINT OPS: 6.107 PCS SETUP-SHUTTLE  | <b>NO<br/>EXERCISE<br/>DURING<br/>DEADBAND<br/>COLLAPSE</b> |
|                |               |                | XLV                        | WELCOME  | WELCOME   | WELCOME   |   |
| 09:00          |               |                | ZVV                        | SAFETY BRIEFING  | SAFETY BRIEFING   | SAFETY BRIEFING   |   |
|                |               |                |                            | POST-DOCKING EVA TRANSFER & RECONFIG<br>(EVA, AIRLOCK CONFIG)                      | P/TV05 ISS INTERNAL OPS (HC)<br>(PHOTO/TV, SCENES) Perform SETUP  | POST-DOCKING EVA TRANSFER & RECONFIG<br>(EVA, AIRLOCK CONFIG)                       |   |
|                |               |                |                            | P/TV09 GLACIER<br>(PHOTO/TV, SCENES)<br>Perform SETUP & OPS                        | ROBO: 1.110 OBSS UNBERTH AND HANDOFF<br>Steps 1-4.2   | 20A ASCENT SAMPLE TRANSFER FROM GLACIER<br>TO MELFI<br>REVIEW ONLY and Ref. MSG XXX |   |
| 00:00          |               |                |                            |  |   |   |   |

# STS-130 FD03

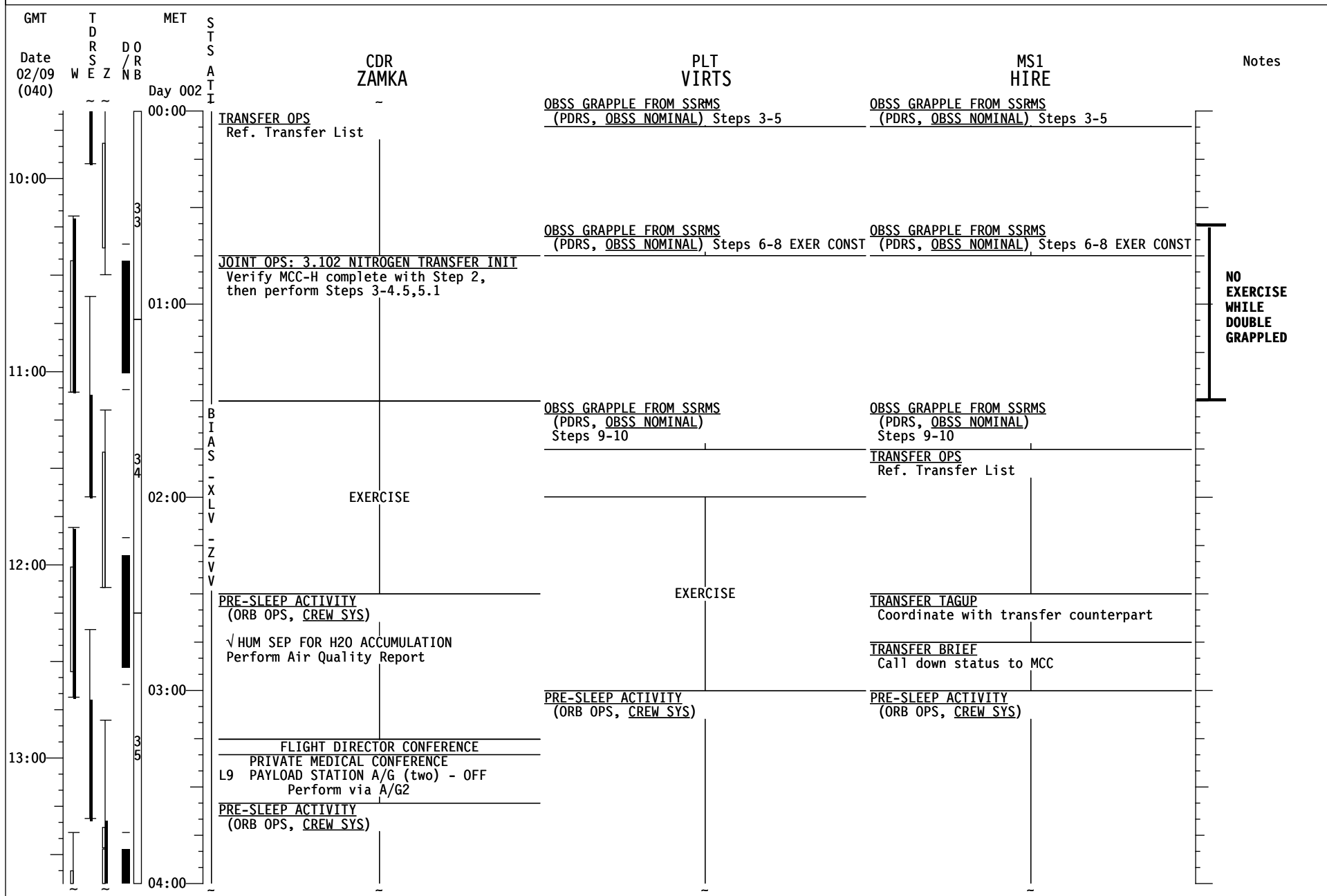



# STS-130 FD03

| GMT            | TDRS<br>W E Z | MET<br>Day 002 | S<br>T<br>S<br>A<br>T<br>I | MS2<br>ROBINSON  | MS3<br>PATRICK  | MS4<br>BEHNKEN  | Notes   |
|----------------|---------------|----------------|----------------------------|--|---|---|---|
| 02/09<br>(040) |               |                |                            | <p><u>P/TV09 GLACIER</u><br/>(PHOTO/TV, SCENES)<br/>Perform SETUP &amp; OPS</p> <p><u>SODF TRANSFER</u><br/>Ref. Transfer List &amp; MSG XXX</p> | <p><u>ROBO: 1.110 OBSS UNBERTH AND HANDOFF</u><br/>Steps 4.3-6</p>  | <p><u>20A ASCENT SAMPLE TRANSFER FROM GLACIER TO MELFI</u> Ref. MSG XXX</p>   |   |
| 10:00          |               |                |                            |  |   | <p><u>GLACIER CONFIG FOR DESCENT (ASSY OPS,CC)</u></p>  |   |
|                |               |                |                            | <p><u>PLAYBACK (DIGITAL) DOCKING</u><br/>(PHOTO/TV, CUE CARD)<br/>KU TDRW: (00:47-01:27)</p>   | <p><u>ROBO: 1.110 OBSS UNBERTH AND HANDOFF</u><br/>Steps 7-9<br/>EXERCISE CONSTRAINT</p>  |   | <b>NO<br/>EXERCISE<br/>WHILE<br/>DOUBLE<br/>GRAPPLD</b> |
| 11:00          |               |                |                            | <p><u>TRANSFER OPS</u><br/>Ref. Transfer List</p>  |   | <p><u>PAYLOADS CC (ASSY OPS,CC) GLACIER</u></p>   |   |
|                |               |                |                            |  | <p><u>EVA SYSTEMS: 1.305 EQUIPMENT LOCK PREP</u><br/>Steps 1-3 already complete</p>   | <p><u>EVA SYSTEMS: 1.305 EQUIPMENT LOCK PREP</u><br/>Steps 1-3 already complete</p>   |   |
| 12:00          |               |                |                            | <p><u>PRE-SLEEP ACTIVITY</u><br/>(ORB OPS, CREW SYS)</p>   | <p><u>EVA SYSTEMS: 1.307 REBA INSTALLATION</u><br/>Verify LiOH S/Ns with MCC<br/>Ref.STS-130 Consumables Tracking CC(EVA)</p> <p><u>EVA SYSTEMS: 1.403 REBA POWERED HARDWARE CHECKOUT</u></p> | <p><u>EVA SYSTEMS: 1.307 REBA INSTALLATION</u><br/>Verify LiOH S/Ns with MCC<br/>Ref.STS-130 Consumables Tracking CC(EVA)</p> <p><u>EVA SYSTEMS: 1.403 REBA POWERED HARDWARE CHECKOUT</u></p> |   |
| 13:00          |               |                |                            |  | <p><u>PRE-SLEEP ACTIVITY</u><br/>(ORB OPS, CREW SYS)</p>  | <p><u>PRE-SLEEP ACTIVITY</u><br/>(ORB OPS, CREW SYS)</p>  |   |
| 04:00          |               |                |                            |  |   |   |   |

# STS-130 FD03

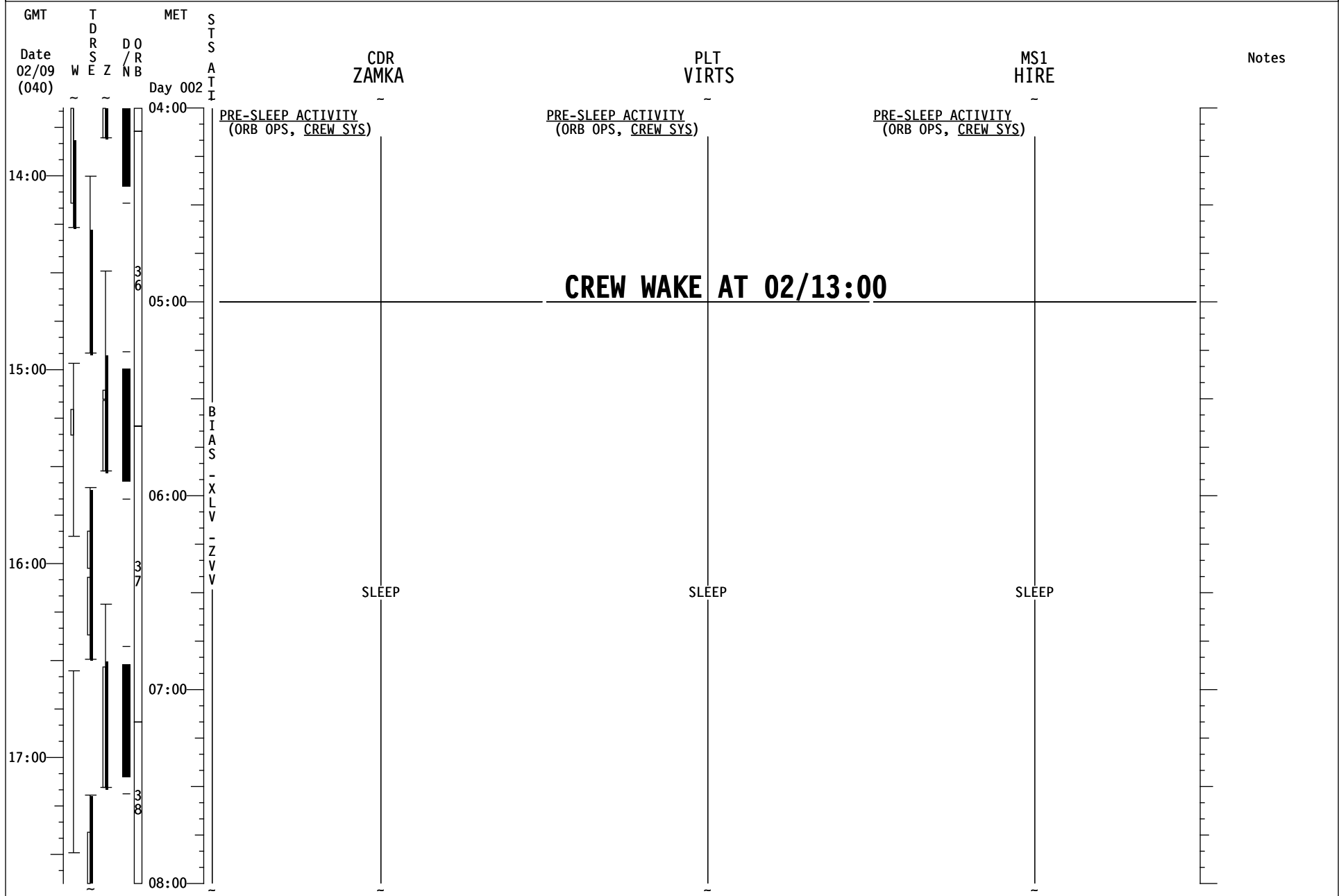

# STS-130 FD03

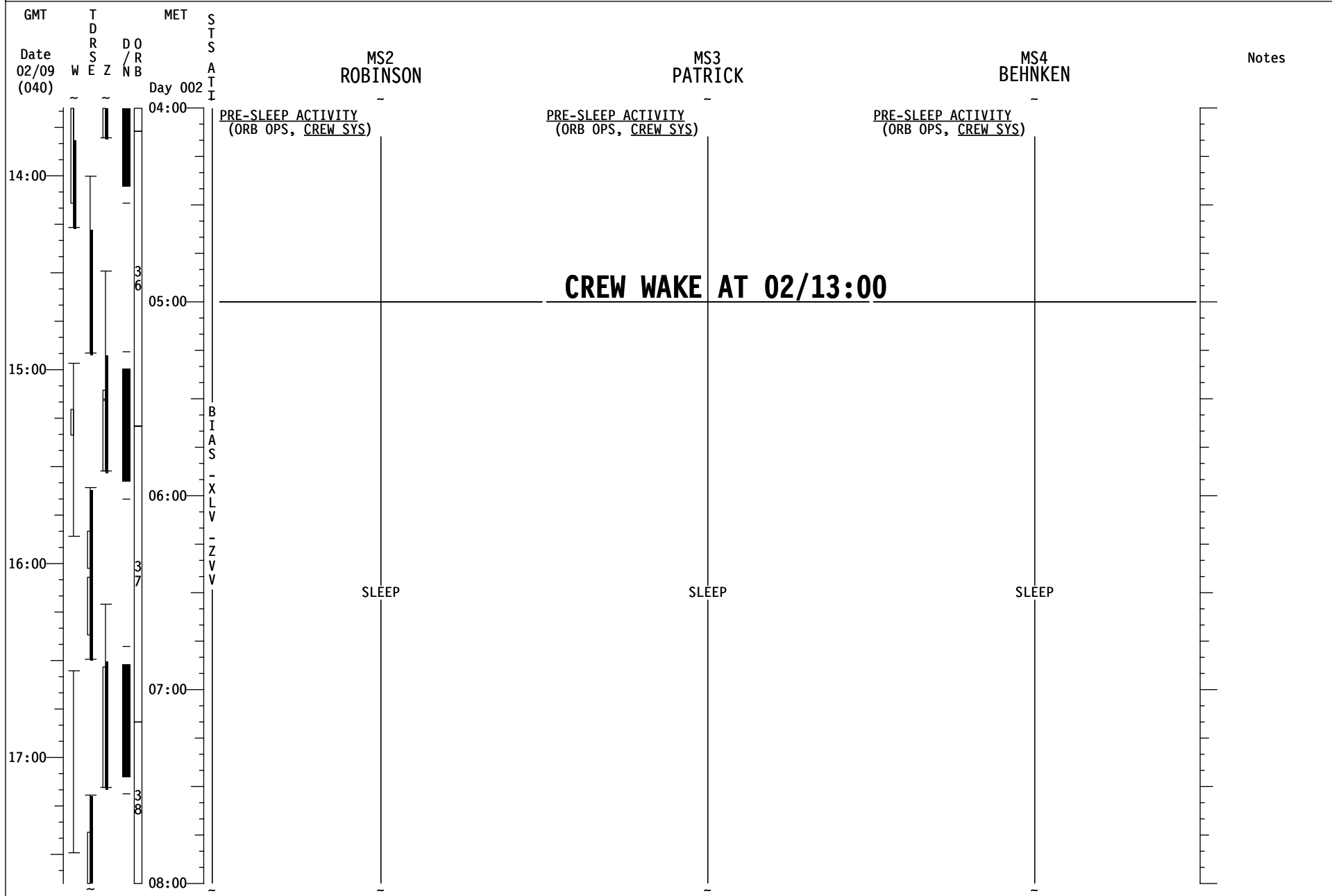

# STS-130 FD03

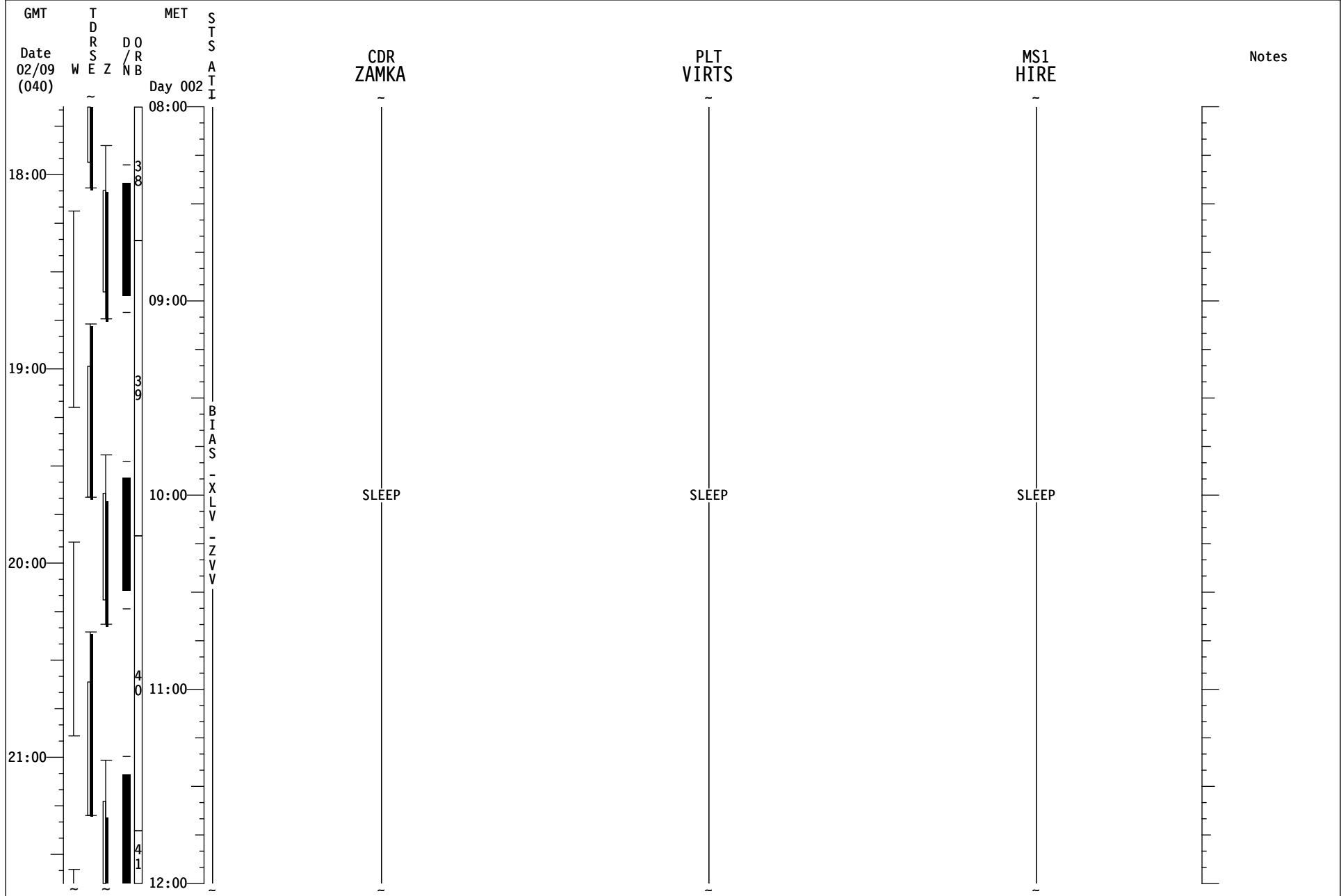

# STS-130 FD03

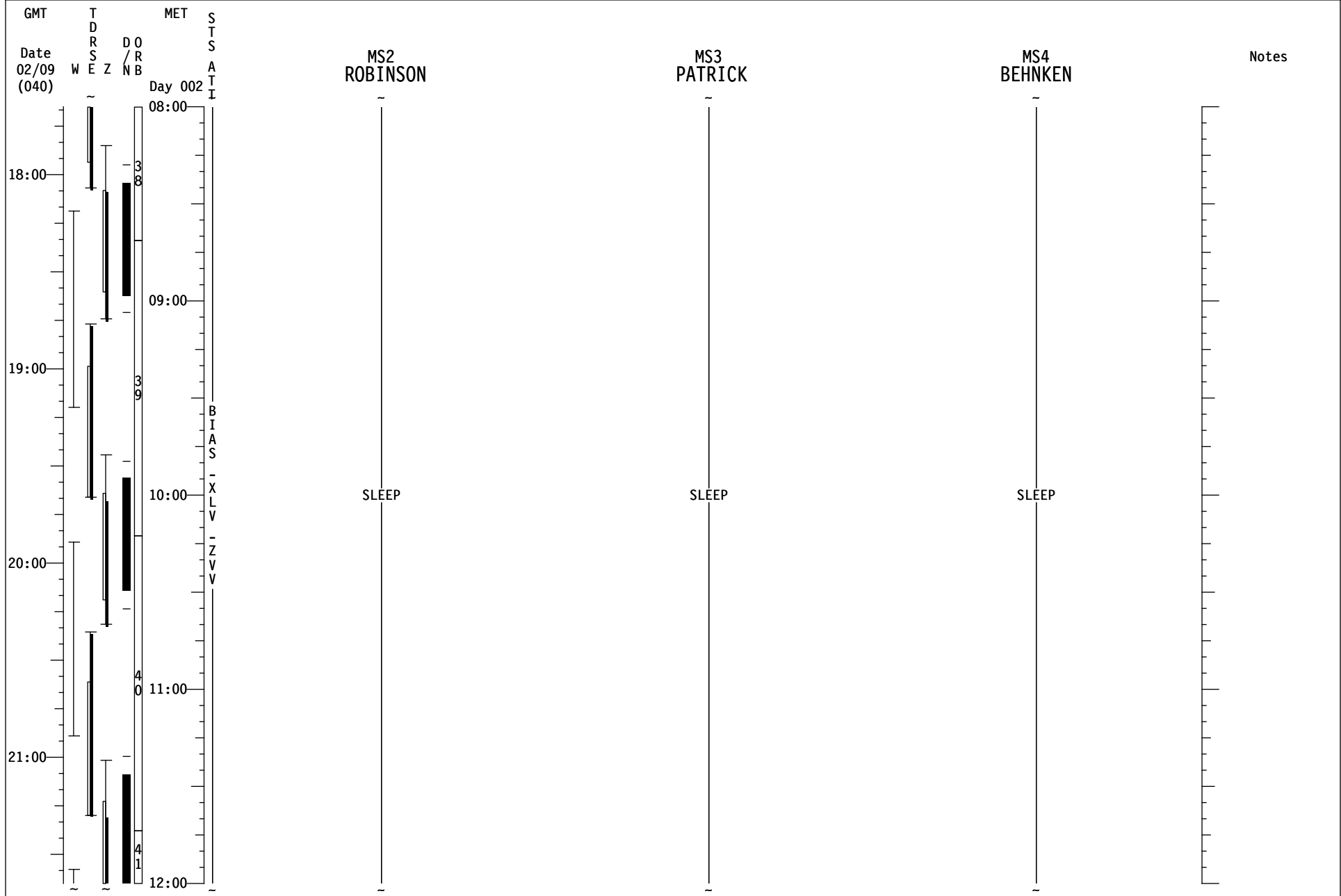

# STS-130 FD04

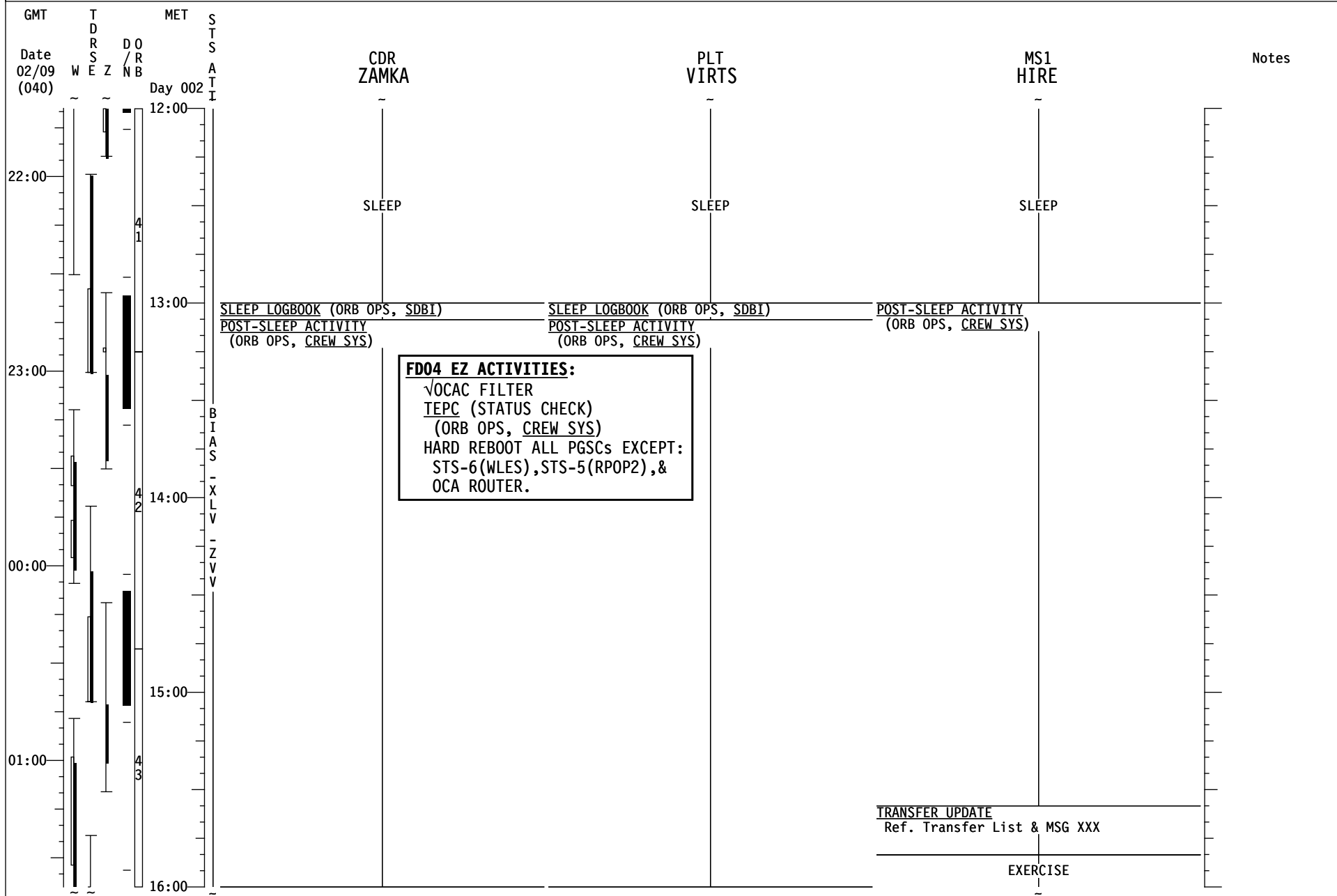

# STS-130 FD04

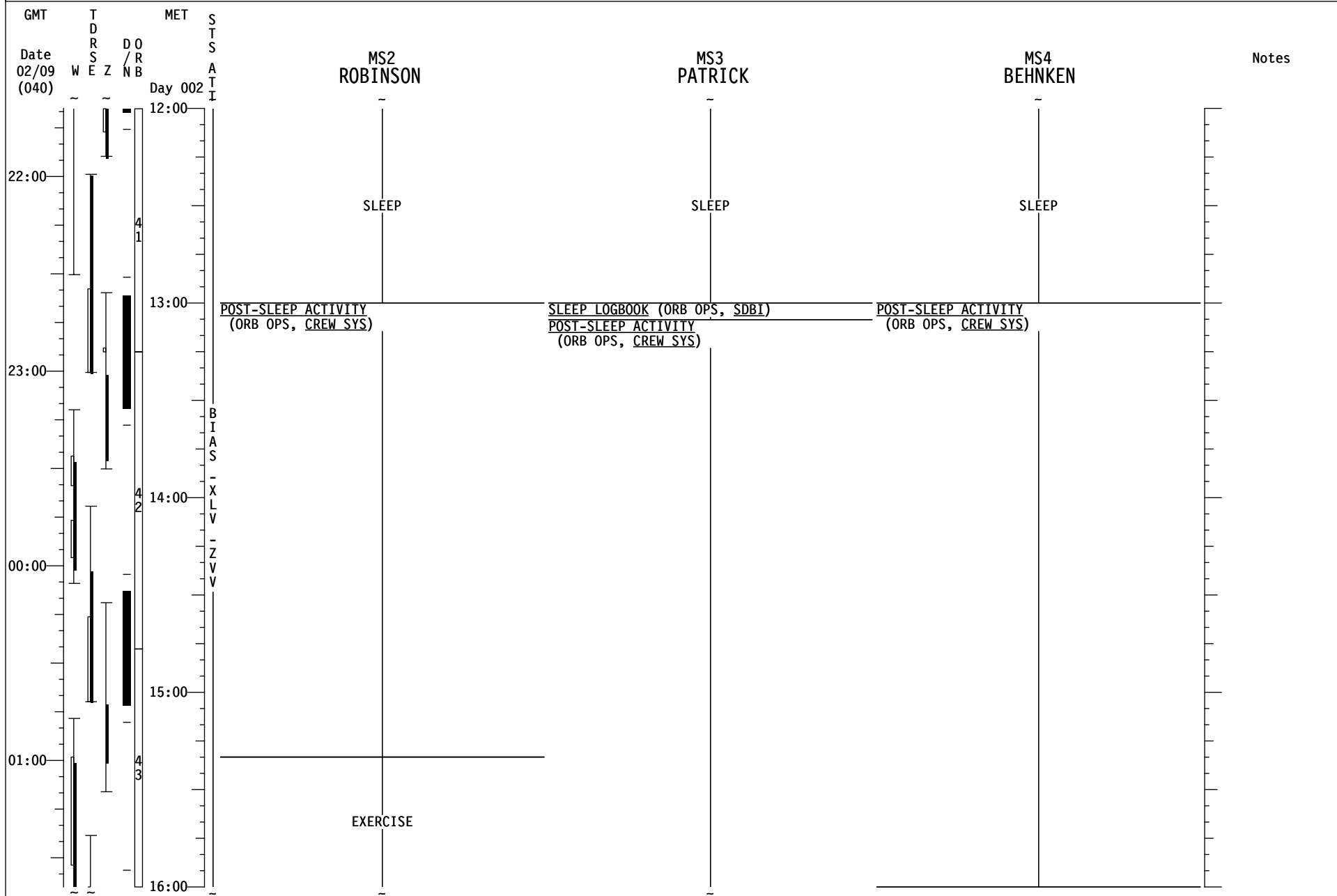

# STS-130 FD04

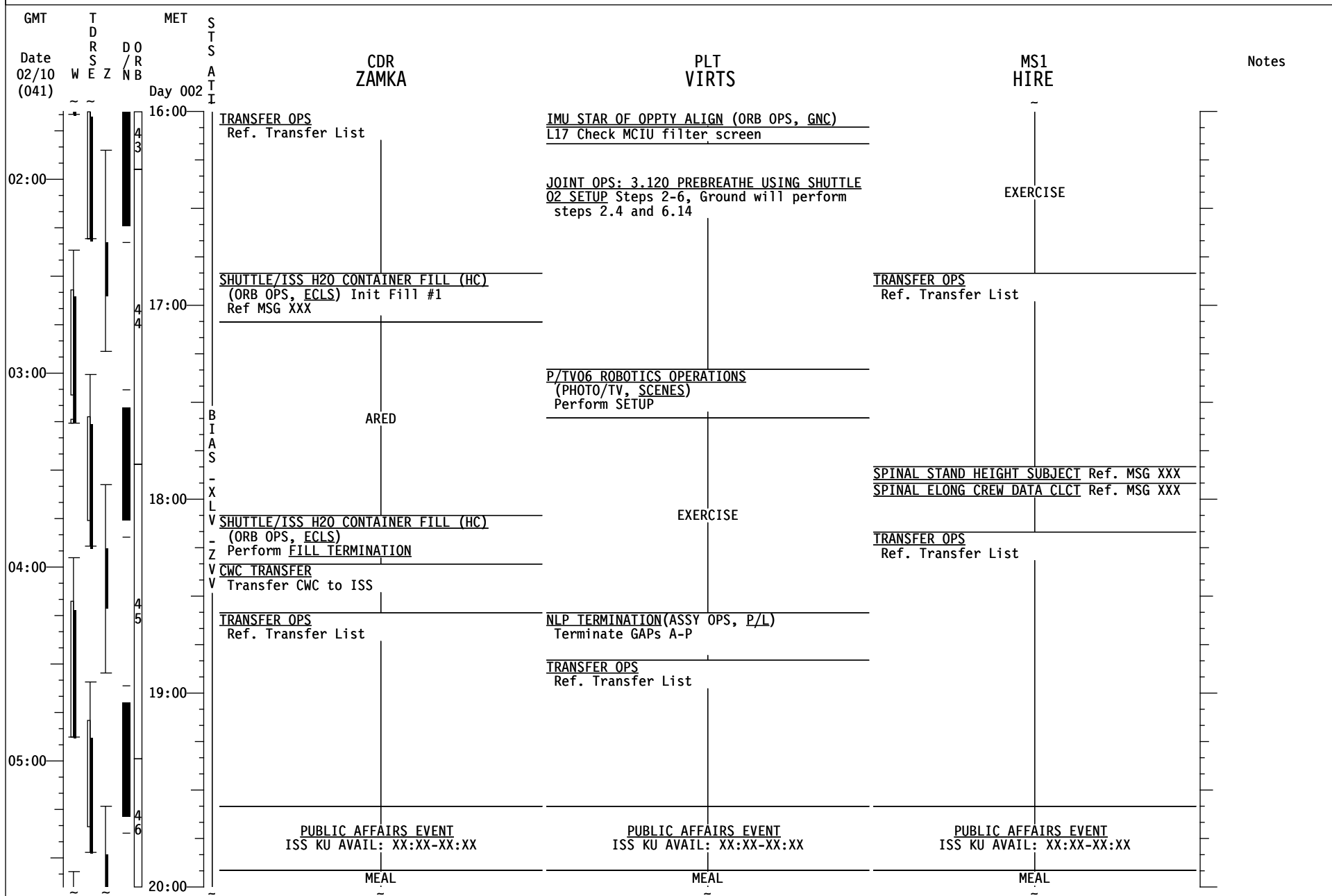



# STS-130 FD04

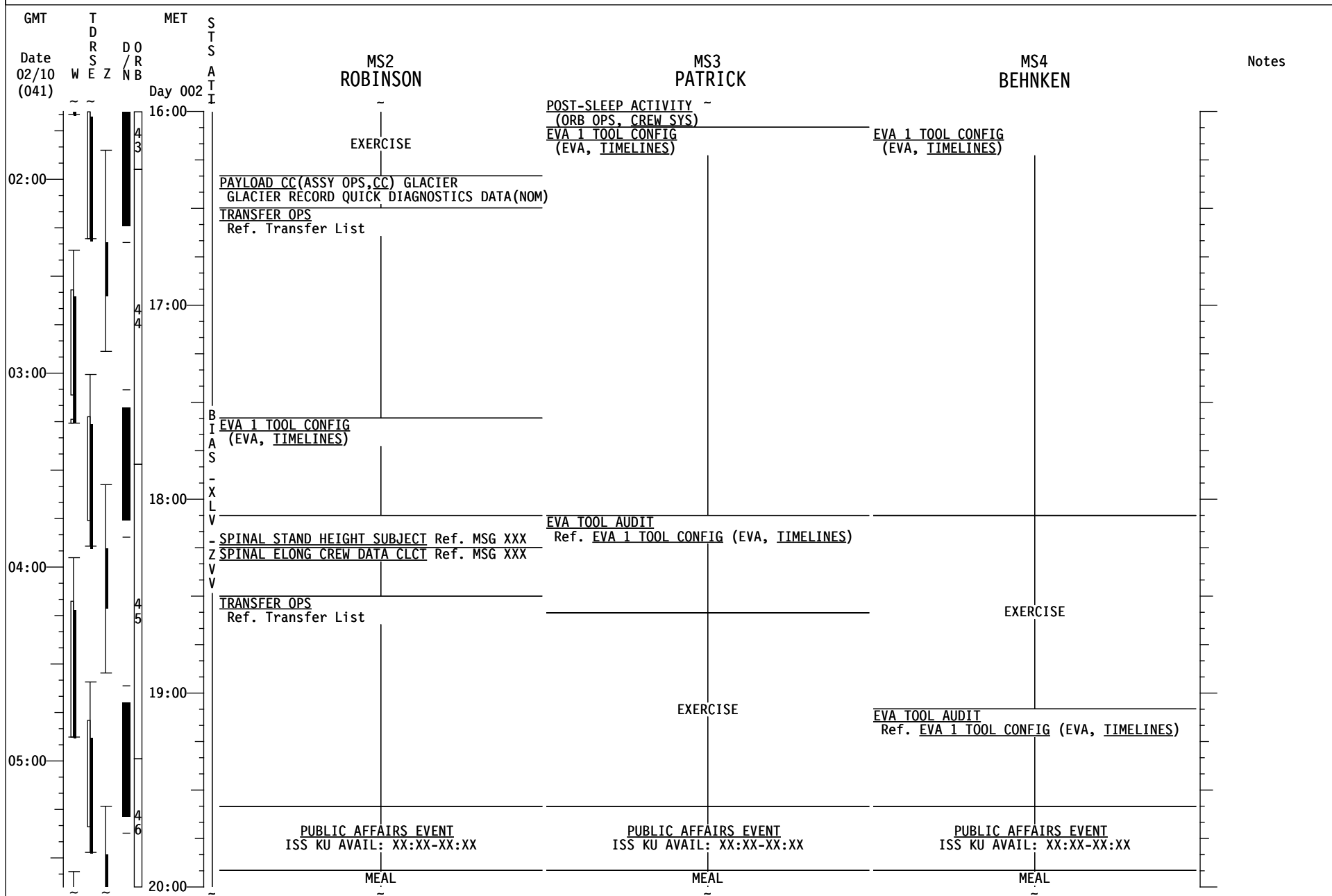

# STS-130 FD04

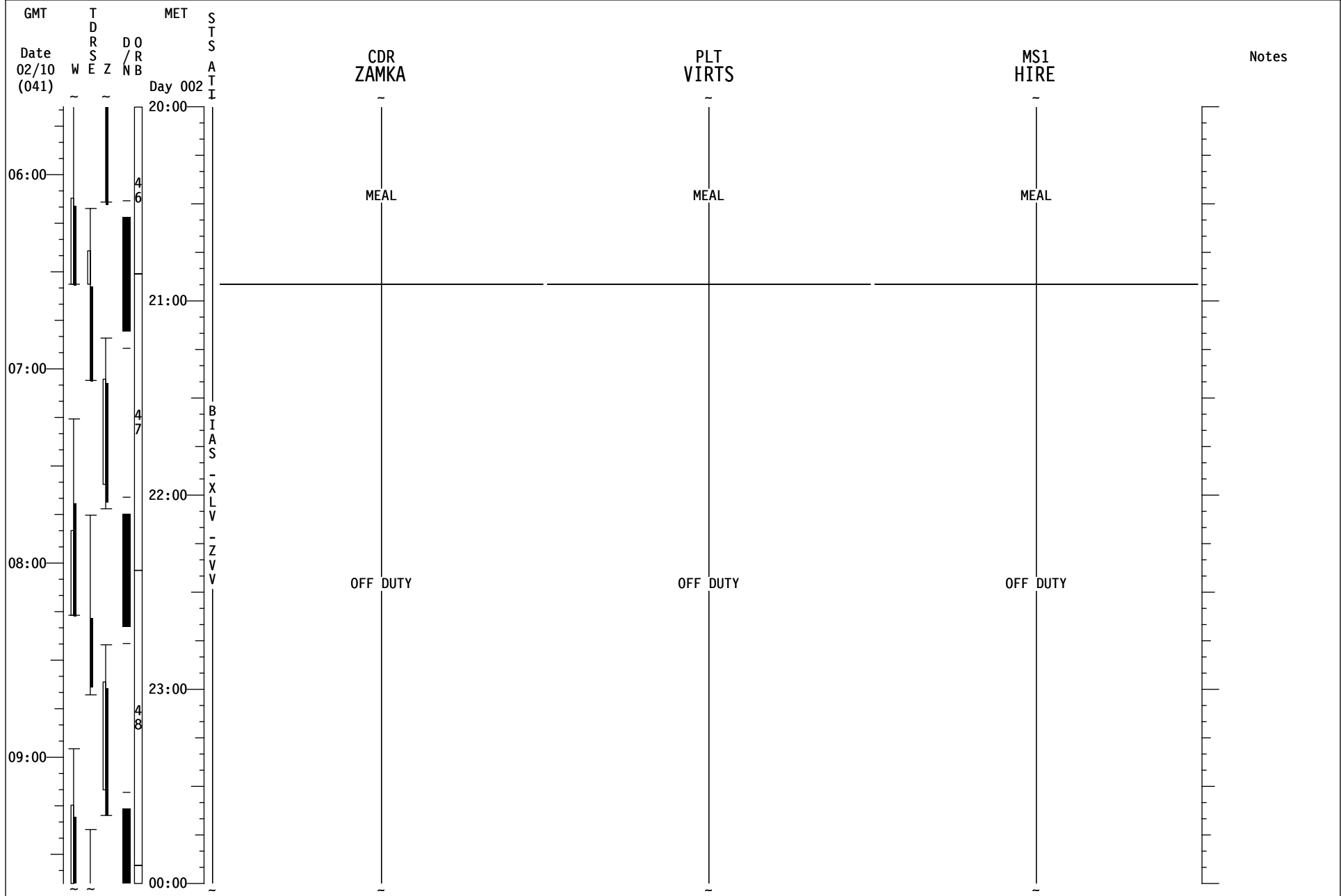

# STS-130 FD04

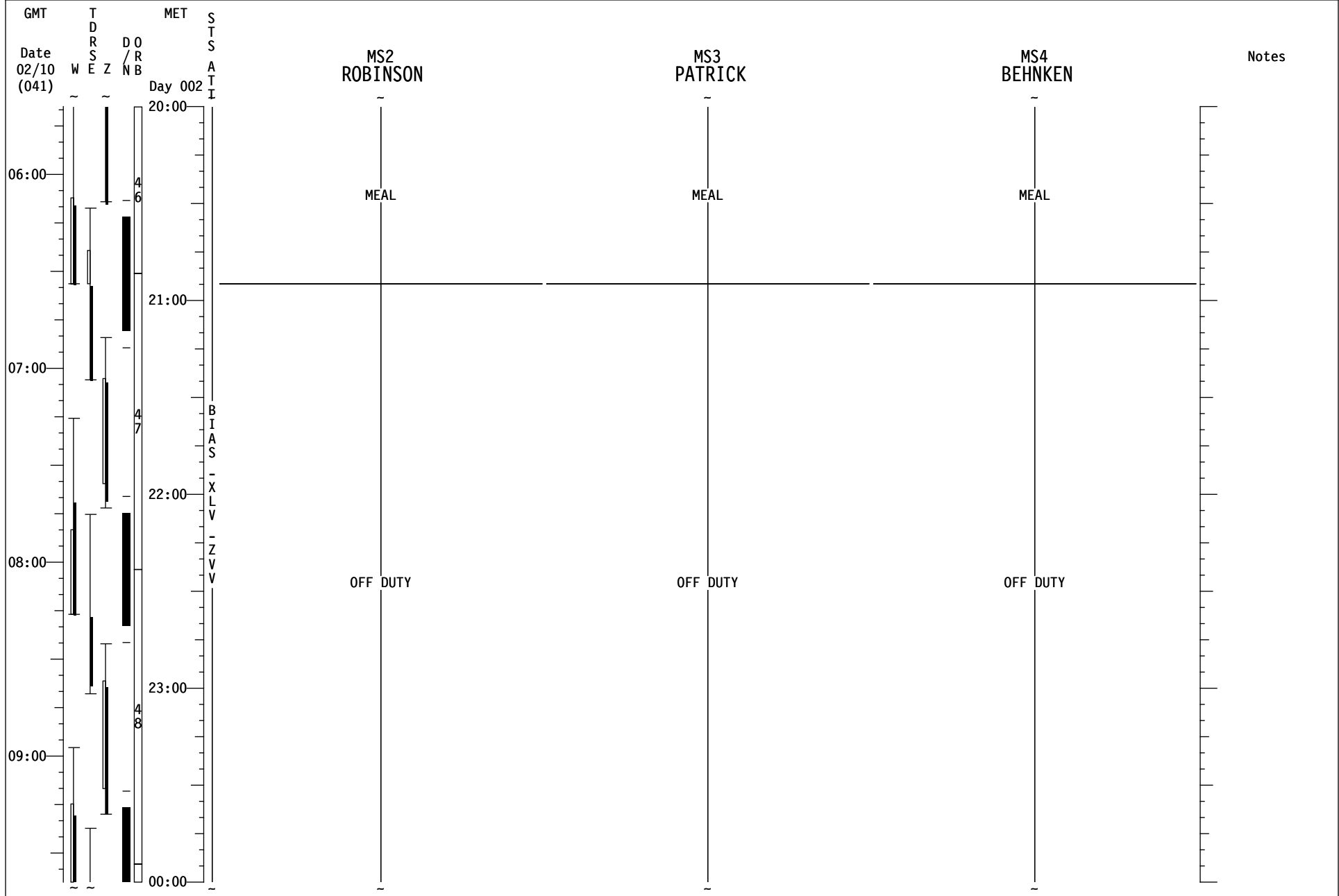

# STS-130 FD04

| GMT              | TDRS<br>W E Z | MET<br>Day 003 | S<br>T<br>S<br>A<br>T<br>I | CDR<br>ZAMKA  | PLT<br>VIRTS   | MS1<br>HIRE  | Notes |
|------------------|---------------|----------------|----------------------------|---|--|--|-------|
| Date 02/10 (041) |               |                |                            |   |  |  |       |
| 00:00            |               |                |                            | OFF DUTY  | OFF DUTY   | OFF DUTY   |       |
| 10:00            |               |                |                            |   |  |  |       |
| 11:00            |               |                |                            | <u>EVA PROCEDURE REVIEW</u><br>Ref. <u>EVA 1 BRIEFING CARD</u><br>(EVA, <u>TIMELINES</u> )  | <u>EVA PROCEDURE REVIEW</u><br>Ref. <u>EVA 1 BRIEFING CARD</u><br>(EVA, <u>TIMELINES</u> ) | <u>EVA PROCEDURE REVIEW</u><br>Ref. <u>EVA 1 BRIEFING CARD</u><br>(EVA, <u>TIMELINES</u> ) |       |
| 12:00            |               |                |                            | <u>X CSA-02 READINGS</u><br>L Report CSA-02 readings to MCC-H prior to<br>Campout Hatch Closure.  | <u>PRE-SLEEP ACTIVITY</u><br>(ORB OPS, <u>CREW SYS</u> )                                   | <u>TRANSFER TAGUP</u><br>Coordinate with transfer counterpart                              |       |
|                  |               |                |                            | <u>PRE-SLEEP ACTIVITY</u><br>(ORB OPS, <u>CREW SYS</u> )  |  | <u>TRANSFER BRIEF</u><br>Call down status to MCC   |       |
| 13:00            |               |                |                            | <u>FLIGHT DIRECTOR CONFERENCE</u><br><u>PRIVATE MEDICAL CONFERENCE</u><br>L9 <u>PAYLOAD STATION A/G (two) - OFF</u><br>Perform via A/G2 |  | <u>PRE-SLEEP ACTIVITY</u><br>(ORB OPS, <u>CREW SYS</u> )                                   |       |
| 04:00            |               |                |                            | <u>EVA SYSTEMS: 1.206 10.2 PSIA CAMPOUT MASK</u><br><u>PREBREATHE Steps 1-16</u><br>Ref. <u>STS-130 Consumables Tracking CC(EVA)</u>    |  |  |       |

# STS-130 FD04

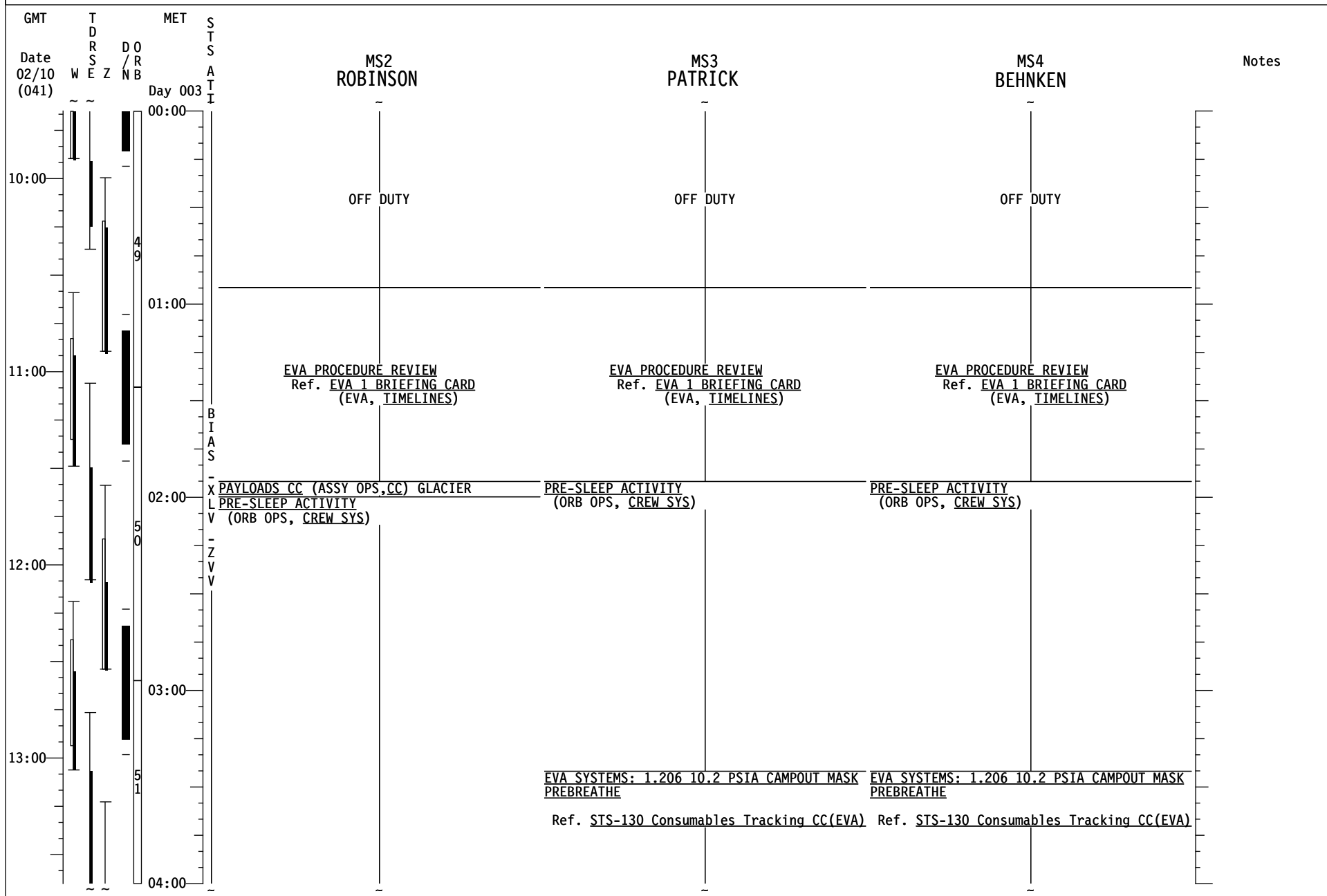

# STS-130 FD04

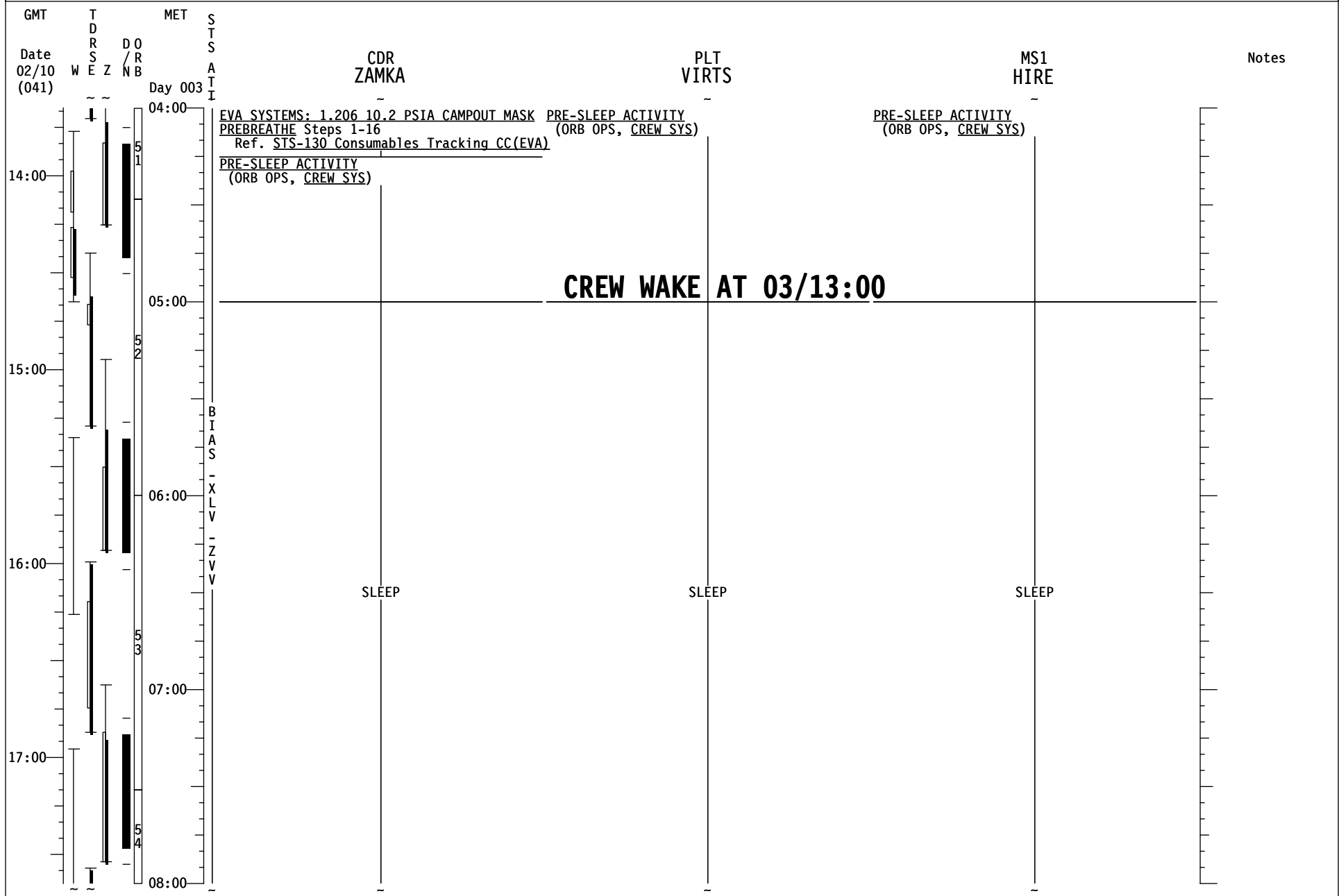

# STS-130 FD04

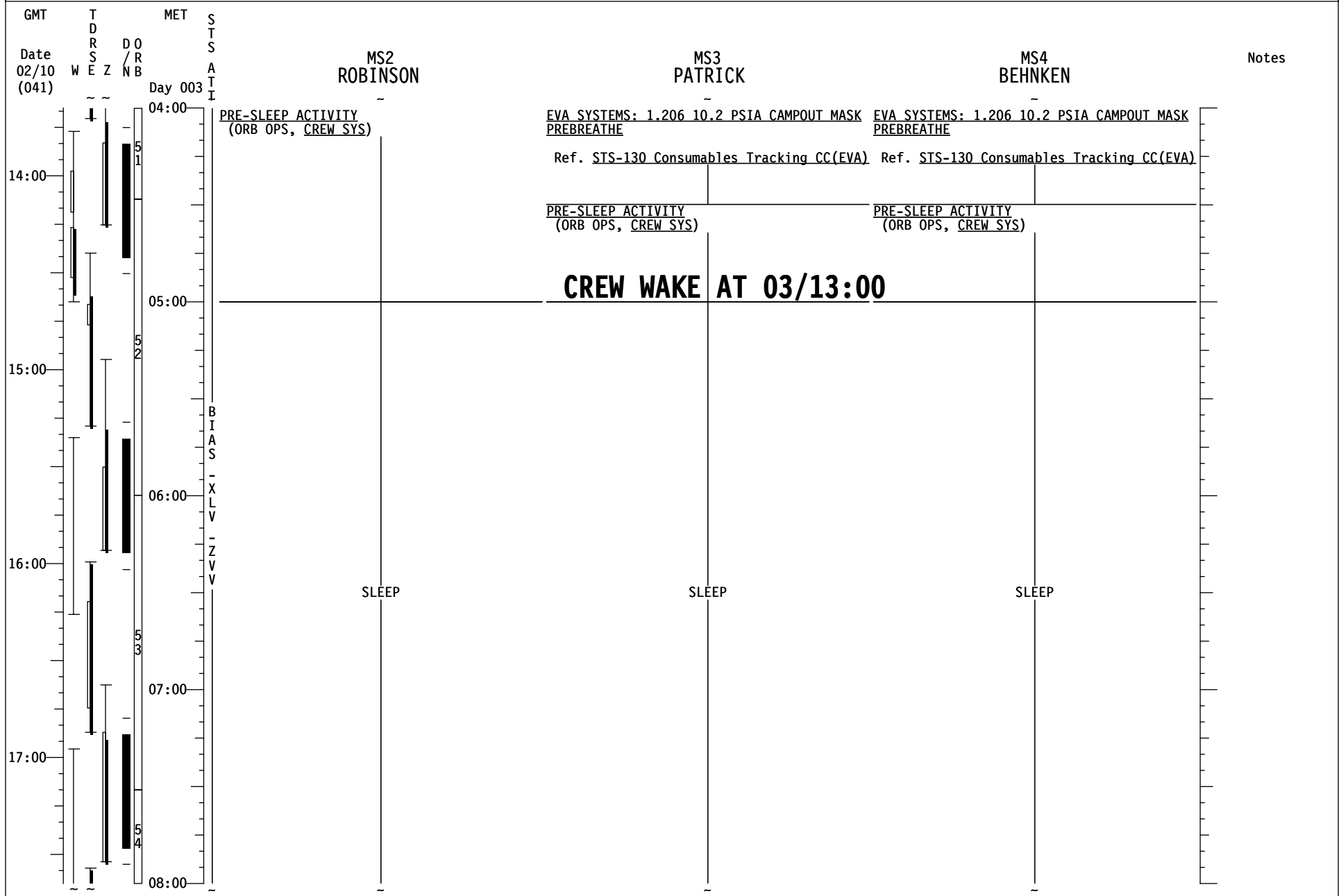

# STS-130 FD04

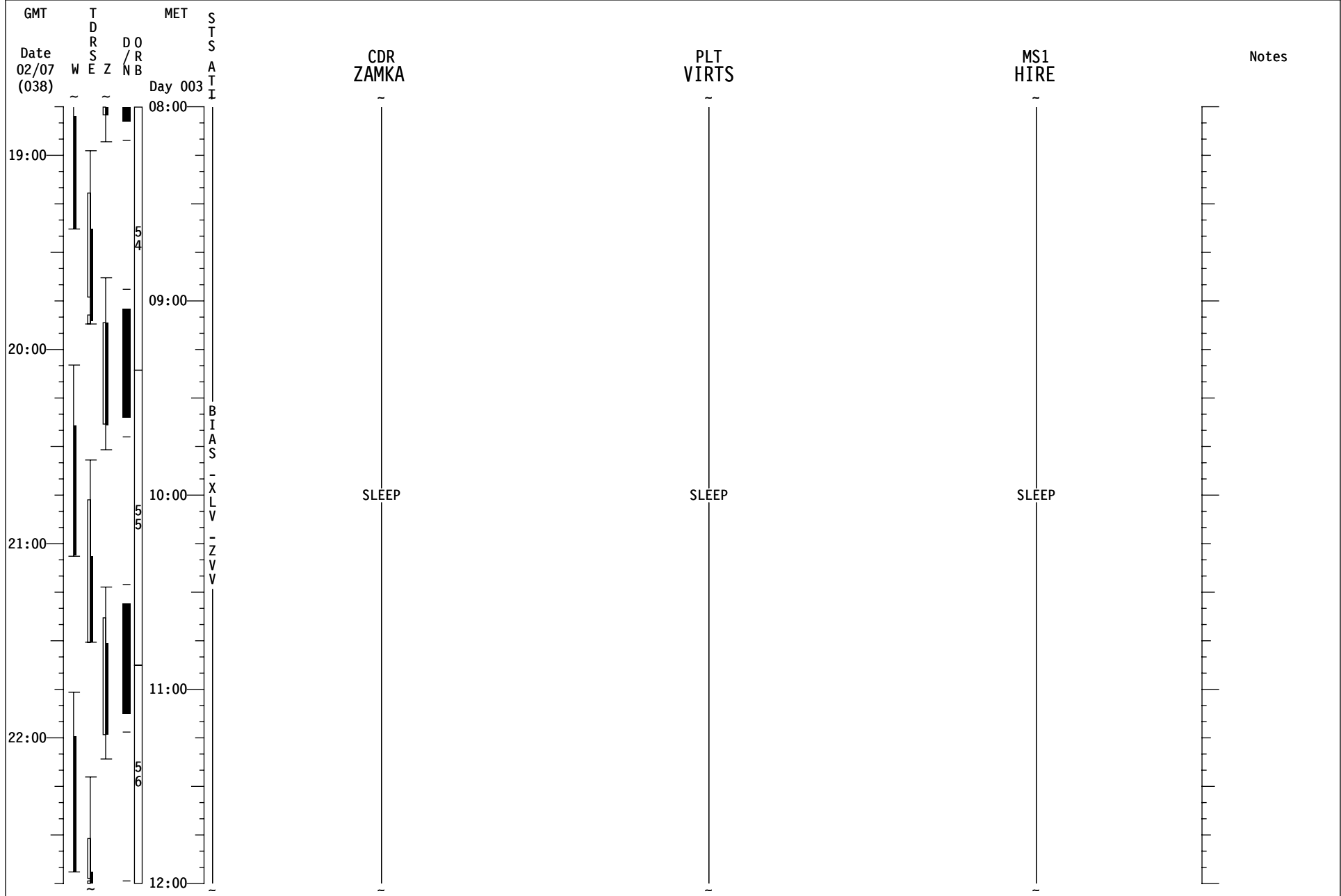



# STS-130 FD04

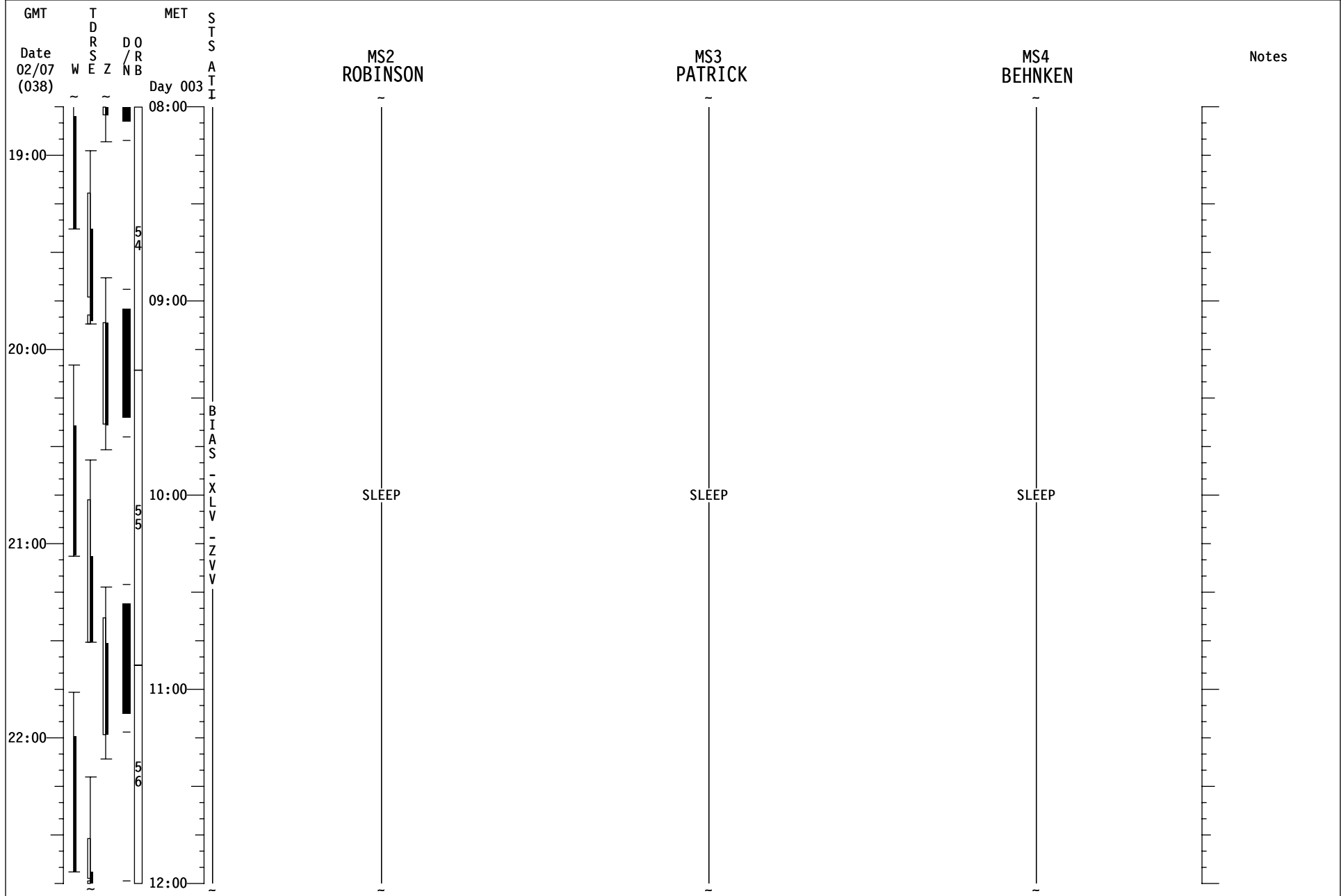

# STS-130 FD05

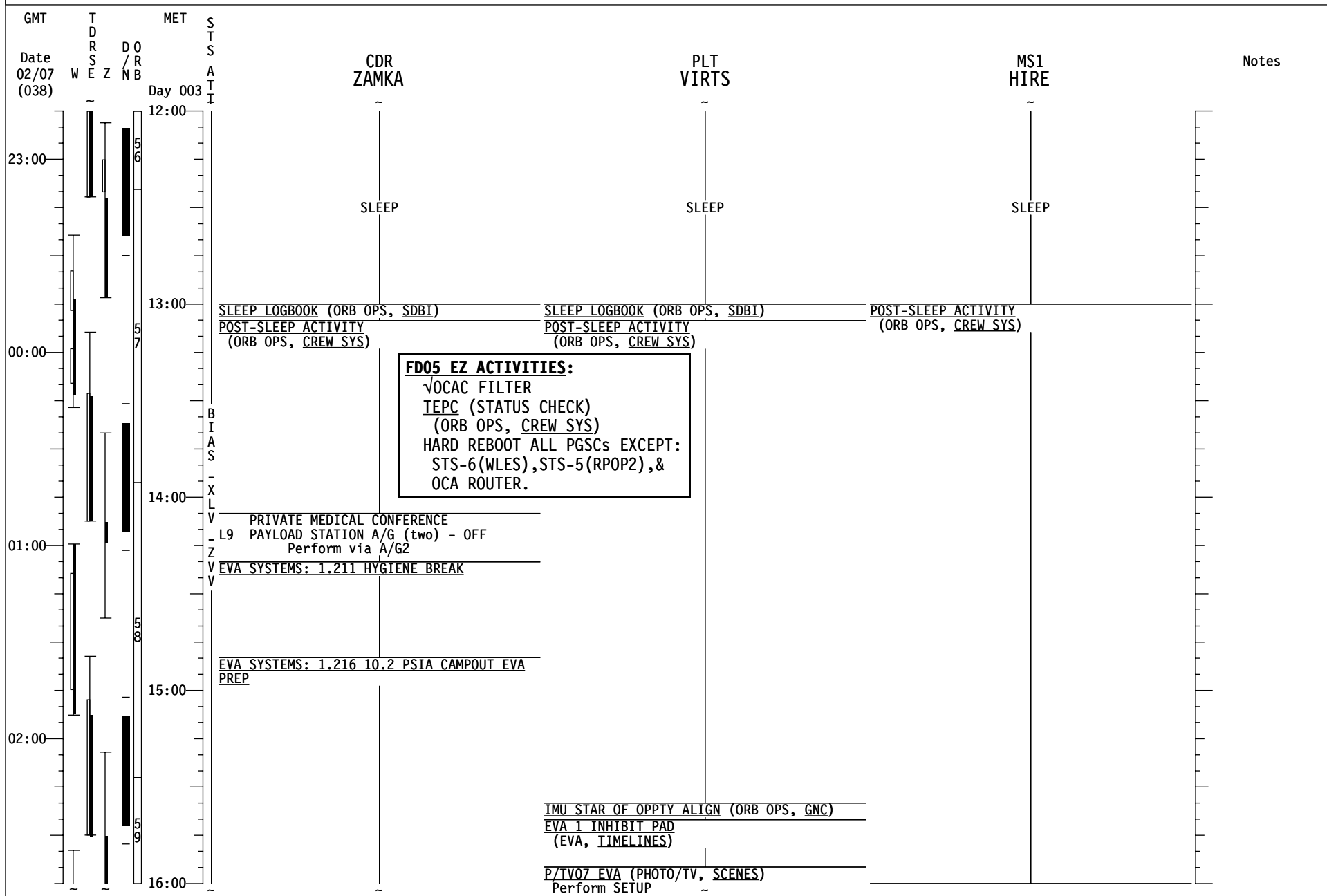

# STS-130 FD05

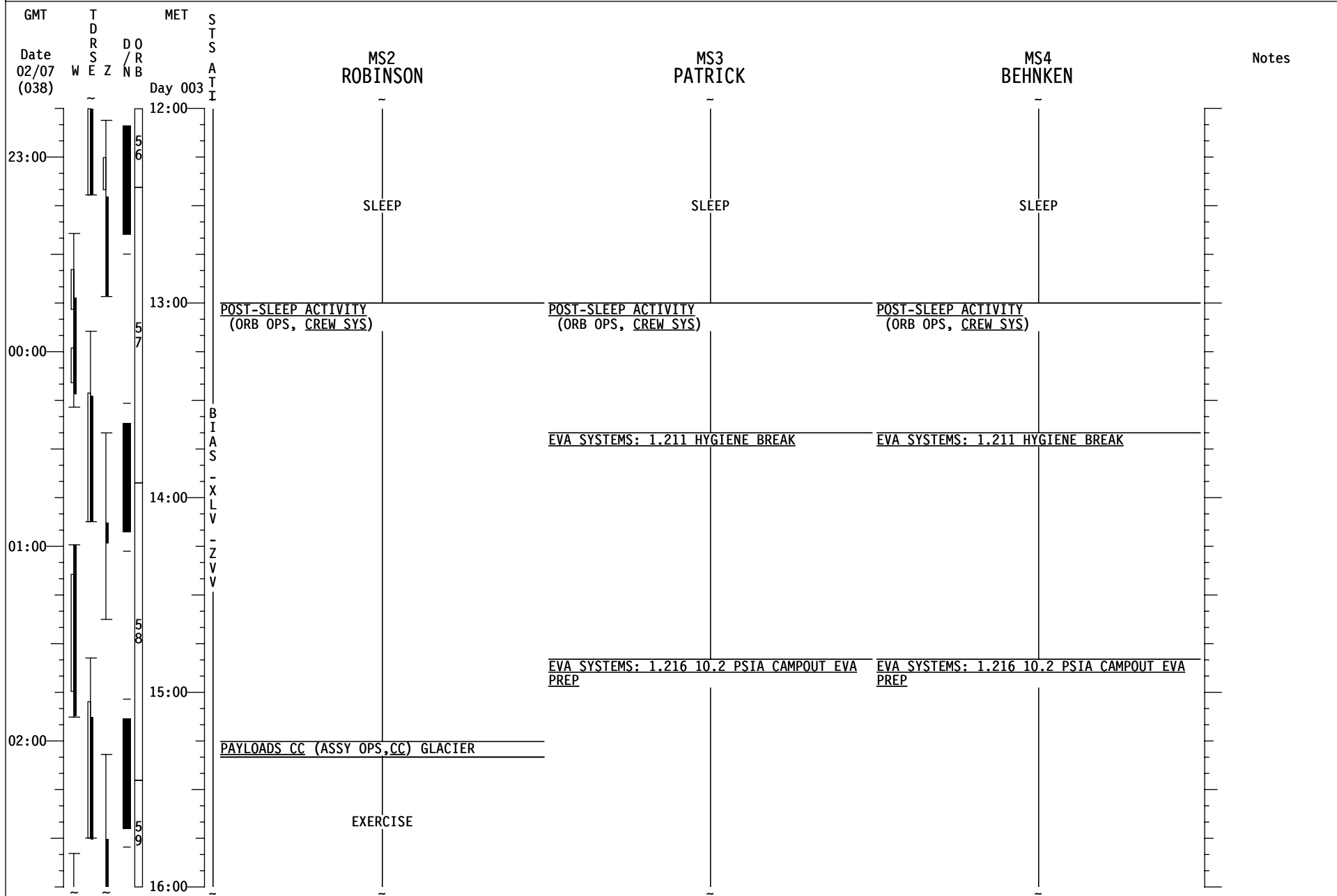

# STS-130 FD05

| GMT              | TDRSEZ | MET     | SATS | CDR ZAMKA   | PLT VIRT5   | MS1 HIRE  | Notes  |
|------------------|--------|---------|------|---|---|---|--|
| Date 02/08 (039) | W E Z  | Day 003 | DAY  |   |   |   |  |
| 03:00            |        |         |      | EVA SYSTEMS: 1.216 10.2 PSIA CAMPOUT EVA PREP   | P/TV07 EVA (PHOTO/TV, SCENES)<br>Perform SETUP                                  | TRANSFER UPDATE<br>Ref. Transfer List & MSG XXX                                 |  |
|                  |        |         |      | EVA SYSTEMS: 1.220 EMU PURGE  |   |   |  |
|                  |        |         |      | EVA SYSTEMS: 1.225 EMU PREBREATHE   |   |   |  |
| 04:00            |        |         |      |   | ARED  | EXERCISE  |  |
|                  |        |         |      | EVA SYSTEMS: CREWLOCK DEPRESS/REPRESS (CC)  |   |   |  |
|                  |        |         |      |   | ROBO: 1.210 SSRMS BERTHED NODE 3 GRAPPLE  | ROBO: 1.210 SSRMS BERTHED NODE 3 GRAPPLE  |  |
|                  |        |         |      |   | TRANSFER OPS<br>Ref. Transfer List  | S&M: 1.403 CBCS INSTALL/REMOVAL-GEN<br>Steps 10,11.3-11.5                       |  |
| 05:00            |        |         |      | X EVA SYSTEMS: CREWLOCK POST DEPRESS (CC)<br>L N2 REPRESS INIT [A]<br>V P/TV07 EVA<br>(PHOTO/TV, SCENES)<br>Perform OPS |   | I.104 VESTIBULE OUTFITTING NOD1 TO NOD3<br>(ASSY OPS, ACT&C/Q)<br>Step 1.1      |  |
|                  |        |         |      | A N2 REPRESS USING P/L N2 VLVS<br>(ORB OPS, ECLS) Steps 1-6;<br>on MCC go, perform Step 7.<br>Work the ()s              |   | I.117 NODE 1/NODE 3 VEST PRESS & LEAK CK<br>(ASSY OPS, ACT&C/Q)<br>Steps 1-4    |  |
|                  |        |         |      | B N2 REPRESS USING P/L N2 VLVS<br>(ORB OPS, ECLS) on MCC GO,<br>perform Steps 8-14. Work the ()s                        |   | TRANSFER OPS<br>Ref. Transfer List  |  |
| 06:00            |        |         |      |   | ROBO: 1.220 SSRMS NODE 3 UNBERTH TO INSTL<br>Steps 1-13<br>EXERCISE CONSTRAINTS | ROBO: 1.220 SSRMS NODE 3 UNBERTH TO INSTL<br>Steps 1-13<br>EXERCISE CONSTRAINTS | <b>NO EXERCISE<br/>FROM PRE-INSTL<br/>UNTIL A-BOLTS<br/>COMPLETE</b> |
|                  |        |         |      | N2 REPRESS TERM (On MCC GO) [B]   |   |   |  |
| 20:00            |        |         |      | P/TV07 EVA (PHOTO/TV, SCENES)<br>Perform OPS  |   |   |  |

# STS-130 FD05

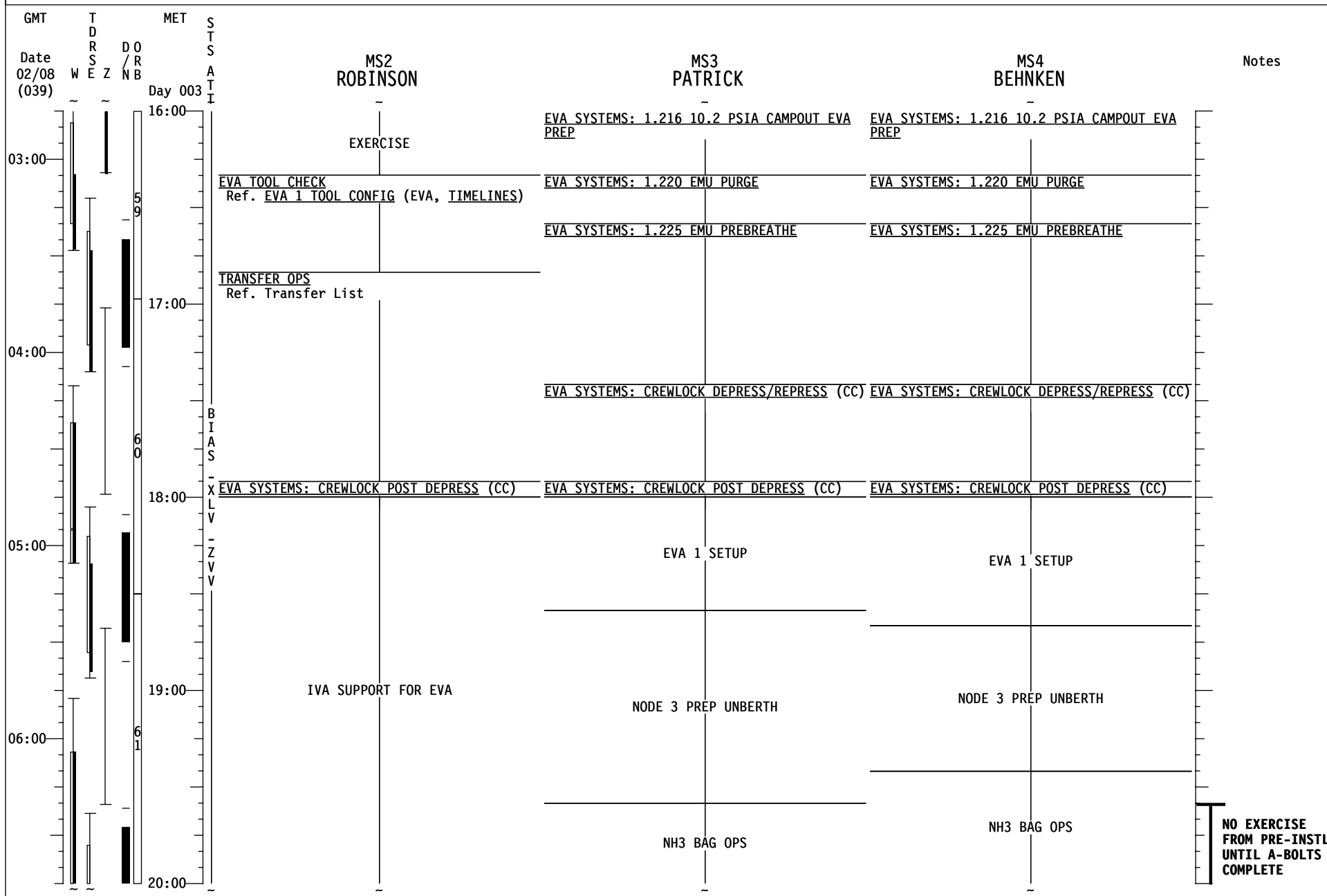

# STS-130 FD05

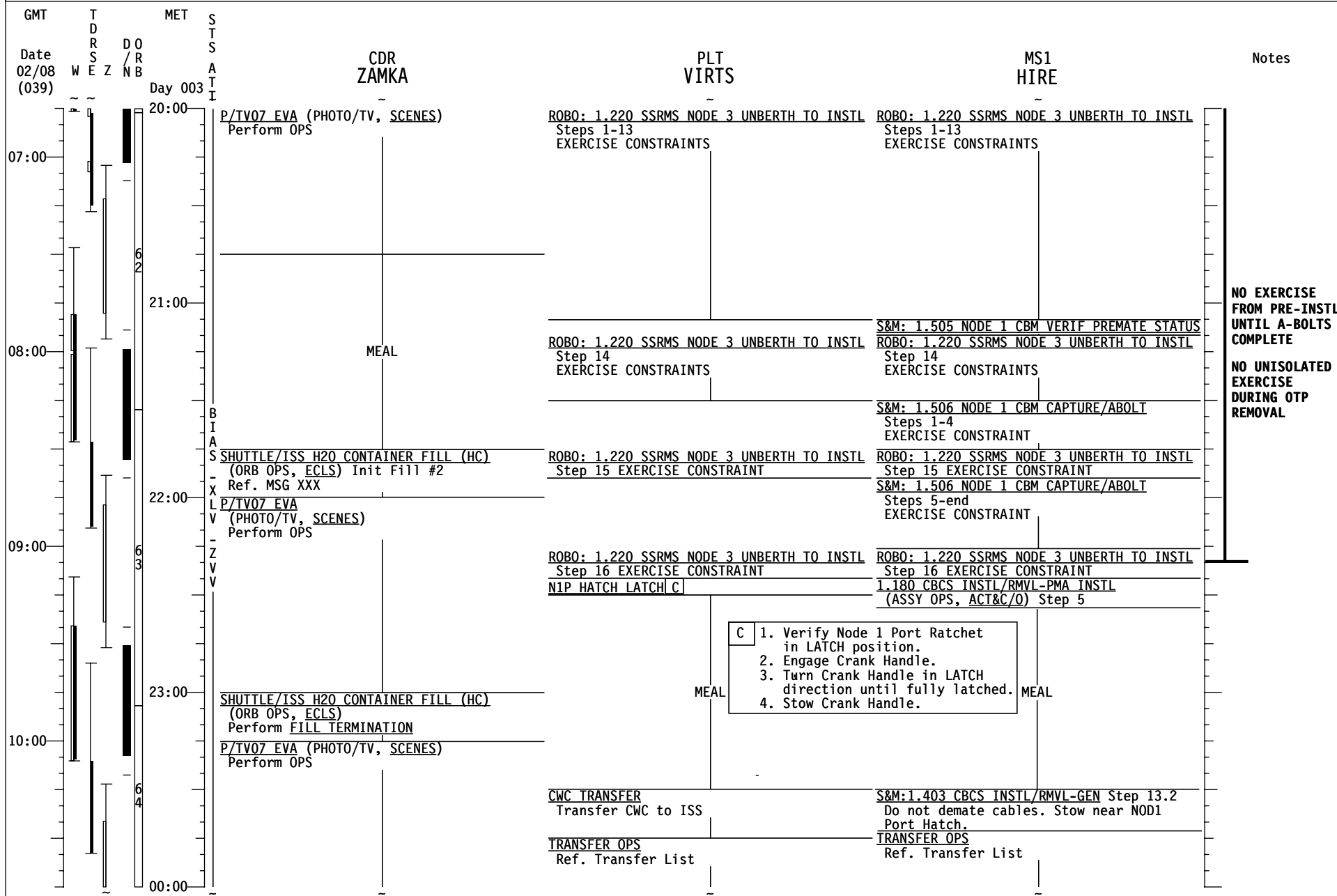

- C**

  1. Verify Node 1 Port Ratchet in LATCH position.
  2. Engage Crank Handle.
  3. Turn Crank Handle in LATCH direction until fully latched.
  4. Stow Crank Handle.

# STS-130 FD05

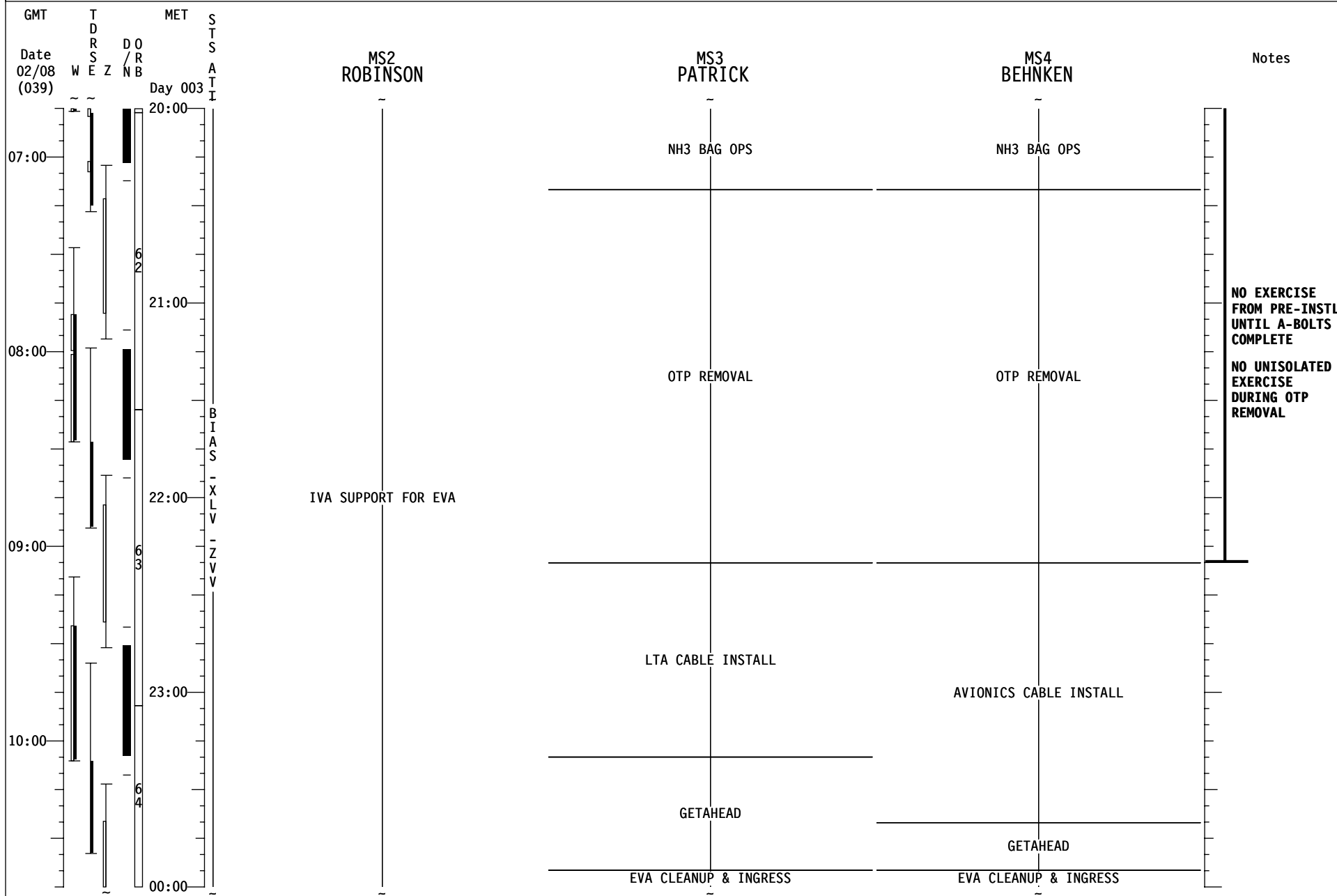

# STS-130 FD05

| GMT            | TDRS<br>W E Z | MET<br>Day 004 | S<br>T<br>S<br>A<br>T<br>I | CDR<br>ZAMKA  | PLT<br>VIRTS   | MS1<br>HIRE   | Notes   |
|----------------|---------------|----------------|----------------------------|---|--|---|---|
| 02/08<br>(039) |               |                |                            |   |  |   |   |
| 11:00          |               |                |                            | P/TV07 EVA (PHOTO/TV, SCENES)<br>Perform OPS  | <u>TRANSFER OPS</u><br>Ref. Transfer List  | <u>TRANSFER OPS</u><br>Ref. Transfer List   |   |
|                |               |                |                            | <u>EVA SYSTEMS: PRE REPRESS (CC)</u><br><u>EVA SYSTEMS: CREWLOCK DEPRESS/REPRESS (CC)</u>   |  | Verify Node 1 Port Hatch Latched, then:<br><u>1.117 NODE 1/NODE 3 VEST PRESS &amp; LEAK CK</u><br>(ASSY OPS, ACT&C/Q) Steps 5-7.4 |   |
|                |               |                |                            | <u>EVA SYSTEMS: 1.240 POST EVA</u><br>Perform Water Recharge, No Metox Regen  | After NODE 3 INSTALL:<br>VA/FREE/VERN<br>Permanent DAP Edit: A11,A12,B12,B13:CA=7                |   |   |
|                |               |                |                            | Ref. STS-130 Consumables Tracking CC(EVA)<br>Ref. STS-130 Battery Recharge Plan (EVA)   | <u>FILTER CLEANING</u><br>(IFM, SCHEDULED MAINTENANCE)<br>Inspect filters and clean as necessary |   |   |
| 12:00          |               |                |                            |   |  |   |   |
|                |               |                |                            |   |  |   | <u>1.117 NODE 1/NODE 3 VEST PRESS &amp; LEAK CK</u><br>(ASSY OPS, ACT&C/Q)<br>Steps 7.6-9.7 |
|                |               |                |                            |   | <u>PRE-SLEEP ACTIVITY</u><br>(ORB OPS, CREW SYS)   |   |   |
|                |               |                |                            |   |  | <u>TRANSFER TAGUP</u><br>Coordinate with transfer counterpart   |   |
| 13:00          |               |                |                            | <u>EVA SYSTEMS: 1.605 BSA BATTERY RECHARGE</u><br>INITIATE<br>Ref. STS-130 Consumables Tracking CC(EVA)<br>Ref. STS-130 Battery Recharge Plan (EVA) |  | <u>TRANSFER BRIEF</u><br>Call down status to MCC  |   |
|                |               |                |                            | <u>PRE-SLEEP ACTIVITY</u><br>(ORB OPS, CREW SYS)  |  | <u>PRE-SLEEP ACTIVITY</u><br>(ORB OPS, CREW SYS)  |   |
|                |               |                |                            | FLIGHT DIRECTOR CONFERENCE<br>PRIVATE MEDICAL CONFERENCE<br>L9 PAYLOAD STATION A/G (two) - OFF<br>Perform via A/G2                                  |  |   |   |
|                |               |                |                            | <u>PRE-SLEEP ACTIVITY</u><br>(ORB OPS, CREW SYS)  |  |   |   |
| 14:00          |               |                |                            |   |  |   |   |
|                |               |                |                            |   |  |   |   |
| 04:00          |               |                |                            |   |  |   |   |



# STS-130 FD05

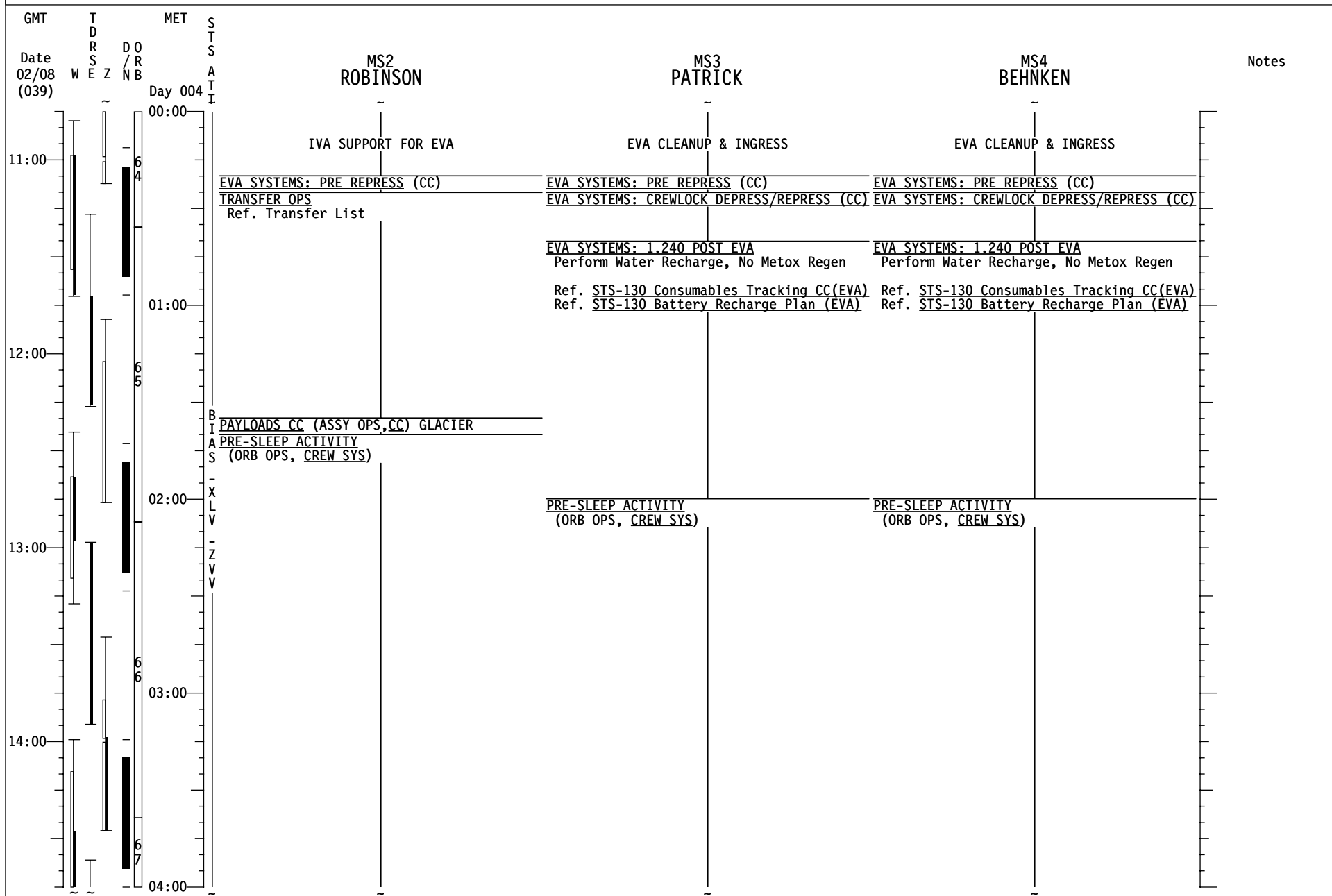

# STS-130 FD05

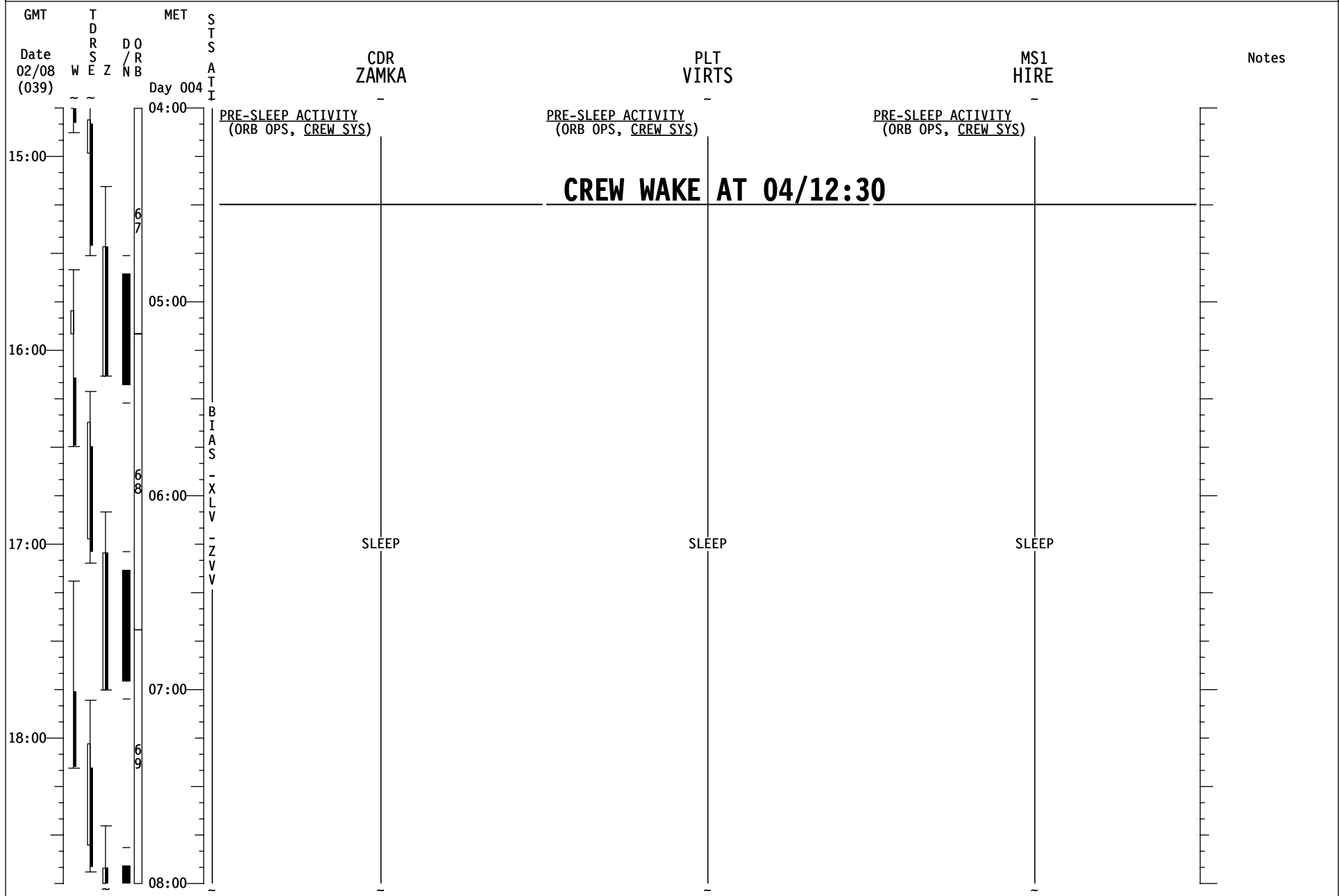

# STS-130 FD05

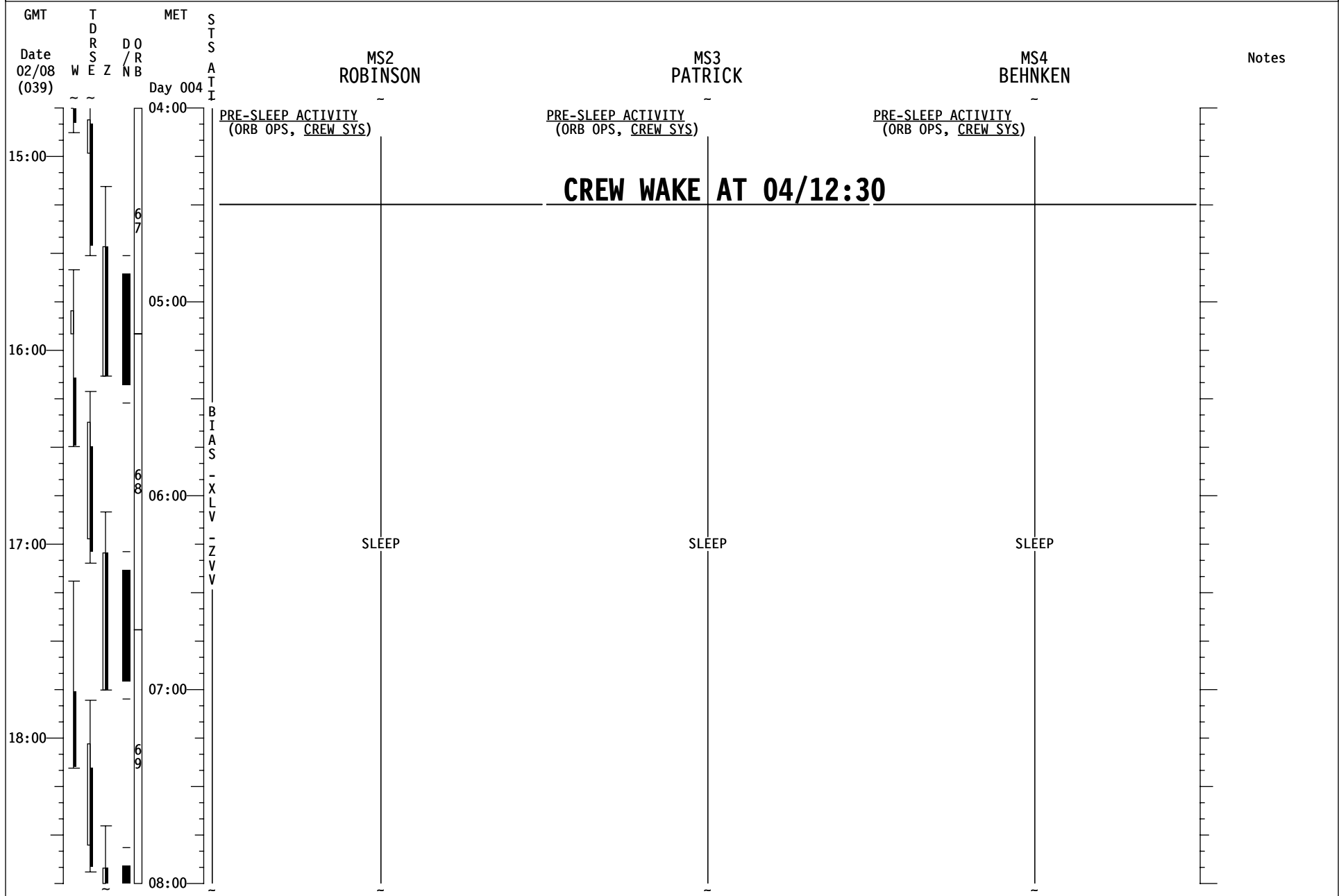

# STS-130 FD05

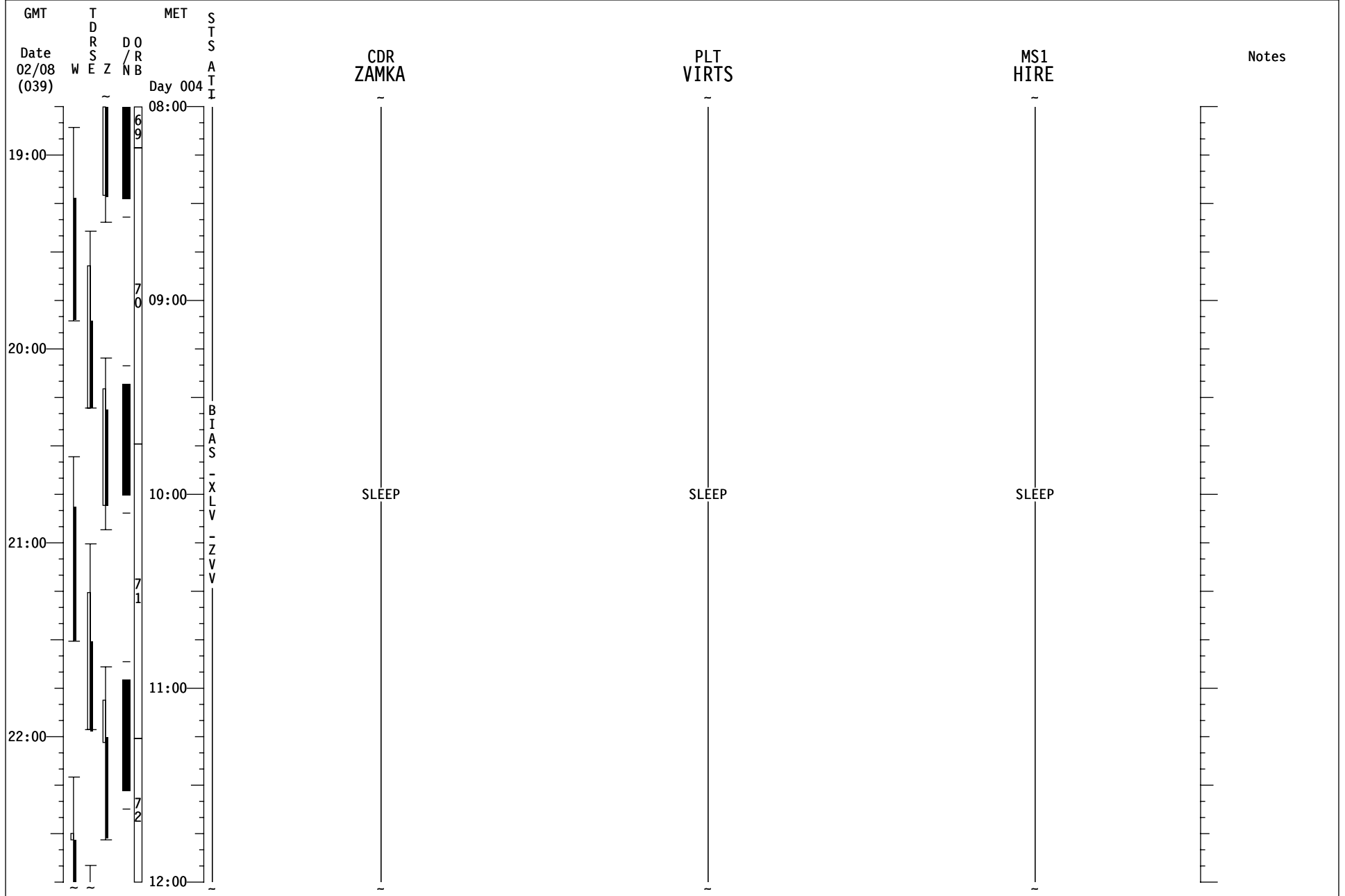

# STS-130 FD05

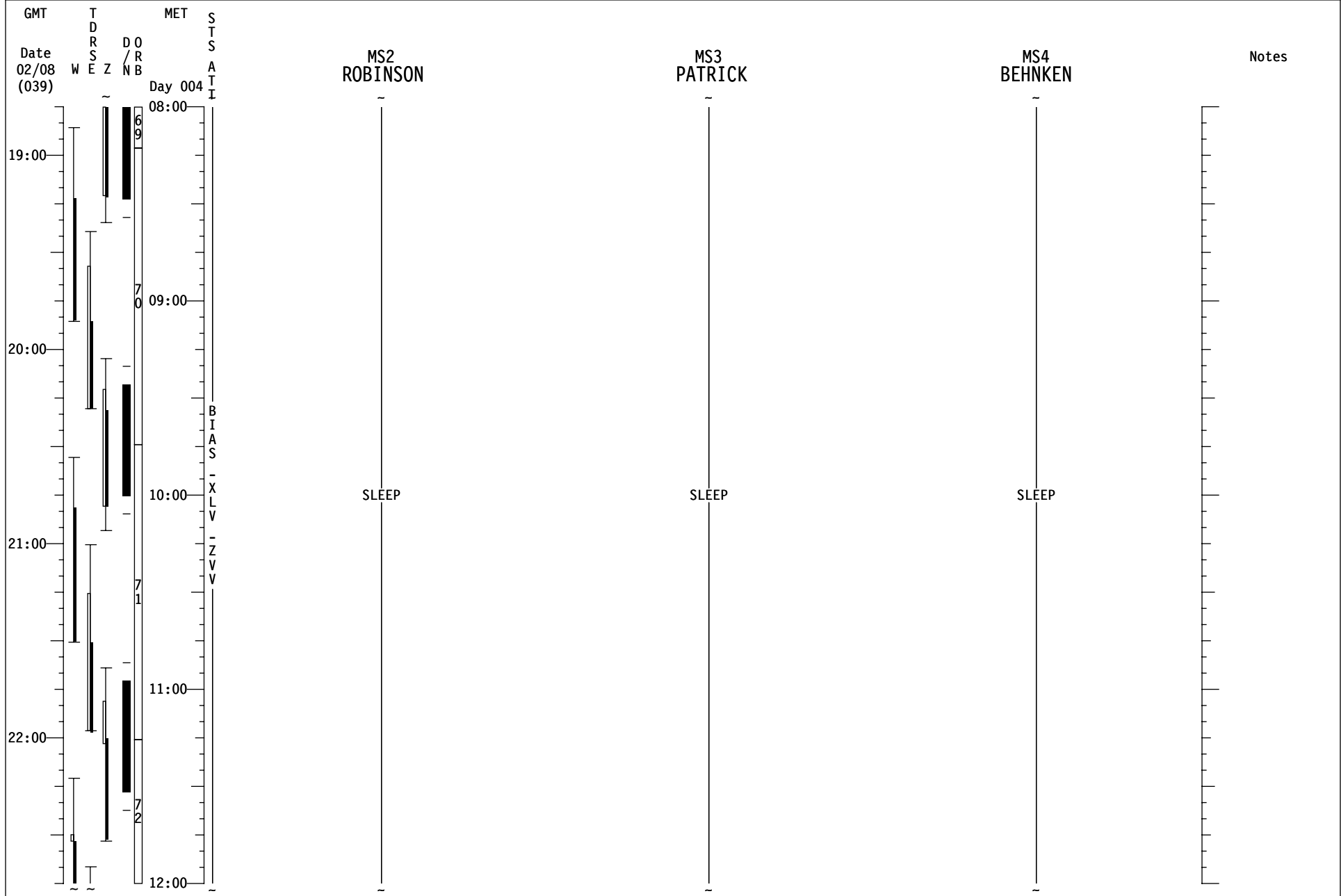

# STS-130 FD06

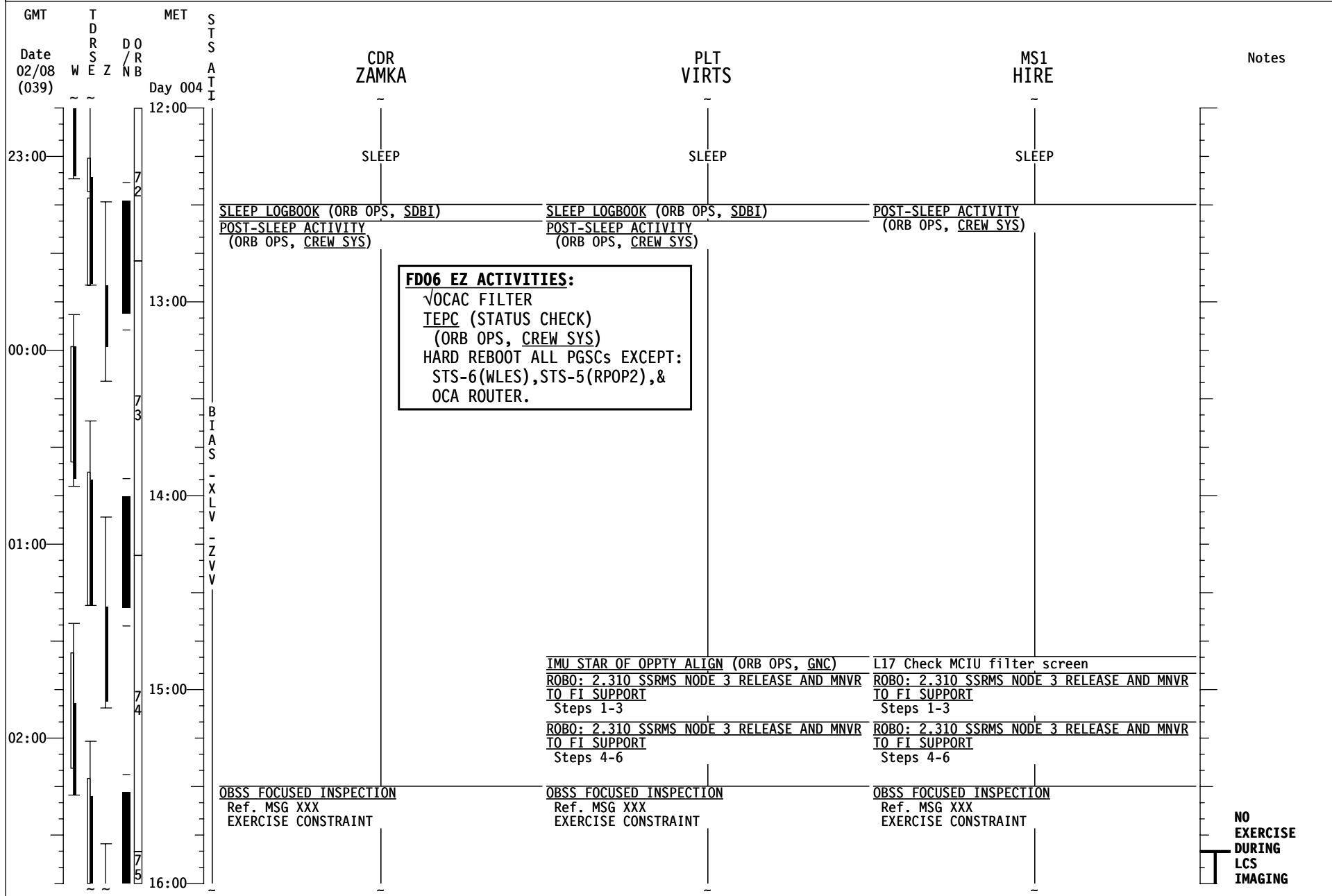

**NO EXERCISE DURING LCS IMAGING**

# STS-130 FD06

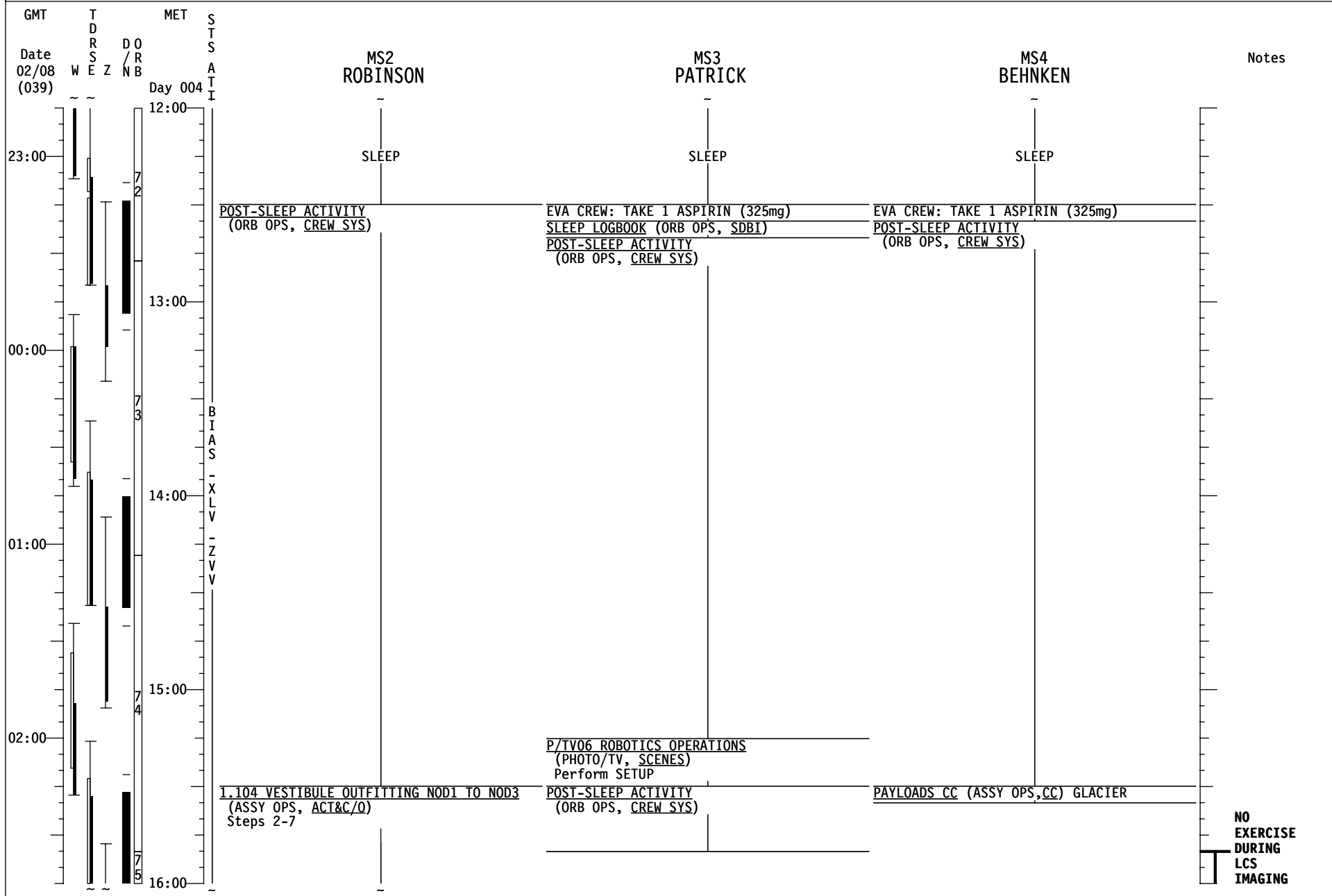

**NO EXERCISE DURING LCS IMAGING**

# STS-130 FD06

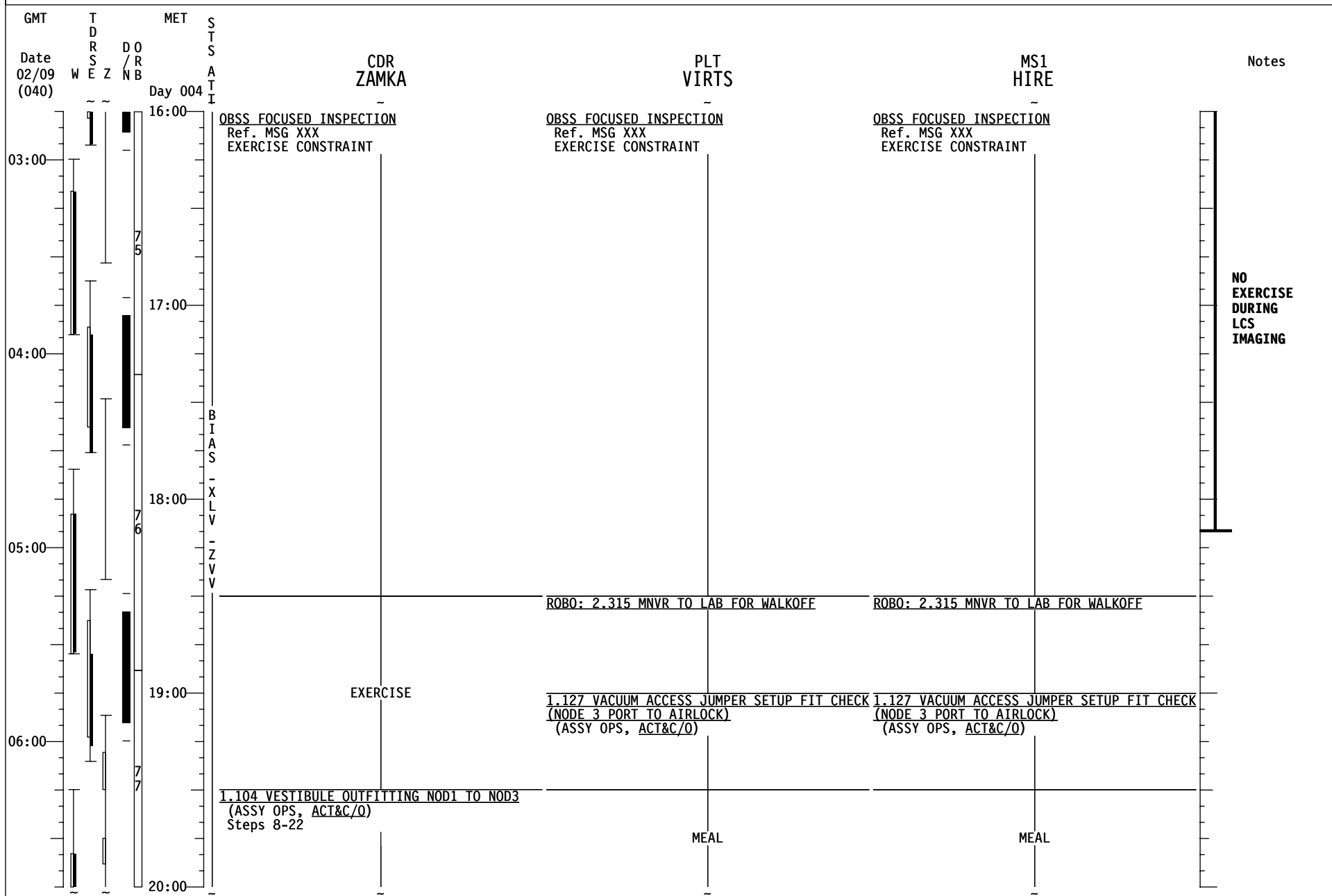

NO  
EXERCISE  
DURING  
LCS  
IMAGING



# STS-130 FD06

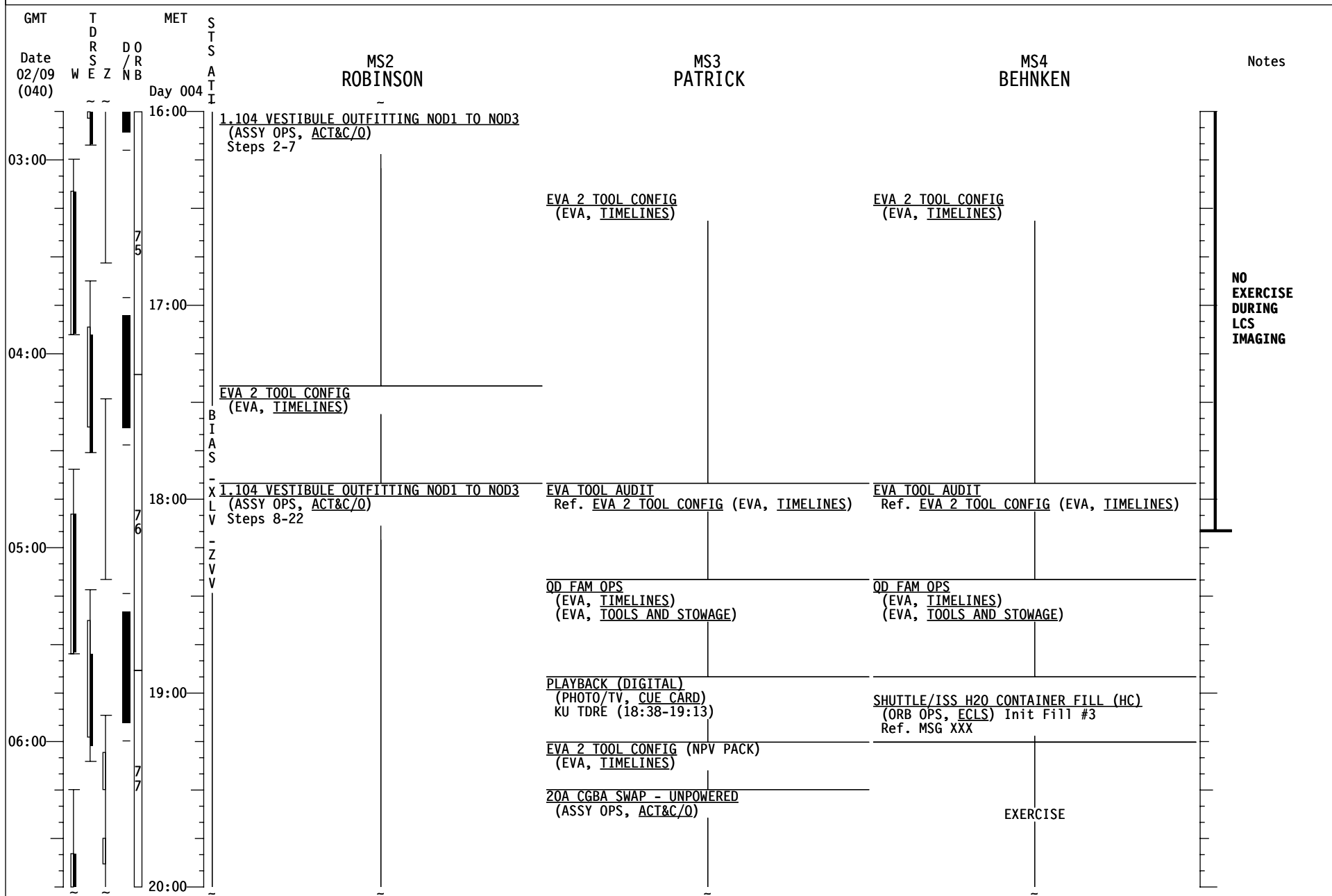

# STS-130 FD06

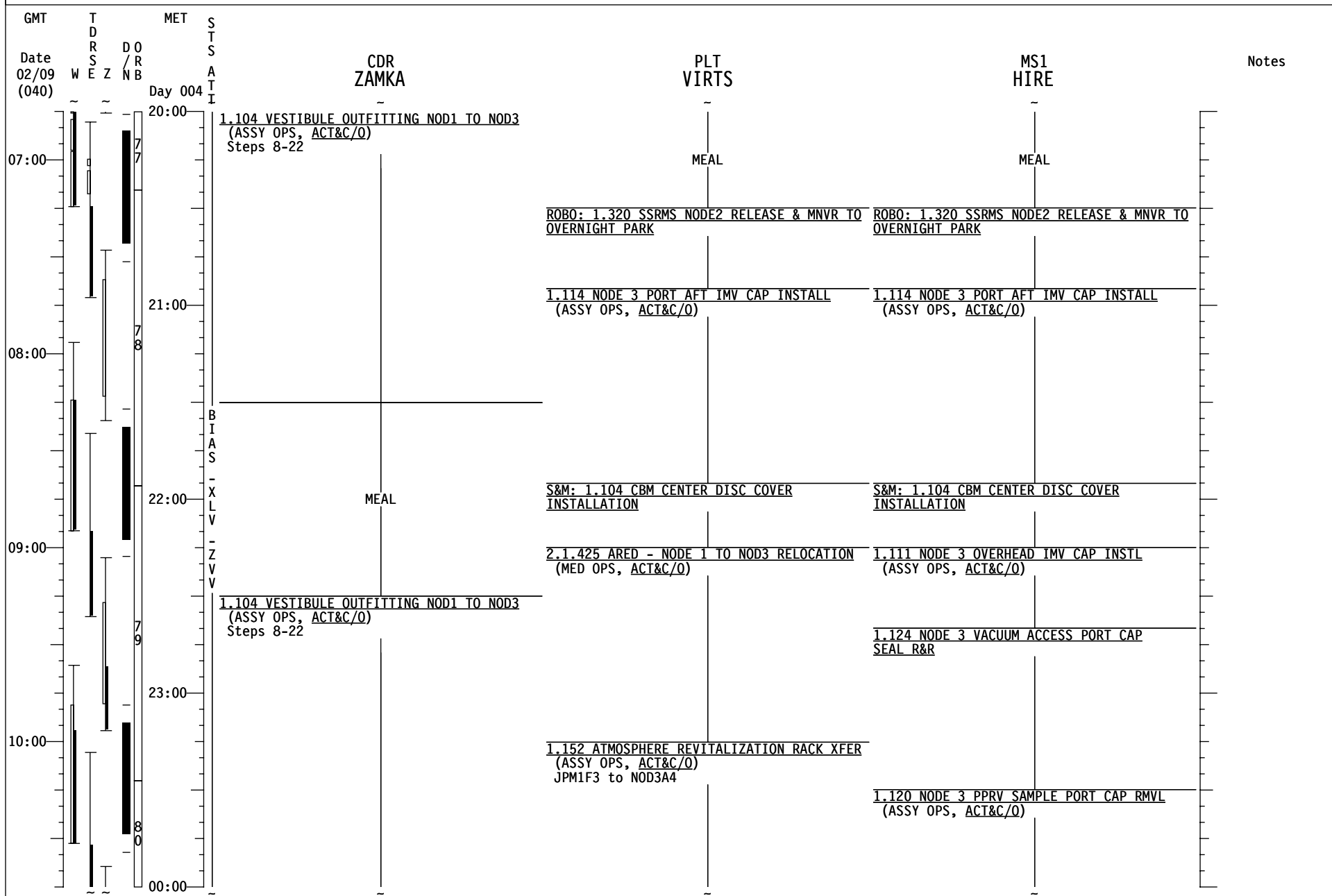

# STS-130 FD06

| GMT            | T D R S<br>W E Z | MET<br>D O R B<br>N B | S T S<br>A T T I | MS2<br>ROBINSON  | MS3<br>PATRICK  | MS4<br>BEHNKEN  | Notes |
|----------------|------------------|-----------------------|------------------|--|---|---|-------|
| 02/09<br>(040) |                  | Day 004               |                  |  |   |   |       |
| 20:00          |                  |                       |                  | 1.104 VESTIBULE OUTFITTING NOD1 TO NOD3<br>(ASSY OPS, ACT&C/O)<br>Steps 8-22 | 20A CGBA SWAP - UNPOWERED<br>(ASSY OPS, ACT&C/O)  | EXERCISE  |       |
| 07:00          |                  |                       |                  |  |   | SHUTTLE/ISS H2O CONTAINER FILL (HC)<br>(ORB OPS, ECLS)<br>Perform FILL TERMINATION  |       |
| 08:00          |                  |                       |                  | MEAL   | MEAL  | MEAL  |       |
| 21:00          |                  |                       |                  |  |   |   |       |
| 09:00          |                  |                       |                  | 1.104 VESTIBULE OUTFITTING NOD1 TO NOD3<br>(ASSY OPS, ACT&C/O)<br>Steps 8-22 |   |   |       |
| 22:00          |                  |                       |                  |  | PUBLIC AFFAIRS EVENT<br>ISS KU AVAIL: 21:36-22:03   | PUBLIC AFFAIRS EVENT<br>ISS KU AVAIL: 21:36-22:03   |       |
|                |                  |                       |                  |  | A  Ref. STS-130 Consumables Tracking CC (EVA)<br>Ref. STS-130 Battery Recharge Plan (EVA) | EVA SYSTEMS: 1.605 BSA BATTERY RECHARGE<br>TERMINATE [A]<br>EVA SYSTEMS: 1.605 BSA BATTERY RECHARGE<br>INITIATE [A]<br>EMU LIOH & BATTERY INSTALL [A]<br>Ref. EVA SYS: 1.515 EMU METOX/LIOH/BATT<br>REPLACEMENT |       |
| 10:00          |                  |                       |                  |  | EXERCISE  | PWR FILL (ORB OPS, ECLS)<br>Perform WATER FILL #1<br>Fill SN TBS (Barcode #TBS)<br>Fill dur ~30 min   |       |
|                |                  |                       |                  |  |   | PWR TRANSFER<br>Transfer PWR to ISS   |       |
|                |                  |                       |                  |  |   | CWC TRANSFER<br>Transfer CWC to ISS   |       |
| 00:00          |                  |                       |                  |  | EVA SYSTEMS: 1.305 EQUIPMENT LOCK PREP<br>Fill 2 Drink Bags (1 per EVA crew member)       | EVA SYSTEMS: 1.305 EQUIPMENT LOCK PREP<br>Fill 2 Drink Bags (1 per EVA crew member)   |       |

# STS-130 FD06

| GMT<br>Date<br>02/09<br>(040) | TDRS<br>W E Z | MET<br>DORNB<br>Day 005 | STS<br>A T I | CDR<br>ZAMKA   | PLT<br>VIRTS   | MS1<br>HIRE  | Notes |
|-------------------------------|---------------|-------------------------|--------------|--|--|--|-------|
|                               |               |                         |              | <u>1.104 VESTIBULE OUTFITTING NOD1 TO NOD3</u><br>(ASSY OPS, ACT&C/O)<br>Steps 8-22  | <u>1.152 ATMOSPHERE REVITALIZATION RACK XFER</u><br>(ASSY OPS, ACT&C/O)<br>JPM1F3 to NOD3A4<br><br><u>TV (ILLUMINATOR OPS) (PHOTO/TV, CC)</u><br>ILLUMINATORS ON - A & D | <u>1.120 NODE 3 PPRV SAMPLE PORT CAP RMVL</u><br>(ASSY OPS, ACT&C/O)               |       |
| 11:00                         |               |                         |              |  |  |  |       |
|                               |               |                         |              | <u>EVA PROCEDURE REVIEW</u><br>Ref. <u>EVA 2 BRIEFING CARD</u><br>(EVA, TIMELINES)   | <u>EVA PROCEDURE REVIEW</u><br>Ref. <u>EVA 2 BRIEFING CARD</u><br>(EVA, TIMELINES)   | <u>EVA PROCEDURE REVIEW</u><br>Ref. <u>EVA 2 BRIEFING CARD</u><br>(EVA, TIMELINES) |       |
| 12:00                         |               |                         |              |  |  |  |       |
|                               |               |                         |              | <u>PRE-SLEEP ACTIVITY</u><br>(ORB OPS, CREW SYS)   | <u>PUBLIC AFFAIRS EVENT</u><br>ISS KU AVAIL: 01:22-01:52   | <u>PUBLIC AFFAIRS EVENT</u><br>ISS KU AVAIL: 01:22-01:52                           |       |
|                               |               |                         |              |  | <u>PRE-SLEEP ACTIVITY</u><br>(ORB OPS, CREW SYS)   |  |       |
| 13:00                         |               |                         |              |  |  | <u>PRE-SLEEP ACTIVITY</u><br>(ORB OPS, CREW SYS)                                   |       |
|                               |               |                         |              | <u>FLIGHT DIRECTOR CONFERENCE</u><br><u>PRIVATE MEDICAL CONFERENCE</u><br>L9 PAYLOAD STATION A/G (two) - OFF<br>Perform via A/G2         |  |  |       |
|                               |               |                         |              | <u>EVA SYSTEMS: 1.206 10.2 PSIA CAMPOUT MASK</u><br><u>PREBREATHE Steps 1-16</u><br><br>Ref. <u>STS-130 Consumables Tracking CC(EVA)</u> |  |  |       |
| 14:00                         |               |                         |              |  |  |  |       |
|                               |               |                         |              | <u>PRE-SLEEP ACTIVITY</u><br>(ORB OPS, CREW SYS)   |  |  |       |
| 04:00                         |               |                         |              |  |  |  |       |

# STS-130 FD06

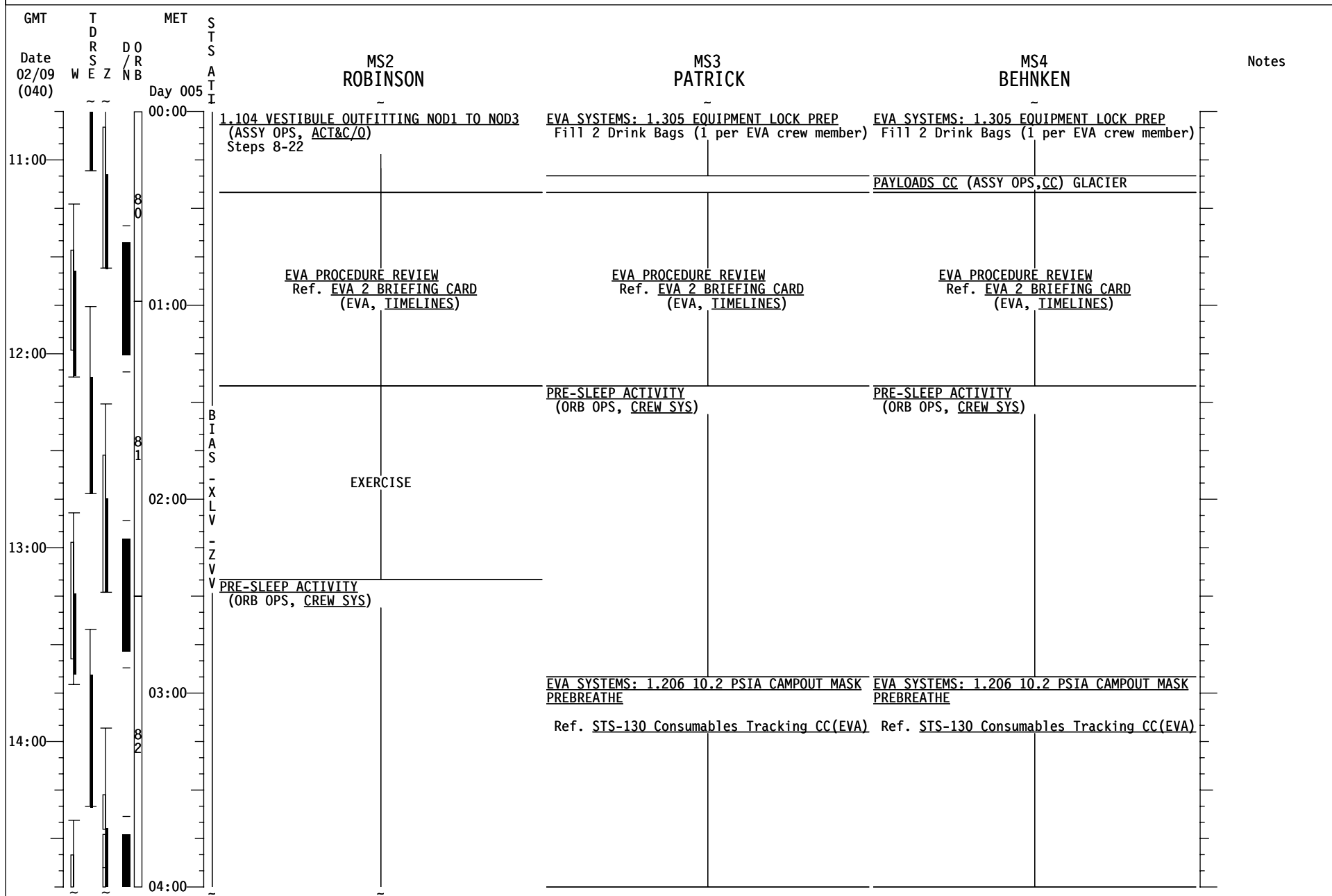

# STS-130 FD06

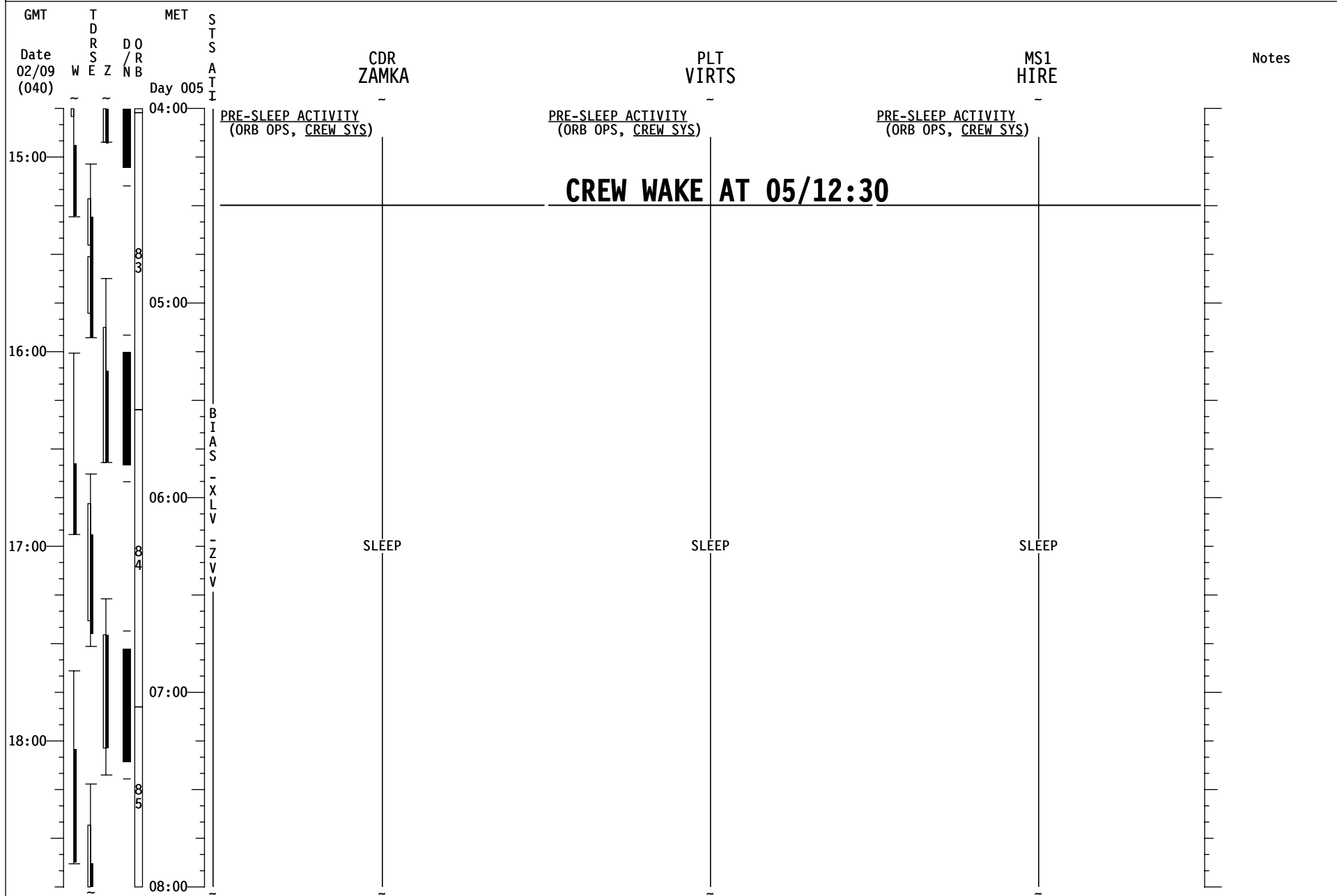

# STS-130 FD06

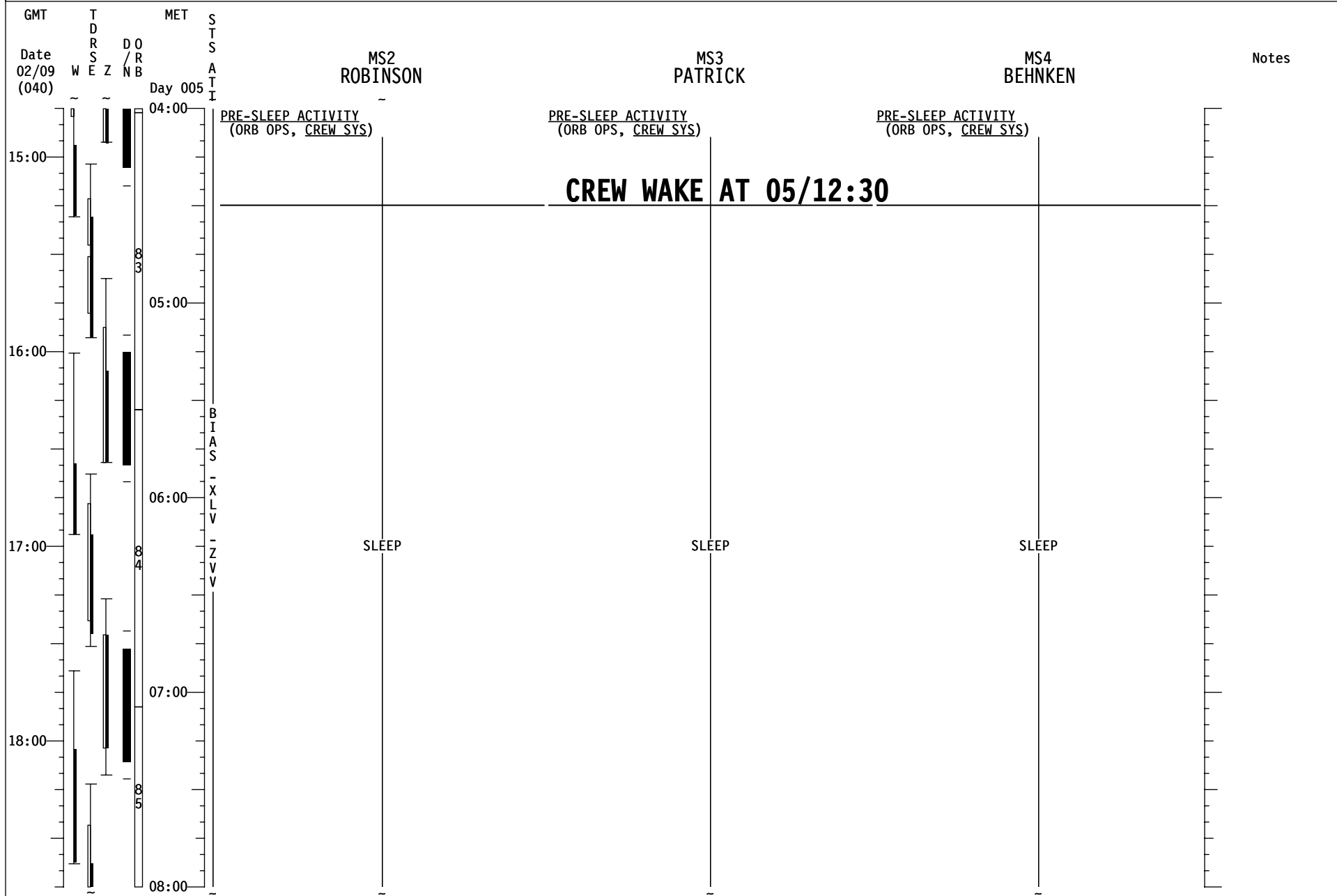

# STS-130 FD06

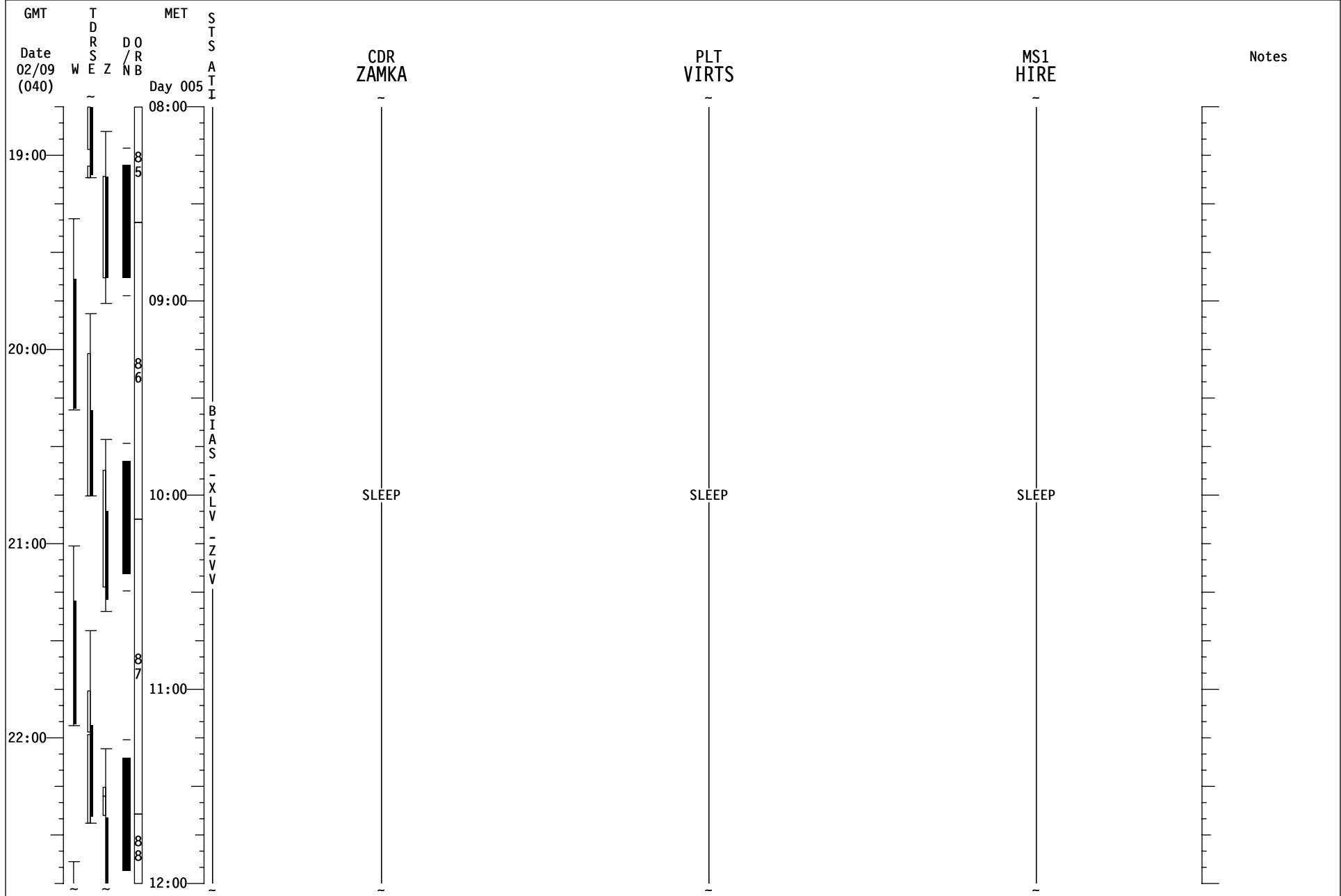



STS-130 FD06

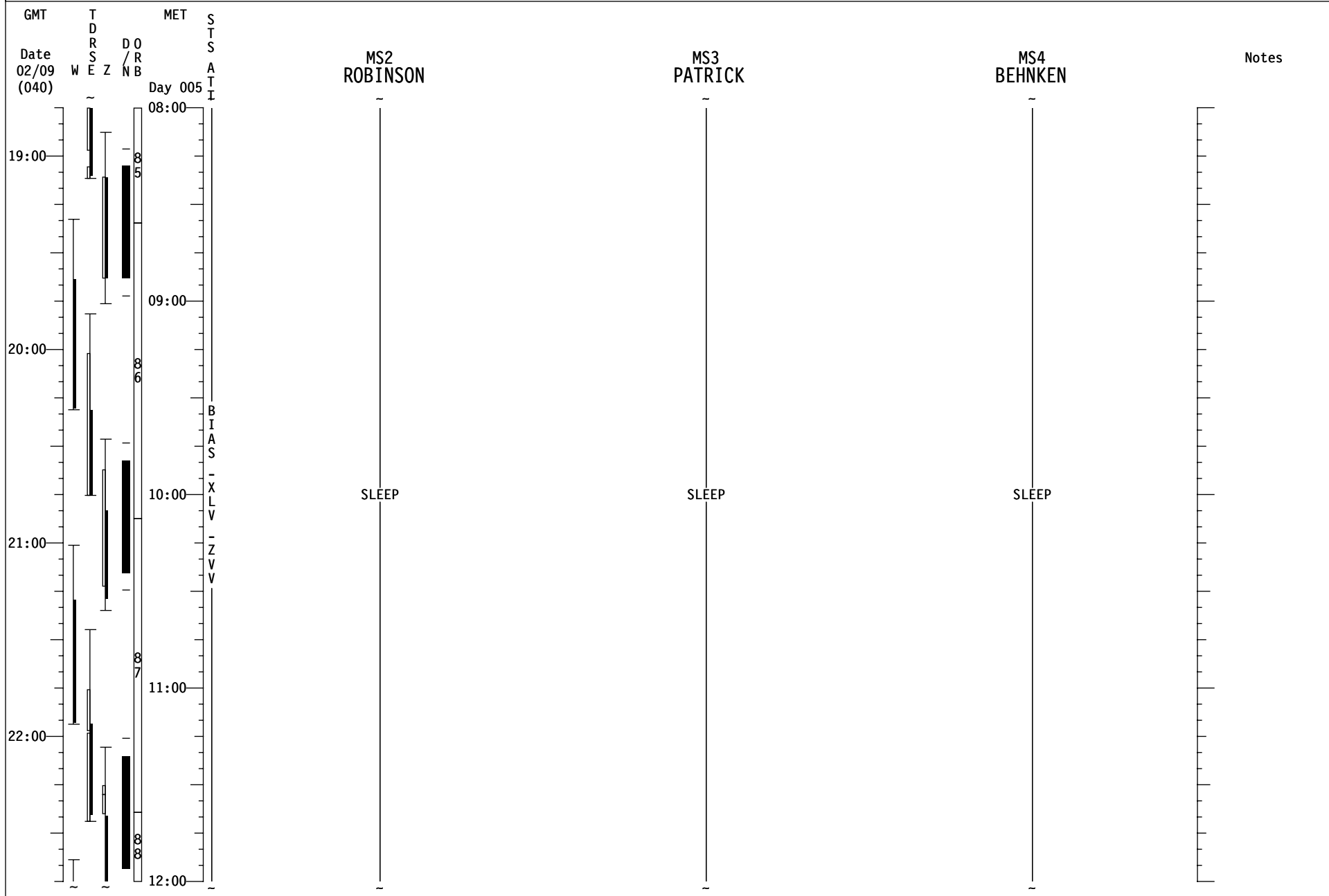

# STS-130 FD07

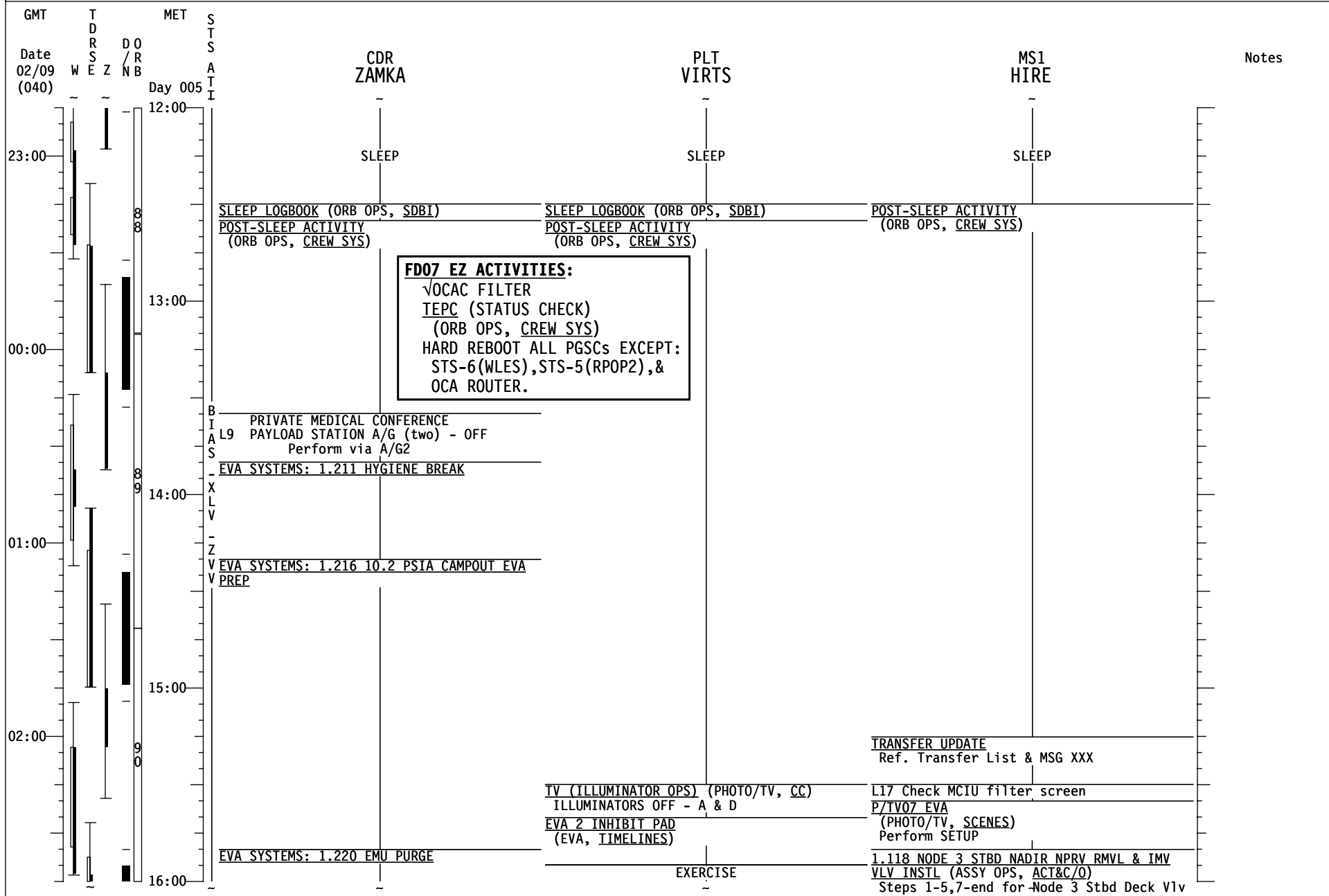

# STS-130 FD07

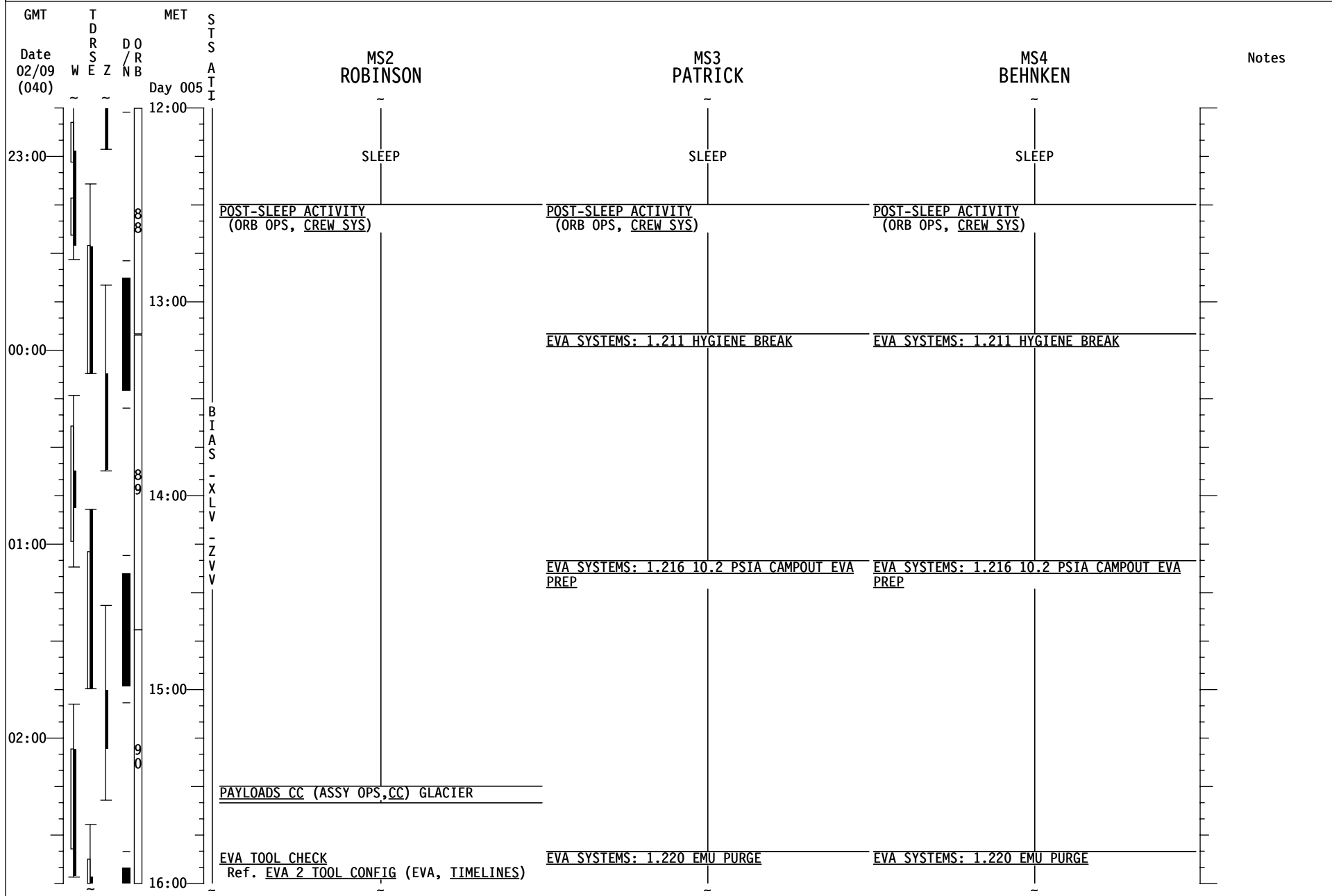

# STS-130 FD07

| GMT   | TDRS<br>W E Z | MET<br>Day 005 | S<br>T<br>S<br>A<br>T<br>I | CDR<br>ZAMKA   | PLT<br>VIRTS                               | MS1<br>HIRE   | Notes  |
|-------|---------------|----------------|----------------------------|--|--|---|--|
| 03:00 |               |                |                            | EVA SYSTEMS: 1.220 EMU PURGE<br>EVA SYSTEMS: 1.225 EMU PREBREATHE  | EXERCISE                                   | 1.118 NODE 3 STBD NADIR NPRV RMLV & IMV<br>VLV INSTL (ASSY OPS, ACT&C/O)<br>Steps 1-5,7-end for Node 3 Stbd Deck V1v  |  |
| 04:00 |               |                |                            | EVA SYSTEMS: CREWLOCK DEPRESS/REPRESS (CC)<br>EVA SYSTEMS: CREWLOCK POST DEPRESS (CC)<br>PRLA CLOSE (ORB OPS, PRLA)<br>IMU STAR OF OPPTY ALIGN (ORB OPS, GNC)<br>P/TV07 EVA (PHOTO/TV, SCENES) Perform OPS | L10H TRANSFER<br>Ref. Transfer List        | 1.119 NODE 3 STBD ZENITH NPRV RMLV & IMV<br>VLV INSTL (ASSY OPS, ACT&C/O)<br>Steps 1-5,7-end for Node 3 Stbd Ovhd V1v |  |
| 05:00 |               |                |                            |  | ISP STOWAGE TRANSFER<br>Ref. Transfer List | 1.129 NODE 1 AND NODE 3 PORTABLE WATER BUS<br>PURGE AND VACUUM BACKFILL (ASSY OPS, ACT&C/O)                           |  |
| 06:00 |               |                |                            | SHUTTLE/ISS H2O CONTAINER FILL (HC)<br>(ORB OPS, ECLS) Init Fill #4<br>Ref. MSG XXX  |  |   | NO UNISOLATED EXERCISE DURING NH3 JUMPER INSTALL |
| 20:00 |               |                |                            | MEAL   | MEAL                                       | MEAL  |  |

# STS-130 FD07

| GMT              | T D R S E Z | MET     | S T S A T I | MS2<br>ROBINSON   | MS3<br>PATRICK  | MS4<br>BEHNKEN  | Notes  |
|------------------|-------------|---------|-------------|---|---|---|--|
| Date 02/10 (041) | W E Z       | Day 005 |             |   |   |   |  |
| 03:00            |             | 16:00   |             | EVA TOOL CHECK<br>Ref. EVA 2 TOOL CONFIG (EVA, TIMELINES) | EVA SYSTEMS: 1.220 EMU PURGE<br>EVA SYSTEMS: 1.225 EMU PREBREATHE | EVA SYSTEMS: 1.220 EMU PURGE<br>EVA SYSTEMS: 1.225 EMU PREBREATHE |  |
|                  |             |         |             | TRANSFER OPS<br>Ref. Transfer List                        |   |   |  |
| 04:00            |             | 17:00   |             |   | EVA SYSTEMS: CREWLOCK DEPRESS/REPRESS (CC)                        | EVA SYSTEMS: CREWLOCK DEPRESS/REPRESS (CC)                        |  |
|                  |             |         |             | EVA SYSTEMS: CREWLOCK POST DEPRESS (CC)                   | EVA SYSTEMS: CREWLOCK POST DEPRESS (CC)                           | EVA SYSTEMS: CREWLOCK POST DEPRESS (CC)                           |  |
|                  |             |         |             |   | EVA 2 SETUP   | EVA 2 SETUP   |  |
| 05:00            |             | 18:00   |             |   | NODE 3 MLI LAYOUT   | NODE 3 MLI LAYOUT   |  |
|                  |             |         |             | IVA SUPPORT FOR EVA                                       |   |   |  |
| 06:00            |             | 19:00   |             |   | NH3 JUMPER INSTALL  | NH3 JUMPER INSTALL  | NO UNISOLATED EXERCISE DURING NH3 JUMPER INSTALL |
|                  |             |         |             |   | NH3 MLI INSTALL   | NH3 MLI INSTALL   |  |
| 20:00            |             |         |             |   |   |   |  |

# STS-130 FD07

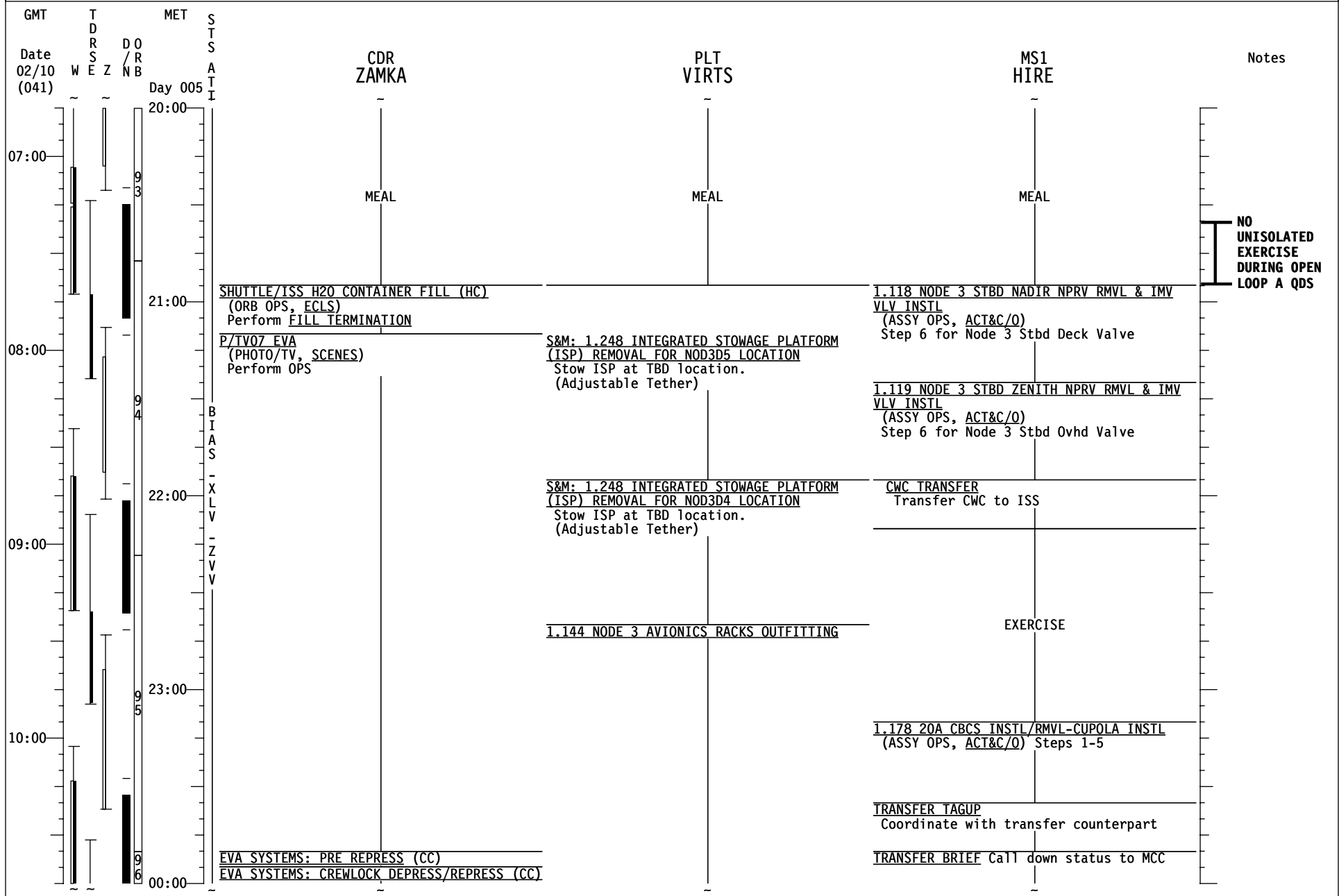

# STS-130 FD07

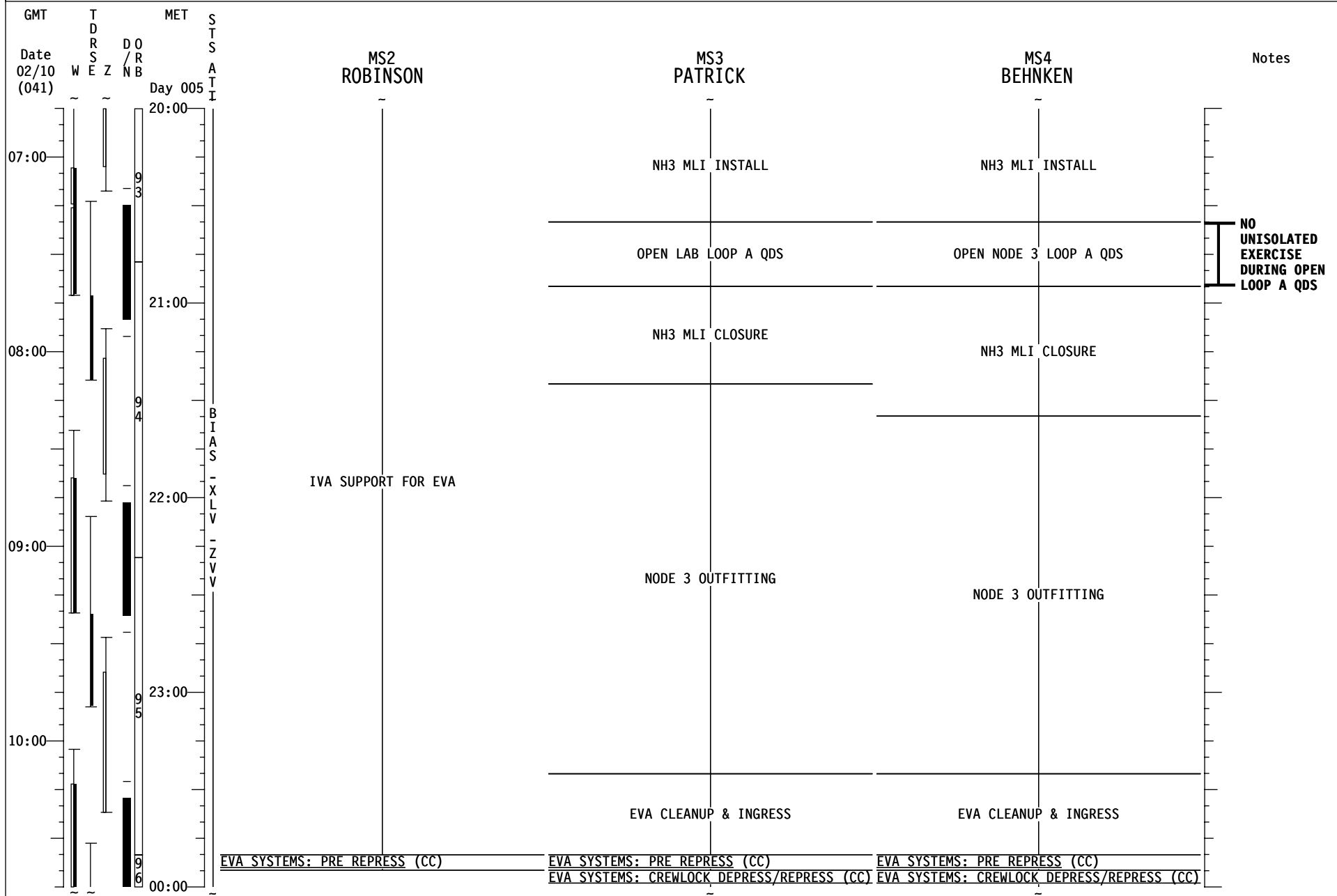

# STS-130 FD07

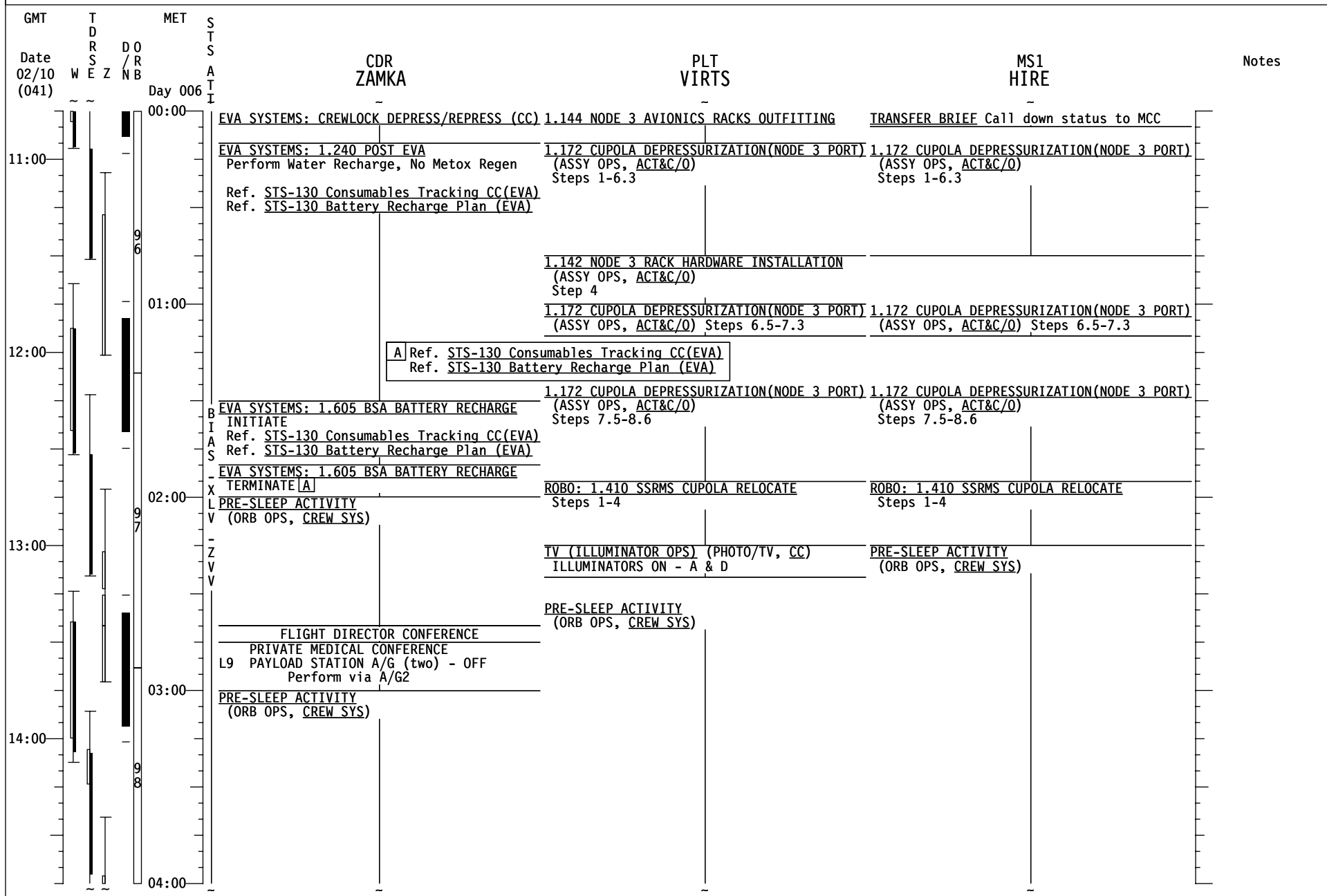



# STS-130 FD07

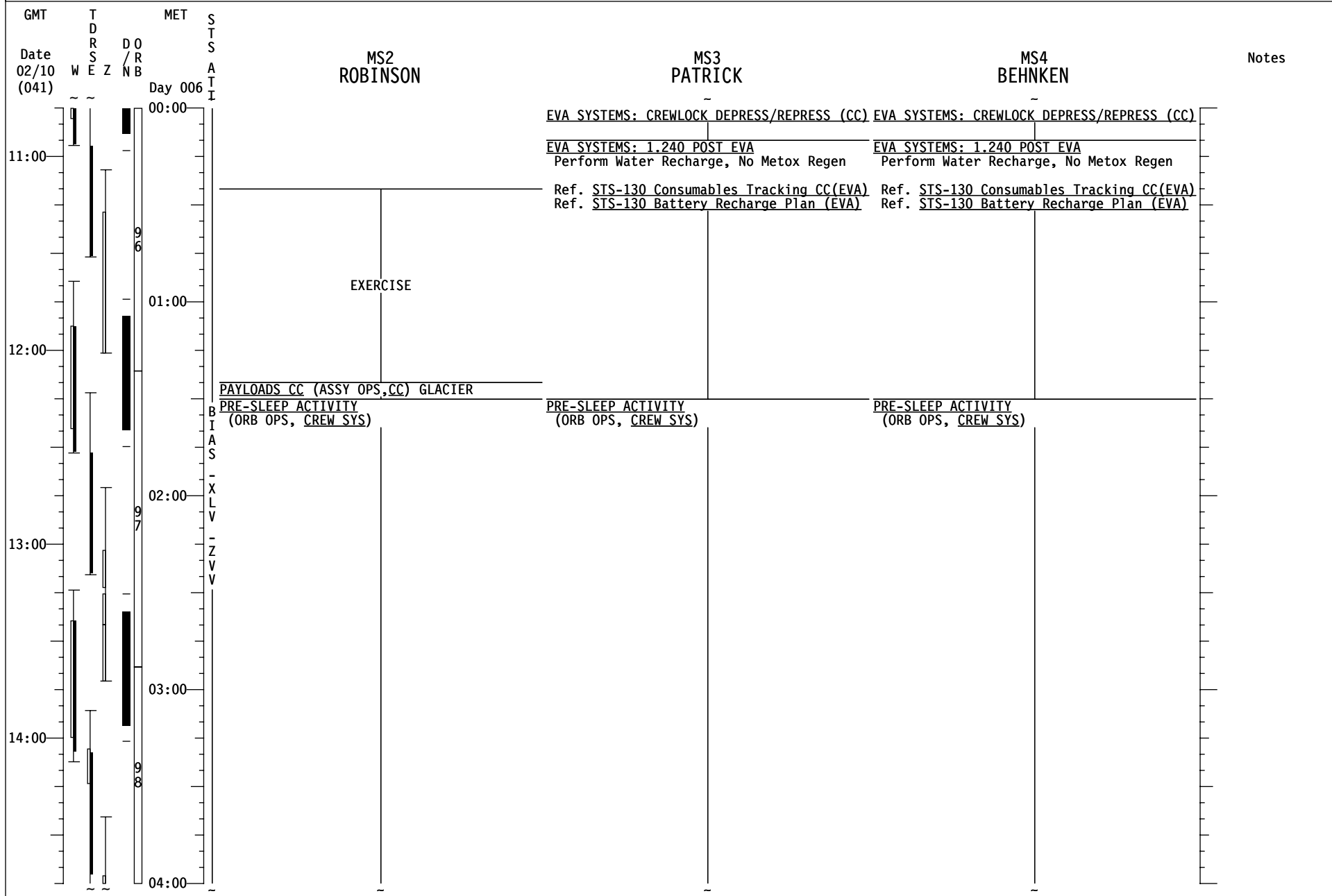

# STS-130 FD07

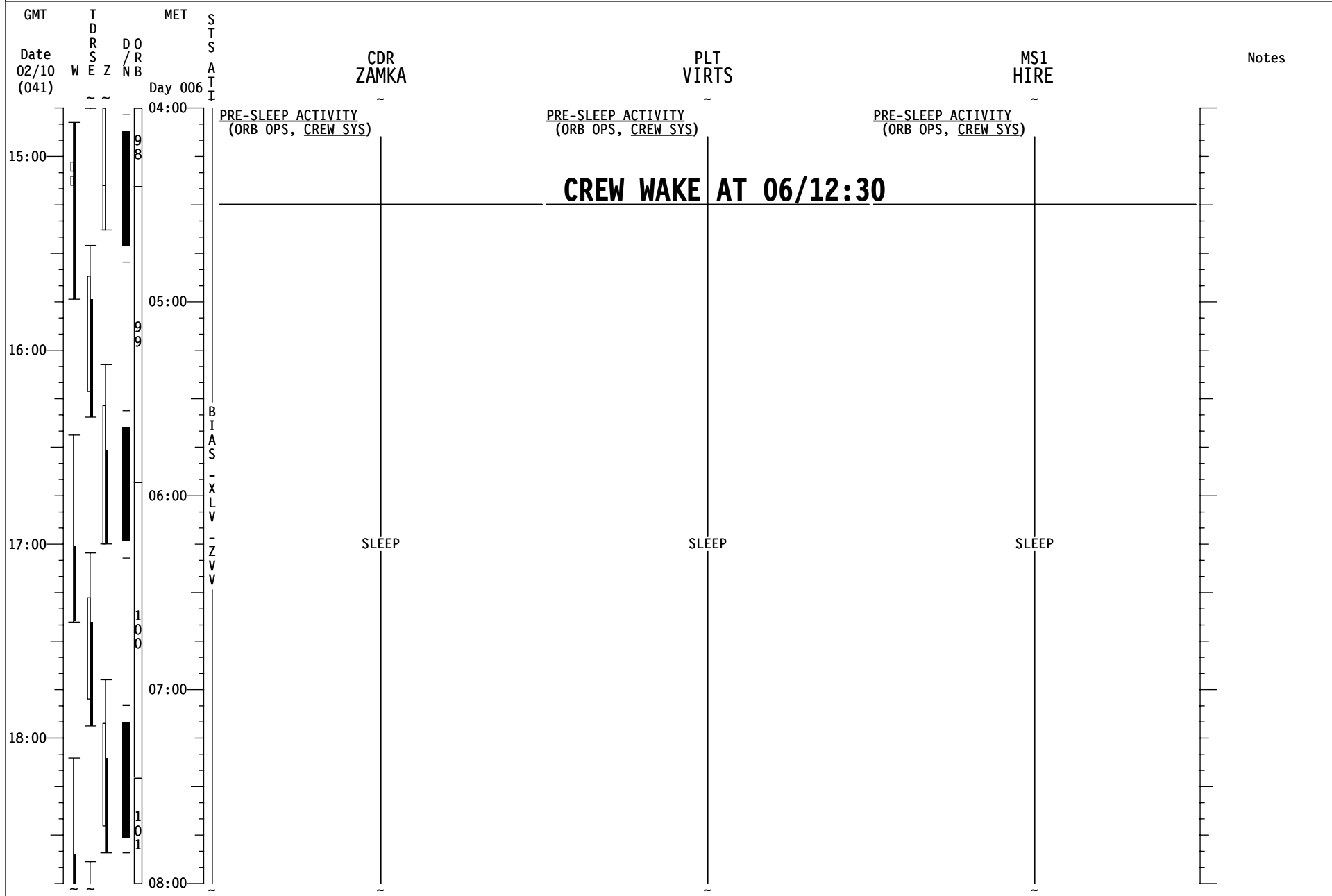

# STS-130 FD07

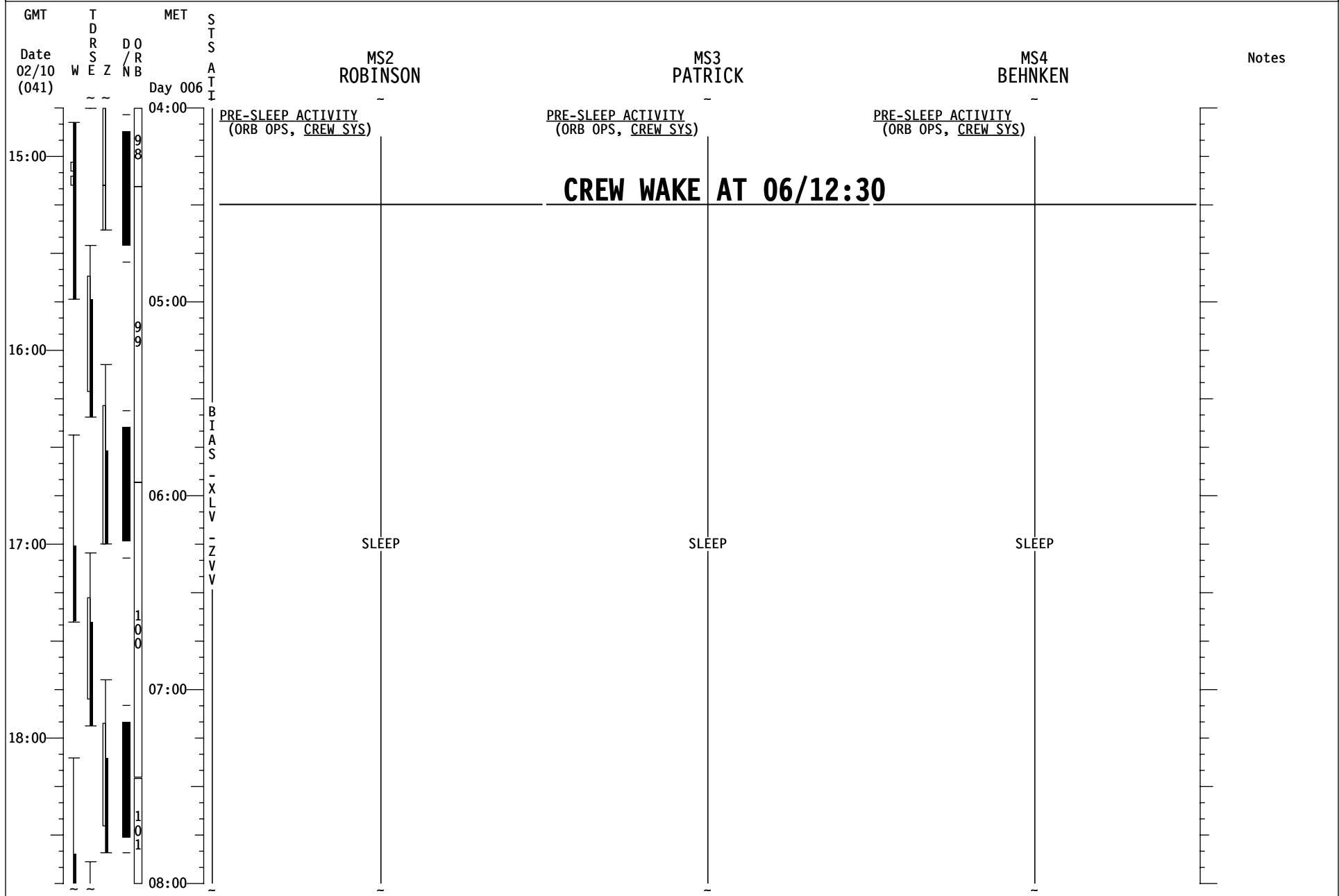

# STS-130 FD07

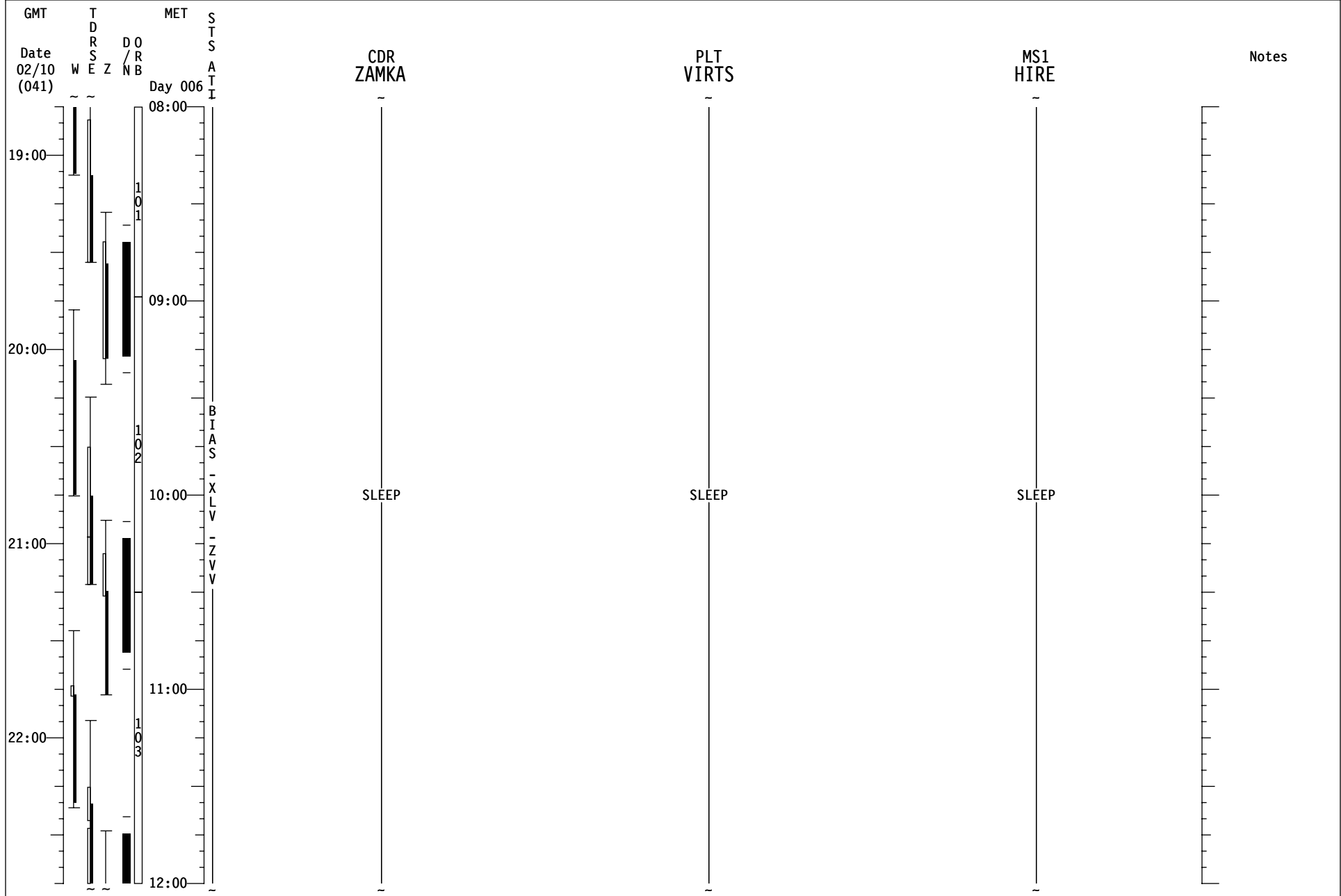



# STS-130 FD08

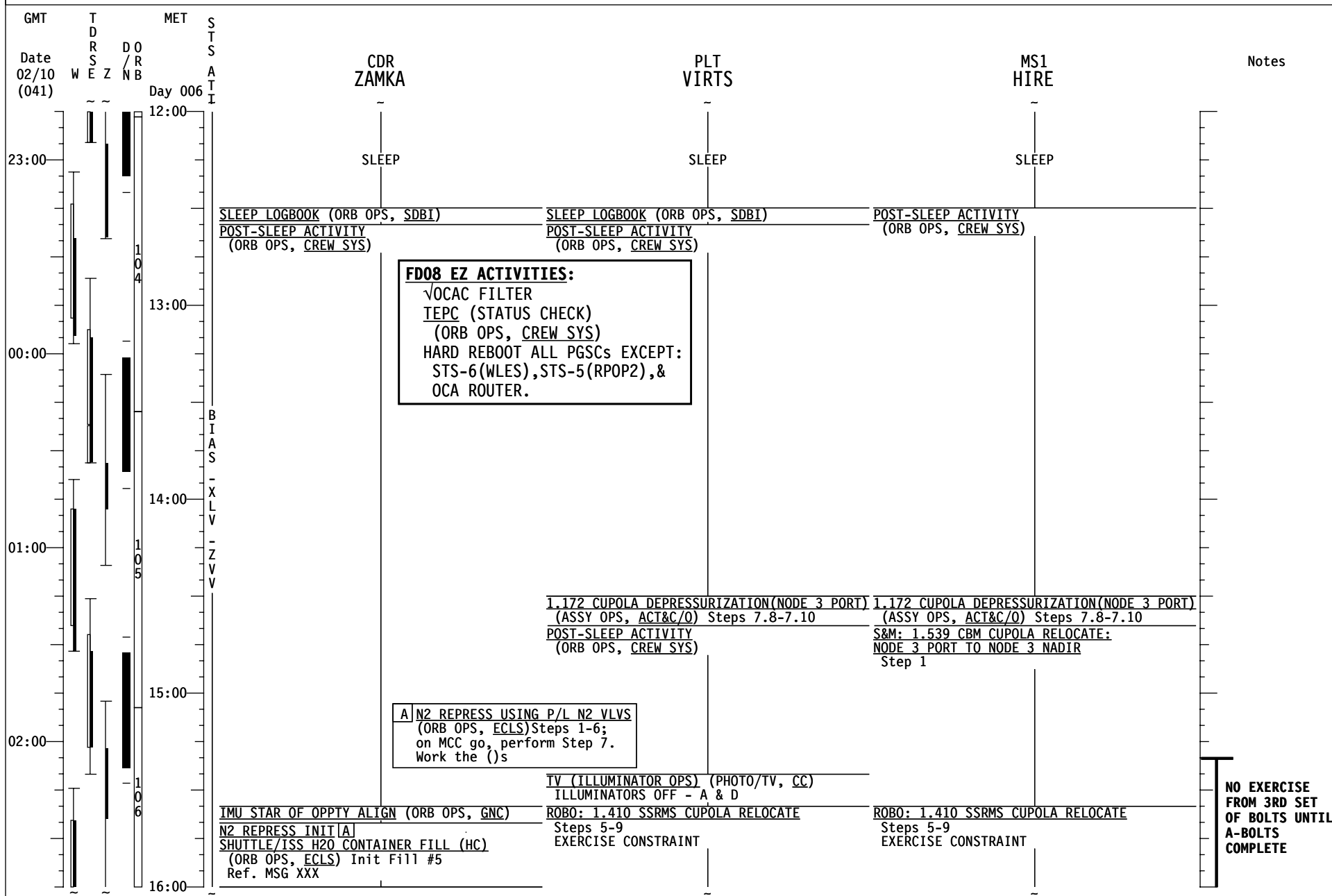

# STS-130 FD08

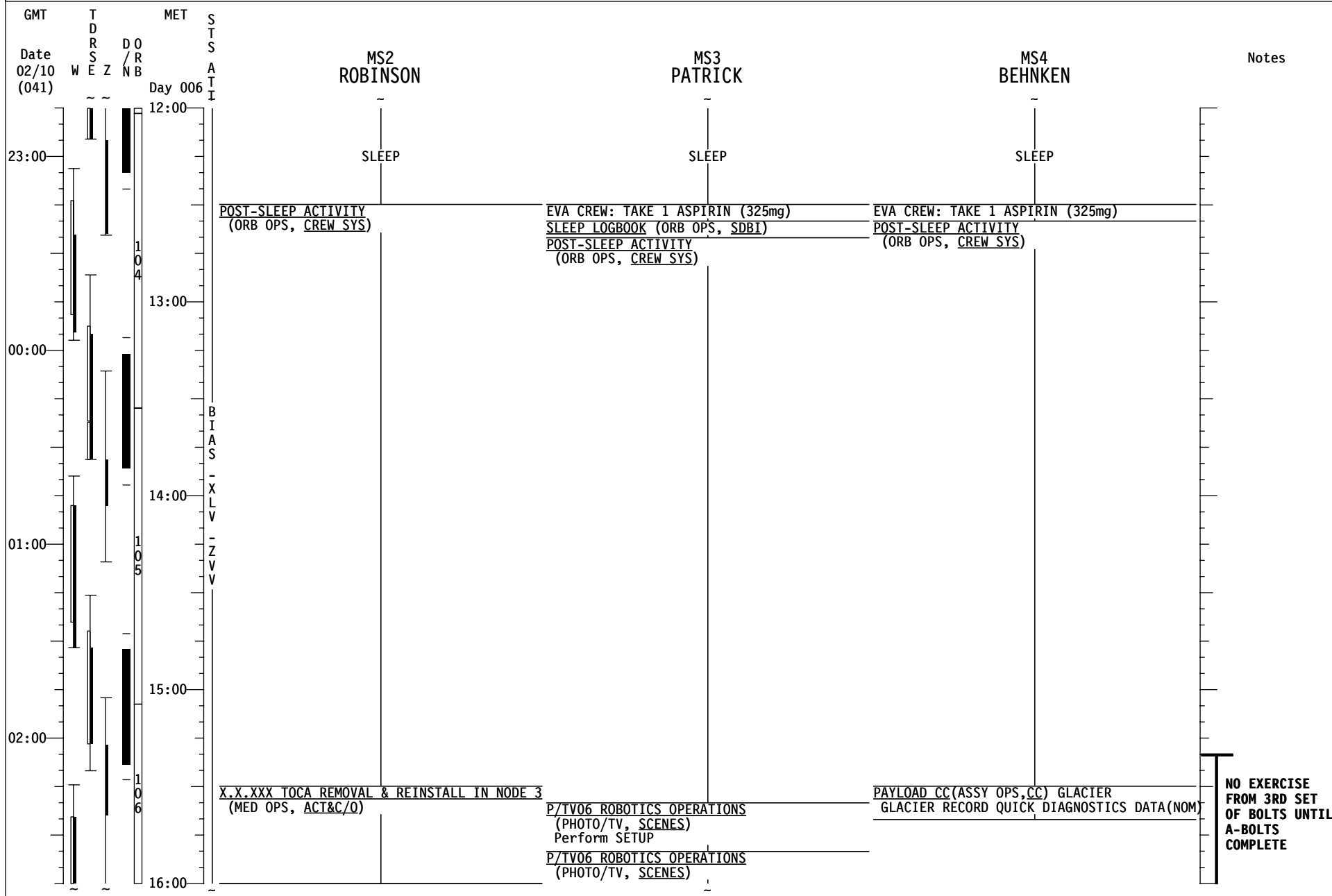

# STS-130 FD08

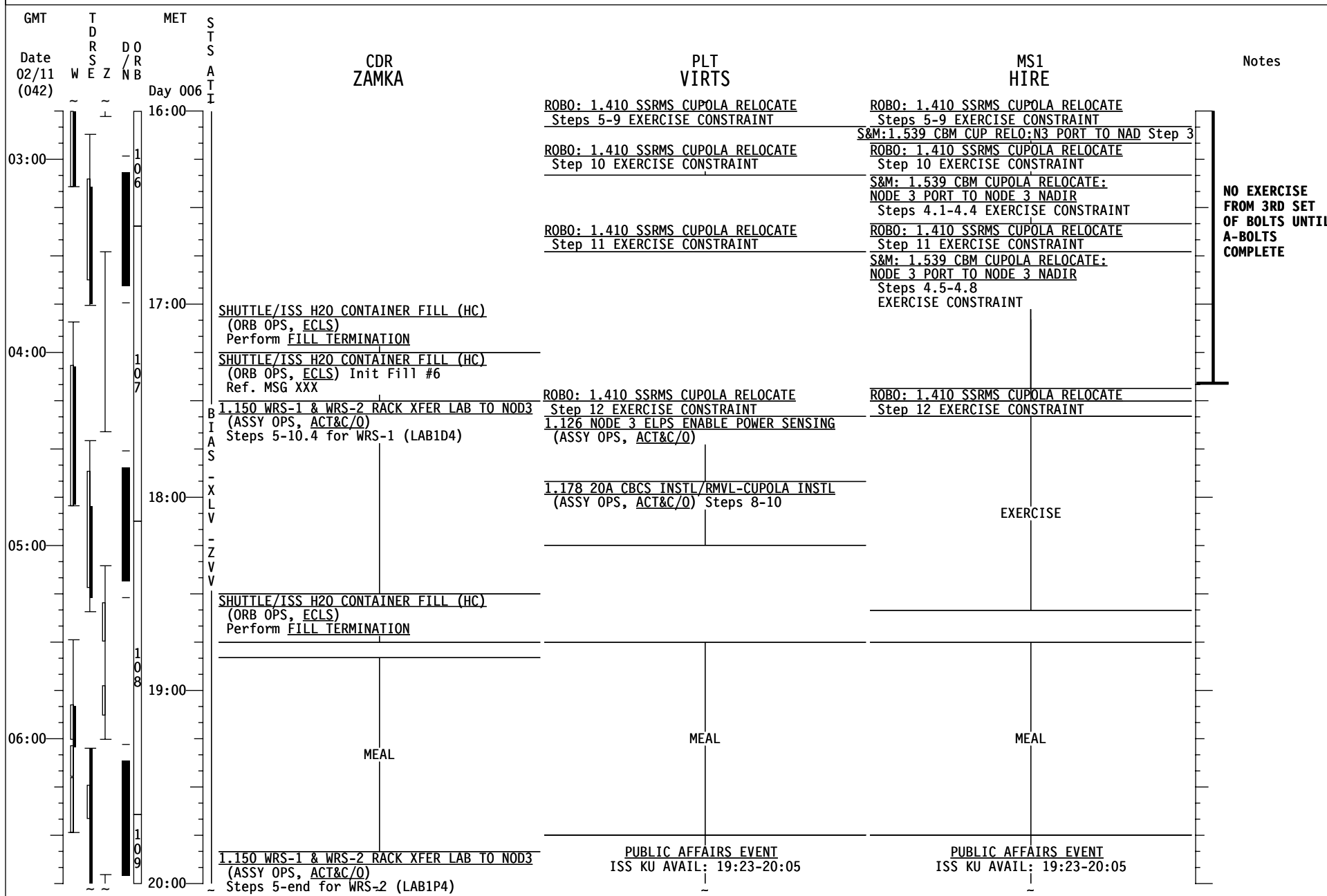





# STS-130 FD08

| GMT              | TDRS<br>W E Z | MET<br>DO<br>R<br>NB | S<br>T<br>S<br>A<br>T<br>I | CDR<br>ZAMKA   | PLT<br>VIRTS   | MS1<br>HIRE  | Notes                                   |
|------------------|---------------|----------------------|----------------------------|--|--|--|---|
| Date 02/11 (042) |               | Day 006              |                            |  |  |  |   |
| 07:00            |               |                      |                            | 1.150 WRS-1 & WRS-2 RACK XFER LAB TO NOD3<br>(ASSY OPS, ACT&C/O)<br>Steps 5-end for WRS-2 (LAB1P4)   | PUBLIC AFFAIRS EVENT See Page 3-82<br>1.156 VESTIBULE OUTFITTING N3-CUPOLA<br>(ASSY OPS, ACT&C/O) Steps 1-22 | PUBLIC AFFAIRS EVENT See Page 3-82<br>1.156 VESTIBULE OUTFITTING N3-CUPOLA<br>(ASSY OPS, ACT&C/O) Steps 1-22 |   |
|                  |               |                      |                            | B N2 REPRESS USING P/L N2 VLVS<br>(ORB OPS, ECLS) on MCC GO,<br>perform Steps 8-14. Work the ( )s  |  |  |   |
|                  |               |                      |                            | N2 REPRESS TERM (On MCC GO) B  |  |  |   |
| 08:00            |               |                      |                            | H/O ATT CONTROL CMG TA to ORB:<br>√MCC for DAP<br>MNVR (TRK) BIAS -XLV +YVV (SIMO DUMP)<br>TGT=2 BV=5 P=164 Y=0 OM=193<br>A12/AUTO/VERN, Init TRK<br>When in attitude, DAP:B12<br>SUPPLY/WASTE WATER DUMP<br>(ORB OPS, ECLS)<br>Initiate Supply Dump |  |  | UPDATE<br>H2O SPLY DUMP<br>QTY TK A & B |
| 09:00            |               |                      |                            | EXERCISE   |  |  |   |
|                  |               |                      |                            | SUPPLY/WASTE WATER DUMP<br>(ORB OPS, ECLS)<br>Terminate Supply Dump  |  |  |   |
| 10:00            |               |                      |                            | MNVR (TRK) BIAS -XLV -ZVV<br>TGT=2 BV=5 P=164 Y=0 OM=167<br>A12/AUTO/VERN, Init TRK  |  |  |   |
|                  |               |                      |                            | When ISS is GO for deadband collapse, DAP:B13  |  |  |   |
|                  |               |                      |                            | C When ISS is GO for att, control, DAP: FREE<br>Then return to DAP A, √A12/FREE/VERN<br>Reconfig DAP B to B12  |  |  |   |
| 00:00            |               |                      |                            | DAP RECONFIG C   |  |  |   |

# STS-130 FD08

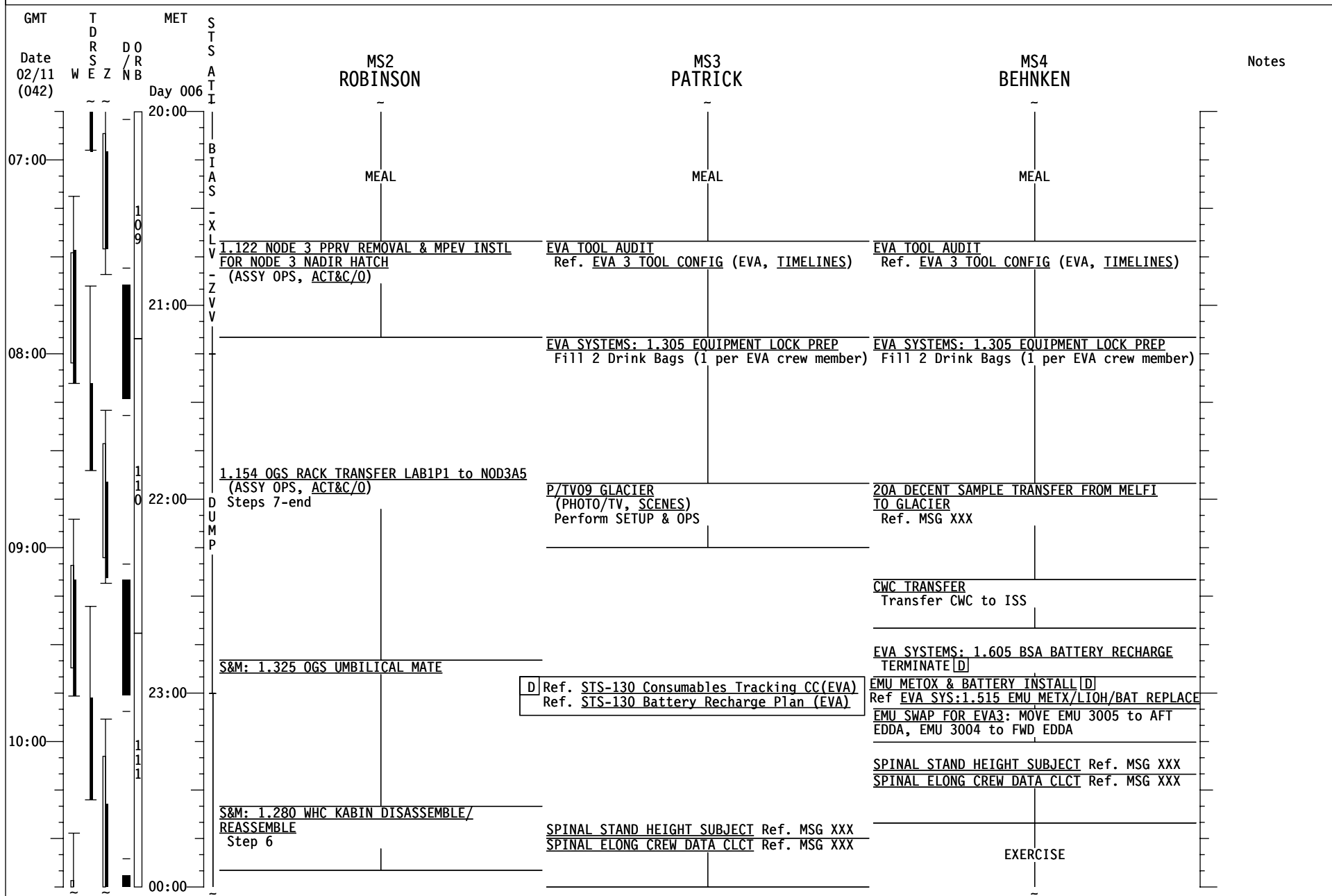

# STS-130 FD08

| GMT              | TDRS<br>W E Z | MET<br>Day 007 | S<br>T<br>S<br>A<br>T<br>I | CDR<br>ZAMKA  | PLT<br>VIRTS  | MS1<br>HIRE  | Notes                                   |
|------------------|---------------|----------------|----------------------------|---|---|--|---|
| Date 02/11 (042) |               |                |                            |   |   |  |   |
| 11:00            |               |                |                            |   |   | <u>SPINAL STAND HEIGHT SUBJECT</u> Ref. MSG XXX<br><u>SPINAL ELONG CREW DATA CLCT</u> Ref. MSG XXX |   |
|                  |               |                |                            |   |   | CUPOLA FN LK CK INIT   |   |
|                  |               |                |                            |   | <u>TV (ILLUMINATOR OPS) (PHOTO/TV, CC)</u><br>ILLUMINATORS ON - A & D |  | UPLINK<br>B21 + Mask<br>Box 20,21,22,23 |
|                  |               |                |                            | <u>FILTER CLEANING</u><br>(IFM, SCHEDULED MAINTENANCE)<br>Inspect filters and clean<br>as necessary             |   |  |   |
| 12:00            |               |                |                            |   | EXERCISE  |  |   |
|                  |               |                |                            |   |   | <u>MYCO BODY SAMPLE COLLECTION</u><br>(ASSY OPS, P/L) REVIEW ONLY                                  |   |
|                  |               |                |                            | <u>NETMEETING VIDEO CONFERENCING (ORB OPS, PGSC)</u><br>Private Medical Conference<br>KU TDRW (01:31-02:04) [E] |   | <u>PRE-SLEEP ACTIVITY</u><br>(ORB OPS, CREW SYS)   |   |
|                  |               |                |                            | FLIGHT DIRECTOR CONFERENCE  | <u>PUBLIC AFFAIRS EVENT</u><br>ISS KU AVAIL: 01:37-01:49              |  |   |
|                  |               |                |                            | <u>PRE-SLEEP ACTIVITY</u><br>(ORB OPS, CREW SYS)  | <u>PRE-SLEEP ACTIVITY</u><br>(ORB OPS, CREW SYS)                      |  |   |
| 13:00            |               |                |                            |   |   |  |   |
|                  |               |                |                            | [E] Omit steps 1,2,3<br>Use A/G2 for audio<br>Inform MCC of which PGSC will be used                             |   |  |   |
|                  |               |                |                            |   |   |  |   |
| 14:00            |               |                |                            |   |   |  |   |
| 04:00            |               |                |                            |   |   |  |   |

# STS-130 FD08

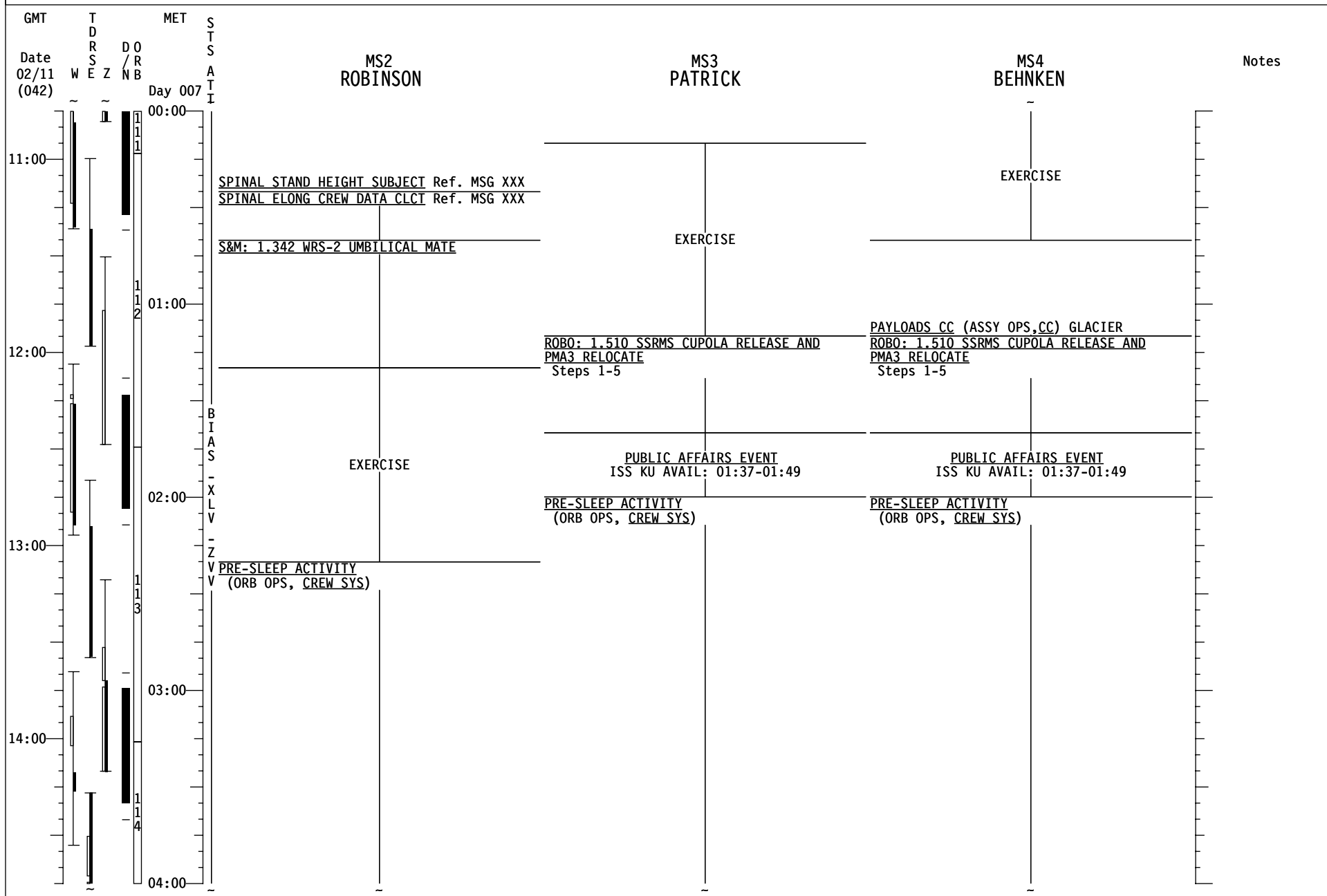

# STS-130 FD08

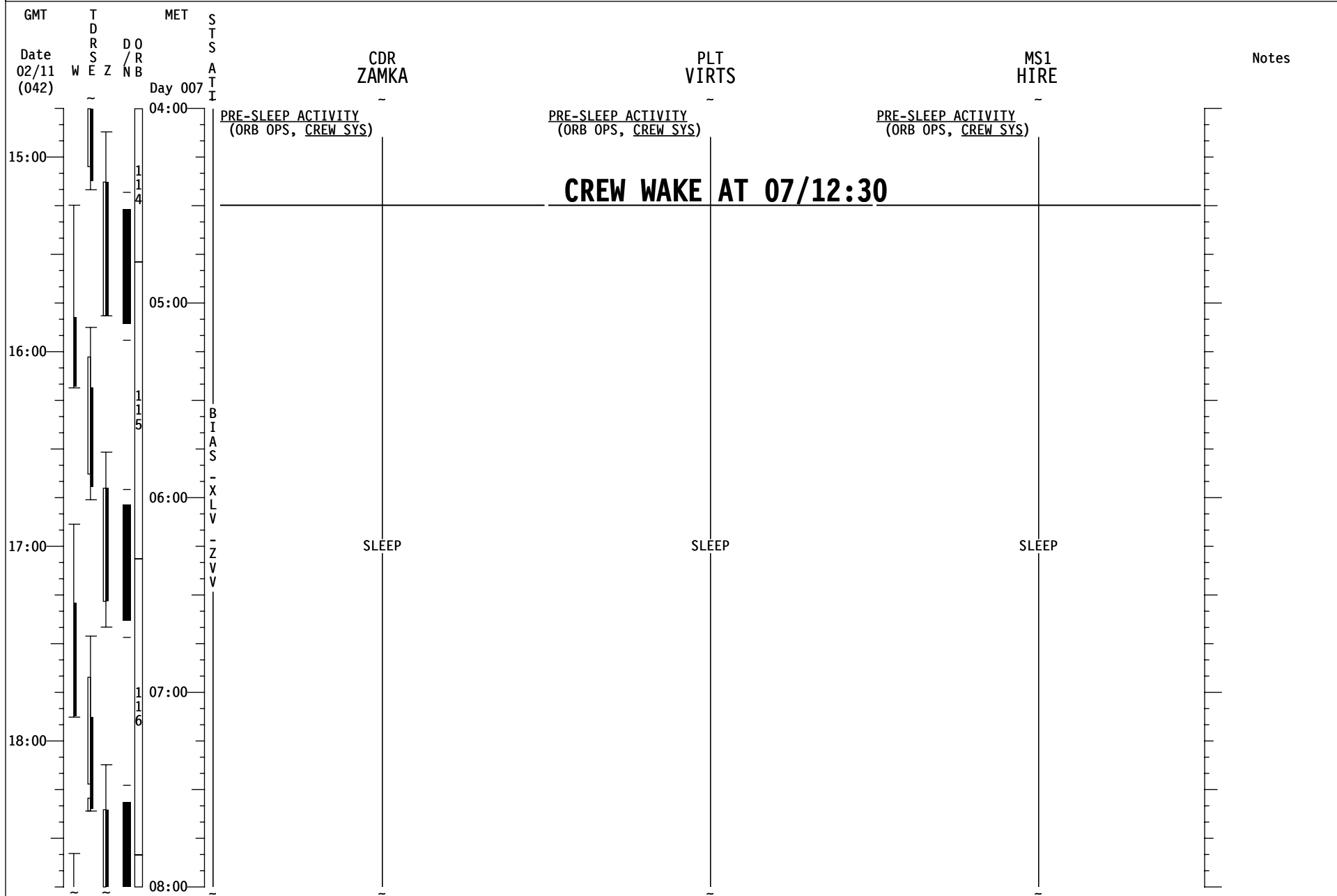

# STS-130 FD08

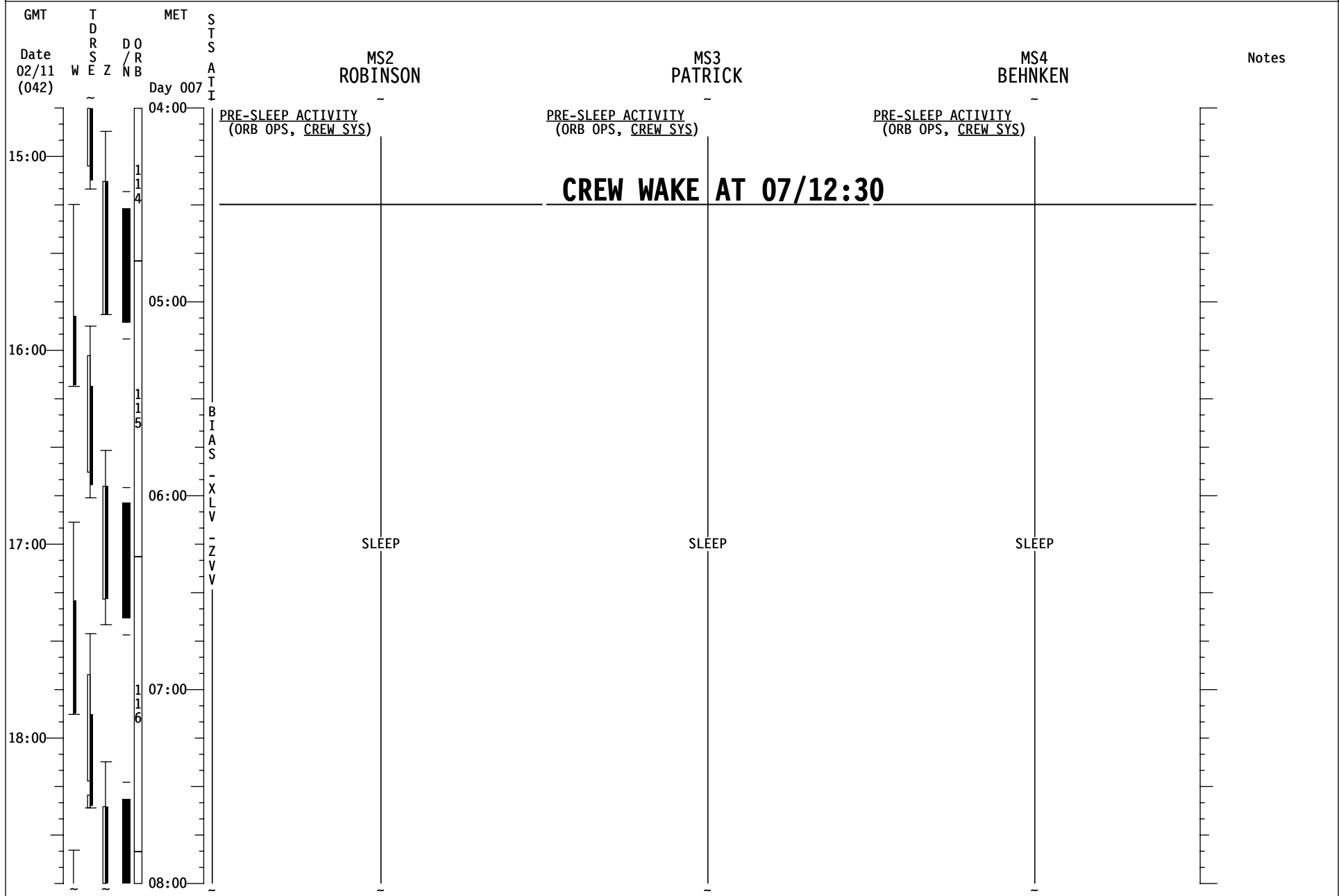

# STS-130 FD08

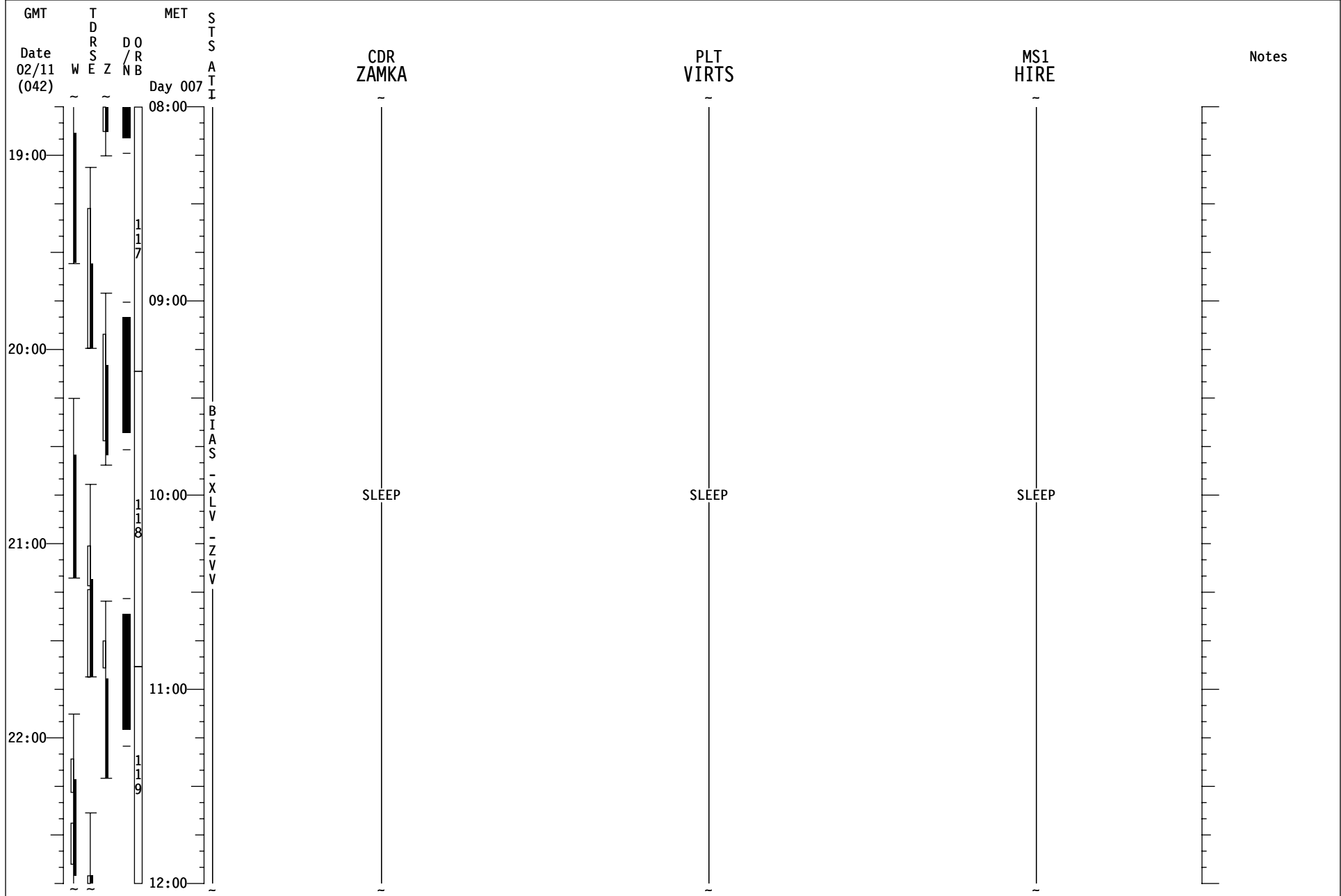



# STS-130 FD08

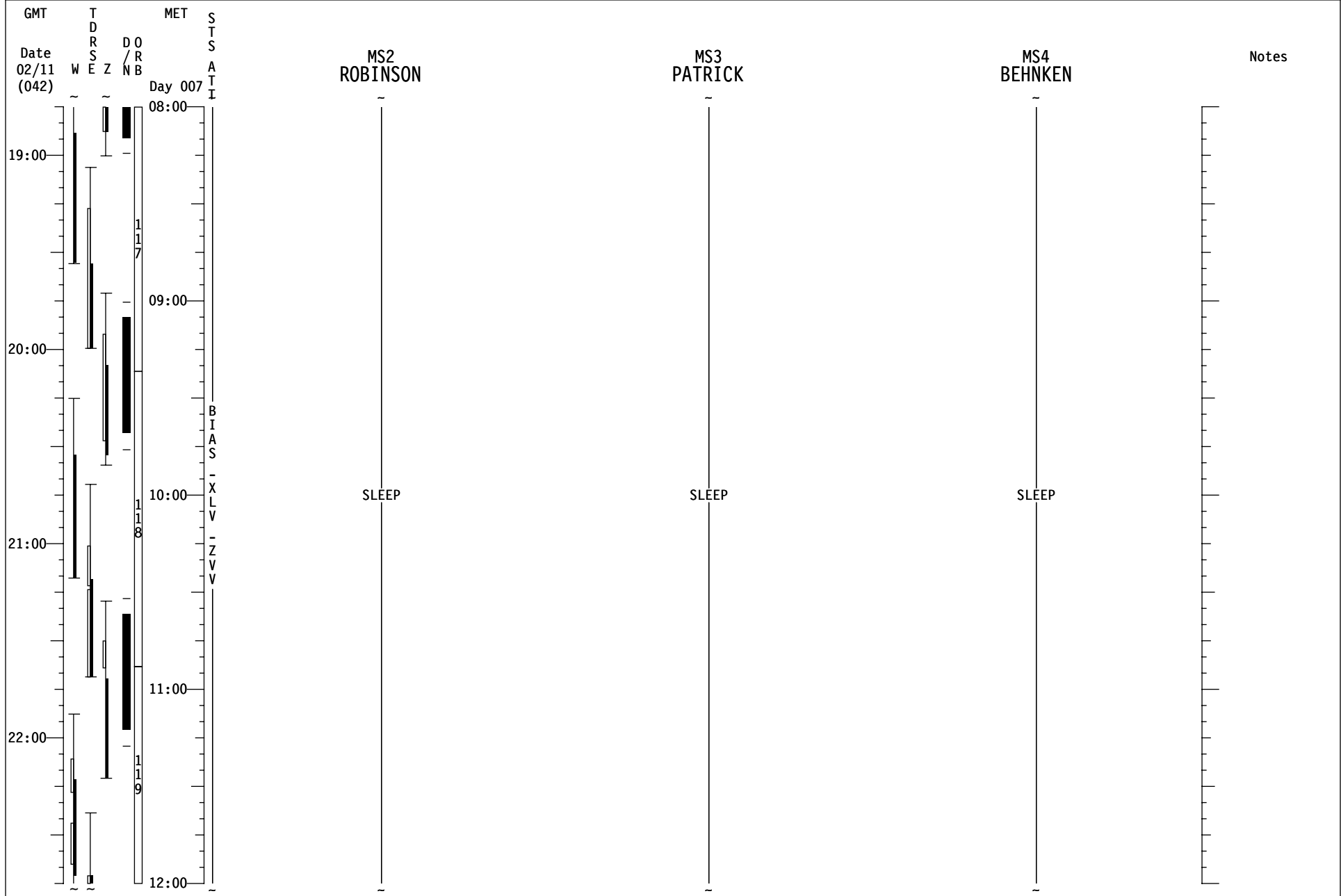

# STS-130 FD09

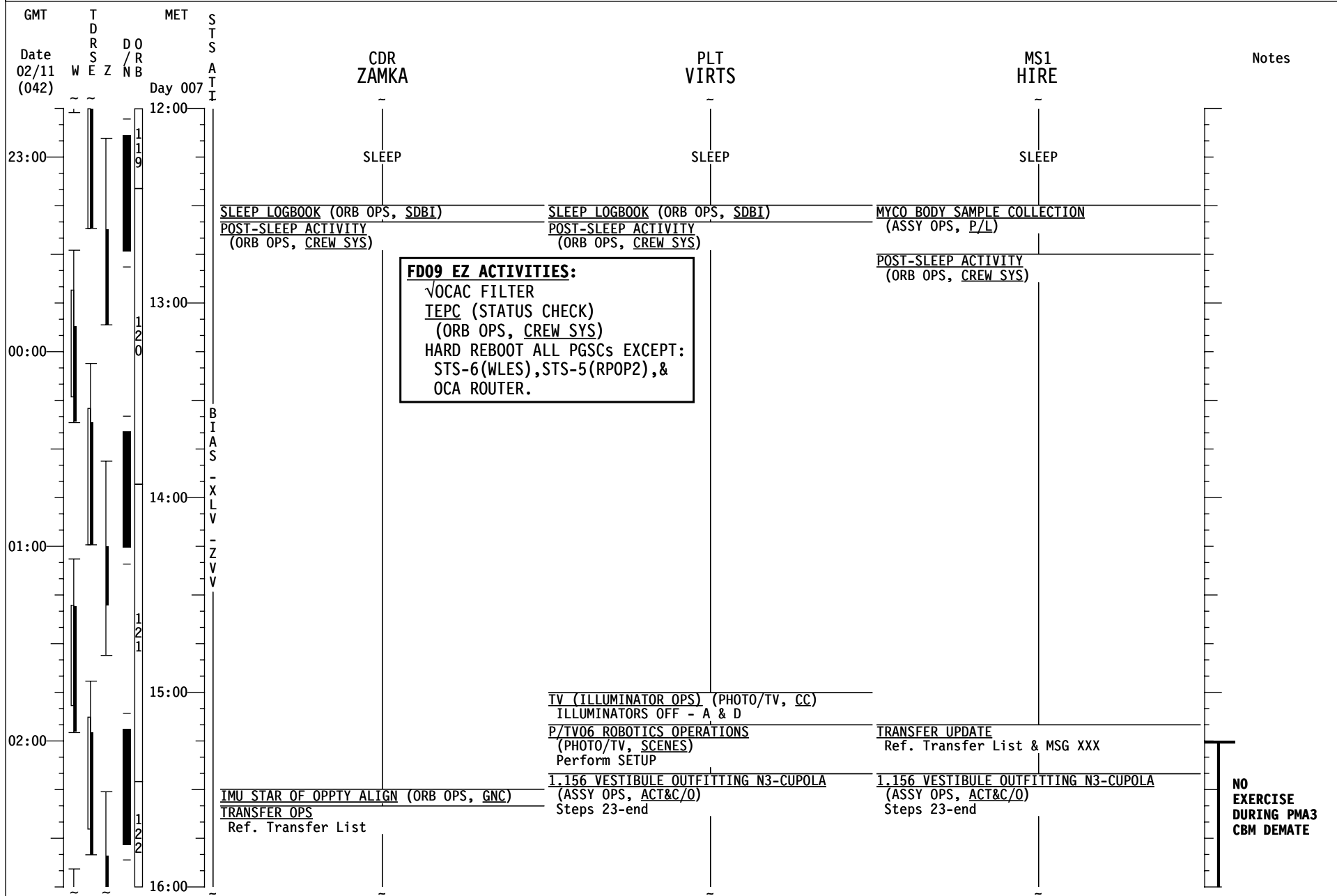

# STS-130 FD09

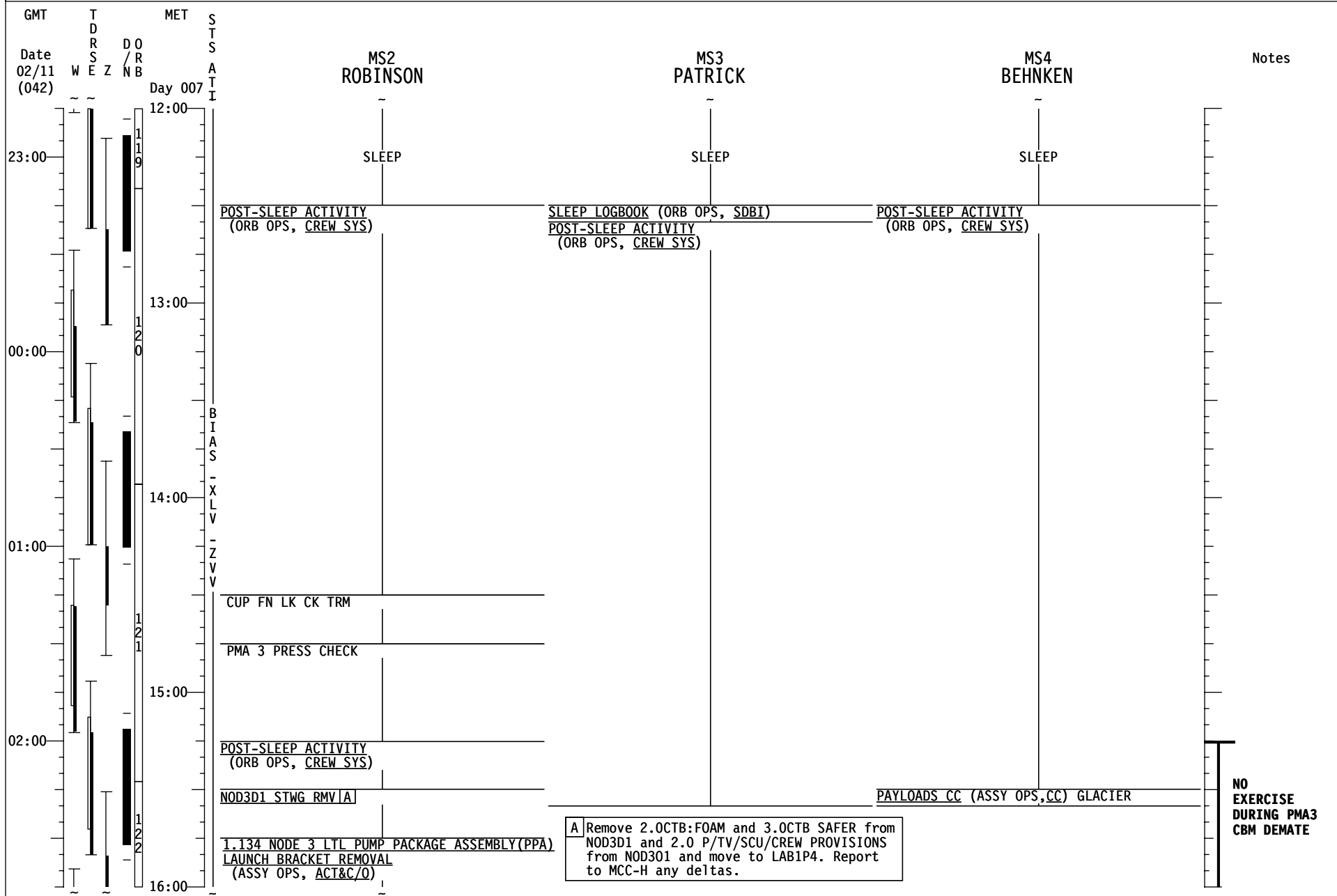

# STS-130 FD09

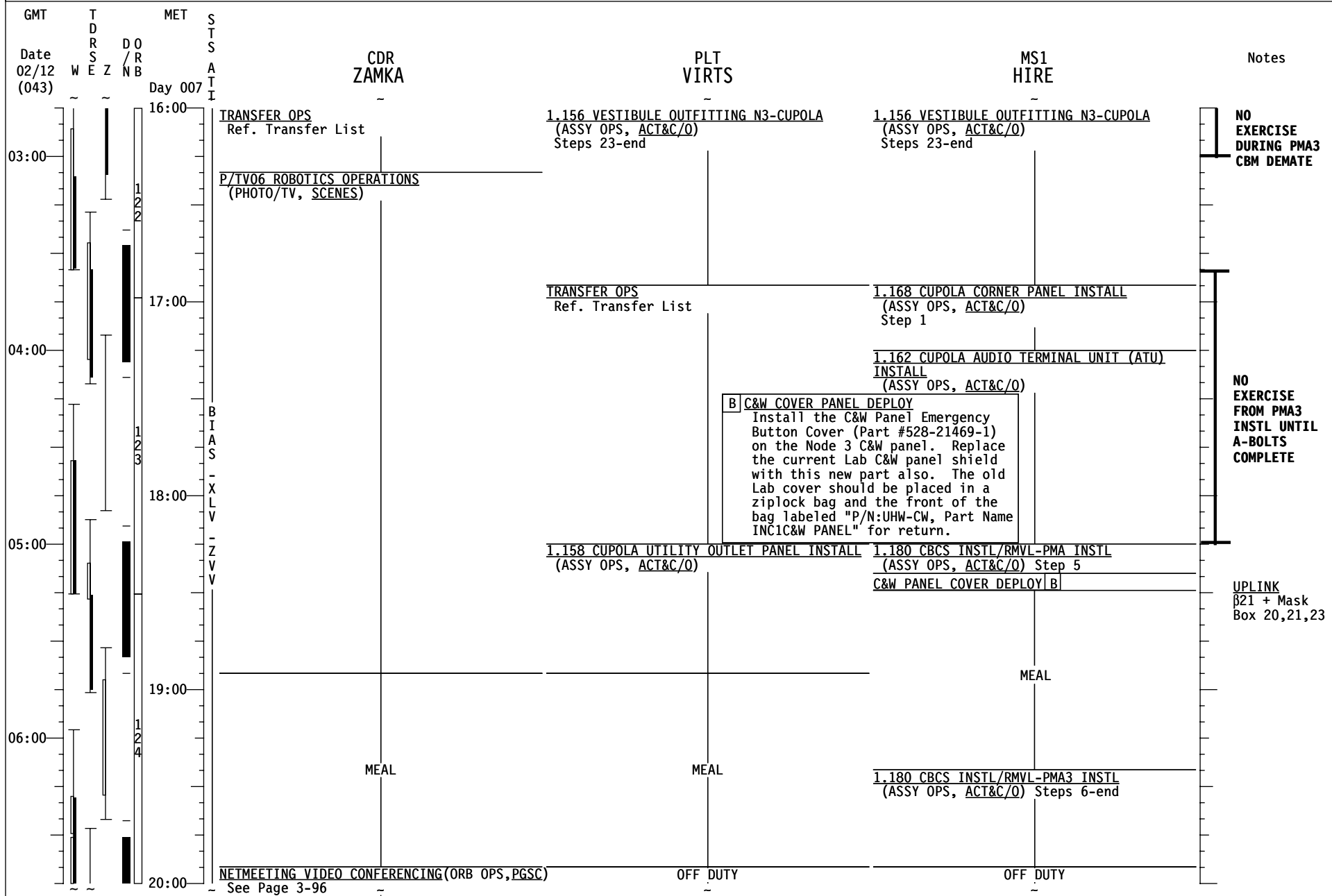

# STS-130 FD09

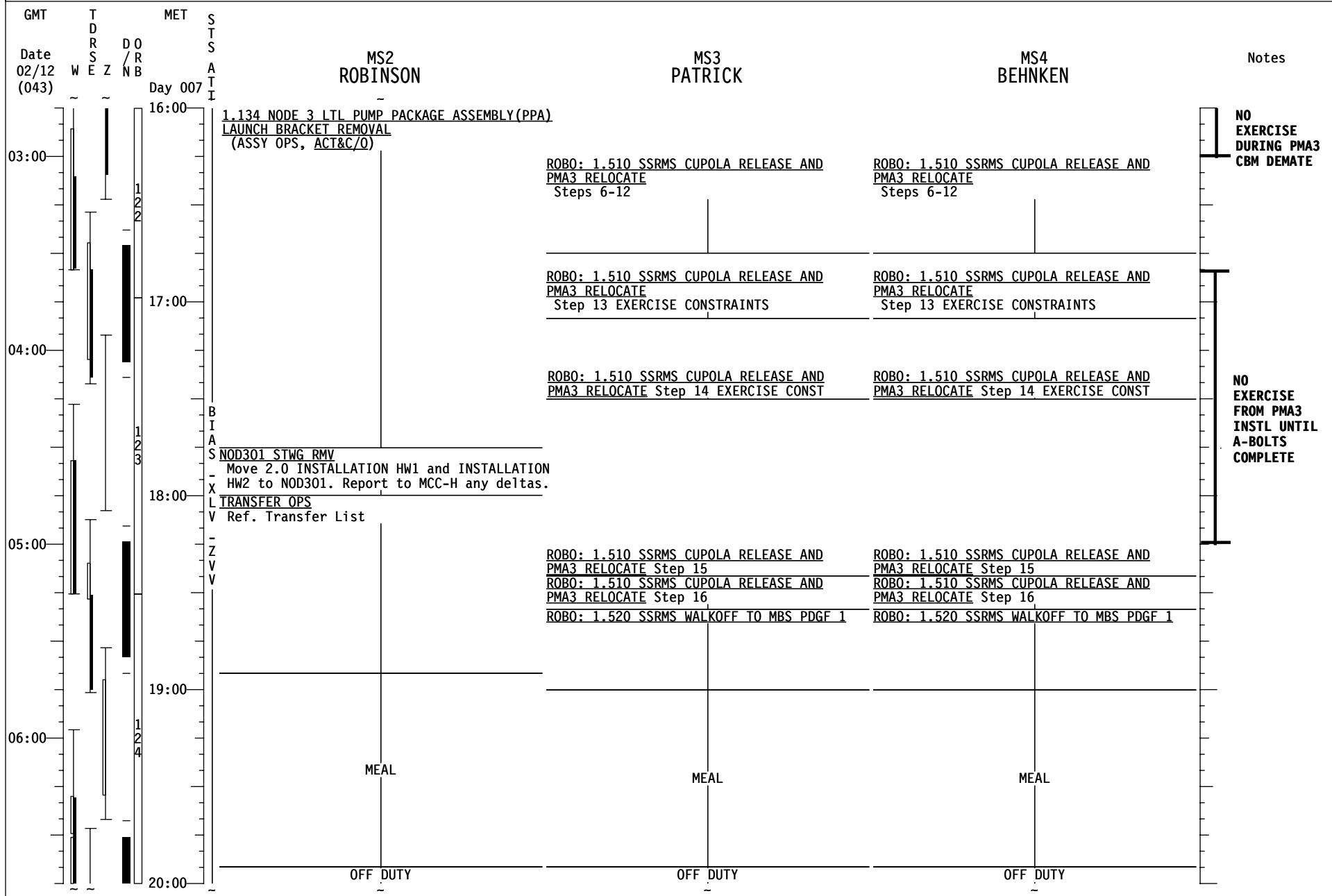

# STS-130 FD09

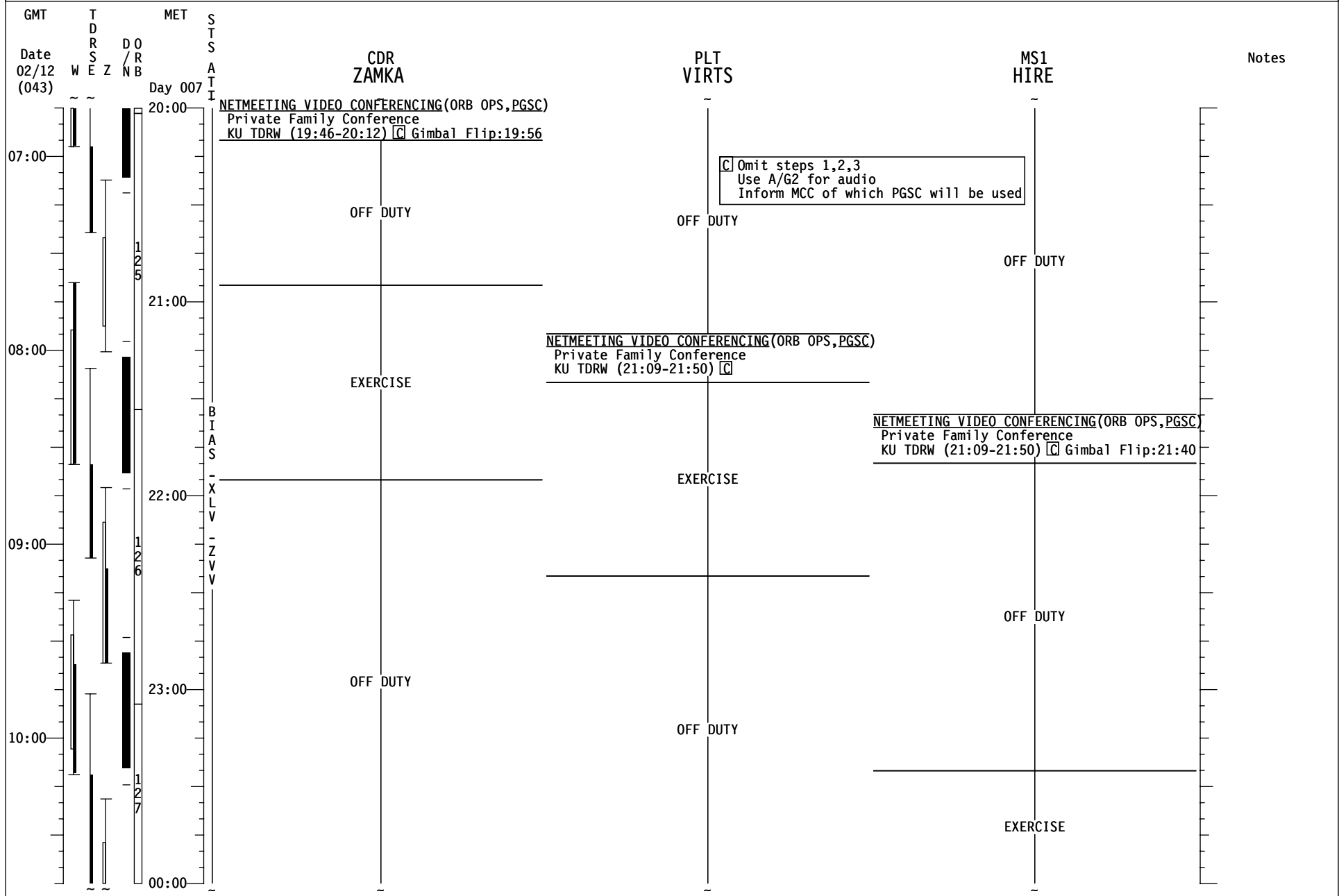

# STS-130 FD09

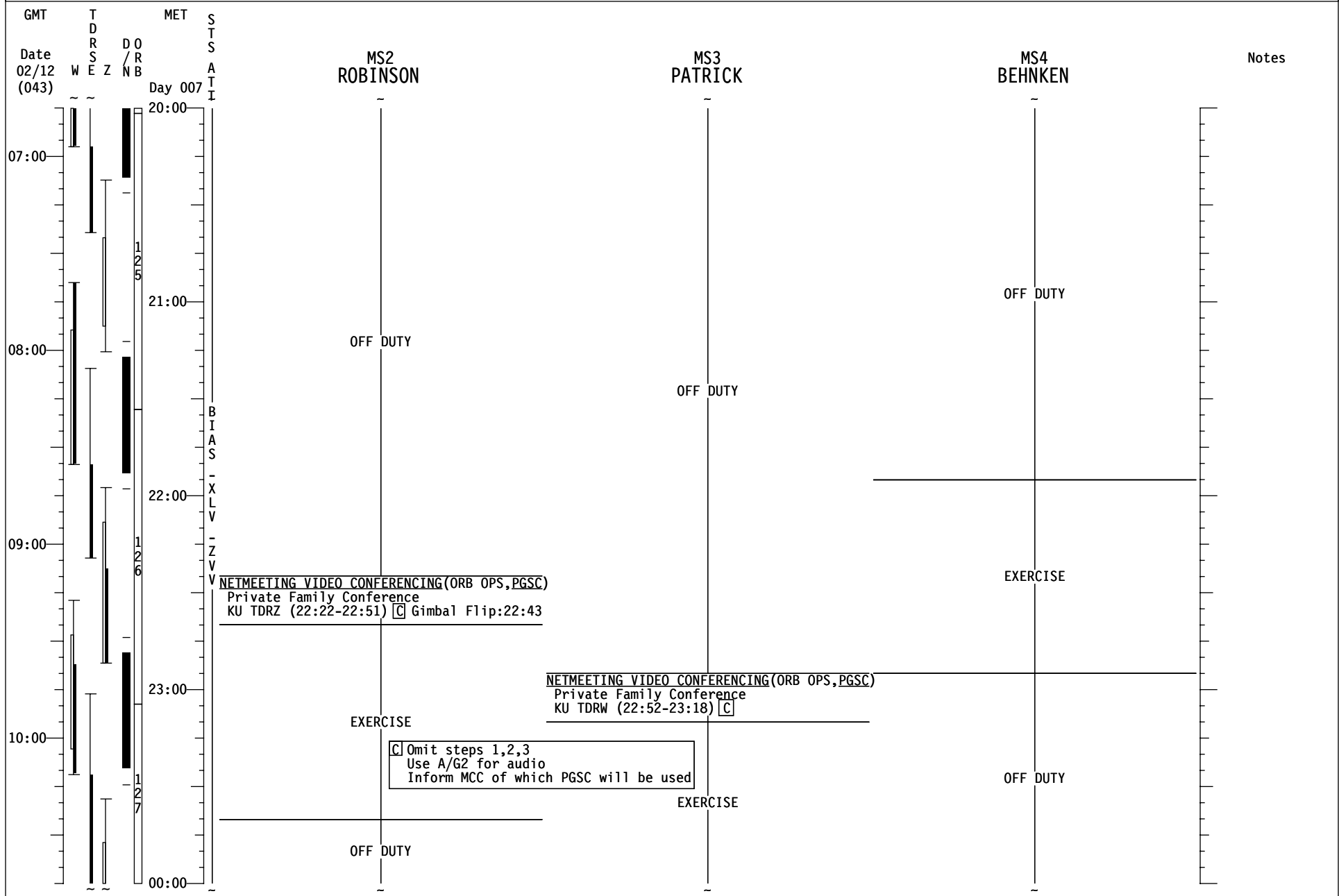

# STS-130 FD09

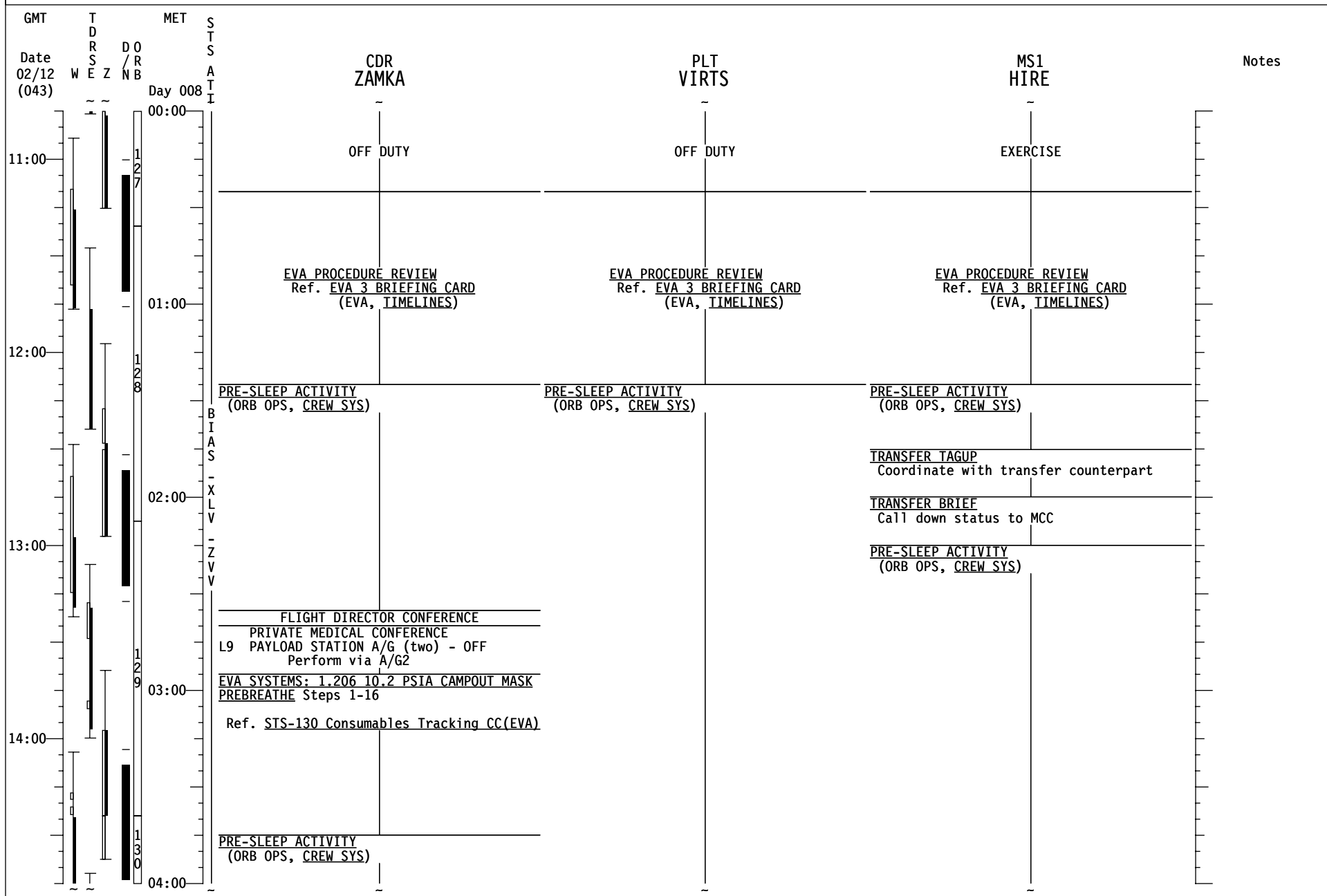



# STS-130 FD09

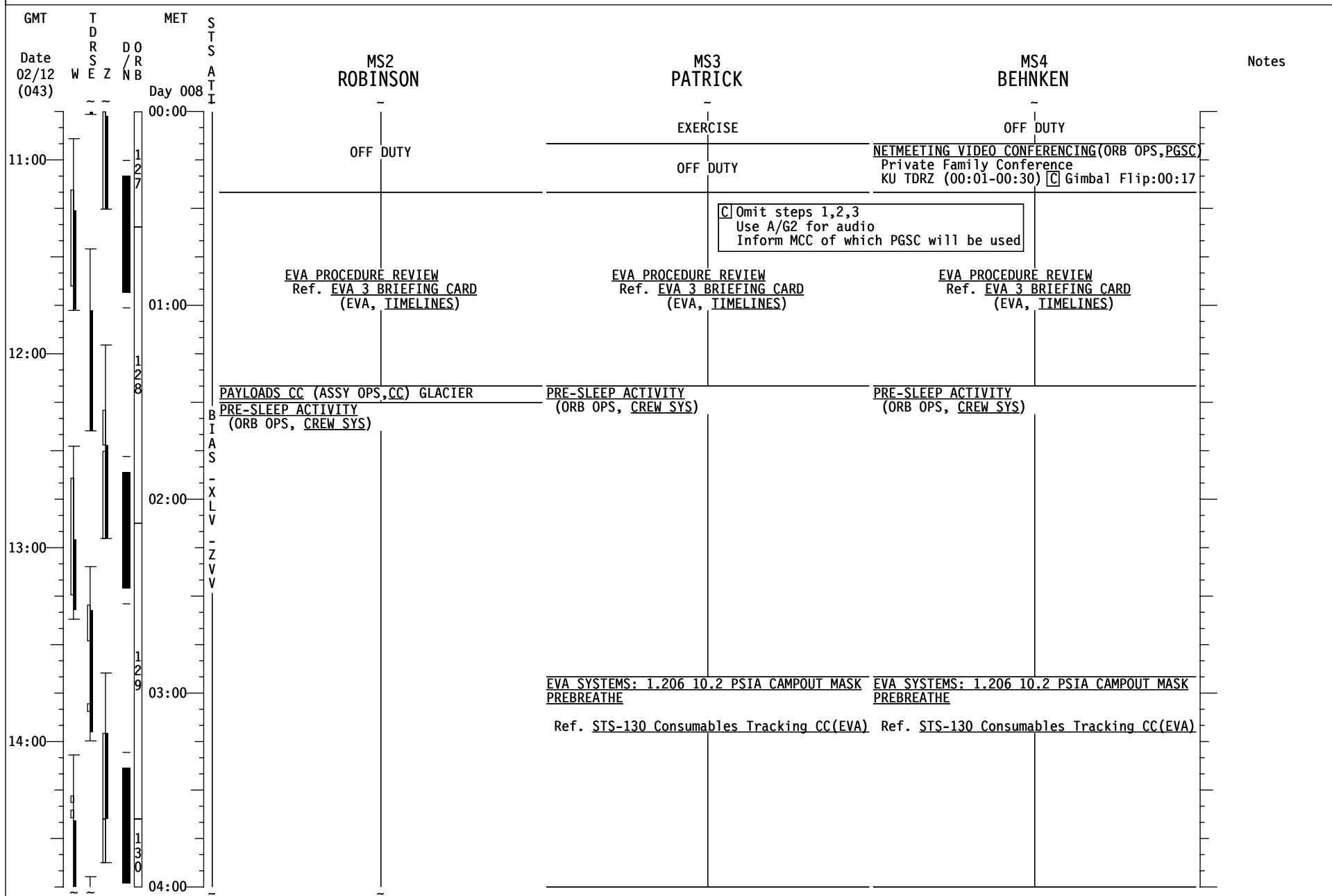

# STS-130 FD09

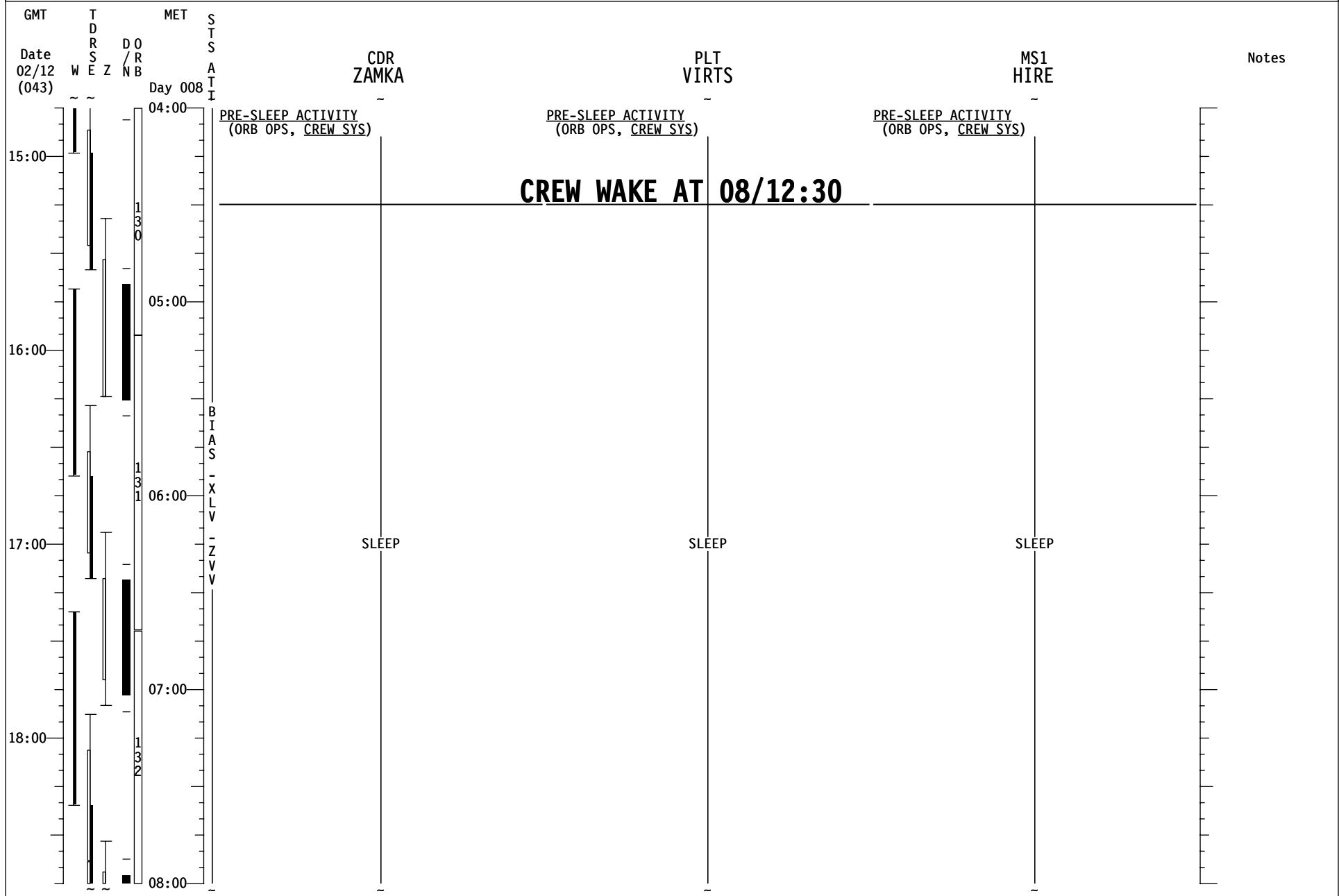

# STS-130 FD09

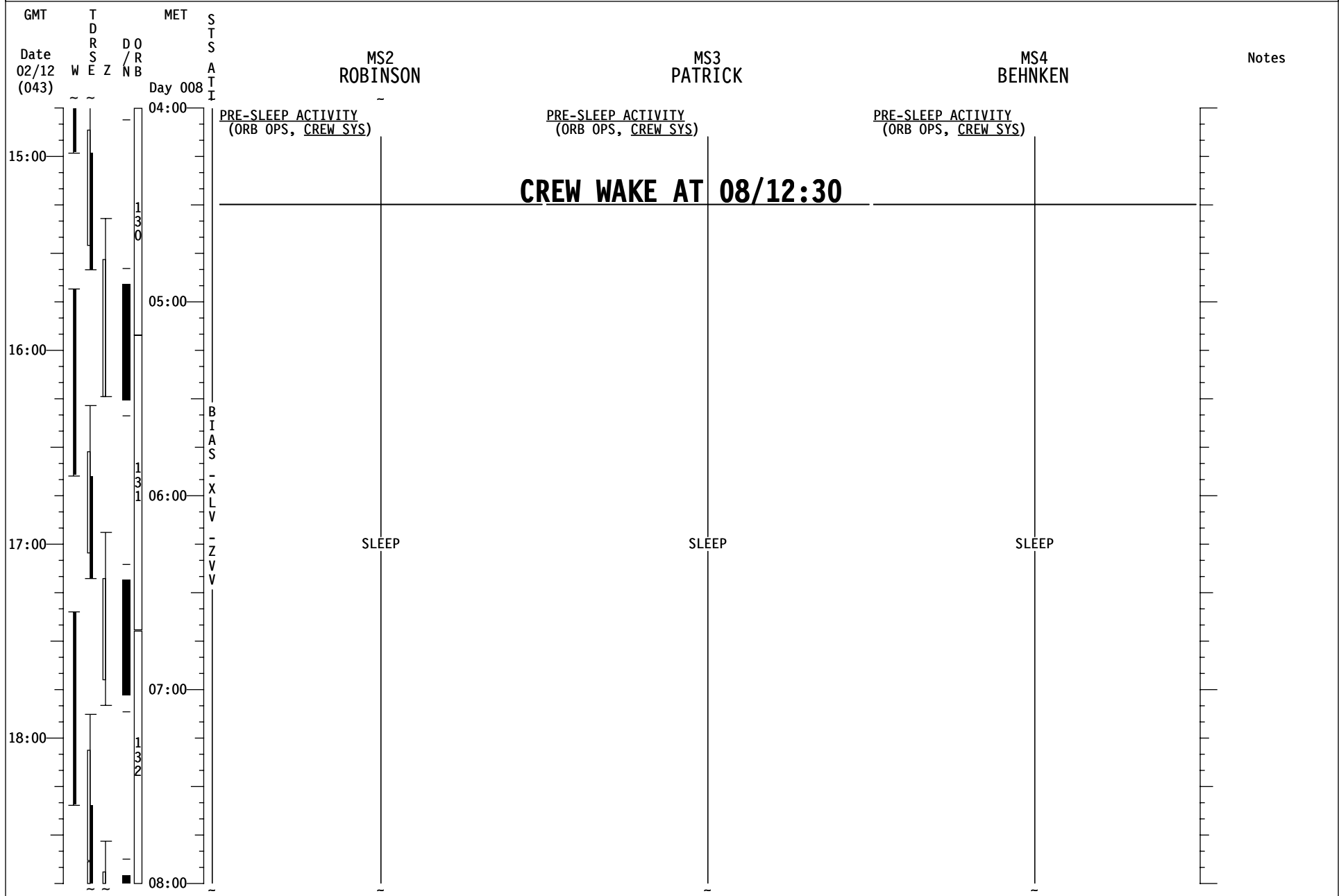





# STS-130 FD10

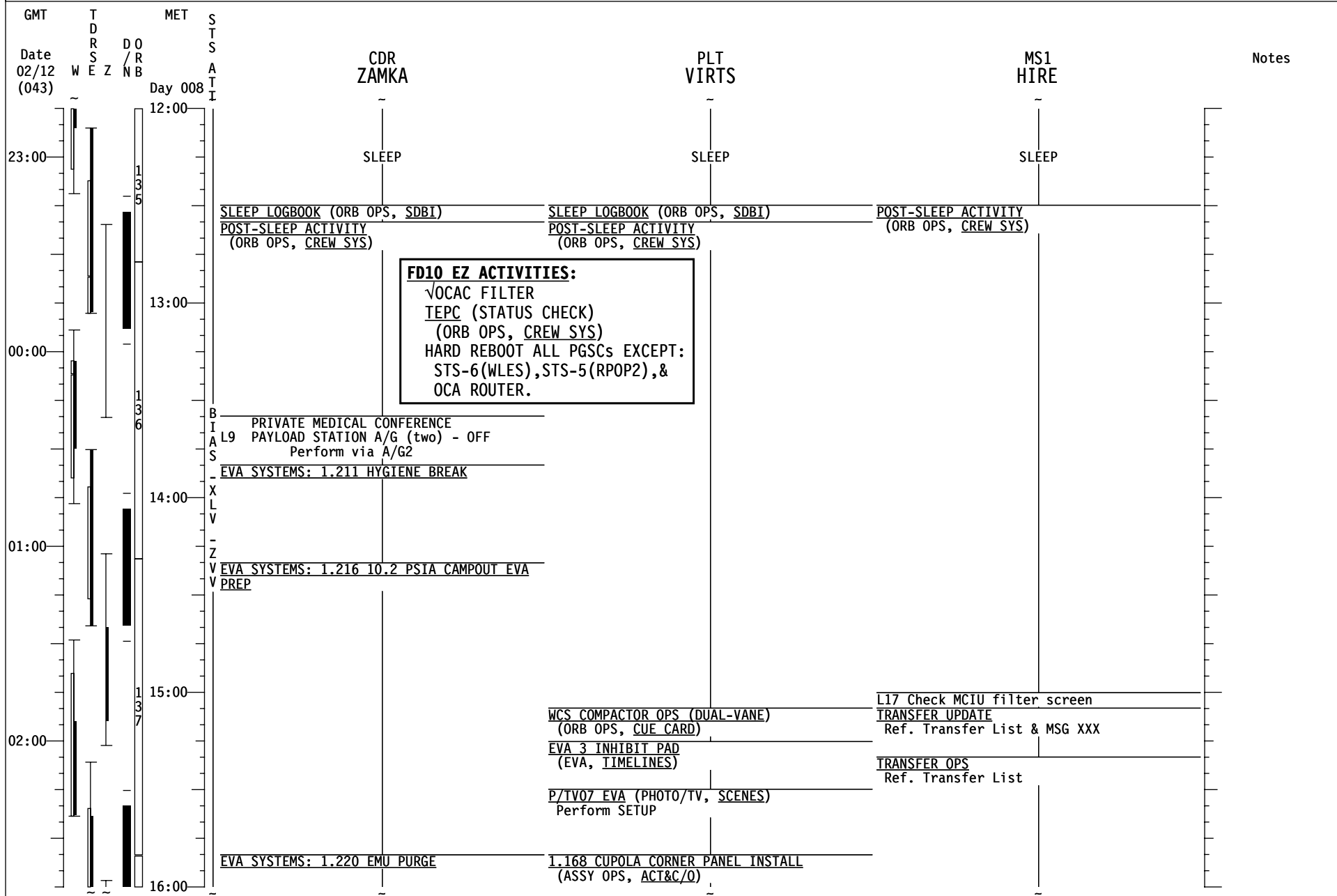

# STS-130 FD10

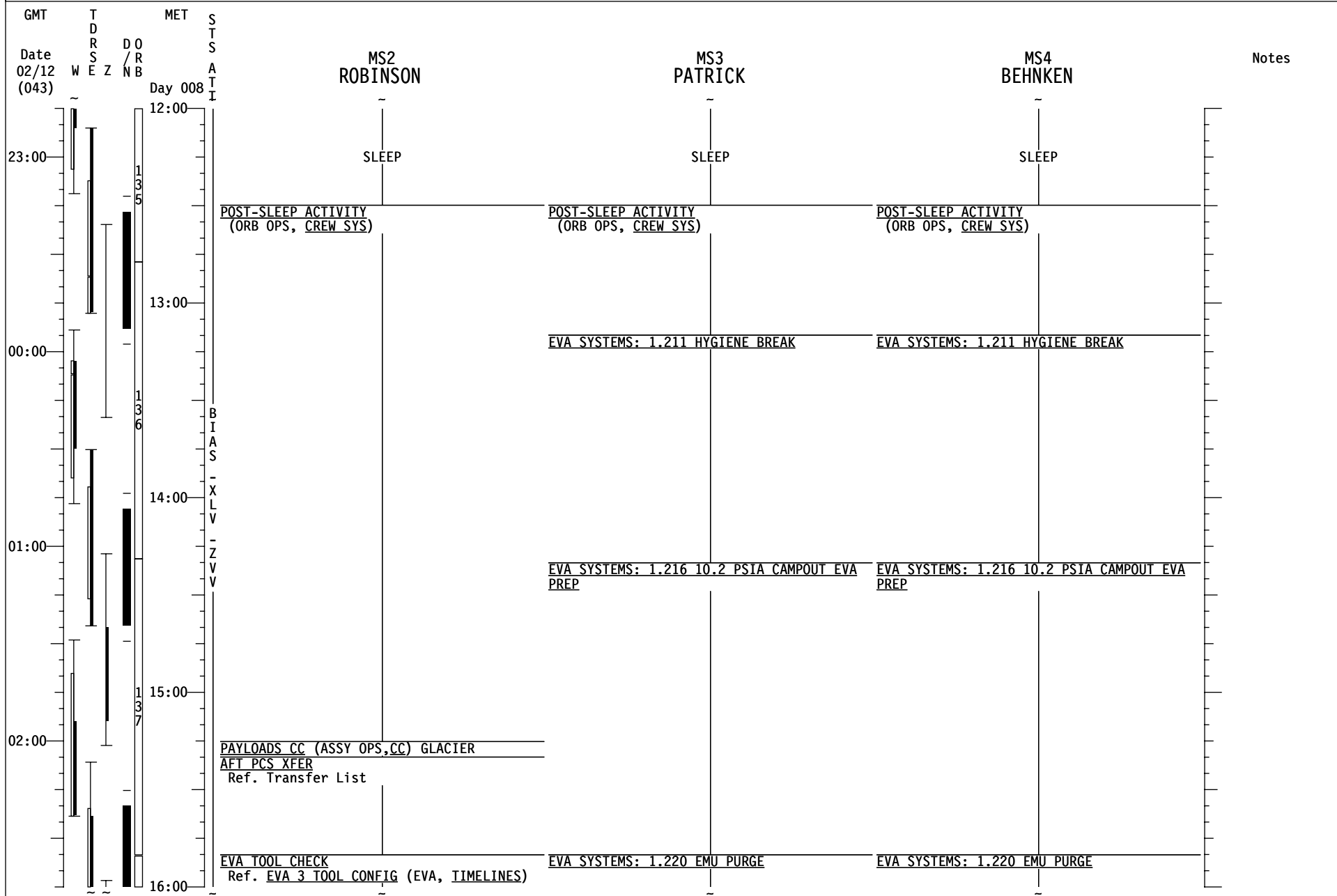

# STS-130 FD10

| GMT              | T D R S E Z | MET     | S T S | CDR ZAMKA   | PLT VIRT5   | MS1 HIRE   | Notes |
|------------------|-------------|---------|-------|---|---|--|-------|
| Date 02/13 (044) | W E Z       | Day 008 | A T I |   |   |  |       |
|                  |             |         |       |   |   |  |       |
| 03:00            |             |         |       | EVA SYSTEMS: 1.220 EMU PURGE<br>EVA SYSTEMS: 1.225 EMU PREBREATHE | 1.168 CUPOLA CORNER PANEL INSTALL<br>(ASSY OPS, ACT&C/O)                                  | TRANSFER OPS<br>Ref. Transfer List   |       |
|                  |             |         |       |   |   | 1.140 CUPOLA & NODE 3/NODE 1 ITCS FILL<br>USING FSS<br>(ASSY OPS, ACT&C/O)<br>Steps 1-15 |       |
| 04:00            |             |         |       | EVA SYSTEMS: CREWLOCK DEPRESS/REPRESS (CC)                        |   |  |       |
|                  |             |         |       | EVA SYSTEMS: CREWLOCK POST DEPRESS (CC)                           |   |  |       |
|                  |             |         |       | IMU STAR OF OPPTY ALIGN (ORB OPS, GNC)                            |   |  |       |
|                  |             |         |       | P/TVO7 EVA (PHOTO/TV, SCENES)<br>Perform OPS                      |   |  |       |
| 05:00            |             |         |       |   | 1.136 NODE 3 MTL PUMP PACKAGE ASSEMBLY(PPA)<br>LAUNCH BRACKET REMOVAL (ASSY OPS, ACT&C/O) |  |       |
|                  |             |         |       |   |   | 1.128 NODE 3 ITCS SAMPLING ADAPTER INSTALL<br>-MTL (NOD306)<br>(ASSY OPS, ACT&C/O)       |       |
| 06:00            |             |         |       |   |   |  |       |
| 20:00            |             |         |       |   |   |  |       |



# STS-130 FD10

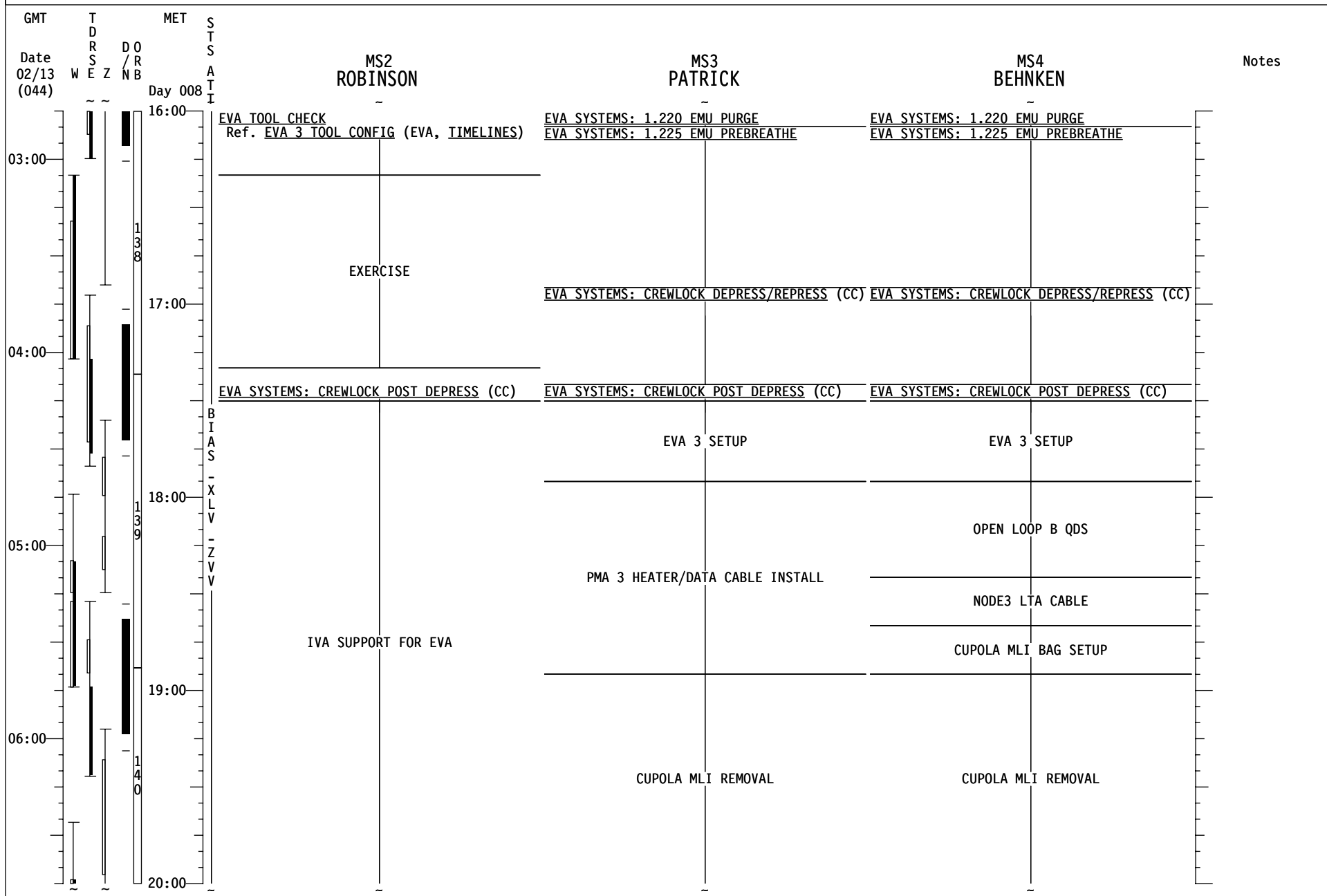

# STS-130 FD10

| GMT              | TDRS<br>W E Z | MET<br>DO<br>RNB | S<br>T<br>S<br>A<br>T<br>I | CDR<br>ZAMKA   | PLT<br>VIRTS  | MS1<br>HIRE   | Notes                              |
|------------------|---------------|------------------|----------------------------|--|---|---|------------------------------------|
| Date 02/13 (044) |               | Day 008          |                            |  |   |   |                                    |
| 07:00            |               |                  |                            | AREP   | MEAL  | MEAL  |                                    |
| 08:00            |               |                  |                            | SHUTTLE/ISS H2O CONTAINER FILL (HC)<br>(ORB OPS, ECLS) Init Fill #7<br>Ref. MSG XXX                    | 1.176 CUPOLA WINDOW SHUTTER TEST<br>(ASSY OPS, ACT&C/O) | 1.140 CUPOLA & NODE 3/NODE 1 ITCS FILL<br>USING FSS<br>(ASSY OPS, ACT&C/O)<br>Steps 17-32 |                                    |
| 09:00            |               |                  |                            | MEAL   | 1.160 CUPOLA RWS RELOCATION<br>(ASSY OPS, ACT&C/O)      |   |                                    |
| 10:00            |               |                  |                            | SHUTTLE/ISS H2O CONTAINER FILL (HC)<br>(ORB OPS, ECLS)<br>Perform FILL TERMINATION                     |   |   |                                    |
|                  |               |                  |                            | PWR FILL<br>(ORB OPS, ECLS)<br>Perform WATER FILL #2<br>Fill SN TBS (Barcode #TBS)<br>Fill dur ~30 min |   |   |                                    |
|                  |               |                  |                            | P/TV07 EVA<br>(PHOTO/TV, SCENES)<br>Perform OPS  |   |   |                                    |
|                  |               |                  |                            |  |   |   | TRANSFER OPS<br>Ref. Transfer List |
| 00:00            |               |                  |                            | EVA SYSTEMS: PRE REPRESS (CC)<br>EVA SYSTEMS: CREWLOCK DEPRESS/REPRESS (CC)                            | AREP  |   |                                    |

# STS-130 FD10

| GMT   | TDRS<br>W E Z | MET<br>Day 008 | S<br>T<br>S<br>A<br>T<br>I | MS2<br>ROBINSON      | MS3<br>PATRICK                | MS4<br>BEHNKEN                             | Notes |
|-------|---------------|----------------|----------------------------|----------------------|-------------------------------|--|-------|
| 07:00 | ~             | 20:00          | 140                        |                      | CUPOLA MLI REMOVAL            | CUPOLA MLI REMOVAL                         |       |
|       |               |                |                            |                      | CUPOLA LL RELEASE             |  |       |
|       |               |                |                            |                      | APFR RELOCATE                 | NODE 3 OIH/OI WIF INSTALL                  |       |
| 08:00 |               | 21:00          | 141                        |                      |                               |  |       |
|       |               |                |                            |                      | VSC VIDEO CABLE INSTALL       | VSC VIDEO CABLE INSTALL                    |       |
| 09:00 |               | 22:00          | 142                        | IVA SUPPORT FOR EVA  |                               | N2 CBM OPS                                 |       |
|       |               |                |                            |                      | P1 P-CLAMP RELEASE            | P1 P-CLAMP RELEASE                         |       |
| 10:00 |               | 23:00          | 143                        |                      | EVA CLEANUP & INGRESS         | EVA CLEANUP & INGRESS                      |       |
|       |               |                |                            |                      | EVA SYSTEMS: PRE REPRESS (CC) | EVA SYSTEMS: PRE REPRESS (CC)              |       |
|       |               |                |                            |                      | TRANSFER OPS                  | EVA SYSTEMS: CREWLOCK DEPRESS/REPRESS (CC) |       |
| 00:00 |               |                |                            | Ref. Transfer List ~ |                               | EVA SYSTEMS: CREWLOCK DEPRESS/REPRESS (CC) |       |

# STS-130 FD10

| GMT              | TDRSZ | MET     | SATS    | CDR ZAMKA   | PLT VIRT  | MS1 HIRE   | Notes |
|------------------|-------|---------|---------|---|---|--|-------|
| Date 02/13 (044) | W E Z | Day 009 | Day 009 |   |   |  |       |
| 11:00            |       |         |         | EVA SYSTEMS: CREWLOCK DEPRESS/REPRESS (CC)  |   |  |       |
|                  |       |         |         | EVA SYSTEMS: 1.240 POST EVA<br>Perform Water Recharge, No Metox Regen                 | ARED  |  |       |
|                  |       |         |         | Ref. STS-130 Consumables Tracking CC(EVA)<br>Ref. STS-130 Battery Recharge Plan (EVA) |   | EXERCISE   |       |
|                  |       |         |         |   | JOINT OPS: 3.123 O2 TRANSFER SETUP (POST PREBREATHE USING SHUTTLE O2)<br>Steps 2-5.8, Ground will perform steps 2.5 and 5.6 |  |       |
| 12:00            |       |         |         |   |   | TRANSFER TAGUP<br>Coordinate with transfer counterpart |       |
|                  |       |         |         |   |   | TRANSFER BRIEF<br>Call down status to MCC              |       |
|                  |       |         |         |   | JOINT OPS: 3.116 HIGH PRESS TANK O2 XFER Step 2   |  |       |
|                  |       |         |         | PRE-SLEEP ACTIVITY (ORB OPS, CREW SYS)  | PRE-SLEEP ACTIVITY (ORB OPS, CREW SYS)  | PRE-SLEEP ACTIVITY (ORB OPS, CREW SYS)                 |       |
| 13:00            |       |         |         | FLIGHT DIRECTOR CONFERENCE  |   |  |       |
|                  |       |         |         | PRIVATE MEDICAL CONFERENCE  |   |  |       |
|                  |       |         |         | PAYLOAD STATION A/G (two) - OFF<br>Perform via A/G2                                   |   |  |       |
|                  |       |         |         | PRE-SLEEP ACTIVITY (ORB OPS, CREW SYS)  |   |  |       |
| 14:00            |       |         |         |   |   |  |       |
| 04:00            |       |         |         |   |   |  |       |

CREW WAKE AT 09/12:00

# STS-130 FD10

| GMT              | T D R S<br>W E Z | MET<br>D O R<br>N B | S T S<br>A T I | MS2<br>ROBINSON  | MS3<br>PATRICK   | MS4<br>BEHNKEN   | Notes |
|------------------|------------------|---------------------|----------------|--|--|--|-------|
| Date 02/13 (044) |                  | Day 009             |                |  |  |  |       |
| 11:00            |                  | 143                 |                | <u>TRANSFER OPS</u><br>Ref. Transfer List  | <u>EVA SYSTEMS: CREWLOCK DEPRESS/REPRESS (CC)</u><br><u>EVA SYSTEMS: 1.240 POST EVA</u><br>Perform Water Recharge, No Metox Regen<br>Ref. <u>STS-130 Consumables Tracking CC(EVA)</u><br>Ref. <u>STS-130 Battery Recharge Plan (EVA)</u> | <u>EVA SYSTEMS: CREWLOCK DEPRESS/REPRESS (CC)</u><br><u>EVA SYSTEMS: 1.240 POST EVA</u><br>Perform Water Recharge, No Metox Regen<br>Ref. <u>STS-130 Consumables Tracking CC(EVA)</u><br>Ref. <u>STS-130 Battery Recharge Plan (EVA)</u> |       |
| 12:00            |                  |                     |                | <u>CWC TRANSFER</u><br>Transfer CWC to ISS<br><br><u>PWR TRANSFER</u><br>Transfer PWR to ISS<br><br><u>PAYLOADS CC (ASSY OPS,CC) GLACIER</u> |  |  |       |
| 13:00            |                  | 144                 |                | <u>PRE-SLEEP ACTIVITY</u><br>(ORB OPS, CREW SYS)   | <u>PRE-SLEEP ACTIVITY</u><br>(ORB OPS, CREW SYS)   | <u>PRE-SLEEP ACTIVITY</u><br>(ORB OPS, CREW SYS)   |       |
| 14:00            |                  | 145                 |                |  |  |  |       |
| 04:00            |                  |                     |                |  | <b>CREW WAKE AT 09/12:00</b>   |  |       |

# STS-130 FD10

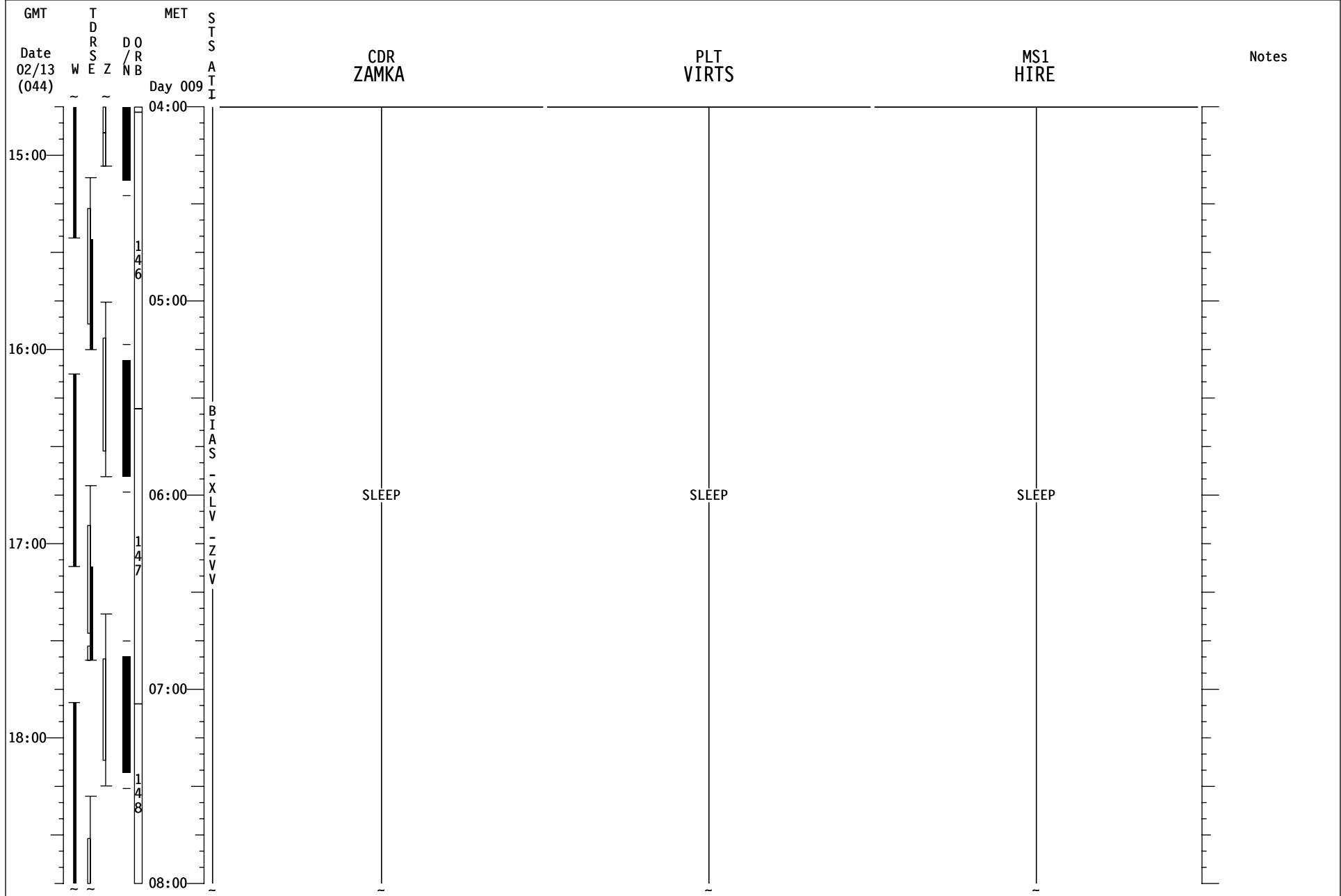

# STS-130 FD10

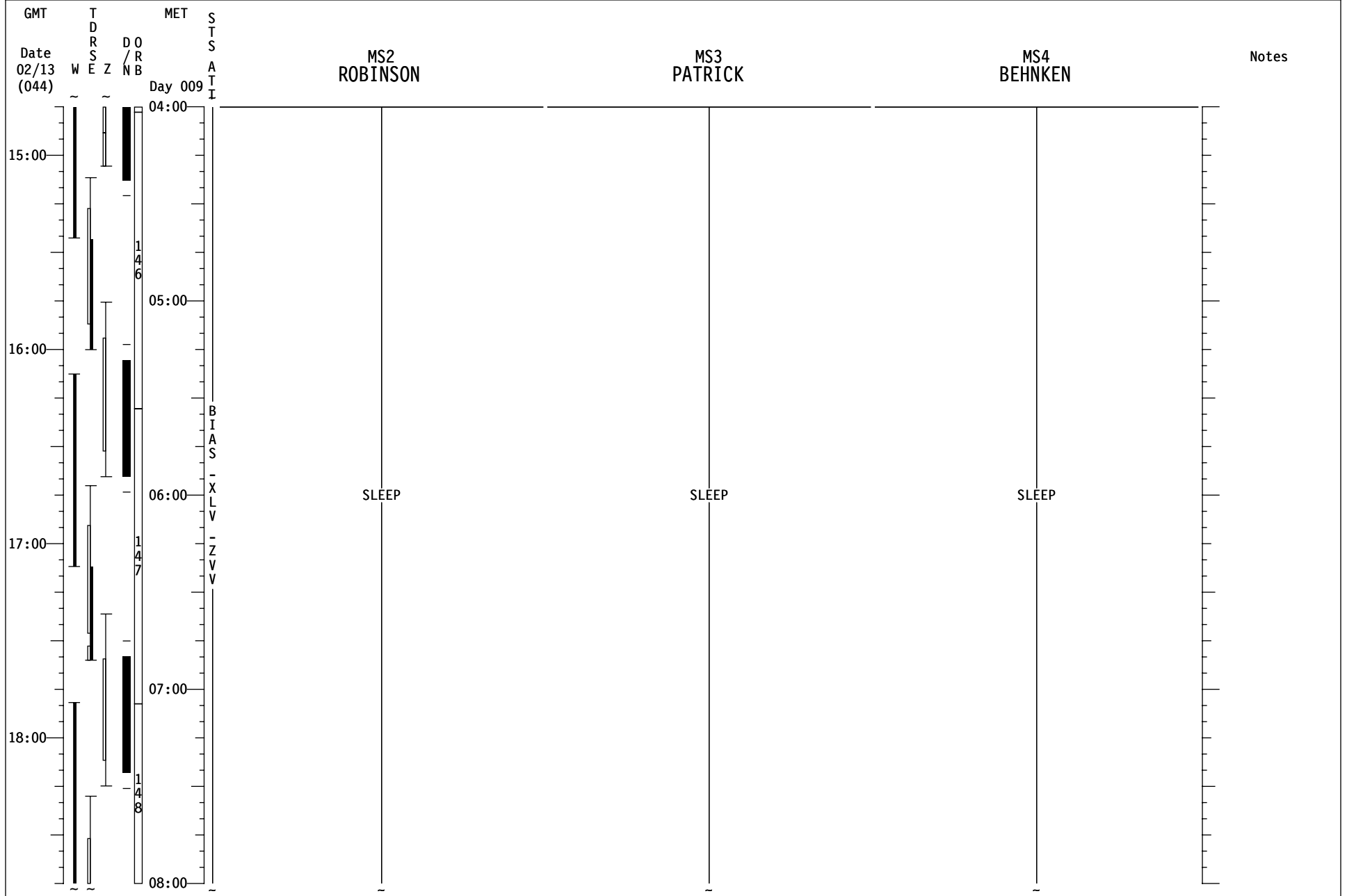

# STS-130 FD11

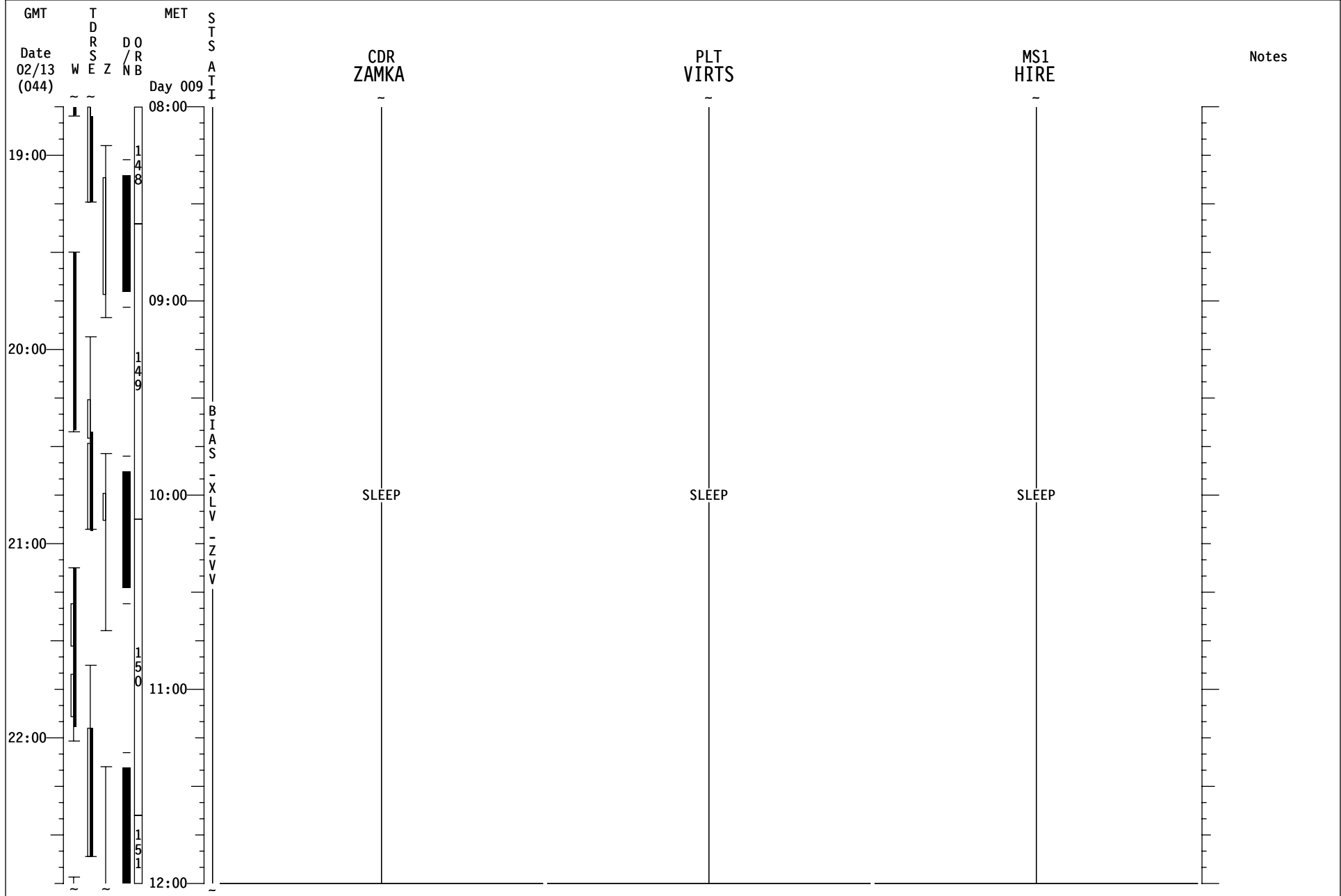





# STS-130 FD11

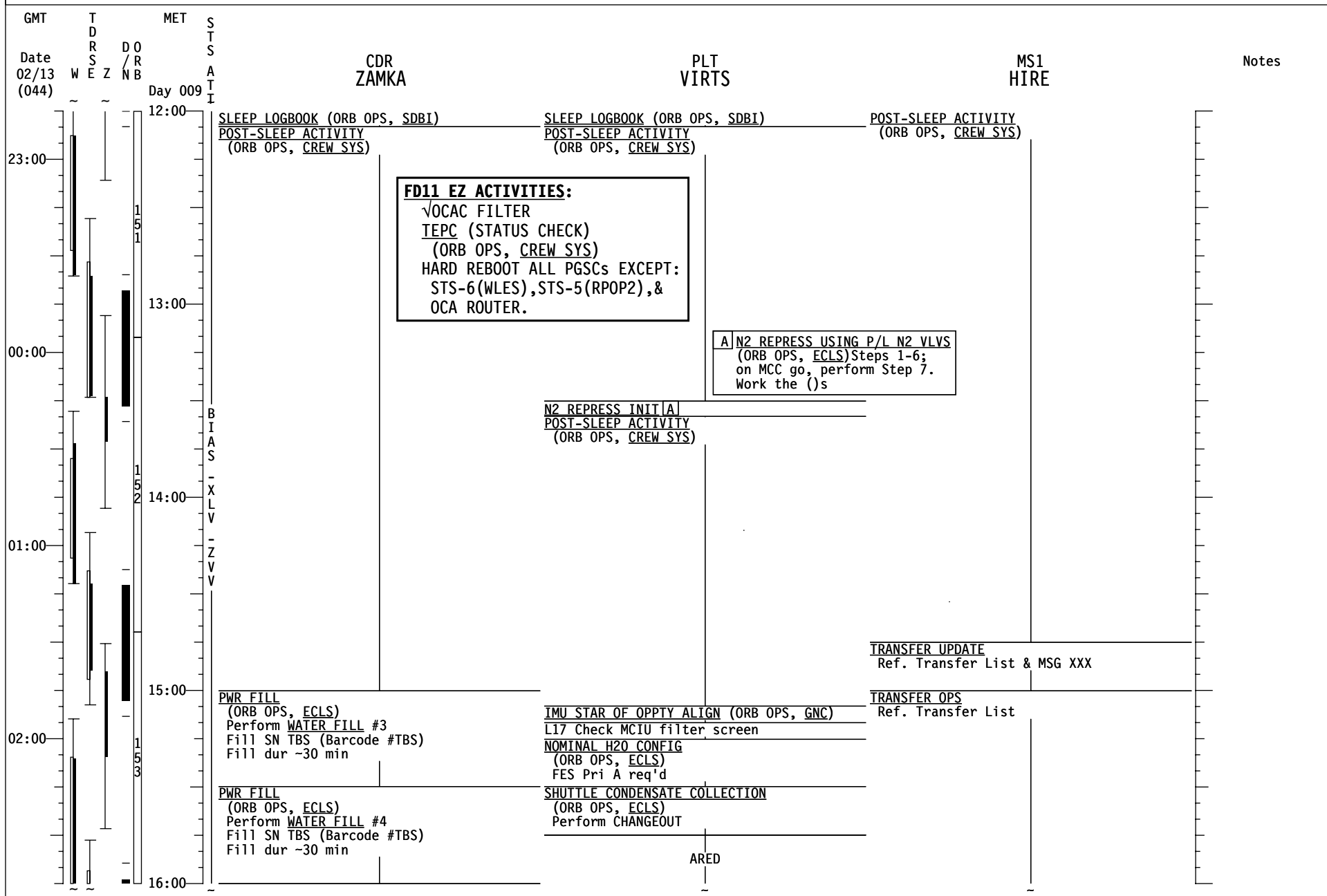

# STS-130 FD11

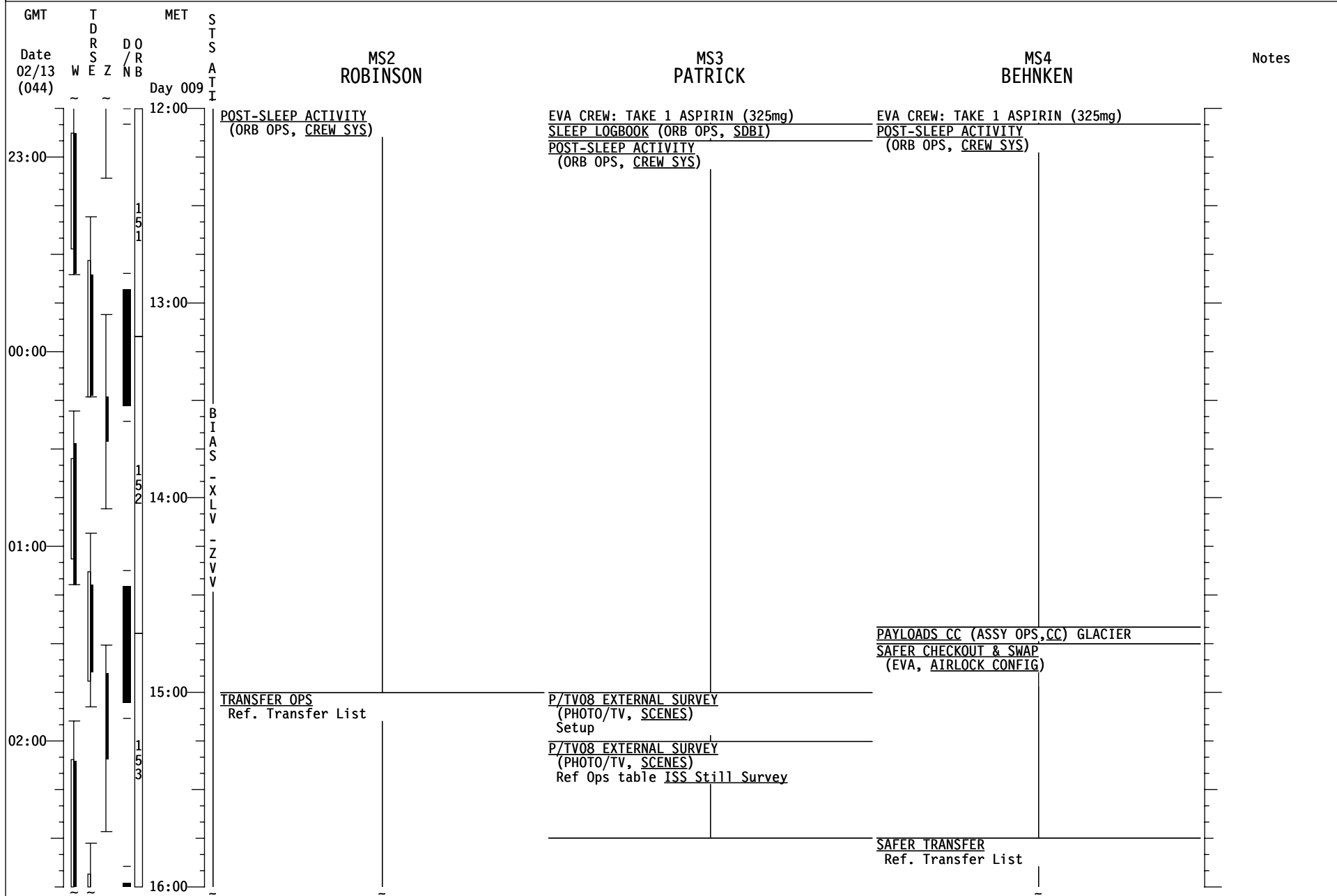



# STS-130 FD11

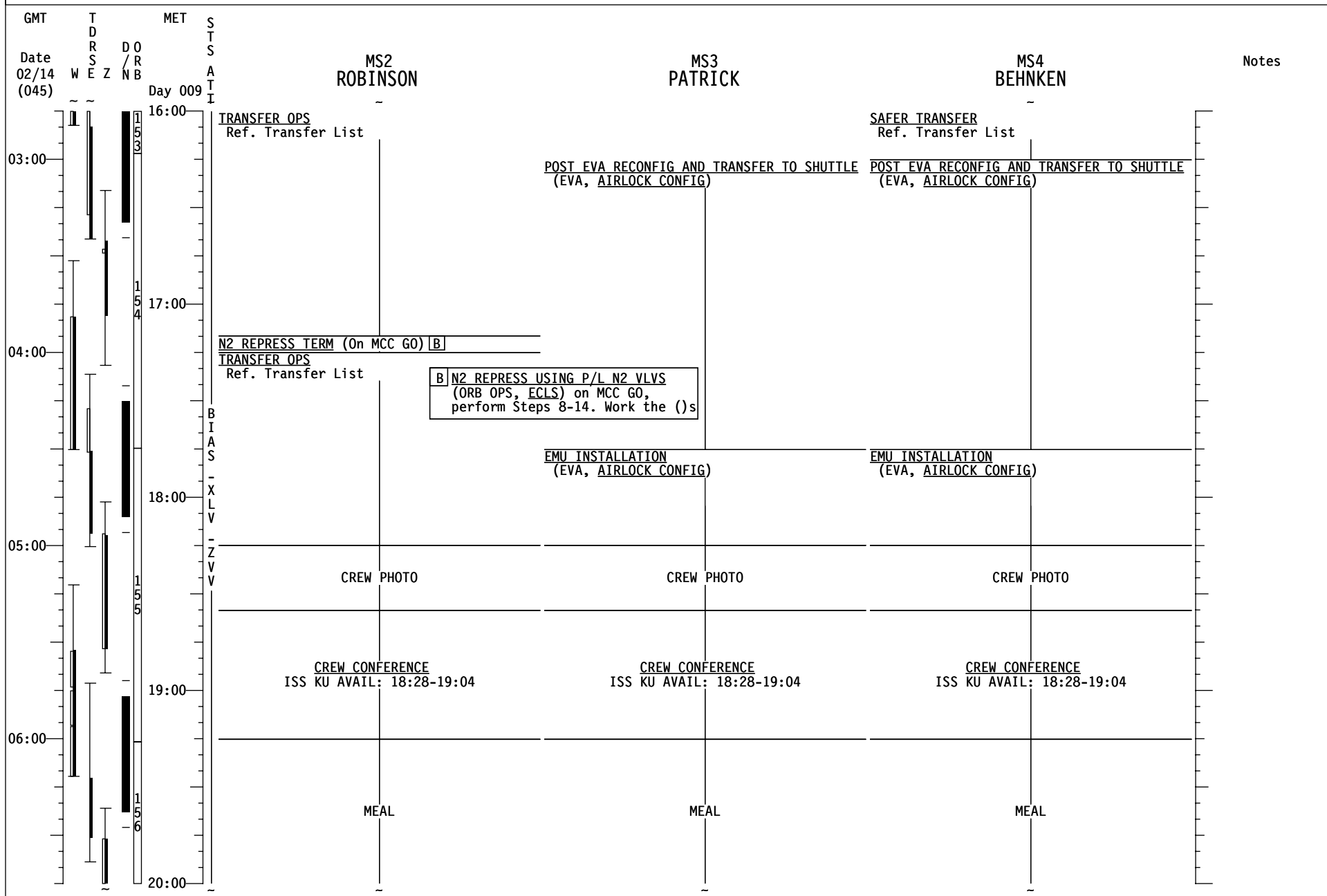



# STS-130 FD11

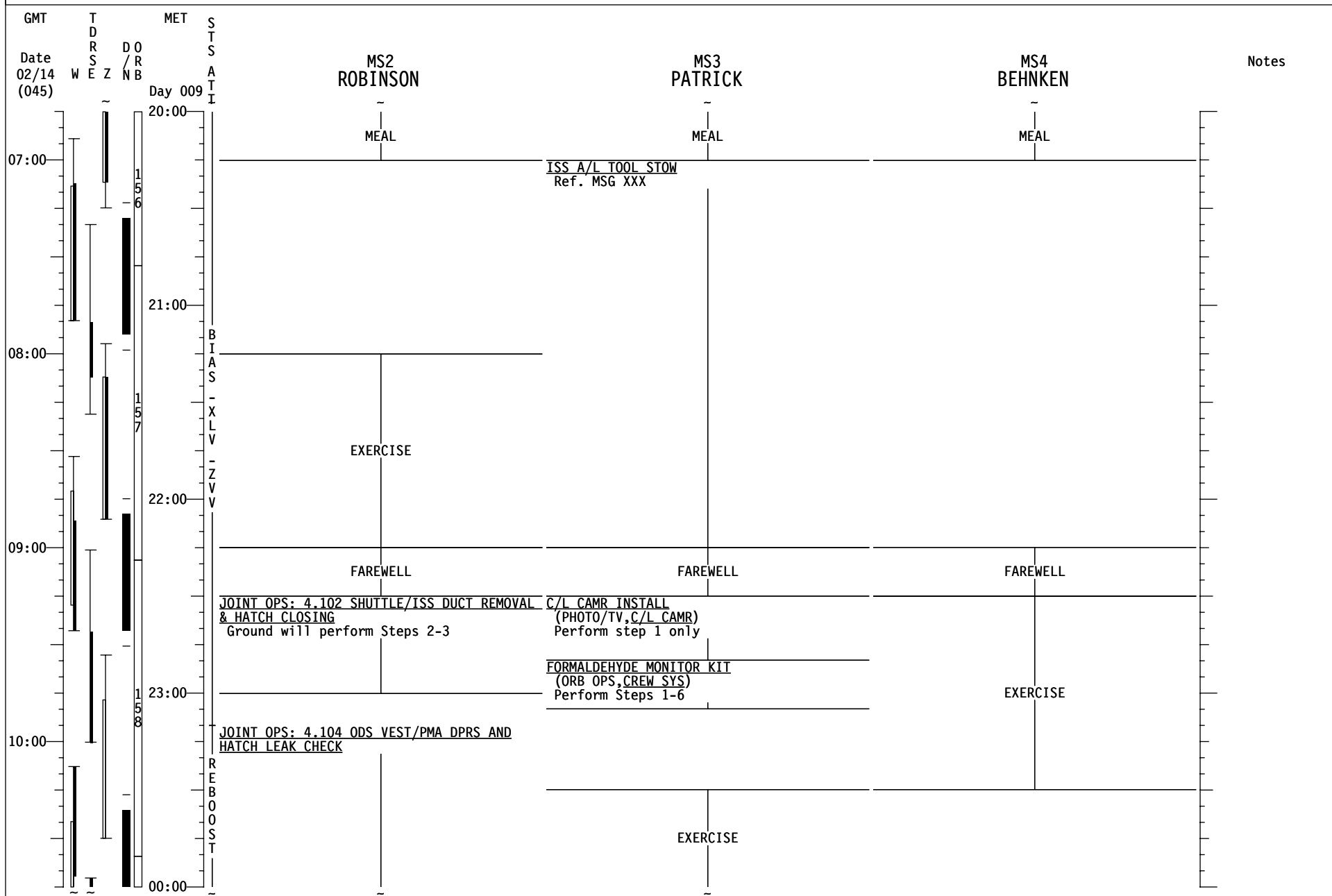

# STS-130 FD11

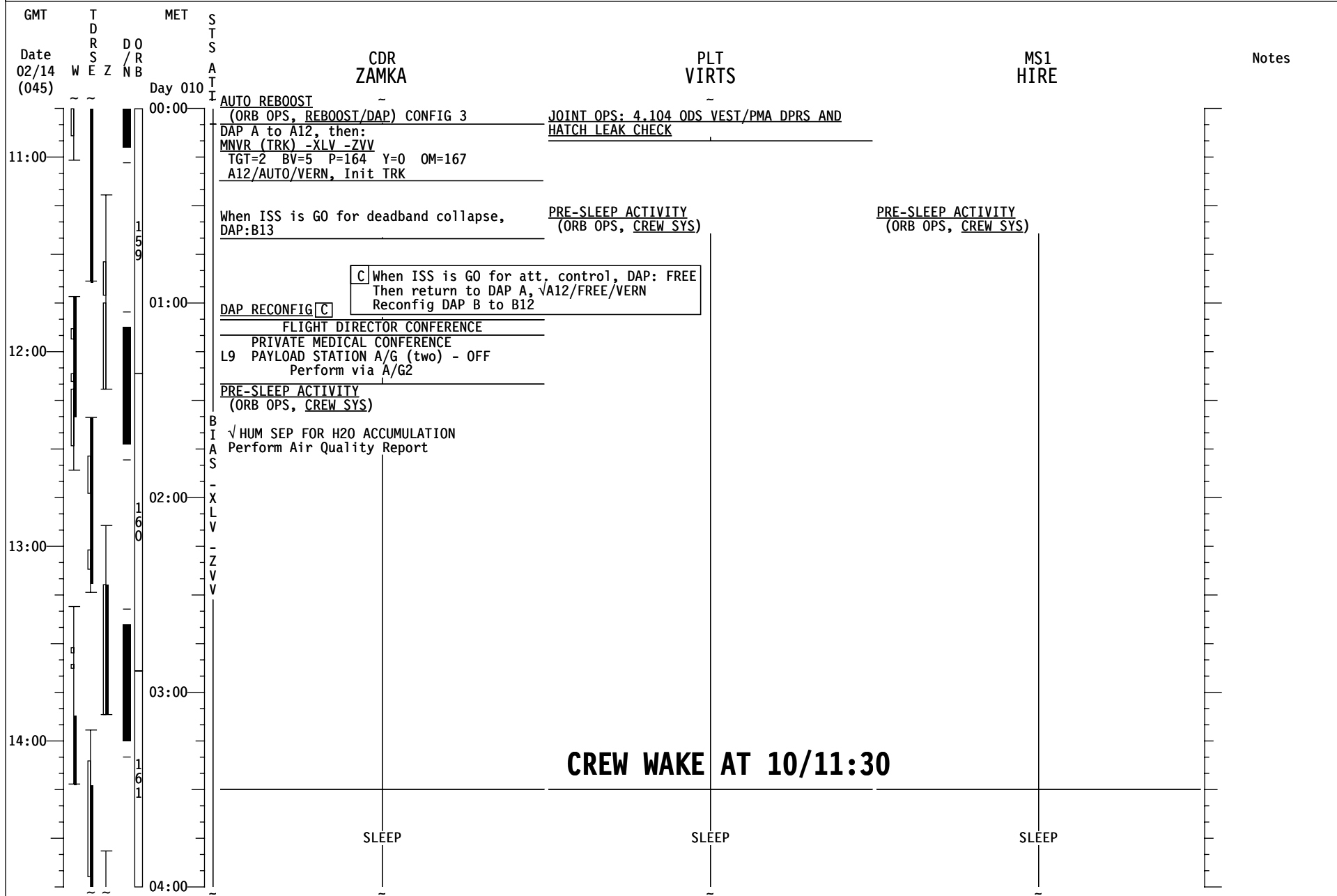



# STS-130 FD11

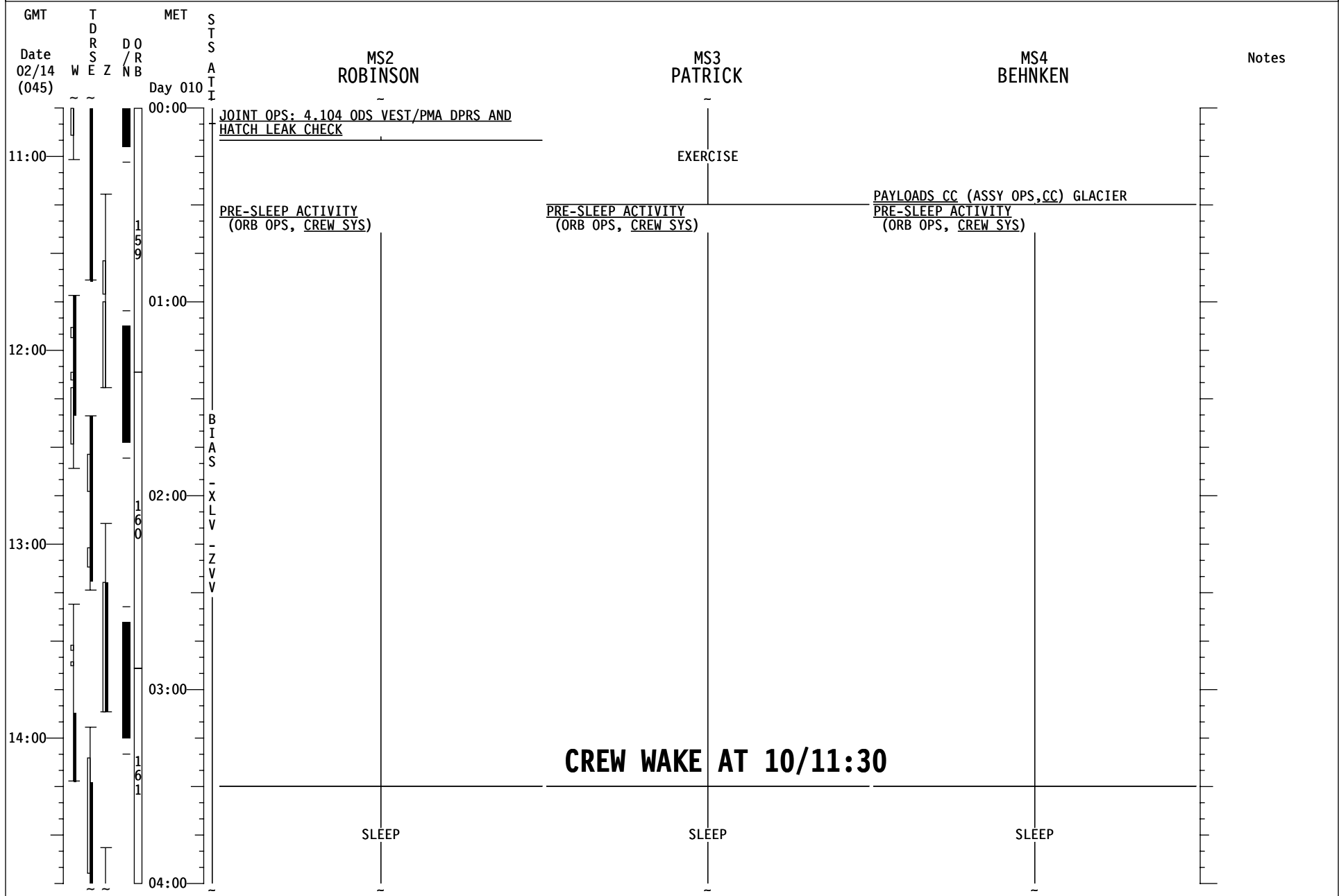

# STS-130 FD11

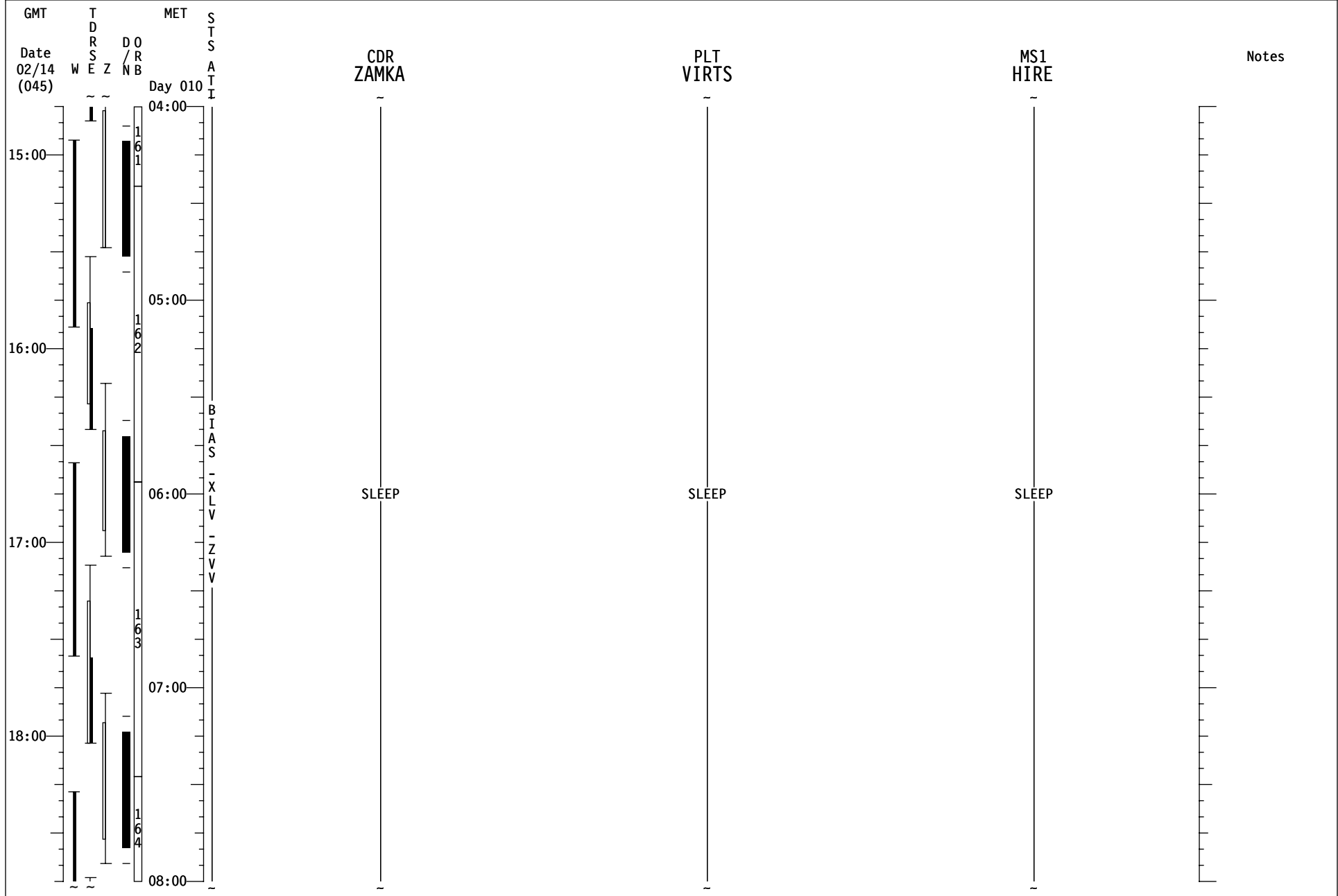



# STS-130 FD12

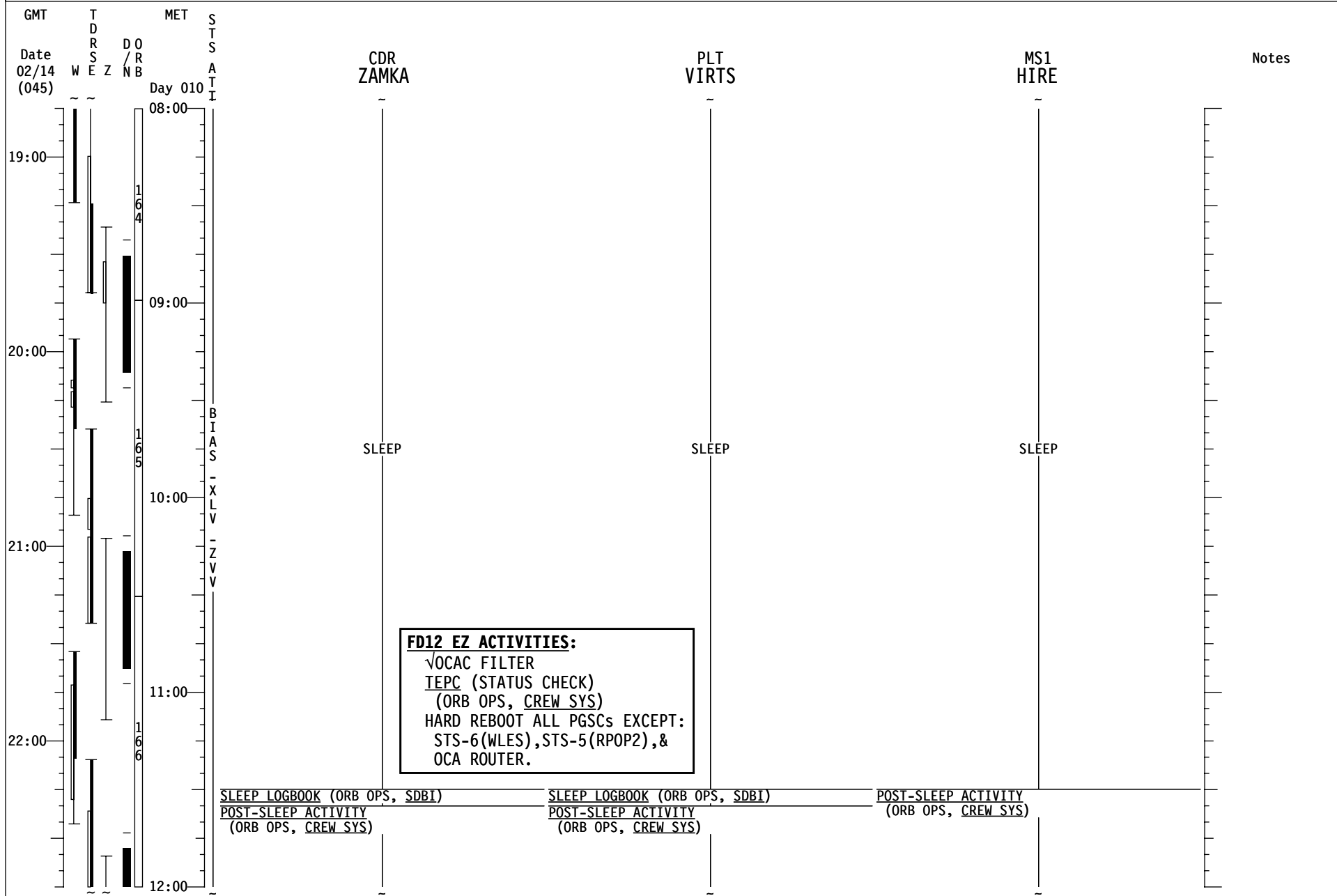

# STS-130 FD12

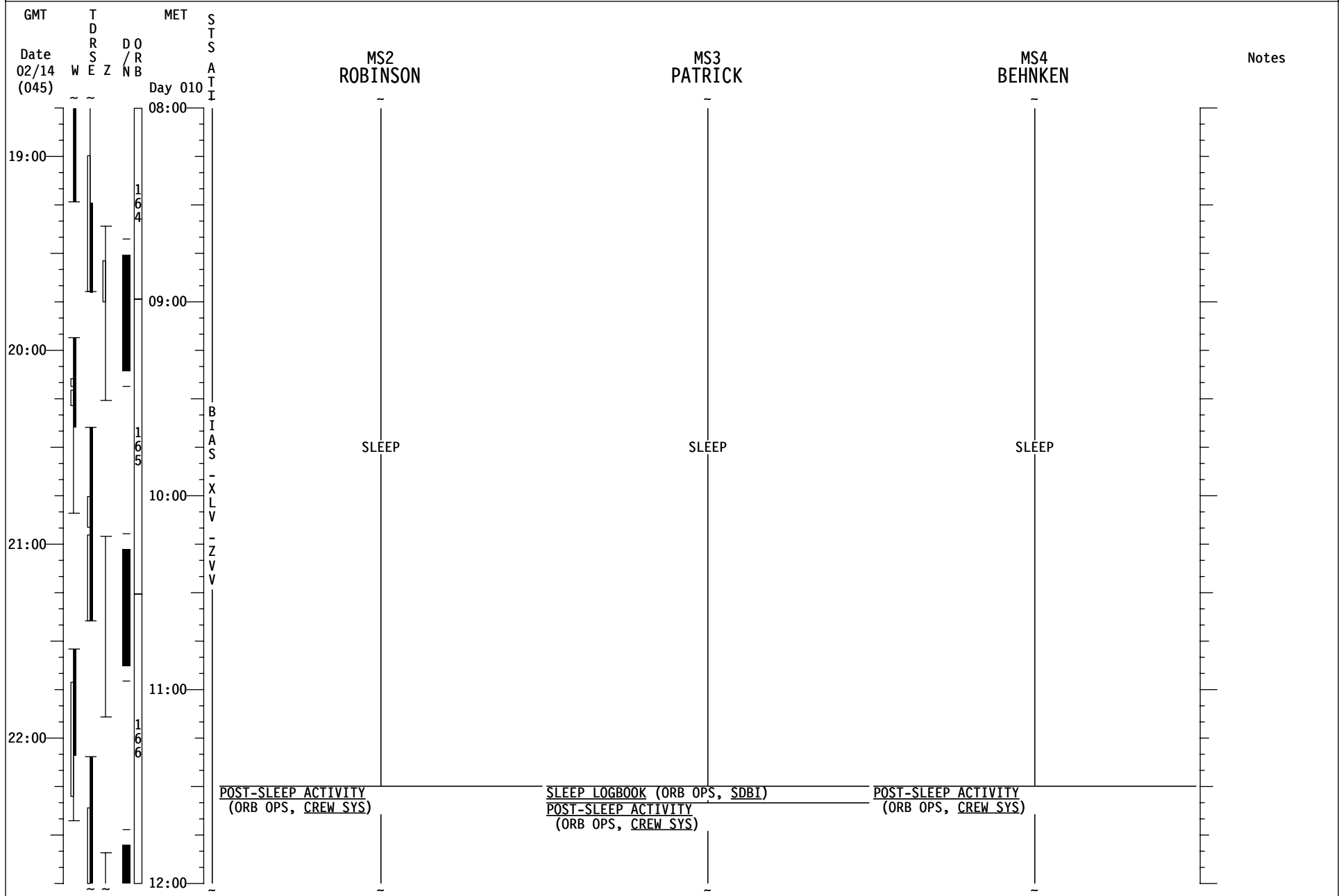

# STS-130 FD12

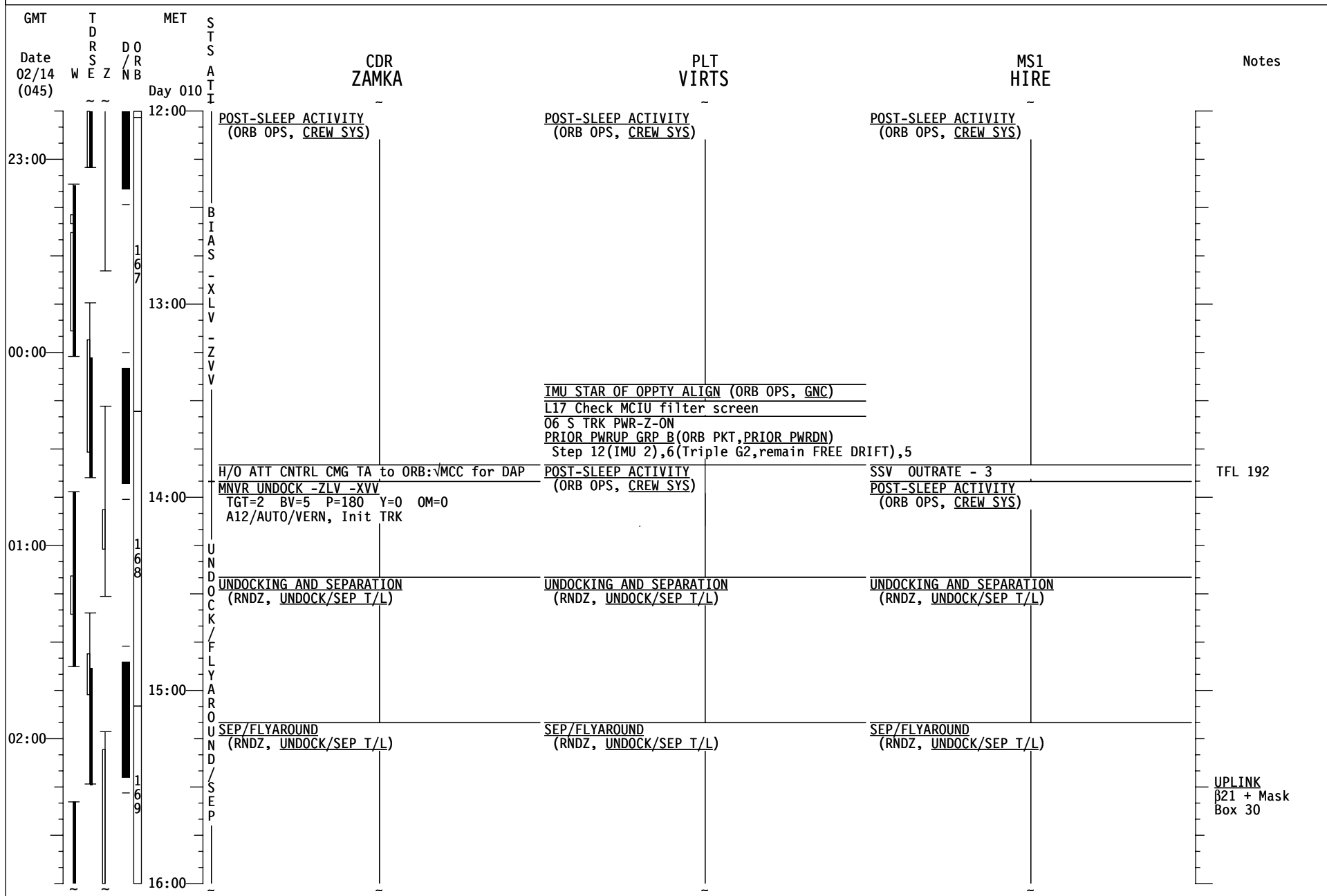

# STS-130 FD12

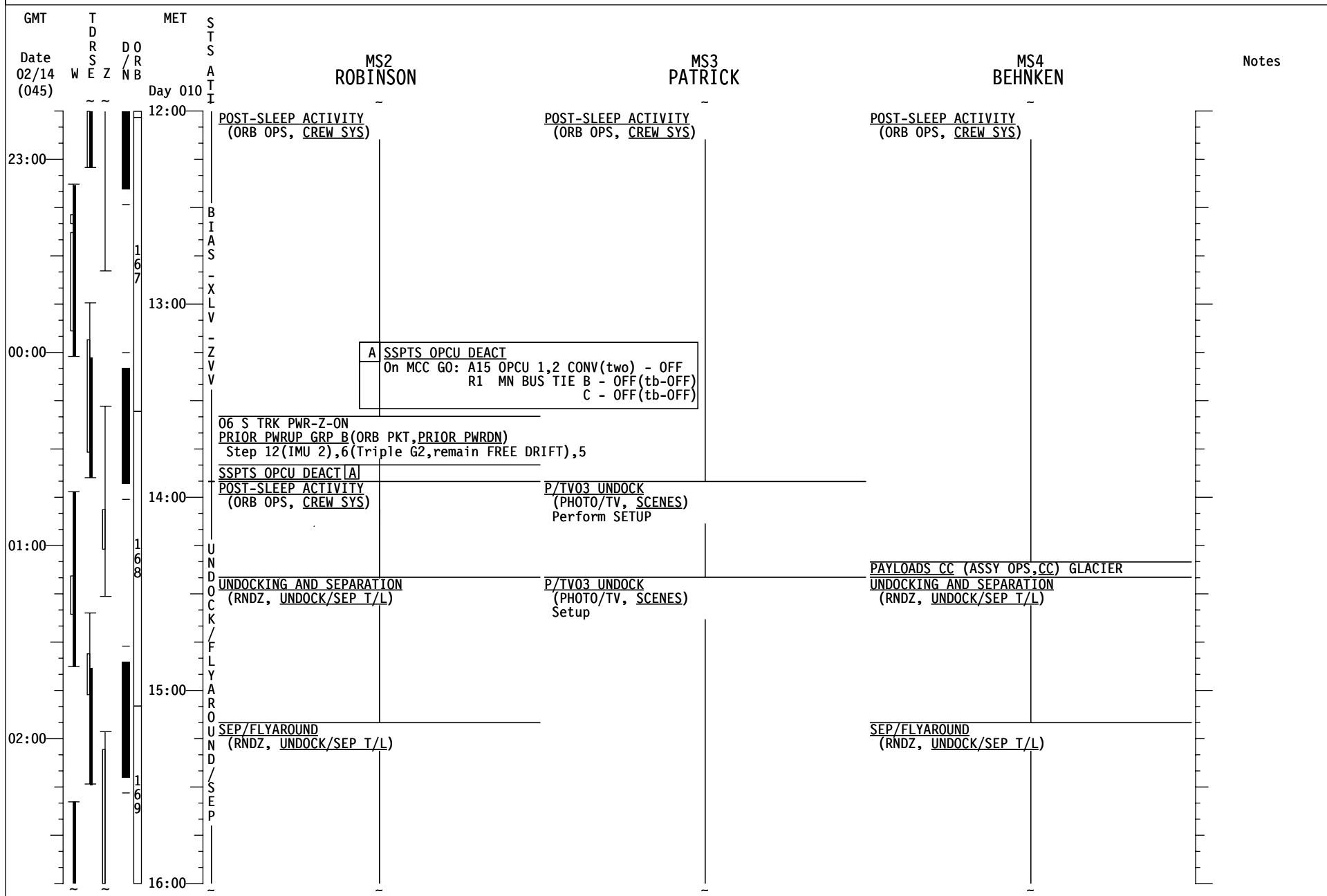









# STS-130 FD12

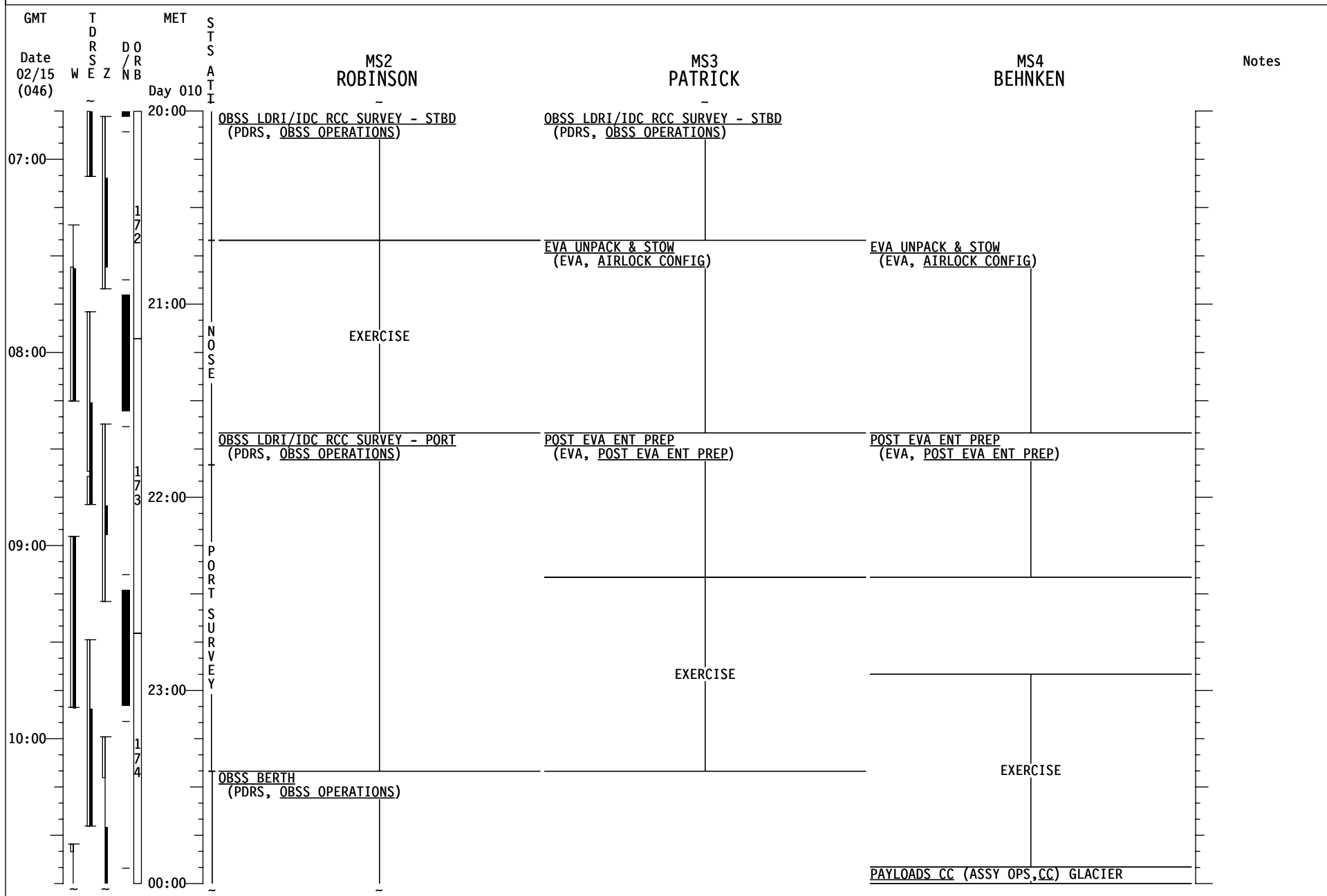

# STS-130 FD12

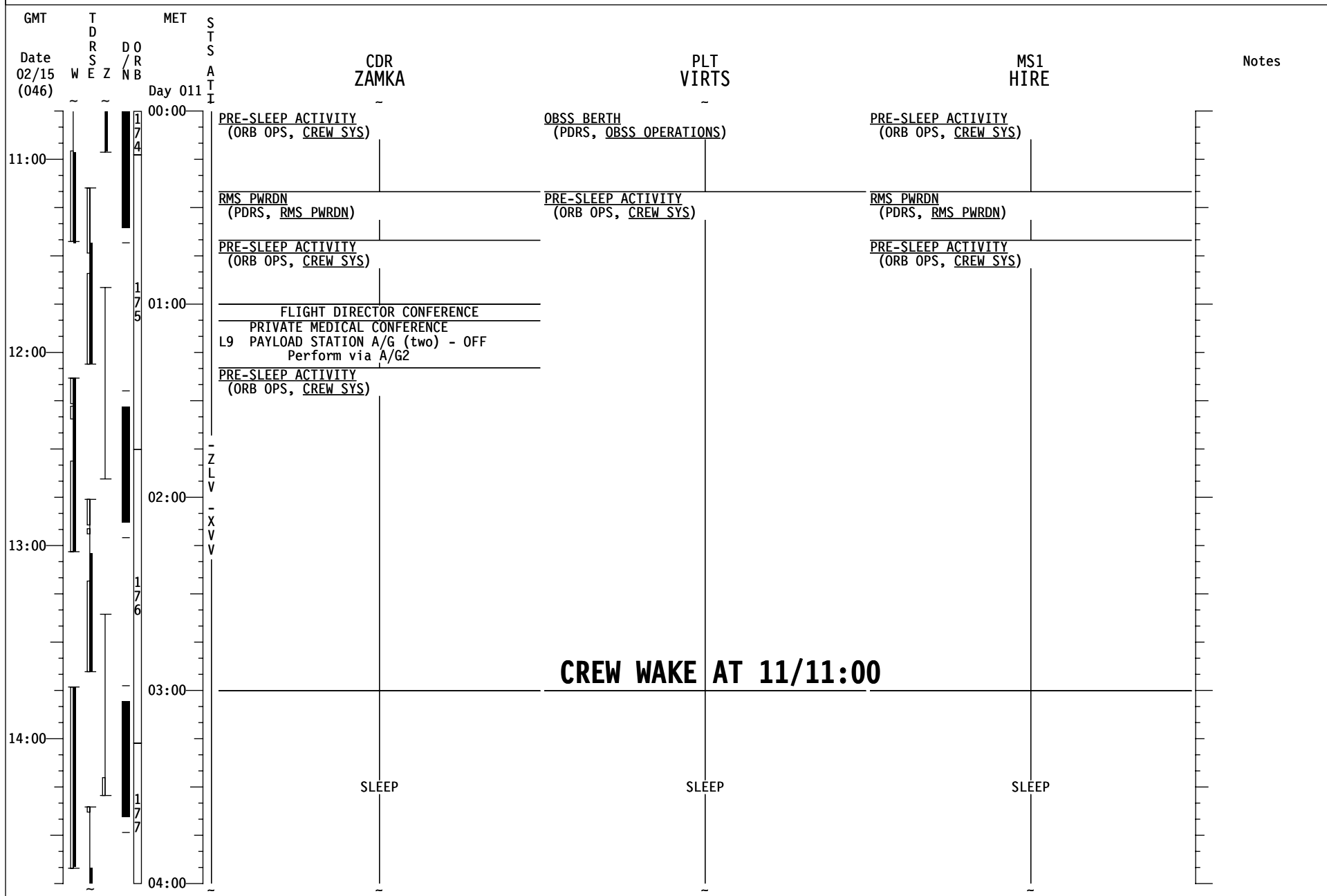

# STS-130 FD12

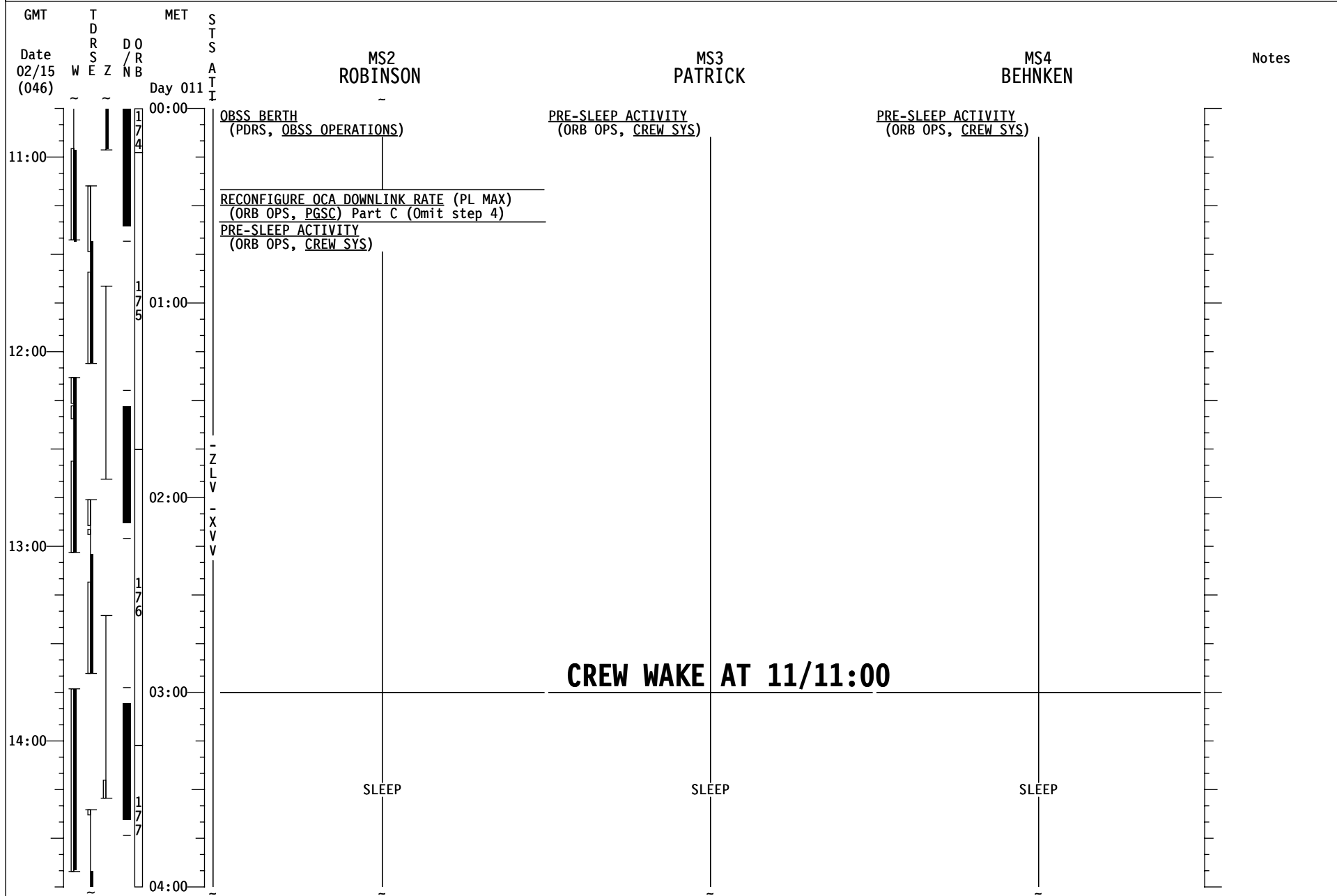

# STS-130 FD12

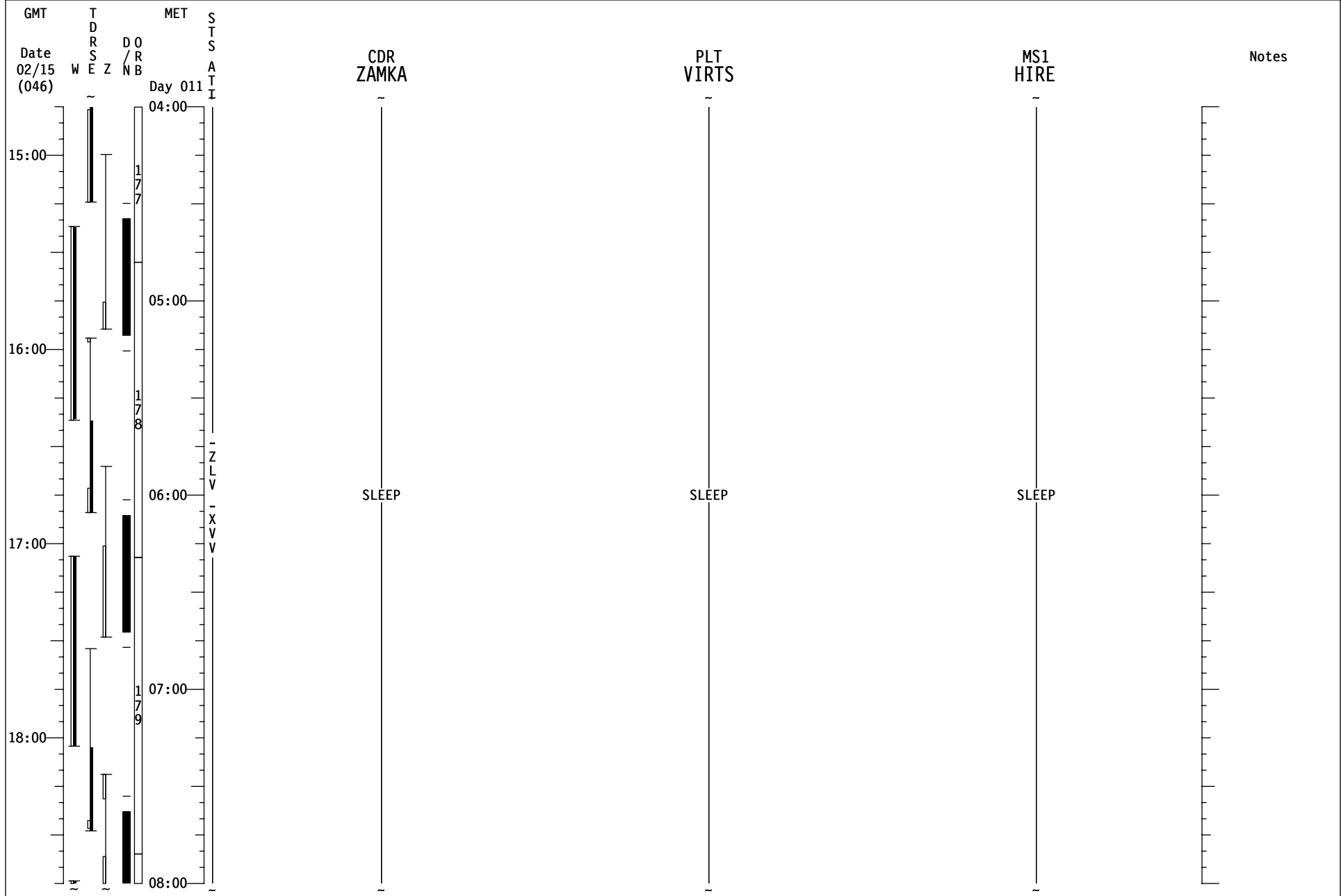

# STS-130 FD12

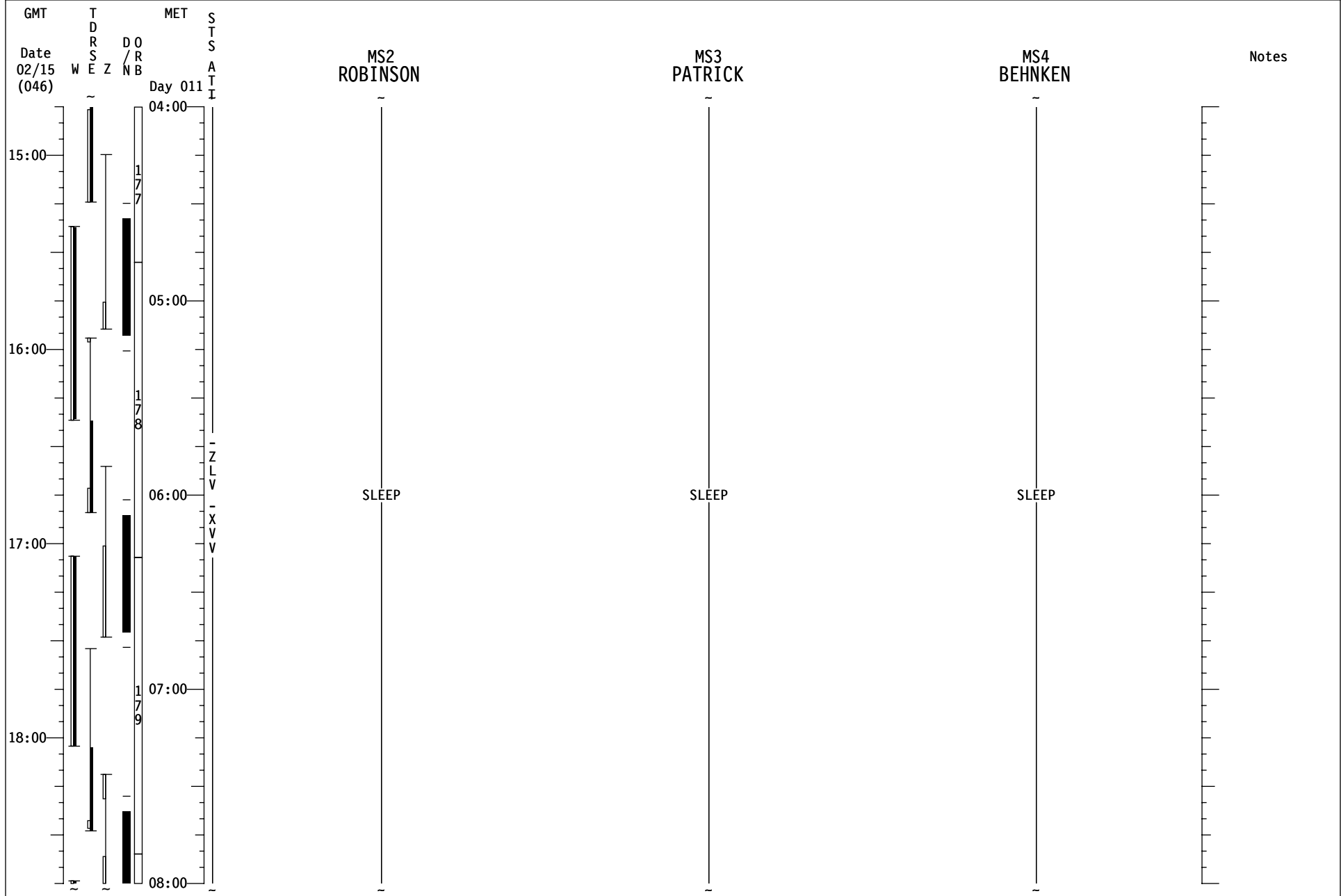

# STS-130 FD13

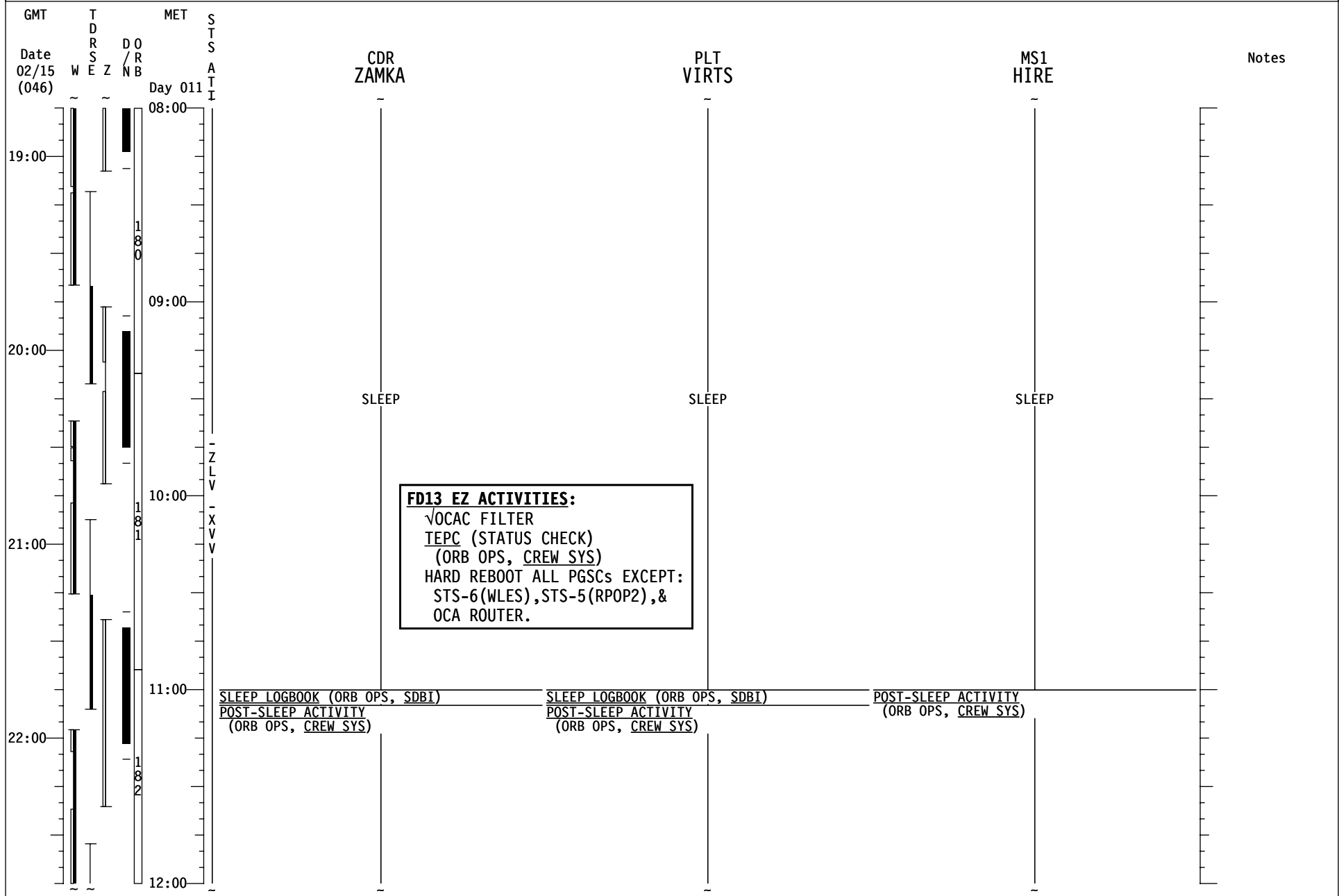





# STS-130 FD13

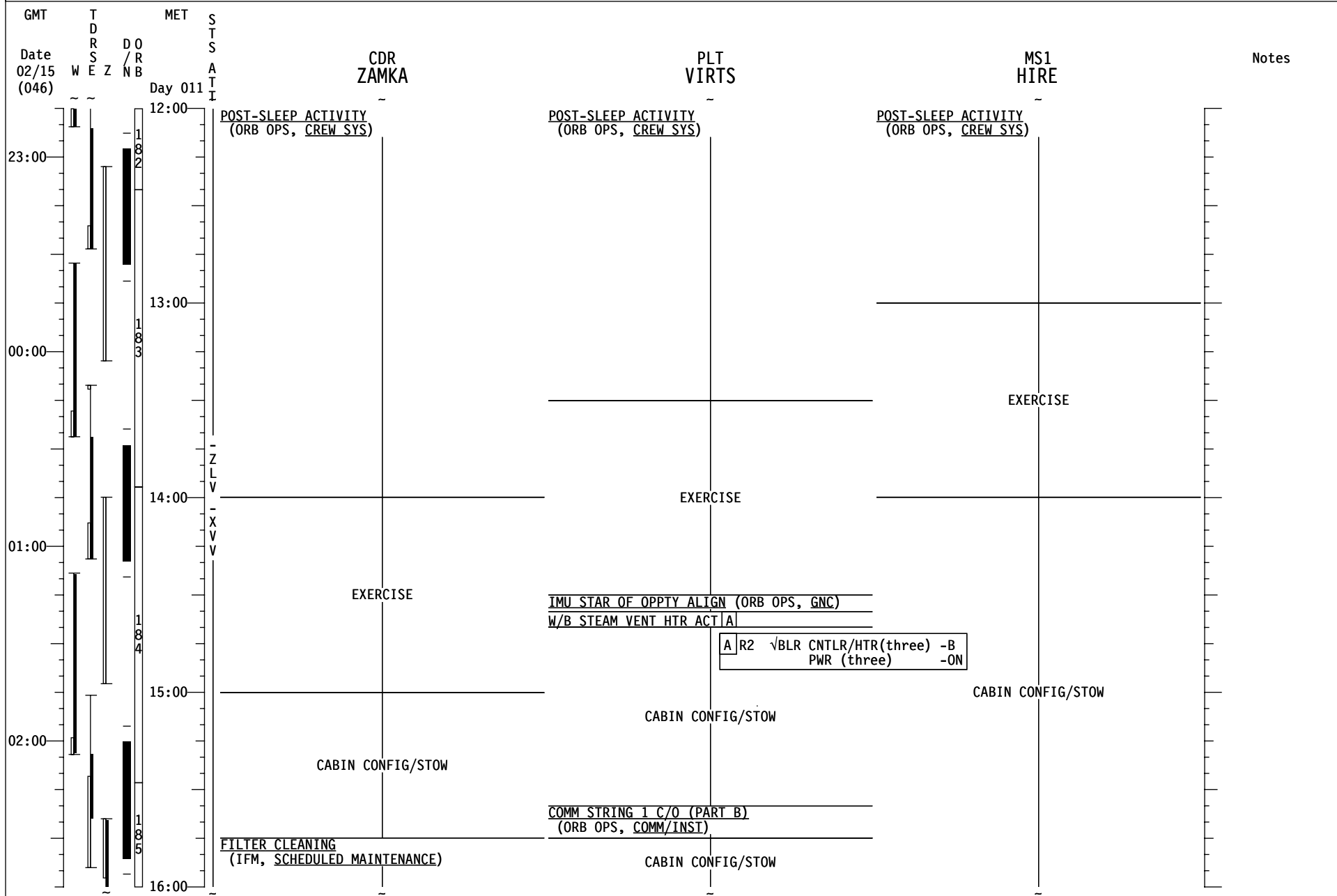

# STS-130 FD13

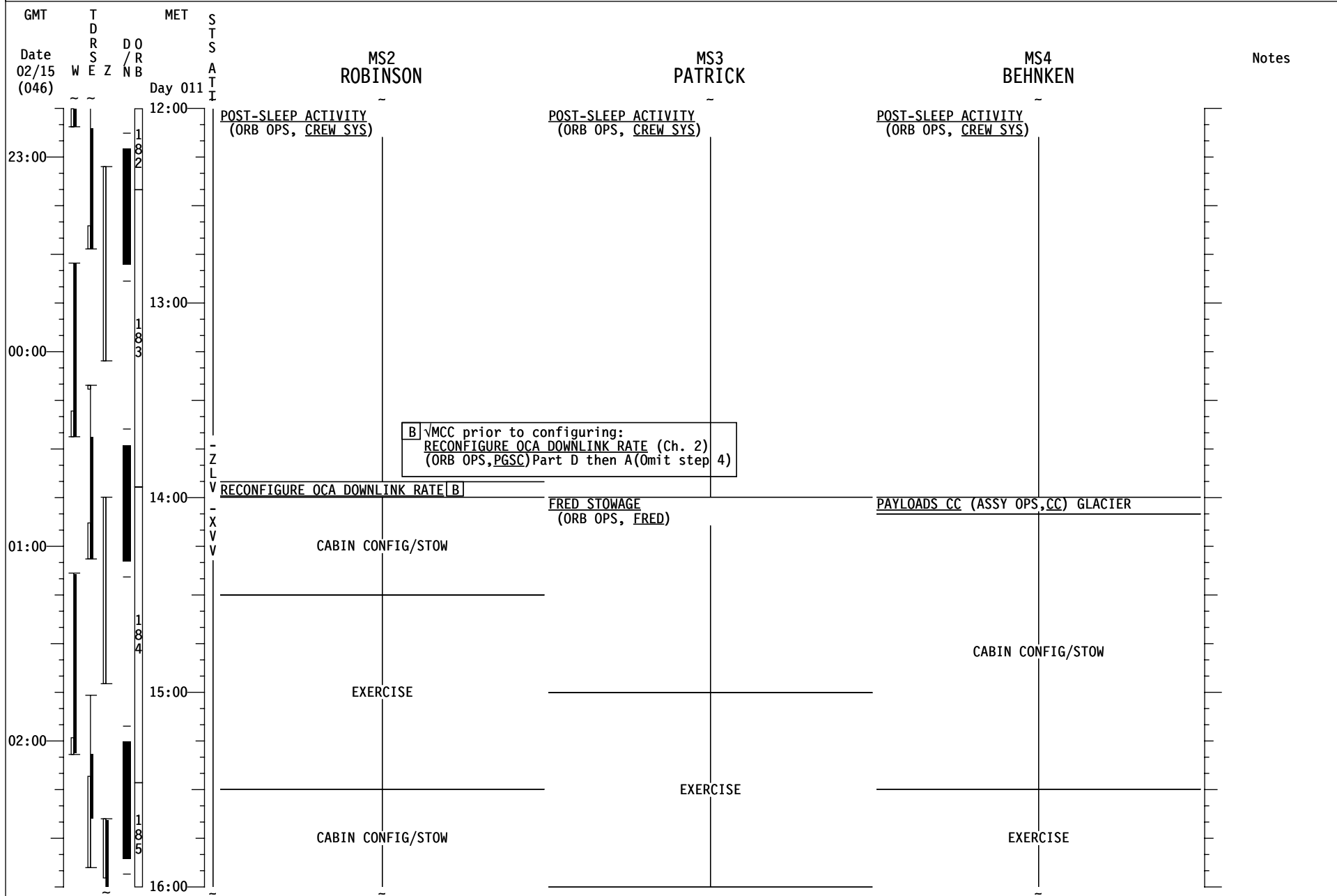

B) √MCC prior to configuring:  
 RECONFIGURE OCA DOWNLINK RATE (Ch. 2)  
 (ORB OPS, PGSC) Part D then A (omit step 4)

# STS-130 FD13

| GMT   | TDRS<br>W E Z | MET<br>Day 011 | STS<br>A T I | CDR<br>ZAMKA   | PLT<br>VIRTS   | MS1<br>HIRE  | Notes   |
|-------|---------------|----------------|--------------|--|--|--|---------|
| 03:00 |               | 16:00          |              | FILTER CLEANING<br>(IFM, SCHEDULED MAINTENANCE)                    | CABIN CONFIG/STOW  | CABIN CONFIG/STOW  |         |
|       |               |                |              | FCS CHECKOUT<br>(ORB OPS, GNC)                                     | FCS CHECKOUT<br>(ORB OPS, GNC)                                     | FCS C/O P/TV SURVEY<br>(PHOTO/TV, REF PROC) Perform SETUP          | TFL 161 |
| 04:00 |               | 17:00          |              |  |  | CABIN CONFIG/STOW  |         |
|       |               |                |              | RCS HOT FIRE TEST<br>(ORB OPS, RCS)<br>In Step 6, DAP:A1/AUTO/VERN | RCS HOT FIRE TEST<br>(ORB OPS, RCS)<br>In Step 6, DAP:A1/AUTO/VERN | HD CC DNLC<br>(PHOTO/TV, CANON G1)                                 | TFL 188 |
| 05:00 |               | 18:00          |              | DEORBIT PREP BRIEFING  | DEORBIT PREP BRIEFING  | DEORBIT PREP BRIEFING  |         |
|       |               |                |              | PUBLIC AFFAIRS EVENT<br>KU TDRE: 18:12-19:07<br>Gimbal Flip: 18:37 | PUBLIC AFFAIRS EVENT<br>KU TDRE: 18:12-19:07<br>Gimbal Flip: 18:37 | PUBLIC AFFAIRS EVENT<br>KU TDRE: 18:12-19:07<br>Gimbal Flip: 18:37 |         |
| 06:00 |               | 19:00          |              | MEAL   | MEAL   | MEAL   |         |
|       |               |                |              |  | SSV DEACTIVATION<br>(PHOTO/TV, SSV)                                | ENTRY VIDEO SETUP<br>(PHOTO/TV, MINI-CAM)                          | TFL 161 |
| 20:00 |               |                |              |  |  |  |         |

# STS-130 FD13

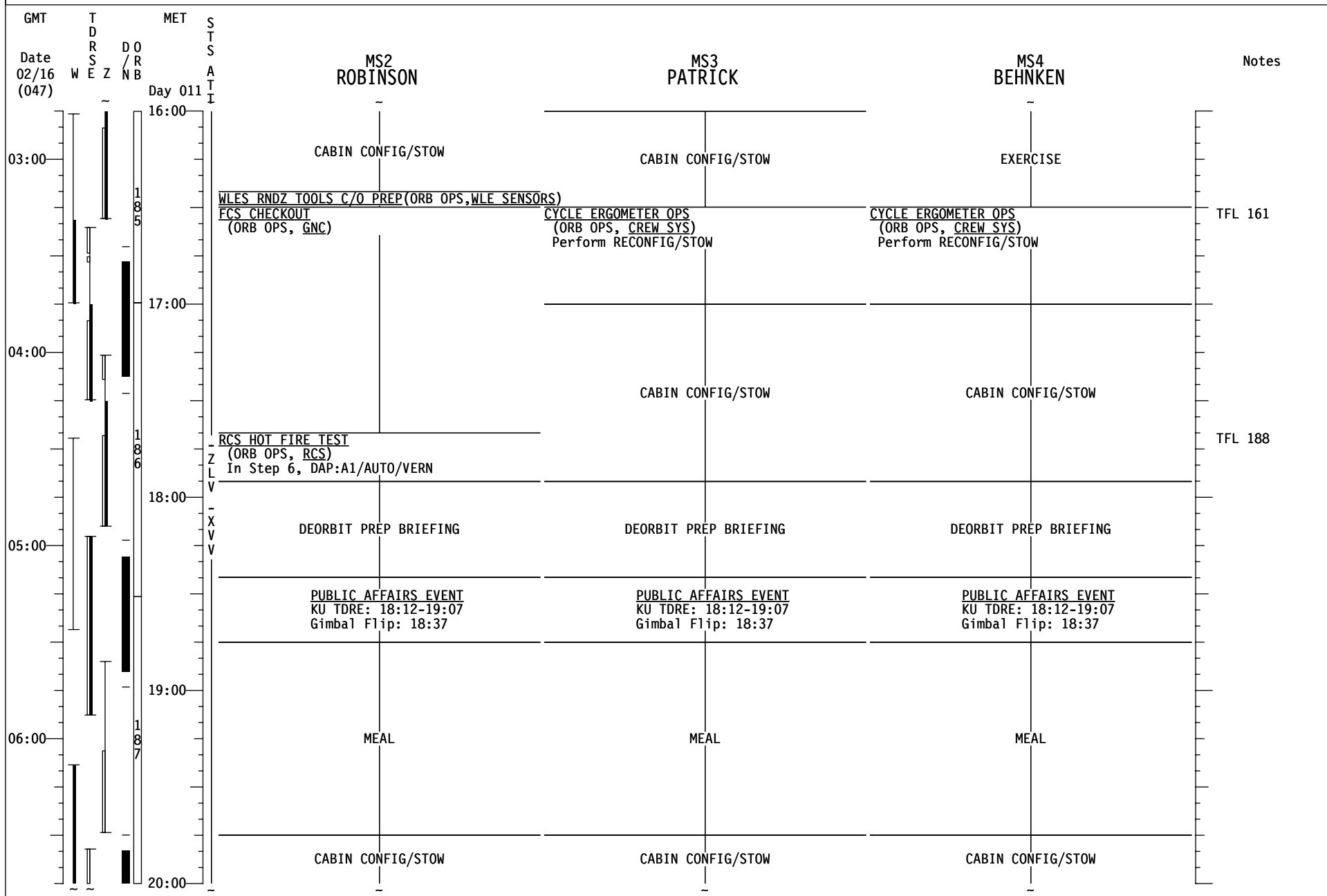

# STS-130 FD13

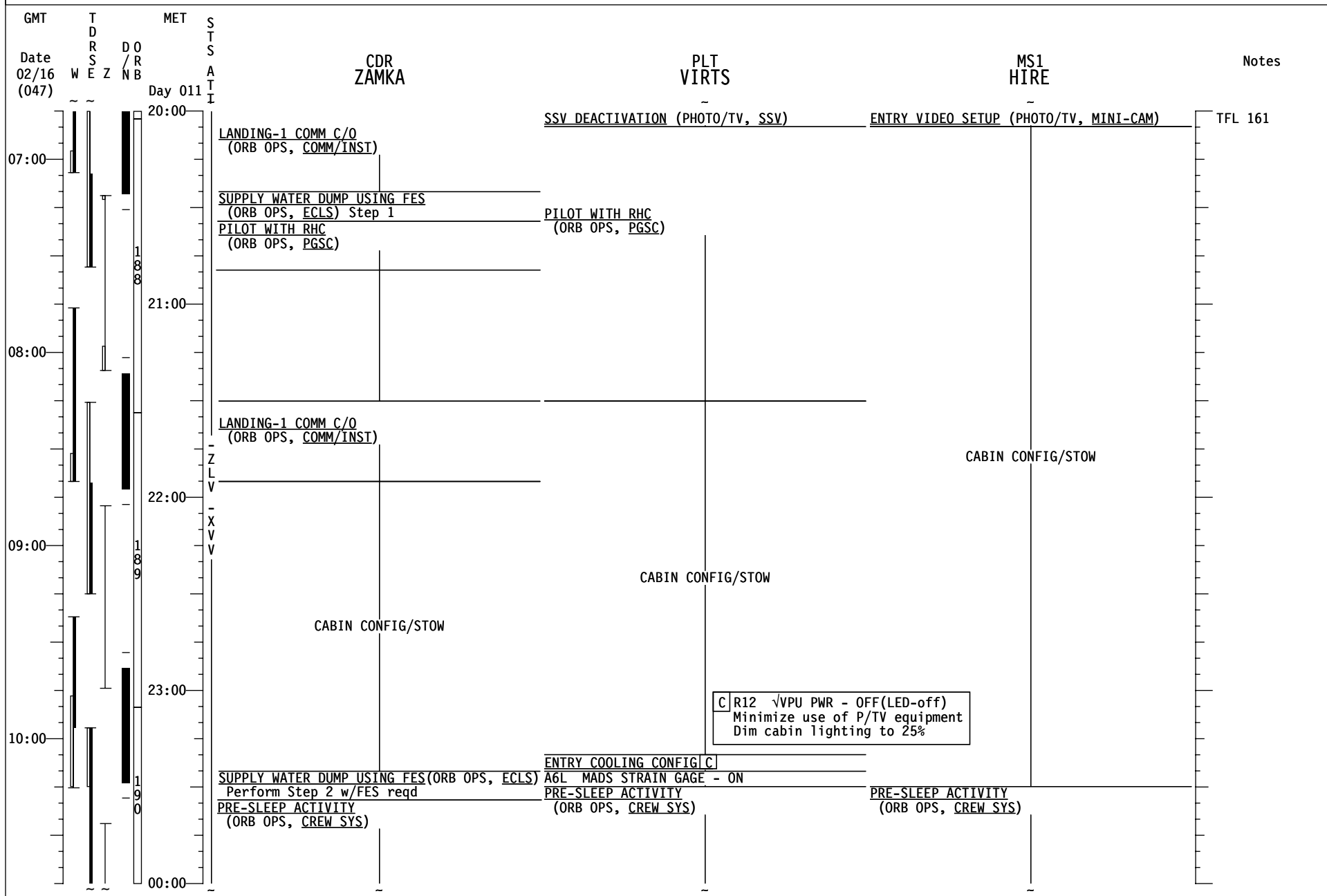

C R12 √VPU PWR - OFF(LED-off)  
Minimize use of P/TV equipment  
Dim cabin lighting to 25%



# STS-130 FD13

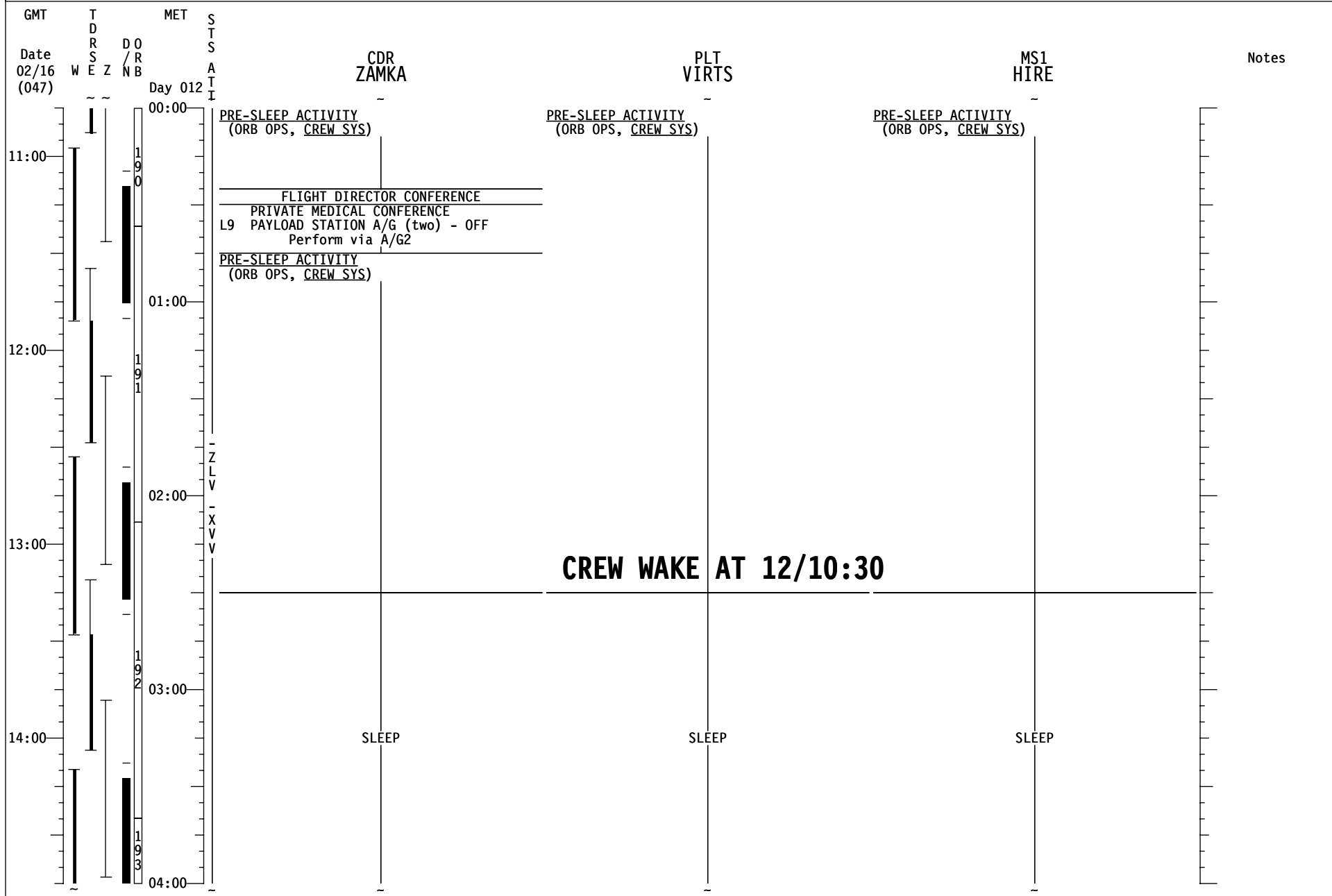



# STS-130 FD13

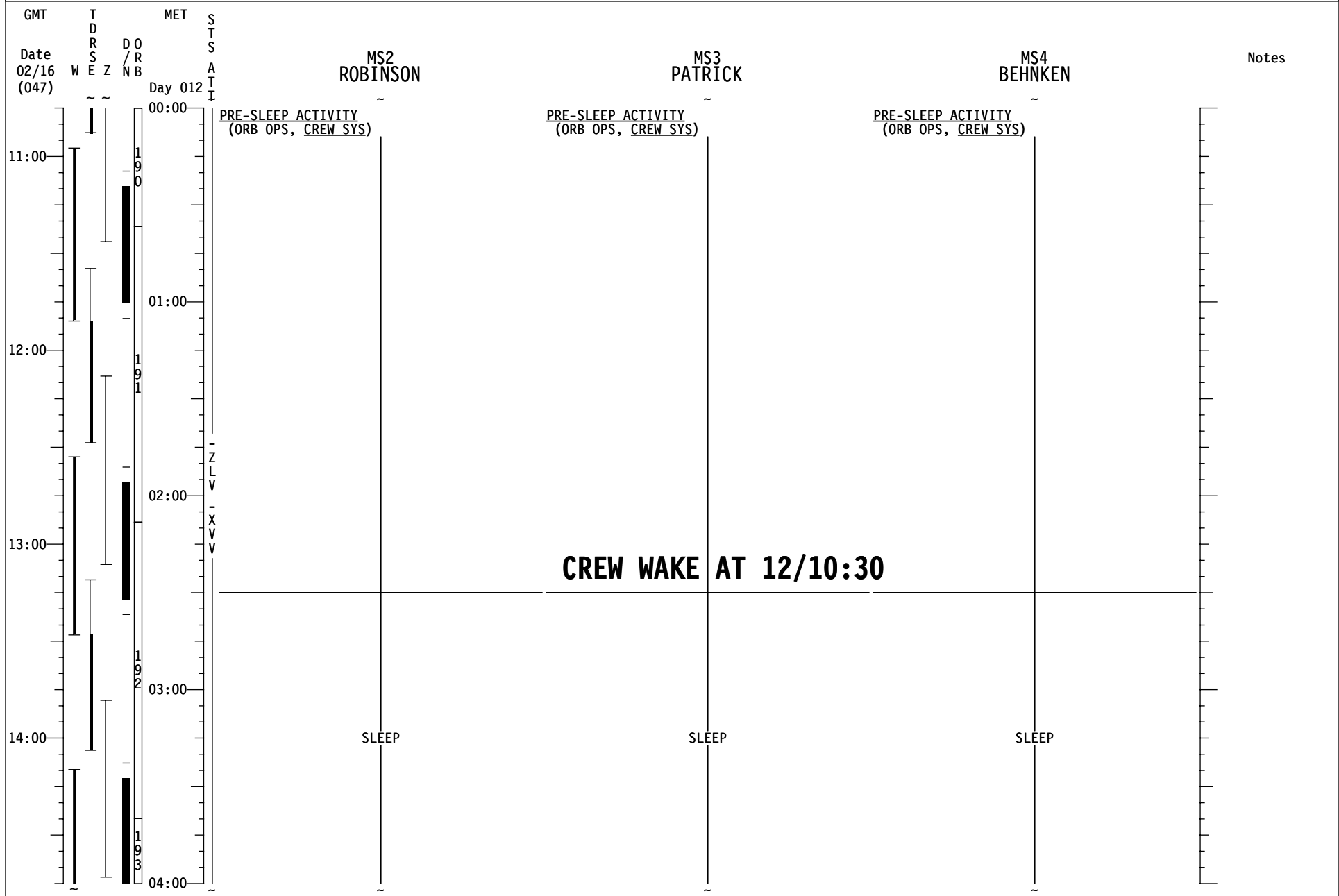



# STS-130 FD13

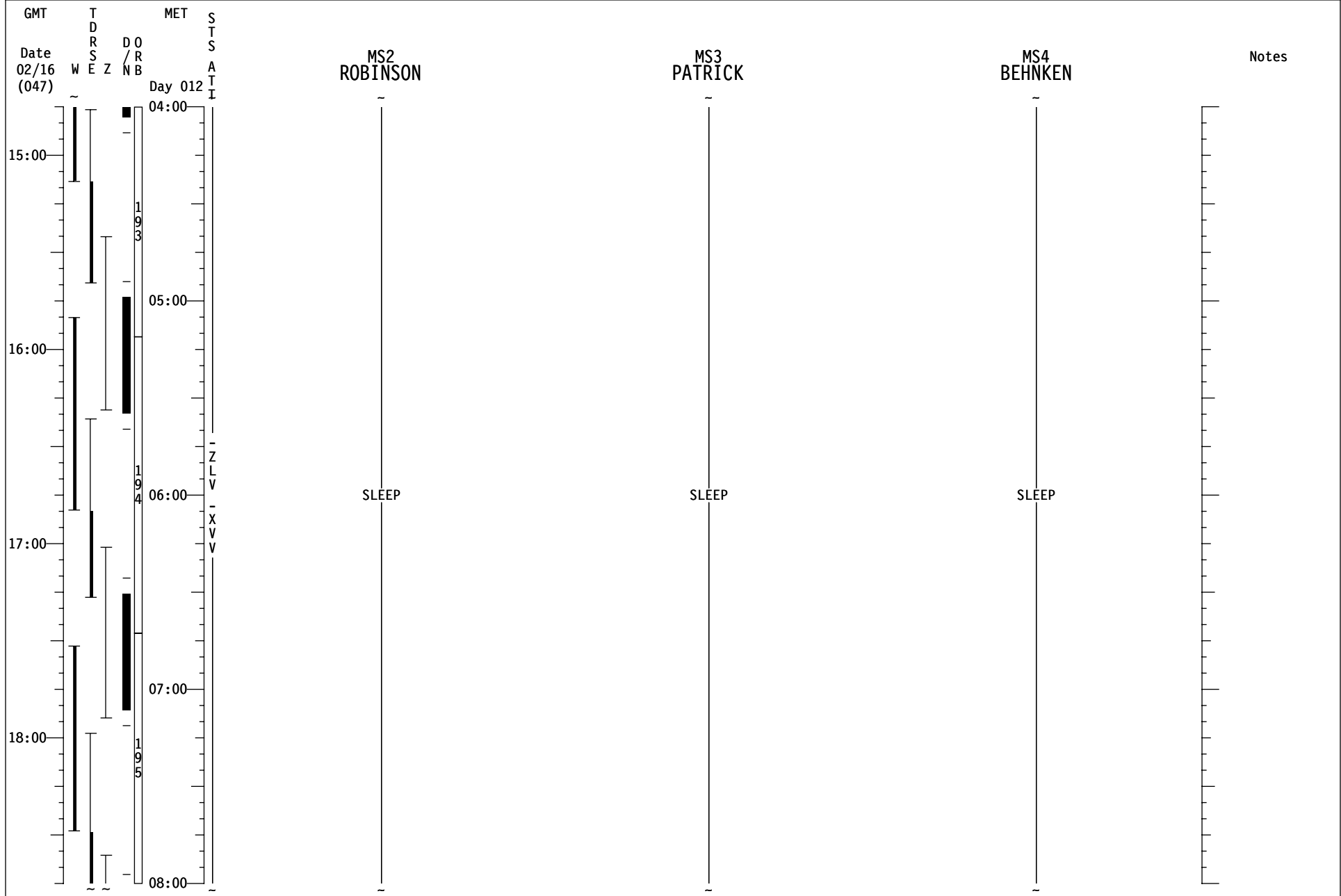

# STS-130 FD14

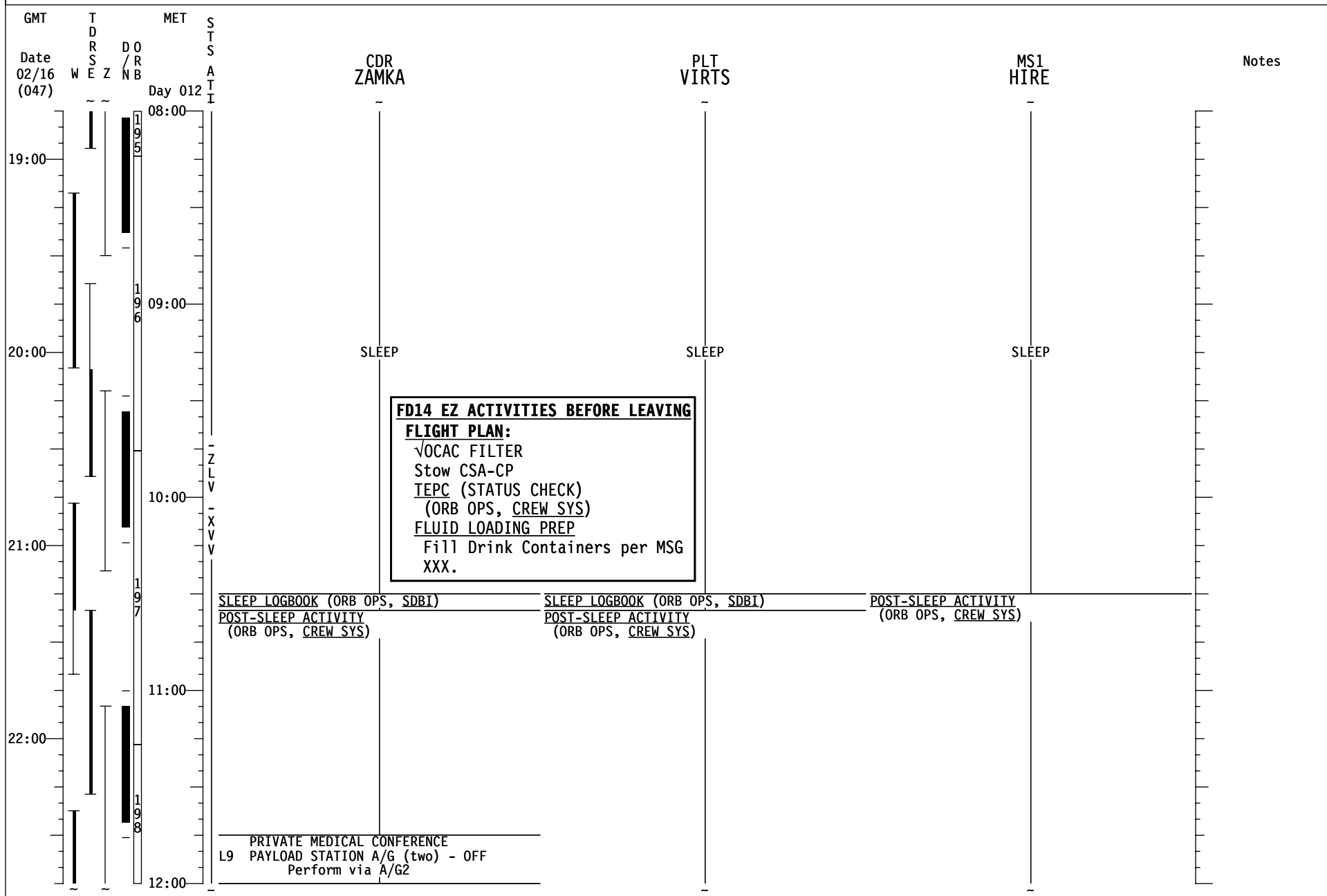

# STS-130 FD14

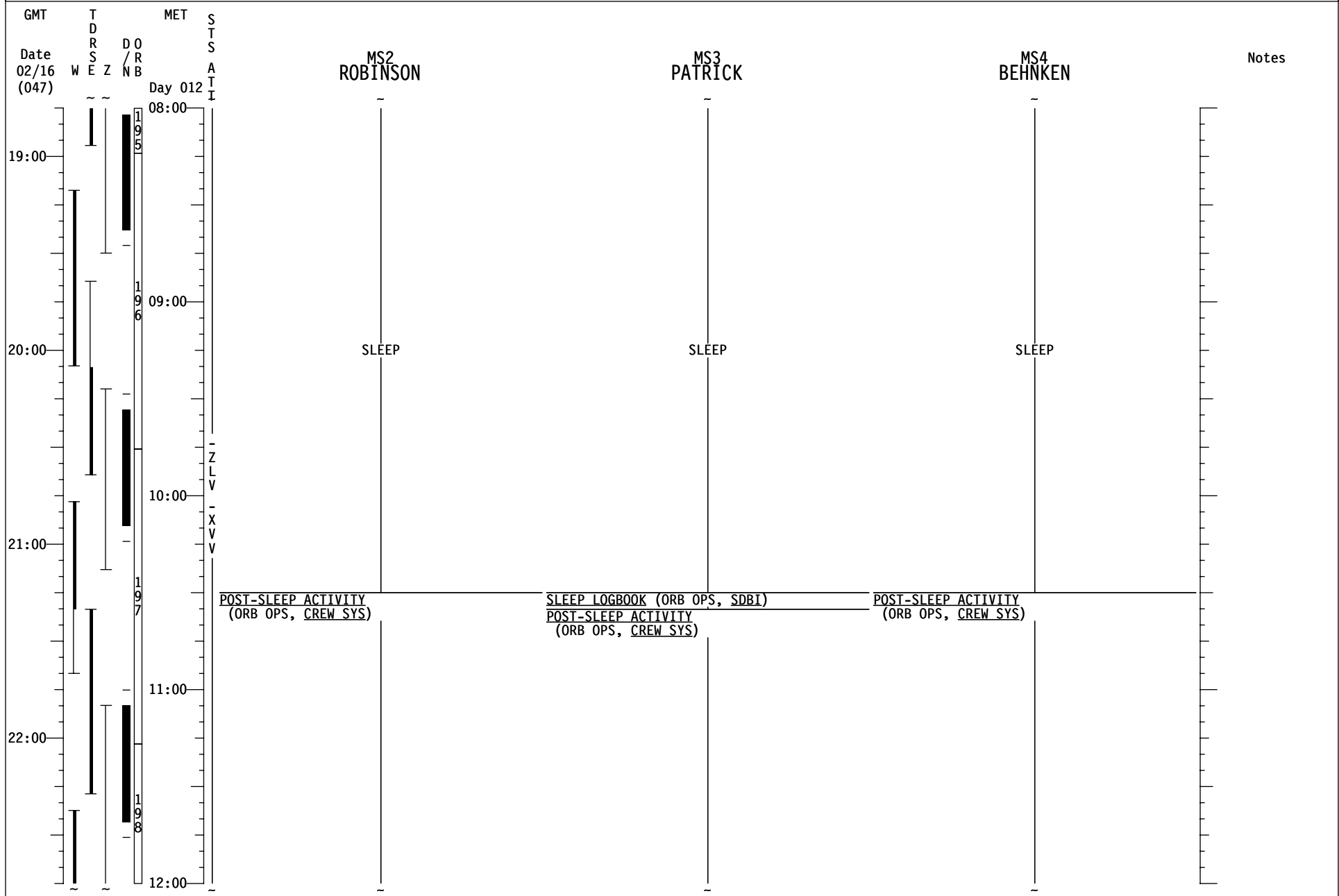

# STS-130 FD14

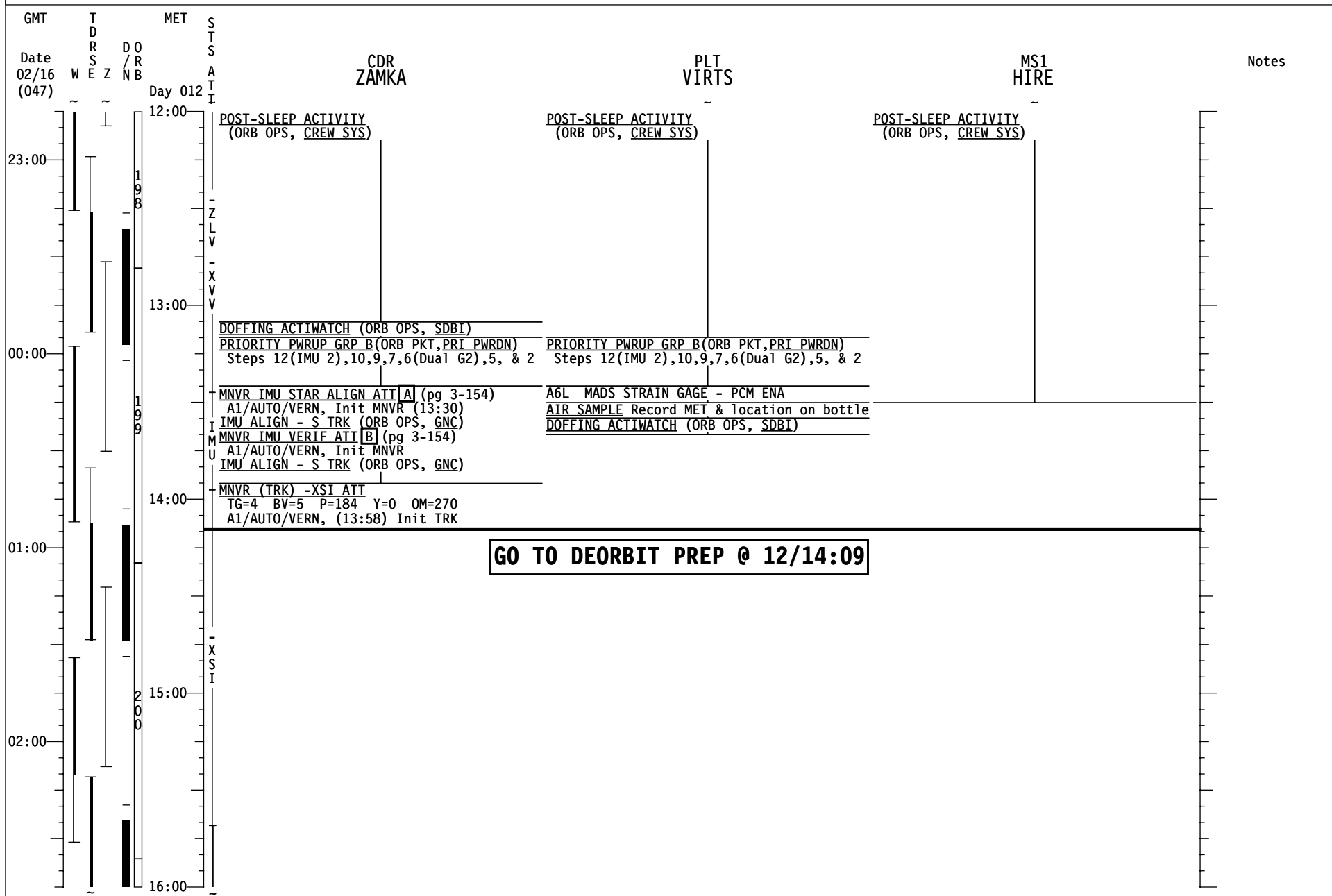

# STS-130 FD14

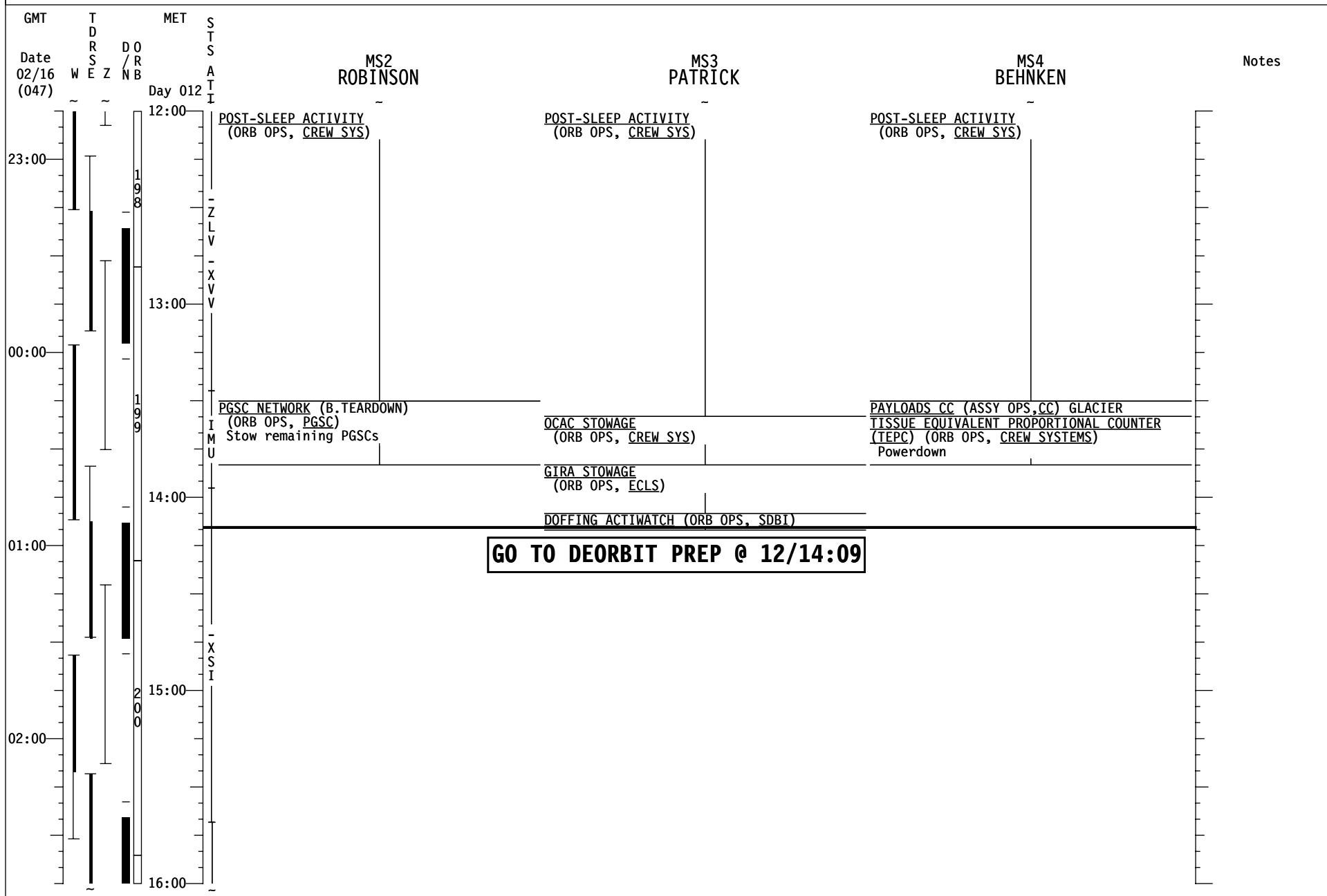







**FLIGHT PLAN**

**STS  
130**