

# TM 9-1900

WAR DEPARTMENT TECHNICAL MANUAL

THIS TEXT WILL BE RETURNED TO THE  
ORDNANCE SCHOOL UPON COMPLETION OF  
THE SUBCOURSE WITH WHICH USED

## AMMUNITION, GENERAL

GEREGISTREERD

26 JAN 1955

IGKL BBV

VERVALLEN

**RESTRICTED. DISSEMINATION OF RESTRICTED MATTER.**

No person is entitled solely by virtue of his grade or position  
to knowledge or possession of classified matter. Such matter  
is entrusted only to those individuals whose official duties  
require such knowledge or possession. (See also paragraph  
23b, AR 380-5; 15 March 1944.)

# WAR DEPARTMENT TECHNICAL MANUAL

TM 9-1900

This Technical Manual supersedes TM 9 1900, dated 3 July 1942, and Changes No. 1, dated August 1943; OST 9 48, Vols. 1 to 57 incl., dated October 1942; OFSTB 1900 11, dated 13 January 1943; OFSTB 1900 13, dated 22 April 1943; WDTB 9 1900 13, dated 22 April 1943; OFSTB 1900 16, dated 11 June 1943; OFSTB 1900 17, dated 20 September 1943; WDTB 9-1900-19, dated 5 August 1944; and WDTB ORD 51, dated 5 March 1943. This Technical Manual supersedes portions of WDTB ORD 194 (a reprint of OFSTB 1900 18), dated 6 November 1943; WDTB ORD 214, dated 28 October 1943; and WDTB ORD 249, dated 1 February 1945.

---

## AMMUNITION, GENERAL



WAR DEPARTMENT

18 JUNE 1945

---

**RESTRICTED. DISSEMINATION OF RESTRICTED MATTER.**

No person is entitled solely by virtue of his grade or position to knowledge or possession of classified matter. Such matter is entrusted only to those individuals whose official duties require such knowledge or possession.

(See also paragraph 23b, AR 380-5; 15 March 1944.)

---



WAR DEPARTMENT

Washington 25, D. C., 18 June 1945

FM 9-1900, Ammunition, General, is published for the information and guidance of all concerned.

I.G. 300.7 (22 Aug 44)

D.O. 300.7/3890

BY ORDER OF THE SECRETARY OF WAR:

G. C. MARSHALL,

*Chief of Staff.*

OFFICIAL:

EDWARD F. WITSELL,

*Major General,*

*Acting The Adjutant General.*

DISTRIBUTION: AAF (5); AGF (5); ASF (2); S Div ASF (1); T of Opn (10); AAF Comd (2); Arm & Sv Bd (1); Tech Sv (2); SyC (10); FC (1); BU (1); PE, Ord O (5); Dist O, 9 (5); Reg O, 9 (2); Establishments, 9 (5) except Am Establishments (2); Decentralized Sub-O, 9 (2); Gen & Sp Sv Sch (10); A (10); CHQ (10); D (2); B 2, 4-6, 18, 44 (1); R 2, 4-11, 17-19, 44, 55 (1); Bn 2-11, 17-19, 44, 55 (1); C 2-11, 17-19, 44, 55 (1); AF (2); W (1); G (1); S (1); LS (1); F (1).

(For explanation of symbols, see FM 21-6.)

# CONTENTS

---

	Paragraphs	Pages
<b>CHAPTER 1. GENERAL</b> .....	1- 58	1- 53
<b>SECTION I. Introduction</b> .....	1- 3	1
II. General discussion .....	4- 10	2- 25
III. Military explosives .....	11- 15	26- 31
IV. Propellants .....	16- 23	31- 37
V. High explosives .....	24- 48	37- 48
VI. Chemical agents .....	49- 58	48- 53
<b>CHAPTER 2. CLASSES OF AMMUNITION</b> .....	59-158	54-212
<b>SECTION I. Small-arms ammunition</b> .....	59- 80	54- 75
II. Grenades .....	81- 91	75- 85
III. Mortar ammunition .....	92- 96	86- 92
IV. Artillery ammunition .....	97-108	93-131
V. Bombs .....	109-119	131-160
VI. Pyrotechnics .....	120-138	160-181
VII. Rockets .....	139-146	181-193
VIII. Land mines .....	147-153	194-204
IX. Demolition materials .....	154-158	204-212



	Paragraphs	Pages
CHAPTER 3. CARE, HANDLING, AND PRESER- VATION	159-223	213-305
SECTION I. General safety precautions	159-166	213-225
II. Storage	167-174	225-260
III. Storage - at supply points and dumps	175-176	261-263
IV. Packing and marking	177-182	263-270
V. Shipping	183-190	270-283
VI. Inspection and surveillance	191-206	283-290
VII. Renovation	207-214	290-294
VIII. Precautions for practice firing	215-223	295-305
CHAPTER 4. DESTRUCTION OF AMMUNITION IN ZONE OF THE INTERIOR	224-242	306-322
CHAPTER 5. REFERENCES	243-245	323-329
		330-335



**RESTRICTED**

This Technical Manual supersedes TM 9-1900, dated 3 July 1942, and Changes No. 1, dated August 1943; OST 9-18, Vols. 1 to 5, incl., dated October 1942; OFSTB 1900-11, dated 13 January 1943; OFSTB 1900-13, dated 22 April 1943; WDTB 9-1900-13, dated 22 April 1943; OFSTB 1900-16, dated 11 June 1943; OFSTB 1900-17, dated 20 September 1943; WDTB 9-1900-19, dated 5 August 1944; and WDTB ORD 51, dated 5 March 1943. This Technical Manual supersedes portions of WDTB ORD 194 (a reprint of OFSTB 1900-18), dated 6 November 1943; WDTB ORD 214, dated 28 October 1944; and WDTB ORD 249, dated 1 February 1945.

**CHAPTER I  
GENERAL****Section I****INTRODUCTION****1. PURPOSE.**

a. This manual is published for the information and guidance of Army personnel concerned with ammunition. Those responsible for the handling of ammunition should become thoroughly familiar with its provisions.

b. The requirements of this manual will apply to Class I, II, and III installations. The requirements of the Ordnance Safety Manual (O.O. Form 7224) will govern Class IV installations under the control of the Chief of Ordnance.

**2. SCOPE.** The information contained in this text is of a general technical nature. It concerns the several types of ammunition, their general characteristics, means of identification, care in handling and use, storage, surveillance, packing and marking, shipping, and the destruction of duds and unserviceable ammunition.

**3. REFERENCES.** Further information concerning specific types of ammunition is contained in specific Technical Manuals and Field Manuals. A complete list of references appears in chapter 5.

## Section II

**GENERAL DISCUSSION****NOMENCLATURE.**

a. **SNL groups.** Standard nomenclature is established so that every item supplied by the Ordnance Department may be specifically identified by name. It consists of the type, size, and model of each item. Its use for all purposes of record is mandatory, except where the use of AIC symbol (par. 4 b) is authorized. Ammunition nomenclature is published in ORD 11 Standard Nomenclature Lists (SNL's) of groups P, R, S, and T, and its exact use will keep to a minimum errors in the shipment, storage, issue, recording, and use of ammunition items.

(1) Group P contains lists of ammunition for medium and heavy field artillery (155-mm gun and above), coast artillery, and anti-aircraft weapons.

(2) Group R contains lists of ammunition for light and medium field, tank, antitank, and aircraft artillery weapons (20-mm gun through 155-mm howitzer), mortars, mines, and demolition material.

(3) Group S contains lists of bombs, grenades, pyrotechnics, and rockets.

(4) Group T contains lists of ammunition for small-arms weapons.

b. **Ammunition Identification Code symbols.** The Ammunition Identification Code (AIC) symbol has been established to facilitate the supply of ammunition in the field. Code symbols assigned to each item of ammunition in a specific packing are to be used in messages, requisitions, and records. These code symbols are published, basically in ORD 11 SNL's of groups P, R, S, and T. A full explanation of the composition and use of the AIC symbol will be found in SB 9-AMM 5 and changes thereto.



## 5. CLASSIFICATION.

a. **General.** Ammunition is classified according to use as service, practice, blank, or drill (or dummy). It may also be classified according to type of filler as explosive, chemical, or inert.

b. **Service ammunition.** Service ammunition is intended to be fired for effect in combat. Such ammunition (except small-arms ammunition) may be further classified according to type as high-explosive, high-explosive-antitank, armor-piercing, gas, smoke, canister, incendiary, illuminating, or pyrotechnic.

c. **Practice ammunition.** Practice ammunition is fired for effect in simulated combat and is provided for training in marksmanship. The projectile in this type of ammunition may have a small quantity of low-explosive filler to serve as a spotting charge, or it may be inert.

d. **Blank ammunition.** Blank ammunition is provided in small and medium calibers for saluting purposes and simulated fire. It has no projectile.

e. **Drill ammunition.** Drill or dummy ammunition is used for training in handling and loading ("service of the piece"). It is completely inert.

## 6. IDENTIFICATION.

a. **General.** Ammunition is completely identified, except as to grade, by painting and marking on original packing containers. For purposes of record, the standard nomenclature of the item, together with its lot number, completely identifies the ammunition. Once removed from its packing, ammunition may be identified by the painting and marking on the ammunition items. Other essential information may also be obtained from the marking on ammunition

---

*General*

---

s. The muzzle velocity of projectiles may be obtained from the g tables and ammunition data cards; in the case of some rounds maller caliber, the muzzle velocity may appear on the packing box. uded in both the marking and the standard nomenclature are:

- 1) A brief description of the type, or suitable abbreviation thereof.
- (2) Caliber, weight, or size.
- (3) Model designation.
- (4) Where required, such additional information as the model and type of fuze, the model of the cannon in which the item is fired, the weight of projectile for which a separate loading propelling charge is suited, etc.
- (5) The lot number is marked on the ammunition but is not a part of the nomenclature. However, when referring to specific ammunition, it is necessary to mention the lot number as well as the standard nomenclature.

**b. Mark or model.** To identify a particular design, a model designation is assigned at the time the model is classified as an adopted type. This model designation becomes an essential part of the nomenclature and is included in the marking of the item. The present system of model designation consists of the letter "M" followed by an arabic numeral, for example, "M1." Modifications are indicated by adding the letter "A" and the appropriate arabic numeral. Thus, "M1A1" indicates the first modification of an item for which the original model designation was "M1." Wherever a "B" suffix appears in a model designation it indicates an item of alternative (or substitute) design, material, or manufacture. Certain items standardized for use by both Army and Navy are designated by "AN" preceding the model designation, for example, AN-M103A1, AN-Mk 19. From World War I to 1 July 1925, it was the practice to assign mark numbers, that is, the word "Mark," abbreviated "Mk," followed

---

*General*

---

by a roman numeral. The modification was indicated by the addition of MI to the mark number, the second MII, etc.; after 2 April 1945, these roman numerals in Mark numbers will be indicated by arabic, rather than roman, numerals. This change from roman to arabic numerals will affect ammunition items in use by the U. S. Army which are of British or Navy origin, and also older army items which are now assigned Mark numbers. Prior to World War II the year in which the design was adopted, preceded by the letter "M," was used as the model designation, for example, M1914.

c. **Ammunition lot number.** At the time of manufacture every item of ammunition is assigned a lot number. Where the size of the item permits, it is marked on the item itself to insure permanency of this means of identification. In addition to this lot number, there is assigned to each complete round of fixed and semifixed ammunition an ammunition lot number which serves to identify the conditions under which the round was assembled, and the components used in the assembly. This ammunition lot number is marked on every complete round of fixed and semifixed ammunition (except where the item is too small) and on all packing containers. It is required for all purposes of record, including reports on condition, functioning, and accidents, in which the ammunition is involved. As far as practicable, all complete rounds of any particular ammunition lot are made up of components selected from the same lot. To obtain the greatest accuracy in any firing, successive rounds should be from the same ammunition lot.

d. **Ammunition data card.** Ammunition data cards will be furnished in the prescribed amounts for all ammunition items of issue except small-arms ammunition. This is a 5- by 8-inch card, on which is printed data concerning the item and its components. Data cards are forwarded with shipping tickets at the time of shipment and are also sent to the ultimate consignee. Information on the cards includes lot number; date packed; identity of components; expected pressures; expected muzzle velocity; assembling and firing instructions, when required; and AIC symbols on lots now being produced.



## General

## 7. PAINTING AND MARKING.

a. **Painting.** Ammunition is painted primarily to prevent rust. Secondary purposes are to provide, by the color, a ready means of identification as to type, and to camouflage the ammunition by the use of lusterless olive-drab paint. See figures 1 to 16, inclusive, for the use of color on ammunition and its packings. The color scheme is as follows:

(1) For ammunition other than bombs, small-arms ammunition, and pyrotechnics:

High-explosive .....	Olive-drab, with marking in yellow
Low-explosive .....	Red, with marking in black
Illuminating .....	Gray, with 1 white band and marking in white
<b>Chemical:</b>	
Persistent casualty gas .....	Gray, with 2 green bands and marking in green
Nonpersistent casualty gas .....	Gray, with 1 green band and marking in green
Persistent harassing gas .....	Gray, with 2 red bands and marking in red
Nonpersistent harassing gas .....	Gray, with 1 red band and marking in red
Smoke .....	Gray, with 1 yellow band and marking in yellow
Incendiary .....	Gray, with 1 purple band and marking in purple
Practice .....	Blue, with marking in white
Dummy or inert .....	Black, with marking in white (bronze or brass assemblies are unpainted).

General

(2) For bombs, other than chemical and practice, the painting is olive-drab, and 1-inch color bands are painted at the nose and tail ends of the body. Markings are in black, except for the incendiary bomb which has purple stenciling. The color of the bands is as follows for the types of bombs indicated:

High-explosive .....	Yellow
Incendiary .....	Purple
Drill or inert .....	Black

When bombs are loaded with Composition B, "COMP. B" is stenciled twice, 180 degrees apart on each band. When bombs are loaded with tritonal, a third color band, 1/2-inch wide, is located midway between the two bands on either end. These bombs have an inert pad in each end. When TNT or COMP. B loaded bombs are equipped with inert pads, they will be stenciled "WITH PADS" to distinguish from bombs with the small filling, but without pads; the purpose of the inert pad is to render the bomb less sensitive to blows on the end during handling and shipping. Practice bombs are painted blue with white markings but have no color bands. Small fragmentation bombs have no color bands but the nose and tail are painted yellow. Chemical bombs are painted gray, except incendiary bombs which are painted olive-drab, and marked with color bands and stenciling in accordance with the color scheme for other ammunition given in step (1), above.

(3) Small-arms cartridges do not require painting. However, the bullet tips of cartridges are painted a distinctive color (fig. 1) to aid in ready identification as to type, as follows:

Ball .....	No color tip
Armor-piercing .....	Black
Armor-piercing-incendiary .....	Aluminum (silver)
Armor-piercing-incendiary-tracer .....	Red with aluminum annulus to the rear

---

 General
 

---

Incendiary	Various shades of blue
Tracer	Various shades of red, <u>such as</u> orange and maroon, and white
Frangible	White tip with green annulus to the rear

(4) Pyrotechnics are not marked in accordance with the general color scheme but, where color markings are used, they indicate the color of the pyrotechnic effect produced. In general, however, pyrotechnics, are painted gray with marking in black. If the body of the item is aluminum or magnesium, it may not be painted. If the item is intended for incendiary purposes, markings are in purple.

b. **Marking.** The marking stenciled or stamped on the ammunition and on its packing container includes all information necessary for complete identification. Further information concerning painting and marking will be found under the specific type of ammunition in chapter 2 and in section IV of chapter 3.

## 8. GRADING.

a. Ammunition is manufactured to rigorous specifications and is thoroughly inspected before acceptance. Ammunition in storage is periodically inspected and tested in accordance with specific instructions furnished by the Chief of Ordnance.

b. Each lot of small-arms ammunition is graded primarily on the qualities which make that lot especially suitable for use in a particular class of small-arms weapons such as aircraft and antiaircraft machine guns, rifles, and ground machine guns (WD SB 9-AMM 4).

c. Each lot of ammunition other than small-arms ammunition is graded as a result of surveillance tests into one of four grades, depending on its serviceability (WD SB 9-AMM 1).



General

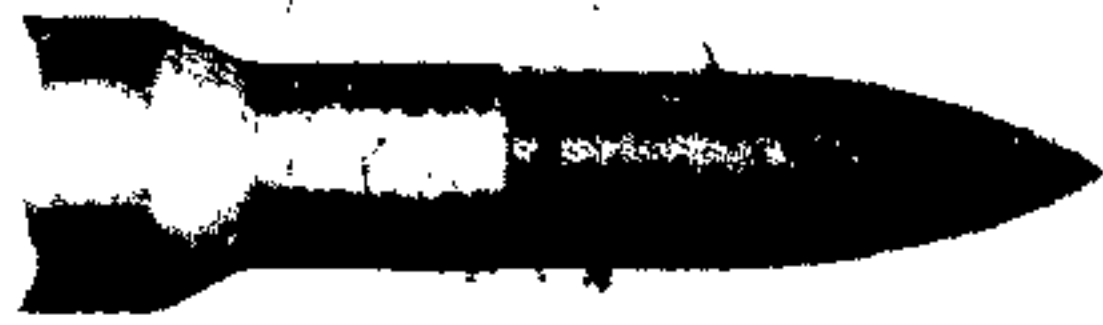

BALL

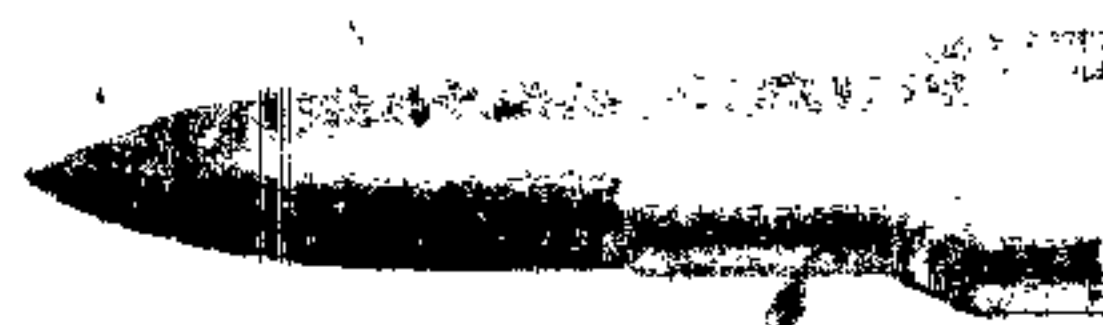

INCENDIARY



HIGH-PRESSURE TEST

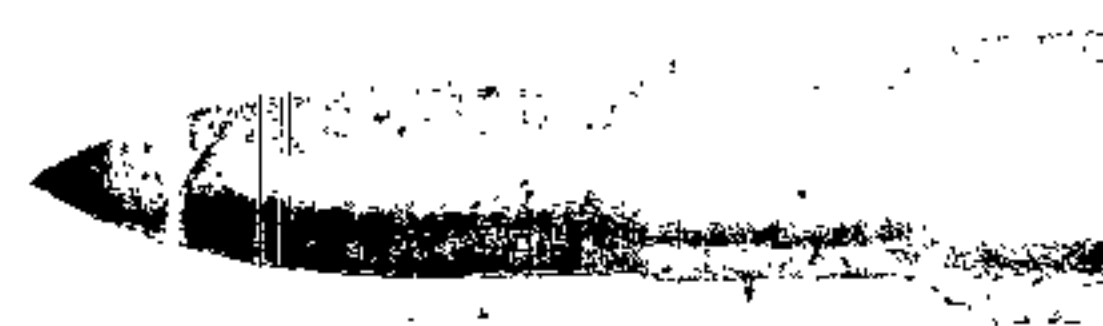

INCENDIARY, CAL. 50,  
M23 (1748)

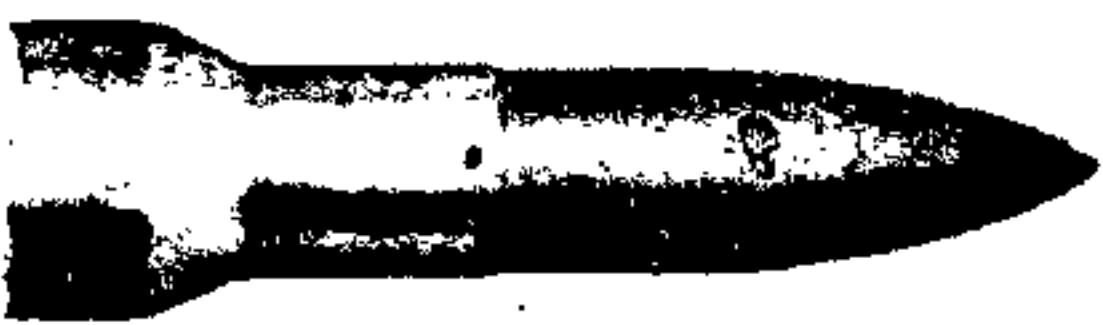

ARMOR-PIERCING

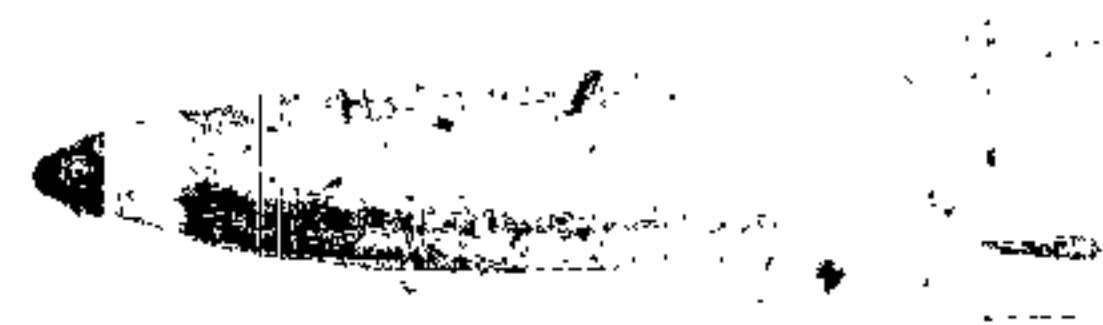

ARMOR-PIERCING,  
INCENDIARY, M7

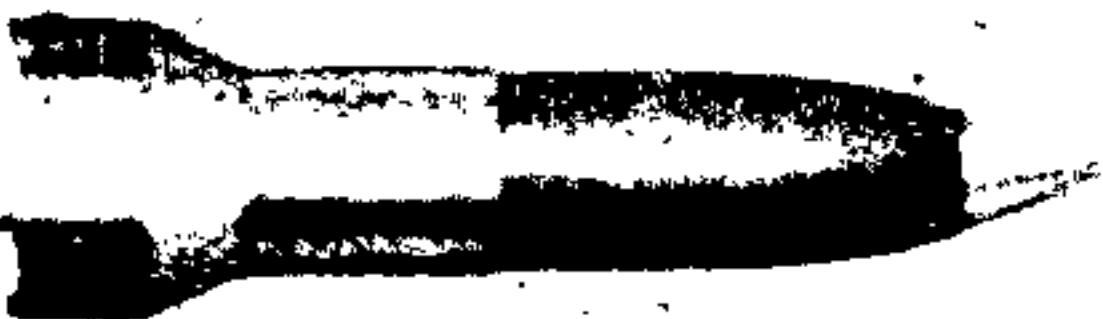

ARMOR-PIERCING,  
INCENDIARY, M8



TRACER, M17



ARMOR-PIERCING,  
INCENDIARY-TRACER

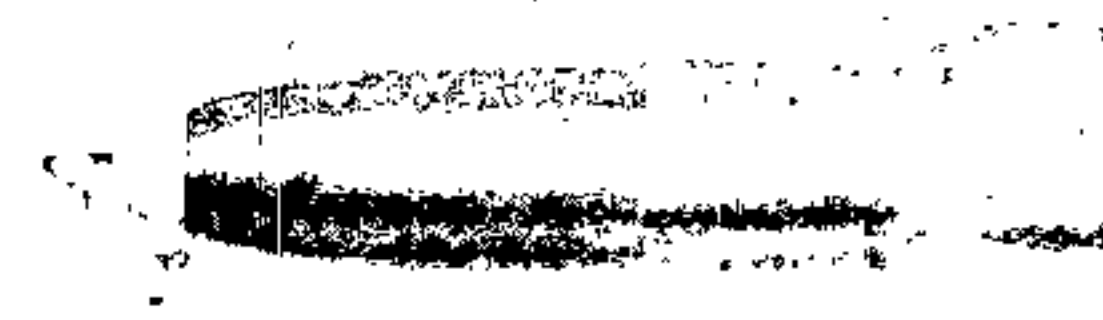

TRACER, M10, T10, T43

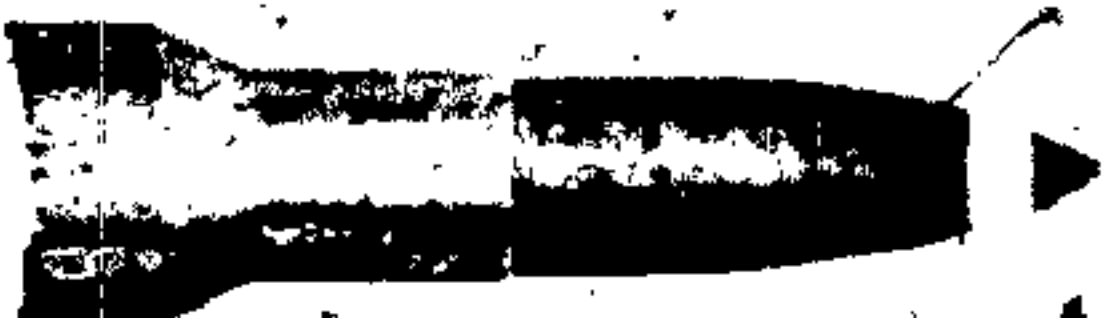

FRANGIBLE

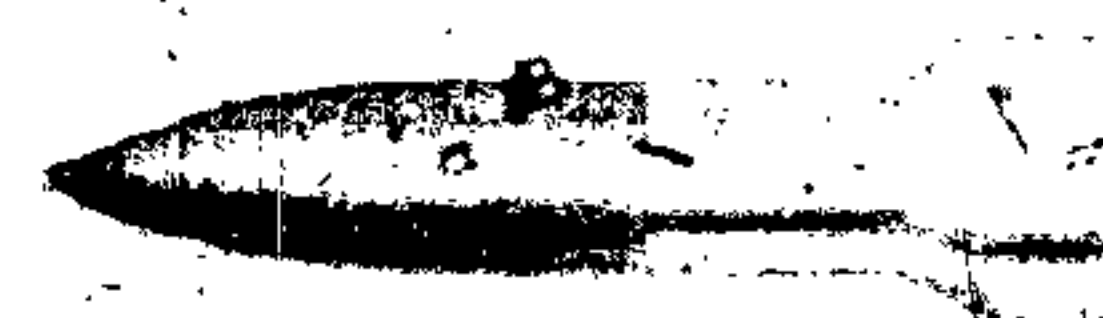

TRACER, M1, M16, T30, M21

Figure 1 - Color Identification of Small-arms Ammunition Types

General



HIGH EXPLOSIVE (E.G., HE, HE, AT, APC-T, W/EXPLOSIVE)

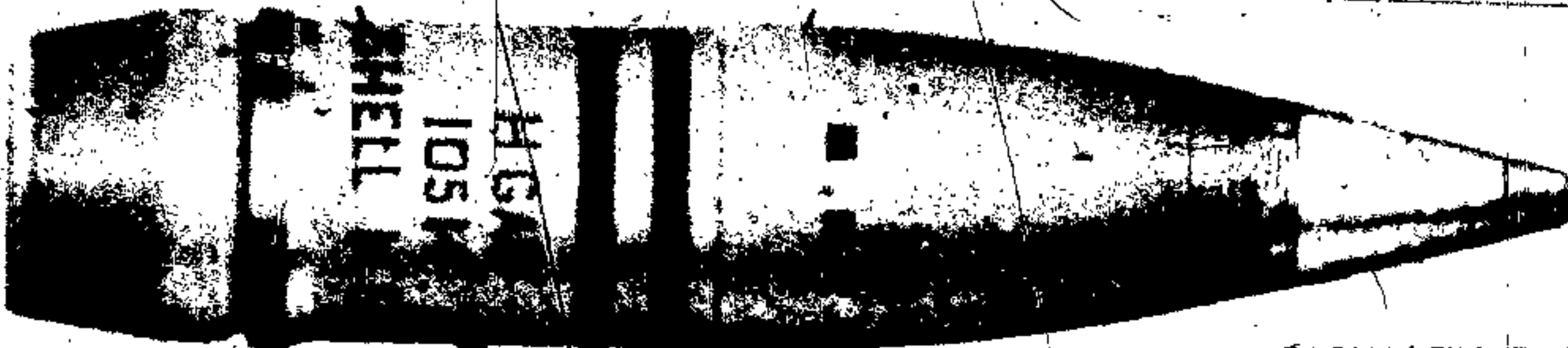

CASUALTY GAS-PERSISTENT



HARASSING GAS-PERSISTENT

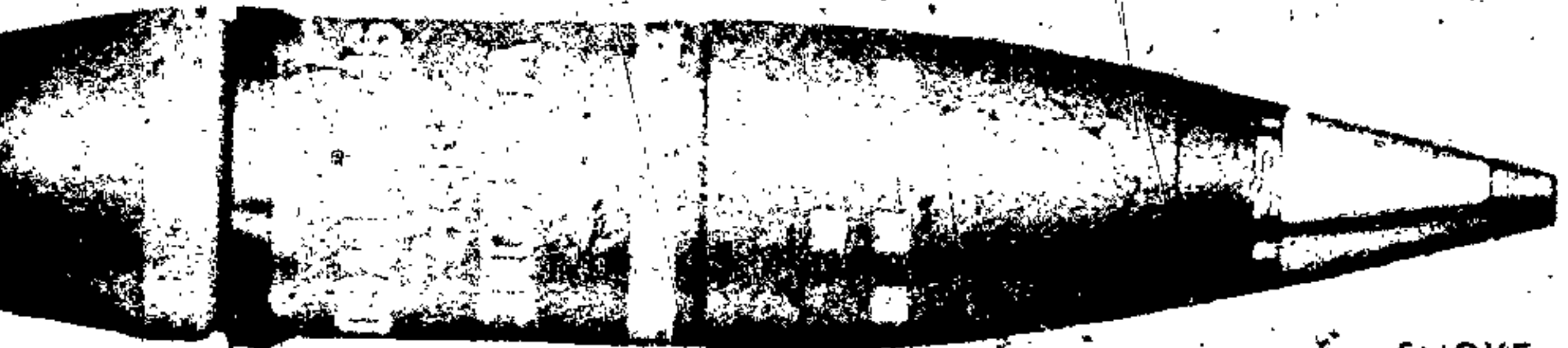

SMOKE



ILLUMINATING



PRACTICE

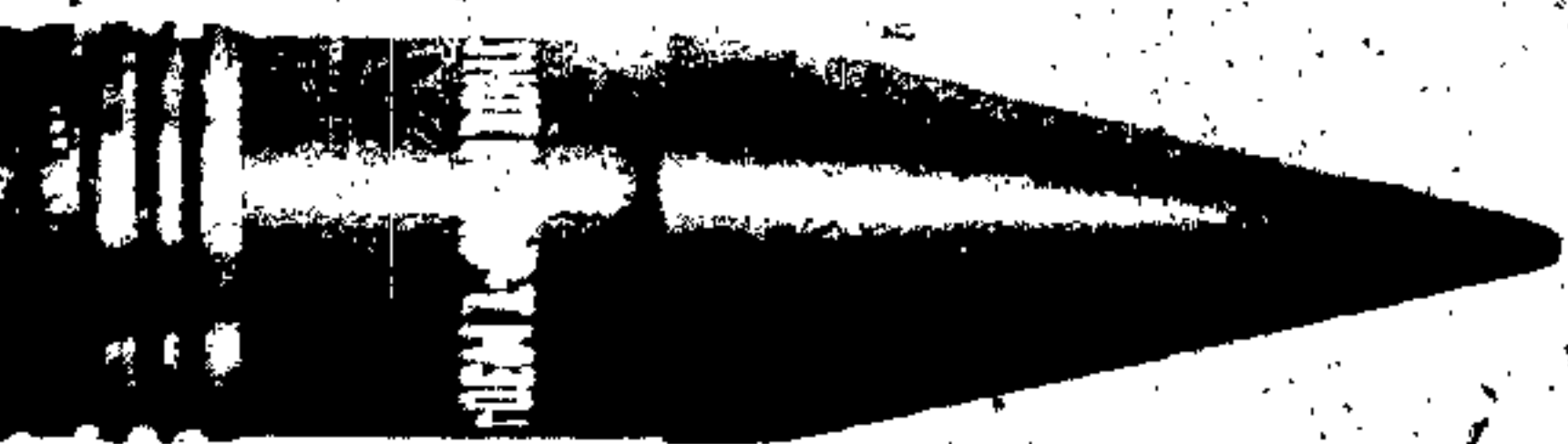

INERT (E.G., HYAP-T, DUMMY, CANISTER, AP-T, APC-T, W/O EXPLOSIVE)

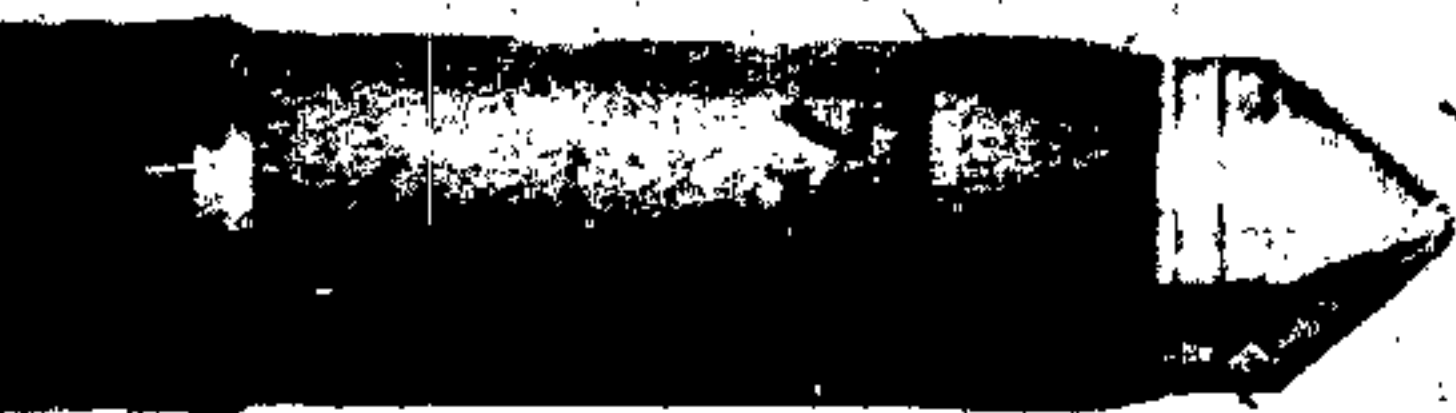

LOW EXPLOSIVE (E.G., SHRAPNEL)

KA PD 97767

Figure 2 - Color Identification of Artillery Projectiles

General

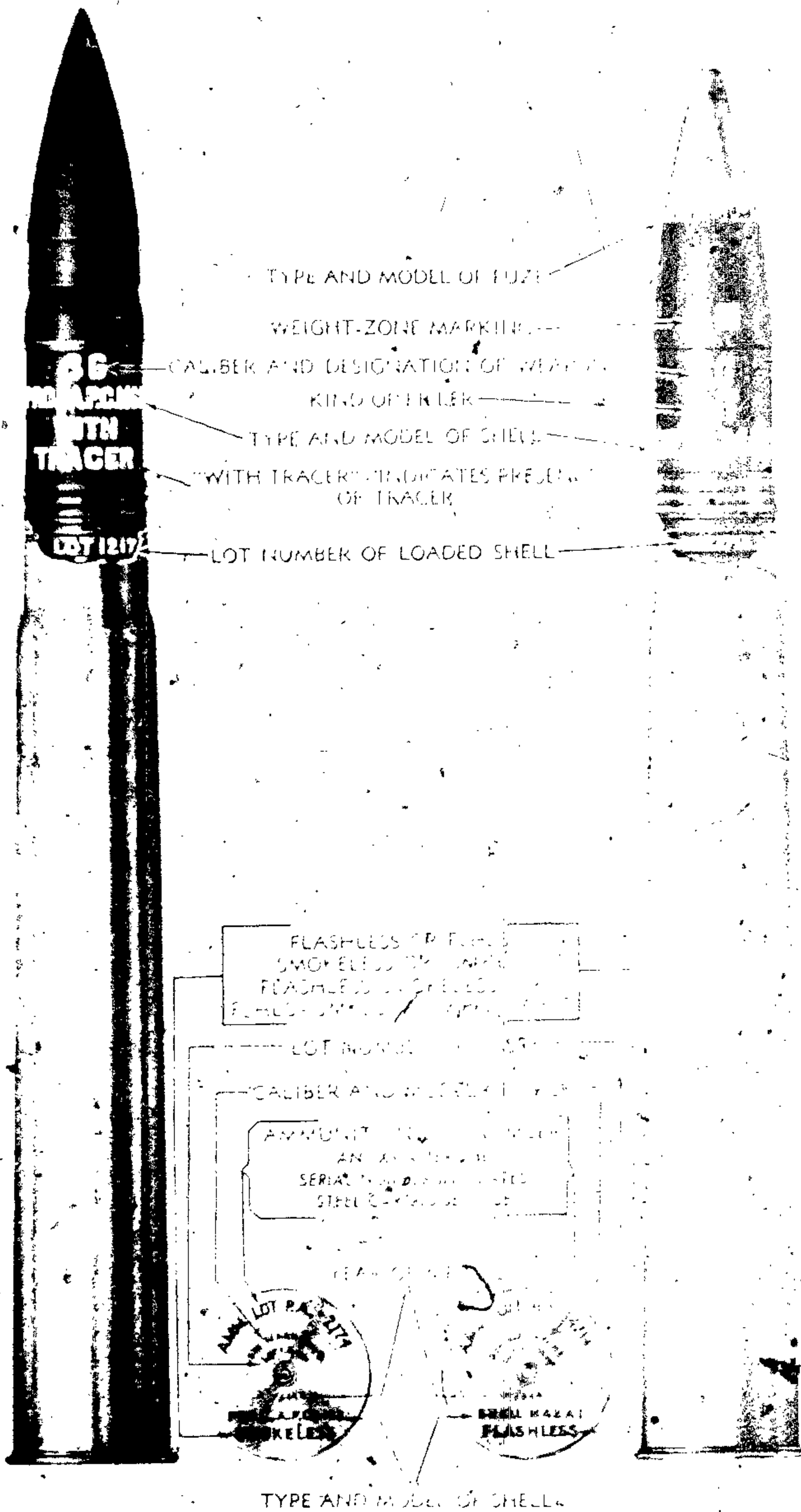

RA PD 80678A

Figure 3 — Typical Marking of Fixed Artillery Ammunition



General

- A - 2 DIAMETRICAL STRIPES AT RIGHT ANGLES AND "REDUCED" INDICATE REDUCED CHARGE
- B - 2 BANDS AND "REDUCED" INDICATE REDUCED CHARGE
- G - 1 DIAMETRICAL STRIPE AND "NORMAL" INDICATE NORMAL CHARGE
- D - 1 BAND AND "NORMAL" INDICATE NORMAL CHARGE
- E - "SUPER" INDICATES SUPERCHARGE
- F - AMMUNITION LOT NUMBER AND LOADER'S INITIALS
- G - MANUFACTURER'S INITIALS AND YEAR OF MANUFACTURE
- H - CALIBER AND MODEL OF CARTRIDGE CASE
- I - MODEL OF SHELL
- J - WEIGHT-ZONE MARKING
- K - KIND OF FILLER
- L - CALIBER AND TYPE OF CANNON

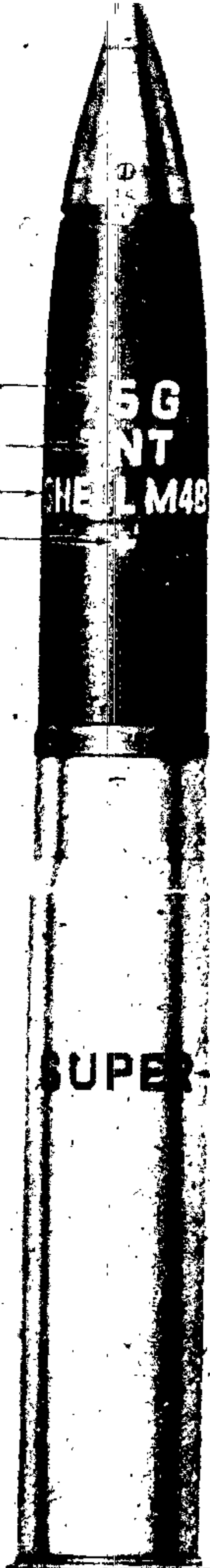
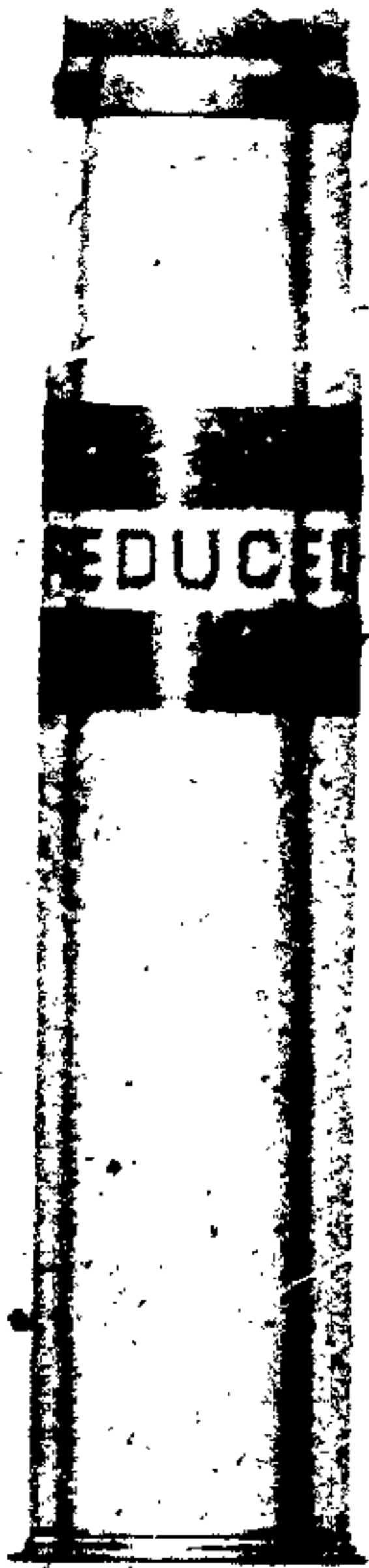

RA PD 80679

Figure 4 - Marking of Fixed Artillery Ammunition To Indicate Reduced, Normal, and Super Charges

General

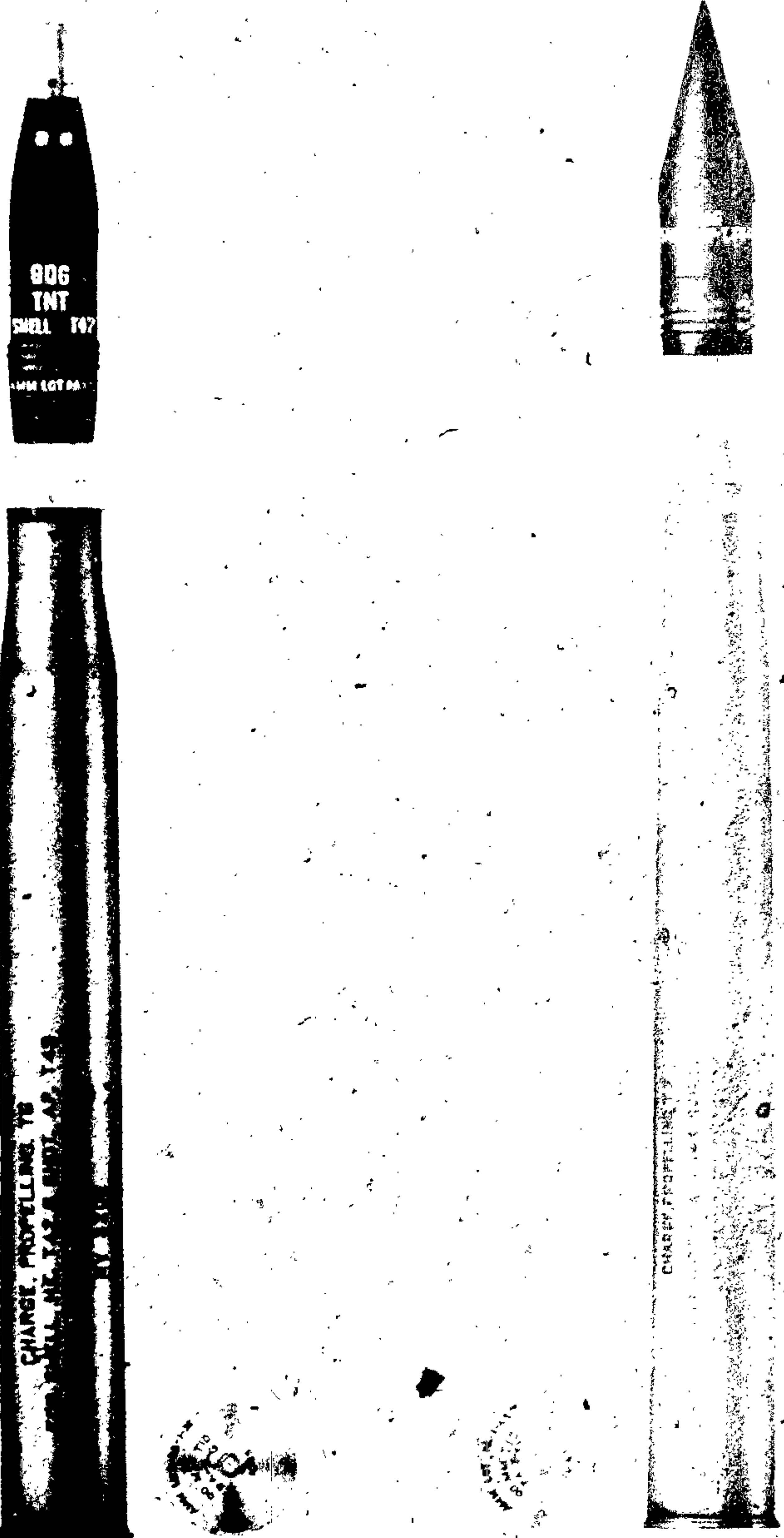
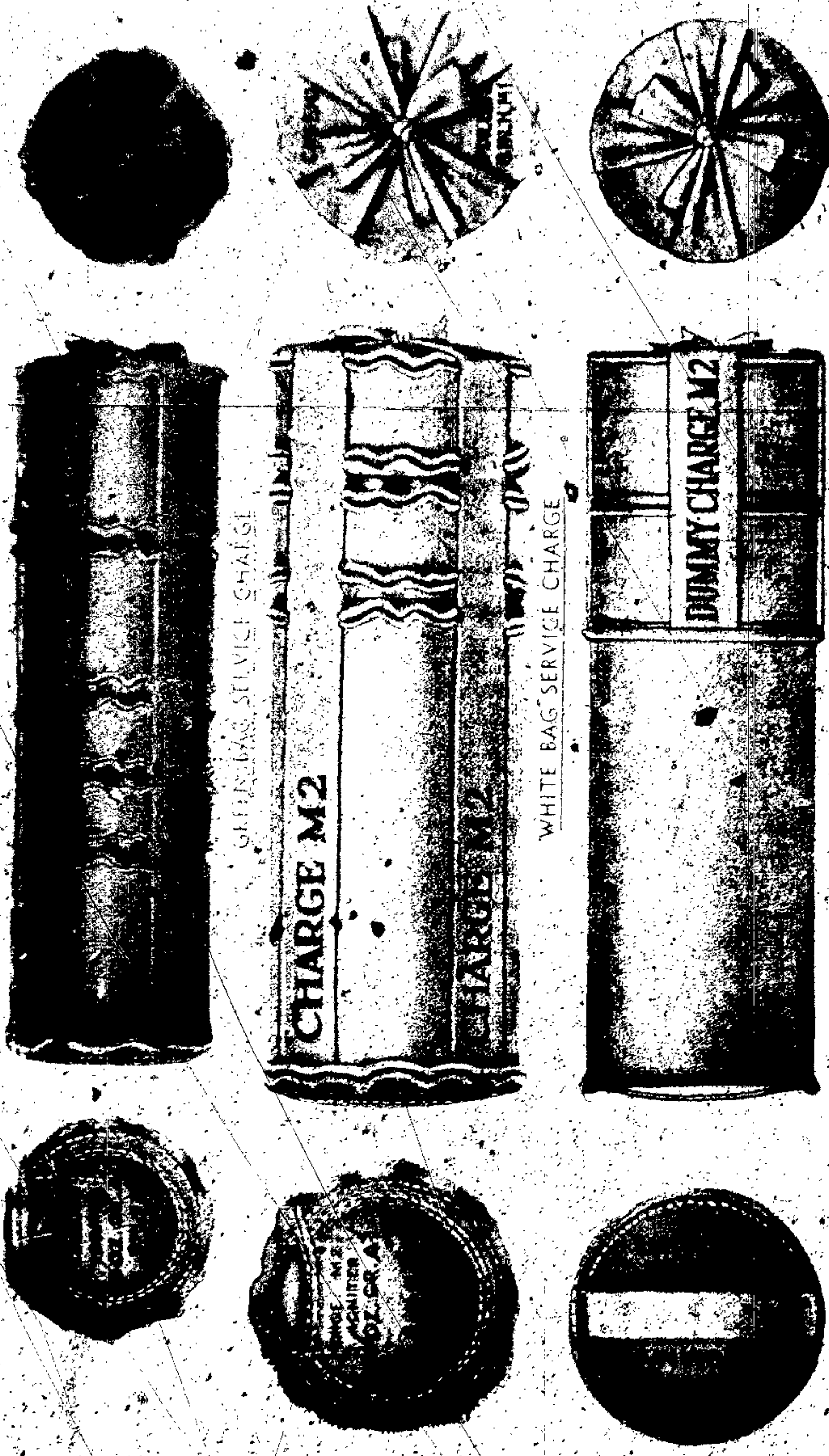

Figure 5 — Marking of 90-mm Separated Artillery Ammunition :

General



RA PD 97766

Figure 6 — Color Identification of Artillery Propelling Charges



General

FOR PRACTICE  
AMMUNITION

FOR CASUALTY  
PERSISTENT GAS  
AMMUNITION

FOR HARASSING  
PERSISTENT GAS  
AMMUNITION

FOR SMOKE  
AMMUNITION

METAL  
CONTAINER

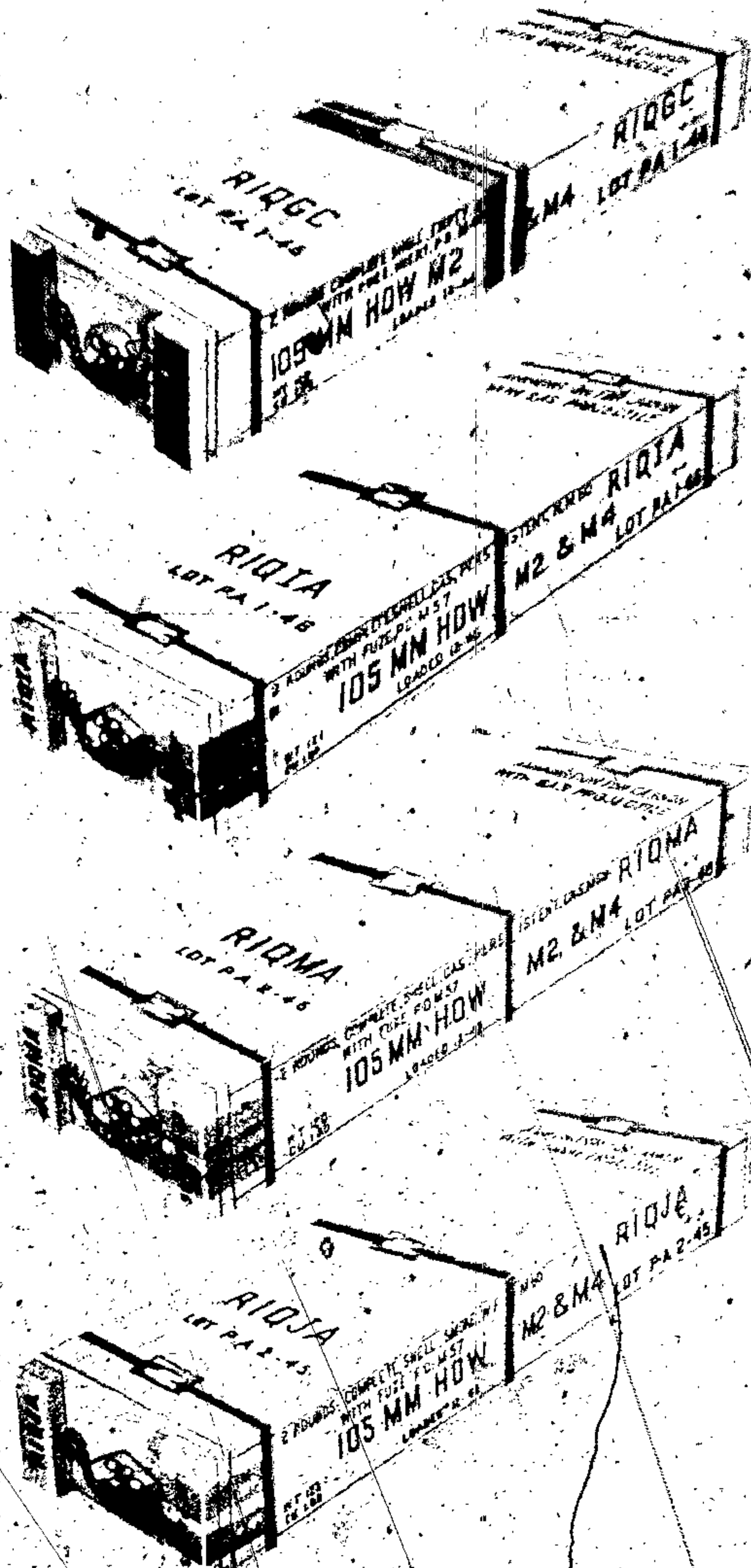

RIQJA LOT PA 2-45  
 105 MM HOW M2 & M4  
 2 ROUNDS COMPLETE SHELLS PER BOX  
 WITH FUZE P. M. S. 7  
 AMMUNITION FOR CANNON WITH EXPLOSIVE PROJECTILES  
 WT 71 CU 8  
 PACKED 12 4 1

RA PD 97765

Figure 7 - Color Marking of Packing Boxes and Metal Containers

General

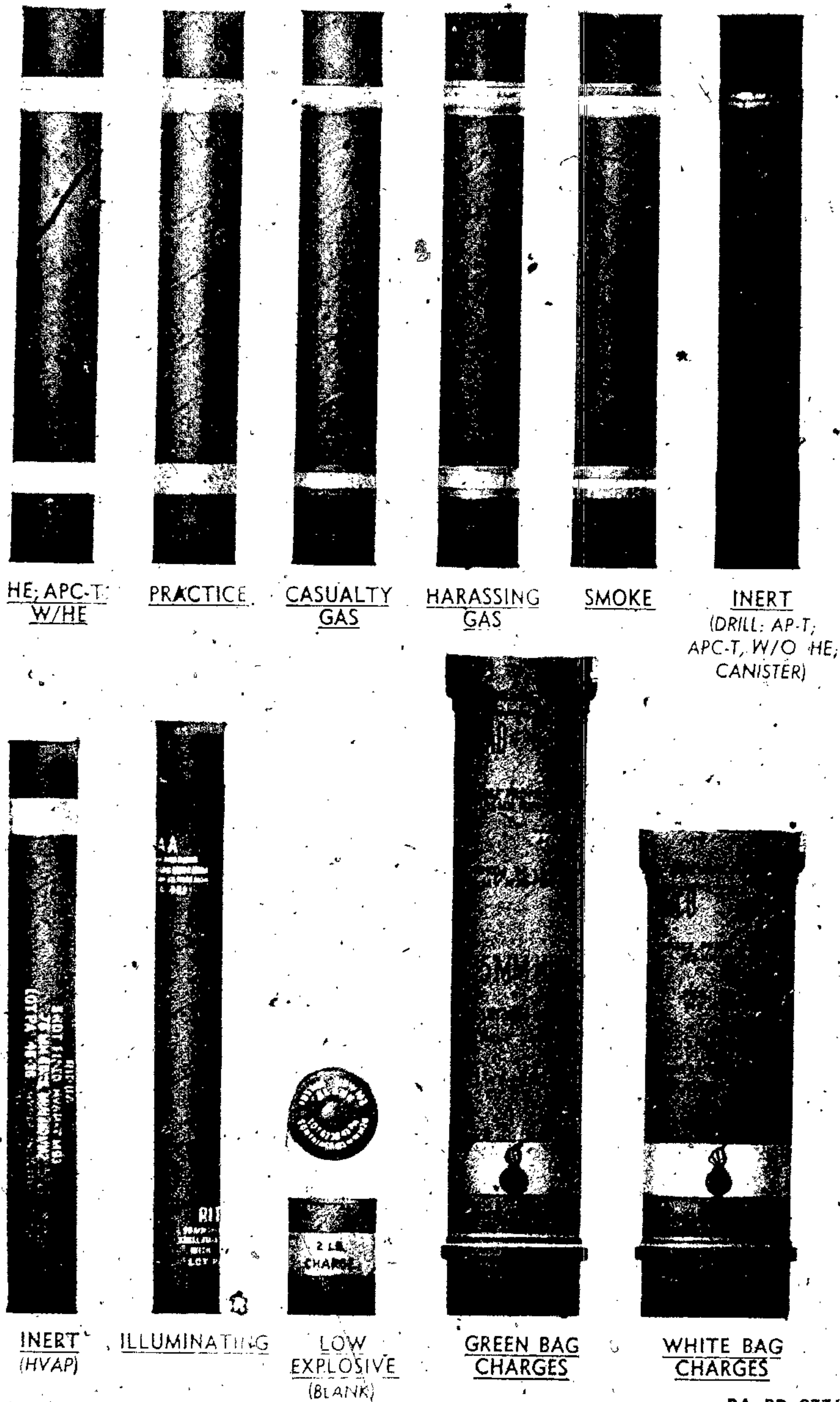

Figure 8 — Color Identification of Fiber Containers and Cartridge Storage Cases

RA PD 97764



General



RA PD 103499

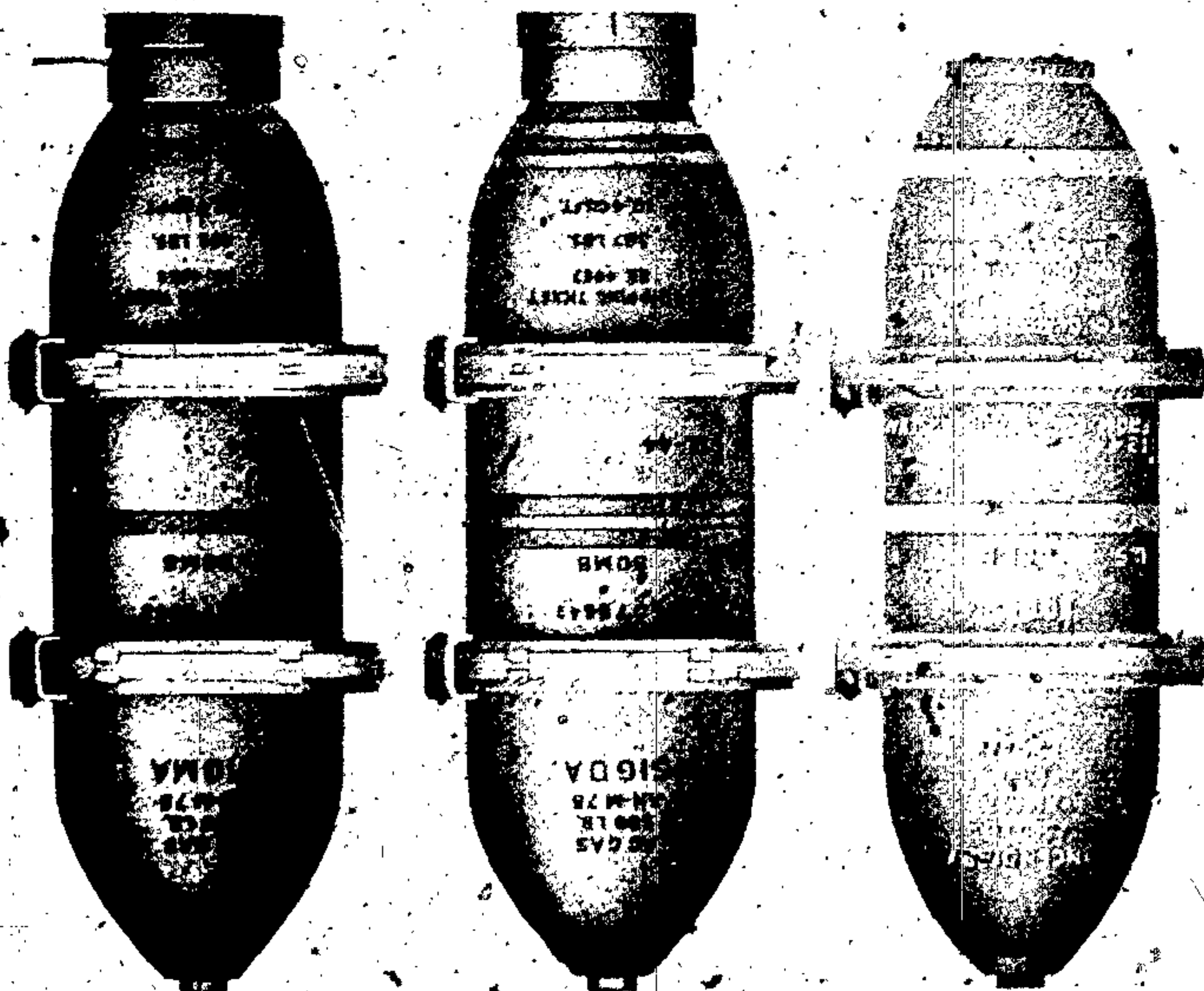

Figure 9 — Color Identification of Bombs



General



PHOTOFLASH

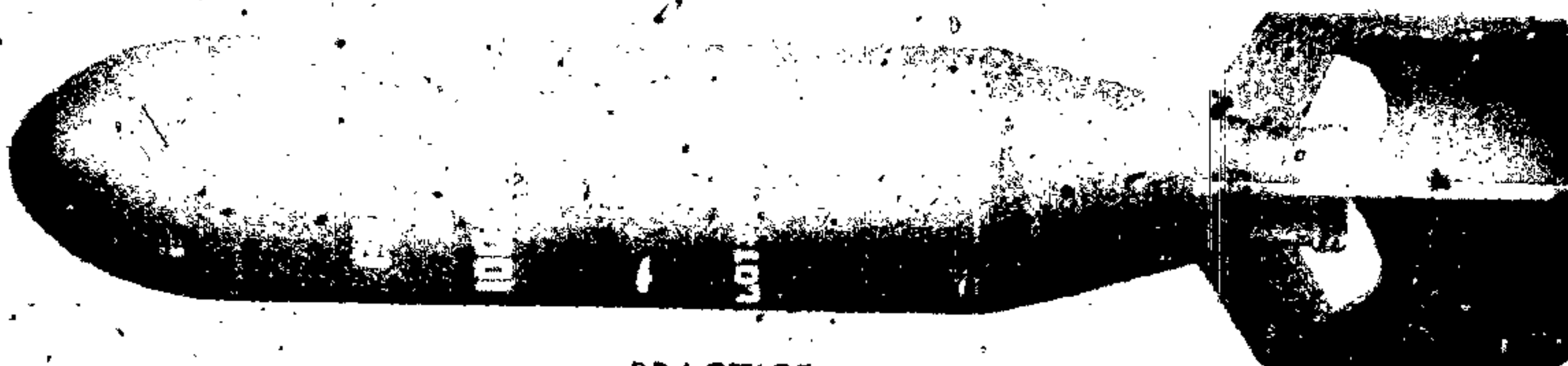

PRACTICE

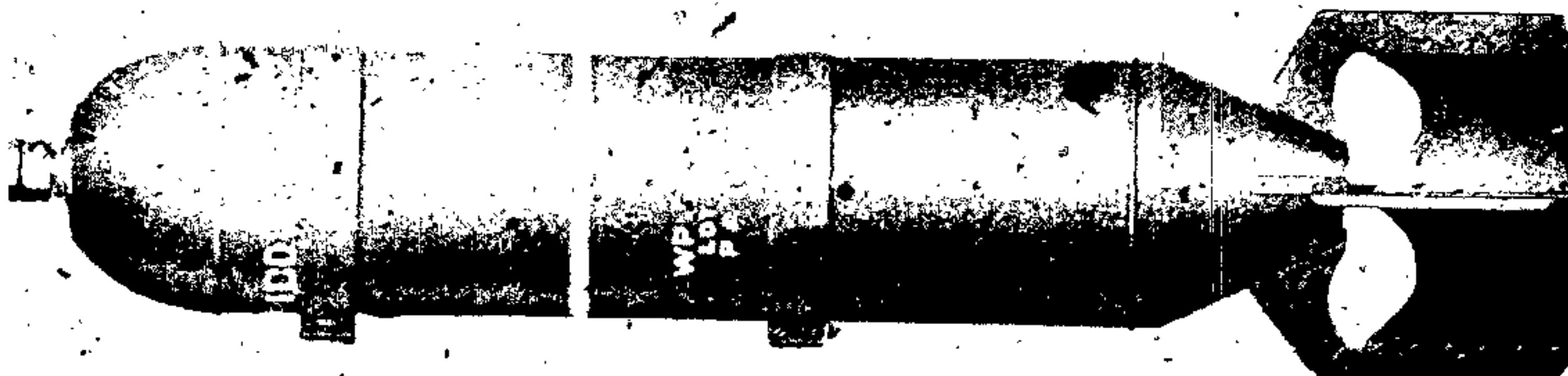

WP SMOKE



DRILL



FRAGMENTATION



INCENDIARY, 4-LB.

Figure 10 — Color Identification of Bombs (Continued)

General



PRACTICE



BLINDING



SUPERNOVA

RA PD 103501

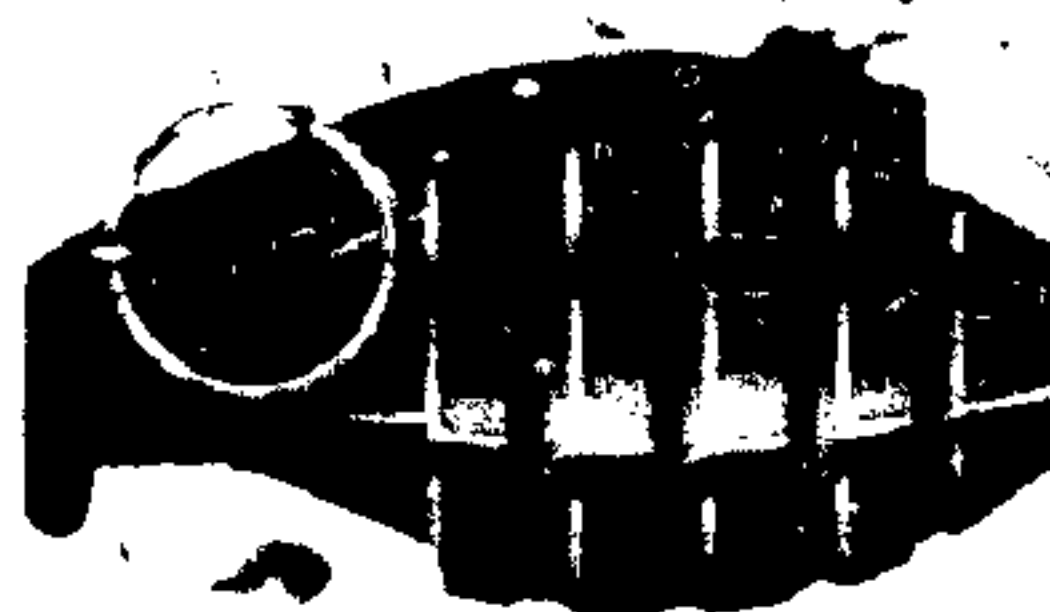

TRAINING



INCENDIARY

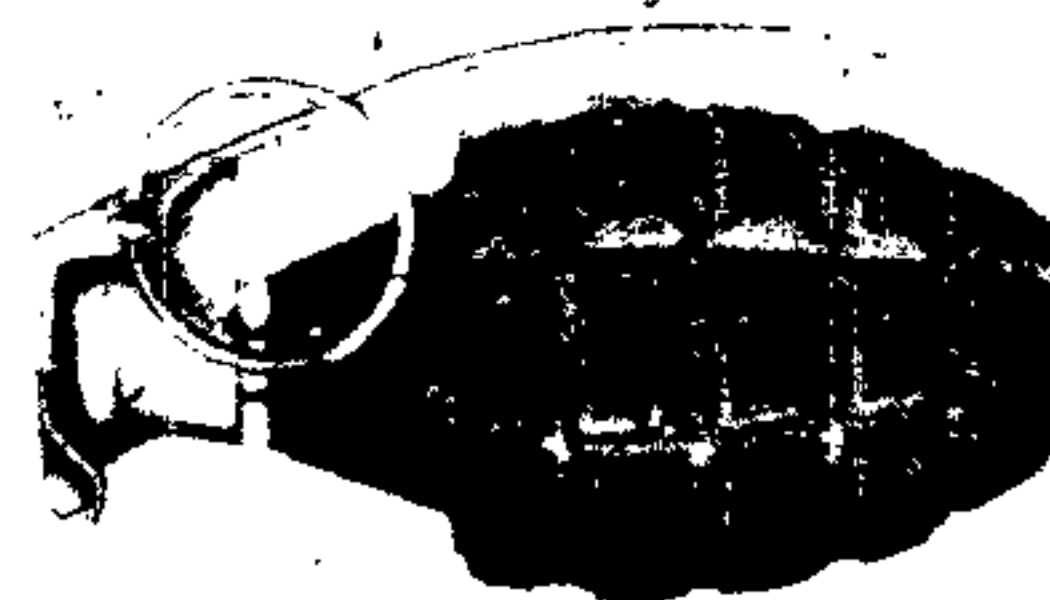

FRAGMENTATION

(W/INT)



SMOKE

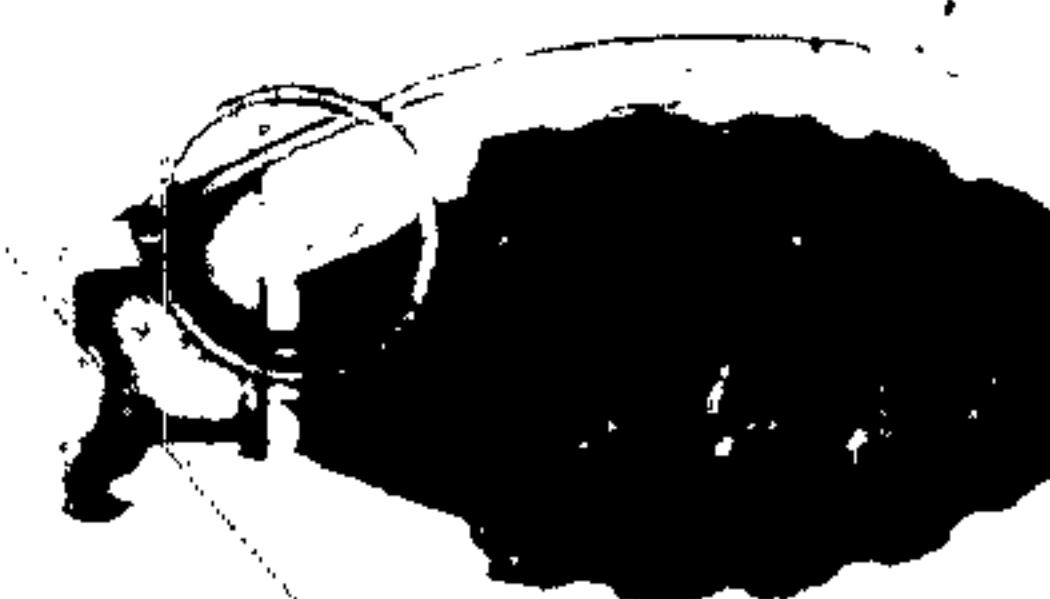

FRAGMENTATION

(W/POWDER)

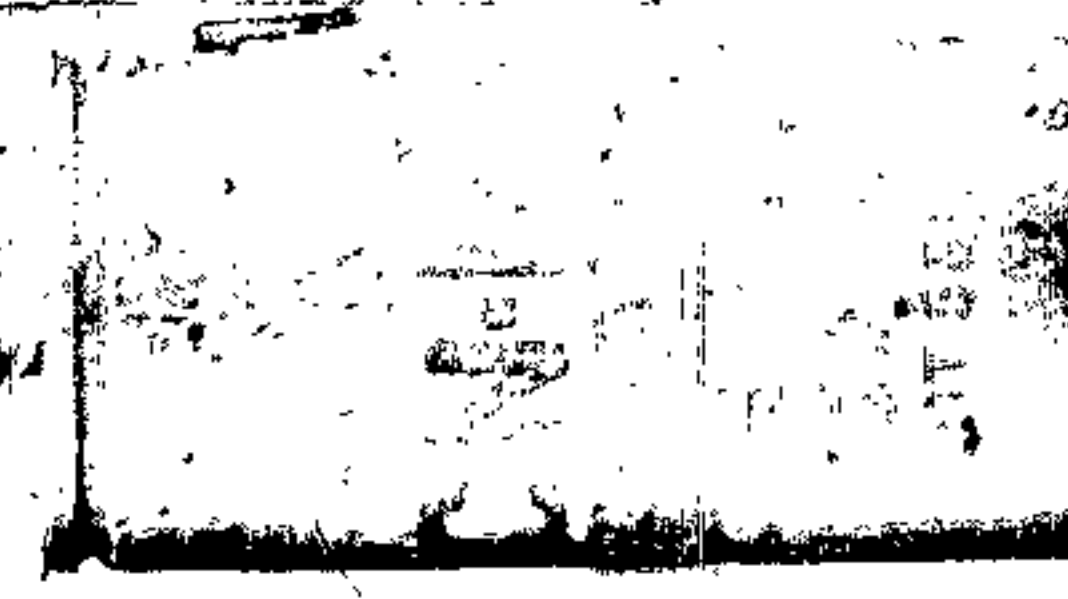

GAS

Figure 11—Color Identification of Hand Grenades

General



HIGH EXPLOSIVE, ANTITANK



PRACTICE

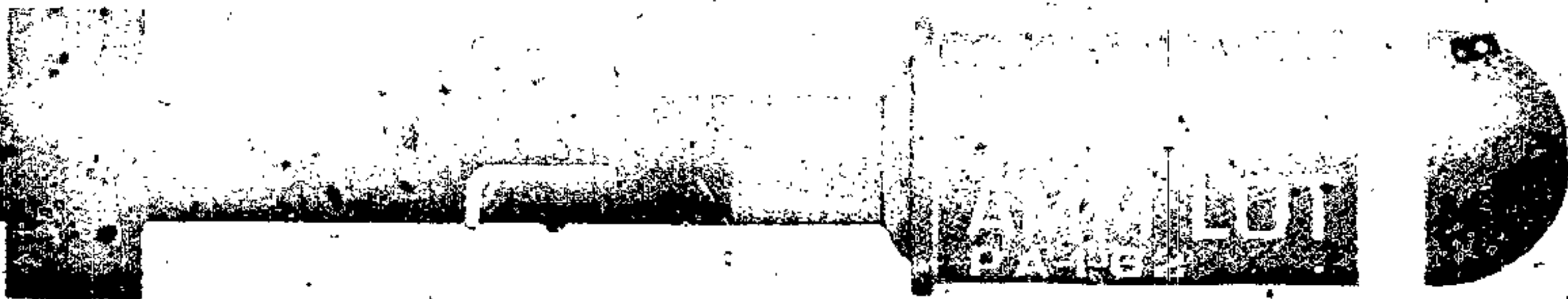

WP SMOKE



7  
COLORED SMOKE

RA PD 103502

Figure 12 - Color Identification of Rifle Grenades



General



TRAINING

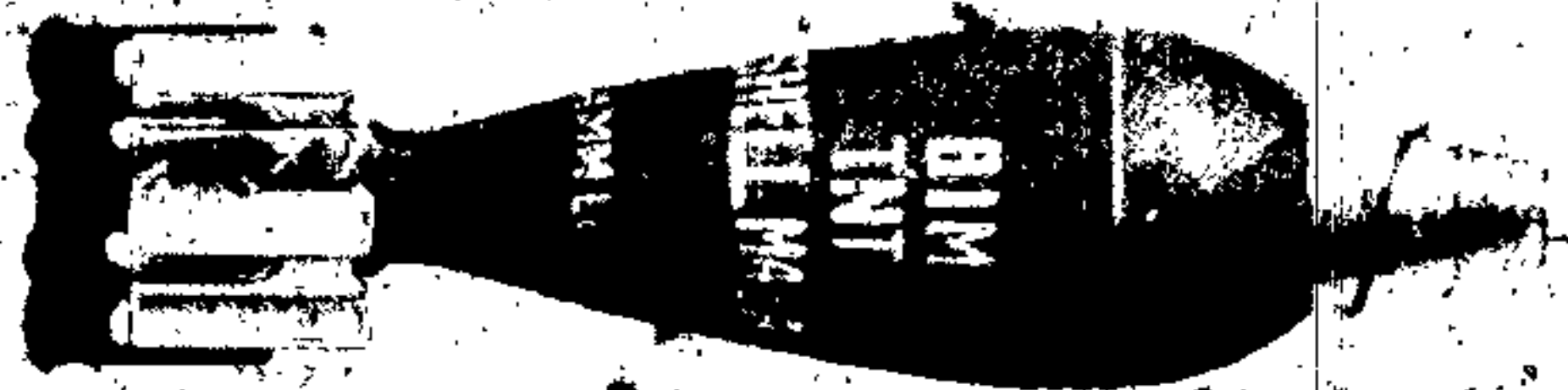

HIGH EXPLOSIVE (LIGHT)

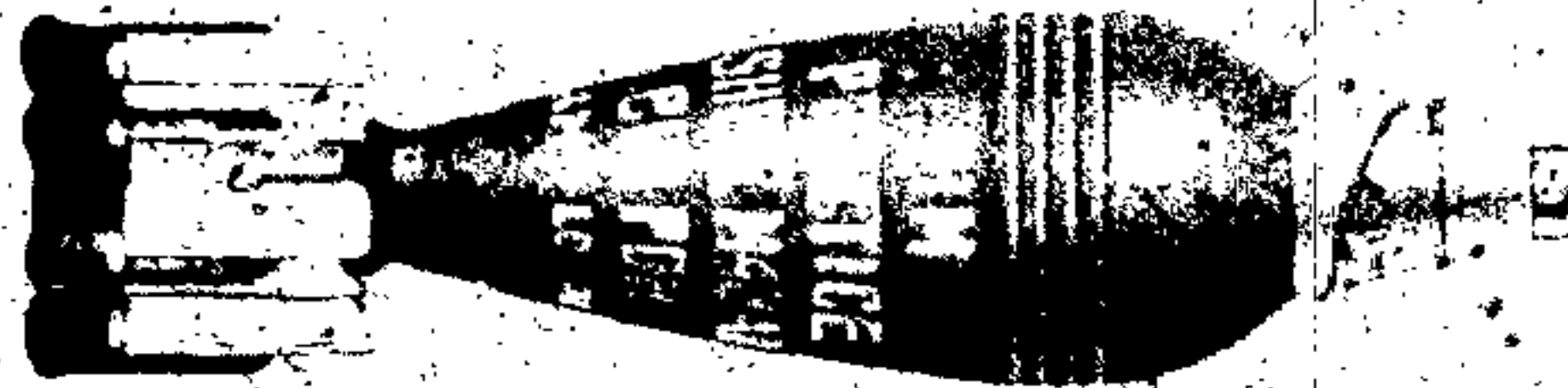

PRACTICE

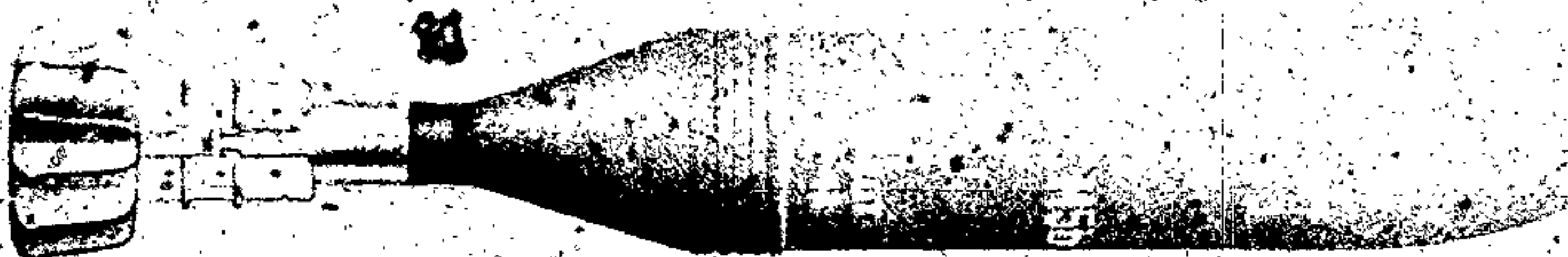

HIGH EXPLOSIVE (HEAVY)



SMOKE

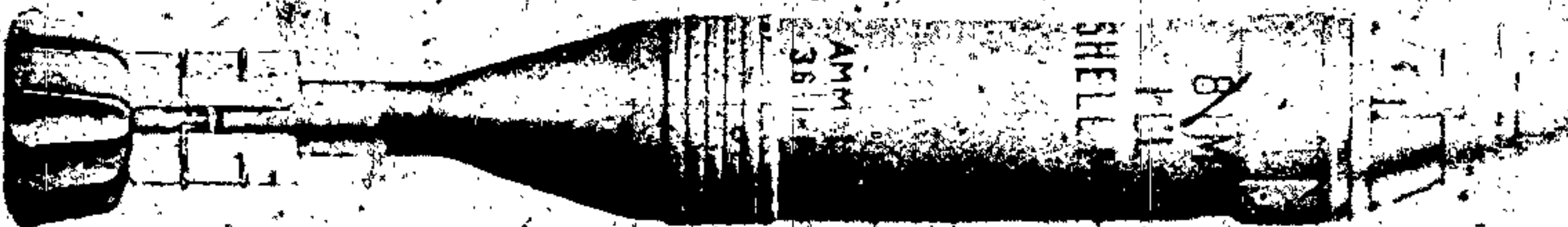

ILLUMINATING

RA PD 103503

Figure 13 - Color Identification of Mortar Shell

General



HIGH-EXPLOSIVE



PRACTICE

BOUNDING TYPE MINES

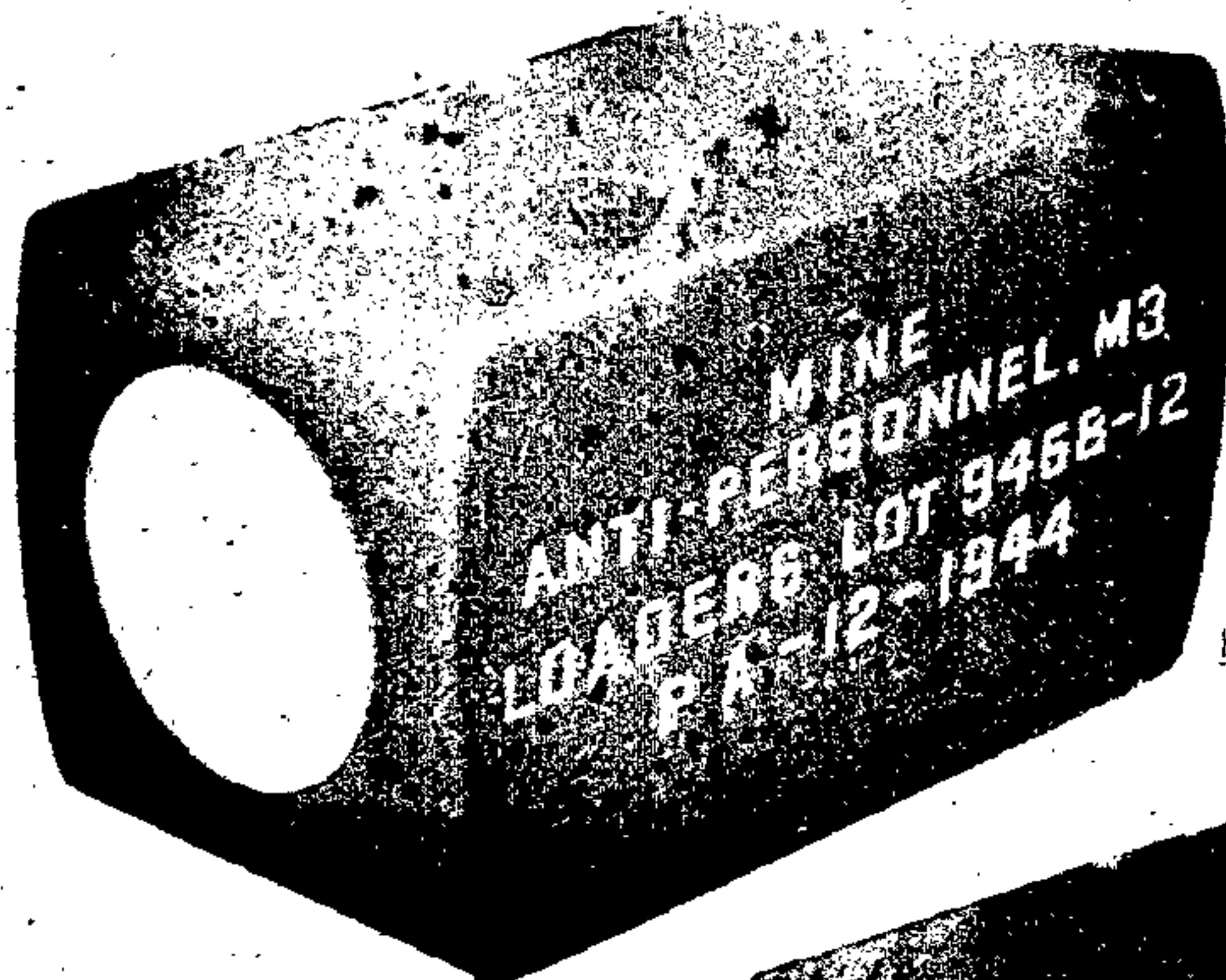

HIGH-EXPLOSIVE

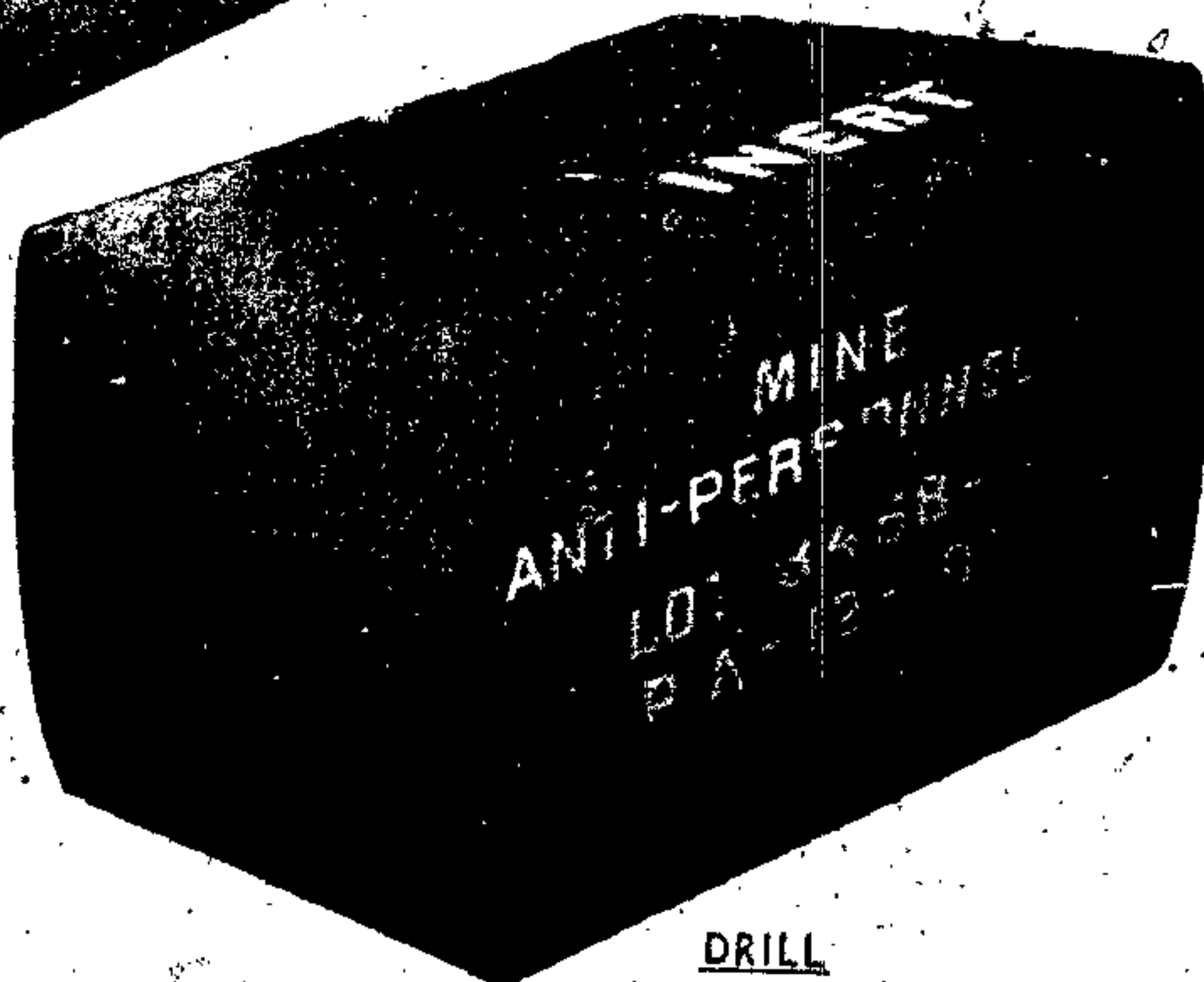

DRILL

CAST-IRON BLOCK TYPE

RA PD 103504

Figure 14 — Color Identification of Antipersonnel Mines



General



LIGHT ANTITANK HE MINE, M7

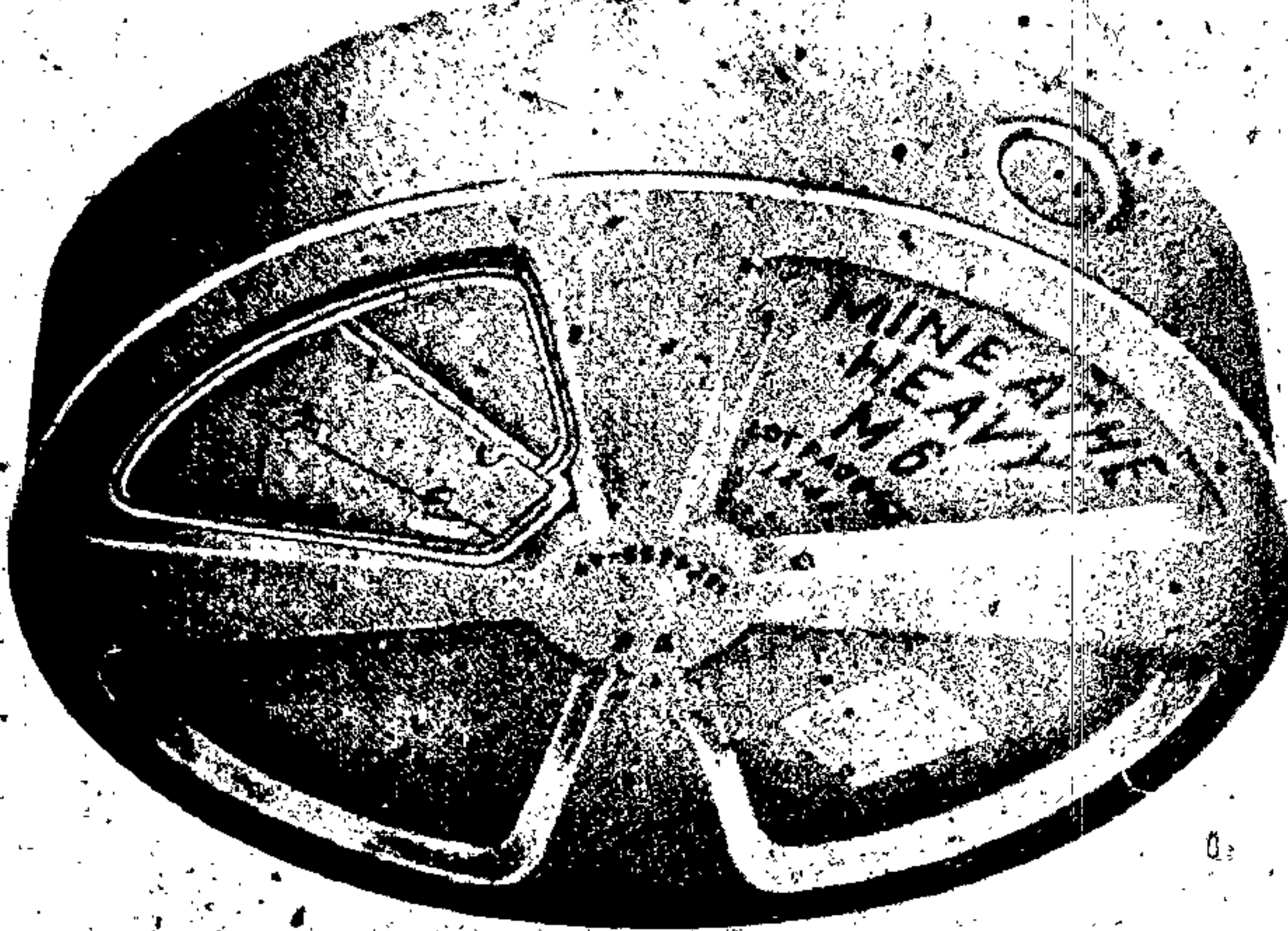

HEAVY ANTITANK HE MINE, M6

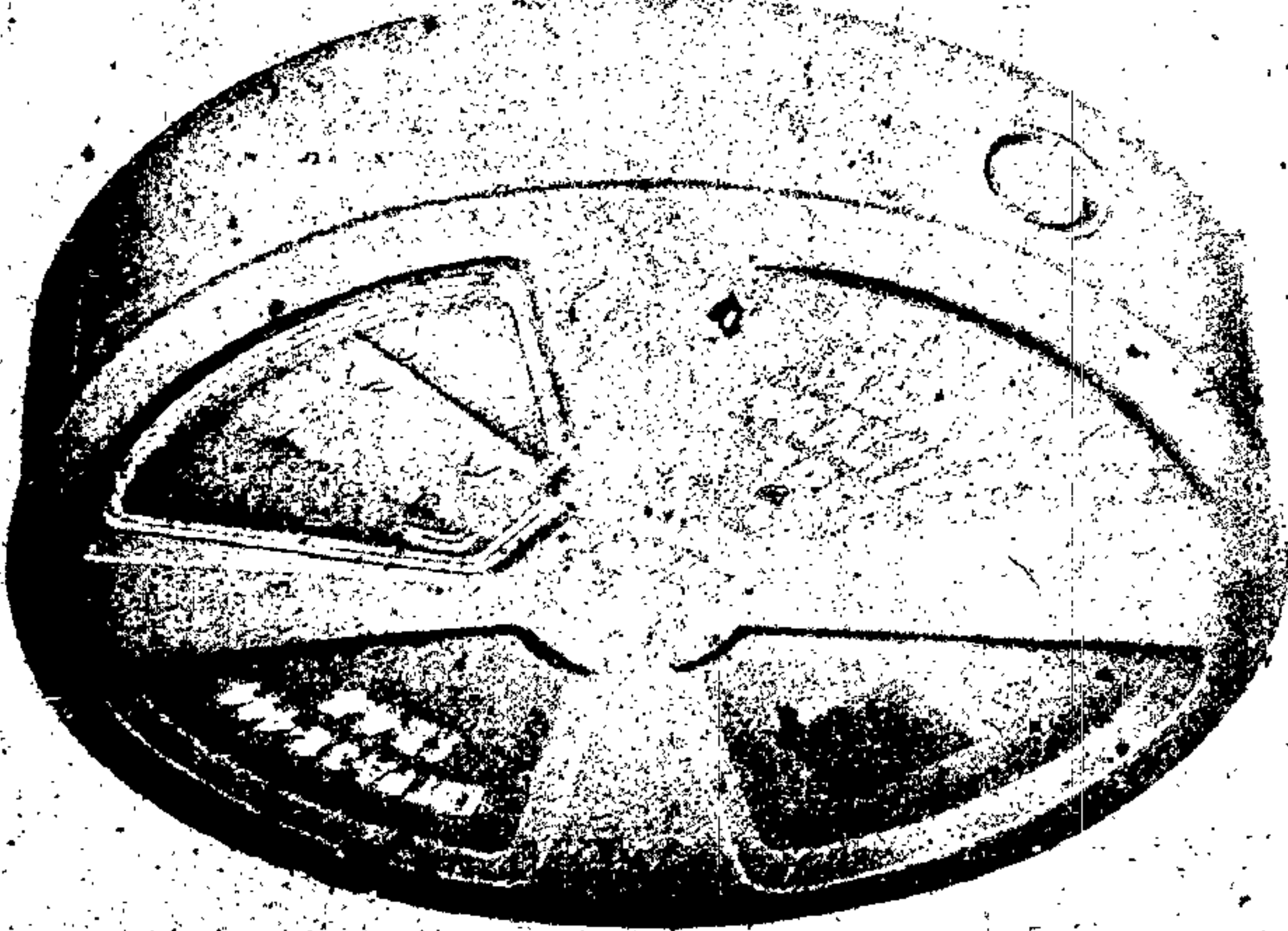

HEAVY ANTITANK PRACTICE MINE, T8E1

RA PD 103578

Figure 15 — Color Identification of Antitank Mines



General



3.25-INCH AA TARGET ROCKET

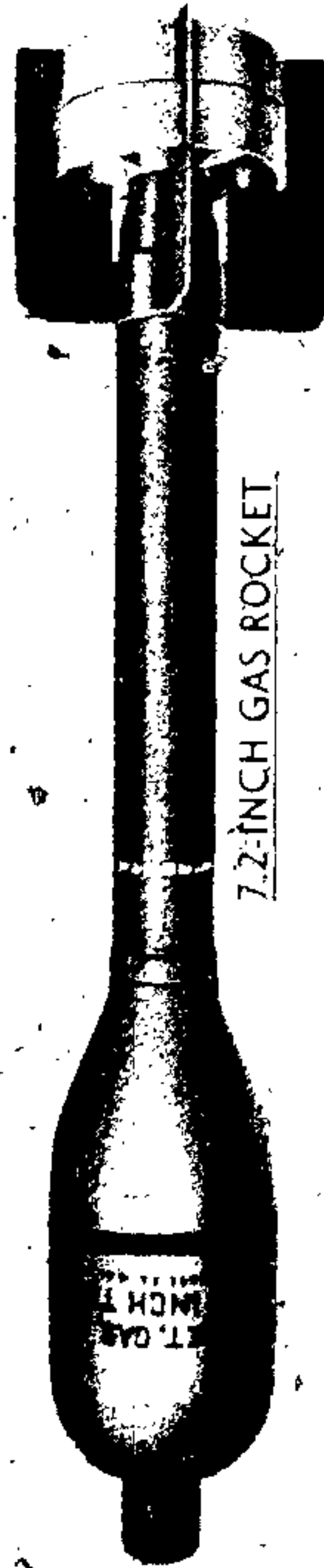

7.2-INCH GAS ROCKET



4.5-INCH HE ROCKET



4.5-INCH SMOKE ROCKET



4.5-INCH PRACTICE ROCKET

RA PD 903579

Figure 16 — Color Identification of Rockets

## 9. PRIORITY OF ISSUE.

a. Subject to special instructions from the Chief of Ordnance, ammunition of appropriate type and model will be used in the following order: limited standard, substitute standard, standard. Within this rule, ammunition which has had the longest, or least favorable storage will be used first. Among lots of equal age, priority of issue will be given to the smallest lot.

b. To prevent the building up of excess stocks in the field, transfers from one station to another should be arranged within the service command if no stock of appropriate grade for immediate use is on hand.

c. Priority of issue for lots of small-arms ammunition is established by the Chief of Ordnance and published in WD SB 9-AMM'4 or in special instructions.

d. Further details will be found in War Department Supply Bulletins of the 9-AMM series and in AR 775-10.

## 10. CARE AND PRESERVATION.

a. In order to keep ammunition in a serviceable condition and ready for immediate issue and use, due consideration should be given to the general rules given below. Detailed information on care and preservation is given in chapters 2 and 3.

b. Store ammunition in the original containers in a dry, well-ventilated place protected from the direct rays of the sun and other sources of excessive heat.

c. Keep ammunition and its containers clean and dry and protected from possible damage.

d. Disassembly of components of ammunition, such as fuzes and primers, without specific authorization, is strictly prohibited. Any alteration of loaded ammunition, except by direction of the technical source concerned and under the supervision of a commissioned officer of that service, is hazardous and must not be undertaken.

e. Do not open sealed containers or remove protective or safety devices until just before use, except as required for inspection.

f. Explosive ammunition must be handled with appropriate care at all times. Explosive elements, such as in primers and fuzes, are sensitive to undue shock and high temperature.

g. Return ammunition prepared for firing but not fired, to its original packing, and mark it appropriately. Use such ammunition first in subsequent firings in order to keep stocks of opened packing at a minimum.

General

Section III

**MILITARY EXPLOSIVES**

11. **GENERAL.** To understand the composition and functioning of a complete round of ammunition, a basic knowledge of the characteristics and uses of military explosives is necessary. In order that ammunition may function at time and place desired, it is necessary to employ different kinds of explosives, each of which has a specific role. Explosives suitable for one purpose may be entirely unsatisfactory for another. Thus, the explosive used to burst a forged steel projectile would not only be unsuited but also highly dangerous if used to propel the projectile out of the weapon. Similarly, the explosives used in initiators, such as in primers and fuzes, are so sensitive to shock that only small quantities can be used safely. The characteristics of various types of explosives are given in sections IV and V. For further information, see TM 4-205 and TM 9-2900.

12. **DEFINITION.** Any mixture or compound which, under the influence of heat or mechanical action, undergoes a sudden chemical change (decomposition) with the liberation of heat and light energy accompanied by a large volume of gases, is called an explosive.

13. **CLASSIFICATION.**

a. Explosives are classified as low and high explosives according to their rates of decomposition when such decomposition is initiated by the spit of a flame or a mechanical shock. A more exact classification for military purposes distinguishes between nonpropagating and self-propagating explosives. Therefore, explosives are divided into two basic groups: Low explosives (propellants) and high explosives.

(1) **LOW EXPLOSIVES.** Low explosives are combustible materials which decompose very rapidly but do not normally explode; this action is called deflagration. In decomposition, they produce a large volume of gases which produce enough pressure to propel a projectile or rocket forward. The rate of burning is an important factor and depends upon such factors as pressure, grain form, composition, etc. Low explosives do not usually propagate a detonation. Under certain conditions, however, they react in the same manner as high explosives, that is, they may detonate.

(2) **HIGH EXPLOSIVES.** High explosives are characterized by the extreme rapidity with which the decomposition occurs; this action is called detonation. They decompose almost instantaneously, either in a manner similar to an extremely rapid combustion, or with rupture and rearrangement of the molecules themselves. In either case, gaseous and/or solid products of reaction are produced. The disruptive effect of the reaction makes the explosive valuable as a bursting charge but precludes its use as a propellant because the gases are



## General

formed so quickly that excessive pressures would be developed which might burst the barrel of the weapon. A detonation may be pictured as resulting from an explosion wave traveling through the high-explosive charge at an extremely high velocity (22,000 to 27,500 feet per second).

#### 14. REQUIREMENTS OF AN EXPLOSIVE.

a. **General military requirements.** Before an explosive can be adopted for military use, it must have the following characteristics:

(1) Chemical stability over extended periods of storage under normal conditions.

(2) Ability to withstand the mechanical shocks incident to loading, transporting, and handling.

(3) Ability to withstand the shock of set-back on firing weapon (when used in artillery shell), or impact when dropped "safe" (when used in bombs).

(4) Susceptibility to complete ignition or detonation under the action of the preceding element of the explosive train.

(5) Brisance (shattering ability).

(6) A reasonable degree of economy in manufacture.

b. **Specific military requirements.** Additional requirements, differing from the basic ones, must be established to make sure that the explosive will perform properly in the capacity desired. In determining by tests whether a given explosive will meet the requirements, consideration must be given to stability, sensitivity, and brisance.

(1) **STABILITY.** Stability refers to the capacity of an explosive to retain unaltered its chemical and physical properties during an indefinite period of storage, under normal conditions or at higher than normal temperatures.

(2) **SENSITIVITY.**

(a) *To shock or impact.* - Sensitivity to impact or shock refers to the ease with which an explosive can be detonated by the sudden application of mechanical force.

(b) *To detonation by means of initiators.* The standard sensitivity to detonation by initiating agents other than mechanical impact is expressed in terms of the amount of initiating explosive as, for example, mercury fulminate required to effect complete detonation of a given weight of explosive under a given set of conditions.

(3) **BRISANCE.** Brisance is the ability of a detonating explosive to shatter material close to it. This property is different from the potential heat energy of the explosive, sometimes referred to as power or strength, which determines the force an explosive can exert when it explodes. Such force depends upon the amount of gas generated and the temperature reached during an explosion, whereas brisance

General

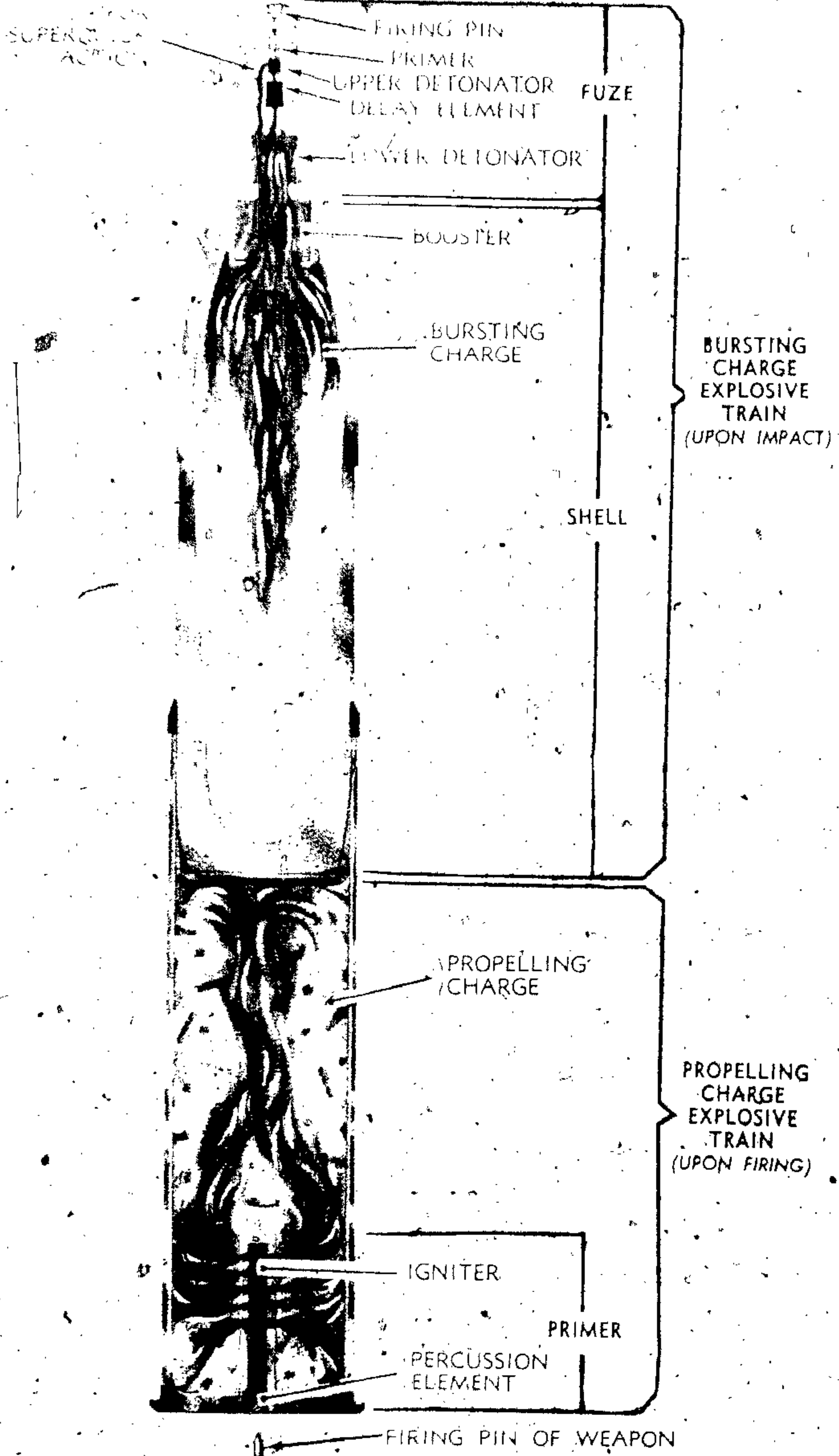

RA PD 80672A

Figure 17 - Explosive Trains in Artillery Ammunition

## General

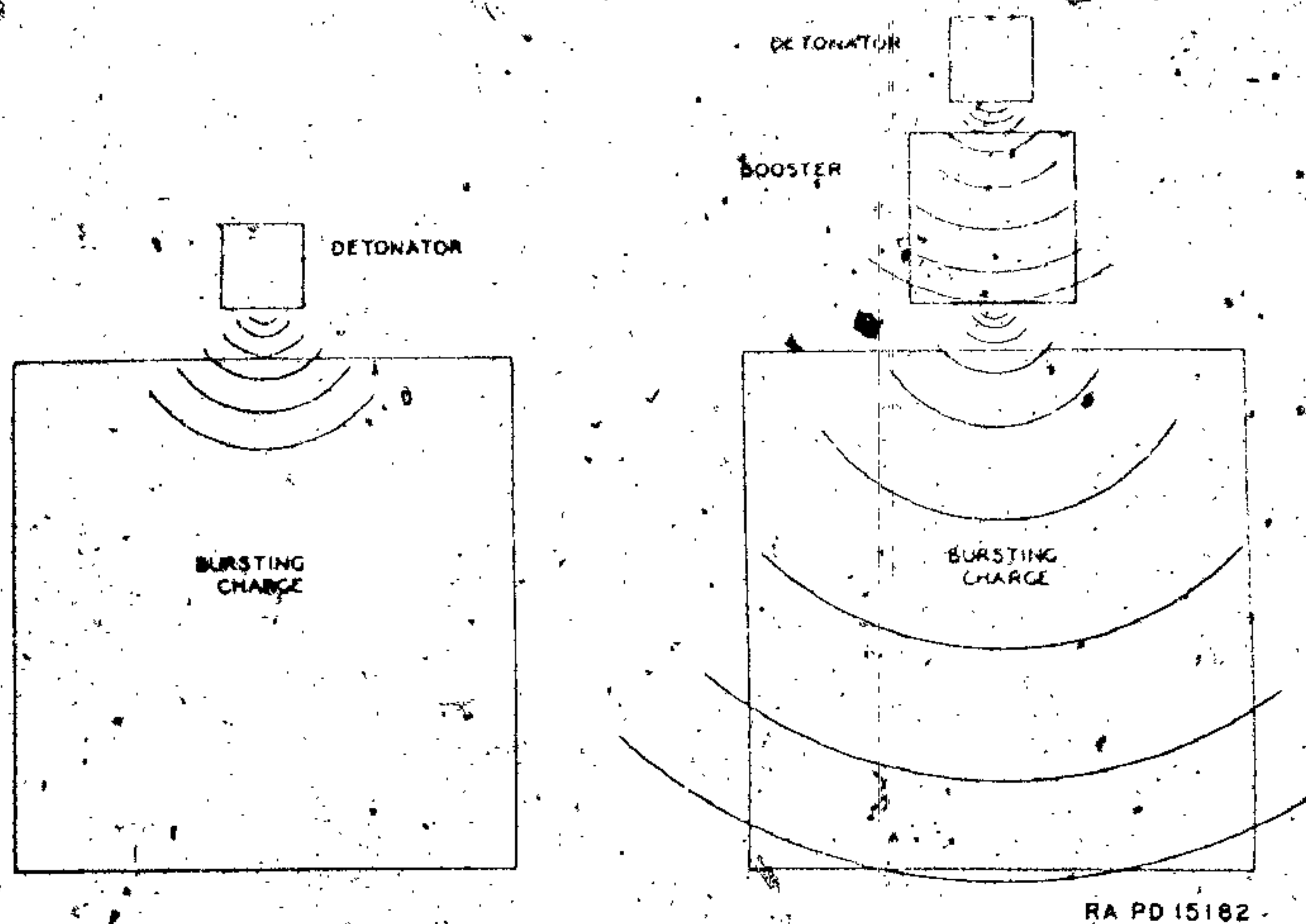

Figure 18 - Detonating Wave Amplified by Use of Booster

depends on the velocity with which a detonation occurs. Black powder, for instance, is a "powerful" explosive because of the large amount of gas that it generates upon explosion, but its brisance is very low because of the low rate of explosion.

## 15. EXPLOSIVE TRAINS.

a. **General.** The arrangement of a series of explosives beginning with a small quantity of sensitive explosive and terminating with a relatively large quantity of comparatively insensitive explosive, termed an "explosive train." In general, there are two such trains (fig. 17): the propelling-charge explosive train (which is always a low-explosive train), and the bursting-charge explosive train (which may be either a high- or low-explosive train). In all explosive ammunition one or both of these explosive trains will be found.

b. **Propelling-charge explosive train.** The propelling-charge explosive train is employed in the ejection of the projectile from the weapon on its way toward its target. This train usually consists of a primer, an igniter or igniting charge, and a propelling charge. Thus a spit of fire from a small quantity of sensitive explosive (the primer) initiated by a blow from the firing pin, is transmitted and intensified (by the igniter) so that a large amount of relatively insensitive explosive (the propelling charge) burns in the proper manner to propel the shell forward.

(1) **SMALL-ARMS AMMUNITION.** In small-arms cartridges, where the propelling charge is relatively small, the igniter is not required. The components in this train are a percussion primer and a propellant.



---

**General**

---

charge. The firing pin explodes the primer and the flame passes through the vent leading to the powder chamber and ignites the propelling charge; the expansion of the resultant gases forces the bullet out through the bore of the weapon.

(2) **ARTILLERY AMMUNITION.** The propelling charge explosion of a round of artillery ammunition is slightly different from the one in small-arms ammunition. In this train, it is necessary to place an auxiliary charge of black powder, called the primer charge or igniter charge, between the primer and the propelling charge. The addition of the primer charge is necessary because the small flame produced by the primer composition is not of sufficient intensity to initiate properly the large quantity of propellant powder. The primer or igniter charge may be contained in the body of the primer, making one assembly of the percussion element of the primer and the primer charge as in fixed ammunition, or it may be divided between the primer body and the igniter pad attached to separate-loading propelling charges.

**c. Bursting-charge explosive trains.**

(1) Although there are two explosive trains—the propelling-charge explosive train and the bursting-charge explosive train—the term “explosive train” as commonly used is intended to mean the bursting-charge explosive train. Bursting-charge explosive trains may be classified as high-explosive trains or low-explosive trains.

(2) **LOW-EXPLOSIVE TRAIN.** When low-explosive projectiles or other types of missile reach the point of functioning, the series of explosions which takes place is known as the low-explosive train. In base-ejection smoke shell, the explosive train consists of a percussion primer, a time train of black powder, a magazine charge of black powder, and an expelling charge of black powder. The action is initiated by the firing pin of the fuze striking the primer, the resultant flame being transmitted through the components named to the expelling charge. The explosion of the expelling charge forces the smoke canisters out of the base of the projectile.

(3) **HIGH-EXPLOSIVE TRAIN.** When the projectile or bomb reaches the target or the point at which it is set to function, the series of explosions which takes place in order to detonate the projectile is known as the high-explosive train. The basic components which must be present in practically all high-explosive trains are a detonator, a booster, and a bursting charge. Other elements are sometimes required, but these three charges are fundamental.

(a) The detonator sets up a high-explosive wave when initiated by the stab action of a firing pin or by a flame. This detonation is so small and weak that it will not initiate a high-order detonation in the bursting charge, unless a booster is placed between the two. The booster picks up the small explosive wave from the detonator and

---

General

---

amplifies it to such an extent that the bursting charge is initiated with a high-order detonation (fig. 18).

(b) To gain the action necessary to control the time and place at which an explosive will function, it is necessary to incorporate other components in the high-explosive train. The action desired may be a burst in the air, a burst instantly upon impact with the target, or a burst shortly after the projectile has penetrated the target. The components which may be used to give these various actions are a primer, a black-powder delay pellet or train, an upper detonator, or any combination of these components. Regardless of the arrangement of the components, the basic chain will remain the same, other components being placed in front of the basic chain.

(c) The action which causes a projectile to burst in the air may be obtained by placing a primer, which is fired when the projectile leaves the weapon or when the bomb is dropped, and a black-powder time train in front of the basic chain. The primer ignites the time-train fangs, which burn for the length of time for which the fuze is set and, in turn, initiate the action of the detonator, booster, and bursting charge.

(d) To burst the projectile promptly upon impact with the target, a superquick or instantaneous action is necessary. This action is usually obtained by placing an upper detonator in the extreme front of the fuze and a lower detonator in the body near the booster charge. In this manner, the detonating wave is transmitted instantly to the bursting charge.

(e) To permit penetration of the target by the projectile, a delay action is necessary. This is obtained by placing a primer and delay element ahead of the detonator. In some cases this combination of primer and delay is inserted between an upper and lower detonator.

(f) A variation of the high-explosive train is found in chemical shell. In this train there is no large bursting charge such as is found in high-explosive projectiles, as it is only necessary to rupture the shell case and allow the chemical contents to escape. The actual bursting of the case is accomplished by an enlarged booster, known as a burster charge, contained in a tube running down the center of the shell.

---

Section IV

**PROPELLANTS**

**16. GENERAL.** All explosives currently used as propellants have a nitrocellulose base and are commonly known as smokeless powders. Various organic and inorganic substances are added to the nitrocellulose base during manufacture to give improved qualities for special purposes. These powders are distinguished by such terms as



General

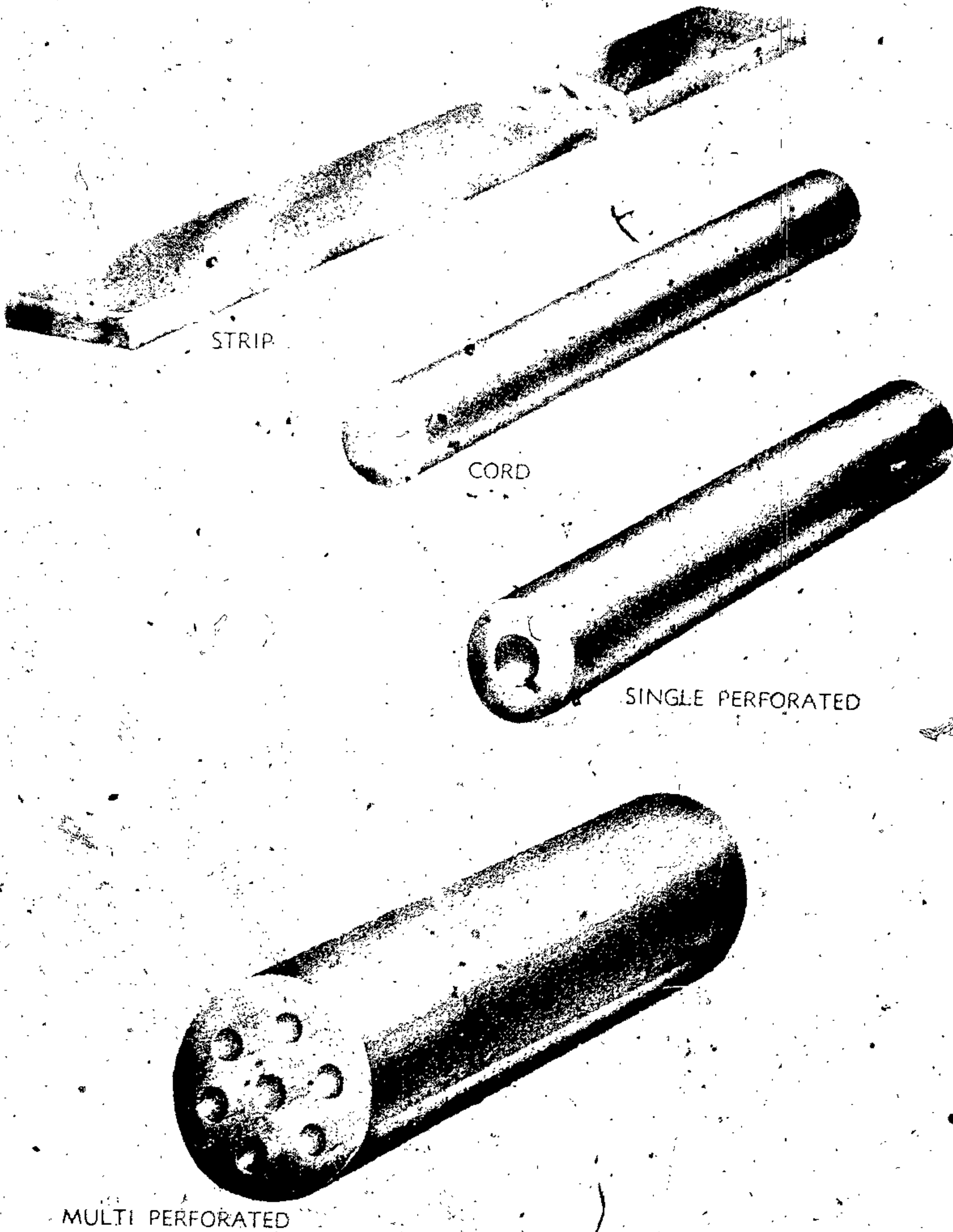

RA PD 80877A

Figure 19 — Types of Powder Grains



## General

double-base, flashless, and smokeless, as well as by commercial trade names or symbols. Black powder, which was formerly classed as a propellant, is no longer used as such but is now used as a delay element, as an igniting charge for propellants, in flash reducers, or for other special purposes.

## 17. SMOKELESS POWDER.

a. **Characteristics.** Smokeless powder is essentially gelatinized nitrocellulose and is manufactured in the form of flakes, strips, pellets, or perforated cylindrical grains (fig. 19). Powder is made in different shapes to obtain certain types of burning (par. 17.c). The cylindrical grains are made in various diameters and lengths. Grains vary in diameter from 0.032 inch for caliber .30 cartridges to 0.947 inch for 16-inch propelling charges, and vary in corresponding lengths from 0.085 inch to 2.170 inches (fig. 20). For small-size grains either no perforation or a single perforation is required. However, for larger grains, seven equally-spaced perforations are present in order to have a large burning surface area (par. 17.c). The critical dimension is the web size, that is, the average thickness of the powder between the perforations. In color, the grains vary from a light amber to a deep brown or black.

b. **Solvent.** Smokeless powder is manufactured to contain in the finished grains a definite amount of solvent (an ether and alcohol mixture). This amount varies from 0.5 to 5 percent. If there is a marked change in the amount of solvent, a change in ballistic properties will result. Powder must be carefully protected against high temperatures and moisture. To guard against changes due to such conditions, smokeless powder is always packed in airtight containers. Some rocket propellant powder may not contain any solvent.

### c. Burning action.

(1) **GENERAL.** Unconfined smokeless powder burns with little ash or smoke but, when confined, its rate of burning increases with temperature and pressure. In order not to exceed the permissible chamber pressure of the weapon in which it is to be used, the rate of burning of the propellant has to be controlled. At constant pressure, the rate of burning is proportional to the powder surface free to burn. Therefore, powder is made into accurate sizes and definite shapes. Figure 21 illustrates the "progressive" burning of a powder grain.

(2) **DEGRESSIVE BURNING.** As the surface of the cord and strip forms of smokeless powder change with burning, the surface of the grain decreases. The burning action of these grains is, therefore, classified as "degressive."

(3) **NEUTRAL BURNING.** As a single-perforated grain burns, the outer surface decreases and the inner surface increases. The result of

General

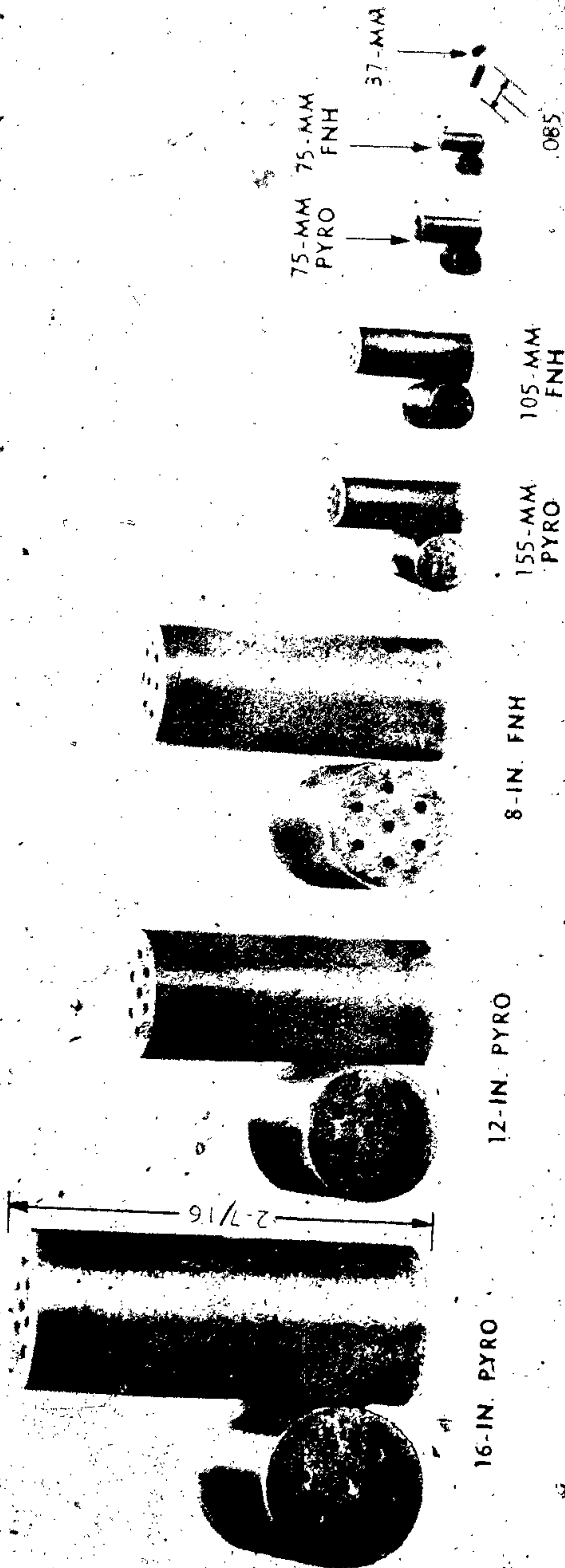

RA PD 80878A

Figure 20 - Typical Powder Grains - Side and End Views



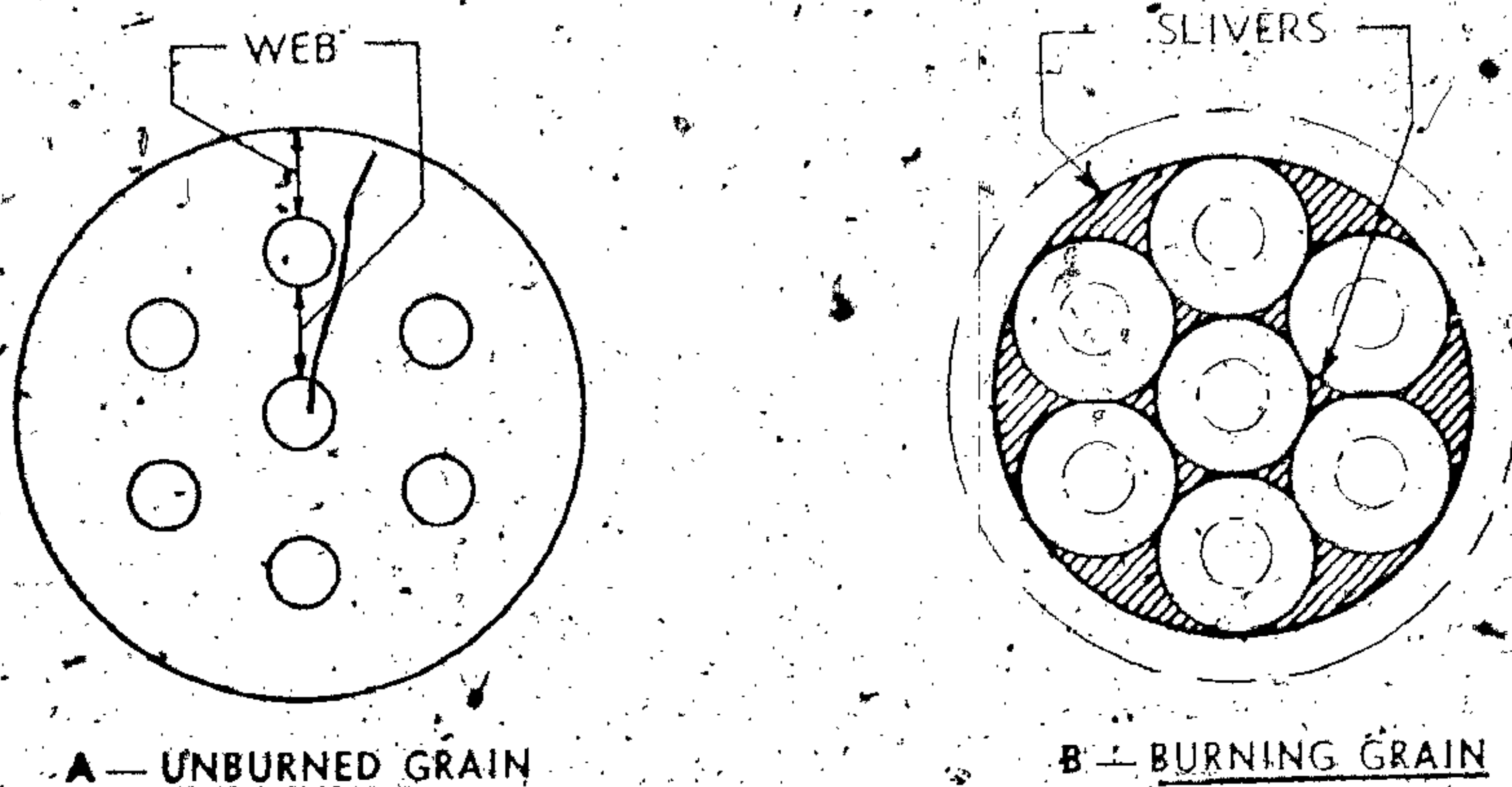

RA PD. 4319A

**Figure 21— Progressive Burning of Powder Grains**

the two actions is that the total surface remains approximately the same in area. The burning of this type of grain is known as "neutral."

(4) **PROGRESSIVE BURNING.** When the multiperforated grain burns, the total surface area increases since the perforated grain burns from the inside and outside at the same time. This type of burning is called "progressive" (fig. 21).

(5) **SLIVERS.** When a multiperforated grain is not completely consumed, portions of the grain remain in the form of slivers (B, fig. 21) and are normally ejected as such from the weapon.

d. **Use.** Nitrocellulose smokeless propellants are used as the propellant for small arms and larger-caliber ammunition. The perforated form of grain is the one most commonly used in United States military powders. Single perforated grains are used for small arms, minor-caliber weapons, and certain howitzers. Powders with seven perforations are used for larger-caliber weapons.

**18. DOUBLE-BASE POWDER (BALLISTITE).** Ballistite is a combination of nitroglycerin and nitrocellulose, containing approximately 13.15 to 13.25 percent nitrogen obtained by mixing pyro powder (12.6 percent nitrogen) with guncotton (13.35 to 13.4 percent nitrogen). The nitroglycerin serves to increase the potential. Small percentages of inorganic salts are often added to reduce the flash and increase the ease of ignition. Ballistite is used in shotgun shells, field mortar increments, and rocket motors. Double base powders cause more erosion in the weapon barrel but are being used increasingly because of the higher muzzle velocities obtainable by their use.



## General

**19. STANDARD SMOKELESS AND FLASHLESS POWDERS.**

a. These powders, which were formerly designated as FNH (flashless-nonhygroscopic) and NH (nonhygroscopic), are a mixture of nitrocellulose and other materials added to cool the products of combustion, thereby reducing the flash and the hygroscopicity, that is, the tendency to absorb moisture. They are used as propellants for most weapons of 37-mm and larger caliber. Nitroglycerin is used in certain powders where especially rapid burning is required and in certain high-velocity rounds and weapons.

b. Rounds of certain caliber, such as 3-inch, 76-mm, and 90-mm, are designated as "flashless," "smokeless," or "flashless-smokeless," dependent upon flash and smoke characteristics upon firing.

c. Whether ammunition upon firing is flashless, smokeless, or both, depends upon the weapons in which used, the type of ignition used, weapon wear, the temperature of the tube of the weapon, and the quantity and design of the propellant powder. Flashless and smokeless are relative terms and have been defined as follows: flashless ammunition does not flash more than 5 percent of the time in weapons of average life under standard conditions; smokeless ammunition produces less than half the amount of smoke produced by ammunition not so designated. A complete round having both these characteristics is designated "flashless-smokeless."

**20. GUNCOTTON.** Guncotton, a nitrocellulose of high nitration (13.35 to 13.4 percent nitrogen) is used in the manufacture of propellants. It is also used in electric primers and in electrically initiated destructors.

**21. EC SMOKELESS POWDER.** EC smokeless powder, or EC blank fire, consists of nitrocellulose with inorganic nitrates. It is usually orange or pink in color and resembles coarse sand, though it is soft and light. It is sensitive to friction, shock, or heat. It absorbs moisture readily and therefore must be protected from the atmosphere. It burns extremely rapidly in the open, but explodes if confined. It is usually exploded by flame from a primer or fuze. It was used at one time as a bursting charge in fragmentation hand grenades. It is used in caliber .30 and caliber .50 blank cartridges, in shotgun shells, and in caliber .20 ammunition.

**22. SMALL-ARMS PROPELLANTS.** Smokeless powder for small arms is usually glazed with graphite to facilitate machine loading and to prevent the accumulation of large charges of static electricity, and thus presents a black, polished appearance. Since the powder grains are small, they ignite more readily and burn more freely than cannon powder, and when moisture is present or abnormal temperatures prevail, they are subject to more rapid deterioration than the larger grains. Many small-arms powders are nearly as sensitive to friction

## General

as black powder. Therefore, precautions used in handling black powder should be observed for small-arms powders. In general, there are two types of small-arms propellants, single-base and double-base. A recent type of small-arms powder is in the form of small spherical graphite-coated balls and is used in carbine and caliber .45 ammunition.

**23. BLACK POWDER.**

a. **General characteristics.** Black powder is an intimate mechanical mixture of finely pulverized potassium nitrate or sodium nitrate, charcoal, and sulfur. The commercial blasting powder with sodium nitrate is now used for saluting purposes. Potassium nitrate is used in the powders for all other military purposes. Black powder is usually in the form of small, black grains which are polished by glazing with graphite. It is subject to rapid deterioration on absorption of moisture, but if kept dry it retains its explosive properties indefinitely. It is one of the most dangerous explosives to handle because it is very easily ignited by heat, friction, or spark.

b. **Uses.** In its several grades, its present military use is practically confined to:

- (1) Ignition and primer charges.
- (2) Expelling charges for base-ejection smoke shell, illuminating shell, and pyrotechnics.
- (3) Delay pellets for primers and fuzes.
- (4) Blank ammunition charges.
- (5) Smoke-puff and spotting charges.
- (6) Bursting charges for practice bombs and shell, and sub-caliber shell.
- (7) Time-train rings in time and combination fuzes.

c. **Precautions.** Black powder is particularly sensitive to shock, friction, heat, flame, or sparks. When black powder is handled in cans or bags or when it is not absolutely protected against sparks, the precautions described in section I of chapter 3 will be strictly observed.

## Section V

**HIGH EXPLOSIVES****24. GENERAL.**

a. High explosives are usually nitration products of organic substances, such as toluene, phenol, pentaerythritol, amines, glycerin, and starch, but may be nitrogen-containing inorganic substances or mixtures of both. Other materials, such as powdered aluminum, plasti-



General

cizing oils, waxes, rubber, etc., may also be added to explosives to obtain desired characteristics.

b. A high explosive may be a pure compound or an intimate mixture of several ingredients. To avoid confusion in the writing of formulas of mixtures, the following order of listing of components, together with their proportions, has been decided upon: inorganic nitrates/explosives other than TNT/TNT/metals/inert materials. Within any of the preceding groups, the components are listed alphabetically should there be more than one of that particular classification.

25. PRIMER MIXTURES.

a. General. A primer mixture is an explosive sensitive to a blow such as that imparted by a firing pin. It is used to transmit shock or a flame to another explosive, a time element, or a detonator.

b. Composition. In a large number of mixtures, the primer mixture consists of mercury fulminate, potassium chlorate, and antimony sulfide, with or without ground glass and/or a binder. However, the chemicals and materials used may be altered, dependent upon the type of action desired. Primarily, however, a primer mixture consists of an initiating high explosive, an oxygen carrier, and a combustible substance.

c. Uses. Primer mixtures are used in the percussion elements of cannon primers, in fuzes, and in small-arms primers, and as the upper layer of a detonator assembly.

26. MERCURY FULMINATE.

a. Characteristics. Mercury fulminate is a heavy crystalline solid, white when pure, but ordinarily having a faint brownish-yellow or grayish tint. It is extremely sensitive to heat, friction, spark, flame, or shock, detonating completely in nearly every instance. Its sensitivity varies with temperature. It has been found that its sensitivity is dependent in part on crystal size. It is nonhygroscopic and may be safely stored for long periods of time at moderate temperatures. However, it will not stand long-term storage at elevated temperatures.

b. Use. For all practical purposes, mercury fulminate has been replaced by lead azide. Its use is limited to small quantities in a few primers, in fuze detonators, and in blasting caps. It may be used alone or mixed with potassium chlorate.

27. LEAD AZIDE. Lead azide is an initiating compound used to detonate high explosives. It is a fine-grained, cream-colored compound. It is sensitive to flame and impact but it is not certain to detonate by the action of a firing pin. It is not easily decomposed on long continued storage at moderately elevated temperatures. It flashes



## General

at a much higher temperature than mercury fulminate. A smaller weight of lead azide than of mercury fulminate is required to detonate an equal amount of TNT, tetryl, etc. Lead azide is replacing mercury fulminate because of its properties and because it stands up better in storage and is less hazardous to manufacture. It is found in primer mixtures and in detonator assemblies in fuzes.

**28. TETRYL.**

a. **Characteristics.** Tetryl (trinitrophenylmethylnitramine) is a yellow crystalline solid. When heated it first melts and then decomposes and explodes. It burns readily and is more easily detonated than TNT or ammonium picrate, being much more sensitive than picric acid. It is detonated by friction, shock, or spark. It is practically nonhygroscopic. Tetryl is stable at all temperatures which may be encountered in storage.

b. **Detonation.** Brisance tests show tetryl to have a very high shattering power. It is greater in brisance than picric acid or TNT and is exceeded only by PETN and some of the newer military explosives, such as RDX.

**c. Use.**

(1) **CHARGES.** Tetryl is the standard booster explosive and is sufficiently insensitive when compressed to be used safely as a booster explosive. The violence of its detonation insures a high-order detonation of the bursting charge. It is used in the form of pressed pellets. Tetryl is the standard bursting charge for small-caliber (20-mm and 37-mm) projectiles. It produces appreciably better fragmentation of these shells than TNT. It is also more readily detonated and yet in small-caliber shell withstands the force of set-back in the weapon. It is also a component of tetrytol.

(2) **DETONATOR.** Tetryl is used in detonators, the tetryl being pressed into the bottom of the detonator shell and then covered with a small priming charge of mercury fulminate, lead azide, or other initiator.

**29. TNT (TRINITROTOLUENE).**

a. **General.** Trinitrotoluene, commonly known as TNT, is a constituent of many explosives, such as amatol, pentolite, tetrytol, torpex, tritonal, picratol, cyclator, ednatol, and Composition B, and has been used by itself under such names as triton, tetryl, trilit, trinol, and tritolo.

b. **Characteristics.** TNT when properly purified is one of the most stable of high explosives and can be stored over long periods of time. It is relatively insensitive to blows or injury. Confined TNT, when detonated, explodes with violence. When ignited by a flame, unconfined TNT burns slowly without explosion, evolving a heavy

General

oily smoke; however, burning or rapid heating of large quantities, especially in closed vessels, may cause violent detonation. It is readily detonated by mercury fulminate, tetryl, and similar high explosives. It is nonhygroscopic and does not form sensitive compounds with metals, but is readily acted upon by alkalis to form unstable compounds which are very sensitive to heat and impact. It usually resembles a light brown sugar but when pure is crystalline and is nearly white. Easily melted and poured into a shell or bomb to form a solid crystalline explosive charge, TNT is a very satisfactory military explosive. The melting point of standard, Grade 1 TNT is 80.2° C. Ammunition loaded with TNT can be stored, handled, and shipped with comparative safety.

c. **Exudation.** When stored in warm climates or during warm summer months, some ammunition loaded with TNT may exude an oily brown liquid. This exudate oozes out around the threads at the nose of the shell and may form a pool on the floor. The exudate is inflammable and may carry small particles of TNT. Pools of exudate should be removed as prescribed in paragraph 197.

d. **Detonation.** TNT in crystalline form can be detonated readily by a No. 6 blasting cap or when highly compressed by a No. 8 blasting cap. When cast, it is necessary to use a booster charge of pressed tetryl or an explosive of similar brisance to insure complete detonation.

e. **Use.**

(1) **BURSTING CHARGE.** TNT is used as a bursting charge for high-explosive shell and bombs either alone or mixed with ammonium nitrate to form 50/50 or 80/20 amatol. Flake TNT is used in 37-mm shell and in fragmentation hand grenades. Other military uses of TNT are in mines and for parts of certain shell and bomb bursters.

(2) **DEMOLITION.** TNT is used to demolish bridges, railroads, fortifications, and other structures and for land mines. For such purposes TNT is used in the form of a large shaped charge or a small highly compressed block inclosed in a fiber container which protects it from crumbling in handling and renders it waterproof. The triton blocks used by the Corps of Engineers are blocks of pressed TNT inclosed in cardboard containers.

(3) **BLASTING.** TNT is suitable for all types of blasting and produces approximately the same effect as the same weight of dynamite of 50 to 60 percent grade.

30. **AMATOL.**

a. **General characteristics.** Amatol, a mechanical mixture of ammonium nitrate and TNT, has approximately the same general characteristics as TNT. It is crystalline, yellow or brownish, and in-



---

**General**

---

sensitive to friction, but it may be detonated by severe impact. It is less sensitive to detonation than TNT but is readily detonated by mercury fulminate and other high explosives. It is less likely to exude than TNT. It is hygroscopic and in the presence of moisture attacks copper, brass, and bronze, forming dangerously sensitive compounds. Amatol, 50/50, has approximately the same rate of detonation and brisance as TNT, while 80/20 amatol is slightly lower in velocity and brisance than TNT. Amatol, 80/20, produces a white smoke on detonation, and amatol, 50/50, produces a smoke less black than straight TNT.

b. **Composition and form.** Amatol, 50/50, consists of 50 percent ammonium nitrate and 50 percent TNT by weight. When hot, it is sufficiently fluid to be poured or cast like TNT. Amatol, 80/20, consists of 80 percent ammonium nitrate and 20 percent TNT. It resembles wet brown sugar. When hot, it becomes plastic and in that state is pressed into shells and bombs.

c. **Use.** Amatol is a substitute for TNT. Amatol, 50/50, is used for 3-inch and larger shell, and 80/20 amatol is used for shell of 155-mm and larger. Amatol is also used in large bombs. Its primary use, however, is for bangalore torpedoes.

### 31. PICRIC ACID (TRINITROPHENOL).

a. **General.** Picric acid, under the name of melinite, was adopted as a military high explosive by the French in 1886 and has been used more extensively as a military explosive by foreign nations than by this country. The British designate it as lyddite.

b. **Characteristics.** Picric acid is a lemon-yellow crystalline solid. It is entirely stable but reacts with metals when moist, forming extremely sensitive compounds. Picric acid is more readily detonated by means of a detonator than TNT but has about the same sensitivity to shock. It is not as toxic as TNT and is also nonhygroscopic although slightly soluble in water. Picric acid has a high melting point—approximately 120° C.

c. **Use.** Picric acid is chiefly used for conversion to ammonium picrate (explosive D) and to form mixtures with other nitro compounds.

### 32. AMMONIUM PICRATE (EXPLOSIVE D).

a. **Characteristics.** Ammonium picrate is the least sensitive of military explosives to shock and friction. This makes it well suited for use as a bursting charge in armor-piercing projectiles. It is slightly inferior in explosive strength to TNT. When heated, it does not melt but decomposes and explodes. It reacts slowly with metals, and when wet it may form sensitive and dangerous compounds with iron, copper, and lead. It is difficult to detonate but burns readily like tar or resin.



General

b. Special precautions.

(1) Ammonium picrate, which has been pressed at a shell-loading plant and removed from a shell, is very much more sensitive to shock or blow than fresh ammonium picrate. It should be protected against shock or fire and should preferably be stored alone in a building.

(2) Although less sensitive than TNT, it can be exploded by severe shock or friction, is highly inflammable, and may detonate when heated to a high temperature.

c. Use. Explosive D is used as a bursting charge for armor-piercing shell, in projectiles for seacoast cannon, and in other types of projectiles which must withstand severe shock and stresses before detonating.

33. PICRATOL.

a. General. Picratol is a mixture of 52 percent explosive D and 48 percent TNT. It can be poured like straight TNT and has approximately the same resistance to shock as that of straight explosive D. The brisance of picratol is between that of explosive D and TNT. Picratol is nonhygroscopic.

b. Use. Picratol is a standard filler for all Army semi-armor-piercing bombs.

34. NITROSTARCH EXPLOSIVES.

a. Characteristics. Nitrostarch is a white finely divided material similar in appearance to ordinary powdered starch. It is considerably more sensitive to friction and impact than TNT, consequently the crushing or breaking of the explosive is hazardous. Nitrostarch is less sensitive than dry guncotton or nitroglycerin. It is highly inflammable, can be ignited by the slightest spark such as may result from friction, and burns with explosive violence.

b. Detonation. Nitrostarch explosives are readily detonated by a No. 6 blasting cap.

c. Use. A nitrostarch demolition explosive, consisting of 1/2-pound or 1-pound (four 1/4-pound) blocks, has been adopted as a substitute for TNT. TNT formulas for computing small charges are directly applicable to the nitrostarch demolition explosive. These blocks must not be broken into fragments, as this may cause detonation.

35. PETN (PENTAERYTHRITETETRANITRATE).

a. Characteristics. PETN has a velocity of detonation greater than that of TNT and is more sensitive to shock or friction than TNT or tetryl. In its pure form, PETN is a white crystalline powder; however, it may be a light gray due to other ingredients. It will detonate under a long, slow pressure. PETN in bulk must be stored wet.

General

b. **Uses.** PETN is suspended in TNT to form pentolite, an explosive of high brisance. It is also used as the explosive core of primacord fuze—a detonating cord which is widely used in demolition work.

**36. PENTOLITE.** Pentolite consists of PETN in a TNT matrix. It is superior to TNT in explosive strength and is less sensitive than PETN. Pentolite 50/50 may be melt-loaded. It is, therefore, satisfactory for use in grenades, rockets, high-explosive-antitank shell, and in shaped charges.

**37. TETRYTOL.**

a. **Characteristics.** Tetrytol is a mixture of 75 percent tetryl and 25 percent TNT. It has higher brisance than TNT and is more effective in cutting through steel and in demolition work. It is less sensitive to shock and friction than tetryl and only slightly more sensitive than TNT. Tetrytol is nonhygroscopic and is suitable for underwater demolition since submergence for 24 hours does not appreciably effect its characteristics.

b. **Use.** Tetrytol is used in chain and individual demolition blocks and in certain destructors.

**38. DYNAMITE.**

a. **General.** Commercial high explosives are more familiarly referred to as dynamite. There are several types, each type being subdivided into a series of grades. Each type and grade differs in one or more characteristics. Dynamite consists of nitroglycerin absorbed in a porous material. The porous composition varies, depending on the type of dynamite. Dynamite is generally available as paraffin-coated 1/2-lb sticks or cartridges and is rated according to the percent by weight of nitroglycerin content.

b. **Characteristics.** Dynamite of from 50- to 60-percent nitroglycerin content is equivalent on an equal-weight basis to TNT in explosive strength. Dynamite of 40 percent is equivalent to TNT in the ratio of 1 1/4-pound dynamite to 1-pound TNT. Straight dynamite is more sensitive to shock and friction than TNT and is capable of being detonated by the action of a rifle bullet. The higher percentages of dynamite have very good water resistance. Explosion of the common types of dynamite produces poisonous fumes which are dangerous in confined places.

c. **Use.** Dynamite is used as a substitute for nitrostarch or TNT and for training purposes. The following limitations are placed on its use:

- (1) Not to be issued or used for destruction of "duds."
- (2) Not to be supplied for training in use of demolition equipment.



General

(3) Not to be used in Coast Artillery submarine mines or mine batteries.

(4) Not to be carried in combat vehicles subject to extremes of temperature.

**39. EDNATOL.**

a. **General characteristics.** Ednatol is a mixture of haleite or explosive H (ethylenedinitramine) and TNT, and is one of the most powerful explosives. It is less sensitive than tetryl, PETN, or RDX. Ednatol is equivalent to tetryl in brisance. It can be cast in the same manner as amatol. It has no tendency to combine with metals in the absence of moisture and has no toxic effect. In the presence of moisture, haleite hydrolyzes slightly giving an acid reaction, but hydrolysis of ednatol is not appreciable. Ednatol is very stable and can be stored for long periods; it is nonhygroscopic.

b. **Use.** Ednatol may be used for the same purposes as pentolite, namely, in rockets, grenades, and high-explosive-antitank shell.

**40. AMMONAL.** The term ammonal refers generally to explosive mixtures containing TNT, ammonium nitrate, and powdered aluminum, with or without other ingredients such as charcoal. A similar British explosive is minol 2. As a rule, ammonal explosives are insensitive and, because of the aluminum content, detonate with resultant higher temperature, greater blast effect, and brighter flash than other high explosives. They are used in proving ground tests of high-explosive artillery shell for better observation.

**41. TRITONAL.** Tritonal is a generic term for explosives containing TNT and aluminum, generally in the ratio of 80/20. It produces a greater blast effect than TNT, or Composition B described below. It is used in light-case and general-purpose bombs.

**42. RDX.** RDX is also known as cyclonite (cyclotrimethylenetrinitramine), CTMTN, C6, hexogen (German), and T4 (Italian). It is a white crystalline solid having a melting point of 202° C. It has about the same power and brisance as PETN. It is more easily initiated by mercury fulminate than is tetryl. It has a high degree of stability in storage. RDX is never used alone but in mixtures with other explosives and/or oils and waxes.

**43. TORPEX.** Torpex is a gray compound consisting of RDX, TNT, aluminum powder, and beeswax (or similar wax). It is a more powerful but much more sensitive explosive than TNT. Torpex is nonhygroscopic, noncorrosive, and has a very high brisance. Under water it is 50 percent more destructive than TNT, whereas in air the difference is approximately 30 percent. Torpex is used as a bursting charge in mines, torpedoes, and depth charges.



---

**General**

---

**44. COMPOSITION A, A-2, AND A-3.** Composition A (COMP. A) is a mixture of RDX and a desensitizer, being semiplastic in nature. Composition A is a mixture incorporated by rolling, whereas Composition A-2 denotes the same explosive prepared by kettle-drying an unrolled mixture, and Composition A-3 a mixture prepared by tray-drying an unrolled product. Composition A-3 is granular in form, resembling tetryl in granulation. It is buff in color and is press-loaded in minor-caliber (20-mm, 37-mm, and 40-mm) shell. It may also be used for boosters, and can be used in armor-piercing shell due to its insensitivity and high brisance.

**45. COMPOSITION B.** Composition B (COMP. B) is a mixture of RDX, TNT, and beeswax or similar wax. It is a nonplastic material which is cast-loaded. It is one of the most powerful explosives. It is less sensitive than tetryl but more sensitive than TNT. Composition B is an authorized filling for AN (Army-Navy) standard aircraft bombs, mines, and torpedoes, and may be used in boosters for large bombs, demolition charges, and larger-caliber projectiles.

**46. COMPOSITION C, C-2, AND C-3.**

a. **General.** Composition C, sometimes referred to as P.E., is a plastic explosive containing RDX and an inert plasticizer. Compositions C-2 and C-3 are similar, except that an explosive plasticizer is used. Composition C-2 indicates a mixture of RDX plus nitrocotton and an explosive plasticizer containing no tetryl. Composition C-3 consists of RDX plus nitrocotton and plasticizer containing tetryl substituted in part for RDX.

b. **Composition C-2.** This explosive is easily moldable at most temperatures. It withstands water submersion well. It is used in the 2 1/4-pound demolition block M3.

c. **Composition C-3.** At temperatures between 0° and 110° F. Composition C-3 is plastic or pliable, closely resembling putty. Below -20° F, it becomes hard and brittle. Above 110° F, it becomes soft and, if kept at this temperature, has a tendency to remain a soft mass. It is considerably less sensitive than TNT and may not always be detonated by a No. 8 blasting cap but will always be detonated by the special Engineer Corps blasting cap. The brownish-yellow plastic, however, has considerably greater brisance than TNT and is particularly effective under water. It is used principally as a command and demolition explosive, either with or without a container. It is also used as a filler in some types of munitions. If its plasticity is lost by long storage at low temperature, it may be restored to satisfactory plasticity by molding with the hands after warming by immersion in warm water. It must not be exposed to open flame as it catches fire easily and burns with an intense flame. If burned in

General

large quantities, the heat generated may make it explode. Its explosion produces poisonous gases in such quantities that its use in closed spaces is dangerous.

47. **PTX-1.** This explosive consists of RDX, tetryl, and TNT. It has a pouring temperature of 90 to 95° C and is castable. It is slightly less stable than Composition B and ednatol. In brisance and power it is equivalent to Composition B and 50/50 pentolite. In general, PTX-1 has approximately the same explosive characteristics as 65/35 tetrytol. This composition does not exude and is less sensitive to impact than 65/35 tetrytol.

48. **PTX-2.** This explosive consists of PETN, RDX, and TNT. It can be poured at 95° C but may be press-loaded or used as a loose filler. It is less sensitive to impact than 50/50 pentolite but more so than Composition B or ednatol. It is more stable than pentolite and it does not exude. PTX-2 is more brisant and is more readily initiated to high-order detonation than any of the binary explosives.

Section VI

**CHEMICAL AGENTS**

49. **DEFINITION.** A chemical agent is a substance which, by its ordinary and direct chemical action and in concentrations attainable in the field, produces a toxic or an irritating (harassing) effect, a screening smoke, an incendiary action, or any combination of these. An agent that produces more than one of these effects is classed according to its principal use.

50. **CLASSIFICATION.** Chemical agents are classified according to tactical use, pathological effect, and purpose, as follows:

a. **War gases.** A gas is an agent which produces either a toxic or irritating physiological effect. Such an agent may be in solid, liquid, or gaseous state, either before or after dispersion. Gases may be persistent (those remaining effective at point of release for more than 10 minutes) or nonpersistent (those becoming ineffective within 10 minutes). Persistent gases are further divided into moderately persistent (those remaining effective in the open 10 minutes to 12 hours) and highly persistent (those remaining effective in the open longer than 12 hours). These gases are classified as;

(1) **CASUALTY GASES.**

(a) Blister gases (vesicants)

(b) Choking gases (lung irritants)

(c) Blood and nerve poisons (systemic poisons)



## General

- (2) HARASSING GASES (irritants):
  - (a) Vomiting gases (sternutators)
  - (b) Tear gases (lacrimators)
- h. Screening smokes.
- c. Incendiaries.
- d. Simulated war gases.

**51. DESCRIPTION.** The type, common name, and symbol of the principal chemical agents are included in the table in figures 22 and 23. The following table includes the symbols and names of chemical agents which are not included in figures 22 and 23 and which may be encountered in the field.

## CWS Symbols and Agents in Addition to Figures 6 and 7

H	Levinstein mustard (30 percent impurities)
HD	Purified mustard
HDV	Thickened purified mustard
HVV	Very viscous solution of methyl methacrylate in purified mustard; HD
HP	Solution of phosphorus in Levinstein mustard
HDP	Solution of phosphorus in purified mustard
HN	Nitrogen mustard
HL	Mustard lewisite
CK	Cyanogen chloride
SA	Arsine
AC	Hydrocyanic acid
CNB	Solution of chloroacetophenone in benzene and carbon tetrachloride
CN-DM	Burning mixture of CN and DM
KJ	Stannic chloride
NC	Chloropierin-stannic chloride
NP	Thickened gasoline, with napalm
IM	Thickened gasoline
F8	Aluminum-barium nitrate mixture
AS	Asbestine suspension
MR	Molasses residuum

Other symbols, such as A1, A2, and D2, may also be encountered but the chemicals associated with them are highly classified for security purposes. A brief description of the principal chemical agents is contained in paragraphs 53 through 58.

**52. PAINTING AND MARKING.**

- a. **Painting.** Chemical ammunition is identified by the base color, gray.



General

SYMBOL	NAME	CLASS	BANDS COLOR	LOADING	ODOR	TACTICAL CLASS	PHYSIOLOGICAL EFFECT
<b>H</b>	<b>MUSTARD</b> <small>DICHLORODITHYLALENE</small>	Gas	2 Green		Garlic Horseradish Mustard		Burns skin or membranes
<b>L</b>	<b>LEWISITE</b> <small>DICHLOROVINYLDICHLORARSINE</small>	Gas	2 Green		Geraniums		Irritates nasal passages. Later skin burns, pain.
<b>ED</b>	<b>ETHYLDICHLORARSINE</b>	Gas	2 Green		Biting Stinging		Causes bilateral sores
<b>PS</b>	<b>CHLORPICRIN</b> <small>TRICHLOROIMINE</small>	Gas	2 Green		Flypaper Anise		Causes sneezing, coughing, crying, lung edema
<b>DP</b>	<b>DIPHOSGENE</b> <small>TRICHLOROMETHYL CHLOROPHOSPHATE</small>	Gas	2 Green		Musty Hay Green Corn Ensilage		Causes coughing, breathing hurts, eyes water, toxic.
<b>CG</b>	<b>PHOSGENE</b> <small>CARBONYL CHLORIDE</small>	Gas	1 Green		Musty Hay Green Corn Ensilage		Irritates lungs
<b>CL</b>	<b>CHLORINE</b>	Gas	1 Green		Highly Pungent		Intense immediate choking
<b>CN</b> (CRS)	<b>CHLORACETOPHENONE</b>	Gas (Solution)	1 Red (2 Red)		Apple blossoms		Makes eyes smart, shut tightly, tears flow. Temporary.
<b>BBC</b>	<b>BROMBENZYL-CYANIDE</b>	Gas	2 Red		Sour fruit		Eyes smart, shut, tears flow. First lasts some time.
<b>DM</b>	<b>ADAMSITE</b> <small>DIPHENYLAMINE CHLORARSINE</small>	Gas	1 Red		Coal Smoke		Causes sneezing, sick depressed feeling
<b>DA</b>	<b>DIPHENYL-CHLORARSINE</b>	Gas	1 Red		Shoe Polish		Causes sneezing, sick depressed feeling
<b>HC</b>	<b>HC MIXTURE</b>	Smoke	1 Yellow		Sharp-acrid		Harmless
<b>FS</b>	<b>SULFUR TRIOXIDE</b> <small>OR CHLOROSULFONIC ACID</small>	Smoke	1 Yellow		Burning matches		Liquid burns skin if allowed to remain
<b>FM</b>	<b>TITANIUM TETRACHLORIDE</b>	Smoke	1 Yellow		Acrid		Harmless
<b>WP</b>	<b>WHITE PHOSPHORUS</b>	Smoke	1 Yellow		Burning matches		Burning pieces adhere to skin, clothing
<b>TH</b>	<b>THERMIT</b> <small>(THERMITE) IRON OXIDE AND ALUMINUM POWDER</small>	Incediary	1 Purple		Odorless		5000 degrees F heat ignites materials

\* CNS, A SOLUTION OF CN IN CHLOROFORM AND CHLORPICRIN, FREQUENTLY USED FOR SHELL FILLING  
 † THE FILLING OF A MAGNESIUM BOMB WHICH SERVES TO IGNITE THE METAL MAGNESIUM CASING

RA PD 27686A

Figure 22 - Chemical Ammunition - Explanatory Chart

General

PROTECTION	FIRST AID	COLOR & STATE		PERSISTENCE	TACTICAL USES
		LOADED	RELEASED		
	Remove clothing. Wash affected parts of body with soapy water. Irrigate eyes with 2% sodium bicarbonate solution.	HEAVY DARK OILY LIQUID	Liquid slowly evaporates.	Open 1 day Woods Week to all winter	To neutralize areas Counter-battery Attack on Personnel
	Apply 2 to 3% solution hydrogen peroxide to skin, wash with soap and water. Irrigate eyes with water or 2% sodium bicarbonate solution.	HEAVY DARK OILY LIQUID	Liquid slowly evaporates.	Open 1 day Woods 1 week	Similar to Mustard
	Apply 2 to 3% solution hydrogen peroxide to skin, wash with soap and water. Irrigate eyes with water or 2% sodium bicarbonate solution.	CLEAR OILY LIQUID	Evaporates at medium rate.	1 hour	Counter-battery Preparation fire Harassing fire
	Wash eyes. Keep quiet and warm. Do not rub eyes.	YELLOW OILY LIQUID	Evaporates like water.	Open 6 hours Woods 12 hours	Harassing and casualty fire
	Keep quiet and warm. Give coffee as a stimulant.	COLORLESS LIQUID	Evaporates like water.	30 minutes	Harassing and casualty fire
	Keep quiet and warm. Give coffee as a stimulant.	COLORLESS LIQUID	Colorless gas	10 to 30 minutes	Surprise attacks, projectiles Gas cloud release. For quick physical effect.
	Keep quiet and warm. Coffee as stimulant.	YELLOW LIQUID	Yellow-green gas	10 minutes	Surprise attacks (cloud)
	Wash eyes with water or boric acid. Do not rub or bandage. Wash skin with 4% Na <sub>2</sub> SO <sub>3</sub> in 50% Alcohol Solution.	WHITE CRYSTALLINE POWDER	Cloud of small, solid particles	10 minutes	Training. Mob control. CNS used in counter-battery to force mask wear.
	Wash eyes with boric acid. Do not bandage.	DARK BROWN OILY LIQUID	Slowly evaporates	Several days (weeks in winter)	To neutralize areas Counter-battery
	Remove to pure air and keep quiet. Breathe small amounts of chlorine.	YELLOW GREEN GRANULAR SOLID	Yellow smoke	10 minutes	Gas Cloud Attacks Mob control
	Remove to pure air, keep quiet. Sniff chlorine from bleaching powder bottle.	WHITE CRYSTALLINE SOLID	Vapor or fine smoke	Summer 10 minutes	Harassing fire
NONE NEEDED	Produces no effect requiring treatment.	GREY SOLID	White to grey smoke	White burning	To screen small operations in own lines and for training purposes.
	Wash with Soda solution.	CLEAR TO BROWN LIQUID	Dense white smoke	5-10 minutes	Airplane spray for screen on broad front.
NONE NEEDED	Produces no effect requiring treatment.	YELLOWISH TO BROWN LIQUID	White smoke	10 minutes	Screening operations
NONE AVAILABLE	Wash with Copper Sulphate solution or immerse in water.	PALE YELLOW SOLID	Burns to white smoke in air.	10 minutes	To screen advancing troops. Cause incendiary effects, losses. Harass enemy observers.
COVER WITH EARTH SAND	Treat for burn.	METALLIC POWDER	White-hot metal.	5 minutes	Destruction of material.

RA PD 27691

Figure 23 - Chemical Ammunition - Explanatory Chart - Continued



General

b. **Marking.** The particular agent used as chemical filler is indicated in the marking on the ammunition by one or two bands and the type of filler and its symbol, all in a distinctive color in accordance with chapter 1, section II.

**53. BLISTER GASES.** Blister gases produce casualties resultant from injuries to the eyes and lungs and skin blisters. The principal blister gases are mustard gas and lewisite.

a. Mustard gas (H) is a dark-brown liquid which slowly evaporates to a colorless gas having the odor of garlic. Purified mustard (HD) may be practically odorless. Its principal physiological effect is that of a blister gas (vesicant), although the blistering does not ordinarily appear for several hours. If inhaled, the vapors have a choking (lung-irritant) effect. For complete protection against H, both gas mask and protective clothing are necessary. The tactical use of H is to neutralize areas, contaminate materiel, cause casualties, and harass enemy personnel. It is projected by artillery and mortar in shells and from airplanes in bombs and sprays. It is left in land mines by retreating troops. It renders food and water unfit for use.

b. Lewisite (L) is a dark-brown liquid evaporating to a colorless gas which has the odor of geraniums. In addition to being a blister and choking gas, lewisite is an arsenical poison. Gas mask and protective clothing are necessary for protection against L. The tactical use of L and the methods of projection are the same as those for H. It renders food and water permanently unfit for use.

**54. CHOKING GASES.** Choking gases injure the respiratory tract--nose, throat, and lungs. The principal choking casualty gases are diphosgene, phosgene, chlorine, and chlorpicrin.

a. Diphosgene (DP) has a toxicity about the same as that of phosgene. It causes watering of the eyes, as well as coughing and occasional vomiting.

b. Phosgene (CG) appears on projection as a whitish cloud, changing to a colorless gas. The toxicity is over ten times that of chlorine. In high concentrations, which are often met in battle, one or two breaths may be fatal in a few hours. Unlike chlorine, CG produces but slight irritation of the sensory nerves in the upper air passages, so the men exposed to this gas are likely to inhale it more deeply than they would equivalent concentrations of chlorine or other gases. For this reason, phosgene is very insidious in its action and men gassed with it often have little or no warning symptoms until too late to avoid serious poisoning. Its tactical use, action on metals, food, and water, are the same as for chlorine.

c. Chlorine (Cl) is a greenish-yellow gas with a pungent odor. Physiologically, it acts as a lung irritant. The service gas mask is sufficient for protection. It is used tactically as a casualty agent. It

---

*General*

---

causes violent coughing immediately and can be fatal on continued exposure. It is used alone and with other of this group in gas-cloud attack from cylinders. It has a vigorous corrosive action on wet or moist metals. Food and water contaminated with chlorine can be made fit for use under the direction of a medical officer.

d. Chlorpicrin (PS) is a colorless oily liquid, changing slowly in the open to a colorless gas. In addition to its lung injurant effects, PS is also a strong tear gas, and has the additional advantage of being capable of penetrating gas mask canisters that are resistant to ordinary acid gases such as chlorine and phosgene. The injurious effects of PS also extend to the stomach and intestines, causing nausea, vomiting, colic, and diarrhea. Since these conditions are difficult to combat in the field and often persist for weeks, even slight cases of PS gassing frequently involve large casualty losses. Tactically, it is used in heavy concentrations as a casualty agent and in lighter concentrations as a harassing agent. PS is used with tear gas in artillery and mortar shells and in airplane bombs and sprays. With phosgene and chlorine, PS is used from cylinders. It has slight action on metals. Contaminated food and water may be rendered fit for use under the direction of a medical officer.

**55. BLOOD AND NERVE POISONS.** These gases may produce toxic effects very rapidly. The principal blood and nerve poisons are hydrocyanic acid and cyanogen chloride.

a. Hydrocyanic acid (AC) forms a colorless gas upon release. Its odor is similar to that of almonds, but is not always readily detected in the field. Its action is very rapid. Its first action is stimulation of the respiratory system, causing deeper inhalation. Death by paralysis of the respiratory system may occur in a few minutes.

b. Cyanogen chloride (CK) forms a colorless gas upon release and has a sharp pungent odor. Its action is very rapid and produces paralysis of the respiratory system. Unlike AC, it first produces an involuntary spasm of short duration of the upper respiratory tract.

**56. HARASSING GASES.** The harassing gases (irritants) are the tear and vomiting gases. The principal ones are:

a. Chloracetophenone (CN), commonly known as tear gas, is typical of the tear gases. It produces profuse weeping and requires the use of a gas mask for protection. It has no permanently injurious effect on the eyes. In higher concentrations, it irritates the skin, producing a burning and itching sensation. CN is used alone in grenades. It is used in benzene and carbon tetrachloride solution alone (CNB) and in chloroform solution with chlorpicrin (CNS) in artillery and mortar shells and from airplanes in bombs and sprays. CN has slight action on metals. It imparts a disagreeable taste to food and water.



General

b. Brombenzylcyanide (BBC) is a tear gas which produces a burning sensation of the mucous membranes and severe irritation and lacrimation of the eyes, with acute pain in the forehead.

c. Adamsite (DM) typifies the vomiting gases. It is a solid which is dispersed by burning-type munitions such as candles and grenades, and appears as a yellow smoke with an odor resembling coal smoke. Physiologically, it causes lacrimation, violent sneezing, intense headache, nausea, and temporary physical debility. For protection, the service gas mask, which is equipped with an efficient smoke filter, is required. Tactically, it is used as a harassing gas. DM has a slight action on metal and renders food and water permanently unfit for use.

d. Diphenylchlorarsine (DA) is a vomiting gas which causes irritation of the throat and lungs. This is followed by a headache, and pains in the jaws and teeth. These symptoms are accompanied by chest pains, nausea, and vomiting.

**57. SCREENING SMOKES.** Smokes are produced by the dispersion of particles in the atmosphere through the burning of solids and the spraying of liquids. They are used to screen movements and activity, to blanket the enemy, to inactivate observers, to spot artillery fire and bombing, and to disguise cloud gas.

a. Hexachlorethane-zinc mixture (HC) can be used only from burning-type ammunition, such as grenades, candles, and base-ignition and base-ejection smoke shell. No protection of materiel is required. HC is harmful (toxic) to unmasked personnel who are exposed to heavy concentrations for short periods or to light concentrations for extended periods of time, but the service mask offers complete protection. Food and water are not spoiled by HC but acquire a disagreeable odor.

b. Sulfur trioxide-chlorosulfonic acid mixture (FS) is a liquid which produces a dense white smoke when dispersed into a humid atmosphere. It is projected in shells, by airplane spray and from portable cylinders. FS liquid is very corrosive, and rubber gloves should be worn in handling it. No mask is necessary for the smoke, which is harmless to personnel except in very heavy concentrations. Liquid FS renders food and water unfit for use; the smoke merely imparts an unpleasant taste. Because of its corrosive nature, certain restrictions are in force on the use of FS (AR 750-10).

c. Titanium tetrachloride (FM) is similar to FS in appearance, properties, and use.

d. White phosphorus (WP) is a yellow, waxy substance which ignites spontaneously and produces a dense white smoke. Its principal use is to produce smoke, although it is an incendiary and casualty agent as well. WP is used only in explosive-type projectiles,

---

*General*

---

artillery and mortar shell, grenades, and airplane bombs. When the projectile explodes, it scatters small pieces of phosphorus which ignite spontaneously upon contact with air. These particles continue to burn even when embedded in the flesh. Phosphorus burns should be kept under water or well packed with moist earth, until the particles are removed. Phosphorus smoke is unpleasant to breathe but harmless; the particles, however, will poison food and water.

**58. INCENDIARIES.** Incendiaries are used to ignite combustible materials, but may also injure personnel. Various types of incendiary agents are used. An aluminum-barium nitrate mixture (F8), thermite (TH), or thermate (TH) are used in magnesium or steel containers.

a. Thermite is a mixture of aluminum and iron and this mixture, upon ignition, produces molten iron.

b. Thermate, a mixture of thermite with other substances (such as barium nitrate) which accelerate the burning, is used in incendiary bombs and grenades.

c. Combustible oils and jelled gasoline are used in bombs and flame throwers. Incendiary mixture (PT-1) is used in bombs.



## CHAPTER 2

## CLASSES OF AMMUNITION

## Section I

## SMALL-ARMS AMMUNITION

## 59. GENERAL.

a. Ammunition used in weapons whose bore is 0.60 inch or less (rifles, carbines, pistols, revolvers, and machine guns) and in shotguns is classed as small-arms ammunition.

b. Many types of cartridges are manufactured to the same profile. Consequently, cartridges of the same caliber although of different model may be very similar in appearance. Each type, and sometimes each model, as in the case of some tracer cartridges, has a characteristic colored bullet tip. Cartridges may be identified as to type, model, and caliber by marking on packing boxes and cartons.

c. The colors used on bullet tips to identify the type of cartridge are shown in figure 1 and described in paragraph 7 a (3).

## 60. CARTRIDGES.

a. General. A round of small-arms ammunition is known as a cartridge. In general, it consists of a bullet, a propelling charge, a primer, and a cartridge case, all assembled into a unit assembly (figs. 24, 25, and 26).

b. Bullet. Bullets for service use have a metal core or slug which is covered with a gilding metal, or gilding-metal-clad steel jacket. In the case of caliber .45 bullets, copper-plated steel may be used instead of gilding metal for the jacket. Ball and tracer bullets have a lead alloy or common steel core or slug, whereas armor-piercing bullets have a hardened steel alloy core. Bullets have a flat or tapered base. A bullet having a tapered base is said to be "boat-tailed." A cannelure, or annular knurl, is rolled or cut into the jacket to provide a recess into which the cartridge case is crimped (figs. 27, 28, 29, and 30).

c. Propelling charge. There are two types of small-arms propellants generally used, the single-base nitrocellulose type and the double-base type. The double-base type is a mixture of nitrocellulose and nitroglycerin which burns more rapidly than the single-base type; it is used in shotgun shells, some caliber .45 rounds, and carbine ammunition. The weight of the charge and granulation of the powder are in accordance with specification requirements for velocity and pressure. The charge is assembled loosely in the cartridge case.

Classes of Ammunition

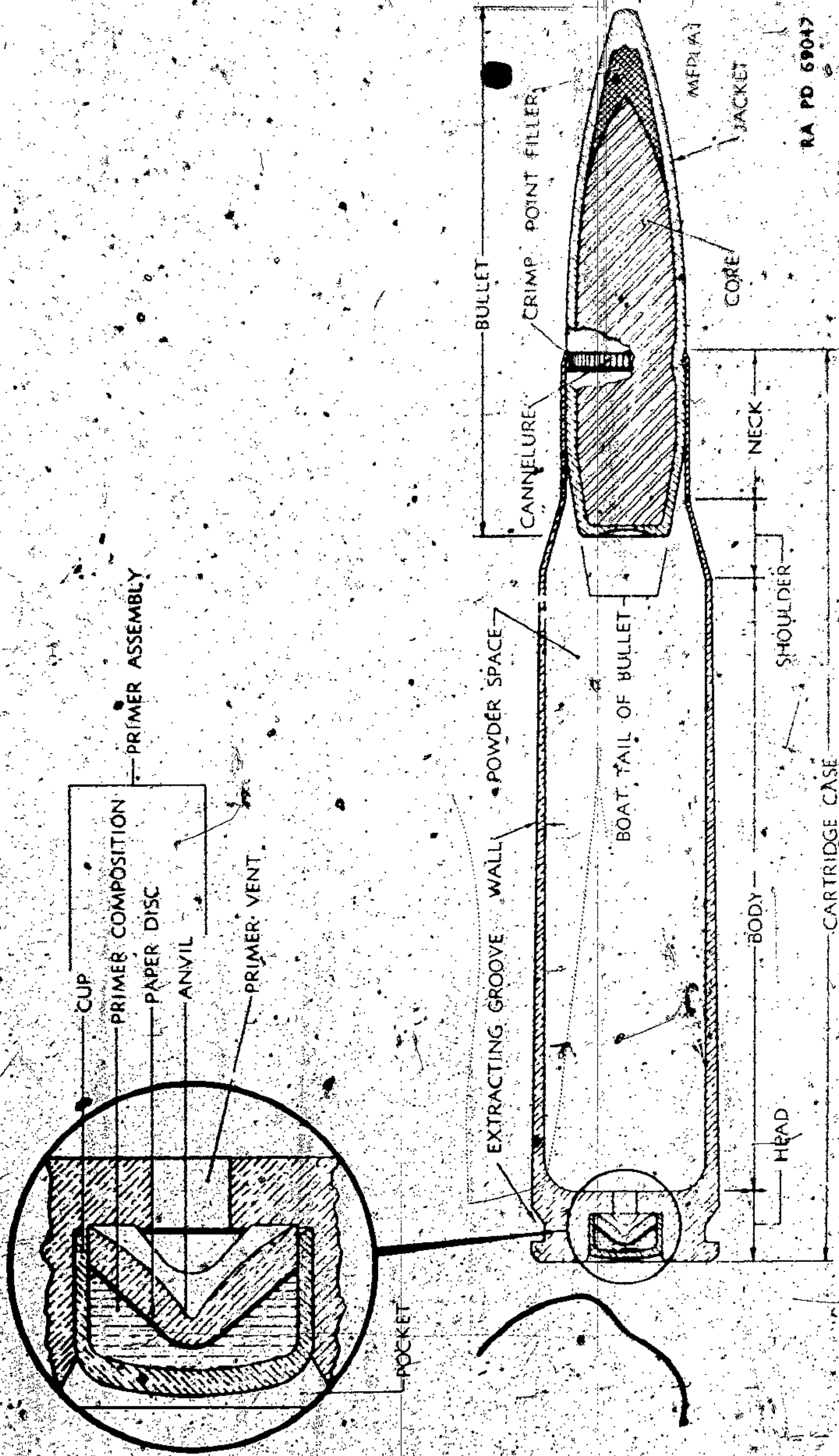
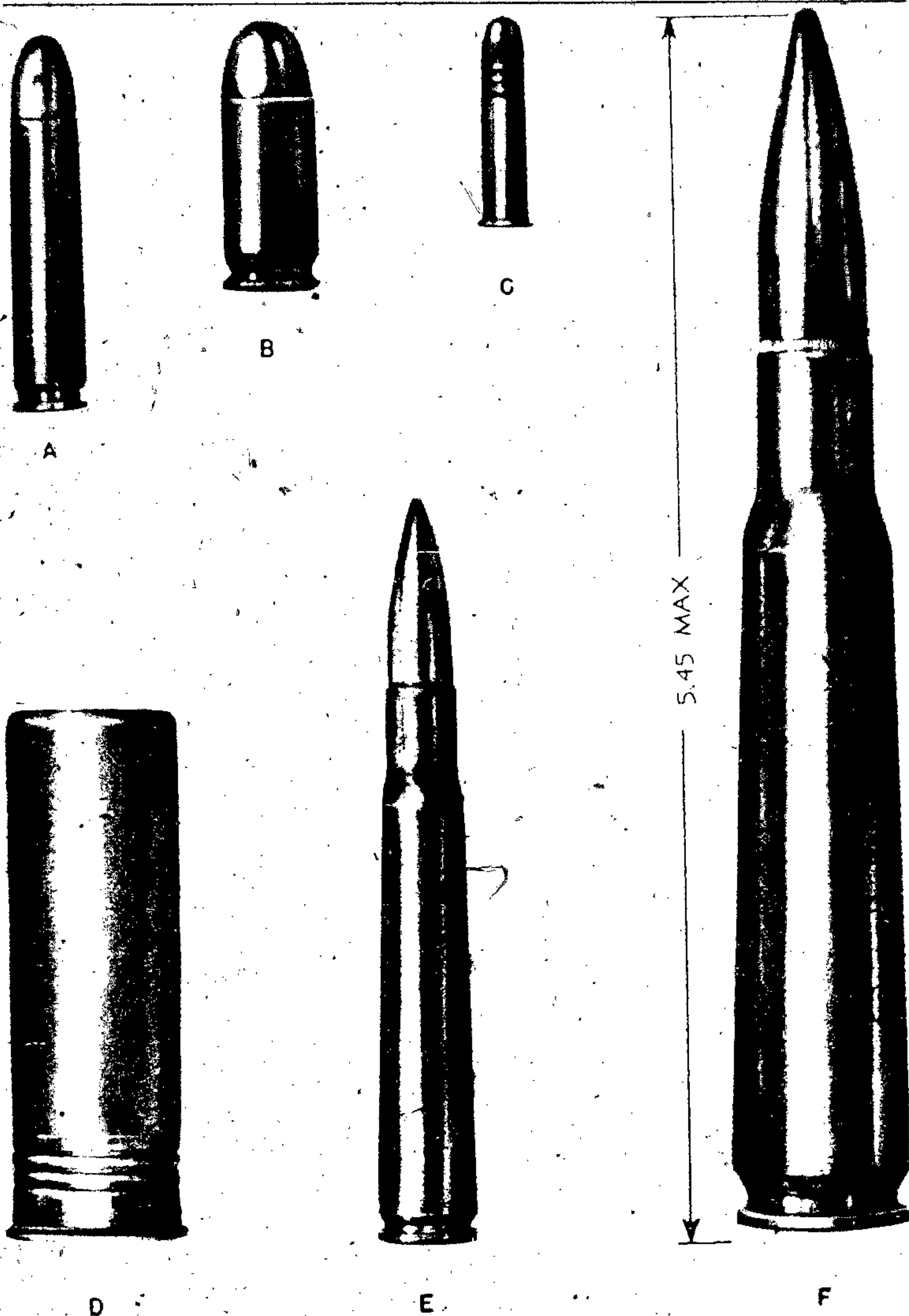

Figure 24 -- Cartridge Terminology



*Classes of Ammunition*



- A — CAL. .30 CARBINE BALL CARTRIDGE, M1
- B — CAL. .45 BALL CARTRIDGE, M1911
- C — CAL. .22 LONG RIFLE BALL CARTRIDGE
- D — 12-GAGE SHOTGUN SHELL
- E — CAL. .30 BALL CARTRIDGE, M2
- F — CAL. .50 BALL CARTRIDGE, M2

RA PD 4507B

**Figure 25 — Types of Small-arms Ammunition**

Classes of Ammunition

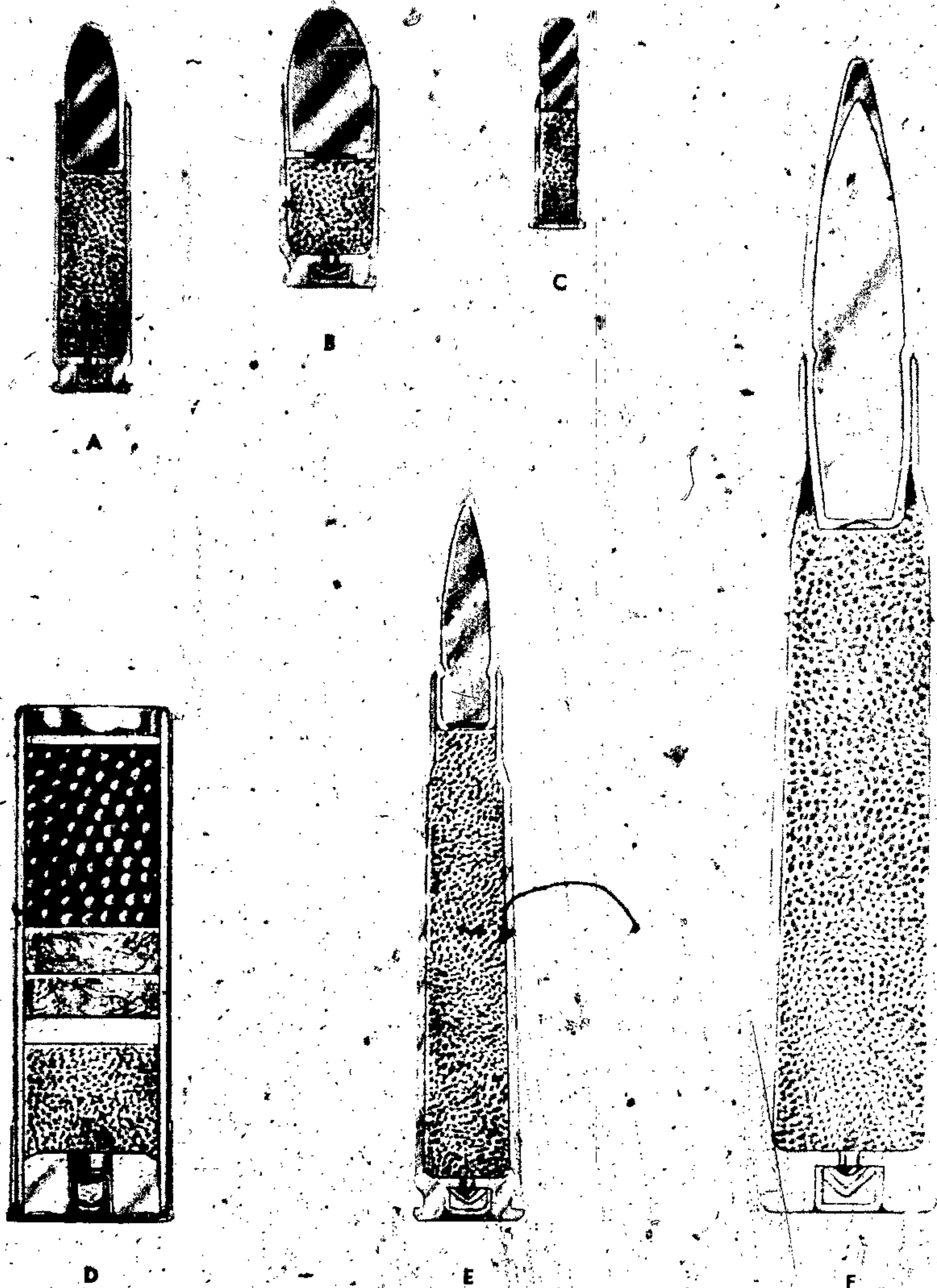

- A - CAL. 30 CARBINE BALL CARTRIDGE, M1
- B - CAL. 45 BALL CARTRIDGE, M1911
- C - CAL. 22 LONG RIFLE BALL CARTRIDGE
- D - 12-GAGE SHOTGUN SHELL
- E - CAL. 30 BALL CARTRIDGE, M2
- F - CAL. 50 BALL CARTRIDGE, M2

- PA PD 89561A

Figure 26 - Types of Small-arms Ammunition - Cross Section



Classes of Ammunition

- A — BASE FILLER-GILDING METAL
- B — COMPOSITION, IGNITER
- C — COMPOSITION, TRACER
- D — CORE-TUNGSTEN CHROME STEEL
- E — JACKET-GILDING METAL OR GILDING METAL CLAD STEEL
- F — POINT FILLER-LEAD "T" SHOT
- G — SLUG-LEAD WITH ANTIMONY
- H — BODY PLUG-LEAD SHOT
- I — INCENDIARY COMPOSITION
- J — STEEL BODY

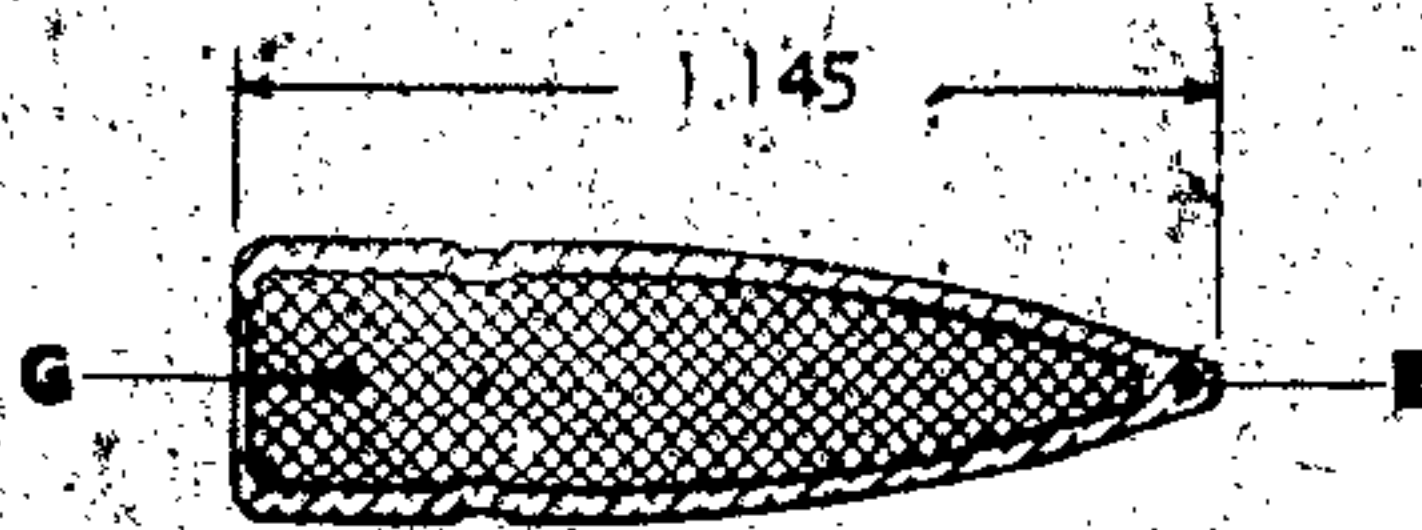

CAL. .30 BALL BULLET, M2

BLACK - APPROX. 5/16"

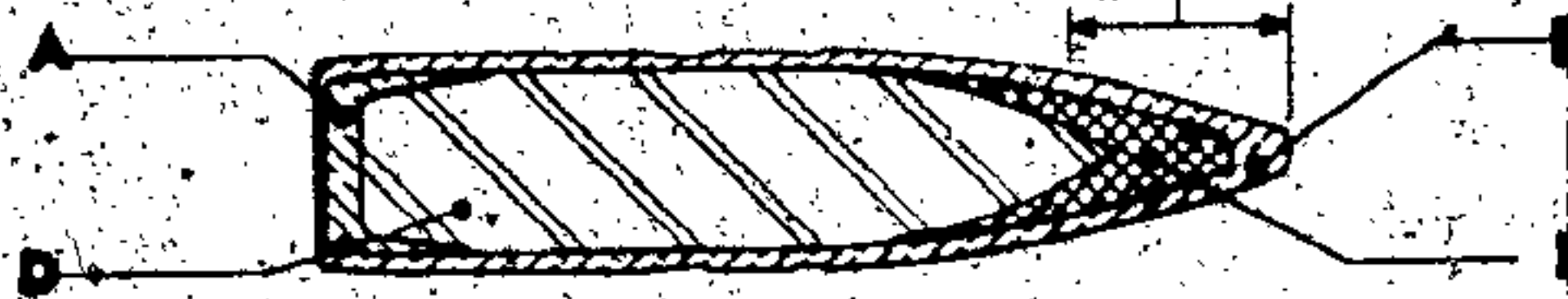

CAL. .30 ARMOR-PIERCING BULLET, M2

RED - APPROX. 5/16"

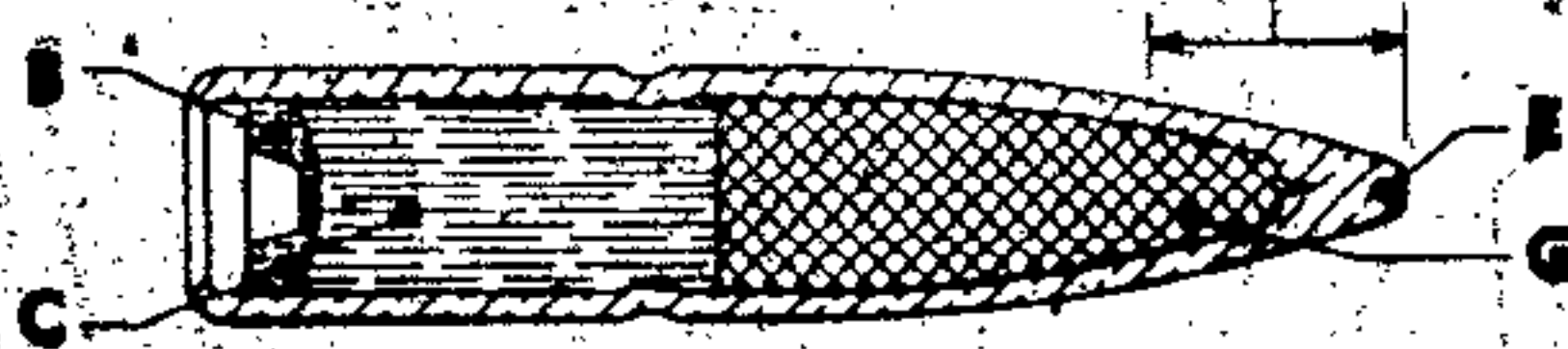

CAL. .30 TRACER BULLET, M1

ORANGE - APPROX. 5/16"

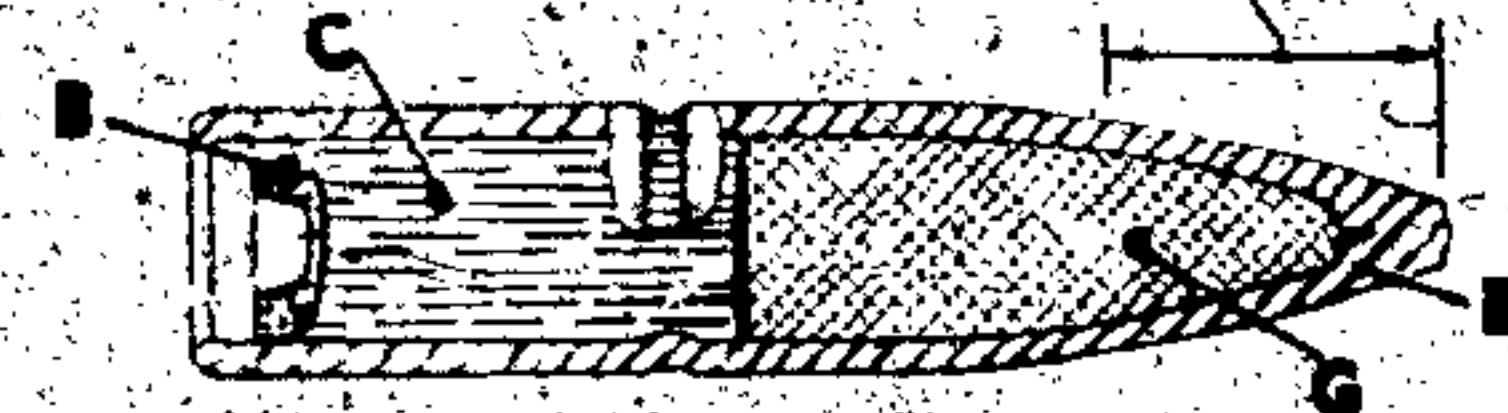

CAL. .30 TRACER BULLET, T10

BLUE - APPROX. 5/16"

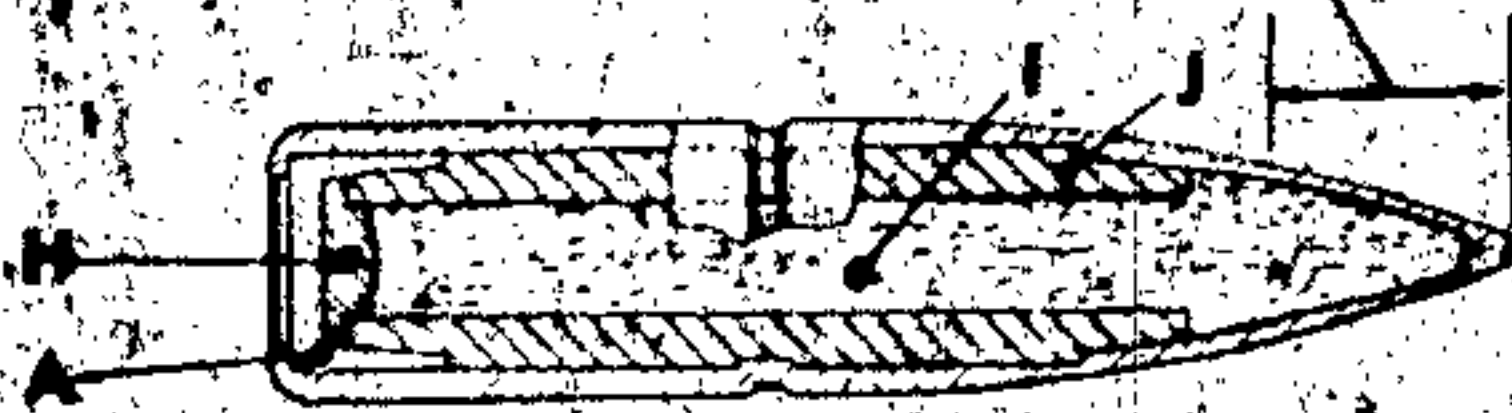

CAL. .30 INCENDIARY BULLET, M1

RA PD 4511C

Figure 27 - Caliber .30 Bullets - Cross Section

Classes of Ammunition

- A — COMPOSITION, IGNITER
- B — COMPOSITION, SUB-IGNITER
- C — COMPOSITION, TRACER
- D — CORE-STEEL
- E — CORE-TUNGSTEN CHROME STEEL
- F — JACKET-GILDING METAL
- G — POINT FILLER LEAD WITH ANTIMONY
- H — SLUG, LEAD WITH ANTIMONY
- I — JACKET-GILDING METAL CLAD STEEL
- J — INCENDIARY MIXTURE
- K — STEEL BODY

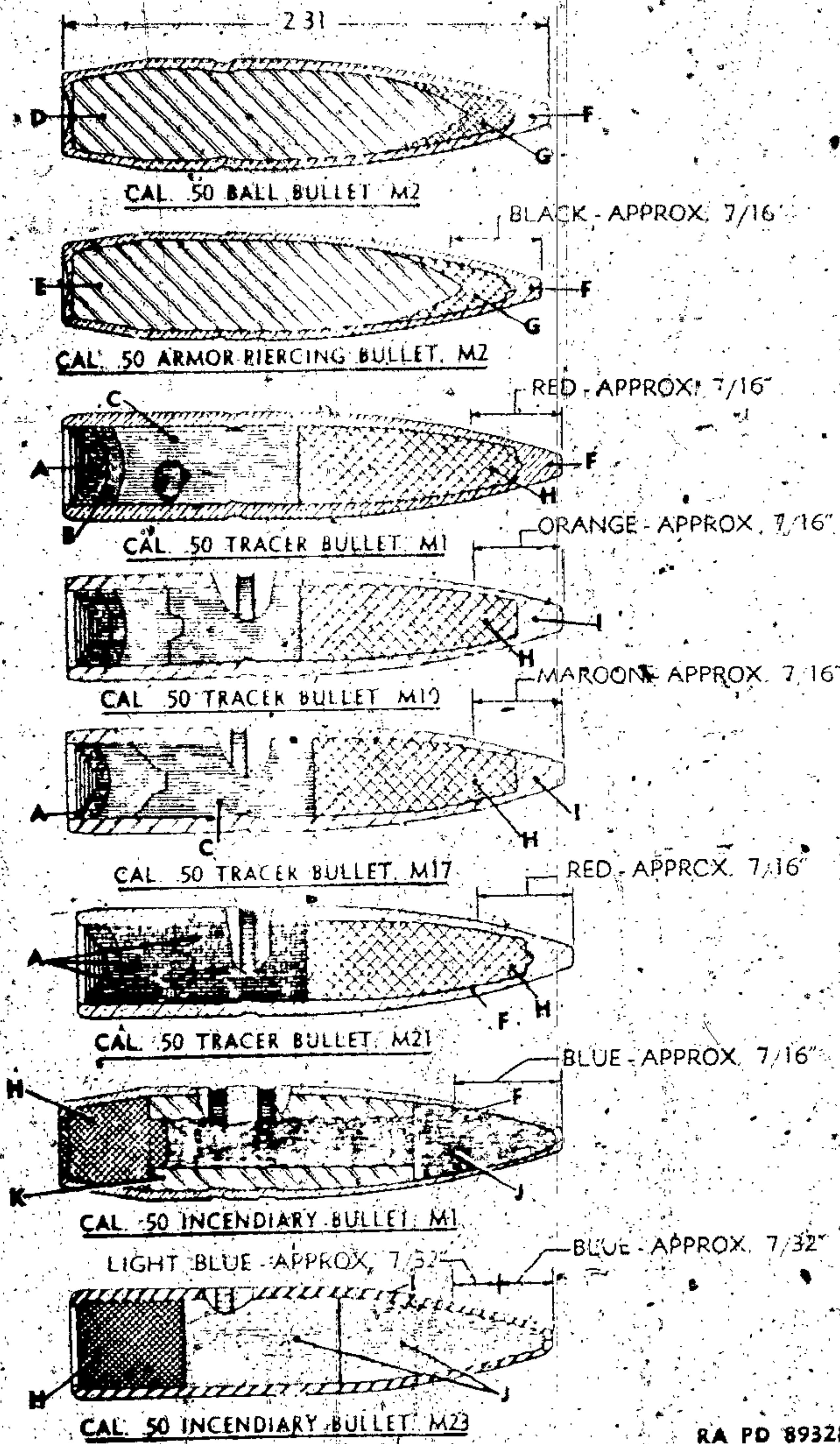

RA PD 89328A

Figure 28 — Caliber .50 Bullets — Cross Section



*Classes of Ammunition*

d. **Primer.** The primer consists of a brass or gilding-metal cup which contains a primer-composition pellet of sensitive explosive, a paper disk, and a brass anvil. A blow from the firing pin on the primer cup compresses the primer composition between the cup and the anvil, and causes the composition to explode. The holes or vents in the anvil allow the flame to pass through the primer vent in the cartridge case and ignite the propellant.

e. **Cartridge case.** The cartridge case is made of drawn brass or steel. It serves as a means whereby the other components—primer, propelling charge and bullet—are assembled into a unit, the cartridge. Another of its functions is to expand and seal the chamber against the escape of gases to the rear when the cartridge is fired. This action is known as obturation. To make the cartridge waterproof and to keep the propelling charge dry, the primer is sealed in the primer seat and the bullet is sealed in the neck of the cartridge case by a thin film of lacquer or varnish at the time of manufacture. An extractor groove, turned in the head of the cartridge case, provides a means of removing the case from the chamber of the weapon.

**61. TYPES.** Small-arms cartridges are classified according to type as follows:

- |                                  |                    |
|----------------------------------|--------------------|
| Ball                             | Dummy              |
| Armor-piercing                   | High-pressure test |
| Armor-piercing-incendiary        | Gallery practice   |
| Armor-piercing-incendiary-tracer | Guard              |
| Incendiary                       | Subcaliber         |
| Tracer                           | Grenade            |
| Blank                            | Shot               |
|                                  | Shotgun shells     |

**62. BALL.** This type of cartridge, intended for use against personnel and light materiel targets, is the oldest service type. It is being replaced for combat purposes, however, by armor-piercing and other types. The term "ball," although no longer accurately describing the shape of the modern bullet, has been continued in use to designate that type of bullet and ammunition used for the same purposes as ammunition of very early design, the bullet of which was actually a ball (figs. 25 to 30). A special high grade of ball ammunition is manufactured each year for the National Matches of that year. The following year it may be used in preliminary firing for such matches. The second year, and thereafter, it is considered as standard service ammunition. The head of each of these cartridges is stamped "N.M." and with the year of manufacture.

**63. ARMOR-PIERCING.** This type of cartridge is intended for use against armored aircraft and vehicles, concrete shelters, and similar built-resisting targets. The bullet has a hardened steel alloy core. In addition, it may have a base filler and a point filler of a softer metal, such as gilding metal (figs. 27 and 28).



## Classes of Ammunition

- A - SLUG-LEAD ALLOY
- B - JACKET-GILDING METAL
- C - JACKET-COPPER-PLATED STEEL
- D - IGNITER
- E - TRACER COMPOSITION

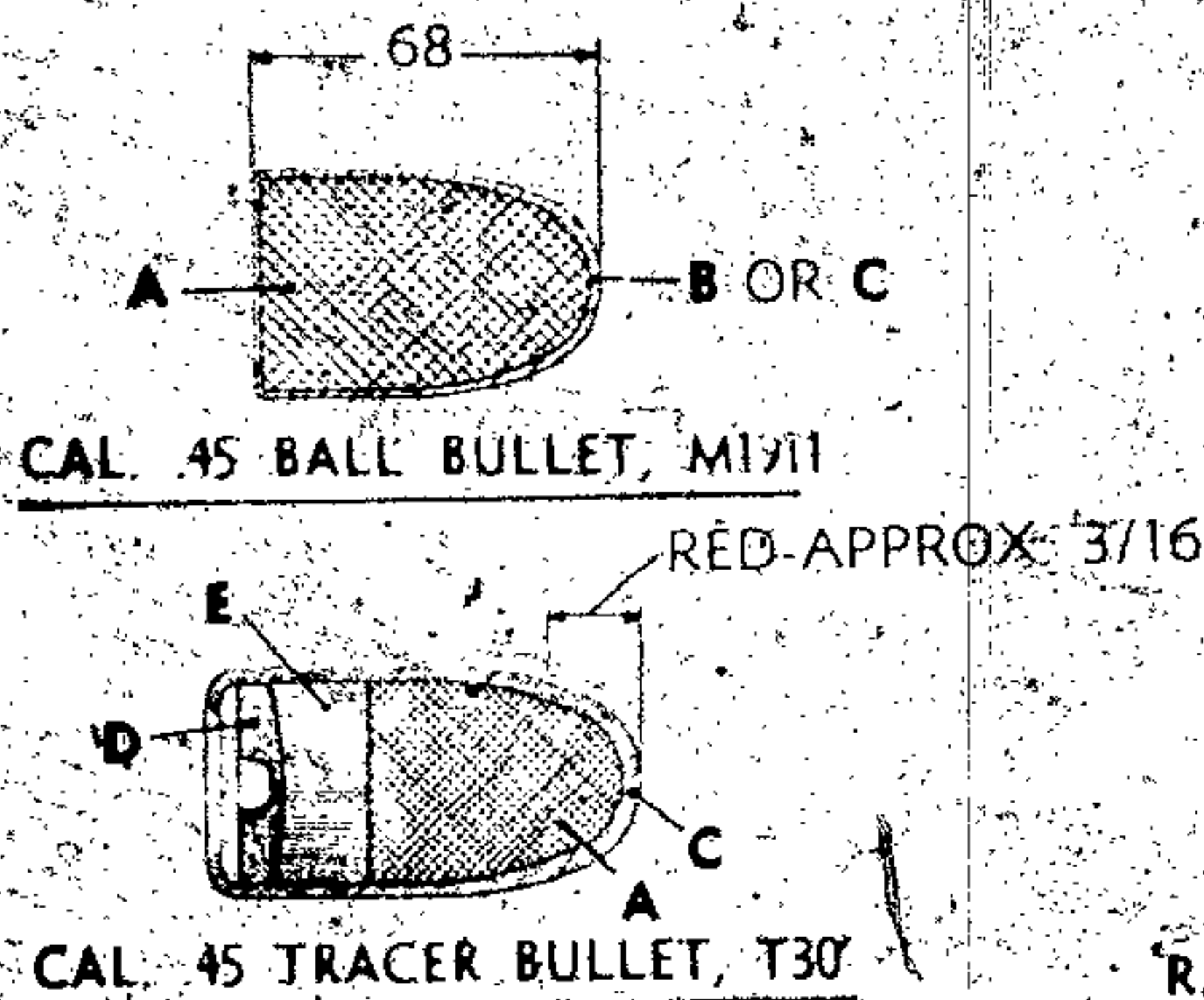

RA PD 89330A

Figure 29 - Caliber .45 Bullets - Cross Section

**64. ARMOR-PIERCING-INCENDIARY.** This type of cartridge is used in caliber .30 and caliber .50 weapons, in lieu of using both armor-piercing and incendiary cartridges.

**65. ARMOR-PIERCING-INCENDIARY-TRACER.** This type of cartridge combines the features of armor-piercing, of incendiary, and of tracer cartridges and is intended to replace these cartridges.

**66. INCENDIARY.** This type of cartridge is similar to that of armor-piercing ammunition in outward appearance. It is used for incendiary purposes against aircraft. It contains an incendiary composition as a central bullet core, which ignites on impact with the target (figs. 27 and 28).

**67. TRACER.** This type of cartridge is intended for use with other types to show the gunner, by its trace, the path of the bullets thus assisting in correcting aim. It may also be used for incendiary purposes. The tracer element consists of a pressed inflammable material in the base of the bullet; this composition is ignited by the propelling charge when the cartridge is fired (figs. 27 through 30). For identification, the nose of the bullet is painted red, orange, or maroon.

**68. BLANK.** This type of cartridge (fig. 31) is distinguished by the absence of a bullet. It is used for simulated fire, training cavalry mounts, and firing salutes. It is also used in machine guns equipped



Classes of Ammunition

- A- SLUG-LEAD ALLOY
- B- JACKET-GILDING METAL
- C- IGNITER
- D- TRACER COMPOSITION
- E- JACKET-GILDING METAL CLAD STEEL



CAL. .30 CARBINE BALL BULLET, M1

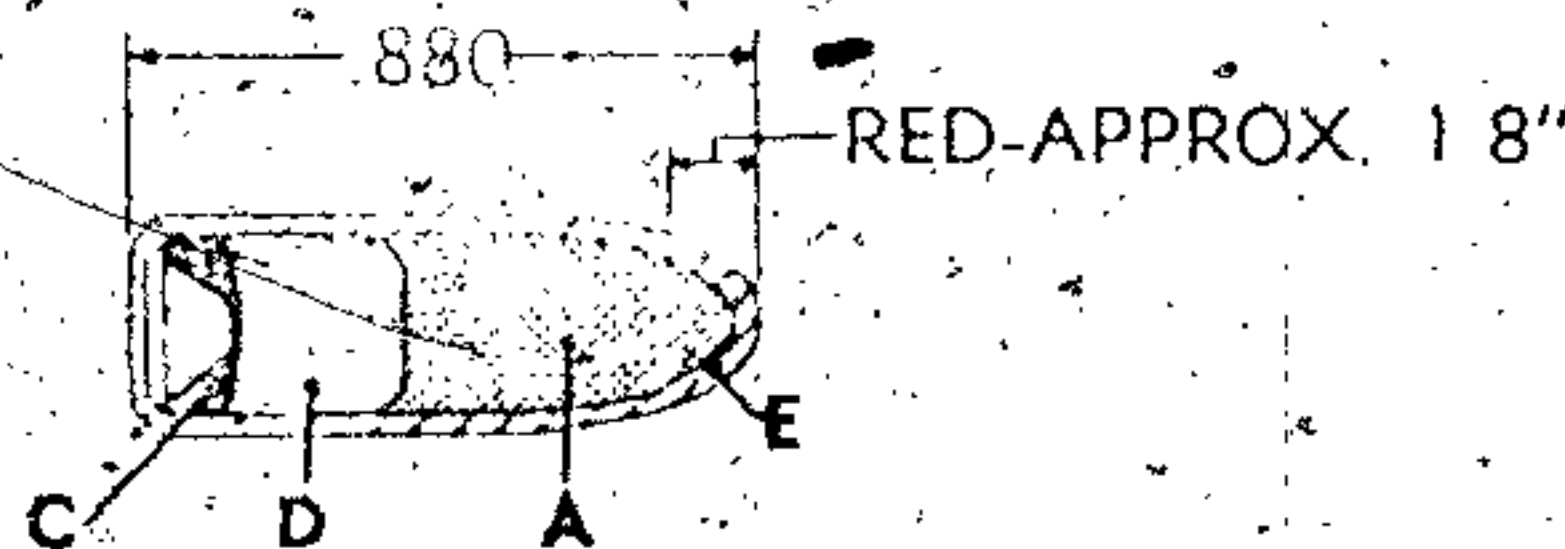

CAL. .30 CARBINE TRACER BULLET, M16

RA PD 89332A

Figure 30 - Carbine Caliber .30 Bullets - Cross Section

with blank-firing attachments in order to operate these weapons for instructional purposes. EC blank powder is used to produce the noise.

**69. DUMMY.** This type of cartridge (fig. 32) is used for practice in loading weapons, to detect flinching in firing weapons, and to simulate firing. The cartridge case of older lots of dummy ammunition is tin-coated. However, the present means of identification of dummy cartridges is by means of holes drilled through the side of the case and by the empty primer hole. The cartridges are completely inert but simulate service rounds in most details.

**70. HIGH-PRESSURE TEST.** This type of cartridge (fig. 33) is manufactured for use in proof firing of small arms. Since the propelling charge of this ammunition develops high pressures, these cartridges should never be used for any other purpose. When used for the purpose intended, all personnel should be protected by adequate cover. This ammunition is distinguished from other types by the tin coating of the cartridge case. In some older lots, the word "TEST" is stamped on the head of the case.

**71. GALLERY PRACTICE.** The present standard for gallery practice is the caliber .22 long rifle cartridge (figs. 25 and 26), a rim-fire cartridge of commercial manufacture. In the past a gallery practice cartridge, caliber .30 M1919 was used, but any available lots of this cartridge are reserved for guard purposes.

## Classes of Ammunition

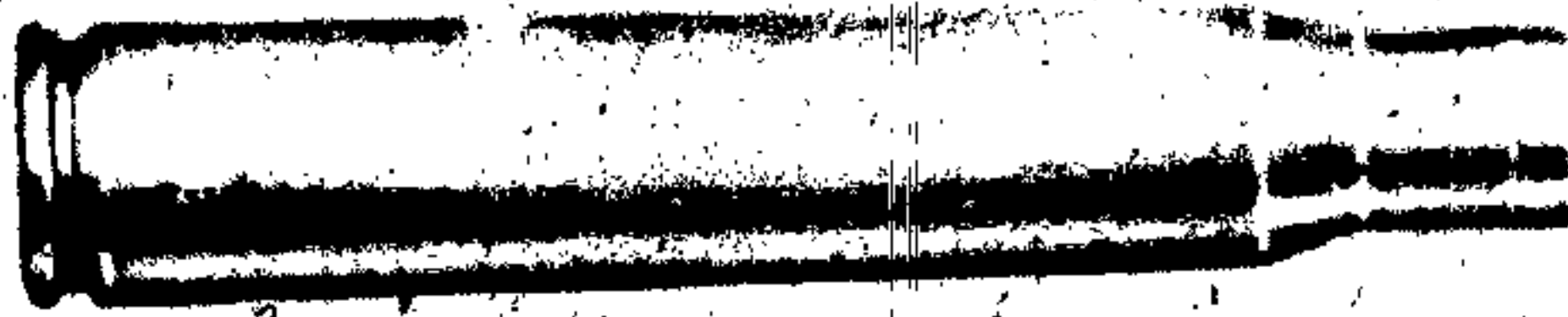

CAL. .30 BLANK CARTRIDGE, M1902

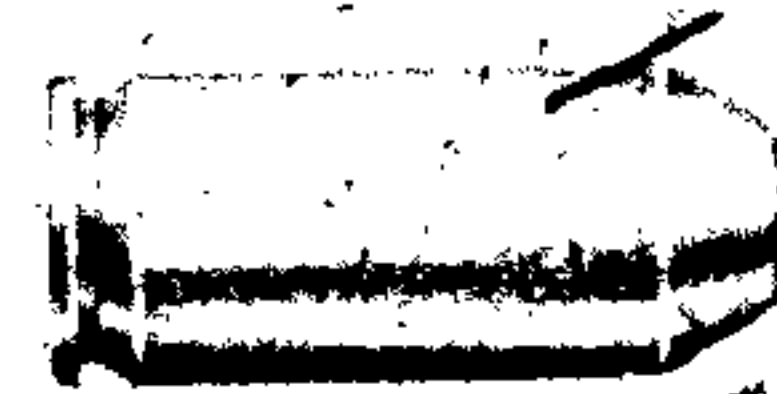
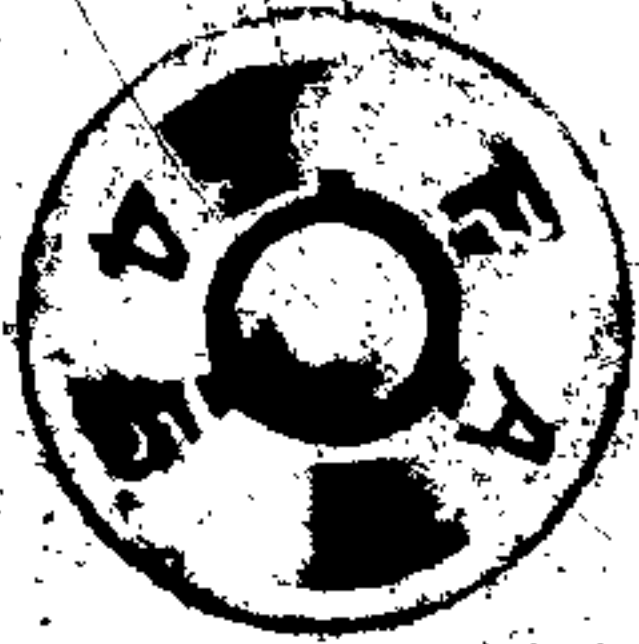
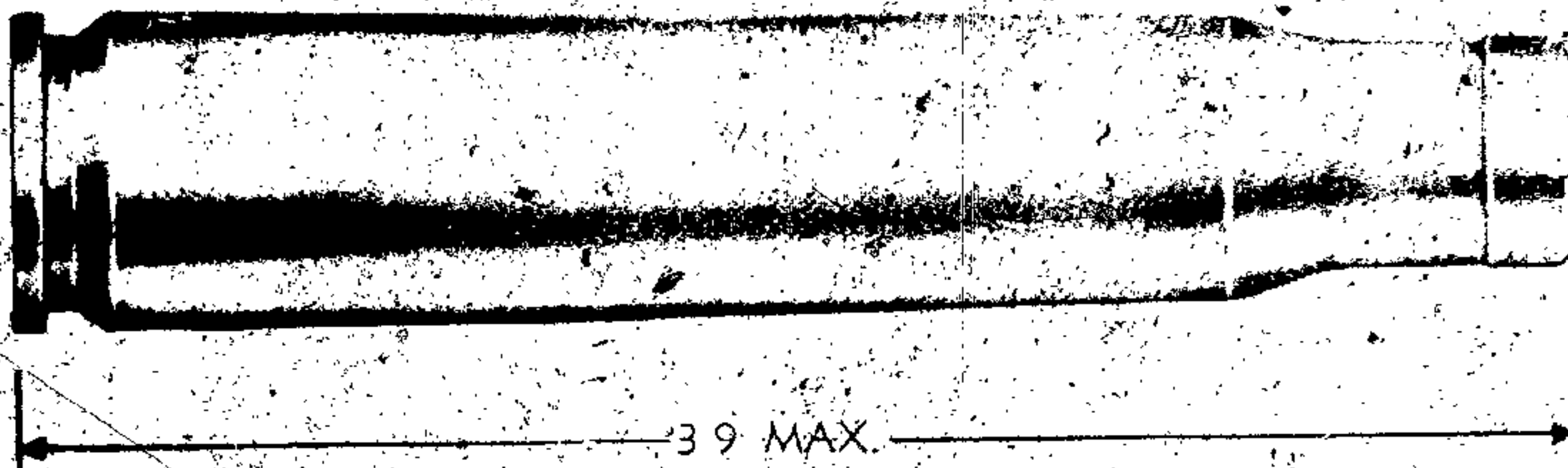
CAL. .45  
BLANK CARTRIDGE, M9

CAL. .50 BLANK CARTRIDGE, M1 (#40)

RA PD 89334A

Figure 31—Blank Cartridges

**72. GUARD.** Guard cartridges consisted of a low-velocity charge and a round-nose lead bullet together with the cartridge case and primer. The guard cartridge M1 was formerly known as the gallery practice cartridge M1919 (par. 71). As in the case of the gallery practice cartridge, the use of the guard cartridge is being discontinued.

**73. SUBCALIBER.**

a. This type of cartridge (fig. 34) is fired from subcaliber tubes inserted in larger weapons. The subcaliber cartridge, caliber .30, M1925 is fired from a "Krag" type of subcaliber tube in 3-inch sea-coast guns. This cartridge is identified by the extracting rim on the head of the case instead of the usual groove.

b. Other cartridges, specifically the standard caliber .22, caliber .30, and caliber .50 ball cartridges, are fired from subcaliber tubes in field, tank, and antitank weapons.



Classes of Ammunition

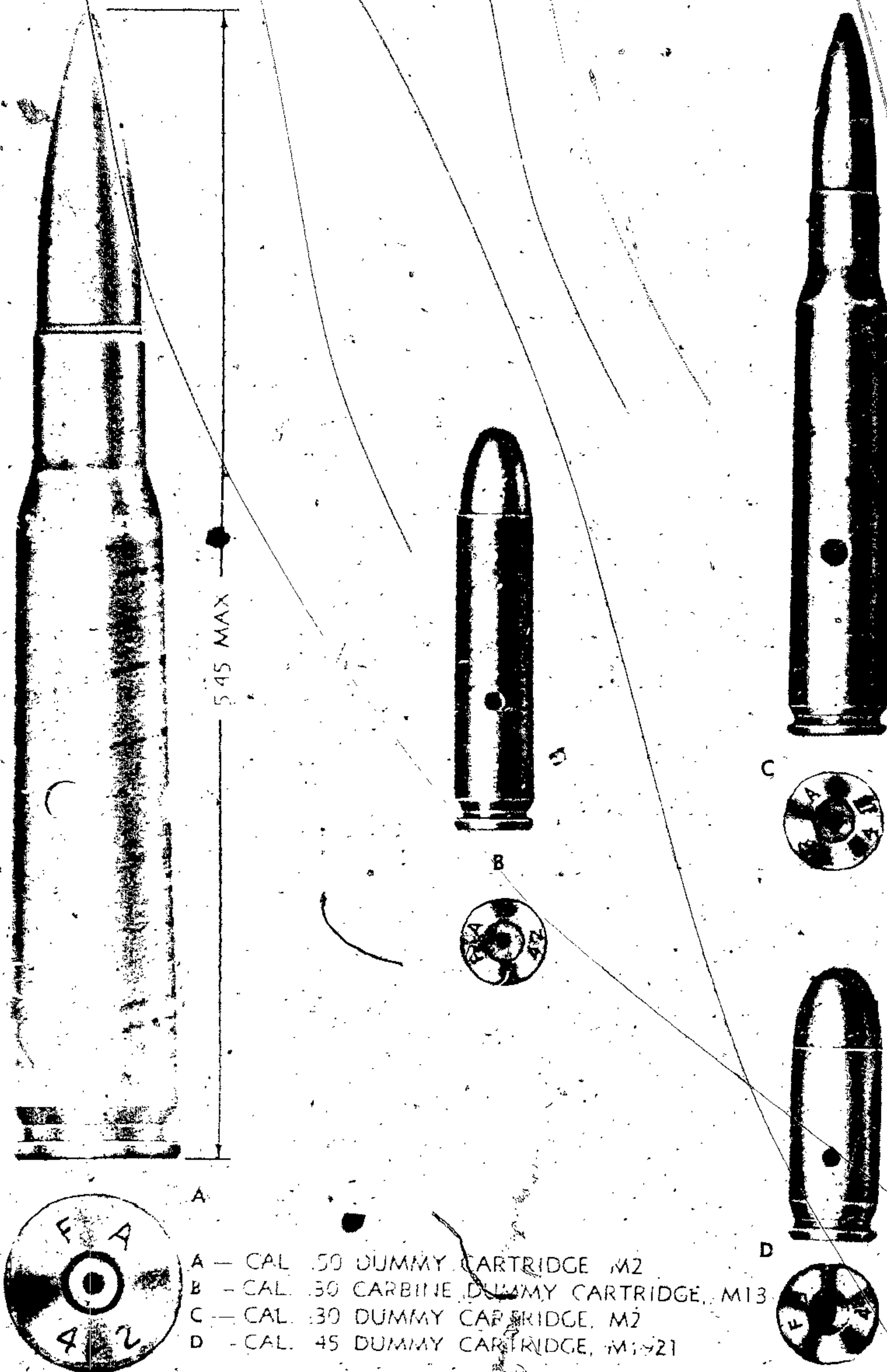

RA PD 89344A

Figure 32 — Dummy Cartridges

Classes of Ammunition

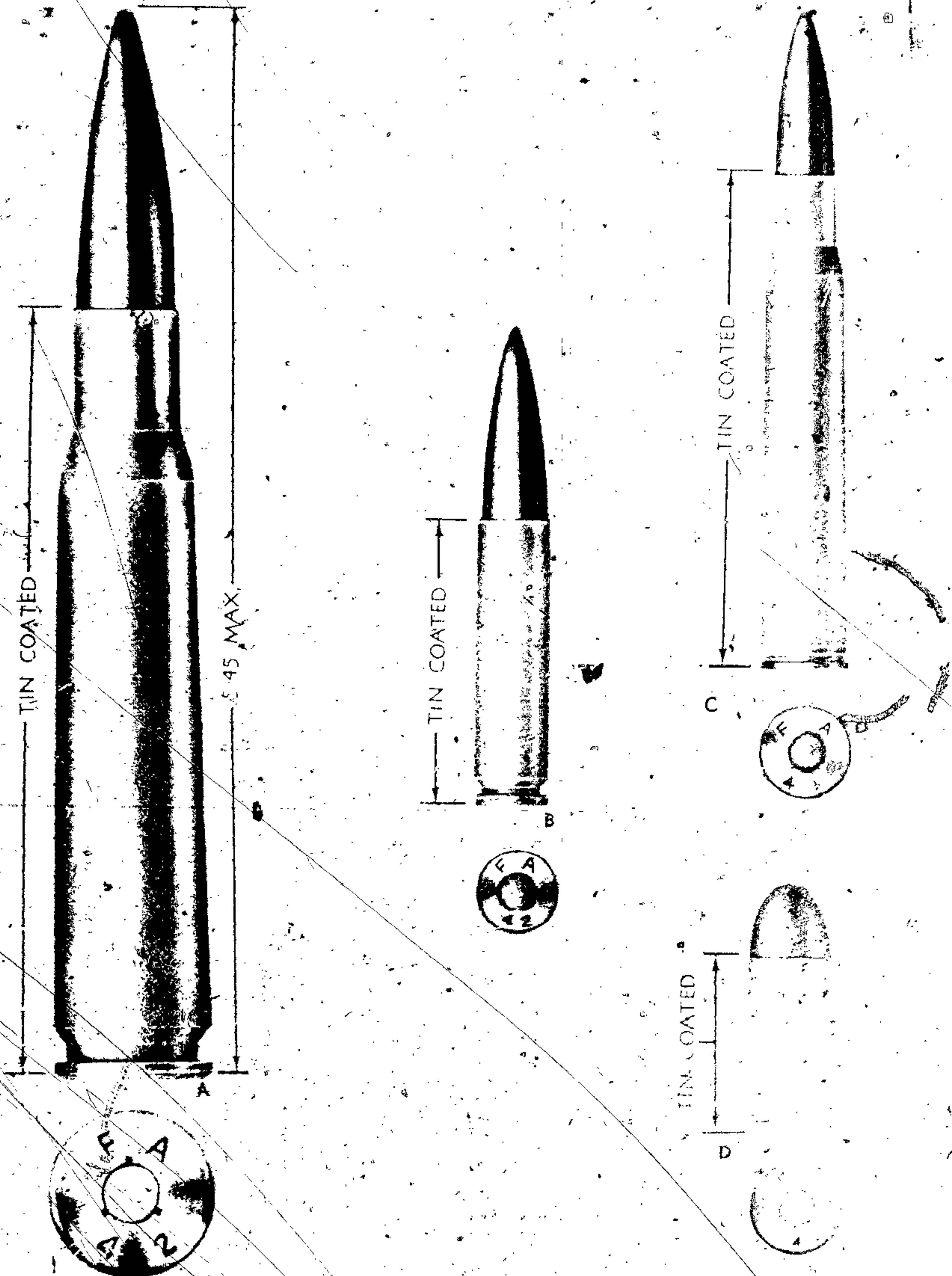

- A — CAL. 50 HIGH PRESSURE TEST CARTRIDGE, M1
- B — CAL. 30 CARBINE HIGH PRESSURE TEST CARTRIDGE, M1B
- C — CAL. 30 HIGH PRESSURE TEST CARTRIDGE, M1
- D — CAL. 45 HIGH PRESSURE TEST CARTRIDGE, M1

RA PD 89346A

Figure 33 — High-pressure Test Cartridges



Classes of Ammunition

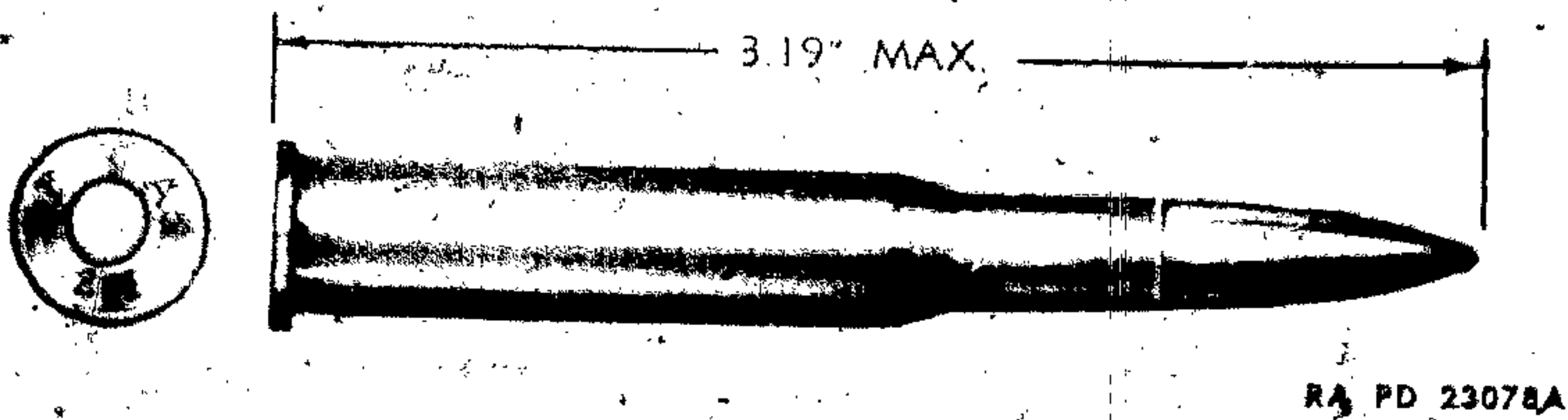
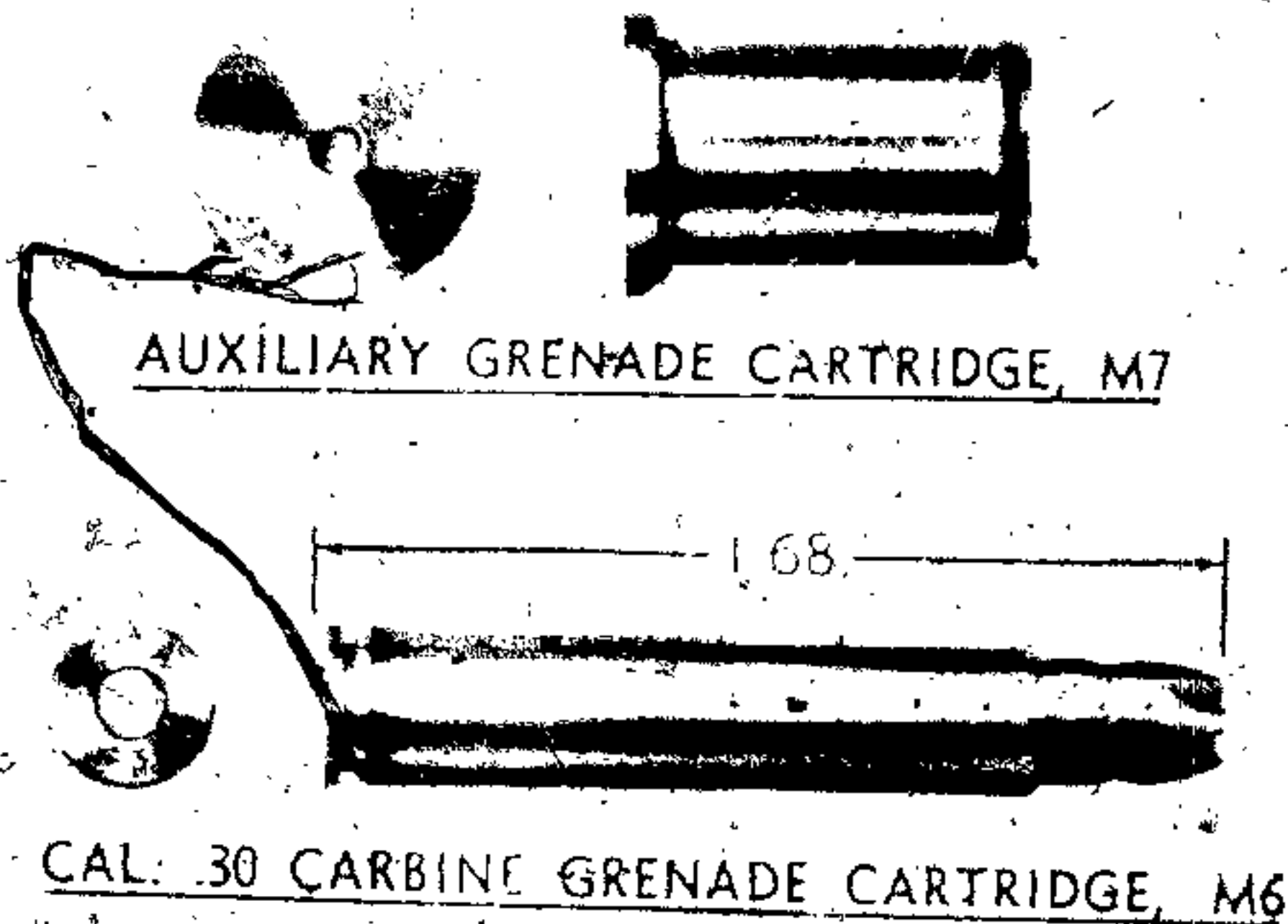

Figure 34 - Caliber .30 Subcaliber Cartridge M1925



CAL. .30 CARBINE GRENADE CARTRIDGE, M6

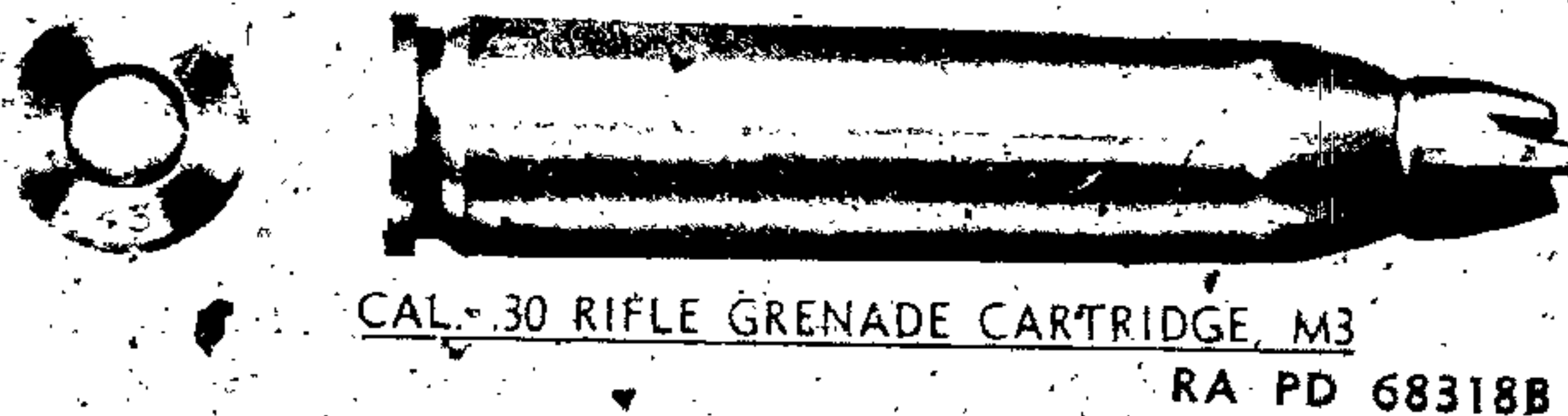

Figure 35 - Grenade Cartridges

**74. GRENADE.** Grenade cartridges (fig. 35) are special blank cartridges for use in propelling grenades from launchers attached to rifles or carbines. The rifle grenade and carbine grenade cartridges are distinguished by a rose-petal crimp at the mouth of the case. The auxiliary grenade cartridge M7 which contains a propellant but no primer is sometimes used in conjunction with the rifle or carbine grenade cartridge to give additional range.

**75. SHOT.** Shot cartridges of caliber .45 (fig. 36) are for use in pistols for hunting small game. Instead of a solid bullet, they contain No. 7½ chilled shot, which is also used in shotgun shell loadings. These cartridges are intended primarily for use by air force personnel as an aid in obtaining food.

**76. SHOTGUN SHELLS.** Shotgun shells (shot shells) of appropriate loads are procured commercially for use in 12-gauge sporting-type and riot-type shotguns (fig. 37).

## Classes of Ammunition

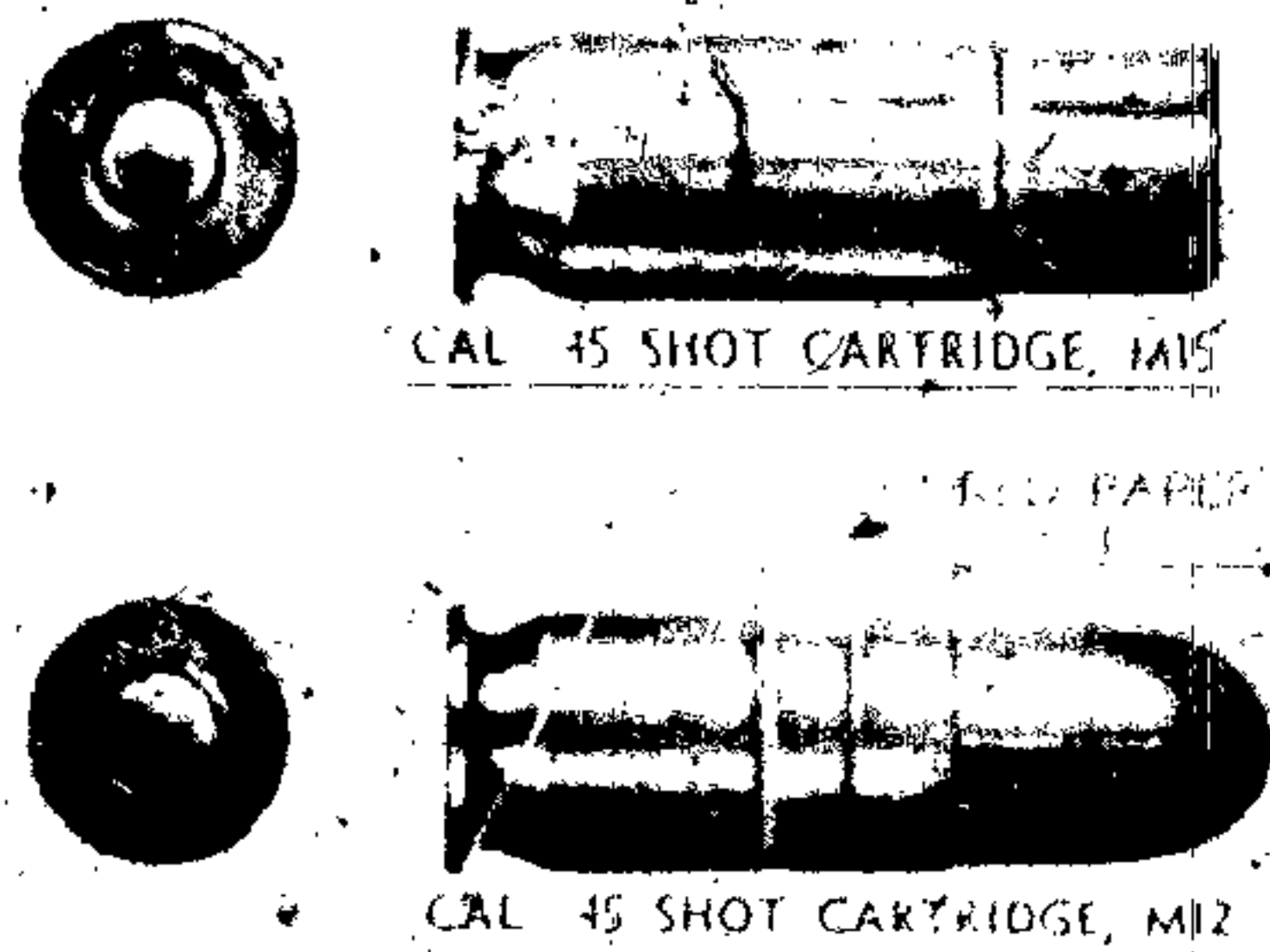

RA PD 89562A

Figure 36 — Caliber .45 Shot Cartridges

**77. GRADES.**

a. Current grades of existing lots of small-arms ammunition are established by the Chief of Ordnance in accordance with acceptance and surveillance tests, and are published in WD SB 9-AMM 4. Grade 3 indicates unserviceable ammunition, which will not be issued or used.

b. Small-arms ammunition which has been graded "For Training Use Only" will not be used in demonstrations or on training courses requiring this ammunition to be fired over the heads of participating troops.

**78. CARE AND PRECAUTIONS IN HANDLING.**

a. Small-arms ammunition is comparatively safe to handle. However, care must be taken to prevent ammunition boxes from becoming broken or damaged. Broken boxes must be repaired immediately, and careful attention given to the transfer of all markings to the new parts of the box. Metal liners should be air-tested and sealed if equipment for this work is available.

b. Ammunition boxes will not be opened until the ammunition is required for use. Ammunition removed from airtight containers, particularly in damp climates, may corrode and become unserviceable.

c. When cartridges are taken from their original packings for loading into clips or machine gun belts, the clips or belts should be tagged or marked so as to preserve the ammunition lot number, thereby preventing the ammunition from falling into grade 3 through loss of lot number (identify).

d. Ammunition should be carefully protected from mud, sand, dirt, and water. If it gets wet or dirty, it should be wiped off at once.



Classes of Ammunition

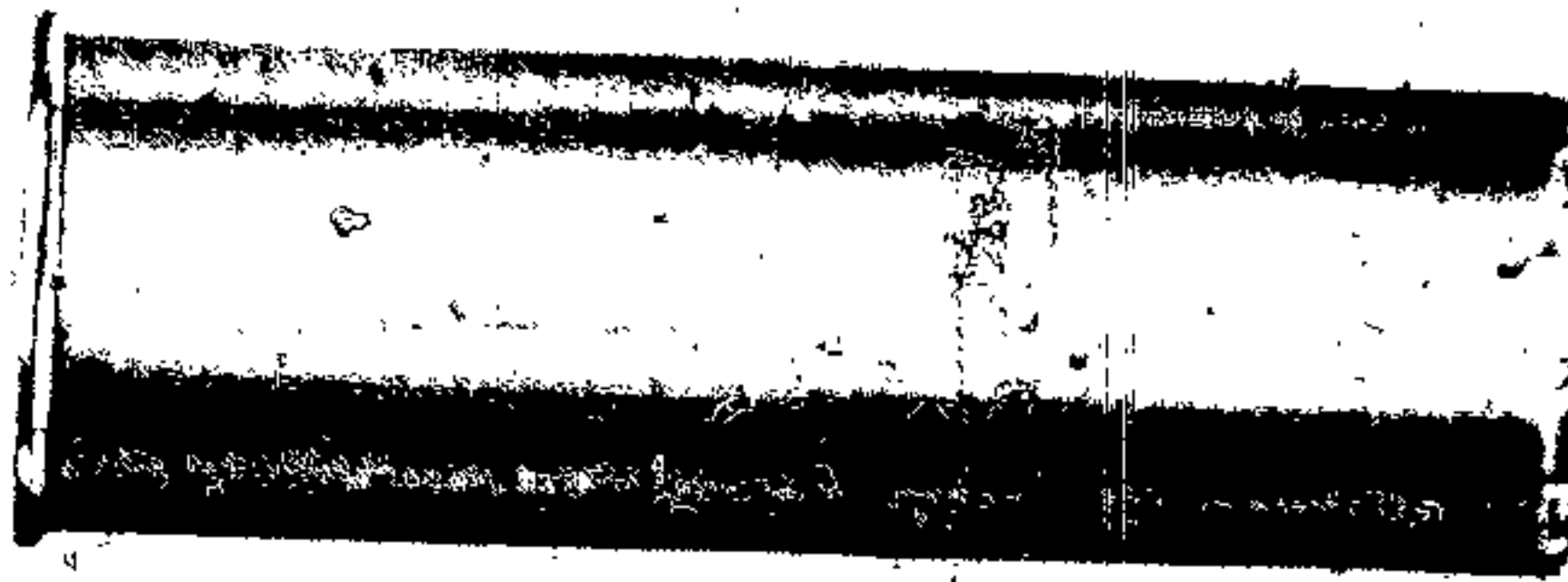

ALL BRASS NO. 00 BUCK 12-GAGE SHOTGUN SHELL, M19

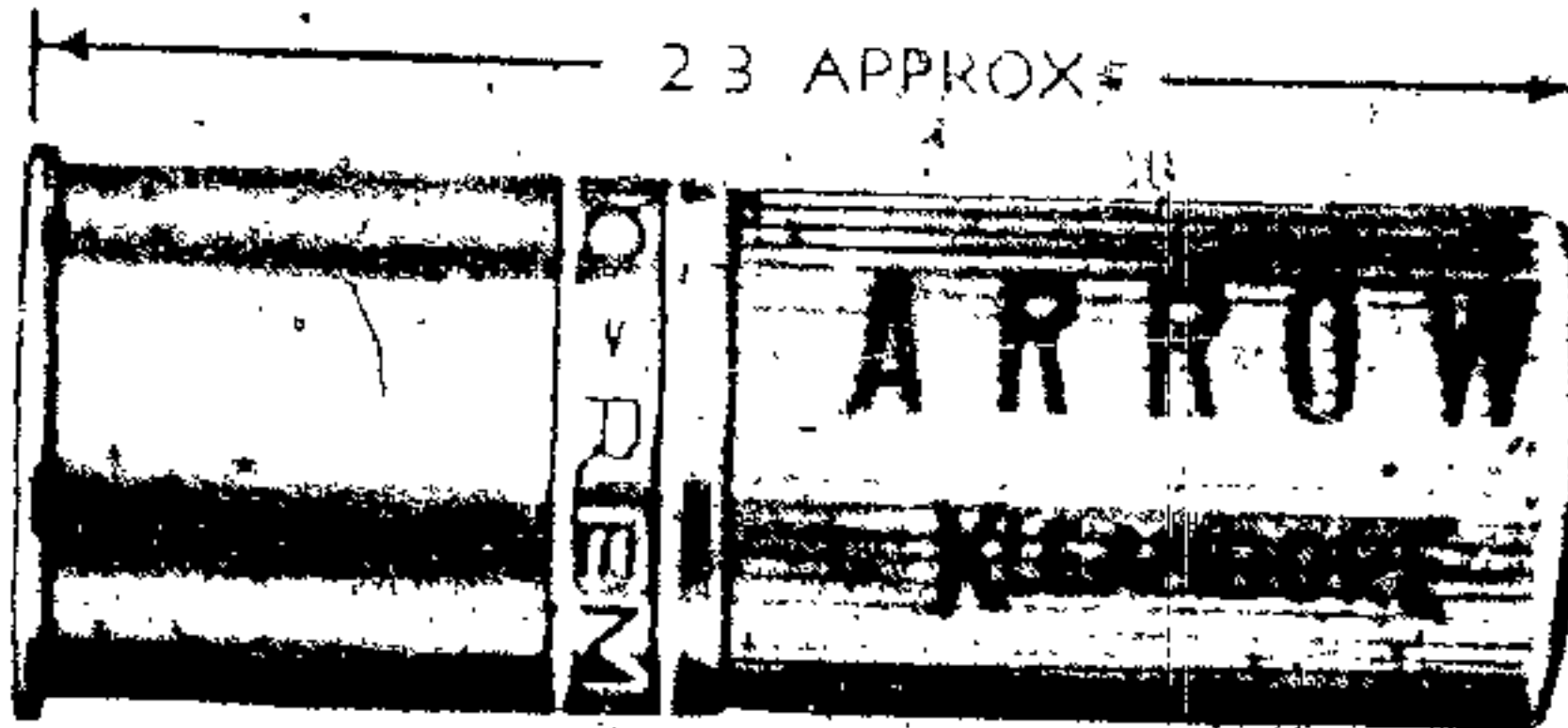
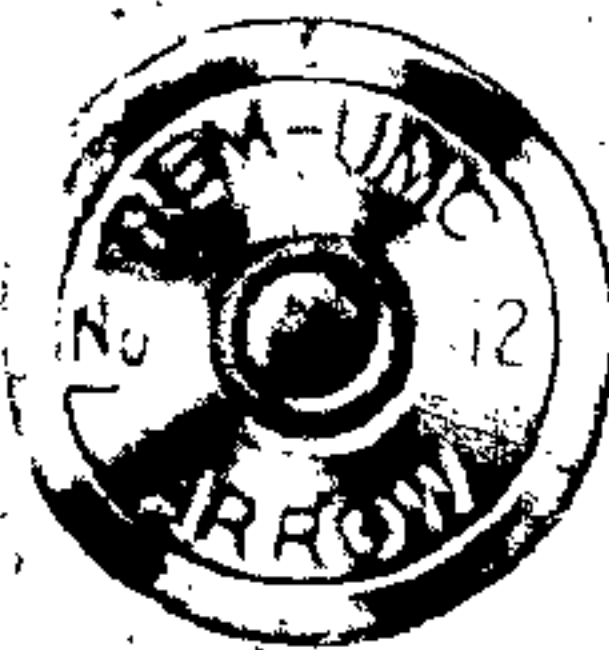

PAPER #00 BUCKSHOT 12-GAGE SHOTGUN SHELL

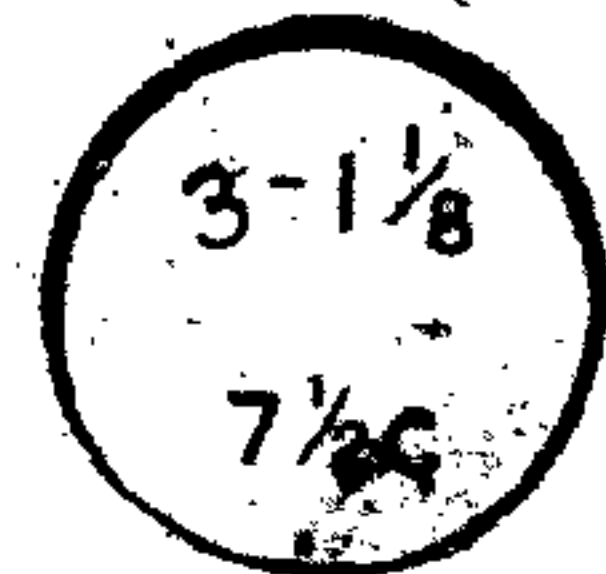

PAPER #7-1/2 CHILLED SHOT 12-GAGE SHOTGUN SHELL

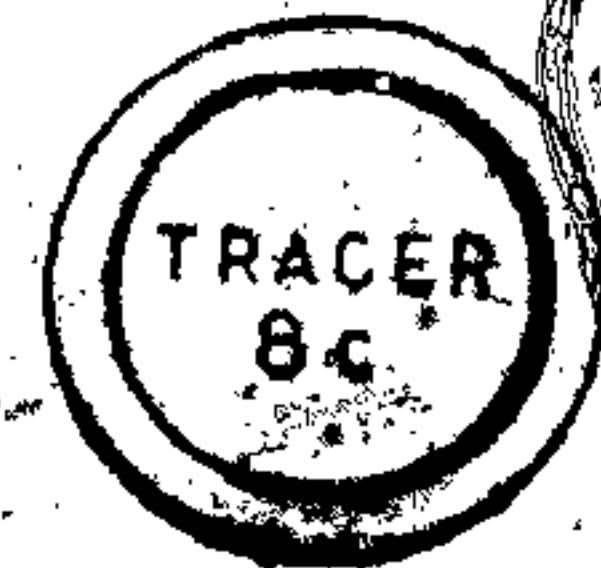
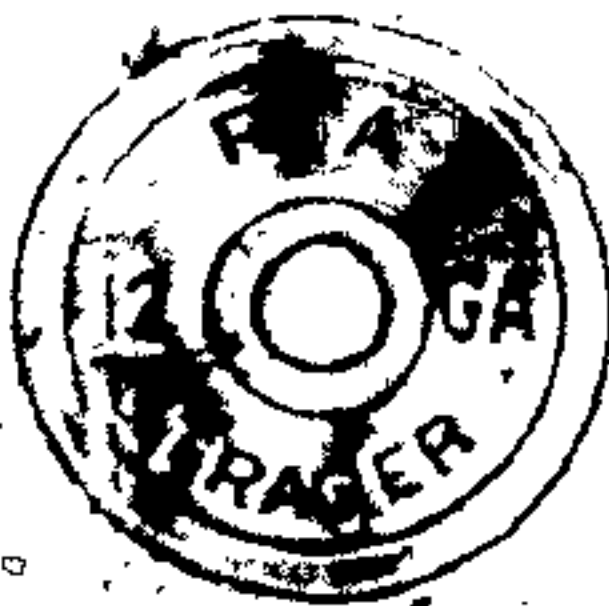

PAPER #8 CHILLED SHOT AND TRACER 12-GAGE SHOTGUN SHELL

RA PD 23080A

Figure 37 — Shotgun Shells, 12-gage

### Classes of Ammunition

If light corrosion or verdigris forms on cartridges, it should be wiped off. However, cartridges should not be polished merely to make them look brighter or better.

e. Ammunition should not be exposed to the direct rays of the sun for any considerable length of time. This is likely to affect its firing qualities.

f. The use of oil or grease on cartridges is dangerous and is prohibited.

g. Cartridges that are dented, have loose bullets, or are otherwise defective should not be fired.

### 79. PRECAUTIONS IN FIRING.

a. Because a misfire cannot immediately be distinguished from a hangfire, it is unsafe to open the bolt of a rifle for at least 10 to 15 seconds after a misfire occurs. When the rifle M1 fails to fire, it should be recocked by means of the trigger guard and refired before the bolt is opened. When the rifle M1903 fails to fire, it should be recocked by drawing back the cocking piece and should be refired before the bolt is opened. The rifle M1917 cannot be recocked without opening the bolt; in case of misfire, wait a full minute before the bolt is opened. When the caliber .30 carbine fails to fire, pull the operating slide to the rear and release the operating rod. If the operating slide goes fully home, aim and fire. To avoid injury in case of hangfire, hold the hand so that no part of the palm or wrist can be struck by the operating slide in its rapid rearward movement.

b. Before firing, be sure that the bore of the weapon is free of any foreign matter such as cleaning patches, mud, sand, snow, etc. Firing a weapon with any obstruction in the bore will result in damage to the weapon and may result in injury to the firer.

c. No small-arms ammunition will be fired until it has been identified positively by ammunition lot number and grade, as published in the latest revision of WD SB 9-AMM 4.

d. For precautions in firing blank ammunition, see TM 9-1990.

e. Any serious malfunction of ammunition must be reported promptly to the ordnance officer under whose supervision the material is maintained and issued. As provided in AR 750-10, the ordnance officer will report such malfunction to the Chief of Ordnance. It is important, therefore, that all evidence be preserved. This includes the cartridge case, other cartridges from the same box, the weapon concerned, and all recoverable pieces—in short, everything that might determine the cause of the malfunction.

### 80. PACKING AND MARKING.

a. **Packing.** Dependent on its intended use, small-arms ammunition is packed in link and web belts, clips, or cartons (figs. 38



Classes of Ammunition

BOX AS RECEIVED

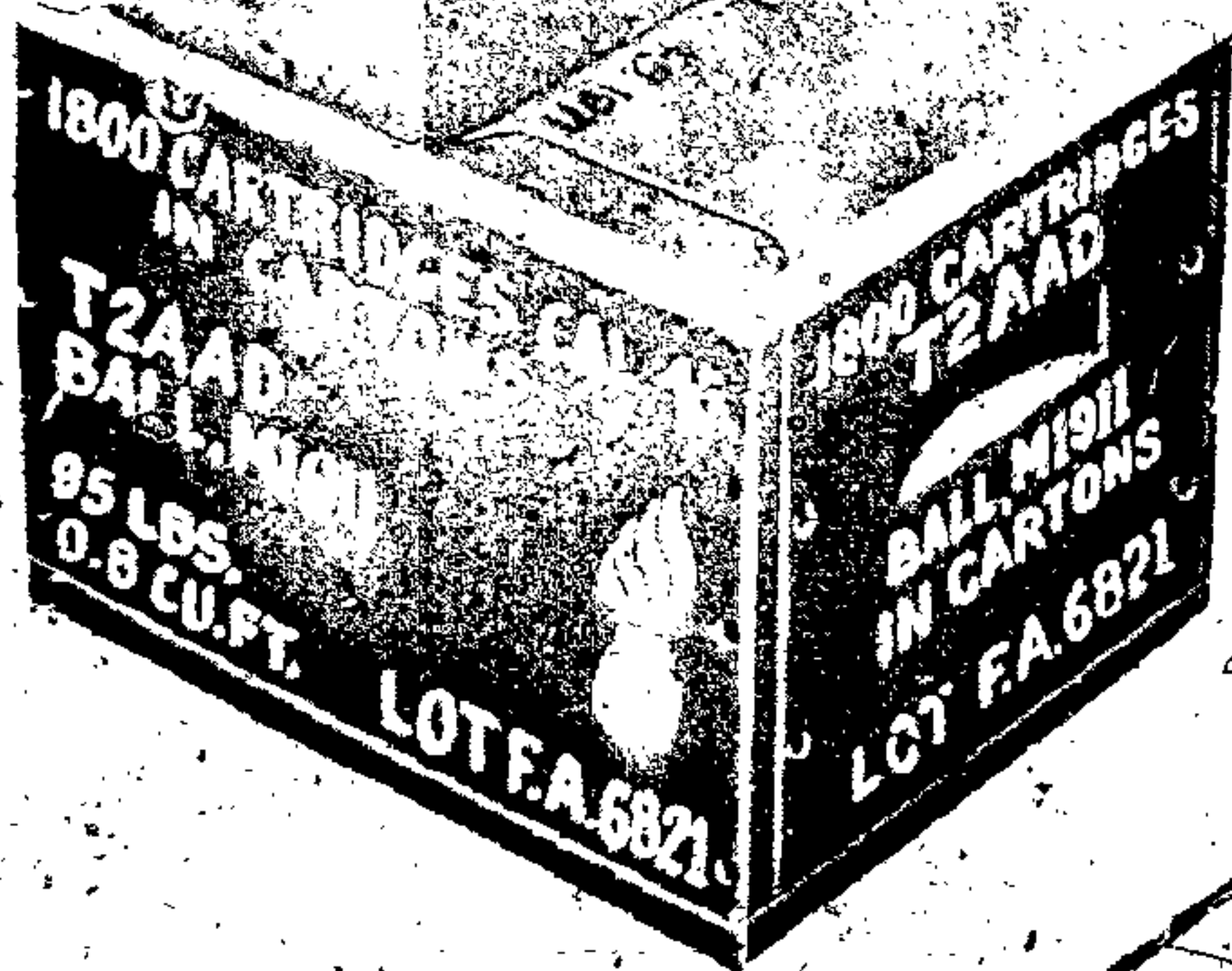

BOX WITH COVER REMOVED SHOWING WAXED CONTAINERS

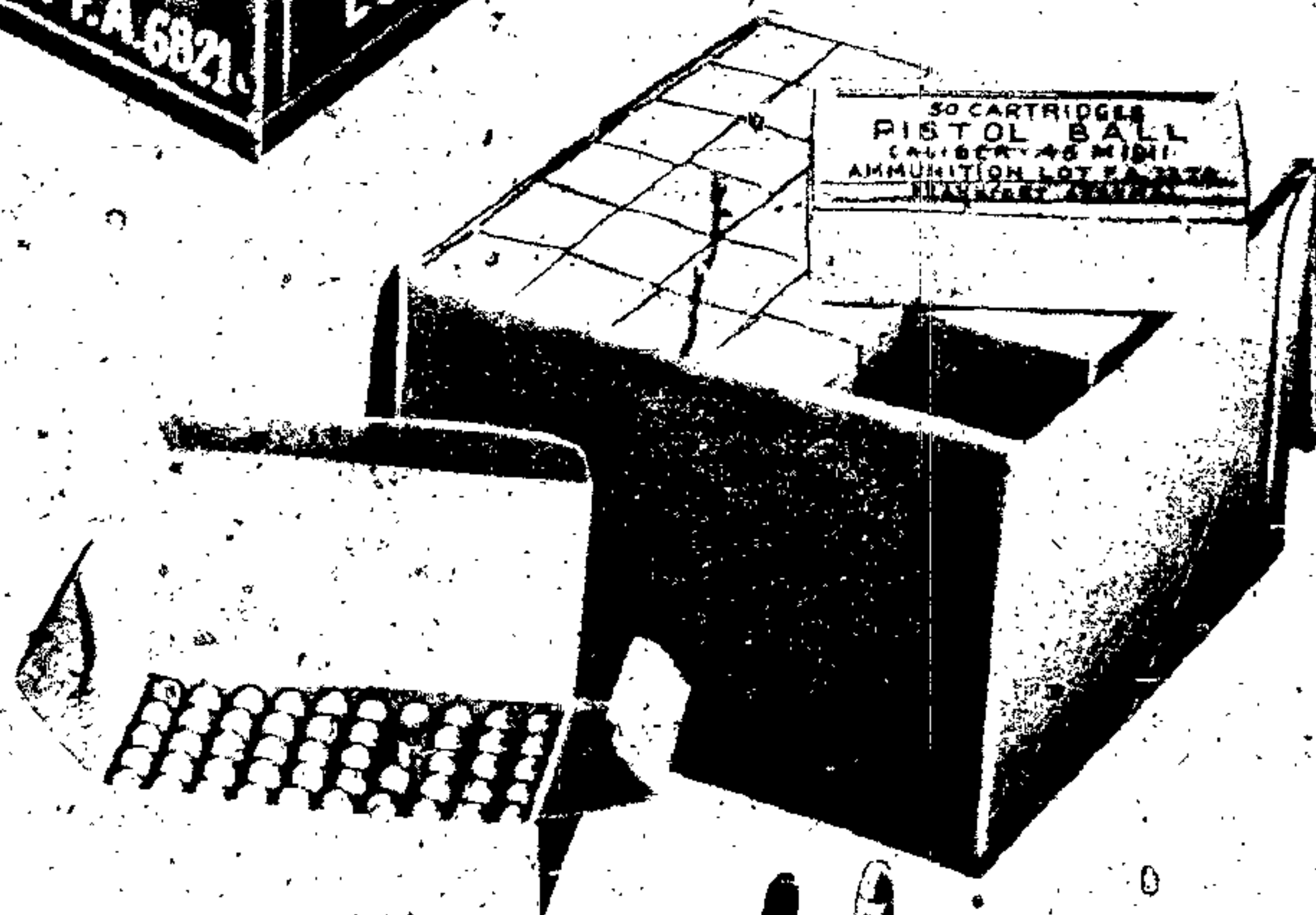

WAXED CONTAINER OPENED SHOWING CARTONS AND CONTENTS

RA PD 64466A

Figure 38 — Boxes Containing Carton-packed Ammunition in Waxed Containers

Classes of Ammunition



Figure 39 - Boxes Containing Carton-packed Ammunition in Metal Cans



Classes of Ammunition

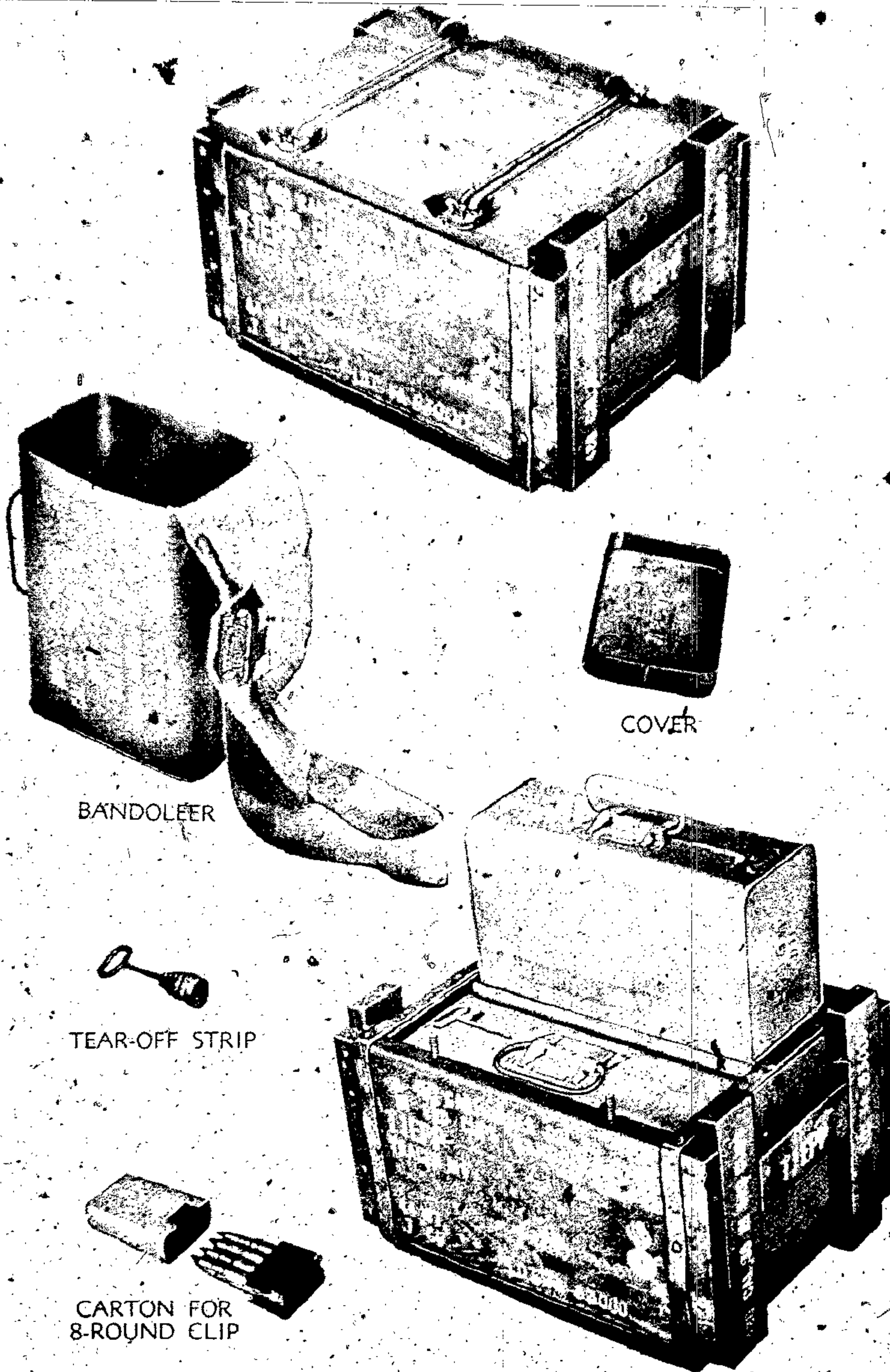

RA PD 97725

Figure 40 — Boxes Containing 8-round Clipped Ammunition in Bandoleers in Metal Cans

Classes of Ammunition



8-RD. CLIPPED

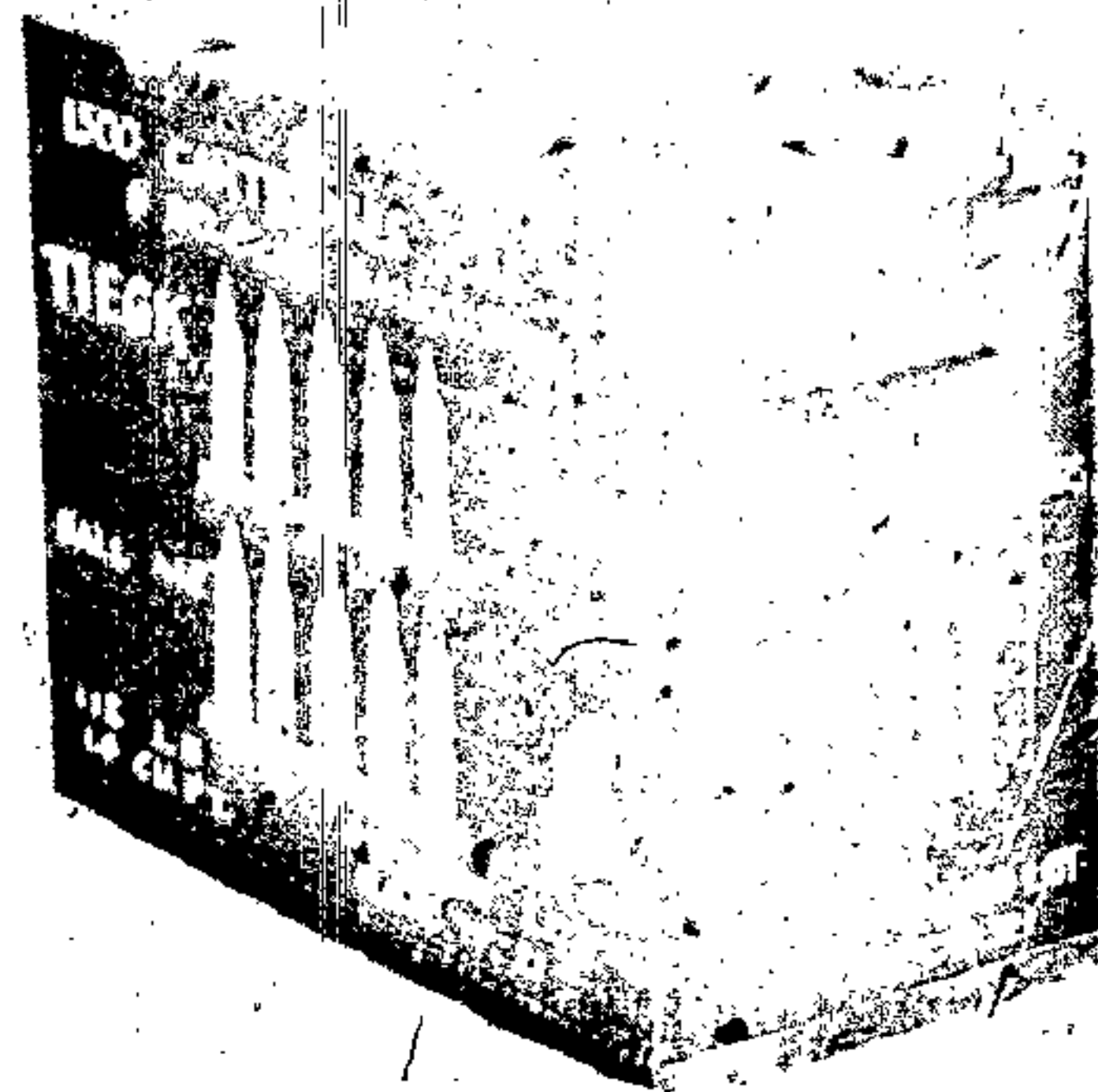

5-RD. CLIPPED

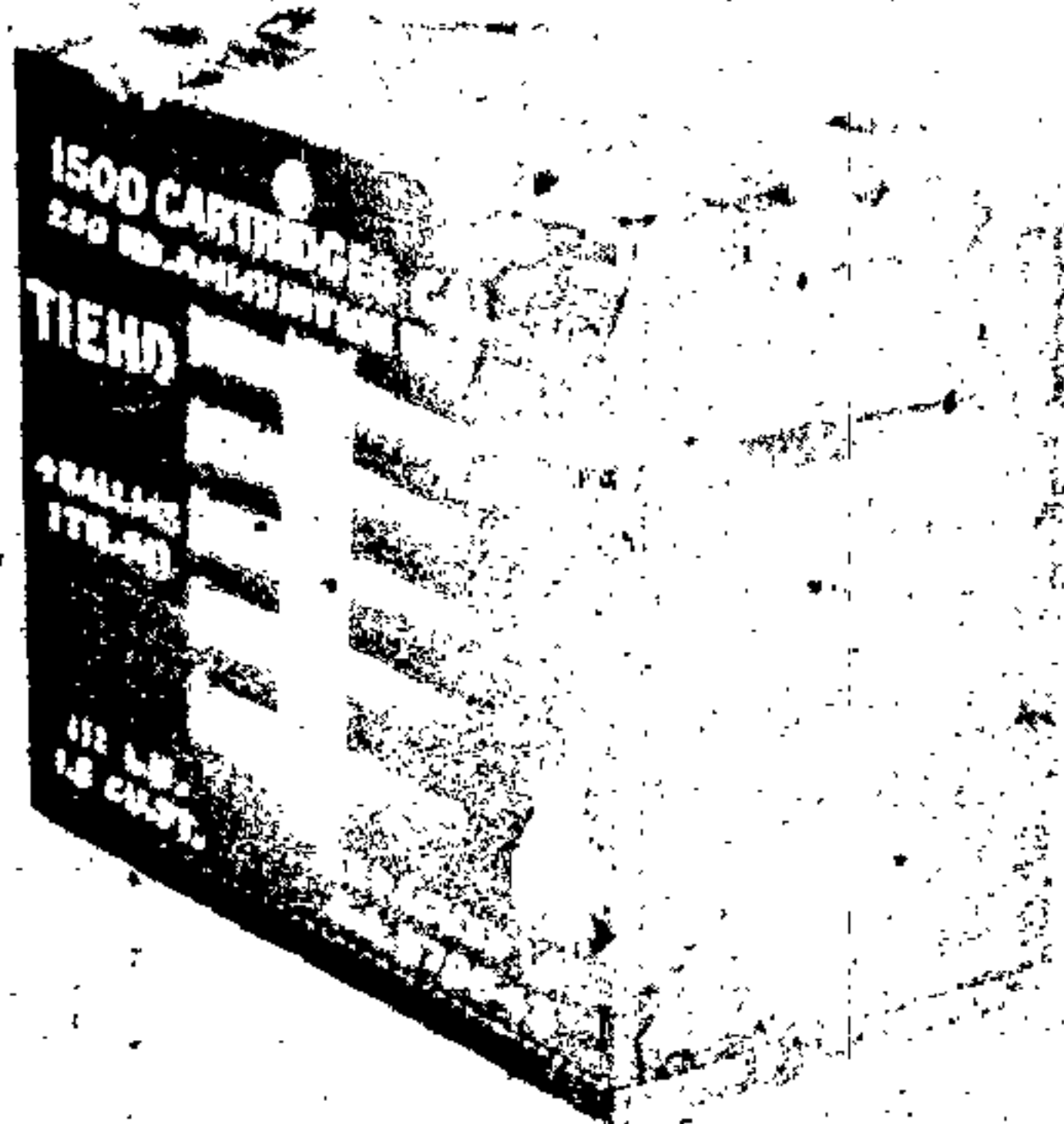

CAL. 30 BELTED

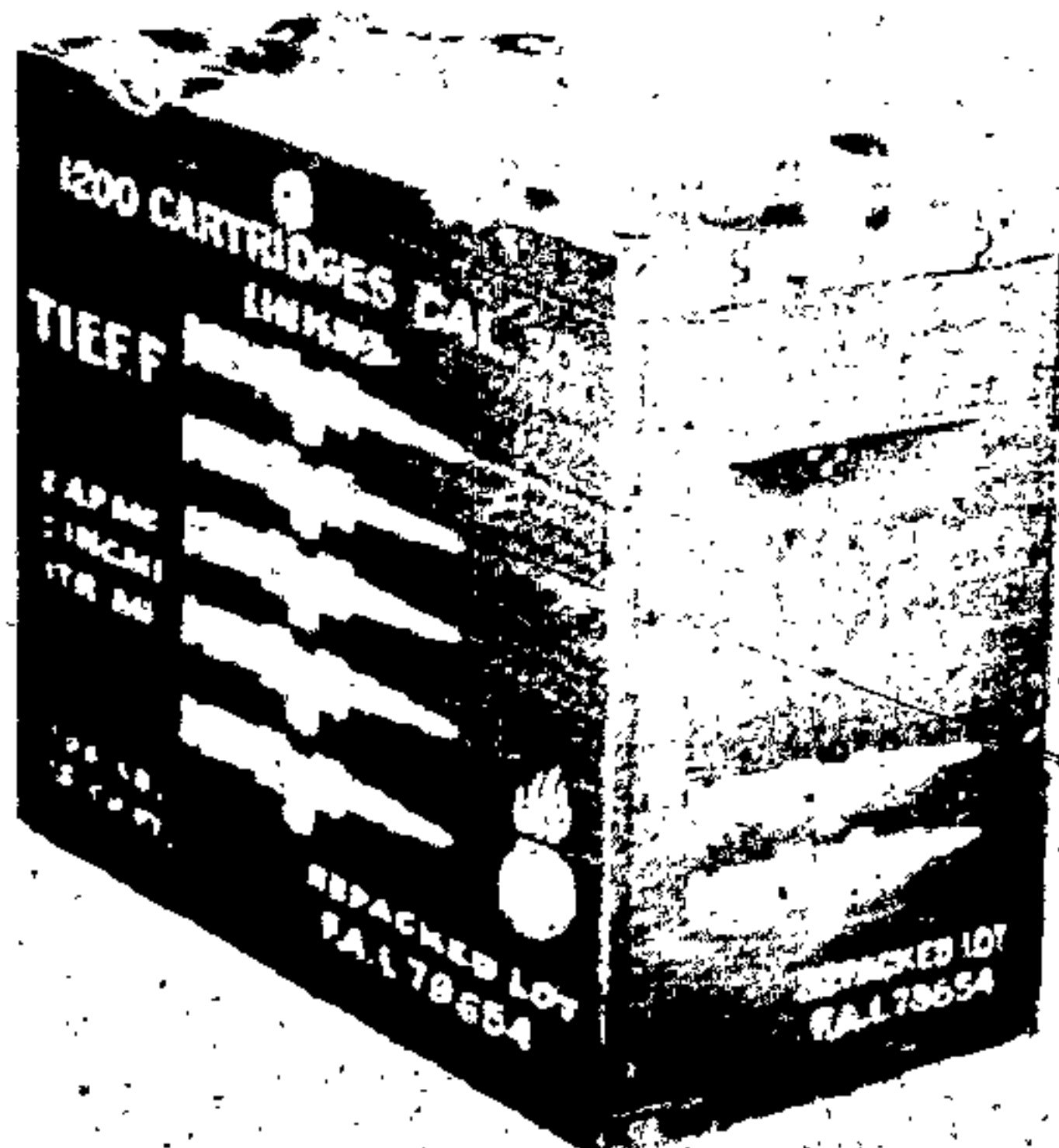

CAL. 30 LINKED

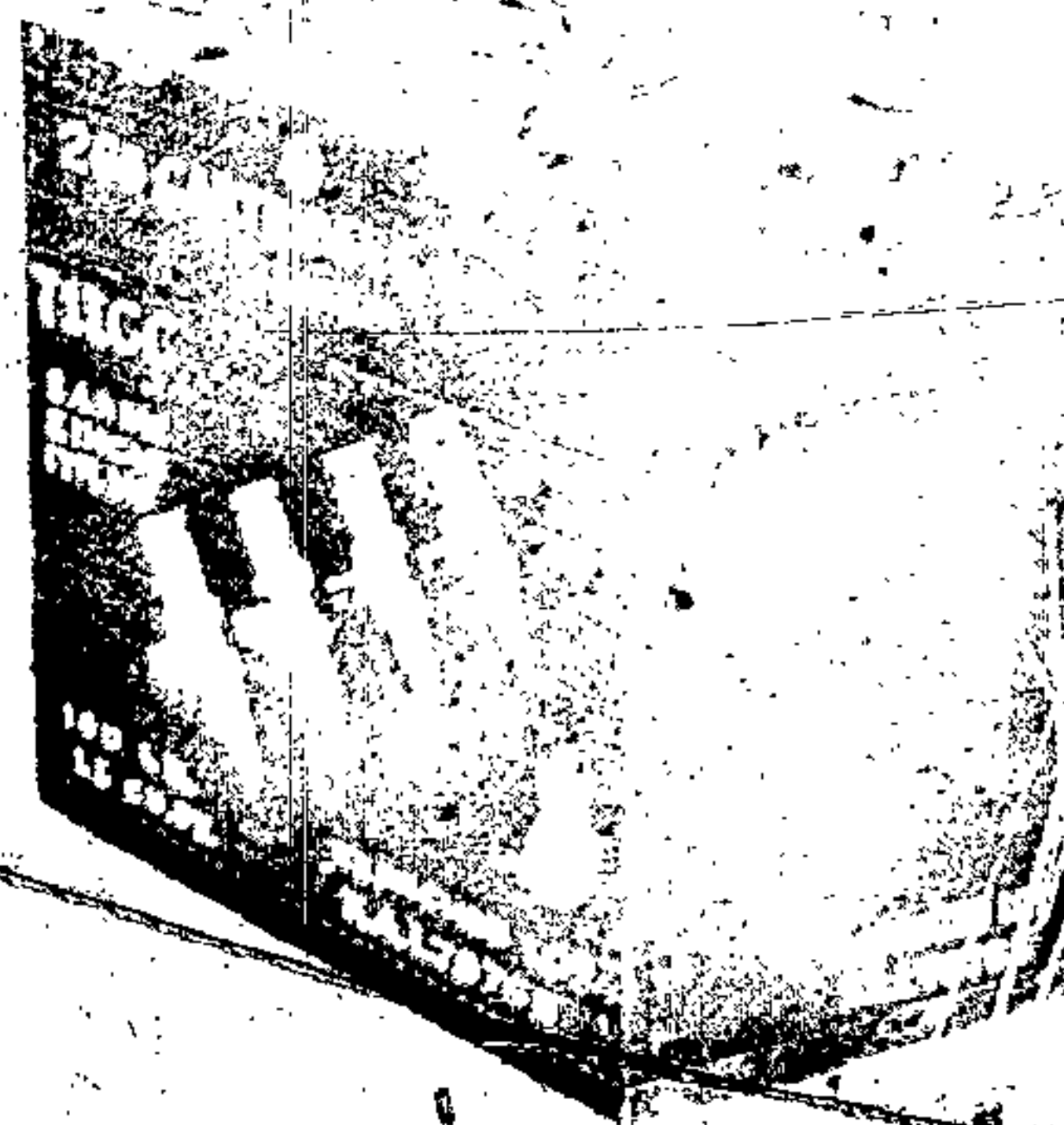

CAL. 50 LINKED

RA PD. 15193P

Figure 41 - Packing Symbols on Small-arms Ammunition Boxes



*Classes of Ammunition*

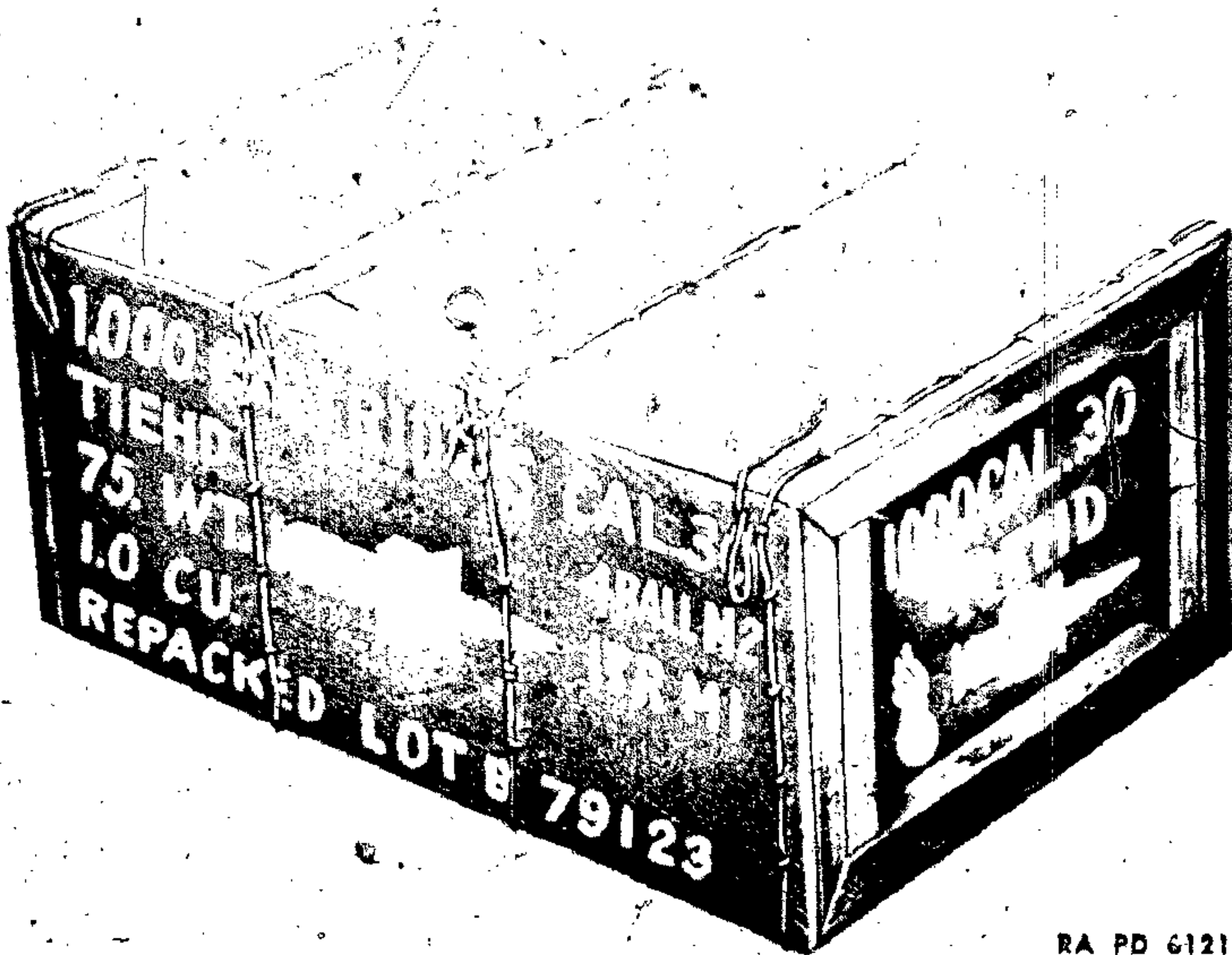

RA PD 61210B

**Figure 42 — Wire-bound Crate for Four Ammunition Boxes, Cal. .30, M1**

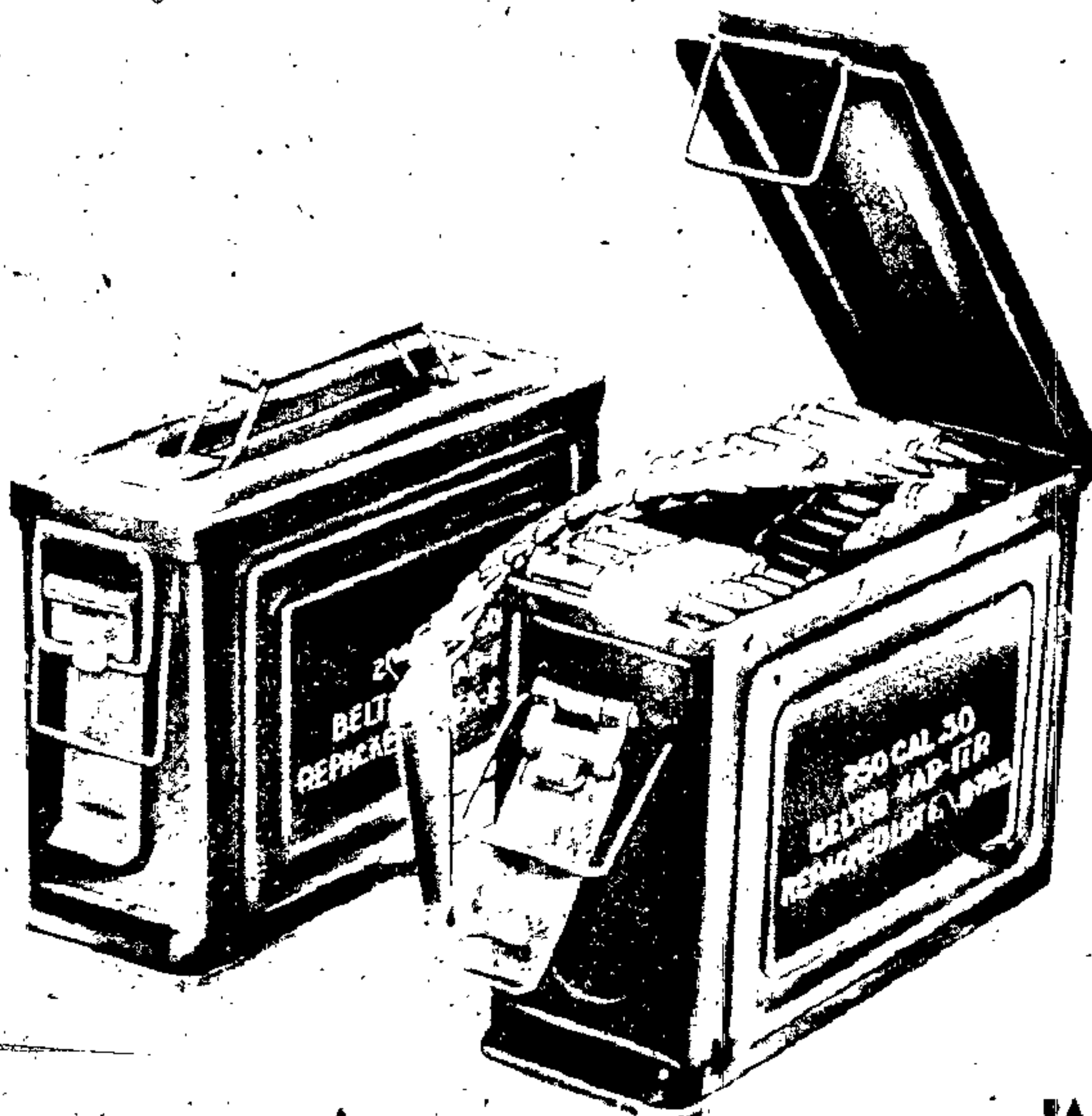

RA PD 68319B

**Figure 43 — Ammunition Box, Cal. .30, M1 (Steel)**

## Classes of Ammunition

through 43). For example, ammunition intended for use in the rifle M1 is packed in 8-round clips. For a detailed description of packing, see ORD 11 SNL's of the T group.

**b. Marking.**

(1) Small-arms packing boxes may be either stained brown with marking in yellow, or unstained with marking in black. Markings for shipment are covered in chapter 3, section IV, and in TM 9-1990.

(2) Instead of the lot number, a repacked lot number may be stenciled on packing boxes containing web belts and metallic link belts; the serial number of the repacked lot number is preceded by the letter "B" for belted ammunition, and "L" for linked cartridges.

(3) To provide a further means of quickly identifying type of packing, stenciled figure silhouettes are used on boxes and crates containing clipped, belted, and linked cartridges. These symbols indicate whether the ammunition is packed in rifle clips, web belts, or linked belts. The silhouettes are vertical for caliber .30 cartridges, and diagonal for caliber .50 cartridges (fig. 41). The absence of stenciled figure silhouettes on boxes indicates carton-packed ammunition (figs. 38 and 39).

(4) The expendable metal ammunition boxes are painted olive drab with marking in yellow (fig. 43).

## Section II

## GRENADES

## 81. GENERAL DESCRIPTION.

**a. Definition.** Grenades are small explosive or chemical missiles intended for use against an enemy at relatively short ranges.

**b. Basic types.** There are two basic types of grenades—those intended to be thrown by hand (figs. 42 and 44) and those intended to be projected from rifles or carbines equipped with suitable grenade launchers (figs. 12 and 45). By attaching a suitable adapter, some of the hand grenades may also be fired from rifles and carbines (figs. 46 and 47). Hand grenades provide the soldier with an auxiliary weapon, similar to a shell or bomb, to supplement his basic weapons. Rifle grenades are valuable not only for specialized use, such as against tanks, but also for covering the ranges between the maximum for hand grenades and the minimum for mortar shells. Special blank cartridges (fig. 35), packed with the rifle grenades, may be used in the weapon for projecting these grenades.

**c. General types.** Both hand and rifle grenades can be classified into three general types, namely: explosive, chemical, and practice or training.



Classes of Ammunition

(1) Explosive grenades are used primarily for antipersonnel (fragmentation or blast) or antitank effect. They may also be used as demolition agents.

(2) Chemical grenades are used for casualty, harassing, incendiary, screening, and signaling purposes. Some of them may also be used for training purposes and destruction.

(3) Practice and training grenades are used in training troops for combat.

d. Fuzing. Grenades thrown by hand are normally fitted with a delay-action fuze. For explosive hand grenades and the chemical M15 (hurting type) WP smoke hand grenade, this delay is set for approximately 4.5 seconds. Burning-type chemical hand grenades use a fuze with a delay of approximately 2 seconds. Rifle grenades are usually fitted with a base fuze that functions on impact.

82. EXPLOSIVE HAND GRENADES.

a. Fragmentation type. The Mk 2 is a typical fragmentation hand grenade (fig. 11 and A, fig. 44). This grenade is made of cast iron varying in thickness from  $\frac{1}{8}$  to  $\frac{1}{4}$  inch. The body is lemon-shaped, approximately  $2\frac{1}{4}$  inches in diameter and  $3\frac{1}{2}$  inches in length without the fuze. It contains an explosive charge which, upon detonation, breaks up the body of the grenade and fuze and projects the fragments outwards in all directions at high velocity. The body is grooved both horizontally and vertically. The fuze for this grenade has a primer, a combustible time-delay train, and a detonator. Attached to the fuze body is a safety lever held in place against the action of the striker spring by means of a safety pin. Just prior to throwing, the safety pin is removed. When the grenade is thrown, the safety lever is pushed off by the striker, allowing the striker to impact against the primer. The primer ignites the time-delay train and, after 4 or 5 seconds, this delay train causes the detonator to explode. This, in turn, causes the explosive filler in the grenade to detonate, thereby fragmenting the grenade. Fragments may fly over 200 yards.

b. Offensive type. The offensive grenade (fig. 11 and C, fig. 44) is intended to have an antipersonnel effect over a small area. It contains more explosive than the fragmentation-type grenade, approximately  $\frac{1}{2}$  pound of pressed TNT, and, therefore, is more useful as a demolition agent. No fragmentation effect is obtained.

83. CHEMICAL HAND GRENADES.

a. Burning type. The standard container for this type of grenade (fig. 11 and D, fig. 44) is a cylindrical steel can  $2\frac{3}{8}$  inches in diameter and  $4\frac{1}{4}$  inches high. The fuze for these grenades is similar to the fuze used in the Mk-2 fragmentation grenade, except that it

Classes of Ammunition

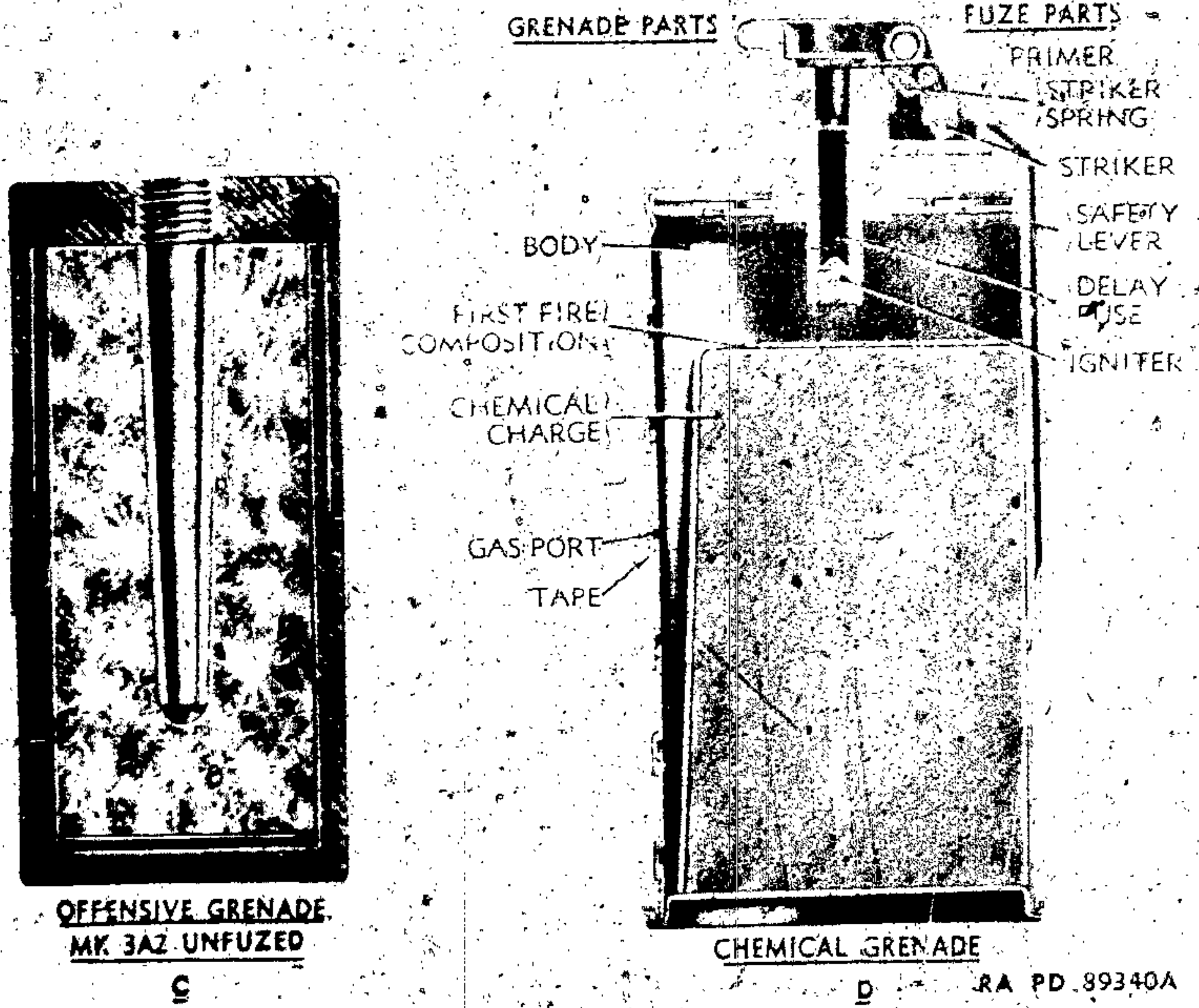
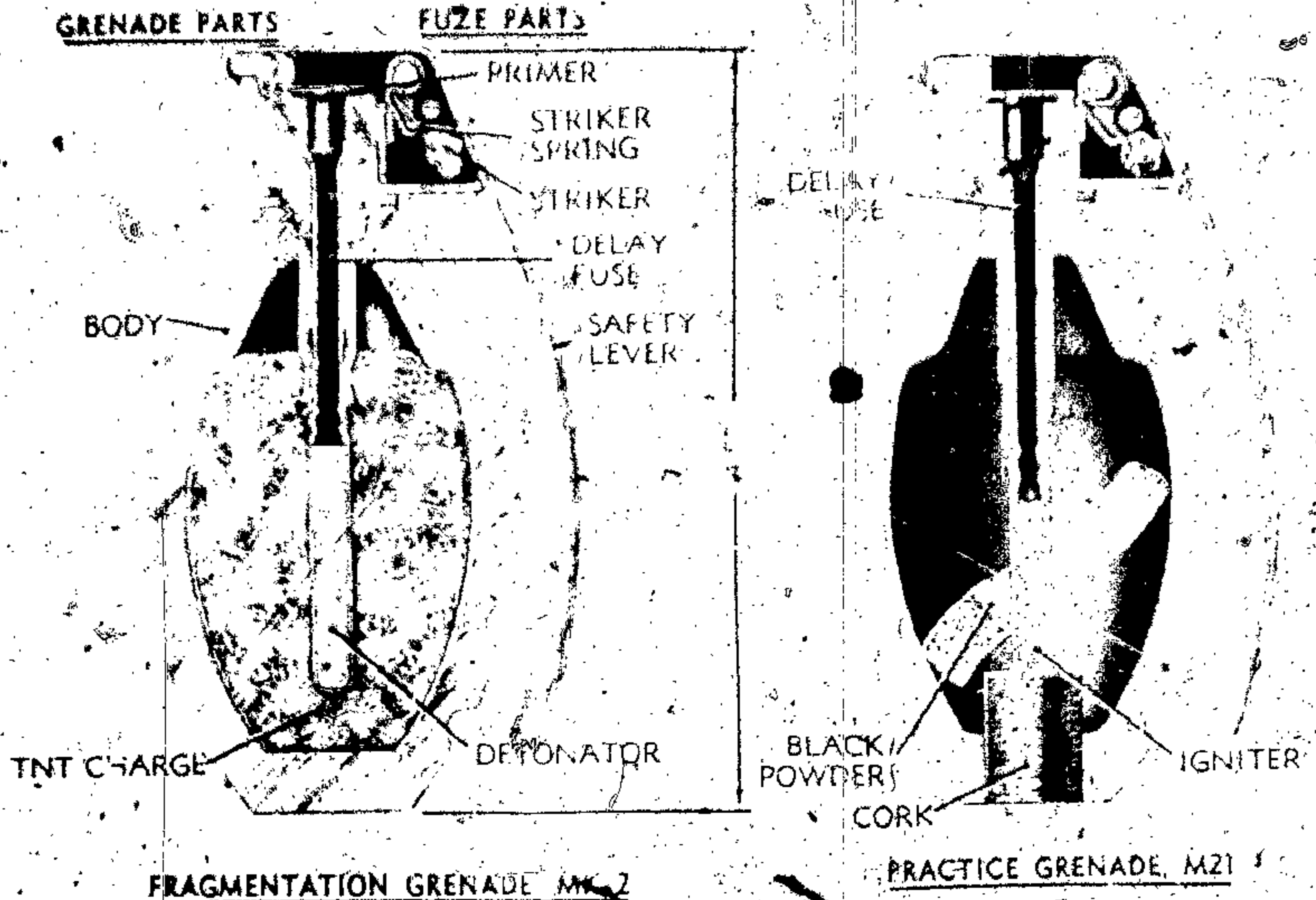

Figure 44 - Hand Grenades - Cross Section



*Classes of Ammunition*

has an igniter instead of a detonator, and has a short delay time of 2 seconds. Grenades of this type have waterproof, adhesive-tape covered, smoke emission holes in the top, sides, or bottom. These grenades are described briefly as follows:

(1) **CN-DM IRRITANT HAND GRENADE.** The products of combustion of the filler in this grenade have a harassing effect. Its principal use is in the control of civil disturbances. The burning time is 20 to 60 seconds. The filler is a composition of tear gas, vomit gas, and smokeless powder.

(2) **CN TEAR HAND GRENADE.** This grenade is identical with the CN-DM grenade except that it has a tear gas filler. Principal uses are in control of civil disturbances, and training in use of the gas mask.

(3) **HC SMOKE GRENADE.** This is an Army-Navy standard white smoke grenade, used for signaling and screening purposes. The container is standard except that there are no emission holes in the side. The burning time is 2 to 2½ minutes.

(4) **TH INCENDIARY GRENADE.** This is an Army-Navy standard munition for setting fire to enemy materiel. The container is standard except that there are no emission holes in the side. Clamps of steel strapping, which fit around the body of the grenade, may be used to nail the grenade against an object to be burned. The filling is thermate, which burns at approximately 4,330° F for 30 to 35 seconds.

(5) **COLORED SMOKE GRENADE M16.** This grenade, used for ground-air and ground-ground signaling purposes is made in the following colors: green, yellow, red, and violet. It is of standard construction and burns for approximately 2 minutes.

(6) **COLORED SMOKE GRENADE M18.** This grenade, available in red, green, yellow, and violet, is also used for signaling purposes. The container has emission holes in the top, and a single hole at the bottom. A tapered hole extends through the center of the grenade from the bottom emission hole to the fuze. The starter mixture lines the tapered cavity. The grenade produces a heavy smoke for approximately 1 minute.

(7) **RED SMOKE GRENADE AN-M3.** This grenade is an Army-Navy air forces official distress signal. It is the standard metal grenade except that the fuze lever is shortened and the body is covered with a metal jacket to which are attached three metal strips which may be bent out from the jacket to keep the grenade from sinking into snow or soft ground. Burning time is 2 to 2½ minutes.

b. **Bursting type.** There is only one standard chemical grenade of this type and it is known as the WP smoke grenade M15. This grenade has a drawn-steel cylindrical body similar in size to the burning-type chemical hand grenades, and is filled with white phos-

Classes of Ammunition

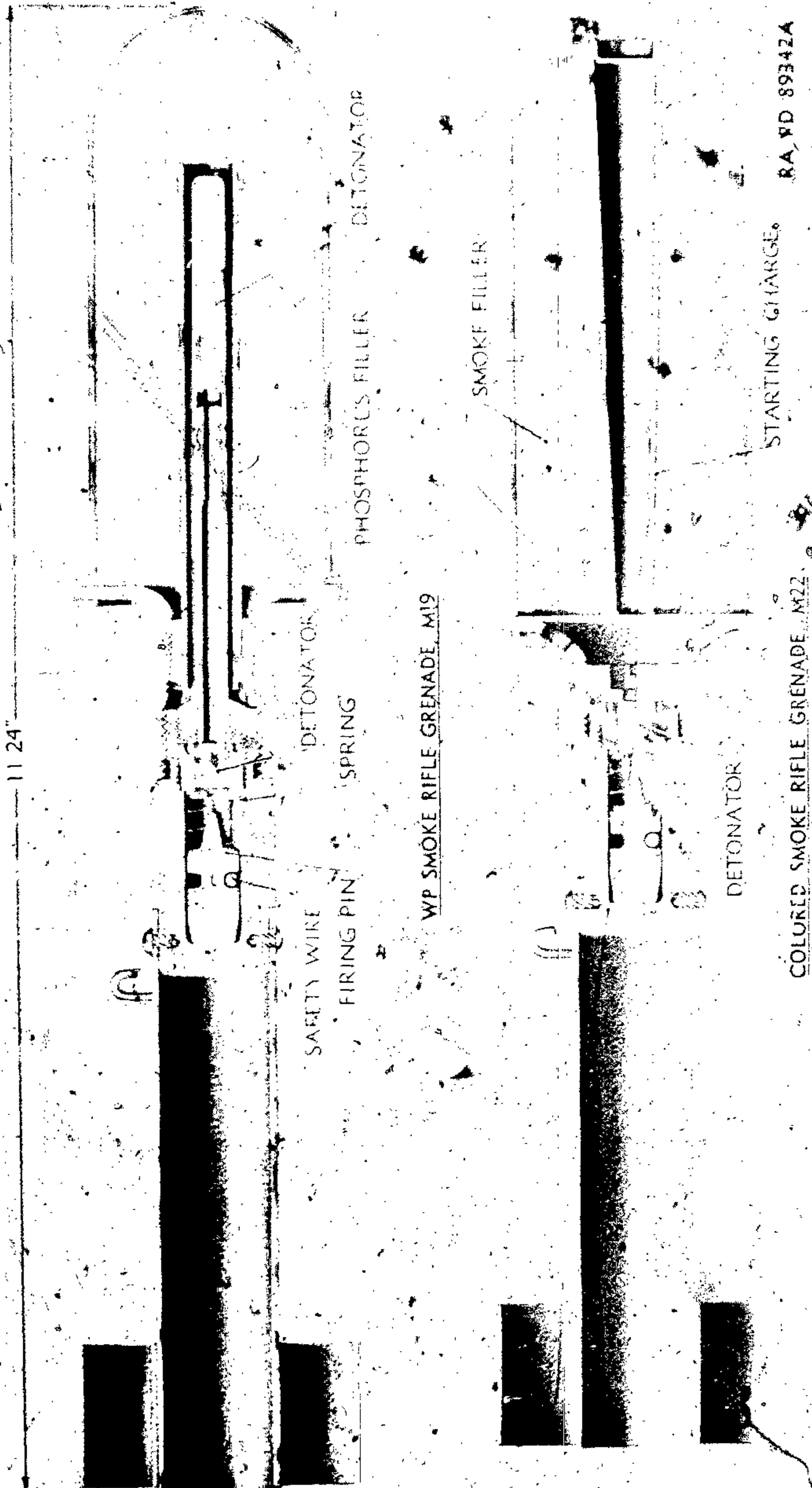

SAFETY WIRE  
 FIRING PIN  
 SPRING  
 DETONATOR  
 PHOSPHORUS FILLER  
 DETONATOR

WP SMOKE RIFLE GRENADE M19

SMOKE FILLER

DETONATOR

STARTING CHARGE

COLORED SMOKE RIFLE GRENADE M22

RA, PD 89342A

Figure 45 - Smoke Rifle Grenades - Cross Section



*Classes of Ammunition*

phorus. The detonating fuze used in this grenade causes it to split open and project burning particles of phosphorus over a radius of about 15 yards. This produces a dense white smoke screen and will cause casualties by burning.

**84. PRACTICE AND TRAINING HAND GRENADES.** This type of grenade (fig. 11 and B, fig. 44) is used in training. They may be inert (training), or loaded with a charge of black powder contained in a cloth tube (practice) - In this case the charge is inserted into the filling hole, which is closed with a cork.

**85. EXPLOSIVE RIFLE GRENADES.** Antitank type: A typical antitank rifle grenade, the M9A1 (fig. 12) consists of a sheet-steel body, cone, and ogive assembly to which is attached a simple base-detonating fuze and a stabilizer and fin assembly. The head of the grenade contains a 4-ounce cast-pentolite, shaped charge for blasting holes in the target. At the same time detonation of the main charge causes fragmentation of the body in a lateral direction. The grenade is intended primarily for use against armored vehicles. It has been found to be most effective against enemy personnel when it is fired at a high angle of elevation (45°).

**86. CHEMICAL RIFLE GRENADES.**

a. **Burning type.** These grenades consist of a deep-drawn, thin-walled steel body with hemispherical ogive and body union assembly to which is attached a simple base fuze and a stabilizer and fin assembly (B, fig. 30). This type of grenade is available with approximately 10<sup>3</sup>/<sub>4</sub> ounces of HC white smoke or 6<sup>1</sup>/<sub>2</sub> ounces of standard colored smoke fillings. Both HC and colored smoke grenades have five sealed smoke emission holes in the body union. The colored smoke grenades also have a smoke emission hole in the ogive. Both of these types of chemical rifle grenades commence burning upon impact, due to the action of the base initiating type of fuze. The HC grenade is intended primarily for screening purposes and the colored smoke grenades for signaling.

b. **Bursting type.** This grenade is the counterpart of the WP smoke hand grenade M15. The WP smoke rifle grenade M19 (A, fig. 45) has a stabilizer and fin assembly identical to that used in the antitank grenade M9A1. It contains approximately 8.5 ounces of white phosphorus and is equipped with a burster actuated by a base-detonating fuze. The spontaneously combustible WP grenade is scattered upon impact.

**87. PRACTICE AND TRAINING RIFLE GRENADE.** There is at present only one standard practice rifle grenade, the M11A3 (fig. 12). This grenade is used only in training and simulates the flight and

Classes of Ammunition

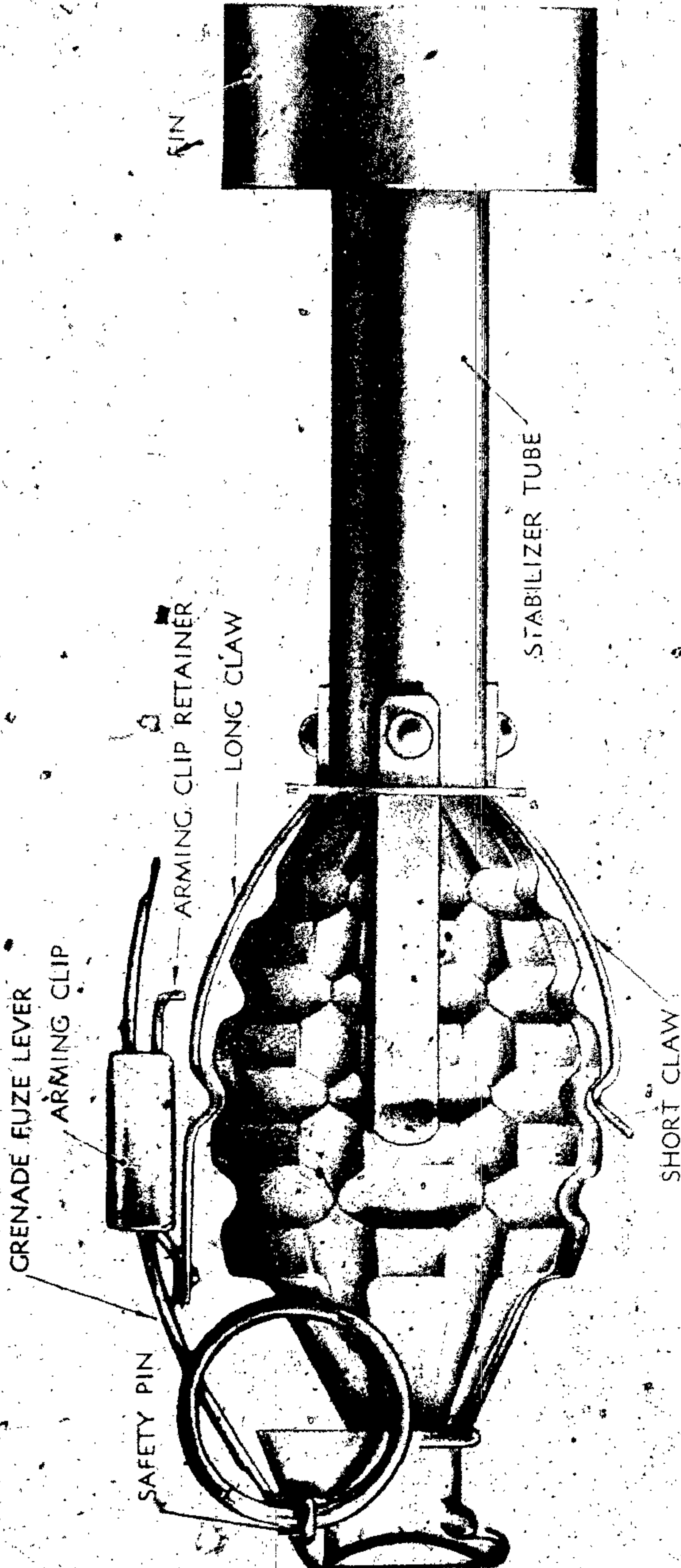

RA PD 68355

Figure 46 — Fragmentation Grenade Projection Adapter M1



Classes of Ammunition

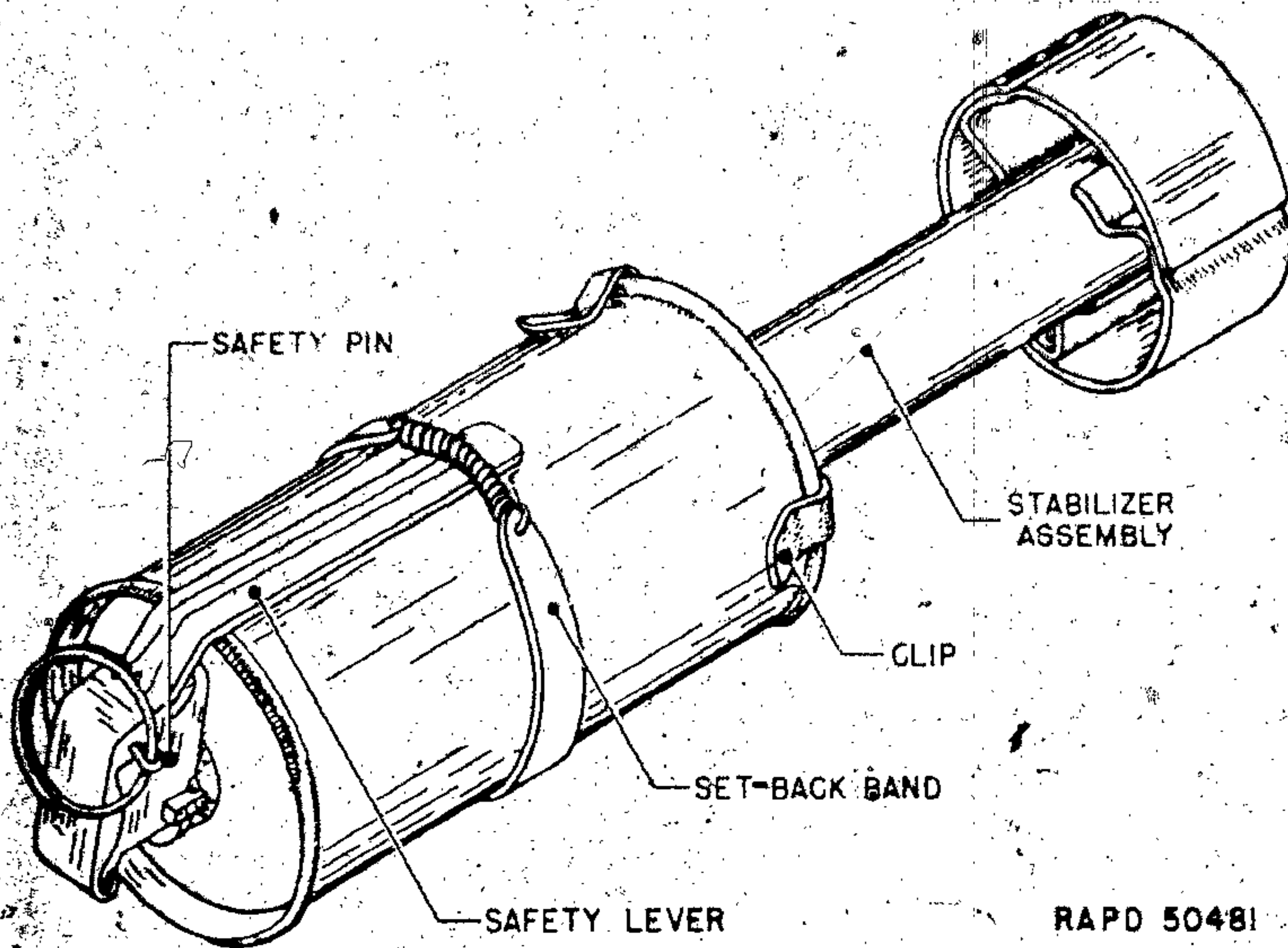

RAPD 50481

Figure 47 - Chemical Grenade Projection Adapter M2

action of the AT grenade M9A1. Being completely inert, this grenade is painted black. For repeated use, it is issued with additional replacement fins and ogives.

**88. GRENADE PROJECTION ADAPTERS:**

a. The grenade projection adapter (fig. 46) assembled to a fragmentation hand grenade Mk 2 permits this hand grenade to be used as a rifle grenade. After removal of the grenade safety pin before firing, the safety lever is held in position by the arming clip. Upon firing the grenade from a launcher-equipped rifle or carbine, the arming clip frees itself from the arming clip retainer, thereby releasing the grenade safety lever and initiating the 5-second fuze. Grenade cartridges are packed in each adapter packing box.

b. The chemical grenade-projection adapter (fig. 47) is intended for use with the chemical hand grenades. It consists of a stabilizer tube, which has a base plate and a three-pronged clip on one end and on the other end, a standard fin similar to that on the grenade M9A1, and a metal setback band which fits around the grenade, over the safety lever. Upon firing the grenade from a launcher-equipped rifle or carbine, the setback band moves to the rear, thereby releasing the grenade safety lever and initiating the 2-second fuze. Grenade cartridges are packed in each adapter cartridge packing box.

Classes of Ammunition

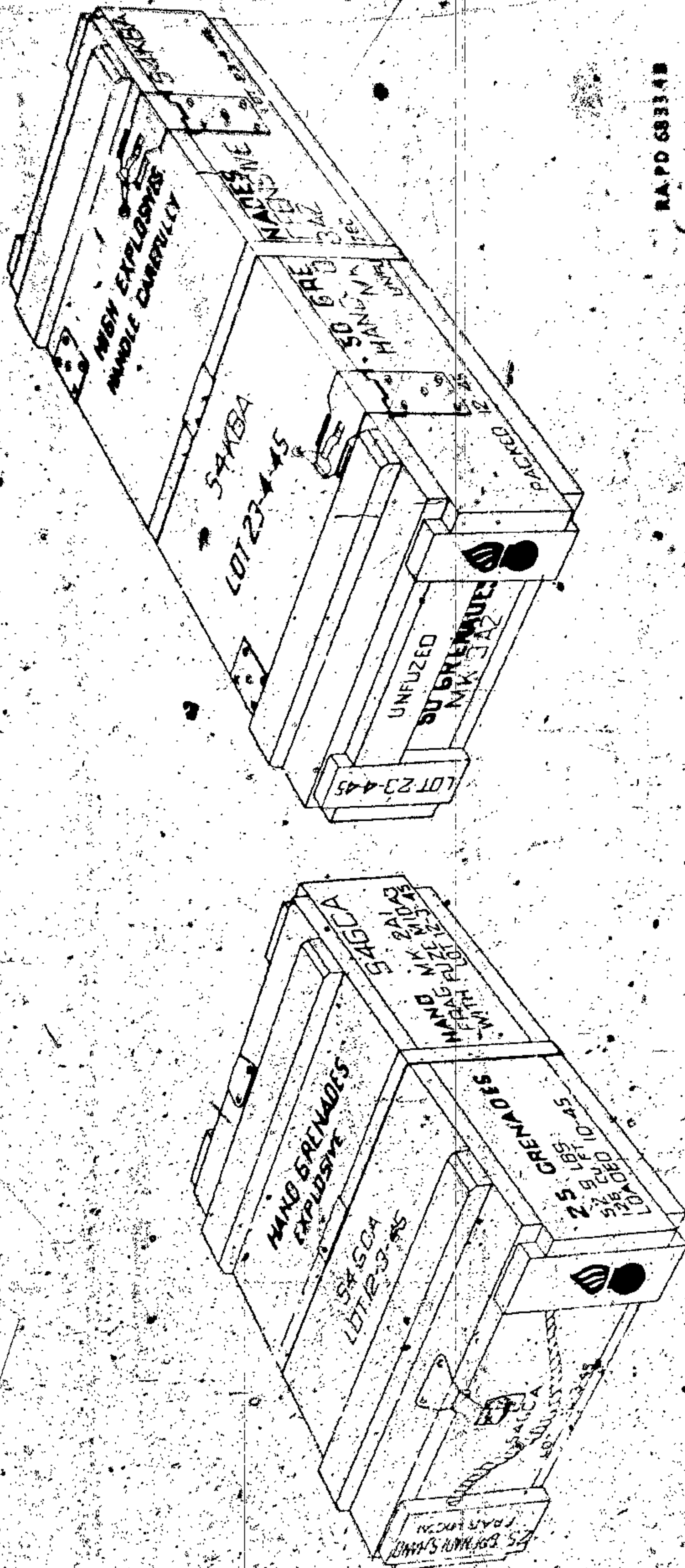

RA PD 6833 AB

Figure 48 - Typical Packing of Hand Grenades



Classes of Ammunition

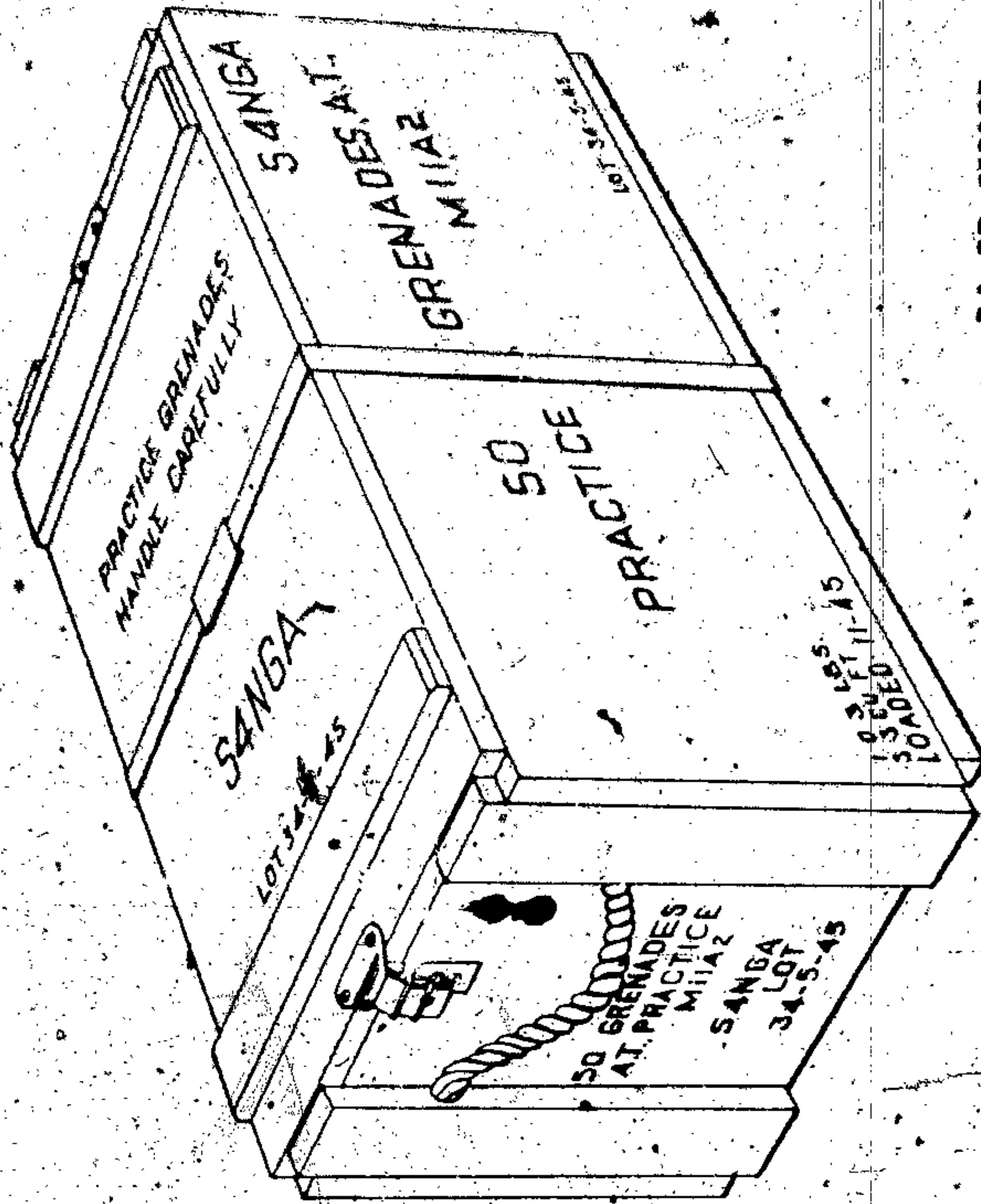

RA PD 68335B

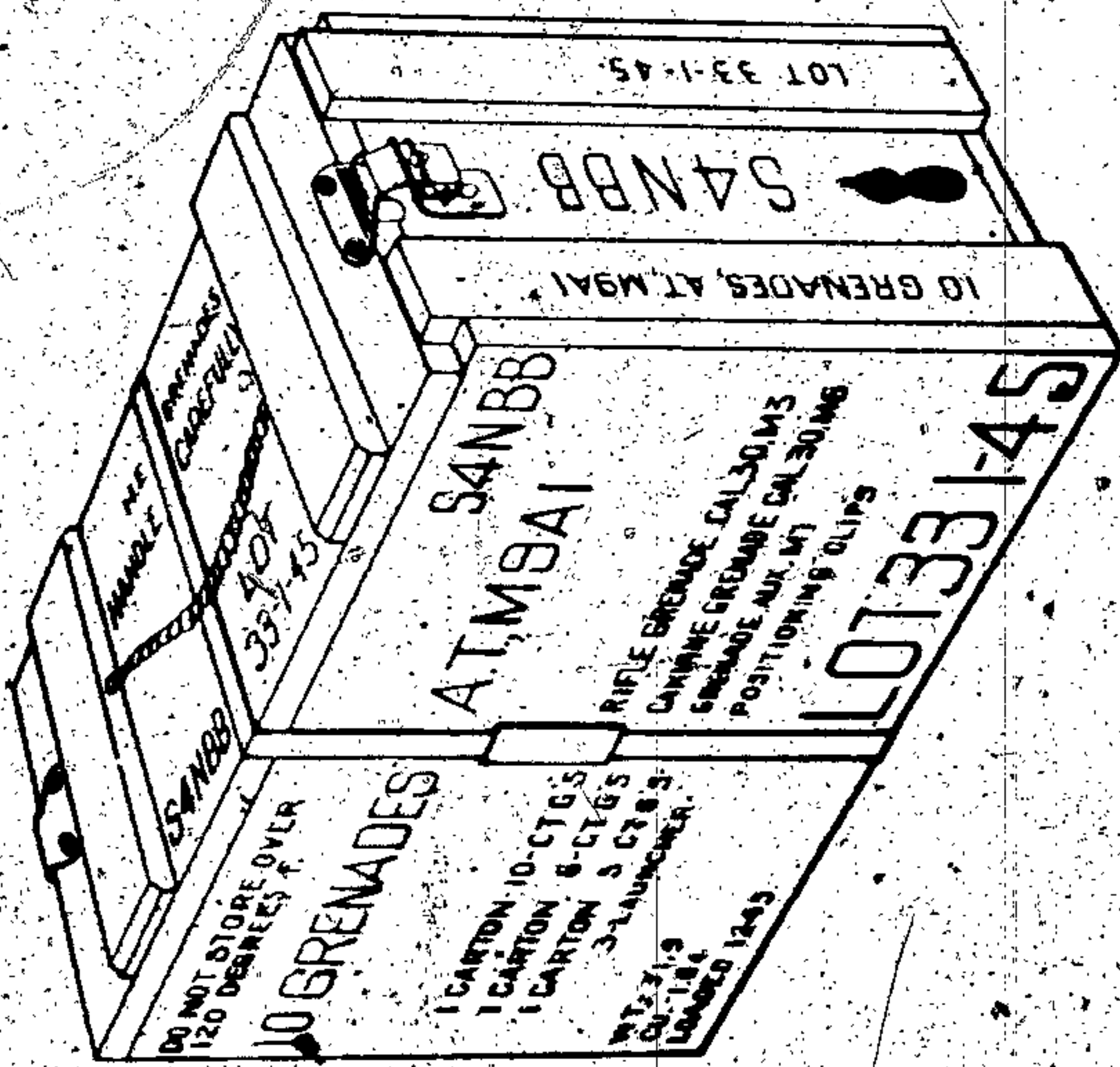

Figure 49 — Typical Packing of Rifle Grenades

---

*Classes of Ammunition*

---

**89. CARE AND PRECAUTIONS IN HANDLING.**

a. **Care.** Information concerning the care to be exercised in handling grenades will be found in chapter 3 of this manual and pertinent Field Manuals.

b. **Precautions.** The following additional safety precautions for handling ammunition will also be observed:

(1) Since fragments may be projected over 200 yards, fragmentation grenades will not be used in training without adequate cover.

(2) The safety pin will be removed just before throwing or launching and at no other time.

(3) Occasionally, chemical grenades may flash. Hence, when used in maneuvers, they will be so thrown as to function not less than 30 feet from personnel.

(4) Duds will be disposed of in accordance with the provisions in chapter 4.

(5) *Rifle grenades must never be launched with a cartridge other than the special grenade cartridges provided for that purpose.*

(6) The fuze furnished with the grenade Mk 2 is noiseless, smokeless, and sparkless. Under no condition, therefore, will the thrower consider the grenade a dud because no noise, smoke, or sparks are observed upon release of the safety lever.

**90. IDENTIFICATION.** High-explosive grenades are painted olive drab with yellow bands around the top of the grenade body. Training hand grenades (inert) are painted black; practice grenades containing a simulated charge are painted blue. Practice rifle grenades are painted black with white stenciling. Chemical grenades are painted blue-gray with identification band and marking in the appropriate color as indicated in chapter 1, section II and in figures 11 and 12. The stabilizer assembly of all rifle grenades is painted olive drab.

**91. PACKING.**

a. Grenades are usually packed as fuzed complete rounds, each in an individual fiber container.

b. Fragmentation grenades are packed 15 or 25 containers per wooden box.

c. The offensive hand grenades are packed 50 per wooden box (fig. 48), and the training grenades are packed 24 per box.

d. The standard packing for rifle grenades is 10 containers per box (fig. 49), with a supply of cartridges for launching from any appropriate weapon. Jungle packing is waterproofed to withstand hot humid climates.

e. Grenade-projection adapters are packed 48 per box, with sufficient number of various grenade cartridges and positioning clips.



**Classes of Ammunition****Section III****MORTAR AMMUNITION****92. DESCRIPTION.**

a. To obtain maximum accuracy and range, projectiles for smooth-bore mortars are stabilized by means of fins assembled to a shaft which is secured to the base end of the projectile; when the fins are omitted, the projectile tends to tumble and be erratic in flight.

b. In general, the ammunition has an adjustable propelling charge, consisting of a number of propellant increments usually sealed in individual cellophane bags, and an ignition cartridge, to permit firing various ranges or zones of fire. The propellant increments are attached to the fin shaft or within the fin blades; the ignition cartridge is inserted in base end of the fin shaft.

c. The primer and ignition cartridge are separate elements. The primer is screwed into the shaft after the ignition cartridge has been inserted. The assembly of the ignition cartridge and the propellant increments make up the required propelling charge; or the ignition cartridges alone may be used for very short range in the 60-mm mortar and with the light-weight round (M43A1) in the 81-mm mortar.

d. Because the complete round (figs. 50 and 51) is loaded into the mortar as a unit and provision is made for adjusting the propelling charge, ammunition of this type comes within the classification of semifixed ammunition.

**93. CLASSIFICATION.**

a. According to the purpose for which it is intended, mortar ammunition is classified as high-explosive, smoke, illuminating, practice, or training.

b. High-explosive mortar shells are used for fragmentation or demolition effect, according to the action of the fuze and design of shell.

c. Smoke shells contain chemical fillers.

d. Illuminating shells are intended for signaling and illuminating purposes.

e. Practice shells may have a spotting charge or may be inert.

f. Training projectiles are provided for training and practice. They are inert and may be fired more than once. Several propelling charges and fins are supplied for each projectile.

Classes of Ammunition

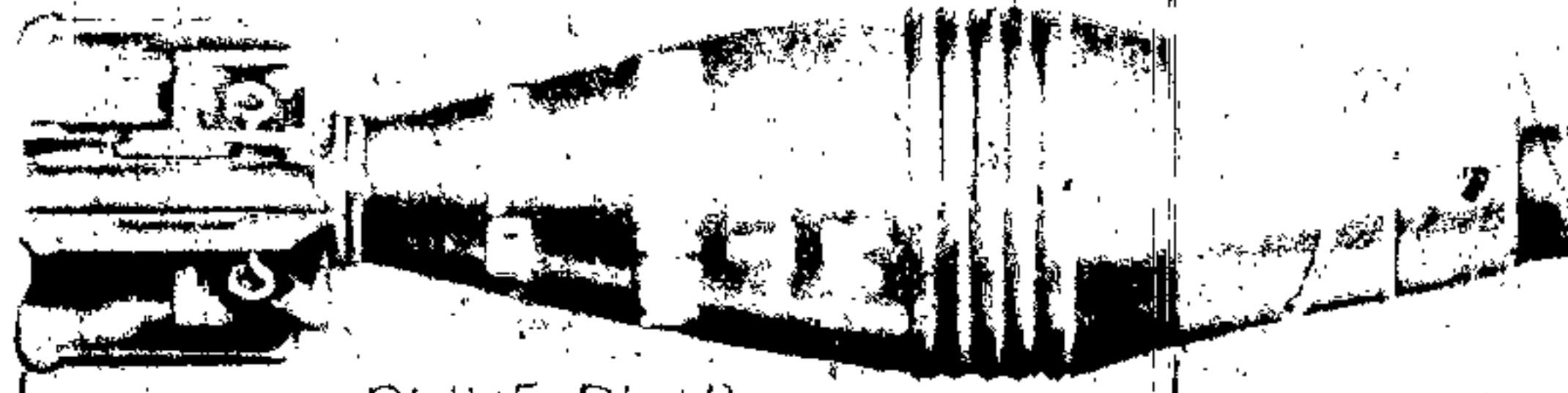

OLIVE DRAB  
(MARKING IN YELLOW)

HE SHELL, M49A2, W PD FUZE, M52



OLIVE DRAB BLUE  
(MARKING IN WHITE)

PRACTICE SHELL M50A2, W PD FUZE, M52



OLIVE DRAB GRAY (MARKING IN YELLOW)

WP SMOKE SHELL, M302, W PD FUZE, M82

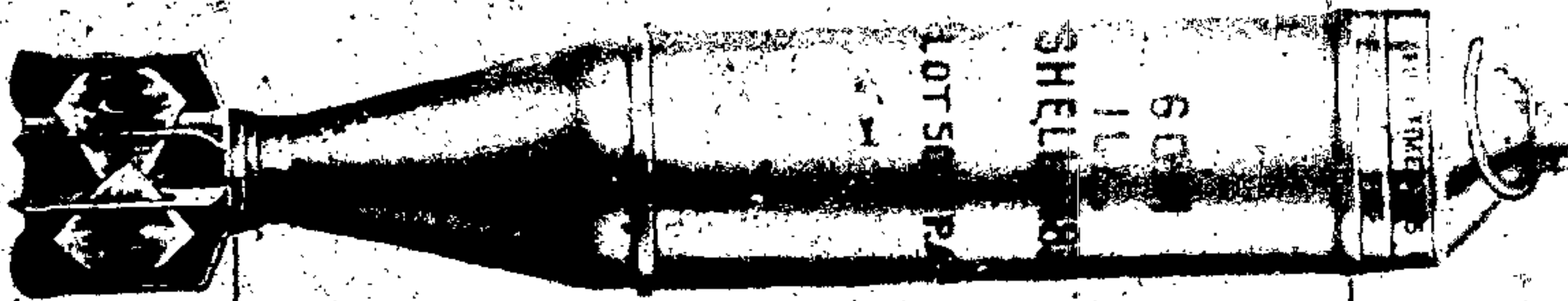

OLIVE DRAB GRAY (MARKING IN BLACK)

14 28 MAX.

ILLUMINATING SHELL, M83A1, W TIME FUZE, M65

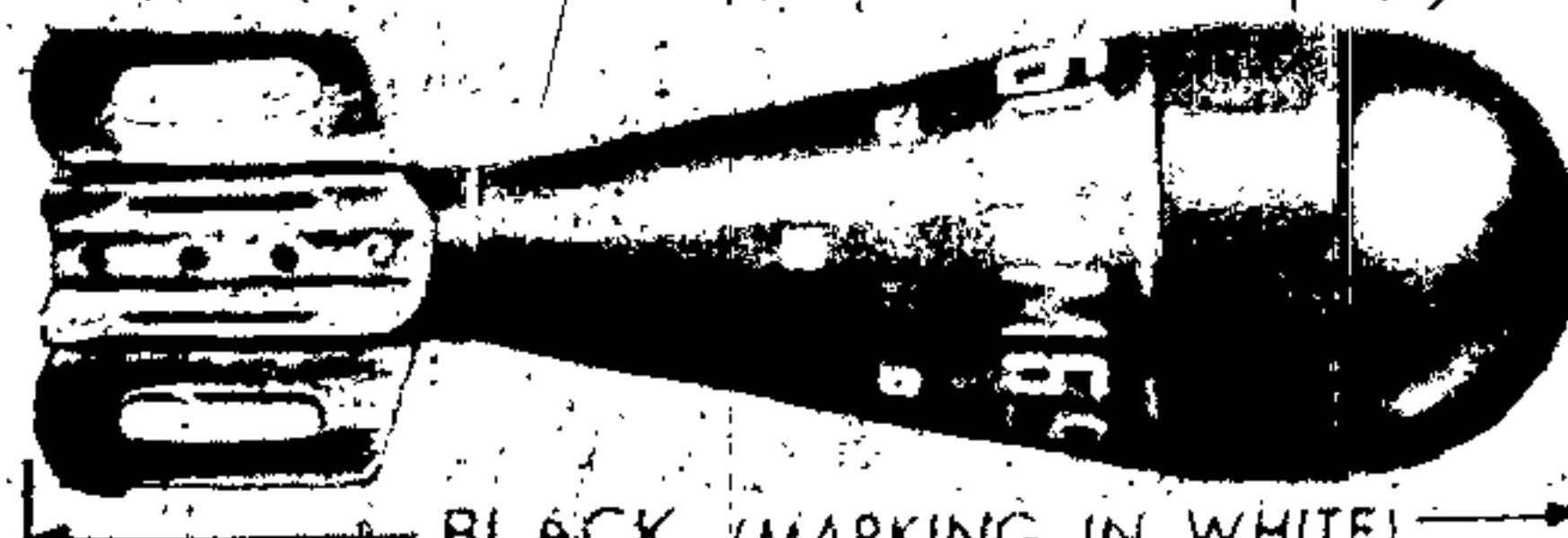

BLACK (MARKING IN WHITE)

TRAINING SHELL, M69

RA PD 64448B

Figure 50 - 60-mm Mortar Ammunition



Classes of Ammunition



TRAINING SHELL, M68

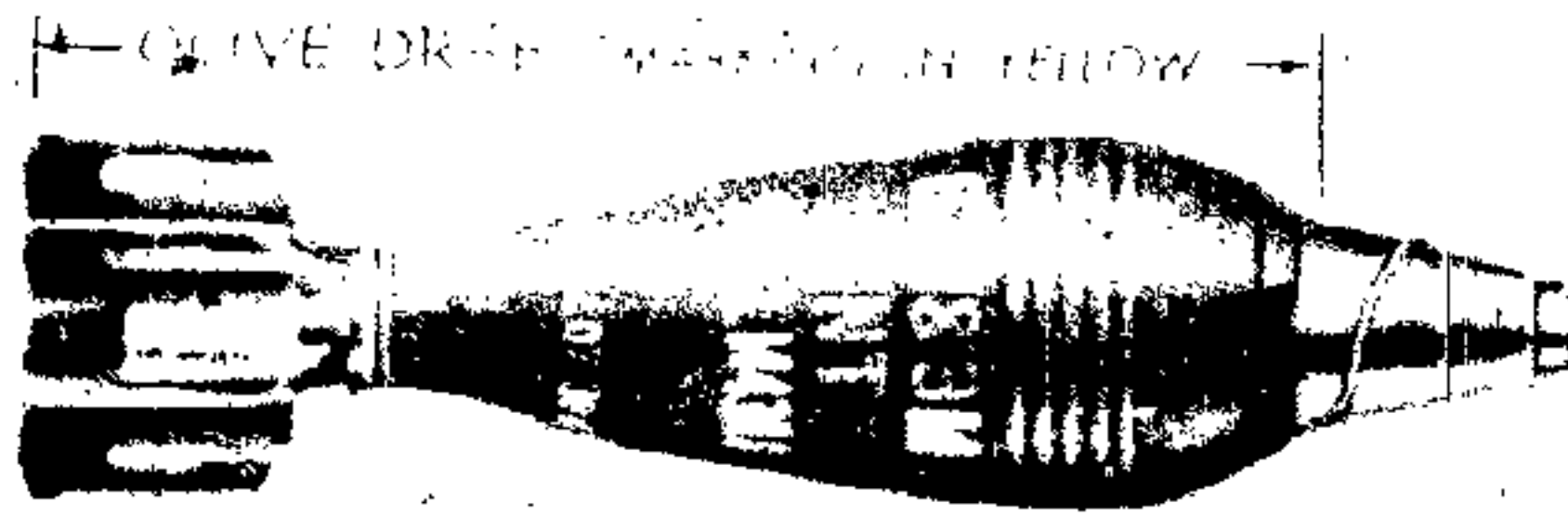

HE SHELL, M3A1, W PD FUZE, M52

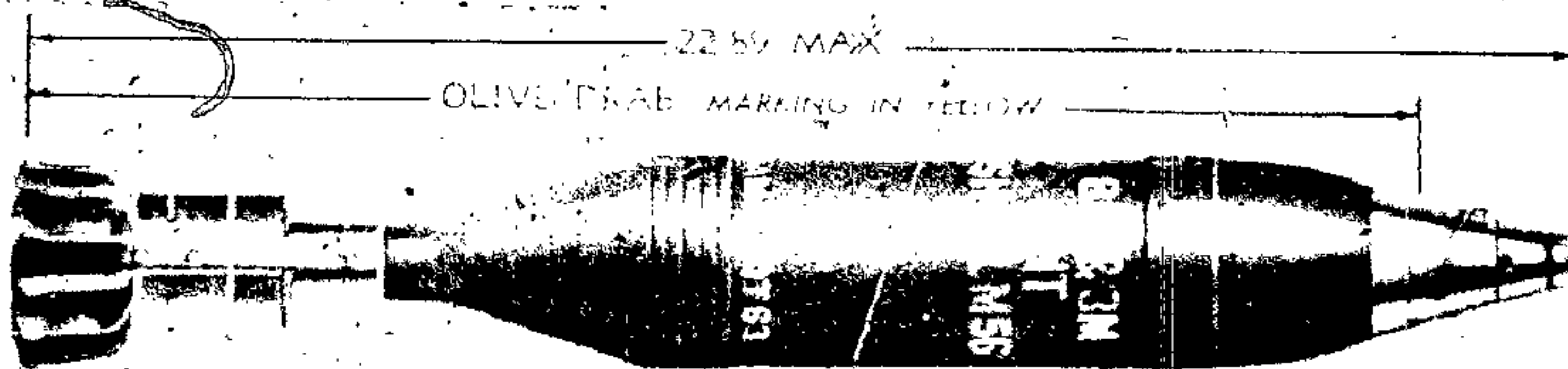

HE SHELL, M56, W PD FUZE, M53A1

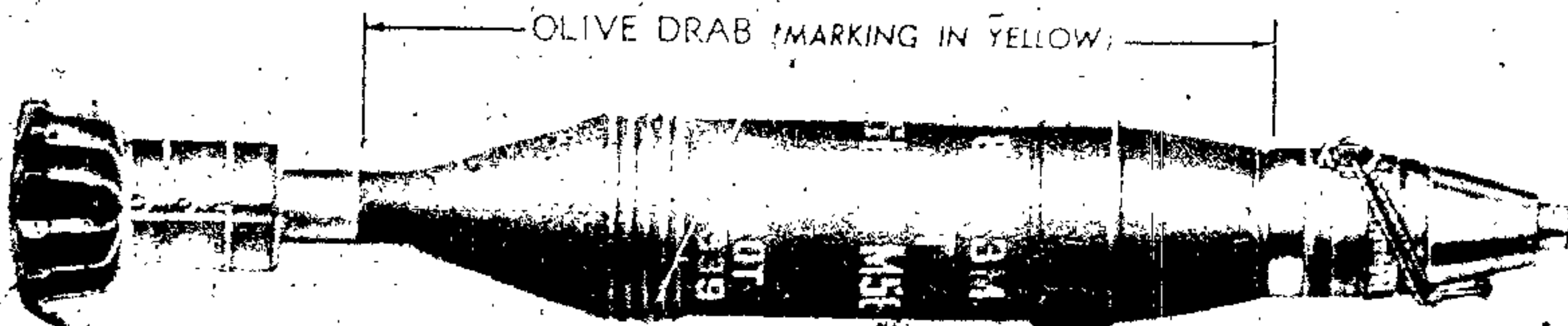

HE SHELL, M56, W, TSQ FUZE, M77



WP SMOKE SHELL, M57, W PD FUZE, M52

RA PD 6449A

Figure 51 — 81-mm Mortar Ammunition

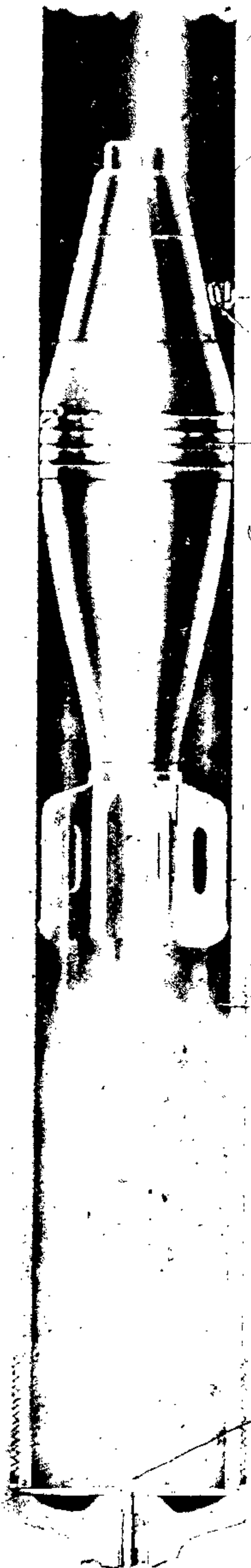

PROPELLENT GASES

FIRING PIN OF MORTAR

RA RD 65179A

Figure 52 - 60-mm Mortar Shell Being Fired



Classes of Ammunition

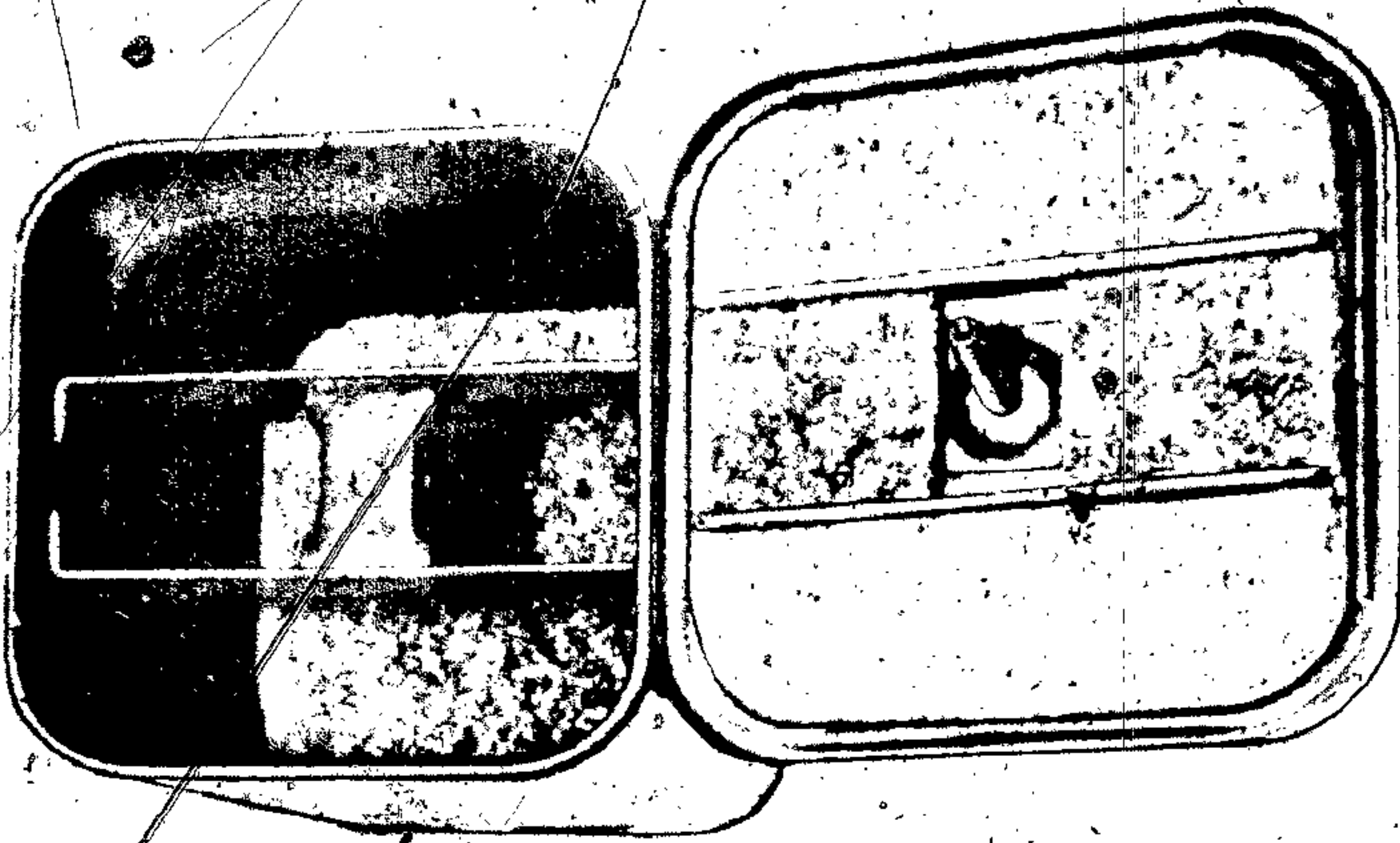

RA PD 97687A

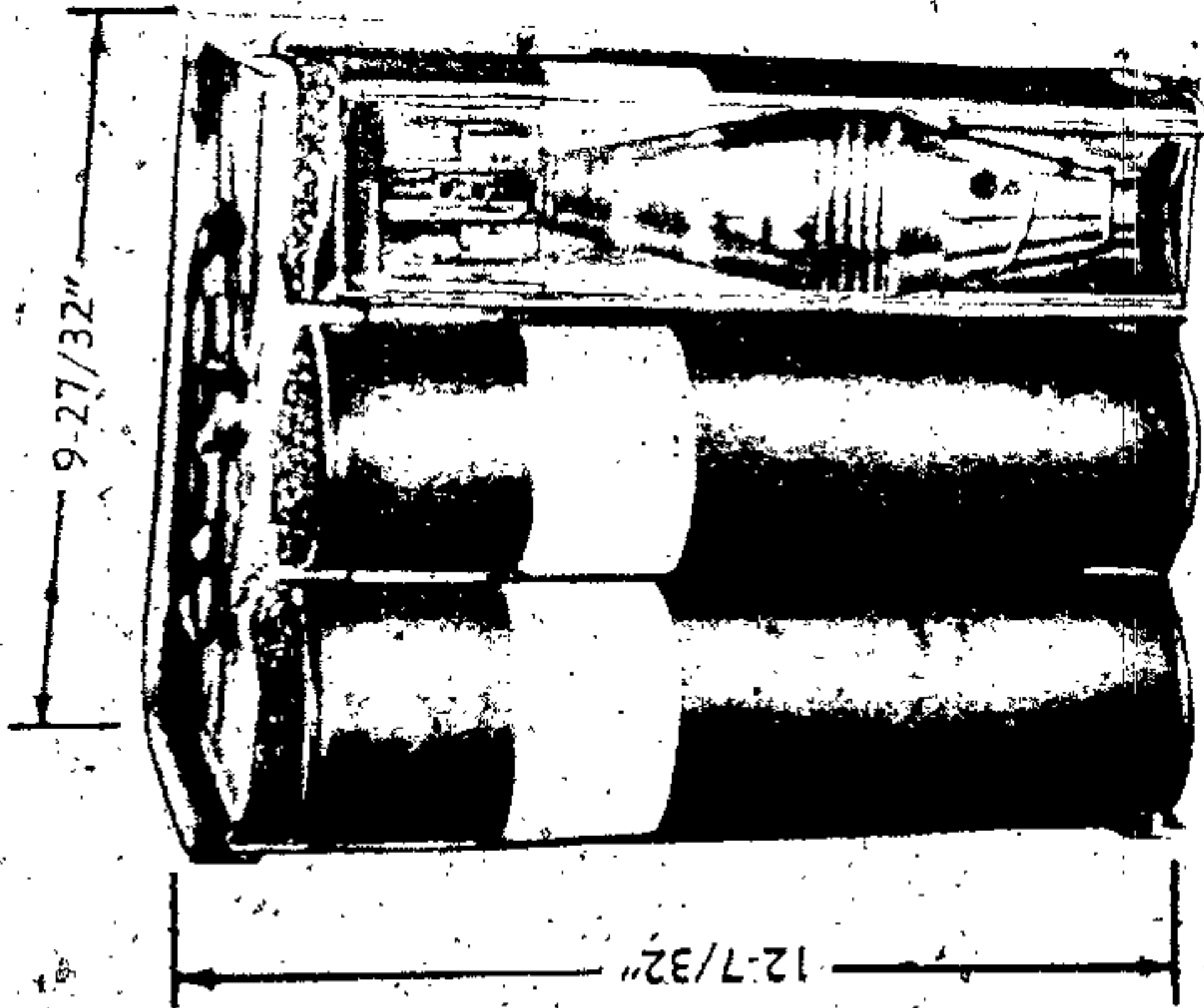
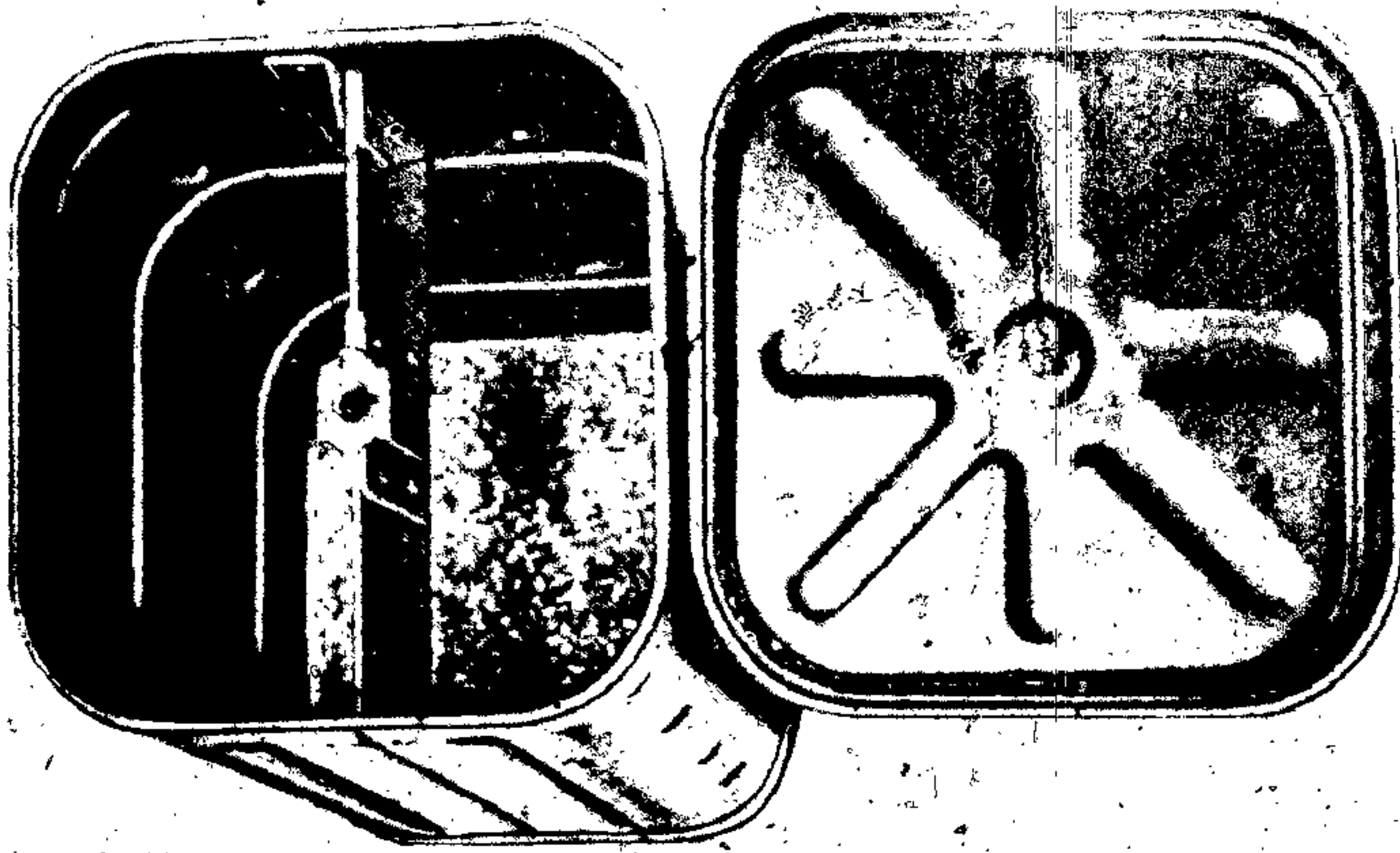

Figure 53 -- Metal Container M139A1 for 60-mm Mortar Ammunition.

Classes of Ammunition



RA PD 97686

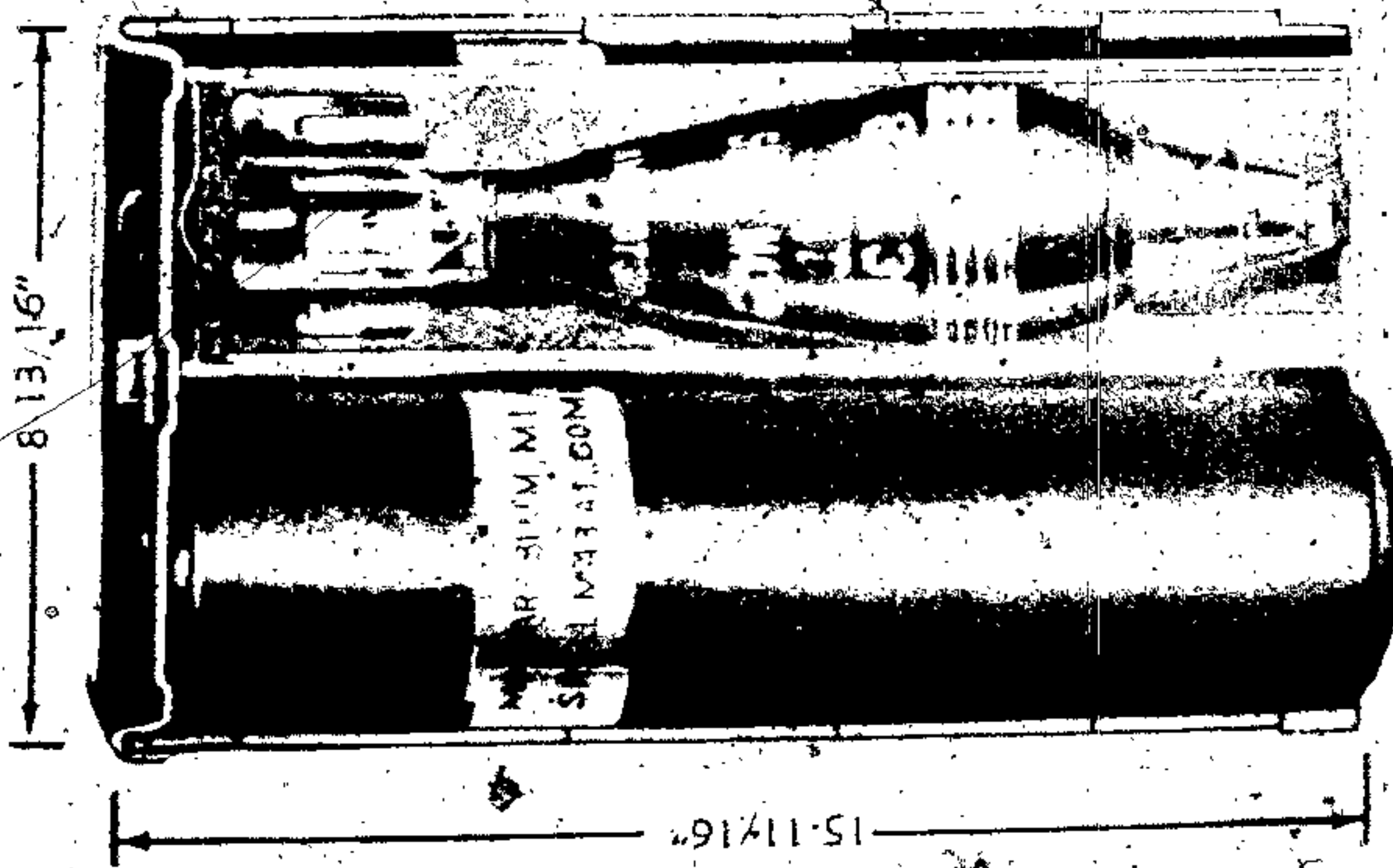

Figure 54 - Metal Container M140A1 for 81-mm Mortar Ammunition



Classes of Ammunition

**94. METHOD OF PROJECTION.** The round is dropped into the mortar tube and upon reaching the bottom of the mortar, the round's primer impinges upon the firing pin of the mortar. This impact sets off the ignition cartridge and propelling charge, and the gas produced forces the round from the mortar (fig. 52). The bourrelet, or gas-check band, prevents practically all the gas from escaping past the shell, and provides a bearing surface for the round in its travel through the bore. A bore-riding pin in the fuze of the shell prevents the fuze from becoming armed until after it leaves the bore of the weapon.

**95. PRECAUTIONS IN HANDLING.**

a. Complete rounds, particularly rounds with fuzes, will be handled with care at all times. Explosive elements in fuzes and primers are particularly sensitive to shock and high temperature.

b. Do not break the moisture-resistant seal on the fiber container until ammunition is to be used.

c. The safety wire will be withdrawn from the fuze only just before firing and at no other time. Be certain the bore-riding pin is in place in the fuze at the time the shell is dropped in the mortar.

d. When loading muzzle-fed mortars, the round is inserted into the mortar, cartridge end first. When the shell is released to slide down the barrel, the hands should be promptly removed from the muzzle.

e. Duds should not be handled or moved. Because their fuzes are armed, they should be destroyed in place as described in chapter 4 of this manual.

**96. PACKING AND MARKING.**

a. **Packing.** Except training ammunition, which may be requisitioned by components, mortar ammunition in the smaller calibers is packed as assembled complete rounds. Each round is packed in an individual fiber container, and then in suitable outer packing. In the case of 60-mm and 81-mm mortar ammunition, clover-leaf bundles, wooden box, or metal containers have been in use. The metal container (figs. 53 and 54) is now the standard packing for this ammunition, but is reserved for shipment to certain theaters.

b. **Marking.** In addition to the painting which identifies the ammunition as to type, the following information is stenciled on the projectiles:

- Caliber and type of mortar in which fired
- Kind of filler
- Model of shell
- Ammunition lot number

## Classes of Ammunition

## Section IV

## ARTILLERY AMMUNITION

## 97. GENERAL.

a. **Complete round.** The term "artillery ammunition" refers to ammunition, except rockets, mortar ammunition, and shotgun shells, used in weapons having a bore diameter of more than 0.60 inch. A complete round of artillery ammunition comprises all of the components necessary to fire a weapon once and to cause the projectile to function at the desired time and place (blank and drill rounds excepted). These components are, in general, the projectile, the fuze, the propelling charge, and the primer. Dependent upon both the type of propelling charge and the method of loading into the weapon, complete rounds of artillery ammunition are known as fixed, semi-fixed, or separate-loading (fig. 55).

b. **Components of a complete round.**

(1) **PROJECTILE.** The projectile is ejected from a weapon by the gas pressure developed by the burning propelling charge. Other terms used in specific nomenclature of certain items in place of "projectile," are "shell" and "shot."

(2) **FUZE.** A fuze is a mechanical device assembled to a projectile to cause it to function at the time and under the circumstances desired.

(3) **PROPELLING CHARGE.** The propelling charge consists of a charge of smokeless powder in a cartridge case, cloth bag, or both.

(4) **PRIMER.** A primer is used to initiate the ignition of a propelling charge. It consists essentially of a small quantity of sensitive explosive and a charge of black powder.

c. **Fixed ammunition.** Complete rounds in which the propelling charge is fixed, that is, not adjustable, and which are loaded into a weapon in one operation, are known as "fixed" ammunition. As usually designed, the propelling charge is loose in a cartridge case which is crimped rigidly to the projectile. The primer is fitted into the base of the cartridge case. For certain calibers, rounds of fixed ammunition are termed *cartridges*.

d. **Semifixed ammunition.** This type of round is characterized by the loose fit of the cartridge case over the projectile so that the propelling charge may be accessible for adjustment for zone firing. Like fixed ammunition, it is loaded into the weapon in one operation. In the usual design of this type of ammunition, the propelling charge is divided into sections, each consisting of propellant powder in a bag. To adjust the propelling charge, the projectile is lifted from the cartridge case, the sections of increments not required are removed, and



Classes of Ammunition

- A - POINT
- B - SIGHT
- C - FUSE
- D - BODY
- E - CASE
- F - BURNING
- G - BURNING
- H - RETAINING BAND
- I - CRIMP
- J - BASE COVER
- K - CARTRIDGE CASE
- L - PROPELLANT CHARGE
- M - PRIMER
- N - FUSE
- O - CRIMP
- P - CENTER PIN WITH PULL RING
- Q - CENTER

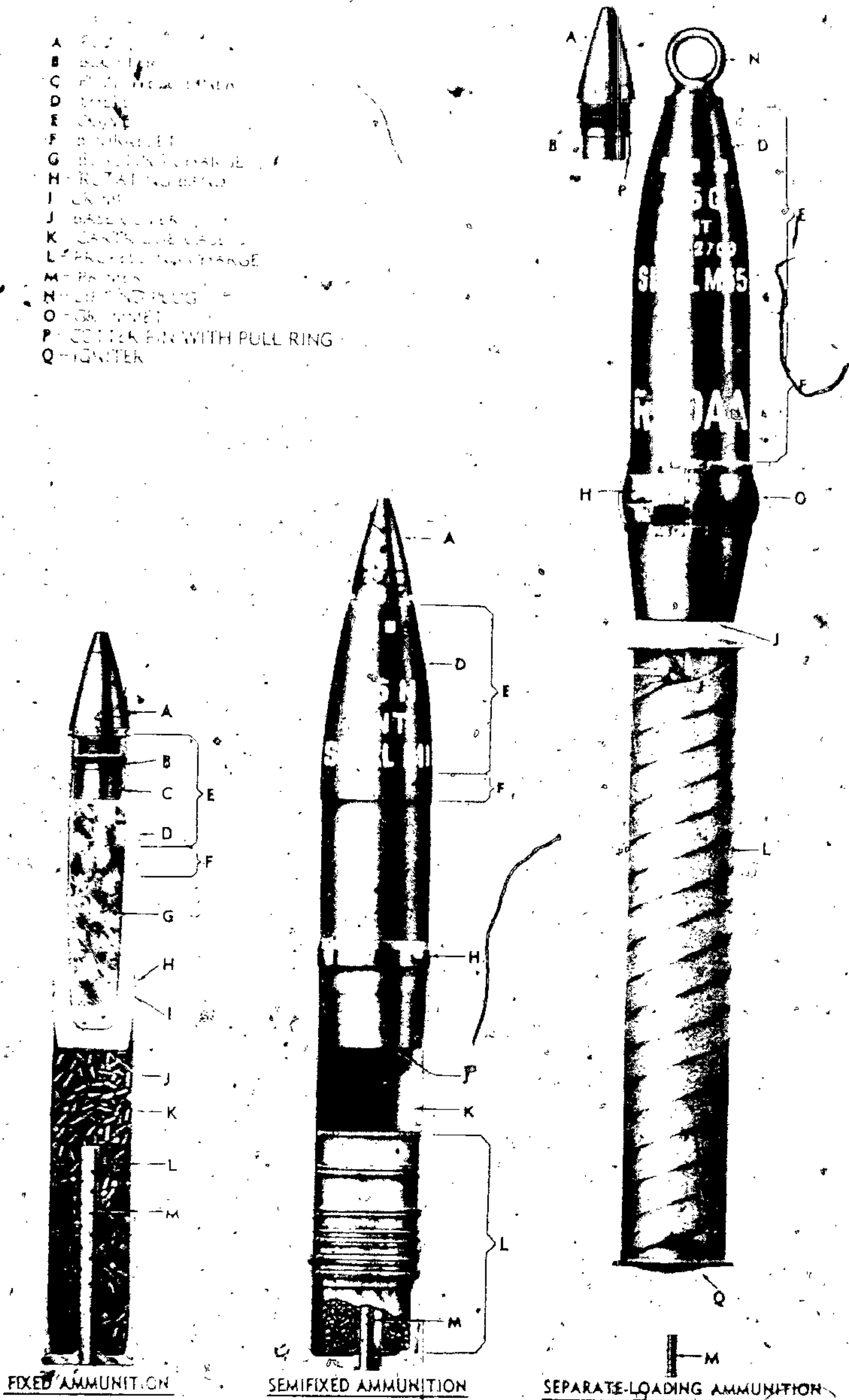

RA PD 80671A

Figure 55 - Types of Complete Rounds of Artillery Ammunition

## Classes of Ammunition

the projectile is reassembled to the cartridge case. As in fixed ammunition, the primer is assembled in the base of the cartridge case. The 105-mm howitzer HE,AT round is a special type in that the charge is fixed; that is, not adjustable; the cartridge case and projectile are not crimped together in this instance because of the method of packing.

e. **Separate-loading ammunition.** Complete rounds in which the separate components—fuzed projectile, propelling charge, and primer—are loaded into the weapon separately are known as "separate-loading" ammunition. Although the propelling charge may be in one section, it is usually divided into sections with each section assembled in a bag. In the case of "separated" ammunition (figs. 5 and 56), the propelling charge is contained in a cartridge case, but the projectile cannot be fitted into the cartridge case and is loaded into the weapon separately.

**98. CLASSIFICATION.**

a. Artillery ammunition is classified according to use as service, practice, blank, or drill. It is classified according to type of filler as explosive, chemical, or inert.

b. Service ammunition is fired for effect in combat. It may be high-explosive, high-explosive-antitank, armor-piercing or armor-piercing-capped (with or without explosive filler), low-explosive (shrapnel), chemical (gas or smoke), illuminating, or inert (canister).

c. Practice ammunition is provided for training in marksmanship. The projectile used may be inert or may have a spotting charge of black powder.

d. Blank ammunition is provided in small and medium calibers for saluting purposes and simulated fire. It has no projectile.

e. Drill or dummy ammunition is provided for practice in loading and handling ("service of the piece"). It is completely inert.

**99. IDENTIFICATION.**

a. In common with other types, artillery ammunition is identified by painting and marking. For the basic color scheme, see chapter 1, section II. The marking on the projectile, (figs. 2, 3, 57, and 58), includes:

(1) Ammunition Identification Code (AIC) symbol—on separate-loading shell.

(2) Caliber and type of weapon in which fired ("75 H," "155 G," etc.).

(3) Kind of filler ("TNT," "WP SMOKE," etc.).

(4) Type and model of projectile ("SHELL, M60," "PROJ. APC-T, M61A1," etc.).



Classes of Ammunition

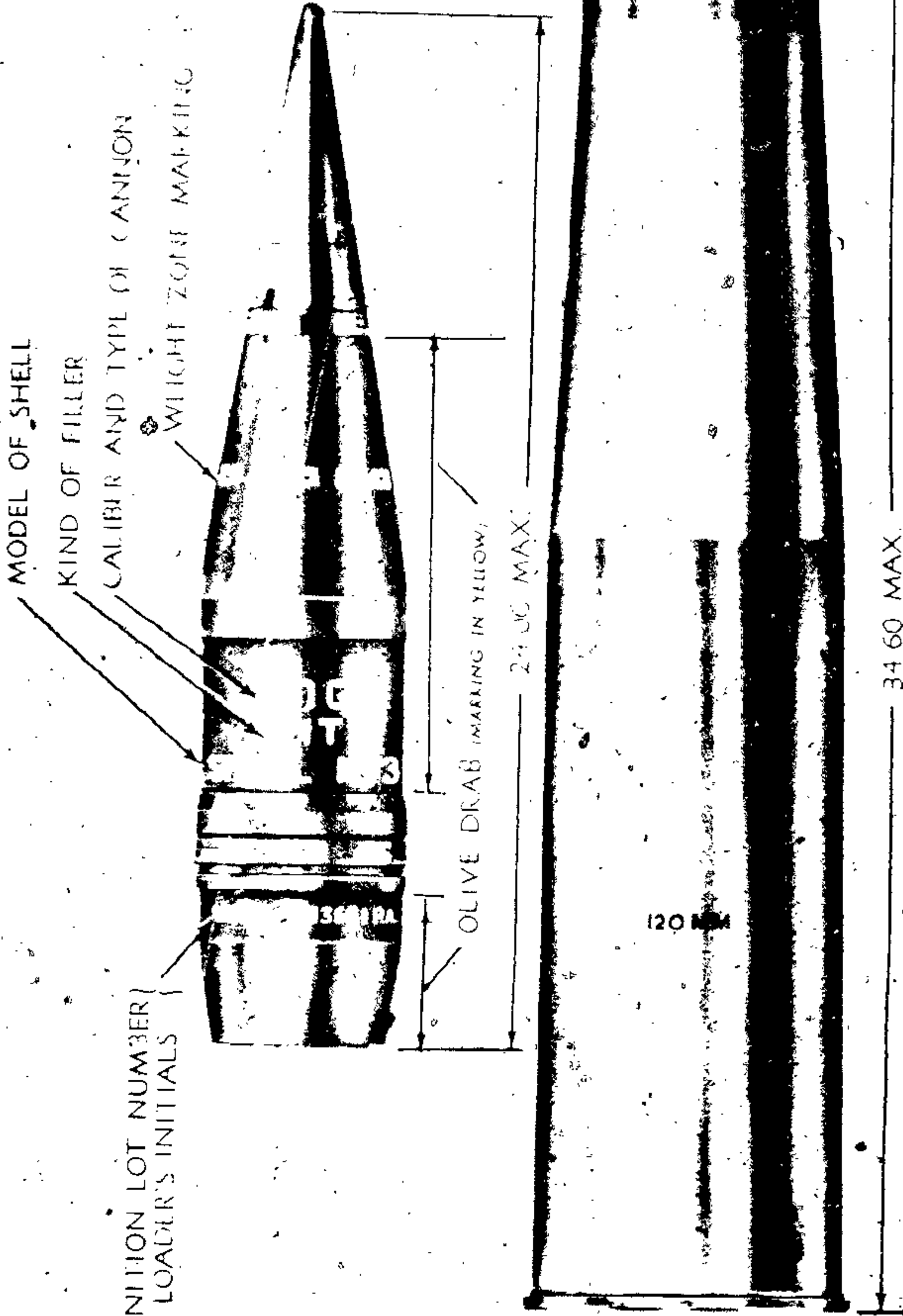

RA PD 65171

Figure 56 — 120-mm Ammunition

### *Classes of Ammunition*

(5) Weight-zone marking (crosses on 75-mm shell and squares on larger-caliber shell; squares on separate-loading shell have prick punches in their centers) or weight in pounds.

(6) Ammunition lot number of filled projectile and in some cases loader's initials.

b. Similar information is marked on other components. Further information is given in pertinent Technical Manuals and Field Manuals.

c. Markings are stenciled on cartridge cases of 75-mm, 76-mm, and 3-inch ammunition to indicate the type of propelling charge. These markings are illustrated in figure 4 for 75-mm gun rounds.

d. An exception to the basic color scheme is the case of 20-mm ammunition; the high-explosive-incendiary projectile has a red body and yellow ogive. Some target-practice projectiles of larger caliber are painted black; when replacement or repainting is required, they will be painted blue in accordance with basic color scheme.

## 100. PROJECTILES.

a. **General.** With a few exceptions, artillery projectiles are of the same general shape, that is, they have a cylindrical body, solid or hollow, and an ogival head. (Canister and base-ignition smoke shell have blunt heads.) The projectiles vary in length from 2 to 6 calibers. The principal characteristic differences are:

- (1) Location of fuzes—point or base.
- (2) Radius of ogive—smaller for low-velocity, larger for high-velocity projectiles.
- (3) Rotating band—narrow for low-velocity, wide for high-velocity projectiles.
- (4) Base—tapered ("boat-tailed") or cylindrical ("square") base.
- (5) Armor-piercing cap—used only with armor-piercing projectiles.
- (6) Windshield (ballistic cap or false ogive)—when required for improved ballistics.
- (7) Filler—high explosive, gas, smoke, illuminant candle and parachute assembly, or others.

### b. Components.

(1) **OGIVE AND WINDSHIELD.** The curved portion of the projectile from the bourrelet to the point is called the ogive. The radius of the ogive is sometimes expressed in calibers, the caliber being the diameter of the bore of the gun. The radius of the ogive influences the flight of the projectile and in present designs generally varies from 6 to 11 calibers. Since armor-piercing projectiles have a short



Classes of Ammunition

- A - WEIGHT ZONE MARKING
- B - WEIGHT TO NEAREST LB
- C - CALIBER AND TYPE OF WEAPON
- D - NAME OF FILLER
- E - LOT NUMBER OF LOADED SHELL
- F - A.I.C. SYMBOL
- G - TYPE AND MODEL OF SHELL

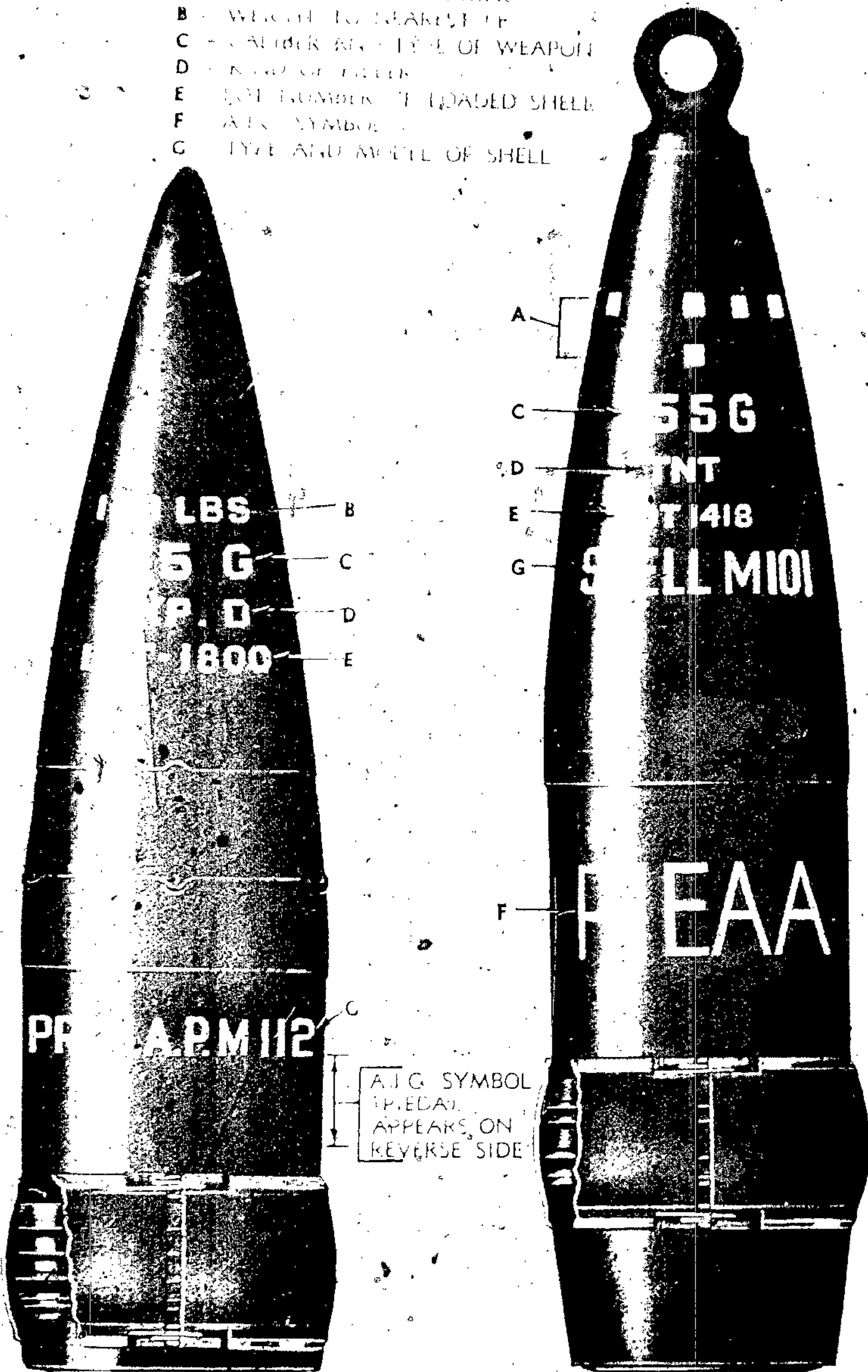

RA PD 65199B

Figure 57 - Marking of Separate-loading Shell - As Shipped

Classes of Ammunition

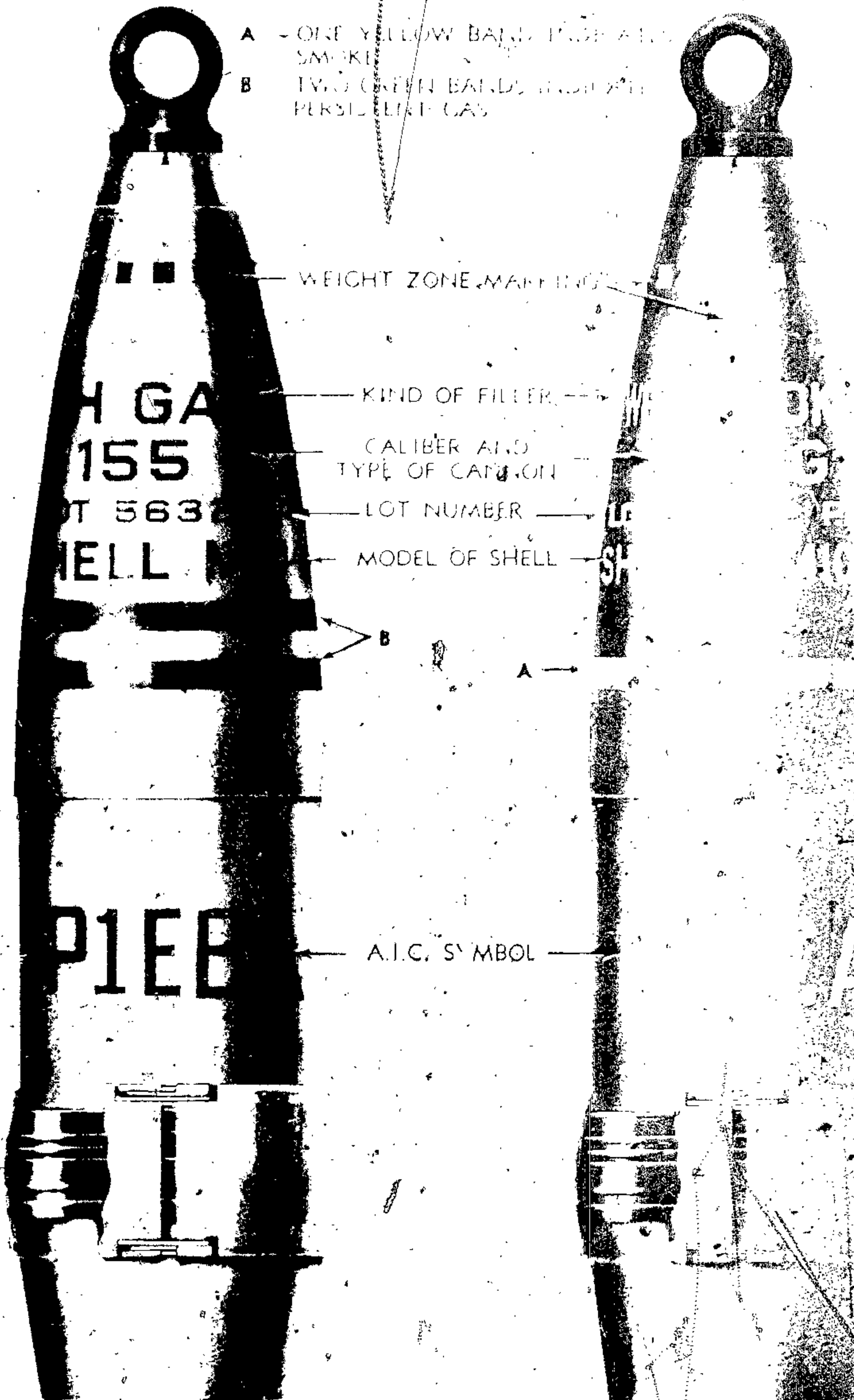

RA PD 65200A

Figure 58 - Marking of Separate-loading Shell - As Shipped (Continued)



Classes of Ammunition

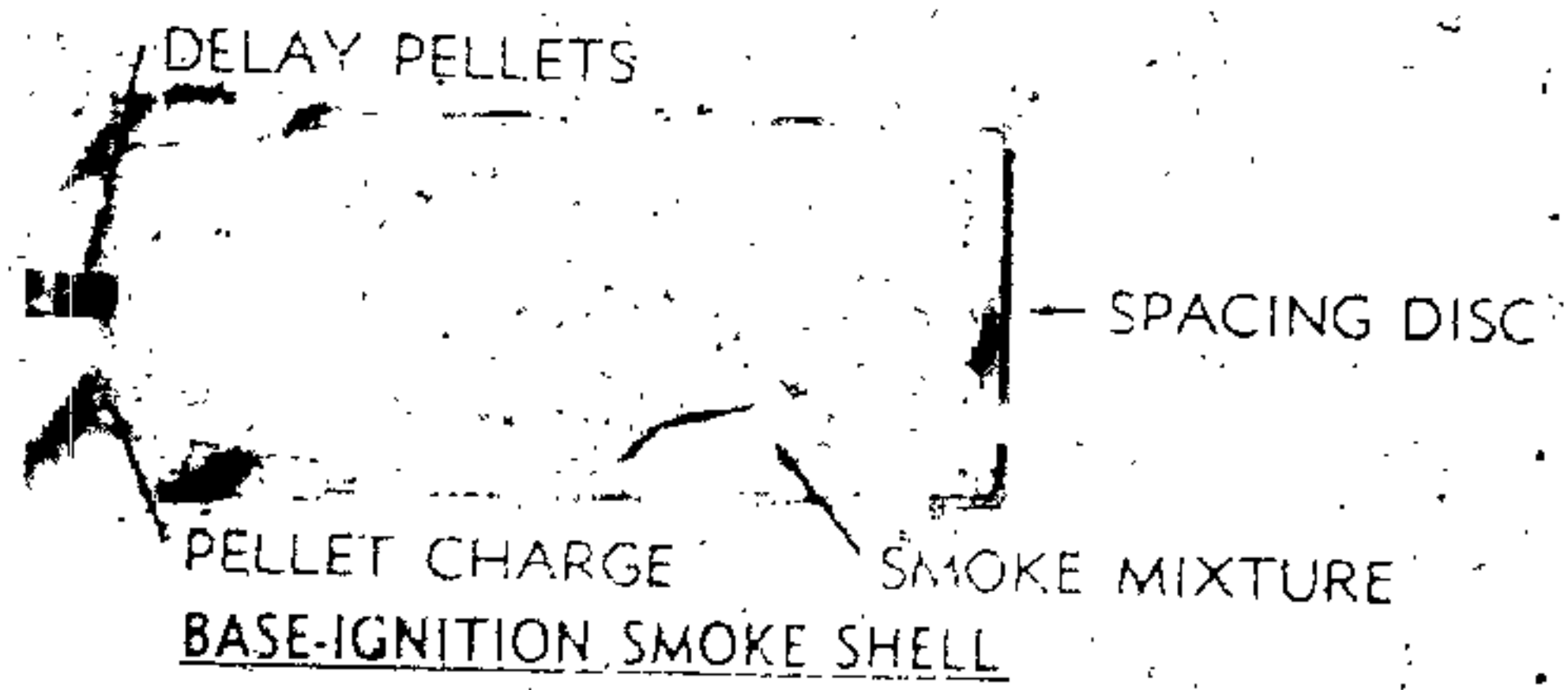
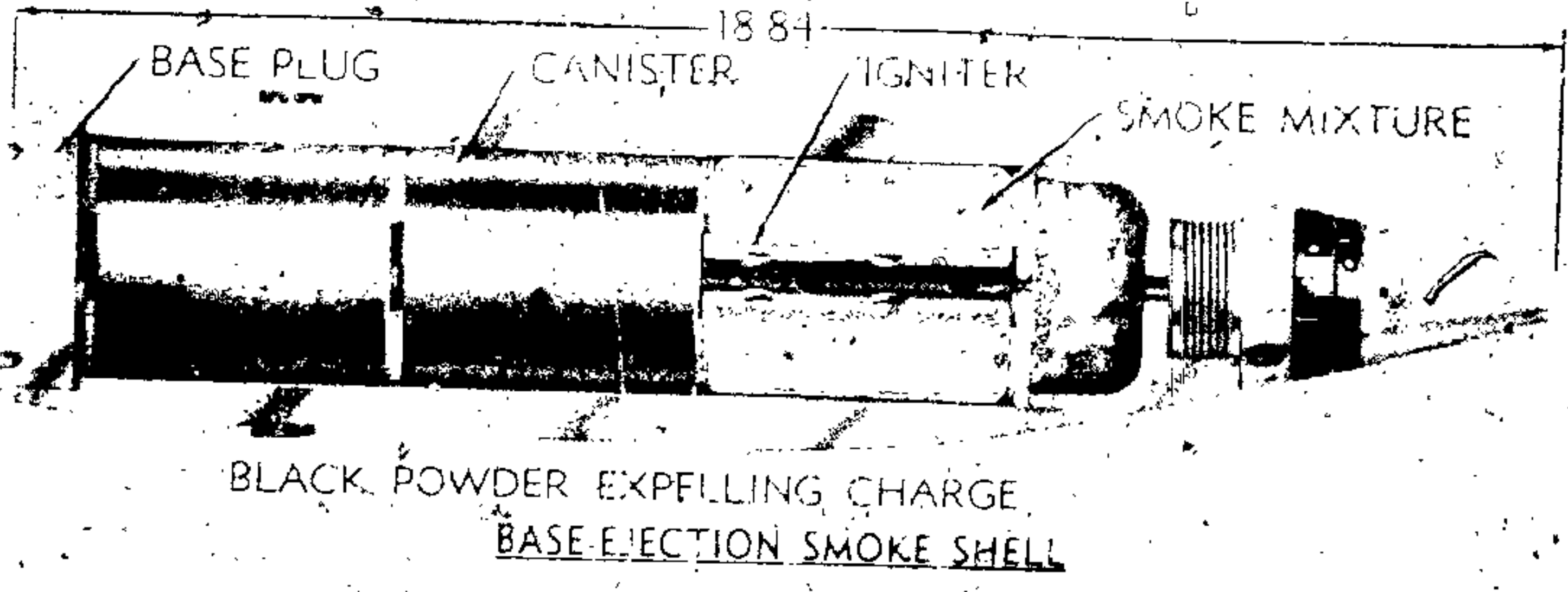
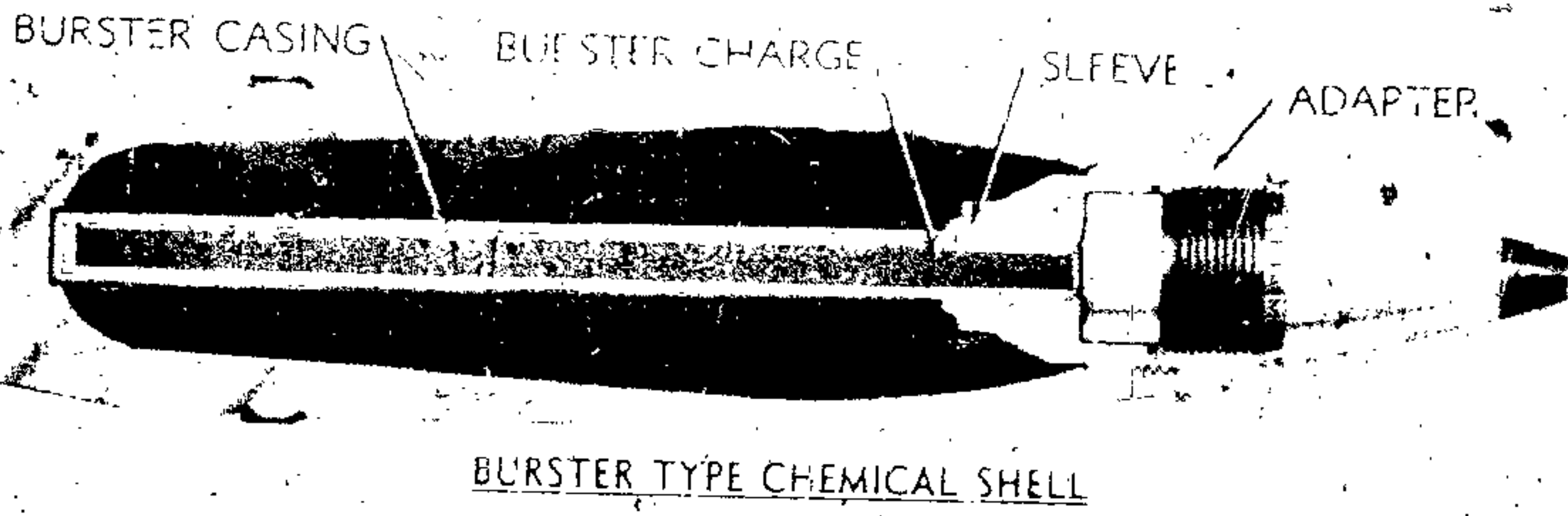
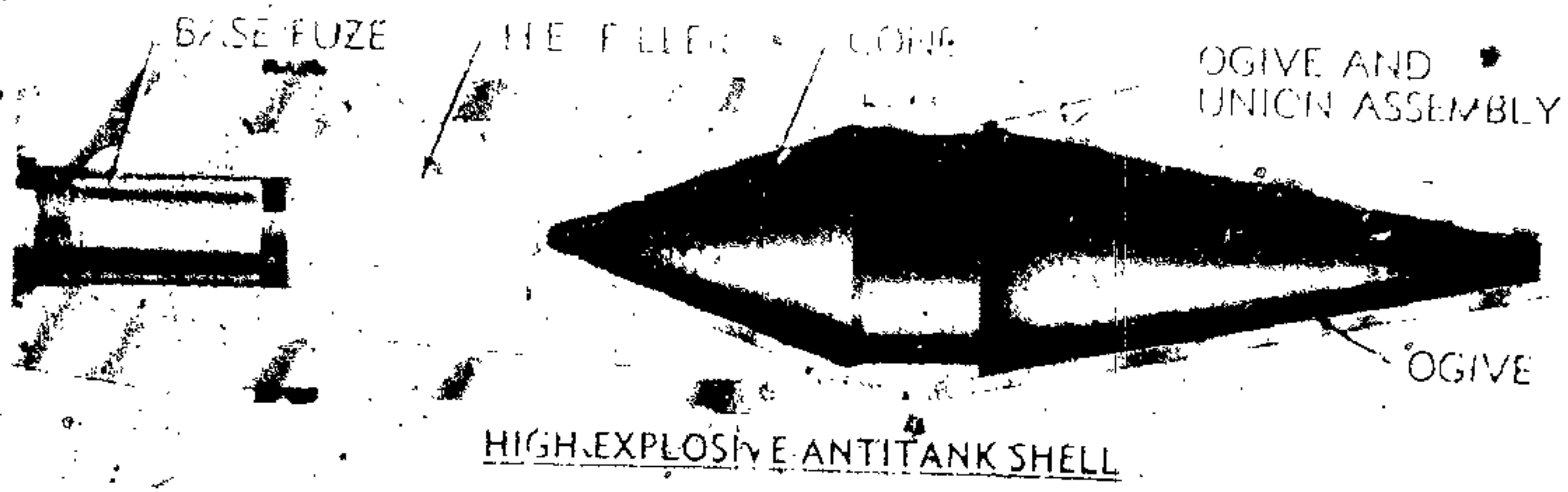

RA PD 97762

Figure 59 - Typical High-explosive, High-explosive-antitank, and Chemical Projectiles

*Classes of Ammunition*

radius of ogive for purposes of penetration, a windshield, often a ballistic cap or false ogive, is placed over the armor-piercing head to improve the ballistic qualities.

(2) **BOURRELET.** The bourrelet is the accurately machined surface, of slightly larger diameter than the body, which bears on the lands of the bore of the weapon. It centers the projectile in its travel through the bore. Generally, it is at the forward end of the body but it may extend from the ogive to the boat-tailed base. Some projectiles of large caliber have a front and rear bourrelet.

(3) **BODY.** While applicable to the entire projectile, the term "body" is used to designate the cylindrical portion of the projectile between the bourrelet and the rotating band. It is machined to smaller diameter than the bourrelet to reduce the surface in contact with the lands of the bore. Only the bourrelet and rotating band bear on the lands.

(4) **ROTATING BAND.** The rotating band is a cylindrical ring of copper or gilding metal, pressed into a knurled or roughened groove near the base of the projectile. It affords a snug seat for the projectile in the forcing cone of the weapon and centers the base in the bore. As the projectile moves forward, the soft rotating band is engraved by the lands of the bore. Because of compression of the band, excessive metal flows toward the rear. This flow of metal is taken up by grooves cut in the rotating band. Since the rifling of the weapon is helical, the engraving of the band imparts rotation to the moving projectile. The rotating band also prevents the escape of the propellant gases forward of the projectile by completely filling the grooves of the rifling.

(5) **TYPE OF BASE.** When the surface to the rear of the rotating band is tapered or conical, it is known as "boat-tailed"; when cylindrical, the projectile is described as having a "square base."

(6) **BASE PLUG.** To facilitate manufacture, armor-piercing projectiles are closed at the base with a heavy steel plug. In the larger calibers, the base plug adapter also provides a seat for the base plug and fuze. In the smaller calibers, if an explosive charge is loaded in the cavity of the projectile, the base plug is replaced by a base fuze. If no explosive is present in the smaller caliber projectile, the base plug contains the tracer element.

(7) **BASE COVER.** The 20-mm projectiles and projectiles of 75-mm or larger caliber containing high explosive, are provided with a base cover to prevent the hot gases of the propelling charge from coming into contact with the explosive filler of the projectile through joints or possible flaws in the metal of the base. The base cover consists of a thin metal disc which may be raked, crimped, or welded to the base of the shell. Small-caliber and medium-caliber armor-piercing projectiles with high-explosive filler and base fuzes are not ordinarily provided with base covers.



Classes of Ammunition

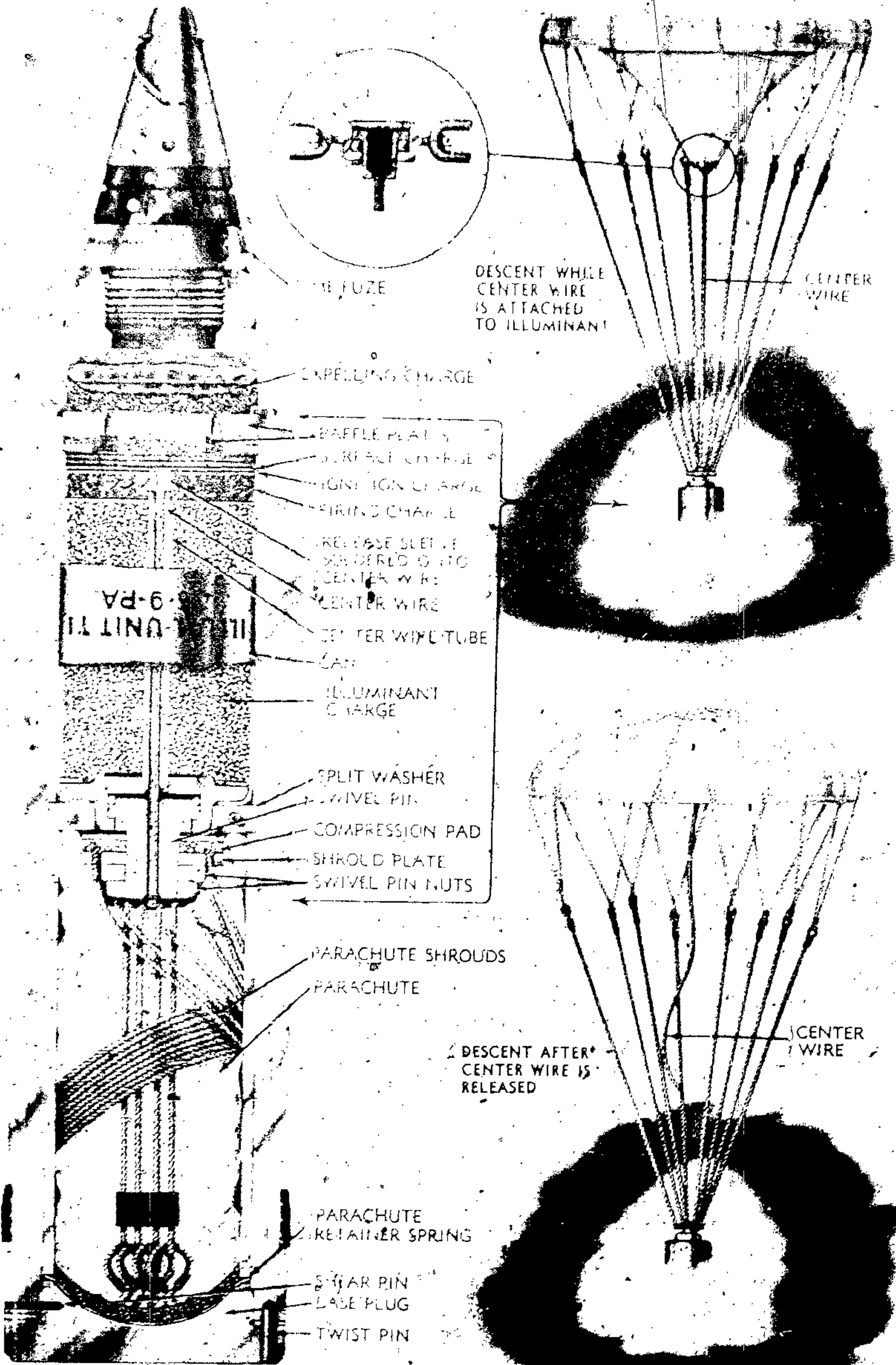

RA PD 97760

Figure 60 — Typical Illuminating Projectile

Classes of Ammunition

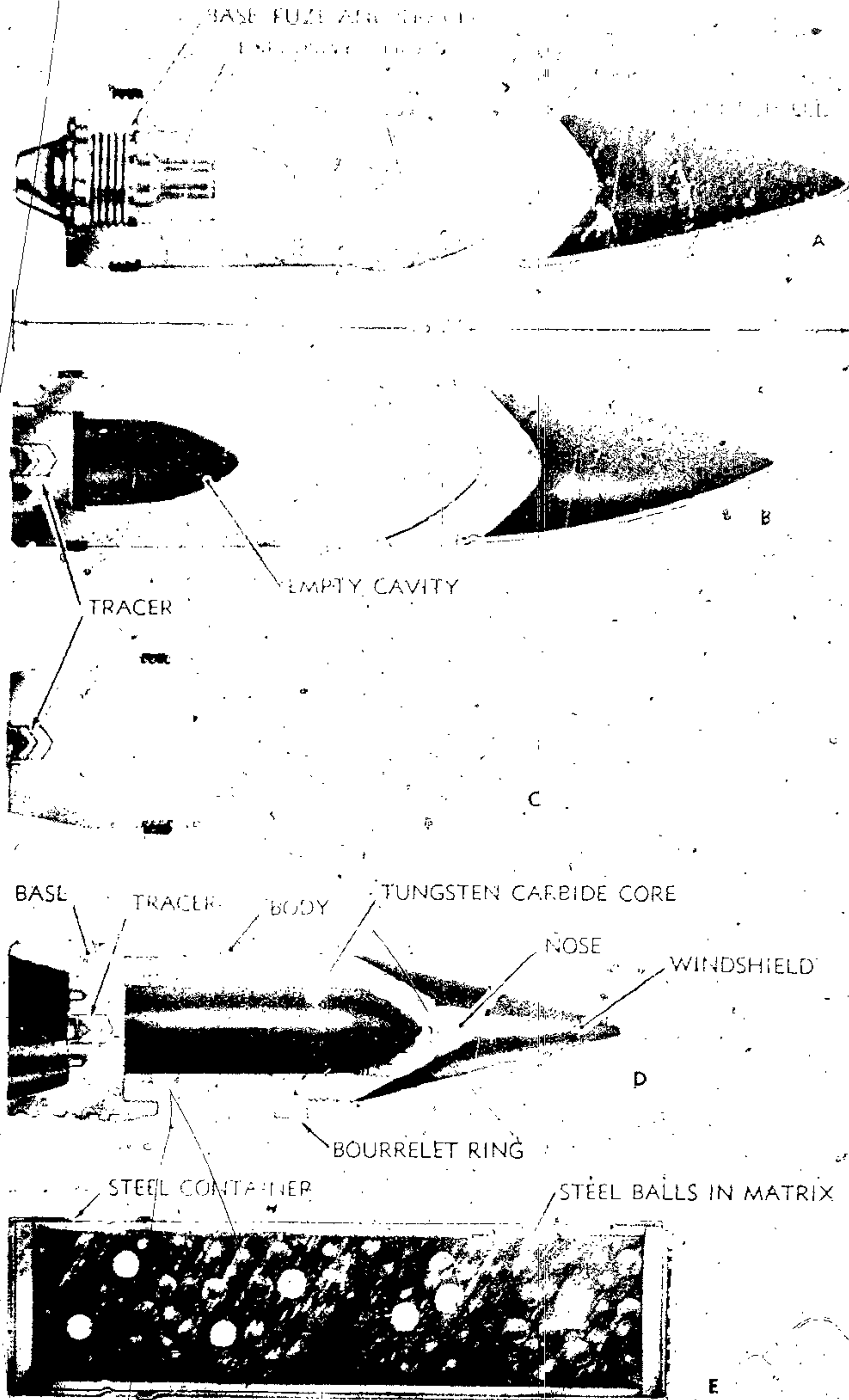

- A— ARMOR PIERCING-CAPPED PROJECTILE, WITH EXPLOSIVE FILLER
- B— ARMOR PIERCING-CAPPED PROJECTILE, EMPTY
- C— ARMOR PIERCING SHOT /
- D— HIGH-VELOCITY ARMOR PIERCING SHOT
- E— CANISTER

RA PD 97763

Figure 61 — Typical Armor-piercing and Canister Projectiles



Classes of Ammunition

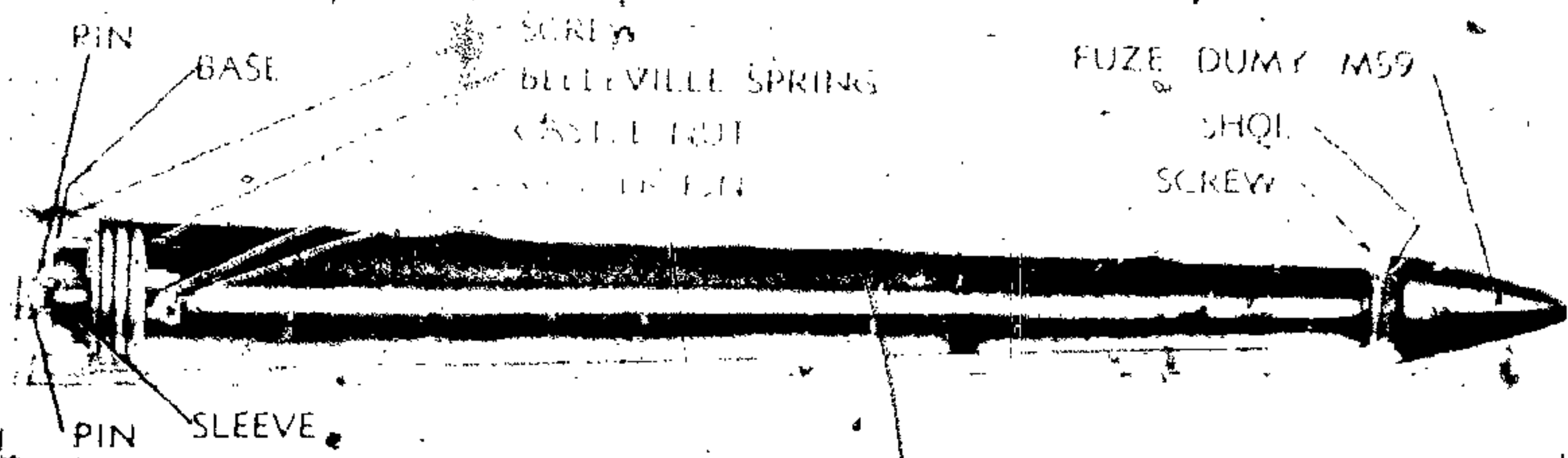

337 MAX.

A - TYPICAL DRILL CARTRIDGE

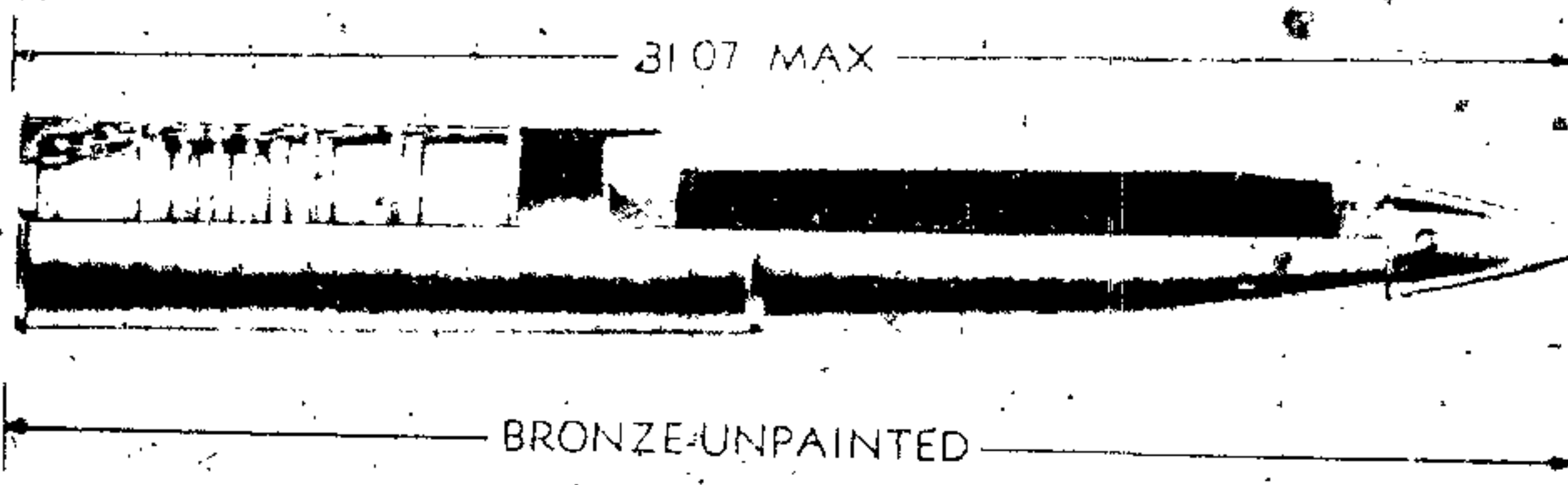

31.07 MAX.

BRONZE UNPAINTED

B - TYPICAL SEMIFIXED DRILL CARTRIDGE

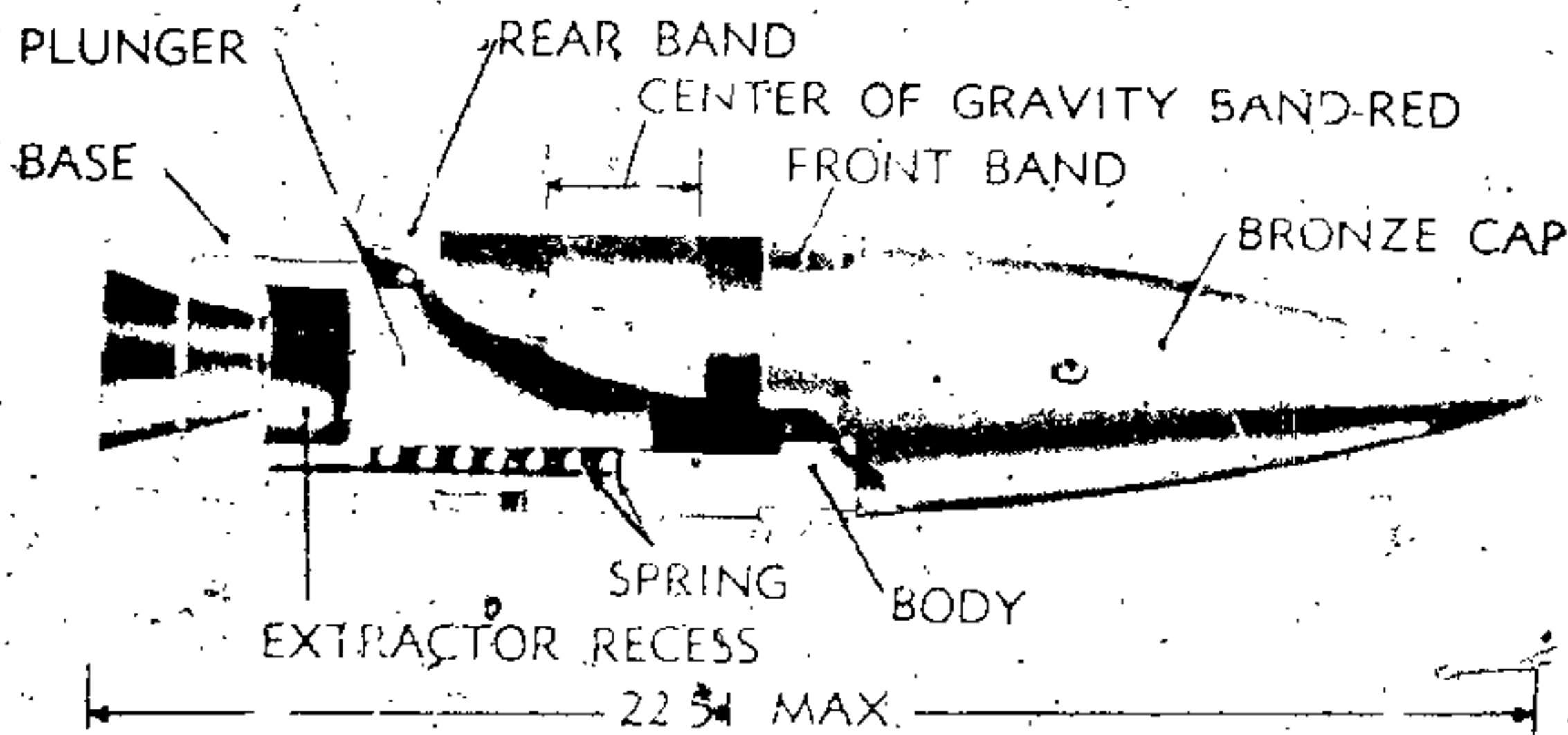

22.51 MAX.

C - TYPICAL SEPARATE-LOADING DUMMY PROJECTILE

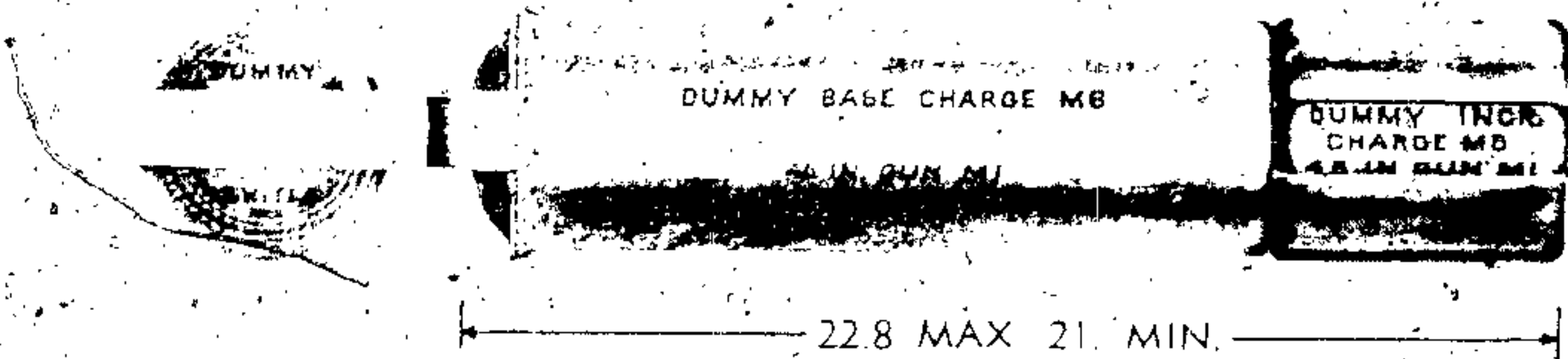

22.8 MAX 21. MIN.

D - TYPICAL SEPARATE-LOADING DUMMY PROPELLING CHARGE

RA PD 89318A

Figure 62 - Drill and Dummy Ammunition

### Classes of Ammunition

(8) **TRACER:** For observation of fire, some projectiles are equipped with a tracer element in the base of the projectile. In most smaller-caliber antiaircraft shell, the tracer is used to ignite the filler, and destroy the shell should it miss the target. Such a tracer is called "shell-destroying (SD)."

#### c. Types of projectiles.

(1) **HIGH-EXPLOSIVE (HE) SHELL.** This projectile (fig. 59), made of common forged steel, has comparatively thin walls and a large bursting charge of high explosive. It is used against personnel and material targets, producing blast and/or mining effect and fragmentation at the target. It may be fitted with either a time or impact fuze, or a concrete-piercing fuze, according to type of action desired.

(2) **HIGH-EXPLOSIVE ANTI-TANK (HEAT) SHELL.** This is a special type of shell (fig. 59) containing a high explosive charge for use against armor plate. Its effect is dependent upon the type and shape of the charge. It has a conical windshield which provides stand-off for the charge, and a base-detonating fuze having nondelay action.

(3) **CHEMICAL SHELL.** There are three general types of chemical shell (fig. 59): burster, base-ejection (BE), and base-ignition (BI).

(a) **Burster:** The burster type is similar to high-explosive shell, except for the type of filler and the absence of a base cover. An explosive charge, termed a burster, and located centrally in the shell, is used to break the shell body and aid in dispersion of the chemical filler.

(b) **Base-ejection (BE).** Base-ejection shells which are set to function in flight do not have a burster, but have an expelling charge of black powder, adjacent to the time fuze. This expelling charge, when ignited by the fuze, ignites the smoke mixture of the canisters, strips the threads of the base plug, and forces the canisters from the base of the shell.

(c) **Base-ignition (BI).** Base-ignition (base-emission) smoke shells have no burster or expelling charge. The smoke mixture is ignited by the propelling charge through a hole in the base of the projectile. Shells of early manufacture have a low-melting-point fusible metal plug in the base hole, while shells of later manufacture have delay pellets of black powder. The action of the delay pellet prevents disclosure of the gun position by the smoke.

(4) **ILLUMINATING SHELL.** These shells (fig. 60) contain a parachute and an illuminant assembly which are ejected by an expelling charge adjacent to the time fuze in a manner similar to base-ejection smoke shell. The illuminant suspended by the parachute burns, lighting up a target area.



---

*Classes of Ammunition*

---

**(5) ARMOR-PIERCING PROJECTILE (AP OR APC).**

(a) Armor-piercing projectiles (fig. 61) are made of heat-treated high-carbon alloy steel. The head is very hard for penetration of armor and the body is tough to withstand the strains imposed by impact and the twisting action of the projectile at angles of impact oblique to normal. A windshield is generally secured to the armor-piercing cap or the head of the projectile to give improved ballistics. A tracer may be present in the base plug or in the base end of the fuze.

(b) Armor-piercing projectiles having no high-explosive filler may be solid or may have a small cavity in the body. When the cavity is filled with explosive D, the projectiles are fitted with a base-detonating fuze having a delay action.

(c) The term "armor-piercing-capped" (APC) refers to a shot or a projectile with an armor-piercing cap for use especially in penetrating face-hardened armor plate. The cap is of forged alloy steel, heat-treated to have a hard face and a relatively soft core. On impact, the hardened face of the cap destroys the hardened surface of the armor plate, while the softer core of the cap protects the hardened point of the projectile by distributing the impact stresses over a large area of the head.

**(6) HIGH-VELOCITY ARMOR-PIERCING SHOT (HVAP).** This shot (fig. 61) is a high-velocity, light-weight projectile having a very hard armor-piercing core of tungsten carbide. The tungsten carbide core, a steel base containing a tracer element, an aluminum body and nose plug, and an aluminum windshield comprise the HVAP-T shot.

**(7) CANISTER.** Canister (fig. 61) consisting of a light metal case, filled with steel balls in a matrix, contains no explosives. It is fired point-blank for effect against personnel. The case breaks upon leaving the muzzle of the cannon, and the balls scatter in the manner of a shotgun shell.

**(8) SHRAPNEL.** Shrapnel are point-fuzed projectiles with a combination time and superquick fuze or a time fuze. An expelling charge of black powder is assembled in the base. A central flash tube connects the fuze and base charge. When the time fuze has burned its predetermined time, the magazine charge flashes through the central tube to ignite the base charge. This results in the ejection of the steel diaphragm, balls, head, and fuze from the case. The case is not ruptured. The balls are projected forward in the form of a cone, due to rotational velocity.

**(9) TARGET PRACTICE.**

(a) Cast-iron shot and sand-loaded shell of the same size, shape, and weight as the service shell it simulates are provided for target practice. Some models may have a small quantity of black powder

### Classes of Ammunition

to serve as a spotting charge.

(b) Subcaliber ammunition consists of complete rounds of small caliber or small-arms cartridges used in practice firing of larger-caliber weapons. The subcaliber ammunition is fired from weapons fitted either on top of or in the bore of the larger weapon. The use of subcaliber guns and ammunition provides low-cost ammunition for training gun crews, avoids wear of the major weapon during practice, and permits firing where range limitations exist.

(10) DRILL OR DUMMY. Inert projectiles and complete rounds (fig. 62) for training are known as drill or dummy ammunition. They are used for training and practice in handling shell and in "service of the piece."

#### 101. FUZES.

a. **General.** An artillery fuze (figs. 63 through 66) is a mechanical device used with a projectile to cause it to function at the time and under the circumstances desired.

##### b. Classification.

(1) Fuzes are classified according to position on the projectile as "point" or "base." They are further classified as "time" or "impact," or a combination of both. Time fuzes contain either a clockwork mechanism or a graduated time element in the form of a compressed black-powder train which may be set to a predetermined time prior to firing. Impact fuzes function on impact with the target. If the fuze is designed to function on impact with a very light materiel target, such as an airplane wing, it is called "supersensitive." Impact fuzes are further classified as superquick, nondelay, or delay. Delay on impact fuzes is usually 0.05, 0.15, or 0.025 seconds. These terms are used in reference to the action at the instant of impact, whereas "time" refers to length of time from the instant of the firing of the weapon to the instant of the functioning of the fuze.

(2) Selective-type fuzes have time action or more than one type of action, for example, superquick and delay, time and superquick (TSQ). Such fuzes can be adjusted in the field for the type of action desired. Time fuzes can be set to function at any desired time of flight after firing by turning a time ring.

##### c. Safety features.

(1) Artillery fuzes contain safety devices which tend to prevent functioning until after the fuze has been subjected to centrifugal and set-back forces, after the round to which it is assembled is fired.

(2) Certain fuzes are considered to be "boresafe." A boresafe (detonator-safe) fuze is one in which the explosive train is so interrupted that prior to firing and while the projectile is still in the bore of the gun, premature explosion of the shell is prevented should any of the more sensitive elements, primer and/or detonator,



Classes of Ammunition

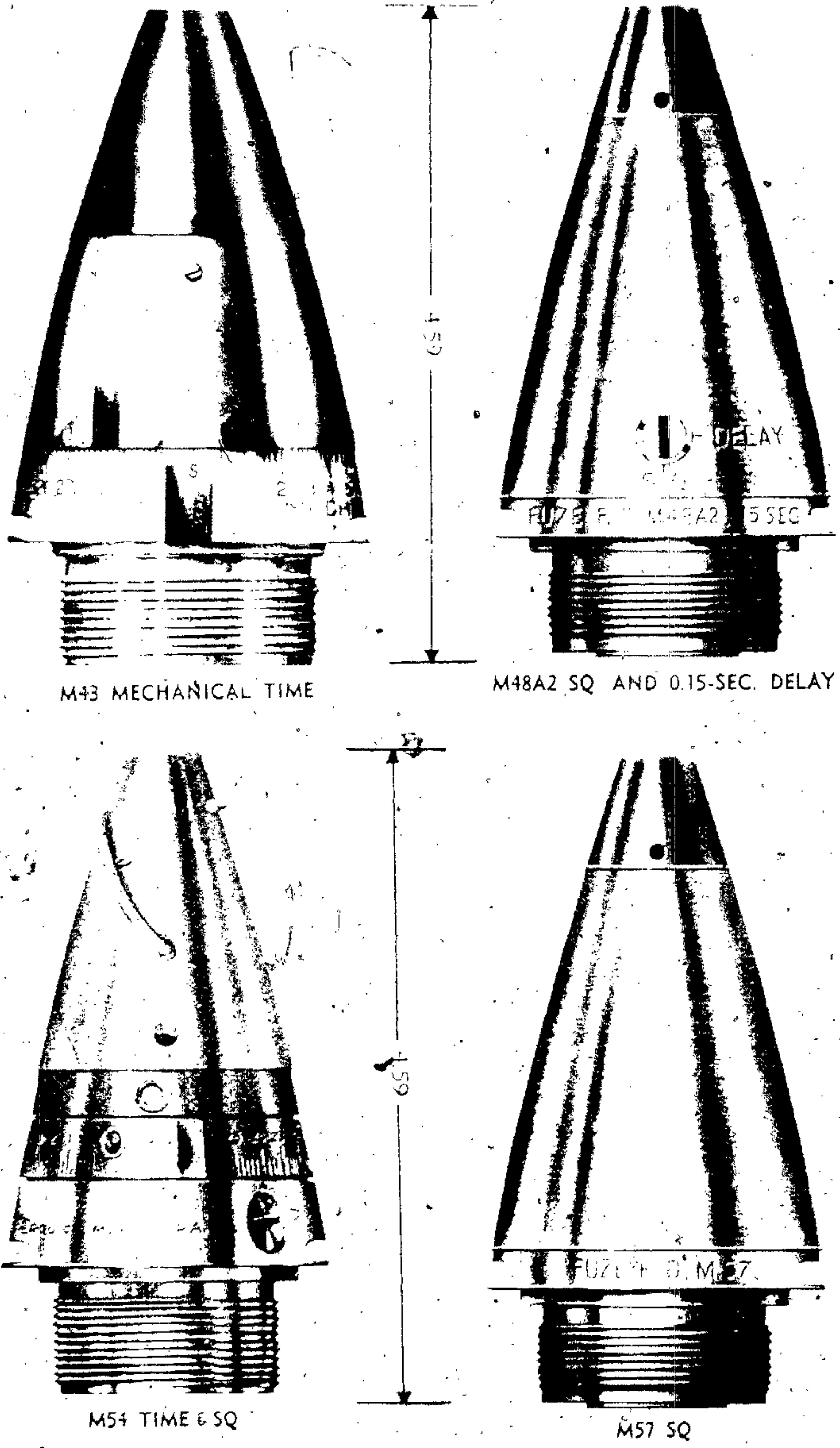

RA PD 89326A

Figure 63 — Fuzes for Fixed and Semifixed Ammunition

Classes of Ammunition

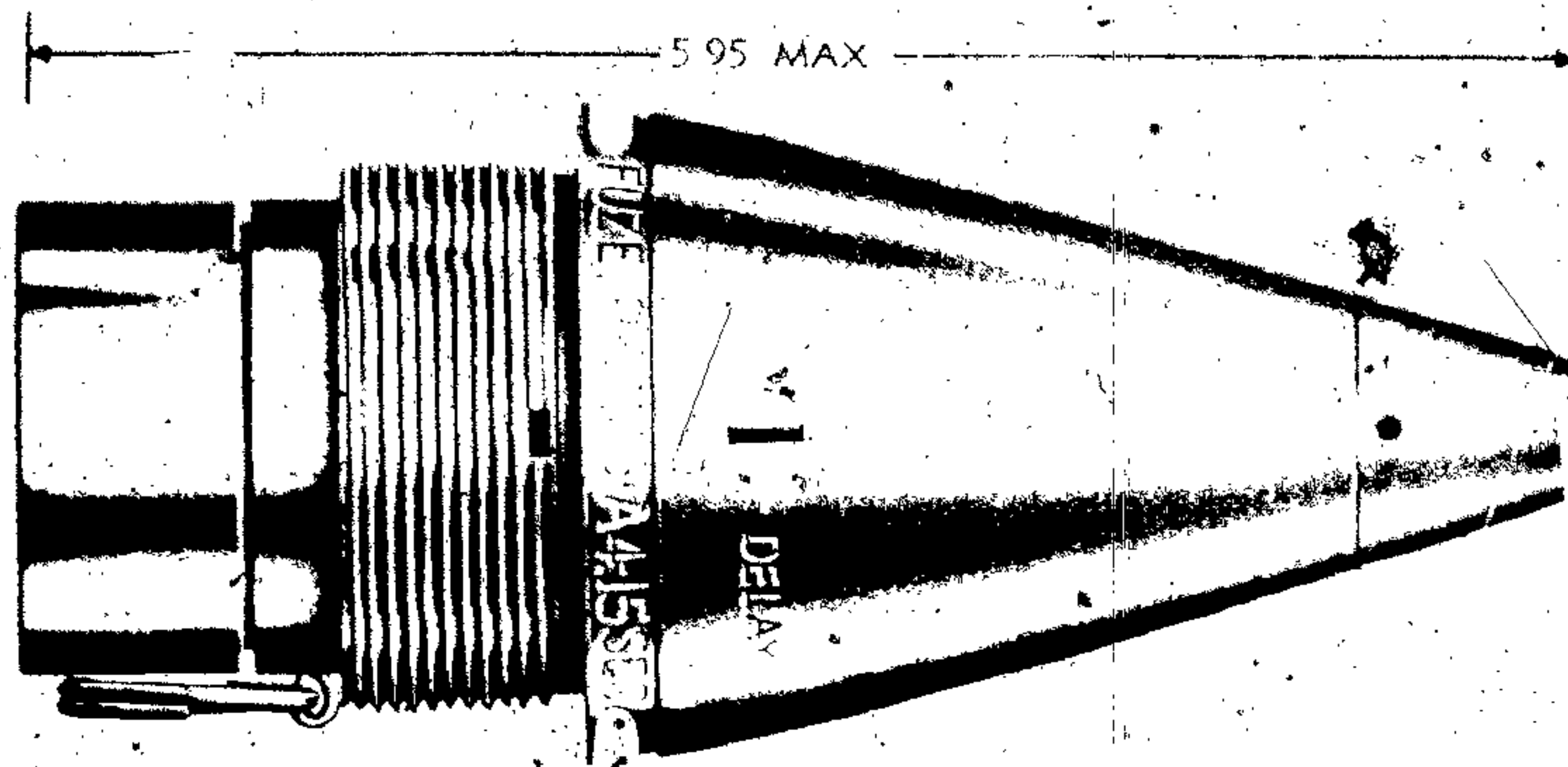

MSTAF PD FUZE 15 SEC DELAY

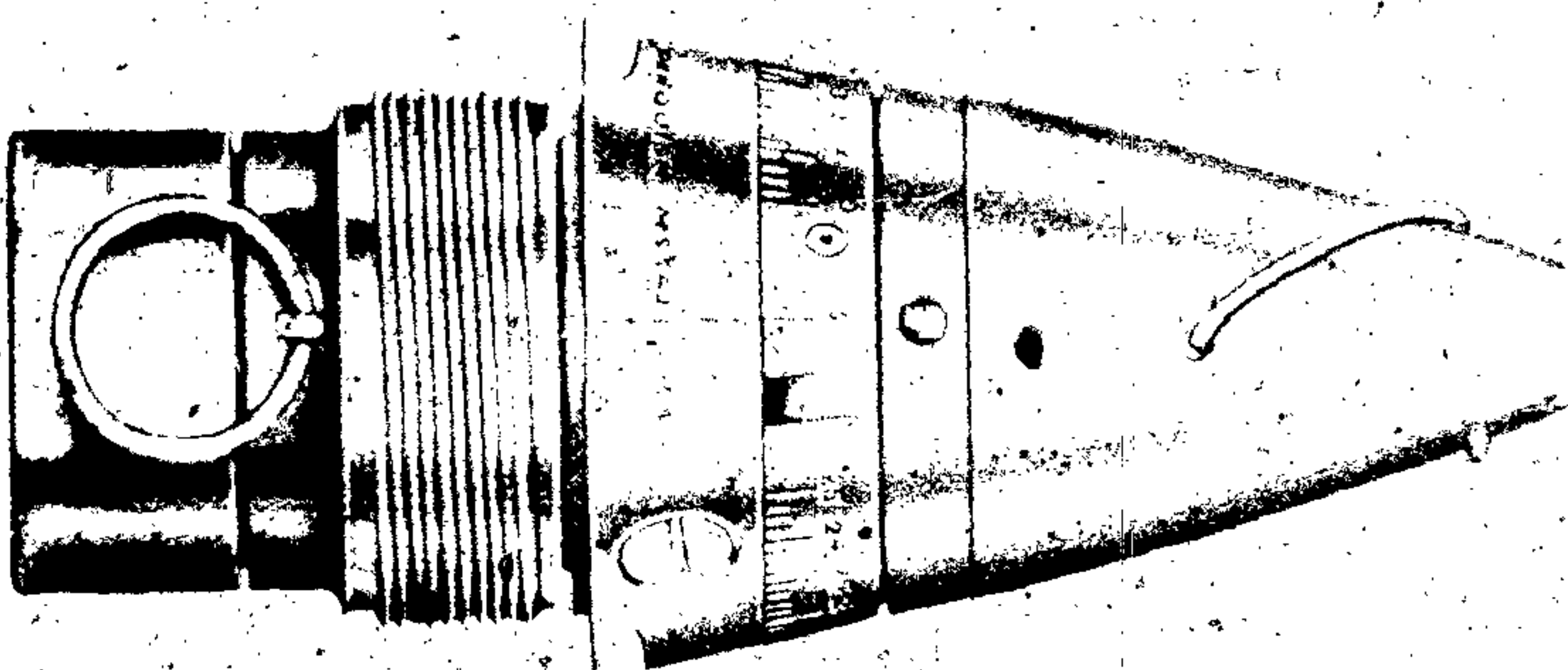

M55A3 150 FUZE

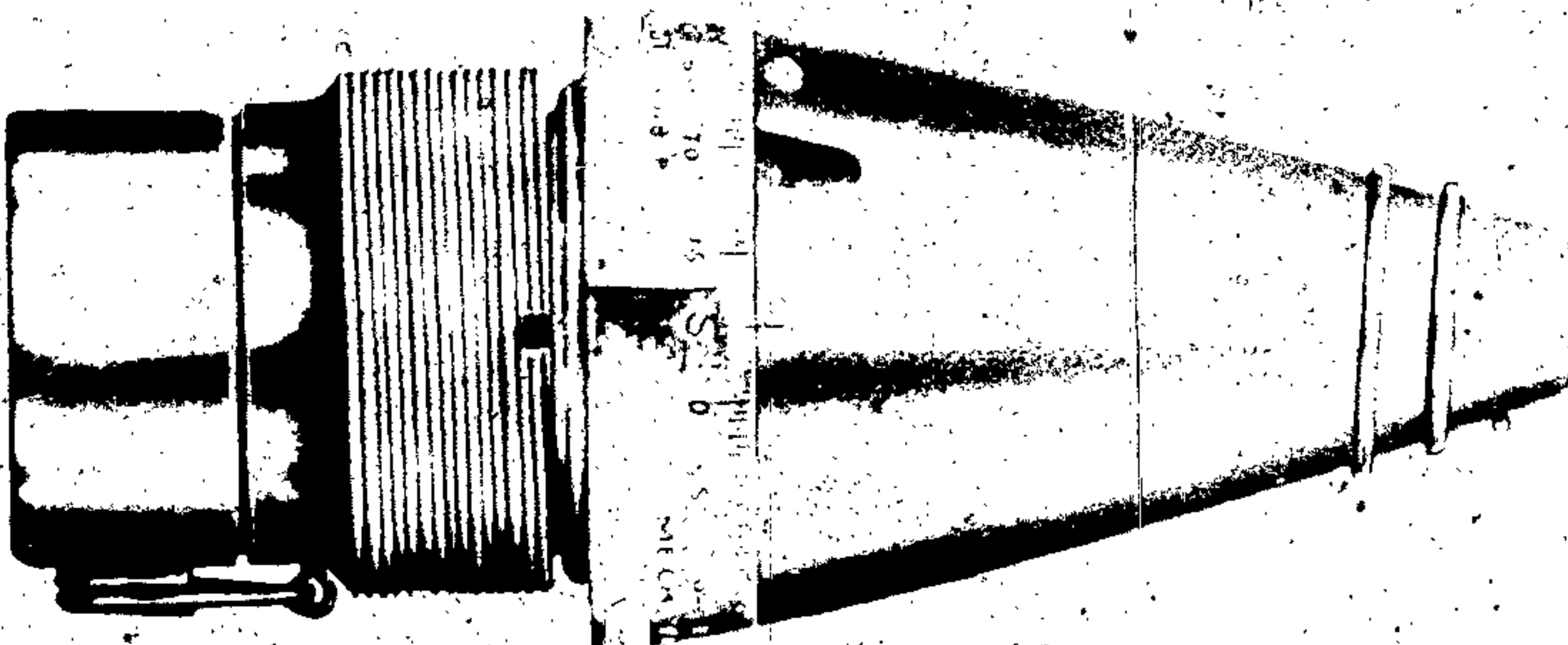

M67A3 MECHANICAL TIME FUZE

RA PD 89322A

Figure 64 - Fuzes for Separate-loading Ammunition



Classes of Ammunition

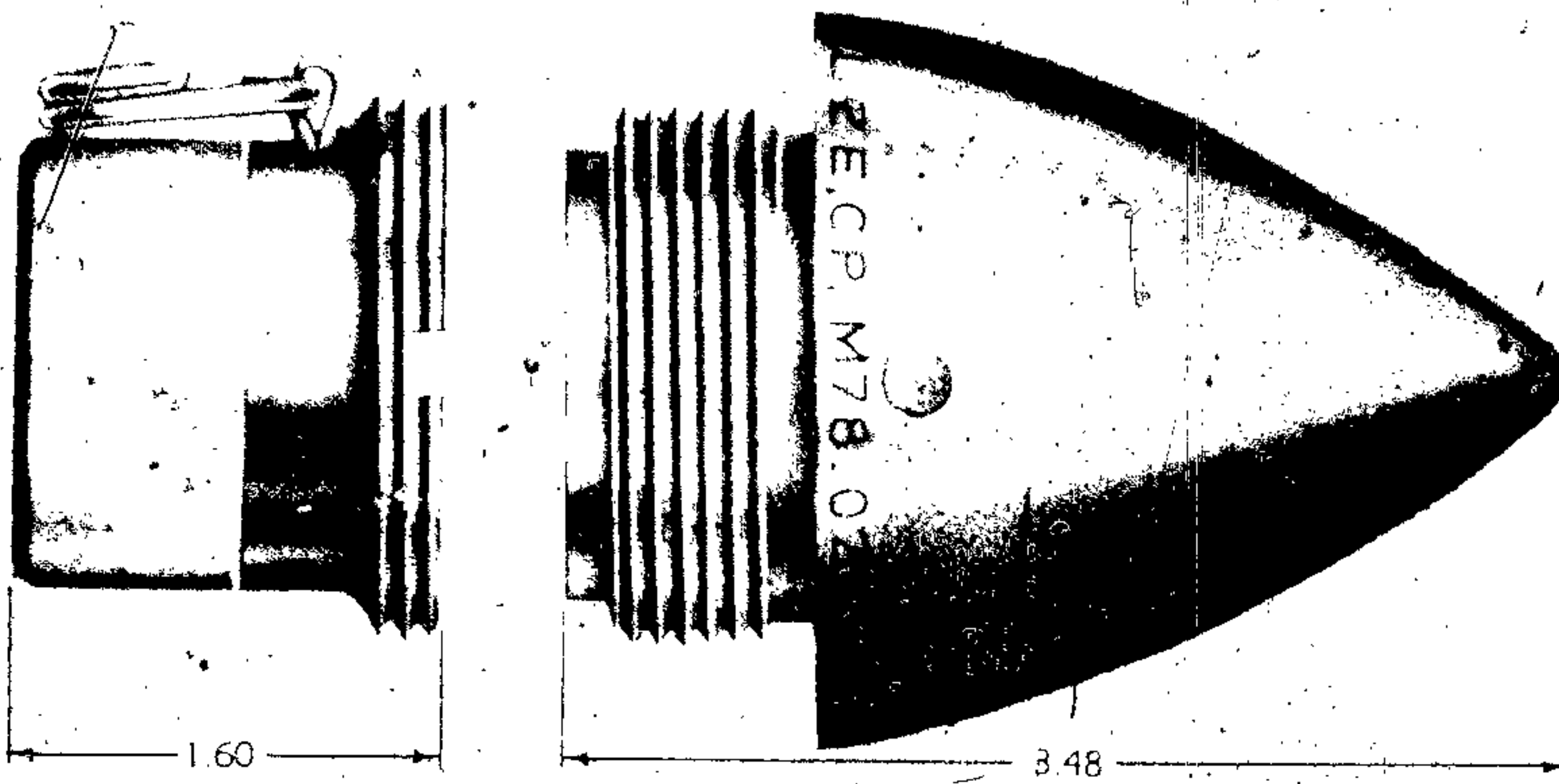

RA PD 104830

Figure 65 — Booster M25 and Concrete-piercing Fuze M78

malfunction.

(3) Fuzes of the impact type are armed by centrifugal or set-back force, or a combination of both, acting on parts of the fuze after the projectile leaves the muzzle of the gun. The time element of time fuzes is initiated at the instant of firing by set-back (that is, the effect of inertia). To prevent accidental arming in handling and shipping, safety devices such as a safety wire or cotter pin may be used. Such safety devices must be removed before firing.

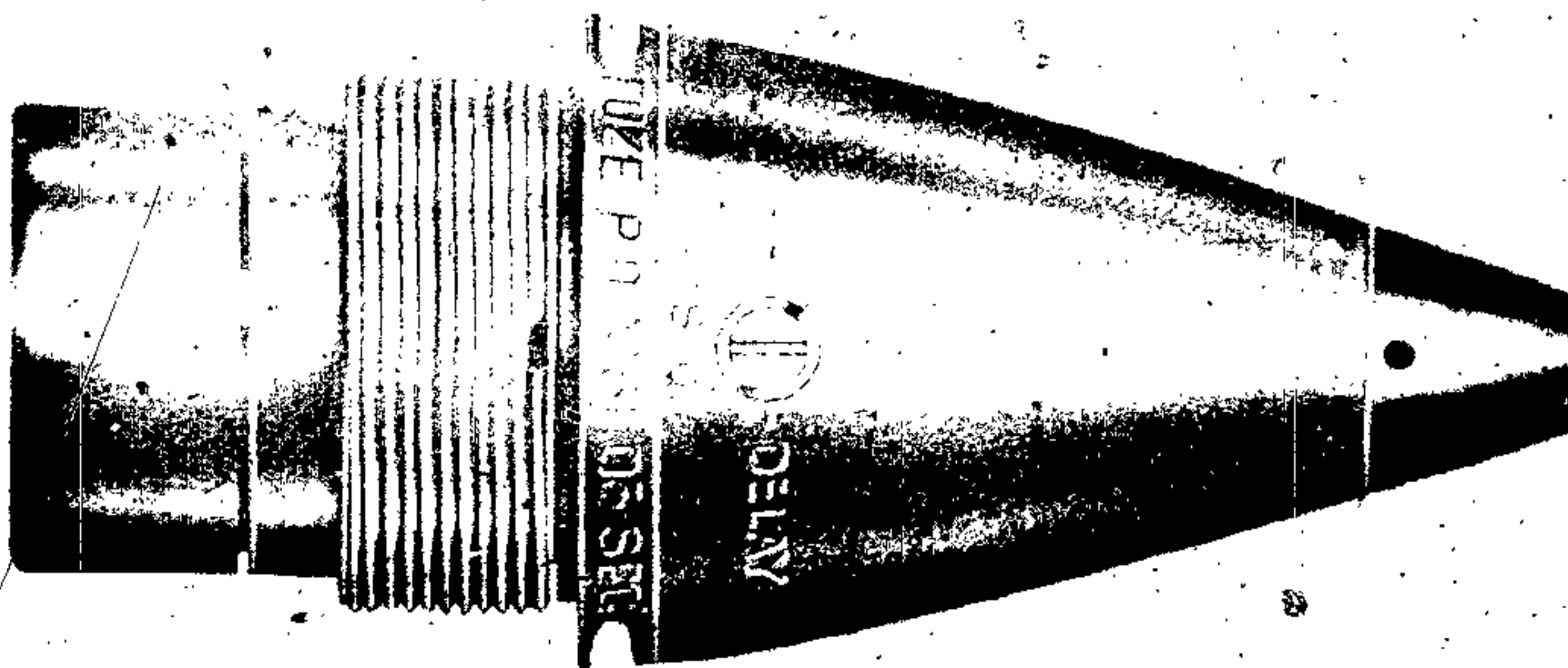

RA PD 104831

Figure 66 — Rocket Fuze M81

---

*Classes of Ammunition*

---

**102. ADAPTERS AND BOOSTERS.**

a. **Adapters.** In chemical shell and in many high-explosive shell of large caliber, openings in the nose are considerably larger than required by the fuzes in order to facilitate the manufacture and loading of the projectiles. For such shell, a suitably threaded metal bushing, called an adapter, is necessary to reduce the size of the opening to conform to the threaded portion of the fuze. In chemical shell, the adapter has an additional function, that of providing a gas-tight seal for the chemical filler.

b. **Boosters.** The term "booster" is applied to the explosive element in the bursting-charge explosive train which detonates the main charge. The booster contains safety devices to prevent premature detonation of the main charge. The booster charge may be incorporated within the fuze itself. It is usually contained in a thin metal or plastic casing which is assembled to and handled as a unit with the fuze. It may be inserted in the shell during loading.

c. **Bursters.** An auxiliary explosive element in burster-type chemical shell, which opens the shell and disperses the chemical agent, is called a "burster." It consists of a burster charge, a container for the charge, and a metal head. The burster as used is contained in a burster casing in the shell.

d. **Adapter-boosters.** In some cases, the booster has been combined with the adapter, the two assemblies thereafter being handled as a unit. Such combinations are known as adapter-boosters. Adapter-boosters are not extensively used in present-day artillery shell.

**103. PROPELLING CHARGES.****a. General.**

(1) In general, propelling charges consist of a charge of a propellant, with an igniter charge of black powder, assembled in a suitable cartridge case, cloth bag, or both.

(2) **PROPELLENT POWDER.** Propellants are described in chapter 1, section IV.

(3) **IGNITER CHARGE.** In fixed and semifixed rounds, the igniter charge of black powder is present in the artillery primer. In "separated" ammunition an auxiliary igniter charge is placed around the primer or on the distance wadding to insure proper ignition of the propellant. In separate-loading rounds, the igniter charge is assembled in an igniter bag sewed to the base end of the propelling charge and in some cases also forming a core running through the center of the propelling charge bag. Cartridge-igniter pads are made of closely woven silk to prevent the black powder from sifting through. Cloth of current manufacture used for the igniter charge is dyed red to indicate the presence of the black-powder igniter. That of earlier manufacture (undyed) is marked "IGNITER."



Classes of Ammunition

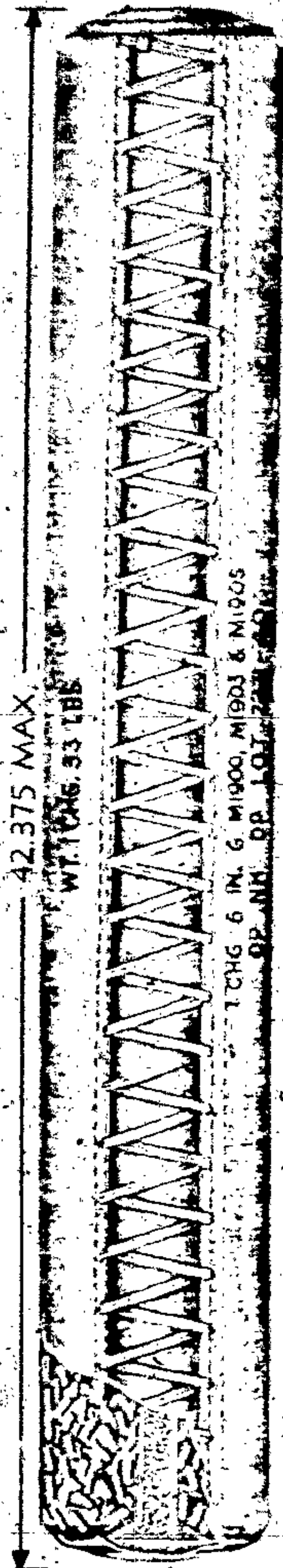

SINGLE SECTION



EQUAL SECTION



UNEQUAL SECTION

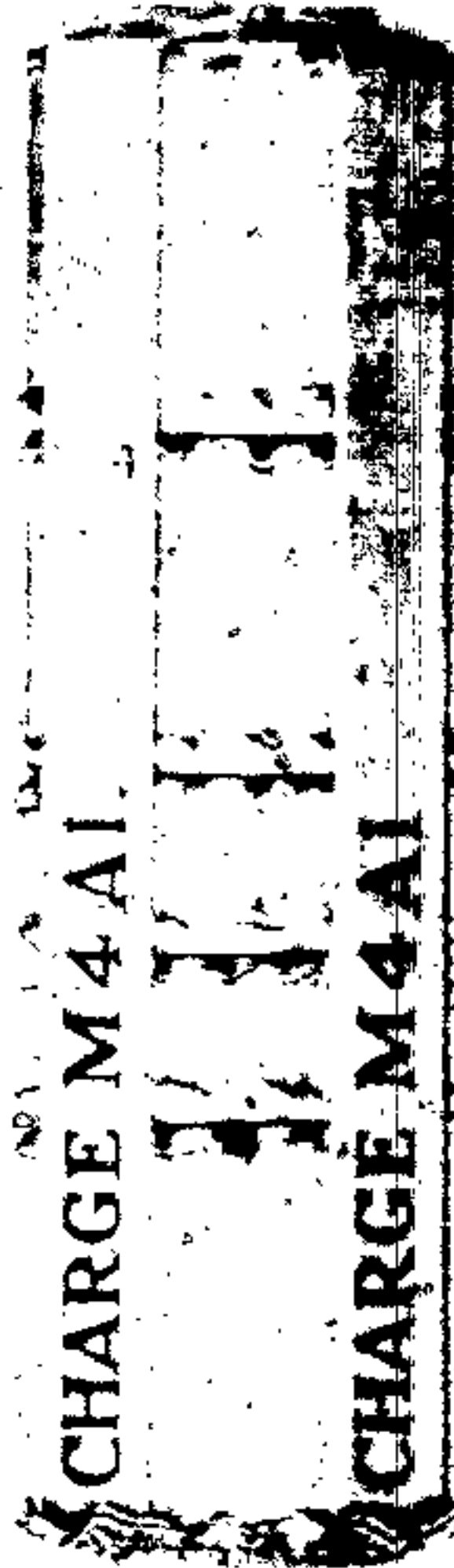

BASE AND INCREMENT SECTION

MULTI SECTION

Figure 67 --Types of Separate-loading Propelling Charges

RA PD 89320

## Classes of Ammunition

(4) **TYPES OF PROPELLING CHARGE.** The type of propelling charge depends upon the kind of ammunition, that is: fixed, semi-fixed, and separate-loading.

**b. Fixed and semifixed charges.**

(1) **CARTRIDGE CASE.** A cartridge case, made of drawn brass or steel, serves as the container for the propelling charge in the case of fixed and semifixed artillery ammunition. Its profile and size conform to that of the powder chamber of the weapon for which the case is intended. The head of the case is relatively thick and has a flange or groove to permit mechanical extraction. Rounds used in automatic guns have cartridge cases with an extracting groove instead of a flange or rim. The cartridge case holds the primer, propelling charge, and the projectile so that the assembly can be inserted into the weapon in one operation. It also provides for obturation, that is, it expands under the pressure of the burning propellant gases and prevents the escape of gas to the rear.

(2) **PROPELLING CHARGE IN FIXED AMMUNITION.** The propelling charge in a round of fixed ammunition is packed loosely in the cartridge case. In some instances where the charge does not fill the case completely, a spacer or distance wadding, usually a cardboard disk and cylinder, is inserted in the neck of the cartridge case, between the powder charge and the base of the projectile.

(3) **PROPELLING CHARGE IN SEMIFIXED AMMUNITION.** In semifixed artillery ammunition, the charge, divided into parts or increments for zone firing, is assembled in several cloth bags. The full charge with all increments in proper order, is assembled in the cartridge case, which is a free fit over the end of the projectile. Each increment is numbered, the base charge being numbered "1." Thus, to arrange a propelling charge in proper order for firing charge 4, the increments would be arranged in the order 1, 2, 3, and 4, increment 4 being placed uppermost.

**c. "Separated" ammunition propelling charge.** This propelling charge is contained in a cartridge case, together with the primer. The charge consists of propellant powder, loosely loaded in a brass cartridge case which is closed by a plug. It will be noted that this ammunition is considered to be separate-loading.

**d. Separate-loading charges (fig. 67).**

(1) **CARTRIDGE BAGS.** Cartridge bags form a suitable and convenient means of containing the smokeless-powder charge in separate-loading ammunition. Cotton cloth is the standard material for cartridge bags.

(2) **SINGLE-SECTION CHARGES.** Separate-loading propelling charges are divided into single-section and multisection charges. In the single-section charge, the propellant powder is contained in a single



# TM 9-1900

DEPARTMENT TECHNICAL MANUAL

F O R T S

TM 9-1900

## AMMUNITION, GENERAL

FORWARD

CHAPTERS

BBV

**RESTRICTED. DISSEMINATION OF RESTRICTED MATTER.**  
No person is entitled solely by virtue of his grade or position to knowledge or possession of classified matter. Such matter is entrusted only to those individuals whose official duties require such knowledge or possession. (See also paragraph 23c AR 360-5, 15 March 1944.)

DEPARTMENT

18 JUN

### Classes of Ammunition

bag, tightly laced or wrapped to give the charge rigidity. The igniting and end igniting charge is divided into three parts, each in its own bag, two end pads, and a core which extends axially through the center of the charge and connects the igniter pads sewed to each end. This type of igniter is termed a "core igniter."

(3) **MULTISECTION CHARGES.** Multisection charges permit the gun crew to vary the size of the propelling charge and facilitate handling the larger and heavier charges. Multisection charges are subdivided into "base and increment," "equal section," and "unequal section" types.

(a) *Base and increment.* This type of propelling charge consists of a base section or charge and one or more increments. The increments may be of equal or unequal weight. Whereas the base section is always fired, the increments may or may not be fired. With some types, one igniter pad is attached to the base end of the base section only, while other types have a core-type igniter in the base section and sometimes in one or more increments as well.

(b) *Equal section.* In this type, the sections are equal in size and weight. It was formerly known as the "aliquot part" charge. It is used in 14-inch gun ammunition and for other, larger-caliber weapons.

(c) *Unequal section.* In the case of certain howitzers, the charge is made up in unequal sections. In the case of guns, the charge may be made up of several equal sections and two or more unequal sections. This type permits firings at reduced velocities and provides the maximum flexibility.

(4) **COLOR.** In certain cases two base and increment charges are provided for one howitzer—one for inner, the other for outer zones of fire. The cloth of the bags for the inner zones is dyed green to distinguish that charge from the other type which is assembled in undyed (white) bags. Accordingly, these two types of charges are called "green bag" and "white bag" charges (fig. 6).

(5) **STACKED CHARGES.** In order that certain long propelling charges will have more rigidity, the grains of powder are arranged or stacked in uniform order and direction. These charges, having the grains with their long axis parallel to the longitudinal axis of the charges, are said to be "stacked."

(6) **FLASH REDUCERS.** Flash reducers are used with propelling charges during night firing. These devices greatly reduce the flash and thereby impede enemy observation of gun positions. The flash reducer developed for the 155-mm guns (fig. 68) consists of two scarlet-dyed cotton strips which are linked together with silk strings. Each strip contains three channels which are filled with chemicals. Two outside channels of each strip contain a mixture of 60 percent potassium sulfate and 40 percent black powder. The center channel contains only black powder. When tied around the charge, the



## Classes of Ammunition

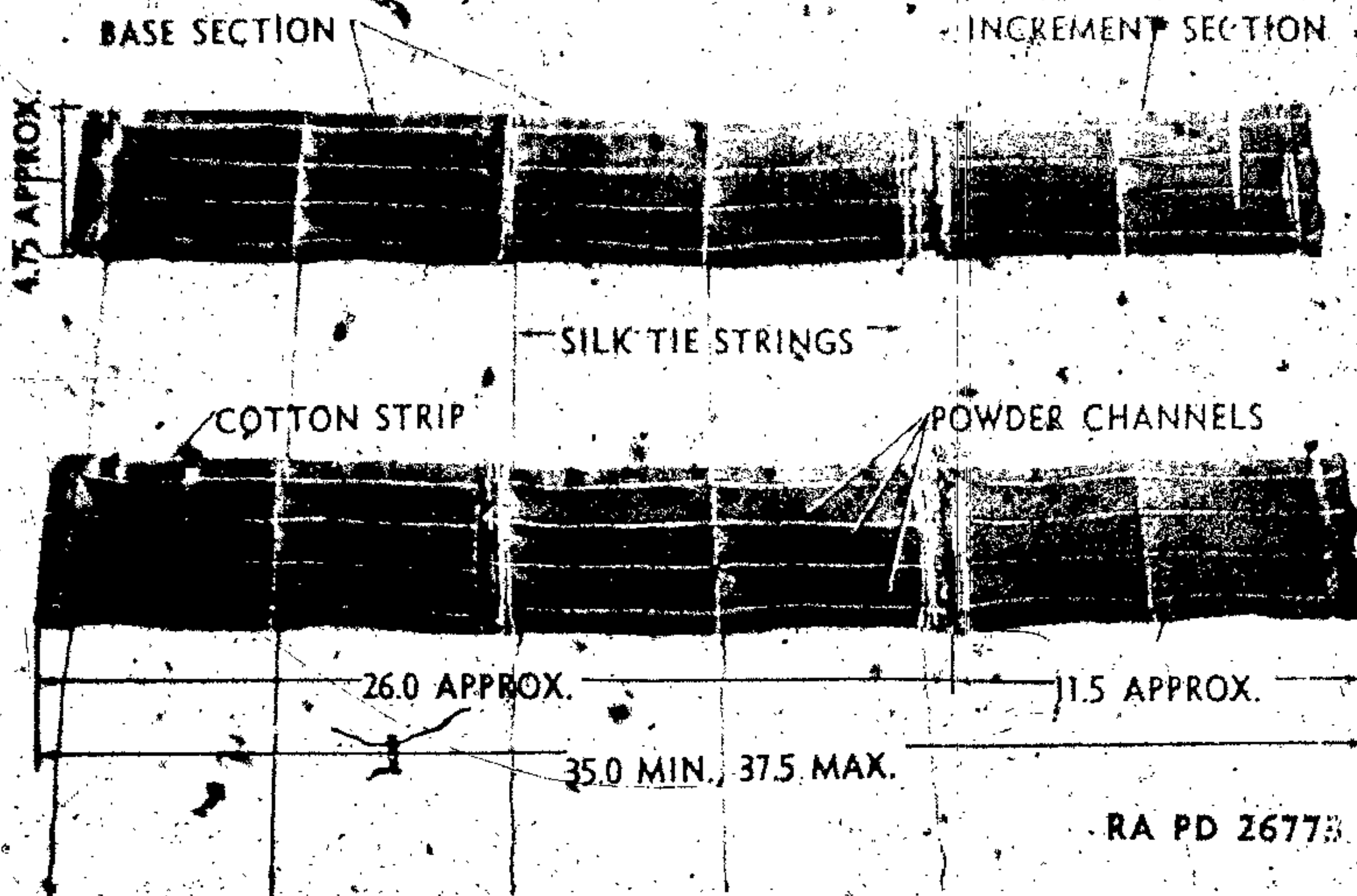

Figure 68 — Flash Reducer for Propelling Charges for 155-mm Guns

strips are opposite each other. Flash reducers are made to fit a specific propelling charge. The use of flash reducers slightly increase the muzzle velocity; therefore, the proper correction must be applied when computing range data during firing.

(7) DUMMY CHARGES. Dummy charges, simulating service charges (fig. 62), are provided for use with drill projectiles to train personnel in "service of the piece."

#### 104. PRIMERS.

a. **General.** A primer is the component used to initiate the combustion of a propelling charge. Artillery primers (fig. 69) consist essentially of a small quantity of sensitive explosive and a charge of black powder, encased in a metal container. In the case of fixed and semifixed ammunition, the primer is forced into the base of the cartridge case at time of manufacture. In the case of separate-loading ammunition, the primer is inserted by hand into the breechblock of the weapon.

b. **Types.** Based on the method of firing, artillery primers are classified as percussion, electric, combination percussion-electric, friction, and ignition.

c. **Percussion primer.** This type of primer, fired by a blow of the firing pin, is generally used in all artillery ammunition except that for harbor defense and railway artillery. The primers used in

Classes of Ammunition

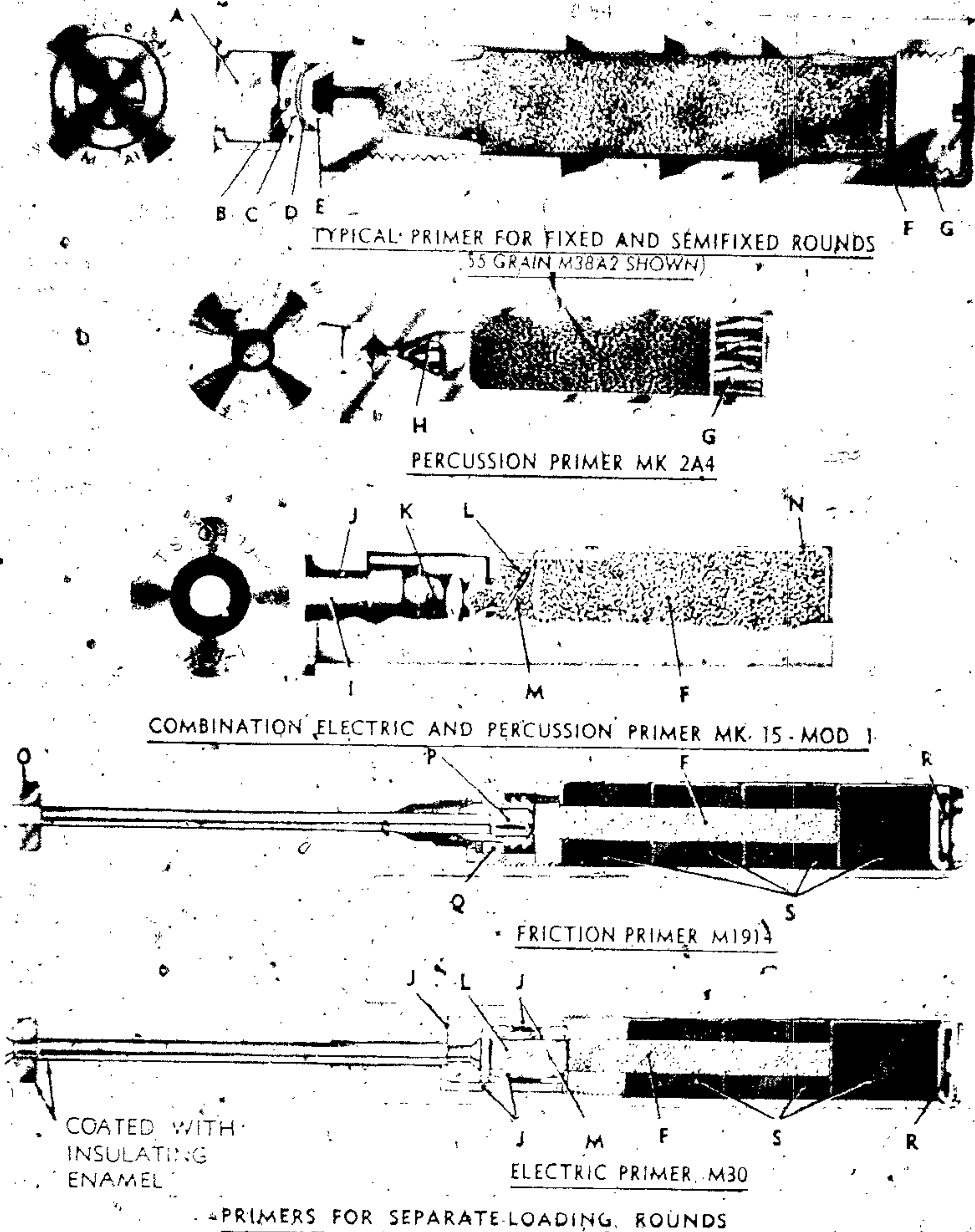

- |                                    |                              |                                  |
|------------------------------------|------------------------------|----------------------------------|
| A — FIRING PLUG                    | H — CONICAL GAS CHECK        | P — SERRATED GAS CHECK           |
| B — PRIMER CUP                     | I — FIRING PLUG              | Q — FRICTION COMPOSITION         |
| C — PERCUSSION ELEMENT CHARGE      | J — INSULATOR                | R — CLOSING CUP                  |
| D — FOILING PAPER                  | K — PLUNGER                  | S — PRESSED BLACK POWDER PELLETS |
| E — ANVIL                          | L — GUN COTTON               |                                  |
| F — IGNITER CHARGE (PRIMER CHARGE) | M — CONTACT OR IGNITION WIRE |                                  |
| G — BODY PLUG                      | N — METALLIC SEAL            |                                  |
|                                    | O — BUTTON                   |                                  |

RA PD 89324A

Figure 69 — Primers — Sectioned



### Classes of Ammunition

cartridge cases contain sufficient black powder to ignite properly the smokeless powder in the cartridge case. Those used with separate-loading propelling charges contain only enough black powder to ignite the black-powder igniter charge attached to the propelling charge.

d. **Electric primer.** This type of primer is fired by the heat generated when an electric current passes through a resistance wire embedded in dry guncotton. It is used only in harbor defense and railway artillery. Although both the friction and electric primers are very similar in appearance, the electric primer is distinguished by black insulation around the contact wire and by a groove machined around the head.

e. **Combination percussion-electric primer.** This primer is fired either electrically or by a blow of the firing pin. It is used only in certain harbor defense and railway artillery.

f. **Friction primer.** This type of primer is fired by the heat generated when a serrated plug is pulled through an explosive composition sensitive to heat or friction. At the present time it is used as a substitute for the electric primer in the event of failure of electric power.

g. **Ignition primers.** The ignition primer, although very similar to the percussion type, differs in that it contains, in lieu of the percussion element, an inert cap with a hole in it. It is intended for use in certain subcaliber ammunition fired by a service primer. The flame from the service primer passes through the hole in the cap of the ignition primer, thus igniting the black-powder charge in the ignition primer.

### 105. BLANK AMMUNITION.

a. **General.** Blank ammunition is provided for cannon of caliber up to and including 105-mm, for practice purposes, for maneuvers, for firing the morning and evening gun, and for saluting.

b. **Complete round.** A complete round of blank ammunition (fig. 70) consists of a cartridge case into which are fitted a percussion primer, a charge of black powder, and a chipboard closing cup sealed in the mount of the case. The cartridge case is usually made by trimming service cartridge cases to the proper length. The black-powder charge in the latest design of blank ammunition consists of a single or double pellet in place of the loose black powder (in bag) formerly used. A hole, into which the primer extends, is left in the center and the pellet is wrapped in cellophane.

106. **POWDER TEMPERATURE INDICATORS.** Powder temperature indicators (fig. 71), used in antiaircraft batteries, enable taking the powder temperatures for ammunition either at battery or in storage at points of supply. They consist of a thermometer

Classes of Ammunition

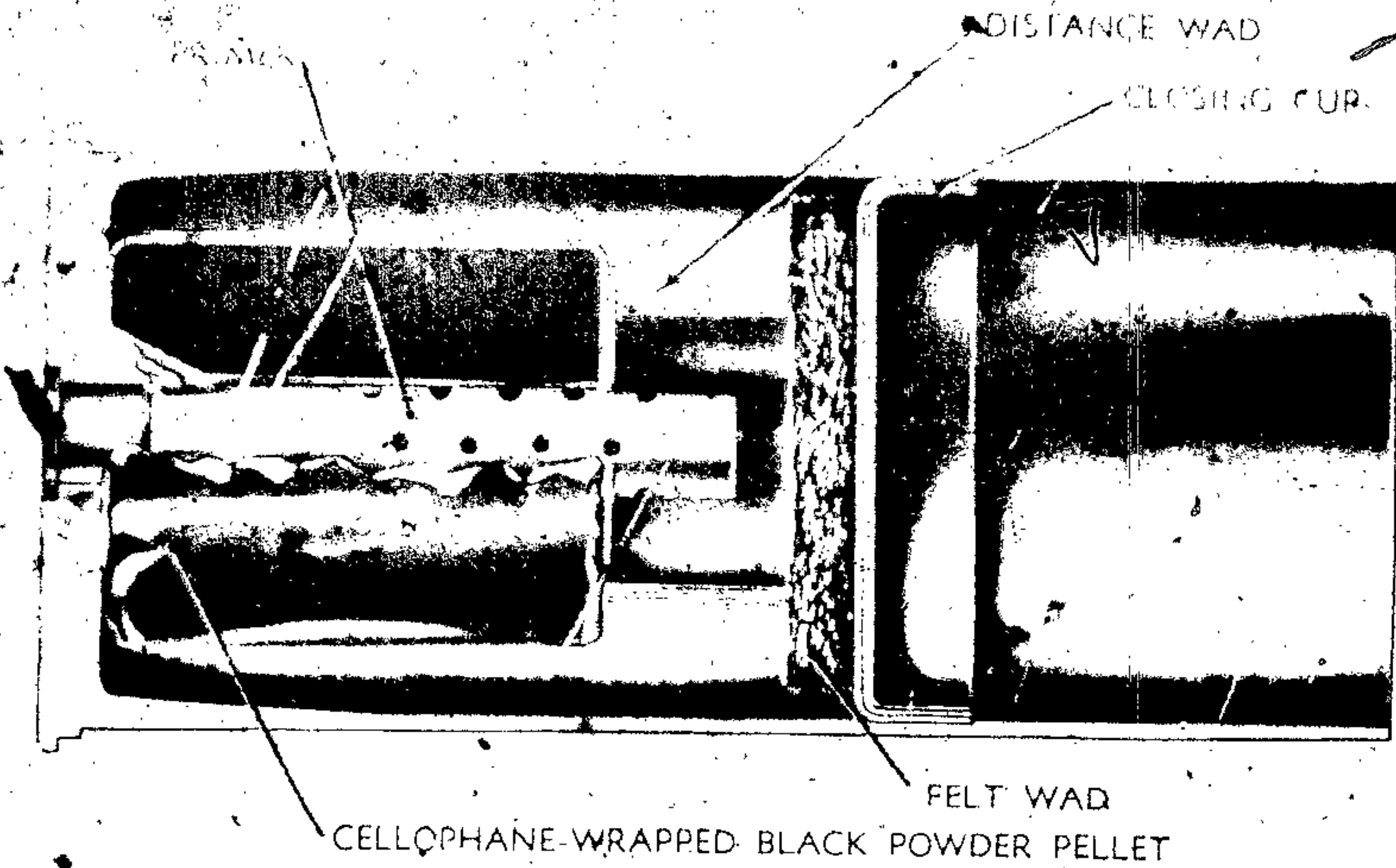

BLANK AMMUNITION (SINGLE PELLET CHARGE), 75-MM GUN OR HOWITZER

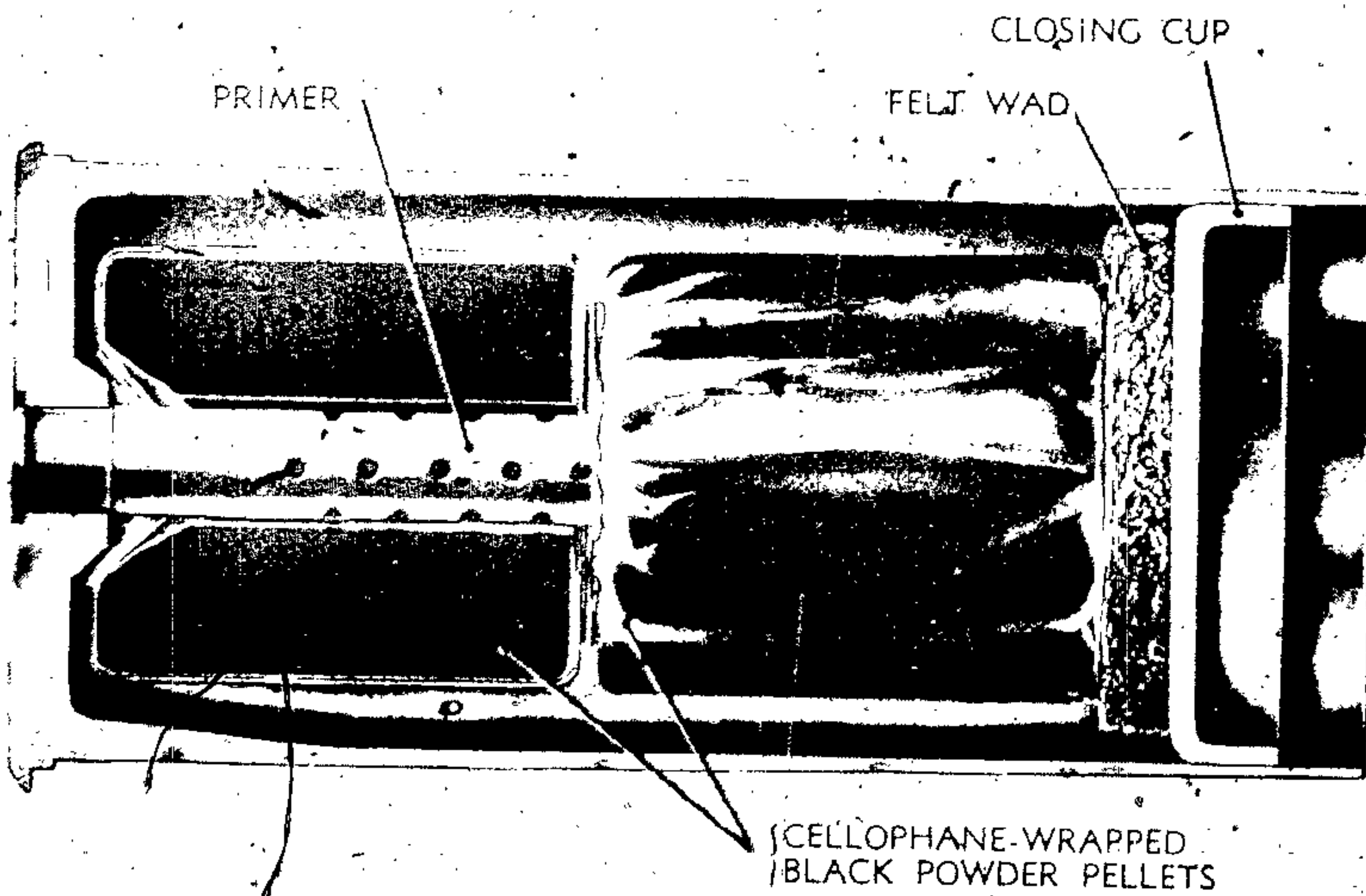

BLANK AMMUNITION (DOUBLE PELLET CHARGE), 75-MM GUN OR HOWITZER

RA PD 89316

Figure 70 - Blank Ammunition - Single and Double Pellets



Classes of Ammunition

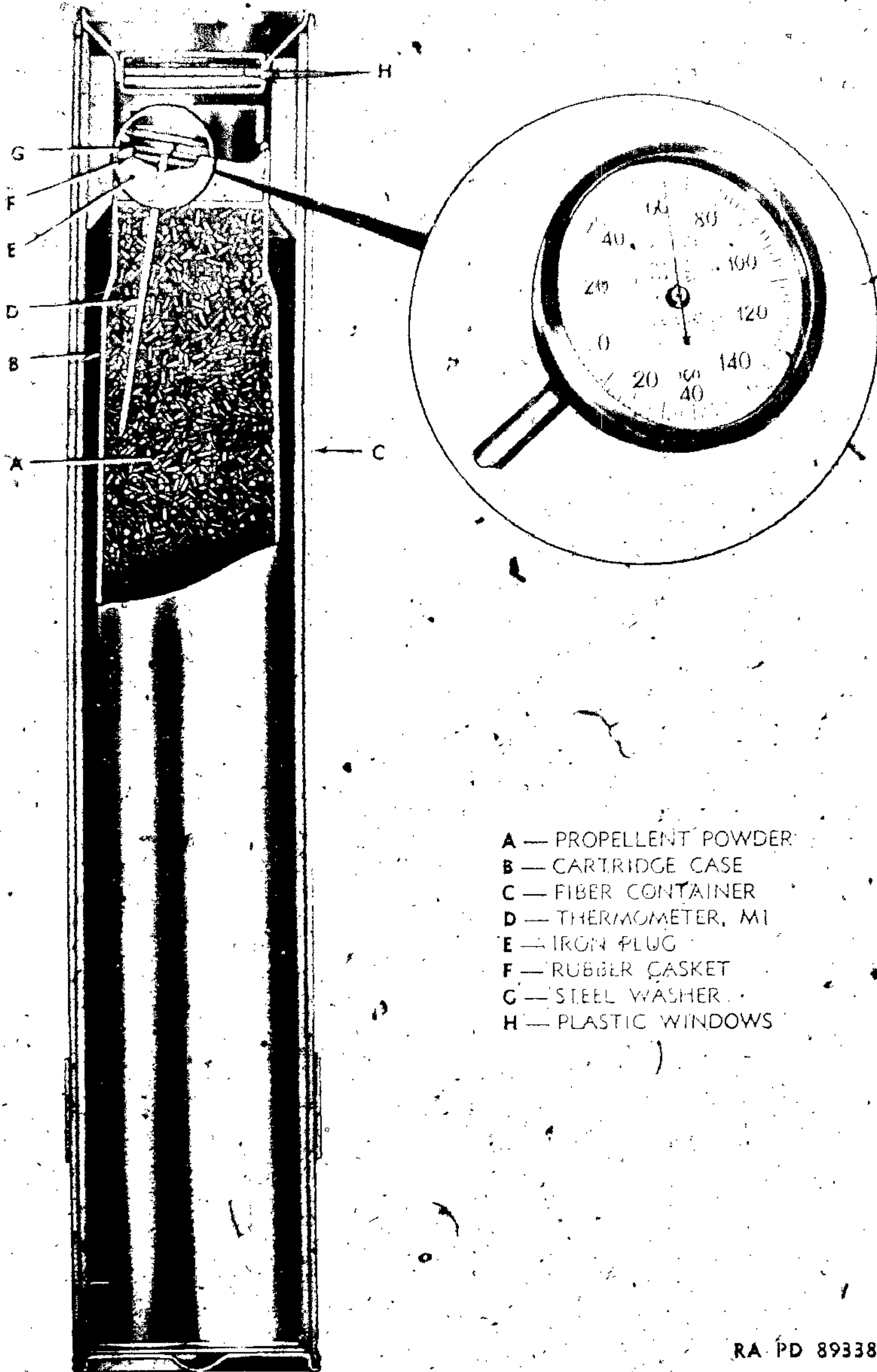

- A — PROPELLENT POWDER
- B — CARTRIDGE CASE
- C — FIBER CONTAINER
- D — THERMOMETER, MI
- E — IRON PLUG
- F — RUBBER GASKET
- G — STEEL WASHER
- H — PLASTIC WINDOWS

RA PD 89338

Figure 71 — Powder-temperature Indicator

Classes of Ammunition

stuck into a powder charge in a service cartridge case which, in turn, is packed in a fiber container. The thermometer can be read through plastic lenses placed in the head of the assembly. They are placed with the lot of ammunition so that the temperature may be noted. Since firing tables are based on the temperature of the powder at 75 F at the time of firing, any deviation from this temperature has to be considered in firing data computations.

**107. CARE AND PRECAUTIONS IN HANDLING.**

a. In addition to the precautions prescribed in chapter 3, the following will be observed:

(1) **PROJECTILES.** Projectiles should be inspected to insure that there is no exudation of the contents, that the bourrelet and rotating band are smooth and free from serious dents or burrs, and that the threads of the adapter are clean. Field artillery projectiles should be clean and free from grease.

(2) **PROPELLANTS.** The propellants of fixed ammunition cannot be readily inspected, but those for other ammunition should be noted when preparing the charge. Make certain that only the proper increments are removed from the adjustable complete charge. There should be no leakage of contents from any of the cartridge bags. For separate-loading ammunition, the tag and igniter pad cover, if present, must be removed prior to loading the charge into the weapon.

(3) **FUZES.** The fuze should be carefully inspected to ascertain that it is properly set, and that no unauthorized removal of parts has been made. No attempt will be made to disassemble fuzes or rounds in the field without specific instructions from the Chief of Ordnance. All separately-issued fuzes should be tightened to the projectile with a fuze wrench. With fixed and semifixed ammunition, the packing stop must be removed from the projectile before firing. Time fuzes which have been set but not fired must be reset at "safe" before being replaced in their containers.

(4) **PRIMERS.** Because of the hygroscopic nature of primers, their container cans should not be opened till necessary. Primers should be inspected particularly for signs of corrosion.

(5) **CARTRIDGE CASES.** Cartridge cases should be carefully inspected for cracks or dents which may affect their functioning or the functioning of the weapon. Badly corroded cartridge cases will increase the difficulty of extraction or may result in split or ruptured cases. Cases with faults which may result in a rupture should not be used. Their use may place a weapon out of action for a considerable period of time while the ruptured case is being removed. With semifixed ammunition, it is important that the mouths of cases not be deformed. If deformed, such a case may be difficult to load and, if loaded, and fired, a serious blow-back may result.



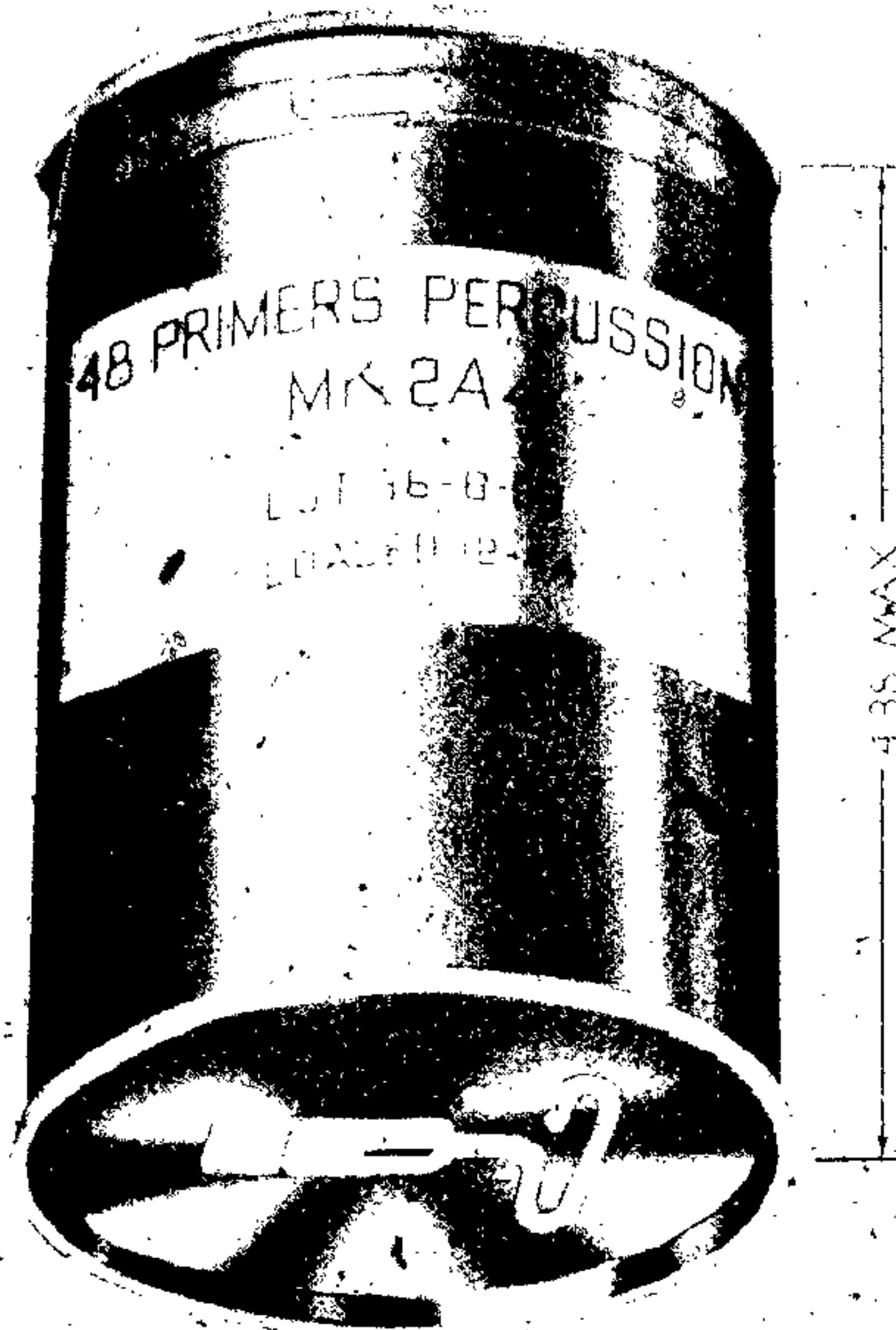

RA PD 104832

Figure 72 - Metal Container for Primers

## 108. PACKING.

a. **General.** Artillery ammunition and components, except separate-loading projectiles, are packed in moisture-resistant fiber containers which are boxed (figs. 73 and 74) or placed in metal containers or in sealed metal cans. Crates may be used for additional protection for certain cartridge-storage cases (metal containers for propelling charges), projectiles having windshields, and dummy projectiles. Some fuzes are now being packed in hermetically sealed cans and then in a wooden box (fig. 76). Separate-loading projectiles are shipped boxed, crated (fig. 75), or uncrated. If uncrated, a grommet is placed around the rotating band and an eyebolt-lifting plug is screwed into the fuze hole (figs. 57 and 58).

b. **Metal containers.** Airtight cylindrical metal containers, known as cartridge-storage cases (fig. 8) are used to pack separate-loading propelling charges. Similar metal containers (figs. 78, 79, 80, and 81) are also used to pack one artillery round, either with or without a fiber container. The metal container has a detachable screen-type cap. To insure compact and tight packing, rubber-felt and cork pads

Classes of Ammunition

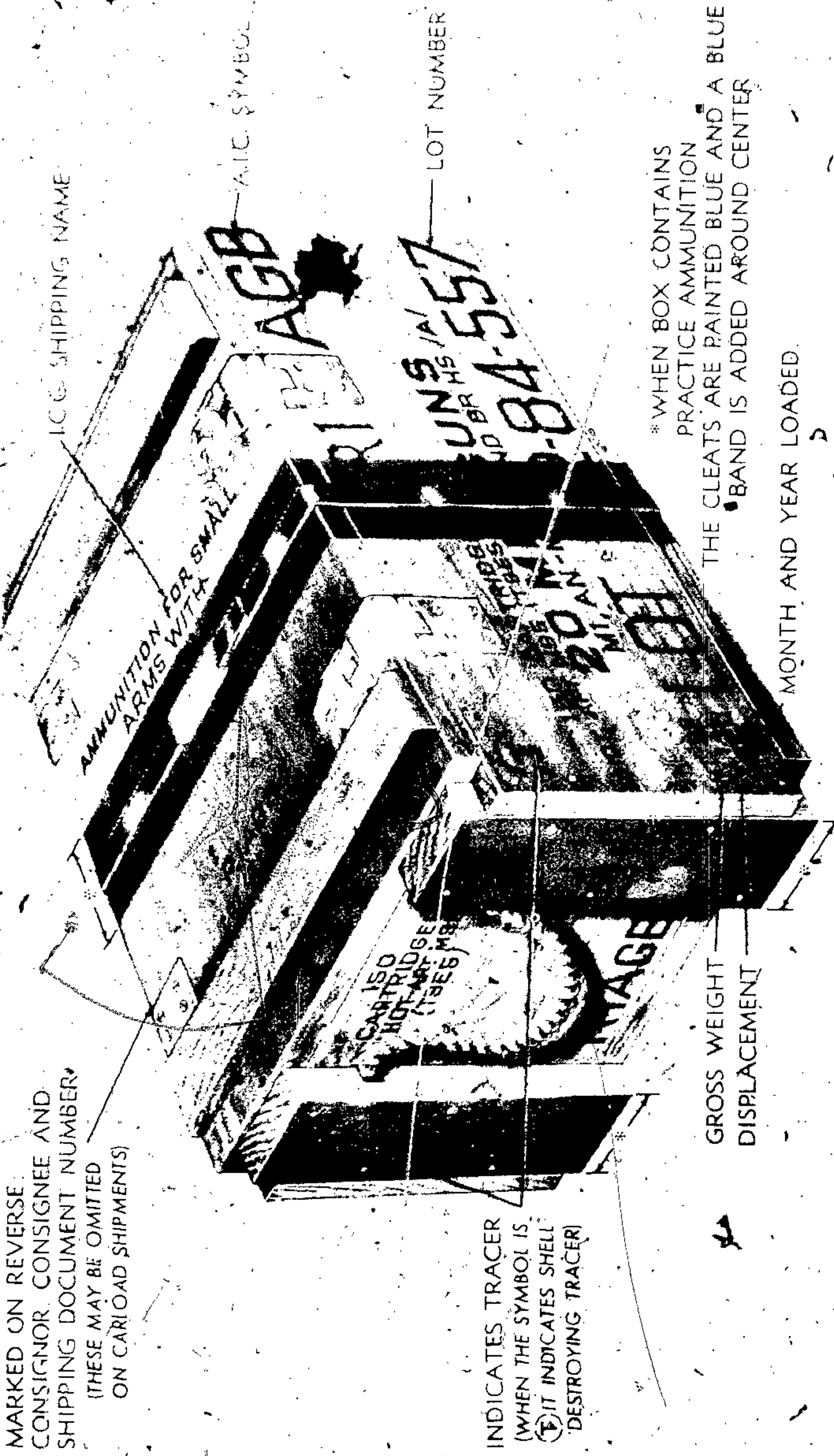
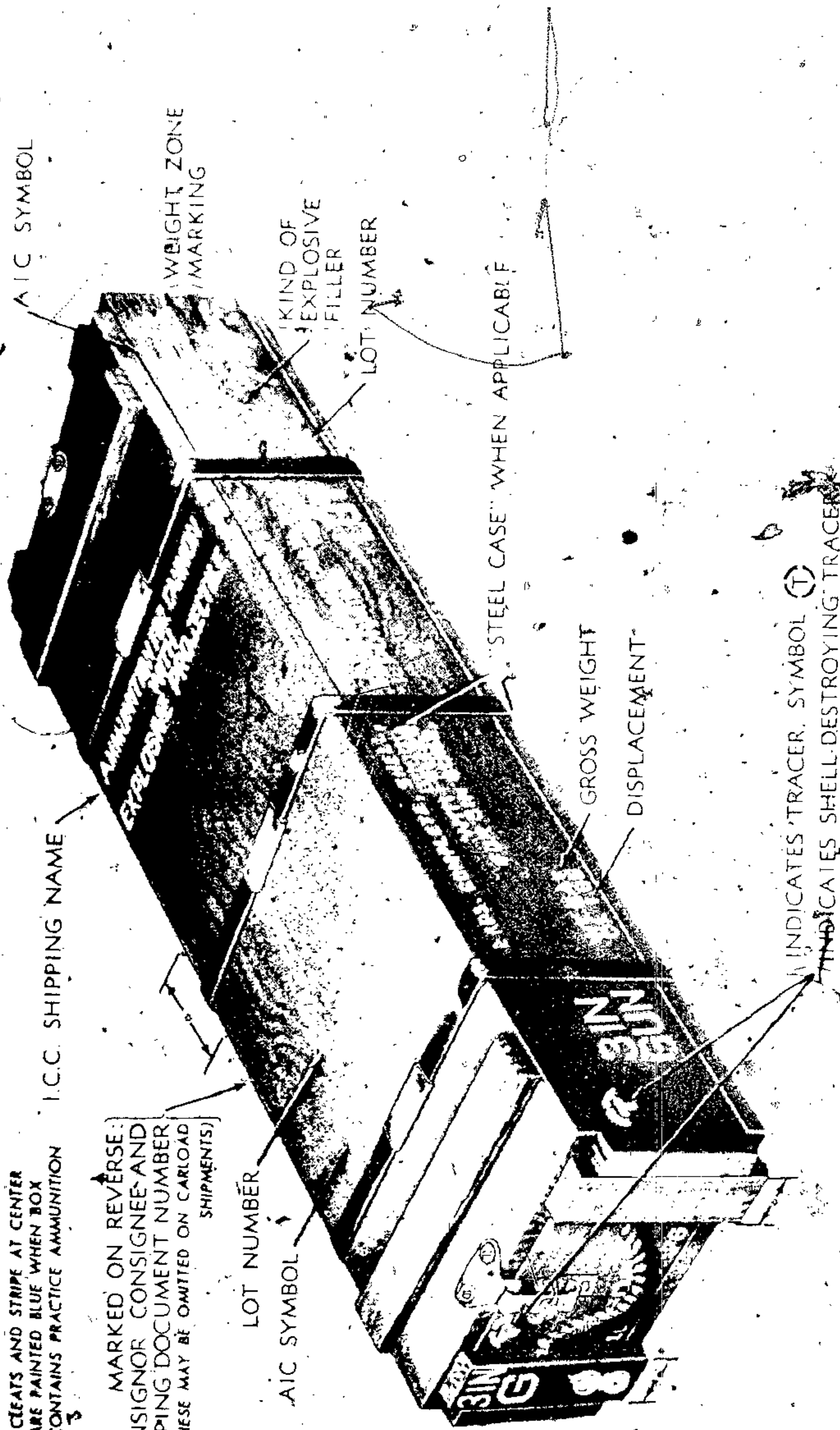

Figure 73 - Typical Packing Box for Small-caliber, Fixed Ammunition



Classes of Ammunition



RA PD 26814A

Figure 74 Typical 2-round Packing Box

Classes of Ammunition

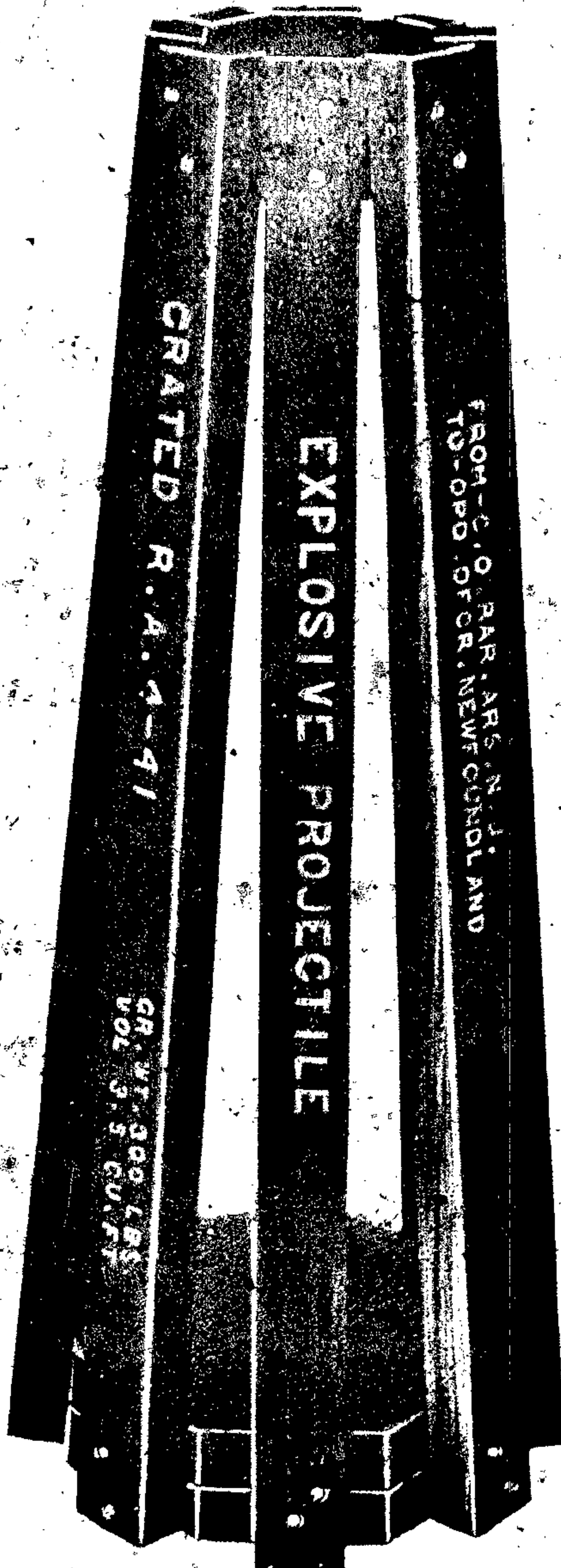

RA PD 80691

Figure 75 — Typical Wooden Packing Crate for Separate-loading Projectile



Classes of Ammunition

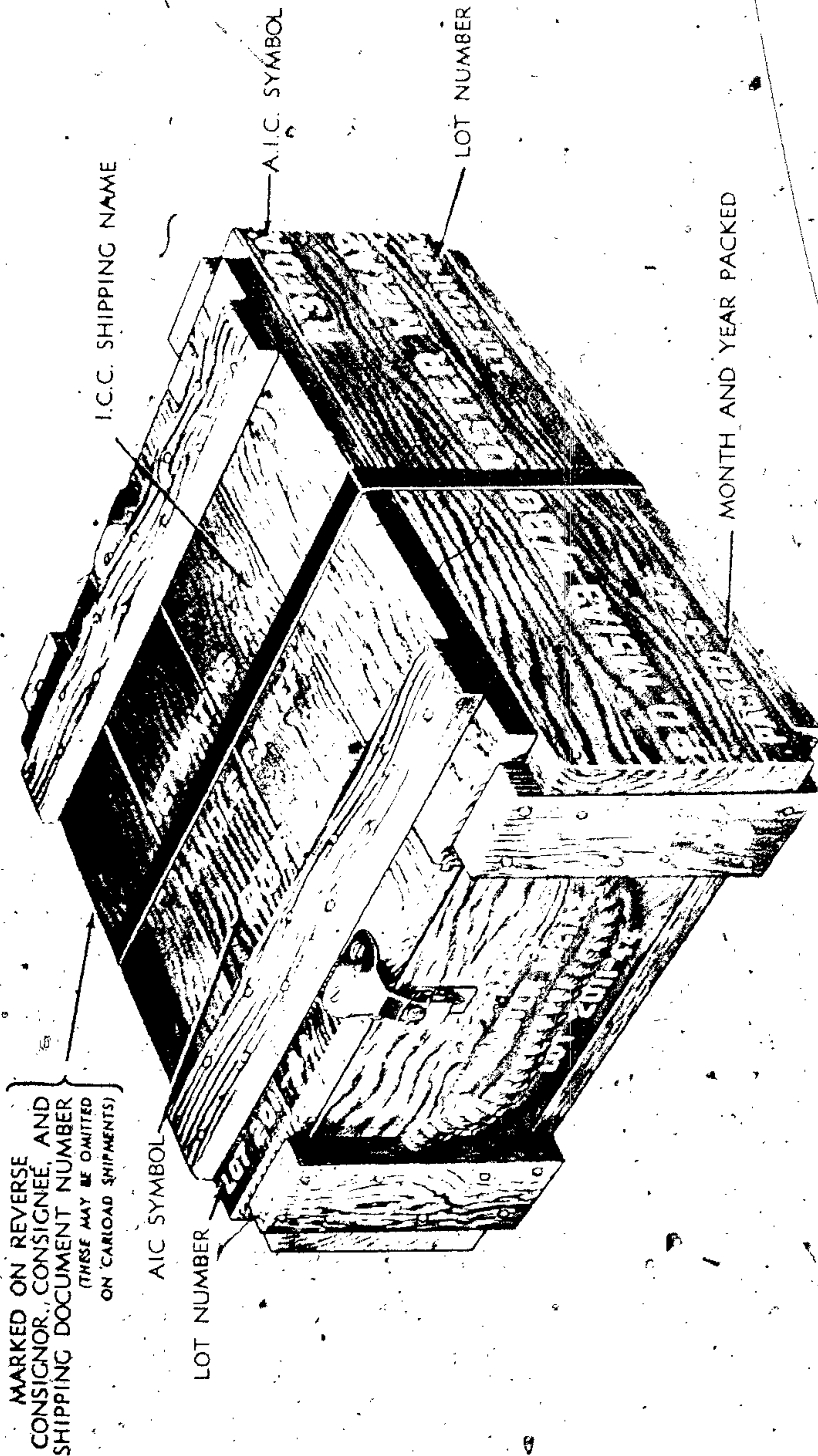

RA PD 65142A

Figure 76 - Typical Packing Box for Fuzes

Classes of Ammunition

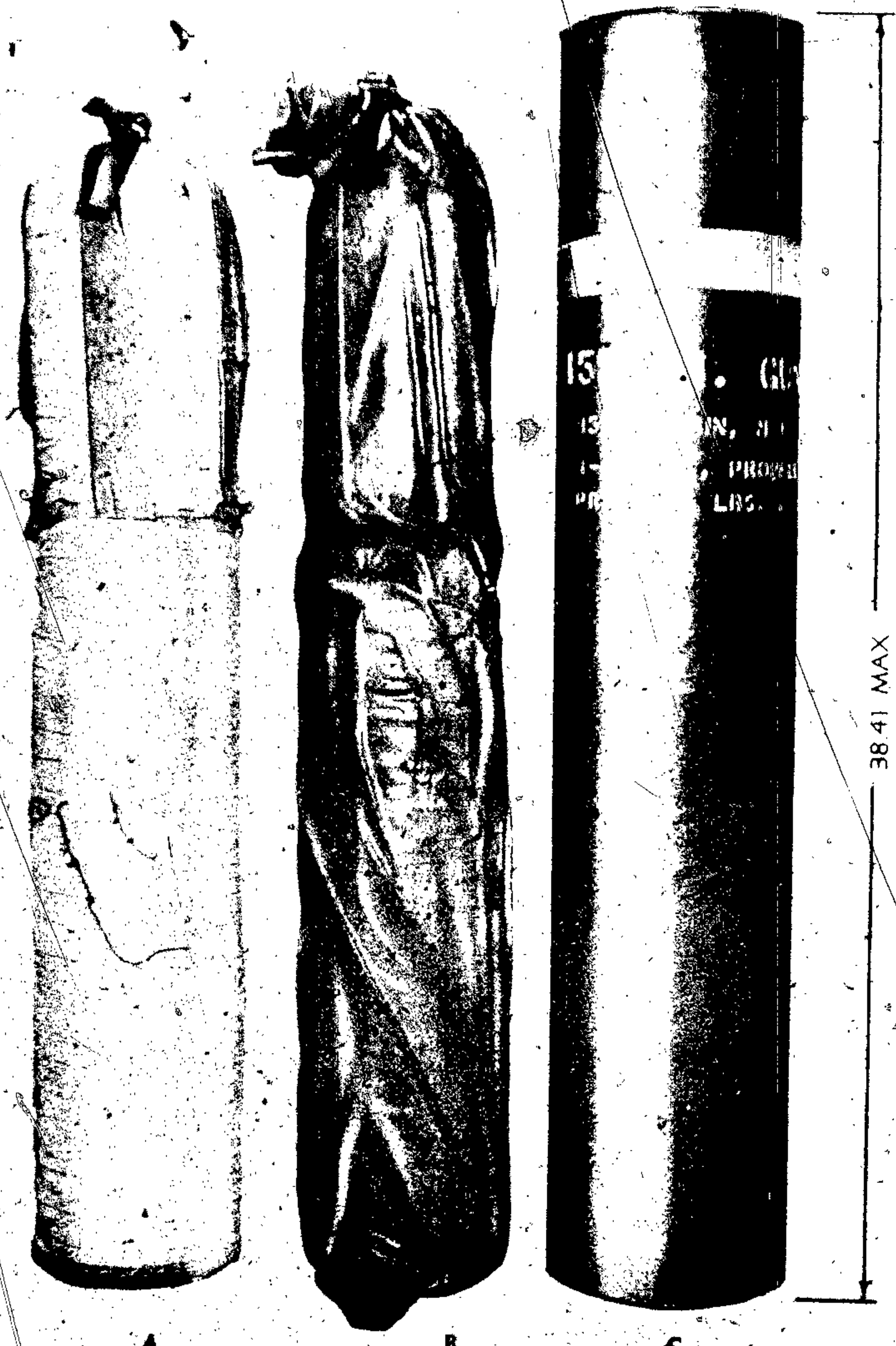

- A — SEPARATE LOADING PROPELLING CHARGE
- B — CHARGE IN WATERPROOF BAG
- C — FIBER CONTAINER - OUTER PACK

RA PD 97755

Figure 77 — Propelling Charge Packed in Waterproof Bag in Fiber Container



*Classes of Ammunition*

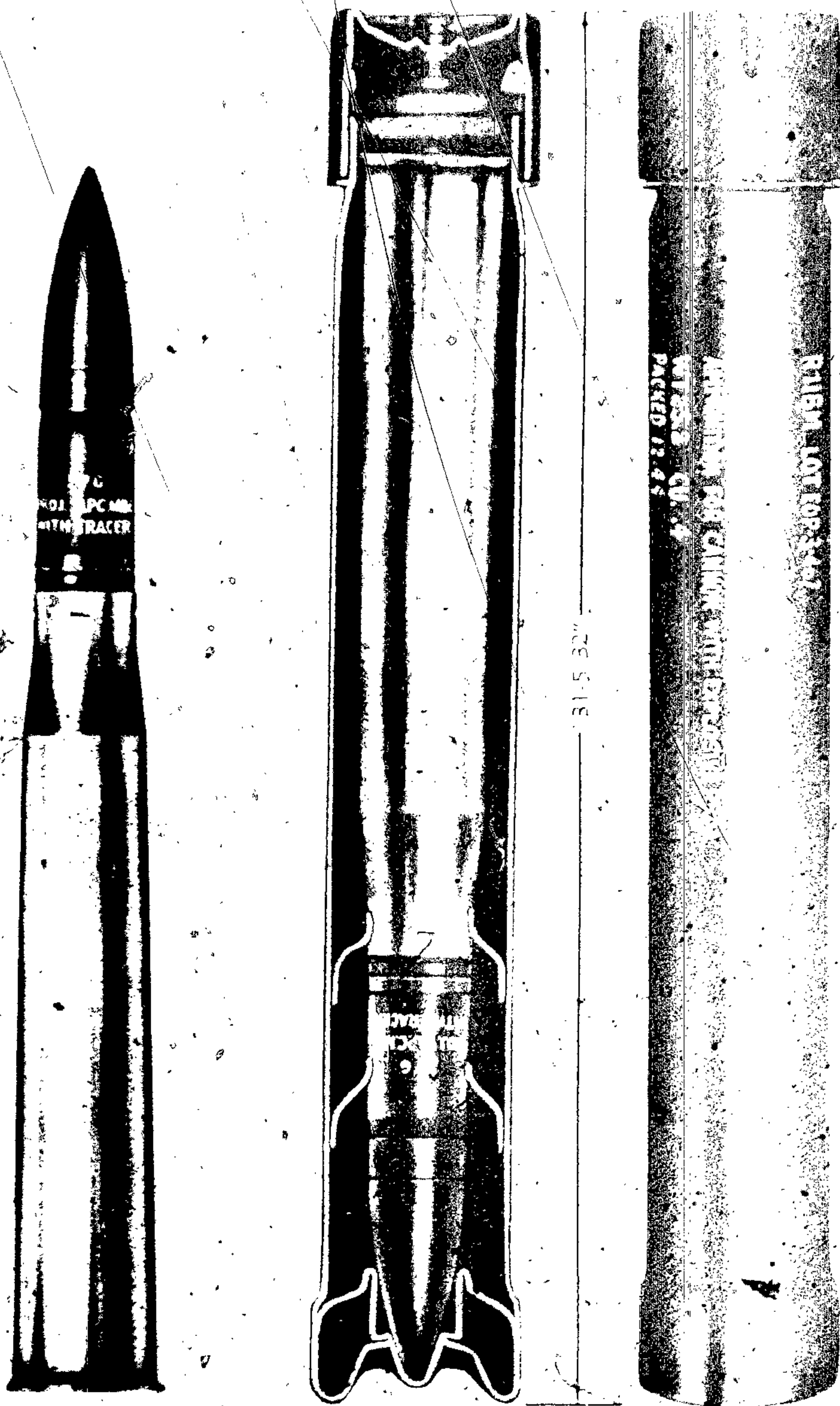

RA PD 97685A

Figure 78 — Metal Container M175 for 57-mm APC-T Rounds

Classes of Ammunition

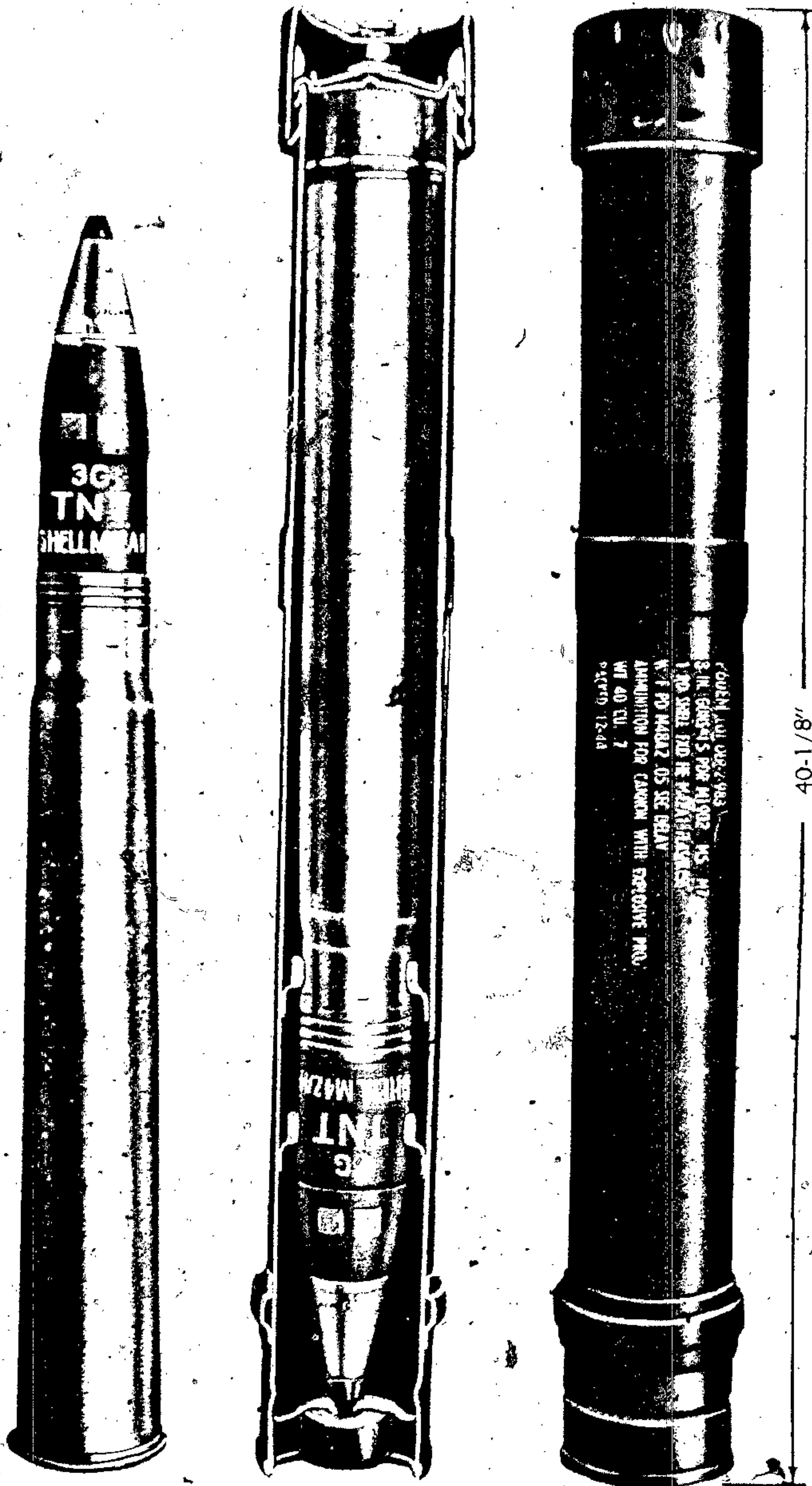

RA PD 97689A

Figure 79 — Metal Container M158 for 3-inch Gun Rounds



Classes of Ammunition

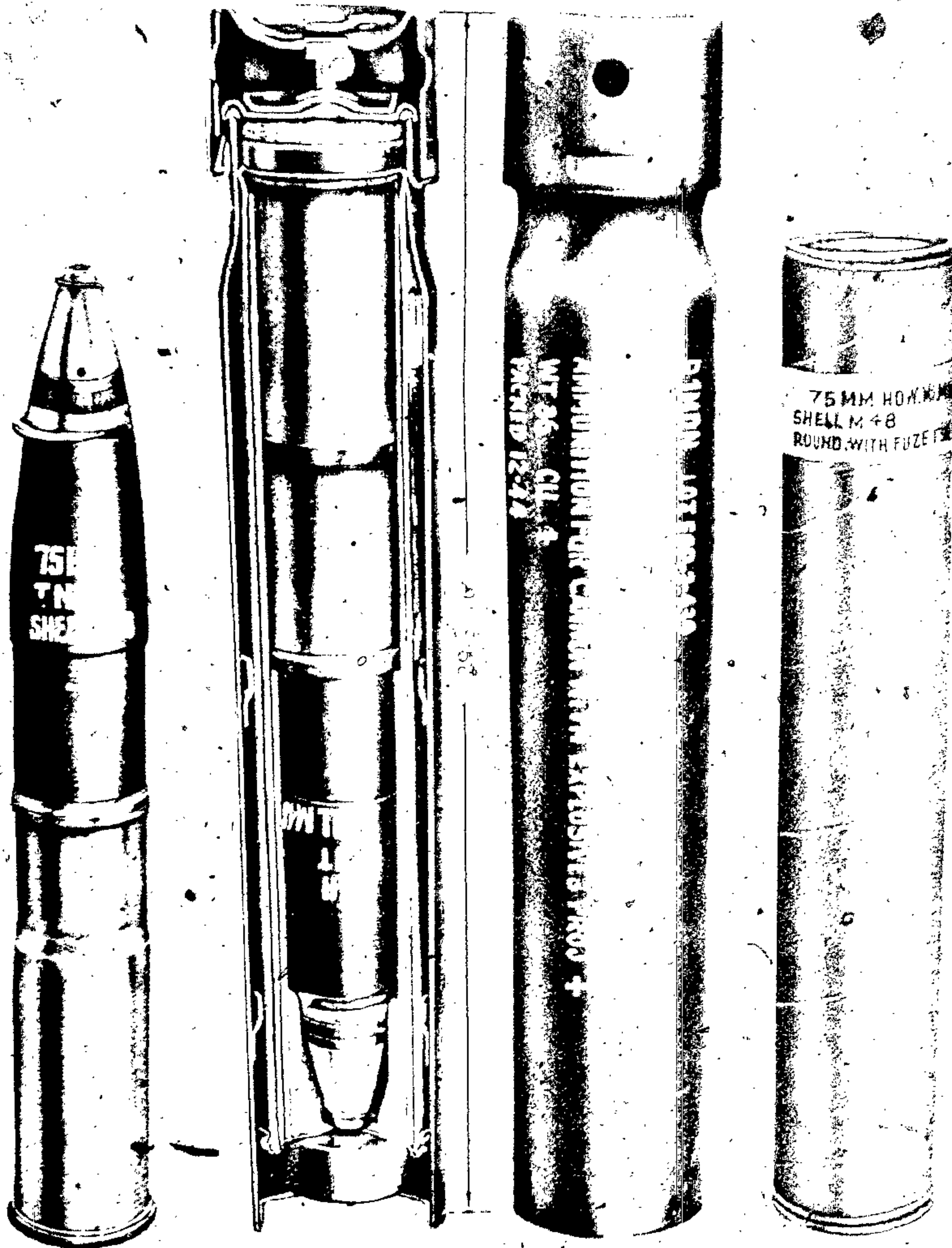

RA PD 97690A

Figure 80 - Metal Container M173 for 75-mm Howitzer Rounds

Classes of Ammunition

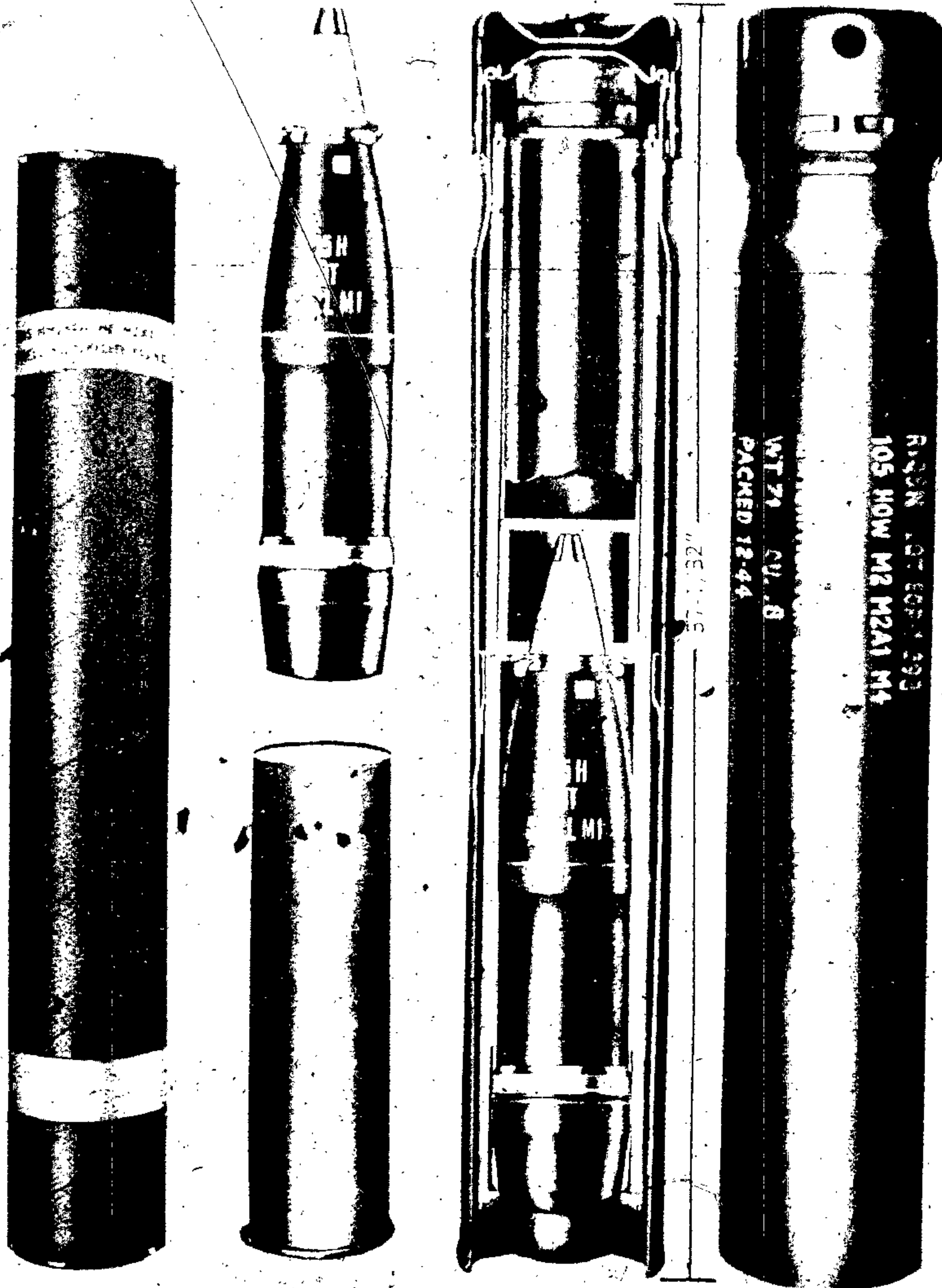

RA PD 97688A

Figure 81 — Metal Container M152 for 105-mm Howitzer Rounds



### Classes of Ammunition

are used in the interior of the container to prevent sideward motion, upper and lower guide rings are provided on the interior of the container.

c. **Metal cans.** A sealed metal can (fig. 72) with metal tear strips is used to pack separate-loading artillery primers. These cans are packed, in turn, in a wooden box.

d. **Waterproof bags.** Propelling charges may be packed in waterproof bag in fiber containers (fig. 77).

### Section V

## BOMBS

### 109. GENERAL.

a. A bomb is a stream-lined container of explosives or chemicals intended for release from aircraft. It consists of a body containing the charge and a device to explode or scatter the charge at the target. Aircraft torpedoes, submarine mines planted by aircraft, rockets, pyrotechnics, and mortar bombs, although similar in nature, are not classified as bombs.

b. For reasons of safety, the components of a bomb are usually stored and shipped separately, and must be assembled prior to use. The components of bombs (fig. 82) differ (depending on the particular type and model) but, in general, they consist of:

- (1) The unfuzed bomb body containing explosive, incendiary, or chemical filler.
- (2) The fuze, or fuzes.
- (3) The fin assembly (assembled to smaller bombs as shipped).
- (4) The arming wire assembly.

c. Bombs are installed in airplanes by means of suspension lugs. Bombs of 100 pounds and more have the suspension lugs on the side of the body, arranged for horizontal suspension of the bomb. Some smaller bombs have one lug on the side and another on the tail end, which permits the bomb to be installed either in a horizontal or vertical bomb rack; others are strapped in clusters of several bombs and suspended as a unit. Some AN bombs have three suspension lugs, two on one side of the bomb body and one on the opposite side to provide for use in both Army and Navy aircraft.

d. The functioning of bombs depends primarily upon the action of the fuze, which may be superquick, delay, or time. The terms "superquick" (instantaneous) and "delay" refer to the action at the instant of fuze impact, whereas "time" refers to the time from the release of the bomb to the instant of function.

Classes of Ammunition



Figure 82 - Components of Bombs



*Classes of Ammunition*

e. Bomb fuzes, after assembly into the bombs, are prevented from arming or functioning during handling by means of an arming wire which is normally removed by the bomb's release from the airplane. When it is necessary to remove the arming wire to unfuze a bomb, instructions attached to the fuze should be followed closely. Provision is made for releasing the bomb "safe" from the airplane without removing the arming wire from the fuze when it is desired that the bomb should land without functioning.

f. A general description of the several types of bombs is included in the following paragraphs.

**110. IDENTIFICATION.** Bombs are painted in accordance with the basic color scheme outlined in chapter 1, section II and illustrated in figures 9 and 10. Bombs are marked to indicate type, weight, model, filler, lot number, and loading plant and date loaded. In addition, the AIC symbol is stenciled on uncrated bombs.

**111. CLASSIFICATION.** Because of the many uses for bombs dropped from aircraft, there are many types and sizes of bombs, ranging in weight from 2 to 4,000 pounds. In common with other types of ammunition, bombs are classified according to filler as explosive, chemical, incendiary, pyrotechnic, and inert. Explosive bombs are classified according to use as general-purpose (GP) (demolition), light case (LC), armor-piercing (AP), semi-armor-piercing (SAP), fragmentation, and depth. Chemical bombs are classified according to type of filler as gas or smoke. Inert bombs are used for practice and drill.

**112. EXPLOSIVE BOMBS.**

a. These bombs are intended for the destruction or demolition of materiel targets. The destructive effect is produced by the violence of the detonation, "blast effect"; by projection of pieces of the case, "fragmentation"; and by displacement of earth and buildings, "mining." An explosive train for bombs is illustrated in figure 83.

b. **General-purpose.** The general-purpose (GP) bomb (fig. 84) meets the requirements of most bombing missions. The various models range in weight from 100 to 2,000 pounds and the quantity of explosive in this type averages 55 percent by weight. General-purpose bombs may be used for blast, fragmentation, or mining effect. They use both nose and tail fuzes. Nose fuzes produce more efficient surface effect, and tail fuzes produce more efficient mining and penetration effect. Both fuzes are generally used, the secondary fuze as insurance against malfunctioning. The metal case is strong enough to withstand impact with ordinary materials when released from high altitude, but it may fail on impact with heavy armor or heavily reinforced concrete structures.

Classes of Ammunition

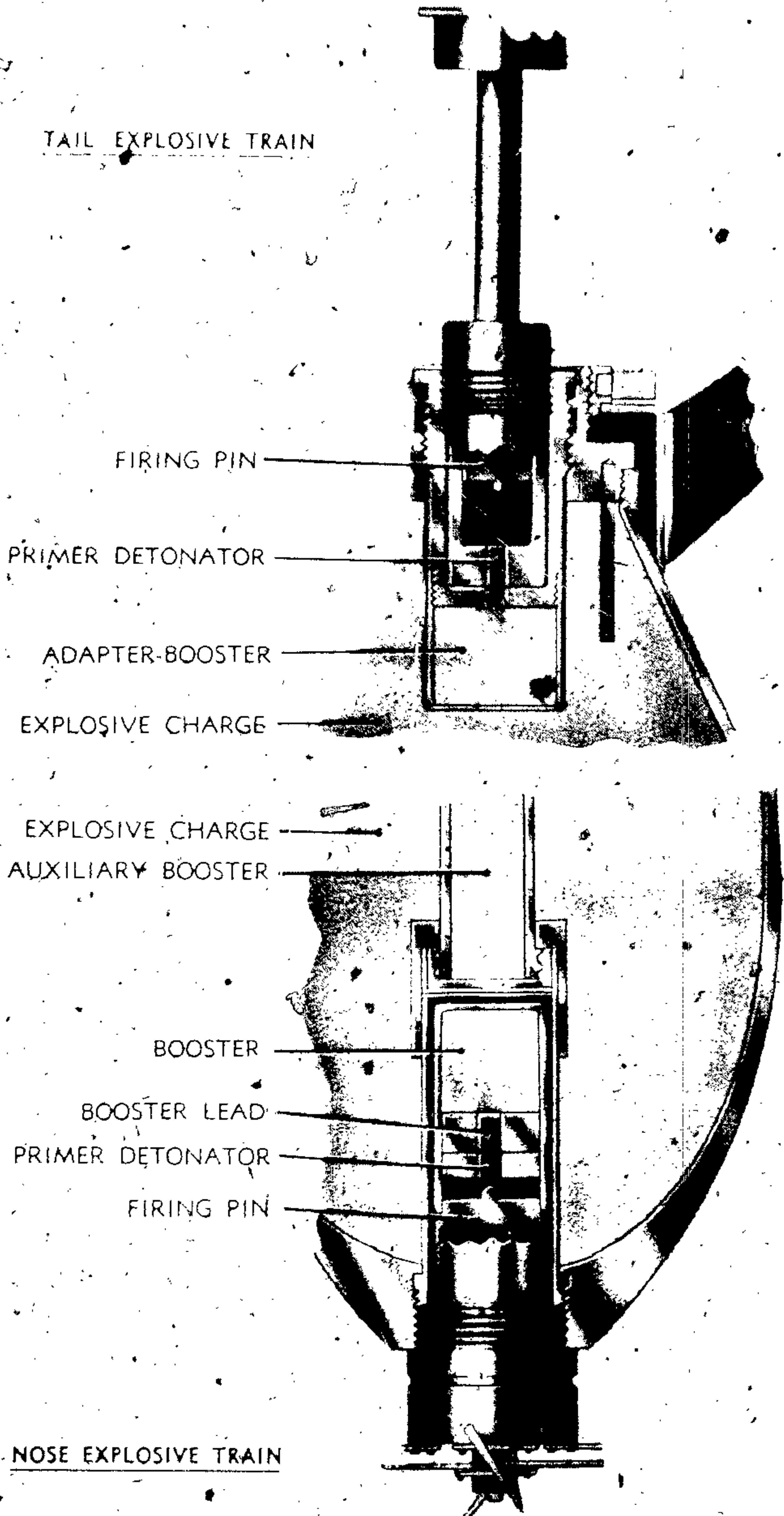

RA PD 65165

Figure 83 - Bomb Explosive Trains



Classes of Ammunition

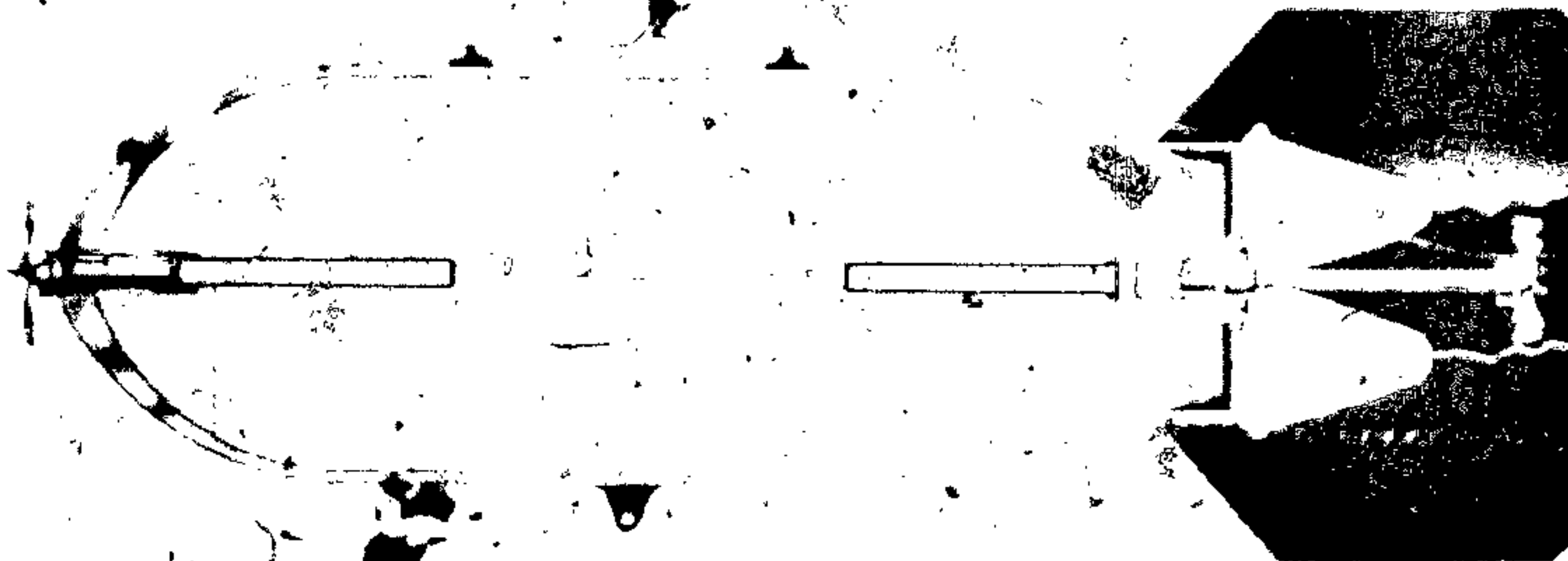

GENERAL PURPOSE BOMB (1000-LB. AN-M65)

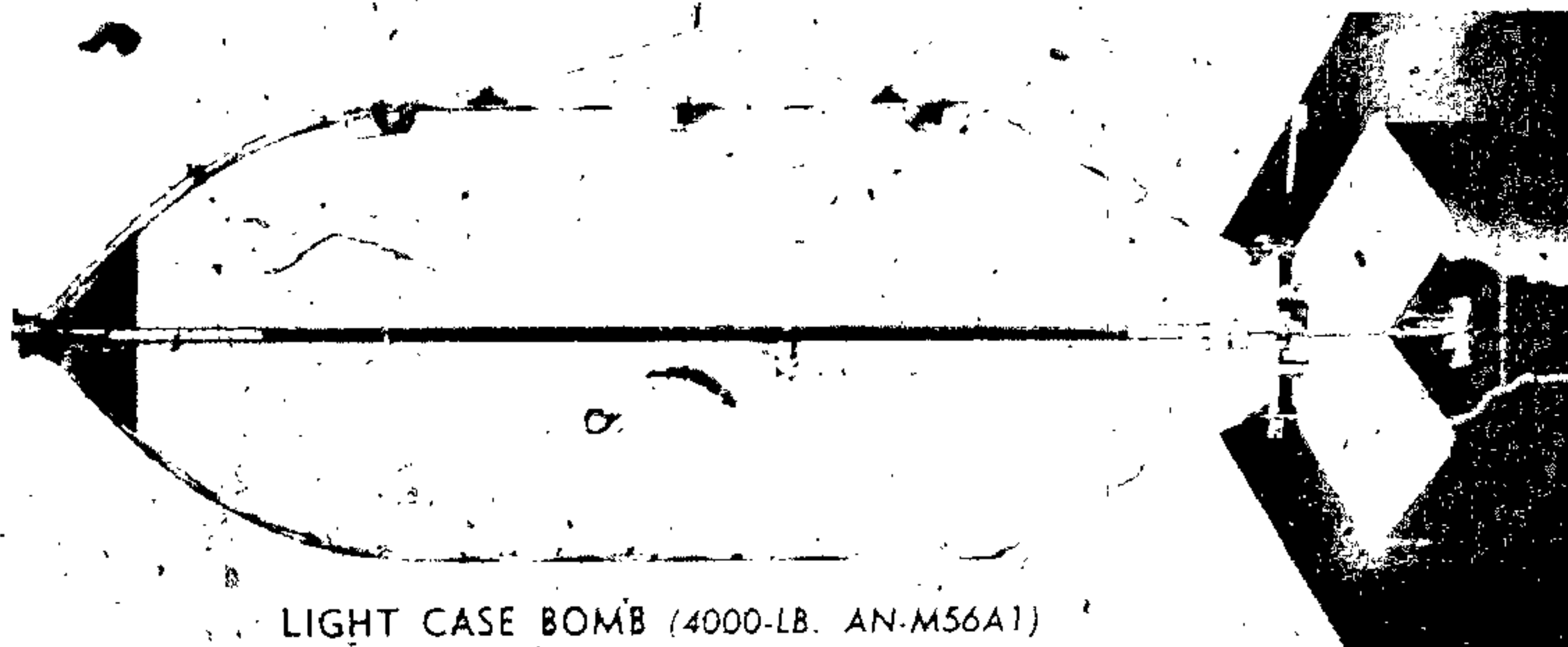

LIGHT CASE BOMB (4000-LB. AN-M56A1)



DEPTH BOMB (650-LB. MK. 29)

RA PD 89357

Figure 84 — Types of Bombs

## Classes of Ammunition

c. **Light-case.** The light-case (LC) bomb (fig. 84) is similar in appearance to the general-purpose bomb but has a thinner, lighter case and contains a higher percentage of explosive filler by weight. Since strength of case has been sacrificed, this bomb cannot be used for penetration and must be fuzed to explode before the case breaks up on impact. Approximately 75 percent of the total weight is high-explosive filler.

d. **Armor-piercing.** The armor-piercing (AP) bomb (fig. 85) is used to pierce deck armor of battleships, heavy concrete structures, and similar highly resistant targets. The nose of the AP bomb is solid and sometimes is fitted with an armor-piercing cap (APC) (fig. 85). These bombs are effective against heavy deck armor when dropped from sufficient altitude to attain their rated velocity. They contain a relatively small percentage (8 to 18 percent) of explosive filler and use tail fuzes of the delay type.

e. **Semi-armor-piercing.** The semi-armor-piercing (SAP) bomb (fig. 85) is conventional in outline, resembling the cylindrical GP bomb. However, the SAP bomb has a heavy case of steel which is drawn into a thickened nose and contains approximately 30 percent by weight of explosive filler. It may be used against concrete pill boxes or other targets of moderately high resistance.

f. **Depth.** The depth bomb (fig. 84) is a special light-case bomb for use against submarines and surface craft. It averages 70 percent by weight of explosive. When detonated by a hydrostatic fuze, the effect of this bomb does not depend upon hitting the target directly but upon the shock of detonation of the explosive being transmitted through the water. The hydrostatic fuze functions at a predetermined depth rather than on impact. If it is desired to use these bombs for demolition effect only, they may be equipped with nose fuzes which function on impact. Fuzes may be of the nose or tail type or installed in a cavity running transversely through the bomb body.

g. **Fragmentation bombs.**

(1) Fragmentation bombs are for use against personnel and light materiel targets. The effect is produced primarily by the fragments of the bomb body projected at high velocity. The blast at the point of impact will cause additional damage to nearby objects. Some fragmentation bombs have stabilizing fins, others, for low-altitude bombing, have parachutes for retarding rate of fall (fig. 86). The design of the bomb body is such as to produce the greatest number of effective fragments. The body walls are of uniform thickness and may be made up of coiled helix springs. Any fragment having 60 foot-pounds of energy will disable personnel. Most types of fragmentation bombs are fitted with a nose fuze only. The weight of the high explosive in these bombs is about 15 percent by weight. Since the fragments are projected at approximately



Classes of Ammunition

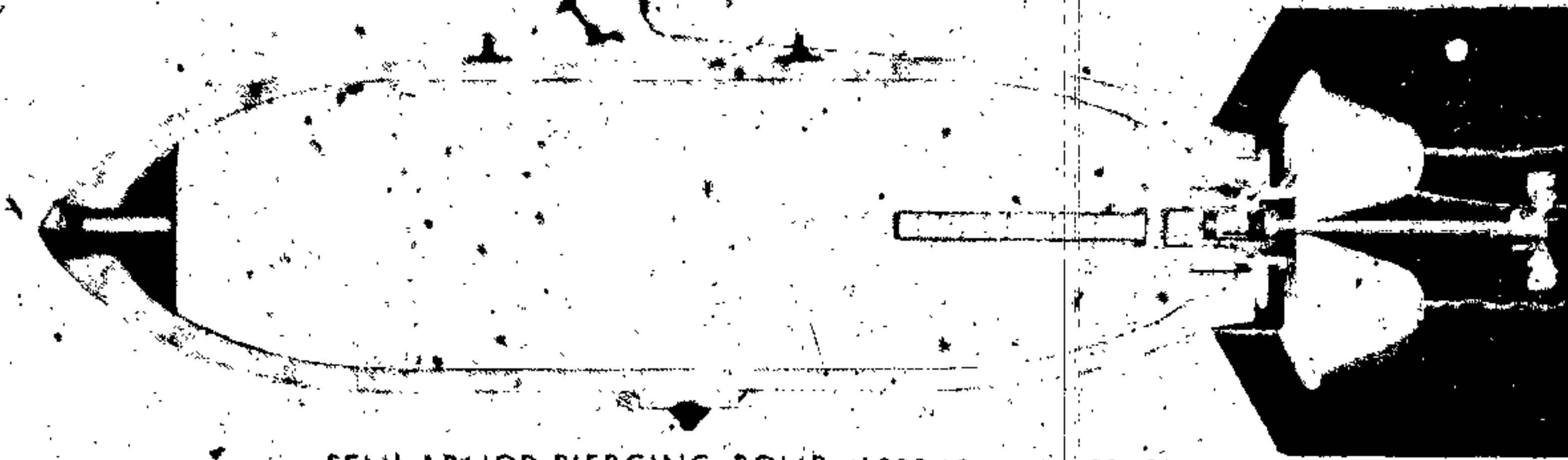

SEMI-ARMOR-PIERCING BOMB (1000-LB. AN M59A1)



CAPPED ARMOR-PIERCING BOMB (1000-LB. M52)

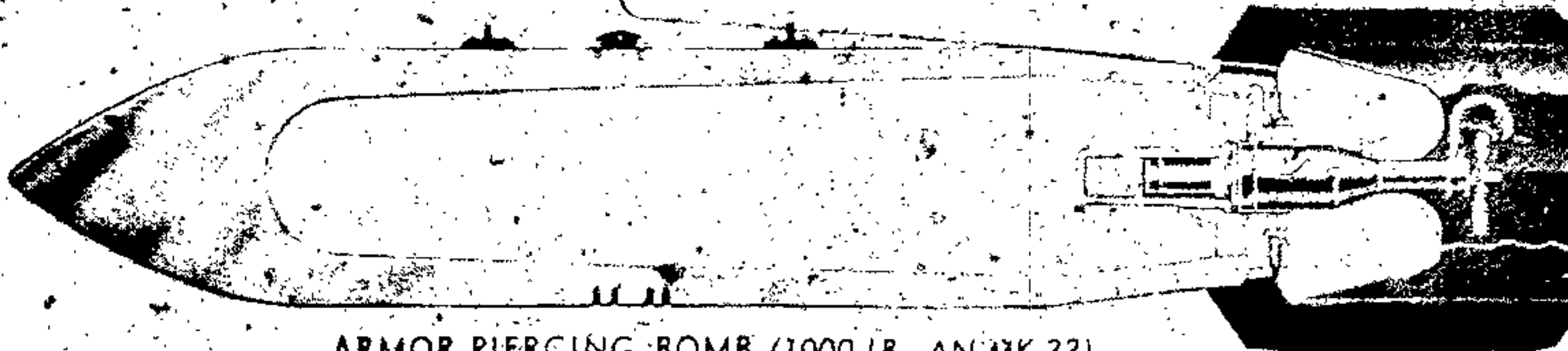

ARMOR-PIERCING BOMB (1000-LB. AN-MK.33)

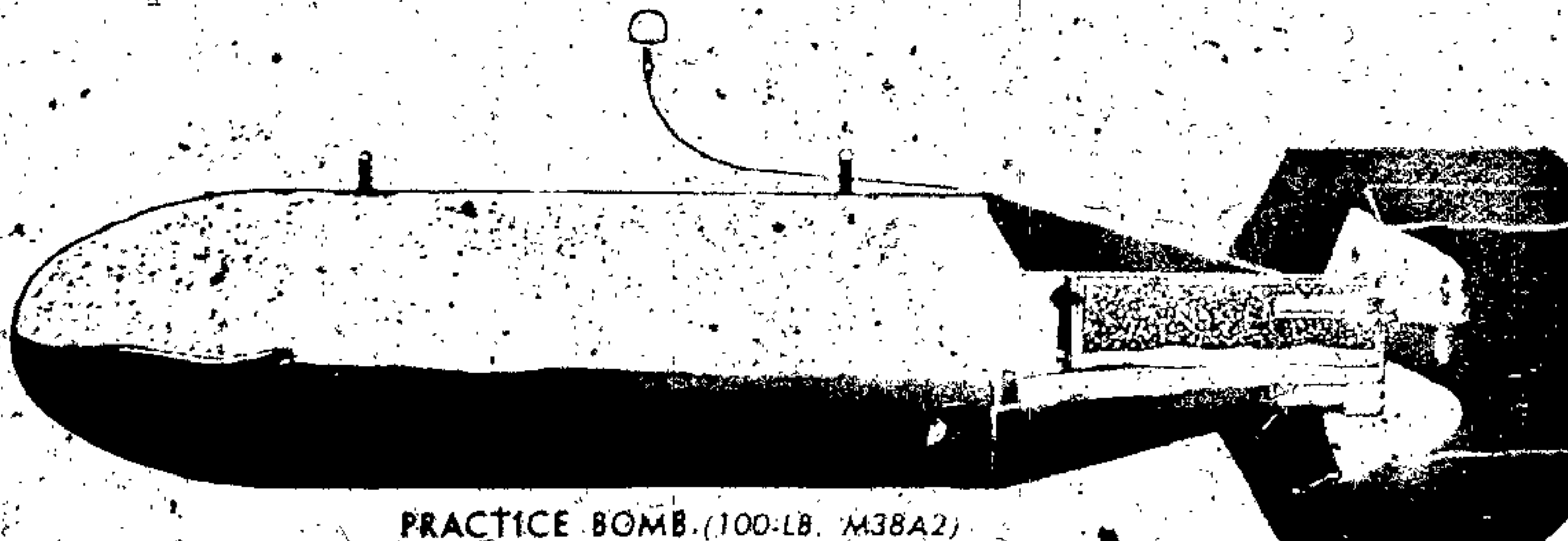

PRACTICE BOMB (100-LB. M38A2)

RA PD 89360

Figure 85 - Types of Bombs (Continued)

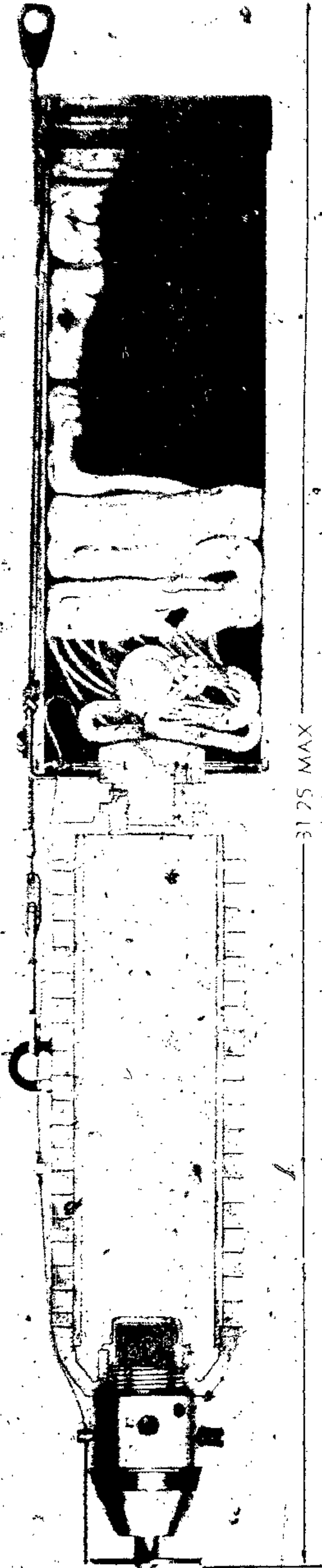

FRAGMENTATION BOMB (PARACHUTE TYPE)

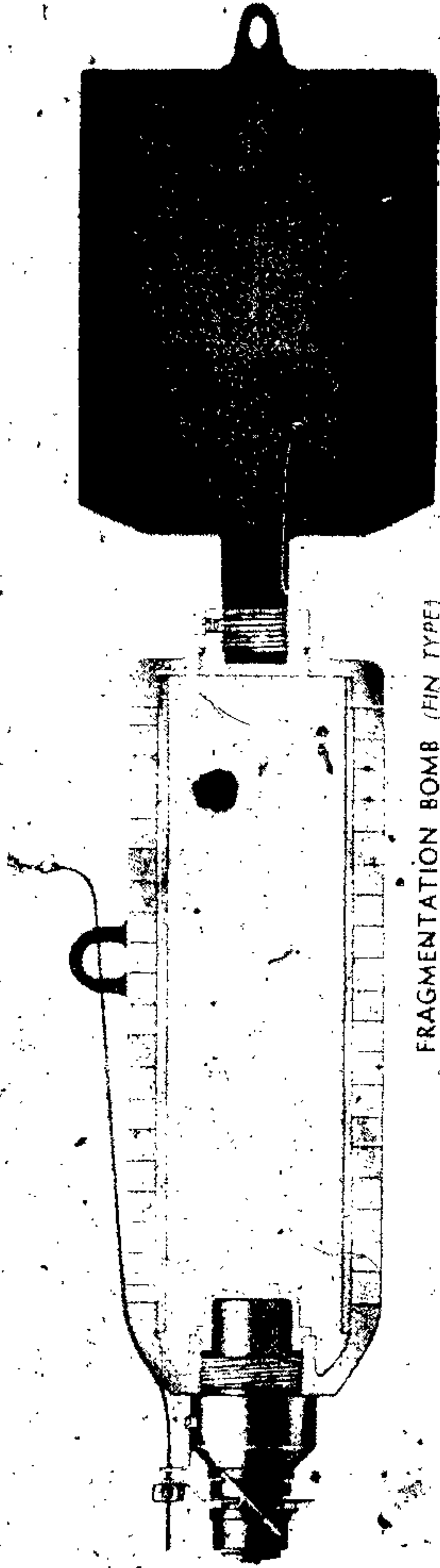

FRAGMENTATION BOMB (FIN TYPE)

RA PD 15007A

Figure 86 — Fragmentation Bombs



Classes of Ammunition

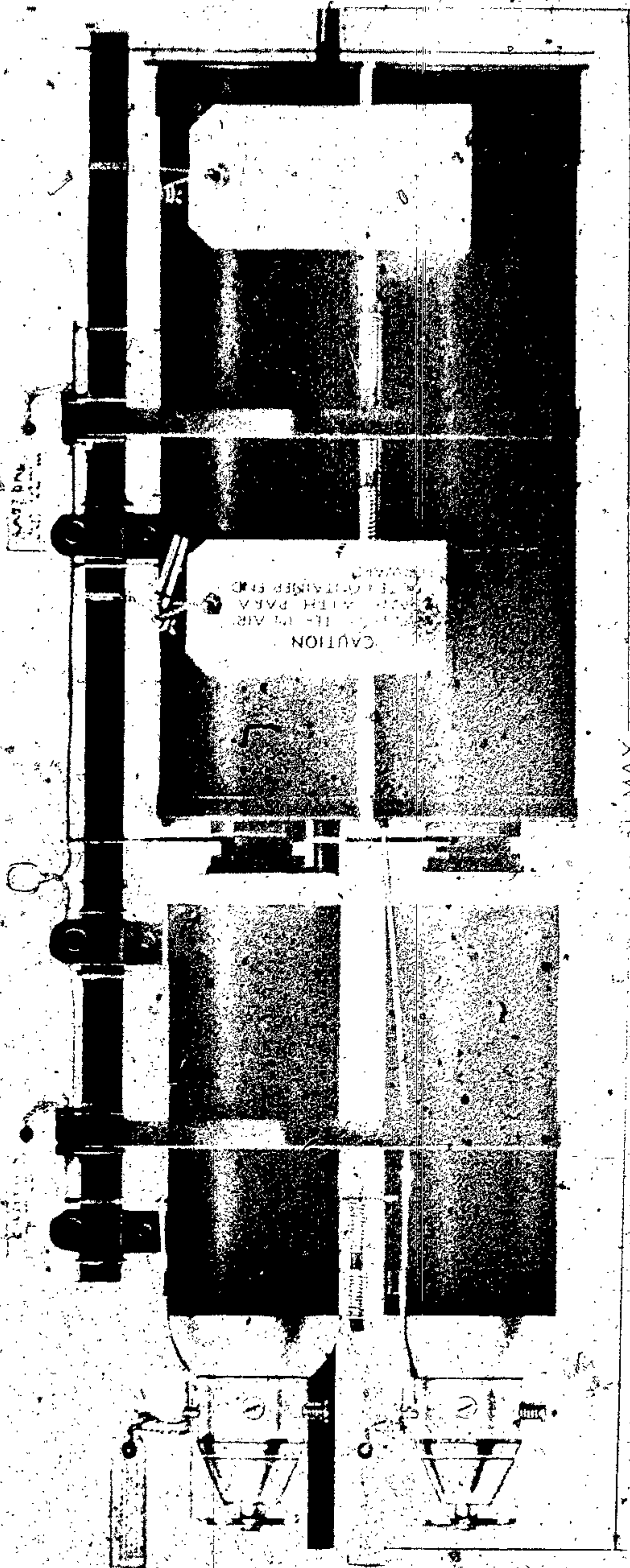

RA PD 15080

31 MAX

Figure 87. Fragmentation Bomb Cluster

*Classes of Ammunition*

---

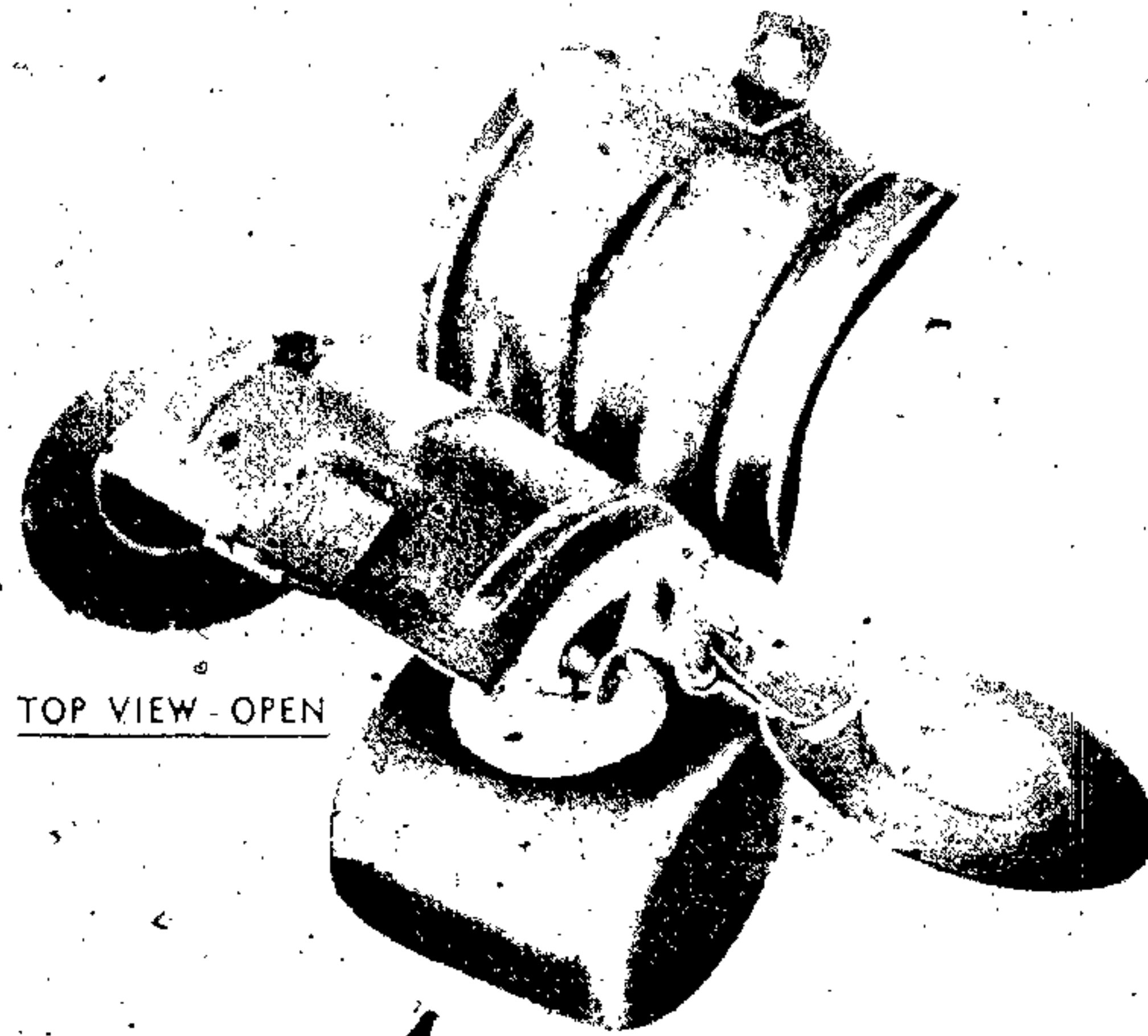

TOP VIEW - OPEN



SIDE VIEW - OPEN

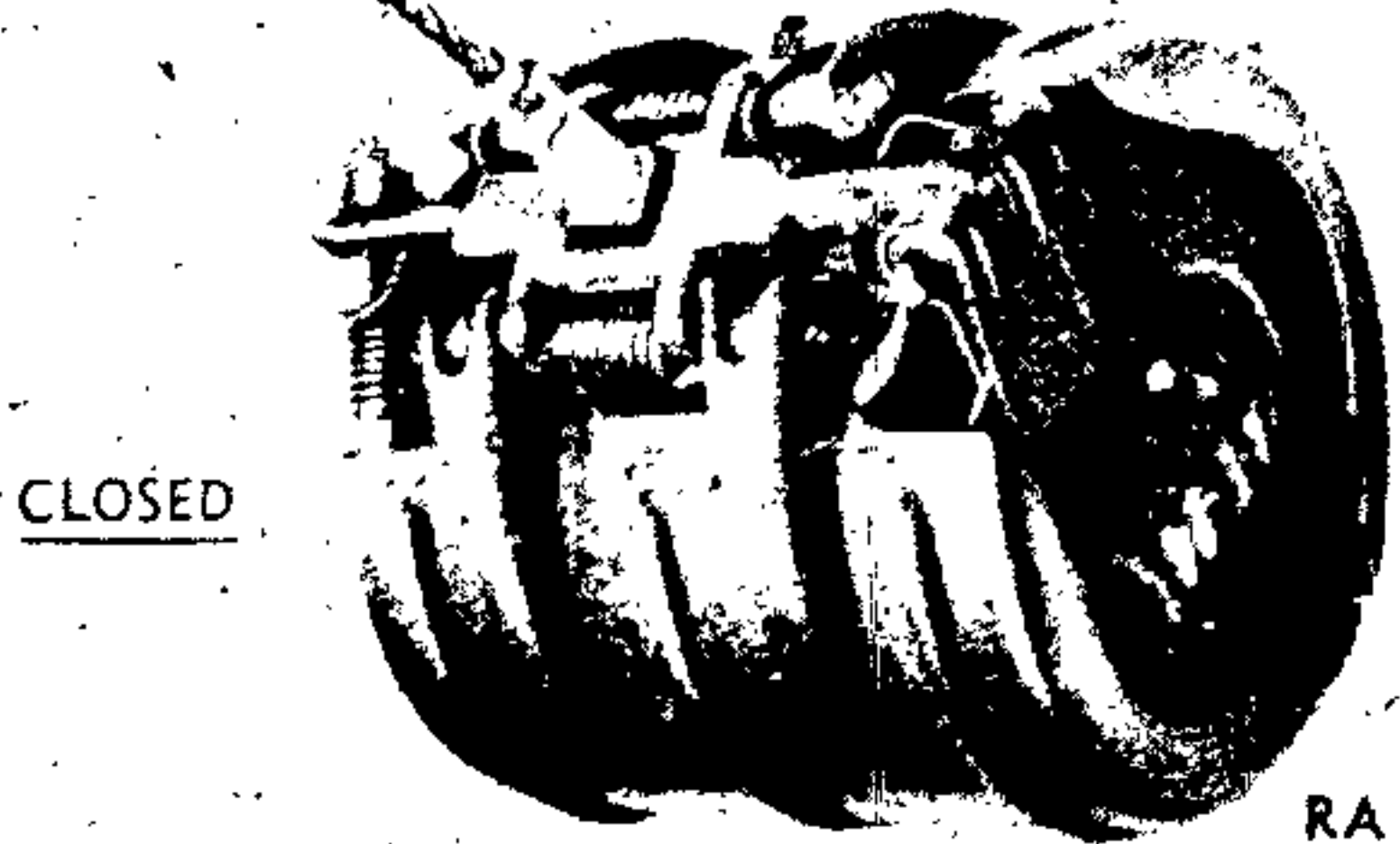

CLOSED

RA PD 65120

**Figure 88 — 4-pound Fragmentation Bomb M83 (Butterfly Bomb)**

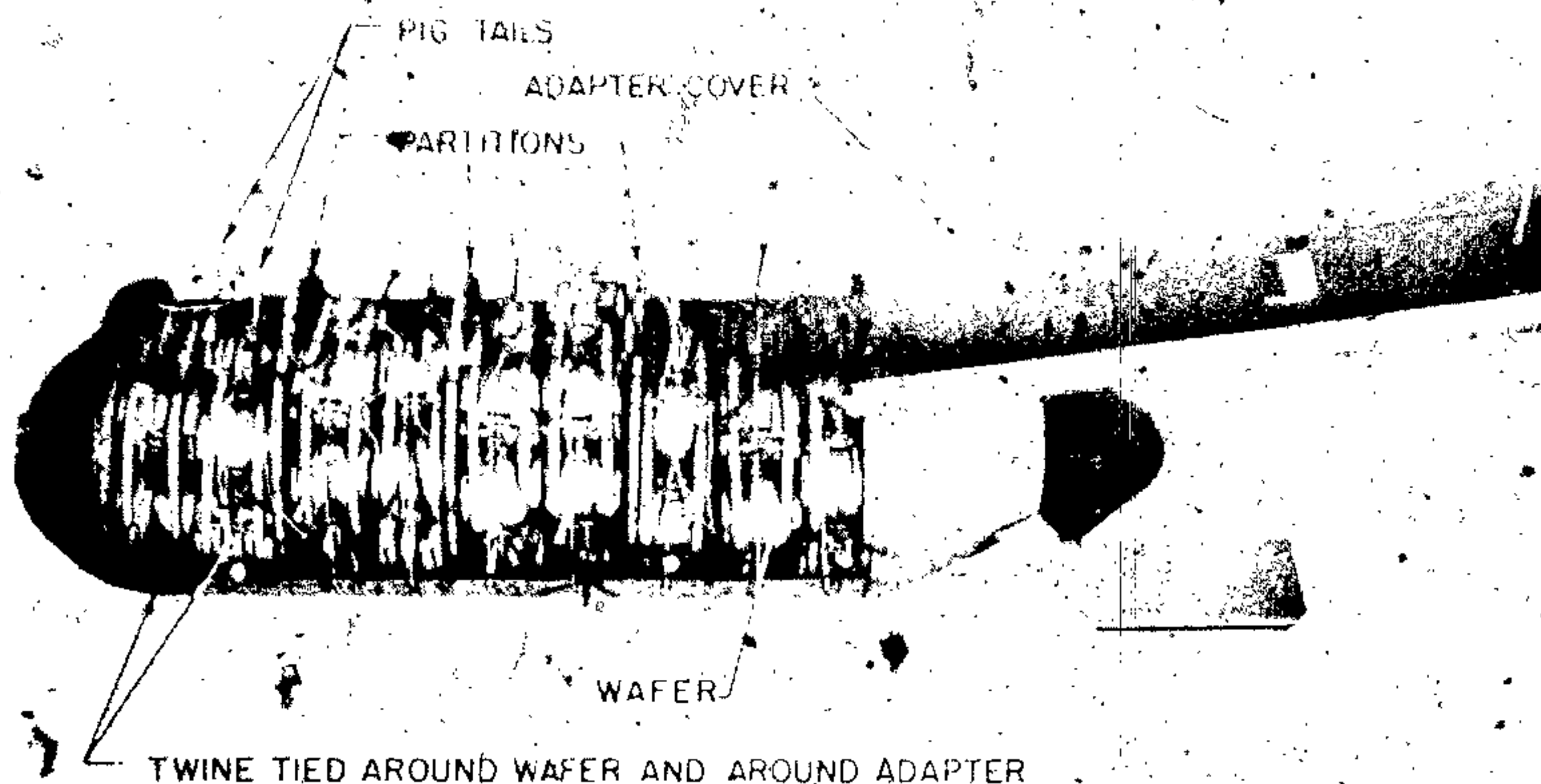

*Classes of Ammunition*

RA PD 50512

**Figure 89 — Wafers in Place in Cluster Adapter**

right angles to the axis of the bomb, the most uniform distribution and greatest destructive effects occur when the bomb is vertical at the instant of functioning.

(2) Fragmentation bombs stabilized by parachutes or fins are fitted with impact-type instantaneous-action fuzes. The bomb explodes instantaneously on impact, projecting a large number of fragments at high velocity.

(3) Small fragmentation bombs are assembled in clusters (fig. 87) for more efficient use and for ease in handling and dropping. Cluster adapters support the individual bombs, and, in turn, are installed in stations for large-size bombs. The cluster is dropped from the airplane as a unit. The arming wire acts to release the bombs from the cluster, either by mechanical means directly, by arming a mechanical time fuze which opens a cluster after an interval, or by firing a cartridge which causes the cluster to open. Cluster adapters have been designed for almost every type of fragmentation bomb, including the butterfly bomb.

(4) The butterfly bomb (fig. 88) is equipped with a case assembly (butterfly wings) which is folded around it. When the cluster is opened, by action of a time fuze, the wings unfold by spring action and begin to rotate, retarding the fall of the bomb and arming its fuze mechanically. The cluster for the butterfly bomb in wafers is shown in figure 89.

(5) Aircraft mines and depth charges are similar to aircraft bombs and contain high-explosive fillers (figs. 90, 91, and 92).

**113. CHEMICAL BOMBS.** Chemical bombs (fig. 93) contain chemical agents which produce a toxic or an irritating physiological effect, or a screening smoke. They are known as gas or smoke,

Classes of Ammunition

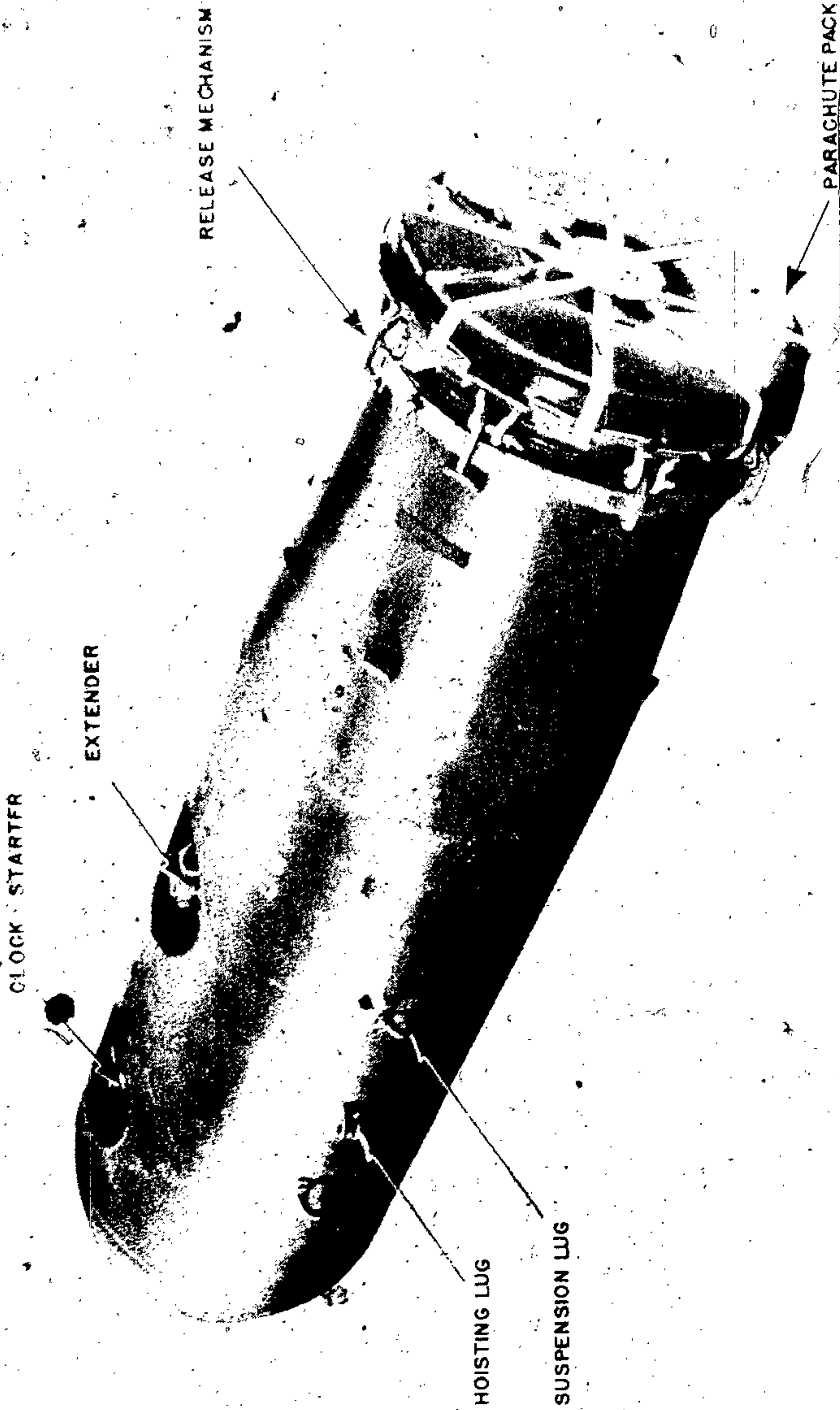

RAPD 80884

Figure 90 — Mk 26 Mod 1 Aircraft Mine



Classes of Ammunition

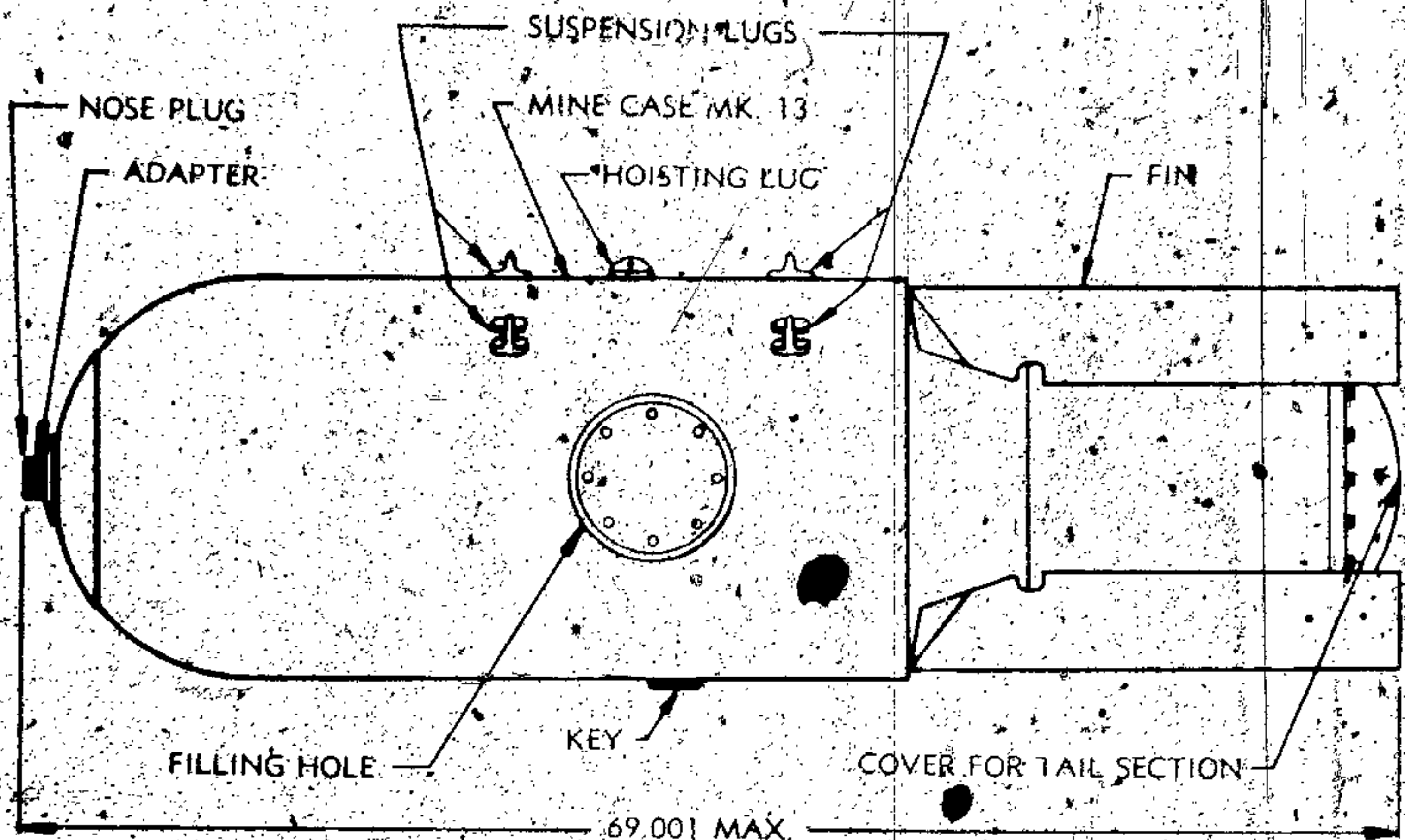

MINE, AIRCRAFT, MK. 13

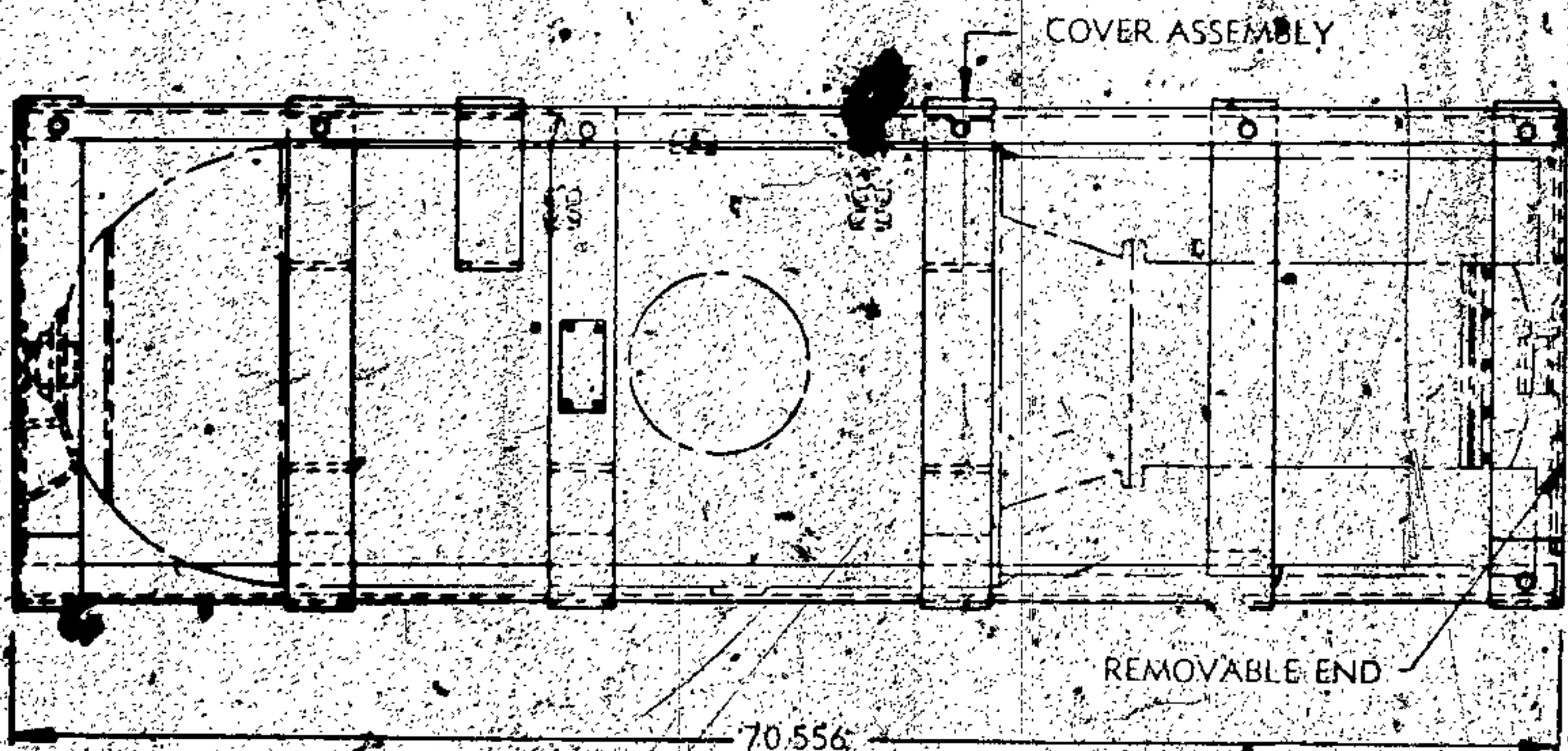

MINE AND CRATE, MK. 13

RA PD 49574

Figure 91 - Mk 13 Aircraft Mine and Crate

Classes of Ammunition

RA PD 2147

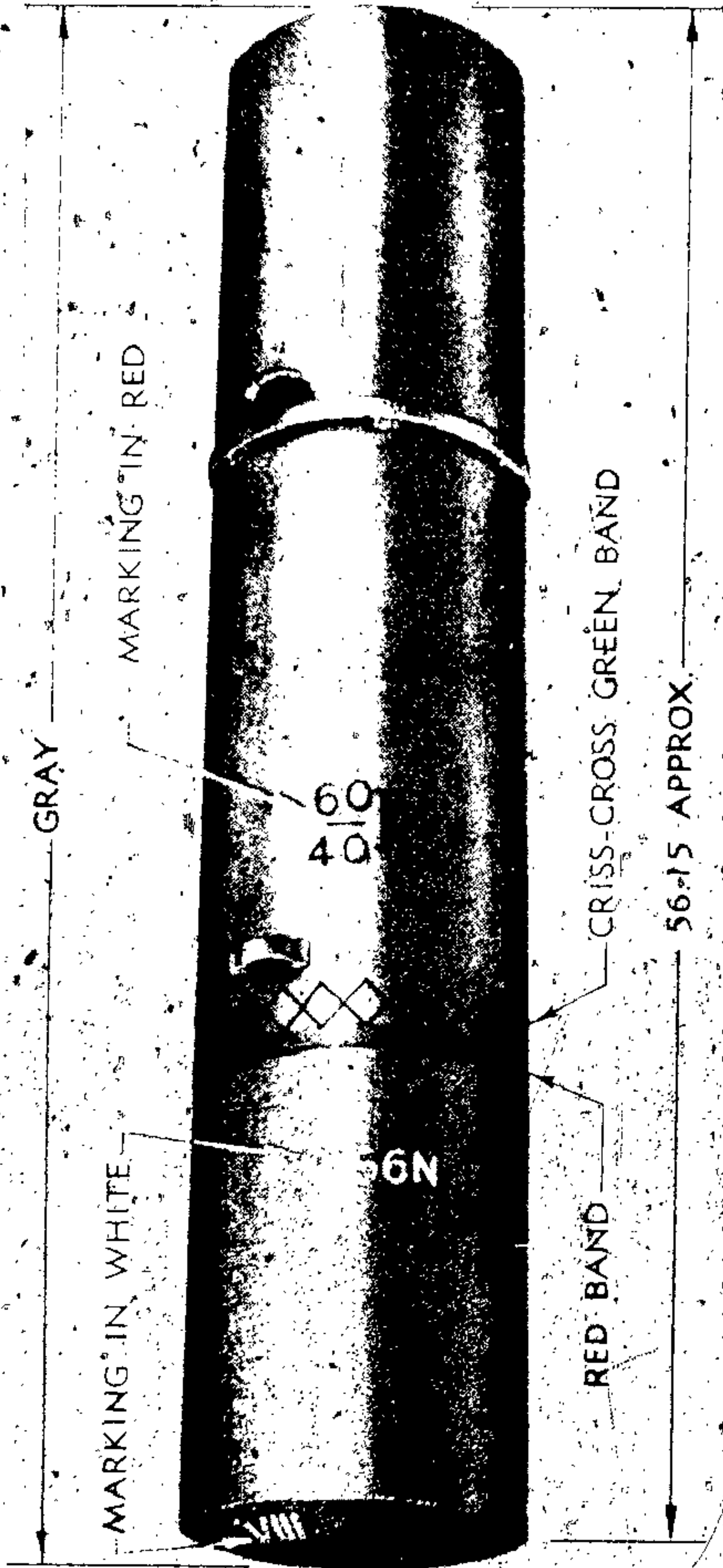
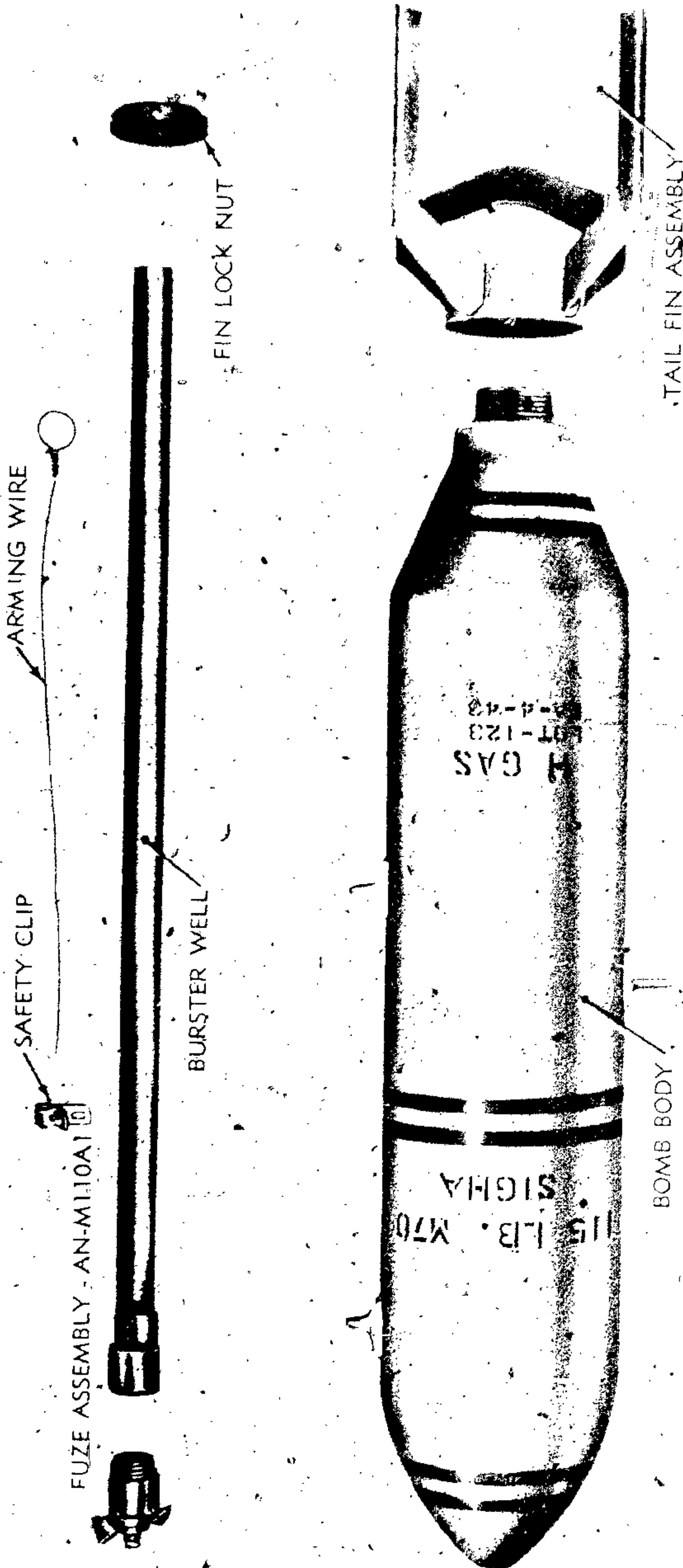

Figure 92 - Aircraft Depth Charge, 250-lb, Mk 8



Classes of Ammunition



RA PD 15073A

Figure 93—Chemical Bomb, H Gas, 115-lb, M70—Showing Components

Classes of Ammunition

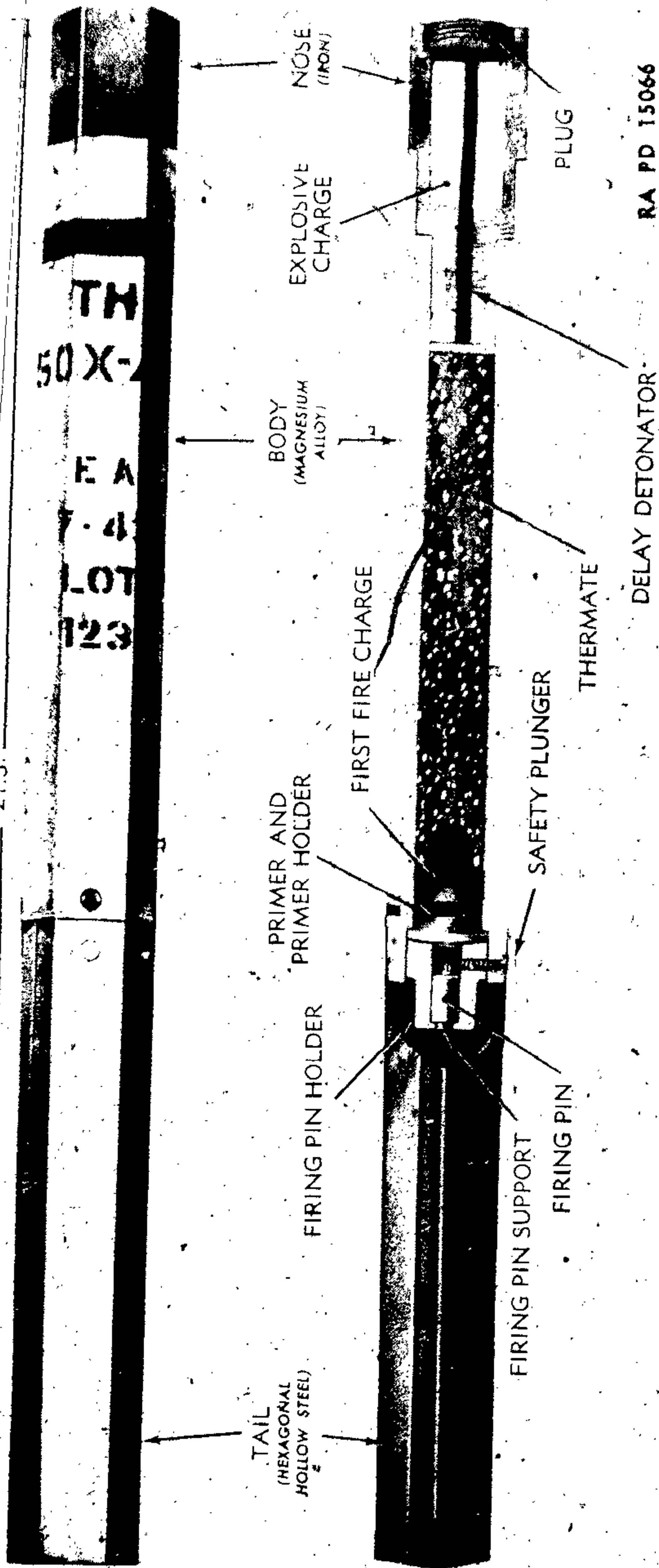
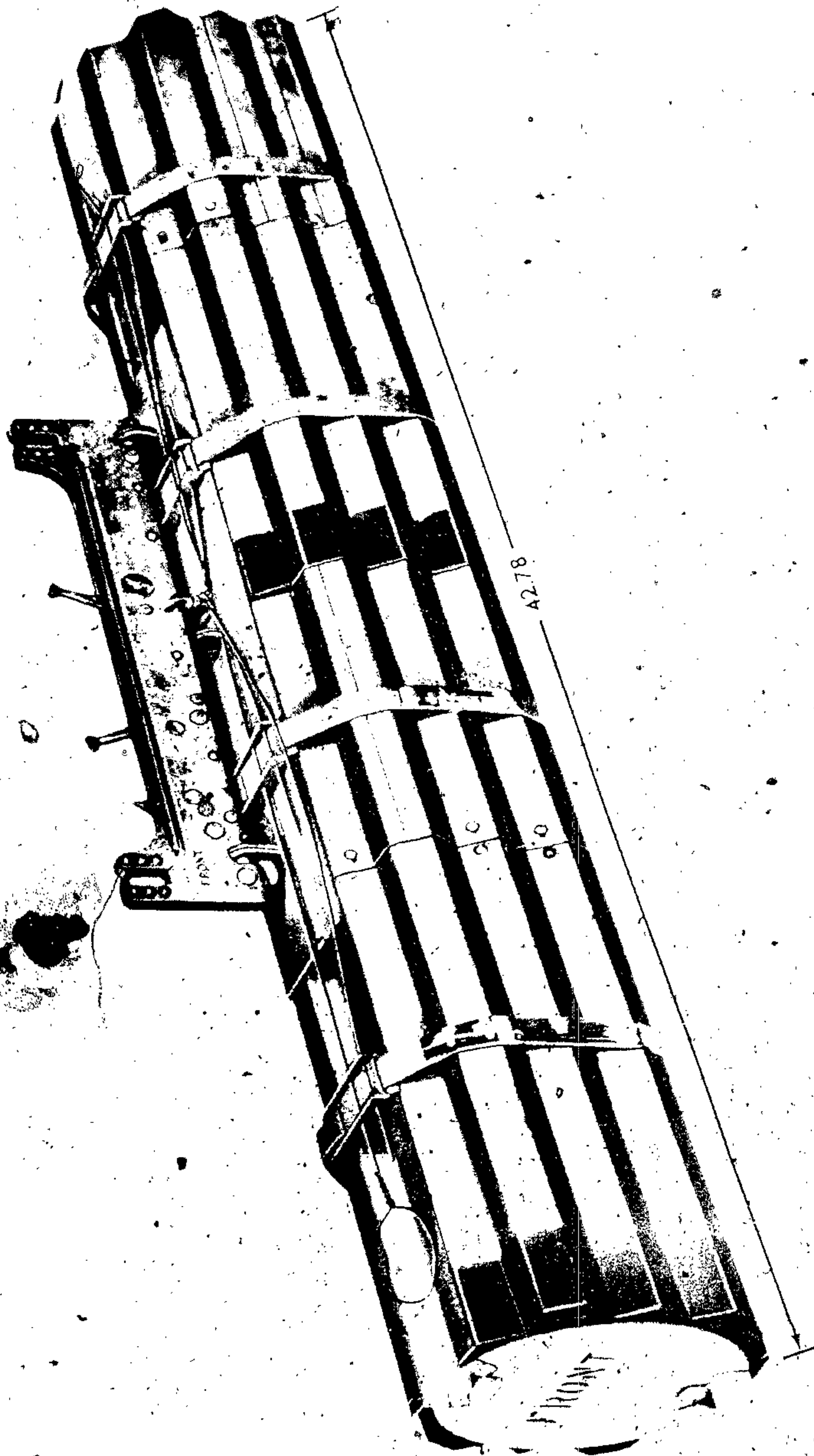

Figure 94 -- 4-lb Incendiary Bomb AN-M50XA3



Classes of Ammunition



RA PD 15081

Figure 95 — Incendiary Bomb Cluster

Classes of Ammunition

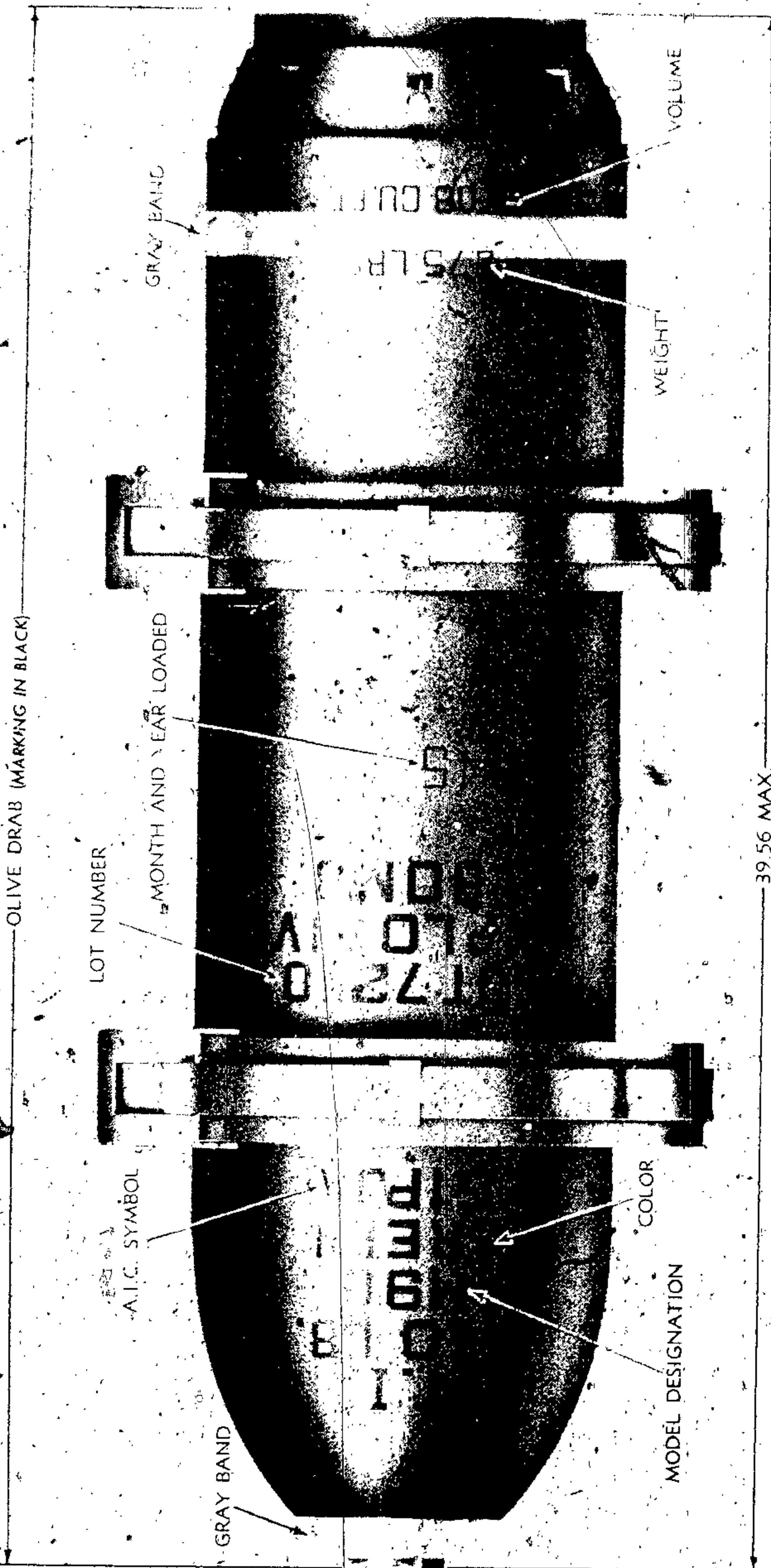

39.56 MAX

RA PD 9710

Figure 96 — 250-lb Green Target Identification Bomb M90 — As Shipped



Classes of Ammunition

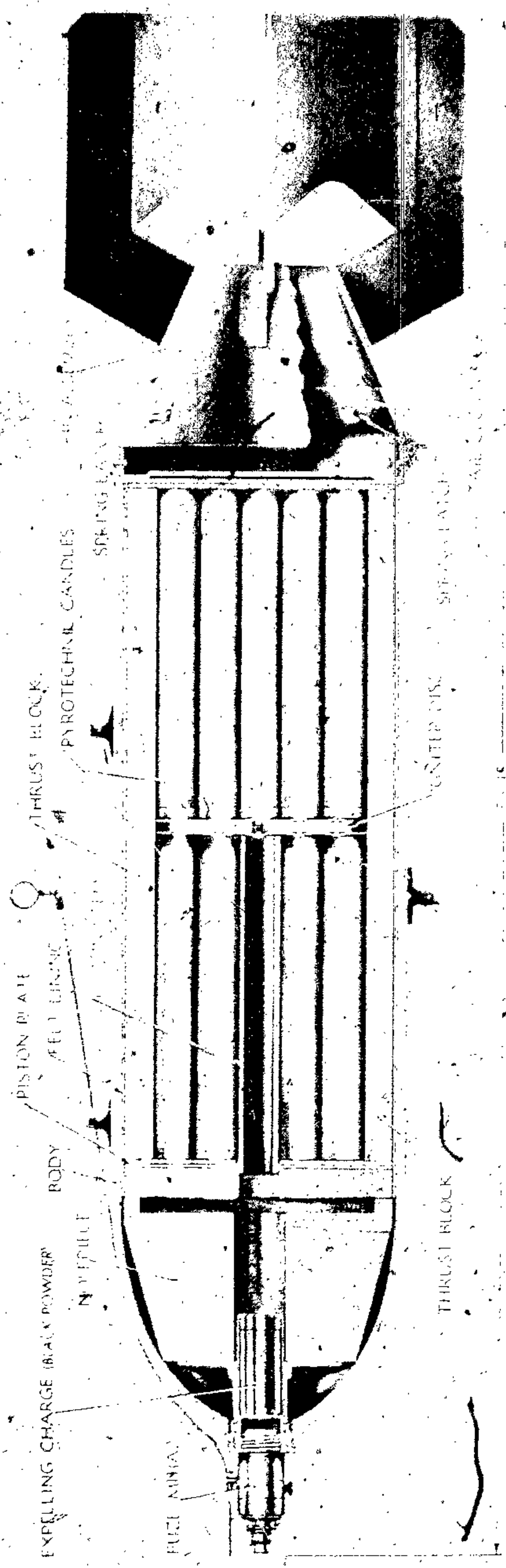

RA PD STUS -

Figure 97 - 250-lb. Green Target Identification Bomb M89, M90, or M98 - Typical Assembly

Classes of Ammunition

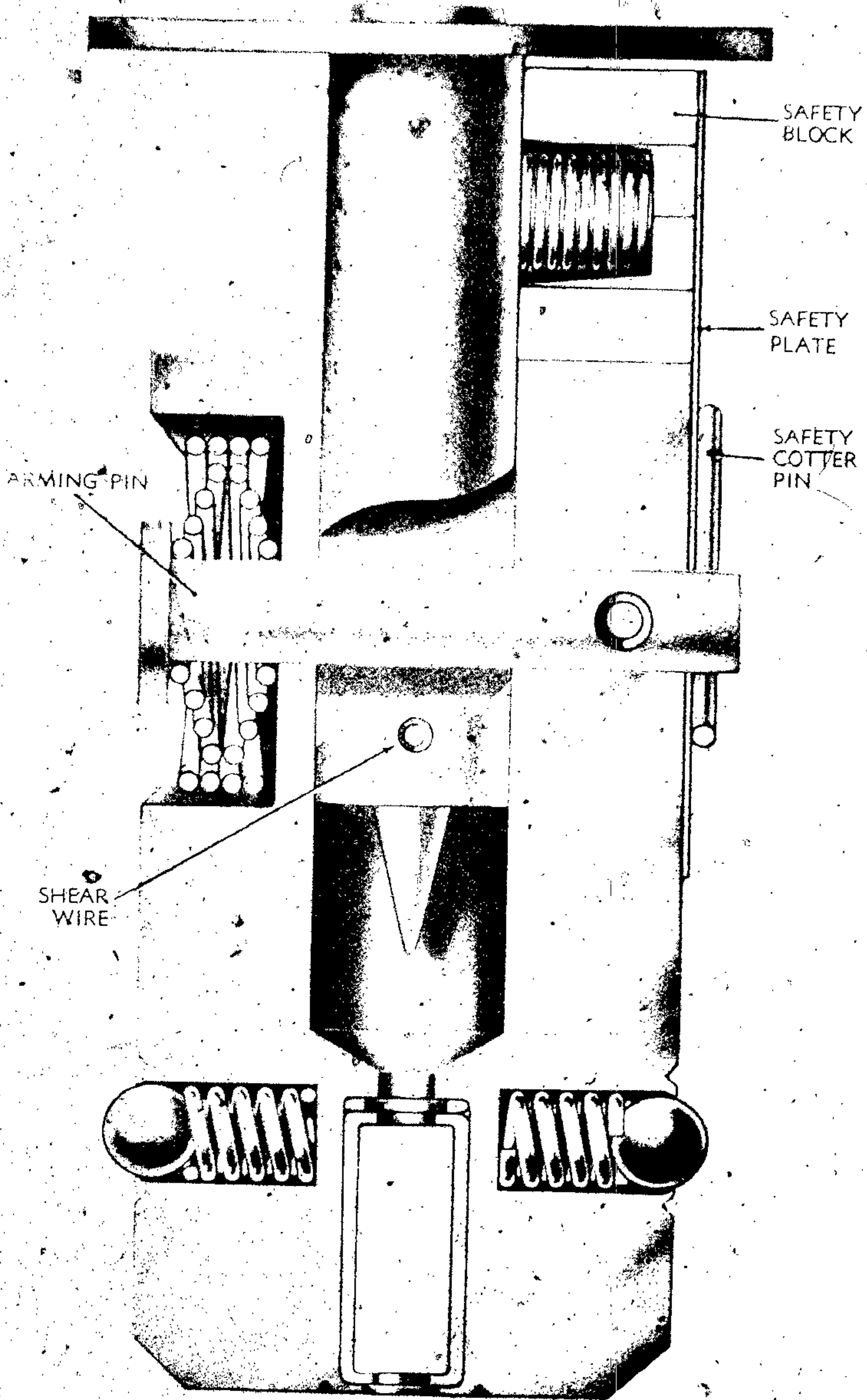

RA PD 15027

Figure 98 - Nose Fuze - Pin Arming Type (M108)



Classes of Ammunition

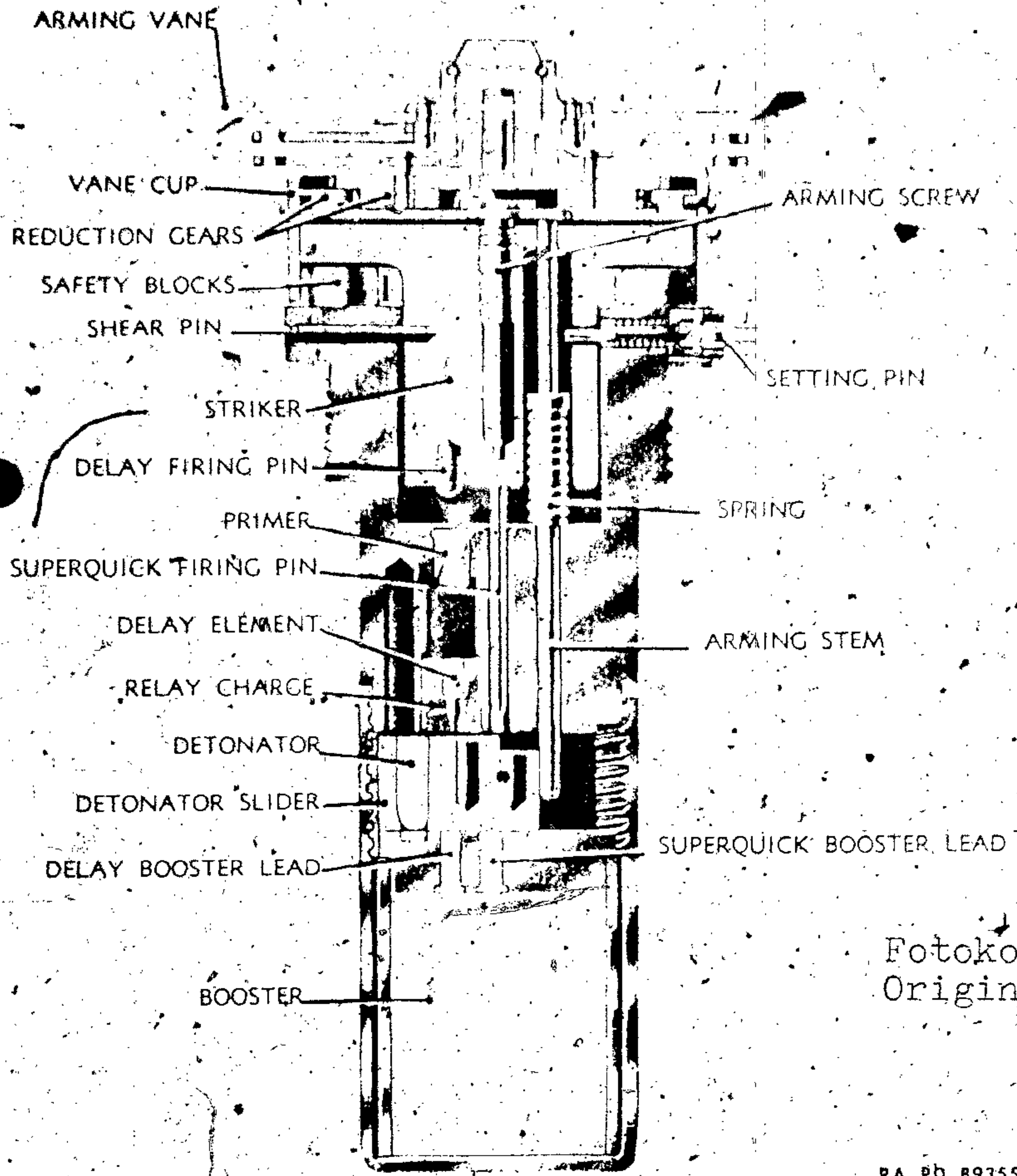

Fotokopie!  
Original fern

RA PD 89355

Figure 99 - Nose Fuze - Vane Arming Type

depending upon the principal effect. The force necessary to open the bomb body and properly disperse the chemical agent is provided by an explosive element called a burster, which extends the length of the bomb cavity. In general, the body serves only as a container for the chemical agent. Small chemical and incendiary bombs are hexagonal in shape to allow better packing in clusters (figs. 94 and 95). Fuze action is superquick (instantaneous) to prevent the waste of any of the charge by its being carried underground.

**114. INCENDIARY BOMBS.** Incendiary bombs contain jelled gasoline, oil, phosphorus, thermite, or magnesium fillers. Small

Classes of Ammunition

Fotokopie!  
Original fehlt!

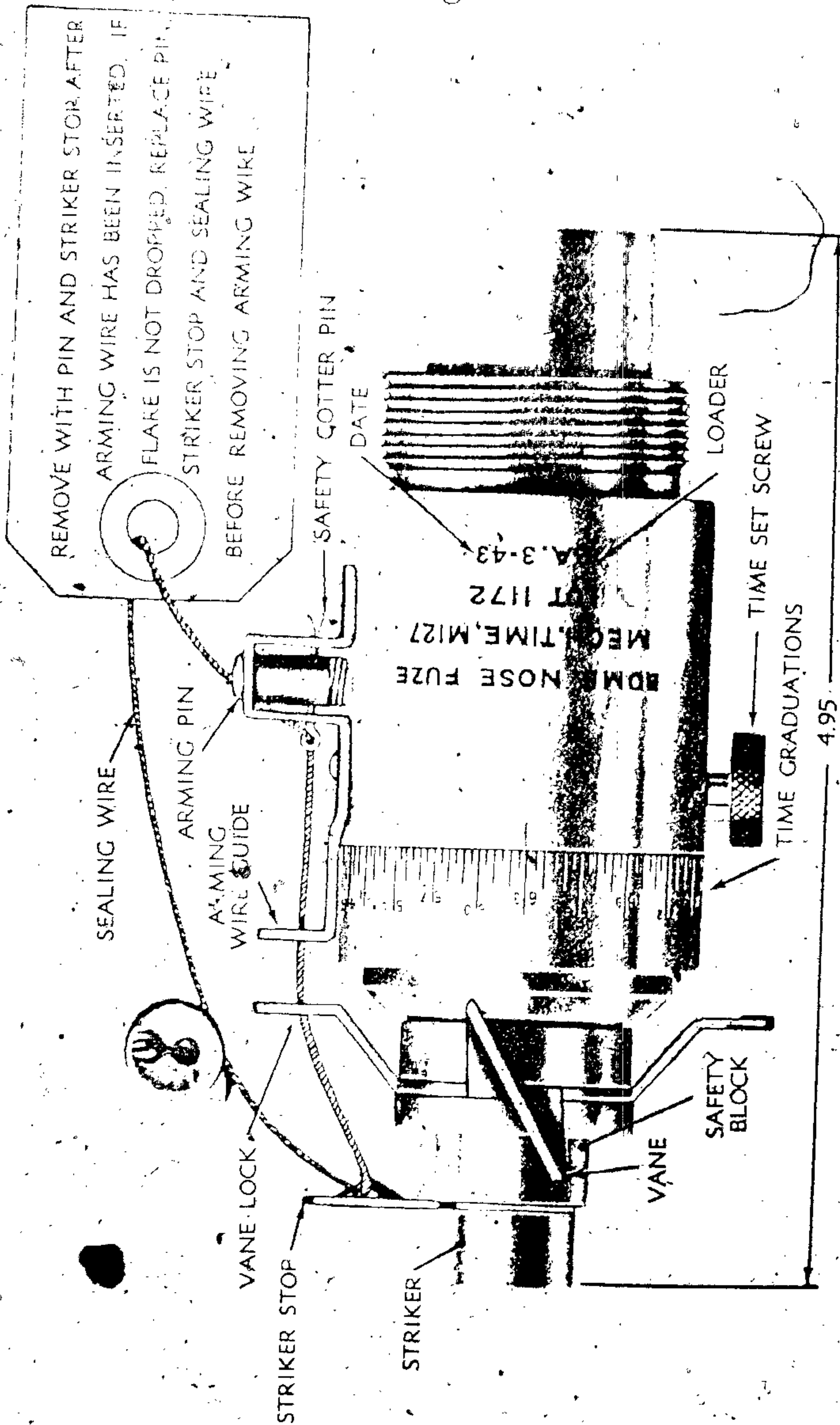

RA PD 15054

Figure 100 — Mechanical Time Bomb Fuze (Nose) M127



---

**Classes of Ammunition**

---

incendiary bombs (fig. 94) are hexagonal in shape and may have a steel case for an incendiary filler or a heavy magnesium alloy case containing an igniting charge; the case itself acts as the main charge. Small incendiary bombs are arranged in a cluster (fig. 95) which falls from the plane as a unit and then comes apart, allowing the bombs to arm and fall separately for coverage of an area target.

**115. PYROTECHNIC AND TARGET IDENTIFICATION BOMBS.**

a. Photoflash bombs contain pyrotechnic material, but because of their explosive nature are called bombs (chap. 2, sec. VI.)

b. Certain skymarker, pathfinder, aircraft flares, and target-identification bombs produce a pyrotechnic effect but resemble bombs in appearance and use. The 100-pound red smoke target-identification bomb M84A1 falls from the aircraft for a length of time set on the bomb mechanical time fuze and then bursts in the air, producing a large cloud of red smoke. This cloud hangs in the air for a considerable period of time. The 250-pound target-identification bombs M89, M90, and M98 (figs. 96 and 97) illuminate and mark targets by the simultaneous ignition and tail ejection of their pyrotechnic candles at a height above ground determined by the selected setting on the mechanical time fuze. These candles fall to the ground and continue to burn for their prescribed time. Candles may be of the nondelay or-exploding type.

**116. PRACTICE BOMBS.** Practice bombs (fig. 85) are provided for training in marksmanship. They may be sand-loaded at point of use and may contain a low-explosive spotting charge; for some uses, such as against water targets, the spotting charge may be omitted. These bombs simulate corresponding service bombs of the fragmentation and demolition types.

**117. DRILL BOMBS.** Completely inert bombs and components are provided for training of ground crews in assembling and handling operations. They are the same size and shape as standard bombs. Drill bombs are made up from the metal parts of service bombs, inert-loaded when necessary.

**118. FUZES.****a. General.**

(1) A fuze is a mechanical device designed to initiate a train of fire or a detonation under the circumstances desired. Fuzes are classified according to position as nose, tail, and transverse, and according to type of functioning as time, impact, and pressure. Time fuzes function a predetermined number of seconds after release. Impact

Classes of Ammunition

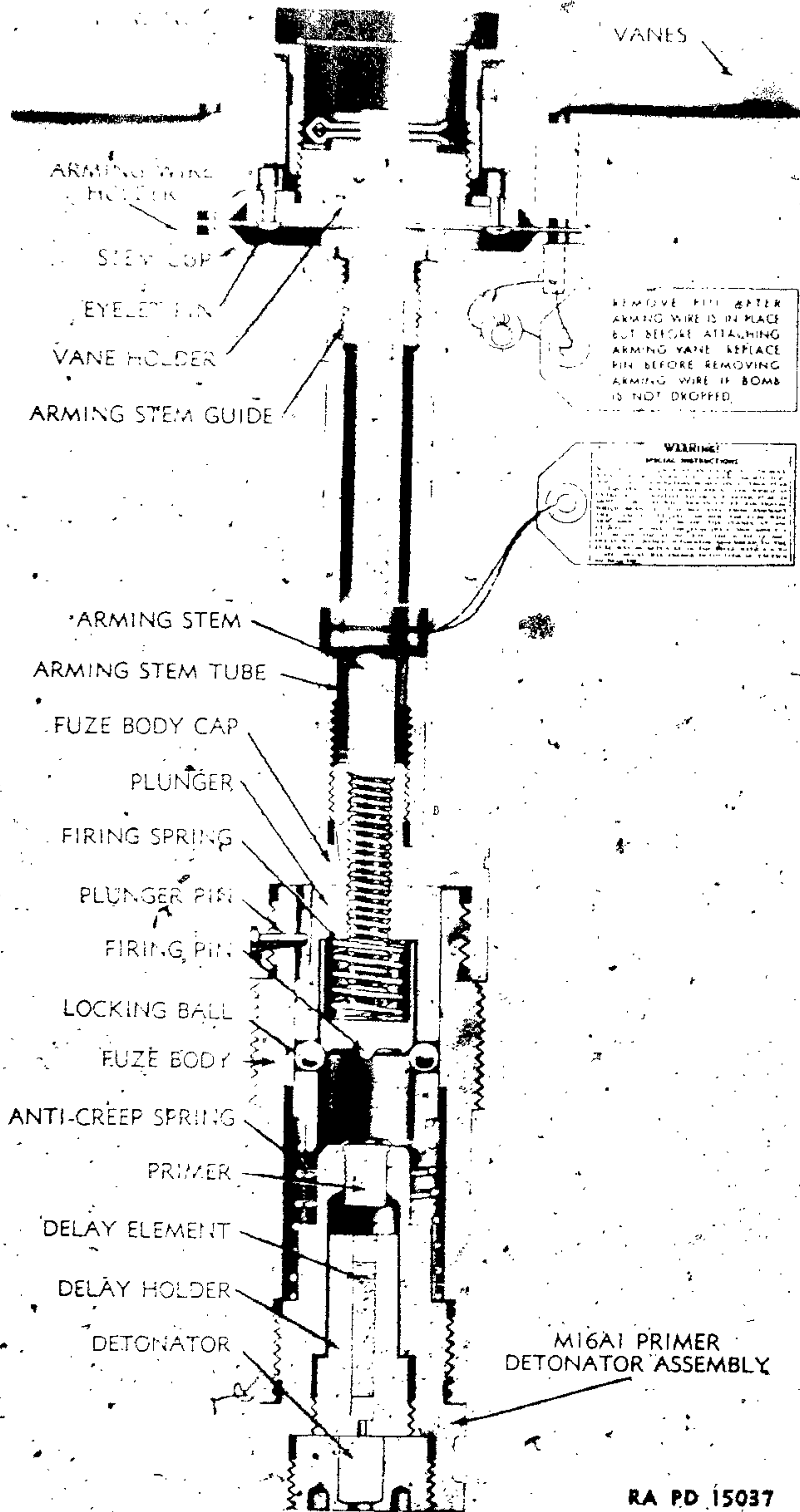

Figure 101 - Tail Fuze - Vane Arming Type (M112A1)



### Classes of Ammunition

fuzes function when the bomb strikes a resistant material. Pressure fuzes function in response to water pressure (hydrostatic) or air pressure (concussion). Impact fuzes are classified as delay when they have a definite time lag between impact and explosion of the bomb, and as superquick (nose) or nondelay (tail) when there is no delay. Delay in fuzes varies from a fraction of a second to many hours and may be provided by a clockwork mechanism or a chemical reaction. Some delay fuzes are equipped with an antihandling device to function on an attempt to defuze the bomb.

(2) Bomb fuzes are shipped in a "safe" condition. They are constructed so that they cannot function when they are "safe" (unarmed). Most fuzes are designed so that an arming wire may be passed through parts of the fuze, mechanically restraining the firing pin or keeping elements of the fuze mechanism out of position until they are moved into functioning position, generally by the rotation of the arming vane. The arming vanes or similar arming mechanisms are held in place by a safety cotter pin which is replaced by the arming wire upon loading of the bomb into an aircraft. Dropping the bomb causes the arming wire to be withdrawn, which permits the fuze to arm. Arming-in-type fuzes may arm immediately on withdrawal of the arming wire or may have an arming delay element, timed by a clockwork mechanism or a powder train, which delays arming until a fixed time has elapsed. In arming-vane-type fuzes the vane is rotated by the air stream as the bomb falls, a fixed number of turns being required to arm the fuze.

(3) Bomb fuzes are generally shipped separate from other bomb components. In most cases in the assembly of fuzes to bombs, tools are not used.

b. **Nose fuzes.** Nose fuzes, in general, are held unarmed by the presence of safety blocks between the striker and the fuze body, thus preventing the firing pin from being driven into the primer. Most nose fuzes have a primer, delay element, detonator, and booster assembled in the fuze body. The working parts of the fuze—except the arming mechanism and striker head—are protected by the bomb case, thus avoiding the possibility of the fuze being crushed on impact before it can function (figs. 98, 99, and 100).

c. **Tail fuzes.** Tail fuzes, in general, are held unarmed by an arming stem screwed into the inertia-type firing pin. In these fuzes, the booster is not assembled to the fuze but to the adapter-booster which is assembled to the bomb (fig. 101). For some fuzes, the primer-detonator assembled thereto may be changed in the field for other primer-detonators of other delay actions.

d. **Hydrostatic and concussion fuzes.** Hydrostatic fuzes (figs. 102 and 103) act under the influence of water pressure to explode the bomb a predetermined depth below the surface of the water.



Classes of Ammunition



FUZE, BOMB, HYDROSTATIC, AN-MK. 229



FUZE, BOMB, HYDROSTATIC, AN-MK. 230

RA PD 1503

Figure 102 -- Hydrostatic Bomb Fuzes AN-MK 229 and AN-MK 230

REMOVE SAFETY COVER ON  
 THESE FUZZES BY  
 PULLING DOWN ON THE  
 SAFETY PIN. DO NOT  
 REMOVE SAFETY COVER  
 THROUGH ANY OTHER  
 MEANS.

REMOVE SAFETY COVER ON  
 THESE FUZZES BY  
 PULLING DOWN ON THE  
 SAFETY PIN. DO NOT  
 REMOVE SAFETY COVER  
 THROUGH ANY OTHER  
 MEANS.



Classes of Ammunition

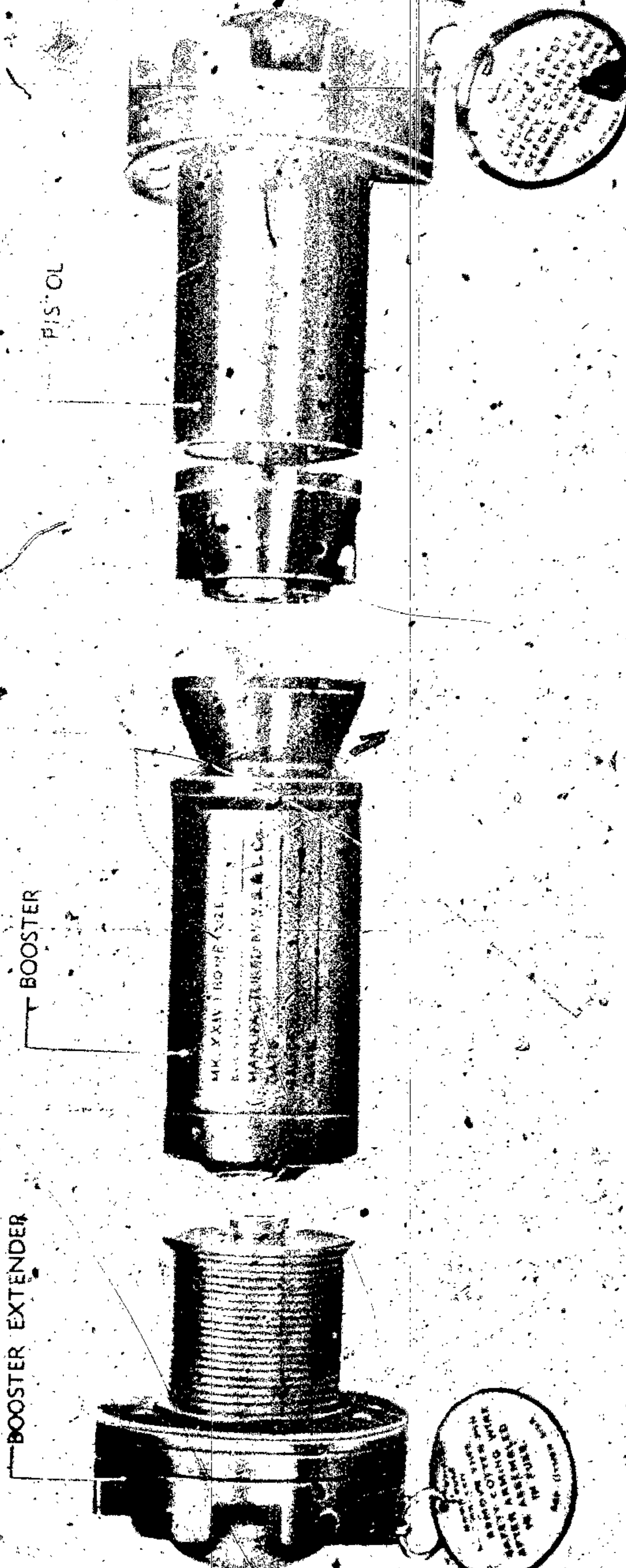

RA PD 2136

Figure 103 - Hydrostatic Transverse Bomb Fuze AN-Mk 24 Mod 1

Classes of Ammunition

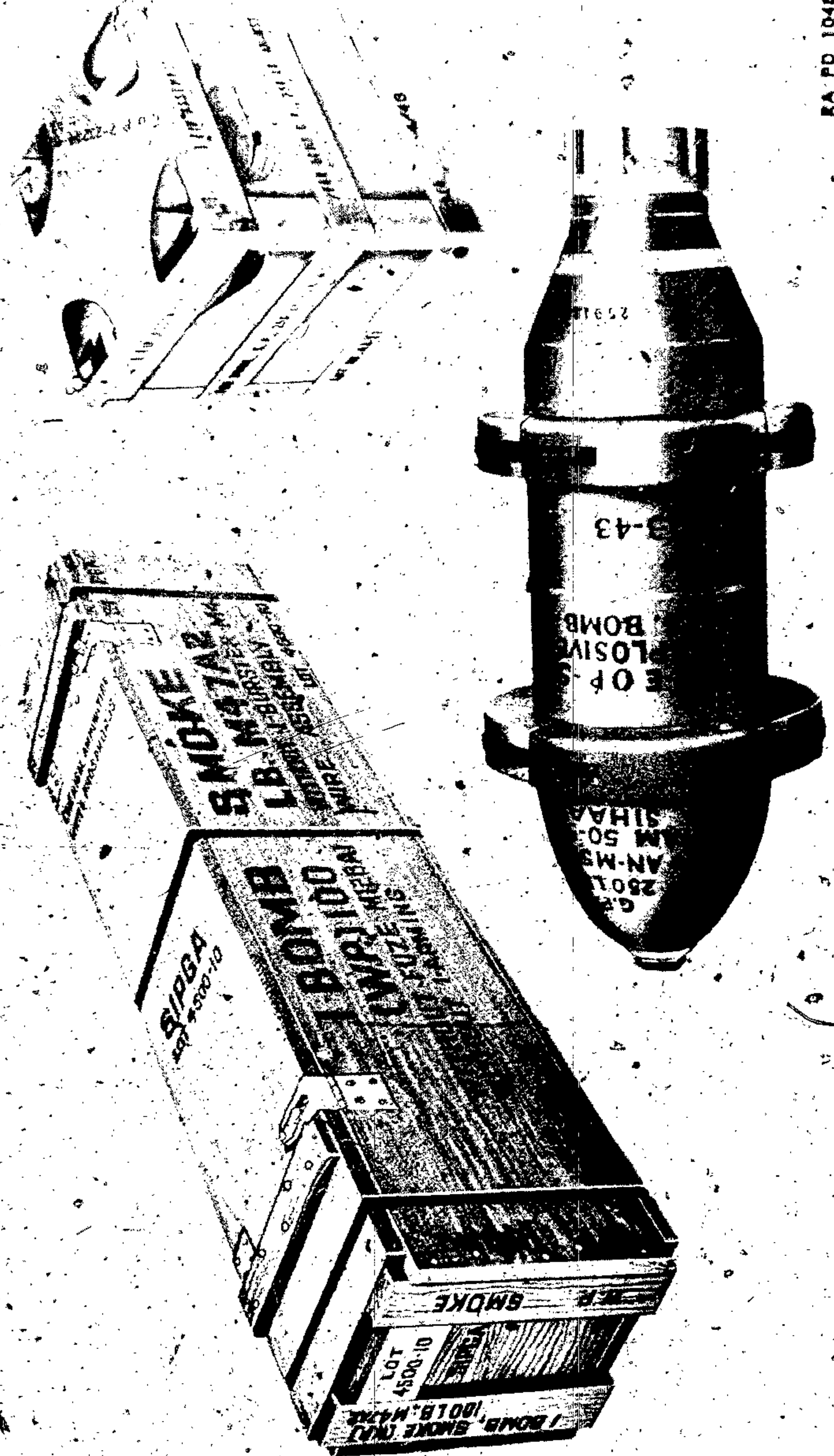

RA PD 104826

Figure 104 - Packing of Bombs



Classes of Ammunition

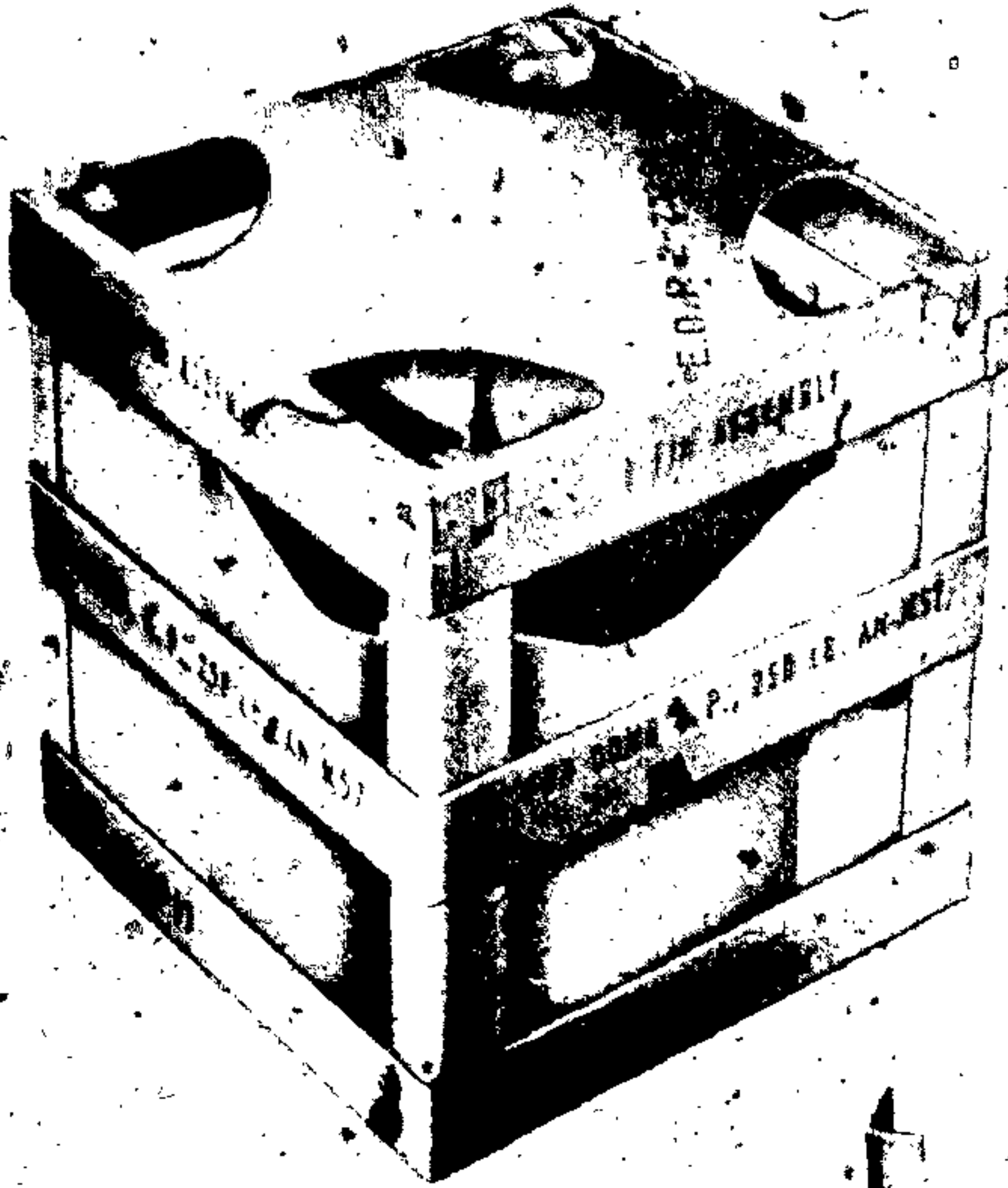

FIN CRATE AS SHIPPED

CRATE WITH COVER REMOVED

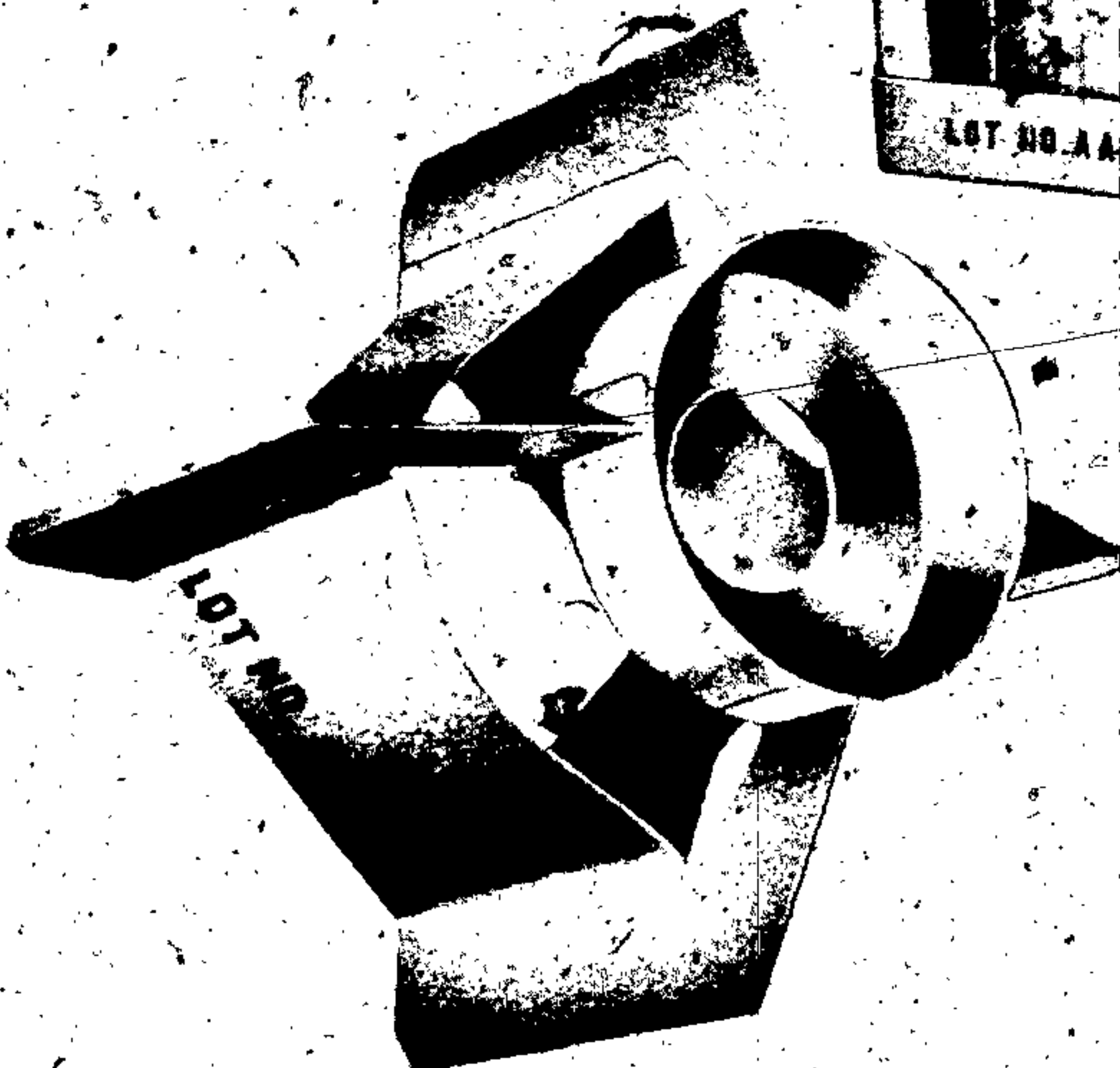

RA PD 1500

Figure 105 - Packing of Bomb Fin Assembly

*Classes of Ammunition*

Concussion fuzes act in response to the concussion wave from the explosion of the preceding bomb in a salvo. Both of these fuzes function on the principle of a bellows or diaphragm working against a spring of fixed strength. When the external pressure overcomes the resistance of the spring, the firing pin is released and driven against the primer by spring action. In some fuzes, provision is made for adjustment by a mechanism controlling the compression of the diaphragm spring.

**119. PACKING AND MARKING.**

a. **Packing.** In general bombs are shipped unfuzed with the fuze holes closed by metal shipping plugs. These plugs are not to be removed except for inspection and for assembly of the complete round. Large bombs are shipped with two paper or metal shipping bands which protect the suspension lugs. The fin assemblies of such bombs are shipped separately in metal crates. Smaller bombs are shipped finned, in metal crates. Small chemical and fragmentation bombs are packed in wooden boxes. Fuzes are packed in individual sealed containers and wooden boxes (figs. 104 and 105).

b. **Marking.**

(1) Wherever appropriate, the color scheme used for painting the bombs (chap. 1, sec. II) is used on the packing boxes or crates. All information for identification and directions for shipping are marked on containers for bombs and components, and on the bomb bodies when no container is used.

(2) A list of all separate components required for the complete round is sometimes stenciled on the shipping container in which these components are ordinarily packed. Usually, however, these components are stored separately and the word "WITHOUT" is stenciled above the list of components on the shipping container. If the separate components are packed with their respective bomb or in assembly for shipment, the word "WITHOUT" is obliterated.

Section VI

**PYROTECHNICS**

**120. GENERAL.** Military pyrotechnics (fig. 106) are fireworks which produce a brilliant light for illumination, or smokes and lights for signaling, in military operations.

**121. CLASSIFICATION.**

a. According to use, pyrotechnics are classified as:

(1) **AIRCRAFT TYPES.** Originally designed for use from or by aircraft.



Classes of Ammunition

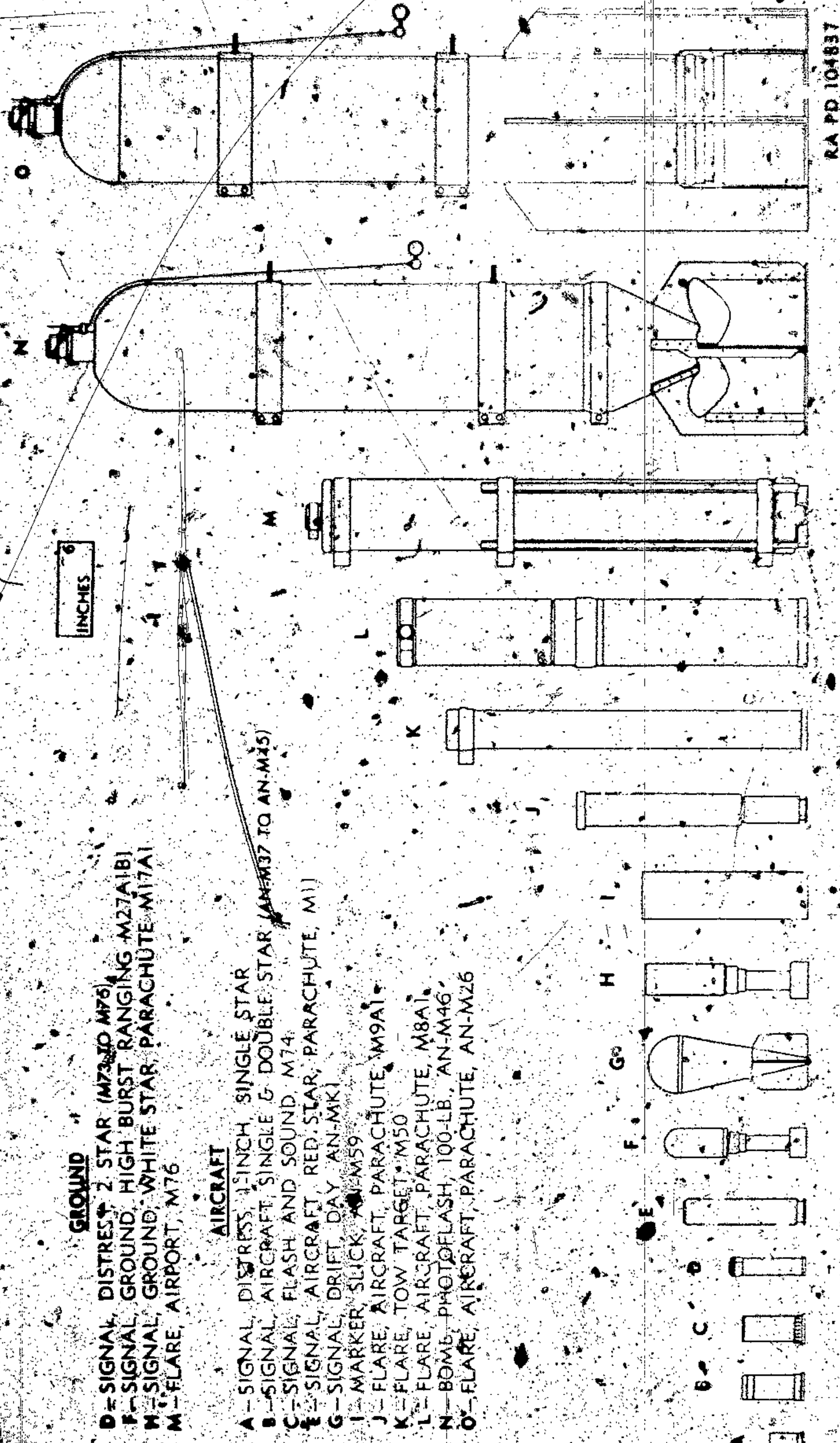

Figure 106 - Military Pyrotechnics. Types and Comparative Sizes

### Classes of Ammunition

(2) Ground use. For use on the ground.

(3) Aerial use. For use in the air they are classified as:

(1) Flares. Flares for illumination for a specific length of time, and photoflash flares for an instantaneous flash for night photography.

(2) Signals. Lights or smokes of various colors for transmission of messages.

(3) Any of the above types when provided with a parachute is designated as a parachute type.

## 22. PYROTECHNIC COMPOSITIONS.

a. Pyrotechnic compositions are a mixture of chemicals which produce illumination.

b. Pyrotechnics generally function by means of an igniter train similar to the explosive train. In general, it is initiated by a primer mixture and intensified by a "first fire compound" which properly ignites the luminous candle.

c. Standard pyrotechnic compositions, in general, consist of compounds to provide oxygen for burning, such as perchlorates and nitrates; powdered aluminum or magnesium for fuel; salts of sodium, barium, copper, or strontium for color; and materials such as asphalt and paraffin for binding and waterproofing.

## 123. VISIBILITY OF PYROTECHNIC SIGNALS.

a. The principal factors controlling the effectiveness of pyrotechnics are design, position and atmospheric conditions.

(1) Factors of design include candlepower, color, and degree of separation of the parts of a composite signal.

(2) Factors of position include height at which the flare or signal functions; distance of observer from signal; distance of flare from objective to be illuminated; background; and relative position of flare, objective, and observer.

(3) Atmospheric conditions include clarity of atmosphere; time (day or night); presence of haze, fog, dust, rain, or snow; and the color and brightness of the sky.

b. Tables of visibility, distinguishability, and distance are published in TM 9-1981.

## 124. FLARES.

a. Flares are used to provide illumination for reconnaissance, observation, bombardment, landing, and practice firing of anti-aircraft guns. While the details of flares vary with their purpose, all have certain common characteristics (figs. 107, 108, and 109):





Figure 107 — Parachute Aircraft Flare M8A1

50 MAX

GRAY (MARKING IN BLACK)

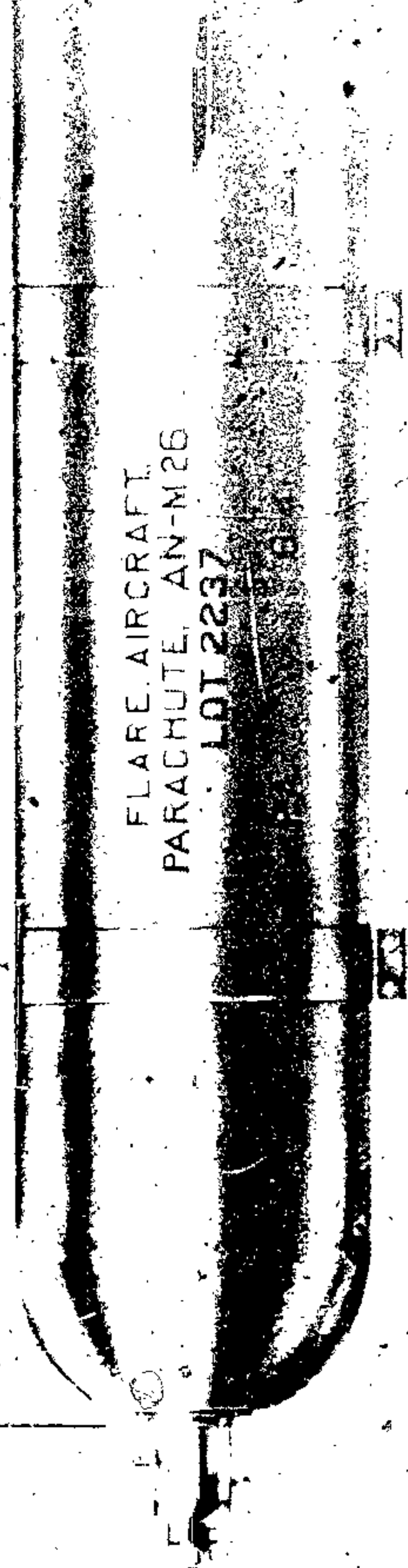
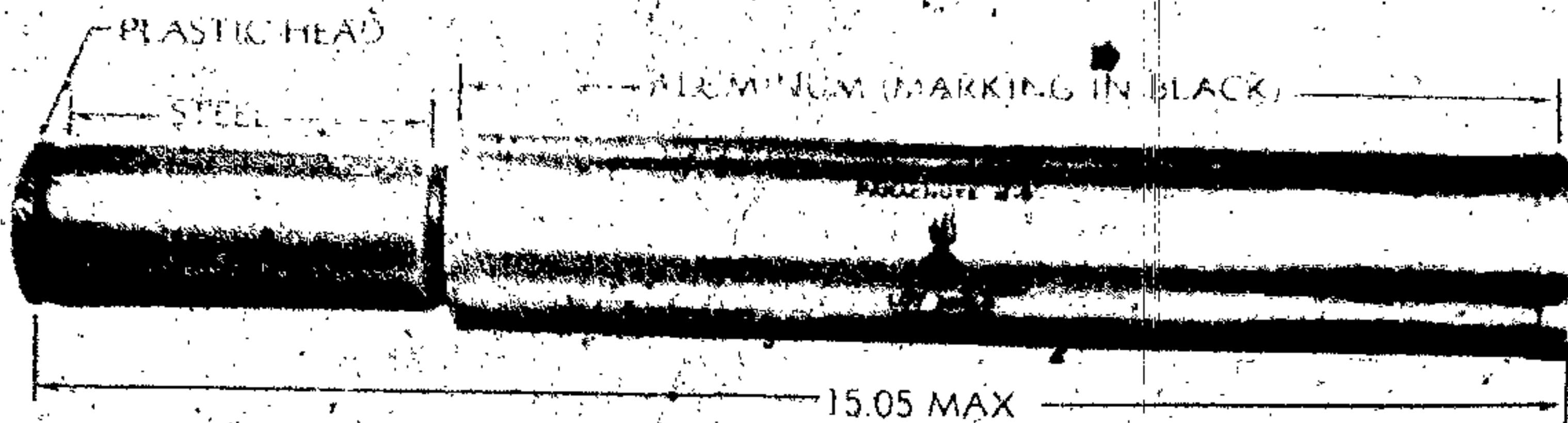

Figure 108 — Parachute Aircraft Flare AN-M26

Classes of Ammunition



RA PD 64447

Figure 109 - Parachute Aircraft Flare M9A1

(1) Production of a white or yellowish light of high intensity ranging from 50,000 candlepower for 1 minute to 1,000,000 candlepower for 3 minutes or longer.

(2) Parachute support, to retard their speed of fall, thus providing efficient illumination for observation.

(3) Delayed ignition, to assure their reaching a specified altitude before ignition. Ignition is usually controlled by the opening of the parachute by means of a wire attached to the parachute cable or shock absorber, this wire pulling ignition wires through the igniting composition. The flame thus produced is then carried by quick-match to the primer, first-fire charge, and the illuminant composition of the candles.

h. - Flares for use below a plane, such as those intended for bombardment purposes, are provided with shades to shield the bombardiers from the glare.

c. Flares that are to be released from launching tubes or racks are equipped with a hangwire assembly which is attached to the arming pawl of the tube or rack. The flares may be released "armed" or "safe." When the flare is released "armed," the hangwire remains attached to the plane and pulls out the parachute or stabilizing sleeve. A section of soft metal tear wire enables the flare to break free. If released "safe," it will not function in the air but may ignite on impact. This possibility must be kept in mind in releasing flares safe over friendly territory.

d. The flare provided as a target for both day and night practice firing of antiaircraft guns, is towed by a plane at the end of a steel cable. See figure 110.

**125. PHOTOFASH BOMBS.** This ammunition item (fig. 111), called "bomb" because of its explosive nature, provides a brilliant light of short duration for night photography. A photoflash bomb which is dropped safe, or whose fuze fails to function, may detonate on impact. The flash from photoflash bombs, even at distances prescribed as safe from bomb fragments, is injurious to the eye because



Classes of Ammunition

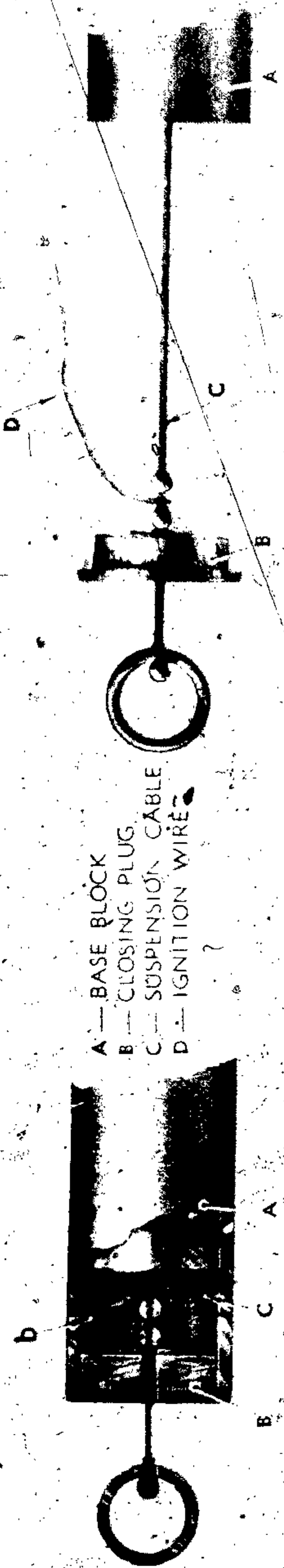

BLUE-GRAY

22.85 MAX.

FLARE, TOW TARGET, M50  
LOT 1440

RA PD 69070A

Figure 110 — Tow-target Flare M50

Classes of Ammunition

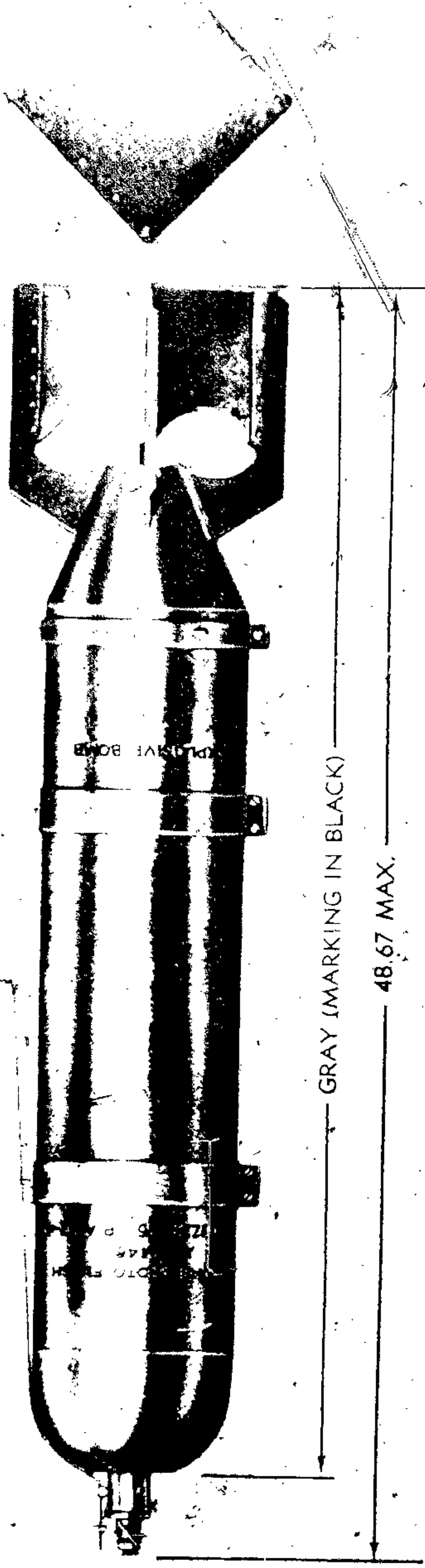

RA PD 7241B

Figure 111 - Photoflash Bomb M46



Classes of Ammunition

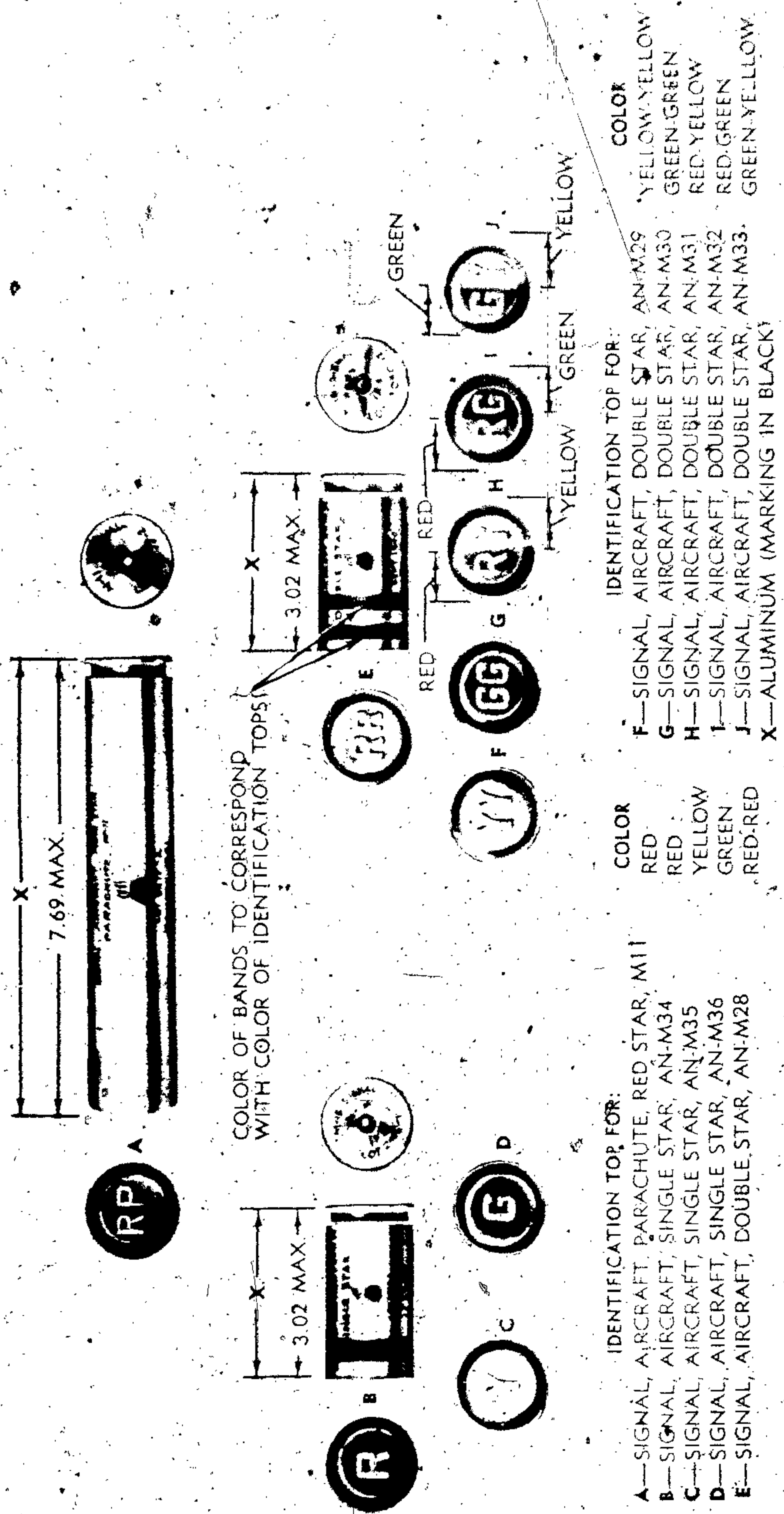

COLOR OF BANDS TO CORRESPOND WITH COLOR OF IDENTIFICATION TOPS

IDENTIFICATION TOP FOR:	COLOR	IDENTIFICATION TOP FOR:	COLOR
A—SIGNAL, AIRCRAFT, PARACHUTE, RED STAR, M11	RED	F—SIGNAL, AIRCRAFT, DOUBLE STAR, AN-M29	YELLOW-YELLOW
B—SIGNAL, AIRCRAFT, SINGLE STAR, AN-M34	RED	G—SIGNAL, AIRCRAFT, DOUBLE STAR, AN-M30	GREEN-GREEN
C—SIGNAL, AIRCRAFT, SINGLE STAR, AN-M35	YELLOW	H—SIGNAL, AIRCRAFT, DOUBLE STAR, AN-M31	RED-YELLOW
D—SIGNAL, AIRCRAFT, SINGLE STAR, AN-M36	GREEN	I—SIGNAL, AIRCRAFT, DOUBLE STAR, AN-M32	RED-GREEN
E—SIGNAL, AIRCRAFT, DOUBLE STAR, AN-M28	RED:RED	J—SIGNAL, AIRCRAFT, DOUBLE STAR, AN-M33	GREEN-YELLOW
		X—ALUMINUM (MARKING IN BLACK)	

RA PD 61186A

Figure 112 - Aircraft Signals (Rimless Types)

Classes of Ammunition

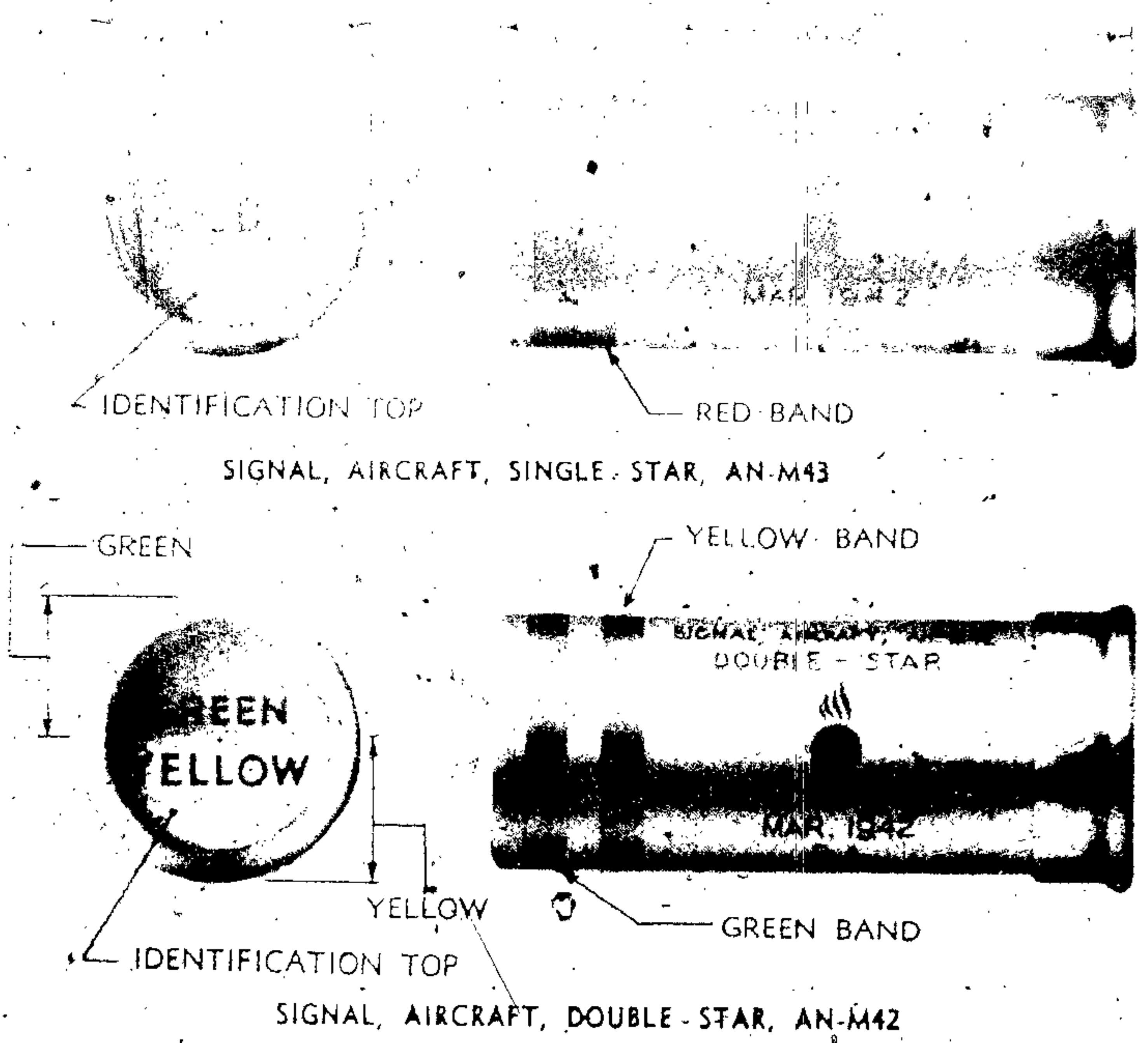

NOTE:—COLOR OF BANDS AND IDENTIFICATION TOPS TO CORRESPOND WITH COLOR OF SIGNAL (SEE TABLE)

SIGNAL	COLOR OF BANDS AND IDENTIFICATION TOPS
AIRCRAFT, DOUBLE - STAR, AN-M37	RED - RED
AIRCRAFT, DOUBLE - STAR, AN-M38	YELLOW - YELLOW
AIRCRAFT, DOUBLE - STAR, AN-M39	GREEN - GREEN
AIRCRAFT, DOUBLE - STAR, AN-M40	RED - YELLOW
AIRCRAFT, DOUBLE - STAR, AN-M41	RED - GREEN
AIRCRAFT, DOUBLE - STAR, AN-M44	YELLOW
AIRCRAFT, DOUBLE - STAR, AN-M45	GREEN

Figure 113 — Aircraft Signals (Cartridge Type)



Classes of Ammunition

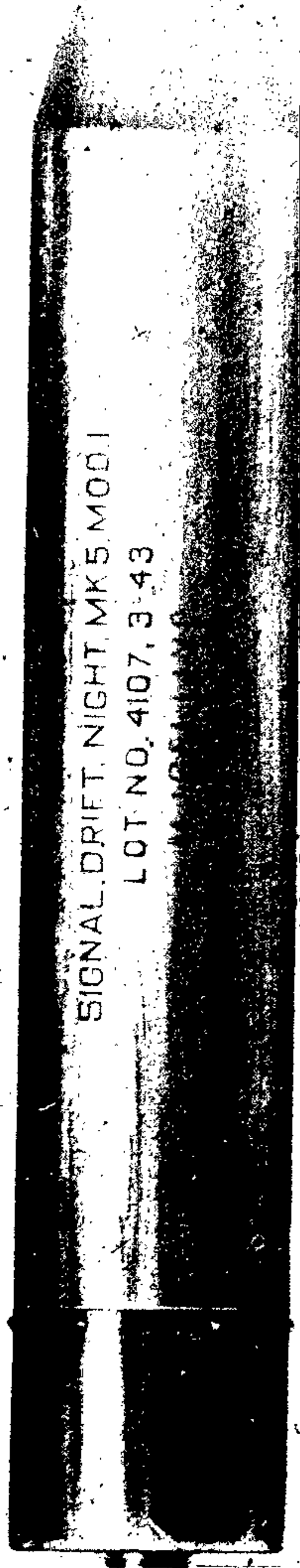

RA 50 5507E

19.420"

Figure 114 — Night Drift Signal AN-Mk 5 Mod 1



Figure 115 - Slick Marker AN-M59

of its brilliant flash. The photoflash bomb, M46 produces a flash which reaches an intensity of 500 to 700 million candlepower for approximately 0.02 second and functions from 5 to 90 seconds, depending on setting of its mechanical time fuse.

**126. AIRCRAFT SIGNALS.**

a. These signals are fired from pyrotechnic discharges which are described in TM 9-290. The signals are provided for signaling from aircraft to other aircraft or to ground units. They may also be fired on the ground. There are two types of aircraft signals:

(1) The rimless type, assembled in an aluminum or plastic-steel barrel. The barrel is in the shape of a cylindrical cup which is grooved near the base or closed end. The primer is pressed into the center of the base. A press fit identification top (closing top) is cemented in the opposite end. (See fig. 112.)

(2) The cartridge type, assembled in a cylindrical shell to which a metal or plastic head, containing the primer, is crimped. The opposite end is closed with a cardboard wad or press fit metal disc which is colored and marked to indicate type of signal. In appearance, it resembles a large shotgun shell (fig. 113).



Classes of Ammunition

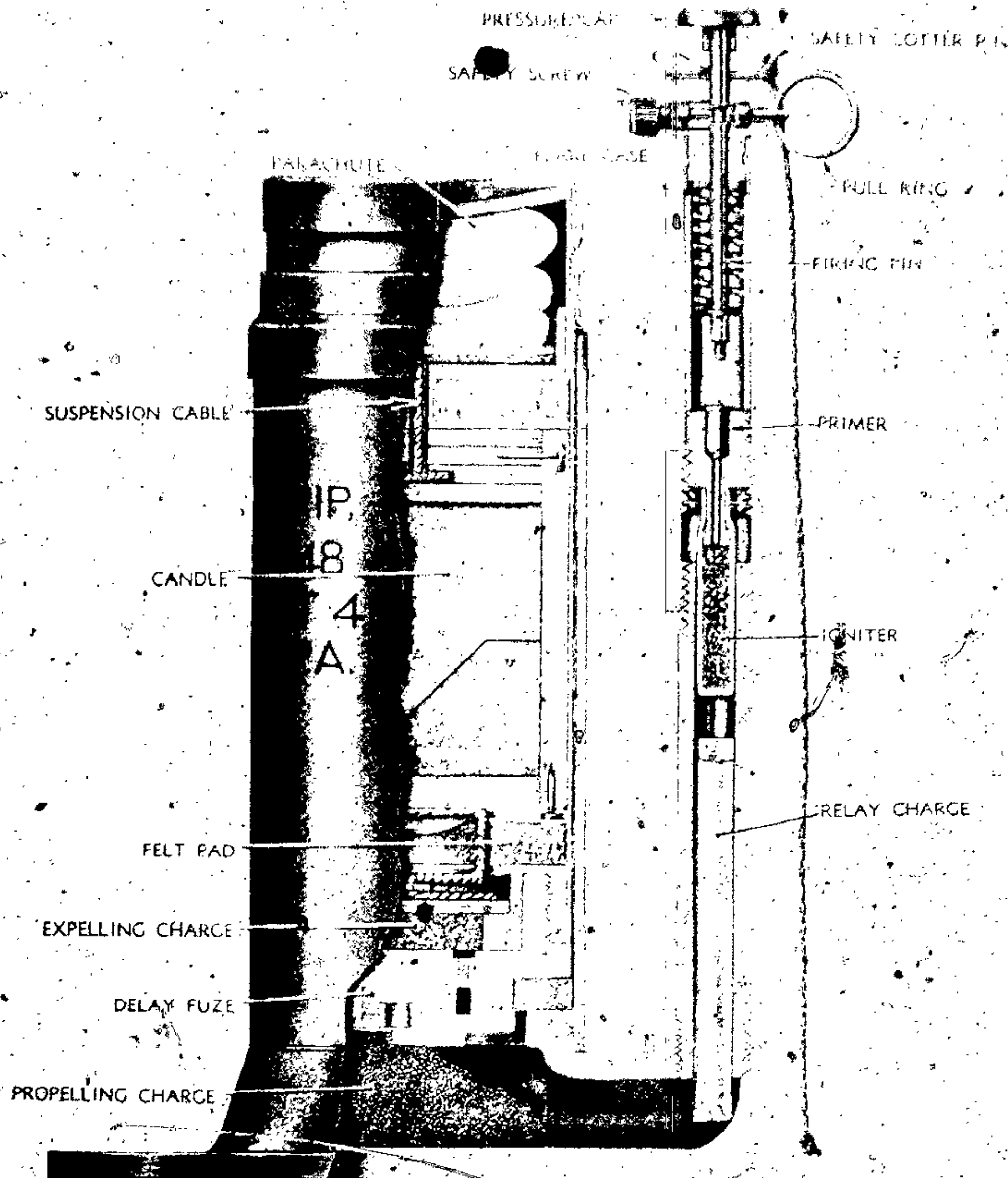

RA PD 69071

Figure 116 - Parachute Trip Flare M48

127. **DRIFT SIGNALS.** Drift signals are provided as an aid to navigation over water by providing a stationary reference point for determination of drift of the airplane. The signals are released from the plane by hand and drop to the water, being stabilized in fall by fins. There are signals for daytime use and others for use at night. Day drift signals contain a metallic powder in a streamlined paper shell which breaks on impact with the water allowing the powder to form a slick on the surface for use as a reference point. Drift signals (fig. 114) for use at night contain a pyrotechnic pellet or candle which is ignited by the fuze on impact with water. The signal will

Classes of Ammunition

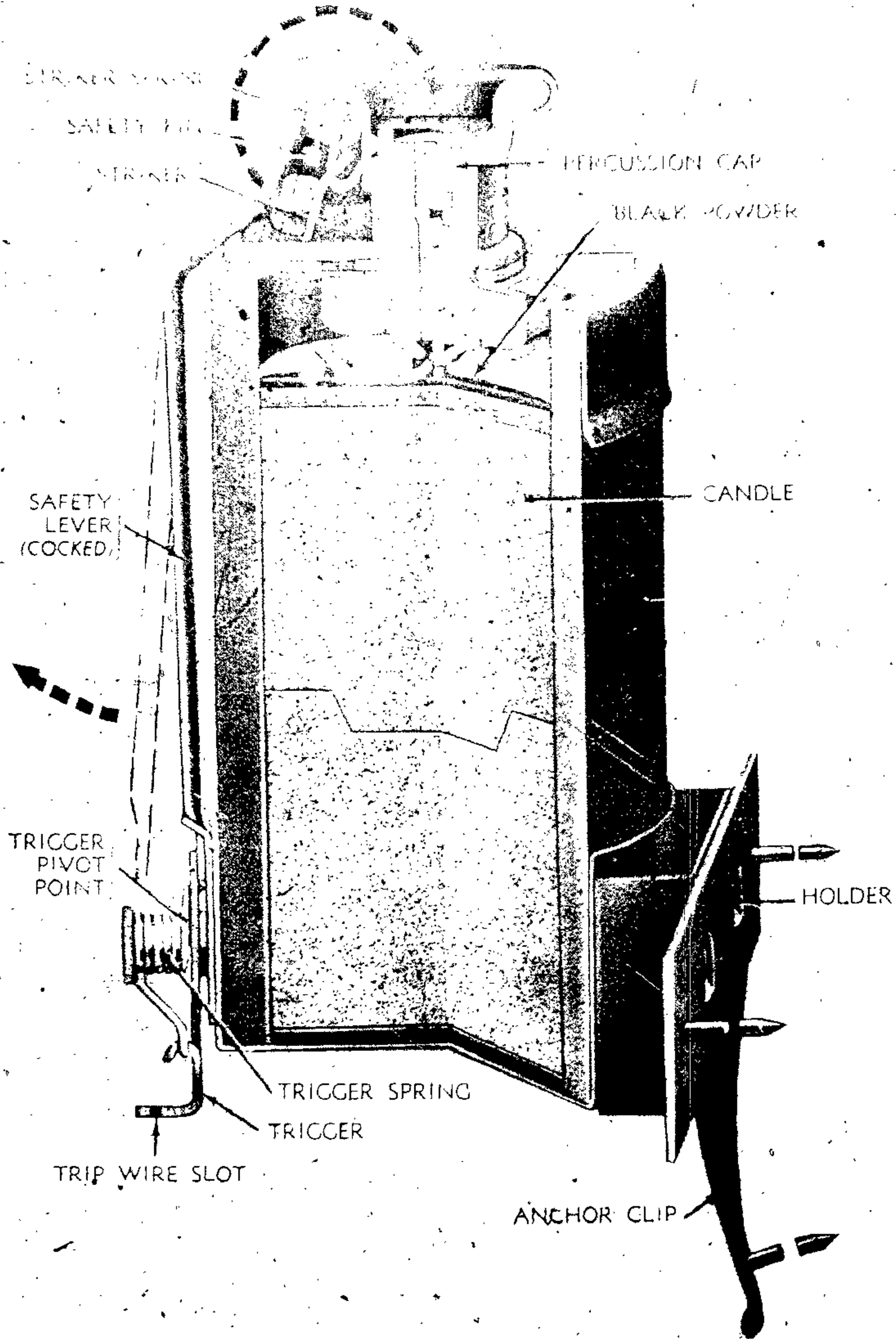

RA PD 89353

Figure 117 - Trip Flare M49



Classes of Ammunition

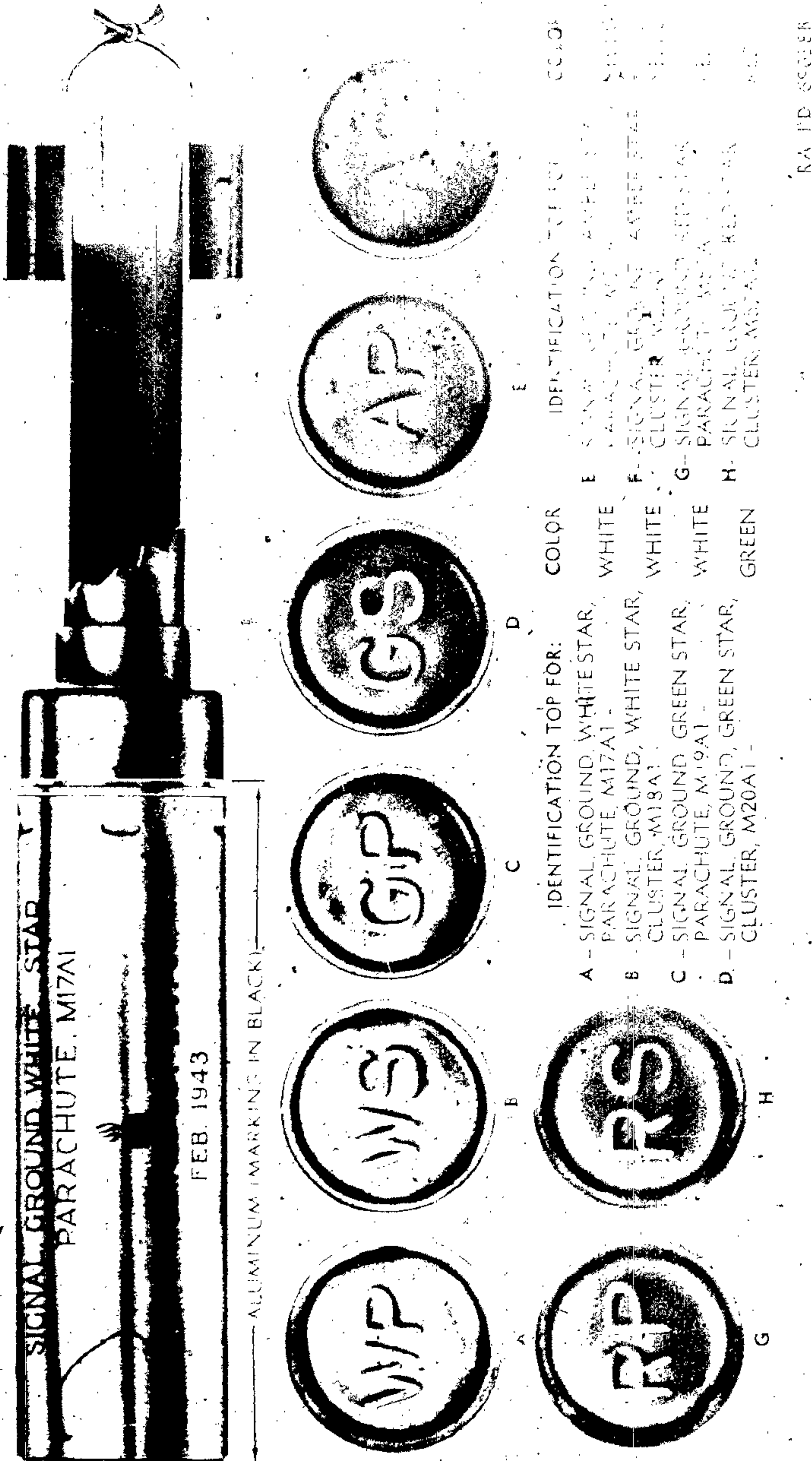
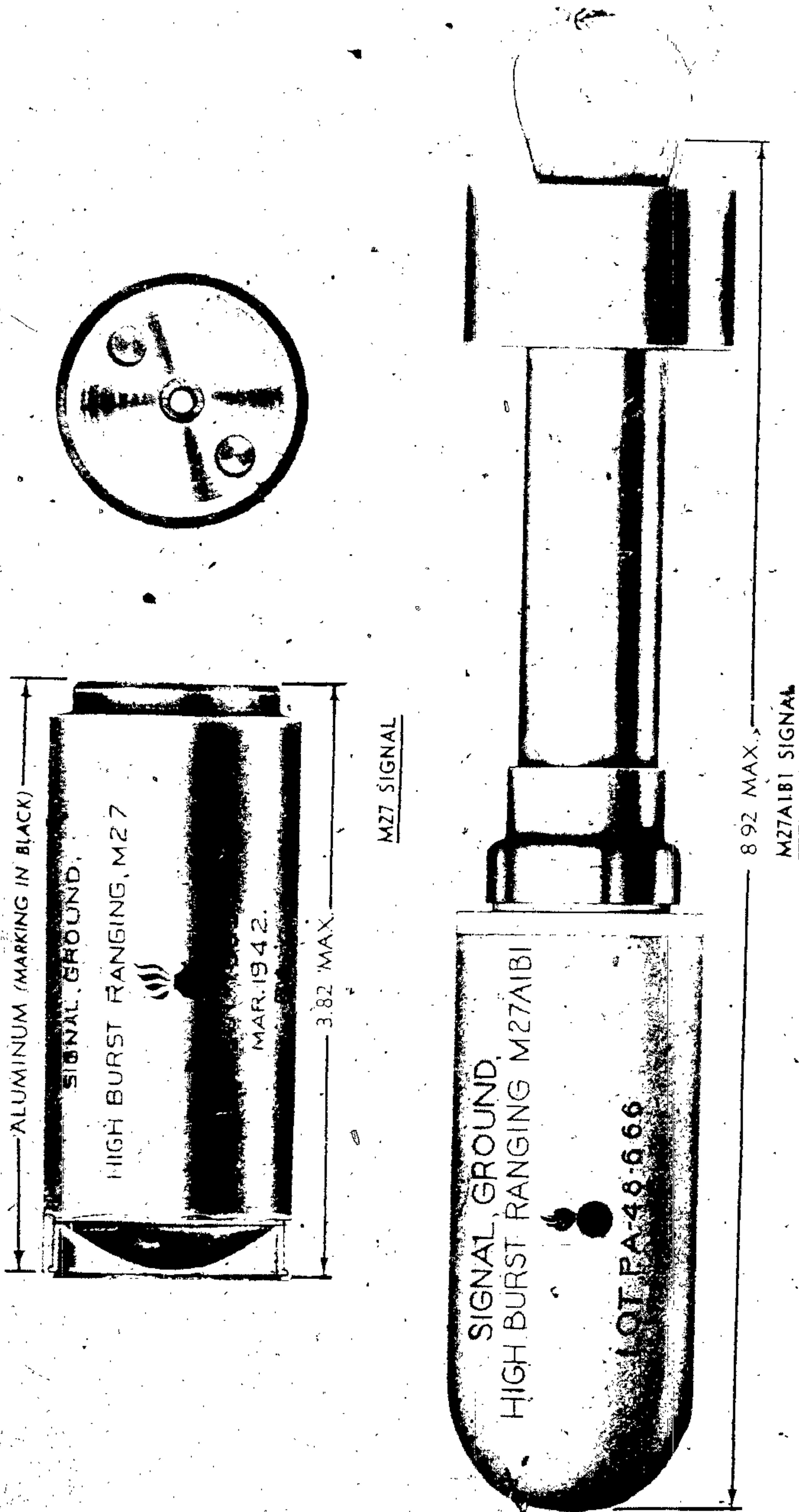

Figure 118 - Ground Signals - Launcher Type

ALUMINUM (MARKING IN BLACK)

Classes of Ammunition



RA PD 104838

Figure 119 — High-burst-ranging Ground Signals



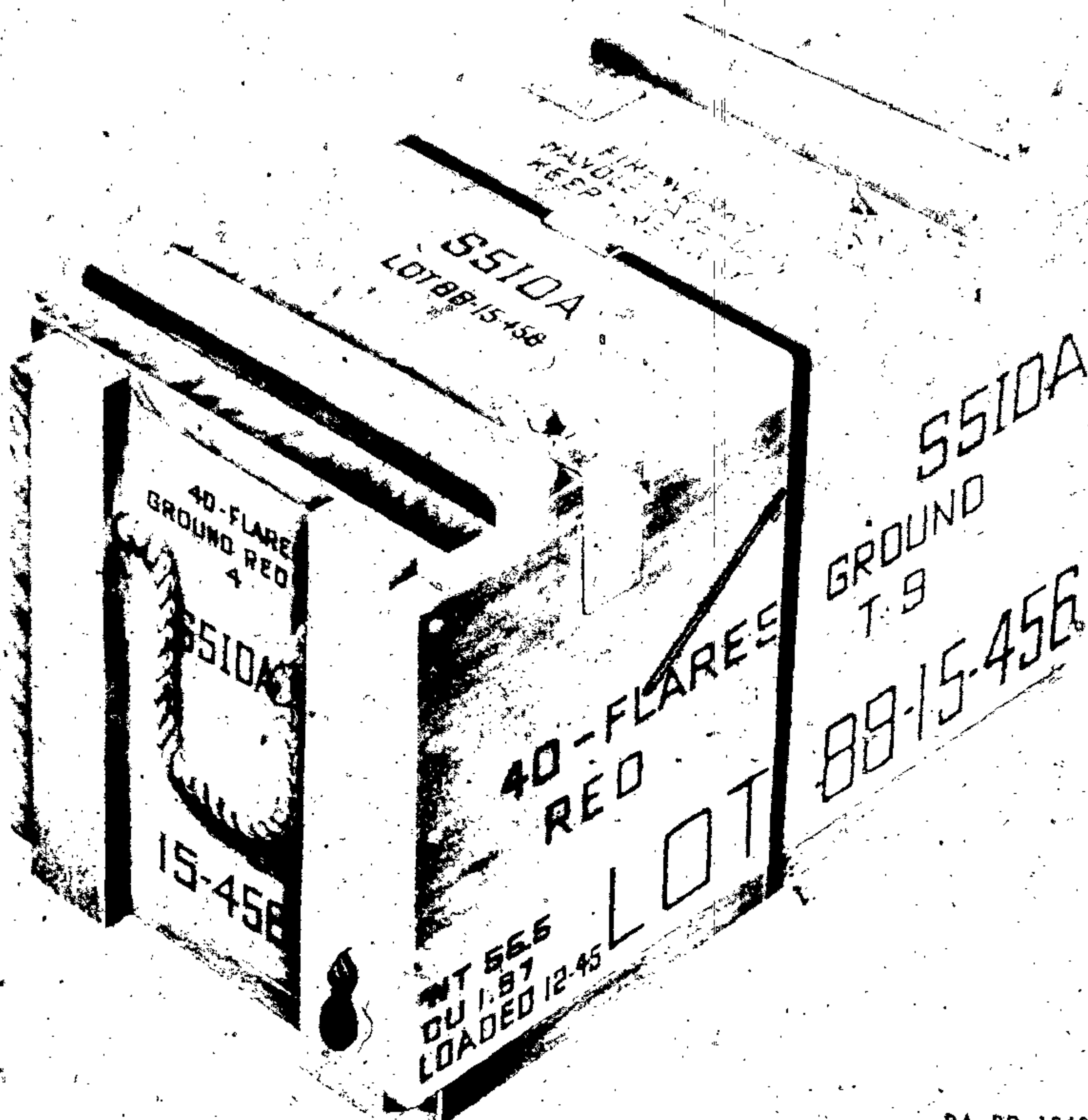

RA PD 104839

Figure 120 - Packing Box for Ground Flares

float, nose down, in the water and emit smoke and flame from a hole in the tail for as long as 17 minutes, serving as a reference point for air navigation at night.

**128. SLICK MARKER.** This item (fig. 115) is used to produce a persistent slick for reference points on the water. It contains a fluorescent dye in a paper composition case which shatters upon impact with the water and forms a slick which may be visible for 10 miles at 3,000 feet altitude.

**129. SMOKE GRENADES.** Both white and colored smoke grenades may be used for signaling. (See chapter 2, section II.)

**130. GROUND TYPE FLARES.**

a. Airport flares are used on the ground to provide illumination for airplane landings at emergency fields or in case of power failure at airports.

Classes of Ammunition

KA PD 104840

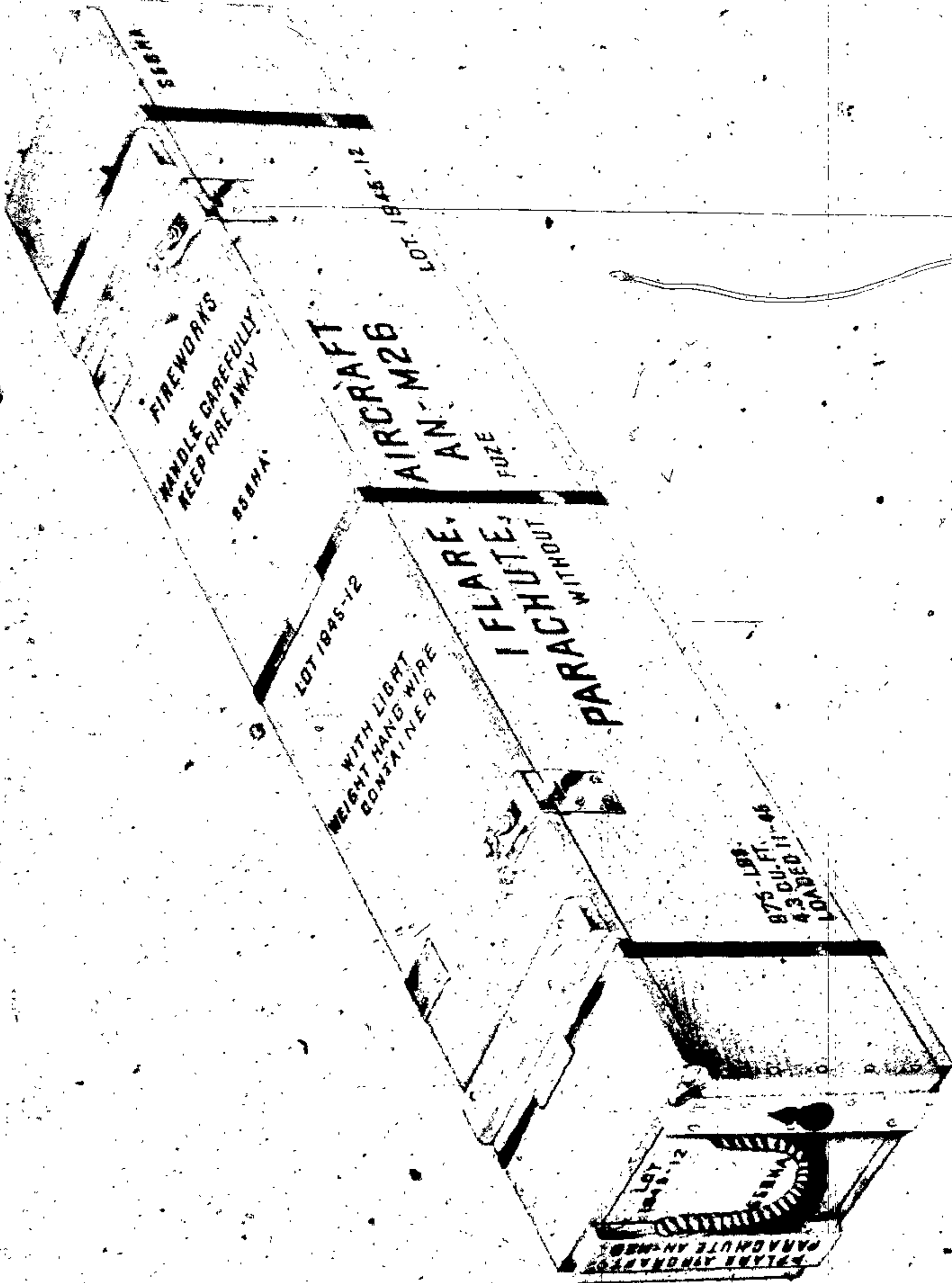

Figure 121 -- Packing Box for Aircraft Parachute Flare



---

*Classes of Ammunition*

---

b. Trip flares are primarily used to give warning of enemy marauders or infiltrating hostile troops. Secondary use of the trip flare is for illumination of such troops, or for signaling. They are similar to booby traps in that they are left in the path of an advancing enemy and depend upon some action of the enemy for initiation. One model resembles a bounding antipersonnel mine (fig. 116), since it propels a shell containing a parachute-supported candle into the air 300 to 500 feet high where the candle is ignited and expelled from the shell case. Another resembles a hand grenade in size and shape (fig. 117) with the addition of a bracket for attachment to a tree or post and a trigger mechanism for firing. Unlike hand grenades, the fuze has no delay element.

**131. ILLUMINATING SHELLS.** These pyrotechnic items are provided for illumination by ground troops of objectives beyond the range of other flares. They are fired from mortars or artillery cannon and contain a flare candle, parachute and time fuze. (See chapter 2, sections III and IV.)

**132. GROUND SIGNALS.**

a. Standard ground signals (fig. 118) are launched by means of grenade launchers M4, M7, and M8 attached to caliber .30 rifles or carbines. These signals consist of the signal assembly and the stabilizer fin assembly. The signals may be green, amber, red, or white in color and may be of the parachute type or five-star cluster type. A new series of ground signals produces red, orange, green, violet, or yellow smoke.

b. The high-burst-ranging signal M27 (fig. 119) is fired from the ground signal launcher M1A1; the high-burst-ranging signal M27A1B1 (fig. 119) is fired from standard grenade launchers similar to standard ground signals. This signal simulates the high burst of artillery shell for ranging practice. It rises to an altitude of approximately 550 feet when fired from the ground launcher M1A1 and approximately 700 feet when fired from the grenade launcher. The burst is accompanied by a flash, a puff of gray smoke, and a noise which can be heard for a distance of at least 2,000 yards.

**133. DISTRESS SIGNAL.** This signal is for use at sea. It is assembled in an all metal body and is not adversely affected by prolonged exposure to water vapor. The distress signal M75 has a self-contained projector and the signals M13 are for use with the pyrotechnic projector M10.

**134. FLASH AND SOUND SIGNAL.** The flash and sound signal M74 is intended primarily for control umpires to simulate air burst of artillery fire for training troops. It is fired from the pyrotechnic

Classes of Ammunition

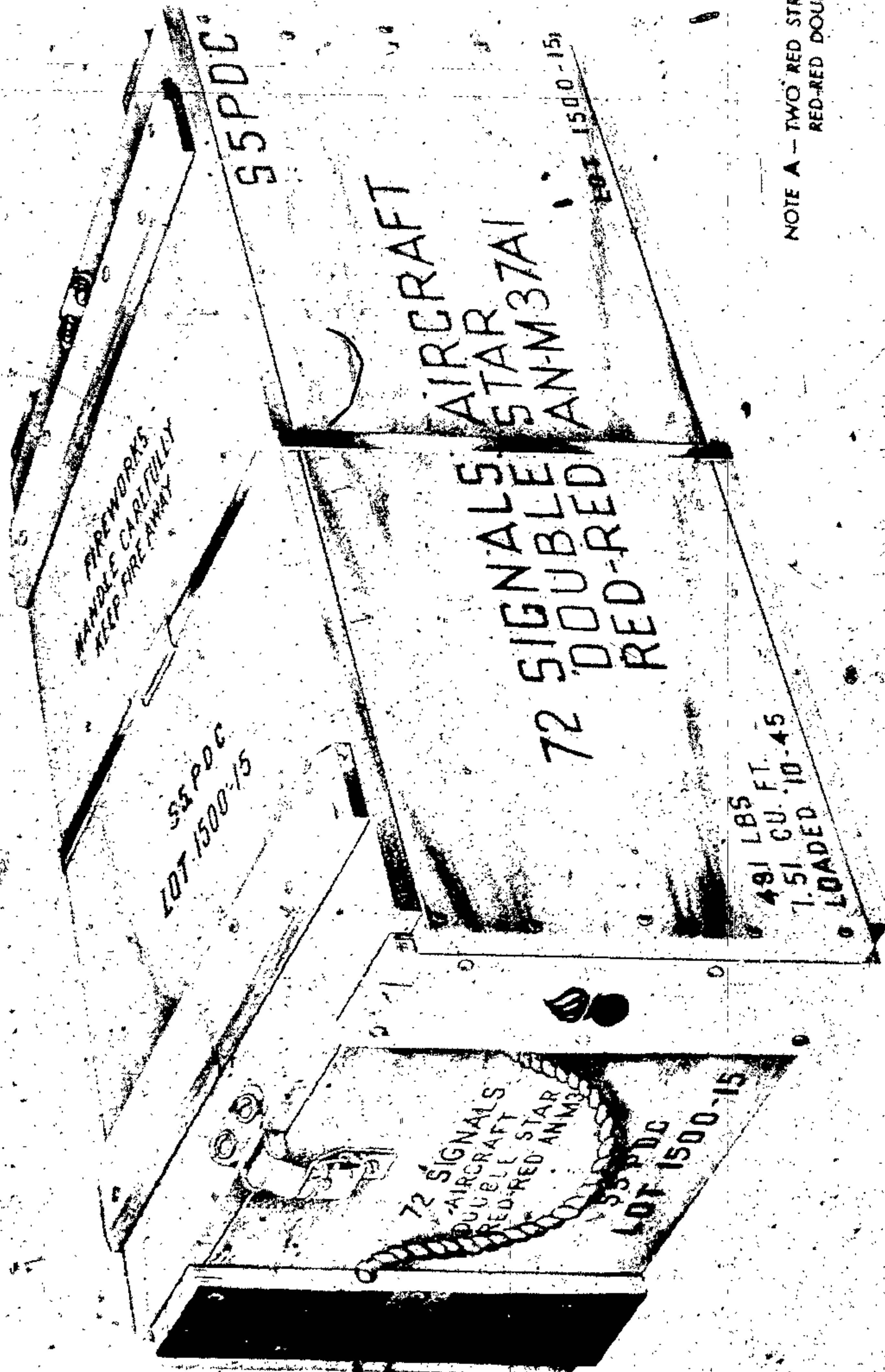

NOTE A - TWO RED STRIPES TO INDICATE RED-RED DOUBLE STAR SIGNAL

RA PD 104841A

Figure 122 - Packing Box for Aircraft Signals



## Classes of Ammunition

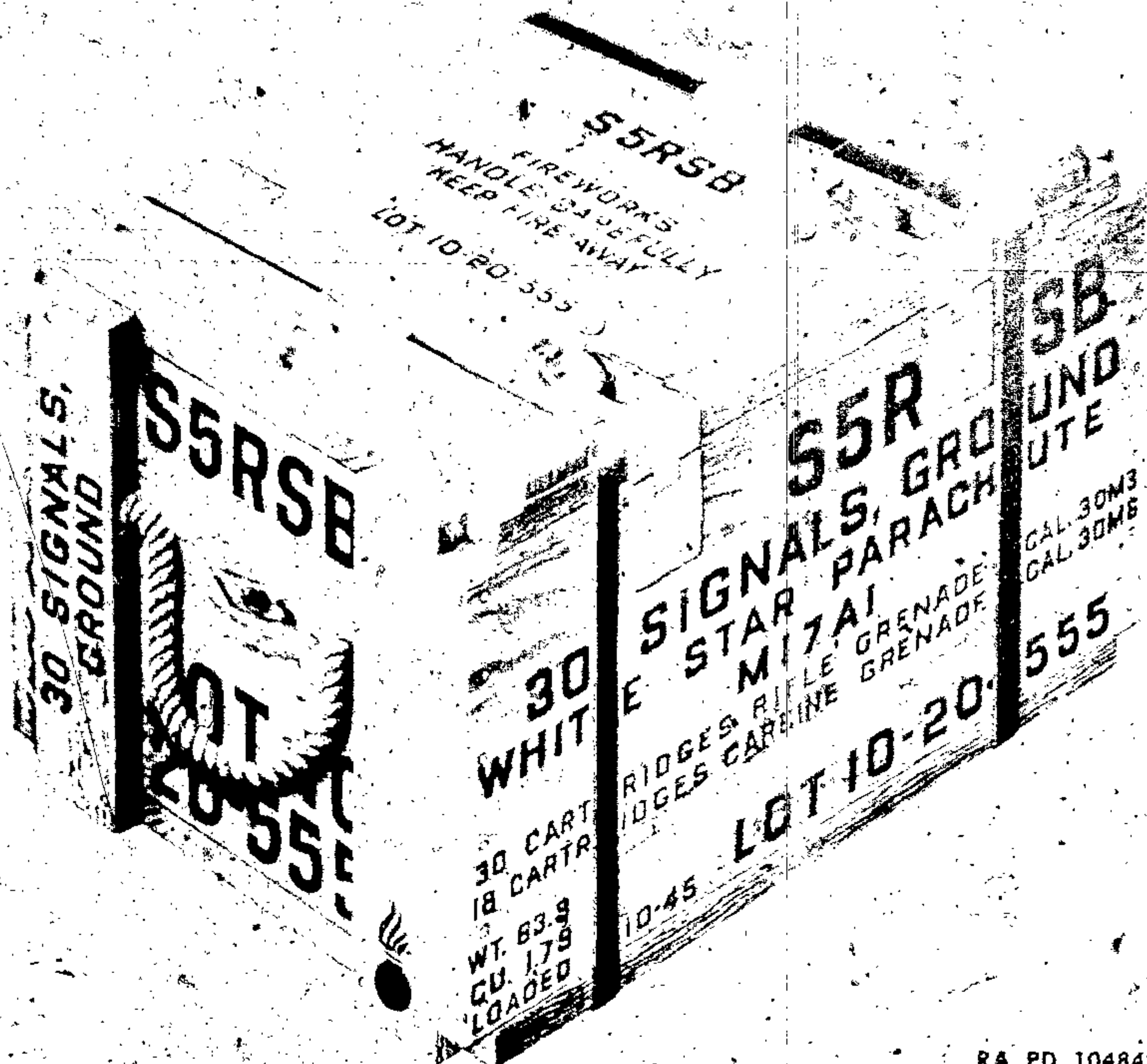

RA PD 104842

Figure 123 - Packing Box for Ground Signals

pistol M8 or the hand pyrotechnic projector M9. In appearance it is similar to the cartridge type aircraft signals. At an elevation of 45 degrees, the height of burst of the signal is about 100 feet.

**135. RED FUSEE.** The 20 minute red fusee M72 is similar to commercial type fusees. It consists of a cylindrical paper tube filled with red flare composition and a sharp nail protruding through the wooden bottom plug. A match head imbedded in the top of the flare composition may be ignited with a striking composition block.

**136. IDENTIFICATION.** In addition to the standard markings and painting (chap. I, sec. II), varieties of one type of signal carry, as a means of identification among themselves, markings as follows:

a. Aircraft signals are distinguished by the color and embossing on the identification top (outer wad), and by bands in the color of the signal produced.

---

*Classes of Ammunition*

---

b. Some ground signals are distinguished by the color and embossing on the fin, others by the color and embossing on the identification top.

c. For information of those installing flares M8A1 and M24 in aircraft, the word "FRONT" is stenciled on the front of the case and the location of suspension bands is indicated by black bands painted on the case.

d. Over-age and substitute composition flares assigned to training will have a blue band approximately 2 inches wide painted around the body immediately below the label. These flares may also be stenciled "FOR TRAINING USE ONLY".

**137. CARE, HANDLING, AND PRESERVATION.** Pyrotechnics contain material of an intrinsically hazardous nature. In general, the same regulations apply to pyrotechnics as for other types of ammunition, covered in chapter 3, sections I and II. In addition, the following will be observed:

a. Pyrotechnics are protected from moisture by moistureproof hermetically sealed containers. When containers show signs of dampness or moisture, they will be opened and if there is evidence of moisture on the pyrotechnics, they will be destroyed by authorized and experienced personnel. As pyrotechnics are very hygroscopic, they should not be removed from standard packings any sooner than necessary prior to use.

b. Besides the hazardous pyrotechnic compositions, pyrotechnics contain sensitive elements, such as fuzes, friction compositions, and primers. Disassembly of pyrotechnics or components is prohibited. Boxes containing signals which are discharged by percussion primers should be placed flat with the top of the box up. Protective or safety devices should not be removed until just before use. Care should be taken to avoid damage to fiber cases and parachute pull-out cords. Pyrotechnics, especially projected types which are seriously dented or deformed will not be used, as a damaged barrel or case might cause a round to become lodged in the bore of the projector. It should be kept in mind that photoflash powder is as hazardous as black powder.

c. Storage of pyrotechnics is described in chapter 3.

d. The incendiary effect of pyrotechnic material should be kept in mind in using such material in the vicinity of dry brush and grass.

e. Pyrotechnic material is poisonous to men and animals if taken internally.

f. During maneuvers over terrain other than military reservations, the location of dud flares and photoflash bombs will be observed and reported. The duds will be sought out and destroyed, as soon as possible, as instructed in chapter 4.



---

 Classes of Ammunition
 

---

**138. PACKING.** Due consideration is given in packing of pyrotechnics to prevent contact with moisture. Pyrotechnics are packed in metal-lined or unlined, nailed or wirebound wooden boxes. Those in unlined boxes are placed in inner containers consisting of sealed corrugated board cartons, cylindrical fiber containers, or metal containers. The cartons are dipped in paraffin to protect the contents from moisture. See figures 120, 121, 122, and 123.

---

 Section VII
 

---

**ROCKETS**

**139. GENERAL:** A rocket is a projectile which is propelled by the reaction, or recoil, from discharging a jet of gas to the rear at high velocity. The gas is produced by the burning of a propelling charge within the rocket itself. A military rocket consists of a head, or shell, and a motor. The head contains the explosive or chemical charge and a fuze; it is similar in function to an artillery shell or a bomb. The motor consists of a tube closed at one end and constricted near the other to form a nozzle; it contains the propelling charge and an igniter. Fins may be attached to the motor to stabilize the rocket in flight. The principal advantages of rocket ammunition are that it imparts little or no recoil to the weapon and does not require a rifled barrel. A further advantage lies in that the forces of setback are spread over a long period of acceleration rather than concentrated in a short time as in a gun. Consequently rocket propulsion can be used for light case missiles of high capacity with fuzes of more fragile construction. The disadvantages are, that protection is required against the blast of hot gas from the tail of the rocket, and that rocket dispersion is greater than that of shell of similar caliber. The weapon used in firing the rocket is designated a launcher since it serves only to give the rocket its initial direction and does not project the rocket as a gun or mortar.

**140. CLASSIFICATION.**

a. **Rockets** are classified according to the filler of the rocket head as explosive, chemical, practice, or target (figs. 16 and 124 through 131).

b. **Explosive rockets.** Explosive rockets contain a high-explosive filler and are further classified as:

(1) **HIGH-EXPLOSIVE (HE)**, which has a relatively large charge of explosive for blast, fragmentation, or mining effect at the target.

(2) **HIGH-EXPLOSIVE, ANTITANK (HEAT)**, which contains a special shaped explosive charge particularly effective against armor.

(3) **DEMOLITION**, which has an exceptionally thin case and a correspondingly large charge of high explosive.

Classes of Ammunition

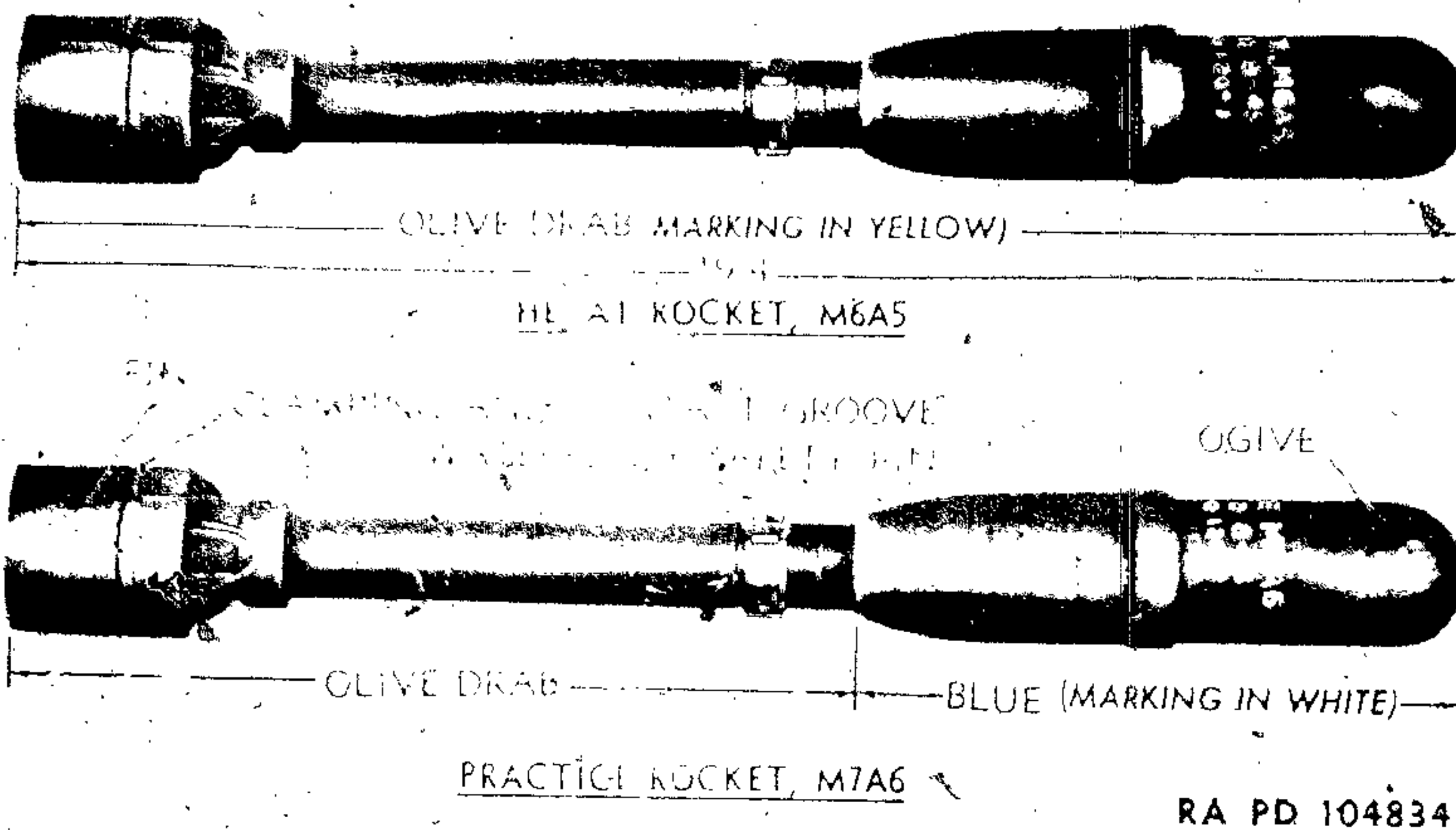

Figure 124 — Rocket M6A5 and Practice Rocket M7A6

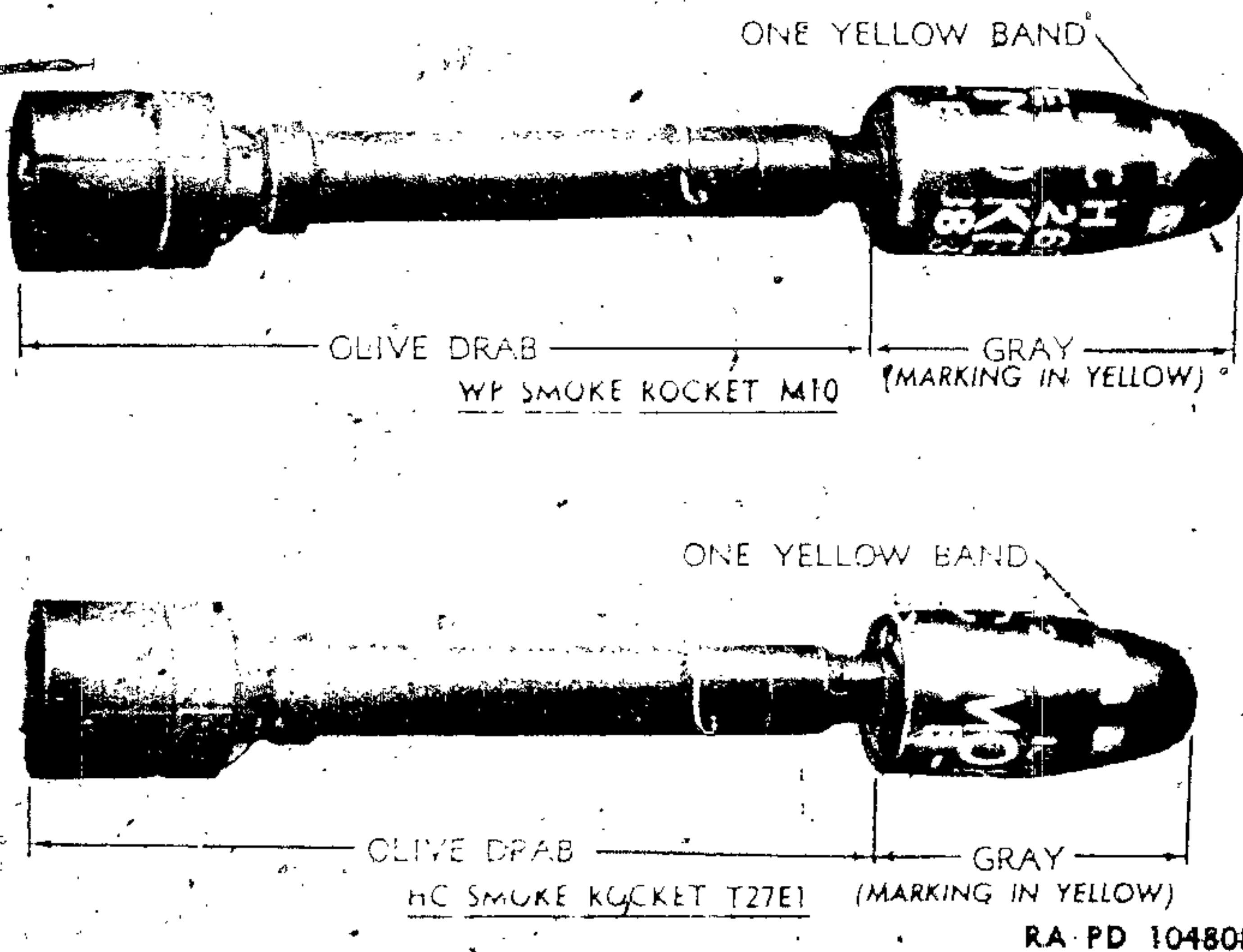

Figure 125 — 2 36-inch Smoke Rockets

c. Chemical rockets. Chemical rockets contain fillers of chemical agents which are classified as:

- (1) GAS, which produces a casualty or harassing effect on personnel.
- (2) SMOKE, which produces a cloud of smoke for screening or signaling.



Classes of Ammunition

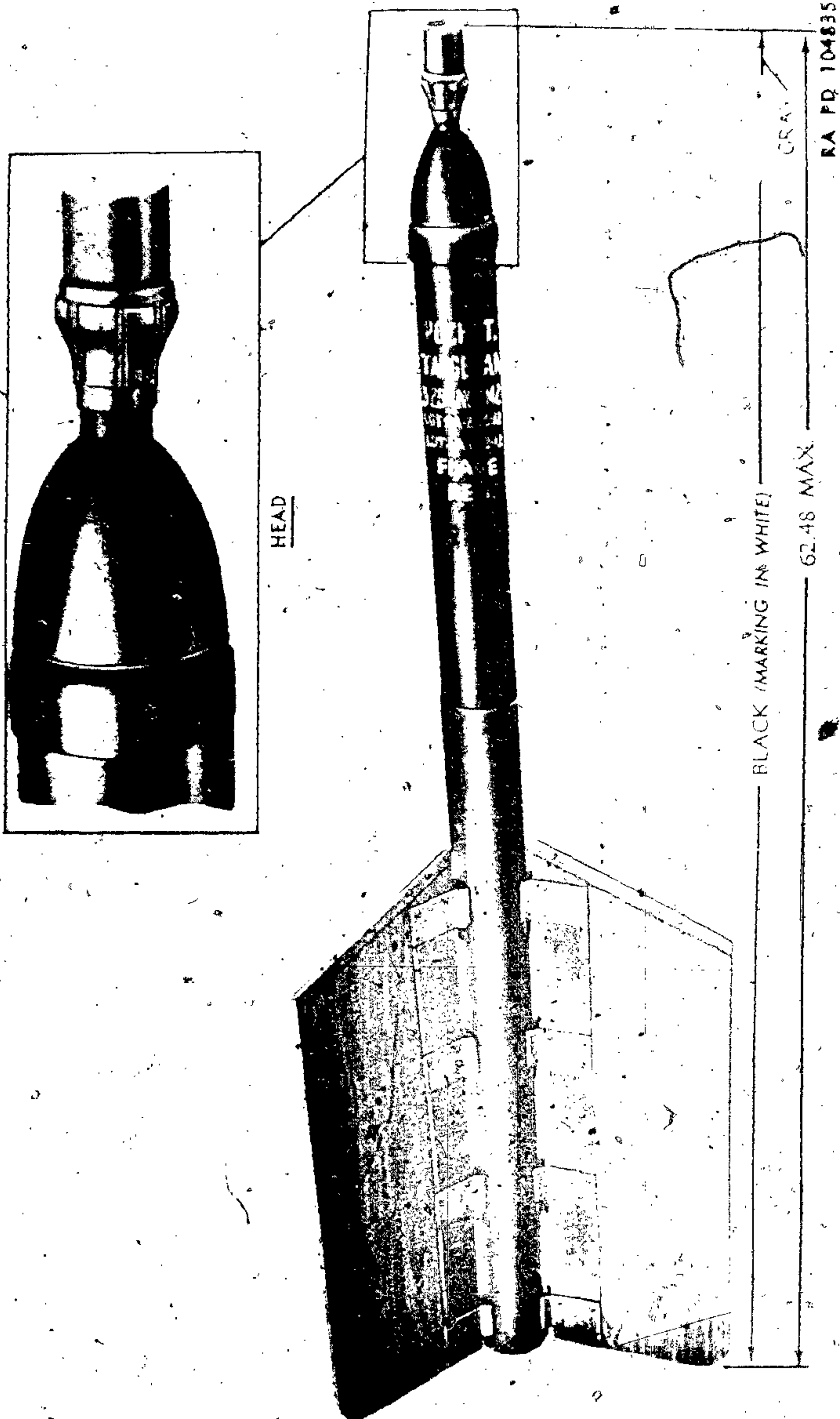
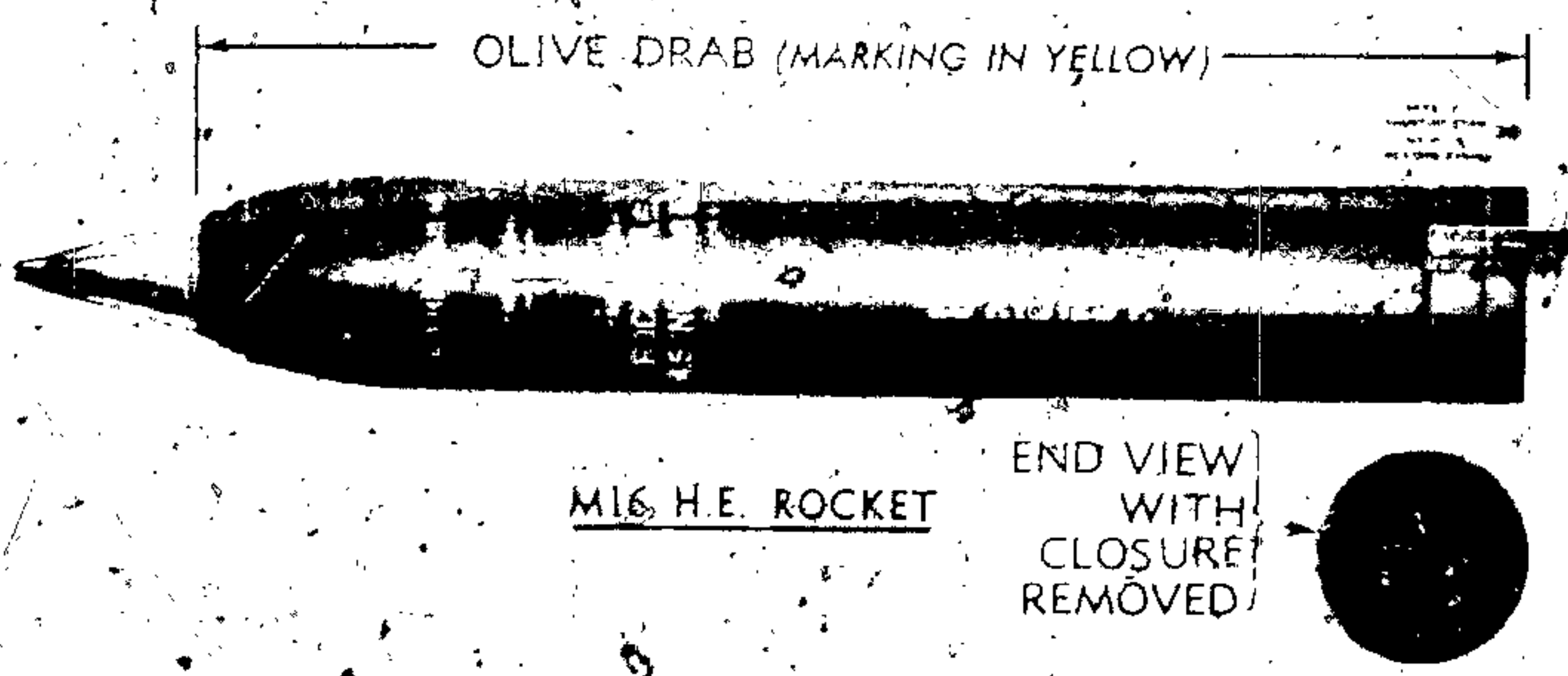
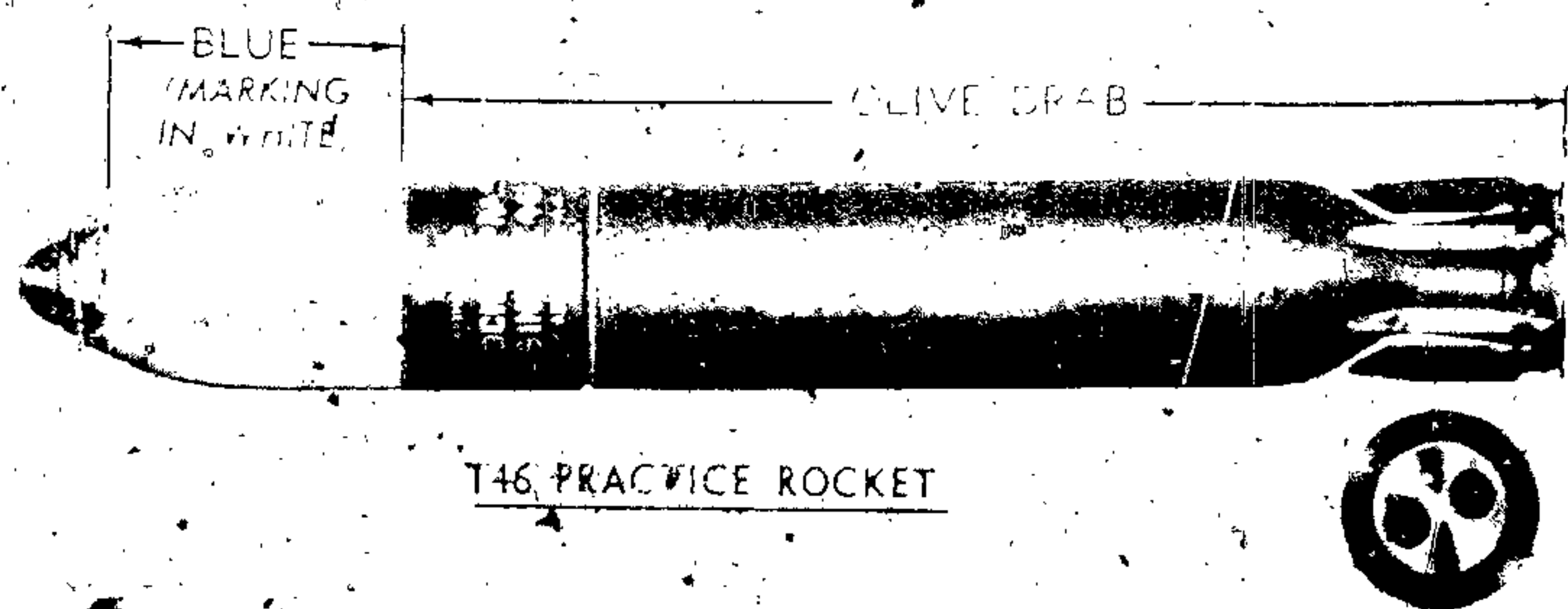
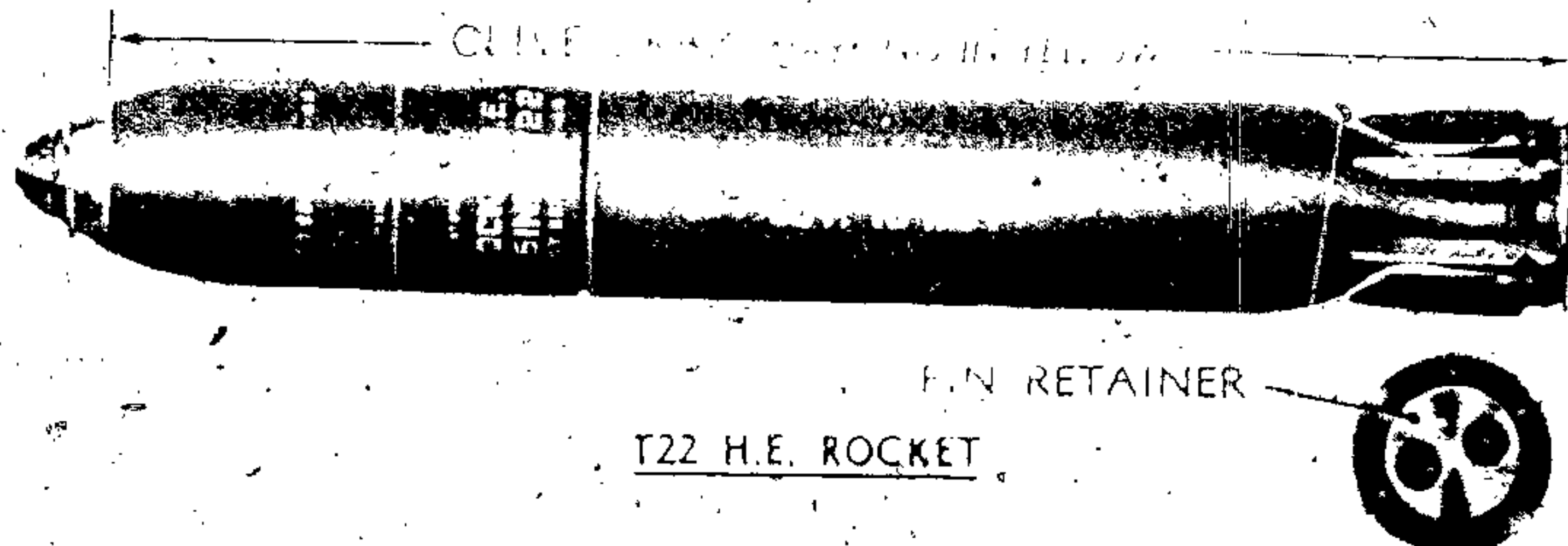
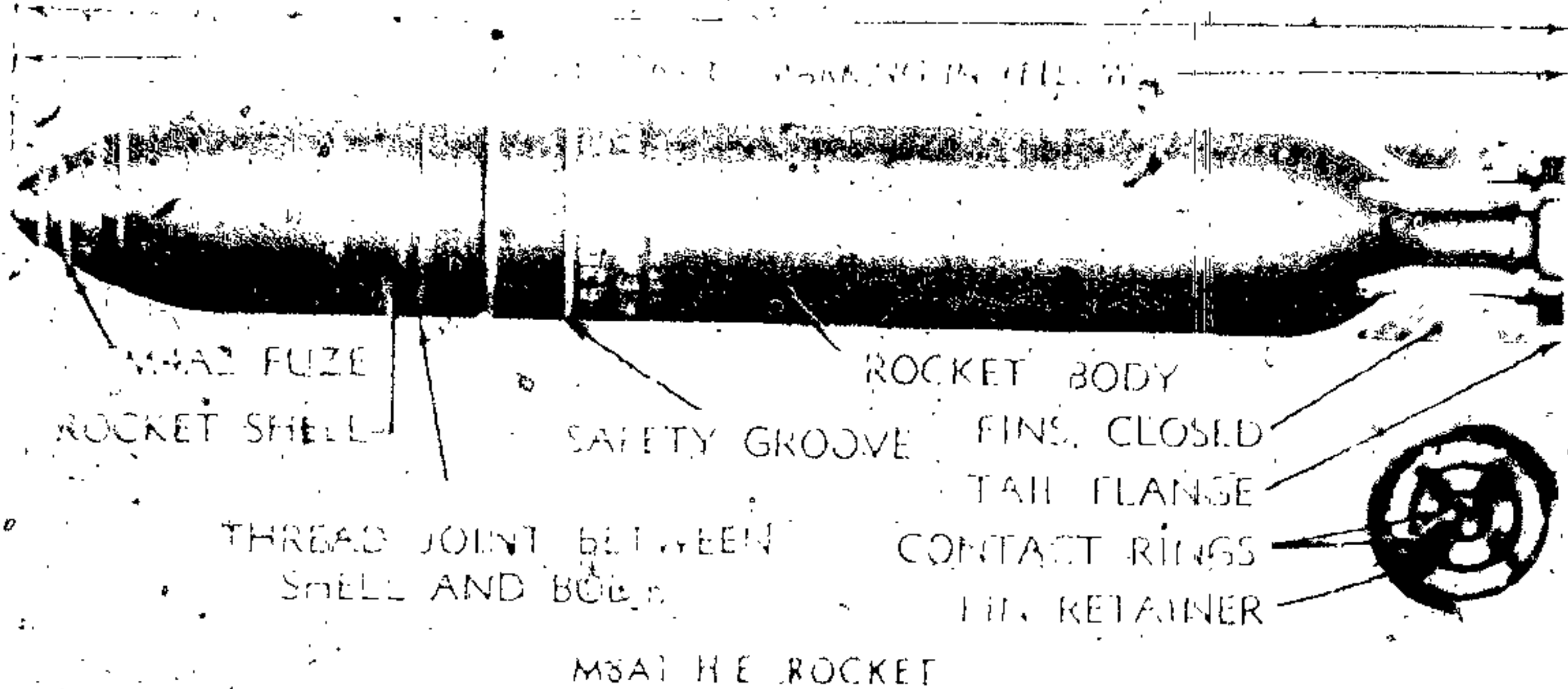

Figure 126 -- 3.25-inch AA Target Rocket M2A1

Classes of Ammunition



RA PD 89364A

Figure 127 - 4.5-inch Rockets



Classes of Ammunition

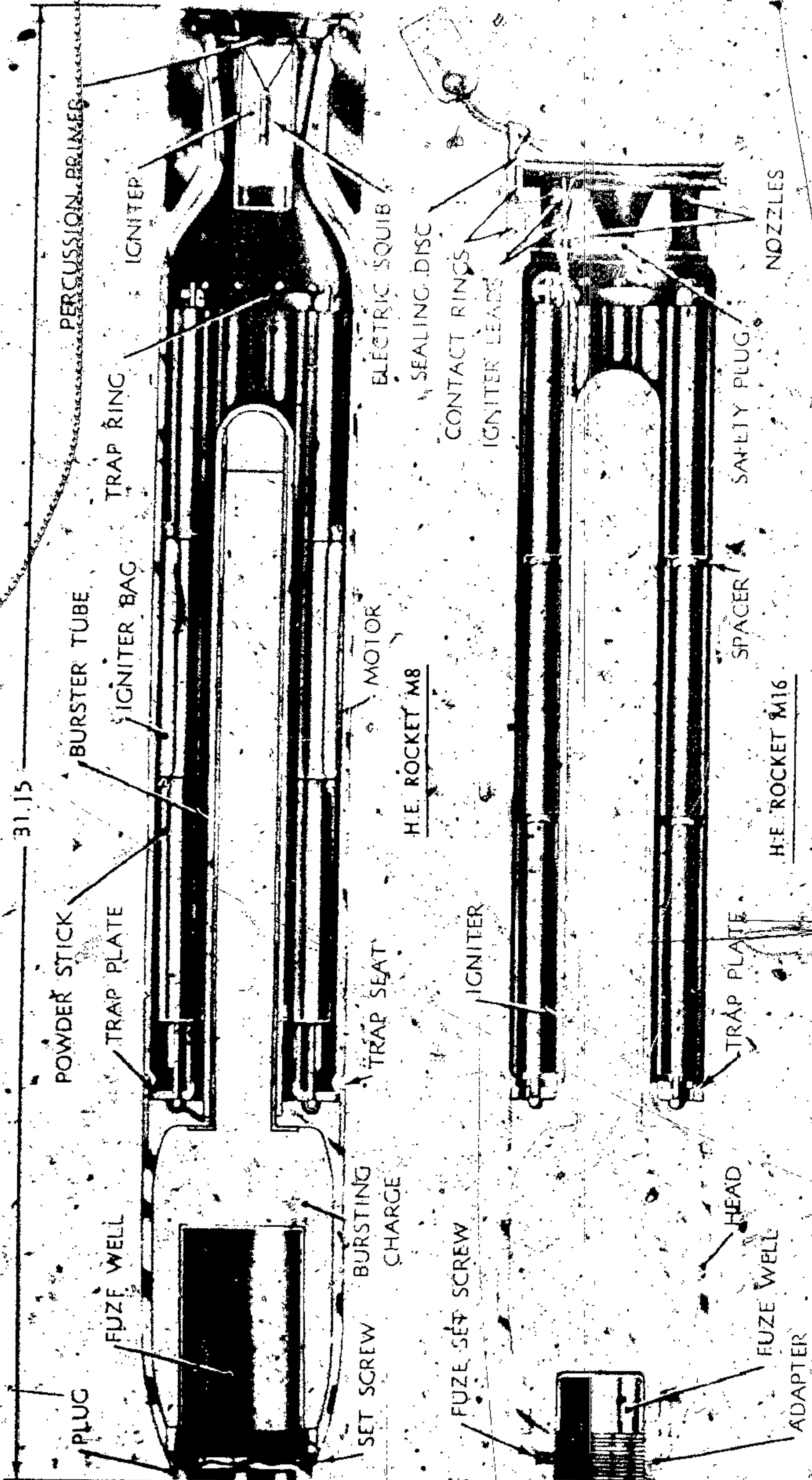
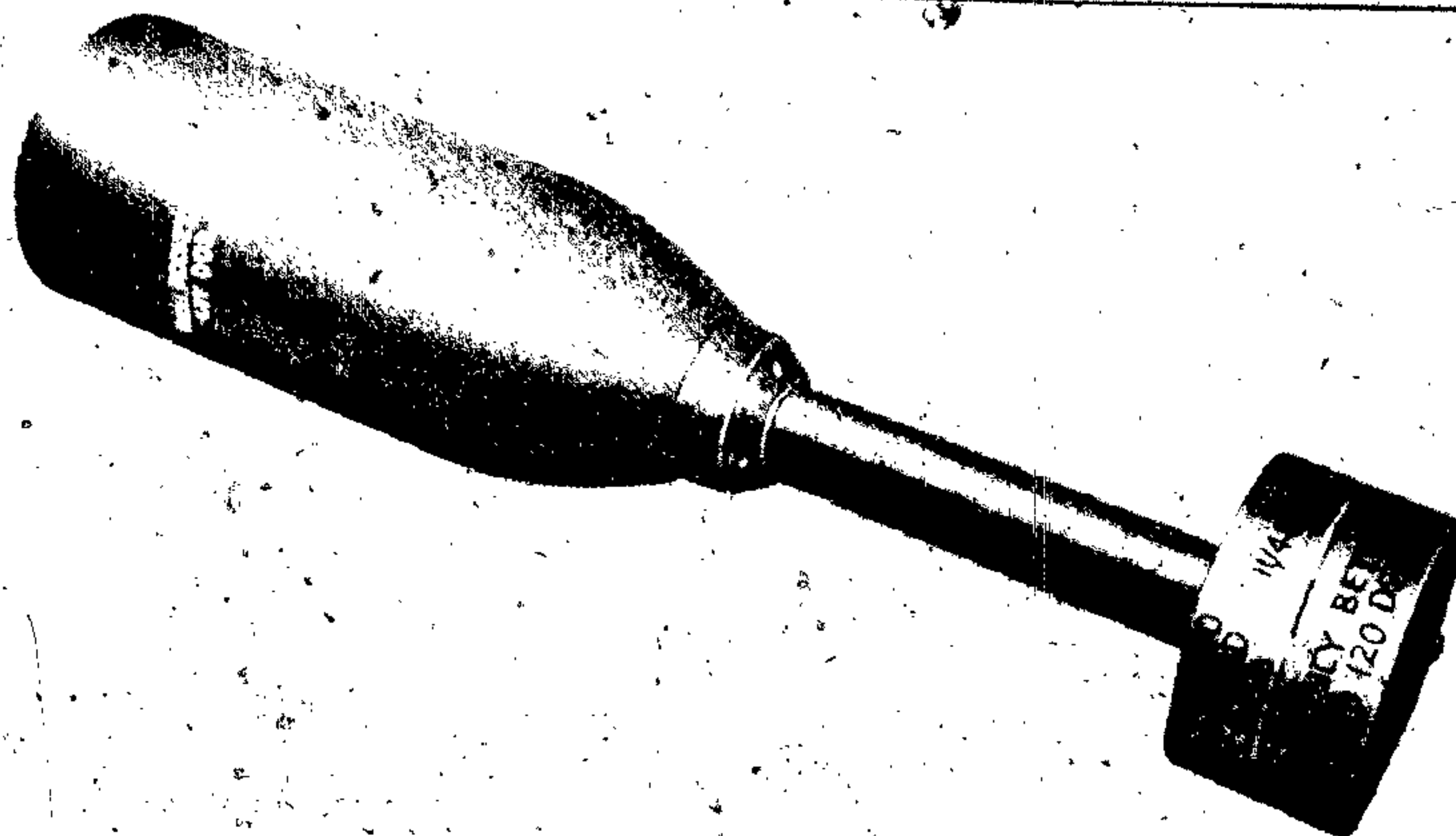

Figure 128 - 4.5-inch Rockets - Cross Section

RA PD 104806

*Classes of Ammunition*

RA PD 50472

**Figure 129 — 7.2-inch HE Rocket T37 — Assembled.**

d. **Practice rockets.** Practice rocket shells are loaded with inert material to the weight of the corresponding service rocket. The fuze may be inert or may contain a spotting charge. The motor for the practice rocket is the same as that of the corresponding service round.

e. **Target rockets.** Target rockets are supplied to furnish fast moving flying targets for automatic AA gun practice.

**141. IDENTIFICATION.** Rockets, in common with other types of ammunition, are identified by the standard nomenclature and lot number of the item. Such identification is marked on all containers and, unless the item is too small, on the ammunition itself. The basic color scheme for painting and marking on the ammunition is given in chapter 1, section II and illustrated in figure 16.

**142. COMPONENTS.**

a. For flexibility of supply, a complete round, as issued, may contain alternative components, only one of which may be used. The complete round may be issued as a single assembled item or as separate components to be assembled in the field.

b. **Head.** The head of the rocket consists of the loaded rocket shell, and the fuze. It is usually assembled to the forward end of the motor, but in some models, the shell may extend into the motor to use the motor tube as an additional source of fragments. It carries the explosive or chemical charge to the target. It may have thin walls to increase its capacity of explosive for blast effect, it may have thick walls to penetrate armor before exploding or it may have walls of medium thickness to provide a maximum number of effective fragments. A fuze is attached to the motor to function it at the time and under the circumstances desired.



Classes of Ammunition

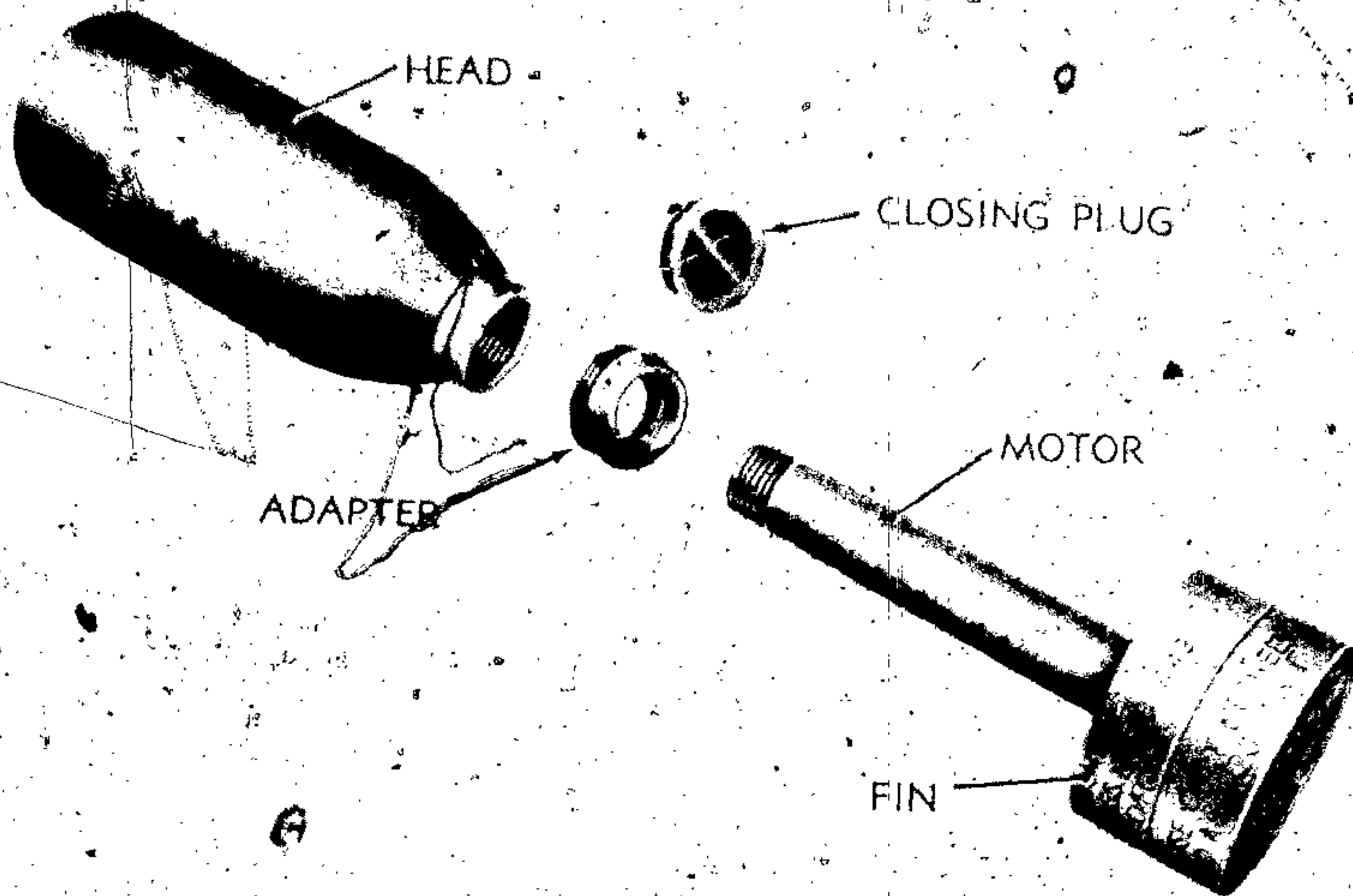

RA PD 50473A

Figure 130 - 7.2-inch HE Rocket T37 - Components

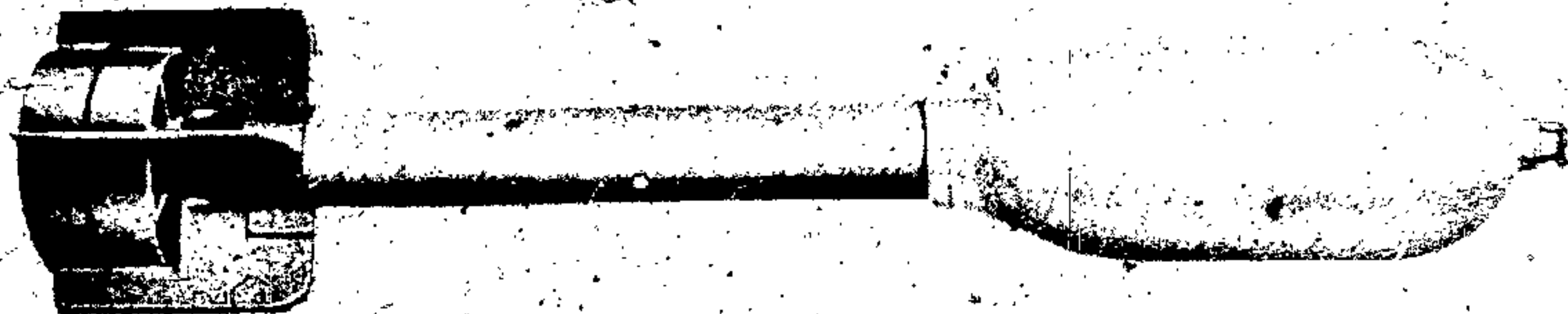

RA PD 58544

Figure 131 - 7.2-inch Chemical Rocket T21

c. Motor.

(1) GENERAL. The rocket motor is assembled to the rear of the head. It consists of a hollow tube which is closed at the forward end and has a nozzle in the form of a venturi tube at the rear. The motor contains the propelling charge and the igniter. Fins for stabilizing the flight of the rocket are attached to the outside of the motor at the rear end, except on spin-stabilized rockets. Spin-stabilized rockets have several venturi tubes concentrically located about and all inclined to the longitudinal axis of the rocket in the same direction so as to produce spin when the gases are emitted through them.

(2) IGNITER. The igniter consists of a primer and a charge of black powder assembled within the motor. The primer is fired by the heat generated in a wire by electric current. The primer ignites the black powder which in turn ignites the propelling charge.

Classes of Ammunition

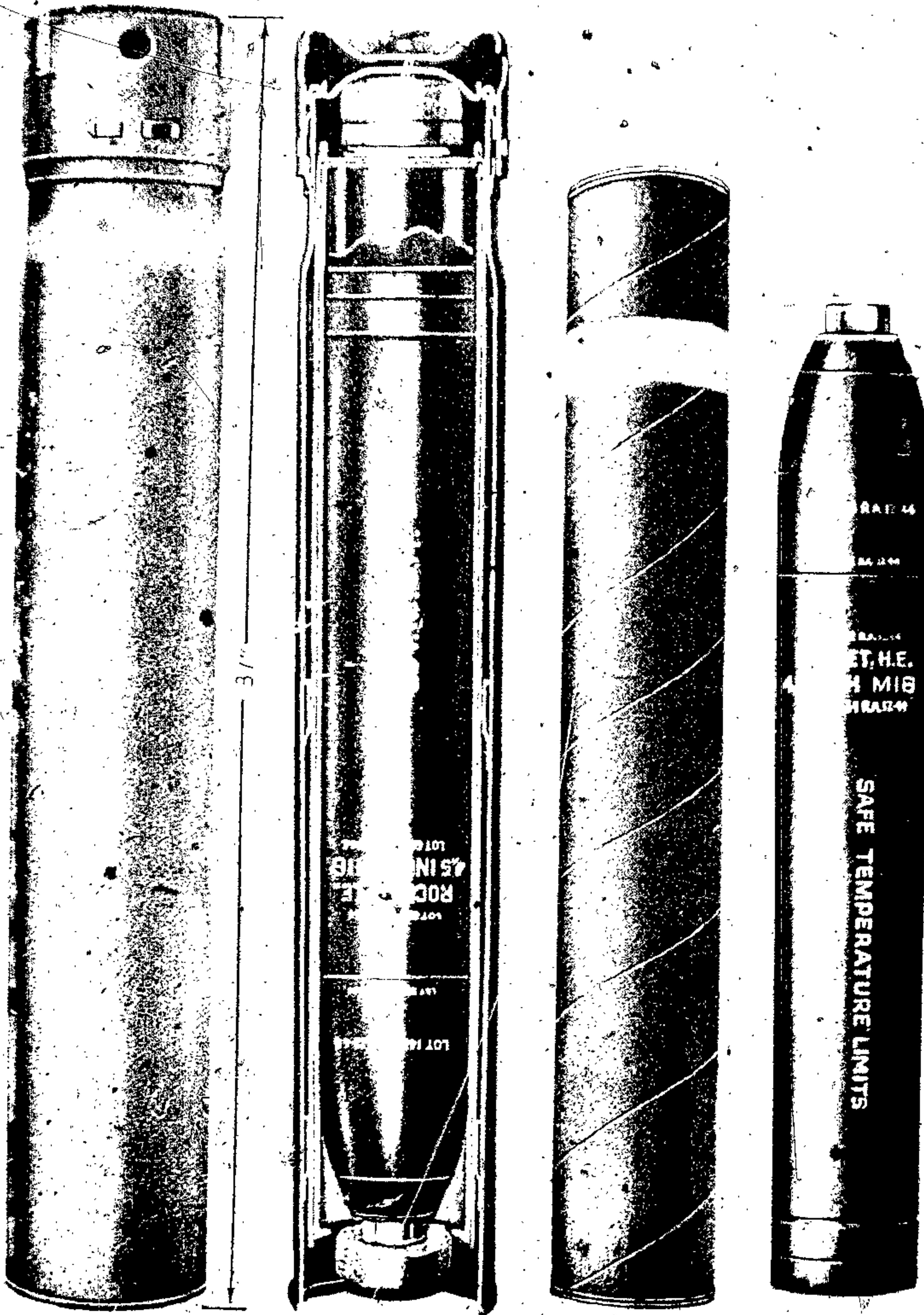

Figure 132—Metal Can Packing for Rocket

RA PD 103581



Classes of Ammunition

(3) **PROPELLING CHARGE.** The propelling charge consists of double-base powder in the form of sticks which may be solid or may have an axial perforation. The size of the propelling charge is usually indicated by the total length of powder sticks plus the web diameter of the grain. This makes for uniformity of burning and controls the burning rate. When the propelling charge is ignited it burns and produces gases under high pressure within the motor. The gases escape through the nozzle producing the jet which drives the rocket. The propelling charge is held in place in the motor by a trap assembly. The trap may be in the form of a grating or may be in the form of a cage with the perforated sticks threaded on the bars.

(4) **EFFECT OF TEMPERATURE.** The burning rate of propellant powder varies with the temperature and the pressure. That is, the higher the temperature or pressure, the faster the powder burns. When rockets are fired at temperatures higher than those for which they are designed, the propelling charge builds up pressure faster than the nozzle can release it and, as a consequence, dangerous pressures are built up which may cause the motor tube to burst. When rockets are fired at temperatures below the specified range, the charge burns slowly and produces erratic ranges. It may also cause undesirable back blast after the rocket leaves the launcher.

**143. LAUNCHERS.**

a. **Characteristics.** To meet the characteristics required of a weapon for firing the rocket, the launcher has only to provide means of aiming, firing, and blast protection.

b. **Aiming.** This requirement is met if the rocket is pointed in the proper direction at the moment of firing. A light metal or plastic tube, a pair of parallel rails or an improvised trough may serve to give the rocket its initial direction. Such devices may be carried by personnel or mounted on a light carriage.

c. **Firing.** In general, rockets are fired by a pair of electrical contacts connecting the igniter with a battery or generator.

d. **Blast protection.** Minor caliber rockets have a short burning time and generally burn out before leaving the launcher. A small conical-blast deflector is sufficient to protect the firer against the occasional long-burning round. In medium and major caliber rockets, the propelling charge continues to burn for 30 to 100 feet beyond the launcher, and blast protection is provided in some cases by metal shields on the carriage and in others by providing lead wires long enough to permit firing the rocket from a safe distance to the side.

e. **Multiple launchers.** A number of tubes or sets of rails may be assembled as a unit and mounted on one carriage. The firing mechanism of such a mount permits firing individually or in salvo.

## Classes of Ammunition

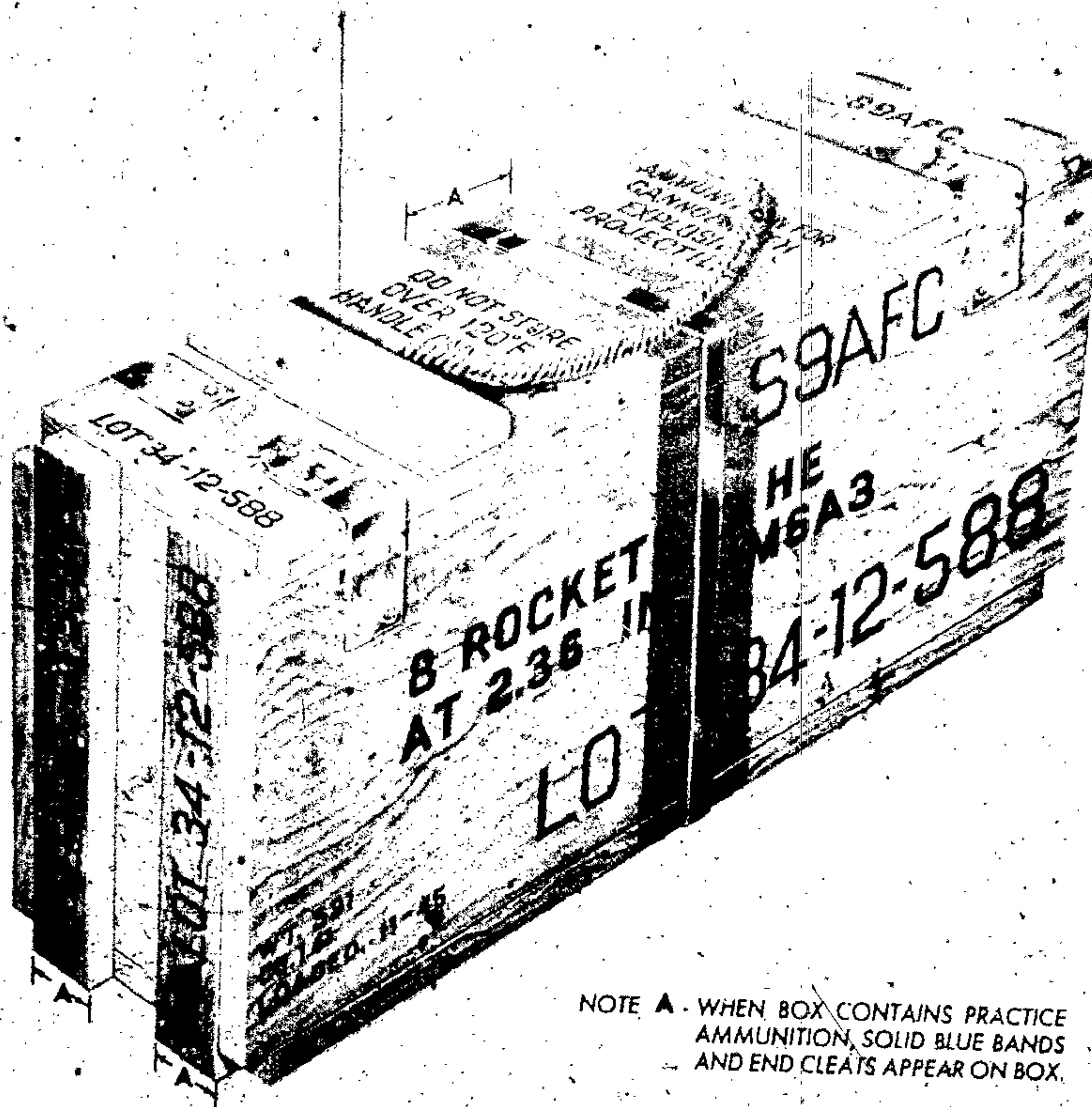

**Figure 133 — Packing Box for 2.36-inch HE, AT, and Practice Rockets**

#### 144. PRECAUTIONS.

- a. In addition to the general precautions in chapter 3, the precautions in the following paragraphs will be observed.
- b. Rockets should be protected against sources of high temperature such as exposure to the direct rays of the sun. Those rockets which are known to have been exposed to higher temperatures than the limits indicated on the packing will not be used. They will be placed in segregated storage until they can be destroyed.
- c. When rockets are involved in a fire, their range is not limited compared to service ranges, as is the case with other types of ammunition. This fact should be kept in mind in storing rockets. They should, if practicable, be kept in barricaded storage.



Classes of Ammunition

Par. 40

RA PD 104844

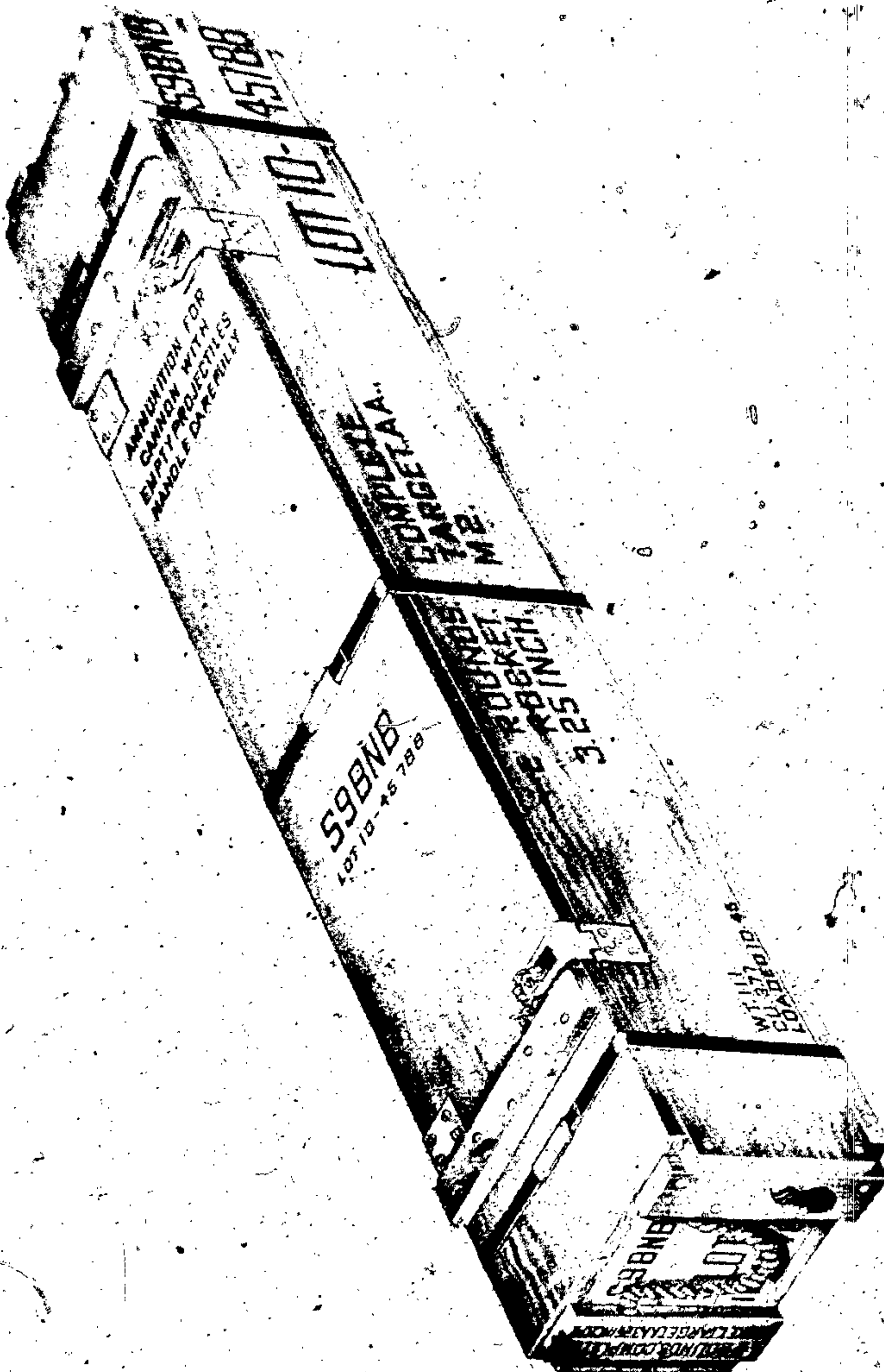
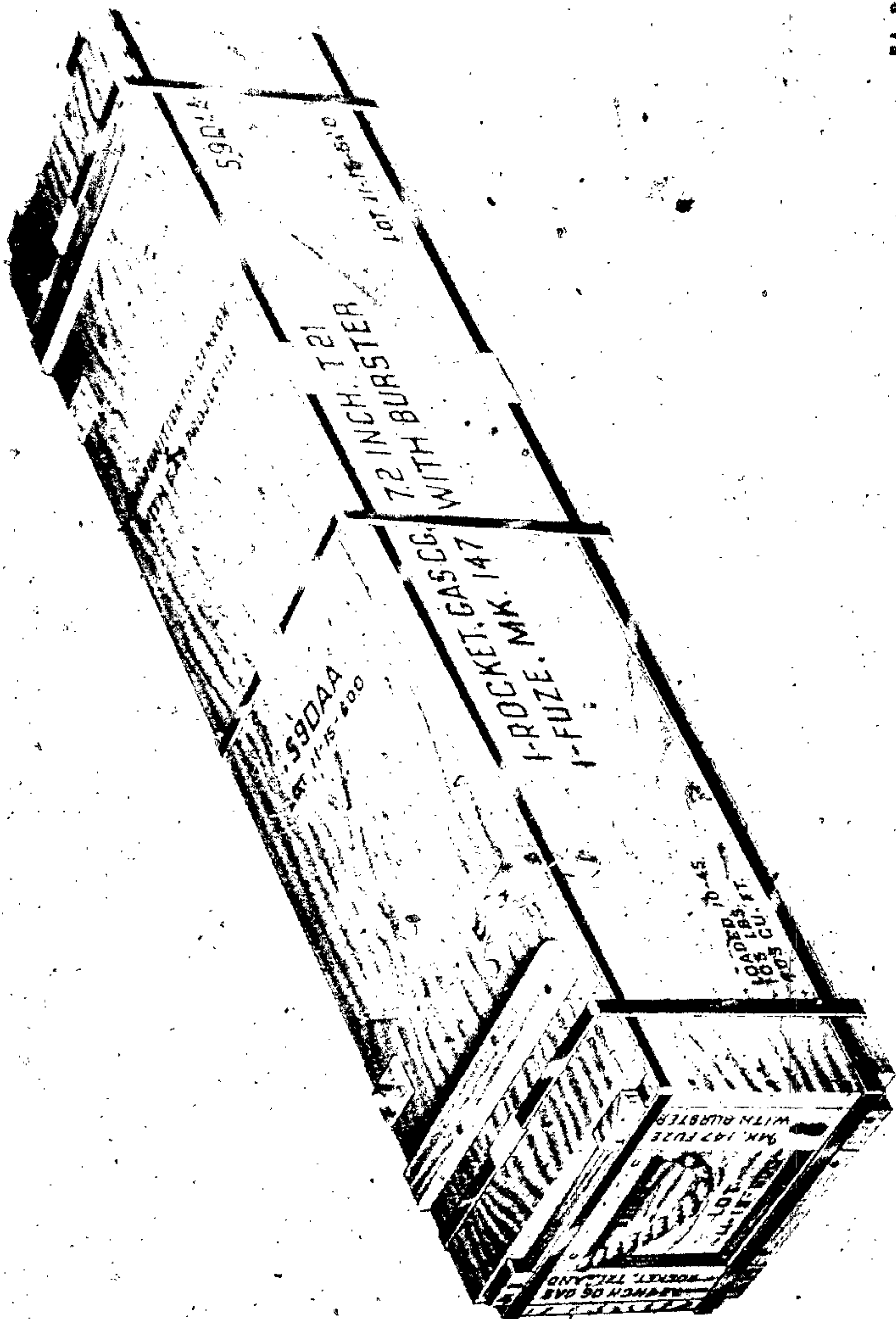

Figure 134 - Packing Box for 3.25-inch AA Target Rocket M2

Class of Ammunition



RA PD 104845

Figure 135 — Packing Box for 7.2-inch CG Gas Rocket T21



Classes of Ammunition

d. Chemical rockets stored for one year will be inspected 100% for corrosion and leakage.

e. If any change is made in an item, such as altering the propelling charge for a different temperature range, the item will be marked to indicate the change. If the item is repacked, the packings will be marked likewise.

f. Care should be exercised to avoid denting motor tubes and bending the fins. Rockets with seriously dented tubes will not be fired because such denting increases the loading density which may cause dangerous pressures on firing. Damaged fins will cause erratic flight.

g. Rockets should not be fired at temperatures outside the limits specified.

h. Care should be exercised in firing through a screen of brush or trees. Impact with a twig or branch may deflect the rocket or cause it to detonate.

i. In making connections for electrically fired rockets, care should be exercised to insure that all connections are good and that uninsulated sections of the firing circuit are protected against short circuit.

j. The blast area to the rear is specified for each type of rocket. Personnel and materiel must not be permitted in this area after a launcher is prepared for firing until the rocket has been fired or the launcher unloaded. If practicable, combustible material should be removed from this area.

k. Ammunition, including rockets for immediate use, will not be stored within 100 yards behind the firing point. Nor will any ammunition be permitted within 10 yards to the side of the firing point unless it has the same protection from blast as is specified for personnel.

**145. PACKING AND SHIPPING.** Small rockets are packed as assembled complete rounds in cylindrical sealed fiber containers which in turn are packed in a wooden box. Medium caliber rockets are packed, unfuzed, in sealed fiber containers which are packed in clover leaf bundles or wooden boxes. Large caliber rocket heads and motors are packed separately. Point fuzes are packed in sealed individual containers, which, in turn, are packed in wooden boxes. Base fuzes are assembled to the rocket shell, as issued. See figures 132 through 135 and ORD 11 SNL S-9.

**146. SUBCALIBER ROCKETS.** As is the case with subcaliber rounds for artillery weapons, subcaliber rockets are used for large caliber rocket launchers.

*Classes of Ammunition*

Section VIII

**LAND MINES**

147. **GENERAL.** All types of land mines consist of a high-explosive charge which is detonated by a mechanical or chemical device (known as the fuze) when actuated by vehicle or personnel. An explosive-containing adapter, known as an activator, is used with some mines so that standard Engineer Corps firing devices may be installed for secondary initiation, such as antilifting devices.

148. **CLASSIFICATION.** Land mines are classified according to use as antitank or antipersonnel and also, as service, practice, or dummy.

149. **METALLIC ANTITANK MINES.**

a. **Purpose.** Antitank mines are intended to immobilize and destroy tracked or wheeled vehicles. Details of construction and performance of individual mines are covered in TM 9-1940 and performance and methods of handling are covered in FM 5-31, Land Mines and Booby Traps.

b. **Antitank mines—older models.** The antitank mines M1A1 and M4 are cylindrical steel cases, approximately 3½ inches high and 8¼ inches in diameter, filled with about 5½ pounds of high explosive. A fuze, issued separate from the mine body, is inserted in the fuze well and held in place by a spider. Pressure of approximately 500 pounds upon the spider by a vehicle will cause functioning of the fuze which detonates the explosive charge of the mine. A safety fork assembled between the striker head of the fuze and the fuze body prevents accidental initiation of the fuze during handling. This safety fork must be removed to arm the fuze. The complete round, mine and fuze, weighs approximately 10½ pounds.

c. **Light antitank mine.** A lightweight, flat, quart-sized mine (fig. 136) filled with about 3 pounds of high explosive, usually tetrytol, is intended for antitank use but it may easily be converted for antipersonnel use. It can be detonated by a force of approximately 190 pounds on the pressure plate. A "U" shaped pressure plate fits over the top of the mine and covers the fuze. A flexible wire rope screwed in one end of the mine serves as a carrying strap. Upon removal of the strap, the threaded well may be used for the insertion of a secondary fuze. The mine is rectangular in shape, approximately 7 inches long by 4½ inches wide by 2½ inches high and weighs about 4 pounds. A number of firing devices may be used to guard against tampering with, or removal of, this mine. The same chemical fuze used in the heavy antitank mine is also used in this mine.



## Classes of Ammunition

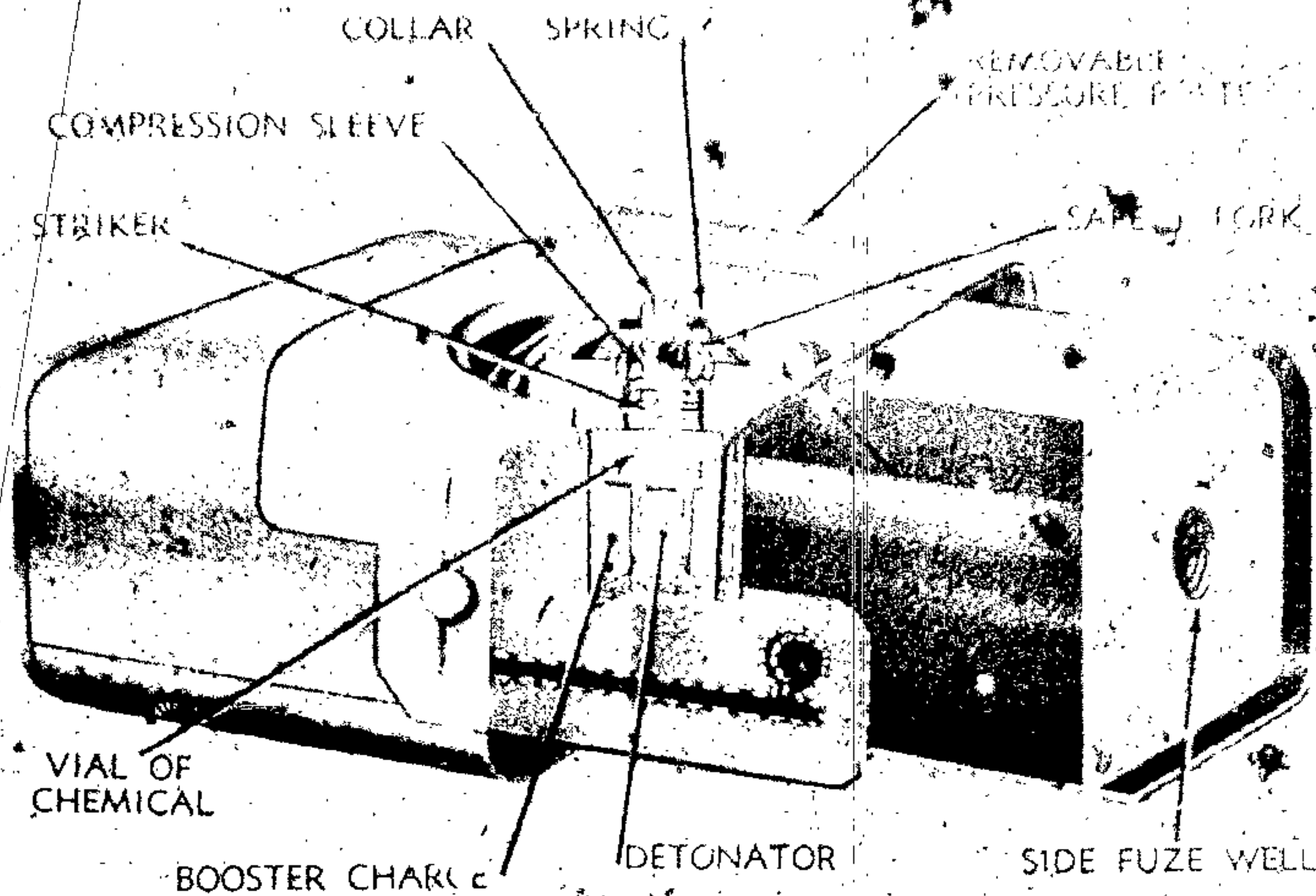

RA PD 89370

**Figure 136 — Light Antitank Mine M7**

d. **Heavy antitank mine.** The heavy antitank mine is a high-explosive type intended primarily for use against tanks (figs. 137 and 138). It has a base diameter of 13 inches and a maximum height of  $3\frac{1}{4}$  inches and is loaded with approximately 12 pounds of TNT. This mine resembles the German Tellermine in appearance. The complete assembly weighs approximately 20 pounds. The carrying handle is attached to the bottom of the mine. Permanently assembled to the mine body is a round pressure plate  $7\frac{1}{2}$  inches in diameter containing a reversible plug which covers the fuze well. The pressure plate is supported internally by circular (Belleville) springs. The chemical fuze used in this mine is also used in the light antitank mine. A force of approximately 300 pounds on the pressure plate is required to cause the fuze to function. This mine is not affected by stones, dirt, or moisture.

### 150. NONMETALLIC ANTITANK MINES.

a. **Purpose.** This type mine was developed as a counter measure against metallic mine detectors.

b. **Nonmetallic antitank mine.** This mine consists of nonmetallic components both in body and fuze. It is approximately  $5\frac{1}{4}$  inches high and 10 inches in diameter (fig. 139). Approximate weight of complete assembly is 15 pounds. This mine is provided with a chemical-type fuze. An activation well is provided in the base of the mine so that firing devices may be inserted, including an anti-

Classes of Ammunition

PRESSURE PLATE PLUG IN SAFE POSITION

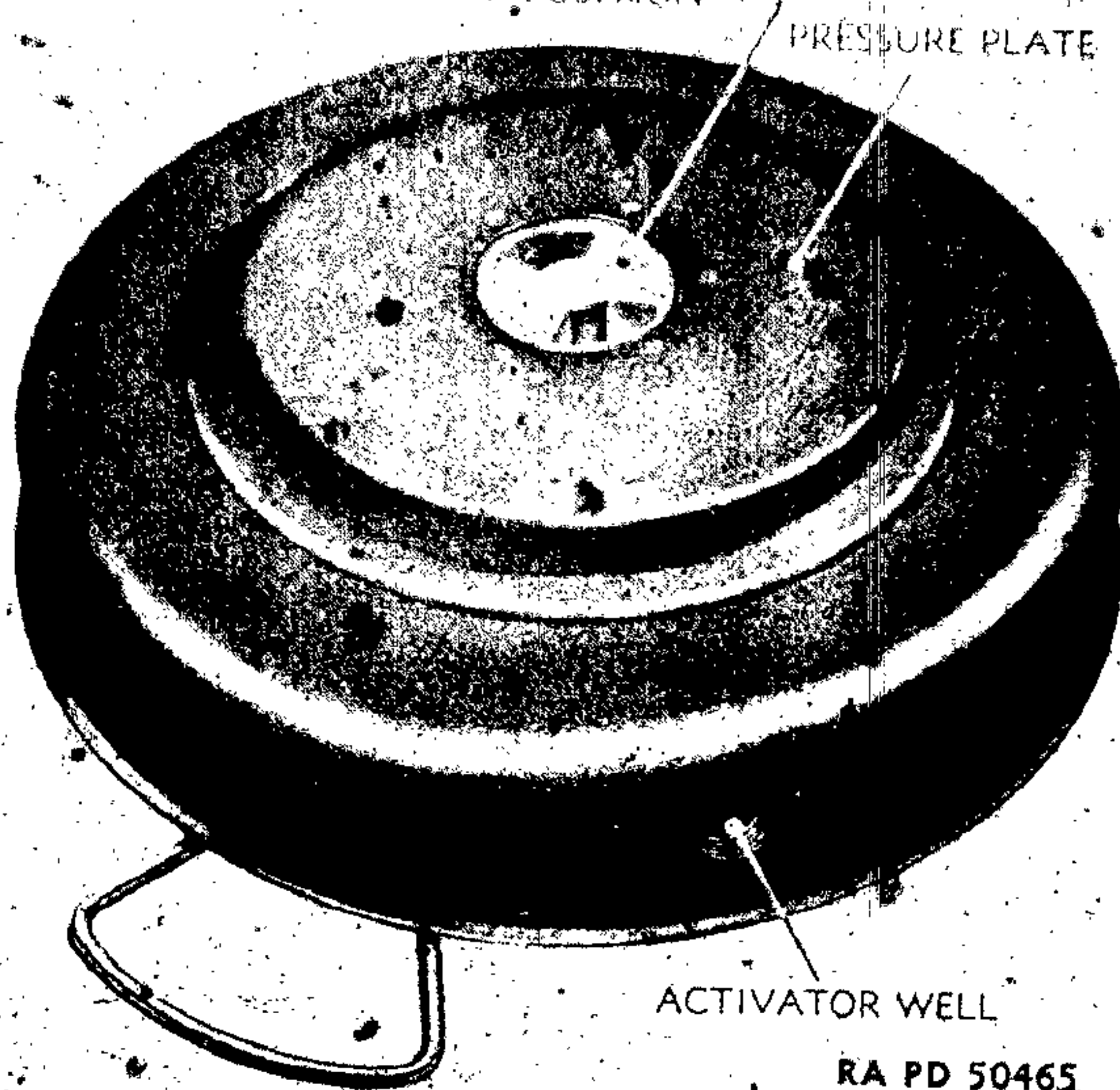

RA PD 50465

Figure 137 — Heavy Antitank Mine M6

lifting device for exploding the mine upon pick-up. There is no spider on the nonmetallic mine as pressure on any part of the top of the mine body will cause the fuze to function. A force of approximately 300 pounds on the pressure plate is required to cause the fuze to function.

**151. ANTITANK PRACTICE MINES.**

a. **Metallic antitank practice mine.** The practice metallic mine M1 has a base diameter of approximately 8<sup>3</sup>/<sub>4</sub> inches and a maximum height of 4<sup>1</sup>/<sub>4</sub> inches. It is similar to the high-explosive mine but upon activation releases only a puff of white smoke. Some lots of this mine have the filling plug in the top of the mine. The complete round consists of three components; an empty mine body (which has five 1-inch holes equally spaced around the side), the spider, and the fuze. Practice fuzes have the striker head painted red. The mine has the same weight and functions in the same manner as the high-explosive mine and is used for training. It is cheap to manufacture and is not dangerous. The M1B1 is a practice metallic mine and resembles the service mine except that the filling hole is in the bottom of the mine body and that all parts are manufactured by stamping. It is approximately 8<sup>1</sup>/<sub>4</sub> inches in diameter and 3<sup>1</sup>/<sub>2</sub> inches high. This mine is sand-filled to weight before it is issued for use in practice.



RA PD 89546

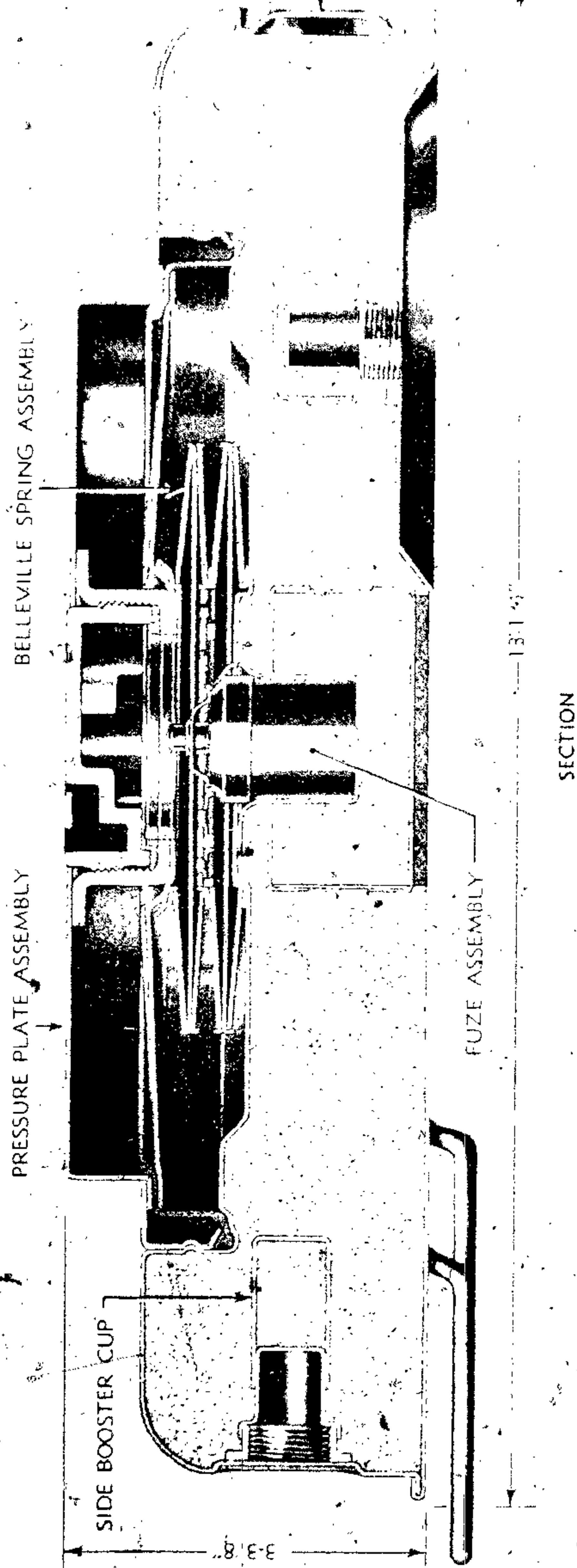

SECTION

Figure 138 — Heavy Antitank Mine M6 — Cross Section

Classes of Ammunition

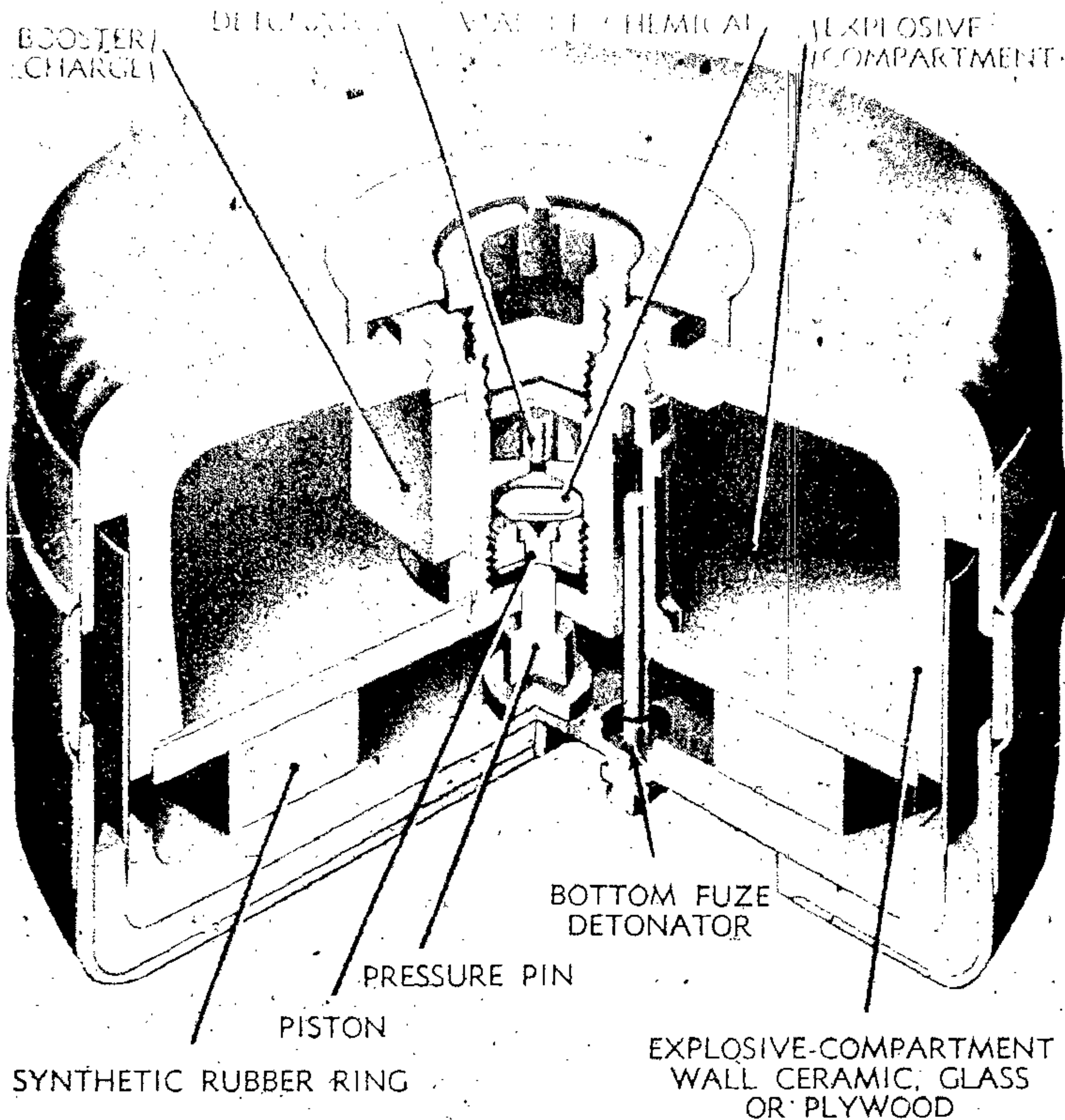

RA PD 89368

Figure 139 - Nonmetallic Antitank Mine M5

b. **Nonmetallic antitank practice mine.** The practice non-metallic mine is identical with the nonmetallic service mine except that it is filled with inert material instead of high explosive and is marked in white. This practice mine has the same weight and functions in the same manner as the service mine. The practice fuze resembles the service fuze in external appearance, except for the marking. After the fuze is initiated there is a delay of 2 to 3 seconds. Then a cloud of smoke is produced and a charge is projected several feet into the air where it explodes with a flash and a loud report.

152. PACKING AND MARKING OF ANTITANK MINES.

a. Metallic mines M1A1 and M4 are packed in wooden boxes, each of which contains five mines and five fuzes. The box is made



## Classes of Ammunition

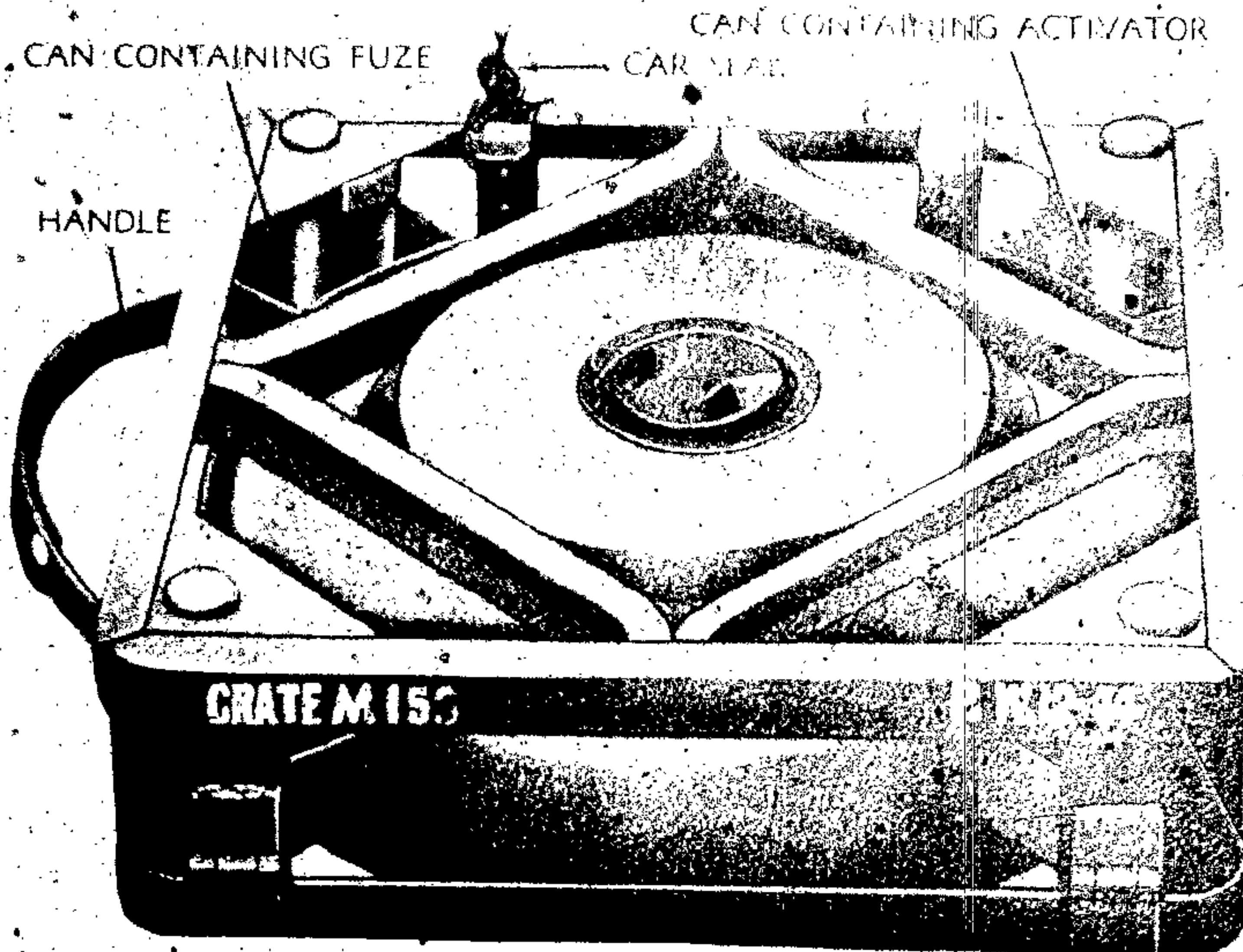

RA PD 89467

**Figure 140 — Metal Crate M153, Containing One Heavy Antitank Mine M6, With Fuze and Activator**

up with a set of plywood-separators. As shipped, the fuzes are placed in a compartment, which occupies one section at the end of the box; the five mines, with spiders nested to the bottoms of the mines, are packed in the other five compartments. Total weight of box including mines and fuzes is  $70\frac{1}{2}$  pounds. The nonmetallic mines are packed in the same manner, but with four mines and four fuzes in a box. Each fuze is packed in a hermetically sealed container, the fuzes being placed in a section in the center of the box. Total weight of box including mines and fuzes is approximately  $88\frac{1}{2}$  pounds. The heavy mine is packed individually in a metal crate (fig. 140), the fuze and the activator, each in a hermetically sealed can, being placed in corners of the crate. Some mines are packed without the activator. Total weight is  $30\frac{1}{2}$  pounds. The light mine is packed in a metal box containing eight mines, eight fuzes, eight carrying handles, and eight cloth bags. Total weight is 56 pounds. In this metal box, there are six compartments, the two outer compartments holding four fuzes each, each fuze in a sealed container with four of the fuzes in a carton. Each of the four central compartments contains two mines. The carrying handles and cloth bags are laid on top of the contents of the box.

Classes of Ammunition

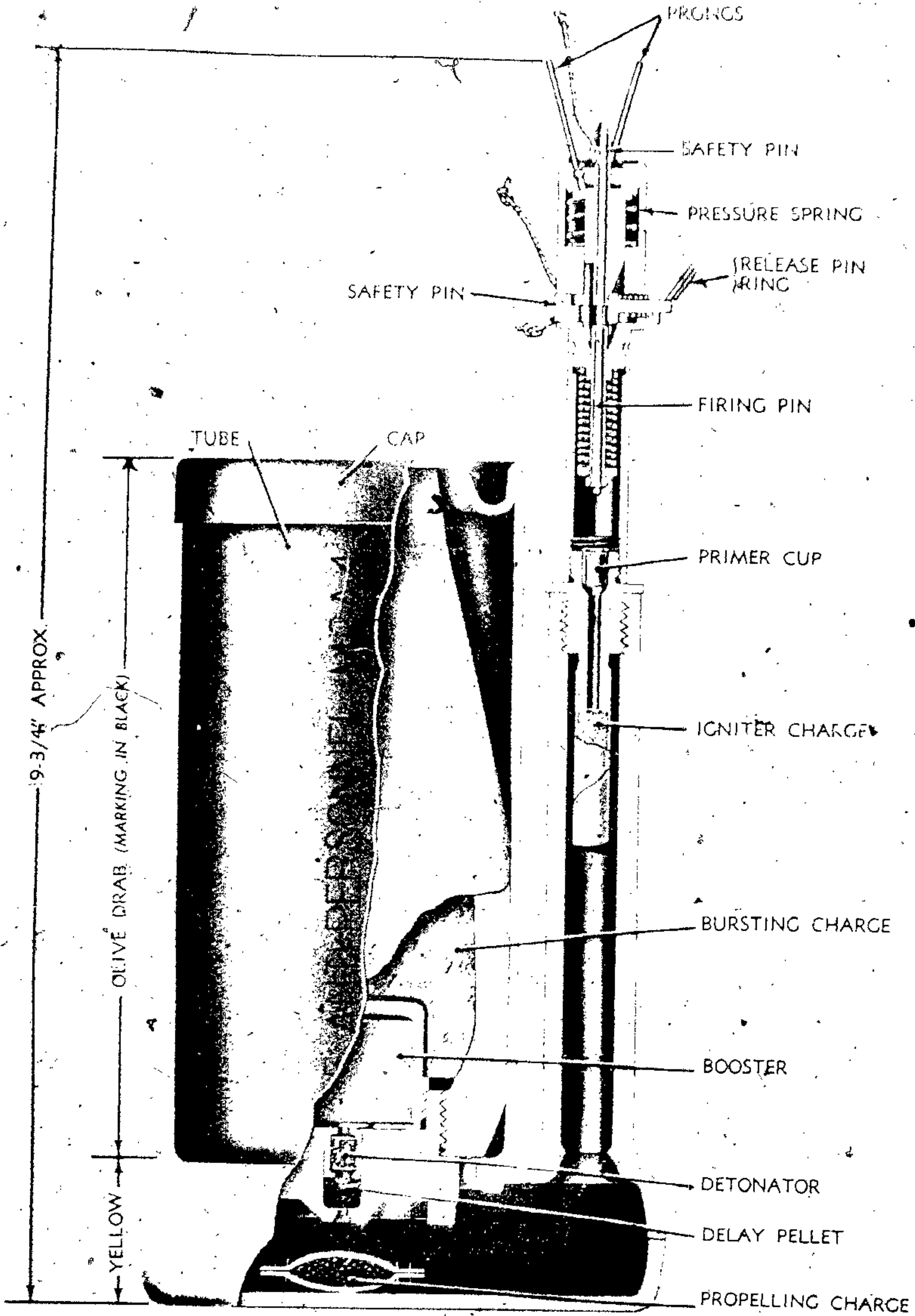

RA PD 89392

Figure 141 - Antipersonnel Mine M2A4, With M6A1 Fuze



### Classes of Ammunition

b. The boxes containing practice mines are painted with a blue band around the center of each box and blue cleats on the ends of each box. Wooden boxes of high-explosive mines are stained light brown with marking in yellow, or, more recently, unstained with marking in black. Metal boxes are painted olive drab.

#### 153. ANTIPERSONNEL MINES.

a. **Purpose.** Issued antipersonnel mines are standardized mechanisms intended for effect against personnel.

b. **"Bounding" antipersonnel mine.** This mine, when functioned, throws a projectile upward to a height of 4 to 6 feet. It has an effective radius of about 30 feet. The complete assembly weighs approximately 5 pounds. The mine has the appearance of a small mortar with an attached firing device (fig. 141). The projectile is thrown into the air by the burning of small propelling charge of black powder in the base of the mine. The mine is painted olive drab on which the markings are in black; the base is painted yellow.

c. **Cast-iron fragmentation mine.** This type of antipersonnel mine resembles a brick (fig. 142). It is approximately 5½ inches high and 3½ inches square. There are three threaded wells in the mine body, one in each of two sides and one in the end, to accommodate standard Corps of Engineers firing devices (fuzes). A relatively heavy charge of TNT and thick walls produce fragmentation and blast effect. When used above the ground, the bursting radius of this mine is greater than that of the bounding type mine. It is painted olive drab with markings in black.

d. **Practice antipersonnel mine.** The practice antipersonnel mine (fig. 143) simulates the "bounding" type antipersonnel mine. The metal parts are the same as those used for the service mine, except for the projectile which is made of cardboard and the igniter which contains a delay element to provide for a delayed functioning of the mine four seconds after functioning of the fuze. The projectile contains a spotting charge assembly which resembles a shotgun shell with a delay element in place of the primer. In order that the mine may be used several times, the following replacement parts are issued:

Primer and igniter assembly.

Cap (cover).

Projectile.

Spotting charge.

Propelling charge.

e. **Packing and marking.** The "bounding" antipersonnel mine is packed complete with a firing device and a spool of steel wire in a corrugated paper jacket. Ten such containers are packed into a

Classes of Ammunition

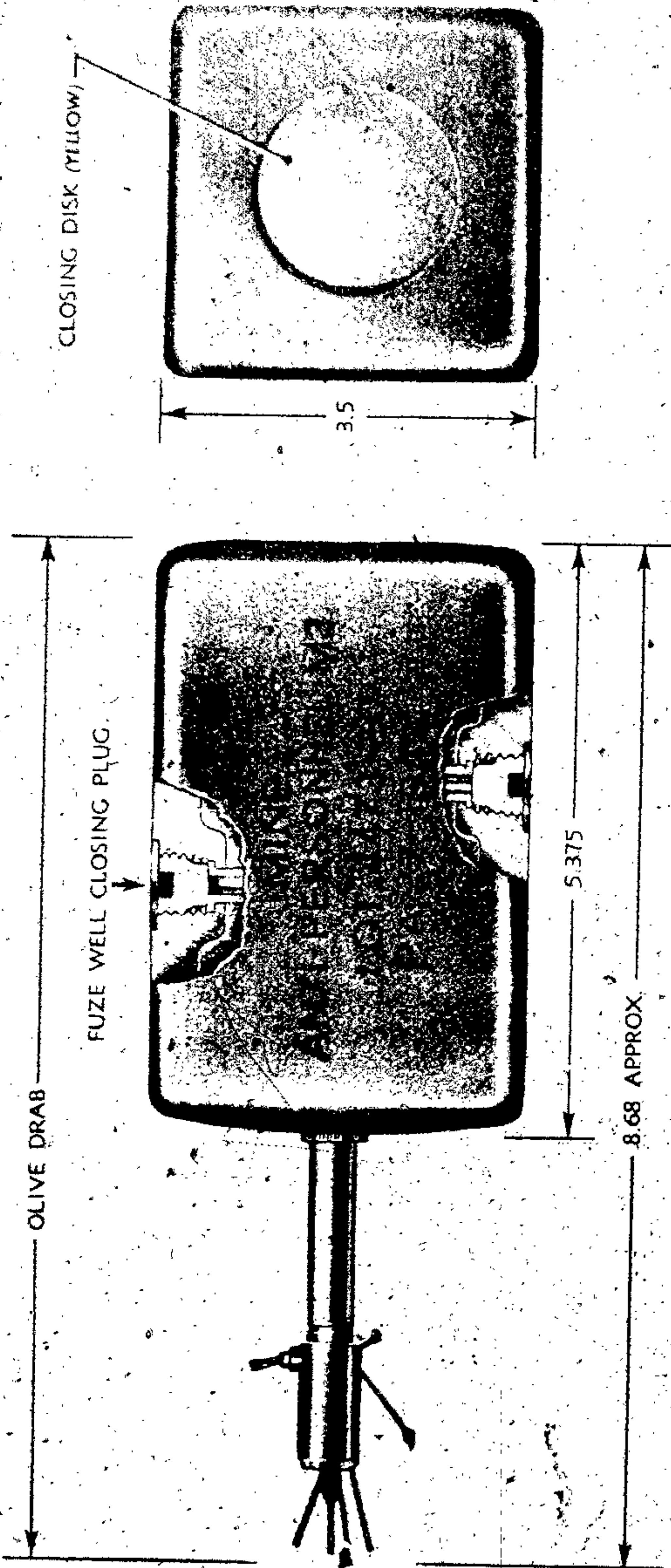

RA PD 49595B

Figure 142 - Antipersonnel Mine M3, With M7A1 Fuze



Classes of Ammunition

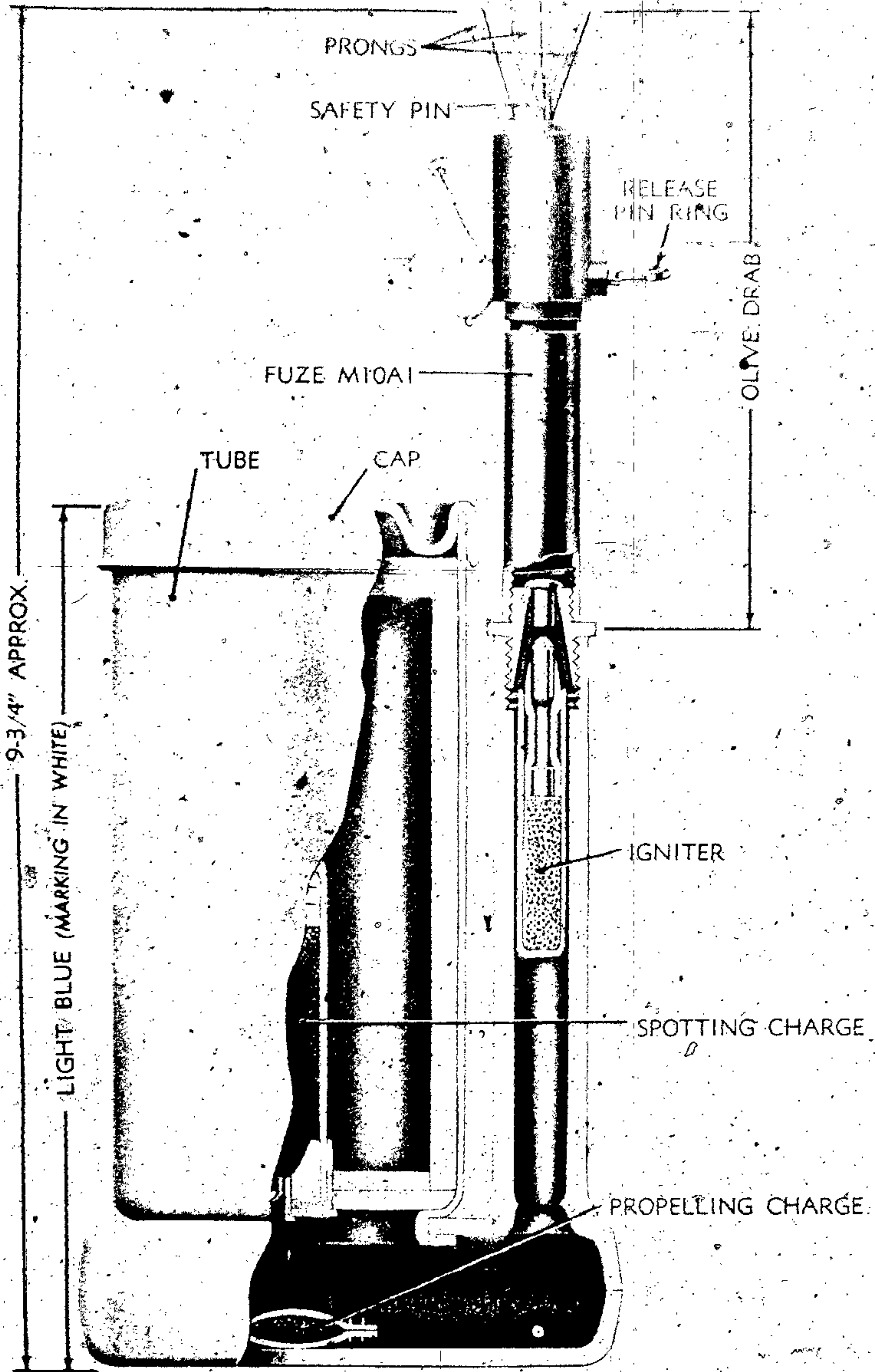

RA PD 89372

Figure 143 — Practice Antipersonnel Mine M8, With M10A1 Fuze

Classes of Ammunition

wooden box, which is stained light brown with marking in yellow, or, more recently, unstained with marking in black. The cast-iron fragmentation antipersonnel mine is packed in a wooden box containing 6 mines, 6 fuzes in individual containers, and 6 spools of wire. The practice antipersonnel mine is packed 2 mine bodies and 2 fuzes, with 20 sets of replacement parts, per wooden box. The box has markings in black, a blue center band and blue vertical end cleats.

Section IX

**DEMOLITION MATERIALS**

**154. GENERAL.** Demolition materials include explosive equipment intended for destruction of obstacles (by bangalore torpedoes), fortifications (by shaped charges), special equipment (by destructors), and general material (by demolition blocks). Most demolition charges may be fired electrically by electric blasting caps or nonelectrically with safety fuse and nonelectric blasting cap or delay detonators. For detailed information, see FM 5-25 and TM 9-1940.

**155. BANGALORE TORPEDOES.** The bangalore torpedo M1A1 (fig. 144) is a tube or pipe filled with high explosive. The steel tube or pipe is 5 feet in length and 2 1/8 inches in diameter, and is grooved and capped at each end. The tube is filled with amatol, with about 4 inches of TNT at each end. The weight of the explosive charge is about 9 pounds. The torpedo may be used as an explosive charge for other demolition purposes. The bangalore torpedo M1A1 is packed 10 per kit or box which also contains 10 connecting sleeves and 1 nose sleeve.

**156. DESTRUCTORS.**

a. General.

(1) Destructors are high-explosive charges fired electrically or by the action of a fuze.

(2) Destructors are for use in certain equipment to be destroyed when the materiel is abandoned or when there is danger of its falling into enemy hands. In general destructors are intended for destruction of the vital parts of the materiel by means of an explosion which is confined within the housing. Destructors may be removed from materiel during normal maintenance repair.

b. Destructor AN-M1. This destructor (fig. 145) is a small explosive container which fits a threaded adapter in certain radio equipment. The head end has a screwdriver slot and is threaded for screwing into the adapter. At the opposite end is a gilding-metal case which is separated from the head end by a plastic tube. The head end contains a small cylinder of nitrocellulose and the ignition wire. The



Classes of Ammunition



NOSE SLEEVE



FUZE WELL

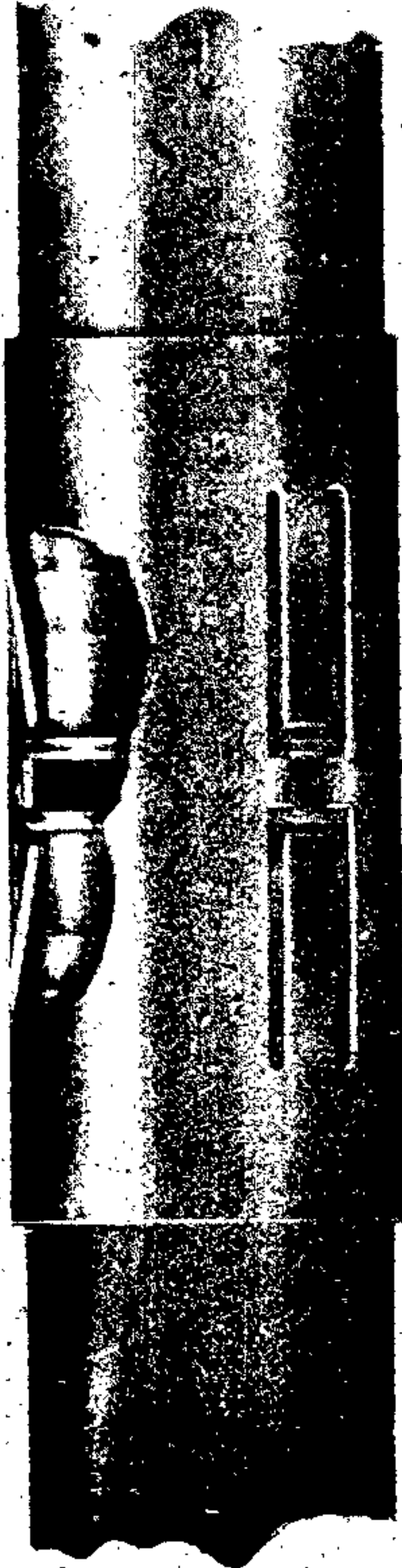

CONNECTING SLEEVE

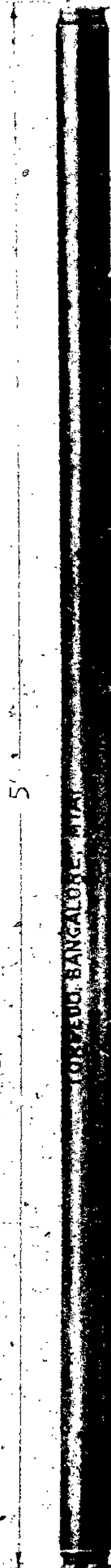

RA PD 69106A

Figure 144 — Bangalore Torpedo M1A1

Classes of Ammunition

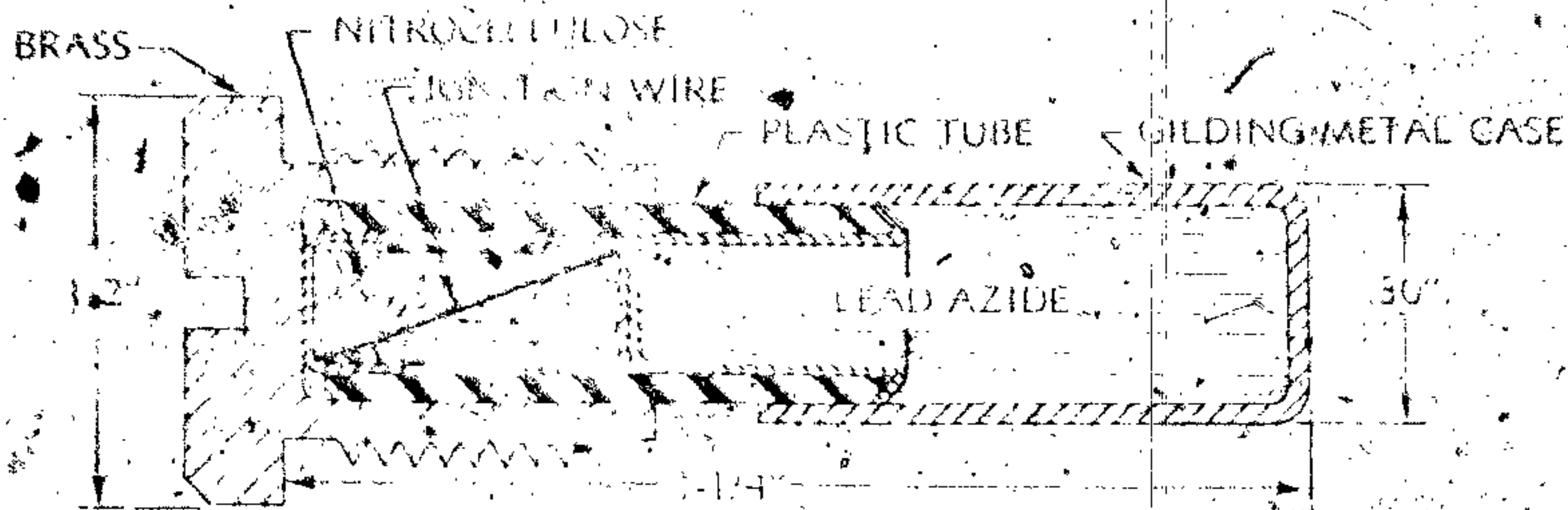

RA PD 35609

Figure 145 - Destructor AN-M1 - Sectioned

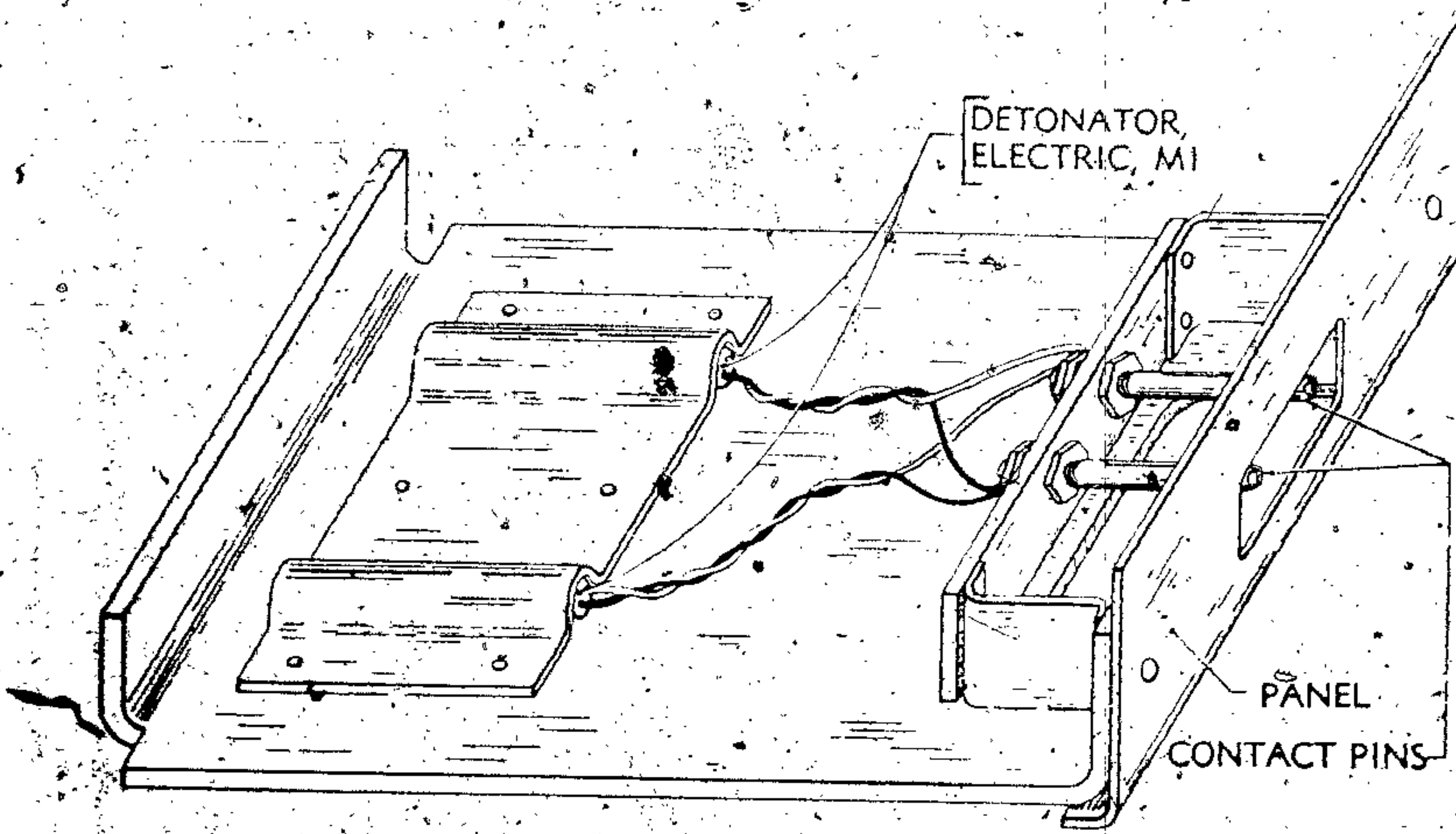

RA PD 35607

Figure 146 - Destructor AN-M2

metal components at each end of the unit are insulated from each other. When the electrical circuit is closed, the current passes through the ignition wire which, in turn, detonates the destructor.

c. **Destructor AN-M2.** This destructor (fig. 146) consists of a simple sheet-metal platform, upon which the various electrical and explosive components are secured. The rear and forward edges of the platform are curved upward and a panel is attached to the forward edge. The whole assembly is 1 1/2 inches high. This destructor fits into an opening in the enclosing box of certain equipment with which it is used. When a switch is closed, the electric current causes the electric detonators to function.

d. **Destructor AN-M3A1.** This destructor (fig. 147) resembles the destructor AN-M1 in general appearance but is much larger. It



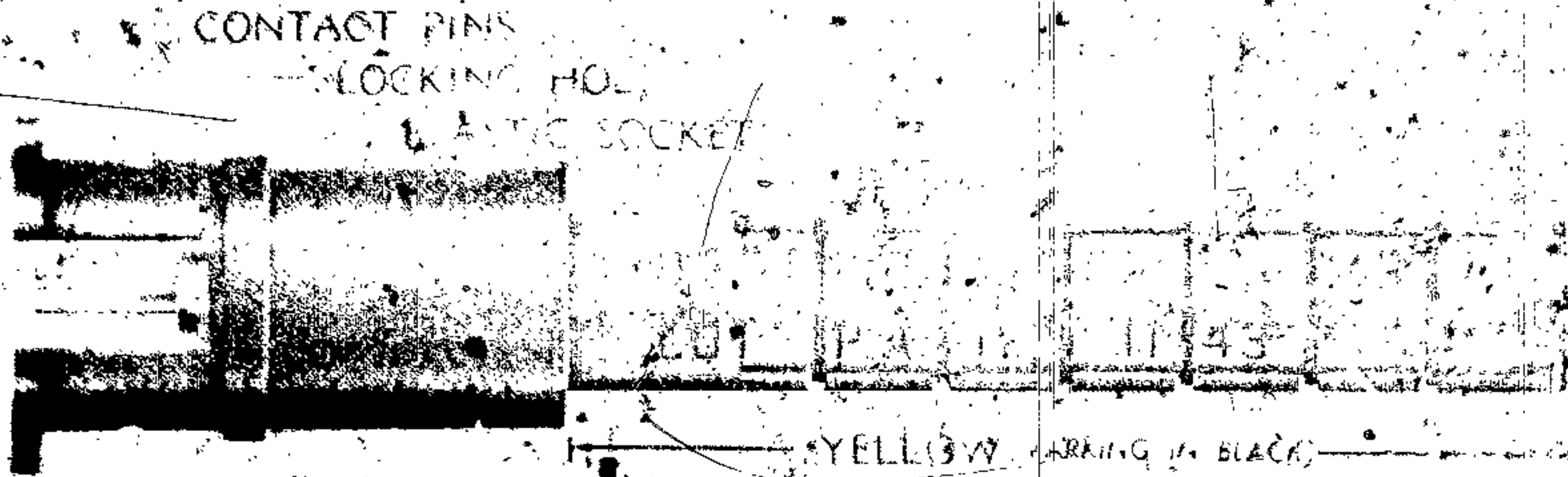

RA PD 8090

Figure 147 - Destructor AN-M3A1

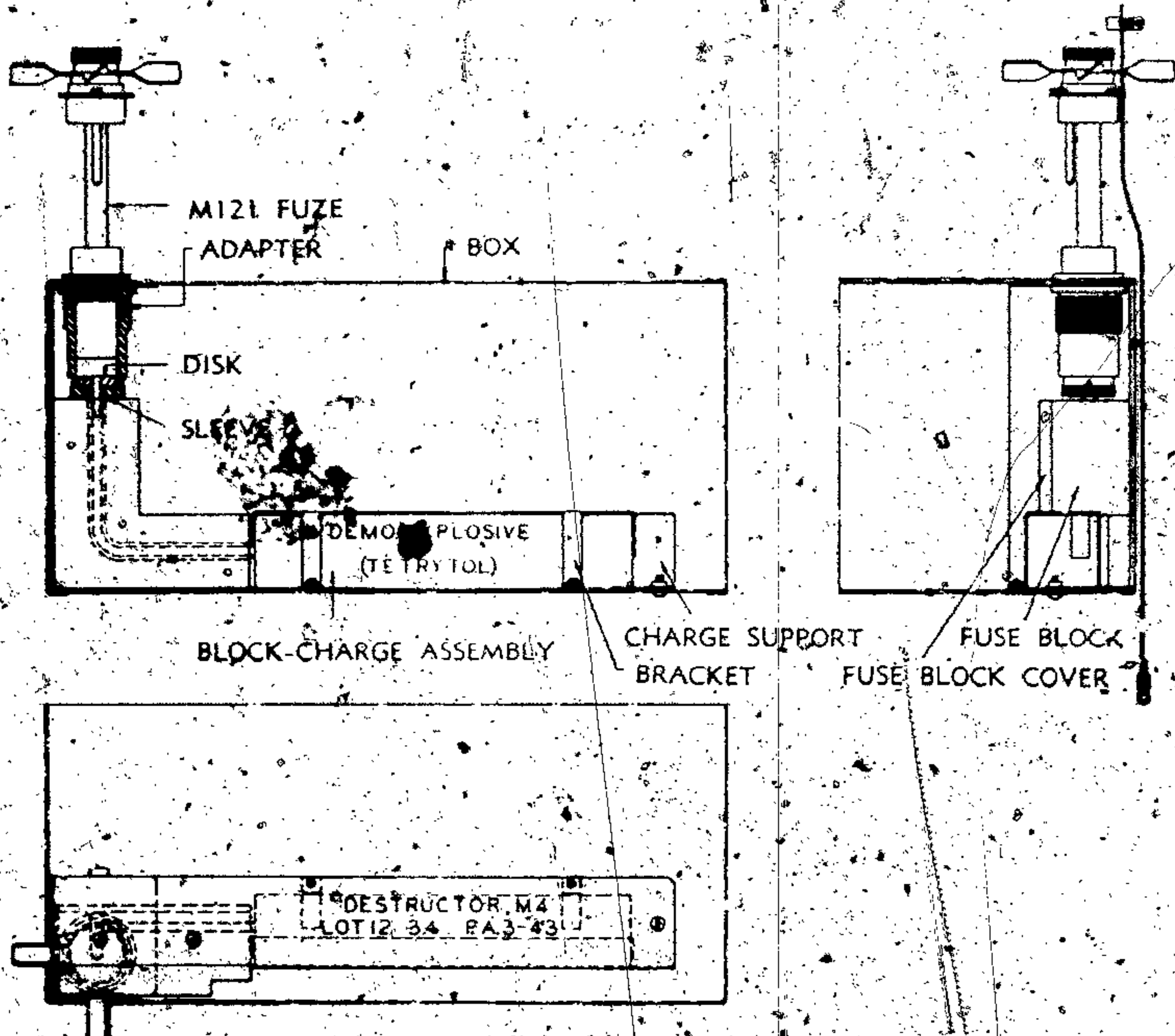

RA PD 89376

Figure 148 - Destructor M4

contains an electric detonator and a 2-gram pellet of tetryl. When a switch is closed, electric current enters the destructor through the two contact posts attached to lead wires from the plane. The current causes the detonator to explode which, in turn, explodes the tetryl pellet.

RA PD 89472

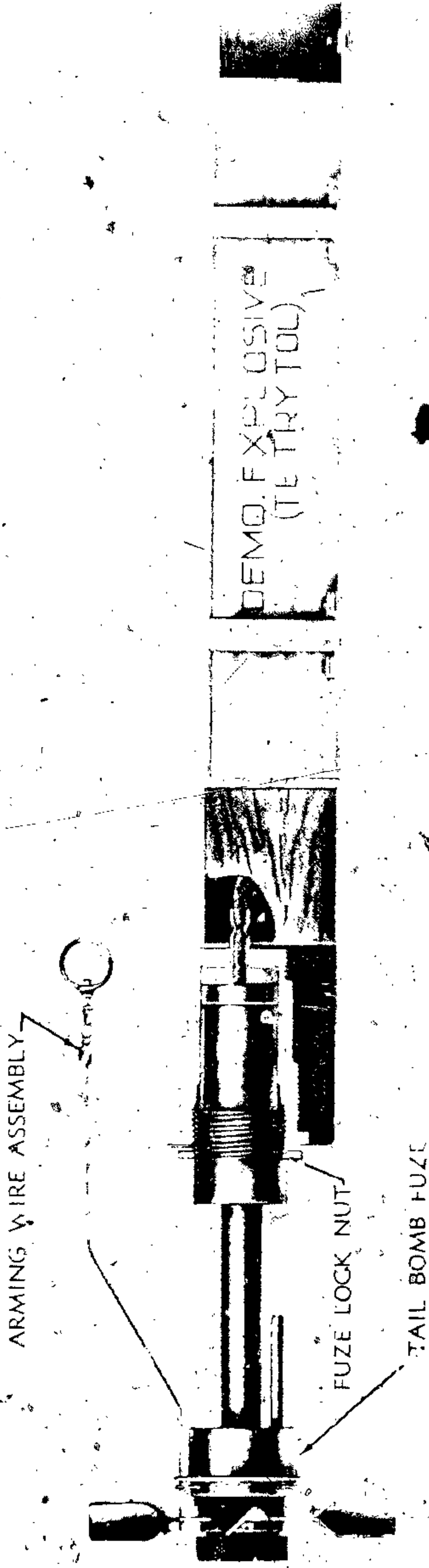

Figure 149 - Destructor M5



Classes of Ammunition

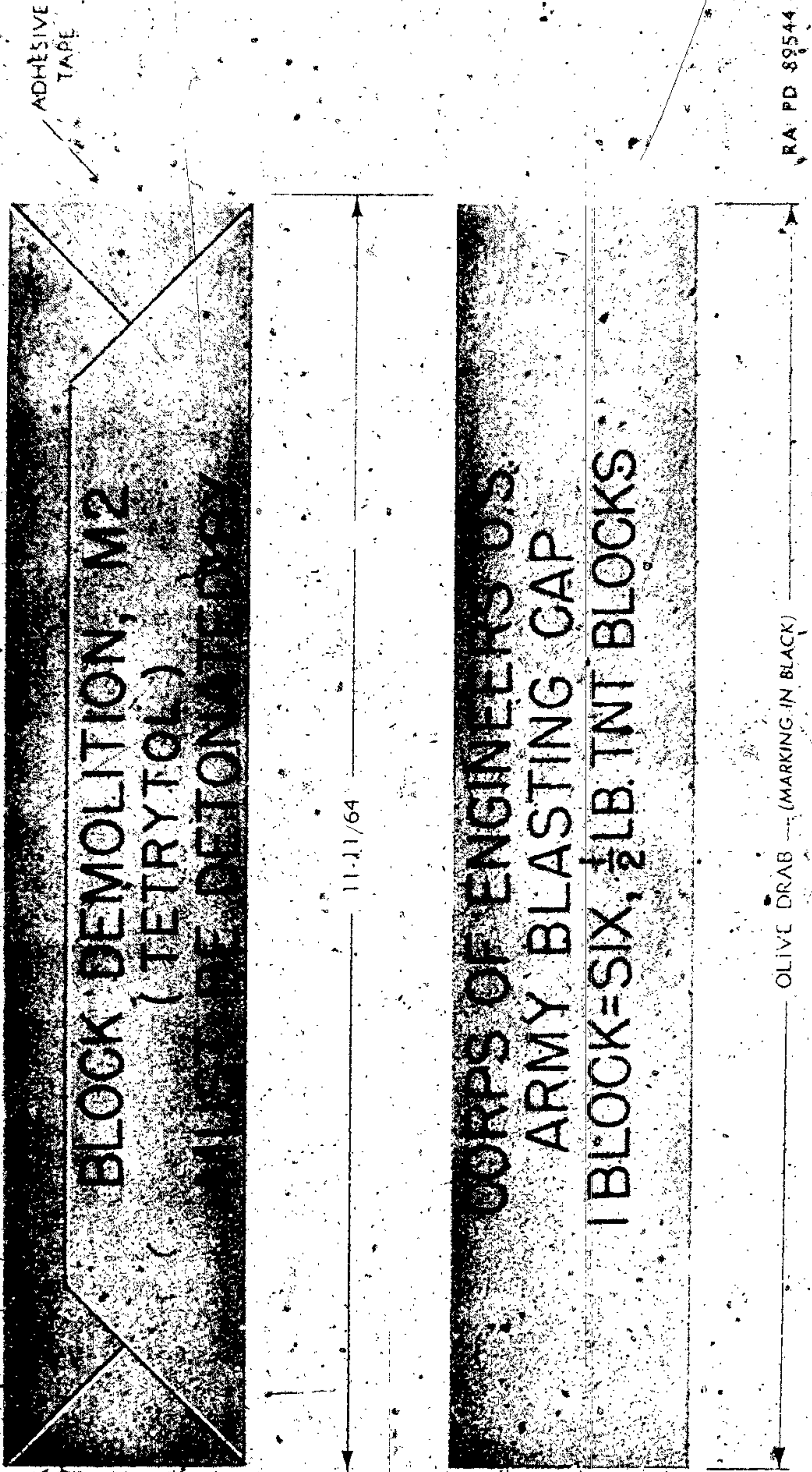
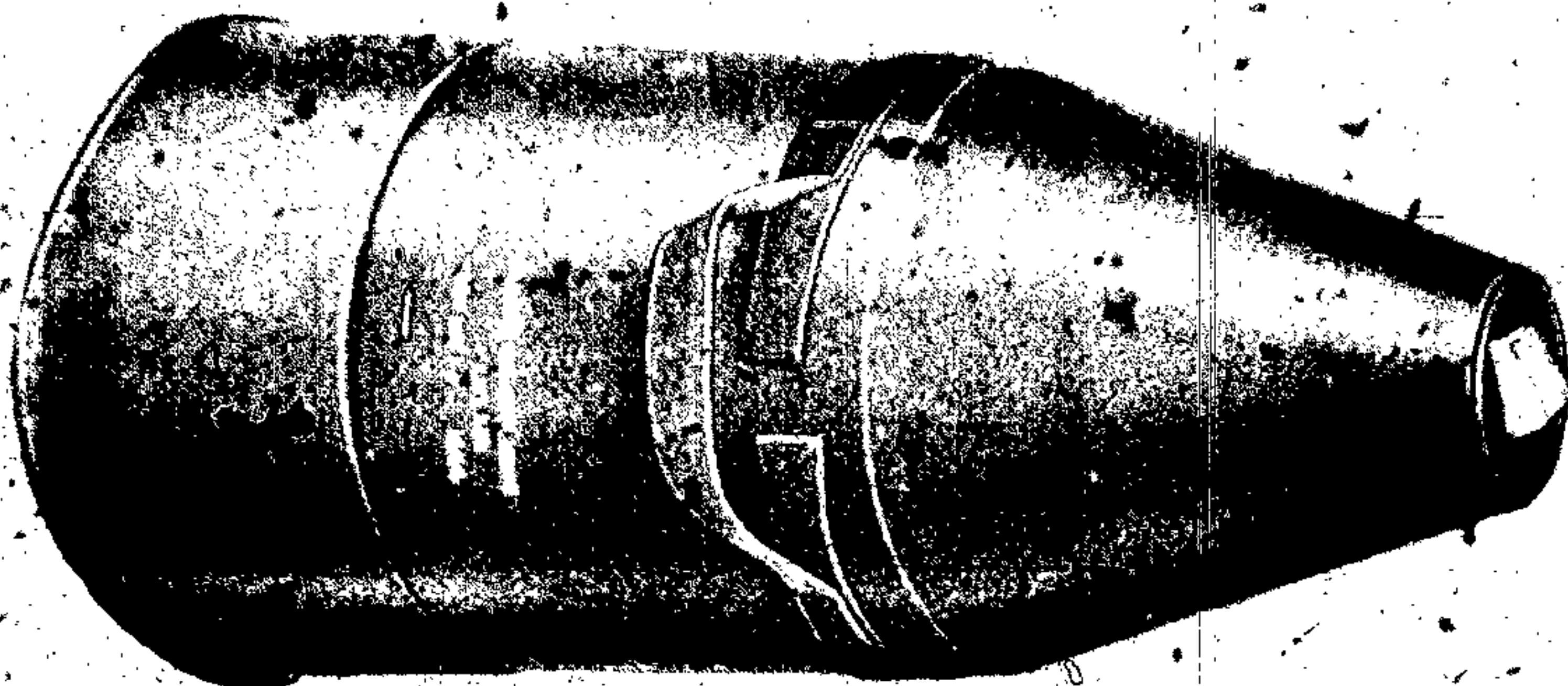

Figure 150 — Demolition Block M2



RA PD 65159A

Figure 151 - Shaped Charge, 15-lb, M2A3

e. **Destructor M4.** This destructor (fig. 148) consists of a 2½-pound block of tetrytol mounted on an L-shaped bracket, an impact-type of bomb tail fuze, and accessories for assembly and mounting in a control unit. The main destructor assembly consists of an adapter, into which the fuze fits, and the explosive block mounted on an L-shaped sheet-metal support.

f. **Destructor M5.** This destructor (fig. 149) is essentially a modification of the destructor M4. The complete assembly weighs approximately 8½ pounds.

### 157. DEMOLITION EXPLOSIVES.

a. **TNT and nitrostarch.** Compressed TNT in ½- and 1-pound blocks, and nitrostarch in ¼-pound blocks, are supplied for demolition and like purposes. These may be used by themselves (with any standard firing mechanism equipped with a detonator) or in conjunction with other demolition materials. Nitrostarch is more sensitive than TNT; hence, nitrostarch blocks should not be crushed or broken.

b. **Demolition block M2.** This demolition block (fig. 150) is a rectangular block of tetrytol, with a detonator well in each end. At the outer end of each well is an adapter threaded to receive any of the standard firing devices. At the inner end of each well is a tetryl pellet cast in the block to act as a booster. The demolition block is packed in a cardboard box, 8 boxes per haversack, 2 haversacks per box.

c. **Demolition block M3.** This demolition block is a rectangular 2¼-pound block of plastic explosive. The block consists of Composition C-3 and one block is equivalent to six ½-pound TNT blocks. This plastic explosive can be molded by hand into any desired shape or position and is very efficient, due to the good contact thus obtained combined with its high power. The demolition block is packed in a cardboard box, 8 boxes per haversack, 2 haversacks per box.



Classes of Ammunition

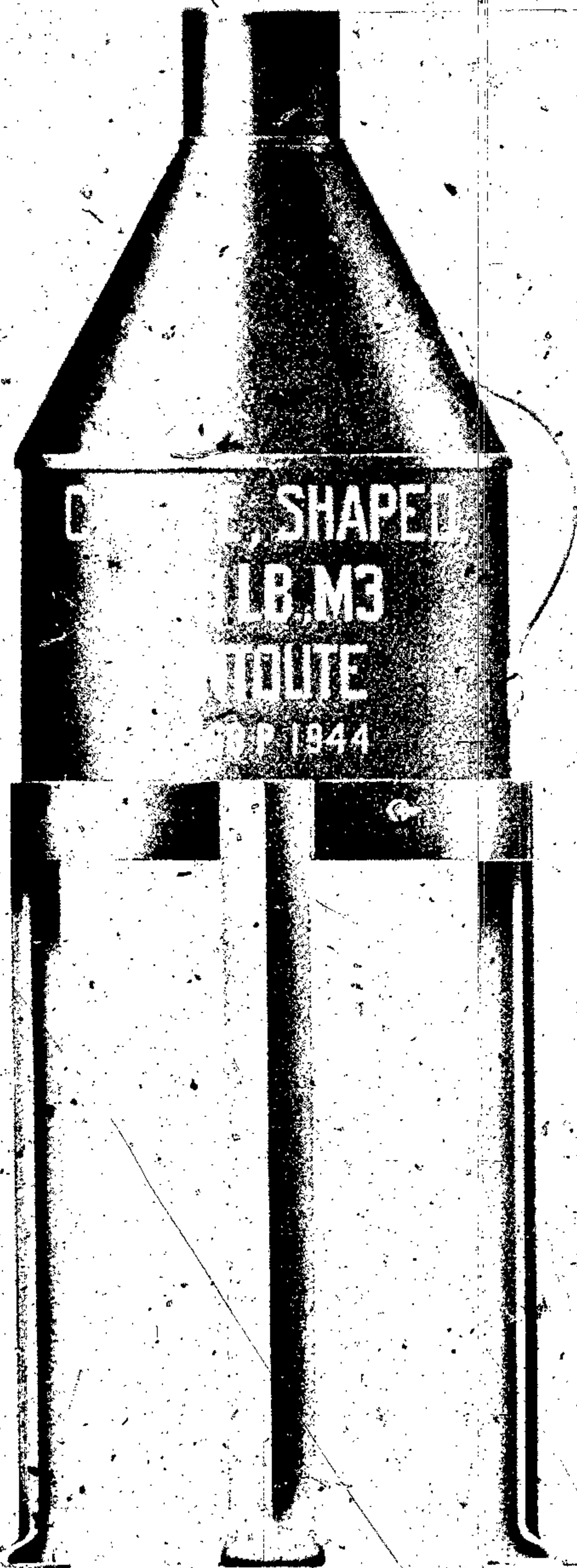

29 1/2"

RA PD 65188A

Figure 152.— Shaped Charge, 40-lb, M3

*Classes of Ammunition*

d. **Demolition Block M4.** This demolition block is a 1/2-pound block of Composition C-3 and has the same plastic qualities as the block M3. The block M4 is packed 104 blocks per box.

**158. SHAPED CHARGES.**

a. Shaped charges are explosives which are formed into special shapes for the purpose of focusing the detonation into a penetrating jet. Such a charge has much greater penetrating capacity than a regular block charge of the same weight.

b. **Shaped charge 15-lb.** This charge (fig. 151) contains approximately 12 pounds of 50/50 pentolite in a moisture-resisting molded fiber container. The top of the charge has a threaded cap well for receiving an Engineer's Special (or other standard issue) blasting cap. The container extends beyond the base of the charge to hold the charge at the correct distance (called "stand-off") from the target to obtain maximum penetration. This charge will penetrate 36 inches of reinforced concrete. If the concrete is of greater thickness, it will produce a hole approximately 30 inches deep and 2 to 3 inches in diameter. This charge is packed 3 per wooden box; 4 in a carton, 2 cartons per wooden box; or 4 in a fiber container, 1 container per wooden box.

c. **Shaped charge 40-lb.** This charge (fig. 152) contains approximately 30 pounds of 50/50 pentolite in a metal container. A threaded cap well is provided for receiving an Engineer's Special (or other standard issue) blasting cap. Metal legs provide the correct stand-off distance which must be maintained for maximum penetration. This charge will penetrate a 60-inch concrete wall. The resulting hole will be large enough to insert a standard bangalore torpedo.



## CHAPTER 3

**CARE, HANDLING, AND PRESERVATION**

## Section 1

**GENERAL SAFETY PRECAUTIONS****159. GENERAL.**

a. This section deals with the hazards inherent in the storage, maintenance, handling, and intraplant transportation of ammunition. Where rules are given covering related subjects and operations, they should be considered as general.

b. When work is done which involves the direct exposure of explosives material to possible friction, sparks, impact, static electricity, etc., the regulations contained in the Ordnance Safety Manual should be followed. Example of such work is ammunition destruction. The Safety Manual covers safety in the performance of the operation and in the type of equipment necessary for the performance of it.

**160. GENERAL PRECAUTIONS.**

a. Investigation of accidents which have occurred in the handling, shipping, and storing of explosives and ammunition indicates that, in most cases where the cause could be determined, the accident was due to circumstances which may be classed as controllable. Therefore, the following general safety precautions will be strictly enforced.

**b. For personnel.**

(1) Ammunition will be handled under the direct supervision of a competent person who understands thoroughly the hazards and risks involved. Persons handling ammunition will be impressed with the fact that their safety, as well as that of others, depends upon the intelligence and care exercised by themselves and by their fellow workers.

(2) Personnel handling ammunition must not tamper with any components or disassemble any components, unless especially authorized to do so. Serious accidents may result.

(3) Persons handling ammunition will clean all mud and grit from their shoes before entering the magazine, car, boat, or vehicle in which there are explosives or ammunition.

(4) Appropriate protective clothing and safety equipment will be provided and its use required.

(5) Safety shoes will be worn in locations where operations require the handling of exposed explosives which may be ignited by static discharge or where there may be exposed explosives capable of being ignited by friction or impact. Details of types of safety shoes, etc.

*Care, Handling, and Preservation*

ditions under which they should be used, and a list of explosives requiring use of such footwear may be obtained from the Office of the Chief of Ordnance.

*In ammunition handling.*

(1) The handling of ammunition should always be conducted so as to limit the number of personnel exposed and the hazardous material handled to as small a quantity as is practicable.

(2) Explosives and ammunition will be handled carefully. Bale hooks will not be used under conditions where the container may be penetrated by the hook or fall off the hook. Containers will not be tumbled, dragged, thrown, or dropped on each other or rolled or walked over on the floor or dropped from tailboards. Bombs equipped with slipping bands may be rolled with care. Separate-loading shell may be rolled, if the rotating band is protected from damage. Metal roller conveyors and trucks may be used except for hazardous explosives which may be ignited by sparks. Such explosives should be handled either by hand or with wooden or nonsparking conveyors.

(3) If the precautions prescribed herein are strictly complied with in handling ammunition containing the newer types of explosives, such as Composition B, pentolite, and tetrytol, it should be no more dangerous than the handling of ammunition loaded with TNT. High-explosive items with thin walls and high charge-weight ratio, require special attention to avoid denting the walls. Such items must not be handled on chutes or otherwise subjected to excessive impact.

(4) No tools or equipment so designed that steel or other spark-producing metal comes in contact with explosive materials will be used in handling hazardous explosives. Safety tools are required in box opening and repair. Such tools are constructed of wood or non-sparking or spark-resistant materials, as bronze, lead, beryllium alloys and monel metal, which, under normal conditions, will not produce sparks.

(5) Gasoline-powered lift trucks will not be used for handling exposed explosives, or be used in locations where exposed explosives are present. They must not be used in igloo magazines.

(6) Explosives and ammunition should not be exposed to moisture or dampness or to the direct rays of the sun for any long period. If it is necessary to leave boxes temporarily outside of magazines or cars, they should be covered with a tarpaulin so placed that there is free circulation of air through the pile.

(7) Ammunition will not be improvised, reconditioned, renovated, or salvaged within the magazine area unless the sites, buildings, or cars in which work is being done are devoted exclusively to such work and are specifically approved. Quantity-distance requirements in chapter 3 section II, must be observed.



### Care, Handling, and Preservation

(8) If explosives spill or lift from a leaky container, all will be stopped until the explosives have been removed, and soil washed or desensitized as far as practicable.

## 161. FIRE PROTECTION.

### a. General.

(1) Fire prevention is of the utmost importance. Many of the fires involving explosives and ammunition are preventable. It is the duty of all concerned in their handling to study the causes of fires and thoroughly inform themselves of the safety precautions that must be taken to prevent them.

(2) A great hazard in and around explosives is heat. Some explosives ignite at temperatures substantially lower than those required to ignite wood, paper, or fabrics, and might result in explosion. Therefore, every effort will be made to maintain normal temperatures surrounding ammunition and explosives.

b. Causes of fires. Fires in magazines and magazine areas may be due to a number of causes, of which the following are most common:

(1) DRY GRASS, LEAVES, AND UNDERBRUSH. These may be ignited by sparks from locomotives, by smoking or the careless use of matches and camp fires.

(2) DETERIORATION OF EXPLOSIVES AND AMMUNITION. This normally occurs at such a slow rate that most explosives and ammunition remain serviceable for many years. However, under unfavorable conditions, explosives and ammunition may produce heat so fast that it cannot be dissipated, causing the explosive or ammunition to burst into flame. Where the explosive or ammunition is confined, an explosion or detonation may result.

(3) REPACKING, RENOVATION, AND SALVAGE OPERATIONS, NOT PROPERLY SUPERVISED AND CONDUCTED IN ACCORDANCE WITH RECOGNIZED SAFETY STANDARDS. The most common sources of trouble are excessive quantities of powder and loose explosives, accumulation of waste paper, broken boxes, unauthorized use of spark producing tools, defective machinery, faulty electrical equipment, etc., and failure to provide the proper barricades and firebreaks necessary to prevent the spread of fire from one operation to another.

(4) LACK OF TRAINING, OR VIOLATIONS OF INSTRUCTIONS OR WRITTEN REGULATIONS. The most common violations involve smoking, carrying matches in forbidden areas and buildings, or tampering with explosives or ammunition, particularly grenades or fuzes.

(5) FAILURE TO UNDERSTAND AND CAREFULLY OBSERVE THE SAFETY PRECAUTIONS PRESCRIBED FOR DESTROYING EXPLOSIVES AND AMMUNITION. The most frequent source of trouble is flying fragments which cause grass fires or explode piles of explosives and ammunition awaiting destruction.

Care, Handling, and Preservation

(6) **SPARKS.** These may be caused by striking iron or steel nails or metal containers with iron or steel tools, or by nails in shoes striking flint, pebbles, sand grains or nails in the floor. Such sparks, small as they are, have caused disastrous explosions of black powder or the dust of other explosives which ignite easily. This hazard is the basis for requiring tools of brass, copper, or other nonsparking materials, cleaning mud and dirt from shoes before entering magazines, and wearing safety shoes approved by the Chief of Ordnance, when exposed explosives are present.

(7) **STATIC ELECTRICITY.** Charges of static electricity can be accumulated on a person and on explosive material such as smokeless powder. The discharge of static electricity is considered a serious hazard in the presence of certain exposed explosives, dust and air mixtures, and inflammable vapor-air mixtures. Processing equipment for such materials subject to static discharge should be electrically grounded; benches and flooring should be covered with electrically grounded conductive material; and personnel provided with safety shoes of authorized types. Cushioned metal chairs should not be used in locations where explosives or highly inflammable materials are present.

(8) **FAILURE TO CONTROL SAFELY THE USE OF HEAT- AND FLAME-PRODUCING EQUIPMENT.** Such equipment may be that used in maintenance work on buildings or that contaminated with explosive material.

(9) **LIGHTNING.** Lightning may strike buildings, trees, or other objects in or near explosive areas. All buildings and structures in storage areas should have complete lightning protection which meets the requirements of the Chief of Ordnance.

(10) **ELECTRIC TRANSMISSION LINES.** These are often blown down or come in contact with combustible materials.

(11) **LACK OF A PROPER MUFFLER,** or the use of a muffler cutout on motor vehicles can cause fires.

**c. Fire-prevention regulations.**

(1) Matches or other flame- or spark-producing devices will not be permitted in any magazine area or explosives area except by written authority of the commanding officer.

(2) Smoking is prohibited in any magazine or magazine area, or around cars, wagons, motor trucks, or boats in which there are explosives or ammunition. Buildings or locations for smoking may be designated outside restricted area, subject to following limitations that:



Care, Handling, and Preservation

(a) Smoking will not be allowed in locations closer than 60 feet to buildings containing explosives, ammunition or hazardous materials.

(b) Windows and doors of buildings close to explosives or ammunition areas which are approved for smoking will be fitted with wire screens.

(c) Suitable receptacles must be provided for cigarette and cigar butts and pipeheels.

(d) Only permanently installed electric lighters of approved types shall be used in the building.

(e) Hand fire extinguishers, sand boxes, and water barrels with buckets will be furnished as required for each room or building in which smoking is permitted. Persons whose clothing is contaminated with explosives or other hazardous materials will not be permitted in such areas.

(3) All flashlight or storage-battery lamps used in buildings containing explosives or flammable vapors shall be types approved as "permissible" by the United States Bureau of Mines or by a similarly recognized testing laboratory for that specific type of exposure.

(4) If gasoline or electric-powered lift trucks are used for transporting explosives or ammunition, the requirements of the Chief of Ordnance will be complied with.

(5) Where it is necessary to install power transmission and service lines in the vicinity of buildings containing explosives, the distance of the lines from the buildings will be greater than the distance between the poles which support the lines. This is to prevent broken wires from hitting the building. Overhead transmission line must not pass within 50 feet of the buildings. In future installations, power lines and services entering buildings containing explosives must be placed underground within 50 feet of the building.

(6) Vegetation in the form of grass, undergrowth, weeds, etc. which is or may become a fire hazard will be controlled by the use of chemical weed killer or by mowing, plowing, cutting, livestock grazing or, in calm weather and with proper control, by burning. Chemical weed killers should not contain chlorates or other substances which may ignite spontaneously under hot dry conditions. Burning should not be permitted within the 50-foot space specified in the paragraph below. Brush, grass, wood, etc., in piles, will not be burned within 200 feet of a magazine. Reserve supplies of dunnage should not be stored haphazardly inside the magazine area and in no case within the 50-foot firebreak around the magazine.

(7) A firebreak at least 50 feet wide and as free as practicable from inflammable material will be maintained around each above-

Care, Handling, and Preservation

ground magazine. The earth adjacent to and extending over igloo magazines will be cleared of dry debris. Firebreaks around the entire magazine area and at other places within the magazine area, such as along railroad tracks, will be maintained wherever necessary.

(8) Locomotives, trains, and other rail vehicles used in the magazine area will be so equipped that the communication of fire is prevented insofar as practicable. Inspections will be made regularly to insure that safe conditions are maintained.

(9) Gasoline or other highly inflammable liquids will not be used for cleaning purposes. Solvent dry cleaning, Federal Specification P-S-661a (Quartermaster issue) will be used in all cases where solvents of this nature are required. Dry-cleaning solvent is inflammable differing principally from gasoline in having a higher flash-point. When handling dry-cleaning solvent, AR. 850-20, "Precautions in Handling Gasoline", will be observed in all cases. This regulation does not prohibit the use of trisodium phosphate, trichloroethylene, tetrachloroethane, or similar cleaning of degreasing substances for cleaning operations. However, since many of the industrial organic solvents have pronounced toxic properties, particularly in vapor form, care must be taken in the selection of degreasing substances and apparatus. Adequate ventilation must be provided.

(10) Automobile parking should be regulated so that automobiles will not be parked closer than 25 feet to buildings or fire hydrants.

(11) Ammunition boxes, containers, dunnage, and lumber must be stacked in an orderly manner when in the vicinity of explosives renovation, handling, or storage operations. Stacks of such combustible materials must be limited to small areas between fire breaks. This is a means of limiting the spread of fire insofar as it is practicable considering the available space, available means of extinguishing fire, and the probability of fire occurring. Under average conditions, areas under solid stacks of such materials should be limited to 1,500 square feet separated from other similar areas by 25-foot fire breaks in which vegetation has been cut and controlled. Bulk stacking of such materials should not be closer than 500 feet to magazines or other buildings containing high explosives, except that working quantities within practicable limits may be stacked in the vicinity of explosive magazines, but not closer than 50 feet. Water barrels and pails should be liberally provided in such areas with which to extinguish incipient fires.

(12) The above rules will be supplemented by such additional rules as the commanding officer deems necessary to secure adequate protection against fires.



Care, Handling, and Preservation**d. Fire-fighting facilities.**

(1) A fire involving explosives or ammunition may result so quickly in an intense conflagration or explosion that means for immediately attacking the first small blaze detected are vitally important. Immediate use must often be made of hand equipment. In addition to organized permanent facilities, the following types of fire-fighting equipment may be used to good advantage:

(a) Barrels and buckets filled with water, placed at each magazine. If this class of fire-fighting equipment is always maintained so that it can be depended upon in case of fire, it is a valuable fire protection. However, in the summer time the barrels must be frequently refilled, and in freezing weather calcium chloride or salt must be added. Buckets deteriorate rapidly unless they are frequently painted or protected from the weather, and are blown about by windstorms if they are not securely fastened in place. Fastening devices must be releasable at will.

(b) Boxes and buckets filled with sand, and shovels.

(c) During freezing weather, trucks and trailers filled with water will require heated storage. Provision should be made for rapid movement of the equipment to the scene of the fire.

(d) To combat grass or forest fires in or near the magazine areas, there will be maintained at suitable locations an adequate supply of gunny sacks, brooms, rakes, hoes, or other similar equipment. This equipment should be regularly inspected and protected against theft or unauthorized use.

(2) When explosives and ammunition are being handled or work is being done in the immediate vicinity of such stores, there will be present, ready for immediate use, two chemical or other type hand fire extinguishers. It is not required that these be permanently located in a magazine, although this should be done if practicable, but it is required that these be in an accessible location. Serious fires may be avoided by the prompt use of hand fire extinguishers. They are required primarily for use on incipient fires in inert combustibles such as grass, grease, oil, dunnage, etc., which if not extinguished might reach explosives. Personnel other than the one using the extinguisher should seek safety immediately, reporting the fire enroute.

(3) The water distribution system should be protected by sectional control valves so that damaged sections of the main can be cut off without impairing the operation of the remainder of the system. Water mains should not be located under railroads or roads used for conveying large quantities of explosives or ammunition, as a

*Care, Handling, and Preservation*

detonation may cause a breakage of the main. When it is necessary to have water mains pass under railroads or roads, cars or trucks loaded with explosives or ammunition will not be permitted to remain over these water mains longer than necessary for continuous travel and suitable signs will indicate such location. Water mains should be protected with cut-off valves on both sides of the railroad or road. Fire hydrants should be connected to a looped grid system so as to provide supply from more than one direction.

(4) The duties of guards, firemen, military personnel, and others will be so arranged that an adequate fire-fighting force will be available at all times.

(5) Fire drills and inspections will be carefully conducted to insure that fire-fighting forces understand their duties and that fire-fighting equipment functions dependably under actual working conditions. Frequently, hose not tested to working pressures burst when most needed.

**162. FIRES IN WHICH EXPLOSIVES ARE INVOLVED.**

a. Fires which may occur in buildings or magazines containing explosives will vary in intensity and effect, depending on the material involved in the fire. Certain explosives will detonate or explode immediately on contact with a spark or flame, or when subjected to frictional heat or concussion. Fire may or may not result from the detonation. Some explosive substances may burn freely while others will be subject to explosion while burning, or will develop such intense heat as in the case of smokeless powder, that fire-fighting efforts will be impossible. Fire-fighting forces should be well acquainted with the hazards and best methods of combating fires in all such materials under their protection.

b. With certain exceptions water will be used as the fire-fighting medium. Generally speaking, large volumes of water spray or fog produced by nozzles designed for the purpose will prove more efficient than solid streams of water for extinguishing fires of an explosive nature. Solid streams of water at high pressures should be used when consideration for the safety of fire-fighting personnel makes it impossible to approach the seat of the fire. In fire-force training programs, emphasis should be placed on laying as many hose lines as possible, in order to surround and confine the fire.

**163. GENERAL INSTRUCTIONS IN COMBATING FIRES INVOLVING EXPLOSIVES.**

a. General instructions which will be followed in combating any fires involving explosives and ammunition are as follows:



**Safe Handling, and Preservation**

(1) When a guard or watchman discovers smoke coming from a closed magazine, or other evidence that a magazine is afire, he will give the alarm as quickly as possible. He will not enter the burning building since he may become trapped and be unable to give the alarm. If the fire is discovered in the grass or other combustible material surrounding the magazine, the alarm should be given immediately and the guard should then do all that is possible, using extinguishers, water from nearby water barrels, or grass fire-fighting tools, to extinguish or control the fire until the fire-fighting forces arrive.

(2) When a workman or other person discovers a fire in a building where people are working and explosives are present, personnel present will be evacuated by suitable signal in accordance with pre-arranged plans. At least one responsible messenger will be dispatched in the direction from which the fire department is expected, to inform them of the nature and extent of the fire. The officer in charge of fire fighters will not permit the advance of his men to such a fire unless he has what he believes to be accurate information as to the existing conditions and concludes therefrom that he is justified in doing so (par. 165).

(3) Fire-fighting forces will attack a grass fire vigorously and endeavor to extinguish it even when it is close to a magazine. If a fire has actually gained headway in a magazine, fire-fighting forces should either combat the fire or seek the nearest suitable protection, depending on the type of ammunition or explosives within the magazine (par. 165).

**164. IDENTIFICATION OF MAGAZINES.** As a means of providing a guide to fire-fighting forces, the Ordnance Department divides explosives into four groups in accordance with the general burning or explosive characteristics of the materials and the relative danger encountered in fighting fires in which they are present. The four groups are identified by symbol numbers 1 through 4, the hazard to fire fighters increasing progressively with the numbers. Ordnance regulations require that ordnance buildings containing hazardous or explosive materials, except igloo magazines, be plainly marked with the symbol number (no less than 24 inches high) of the most hazardous material contained therein, as described in paragraph 165.

**165. FIRE HAZARD GROUPS AND FIRE-FIGHTING PROCEDURES.**

a. **Symbol 1.** This group consists of Classes 1, 11, and 12 ammunition; metallic powders in ICC approved shipping containers; and chlorates, perchlorates, peroxides, nitrates, and other inorganic oxidiz-

*Care, Handling, and Preservation*

ing agents in sealed containers. While these materials are principally fire hazards and fires in which they are involved may be fought, minor explosions may be expected so that extreme caution must be exercised in accordance with the following:

(1) **SMALL-ARMS AMMUNITION.** Shipping containers of small-arms ammunition, especially when tracer and incendiary rounds are included will continue to burn fiercely even after the magazine has been consumed. Personnel attempting to fight the fire after fire has reached the ammunition itself must be shielded from light hot missiles which may be expected to travel up to 200 yards at a velocity of approximately 200 feet per second. Sheet metal covered wooden shields can be used and moved to various vantage points. When practicable to use water spray, it will be found very effective in extinguishing such fires.

(2) Oxidizing agents are not flammable in themselves, but when heated in a fire involving combustibles, give off oxygen which greatly facilitates burning. Fire fighters should be provided with suitable masks to guard against poisonous fumes resulting from such fires. Cooling or drowning with large quantities of water may serve to control or extinguish these fires, but after the fire has gained considerable headway, fire-fighting efforts may, of necessity, be confined to protecting adjacent property as much as possible.

(3) **CHEMICAL AMMUNITION.** For fires involving chemical ammunition containing blistering agents, all fire fighters will be protected by masks and complete protective clothing. If practicable, such fires will be fought from the windward side. All unprotected personnel downwind will be evacuated and civilian inhabitants warned. Fires involving toxic chemicals will be fought with similar precautions except that the danger area downwind is less. Fire fighters will be protected with suitable masks. In fires involving HC smoke mixture, attempts should be made to remove and segregate the burning containers. When a relatively small amount of HC smoke mixture is involved in a fire, it can be "drowned" with water. Water will also serve to cool adjacent containers to prevent further spread. Unless water can be applied in large amounts, in relation to the actual HC smoke mixture which is exposed and burning, the efforts to fight the fire will be ineffective and the material may explode. Fire fighters should not enter magazines containing a high concentration of HC smoke unless adequately protected by oxygen masks and supplied with life lines.

b. Symbol 2. This group consists of Class 3 ammunition and



*Care, Handling, and Preservation*

(1) Personnel discovering such a fire should attempt to put the fire out with the equipment on hand if the fire is in the incipient stage. The fire-fighting organization should fight the fire if there is a possibility of extinguishing it. If this does not seem possible, the building should be abandoned and the fire-fighting efforts concentrated on preventing the spread of the fire. Large explosions may be expected from fire in these materials. Personnel should exercise due precautions to prevent injury to themselves and their equipment.

c. **Symbol 3.** This group consists of Class 2 smokeless powder in bulk shipping containers and Class 2 pyrotechnic material.

(1) Unless the fire is of a minor nature and does not involve the explosive itself, and there is a chance of controlling it, fire-fighting should be confined to preventing the spread of the fire to other buildings. These materials burn with intense heat and personnel and fire-fighting equipment should be adequately protected.

(2) **PHOSPHORUS.** In fires involving phosphorus, personnel entering magazines with portable extinguishers will have life lines attached in order to be able to find their way out through the heavy smoke. It should be remembered that phosphorus will stop burning only so long as it is under water; when exposed again to the air, it ignites spontaneously.

(3) **PYROTECHNICS.** When fire involves pyrotechnics and large quantities of magnesium-type incendiaries, fire fighters should confine efforts to protecting adjacent buildings and magazines. Water may accelerate burning and cause explosions which may scatter burning material. The use of carbon dioxide and carbon tetrachloride extinguishers on such fires will create poisonous gases. Small fires involving 50 pounds or less of magnesium can be smothered with dry inert material which is powdered or granular, such as hard coal, tar, pitch, graphite (preferably coated to eliminate dust), rust-free cast-iron borings, soft coal, talc, salt, or sand. Asbestos, sand, salt, and talc are not inert in magnesium fires, but may be used dry if the fire is small. The powder should be placed over the burning material so as to cover it to a depth of one inch or more. It should not be disturbed until the magnesium has cooled except when the fire is on a floor of flammable material, in which case, after the fire is covered, a two-inch layer of extinguishing powder should be put on the floor beside the fire and the burning material raked onto the insulating layer and resmothered.

d. **Symbol 4.** This group includes Classes 4, 5, 6, 7, 8, 9, and 10 ammunition and explosives.

*Care, Handling, and Preservation*

(1) Every effort should be made to prevent a fire from reaching this class of material, which is especially hazardous. If a fire occurs in such a magazine when personnel are present, they should attempt to put the fire out with the equipment at hand, providing it has not actually reached the material and there is a good chance of putting the fire out. Otherwise, they will evacuate the magazine and take cover. If fire breaks out in a magazine containing high explosives, fire-fighting forces will not immediately approach the fire. Unless specific information is available either from one who was present when the fire was discovered or from intimate knowledge of the construction of the building and location of the explosives indicating that it is safe to approach the fire, fire fighting forces will remain a thousand feet distant where up to 50,000 pounds of high explosives are involved, or proportionally greater distance up to 2,000 feet for 100,000 pounds of high explosives, until explosions have occurred, indicating the probable destruction of the explosives present. Fire-fighting forces and their equipment must not be exposed to unnecessary risk where these materials are involved. Demolition or general purpose bombs, and antitank mines are liable to detonate en masse, and propelling charges may explode, producing heat that may blister the paint on buildings 500 feet away. Bulk high explosives packed in boxes will usually burn quietly, but may detonate. Black powder, photoflash bombs, smokeless powder in bulk, and unpacked propelling charges, explode or flash so quickly that there is no time to do anything to save the magazine involved. In almost every instance, the efforts of fire fighters will be confined to preventing fire from spreading to adjacent buildings or magazines.

**166. GUARD PROTECTION.**

a. Magazines and areas in which there are explosives and ammunition will be guarded adequately at all times. Magazine areas should be protected by non-climbable fences, entrances to which will be locked unless guards are stationed at them. Special precautions will be taken to guard areas which are not protected by a suitable fence.

b. Guards, and others in charge of explosives and ammunition, will be thoroughly instructed in the hazards due to fire and explosions and the safety precautions to be taken. They will be instructed that their most important duty is to protect explosives and ammunition against fire. Alarms will be given with the greatest possible speed so as to start action instantly. Serious fires and explosions have been avoided by prompt action of fire-fighting forces. After giving the alarm, guards will exert every effort to hold the fire under control until the fire-



Care, Handling, and Preservation

fighting forces arrive, except that should a fire occur in a closed magazine, they will not attempt to enter the magazine.

c. Hunters either inside or outside a magazine area who are found using fire-arms in a manner which may endanger stores will be reported. Hunters in such areas should be warned not to shoot.

d. Except under emergency conditions, guards protecting ammunition and explosives, will not be armed with rifles. Generally, shot-guns are recommended for guard purposes. Many military explosives are not initiated by low velocity projectiles, but any bullet striking explosives may cause a serious fire and/or explosion. Guards protecting explosives or ammunition will be instructed regarding the danger of firing in the direction of a magazine.

e. Guards should be instructed to make a prompt report of the following:

- (1) Any unusual occurrence in or near a magazine area.
- (2) Grass or forest fires in areas adjacent to the magazine area.
- (3) Dangerous practices of personnel working in magazines or explosives areas, such as smoking, unauthorized use of fire equipment and tampering with ammunition or electrical equipment.
- (4) Unlocked magazines doors and shutters, defective telephone and electric wires, and openings in fences surrounding the magazines.

---

 Section II

**STORAGE**
**167. GENERAL.**

a. In these general precautions, the word "magazine" is intended to cover any space containing a supply of explosive material, and includes such places as an above-ground magazine, earth-covered igloo-type magazine, railroad car, the body of a motor truck, a temporary shelter, or a stack.

b. General storage regulations are contained in AR 700-10. Regulations for ordnance establishments are contained in the Ordnance Safety Manual (O.O. Form No. 7224), and Ordnance Department Safety Bulletins which supplement that manual. Regulations and instructions in this section are for Zone of Interior Class I, II and III installations which store limited quantities of explosives and ammunition. Larger quantities should be stored in accordance with regula-

*Care, Handling, and Preservation*

tions prescribed for Class IV installations under the control of the Chief of Ordnance. Regulations for overseas installations are contained in FM 9-6, "Ammunition Supply," and FM 9-20, "Ordnance Ammunition Company, Ordnance Ammunition Battalion."

**168. GENERAL STORAGE PRECAUTIONS.**

a. Explosives and ammunition should be stored in buildings designed, designated, and isolated for the specific purpose. Explosives and ammunition will not be stored in buildings which are used for other purposes such as basements or attics of barracks, company supply rooms, or general storehouses. When specially constructed magazines are not available, the buildings used must afford good protection against moisture and dampness, and have means for adequate ventilation. They must be floored with approved material and may not be heated by open fires or stoves.

b. Ammunition should be stacked by lot number in stacks arranged so that no obstacle is offered to free circulation of air beneath and throughout the stack. When more than one lot is stored, all items or containers of a lot should be stored together and the line of separation between lots clearly indicated. Lots of ammunition should never be mixed at random. The tops of ammunition stacks should be below the level of the eaves to avoid the heated space directly beneath the roof. The bottom layer should be raised off the floor about two inches. Dunnage should be level; if necessary, shims or wedges should be used. Stacks should not be so high that ammunition or its containers in the lower layers will be crushed or deformed. Partly filled boxes should be fastened securely, marked, and kept on the top of the pile.

c. Boxes, cases, and other containers of ammunition should be clean and dry before being stored. Ammunition containers should not be opened in a magazine. They should not be stored after having been opened unless they are securely closed, except that ammunition and explosives in damaged containers in process of being repaired may be stored overnight in magazines. When it is necessary to store ammunition and explosives overnight in damaged containers, they should be separated from serviceable ammunition. Repair or change of container will not take place in or within 100 feet of a magazine containing explosives.

d. Rounds or components will not be kept loose in a magazine. No empty container, excess dunnage, or tools should be permitted to remain in a magazine. No oily rags, paint, turpentine, etc., will be left in a magazine containing ammunition or explosives.



Care, Handling, and Preservation

e. Improvised ammunition such as "Molotov Cocktails," hand grenades of nitro starch, commercial fireworks intended to simulate ammunition, and other nonstandard devices should be prepared in an isolated area or building free of loose explosives and waste paper or other combustible material. All such work should be performed under direct supervision of competent experienced persons. The quantity of explosives present should be the minimum necessary for the operation, which should be carried out in conformity with quantity-distance and inhabited-building distance requirements for class 10 ammunition given in paragraph 172. The number of persons permitted at or near the operations should be kept to a minimum. When a surplus of such material must be stored, under no circumstances should it be stored in a magazine with other explosives or ammunition because the items are generally of substandard construction and the explosive content may be of such a nature as to present a serious hazard in storage and handling.

f. Inflammable liquids and ammunition should not be stored together or close to each other. Ammunition should be separated by the inhabited-building distance (par. 172) from handling or storage of inflammable liquids to prevent fires originating in one area spreading to another.

g. Chemical ammunition will be stored separately, so placed that each container may be inspected for leaks and may be easily removed.

h. Ammunition assembled with tracer pyrotechnics, propelling charges, and other ammunition items, should be stored under the best cover available, preferably in a building providing protection against dampness and having adequate ventilation. Tracer ammunition is subject to rapid deterioration if damp and may ignite spontaneously.

i. Truck motors should not be started while the magazine door is open. However, a motortruck may approach a magazine without the necessity of closing the magazine doors provided the following requirements are complied with:

(1) The motor exhaust is equipped with an effective spark- and flame-arresting device in the exhaust line.

(2) No exposed explosive material is being transported or handled.

(3) No explosive material is located on the platform or otherwise outside the magazine or truck while the engine is running.

**169. OUTSIDE STORAGE.**

a. Outside storage of explosives and ammunition is neither desirable nor recommended, and must be resorted to only as an emergency expedient. When such storage must be employed, bombs and separate-loading shell will be given preference over packaged ammu-

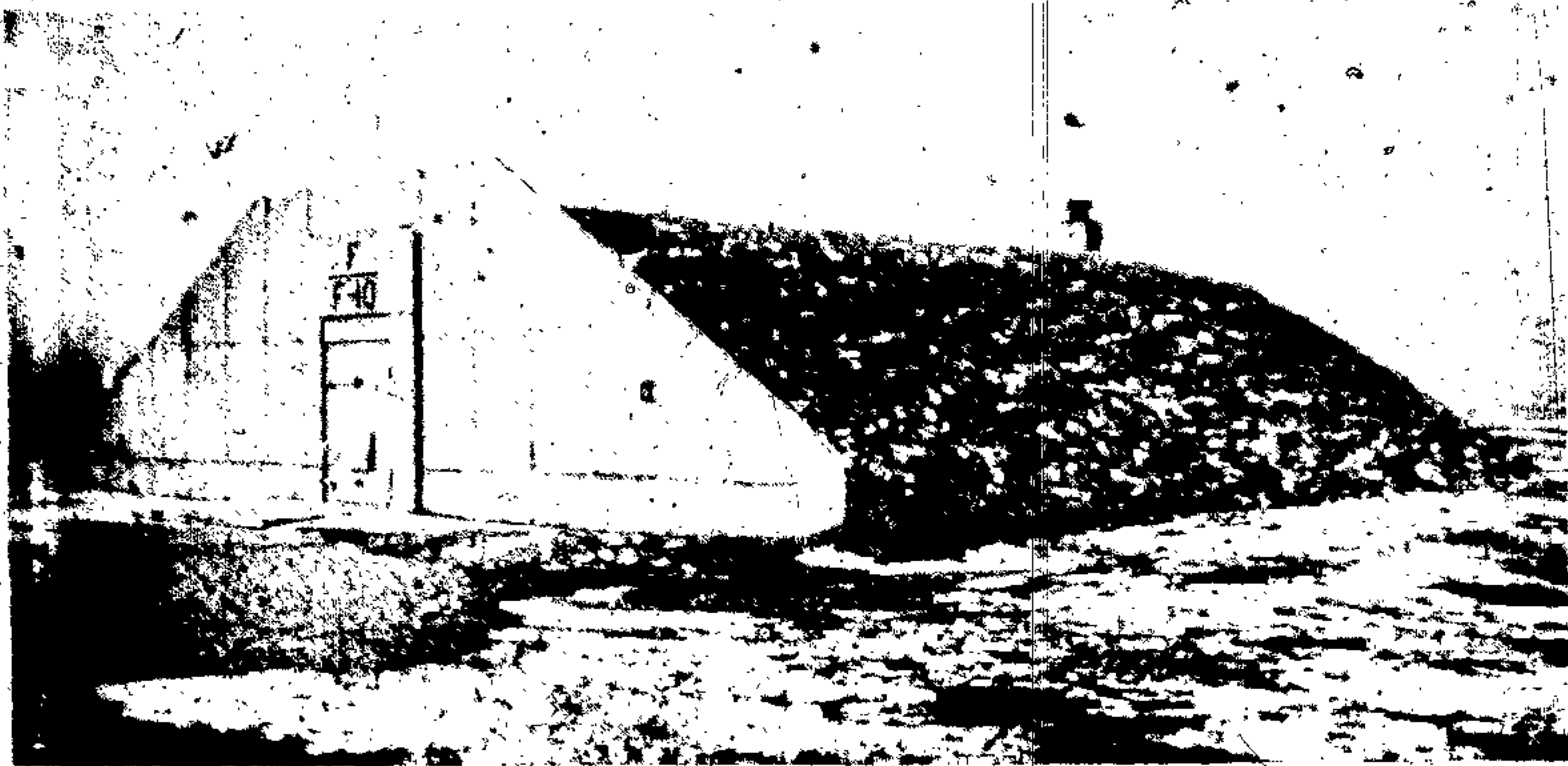
*Care, Handling, and Preservation*

RA PD 89380

**Figure 153 — Igloo-type Magazine**

nitron. In order that outside storage of explosives and ammunition may be kept to a minimum, full advantage must be taken of the cubic capacity of all magazines, within the limits prescribed by this manual. When it becomes necessary to utilize outside storage within the continental United States, it shall be in accordance with the distance requirements of paragraph 172.

**b.** Sites for outdoor storage will be carefully chosen to avoid exposure to power lines. Ammunition should not be located adjacent to reservoirs, underground water mains, electric cables, or sewer lines. Outdoor storage should be located where there is good surface drainage. Outdoor storage shall conform to quantity-distance requirements for above-ground magazines.

**c.** The supporting timbers or platforms upon which ammunition is stored should be well constructed to prevent falling, sagging, and shifting of the ammunition.

**d.** Crated and packaged ammunition, smokeless powder, pyrotechnics, and bulk high explosives should not be stored outdoors. Efforts should be made to avoid the necessity for outdoor storage of any type of ammunition.

**e.** Care will be exercised in closing openings in loaded bombs and other ammunition which have not been completely assembled. Temporary plugs used as closures should be set down against suitable washers so that dirt and moisture cannot enter.

**f.** It is advisable to cover piles of bombs and shell with some type of waterproof material to guard against direct exposure to the atmosphere, provided that adequate ventilation is assured.

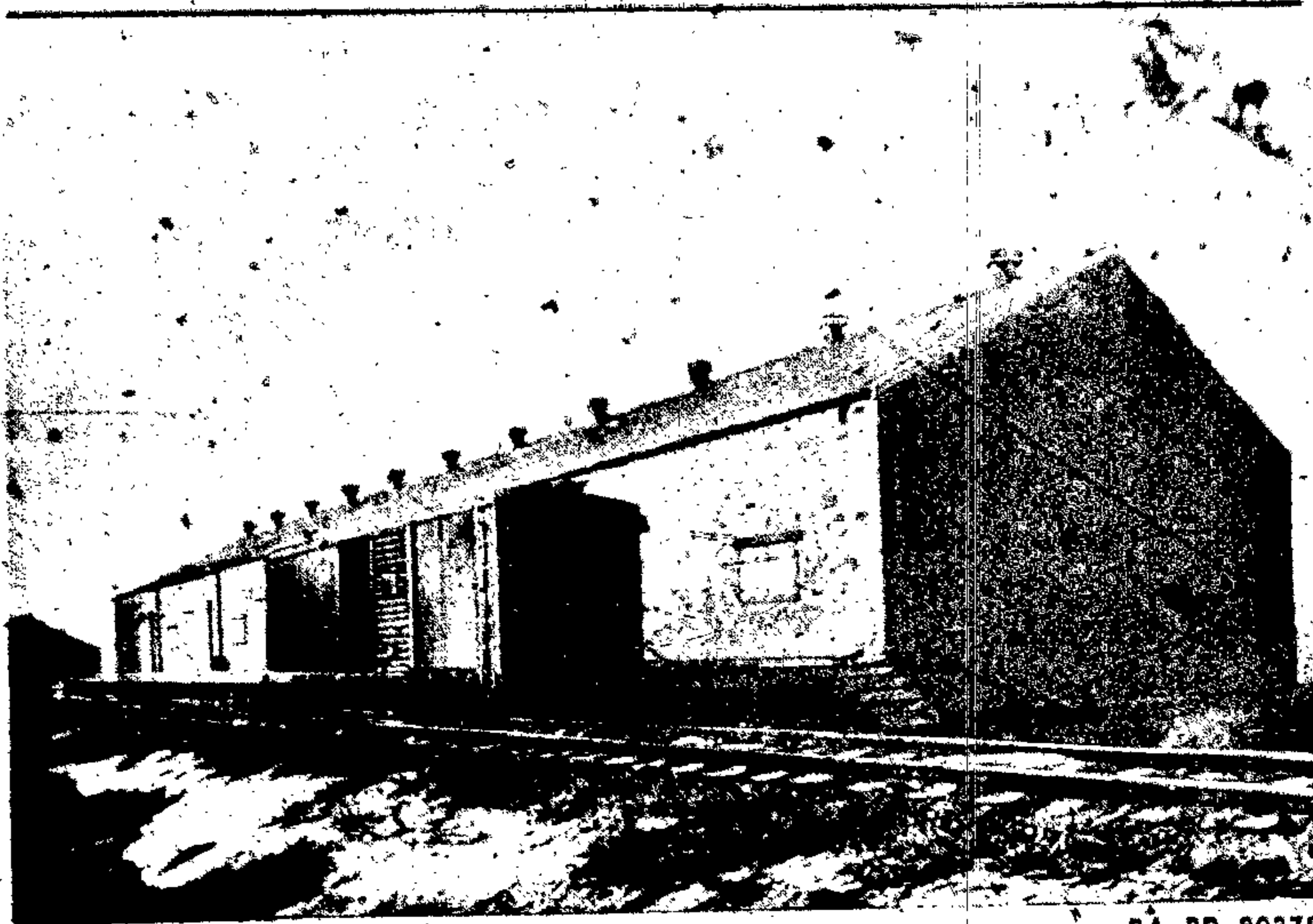

*Care, Handling, and Preservation*

RA PD 89378

**Figure 154 — Standard Magazine**

g. Frequent inspections shall be made to locate sagging piles and to detect accumulation of trash between or under the stacks.

**170. TEMPORARY STORAGE AND HOLDING YARDS.**

a. **Temporary storage yards.** In some cases, it may be found necessary to hold cars of ammunition for a period of more than 24 hours but not exceeding 2 weeks. The cars are considered as above-ground magazines. Existing tracks may be utilized provided quantity-distances for above-ground magazines are complied with. The cars should be grouped so that each group is limited to 250,000 pounds of high explosive, and so that groups are separated from each other by a minimum distance of 800 feet. If the full distances cannot be provided, then groups may be spaced 400 feet apart in all directions, provided one or more cars of inert materials or of small-arms ammunition are spotted between the groups.

b. **Holding yards.** The cars on the tracks are considered as above-ground magazines. To provide flexibility of storage, yards should be laid out so that the tracks are 400 feet apart with a barricade between the tracks. The cars shall be in groups so that each group is limited to 250,000 pounds of high explosive and the distance between groups is 800 feet unbarricaded or 400 feet barricaded.

**171. MAGAZINES AND MAGAZINE AREAS.**

a. **Magazine areas.** It is essential that explosives and ammunition be segregated in an area specifically set aside for their exclusive



Care, Handling, and Preservation

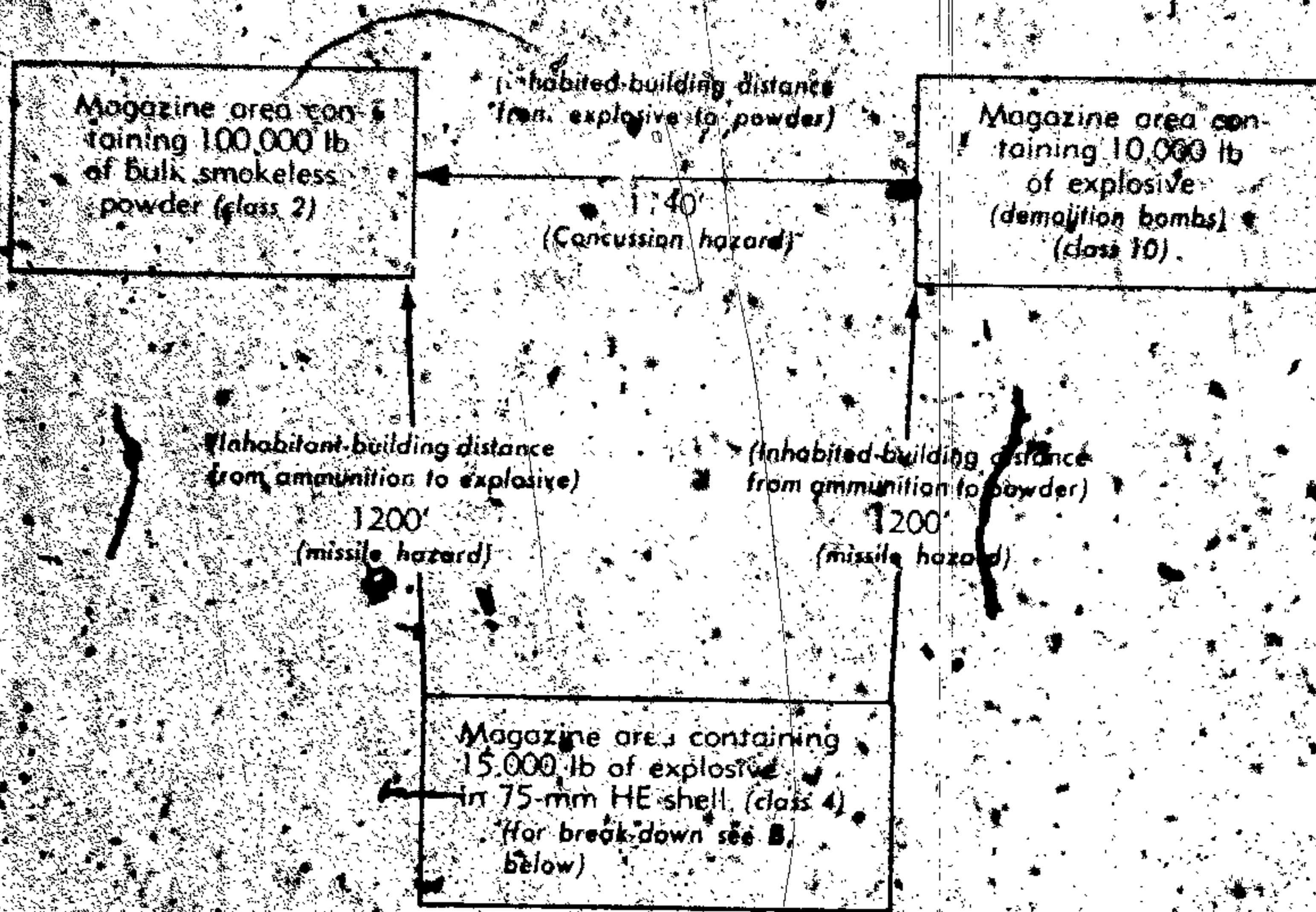

A — Inhabited-building distances must separate magazine areas.

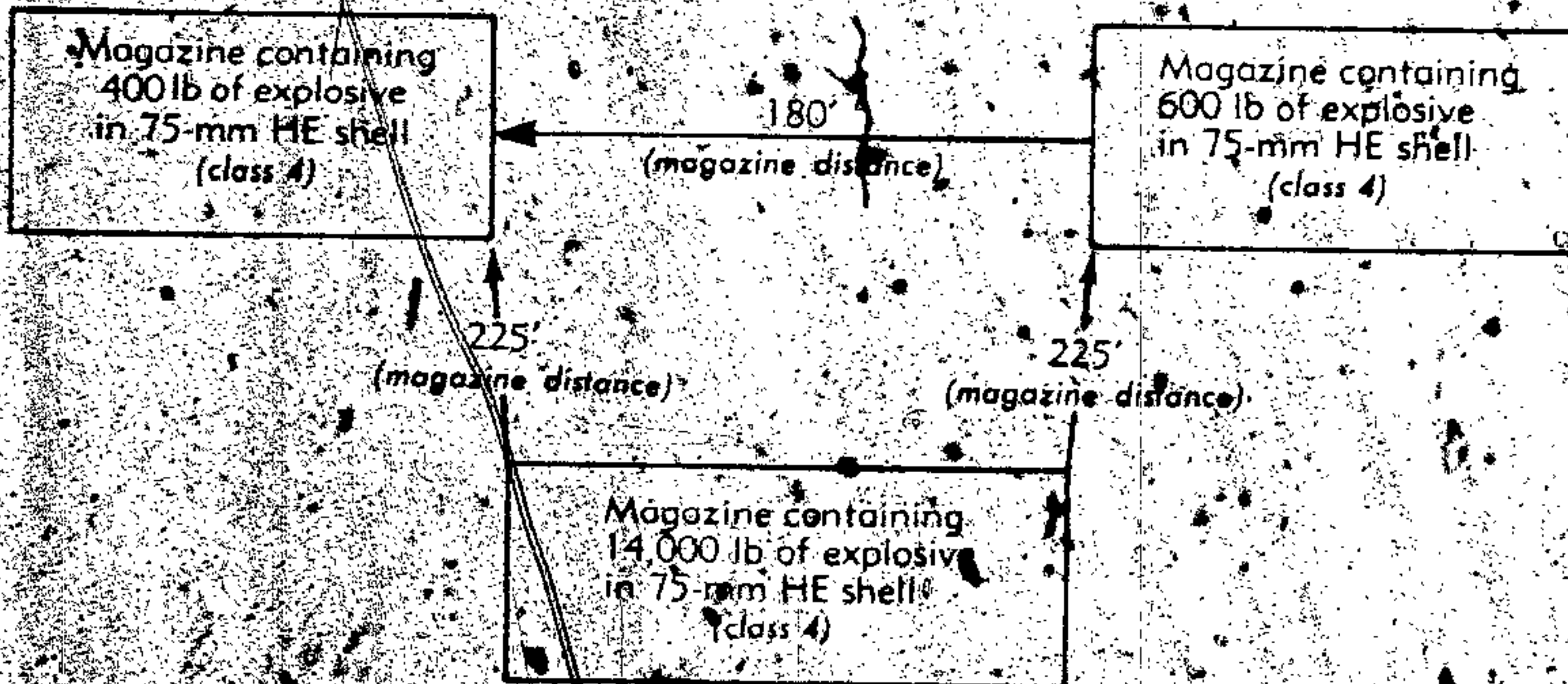

B — Magazine distances must separate magazines within a magazine area.

RA PD 89388A

Figure 155 — Spacing Magazines and Magazine Areas



*Care, Handling, and Preservation*

storage. This area need not be large, but it is important that it be segregated from barracks, hospitals, administration buildings, public highways, inhabited buildings and railroads. Magazine areas should be laid out with regard to access from more than one direction; roads and tracks should be looped. Magazines should not be located over important water mains or close enough to important power lines to damage them in case of an explosion.

**b. Magazines.** Magazines (figs. 153 and 154) should be designed, constructed, and located with special attention to the class of materials to be stored therein and should comply with the following general requirements:

(1) Magazines should be constructed of materials which, in the event of an explosion, will not form dangerous missiles or firebrands. Magazines should not be located upon continuous rock strata because of the possible transmission of shock wave to excessive distances.

(2) Magazines should be fireproof unless the nature of the hazard permits the use of a frame building covered with fire-resistant material such as corrugated sheet asbestos. Where it has been necessary to construct concrete-floored, wooden-arched, earth-covered igloos in lieu of the more permanent type of construction (fig. 153), exposed wooden portions of these temporary structures should be covered with a fire-resistant material such as sheet rock, asbestos, or a comparable product. Provision should be made to cover as much as possible of the front and rear, as well as the sides, of these igloos with earth as an extra precaution. With this type of construction, additional care should be taken to prevent seepage of moisture into the structure.

(3) Each magazine should be provided with ventilators which should be screened against sparks.

(4) All doors should be made to fit tightly so as to seal against sparks, dust, and dirt, and should be fire-resistant.

(5) Magazines should be built on well-drained ground.

(6) Magazines must be located so as to be accessible to adequate transportation facilities.

(7) Magazines must be protected against lightning by an efficient lightning protection system. Details and specifications of lightning protection systems prescribed for ordnance establishments are contained in drawings prepared by the Ordnance Department.

**c. New construction.** The construction of new buildings or magazines for the storage of explosives and ammunition will be in accordance with drawings and specifications for magazines prepared by the

*Care, Handling, and Preservation*

Ordnance Department. Lay-out plans for proposed magazine areas and their location on a reservation must be approved by the Chief of Ordnance.

d. **Arrangement of magazines.** In arranging the storage of hazardous material in above-ground (not concrete igloo-type) magazines, the following general principles should be followed as guides for preventing the spread of damage throughout an entire area in case of a fire or explosion in one part of the area:

(1) Smokeless powder or other materials which may become hazardous if the buildings in which they are stored are damaged or demolished, or which may be ignited or exploded by burning or exploding missiles, should be stored at inhabited-building distances from high-explosives and ammunition magazines.

(2) Bulk high explosives or bombs should be stored so they will be protected from missiles which may be thrown from ammunition magazines as a result of explosions. This principle requires that a magazine in which bulk explosive is stored be at missile distance from a magazine in which ammunition is stored.

(3) In applying the principles set forth in (1) and (2) above, magazines situated between areas in which ammunition, high explosives, or smokeless powder are stored may be used for the storage of such other material as will minimize the danger of fires or explosives progressing from area to area (fig. 155).

e. **Care and maintenance of magazines.** Regular inspection will be made of each magazine and magazine area to see if repairs are needed, and to insure that the general safety regulations set forth in this manual, particularly those which refer to the cleanliness of magazines and elimination of fire hazards, are strictly observed.

(1) To insure continuous and reliable protection, lightning protection systems should be inspected not less than twice a year. Once yearly, each system should be tested electrically. Guidance for the tests and the equipment with which to make them may be obtained from the Office of the Chief of Ordnance.

(2) Roofs must be maintained in the best possible condition and ventilators screened against sparks. There must be no unprotected openings around the foundation and no cracks in the walls. Doors must be tight and sparkproof.

(3) Interiors of magazines must be clean. Paint, oil, gasoline, waste, rags, and other such extraneous inflammable material should not be left in magazines.



Care, Handling, and Preservation

(4) Floors must be free of grit and such stains as those caused by exuding shell or dynamite. Exudate from shell should be removed by scrubbing with hot water. Exudate or oily stain from dynamite must be removed by scrubbing with hot water, acetone, or other suitable solvents.

(5) The 50-foot firebreak must be kept free from inflammable materials. Fire-fighting equipment such as water barrels and sand boxes must be kept full and ready for use.

(6) Magazines must be kept locked, except when opened for necessary operations or inspection.

(7) When open, a magazine must be in the personal care of an officer or other responsible person other than the nearest sentry.

(8) Keys must be under the supervision of the individual responsible for them.

(9) When leaving the magazine, the person in charge of operations must make sure that all doors and shutters are securely locked.

(10) A magazine placard, "Storage and Care of Explosives," O.O. Form No. 5991, must be posted in every magazine, positioned so that it will be conspicuous to all working personnel inside.

f. **Repairs to magazines.** Magazines will be repaired under direct supervision of a competent person who will decide whether or not the contents of the magazines are to be removed while repairs are made. Under normal conditions, roofs, lightning rods, ventilators, doors, etc., may be repaired, and minor repairs may be made to the interior of the magazine without removing the contents. *This does not apply to magazines containing bulk explosives.* When magazines are repaired, the general safety precautions set forth in this manual will be complied with. In addition, the following special regulations will be observed:

(1) Work will be done by careful, experienced workmen.

(2) The floor in the vicinity of the work will be swept and any stains scrubbed with hot water.

(3) No work requiring soldering, melting of asphalt, or use of a blowtorch will be done in a magazine containing explosives or ammunition.

(4) No repairs will be made to the interior of a magazine containing bulk explosives until all explosives have been removed and the interior washed with water.

(5) All persons should be searched for matches before being allowed to enter any magazine.

Care, Handling, and Preservation

(6) All magazines should be carefully swept after repairs have been completed, all tools should be removed after repairs have been completed.

(7) The magazine will be inspected by competent authority after repairs have been completed.

172. QUANTITY-DISTANCE CLASSES AND TABLES.

a. To reduce to a minimum the hazards and risks due to fire and explosion, these regulations prescribe:

(1) The distances which will be maintained between magazines at military establishments and public highways, public buildings, public railways, and inhabited buildings.

(2) The distances that will be maintained between magazines.

(3) The maximum quantity that will be permitted in any one magazine.

b. These precautions not only protect persons and property in the territory adjacent to military establishments, but also reduce to a minimum the possibility of any explosion involving large masses of explosives and ammunition, and limit the quantity of military supplies that may be lost in any one explosion.

(1) In time of war, military requirements may make full compliance with safety regulations especially difficult. Since the purpose of the regulations is to reduce to a minimum the losses of personnel and military stores, and to maintain the full utility of military establishments, the compliance with explosives and ammunition regulations is considered highly important in war time.

(2) In time of peace, the quantity-distance tables set forth below will be strictly complied with except when subject to reductions under special conditions as indicated below and in case of existing emplacement magazines at harbor-defense installations. Such harbor-defense magazines may be used for the storage of ammunition pertaining to the armament of the emplacement and not in excess of its war reserve allowance. Magazines of emplacements from which the armament has been removed or has become obsolete may be used for the storage of any class of ammunition and explosives, provided the quantity-distance tables are complied with.

(3) Buildings at military establishments where personnel are regularly located will be placed at inhabited-building distances from magazines, except when the buildings are used for operations incident to the magazine area.



*Care, Handling, and Preservation*

e. The distances specified in these tables offer protection against structural damage and most missiles. Occasional missiles which travel a mile or more are not considered because of their rarity, especially when the amount of material involved in one explosion is limited by keeping piles small and spacing them so as to limit the explosion to one pile. It will be noted that the distances specified in the tables are based not on the total amount of explosives in the magazines, but upon the missile hazard and the amount that may be involved in one explosion. The specified distances may be changed under the following special conditions:

(1) In storage of classes 8, 9, and 10 items, when a magazine is effectively barricaded or screened from other buildings, magazines, railway, and highway, the distances may be reduced one-half. Effective screening can be obtained by utilizing natural features of the ground or by an artificial barricade at least 4 feet from the magazine, at least 3 feet thick at the top, at least high enough so that the straight line extended from the top of the side wall of the magazine to the top of the barricade will pass above any part of a building to be protected, and at least 12 feet above any public highway or public railway. Artificial barricades should consist of earth or sand fill, with not more than 15 percent of stones on ground, which should pass through 1-inch openings.

(2) Magazines of standard earth-covered concrete-arch type (igloo type) and emplacement magazines, are considered barricaded on all sides except that of the entrance, which side may be barricaded if local conditions require.

(3) Harbor defense emplacement magazines in a group, being separated from each other by substantial dividing walls, need not comply with the intermagazine distances. However, each magazine, as a unit, must comply with the table distances for inhabited building, public highway, and public railway.

(4) Where the construction of the magazine is such as effectually to stop the missiles resulting from an explosion in another magazine, the distances between the two may be based upon the total explosives material in ammunition components in the latter magazine, considered as class 9 instead of the distance prescribed for the class stored. Such magazines are the standard earth-covered concrete-arch type (igloo type) and emplacement magazines. The quantity to be considered will be the total quantity to be stored in the magazine except where specific cases are excepted in step (5), below.

(5) SPECIAL REQUIREMENTS FOR SPECIFIC CLASSES OF AMMUNITION. When ammunition of Classes 6 and 7 are stored in igloo magazines in accordance with Ordnance drawings, the aisle width is not sufficient to preclude mass detonation. Therefore, quantity-distance

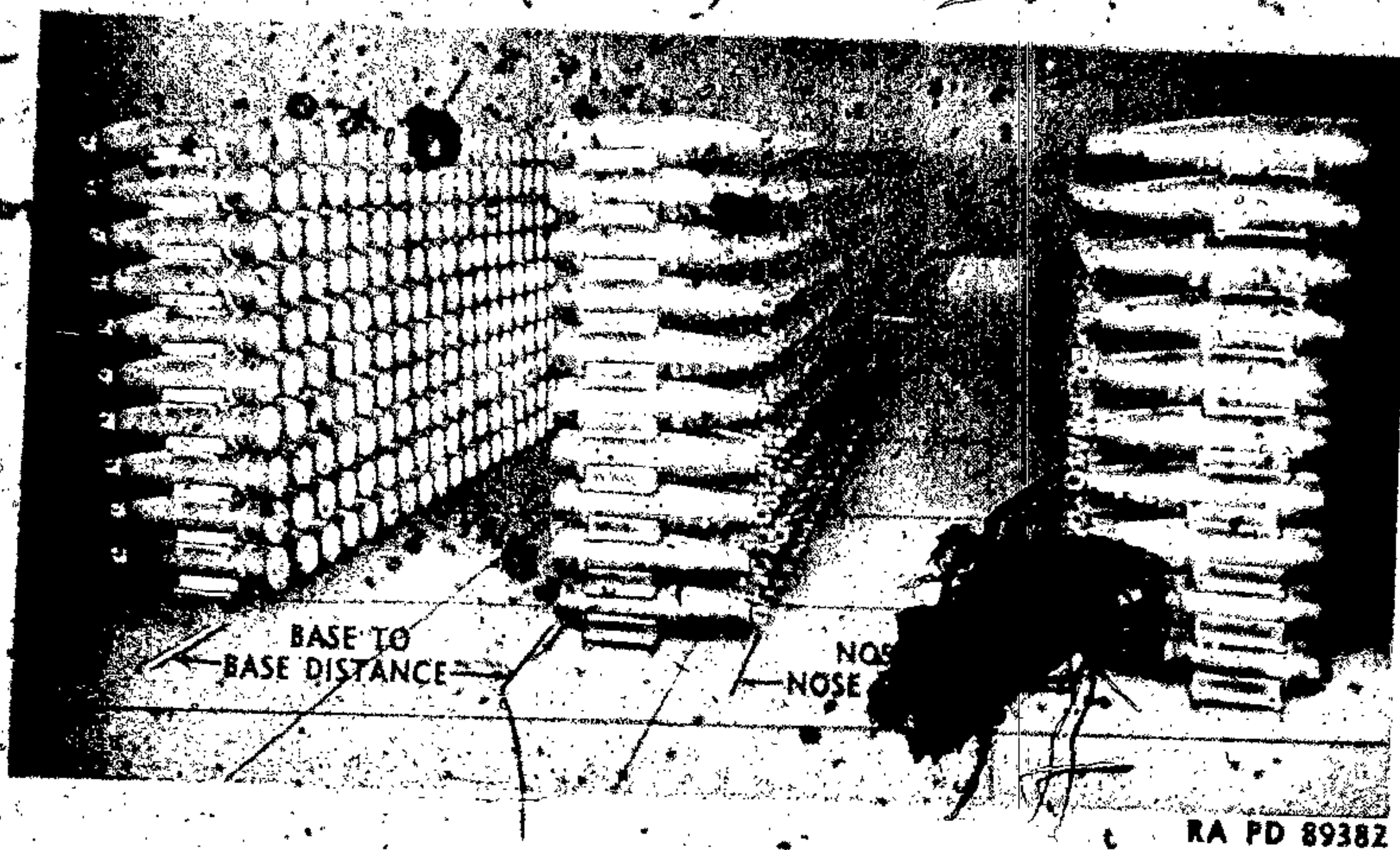

**Figure 156 - Method of Stacking Shell in Above-ground Magazine Storage**

requirements for Classes 6 and 7 when so stored including the maximum permitted in each magazine, shall be those prescribed for Classes 9 and 10. In above-ground storage magazines, the quantity-distance tables for ammunition and ammunition components of Classes 6 and 7 are based on the assumption that on initiation mass detonations will not occur, and that the detonation at any one instant will be limited to the amount contained in one stack and that the missile distance is the controlling consideration. Ammunition of Class 6 stored in above-ground magazines shall be spaced in stacks containing not over 5,000 pounds of explosives each, with stacks spaced at a minimum of 2 feet apart. Ammunition of Class 7 stored in above-ground magazines shall be placed in stacks containing not more than 15,000 pounds of explosives each and spaced in accordance with Ordnance Drawing 19-48-12. See figures 156, 157, and 158. If stacking requirements are not satisfied in the storage of Classes 6 and 7 material, it will be assumed that, on initiation, all ammunition in one magazine will detonate en masse and that the quantity-distance requirements, including the maximum permitted in each magazine, shall be those prescribed for Classes 9 and 10.

d. **Definitions.** Terms used in the following tables are defined as follows:

(1) **INHABITED BUILDING.** Any building or structure occupied in whole or in part as a habitation for human beings, where people



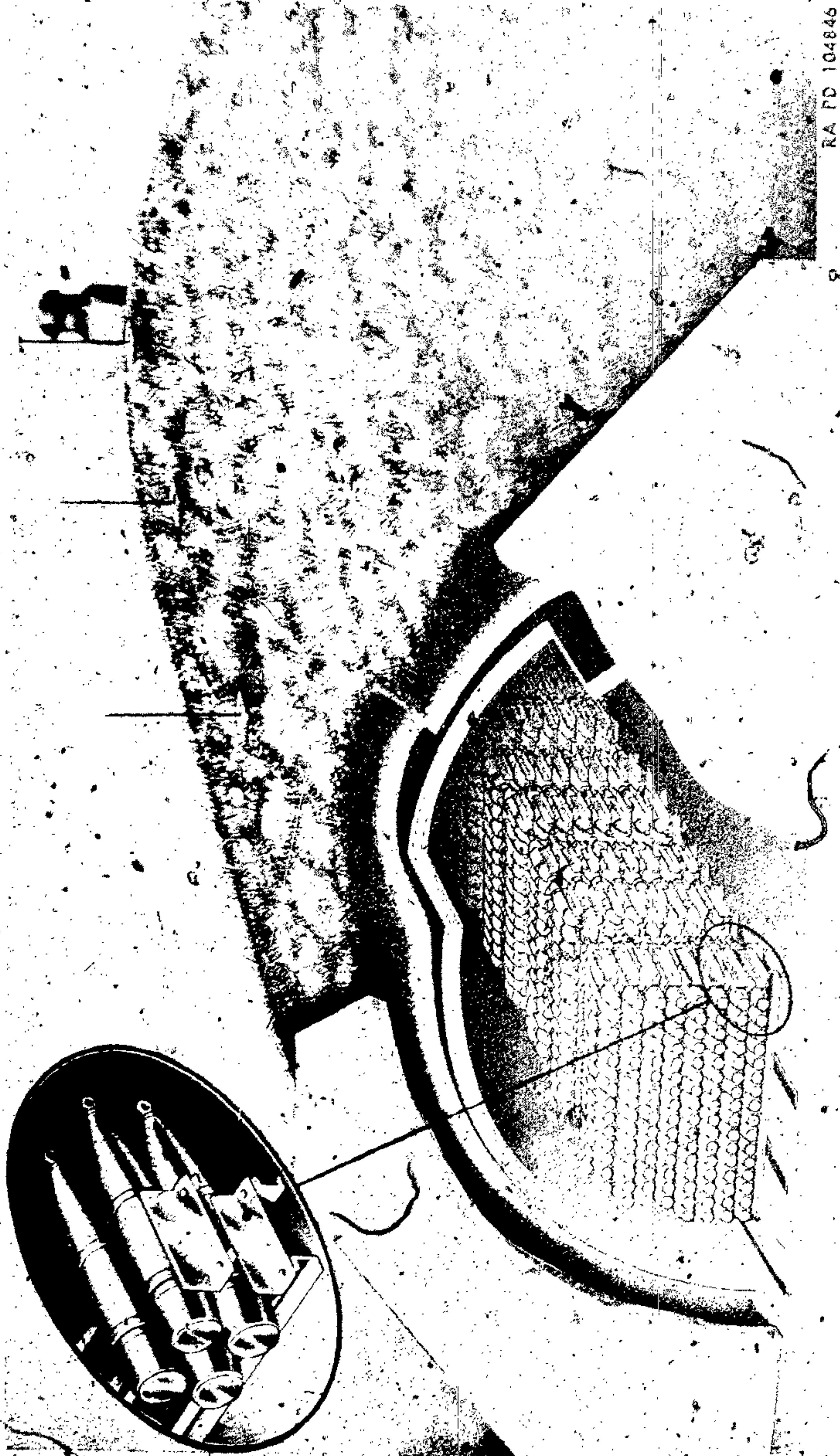

RA PD 104846

Figure 157 — Method of Stacking Shell in Igloo Magazine Storage



Care, Handling, and Preservation

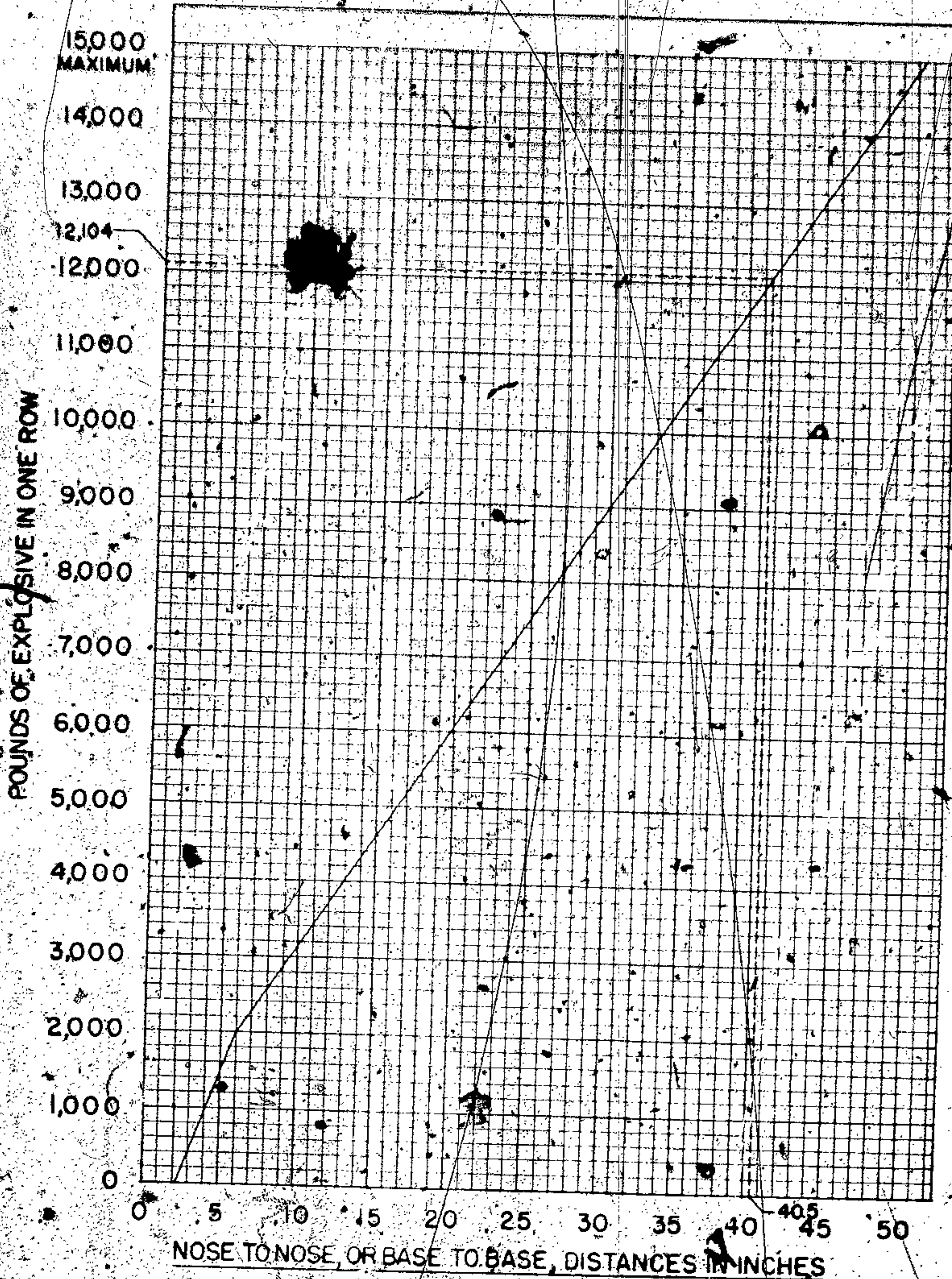

EXAMPLE SHOWN: M107 HE SHELL FOR 155-MM HOW. CONTAINS 15.13 LBS. OF EXPLOSIVE PER SHELL. STORING 80 SHELLS 10 HIGH, OR 800 SHELLS IN ONE ROW IS EQUAL TO 800 X 15.13, OR 12,104 LBS. OF EXPLOSIVE. FROM THE CHART, 12,104 LBS IS EQUIVALENT TO A NOSE TO NOSE, OR BASE TO BASE, DISTANCE OF 40.5 INCHES.

NOTE: THE DISTANCES BETWEEN PILES SHOWN BY THIS CHART ARE INTENDED TO LIMIT EXPLOSIONS TO ONE PILE.

RA PD 89396

Figure 158 — Quantity-Distance Chart for Above-ground Magazine Storage of Separate-loading Projectiles



Care, Handling, and Preservation

are accustomed to assemble, both within and outside of Government establishments. However, buildings on Government establishments in which people are regularly engaged in operations which require the location of such buildings in the magazine area, may be placed in accordance with intraplant or magazine-to-magazine distances. Land limits or boundaries of military reservations will be considered possible sites of inhabited buildings.

(2) **PUBLIC RAILWAY.** Any steam, electric, or other railroad which carries passengers for hire.

(3) **PUBLIC HIGHWAY.** Any street, alley, road, or navigable stream open to the use of the general public.

(4) **NAVIGABLE STREAM.** A body of water capable of extensive navigation by tugs, barges, or larger vessels.

(5) **NEAREST MAGAZINES.** The nearest magazines containing explosives or ammunition. The amount of explosives or ammunition permitted to be stored in a magazine can sometimes be increased if the nearest magazines are filled with inert materials, thus greatly increasing the distances to the nearest magazines containing explosives or ammunition.

(6) **MAXIMUM PERMITTED.** The largest amount of explosives or ammunition permitted to be stored in a magazine even if it is more isolated than the tables prescribe. It is imperative that the loss of military supplies be kept to an absolute minimum.

(7) **STRUCTURAL DAMAGE.** The serious weakening or displacement of foundations or brick or stone supporting walls or the breaking of wooden main supporting members in outside or inside walls. No readily reparable damage such as broken glass or loosened plaster is considered structural damage.

e. **Explosive content.** The explosive content of ammunition or components is shown in the technical manuals for each caliber and type of gun, on ordnance drawings, and in ORD 11 SNL's; if such information is not available, it should be requested from the Chief of Ordnance. The quantities shown in the following tables were computed as follows:

(1) **SMOKELESS POWDER.** The quantities in pounds are the net weights of the powder in the boxes or in the propelling charges.

(2) **PYROTECHNICS.** The quantities are based on the net weight of the illuminant or explosive composition.

(3) **SEPARATE-LOADING AND UNFIXED SHELL AND BOMBS.** The quantities are computed by taking the net weight of explosive in the charge of one shell and multiplying by the number of shell or bombs in the magazine.

*Care, Handling, and Preservation*

(4) **FIXED AMMUNITION.** The quantity is the net weight of the high-explosive charge in the shell multiplied by the number of rounds. The smokeless powder propelling charge is so much less hazardous that it is not included in the computation for this class of ammunition.

(5) **ROCKETS.** The quantity to be considered for quantity-distance purposes is the weight of the high explosive in the head (shell) plus the weight of the propelling charge in the motor. If there is a detonation of the explosive in the head, the propelling charge may be expected to detonate as well. For classification of rocket motors refer to subparagraph f (4).

f. **Classes of explosives and ammunition.** The grouping of explosives and ammunition into classes listed below does not imply that the items in a particular class are to be stored together but means merely that the hazards involved are similar for all items in the same class. The items which may be stored together on one magazine are set forth in the Combination Storage Chart, paragraph 173. The maximum amount of explosives permitted in any location is the top limit for the distance specified. However, the quantity may be excessive for any particular case under conditions surrounding the individual operations. Therefore, it is mandatory that local limits be established in amount no greater than those consistent with continuous and efficient operation. Operations and personnel will be so arranged consistent with continuous efficiency as to constitute the smallest personnel exposure to any one explosion hazard. When military explosives and ammunition are packed in accordance with the provisions of War Department drawings and specifications, they may be grouped, according to the degree of hazard involved, into the following classes:

(1) **CLASS 1.** *Small-arm ammunition including 20-mm, except HE and HE-I rounds; mechanical time fuzes without boosters; AT practice grenade; Engineer Corps combination, pull, pressure, and release firing devices; thermit; miner's safety fuse; fuse lighters M1 and M2.* This class is principally a fire hazard. No quantity limit is placed on storage of materials in this class.

(2) **CLASS 2.** *Single-base multiperforated smokeless powder of web thickness greater than 0.019 inch; chemical ammunition containing phosphorus (except complete rounds); thermite and similar burning compositions; illuminating, flare, or signal compositions which have been consolidated in the final press operations so that no explosive material is exposed; 60-mm and 81-mm mortar illuminating shell.* These materials may become unsafe under extreme conditions of moisture, high temperature, or age. They burn with intense heat, but usually do not form dangerous missiles or generate pressures which will cause serious structural damage to adjacent magazines.



Care, Handling, and Preservation

CLASS 2. QUANTITY-DISTANCE TABLE

Smokeless powder in containers (in boxes, powder cans, cartridge storage cases, etc.); pyrotechnics (footnote<sup>1</sup>); chemical ammunition containing phosphorus (except complete rounds); or 60-mm and 81-mm mortar illuminating shell (footnote<sup>4</sup>)

QUANTITY (POUNDS)		MINIMUM UNBARRICADED DISTANCE IN FEET FROM NEAREST			
Over	Not Over	Inhabited Building	Public Railway	Public Highway	Magazine
100	1,000	75	75	75	50
1,000	5,000	115	115	115	75
5,000	10,000	150	150	150	100
10,000	20,000	190	190	190	125
20,000	30,000	215	215	215	145
30,000	40,000	235	235	235	155
40,000	50,000	250	250	250	165
50,000	60,000	260	260	260	175
60,000	70,000	270	270	270	185
70,000	80,000	280	280	280	190
80,000	90,000	295	295	295	195
90,000	100,000	300	300	300	200
100,000	200,000	375	375	375	250
200,000	300,000	450	450	450	300
300,000	400,000	525	525	525	350
400,000	500,000 <sup>2</sup>	600	600	600	400

Smokeless powder in bulk (not in containers)

100	1,000	100	100	100	50
1,000	5,000	150	150	150	75
5,000	10,000	200	200	200	100
10,000	20,000	250	250	250	125
20,000	30,000	285	285	285	145
30,000	40,000	310	310	310	155
40,000	50,000	330	330	330	165
50,000	60,000	345	345	345	175
60,000	70,000	360	360	360	185
70,000	80,000	375	375	375	190
80,000	90,000	390	390	390	195
90,000	100,000	400	400	400	200
100,000	200,000	500	500	500	250
200,000	300,000 <sup>2</sup>	600	600	600	300

<sup>1</sup>For storage of Class 2 pyrotechnics and pyrotechnic materials, the following figures apply under the conditions given:

(a) Illuminating, flare or signal compositions which have been consolidated in the final press operations and are so closed that no explosive material is exposed, and military pyrotechnics, except Class 3 material, that have been boxed and are ready for shipment, may be stored at one-half of the Class 2 distances.

(b) In quantities from 100 to 500 pounds, inhabited building, public railway, and public highway distances are 50 feet; magazine distance is 35 feet.

(c) Total quantity of pyrotechnic or pyrotechnic materials at any one location should not exceed 50,000 pounds and must not exceed 200,000 pounds.

<sup>2</sup>For storage in standard igloo magazines, prescribed distances may be halved from all sides except the door end.

<sup>3</sup>Maximum quantity permitted at any one location (except pyrotechnics and pyrotechnic materials).

<sup>4</sup>When necessary, 60-mm and 81-mm mortar illuminating shell may be stored with Class 4 items.

Care, Handling, and Preservation

(3) CLASS 3. All loaded fuzes except fuzes containing HE loaded boosters; AT practice mines containing a smoke charge; and artillery primers. These usually explode progressively, not more than a box or two at a time. Pressures which will cause structural damage to adjacent magazines usually are not generated. Missiles are small and light, and usually fall within 100 yards.

CLASS 3. QUANTITY-DISTANCE TABLE

QUANTITY (POUNDS OF EXPLOSIVE)	MINIMUM UNBARRICADED DISTANCE IN FEET FROM NEAREST				
	Not Over	Inhabited Building	Public Railway	Public Highway	Magazine
50	400	400	400	400	60
200	400	400	400	400	100
1,000	400	400	400	400	180
10,000*	400	400	400	400	300

\*For storage in standard igloo magazines, prescribed distances may be halved from all sides except the door end.

\*Maximum quantity permitted at any one location.

(4) CLASS 4. When packed in accordance with ordnance drawings and specifications: Fixed and semifixed artillery ammunition including 20-mm HE-I (complete rounds), with all types of projectiles except pentolite-loaded shell; light mortar ammunition (81-mm and smaller); grenades, including practice grenade Mk 2; antipersonnel mine M2; blank ammunition for cannon; rocket ammunition assembled in complete rounds, except those with HE-loaded heads but including 4.5-inch TNT-loaded rocket T22, and rocket motors (see footnote, Class 4 Quantity-Distance Table). Items in this class usually explode progressively, only a few boxes at a time, and many explosions of individual rounds are of low order. Pressures which will cause structural damage to adjacent magazines usually are not generated. Most missiles will fall within 200 yards. This class includes all fixed and semifixed chemical shell (complete rounds) for artillery except that quantity limitation does not apply. It also includes 76-mm and 3-inch illuminating projectile, complete rounds. Although 60-mm and 81-mm mortar illuminating shell are Class 2 items, they may be stored with Class 4 items when necessary.

(5) CLASS 5. Separate-loading shell, loaded with explosive D, and all calibers of shell not assembled to or packed with cartridge cases. These usually explode, one shell at a time and, in nearly all cases, with low order. The missiles are limited as to number and range, and most of them fall within 400 yards.

(6) CLASS 6. Fuzes containing HE-loaded boosters, adapter-boosters; packed separately in boxes. These items usually explode progressively by stacks. Structural damage caused by the pressures is usually limited to adjacent magazines. Missiles are light and usually fall within 200 yards.



Care, Handling, and Preservation

**CLASS 4. QUANTITY-DISTANCE TABLE**

QUANTITY (POUNDS OF EXPLOSIVE) Not Over	MINIMUM UNBARRICADED DISTANCE IN FEET FROM NEAREST			
	Inhabited Building	Public Railway	Public Highway	Magazine
50	1,200	1,200	1,200	60
500	1,200	1,200	1,200	140
1,000	1,200	1,200	1,200	180
50,000	1,200	1,200	1,200	225
500,000 <sup>2</sup>	1,200	1,200	1,200	300

<sup>1</sup>For storage in standard igloo magazines, prescribed distances may be halved from all sides except the door end.

<sup>2</sup>Maximum quantity permitted at any one location.

<sup>3</sup>Class 4 rockets with motors assembled to loaded or unloaded heads, should not be stored in above-ground magazines located at less than the following missile distances from the listed locations:

LOCATION	MINIMUM MISSILE DISTANCE
Inhabited Building	Maximum flight range of rocket or 4,310 feet, whichever is less
Public Railway	60% of maximum flight range of rocket or 2,590 feet, whichever is less
Public Highway	30% of maximum flight range of rocket or 1,300 feet, whichever is less

**CLASS 5. QUANTITY-DISTANCE TABLE**

QUANTITY (POUNDS OF EXPLOSIVE) Not Over	MINIMUM UNBARRICADED DISTANCE IN FEET FROM NEAREST			
	Inhabited Building	Public Railway	Public Highway	Magazine
1,000	1,200	1,200	1,200	100
25,000	1,200	1,200	1,200	200
650,000 <sup>2</sup>	1,200	1,200	1,200	300

<sup>1</sup>For storage in standard igloo magazines, prescribed distances may be halved from all sides except the door end.

<sup>2</sup>Maximum quantity permitted at any one location.

**CLASS 6. QUANTITY-DISTANCE TABLE**

QUANTITY (POUNDS OF EXPLOSIVE) Not Over	MINIMUM UNBARRICADED DISTANCE IN FEET FROM NEAREST			
	Inhabited Building	Public Railway	Public Highway	Magazine
50	240	140	70	60
200	240	140	70	100
5,000	1,500	900	450	200
100,000 <sup>2</sup>	1,500	900	450	300

<sup>1</sup>When items of this class are stored in concrete igloo magazines, the quantity-distance requirements of Class 9, bulk explosives, will govern, except that no distances less than one-half the distance prescribed in this table for Class 6 items are authorized. The quantity of explosive material given in paragraph 172 c (5) may be used when in above-ground magazines if the material is stacked and segregated in accordance with Ordnance drawings.

<sup>2</sup>For storage in standard igloo magazines, prescribed distances may be halved from all sides except the door end.

<sup>3</sup>Maximum quantity permitted at any one location.

Care, Handling, and Preservation

(7) CLASS 7. *Separate-loading HE shell of all calibers, except shell loaded with explosive D.* All in a magazine may explode but the explosion may be limited to one pile by arranging the material in accordance with instructions for piling separate-loading shell given in paragraph 172 c (5). Structural damage, usually is limited to adjacent buildings. Most missiles will fall within 500 yards.

CLASS 7. QUANTITY-DISTANCE TABLE

QUANTITY (POUNDS OF EXPLOSIVE)	MINIMUM UNBARRICADED DISTANCE IN FEET FROM NEAREST <sup>1</sup>			
	Inhabited Building	Public Railway	Public Highway	Magazine
Net Over 25,000	1,800	1,800	1,800	200
500,000 <sup>3</sup>	1,800	1,800	1,800	300

<sup>1</sup>When items of this class are stored in concrete igloo magazines, the quantity-distance requirements of Class 9, bulk explosives, will govern, except that no distances less than one-half the distance prescribed in this table for Class 7 items are authorized. The quantity considered will be in accordance with paragraph 172 c (5), when stacked and properly segregated in above-ground magazines.

<sup>2</sup>For storage in standard igloo magazines, prescribed distances may be halved from all sides except the door end.

<sup>3</sup>Maximum quantity permitted at any one location. When magazines with maximum capacities substantially less than this quantity are in use or to be installed, reduced distances may be obtained from the Office of the Chief of Ordnance.

(8) CLASS 8. *Primer percussion elements, detonators, primer-detonators for bombs, detonating elements, and blasting caps, packed in accordance with ordnance drawings.* All the contents of a magazine may explode at one time. However, as the total amount of explosives is small and not closely confined, structural damage usually limited to adjacent magazines. Light missiles of very limited range are formed.

CLASS 8. QUANTITY-DISTANCE TABLE

QUANTITY (POUNDS OF EXPLOSIVE)	MINIMUM UNBARRICADED DISTANCE IN FEET FROM NEAREST <sup>1</sup>			
	Inhabited Building	Public Railway	Public Highway	Magazine
Net Over 2,000 <sup>2</sup>	980	590	300	300
5,000	1,200	720	360	300
10,000	1,500	900	450	300
15,000	1,610	970	490	300
20,000 <sup>3</sup>	1,740	1,040	520	300

<sup>1</sup>For storage in standard igloo magazines, prescribed distances may be halved from all sides except the door end. Distances for above-ground magazines may be reduced one-half by use of barricades.

<sup>2</sup>For quantities less than 2,000 pounds of explosive, distances given in the table for Class 9 and Class 10 explosives may be used.

<sup>3</sup>Maximum quantity permitted at any one location.



Care, Handling, and Preservation

(9) CLASS 9. Bulk priming, initiating, and high explosives; flash-light powder; photoflash composition; demolition blocks; "primaco" detonating cord; spotting charges; black powder; dynamite; Mk 3-series offensive hand grenades; loose pyrotechnic materials before final consolidation, except thermate and other slow burning incendiary compounds (footnote Class 9 Quantity-Distance Table); EC blank fire powder containing less than 30 percent water; quickmatch; double-base smokeless powder, and single-base smokeless powder with web thickness less than 0.019 inch. Explosives in this group include lead azide, mercury fulminate, PETN, pentolite, tetrytol, RDX, Composition A, Composition B, Composition B-2, Composition C, Composition C-2, torpex, and mixtures of magnesium and black powder. If more than 2,500 pounds of lead azide, mercury fulminate, or PETN are to be stored in a single magazine, special permission must be obtained from the office of the Chief of Ordnance. In a fire, black powder burns with explosive rapidity; high explosives may burn or explode depending upon the material, quantity, and degree of confinement.

(10) CLASS 10. Demolition, fragmentation, and photoflash bombs; bombs loaded with Comp. B and tritonal; bangalore torpedoes; torpedo warheads; HE antitank mines; antipersonnel mines M3; HE-loaded AT grenades; HE 4.2-inch mortar shell; Livens HE shell bursters for chemical shell or bombs; auxiliary boosters; HE mortar ammunition (larger than 81 mm); HE rocket shell with or without motors assembled thereto, except 4.5-inch TNT-loaded rocket T22, and fixed and semifixed artillery ammunition containing pentolite, assembled as complete rounds (footnote<sup>5</sup>, Classes 9 and 10 Quantity-Distance Table). All the contents of a magazine may explode at one time. If this happens, structural damage caused by the pressure generated is not likely to occur at the distance given in the table. Most missiles will fall well within these distances. When fragmentation bombs are concerned, distances specified in Classes 9 and 10 table will not be less than the distances as stated in the Class 4 Quantity-Distance Table, but may be one-half the distance as stated in the Class 4 table when stored in concrete igloo magazines, except from the door end.

(11) CLASS 11. Chemical ammunition except complete rounds and that containing white phosphorus. Chemical shell, bombs, and grenades stored and issued by the Ordnance Department are not

Care, Handling, and Preservation

CLASSES 9 AND 10. QUANTITY-DISTANCE TABLE

QUANTITY (POUNDS OF EXPLOSIVE)		MINIMUM UNBARRICADED DISTANCE IN FEET FROM NEAREST:			
Over	Not Over	Inhabited Building	Public Railway	Public Highway	Magazine
—	10	145	90	45	60
10	25	145	90	45	60
25	50	145	90	45	60
50	100	240	140	70	80
100	200	390	230	110	100
200	300	520	310	150	120
300	400	640	380	190	130
400	500	720	430	220	140
500	600	800	480	240	150
600	700	860	520	260	158
700	800	920	550	280	165
800	900	980	590	300	170
900	1,000	1,020	610	310	180
1,000	1,500	1,120	670	330	210
1,500	2,000	1,200	720	360	230
2,000	3,000	1,320	790	390	260
3,000	4,000	1,420	850	420	280
4,000	5,000	1,500	900	450	300
5,000	6,000	1,560	940	470	300
6,000	7,000	1,610	970	490	300
7,000	8,000	1,660	1,000	500	300
8,000	9,000	1,700	1,020	510	300
9,000	10,000	1,740	1,040	520	300
10,000	15,000	1,890	1,130	560	300
15,000	20,000	2,040	1,200	600	300
20,000	25,000	2,180	1,310	650	300
25,000	30,000	2,320	1,390	690	300
30,000	35,000	2,450	1,470	730	300
35,000	40,000	2,570	1,540	770	300
40,000	45,000	2,690	1,610	800	300
45,000	50,000	2,810	1,680	840	300
50,000	55,000	2,920	1,750	880	400
55,000	60,000	3,030	1,820	910	400
60,000	65,000	3,130	1,880	940	400
65,000	70,000	3,220	1,930	970	400
70,000	75,000	3,310	1,990	1,000	400
75,000	80,000	3,390	2,040	1,020	400
80,000	85,000	3,460	2,080	1,040	400
85,000	90,000	3,520	2,120	1,060	400
90,000	95,000	3,580	2,150	1,080	400
95,000	100,000	3,630	2,180	1,090	400
100,000	125,000	3,750	2,250	1,120	800
125,000	150,000	3,870	2,320	1,160	800
150,000	175,000	3,980	2,390	1,190	800
175,000	200,000	4,090	2,450	1,220	800
200,000	225,000	4,200	2,520	1,260	800
225,000	250,000 <sup>1</sup>	4,310	2,590	1,300	800

<sup>1</sup>For storage of Class 9 and 10 pyrotechnics or pyrotechnic materials, the total quantity of hazardous material at any one location should not exceed 50,000 pounds and must not exceed 200,000 pounds.

<sup>2</sup>For storage in standard igloo magazines, prescribed distances may be halved from all sides except the door end. Distances in above-ground magazines may be reduced to one-half by use of barricades.

<sup>3</sup>Maximum permitted at any one location.

<sup>4</sup>If rockets with motors assembled to shell not filled with high explosive are stored in above-ground magazines, the magazines should be separated from each other by Class 4 distances. TNT-loaded rockets with loaded motors assembled to shell are designated Class 10 ammuni-



Care, Handling, and Preservation

considered to be an explosive hazard, and no limit has been placed on this type of ammunition as far as quantity-distance limits are concerned. However, storage must comply with the requirements of paragraph 174 and the Combination Storage Chart, paragraph 173.

(12) CLASS 12. Explosives such as ammonium nitrate, DNT, and wet nitrocellulose. These materials are insensitive and can be detonated only by very strong initiation. When stored in an explosives area where there is a possibility that explosives may be projected into them, they will be stored in accordance with the regulations for Class 9 explosives. When stored in an area of fire hazards only and separated by inhabited-building distances from areas containing explosives or ammunition, these materials may be stored in accordance with the regulations for smokeless powder (see Class 2 Quantity-Distance Table).

g. Quantity-Distance table for hillside magazines. This table applies to magazines so constructed that they are covered by earth at least to the highest point reached by explosives stored within them, and separated from each other by continuous ground in such manner that the level of the separating material does not fall below the line joining the highest points reached by explosives stored within adjacent magazines.

QUANTITY OF HIGH EXPLOSIVES (in pounds up to)	DISTANCE (in feet)
20,000	100
30,000	110
40,000	120
50,000	130
60,000	135
70,000	140
80,000	145
90,000	150
100,000	155
125,000	165
150,000	175
175,000	185
200,000	190
250,000	200

tion. The missile distance in the table below should be observed for all rockets with loaded motors attached to loaded or unloaded shell when stored in above-ground magazines.

LOCATION	MINIMUM MISSILE DISTANCE
Inhabited Building	Maximum flight range of rocket or 4,310 feet, whichever is less
Public Railway	60% of maximum flight range of rocket or 2,590 feet, whichever is less
Public Highway	30% of maximum flight range of rocket or 1,300 feet, whichever is less

\*For storage of fixed and semifixed artillery ammunition containing pentolite, Class 9 and 10 quantity-distances apply except that distances less than those applicable to Class 4 ammunition are not authorized.

Care, Handling, and Preservation

b. Intraplant quantity-distance table.

QUANTITY OF EXPLOSIVES <sup>1</sup> IN SEPARATE BUILDING OR WITHIN SUBSTANTIAL DIVIDING WALLS (IN POUNDS)		MINIMUM UNBARRICADED DISTANCE BETWEEN (IN FEET)
Over	Not Over	
—	10	—
10	25	40
25	50	60
50	100	80
100	200	100
200	300	120
300	400	130
400	500	140
500	750	160
750	1,000	180
1,000	1,500	210
1,500	2,000	230
2,000	3,000	260
3,000	4,000	280
4,000	5,000	300
5,000	6,000	320
6,000	7,000	340
7,000	8,000	360
8,000	9,000	380
9,000	10,000	400
10,000	12,500	420
12,500	15,000	450
15,000	17,500	470
17,500	20,000	490
20,000	25,000	530
25,000	30,000	560
30,000	35,000	590
35,000	40,000	620
40,000	45,000	640
45,000	50,000	660
50,000	55,000	680
55,000	60,000	700
60,000	65,000	720
65,000	70,000	740
70,000	75,000	770
75,000	80,000	780
80,000	85,000	790
85,000	90,000	800
90,000	95,000	820
95,000	100,000	830
100,000	125,000	900
125,000	150,000	950
150,000	175,000	1,000
175,000	200,000	1,050
200,000	225,000	1,100
225,000	250,000	1,150

<sup>1</sup>Applies to high explosives or items loaded with high explosives.



### 173. COMBINATION (MIXED) STORAGE OF AMMUNITION AND EXPLOSIVES AT POSTS, CAMPS, AND STATIONS.

a. The following table and chart show the ammunition and explosives which may be stored together at posts, camps, and stations. All items in a group may be stored together. Where an "X" appears at the intersection of a horizontal row and a vertical column all items in the two groups may be stored together. Where an "O" appears at the intersections of a horizontal row and a vertical column all items in those two groups may be stored together if the total explosives content of the items of the two groups stored together in one magazine or revetment does not exceed 1000 pounds.

b. Mixed storage as permitted by this table and chart does not authorize violation of the quantity-distance tables for the storage of ammunition and explosives at posts, camps, and stations. Where two or more quantity-distance classes of ammunition and explosives are stored together in a magazine or revetment the intermagazine distance and safety distances to inhabited buildings, public railways, and public highways shall be those specified for the most hazardous class of material stored therein.

c. **Groups.** Ammunition and explosives are classified into groups as follows and shown in the Combination Storage Chart below:

- I. **CARTRIDGES FOR SMALL ARMS AND OTHER SIMILAR CARTRIDGES EXCEPT THOSE WITH EXPLOSIVE BULLETS:** Included are ball, tracer, armor-piercing, incendiary, armor-piercing-incendiary, blank, frangible, gallery practice, guard, high-pressure test, and subcaliber cartridges, calibers .22 to .60 inclusive; 20-mm cartridges, armor-piercing, ball, and practice; shotgun cartridges; grenade propelling cartridges, trench and field mortars ignition cartridges, blank cartridges for miniature bombs, and cartridges for bomb cluster adapters, when stored separately from the complete rounds of which they are components; and cartridges packed with grenade projection adapters.
- II. **MILITARY PYROTECHNICS:** Included are all types of aircraft and ground signals, flares, and lights.
- III. **SMOKE AMMUNITION EXCEPT THAT LOADED WITH WP:** Included are all fixed, semifixed, and separate-loading shell, mortar shell, grenades, rockets, bombs; smoke pots, and drums, and containers filled with HC, FS, FM, and colored smoke mixtures.
- IV. **INCENDIARY AMMUNITION:** Included are bombs, grenades, and rockets.

Care, Handling, and Preservation

COMBINATION STORAGE CHART

GROUPS	I	II	III	IV	V	VI	VII	VIII	IX	X	XI	XII	XIII	XIV	XV	XVI	XVII	XVIII
I. Cartridges for small arms and other similar cartridges	X	X	O	O	O	O	O	X	X	X	X	O	O	O	O	O	O	O
II. Military pyrotechnics	X	X																
III. Smoke ammunition, except WP	O		X	X	O	O												
IV. Incendiary bombs, grenades and rockets	O		X	X	O	O												
V. WP ammunition	O		O	O	X	O												
VI. Chemical ammunition	O		O	O	O	X												
VII. Separate-loading propelling charges and bulk powder	O						X											
VIII. Fuzes, primers, bursters, boosters, etc.	X							X										
IX. Fixed and semifixed ammunition except gas and smoke	X								X	X	O	O						
X. Mortar ammunition and grenades except gas and smoke	X								X	X	O	O						
XI. Rockets, except gas and smoke	X								O	O	X	O						
XII. Land mines, mortar ammunition and fragmentation bombs	X								O	O	O	X						
XIII. Separate-loading projectiles	O												X					
XIV. Bombs, depth charges, aerial mines except gas and smoke	O													X				
XV. Demolition materials	O														X	O	O	O
XVI. Dynamite	O														O	X	O	O
XVII. Black powder ammunition and bulk black powder	O														O	O	X	O
XVIII. Photoflash bombs	O														O	O	O	X

<sup>1</sup>An "X" at the intersection of a horizontal row and a vertical column denotes that all items in the two groups may be stored together.

<sup>2</sup>An "O" at the intersection of a horizontal row and a vertical column denotes that all items in the two groups may be stored together if the explosive content of the items of the two groups stored together in one magazine or revetment does not exceed 1000 pounds.



*Care, Handling, and Preservation*

- IV. WP AMMUNITION:** Included are fixed, semifixed, and separate-loading shell, mortar shell, grenades, rockets, and bombs, loaded with white phosphorus.
- VI. CHEMICAL AMMUNITION:** Included are fixed, mixed, and separate-loading shell, mortar shell, grenades, rockets, and bombs, loaded with H, L, CG, PS, CNS, GNB, AC, GC, A-1, A-2, CK, E-1, P-1, CN, CN-DM, DM, NC, and CI chemical compositions.
- VII. SEPARATE-LOADING PROPELLING CHARGES AND BULK PROPELLANT POWDERS:** Included are propelling charges for calibers 4.5-inch to 16-inch inclusive, bulk propellant powders of all classes, mortar increments, and other propelling charges, when packed separately from the complete rounds or complete charges of which they are a component.
- VIII. FUZES, PRIMERS, BOOSTERS, AND BURSTERS:** Included are adapters, adapter boosters, fuzes (all types), primers, primer-detonators, detonators, blasting caps, percussion caps, destructors, and bursters.
- IX. FIXED AND SEMIFIXED AMMUNITION, EXCEPT SMOKE, INCENDIARY, WP, AND CHEMICAL:** Included are high-explosive, high-explosive-antitank, shot, armor-piercing, practice, canister, shrapnel, and illuminating ammunition for calibers 37-mm to 120-mm; high-explosive, incendiary, and high-explosive-incendiary, 20-mm ammunition; all cartridges for 40-mm and 57-mm guns, and cartridges for small arms with explosive bullets.
- X. MORTAR AMMUNITION UP TO AND INCLUDING 81-MM (3-INCH) AND HAND AND RIFLE GRENADES EXCEPT SMOKE, INCENDIARY, WP, AND CHEMICAL:** Included are high-explosive, illuminating, and practice ammunition; antitank, offensive, fragmentation, and practice hand and rifle grenades; and grenade kits.
- XI. ROCKETS, EXCEPT SMOKE, INCENDIARY, WP, AND CHEMICAL:** Included are high-explosive, high-explosive-antitank, illuminating, target, and practice rockets; motors and all loaded components for rockets.
- XII. LAND MINES, FRAGMENTATION BOMBS (FUZED), AND MORTAR SHELL 105-MM AND LARGER, EXCEPT SMOKE, INCENDIARY, WP, AND CHEMICAL:** Included are antitank, antipersonnel, and practice mines (with fuzes); fragmentation bombs (fuzed); bomb clusters, high-explosive and practice; and high-explosive and practice mortar shell.
- XIII. SEPARATE-LOADING PROJECTILES, EXCEPT WP, SMOKE AND CHEMICAL:** Included are high-explosive, armor-piercing.

*Care, Handling, and Preservation*

deck-piercing, and illuminating shell, and shrapnel for calibers 4.5-inch to 16-inch, inclusive.

XIV. BOMBS, DEPTH CHARGES, AERIAL MINES AND AERIAL TORPEDOES EXCEPT SMOKE, INCENDIARY, WP, AND CHEMICAL: Included are demolition, general purpose, armor-piercing, semi-armor-piercing, high capacity, light case, and leaflet bombs; depth charges; aerial mines; and aerial torpedoes.

XV. DEMOLITION MATERIALS, AND BULK EXPLOSIVES: Included are bulk TNT, bulk explosive "D," plastic explosives, demolition blocks, nitrostarch, cratering explosives, bangalore torpedoes, shaped charges, snake charges, primacord and condau detonant.

XVI. DYNAMITE, ALL TYPES.

XVII. BLANK AMMUNITION FOR CANNON, SPOTTING CHARGES, SMOKE PUFF CHARGES, BULK BLACK POWDER: Included are all components loaded with black powder (except fuzes) packed separately from the complete rounds of which they are components; and all fireworks including simulated grenades, dago bombs, firecrackers, etc.

XVIII. PHOTOFLASH BOMBS AND PHOTOFLASH POWDER.

**I. I. STORAGE OF SPECIFIC TYPES.**

a. Black powder. Black powder in bulk, saluting, practice-bomb, and smoke-puff charges should be stored in dry and, if practicable, bulletproof magazines. Black powder will never be handled or stored in a barracks, general supply room, inhabited building, or any building heated by stoves or open fires. In a magazine containing black powder, explosives-operations safety (nonsparking) shoes will be worn, and no work will be done other than that involved in the actual storage and removal of the powder from the containers and the removal of spilled grains. The floor of the building in which such operations as repacking of black powder is performed should be covered with a tarpaulin or canvas. Black powder does not deteriorate in storage if kept dry. Containers of saluting, practice, and smoke-puff charges are stored with tops up. Containers of black powder should be carefully examined at the time of receipt for weak spots and holes, with special attention to examination for small holes, such as nail punctures, which are not immediately evident. Damaged containers are not repaired; their contents are transferred to serviceable drums. Condensed moisture may rust the container or corrode the cap. When containers are painted, caps replaced, or contents transferred, the following conditions must prevail:

(1) The work will be done at least 100 feet from any magazine containing explosives or ammunition.



Care, Handling, and Preservation

(2) If any powder is spilled, work will stop until the spillage is carefully taken up and the spot washed with water. The powder taken up will be destroyed by dumping in water.

(3) If tools are required to open a container, only safety tools will be used, and the operator will be protected by a barricade and the work will be done in strict compliance with instructions issued for this purpose by the Chief of Ordnance.

(4) The quantity of powder in the vicinity of operations will be kept to a minimum.

(5) Special care will be observed to see that all information marked on the original container is reproduced when repainting the old container or transferring the contents to a new container.

(6) Empty black powder containers will be thoroughly washed out with water.

b. **High explosives**—TNT, explosive D, tetryl, triton blocks. These are stable in storage and require only protection from moisture and, if practicable, from rifle bullets. They are stored in wax paper-lined wooden boxes. In handling loose explosives of this class, explosives-operations safety (nonsparking) shoes should be worn. Nonsparking tools should be used in opening boxes. Broken containers may be repaired or contents transferred only at a distance of 100 feet from a magazine containing explosives or ammunition.

c. **Dynamite.** Dynamite is sensitive to heat and shock. It should be stored in fireproof, bulletproof magazines. Nonsparking tools will be used in opening cases. Empty containers that have been used for dynamite will be destroyed by burning. Oily stains of nitroglycerin will be scrubbed up with a solution consisting of 1/2 gallon of water, 1/2 gallon of wood alcohol, and 2 pounds of sodium sulfite or potassium sulfite. Store cases of dynamite initially right side up, so cartridges will lie flat. However, in order to eliminate the possibility of exudation of nitroglycerin from the cartridges, it will be necessary to turn the cases, based on average storage temperatures, in accordance with the following:

Average Storage Temperature	Interval Between Turnings
Below 30° F	Do not turn
30 to 50° F	Six weeks
60 to 75° F	One month
Over 75° F	Two weeks

The first turning will result in the cases being bottom side up, with the cartridges still in a horizontal position. Frozen dynamite will not be turned. Where definite knowledge as to the composition of the dynamite is available, straight ammonium nitrate dynamites need not be turned.

*Care, Handling, and Preservation*

d. Bulk smokeless powder and separate-loading propelling charges.

(1) These should be stored insofar as practicable in magazines which are well-ventilated and dry. Since smokeless powder is principally a fire hazard, a well-ventilated frame structure covered with corrugated sheet asbestos and built on well-drained ground may be used. Such buildings are often more easily kept dry than fireproof magazines. Bulk smokeless powder is packed in a steel or in metal-lined wooden boxes, which are stored on their sides with dunnage enough to insure free circulation of air through all parts of the pile.

(2) The method of storing propelling charges in fiber or metal containers and bulk powder in boxes is shown on ordnance drawings. When containers of charges 10 inches in caliber and over are stored on their sides, provision must be made to prevent the weight of the upper layers crushing the containers in the lower.

(3) Boxes, crates, bundles, and containers should be stored so that the covers can be readily inspected or removed and so that the containers may be airtested in storage.

(4) Magazines in which smokeless powder is stored should be equipped with a maximum-minimum thermometer which should be read daily or as often as necessary. If the temperature exceeds 100° F for 24 hours or 85° F for 72 hours the magazine should be cooled by wetting down the exterior with water or by opening the doors and ventilators at night and closing them in the morning. If this fails to reduce the temperature, the Commanding Officer will decide whether the stores are to be removed to another magazine. When magazines are cooled by such ventilation at night, effective measures will be taken to protect against fire and to close the doors in case of rain.

(5) Smokeless powder, in bulk or in separate-loading charges, is always packed in airtight containers. It is important that such containers remain airtight until the powder is used. When a shipment is received, every container is given a visual inspection to see that it is not damaged and that the cover is in good condition and tight.

(6) Metal containers for propelling charges are fitted with a test hole and plug in the cover so that they can be tested for airtightness after the containers have been opened and closed. Every container in which a propelling charge is stored will be airtested when received and whenever it is subject to handling that might cause it to leak. The testing should be done with a testing set similar to the cartridge-storage-case testing set M1, 24-12-2. However, a motor-driven air compressor will not be taken into a magazine in which explosives or ammunition are stored. If the compressor is driven by a gasoline motor, the motor should be placed no closer than 75 feet to the magazine or any explosive material. A pressure of 3 to 5 pounds is



### Care, Handling, and Preservation

used and if no drop in pressure is observed in one minute it may be assumed the case is not leaking.

(7) The normal odor in a smokeless powder magazine is a faint odor of alcohol-ether. If this odor is strong, it probably indicates a leaky container. Every leaking container will be repaired or the contents transferred to an airtight container. If the contents of any container show evidence of dampness or moisture, it should be segregated and reported to the Service, Command or department ordnance officer. Leaks due to covers or gaskets may be repaired without removing the charge from the container or the container from the magazine, provided care is taken to guard against sparks. Repair of leaks in other parts of the container will be undertaken only after the removal of the charge from the container and the container from the magazine.

(8) Personnel engaged in air testing must become familiar with the odor and appearance of decomposing powder. They should examine each container opened for air test for the characteristic odor. One of the first evidences of dangerous deterioration is the presence of the acid odor of nitrous fumes in place of the normally present odor of alcohol-ether. The odor of decomposing powder is so characteristic that it should not be mistaken.

(9) Fiber containers of separate-loading propelling charges are not usually opened unless they are damaged; then the charge is transferred to a serviceable metal container. Fiber containers are not repaired.

(10) Metal containers may rust. They may be repainted but must be removed from the magazine to do so. Care must be taken to reproduce faithfully the original markings whenever containers are repainted or changed.

(11) Some fine-grain smokeless powders are almost as sensitive as black powder and equal precautions should be observed. The principal safety measure in regard to smokeless powder, however, is the careful watch for deterioration.

#### e. Small-arms ammunition.

(1) Small-arms ammunition may be stored in any magazine or warehouse which offers good protection against the weather. When magazine space is limited, it may be stored in a general warehouse by partitioning or screening off a section for its exclusive use. This refers to small-arms ammunition only and not to other types with which it may be stored in a magazine. Good protection against moisture and high temperature should be provided. Free ventilation of all parts of the pile should be insured, dunnage being used where necessary. Skylights and windows near piles should be shaded so that ammunition will not be exposed to direct sunlight. Care should be taken to avoid piling ammunition near steam pipes. Small-arms am-



*Care, Handling, and Preservation*

ammunition packed in boxes fitted with airtight metal liners should not have these liners opened until the ammunition is about to be used. When only a part of a box is used the remaining ammunition in the box should be protected against unauthorized handling and use by firmly fastening the cover in place. Serviceable ammunition turned in by troops should not be stored in open boxes. It should be re-packed for storing and reissued at the first opportunity, provided it can be identified by lot number. If it cannot be identified by lot, it automatically becomes grade 3 with certain exceptions and should be disposed of in accordance with directions in WD SB 9-AMM 4.

(2) Tracer and shotgun ammunition should always be stored under the best cover available, preferably in a building providing protection against dampness and having adequate ventilation.

**f. Fixed and semifixed ammunition, grenades, antipersonnel mines, and mortar shell.**

(1) These may be stored in any magazine with good protection from the weather but preferably in fireproof or fire-resistant magazines to reduce to a minimum the danger of fire or explosion. Most of the standard boxes and bundles in which this type of ammunition is packed are provided with cleats and those that are not may be piled with dunnage to insure free circulation of air. Except small-arms ammunition, fixed ammunition is usually packed in individual fiber containers which are then packed in bundles of three containers. If the ammunition is not removed from these sealed containers until it is used, it should remain in good condition. Serviceable rounds which have been removed from their containers, such as those turned in by troops, should be placed in containers which should then be sealed with friction tape and shellac before they are again placed in storage. This procedure will protect the round against deterioration and the primer against accidental blows.

(2) Assembly of fuzes to unfuzed stems is forbidden within 100 feet of a magazine containing explosives or ammunition.

(3) It is sound policy to mix quantities of different sizes and types in each of several magazines rather than to store only one kind in each magazine. For example, there may be on hand a sufficient quantity of 75-mm high-explosive rounds to fill one magazine and enough 75-mm armor-piercing rounds for another. Rather than store all high-explosive rounds in one magazine and all armor-piercing rounds in another, it is better storage practice to store half of each type in each magazine. Thus, in case of accident to one magazine, there is still a supply of both types of ammunition on hand.

**g. Separate-loading shell.**

(1) Separate-loading and unfixed shell should be stored in fireproof magazines containing a minimum of inflammable materials. Iron or steel dunnage is preferred to wood and it should be connected



Care, Handling, and Preservation

by electrical conductors and grounded. If it is necessary to use wood for dunnage, the amount should be kept to an absolute minimum. Unfuzed shell should be fitted with an iron or steel fuze hole plug. If it is necessary to roll fuzed shell, it should be done carefully and slowly in order to avoid the risk of arming the fuze.

(2) In order to confine an explosion to one stack of shell in above-ground magazine storage, the following precautions will be observed:

(a) Shell should be stored in single stacks; nose to nose and base to base (fig. 156). Shell up to and including 10 inches in diameter should be stacked in accordance with figure 156, and distances specified should be maintained if the shell are loaded with TNT or amatol. If the shell are loaded with explosive D, the distance need be only large enough to permit inspection of the shell and of the fuze cavities.

1. In igloo-type magazines, shell stored in double stacks, base-to-base in contact, with an inspection aisle between noses (fig. 125.1).

(b) The nose-to-nose and base-to-base distances between rows should be equal.

(c) The nose-to-nose distances for each caliber shell (fig. 158 and ordnance drawings) should be strictly observed and the number of shell in each stack should be kept at a minimum consistent with the storage space available.

(3) Shell over 10 inches in diameter may be stored on their sides or on their bases. When stored on their bases, there should be a 1-inch board between the shell and the floor to protect the shell from moisture; shell loaded with explosive D may be stored in intimate contact but shell loaded with TNT should be separated by a distance equal to the caliber of the shell.

(4) The rotating bands on all projectiles should be carefully protected by grommets or some other effective means. Dents or cuts in the band may cause the shell to function improperly in the gun.

h. **Bombs.** GP and SAP bombs have comparatively thin walls and are one of the most hazardous types of ammunition to store because of their tendency to detonate in mass if a fire occurs in, or a heated fragment be projected into, the magazine in which they are stored. Safety can be obtained only by reducing the possibility of fire to the absolute minimum. Bombs should be stored in a fireproof magazine with iron or steel dunnage. If wood must be used for dunnage, the amount should be kept to a minimum. Steel dunnage should be connected by electrical connectors and grounded. A ground system separate from the lightning protective system of the magazine should be provided. Bombs not intended for immediate shipment should be stored as above. Fuzes or primer-detonators should be

### Care, Handling, and Preservation

stored in a separate magazine. All bombs should be stacked so that the fuze cavity can be easily inspected. Fragmentation bombs are stored in the same manner as GP and SAP bombs.

i. **Fuzes, primers, primer-detonators, detonators, and boosters.** These components are usually packed in hermetically sealed containers and boxes. Care should be taken in packing to see that they are properly supported in racks or trays and protected against shock or rough handling. Even when properly packed, this class of components should be handled with great care. Partly filled boxes should be kept securely closed. Magazines for the storage of fuzes should be small to limit the loss of this type of material, and the quantity of fuzes, primers, etc., stored in any one magazine should be kept to a minimum, consistent with the storage space available. Storage of all on hand of any one type in a single magazine is to be avoided if possible.

j. **Pyrotechnics.** Pyrotechnics require protection against moisture, dampness, and high temperature. Dry, well-ventilated magazines of approved fire-retardant construction shall be used for storage. Maximum and minimum thermometers will be placed in representative magazines in which pyrotechnics are stored. In general, the magazines should not be provided with heat. Except those used solely for storage of Class 1 material or finished boxed pyrotechnic ammunition, magazines should not be provided with interior illumination other than through use of portable safety battery lamps. Pyrotechnic material that has been wet is hazardous to store, consequently any boxes that show signs of dampness will be opened and if the pyrotechnic material is wet, it should be destroyed (chap. 4). Pyrotechnics should be handled with care even when properly packed. Certain kinds of this material deteriorate with age and have an expiration date on the containers. Care should be taken to observe the direction for disposal of this material at the time indicated.

k. **Chemical ammunition:**

(1) Chemical ammunition should not be stored with other classes, principally because of the difficulty and danger encountered in fighting a fire involving chemical materials. All munitions containing chemical agents are stored in such a manner that each item is accessible for inspection and may be easily removed from storage in case it should develop a leak. This type of ammunition must be inspected for leaks once a month. Any leaking container should be removed downwind to await disposal.

(2) Whenever a magazine containing chemical ammunition is opened, a responsible officer or foreman should be present to detect the odor of escaping gas. If such an odor is present, all persons entering the magazine will wear the protective devices proper for



**Care, Handling, and Preservation**

the group, all windows and doors of the magazine will be opened, and the leaking container sought out and removed.

(3) Each type of chemical ammunition is preferably stored alone, but may be stored with other chemicals within the same storage group. The special equipment, as listed for each group of chemical agents, should be available in the vicinity, but not in the magazine. The chemical agents are grouped as follows:

(a) *Group A: persistent blister casualty gases, H, L, ED, and PS.* Magazines for this group should have surface-hardened concrete floors. Special equipment should include gas mask, protective suit, boots, and gloves for each officer, man, or fireman whose duties require his presence in the magazine; chloride of lime; ketosene and flannel cloths; sodium bicarbonate; boric acid; soap; and ample washing facilities.

(b) *Group B: harassing and nonpersistent casualty gases and smoke-producing chemical munitions, except WP.* Magazines should have surface-hardened concrete floors and free ventilation. Special equipment should include gas masks, gloves, saturated solution of sodium sulfite, saturated alcoholic solution of sodium hydroxide, sitters, and wool blankets. Masks will be carried at all times by personnel in the magazine.

(c) *Group C: spontaneously inflammable munition, phosphorus (WP).* This type magazine should have concrete floors with elevated sills to permit flooding. Special equipment includes tubs or barrels filled with water and large enough to contain the largest component stored. In addition, there should be available rubber gloves and boots, sponges, pails, and copper sulfate solution. Where temperature cannot be controlled in storage, special care must be taken in the storing of shell containing white phosphorus. White phosphorus will melt at temperatures above 105° F. Upon cooling and solidification of the white phosphorus, a void is formed in the top of the shell filler (in the base if the shell is stored nose down; on the side, if stored on the side) adversely affecting ballistics upon use. Where temperature cannot be maintained below the melting point, storage should be arranged so that the ammunition is stored on its base, even if this requires rearranging rounds within their packing. Where this is impracticable, the ammunition should be stored on its side.

(d) *Group D: incendiary and readily inflammable substances TH, FS, HC, CN, CN-DM grenades.* No water is to be used in this magazine. No special precautions are necessary except to keep water and fire away, and to remove leaking containers to prevent an accumulation of loose material in the magazine.

(4) Munitions from two or more groups will not be stored together without the specific approval of the Chief of Ordnance.

*Care, Handling, and Preservation***l. Rockets.**

(1) Rockets should be stored in a dry, cool place, and never in the direct rays of the sun. They should not be stored where temperatures exceed 120° F. unless otherwise specified on the packing container. Rocket ammunition which is stored with motor assembled to the shell should be given special attention for safety. Rough handling must be avoided as the missile range of rockets greatly extends danger area in event of accident over that of ordinary fixed ammunition. Storage should be with nose down when possible, or if not possible, with all rockets in a single magazine pointed in the same direction. In above-ground magazines, the direction selected for positioning rockets should offer the least damage to personnel and property in case of accidental ignition; in igloos, rockets shall not point toward door ends. Storage in above-ground magazines should be avoided whenever practicable.

(2) Since rocket propelling charges are ignited by electrical means, care must be taken to protect rockets from being ignited by stray electrical currents such as might arise from contact with extension cords, lights, or electrical tools. This hazard exists chiefly in loading and assembly operations. However, rocket ammunition packed for shipment is not any more susceptible than other types of ammunition nor is it susceptible to ignition by external sparks such as those which might be struck from steel wheels and rails.

(3) Rockets should be stored alone whenever possible. However, when combined storage is necessary, chemical-loaded rockets with or without motors may be stored with similar chemical ammunition. Practice or inert-loaded rockets with motors may be stored with fixed and semifixed shell and shrapnel. Rocket motors not assembled to the head may be stored with blank ammunition for cannon or with rockets to which they belong.

**m. Inert materials.** Inert materials or empty components of ammunition such as drill cartridges, target-practice projectiles, or empty shell should be stored in buildings which afford good protection against moisture and dampness. Dummy or inert ammunition should not be stored in magazines with live or practice ammunition if other storage space is available. If it is necessary to store such items with live or practice ammunition, it will be segregated and identified clearly. They should be cleaned, repainted, and slushed when necessary, and should not be allowed to deteriorate. Shell should be carefully stored to guard against damage to the rotating band.



## Section III

**STORAGE AT SUPPLY POINTS AND DUMPS****175. SUPPLY POINTS AND DISTRIBUTING POINTS.**

a. **General.** The details concerning ammunition supply points, as discussed in this section, are primarily applicable to those installations in the Zone of the Interior, and at posts, camps, and stations. A complete discussion of the subject for application to the Theater of Operations (the communication zone and the combat zone) is contained in ordnance Field Manuals.

b. **Location.** Supply points and distributing points should be located in the best available network of roads and near a railroad.

c. **Lay-out.** In planning the lay-out of supply points and distributing points, consideration should be given to the following:

(1) **AMOUNTS AND KINDS REQUIRED.** It is desirable that a field unit supply train be able to take on its complete load from stacks in a straight line or in a single area without having to enter and congest another area of the supply point.

(2) **EASE OF ACCESS.** They should be on good roads near, but not on, main highways. Conspicuous signs should be posted on roads leading in, and military police should be notified of names and locations of dumps within their areas.

(3) **TRAFFIC CONTROL.** Roads should preferably be laid out in complete loops instead of turn-arounds. This has an additional advantage in that it provides access to piles from either of two directions. One-way traffic should be established.

(4) **SEGREGATION BY LOTS.** As a general rule, ammunition should be piled so the lot numbers are easily inspected. Quantities issued to a single unit should be, if practicable, all of one lot.

d. **Fire protection.**

(1) The principal hazards in the storage of ammunition in the field is fire, which may be spread by hot missiles resulting from explosions in one stack igniting packing material of nearby stacks, or by travel of the fire through grass, weeds, dry woods, etc. Effort should be made, therefore, to provide protective covering for stacks, such as concrete or metal shelters. Firebreaks should be cleared by burning out brush or by turning the soil over, unless the undergrowth is essential for camouflage.

(2) The commanding officer will appoint a fire marshal who will be responsible for rigid enforcement of fire-preventive measures. The fire marshal will prepare rules covering all local conditions and special fire risks. He will exercise strict fire discipline within depot or dump.

Care, Handling, and Preservation

(3) Fire extinguishers, water barrels, sand boxes, and other fire-fighting equipment should be provided. A supply of ropes and hooks should be kept on hand to tear down piles of boxes should they catch fire. Spontaneous combustion due to presence of greasy rags or oily waste should be guarded against. The direct rays of the sun on ammunition, especially that containing smokeless powder, is likely to cause spontaneous combustion.

**176. STORAGE OF AMMUNITION AND EXPLOSIVES.**

a. **Classes.** When establishing dumps, the following classes of ammunition are considered:

- Antitank mines
- Bombs (containing explosive D)
- Bombs, fragmentation
- Bombs, torpedoes, and aerial mines (not containing explosive D)
- Boxed artillery ammunition
- Chemical ammunition
- Fuzes, primers, detonators
- Grenades
- Mortar shell
- Propellent charges
- Pyrotechnics
- Separate-loading shell
- Small-arms ammunition

b. **Quantity and distance.** These classes should not be stored together. Whenever practicable, the distance between stacks and classes should be in accordance with paragraph 172.

c. **Precautions.**

(1) Ammunition and components should be stored so that the neighboring piles will not be detonated by the explosion of one pile and so that not all of one type of component or complete round will be lost in any one explosion. There should be at least two piles of every type of ammunition or component stored. It is particularly important that fuzes, primers, detonators, etc., should be distributed as widely as storage facilities permit.

(2) Ammunition piled in the open should be raised off the ground at least 6 inches and protected from rain and direct sun by paulins. If drainage is not good, ditches should be dug around piles. All piles, indoor and outdoor, should be made with liberal use of dunnage and away from contact with walls, barricades, etc., to insure free circulation of air. Where tarpaulins are used, adequate provision should be made for ventilation. The top of the tarpaulin should not rest on the top of the stack or in contact with boxes but should be raised from the stack at least 6 inches.



---

*Care, Handling, and Preservation*

---

(3) During the time ammunition is in dumps, advantage should be taken of every opportunity to place each round in good condition for firing. Lost fuze hole plugs should be replaced, burs in threads and rotating bands removed, and any other defect that might affect the serviceability of ammunition should be corrected. However, the work should be done at a safe distance from the piles.

(4) All ammunition should be stored out of the direct rays of the sun.

d. **Chemical ammunition.** Chemical ammunition should always be stored away from other munitions, and gas shell should always be stored on their bases. The following additional precautions should be taken in storing and handling this type:

(1) Shell should be stored so that a leaky container can be removed immediately upon detection.

(2) Every man working near gas shell should be equipped with a gas mask.

(3) Tubes of oxygen and first-aid equipment should be placed in conspicuous places in charge of a chemical noncommissioned officer.

(4) Should an accident occur and a worker be overcome, first-aid remedy will be applied and a doctor called.

(5) Any type of ammunition exposed to gas must be cleaned with an oily cloth at once.

(6) Conspicuous wind vanes should be set up in places where gas shell are handled.

(7) Munitions containing phosphorus should always be stored alone and water-filled tubs kept available. Phosphorus ignites spontaneously when exposed to air, and submerging in water will extinguish the fire only as long as the material is kept submerged. Leaky phosphorus shell must be kept under water until they can be destroyed.

(8) Pyrotechnics, incendiaries, and HC, CN-DM, and CN grenades should be kept dry.

(9) Full use of dunnage should be made in storing chemical ammunition.

---

**Section IV****PACKING AND MARKING****177. GENERAL:****a. Purpose of packing.**

(1) In order that ammunition may reach the firing line in a serviceable condition, it is essential that each unit of issue be suitably

### Care, Handling, and Preservation

packed to withstand handling, storage, and transportation. Once a unit of ammunition has been removed from its approved container, there is no assurance of its continued serviceability. Therefore, necessary precautions should be taken in its further handling and storage.

(2) When a waterproof container is opened, the contents are immediately subject to the effects of moisture which is the agent most active in causing the deterioration of ammunition. If immediate use of the ammunition is not contemplated, the container should be effectively resealed.

#### b. Marking.

(1) Marking includes painting, stenciling, and stamping of containers and of the ammunition itself (par. 7).

(2) Explosives and other hazardous articles offered for shipment on a common carrier will be marked to comply with Interstate Commerce Commission regulations. These markings include the ICC shipping name and dangerous commodity designation. In addition, on LCL shipments, certain labels are required to indicate the nature of the contents.

(3) Explosives and ammunition will be marked in accordance with Army Regulation, specifications, and drawings. Standard and special markings are listed in U. S. Army Specification No. 100-2E and are further described and explained in Technical Manuals and in other sections of this manual. Markings furnish essential information, permitting proper handling, storage, and issue of the round or component.

(4) New painting or remarking of ammunition and components should be a facsimile of that on the original container or ammunition unless the Chief of Ordnance issues specific instructions to the contrary. Explosives and ammunition obtained from salvage operations, or materiel whose identification has been lost, should be marked clearly to show the nature of the goods and, if offered for shipment, to comply with Interstate Commerce Commission regulations.

## 178. PACKINGS.

a. Design and construction. The design and construction of packings depend upon the hazard involved, the facilities for storage and transportation, and the protection required for the item packed.

b. Types. Wooden boxes and crates are used more often than other types. The trend in design is toward the use of standard 1-inch, or heavier, lumber. However, veneer boxes with reinforcing cleats and encircling wire have been adopted as standard in several instances. Wire-bound boxes cannot be reused as often as the heavier wooden boxes; but their low cost is an important factor, particularly when reuse of the box is not warranted. Cylindrical, watertight,



*Care, Handling, and Preservation*

metal containers, holding one or more rounds or propelling charges, are used for packing ammunition intended for tropical climates. The ammunition may or may not be packed in fiber containers before insertion in the metal container. Some separate-loading propelling charges are packed in a waterproof bag and then placed in a fiber container. Four general types of packing—boxes, crates, metal containers, and fiber containers—are described below.

**(1) BOXES.**

(a) *End opening.* One removable end, permitting boxes to be stacked on their sides and opened without removal from the stacked pile.

(b) *Chest type or hinged top.* Permits repeated use and easy access to the contents. Most recent types have a toggle-type fastener.

(c) *Bolt and wingnut.* Bolts and wingnuts hold down the top cover. These boxes are used for small-arms cartridges.

(d) *Metal.* Used for small-arms cartridge packings and for storing 40-mm ammunition. These sheet-steel containers are sealed by rubber gaskets under the cover.

**(2) CRATES.** Used for bombs, projectiles, components, and metal powder containers to give added strength and protection, and where packing in a closed box is not necessary. For some types of bombs, only steel crates are used in shipment. Other crates are wooden, some of which may be wire-bound.

**(3) METAL CONTAINERS.**

(a) *Cartridge-storage cases* are cylindrical, moistureproof steel containers for packing separate-loading propelling charges. A test hole is provided in the cover for air-pressure testing.

(b) *Metal containers* are used for packing single rounds of artillery ammunition, either bare or in fiber container. Eight 60-mm, or four or one 81-mm, rounds are also packed in metal containers. These metal containers are provided as standard for those theaters where waterproofing is essential. The single-round metal containers are cylindrical steel tubes with a detachable screw-type cover. The steel cover is provided with a rubber gasket and is clamped tight to the container by means of a spider, screw, and pressure plate. Cork and felt pads are furnished to provide a snug fit for the round or fiber container in which the round is packed. Some metal containers are provided with test holes for air-pressure testing.

**(4) FIBER CONTAINERS.** A slip-cover fiber container of the mailing-tube type is used for the packing of complete rounds, separate-loading propelling charges for artillery weapons, hand grenades, assemblies of boosters and fuzes, fuzes, and mortar ammunition. These fiber containers were formerly shipped in bundles of three, held together by two clover-leaf-shaped, metal, end covers. Fiber containers

Care, Handling, and Preservation

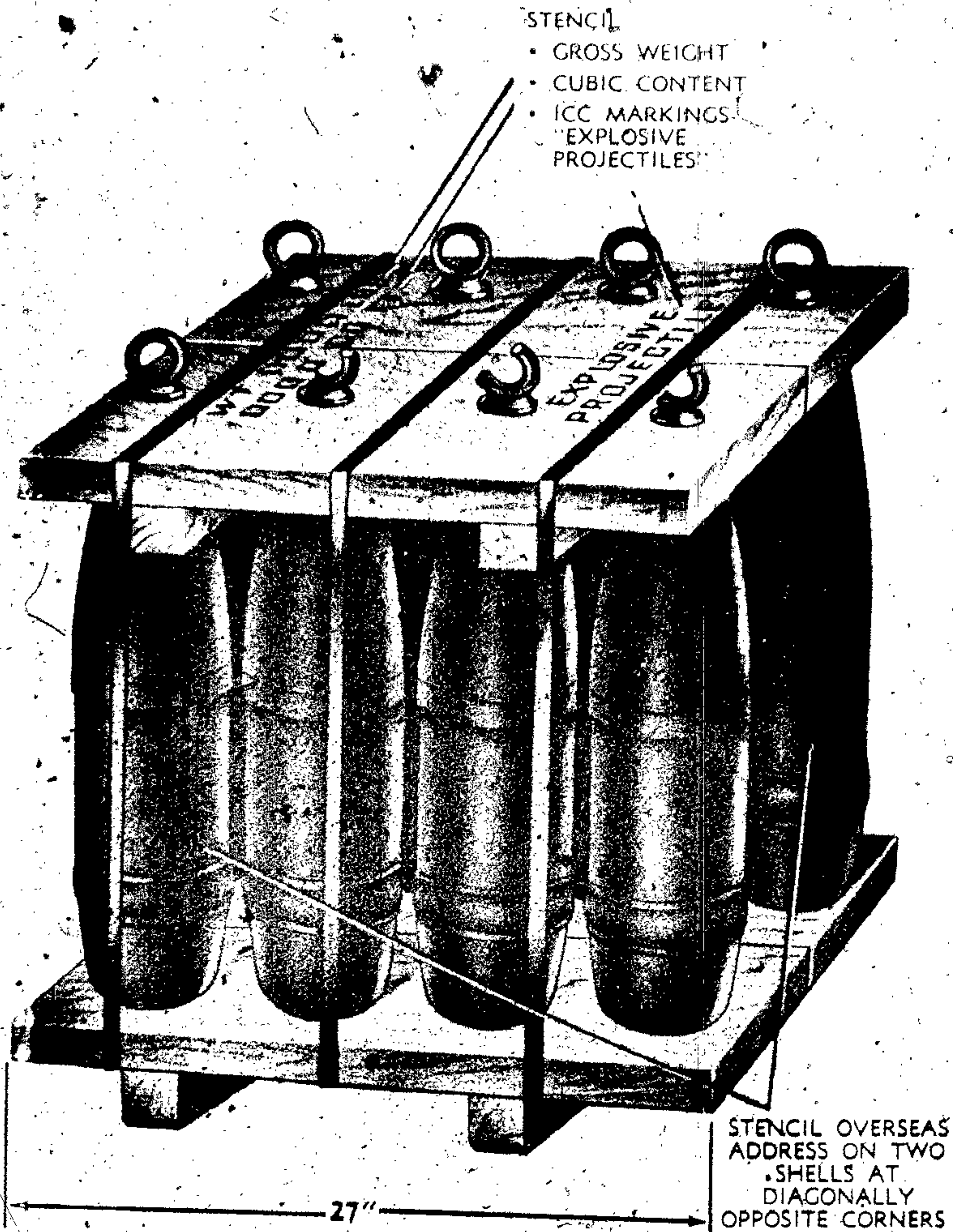

Figure 159 — Palletization of 155-mm Shell



Care, Handling, and Preservation

with complete rounds (57-mm through 105-mm), may be packed two or four per wooden box, in crated clover-leaf, 3-round bundles, or in single-round metal containers. Fiber containers for certain rounds of fuzed semifixed ammunition have covers at each end; the projectile and cartridge case can then be inserted at opposite ends, relieving the neck of the cartridge case of excessive weight. In both single- and double-end containers, a U-shaped metal packing stop is used for fuzed projectiles.

**(5) MISCELLANEOUS.**

(a) Metal cans made of terneplate or tin plate are used for packing small-arms cartridges, small components of ammunition, fuzes, rifle grenades, etc., individually or in small quantities, to preserve them against moisture. Metal liners for wooden boxes are also used in many types of packing of components, for certain small-caliber complete rounds where a moistureproof container is desired, or for shipments of smokeless powder. Stainless-steel-lined plywood boxes are generally used for storage of nitrocellulose cannon powders.

(b) All-steel boxes of both Army-Navy design are used for storing nitrocellulose cannon powders having a web of 0.019 inch and more. Sheet-steel cylindrical drums are used for black powder, which is contained in a cloth bag inside the drum. The drums are crated for overseas shipments.

(c) Fiber cartons are used for packing primers or small fuzes, a small number being packed in each carton. The carton can be made moistureproof by wrapping in a grade C, type I paper, conforming to U. S. Army No. 100-15 (JAN-P-121), and immersion in dip coating sealing compound conforming to U. S. Army No. 100-34 (JAN-P-115).

(d) Packings known as "jungle-packs" contain additional waterproof containers or envelopes so that the ammunition may better withstand hot humid climates.

c. Palletization (fig. 159) has been authorized to reduce handling time and save man hours in storage and shipment of certain types of ammunition. Pallets are constructed of lumber in accordance with ordnance drawings. When palletized ammunition is shipped, a notation to that effect will appear on the repship.

**179. REGULATIONS.**

a. General regulations governing the packing, marking, and shipping of explosives and ammunition are set forth in AR 55-155. All shipments of explosives and ammunition made by the War Department will comply with applicable requirements of Interstate Commerce Commission, Bureau of Explosives Regulations, Port and Harbor Regulations, State and Municipal laws, and pertinent Army Regulations.

*Care, Handling, and Preservation*

b. Explosives and other dangerous articles offered for shipment on a common carrier will be packed to comply with Interstate Commerce Commission regulations, but paragraph 14 (a), section I, of these regulations states that "shipments of explosives offered by or consigned to the War and Navy Departments of the United States Government must be packed, including limitations of weight, in accordance with these regulations or as required by their regulations." Any proposed departure from the requirements of Interstate Commerce Commission regulations must be submitted to the Chief of Ordnance for decision.

c. Military explosive and ammunition are packed in accordance with U. S. Army specifications and drawings. The methods of packing specified are used not only to meet military requirements and protect the articles from damage in transit but are also designed to comply with Interstate Commerce Commission regulations.

d. When shipments of explosives and other dangerous articles are to be made and containers which comply with U. S. Army specifications for the particular article to be shipped are not available, containers complying with Interstate Commerce Commission regulations will be used. This applies particularly to the shipment of deteriorated explosives or ammunition, and to powder, explosives, and loaded components of ammunition obtained from salvage operations.

e. Other regulations concerning packing will be found in the various Technical Manuals, Standard Nomenclature Lists, Ordnance Safety Manual O.O. No. 7224, Ordnance Department Safety Bulletins, and AR 55-470. (shipments by water).

**180. SEALING.**

a. Packings are sealed for airtightness by closing the test hole of airtight containers or cases with solder or a plug. Fiber containers are sealed with water-resistant adhesive tape at the joint formed by the body and cover, but they are not considered completely airtight.

b. After the contents are properly packed, each container is sealed in some manner which will indicate whether or not the container has been tampered with. The method of sealing depends upon the type and construction of the container. Where metal strapping or wire is used around boxes, other seals are not necessary and will not be used in the future.

**181. MARKING.**

a. General. This paragraph covers markings for items as packed and shipped. For marking and painting on ammunition items themselves, see basic color schemes given in paragraph 7; sections in



Care, Handling, and Preservation

chapter 2 of this manual, and other Technical Manuals on Ammunition.

b. **On ammunition.** The markings on uncrated bombs and uncrated shell serve also as a means of identification for shipping purposes.

c. **On containers.**

(1) Containers of ammunition and explosives are marked to provide a ready means of identification as to contents. Packing containers are also marked in accordance with Army Regulations, specifications, and ICC regulations.

(2) With certain exceptions given in AR 55-155, each package of supplies turned over for shipment on a Government bill of lading is marked with:

(a) Name and address of destination of port officer (or code designation).

(b) Name and address of ultimate consignee.

(c) List and description of contents.

(d) Ammunition code symbol, published in ORD 11 SNL's.

(e) Gross weight in pounds, displacement in cubic feet.

(f) The number of the package.\*

(g) The letter "U. S." in several conspicuous places.\*

(h) Order number or contract number.\*

(i) Ordnance insignia.

(j) Name or designation of consignor preceded by the word "From."\*

(k) Lot number.

(l) Month and year packed.

(m) Inspector's stamp.

(3) The adhesive sealing strips on fiber containers are in the same color as ammunition item, in accordance with basic color scheme. Thus, blank ammunition has sealing strips in red, to indicate low explosive (black powder). It will be noted, however, that for rounds with high-explosive projectiles, the strips are yellow.

(4) The top of boxes containing ammunition used in both American and British guns (for example, some lots of 20-mm ammunition) are marked "COMMON AMMN."

(5) For further information on regulations governing marking of containers for shipment, consult AR 55-155 and AR 55-470 (shipments by water). Shipping names are published in ORD 11 SNL's.

(6) Markings on boxes, barrels, or crates are made in stencil.

\*For LCE shipments only.

*Care, Handling, and Preservation*

black or stencil white, whichever is more appropriate. On boxes of ammunition which are stained brown, the marking is in yellow; on unstained boxes, the marking is black. When it is impracticable to stencil or paint the markings on the containers, or when a container is not used in shipping, at least two shipping tags bearing markings should be used. The shipping tags may be of cloth, leather, metal, or waterproof paper, and are attached to the article by wire. The use of writing ink, chalk, or marking material other than waterproof ink or paint is prohibited.

(7) Metal containers are painted olive drab; marking in yellow.

(8) Containers for green bag propelling charge, white bag propelling charge, or section of propelling charge containing the black powder igniter are painted with green, white, or red stripes, respectively. Containers containing igniters only are painted completely red.

(9) Containers for rounds having high-explosive shell have a yellow strip; having chemical shell, a gray strip (superimposed with yellow, red, or green bands to indicate smoke or gas fillers); or having inert shell, a black strip.

(10) Containers for ammunition assembled with shell which have the supplementary bursting charge have stenciled thereon "W/SUPPL. CHG." and the letter "P."

d. On pallets. Boxes, containers, or un-rated shell and bombs are packed for shipment and storage in pallets. Pallets are marked so that the shipping name, weight, and cubic feet are stenciled on the top section of the pallet. The overseas address, if any, is stenciled on two boxes, containers, shells, or bombs both being in diagonally opposite corners of the pallet (fig. 159).

182. **LOT NUMBER.** Lot numbers are basically described in chapter 1, section II.

Section V

**SHIPPING**

183. **GENERAL.** The information contained in this section outlines the special regulations controlling the shipping and transportation of explosives and ammunition. The general regulations are contained in AR 55-155 which apply to government as well as to commercial shipments. Shipments made by military establishments will comply with applicable requirements of these regulations and recommendations. When any difficulties are encountered in complying with these regulations, a report in detail will be submitted to the Chief of Ordnance through appropriate channels.



*Care, Handling, and Preservation***184. REGULATIONS AND REFERENCES.**

a. **Military.** A list of publications controlling transportation of explosives is provided in chapter 5.

b. **Nonmilitary.** Regulations for the transportation of explosives, inflammable, and other dangerous articles by rail, motor vehicles, and merchant vessels are prescribed by the Interstate Commerce Commission, (for rail and motor vehicles, see par. 185) and U. S. Coast Guard (for merchant vessels, see Regulations Governing Transportation of Military Explosives on Board Vessels During Present Emergency and Regulations for the Security of Vessels in Port).

c. **State and municipal laws, ordinances, and regulations.** In addition to the Federal laws governing interstate transportation of explosives and other dangerous articles, each state and nearly all municipalities have laws or ordinances regulating the transportation of explosives and other dangerous articles within their jurisdiction. Shipments of explosives and ammunition will comply with applicable requirements of Interstate Commerce Commission regulations, Port and Harbor regulations, State and Municipal laws, and recommendations by Bureau of Explosives.

d. **Rail regulations.** For these regulations, consult "Interstate Commerce Commission Regulations for Transportation of Explosives and other Dangerous Articles by Freight," published by the Bureau of Explosives, 30 Vesey Street, New York, New York; and see specific application by reference to items involved in index of Consolidated Freight Classification.

**185. INTERSTATE COMMERCE COMMISSION REGULATIONS.**

a. The transportation of explosives and other dangerous articles within the limits of the jurisdiction of the United States is regulated by Federal law, Act of March 4, 1909, chapter 321, sections 232 and 234 (35 Stat. 1134), as amended by the act of March 4, 1921, chapter 172 (41 Stat. 1444-1445), and the Dangerous Cargo Act of October 9, 1940 (Public No. 809, 76th Cong.). Violations of this act are punishable by severe fines and imprisonment.

b. Section 233 of the above-mentioned act, as amended, reads in part as follows: "The Interstate Commerce Commission shall formulate regulations for the safe transportation, within the limits of the jurisdiction of the United States, of explosives and other dangerous articles, which shall be binding upon all common carriers engaged in interstate or foreign commerce which transport explosives or other dangerous articles via any common carrier engaged in interstate or foreign commerce by land or water." Section 235 of the Act of March 4, 1921 requires the shipper of explosives and other dangerous articles to describe, pack, and mark all packages properly, and to

Care, Handling, and Preservation

THE NUMBER OF PROJECTILES IS DEPENDENT ON CAPACITY OF FREIGHT CAR AND WEIGHT OF PROJECTILES. FOR DETAILS SEE ORDNANCE DEPARTMENT DRAWINGS, NOS. 79-3-2 AND 79-3-3.

2" X 6" FOR PROJECTILES LARGER THAN 155 MM. 2" X 4" FOR 155 M.M. AND 6 INCH PROJECTILES

2" X 6" EVERY 3 OR 4 ROWS, FOR PROJECTILES LARGER THAN 155 M.M. 2" X 4" EVERY 6 ROWS, FOR 155 M.M. AND 6 INCH PROJECTILES

REMAINING SEPARATORS 1" X 3" FOR PROJECTILES LARGER THAN 155 M.M. 1" X 2" FOR 155 M.M. AND 6 INCH PROJECTILES.

1" FALSE FLOOR LAID PERPENDICULAR TO CAR FLOOR.

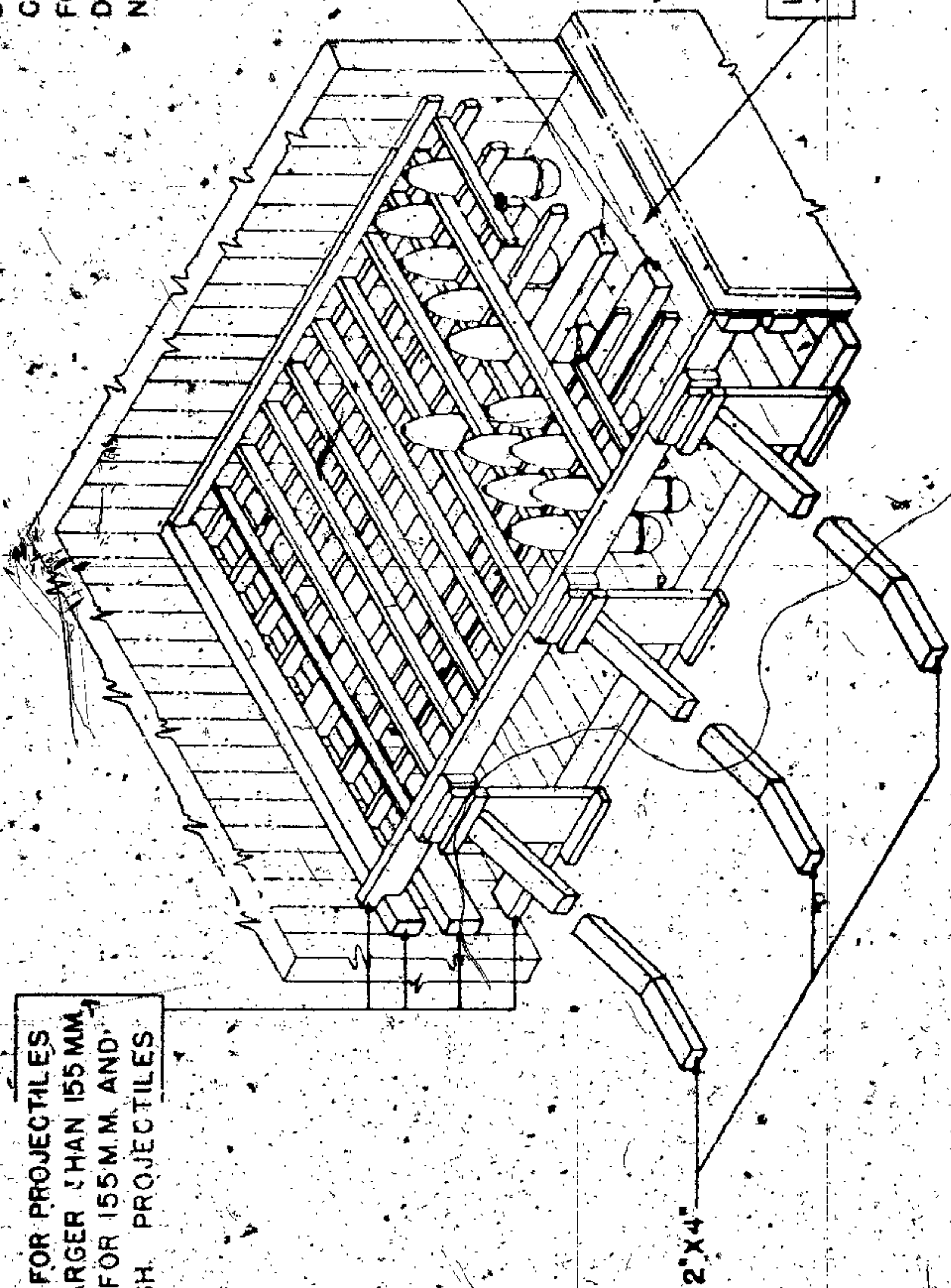

Figure 160 - Method of Stowing Shell in Freight Cars

RA PD 4025A



---

*Care, Handling, and Preservation*

---

inform the agency transporting the packages of the true nature of contents. Violations of this act are punishable by severe fines and imprisonment. ICC Freight Tariff No. 3 prescribes regulations for transportation by water.

c. Under the authority of the above-quoted act, as amended, the Interstate Commerce Commission has published regulations governing the transportation of explosives and other dangerous articles by rail, motor vehicle (highway), and vessel.

**186. U. S. COAST GUARD.** The U. S. Coast Guard prescribes regulations governing the storage, stowage, and use of explosives and ammunition on board merchant vessels. It is responsible for security and supervision of vessels, which includes barges, unless specifically exempt. (See Regulations Covering Transportation of Military Explosives On Board Vessels During Present Emergency.)

### **187. COMBINATION OF TYPES FOR SHIPPING BY RAIL OR MOTOR VEHICLE.**

a. Regulations of the ICC restrict the shipping of different types of explosives and ammunition in the same car or truck. These restrictions are specified in the Loading and Storage Chart of Explosives and Other Dangerous Articles and published in ICC Regulations. The restrictions may be summarized as follows:

- (1) Bulk initiating explosives may not be shipped dry.
- (2) Initiating components such as detonating fuzes, blasting caps, boosters, and bursters may not be shipped with any other high-explosive item except when assembled thereto. A further exception is permitted in case of emergency certified by the Office of the Chief of Ordnance, in which case initiating components may be shipped with high-explosive components provided they are separated by a 3-foot sand barricade.
- (3) Fireworks may not be shipped with high explosives or black powder.
- (4) Chemical agents may not be shipped with high explosives or black powder.

### **188. RAIL SHIPMENT.**

a. **Loading.** When loading freight cars for shipment (figs. 160, 161, and 162), Bureau of Explosives Pamphlets No. 6 and 6A should be consulted. These pamphlets govern the methods of loading, stowing, and bracing of carload and less than carload (LCL) shipments of explosives and other dangerous articles, loaded shells (projectiles) and loaded bombs not covered in ordnance drawings. Ordnance drawings, specifications, and standard practice sheets contain certain technical information required in the carloading and storage and marking

Care, Handling, and Preservation

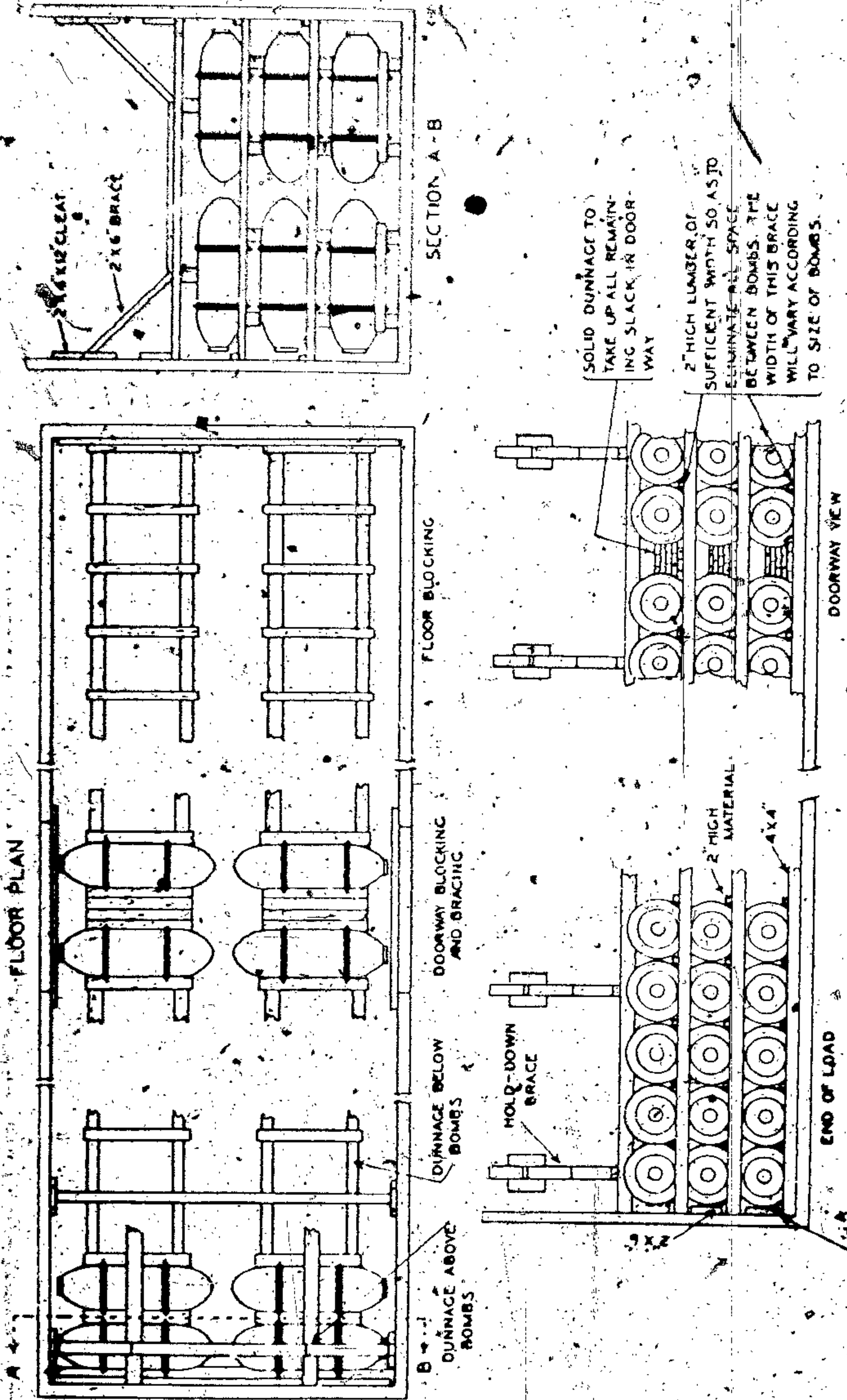

© RA PD 23061

Figure 161 — Bracing of 300-, 500-, and 600-pound Bombs in Freight Cars



Care, Handling, and Preservation

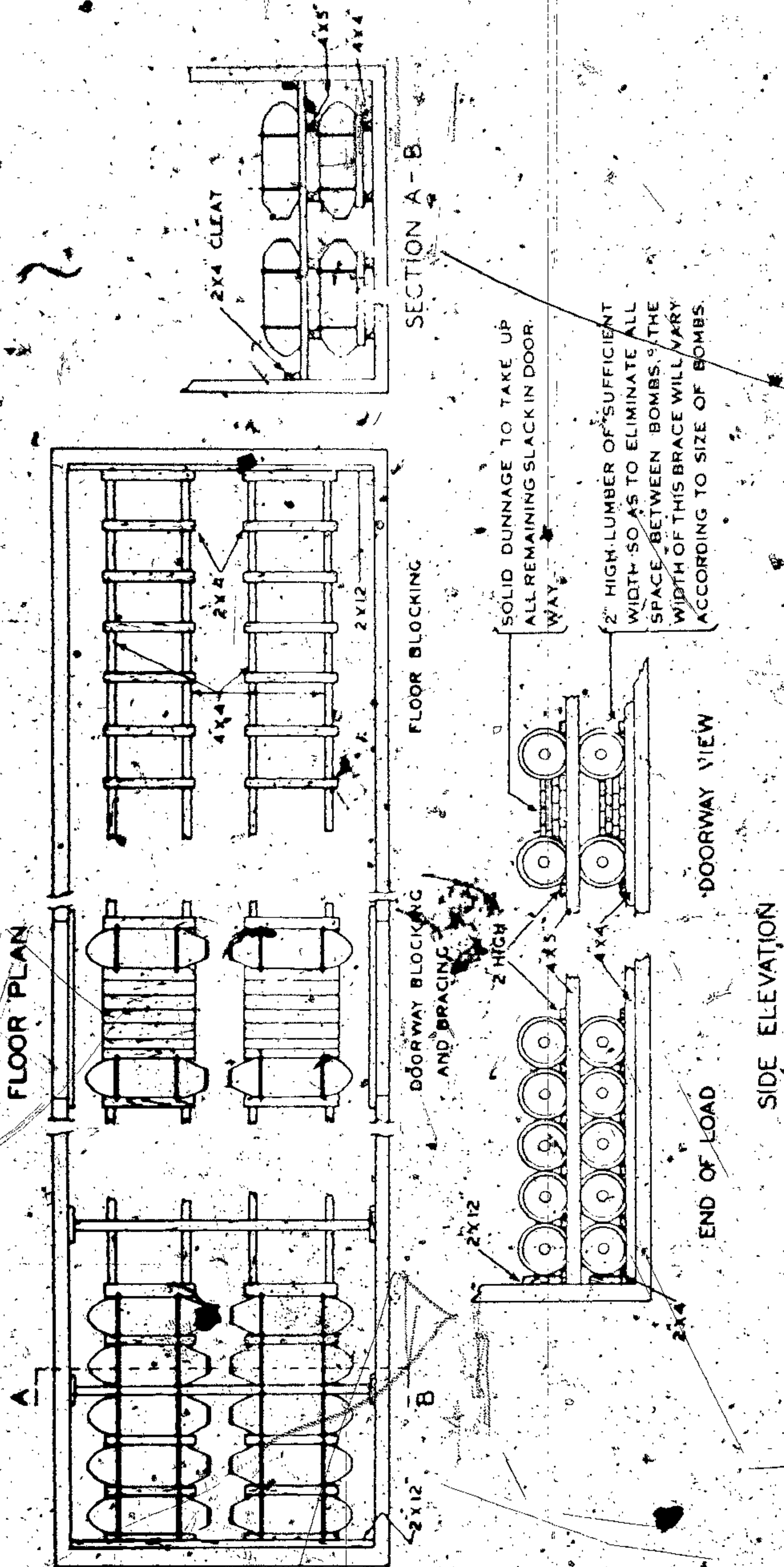

RA PD 23062

Figure 162 - Bracing of 1000- and 1100-pound Bombs in Freight Cars

Care, Handling, and Preservation

of ammunition. They may be obtained by applying directly to the Office of the Chief of Ordnance. The Chief of Ordnance has compiled a series of volumed drawings covering ammunition storage, loading, and blocking which are in class and division 19-48. Items are listed by Ammunition Identification Code Symbol, packing, drawing, and abbreviated nomenclature. For information on legal requirements, consult ICC regulations.

b. The cargo should be studied and decision on appropriate stowage made beforehand. The car best suited for the needs at hand should be ordered. When the car arrives, it should be given a thorough sweeping and inspection for protruding nails and bolt heads, which must be removed or covered with wood. The sides of the car should be boarded up where necessary to obtain an even bearing and proper dunnage (see Bureau of Explosives Pamphlets). Substantial gangways should be provided; obstructions which may prevent free entry to the car removed; the immediate vicinity cleared of leaves, dry grass, and other inflammable materials; and the brakes set and wheels chocked. During loading operations, the car and magazine door should be closed when engines or speeders are passing. Cars should not be left partly loaded unless it is impossible to finish loading at one time, in which case car doors must be securely locked. After loading, the shipment should be properly braced and stayed, the car properly sealed and placarded (see ICC regulations), and a permanent record of car numbers kept. Too much importance cannot be placed on proper blocking and staying. In many cases the bracing may seem excessive for the packages involved; however, if a car loaded with packages of explosives, moving at a rate of 5 miles per hour, should bump a solid train of loaded cars, the packages may be subjected to a pressure as high as 5 times the total weight of packages involved. For example, under these circumstances a 58-pound box momentarily approaches 290 pounds of pressure. In unloading cars the same safety precautions that have been outlined above should be observed. An inspection must be made of the method of blocking, staying, and condition and serviceability of contents before releasing a car for shipment. All cars that have contained explosives should be carefully swept and all placards removed. Sweepings should be thrown in running water, burned, or placed in a metal receptacle for later disposition. All shipments received in a badly damaged condition should be reported through channels to the Chief of Ordnance.

c. Certified cars. Interstate Commerce Commission regulations require the use of a "certified car" for shipment of many explosives; refer to ICC Freight Tariff No. 4 for exceptions. A "car certified" for shipment of certain explosives (see ICC regulations) must be signed in duplicate by a representative of the carrier and of the shipper after shipment is loaded and properly braced. Two of these must be



### Care, Handling, and Preservation

attached outside the doors or to the sides of the car; one on each side, in addition to required explosive placard.

d. **Spotting of loaded cars.** Loaded railroad cars will not be left in the open area between magazines, where they may act as an intermediate step in propagation of an explosion. Railroad loading and unloading facilities for ammunition should be separated from inhabited buildings, public highways, and public railroads in accordance with quantity-distance requirements, chapter 3, section II. Cars should not remain at the loading or unloading facilities longer than 24 hours. Not more than one car should be permitted at the unloading facilities at one time (this does not apply to Ports of Embarkation). Additional cars should be held on an isolated spur. Cars containing ammunition should not be in groups of more than three when spotted on the spur, and the groups should be separated by 40 feet. Before cars containing explosives and ammunition are moved by a locomotive, the air brake couplings must be coupled and tested to assure that the air brakes are in proper working condition. When cars are spotted and engines are detached, the hand brakes must be set. During the moving of a car by pinchbar, a man must be stationed at the hand brake at all times. "Dropping," "bumping," "kicking," the use of the flying switch with cars loaded with explosives and ammunition is prohibited.

e. **Inspection of incoming shipments.**

(1) All railway cars before entering a military installation, must receive complete exterior inspection. This includes examination of car seals for tampering and verification of numbers against shipping papers and bill of lading to insure that cars have not been opened in transit. If car seals have been tampered with or do not correspond with documents, or sabotage is suspected, the car should be inspected by authorized personnel at a special location.

(2) Complete interior inspection is made when the cars are opened. Check contents for conditions and serviceability, and blocking and staying methods if damage is prevalent.

### 189. WATER SHIPMENTS.

a. **Regulations.** Shipments of explosives and other dangerous articles aboard vessels (including lighters and barges) by commercial service shall conform to the regulations prescribed by the U. S. Coast Guard Regulations Governing Transportation of Military Explosives on Board Vessels during present Emergency, and ICC Tariff No. 3. These regulations permit the transportation of military explosives and ammunition in accordance with requirements of the War and Navy Departments. AR 55-470 contains regulations governing transportation of military explosives, inflammables, and chemical materials. Also regulations of ports and harbors of the cities and states affected should be consulted and complied with.

*Care, Handling, and Preservation*

## b. Precautions and safe handling.

(1) Transportation of explosives, except small-arms ammunition, on ships carrying passengers is prohibited except for combat loading and other operational requirements which may be excepted upon decision by competent authority. Equipment to be used for shipment should be inspected and declared as acceptable by duly authorized port authorities. Regulations covering use of fires, stoves, gasoline, matches, smoking, flags, anchors, lamps, hooks, etc., should be consulted and strictly complied with. Persons under the influence of liquor or drugs should not be permitted on board a vessel while loading, unloading, or transporting of explosives and ammunition is in progress. No repairs other than emergency repairs shall be undertaken while any explosives are on board as cargo, and operations with equipment necessitating the use of open flames or acid is prohibited except upon special permission of port authorities. Explosives shall be stowed and segregated by groups according to Coast Guard regulations.

(2) Ammunition or explosives in bulk may be stowed in a hold before or after other cargo, provided all precautions are made against the hazard of articles being dropped from the sling. As far as practicable all work in connection with the construction of a magazine, or other conditioning of holds, decks, or hatches, shall be completed prior to actual loading of ammunition or bulk explosives.

(3) The floors of all magazines and holds shall be cleared of all rubbish, discarded dunnage, and spilled explosives, and swept broom clean before any ammunition or explosives are loaded onto the vessel. Buildings shall also be examined and any residue of previous cargo removed therefrom.

(4) The hatches of the vessel will be kept closed except during loading or unloading operations, and when so closed will be covered with tarpaulin and battened.

(5) If loading or unloading is not completed during operational time, proper precautions will be taken to guard and protect the cargo against fire, and a sufficient crew will be left in charge to handle the vessel in case of emergency. Docks should be kept clear of rubbish, etc. Ammunition and explosives should not be left on a dock or elsewhere unless proper guard is provided or delivery made to authorized persons. Explosives and ammunition will not be left on board overnight unless such action is necessary incident to their transportation. Lighters should not be tied up to that part of a vessel or dock where the fireroom or boiler is located. Explosives should be kept as far away from the boiler room and engine room as is possible.

(6) The use of oil or chemical burning lamps or lanterns is prohibited when loading. Only electric lanterns will be used when a movable artificial light is necessary.



*Care, Handling, and Preservation*

(7) Lighters, barges, scows, and tugs engaged in hauling vessels or vessels berthed at an ammunition loading pier loaded with explosives must have their funnels or smoke stacks covered with screening of suitable size to prevent the escape of sparks. This screening must be renewed whenever it is broken.

(8) Magazines (cargo space) for explosives and ammunition and all metal obstructions and constructions must be lined entirely with wood or authorized wood substitute not less than 1 inch thick, nailed with cement-coated nails and countersunk.

(9) Explosives awaiting removal or delivery should be stored outside the dock or wharf when practicable and every possible effort must be made to reduce the time of such storage. Storage of these materials must be in a safe place and away from dangerous articles.

(10) Packages of explosive and ammunition must not be handled roughly, thrown, dropped, dragged, or rolled over each other or over decks.

(11) Metal hand hooks shall not be used in handling packages of explosives. Cant hooks shall not be used for raising or lowering barrels, drums, or other containers of explosives.

(12) Containers of explosives showing evidence of damage or leakage shall not be accepted for transportation or storage on board a vessel. Recovering or repacking of damaged or faulty containers should be done at a safe distance from the vessel.

**190. MOTORTRUCK SHIPMENTS.****a. Regulations.**

(1) Regulations governing transportation of ammunition and explosives by truck is fully covered by ICC Motor Carrier Regulations, part No. 7, for commercial carrier, and AR 55-155 for government-operated vehicles, and will be strictly adhered to. Most states and cities, towns, villages, etc., have their own laws concerning the transportation of explosives and other dangerous articles within their jurisdiction. The local authorities of those sections through which motor shipments will pass should be consulted and their rules, regulations, and recommendations as to the best route to follow in order to avoid congested areas, be strictly adhered to. On request, local public safety authorities will provide escorts or guards for movement of explosives through their jurisdiction. If compliance with these rules is impracticable, the matter shall be referred to the Chief of Ordnance in detail.

(2) Except in cases of emergency, shipments of ammunition or explosive materials, except small-arms ammunition, will not be shipped by motortruck without prior approval of the War Department. This does not apply to local or nearby hauling but it is intended to prevent truck shipment where rail or water facilities are available.

*Care, Handling, and Preservation*

(3) Explosives and other dangerous articles will not be shipped by any commercial highway carrier nor will local drayage thereof by any commercial concerns be engaged, unless the carrier or drayage concern files a certificate with the controlling transportation officer stating that said carrier or drayage concern will comply with all laws and regulations promulgated by federal, state, and local governments and municipalities that may be applicable to and govern each particular shipment of explosives and other dangerous articles. Motor carriers not licensed by the ICC may transport explosives in interstate commerce provided parts 2, 3, 6, and 7 of the Motor Carrier Safety Regulations are observed.

(4) When government-operated vehicles are used in transporting explosive material, the shipping officer will take all necessary and reasonable precautions to insure safe transit. Except in time of emergency, the shipping officer will be responsible for the observation of all ICC regulations applicable. If the commanding officer of an arsenal or depot or a general or field officer of the line declares the shipment as an emergency, the shipping officer will take every reasonable precaution to insure safe movement of the explosives, toxic gases, or other dangerous articles while in transit on government reservations and public highways.

(5) When trucks have been loaded and ready for movement, the drivers will be informed of the true nature of the explosives on the trucks, the fire hazards, the methods to be used in fighting fires involving the truck or cargo, the missile distance in case of explosion, proper distance to maintain between other trucks, and any other information that will bring about safe delivery of the shipment to its destination.

(6) Any explosive or ammunition accepted for rail shipment is equally acceptable for movement by truck (par. 188), and loading and storage chart for items that may be loaded on motor vehicles is similar to that used on railroad cars. For further description, see ICC, part No. 7. In passenger-carrying vehicles, however, explosives and chemical agents may not be transported, except small-arms ammunition, laboratory samples, and class B solid poisons, or shipments weighing less than 100 pounds.

**b. Precautions and safe handling:**

(1) Every precaution against fire must be observed. Trucks should be inspected daily to ascertain that electric wiring, lights, brakes, gasoline tanks, and lines are in good working order, the engine clean of dust and oil, and the engine pan is free from accumulations of dirt and grease. Accumulations of oil or grease splashed from the universal joint, transmission, or other moving parts, on the under side of the footboards or body of the car should be cleaned thoroughly after each long trip or day's work. Leaking gasoline tanks or lines should be repaired immediately, and lighted cigarettes, cigars, pipes,



*Care, Handling, and Preservation*

and open lights must be kept away from the vicinity when filling gasoline tanks. When necessary to use matches, only safety matches may be used. They must be kept in a metal container in the tool box. Use of "strike anywhere" matches is prohibited. The amount of waste in a truck should be kept to a minimum, and oily and clean waste should be separated. Trash should not be permitted to accumulate in the tool box.

(2) All trucks will be provided with at least one properly filled fire extinguisher. All drivers and other employees should be instructed as to the best methods of extinguishing gasoline fires with Pyrene and should be impressed with the fact that in nearly all cases there is time to extinguish a fire, as it takes an appreciable time to heat ammunition to the point where it will explode. A box containing 3 cubic feet of sand should be carried on each vehicle.

(3) When ammunition and explosives are being transported in a convoy of trucks, it is advisable that they do not become widely separated but a safe distance between each truck be maintained to avoid danger of collision. The convoy should be stopped once each hour during the trip, to inspect each truckload, in a location not within or close to limits of cities, towns, or municipalities. Driving through congested areas should be avoided when possible. Trucks should maintain a moderate speed and make a full stop at railroad crossings. Unauthorized persons will not be permitted to ride on trucks. If a truck catches fire, the other trucks will proceed to a safe distance in case an explosion may occur and guards posted at a distance of several hundred yards on each side of the truck to stop all traffic. In case a truck breaks down and cannot be towed to its destination by one of the other trucks, a two-man guard should be stationed and the post to which the convoy is proceeding should be notified so that a truck can be dispatched at once with loading personnel to relieve the disabled truck of its load.

(4) Fuzes or other detonating agents should not be transported with other explosives. An exception is ammunition for cannon shipped with fuzes or boosters assembled. The load should be well braced and stayed and tarpaulin spread to protect the load from the weather and from sparks. As an ICC War Emergency Regulation, fuzes may be transported with other explosives if a 3-foot sand barrier separates the fuzes from the other explosives.

(5) Explosives and ammunition should not be unloaded or piled immediately back of the exhaust. This regulation is intended to apply to bulk shipments of ammunition by motor truck. No regulations will be construed to prohibit the carrying of complete rounds of artillery ammunition, including fuzes and primers, in one vehicle by combat units.

(6) When transporting artillery ammunition, all projectiles should be parallel to the side of the truck so that the projectile will

*Care, Handling, and Preservation*

not roll back against the tail gate of the truck. If it is necessary to place more than one layer of projectiles in the truck, strips of plank-  
ing should be placed over the first layer of projectiles to protect the  
rotating bands from becoming deformed through contact with other  
projectiles when the truck is in motion.

(7) No container of explosives or other dangerous articles may  
be accepted by a motor carrier if damaged or in a leaking condition.  
Any container found broken or leaking during transit may be repaired  
when practicable and not dangerous. Repairs should be done in  
accordance with best and safest practice known and at least 100 feet  
from other explosives or ammunition. If the damaged container  
cannot be repaired, it should be reinforced by heavy wrapping paper  
and twine, placed in another storage box, and surrounded by dry fine  
sawdust, dry clean cotton waste, or wads made from dry newspapers  
and box cover securely attached. When leaking and damaged con-  
tainer is beyond recuperage, it may not be transported beyond the  
minimum distance necessary to reach a place where the explosive  
may be disposed of with safety.

(8) Trucks must have pneumatic rubber tires and brakes on all  
four wheels.

(9) All artificial lighting must be electric.

(10) Fuel tank inlets and connections should be equipped with  
a device to relieve internal pressure and placed so that no overflow  
can spill on the exhaust, and exhaust pipes will be protected by a  
properly constructed flame baffle.

(11) The floors of all vehicles must be tight, and exposed metal  
on the body covered or protected with wood or nonmetallic material.

(12) Lighting equipment on vehicles should be in conformance  
with the standards prescribed by the ICC or the laws of the state  
within which the vehicle is operating.

(13) Motortrucks containing explosives will never be taken into  
a garage or repair shop for repair or storage unless it is an open, sun-  
shaded garage where no open-flame lighter burner is in use.

(14) When possible explosives will be transported during day-  
light.

(15) ICC rules forbid transportation of explosives on any full or  
pole trailer.

(16) Interiors of trucks must be free of bolts, nails, or other  
projections which may damage containers.

(17) The entire load must be within the body of the vehicle, and  
the tailboard of gate must be closed and secured during transit.

(18) The engines of all trucks must be stopped, all brakes set,  
and wheels chocked before loading and unloading.



*Care, Handling, and Preservation.*

(19) Loaded trucks will not be left in the open area between magazines as they may act as an intermediate step in propagating an explosion.

(20) Refueling should be reduced to a minimum. The electric ignition system should be turned off and the engine stopped during the refueling process. If the engine is provided with a magneto, it should be grounded.

(21) For any continuous trip longer than 8 hours, the driver must be accompanied by an assistant. Smoking will not be permitted in the cabs of vehicles transporting explosives. The car will not be left unattended on a public street or highway.

(22) Every shipment of dangerous explosive will be delivered only to a person authorized to receive it, except such shipments as are placed in magazines which are immediately thereafter locked.

(23) Motor vehicles carrying explosives or ammunition will have the prescribed placarding with lettering no less than 3 inches high on a suitable background. Four "Explosive" signs are required, one on the rear, front, and on each side. When transporting more than one class of explosives or dangerous articles, no more than one kind of sign lettering or placard need be displayed and that one must be the one which designates the most dangerous article being transported.

(24) In case of accident, all unbroken packages and as much of any broken packages as possible will be carefully gathered and removed to a place of safety in order to prevent fire or explosion. Care should be taken not to produce sparks. In the event that a motor vehicle is entangled with another or with an object or structure, no attempt will be made to disentangle the vehicle until the load is removed to a place 300 feet from the vehicle or any habitation. Inhabitants and other vehicles will be warned of the danger.

(25) When explosives and ammunition are being transported by truck from railroad loading and unloading facilities to or from the magazine area, a route should be selected which avoids travel through congested areas of the post.

## Section VI

**INSPECTION AND SURVEILLANCE****191. DEFINITIONS.**

a. **Inspection.** Periodic and special visual examinations which may include gaging, weighing, or investigation of components as required for the purposes of determining the current serviceability of the stocks on hand and detecting evidences of deterioration.

b. **Maintenance.** The care taken and work done to keep the ammunition in good condition.

*Care, Handling, and Preservation*

c. **Surveillance.** Observation, inspection, investigation, test, study, and classification of ammunition and ammunition components and explosives in movement, storage, and use, with respect to degree of serviceability and rate of deterioration.

d. **Grading.** See chapter 1, section II.

**192. INSPECTION OF MAGAZINES AND MAGAZINE AREAS.**

a. Magazines and magazine areas should be inspected once a month, or more frequently as may be required by regulations and conditions, to see that all conditions are normal, that neither humidity nor temperature is or has been too high within the magazine and that containers are in a satisfactory condition.

b. The following is a summary of conditions that should apply when ammunition is inspected:

(1) The location of magazines should conform to the quantity-distance tables in regard to distance from inhabited buildings, from public highways and railroads, and from each other.

(2) The magazine area should be well guarded and protected against fire.

(3) The required firebreaks should be provided and free from rubbish and inflammable material.

(4) The magazines should be well and suitably constructed.

(5) The magazines should be in good repair, dry, and well ventilated.

(6) The interiors of magazines should be clean and neat with stores arranged in orderly piles.

(7) The requirements of the Mixed Storage Chart, paragraph 173, should be met.

(8) The stores should be properly identified by lot number and piled with no more than one lot in each pile.

(9) Outer containers should be securely closed.

(10) Loose rounds, damaged containers, empty containers, paint, oil, waste, rags, tools, and other prohibited articles should not be present in the magazine.

(11) All ammunition, explosives, and load components (except small-arms ammunition) should be stored in segregated magazines and not in buildings used for other purposes.

(12) Exudate should be removed from magazines promptly.

(13) Files of publications should not be kept in magazines.

**193. SMOKELESS POWDER.**

a. Smokeless powder in bulk and separate-loading propelling charges should be inspected to see that all containers have lids fas-



Care, Handling, and Preservation

tened firmly in place, that containers are airtight and in good condition. They should be examined for evidence of having been subjected to moisture and dampness and, in warm weather and climates, the records of the maximum-minimum thermometer examined. Metal containers of separate-loading propelling charges should be air-tested. Air-testing personnel should be familiar with the odor of decomposing powder and should note carefully the odor from each container as it opened for air test.

(1) When smokeless powder reaches an age at which it may be expected to deteriorate with increased rapidity, each container is inspected at least every 12 months. Propelling charges of lots that satisfactorily passed previous inspection should be reinspected at 12-month intervals. If it appears that it will be necessary to withhold inspection so that the elapsed time will be greater than 14 months, prior authority will be obtained from the Chief of Ordnance. Methods of inspection and tests to be performed are laid down each year by the Chief of Ordnance and published in WDSB 9-AMM 7.

(2) Where the number of defective propelling charges in any one lot reaches 10 percent, the balance of the lot will thereafter be inspected at 6-month intervals.

b. During inspection, minor repairs such as tightening lacings and replacing gaskets should be effected.

c. In large magazines, instead of dating each methyl-violet test paper individually, a record may be kept in the magazine of the date of inspection. If any lots containing such undated papers are shipped elsewhere, the date of last inspection which normally appears on the test paper will be shown on the shipping ticket.

**194. FIXED AND SEMIFIXED AMMUNITION AND GRENADES.**

a. All stocks on hand should be inspected to see that they can be readily identified as to kind and lot number and that the ammunition has not been subjected to moisture and dampness. Containers should be examined to see that they have not been opened nor individual rounds removed from their sealed containers. Serviceable rounds turned in by troops should be examined to see that they have been properly repacked and sealed. Unserviceable rounds on hand should be examined to see that they are packed in closed containers and inquiry made to ascertain that they have been reported for disposition.

b. When any large number of rounds of fixed or semifixed ammunition has been in storage 5 years or more, provision should be made for the inspection of the propelling powder from representative lots of the rounds. This requires disassembly of the round and should be done with extreme care by experienced personnel only. Request may be made of the appropriate service command for shipping representative rounds of the lots to ordnance establishments or

*Care, Handling, and Preservation*

for an ammunition inspector to supervise the disassembly and inspection. These representative rounds should be examined as follows:

(1) Three packages representing each lot will be removed from the magazine to a location in accordance with safety requirements, and one round of ammunition will be selected at random from each package. These rounds should be removed from the magazine and disassembled with care. Immediately after the shell is removed from the cartridge case, the odor from the powder will be noted. All instances of the odor of nitrous fumes will be reported. In general, any charge containing an excess of one percent deteriorated grains will have a marked odor of nitrous fumes. If nitrous fumes are detected, the smokeless powder from that round will be destroyed, the primer fired, and the balance of the round shipped to the nearest ordnance depot. The entire lot will then be held for disposition.

(2) Semifixed ammunition will be inspected as described above except that, when the charge is contained in bags, the bags only will be inspected for partial or total discoloration and subjected to a manual test to determine the serviceability of the cartridge case cloth. Rounds containing bags which are discolored or spotted, in which the bags are weak due to deteriorated smokeless powder, will be disposed of as described above.

(3) Mortar shell, grenades, mines, and rockets are inspected as in subparagraph a, above, except that extreme care is taken to see that all grenades and grenade fuzes are in containers which are so effectively closed that the articles cannot be easily removed and handled.

(4) A report in duplicate for each lot inspected will be forwarded, through channels, to the Chief of Ordnance.

e. Cartridge cases should be inspected, as occasionally burs, projections, and slight imperfections are formed on the mouth of cases during seating or crimping operations on an assembling machine. Such irregularities must be removed so that the rounds may chamber correctly. The use of power-driven grinding wheels on loaded material is prohibited. Although it is preferable that no filing or grinding be done on loaded cartridge cases, the careful use of a file for this purpose may be permitted when necessary. When filing, the rate must be limited so that the heat generated will not be dangerous. Protection should be given the primer.

### 195. SMALL-ARMS AMMUNITION:

a. TM 9-1990 and WDSB 9-AMM 4 should be available for reference.

b. An examination should be made to verify the following:

(1). That all ammunition on hand is properly identified.

(2). That outer container seals have not been broken or liners opened.



*Care, Handling, and Preservation*

(3) That covers of partly filled outer containers are firmly fastened.

(4) That an excessive quantity of grade 3 ammunition has not accumulated.

(5) That grade 3 ammunition has been reported (par. 8).

(6) That there is no great accumulation of serviceable rounds of ammunition not packed in clips of bandoleers or in the regularly prescribed manner.

(7) That there is no accumulation of otherwise serviceable ammunition not identified by lot number.

c. The contents of representative containers of lots that have been in storage for 1 year should be inspected for corrosion, season cracking, dents, or other defects of the cartridge case, and for loose bullets or split tracer bullets.

d. Serious defects should be reported at once and, if the number of defective cartridges is greater than 20 percent, the lot should be held for instructions from the Chief of Ordnance.

**196. BULK EXPLOSIVES.**

a. **High explosives and black powder.** Black powder in bulk, practice bomb and smoke-puff charges, TNT in bulk and blocks, explosive D, and dynamite should be examined to see that the containers are in good condition, that there are no open containers, and that explosives are not sitting from the containers. Black powder containers should be examined for rust and for evidence that containers have been opened in an improper manner, such as by the use of a cold chisel, hatchet or other unsuitable tool. Dynamite containers should be examined for signs of exudation and other evidence of nitroglycerin on the case or on the floor.

b. **Bulk powder (smokeless).**

(1) Bulk powder of lots that satisfactorily passed previous inspections should be reinspected at 12-month intervals. The action provided in paragraph 193 a applies when it appears the period will be greater than 14 months.

(2) Bulk powder from lots in which 10 percent or more of the lot was found defective will be reinspected at 6-month intervals. Each box will be opened. If the powder smells of nitrous fumes, or if the N/10 methyl-violet paper has turned white, that box will immediately be segregated and subsequently disposed of. Bulk powder segregated will be reported on Ammunition Condition Report as grade III for disposition by the Chief of Ordnance. If neither of the above defects are found, a new dated N/10 methyl-violet paper will be placed in the box, and the box returned to storage. If the amount of defective powder in any one lot equals 10 percent of the

Care, Handling, and Preservation

lot, the balance of the lot will be inspected thereafter at 6-month intervals.

(3) For further information, see WDSB 9-AMM 7.

**197. SEPARATE-LOADING SHELL.**

a. Separate and unfixed shell should be inspected to see that they are piled in the manner, and with the clearance, prescribed in chapter 3, section II. Shell should be inspected for rust or corrosion and some of the fuze hole plugs should be removed to see that the threads are not burred or rusty and that the cavity is clear. Fuze hole plugs which require excessive force to remove should not be removed in the magazine. When necessary to remove such plugs, barricaded protection should be provided. Bands should be protected against dents, cuts, and pressure from upper layers of shell. Shell should be examined to see that they are properly painted and marked as required. TNT or amatol shell should be examined for exudate. Any exudate formed on shell or the floor should be scrubbed up with hot water or acetone. Exuding shell should be reported and held for disposition. Exudate is an oily brown liquid that oozes out around the thread in the nose of a shell. It is inflammable and may carry small particles of TNT. If the exudation is slight, the service command or department ordnance officer may permit the shell to be used after the exudate has been thoroughly cleaned off. If the exudation is excessive and drips on the other shell or the floor, the shell will not be used.

b. When it becomes necessary to recondition the exterior surfaces of projectiles, they should first be thoroughly cleaned. Metal does not stop rusting unless all signs of rust are removed from the shell. Light engine oil should be applied and cleaned off with dry-cleaning solvent after 2 or 3 weeks; then paint, with one coat of primer and one, or two if necessary, coats of paint. Provision must be made for stenciling lot numbers and other identifying marks on projectiles and storing them so that the shell may be readily identified by lot number.

**198. BOMBS.** The requirements for the inspection of fragmentation bombs are similar to those for fixed ammunition. General-purpose bombs are inspected to see that the regulations laid down for storage are strictly complied with. Examination should be made for exudate, rust, and corrosion. Fin assemblies should be protected. Fuze hole plugs should be removed from representative sample to see that threads and cavities are in good condition. Painting and marking should be in accordance with regulations. Exuding bombs are cleaned the same as exuding shell (par. 197, a), but there are no restrictions as to their issue.



Care, Handling, and Preservation

**199. SUBMARINE MINE EXPLOSIVES.** All submarine mine explosives, including bulk TNT and blasting caps, should be inspected annually. The inspection of TNT will be made as required by paragraph 196 and the inspection of electric blasting caps as required by paragraph 200. In addition, representative samples will be tested with an approved-type electric blasting cap circuit tester. Any questionable blasting caps should also be tested with the circuit tester.

**200. FUZES AND SMALL ITEMS.** Fuzes and other small loaded components and ammunition items should be examined to see that they are stored in sealed containers and well protected against moisture. Partly filled outer containers are examined to see that they have been properly resealed. A check should be made to see that the components are suitable for use with the ammunition on hand and that the required number is available. Components which have been in storage more than 1 year will have a representative outer container of each lot opened and the contents examined for rust, discoloration, and corrosion. Satisfactory items are resealed by resoldering containers or sealing with friction tape and a coat of shellac. Questionable items will not be issued but will be reported to the Chief of Ordnance for disposition.

**201. PYROTECHNICS.** Pyrotechnics should be examined to see that all containers are in good condition, and that they are effectively closed so that the contents cannot be easily removed or handled.

**202. CHEMICAL AMMUNITION.** Chemical ammunition should be inspected to see that it is stored so that any leaky container can be readily removed and that facilities for handling leaky containers are available. The ammunition should be examined monthly for leaks and every 6 months for rust or corrosion. Boxes should be examined to see if there are any instructions thereon requiring the destruction or use of the contents by a certain date. Containers which develop leaks should be reported, through channels, to the Chief of Ordnance. Such reports should include information as to type, lot, date discovered, nature of leak, and whether apparently caused by defective material or improper handling, and disposition made of container or disposition recommended.

**203. INERT COMPONENTS.** Inert or empty components of ammunition should be inspected to see that they are properly protected against rust and corrosion, or if they need a renewal of a protective coating of paint or grease.

**204. OUTDOOR STORAGE.** Ammunition stored outdoors should be frequently inspected for signs of deterioration or loose components.

*Care, Handling, and Preservation***205. REPORT OF UNSERVICEABLE AND DEFECTIVE AMMUNITION.**

a. When the material in the hands of troops is inspected, inquiry should be made as to any ammunition failures experienced since the date of the last inspection and whether such failures have been reported. If no report has been made through channels to the Chief of Ordnance, all available details of failures will be collected and so reported.

b. If the inspector finds defects in ammunition which will require the expenditure of labor or funds to correct, he should take care to examine a sufficient number of containers or rounds to insure a report on average conditions and not isolated cases. The examination of fire containers, selected at random, should be sufficient for a report that will reflect average conditions.

**206. PUBLICATION FILE.**

a. A file of pertinent Technical Regulations, Technical Manuals, Field Manuals, WDSB's, Ordnance Field Service Bulletins, and Ordnance Department Safety Bulletins, together with a copy of the Ordnance Safety Manual, O.O. Form No. 7274, will be kept complete and up-to-date. The service command or department ordnance officer or his assistant should determine, when inspecting ammunition at a post, camp, or station, that such files are available and their contents thoroughly understood.

b. Additional information regarding inspection and surveillance may be found in chapter 5.

---

**Section VII****RENOVATION****207. DEFINITIONS.**

a. **Renovation** denotes all activities, necessary to place ammunition in a serviceable condition, which involve disassembly of the item. Such disassembly does not mean that which is involved in ordinary operation such as the fuzing and unfuzing that may be performed by a gun crew, but that which involves the opening of a joint which originally was intended to be permanent, as shown by crimping, staking, or cementing. Renovation may be necessary to replace a component which has become unserviceable or undesirable because of deterioration, damage, or change of design. Renovation of ammunition includes such reconditioning, salvage, and destruction of unusable components as may be required.



Care, Handling, and Preservation

b. **Reconditioning** denotes those maintenance and repair activities which do not involve replacement of unserviceable components. It includes such operations as derusting, repainting, restenciling, repair of containers, and superficial repair as removing dents from cartridge cases and straightening bomb fins, etc.

c. **Maintenance** is an all-inclusive term involving reconditioning and renovation as defined above. More specifically, maintenance is the maintaining of stocks of ammunition, ammunition components, and explosives in serviceable condition for immediate use.

d. **Salvage** includes operations necessary to disassemble or break down ammunition and ammunition components in order to recover therefrom all materials and components which are or may be serviceable or which may have value as scrap.

**208. DESTRUCTION OF UNFIT OR UNSALVAGE AMMUNITION.** Ammunition or its components which are unfit for salvage or are unsafe to handle are disposed of by such methods of destruction as detonation, burning, or dumping at sea, as described in chapter 4.

**209. AUTHORITY FOR RENOVATION.**

a. Renovation of ammunition, ammunition components, and explosives will be undertaken in the Zone of the Interior only upon receipt of specific authority and instructions from the Chief of Ordnance.

b. The Chief of Ordnance issues orders for renovation operations based upon one of the following:

(1) Surveillance reports from an ordnance activity to which ammunition inspectors are assigned, either in the United States or the overseas departments.

(2) Reports of functioning or other tests, either surveillance, acceptance, or special.

(3) Reports from the using services usually originating from ordnance officers assigned to class I, II, or III installations or with command organizations.

(4) Reports of malfunctions and accidents from the using services, submitted in accordance with AR 750-10, which may disclose a desirable engineering charge.

**210. SAFETY REQUIREMENTS.**

a. Renovation should be performed in an isolated area or building specifically designated for that purpose. The quantity of explosives present should be the minimum necessary to carry out the operation. These operations should be carried out in conformity with the quantity-distance requirements of chapter 3, section II, based upon the total quantity at the operation. The number of persons

### Care, Handling, and Preservation

permitted at or near the operations should be kept to a minimum. The area or buildings should be free of loose explosives, waste paper, and other combustible material. All work will be performed under the direct and competent supervision of experienced personnel.

b. Renovation operations are hazardous and require a thorough knowledge of the activities involved, the hazards to be guarded against, and the precautionary methods necessary for greatest protection to personnel and property. The equipment used must be designed with this in mind and, in many instances, operations must be conducted in workrooms barricaded for the protection of personnel and property in the vicinity of the hazardous operations. Barricades may be of three general types: reinforced concrete, metal, or earth, or any acceptable combination thereof. The height and thickness of the barricade are governed by the renovation requirements. The decision as to the number and type of operations to be conducted behind a barricade should be based on the hazards involved, and the barricade, equipment, and tools to be used should be designed to make the best and most efficient use of the protection afforded by the installation.

## 211. SAFETY REGULATIONS FOR MAINTENANCE AND SALVAGE OF EXPLOSIVES OR AMMUNITION.

a. Ammunition or explosives shall not be renovated or salvaged within a magazine where other ammunition or explosives are stored. These operations shall not be carried on within the magazine area unless the site, empty magazine, buildings, or cars in which the work is done are devoted exclusively to such work, and are specifically approved by the Chief of Ordnance. Such operations may be carried out in an empty magazine or in the open at intraplant quantity-distance requirements, but in no case at less than 100 feet from the nearest location of explosives.

b. The quantity of explosives or ammunition involved or present in any operation at one time in one location shall be limited to the minimum quantity necessary to carry out the operation, thus:

- (1) Black powder, 100 pounds.
- (2) Separate-loading propelling charges—1 open container, and four closed containers.
- (3) High explosives are limited to one open container of 100 pounds and four closed containers.
- (4) Smokeless powder limits shall be one open container and nine closed containers.

c. Hazardous operations, such as those involving the removal of boosters from shells, and the disassembly of fuzes and grenades, shall be barricaded to reduce operating hazards. Disassembly of ammuni-



Care, Handling and Preservation

tion and bombs and other similar disassembly operations shall be performed behind an adequate barricade. Examples are:

(1) Disassembly of loaded boosters, bursters, loaded fuzes, loaded primers, and blank ammunition.

(2) Removal of boosters and fuze seat liners from loaded bombs, base plugs from loaded projectiles, and loaded boosters from loaded shells.

d. The following and very similar disassembling operations may be performed without a barricade provided the assembly has been usual and the ordinary equipment, tools, and methods used in the assembly are sufficient to accomplish the disassembly without the application of undue force. Care must be taken to ascertain that the surfaces to be separated are not corroded, contain no hardened glue or other binding agents, and are not sealed with metallic caulking. If undue force is necessary, these operations must be accomplished behind a barricade.

(1) Removal of loaded fuzes and fuze well cups and ignition cartridges from loaded shells, 60-mm and 81-mm primers, and disassembly of projectiles and cartridge cases in fixed ammunition, and the removal of set screws from loaded projectiles.

(2) When stake punch marks must be removed with drilling equipment, the equipment must be provided with a positive stop to prevent the contact of the drill with the fuze or booster parts, or with the explosives in the shell or its contents.

(3) The removal of hand grenade fuzes from loaded grenades must be performed immediately in front of a suitable protective tank equipped with an effective baffle, into which the grenade can be deposited should a premature ignition of the firing medium occur.

e. When soldering operations are performed upon metal containers, precautions shall be taken to insure that they contain no loose grains of powder or explosives dust.

f. All salvage components must be kept separate until disposed of in accordance with Army Regulations or directions of the Chief of Ordnance.

**212. EQUIPMENT FOR BARRICADES.**

a. Normally the equipment required for barricaded operations consists of a suitable barricade, holding devices, operating device, means of following the operation, and method of safely transmitting power required for the operation.

(1) A suitable barricade is one that will afford the necessary protection to personnel and property. The location of the barricade should be such that it will equal or exceed the minimum safety dis-



### Care, Handling, and Preservation

tances required by the class and quantity of explosive involved, as shown in paragraph 172.

(2) A suitable holding device, located to the rear of the barricade, may consist of some form of a vise or jig on either a fixed or an adjustable base, placed in such a manner as to hold the item in a centered position so as to permit the proper application of the operating device.

(3) A suitable operating device may be a wrench or other tool designed to fit the item for the work to be performed.

(4) A suitable means for observation may be furnished by a mirror or series of mirrors located so as to keep the personnel at a safe distance from the operation.

(5) A suitable method of transmitting power to the operating device normally consists of a shaft extending through the barricade and should have a positive stop on the operating side to prevent its being blown forward through the wall, in event of an explosion. Personnel should not be exposed in a direct line with a shop which extends through a barricade.

**213. TOOLS AND SUPPLIES.** Tools and supplies for ammunition renovation are listed in ORD 10 SNL N-500-GA and described in TM 9-1905. Other tools and equipment that have to be designed should meet strength requirements and guard against the introduction of chemical, mechanical, or electric hazards over and above the normal hazard of the ammunition and explosives involved. When exposed explosives are involved, the use of safety tools and equipment, which may be made of nonsparking metals, wood, or fiber, is required. The use of certain types of nonsparking tools must be judicious, however, because certain types of nonsparking metals may form sensitive salt compounds with certain types of explosives; for example, the use of any copper-bearing metal with explosives containing nitrates.

### 214. PLANNING OPERATIONS.

a. In planning normal operations, the sequence of operations should be considered in four separate phases (not considering movement to and from storage):

(1) **DISASSEMBLY GROUP.** Removing packing materials, and disassembling ammunition preparatory to renovation.

(2) **REASSEMBLY GROUP.** All preparation for and proper reassembly of the item.

(3) **FINISH GROUP.** All necessary reconditioning and returning of the items to their packages, with necessary package marking and repair.

(4) **DISPOSAL GROUP.** Disposing of all unserviceable or unusable component parts, waste explosives, etc., that may accumulate during renovation operations.



## Section VIII

**PRECAUTIONS FOR PRACTICE FIRING**

**215. GENERAL.** Specifications, standards, and limits of precision are prescribed for the manufacture and preparation of ammunition. In spite of this, inherent limitations exist and malfunctions of ammunition may occur. The immediate problem is to prevent the occurrence of malfunctions wherever possible, to minimize the effect when they do occur, and to avert, through experience, similar malfunctions in the future. The general safety precautions, chapter 3, section I, should be observed wherever applicable. The specific regulations and precautions for the use of each type of ammunition given in this section and in chapter 2 will be observed.

**216. GENERAL PRECAUTIONS BEFORE FIRING.**

**a. Status of ammunition lots.** A check should be made to determine the status of the lot of ammunition intended for issue. Ammunition should not be fired if the lot number is not positively known. If defects which may affect the safety and functioning of the ammunition are found in a lot graded as suitable for firing, a prompt report of the condition will be submitted to the service command or department ordnance officer. Firing of that lot of ammunition will be suspended pending instructions from the proper ordnance officer. If malfunctioning occurs during firing, a prompt report on the ammunition lot will be made as prescribed in AR 750-10.

**b. Alterations and substitutions.** Any alteration of loaded ammunition except in accordance with specific instructions from the Chief of Ordnance is hazardous and therefore prohibited. Serious and fatal accidents have resulted from substitution of propelling charges, fuzes, primers, and projectiles, and from the local preparation and loading of practice ammunition, including grenades, pyrotechnics, etc.

**c. Placing ammunition.** All ammunition at the firing point will be so placed as to minimize the possibility of ignition, explosion, or detonation in case of accident at the gun position. It should be in a dry place and protected from the direct rays of the sun by tarpaulin or other covering. There should be ample circulation of air through and on all sides of the stack. Erratic ranges and dangerously high pressures may result from overheated ammunition. White-phosphorus shell will be stacked (preferably with the base of the projectile down, although if the temperature is not expected to exceed 105° F, this precaution is not necessary) in a space cleared of all combustible material, away from personnel and other ammunition. All components in the field should be stored separately and in small amounts to minimize danger from accidental burning of

*Care, Handling, and Preservation*

powder or detonation of projectiles, fuzes, and primers. Chemical ammunition is stored away from other types of ammunition.

d. **Safety zones.** Data for delimiting safety zones for ranges in firing small arms, artillery weapons, and chemical-warfare weapons will be found in AR 750-10.

e. **Smoking.** Smoking by anyone handling, or in the vicinity of, explosives or ammunition is prohibited.

f. **Lights.** Use of any lights other than approved lanterns or flashlights in the vicinity of explosives or ammunition is prohibited.

g. **Handling.** Care should be taken not to drop projectiles, powder containers, or fuze or primer containers. Projectiles should not be allowed to strike together. All safety precautions for handling ammunition given in Technical Manuals and in this manual will be rigidly observed.

h. **Packings.** Moisture-resistant seals of packed ammunition should not be broken until the ammunition is ready to be used. Rounds should not be withdrawn from containers until they are ready to be fired unless the ammunition is to be loaded directly into the caisson. Safety devices on fuzes will be removed just before firing and at no other time. Components of rounds prepared for firing but not fired will be returned to their original condition and packings and appropriately marked and resealed. Such components will be used first in subsequent firings in order that stocks of opened packings may be kept at a minimum.

i. **Cleanliness.** The complete round or each component should be inspected by a member of the gun crew for burrs, dents, gravel, dirt, grease, and other materials before loading into the gun. A cloth should be kept nearby for wiping off grease, dirt, and foreign matter. Ammunition must be clean and free from dents, which will interfere with proper seating of the round, before it is placed in the weapon.

**217. GENERAL PRECAUTIONS DURING AND AFTER FIRING.**

a. **Defects and malfunctionings.** AR 750-10 provides that all officers having charge of firing must make a report to the local ordnance officer of any ordnance materiel issued to the troops which malfunctions in firing or reveals defects either in firing or in storage, including such malfunctionings and defects as are noted in target-practice reports. It is the duty of the local ordnance officer to investigate all cases of malfunctioning and defects observed by him or reported to him, and to report serious cases to the Chief of Ordnance through the service command ordnance officer. Whenever an accident occurs which results in injury to personnel or damage to materiel, the lot of ammunition will be suspended from use and an immediate report will be made directly to the Chief of Ordnance by the ordnance



---

*Care, Handling, and Preservation*

---

officer under whose supervision the materiel is maintained or issued. One copy of this report will be sent to the service command ordnance officer. Accidents of a serious or potentially serious nature require a report by the quickest means of communication available. Insofar as practicable all evidence will be preserved and not be disturbed until the arrival of an investigating officer.

b. **Protection of personnel.** AR 750-10 gives the regulations and details for protection of persons in the vicinity of the firing point. Any individual in the military service who observes a condition which makes firing obviously unsafe will immediately command "CEASE FIRING." If at a distance from the unit firing, he will make the prescribed signal to halt firing. When chemical ammunition other than smoke is fired, all persons will be provided with gas masks. Consult AR 750-10 for regulations governing the use of service ammunition for training purposes.

c. **Firing through trees.** When firing ammunition from a mask of trees, a premature burst may result if a fired shell or shrapnel strikes the branch of a tree. The striking of even a twig by a shell fitted with a time fuze may derange the setting or deform the time ring and cause a premature burst.

d. **Duds.** A dud is a discharged but unexploded bomb, projectile, or grenade. It may result from defects in the fuze, booster, or charge; from the unscrewing of fuzes in flight; or from the character of the ground at the point of impact. Whenever a dud can be readily located and examined without moving it, an effort should be made to determine the cause of the failure. A dud is a source of danger and if improperly handled may explode and injure personnel. A comparatively slight blow or disturbance may cause it to explode. Duds should be destroyed in place (for methods of destroying see chapter 4).

## 218. SMALL-ARMS AMMUNITION.

a. **Inspection.** Small-arms ammunition will be examined before issue. The procedure for examination and the defects to look for are described in TM 9-1990. WDSB 9-AMM 4 contains essential information concerning the grading of small-arms ammunition and the disposition of fired components and unserviceable rounds in accordance with AR 775-10. Lots having more than 5 percent of defective cartridges will be subjected to 100 percent inspection, defective rounds culled out, the serviceable cartridges repacked prior to issue, and report made to the Chief of Ordnance. Normally, small-arms ammunition will have no visual defects unless it has been stored for a considerable period; ammunition with less than 5 percent visibly defective rounds may be issued without 100-percent inspection. If 20 percent or more are defective, the lot is withdrawn from

**Care, Handling, and Preservation**

service and held for disposition. The post ordnance officer should see that the troops are instructed as to the kinds of visible defects which can be readily detected and the correct manner in which to cull ammunition. Particular attention should be paid to incipient cracks which are not easily detected unless the thumb is pressed against the bullet, thus exposing the crack in the cartridge case. Defective cartridges will be considered as grade 3 ammunition.

**b. Identification.** Since different types of small-arms ammunition are of similar appearance, the kind of ammunition being issued will be strictly checked from the markings on the packing.

**c. Firing blank cartridges.** Blank cartridges should not be fired at a representative enemy at distances less than 20 yards, as the wad or paper cup may fail to break up.

**d. Misfires and hangfires.**

(1) For procedure in the event of an apparent misfire, see chapter 2, section I.

(2) When a hangfire occurs, in any lot, its use should be suspended and a report will be made as prescribed in AR 750-10 to the post ordnance officer, giving the number of the lot involved. The ammunition lot thus affected will be withdrawn and replaced by serviceable ammunition.

**e. Lodged bullets.** When a bullet lodges in the bore of a rifle, pistol, or machine gun, it should be removed by the application of pressure from the muzzle end of the weapon. *To attempt to shoot the bullet out with another cartridge is extremely dangerous and therefore prohibited.*

**f. Defective rounds.** Dented cartridges, cartridges with loose bullets, or otherwise defective rounds should not be fired.

**g. Misfires in blank firing.** Misfires in which the primer explodes but fails to ignite the powder charge have proved dangerous in firing automatic arms with blank-firing attachments. Some of the powder is blown into the bore and becomes lodged in the blank-firing attachments. A series of such rounds will cause an accumulation of powder sufficient to result in serious damage when ignited by a normal cartridge. When misfires in excess of 5 percent occur in firing blank cartridges, the firing of that lot of ammunition will be suspended and reported to the Chief of Ordnance.

**h. Armor-piercing ammunition.** The use of armor-piercing cartridges is prohibited in demonstrations in which tanks take part. When using armor-piercing ammunition, the cores of bullets which fail to penetrate will rebound. The radius of rebound depends on several factors but may be estimated, as a maximum of 100 yards for caliber .30 and 200 yards for caliber .50 armor-piercing ammunition.



**Care, Handling, and Preservation**

i. **Protection of ammunition.** After a container of ammunition is opened and cartridges issued, each man should take care of his own ammunition. The primer should be protected from blows by sharp instruments, as such a blow might explode the cartridge.

j. **Use of oil or grease.** The use of oil or grease on cartridges is prohibited. These agents cause injurious abrasives to collect in automatic weapons and produce excessive and hazardous pressures on the rifle bolts when nonautomatic rifles are fired. **NOTE:** This restriction is not applicable to 20-mm ammunition.

**219. ARTILLERY AMMUNITION.**

a. **Examination.** Before firing, representative samples from each lot of ammunition should be examined for visible defects such as exudation, corroded fuzes, looseness of projectiles in cartridge cases, damaged rotating bands, and excessive moisture and dampness, etc. If these defects are likely to cause difficulty when the fuze is set or the round is loaded into the gun, or question exists as to the safety and functioning of the ammunition, it should not be used until it has been examined by the service command ordnance officer or his assistants. Care should be used in condemning ammunition from use, as shell which are exuding slightly can be made serviceable as prescribed in War Department Supply Bulletins. Often, fuzes which are only slightly corroded or discolored are serviceable and can be used.

b. **Packings.** If the ammunition is packed in individual tin or fiber containers, the containers should be opened by means of the tear strip provided; the round should not be withdrawn from the container until it is to be fired unless the ammunition is loaded directly into the caisson. All powder charges except the charge to be served to the piece for the next succeeding round will be kept in their containers.

c. **Placing of ammunition.** At the firing point, ammunition which is not carried in caissons should be located to the left of the caisson, and not directly to the rear of the gun. It should be protected from moisture, dampness, and the direct rays of the sun by a tarpaulin so placed that air can circulate through the pile.

d. **Propelling charges.**

(1) **PREMATURE IGNITION.** The powder charge for a round will not be brought near the breech of the gun until the preceding round has been fired, the powder chamber carefully sponged with a wet sponge or cleared of any possible smoldering remains by use of the gas ejectors, and the face of the mushroom head has been wiped.

(2) **FLAREBACKS.** When the breechblock is withdrawn, the gases remaining in the bore sometimes pass to the rear and ignite upon striking the air, regardless of the direction of the wind. Flames of

Care, Handling, and Preservation

varying length and intensity result. Precautions must be taken to prevent the flame from reaching a new propelling charge, as well as to prevent serious burns to the breech detail.

(3) **BLENDING.** Propelling charges will be fired as received. Blending will not be resorted to except in special cases where the necessity therefor has been approved by the Chief of Ordnance, who will furnish the necessary instructions.

(4) **ERRATIC AND EXCESSIVE PRESSURES.** Erratic pressures or ranges may be due to deteriorating propelling charges, improper ignition of the propelling charges, defective or loose rotating bands, and, in the case of separate-loading ammunition, improper wrapping or lacing of the charge. Excessive pressures are likely to develop if the diameter of the propelling charge is altered so as to prevent the projection of the flame from the igniter to the front of the powder charge. For further information, see AR 750-10. All powder lots giving excess pressures should be immediately suspended from use, pending instructions from the Chief of Ordnance.

(5) **MAXIMUM RANGES.** The term "supercharge" is purposely used in referring to the propelling charge required to give maximum range. It cannot be too strongly emphasized that the "normal charge" should be used always within the ranges obtainable, and that the use of supercharges must be avoided except where maximum ranges are necessary. If this is not complied with, excessive wear of the guns will result. With multisection propelling charges, the complete charge is used when supercharge is desired; only the base section and such lower zone increments as may be required are used in the lower and intermediate ranges. Where the charge is of base and increment type, only the base charge is used when the normal charge is desired.

(6) **IGNITERS.**

(a) When loading the separate-loading propelling charge into the gun, be sure that an igniter is always on the end of the charge toward the breech. The cloth used for assembling igniters is dyed red and indicates clearly the end which should be at the rear of the chamber. The red dye also indicates that the igniter contains black powder. Undyed igniter cloth has been used, however, for some propelling charges now in the service. In this case the igniter end can be identified by the quilting used to hold the black powder in position and by the words "IGNITING POWDER" stenciled on the igniter.

(b) Propelling charges should not be placed in the gun with the igniter fastened to them by safety pins. Before firing, the safety pins should be removed and the igniter pad attached to the charge by sewing, the stitching being caught in at least three places, 120 degrees apart.



### Care, Handling, and Preservation

(c) It is the practice to pack one igniter in each cartridge-storage case. Surplus igniters remaining after firing should be destroyed in accordance with chapter 4.

(7) • TAGS AND PROTECTOR CAPS. Igniter-protector caps and data tags will be removed from propelling charges before loading into the gun.

#### e. Difficulties in loading or extracting ammunition.

(1) Difficulties in loading or extracting ammunition may be due to dented or bulged cartridge cases, or to foreign material in the chamber or bore of the gun. When the cartridge case is hard to extract, an inspection of the chamber should be made to determine whether the chamber is fouled, scored, or pitted. If it is fouled, it can be readily cleaned; but if it is pitted or scored, a report should be made to the post ordnance officer. The use of a tool to strike the base of a cartridge case to chamber rounds is prohibited. Personnel should be protected in case a round is partially chambered and the breechblock is completely closed. In a heater chamber, ignition of the propellant powder may occur.

(2) If a projectile cannot be readily extracted from the gun or if a projectile becomes separated from the cartridge case when the breech is opened, it should be fired out, if possible, particularly if the cartridge case will slip over the base of the projectile and will chamber in the normal position. If the cartridge case will not slip over the base of the projectile, the cartridge case should be shortened the necessary minimum amount; when this is done, a reduced charge should be used (approximately half of a normal charge) because of the reduced obturation, particular care being taken that the point of impact of the projectile is such as not to endanger personnel or property. If this is not possible, the projectile should be removed under the direct supervision of an officer, using a rammer which bears only on the projectile and provides for clearance around the fuze.

(3) If a rammer is used, extreme care should be exercised to prevent any force from being applied against the fuze. The Edwards rammer, designated as RAMMER, unloading, M1, is provided for this purpose for use with 75-mm point-fuzed projectiles (fig. 163).

(4) The removal of the projectile, whether by firing out or by ramming, should be done under the direct supervision of an officer.

f. Misfires. When a misfire occurs, the following precautions will be observed:

(1) FIXED OR SEMIFIXED AMMUNITION. Two attempts will be made to fire, except in the case of guns which cannot be recocked without opening the breech. Upon failure to fire for 30 seconds, the misfired round will be removed. If it is not possible to remove



Care, Handling, and Preservation

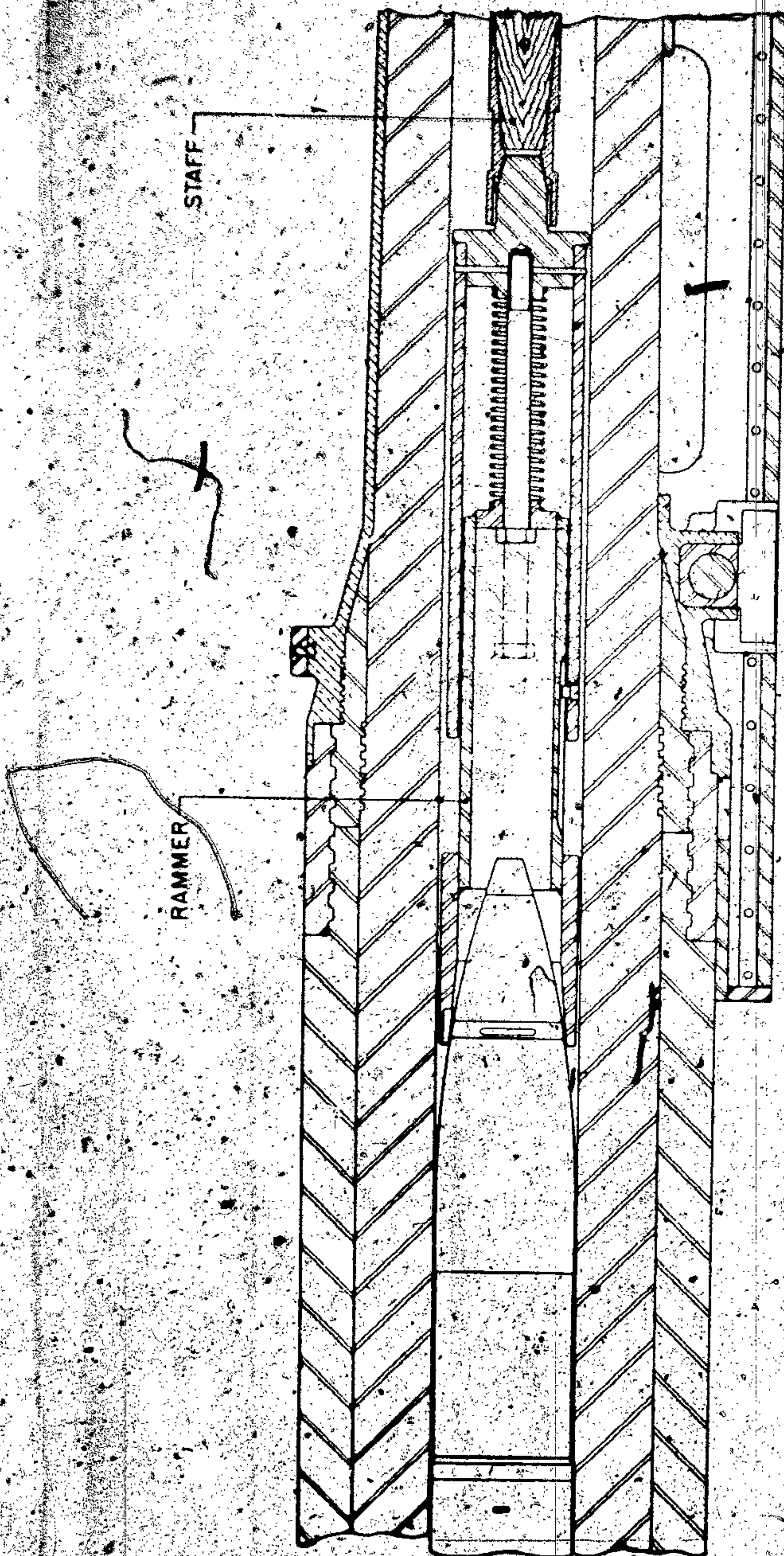

RA PD 4031

Figure 163 - Rammer M1 for 75-mm Guns - Method of Removing Shell From Gun



Care, Handling, and Preservation

the round from a hot tube within 45 seconds after the original misfire, water should be played on the barrel until it is cool. The safest time to remove a misfired round of fixed ammunition is between 30 and 45 seconds after its occurrence.

(2) SEPARATE-LOADING AMMUNITION.

(a) Two attempts will be made to fire the primer before it may be removed. If the primer is heard to fire, a minimum of 60 seconds will be allowed before the breech may be opened and the faulty charge removed. The faulty charge must be stored separately from other charges.

(b) If the primer is not heard to fire, two more attempts to fire will be made. Then proceed as follows:

1. If the primer can be removed by a person standing clear of the path of recoil, after 2 minutes have elapsed, the primer may be removed and a new one inserted. If the second primer fails, 10 minutes should be allowed to pass and then the breech may be opened.

2. If the primer cannot be removed safely as described above, no attempt will be made to open the breech or replace the primer for 15 minutes.

(c) Misfire primers should be handled carefully and disposed of quickly, owing to the chance of a primer hangfire. Further information will be found in AR 750-10 and the Technical Manuals and Field Manuals pertaining to the piece.

g. Fuzes.

(1) Extreme care must be taken in handling and assembling fuzes to shell or bombs. All fuzes must be treated as delicate mechanisms. The forces which arm a fuze on firing a weapon can be simulated by rolling or dropping, and a fuze so armed may be functioned by the impact of a blow or by dropping.

(2) In the assembly of fuzes and projectiles, the fuze body, threads, adapter, and fuze cavity must be inspected to insure that grit, grease, or other foreign material is not present. This is necessary for proper seating of the fuze without the use of excessive force. Cleaning of the fuze cavity should be accomplished with a piece of cloth and a small stick which can be inserted into the cavity. Fuze hole lifting plugs should not be removed except for inspection or when the fuze is about to be inserted.

(3) When ammunition or projectiles are issued fuzed, no attempt will be made to remove the fuzes without specific authority and instructions from the Chief of Ordnance.

(4) Fuzes will not be altered. Any attempt to alter or disassemble fuzes in the field is dangerous and is prohibited except under specific direction of the Chief of Ordnance. The only authorized assembling or disassembly operations are screwing the fuze into th

### Care, Handling, and Preservation

projectile if the round was not issued fuze, or unscrewing the fuze from the projectile if not fired.

(5) Every precaution should be taken to keep moisture away from powder-train time fuzes.

(6) Time fuzes are always issued set "safe," and if not used after making a setting, they should be reset to safe before storing.

(7) When ready to be loaded into the gun, each round which contains a time fuze or point-detonating fuze should be kept out of the path of recoil until recoil of the previous round has taken place; this practice will prevent a heavy blow on the fuze. If fuzed rounds are accidentally struck in this manner, they will not be fired under any circumstances but will be immediately placed in a segregated location and reported to the post ordnance officer for examination and necessary action.

(8) When checking the accuracy of fuze setting by cutting trial fuzes, no fuze should be cut more than twice.

## 220. BLANK AMMUNITION.

a. Only blank ammunition furnished by the Ordnance Department will be used. Blank ammunition is issued to the using services in complete rounds only. Smoke-puff charges or blank ammunition will not be improvised when they are not provided.

b. If kept intact, handled with care, and protected from heat, the complete round of blank ammunition is comparatively safe. The following precautions, however, should be observed:

(1) Under no circumstances will rounds of blank ammunition be tampered with in the field.

(2) Blank ammunition should not be removed from the fiber container sooner than is necessary before firing. Remaining rounds should be kept away from the gun.

(3) Identification of the ammunition before firing must be positive, and no attempt should be made to use it in a gun other than that for which it is intended.

(4) Any round in which the chipboard closing cup is not firmly in place should not be fired and should be handled with care until disposed of as directed in chapter 4.

## 221. PYROTECHNICS, GRENADES, AND CHEMICAL AMMUNITION.

a. Pyrotechnics and grenades should be located some distance either to the right or left of the firing points, never directly behind. Protective measures against grass fires should be provided, and extreme care should be taken to prevent a grenade or piece of burning pyrotechnic material from dropping into boxes of ammunition.



---

*Care, Handling, and Preservation*

---

Pyrotechnics which have been unsealed should be disposed of as provided in OFSB 3-9.

b. In order to prevent accidents from the use of lethal or toxic chemical ammunition, no live chemical ammunition other than non-toxic smoke and nontoxic lachrymatory gas will be used for training purposes, including target practice, demonstrations, and tactical exercises; except under the personal and direct supervision of a commissioned officer of the Chemical Warfare Service. This limitation does not apply to the use of instructional gas identification sets or detonation gas identification sets. Smoke-producing materials will not be released in training within 300 yards of personnel, livestock, buildings, equipment, or other objects which may be damaged. Equipment contaminated with corrosive acids produced by liquid smokes will be washed with water as soon as possible except when other methods of protection or cleaning are prescribed in the appropriate Technical Manuals.

c. Burning-type grenades, smoke pots, and two-compartment candles should be stored in a cool, dry place. They should not be ignited within 5 feet of dry grass or other inflammable materials. Burning-type grenades will not be fired closer than 20 feet from personnel, because grenades occasionally flash. When firing smoke pots, care should be taken not to have the face directly above the smoke pot.

d. Unfuzed grenades will not be fuzed in ammunition dumps or storage magazines, or in greater quantities than are needed for immediate use.

**222. BOMBS.** Altitudes and distances safe from fragmentation and blast effect will be specified by the Commanding General, Army Air Forces (par. 21, AR 750-10, 22 January 1944). Safety precautions and methods of unfuzing, disassembly, and handling bombs are contained in TM 9-1980. All live bombs will be carried safe and will not be armed until released.

**223. MORTAR AMMUNITION.** The same safety precautions will be observed in the field in the handling and use of mortar ammunition as apply to artillery shell (par. 219). Further information will be found in FM 23-85 and FM 23-90.

CHAPTER 4

**DESTRUCTION OF AMMUNITION IN ZONE OF THE INTERIOR**

**224. GENERAL.**

**a. General.**

(1) The instructions set forth in this section are for destroying limited quantities of explosives and ammunition. The term "limited" is defined in subparagraph d, below. When larger quantities are to be destroyed or the instructions set forth cannot be complied with, special instructions will be furnished by the Chief of Ordnance.

(2) Unserviceable ammunition, ammunition components, and explosives which constitute a hazard, cannot be salvaged, or are unfit for their intended purpose and cannot be used to advantage for any other purpose should be destroyed in accordance with existing regulations. As a general rule at Class I, II, or III installation, the only ammunition items requiring destruction are obsolete or deteriorated ammunition (which may be considered together) and duds.

(3) Lumber which has been exposed to explosives and which cannot be readily decontaminated should be destroyed by burning only under conditions approved for safety. Examples of such lumber are wooden sections of tanks, vats, hoods, pipe lines, etc., in which hazardous material is impregnated. However, if wood has been exposed to explosive material to a limited extent, it may be possible to decontaminate it completely by washing or steaming.

**b. Responsibility and procedure.** Prior to destruction, an Ammunition Condition Report (O.O. Form 517—formerly O.O. 7235) will be submitted to the Chief of Ordnance in order that the disposition may be approved. This report will be prepared in accordance with instructions on the reverse side of the form. An exception is deteriorated explosives or ammunition which is found to be immediately dangerous to life or property; in such instances, disposition may be made by order of the local commanding officer. The responsibility for disposition is a function of the inspector; the responsibility for destruction is a function of the post ordnance officer. Where local break-down of unserviceable ammunition is ordered, technical instructions for the work will be furnished by the Chief of Ordnance.

**c. Methods.** Destruction of explosive material will be accomplished by burning, exploding, or dumping at sea, as specified below. Burying of explosives or ammunition or dumping them into waste places, pits, wells, marshes, shallow streams, or inland waterways is *absolutely prohibited*; except that loose black powder (par. 227) may be disposed of by dumping into a stream or body of water. Methods for destruction are generally based on the number of units to be destroyed, the size and nature of each unit, the facilities available, and the topography of the land.



Destruction of Ammunition in Zone of the Interior

d. **Quantity of ammunition and explosives.** By a "limited" quantity of ammunition and explosives, this section refers to the number of unexploded shell and other ammunition normally found on a target range or in the field as an accumulation from firings or other peacetime maneuvers. Larger quantities, generally referring to ammunition resulting from deterioration in storage or from obsolescence, are to be destroyed according to specific instructions from the Chief of Ordnance.

e. **Materials used in destroying by explosion.** Charges of 1/2-pound blocks of TNT or sticks of dynamite are used. These are set off either by time fuse (safety fuse) and a blasting cap, or by a magneto and an electric blasting cap. In no case will "instantaneous" fuse be used. For demolition purposes nitrostarch blocks have been authorized as a substitute for TNT blocks. Nitrostarch is a hard dense substance considerably more sensitive to friction and impact than TNT. *The crushing or breaking of the nitrostarch blocks is hazardous.* Dynamite is not to be used in the destruction of duds.

f. **Materials used in destroying by fire.** Fires used in destroying small ammunition components may be made from scrap lumber, wood, or such material as excelsior. When components to be destroyed are laid on the pile before lighting, the fire will be lit from a distance by means of a train of inflammable material or by a charge of black powder ignited with an electric squib.

g. **Specific types.** Information dealing with the particular type to be destroyed will be found in the paragraphs following.

h. **Demolition methods.** For details of methods and procedure of demolition work, consult FM 5-25.

**225. DUMPING AT SEA.**

a. When burning or detonation of explosives or ammunition is impractical, dumping at sea at depths not less than 900 feet and not less than 10 miles from shore is permitted. Before disposal, by dumping in the sea, of any ammunition, every effort will be made to salvage it for further use or reclamation of component parts. Dumping in the sea will, in every instance, be done only upon War Department order.

b. Navy, Coast Guard, and port authorities must be consulted and their regulations regarding transfer and disposal of material of this nature must be observed. Ammunition items must be removed from containers before being dumped overboard. The location selected for dumping should be appreciably deeper than surrounding locations to preclude the possibility of ammunition being washed toward the shore by tidal action.



*Destruction of Ammunition in Zone of the Interior*

c. In transit, the boat or barge will display a large red flag at least 10 feet above the deck and a competent person will be constantly on the alert to warn approaching craft of danger. When necessary, a War Department representative, who is familiar with the hazards involved in handling ammunition, will accompany commercial vessels contracted to dump such material in the capacity of a safety adviser.

**226. SAFETY PRECAUTIONS.**

a. **General.** Safety is the major consideration in destroying ammunition and explosives. It is highly advisable to test all safety devices beforehand by subjecting them to the severest test they may be called upon to withstand, provided that such test is reasonable and practicable. Only after safety requirements have been met should salvage and economy be considered. It may be necessary to improvise apparatus to accomplish the desired results, and it is essential that the destruction procedure be analyzed and planned in detail for compliance with the general safety precautions in chapter 3, section I. The general safety precautions that must always be complied with in destroying ammunition are described below.

b. **Selection of site.**

(1) **FOR DESTRUCTION BY BURNING.** The selection of a site for destruction of explosives by burning should be based on the principle of obtaining the maximum practicable distance from all magazines, inhabited buildings, operating buildings, public highways, and railways. Consideration should be given to the direction of prevailing winds. Wherever possible, natural barricades should be utilized between the burning site and operating buildings and magazines. The burning site should be approximately inhabited building distances from all structures and public thoroughfares.

(2) **FOR DESTRUCTION BY DETONATION.** The selection of a site for destruction of ammunition by detonation is based on the same principles as in step (1), above. Such a site should be 3,600 feet from public highways, public railways, inhabited buildings, magazines, and operating buildings. Where this distance cannot be obtained, a pit or trench should be used to limit the range of missiles. The 3,600-foot limitation does not apply where substantially constructed destruction chambers are used. Pits will not be required when the destruction takes place on an artillery range or similar site where a cover of earth 2 feet thick should be used to limit the range of fragments. Combustible rubbish should be destroyed at a location removed from those places where explosives and explosive-contaminated material are destroyed. Where limited space does not permit separate burning grounds, a part of the explosive destruction may be reserved for burning rubbish, provided the two areas are not operated simul-



Destruction of Ammunition in Zone of the Interior

taneously. Such an area should be enclosed by a substantial wire mesh, not over 1/2-inch mesh.

c. **Maintenance of grounds.** All dry grass, leaves, and other inflammable materials within a radius of 200 feet from the point of destruction will be removed. Fire-fighting facilities for combating grass fires should be kept readily available and, if practicable the ground at the point of destruction should be wet down with water at the close of each day's operations. The use of concrete mats for burning or detonation is not permitted.

d. **Protection for personnel.** Personnel engaged in demolition work should always have ample time to reach shelter affording substantial overhead cover and splinter-proof protection. The signal for detonation should be given by the individual setting the blastings, and only after all personnel in the vicinity are protected by substantial cover or have reached a safe distance. If an electric blasting machine is used, the wires will not be connected to the terminal until all persons have reached cover and the person in charge of the blasting is assured that the area is properly cleared of all personnel. Dependent upon local conditions, temporary or permanent barricades will be provided and safety distances will be observed by all persons.

e. **Safety distance requirements for preparation of primers and demolition charges.** It is extremely important that personnel take adequate precautions to prevent accidental explosions while preparing primers for demolition activities. In addition to the general safety precautions currently in force, the following safety rules for the preparation of primers and demolition charges will be strictly observed.

(1) Test burning of time fuse (safety fuse), for determination of rate of burning of the roll, will be done at a minimum safety distance of 25 feet from exposed blasting caps or explosives in the direction toward which the air current is moving.

(2) Cutting square across end of time fuse (safety fuse), remove and discard 2 or 3 inches of fuse from each roll.

(3) Cut off and test a 1-foot length from each roll for determination of burning time. All fuse in the same roll should burn at a uniform rate, though rate of burning may vary from approximately 45 seconds per foot in different rolls.

(4) The supply of blasting caps for the required operation will be at minimum of 25 feet from the supply of explosives.

(5) The preparation of nonelectric primers will be performed not less than 25 feet from the supply of blasting caps or explosives.

(6) Cut sufficient time fuse (safety fuse) to permit firer to reach a place of safety before the charge explodes.

(7) Select one nonelectric blasting cap, hold it open end down



Destruction of Ammunition in Zone of the Interior

and shake gently to remove dirt or other foreign matter. Hold the desired length of time fuse (safety fuse) vertical and gently slip the cap down over the fuse until the explosive is in contact with the end of the fuse. If the fuse appears too large to enter the blasting cap easily, the end to enter the cap may be rolled between the fingers.

**CAUTION:** Do not use force.

(8) When the fuse is properly seated within the cap, place a standard-type cap crimper over the cap at the fuse end, hold by the fuse and crimp cap to fuse.

(9) No more than six blasting caps will be permitted at the site selected for preparation of primers at any one time.

(10) The priming of explosives will be performed at a distance of not less than 25 feet from the site of any other permissible storage or operation point involved in connection with the preparation of primers and demolition charges.

(11) Not more than one primed charge of explosives will be permitted at any site at any one time.

(12) The preparation of primers and the priming of explosives will not be performed in advance of requirements for use of same, in view of possible atmospheric effects.

(13) Bring to the site of the operation only sufficient explosives to meet the requirement of the operation involved.

**f. Removal from containers.** Explosives or ammunition to be destroyed by burning will be removed from containers, as any attempt to burn explosives or ammunition under even slight confinement may result in an explosion or detonation.

**g. Determining quantity to be destroyed.** The quantity of material to be destroyed at one time will depend upon local conditions. This quantity will be carefully determined by starting with a limited number and then gradually increasing that number until the maximum which can be destroyed without damage to surrounding property or causing disturbance to civilian areas is determined. The responsible individual will make sure before he gives the signal for detonation that there is no unauthorized person in the danger area and that all authorized persons are protected by adequate distance and cover.

**h. Collection of unexploded ammunition.** As some types of ammunition are comparatively difficult to explode, a search of the surrounding grounds should be made after each blast and any material which has been thrown from the pit and not detonated should be collected and included with the next charge to be destroyed.

**i. Segregation of material awaiting destruction.** Explosives or ammunition awaiting destruction will not be piled within 200 feet of the point of destruction and will be protected from grass fires, burn-



*Destruction of Ammunition in Zone of the Interior*

ing embers, and flying fragments. All dry grass, leaves, and other inflammable material will be removed from the area within a radius of 50 feet of the pile.

j. **Caution against re-ignition.** In repeating burning operations care will be taken to guard against material being ignited from burning residue or heat in the ground.

k. **Improvising.** The use of improvised methods for exploding, blasting caps is prohibited.

l. **Misfires.** In case of a misfire, personnel will not approach the pit, trench, or point of detonation until a period of 30 minutes has elapsed.

m. **Use of trained personnel.** Destruction of ammunition will never be attempted by inexperienced or untrained personnel. The number of personnel engaged in such operations will be kept at a minimum consistent with safety, but no person will be permitted to work alone.

n. **Guarding demolition area.** Guards, safety signals, and warning signs will be used as required to keep unauthorized personnel from danger areas during destruction operations.

o. **Additional instructions.** In the absence of specific regulations or information covering any phase of the destruction of explosive material, instructions will be requested from the Chief of Ordnance.

**227. BULK EXPLOSIVES:**

a. **Black powder.** The safest method of destroying black powder is to dump it in a stream or body of water; if no suitable body of water is convenient, it may be burned. Only tools of wood or non-sparking metal will be used in opening the containers. The contents of one container only will be burned at one time provided that quantity does not exceed 50 pounds. The powder must be removed from the container and spread out on the ground in a train about 2 inches wide, care being taken that no part of the train parallels another part except at a distance of more than 10 feet. A train of inflammable material, such as excelsior, about 25 feet long and extending to windward must be used to ignite the powder, as the resulting flare of explosion is so quick that there will be no opportunity to withdraw. The emptied containers will be thoroughly washed on the inside with water, as serious explosions have occurred with supposedly empty black-powder cans. Safety precautions, particularly those in paragraph 226, should be observed. Wet black powder on drying may resume its explosive properties.

b. **TNT, explosive D, and tetryl** will be destroyed by burning. They must not be dumped into water, as they poison it. The explo-

*Destruction of Ammunition in Zone of the Interior*

sive to be burned will be removed from containers and spread in a thin layer, not more than 3 or 4 inches thick, on another layer of inflammable material, such as excelsior. A train of inflammable material will be used to ignite the explosive. Safety precautions in paragraph 226 should be observed. High explosives should not be burned in lump form. If explosives must be burned in lump form, the quantities should be less than stipulated below for loose explosives, and an explosion may occur. Instances are on record of explosives below (which in most instances burn), detonating while being burned. The maximum amounts of loose high explosives which may be burned at one time shall be limited as follows:

- (1) DNT, TNT, explosive D—500 pounds.
- (2) Pentolite, tetrytol—250 pounds.
- (3) Tetryl, composition A, B, and C, RDX, haleite—50 pounds.

c. **Smokeless powder.** Small quantities of smokeless powder (a few boxes) up to 500 pounds may be destroyed with safety if the powder is removed from the containers and spread out on bare ground in a train of limited width and thickness dependent upon the granulation of the powder. A train of inflammable material about 25 feet long on the windward side, should be used to ignite the powder; this allows personnel sufficient time to get away from the intense heat which is generated when smokeless powder burns. Safety precautions in paragraph 226 should be observed.

d. **Dynamite.** Not more than 100 pounds are to be destroyed by burning at one time. To destroy by burning, dynamite cartridges, except frozen cartridges, should be slit lengthwise into halves with an ordinary knife; knives with closing blades should not be used. The slit cartridges are placed in a single layer, not greater in width than the length of one cartridge, on hay, excelsior, or other combustible material. The combustible train should be of sufficient length to allow personnel to reach cover or a safe distance before the dynamite begins to burn. The dynamite containers should be burned at the same time. Dynamite awaiting destruction should be shielded from the direct rays of the sun. Frozen cartridges shall be carefully thawed, in accordance with instructions contained in FM 5-25, prior to burning.

e. **Other explosives.** If it is necessary to destroy other explosives, such as mercury fulminate, lead azide, picric acid, etc., special instructions will be requested from the Chief of Ordnance.

**228. SEPARATE-LOADING PROPELLING CHARGES.** Extreme precautions will be taken against sparks. The smokeless powder charges will be removed to the burning ground before being opened. There the powder will be removed from the bag by cutting one of the seams, care being taken not to disturb the black-powder igniting charge. The empty bag and igniter should be immediately and com-



Destruction of Ammunition in Zone of the Interior

pletely submerged in water and the igniter cut open under water. The smokeless powder will be burned as described in paragraph 227 c. The igniter and cartridge bags, after having been thoroughly soaked in water for at least 72 hours, should be removed and allowed to dry in the open; they may then be burned in a pit or trench. Soaking in water is absolutely necessary because the confinement of the black powder by the powder bag, slight as it may be, is sufficient to cause explosion and projection of the burning bags and igniters to distances of 200 feet or more. Bags and igniters awaiting destruction by fire must be kept in a securely closed container. It is permissible, when practicable, to destroy bags and igniters by dumping them in a body of water after the propellant powder has been removed and the various sections of the quilted igniter are cut open while the bag and igniter are still submerged in water. This cutting is necessary to release air trapped in the quilted igniter sections, which would cause the bags and igniters to float on top of the water.

**229. ARTILLERY SHELL.**

a. The following general instructions for destroying artillery shell by detonation also apply to bombs, mortar shell, rocket shell separated from their motors, and other relatively large components containing high explosive. However, it must be kept in mind that bombs, mortar shell, rocket shell, and antitank mines, are composed of as much as 60 percent by weight of explosive and have relatively thin walls, as compared with the 10 to 15 percent of explosive and the relatively heavy walls of artillery shell. Therefore, the number of units of bombs, mortar shell, rocket shell, and mines destroyed in one operation should be reduced accordingly. Shaped charges require extreme care in destruction and should be accomplished in small quantities or singly. Fixed shell and rocket shell (heads) will be disassembled from complete rounds and destroyed in the same manner as separate-loading shell (see below). Before undertaking any demolition operation, the proposed procedure will be checked against the safety precautions prescribed in paragraph 226.

b. The following general instructions contemplate the use of a pit or bombproof hut. An artillery range or similar site, when available, may be used. Note especially paragraph 226 b (2).

c. The projectile to be destroyed will be placed on its side in a trench or pit about 4 feet deep. The number of TNT blocks (or their equivalent) specified in the following table will be placed in contact with the side of the projectile and held in position by earth packed around the projectile. The TNT block is placed on its side; if two blocks are used, one is placed on top of the other. If three blocks are used, two are placed close together on the shell and the third on top of these. If five blocks are used, there will be two layers of two blocks each, with a fifth on top. The demolition blocks are

Destruction of Ammunition in Zone of the Interior

detonated by means of an electric blasting cap or miner's safety fuse and cap.

DESTRUCTION OF SHELL BY DETONATION

Caliber of Shell To Be Destroyed	No. of 1/2-pound TNT Blocks or Their Equivalent
37-mm, 57-mm	1
75-mm, 76-mm, 3-inch	2
120-mm, 155-mm, 6-inch	3
8-inch, 240-mm	4
10-inch, 12-inch	5
14-inch, 16-inch	6

d. One end of the required length of time fuse (safety fuse) (par. 226 e) will be cut and inserted in a C or E special blasting cap until it just touches the charge. The cap will then be lightly crimped to the fuse with a fuse crimper or suitable tool, care being taken not to press the fuse too tightly against the fulminate charge of the blasting cap. A No. 8 electric blasting cap with the necessary length of lead wire and a hand exploder may be used instead of the blasting cap with miner's safety fuse. The blasting cap will be placed in the hole drilled in the TNT block (the top block when more than one block is used), and if necessary tied around it to hold it securely in place. In no case should a cap weaker than the ordinary commercial No. 8 blasting cap be used.

e. In case of a misfire, the precaution in paragraph 226 l should be observed. After the blast, comply with paragraph 226 h.

f. Point-fuzed shell fitted with Mark series adapters and boosters can be detonated without the use of TNT blocks. A No. 8 blasting cap securely held in place in the fuze cavity with a small amount of mud packed around the top of the cap will usually insure complete detonation of loaded shell.

**230. BLANK AMMUNITION FOR CANNON.** Rounds of blank ammunition which have misfired will be destroyed locally under the supervision of a commissioned officer or personnel designated for this purpose by the service command ordnance officer. All precautions for handling black powder, chapter 1, section IV, and for destroying ammunition, paragraphs 226 and 227, should be observed. An extractor (brass) having a wood-screw thread can be used to remove the closing cap and wad; the black powder pellets may be removed by tipping the cartridge case forward and catching them in the hand; and the primer may be removed by means of a press having a hollow guide and/or ram to carry force of possible primer functioning away from the operator. Before removing the primer with a press, be sure that corrosion will not bind the primer and cause the application of too much pressure. Also, be sure to take all possible precautions to see that no powder dust adheres to the primer.



Destruction of Ammunition in Zone of the Interior

**231. BOMBS.** Bombs should be destroyed in accordance with paragraph 229. However, bombs have such thin walls and contain so much more explosive than shell of corresponding weight and usually detonate so completely that extreme precautions must be taken to avoid structural damage to buildings and injuries to personnel. The destruction of bombs larger than 100 pounds should not be undertaken without the specific approval of the Chief of Ordnance. Bombs awaiting destruction should be segregated in small piles 100 feet or more apart and at least 300 feet from the detonating pit. Extreme precautions must be taken to protect bombs awaiting destruction against accidental detonation by fire, fragments, or sympathetic detonation.

**232. MORTAR SHELL.** Mortar shell should be destroyed in accordance with the instructions in paragraph 229. Care will be taken to limit the number destroyed at any one time and to protect shell awaiting destruction from flying fragments.

**233. ROCKET SHELL.** Rocket shell, which are separated from their motors, should be destroyed in accordance with the instructions in paragraph 229. Care will be taken to limit the number destroyed at one time and to protect shell awaiting destruction from flying fragments. Rockets having motors attached thereto will be destroyed in accordance with instructions from the Chief of Ordnance.

**234. PENTOLITE AND TETRYTOL-FILLED AMMUNITION.**

a. Ammunition filled with pentolite or tetrytol have shaped charges. These include high-explosive antitank shell, grenades, and rocket shell, and demolition shaped charges. Extreme care should be observed in destroying this type of ammunition, and the following precautions should be observed:

(1) Only small quantities or single items should be destroyed at one time.

(2) Fragmentation as well as blast effect should be expected and guarded against.

**235. SMALL-ARMS AMMUNITION.**

a. All unserviceable caliber .22 and shotgun ammunition will be destroyed locally. Ordnance field representatives, within their jurisdiction, are charged with the disposition of all other unserviceable small-arms ammunition and accumulations from rings. Reference to WD SB 9-AMM 4 should be made for procedure to be followed in disposition.

b. Small-arms ammunition should be destroyed in a pit which is approximately 6 feet square and 4 feet deep. An inclined chute such as a piece of 2-inch pipe should be provided, and this chute should be placed so that one end is over the center of the pit and the



**Destruction of Ammunition in Zone of the Interior**

other behind the barricade. Precautions should be taken to baffle the open end behind the barricade so that the operator cannot look down the pipe. A hot fire should be built in the pit, and then the pit should be covered with a piece of sheet iron or other suitable material to confine flying fragments. The cartridges should be fed into the fire through the pipe, and care should be taken to prevent an accumulation of unexploded ammunition in the pit. A furnace or burning kettle designed to accomplish the above destruction by burning is also satisfactory. Approved equipment and building drawings showing barricades will be supplied by the Chief of Ordnance on request.

**236. SMALL COMPONENTS EXCEPT PRIMERS.**

a. These components, artillery and grenade fuzes, boosters, detonators, and similar material, may be destroyed either by burning or by detonating. For destruction of primers see paragraph 237.

b. In destruction by burning, the same instructions given in paragraph 235 b for the destruction of small-arms ammunition should be followed. Caution should be exercised in introducing components into the fire because normal action cannot be expected under intense heat. The explosion of a previously introduced component should be heard before introducing another.

c. When destroying these components by detonation, a small number of components, depending upon the type and kind, should be placed in contact with one another in an open container. This container should then be placed in a pit or trench approximately 4 feet deep. On top of each container and in contact with the components, one or more TNT blocks fitted with an electric blasting cap or with a C of E special blasting cap and time fuse (safety fuse) should be placed. The pit should then be covered with a layer of logs and earth or other suitable cover, and the components should then be detonated in accordance with the safety precautions outlined in paragraphs 224 and 226.

d. The following method of destruction of unserviceable HE antitank mine fuzes should be followed:

(1) The available safety distances will determine the number of fuzes that may be destroyed at one time (based on actual fragment distances reported from destruction of fuzes in quantities) together with recommended minimum safety distances for each, as set forth below:

(a) Where pile is covered with earth (2 feet):

No. of Fuzes	Fragment Distance (approximate yards)	Recommended Safety Distance (minimum yards)
12	200	400
56	350	525
152	525	800
702	525	800



**Destruction of Ammunition in Zone of the Interior****(b) Where pile is not covered with earth:**

No. of Fuzes	Fragment Distance (approximate yards)	Recommended Safety Distance (minimum yards)
702*	800	1200

\*Other quantities may be selected for detonation at one time, although 702 was adopted as reaching the upper limit of efficiency in piling.

(2) Between storage point and destruction area, handle all fuzes with striker end up; exercise extreme care and caution.

(3) Make a double pyramid pile of the quantity selected for destruction; the bottom row should be on level ground or on a wooden board of sufficient length to carry the bottom row of the pile. Place the fuzes on the side with the rows base to base, in intimate contact, and with the projecting portions of the safety fork fitted into the grooves carrying the same component in the adjacent fuzes. The fuzes must be kept in contact with each other.

(4) Place two No. 6 or No. 8 blasting caps (lightly taped if necessary to hold them in position) side by side between the bases of the two top fuzes of each pyramid so that the end of the caps is at the approximate center of the base of the fuze. A slight "mud capping" of the caps is desirable if carefully applied. The pile is then ready for detonation.

**237. PRIMERS.**

a. Large primers, 100-grain or more, may be destroyed by burning according to the instructions for destruction of small-arms ammunition in paragraph 235. b. Primers, other than small-arms primers, are dropped one at a time into the fire. Large primers will be destroyed only in this manner because they are subject to explosion in mass if destroyed by burning in large quantities.

b. Primers, except the 100-grain or larger primers, may be burned in a trench approximately 2 feet deep, 1 foot wide, and of sufficient length to accommodate the number of primers to be burned at one time. The trench should be prepared with a quantity of excelsior or similar combustible material sufficient to insure a hot fire throughout its length. The primers should be removed from boxes and placed on the excelsior before the fire is lighted. Pasteboard cartons need not be opened before they are placed in the trench. To confine fragments as much as possible, a piece of sheet metal should be placed over the trench. After the primers and cover are in place, a train of combustible material leading into the pit should be prepared and lighted. Personnel should then take cover or withdraw to a safe distance.

c. If a suitable tank or kettle is available for use, a smaller number of primers may be placed in it and a small-mesh screen placed over the top. By building a fire underneath, the primers will be exploded. A convenient receptacle is an iron tank cut in half

*Destruction of Ammunition in Zone of the Interior*

longitudinally and the open side placed on railroad iron or other suitable grating that will not let the primers drop into the fire. A large hole, approximately 12 inches in diameter, with a pipe located above the height of a man's head, should be provided and about 50 primers put in at one time. The boiler should be equipped with a smokestack so that a draft will be formed through the grating. Packing material, if inflammable, need not be removed from the primers.

d. If a burning pit constructed of railroad iron or similar material is available, a fire may be built in it and a box of primers destroyed at one time (provided the packing is inflammable) by throwing the box into the pit and taking cover.

e. The smaller end vent primers may be destroyed by building a firebox, over which a basket of primers may be pulled on railroad iron from behind a barricade. The fire should be started before the primers are pulled over it. When all primers have been fired, the basket should be pulled off, emptied, cooled, reloaded, and again pulled over the fire.

f. The stock of primers awaiting destruction will not be allowed within 300 feet of the burning operations, and great care will be taken to protect the pile from accidental ignition by flying fragments or sparks. This stock will be limited to a day's supply. Other applicable regulations contained in paragraph 226 will be strictly observed.

**238. GRENADES.**

a. **General.** Grenades may be destroyed by burning or detonation in accordance with the following instructions. Strict compliance with applicable regulations of paragraph 226 is essential for the protection of personnel and property. Destruction by detonation should generally be applied to high-explosive grenades, whereas destruction by burning is applied generally to other types of grenades.

b. **Destruction by detonation.** Not more than twenty grenades should be placed in a pit about 4 feet deep. They should be piled so that they come in close contact with each other; on top of the pile should be placed, in intimate contact, three 1/2-pound TNT blocks, one of which is provided with an electric blasting cap or C of E special blasting cap fitted with several feet of time fuse (safety fuse). The grenades and TNT blocks should be covered with a layer of earth about 1 foot thick which is tamped lightly to obtain the maximum efficiency of the TNT blocks, and the pit should be covered as prescribed in paragraph 226.

c. **Destruction by burning.** A pit 2 feet square by 3 feet deep fitted loosely with an iron plate or heavy board cover is used. Grenades should be put in the fire one at a time. Another should



Destruction of Ammunition in Zone of the Interior

not be put in until the previous grenade is detonated. Care should be taken in introducing explosives into the fire, as normal action cannot be expected under intense heat. The only time to investigate an unusual delay in the explosion of a grenade is when the fire has burned out and the pit is cold. Instead of dropping grenades singly and covering each time, an inclined chute which is baffled at the open end may be used.

**239. PYROTECHNICS.**

a. **General.** Pyrotechnics, except photoflash bombs and parachute flares, will be destroyed in accordance with the instructions for burning of primers (par. 237.b). Loose pyrotechnic materials should be burned under the same conditions as black powder and the same precautions should be observed (par. 227 a). Water-wet pyrotechnic materials may be burned in small quantities in furnaces designed for that purpose and approved by the Chief of Ordnance.

b. **Parachute flares.** Parachute flares will be destroyed by burning in the open and in a vertical position on the ground. The individual flares must be located at least 4 feet apart and placed on top of a layer of combustible material. After lighting the train of combustible material, personnel should take cover and observe safety distances.

c. **Photoflash bombs.** Photoflash bombs are dangerous and should be handled with care. They should be destroyed by the use of TNT blocks, similar to the procedure for artillery shell (par. 229). Duds of photoflash bombs should not be handled or moved but destroyed in place in accordance with instructions in paragraph 242. Due to the thinness of the case, a single block of TNT is sufficient to accomplish destruction. A strict compliance with the applicable regulations of paragraph 226 is essential.

**NOTE.** *Due to the brilliance of the flash, it is injurious to vision to watch the destruction of photoflash bombs even at distances prescribed in this manual as safe against fragments.*

**240. CHEMICAL AMMUNITION.**

In general, grenades, bombs, and shell loaded with chemical filler should be destroyed in a manner similar to that prescribed in paragraph 229 for destroying artillery shell. Before destroying chemical ammunition, however, special instructions should be obtained from the Chief of Ordnance concerning any exceptional hazards. When a leaking shell or component is located, the individual in charge of the magazine will be notified in order that he may direct the disposition of the shell. As chemical shell contains a comparatively small amount of explosives, the charge of TNT blocks to be used for demolition should be as follows:

## Destruction of Ammunition in Zone of the Interior

Chemical Shell or Component	No. of 1/2-pound TNT Blocks or Their Equivalent
75-mm shell	4
155-mm shell	5
8-inch shell	6
60-mm and 81-mm mortar	2
4.2-inch chemical mortar shell	3
8-inch chemical mortar shell	3
5-lb bomb	1
25-, 30-, and 50-lb bomb	2
100-lb bomb	3

## b. Dangerous chemical ammunition.

(1) Immediately hazardous unserviceable chemical ammunition may be destroyed by exploding in the open if a sufficiently isolated area is available. The point where the shell is exploded should be chosen so that for a period of approximately 48 hours personnel can be excluded from the area 1 mile downwind from the point where the shell is exploded. For a period of about 2 weeks, all personnel must be prevented from passing within a distance of 150 yards from the point where the shell is exploded. Where a sufficiently isolated area is not available, single unserviceable gas-filled shell may be destroyed in a pit 6 feet deep. The shell with its bursting charge is placed at the bottom of the pit, the pit is back-filled, and the shell exploded. Five gallons of freshly prepared bleaching solution should be poured on the fill, and sufficient dry bleach (chloride of lime) should then be scattered over the fill to cover the disturbed ground to a depth of 2 inches. A permanent sign should be placed on the fill, prohibiting digging in the vicinity.

(2) Where a sufficiently isolated area is not available, chemical ammunition may be destroyed by placing in a pit, approximately 20 feet in diameter and 4 feet deep, on top of a wooden platform and surrounded by dry scrap wood. Arrange demolition charges and cover the ammunition with about 2 feet of earth; the charges are to be so arranged that they will function after the scrap wood has been ignited and the fire has gained headway; in this way the chemical filler will be burned as it comes from the item without undue contamination of the surrounding area. Under normal conditions, the chemical filler will burn clean and no shell fragments will leave the pit. As a matter of general safety, no personnel should approach the pit for 48 hours.

**241. ANTITANK MINES.** If marks on the mine or on the ground indicate that it has been run over by a vehicle, the mine should be considered as a dud and should not be handled or jarred, and should be destroyed in place by detonation with a TNT or nitrostarch block (par. 242). Only mines that have not been tampered with, handled, or disturbed in any manner may have the safety fork replaced and then taken up. The safety fork must be replaced



*Destruction of Ammunition in Zone of the Interior*

before the mine is handled or the fuze removed. Unserviceable antitank mines will be destroyed in the same manner and with the same precautions as bombs (pars. 229 and 231).

**242. TARGET RANGES.**

a. **General.** Explosive missiles which have failed to function after firing are termed "duds." AR 750-10 prescribes that, after firing on a range has been completed and before free access to it is allowed to personnel in general, the range will be thoroughly policed and all duds destroyed by competent personnel. Duds of photoflash bombs or aircraft flares released during flight over land areas other than target ranges will be recovered and destroyed. See paragraph 239.

b. **Safety precautions.** Target ranges are dangerous because of flying missiles during target practice and unexploded ammunition which may remain on the range after target practice. Safety precautions should therefore include means for preventing trespass upon the target range by unauthorized or careless persons and for removing from the range all unexploded ammunition which has been fired. In addition to the safety measures employed at and near the firing line, such as red flags, markers, or fences, the boundary or terrain which is likely to receive missiles from the firing line should be placarded with signs which indicate the danger zone and the hazards attendant upon entering such zones at specified times. The signs should also emphasize the dangers connected with picking up unexploded ammunition and should prohibit either trespass on the range or the removal of souvenirs from areas, under penalties provided by law. The placarding of the target ranges is a matter of public safety and must never be neglected.

c. **Destroying duds.**

(1) The policing of a target range and safeguarding the command are functions of the commanding officer. Immediately after target practice is completed, the entire range should be carefully policed for unexploded ammunition, under the supervision of an authorized individual who is thoroughly familiar with the dangers incident to such operations. Unexploded projectiles and other components of ammunition which have been fired are dangerous to handle and should not be touched or jarred where it is practicable to destroy them by the use of TNT blocks. However, unfuzed duds may be handled with comparative safety.

(2) In those rare cases in which it is necessary to remove a dud from any location before destroying it, all operations connected with this procedure should be done either by or under the direct supervision of personnel who are thoroughly familiar with the dangers of such an operation and who are qualified to do this work.

(3) To move or roll an unexploded fired projectile is to invite disaster, as such an operation may cause movement of the internal

*Destruction of Ammunition in Zone of the Interior*

fuze parts and may cause the projectile to explode. No attempt will be made to disassemble a round of unexploded ammunition except by personnel of the Ordnance Department who are specifically assigned to such work.

(4) Duds on the target range, such as unexploded projectiles, fuzes, grenades, etc., can usually be destroyed in place with TNT or nitrostarch blocks. The dud should be approached only by experienced personnel and, without disturbing the dud, the explosive blocks carefully laid in intimate contact with it. If possible, the blocks should be placed on top of the dud because the wave of detonation tends to be propagated downward. The blocks should then be carefully mud-packed or earth-covered to direct the explosion toward the dud as much as possible. For artillery shell, the number of TNT blocks (or equivalent) to be used should follow the table specified in paragraph 229 c. After placing the charge, the dud should then be covered with sandbags or earth to limit the range of the fragments.

(5) Shell exploded on the ground surface without an earth cover of at least 2 feet, may send fragments 1,000 yards, and all within this danger zone will take cover when the charge is fired. Personnel should never be within 300 feet of a projectile when it explodes, even if suitable protection is at hand. The general instructions for destroying duds on the target range are similar so far as possible to those described for destroying artillery ammunition (par. 229). Duds of photoflash bombs are destroyed in accordance with this paragraph and paragraph 239. The safety precautions in paragraph 226 will be carefully observed.

(6) Gas shells or bombs should be handled in the same manner as other projectiles. Holes or trenches in which gas shells have been exploded must be filled or decontaminated and gas masks worn during the work. Work should always be done on the windward side of the area where gas shells are exploded.

(7) Destruction of duds of spotting-charge assemblies, for the 100-pound practice bomb M38A2 (black powder) will be accomplished by detonation in place. This can be done by the use of demolition blocks or a 15-inch length of primacord which is coiled, placed on top of the charge, taped in place, and detonated with a blasting cap. Destruction of individual unserviceable spotting charges of this type can readily be accomplished by winding a 20-inch length of primacord twice around the charge, taping it in position, and initiating detonation by means of a blasting cap as above.

(8) After the destruction of duds has been completed, the officer in charge of the work will personally superintend a thorough search of the area to insure that no duds have been overlooked.

(9) Additional information on destruction of unexploded projectiles and bombs may be found in FM 9-40 and FM 5-25.



## CHAPTER 5

### REFERENCES

**243. PUBLICATIONS INDEXES.** The following publications indexes should be consulted frequently for latest changes or revisions of references given in this chapter and for new publications relating to materiel covered in this manual:

- |   |                |
|---|----------------|
| a. Introduction to Ordnance Catalog (explaining SNL system)                                 | ASF Cat. ORD 1 |
| b. Ordnance Supply Catalog Index  | ASF Cat. ORD 2 |
| c. Ordnance Major Items and Combinations, and Pertinent Publications                        | WDSB 9-1       |
| d. List and Index of War Department Publications  | FM 21-6        |
| e. List of War Department Films, Film Strips, and Recognition Film Slides                   | FM 21-7        |
| f. Military Training Aids   | FM 21-8        |
| g. Index to Bombing Tables (listing current bombing tables for bombs, clusters, and flares) | Index to BT's  |

### 244. STANDARD NOMENCLATURE LISTS.

#### a. Ammunition for small arms.

Ammunition, revolver, automatic pistol, and sub-machine guns ..... ASF Cat. ORD 11 SNL T-2

Ammunition, rifle, carbine, and automatic gun ..... ASF Cat. ORD 11 SNL T-1

Ammunition, small-arms, obsolete and nonstandard ..... ASF Cat. ORD 11 SNL T-6

Miscellaneous service components of small-arms ammunition and instruction material for Field Service Account ..... ASF Cat. ORD 11 SNL T-4

Packing materials used by Field Service for small-arms service ammunition ..... ASF Cat. ORD 11 SNL T-5

Shells, shotgun ..... ASF Cat. ORD 11 SNL T-3

#### b. Bombs, grenades, pyrotechnics, and rockets.

Ammunition instruction material for grenades, pyrotechnics, and aircraft bombs ..... ASF Cat. ORD 11 SNL S-6

Bombs, aircraft, all types ..... ASF Cat. ORD 11 SNL S-1

\*An up-to-date listing of current Standard Nomenclature Lists is maintained in ASF Cat. ORD 2.

References

Fuzes and miscellaneous explosive components for aircraft bombs	ASF Cat. ORD 11 SNL S-2
Fin assemblies and miscellaneous inert components for aircraft bombs	ASF Cat. ORD 11 SNL S-3
Grenades, hand and rifle, and fuzing components	ASF Cat. ORD 11 SNL S-4
Pyrotechnics, military, all types	ASF Cat. ORD 11 SNL S-5
Rockets, all types, and components	ASF Cat. ORD 11 SNL S-9
Torpedoes and mines	ASF Cat. ORD 11 SNL S-1
<b>c. Cleaning, preserving, and lubricating materials; recoil fluids, special oils, and miscellaneous related items</b>	
	ASF Cat. ORD 5 SNL K-1
<b>d. Ammunition for antiaircraft, harbor defense, heavy field, and railway artillery.</b>	
Ammunition, fixed, including subcaliber ammunition for harbor defense, heavy field, and railway artillery	ASF Cat. ORD 11 SNL P-6
Ammunition for antiaircraft artillery	ASF Cat. ORD 11 SNL P-5
Ammunition instruction material for antiaircraft, harbor defense, heavy field and railway artillery, including complete round data	ASF Cat. ORD 11 SNL P-8
Ammunition, obsolete and nonstandard, for harbor defense, heavy field, and railway artillery	ASF Cat. ORD 11 SNL P-9
Charges, propelling, separate-loading, 6-in. to 240mm inclusive, for harbor defense, heavy field, and railway artillery	ASF Cat. ORD 11 SNL P-2
Charges, propelling, separate loading, 10-in. to 16-in. inclusive, for harbor defense, and railway artillery	ASF Cat. ORD 11 SNL P-4
Fuzes, primers, blank ammunition, and miscellaneous items for antiaircraft, harbor defense, heavy field, and railway artillery	ASF Cat. ORD 11 SNL P-7
Packing materials used by field service for antiaircraft, harbor defense, heavy field, and railway artillery service ammunition	ASF Cat. ORD 11 SNL P-10



References

- Projectile, separate-loading, 6-in. to 240-mm inclusive  
 ASF Cat. ORD 11 SNL P-1
- Projectile, separate-loading, 10-in. to 16-in. inclusive  
 ASF Cat. ORD 11 SNL P-3
- e. Ammunition for pack, light and medium field, aircraft, tank, and antitank artillery.
- Ammunition, blank  
 ASF Cat. ORD 11 SNL R-5
- Ammunition, fixed and semifixed, all types  
 ASF Cat. ORD 11 SNL R-1
- Ammunition instruction materials  
 ASF Cat. ORD 11 SNL R-6
- Ammunition, mortar, including fuzes, propelling charges and other components  
 ASF Cat. ORD 11 SNL R-4
- Ammunition, obsolete and nonstandard  
 ASF Cat. ORD 11 SNL R-8
- Land mines and fuzes, demolition material, and ammunition for simulated artillery and grenade fire  
 ASF Cat. ORD 11 SNL R-7
- Packing materials used by field service  
 ASF Cat. ORD 11 SNL R-10
- Projectiles and propelling charges, separate loading, for medium field artillery, including complete round data  
 ASF Cat. ORD 11 SNL R-2
- Service fuzes and primers  
 ASF Cat. ORD 11 SNL R-3
- f. Tools and supplies.
- Ammunition surveillance, testing, and inspection equipment and supplies  
 ASF Cat. ORD 6 SNL N-10
- General tools and supplies for ordnance ammunition company  
 ASF Cat. ORD 10 SNL N-17
- Tools and supplies for ordnance ammunition renovation platoon  
 ASF Cat. ORD 10 SNL N-500GA
- Tools and tool sets for ordnance bomb disposal squad (separate)  
 ASF Cat. ORD 10 SNL N-500EB
- g. Other services.
- Chemical Warfare Service Supply Catalog. List of Items for Troop Issue  
 ASF Cat. CW 3
- Engineer Supply Catalog. Stock List of All Items  
 ASF Cat. ENG 5

References

245. EXPLANATORY PUBLICATIONS.

a. Regulations.

Administration; posts, camps, and stations	AR 210-10
Fire protection and fire fighting	AR 30-1580
Honors to persons	AR 600-30
List of current pamphlets and changes; distribution	AR 1-10
Lost, destroyed, damaged, or unserviceable property	AR 35-6640
Precautions in handling gasoline	AR 850-20
Qualifications in arms and ammunition training allowances	AR 775-10
Range regulations for firing ammunition for training and target practice	AR 750-10
Salutes and ceremonies	AR 600-25
Supplies: storage and issue	AR 700-10
Transportation by commercial means; general	AR 55-105
Transportation by water of explosives, inflammables, and chemical warfare materials	AR 55-470
Transportation of public property (except animals) and remains	AR 55-155

b. Ammunition, all types.

Ammunition: General	WDSB 9-AMM 1
Ammunition Supply	FM 9-6
Ammunition: Supply within Continental United States	WDSB 9-AMM 6
Ammunition Condition Report	O.O. Form No. 517
Ammunition Identification Code (AIC)	WDSB 9-AMM 5
Application of Suspensions and Releases on Ammunition	WDSB 9-AMM 11
Artillery Ammunition	TM 9-1901
Complete Round Chart	O.O. Form No. 5981
Decontamination	FM 3-220
Decontamination of Armored Force Vehicles	FM 17-59
Defense Against Chemical Attack	FM 21-40
Explosives and Demolitions	FM 5-25
First Aid for Soldiers	FM 21-11
Identification of ammunition lot number prefixes	OFSB 3-16
Inspection Guide, Ammunition	TM 9-1904



## References

Inspection of Propelling Charges and Bulk Powder	WDSB 9-AMM 7
Inspection of Ordnance Materiel	TM 9-1100
Magazine placard	O.O. Form No. 5991
Military Chemistry and Chemical Agents	TM 3-215
Military Explosives	TM 9-2900
Military Sanitation and First Aid	FM 21-10
Miscellaneous Chemical Munitions	TM 3-300
Ammunition: Net Prices	WDSB 9-AMM 3
Ordnance Ammunition Company, Ordnance Ammunition Battalion	FM 9-20
Ordnance Company, Depot	FM 9-25
Ordnance Field Maintenance	FM 9-10
Ordnance Service in the Field	FM 9-5
Ordnance Safety Manual	No. 7224
Reports	WDSB 9-AMM 8
Storage and Shipment of Dangerous Chemicals	TM 3-250
Surveillance Manual	OFSB 3-20
Unexploded Bombs, Organization and Operation for Disposal	FM 9-40
Unsafe Ammunition	WDSB 9-AMM 2
Use of Chemical Agents and Munitions in Training	TM 3-305
<b>c. Ammunition, special types.</b>	
Aircraft Armament and Pyrotechnics	TM 1-409
Aircraft Bombs and Bomb Components	OFSB 3-8
Ammunition: Antiaircraft, Heavy, Field, Sea-coast, and Railway Artillery	OFSB 3-2
Bombs for Aircraft	TM 9-1980
Coast Artillery Ammunition	TM 4-205
Controlled Submarine Mine Materiel	TM 4-220
Corps of Engineers Reference Data	FM 5-35
Field Artillery and Field Mortar Ammunition	OFSB 3-3
Field Artillery Trainer, M3	TM 6-225
Grenades, Hand and Rifle	TM 9-1985
Hand and Rifle Grenades, Rocket, AT, HE, 2.36-inch	FM 23-30
Incendiary Bombs	TM 3-330
Instructions for Use of Rocket Target, M2 by Antiaircraft Units	TM 4-236

References

Instruction Guide, Small Arms Accidents, Mal- functions and Their Causes .....	TM 9-2210
Land Mines .....	TM 9-1940
Land Mines and Booby Traps .....	FM 5-31
Military Pyrotechnics .....	TM 9-1981
Military Pyrotechnics .....	OFSB 3-9
60-mm Mortar M2 .....	FM 23-85
81-mm Mortar M1 .....	FM 23-90
Pyrotechnic Projectors, All Types .....	TM 9-290
Repair of Submarine Mine Cases .....	TM 9-1401
4.5-in. Aircraft Rocket Materiel .....	TM 9-395
Signal Communication .....	FM 1-45
Signal Communication .....	FM 24-5
Small-Arms Ammunition .....	TM 9-1990
Small-Arms Ammunition .....	WDSB 9-AMM 4
Small Arms, Light Field Mortars, and 20-mm Aircraft Guns .....	TM 9-2200
Standard Artillery and Fire Control Materiel .....	TM 9-2300

**d. Cleaning, preserving, and lubricating materials.**

Cleaning, Preserving, Sealing, Lubricating and  
Related Materials Issued for Ordnance Ma-  
teriel .....

TM 9-850

Solvent; dry cleaning..... Federal Specification R-S-661 a

**e. Transportation.**

Explosives or other dangerous articles on board  
vessels .....

U. S. Dept. of Commerce

Regulations for transportation of explosives and  
other dangerous articles by land and water  
in rail freight, express, and baggage services,  
and by motor vehicle (highway) and water  
..... Interstate Commerce Commission

Methods for loading and staying carload and  
less than carload shipments of explosives and  
other dangerous articles (Pamphlet No. 6)

Bureau of Explosives

30 Vesey Street, New York City



References

Methods for loading and bracing (airload and less than airload shipments of loaded projectiles, loaded bombs, etc. (Pamphlet No. 6A) Bureau of Explosives  
30 Vesey Street, New York City

Motor carrier safety regulations (Part 7) transportation of explosives and other dangerous articles Interstate Commerce Commission

I.C.C. Freight Tariff No. 3 Interstate Commerce Commission

I.C.C. Freight Tariff No. 4 Interstate Commerce Commission

Interstate Commerce Commission regulations for transportation of explosives and other dangerous articles by freight Bureau of Explosives  
30 Vesey Street, New York City

Regulations governing transportation of military explosives on board vessels during present emergency U.S. Coast Guard

Regulations for the security of vessels in port U.S. Coast Guard

Standard specification for marking shipments by contractors U.S. Army Specification No. 100-2E

Transportation in the Zone of the Interior TM 55-205

f. Fire-fighting.

Crosby-Fiske-Forster Handbook of Fire Protection National Fire Protection Association

Fire-fighting John J. McCarthy, Asst. Chief of Dept. in Command, N. Y. Fire Dept.

Fire Protection by Troop Organizations in Theaters of Operations FM 5-315

Industrial Fire Brigades, 1st Edition National Fire Protection Association

Suggestions for Fire Fighting and Fire Extinguishment Navy Dept. Bureau of Yards and Docks

g. Miscellaneous.

Abbreviated Firing Tables TM 6-215

Graphical Firing Tables TM 9-526

Dictionary of United States Army Terms TM 20-205

Bomb Racks, Tow Target Equipment, and Flare Racks TM 1-500

Tactics of Chemical Warfare FM 3-5

Chemical Warfare Service: Supply and Field Service FM 3-15

# INDEX

A	Page		Page
Agentite (DM), description	52	Antipersonnel mines	
Adapter boosters	131	description of bounding, cast-	
Adapters, description	111	iron, and practice	201
Aerial mines	282	packing and marking	201
Aircraft signals	170	Artillery mines	
Amatol	40	description	
Ammonal, characteristics	44	metallic	194
Ammonium picrate (See Explosive D)		nonmetallic	195
Ammunition		practice	196
care, handling, and preservation	213	destruction	320
classes; quantity and distance	262	packing and marking	198
classification and identification	3	Armor-piercing ammunition	298
code symbols	2	Armor-piercing bombs	136
combination storage of ammunition and explosives	249	Armor-piercing cartridge (See Cartridges)	
destruction	291, 306	Artillery ammunition	
dumping at sea	307	classification and identification	95
fire hazard groups	221	complete rounds (fixed and semi-fixed)	93
general discussion of small-arms	54	destruction of shells	313
grading	8	difficulties in loading or extracting	301
guard protection	224	examination, packings, and placing	299
inspection		misfires	301
inert components	289		
small-arms	286	<b>B</b>	
lot number and data card	5	Ball cartridge	60
mark or model	4	Bangalore torpedoes	204
materials used in destroying	307	Barricades, equipment for	293
packing and marking	121, 263	Black powder (See Powder, black)	
painting	6	Blank ammunition	
priority of issue	25	care, handling, preservation	120, 304
protection (small-arms)	299	combination storage	252
renovation	290	complete round	117
storage	225	destruction	314
tetrytol-filled	305	Blank cartridges	
(See also Armor-piercing ammunition, Artillery ammunition, Small-arms ammunition and Mortar ammunition)		description	61
		firing	298
		Blister gases	50
		Blood and nerve poisons	51



Index

**B - Contd.**

**Bombs**

combination storage ..... 257

description

  chemical ..... 141

  explosive ..... 135

  incendiary ..... 151

  practice and drill ..... 153

  pyrotechnic and target-identification ..... 153

destruction ..... 315

general discussion ..... 131

identification and classification ..... 131

inspection ..... 208

painting and marking ..... 6

precautions for practice firing ..... 305

storage ..... 257

(See also Photo flash bombs)

**Boosters**

description ..... 111

storage ..... 258

**Bourrelet, definition** ..... 101

**Brombenzylcyanide (BBC)** ..... 52

**Bullets, description** ..... 54

**Bursters**

combination storage ..... 251

description ..... 111

**C**

**Canister, description** ..... 108

**Cartridge case** ..... 60

**Cartridges**

combination storage ..... 249

description

  armor-piercing; ball ..... 50

  armor-piercing-incendiary

    armor-piercing-incendiary

    tracer ..... 61

  blank ..... 61

  dummy, high-pressure test and gallery practice ..... 62

  grenade; shot ..... 66

  guard; subcaliber ..... 53

  firing blank ..... 299

  general discussion ..... 54

  painting and marking ..... 7

  tracer ..... 61

  types ..... 60

Chemical agents

  description

  definition and classification

  Chemical ammunition

  combination storage

  definition

  inspiration

  painting and marking

  precautions for practice firing

  storage ..... 257

Chemical rockets ..... 110

Chloroacetonitrile (CN) ..... 51

Chlorine (Cl) ..... 51

Chlorine in ..... 51

Choking gas ..... 50

Combination storage chart ..... 250

Composition A, A-2, and A-3 ..... 45

Composition B ..... 45

Composition C, C-2, and C-3 ..... 4

Cyanogen chloride (CK) ..... 51

**D**

**Demolition materials**

combination storage ..... 257

demolition blocks

  M2 and M3 ..... 211

  M4 ..... 212

destructors ..... 204, 206, 210

general discussion ..... 204

**Depth bombs, description** ..... 130

**Depth charges** ..... 15

**Destructors**

  AN-M1 ..... 204

  AN-M2 and AN-M3A1 ..... 206

  M4 and M4 ..... 211

**Detonators**

storage ..... 58

use of tetryl in ..... 39

**Diphenylchlorarsine (DA)** ..... 52

**Diphosgene (DP)** ..... 50

**Distributing points** ..... 261

**Duds, destruction** ..... 298, 321

**Dummy cartridges** ..... 5

**Dynamite**

  characteristics and use ..... 43

  combination storage ..... 252

  destruction ..... 12

  storage ..... 53



E	Page
Ednatol characteristics and use	44
Explosive D	
characteristics	41
destruction	311
storage	253
Explosive rockets	181
Explosive trains	29
Explosives	
classes; quantity-distance	240, 262
combination storage of bulk	252
definition and classification	26
destruction	
bulk	311
demolition	219, 212
military requirements	27
Explosives, high	
characteristics	43, 44
detonation	44
general discussion	37, 47
inspection	287
<b>F</b>	
Fire protection	
at supply and distributing points	261
causes of fires	215
fire-fighting	219
fire-prevention regulations	216
from fires involving explosives	220
identification of magazines	221
Firing, practice	295
Firing through trees	298
Fixed ammunition	
inspection	285
misfire	307
storage	251, 256
Flares, description	
general	162
ground type	175
Flash signals (See Signals)	
Fragmentation bombs	
combination storage	251
description	136
Fusee, red, M72	179

Fuzes	Page
care, handling, and preservation	303
classification	107
combination storage	25
description	
bomb nose and tail	155
general	153
hydrostatic and concussion	155
inspection	789
packing and marking	160
safety features	107
storage	258

**G**

Gallery practice cartridge	62
Grenade, chemical hand	76
Grenade, chemical rifle	80
Grenade, explosive hand	76
Grenade, explosive rifle	80
Grenade, practice and training rifle	80
Grenade, smoke	175
Grenade cartridge	66
Grenade projection adapter	
care and precautions in handling;	
identification and packing	83
description	82
Grenades	
description	75
destruction	318
inspection	285
precautions for practice firing	304
uses and fuzing	76
Ground signals (See Signals)	
Guard cartridges	63
Guncotton	36

**H**

Harassing gases	51
Hexachlorethane-zinc mixture	52
High explosive (See Explosives, high)	
High-pressure test cartridge	62
Hydrocyanic acid (AC)	51



Index

I	Page
Illuminating shells .....	105, 177
Incendiaries .....	47, 53
Incendiary ammunition .....	249
Incendiary cartridge .....	61
Inert materials, storage .....	260
Inspection and surveillance .....	283
Interstate Commerce Commission regulations .....	271
<b>L</b>	
Land mines	
classification .....	194, 201
combination storage .....	251
(See also Anti-personnel mines and Antitank mines)	
Launchers .....	189
Lead azide .....	38
Lewisite (L) .....	50
Light-case bombs .....	136
<b>M</b>	
Magazine areas .....	229
Magazines	
arrangement, care, and maintenance .....	232
construction .....	231
inspection .....	284
quantity-distance classes and tables	
general discussion .....	234
tables .....	238, 241, 242
repairs .....	233
Maintenance, definition .....	290
Mercury fulminate .....	38
Mines (See Aerial mines and Land mines)	
Mortar ammunition	
combination storage .....	251
description and classification .....	86
destruction .....	315
precautions for practice firing .....	305
projection, precautions in handling, packing and marking .....	92
Motor truck shipments .....	279
Multiple launchers .....	189
Mustard gas .....	50

Nitrostarch .....	
<b>O</b>	
Oxidizing agents .....	
<b>P</b>	
Painting and marking: 6, 7, 8, 4"	
Pentolite .....	
Pentolite-filled ammunition	
PETN (Pentaerythritol tetranitrate)	
characteristics .....	
uses .....	
Phosgene (CG) .....	
Phosphorus, fire hazards .....	
Photoflash bombs .....	
Picratol .....	
Picric acid (trinitrophenol) .....	
Powder	
characteristics of double-base and smokeless .....	35
inspection of smokeless .....	284
storage .....	
uses .....	
Powder, black	
care, handling, and preservation	
characteristics .....	
destruction .....	
storage .....	
uses .....	
Powder temperature indicators	
Practice rockets .....	
Primer mixtures	
Primer detonators, storage .....	
Primers	
description .....	30
destruction .....	
storage .....	251
types .....	
Projectile, armor-piercing .....	
Projectile, canister .....	
Projectile, drill or dummy .....	
Projectile, high-velocity armor-piercing shot .....	
Projectile, target practice .....	

## Index

P - Contd.	Page	R	Page
Projectiles		Rail shipment	273
combination storage (separate-loading)	251	RDX (cyclonite)	44
general discussion and components	97	Report of unserviceable and defective ammunition	290
types	105	Rockets	
Propellants		classification	181
general discussion	31	description	
small-arms	36	explosive	181
Propellent powder, bulk	251	practice	186
Propelling charges		target	186
blending; erratic and excessive pressures; maximum ranges	300	destruction	315
care and precautions in handling	125	identification and components	186
combination storage (separate-loading)	251	packing and shipping	193
description	54, 189	precautions	190
destruction, (separate-loading)	312	storage	251, 260
general discussion	111		
packing	130	<b>S</b>	
premature ignition and flare-backs	299	Safety precautions in destroying ammunition	308
storage (separate-loading)	254	Safety regulations	292
types	113	Screening smokes	47
Propelling-charge explosive trains	49	Sealing	268
PTX-1	46	Semi-armor-piercing bombs	136
PTX-2	46	Sensitized ammunition	
Publication file	290	inspection	285
Pyrotechnic compositions	162	misfires	301
Pyrotechnic signals	162	storage	251, 256
Pyrotechnics		Shaped charges	212
care, handling, and preservation	180	Shell, artillery	313
classification	150	Shell, chemical	105
destruction	319	Shell, high-explosive	105
fire hazards	223	Shell, high-explosive-antitank (HE, AT)	105
identification	179	Shell, illuminating	105, 177
inspection	289	Shell, mortar	251
packing	181	Shell, separate loading	
painting and marking	8	inspection	288
precautions for practice firing	304	storage	256
storage	249, 258	Shell, shotgun	66
		Shipping	270
		Shrapnel, description	106



Index

S — Contd.	Page	T	Page
Signals, description		Target ranges	111
aircraft	171	Target rockets	106
distress	177	Tetryl	
drift	172	characteristic, detonation, and	
ground, sound, and flash	177	use	39
Slick marker	175	destruction	31
Small-arms ammunition		storage	33
destruction	315	Tetrytol, characteristics and use	43
fire hazards	222	Tetrytol-filled ammunition	315
grades, care and precautions in		Titanium tetrachloride (FM)	2
handling	67	TNT (2,4,6-trinitrobenzene)	
identification	298	characteristics	9
inspection	286, 297	destruction	11
packing and marking	69	exudation, detonation, and use	10
precautions in firing	69	inspection	289
protection	299	storage	283
storage	255	Tools for renovation of ammunition	
Small-arms propellants	36	ton	264
Smoke ammunition	249	Torpedoes	
Smoke puff charges	252	combination storage (aerial)	55
Smokeless powder		description (bangalore)	50
characteristics	33, 36	Torpex	44
inspection	284, 287	Tracer	105
storage	254	Tracer cartridge	61
uses	35, 36	Triton blocks	253
Sound signals (See Signals)		Tritonal	44
Spotting charges	252		
Subcaliber cartridges	63	<b>W</b>	
Submarine mine explosives	289	Water shipments	27
Sulfur trioxide-chlorosulfonic acid		White phosphorus (WP)	52
mixture (FS)	52	WP ammunition	49
Supply points	261		