

TM 9-1901

WAR DEPARTMENT TECHNICAL MANUAL

ARTILLERY AMMUNITION

WAR DEPARTMENT

• 29 JUNE 1944

WAR DEPARTMENT TECHNICAL MANUAL

TM 9-1901

This Technical Manual supersedes TB 9-1901-1, dated 20 March 1944; TB 9-1901-2, dated 25 May 1944; TB 9-1901-3, dated 28 June 1944; TB ORD 7, dated 10 January 1944; and TB ORD 77, dated 5 June 1944.

ARTILLERY
AMMUNITION



WAR DEPARTMENT

29 JUNE 1944

RESTRICTED DISSEMINATION OF RESTRICTED MATTER—
The information contained in restricted documents and the essential characteristics of restricted material may be given to any person known to be in the service of the United States and to persons of undoubted loyalty and discretion who are cooperating in Government work, but will not be communicated to the public or to the press except by authorized military public relations agencies. (See also paragraph 23b, AR 380-5, 15 March 1944.)

WAR DEPARTMENT
Washington 25, D. C., 29 June 1944

TM 9-1901, Artillery Ammunition, is published for the information and guidance of all concerned.

[A.G. 300.7 (10 Feb 44)
O.O. 461/42852 Raritan Ars.]

BY ORDER OF THE SECRETARY OF WAR:

G. C. MARSHALL,
Chief of Staff.

OFFICIAL:

J. A. ULIO,
*Major General,
The Adjutant General.*

DISTRIBUTION: As prescribed in Par 9a, FM 21-6; IC and H 9 (3);
C and H 1 (2); Bn and H 2, 6, 7, 17, 18 and 44 (2);
Ord O 1st thru 15th AF including Tactical AF (10).

IBn 9—T/O 9-15, Ord Am Bn

IC 9—T/O 9-17, Ord Am Co
T/O & E 9-57, Ord Dep Co
T/O 9-177, Ord Bomb Disposal Co
T/O 9-179, Ord Bomb Disposal Sqd (Sep)
T/O & E 9-500, Ord Sv Comp Orgn

(For explanation of symbols, see FM 21-6.)

CONTENTS

	Paragraphs	Pages
CHAPTER 1. GENERAL	1- 17	1- 42
SECTION I. Introduction	1- 3	1- 3
II. General discussion	4- 17	4- 42
CHAPTER 2. FIXED AND SEMIFIXED ROUNDS AND SEPARATE-LOADING PRO- JECTILES	18-304	43-219
SECTION I. Ammunition for 20-mm guns	18- 29	43- 51
II. Ammunition for 37-mm guns	30- 55	52- 70
III. Ammunition for 40-mm guns	56- 66	71- 78
IV. Ammunition for 2-inch mortars	67- 69	79- 82
V. Ammunition for 57-mm guns	70- 75	83- 86
VI. Ammunition for 60-mm mortars	76- 83	87- 97
VII. Ammunition for 75-mm guns	84-121	98-115
VIII. Ammunition for 75-mm how- itzers	122-135	116-123
IX. Ammunition for 76-mm guns	136-146	124-129
X. Ammunition for 3-inch guns	147-176	130-146
XI. Ammunition for 81-mm mortars	177-189	147-159
XII. Ammunition for 90-mm guns	190-201	160-166
XIII. Ammunition for 105-mm how- itzers	202-223	167-178
XIV. Ammunition for 105-mm guns	224-232	179-182
XV. Ammunition for 4.5-inch guns	233-237	183-184
XVI. Ammunition for 120-mm (4.7- inch) guns	238-243	185-187
XVII. Ammunition for 155-mm how- itzers	244-259	188-196
XVIII. Ammunition for 155-mm guns	260-271	197-202
XIX. Ammunition for 8-inch howitzers	272-279	203-205
XX. Ammunition for 8-inch guns	280-284	206-207
XXI. Ammunition for 240-mm how- itzers	285-293	208-211
XXII. Ammunition for subcaliber weapons	294-304	212-219

CONTENTS—Contd.

	Paragraphs	Pages
CHAPTER 3. FUZES, PROPELLING CHARGES, PRIMERS, AND OTHER COM- PONENTS	305-386	220-345
SECTION I. Fuzes	305-341	220-294
II. Propelling charges	342-364	294-317
III. Primers	365-381	318-327
IV. Boosters, adapter-boosters, and burstors	382-384	328-340
V. Eyebolt-lifting plugs and grommets	385-386	341-345
CHAPTER 4. DESTRUCTION OF AMMUNITION UPON IMMINENCE OF CAPTURE IN COMBAT ZONE	387-388	-346
CHAPTER 5. COMPLETE ROUND TABLES	— —	347-378
CHAPTER 6. REFERENCES	389-392	379-381
INDEX		382-388

RESTRICTED

This Technical Manual supersedes TB 9-1901-1, dated 20 March 1944; TB 9-1901-2, dated 25 May 1944; TB 9-1901-3, dated 28 June 1944; TB ORD 7, dated 10 January 1944; and TB ORD 77, dated 5 June 1944.

CHAPTER 1
GENERAL

Section 1

INTRODUCTION

1. PURPOSE.

a. The purpose of this Technical Manual is to impart information of a general and technical nature concerning artillery ammunition, including trench-mortar ammunition, and components thereof, such as may be necessary for their intelligent care, handling, and use. This is a companion volume to TM 9-1900, Ammunition, general.

2. SCOPE.

a. Ammunition for use in artillery weapons, including field, anti-aircraft, aircraft, tank and antitank, and in trench mortars, is described. Coast artillery ammunition has not been described since it is covered in TM 4-205. This manual covers the general characteristics, specific data, means of identification, precautions in handling and use, and general information on packing and shipping. An additional chapter concerns destruction of ammunition in case of imminent capture by the enemy.

3. ARRANGEMENT OF TEXT.

a. Chapter 1 covers general ammunition terms, classification of artillery ammunition, means of identification, explosive charges and chemical fillers, packing and marking for shipment, storage precautions, care in handling and use, and a general discussion of projectiles.

b. Chapter 2 presents specific data for and description of the rounds and projectiles used in artillery weapons and trench mortars. Subcaliber ammunition is covered in this chapter.

c. Chapter 3 deals with the components, other than projectiles, of complete rounds: Fuzes, propelling charges, primers, boosters, bursters, and adapter-boosters. Section V covers the components of separate-loading projectiles used in shipping, namely, grommets and eyebolt-lifting plugs.

d. Chapter 4 describes the destruction of ammunition to avoid capture.

e. Tables of complete rounds for ammunition described in chapter 2 are published in chapter 5.

f. A list of references will be found in chapter 6.

ARTILLERY AMMUNITION

ALUMINUM



BLACK POWDER (FLAKES OR GRAINS)

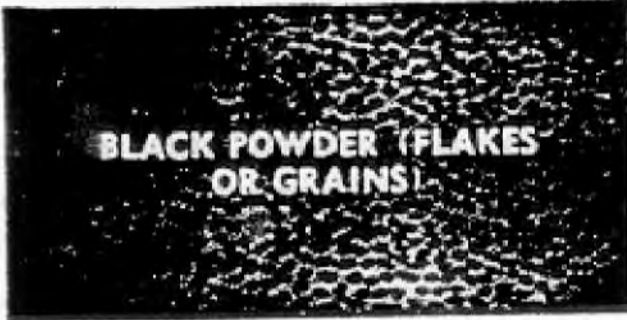

BLACK POWDER (PRESSED)



BRASS

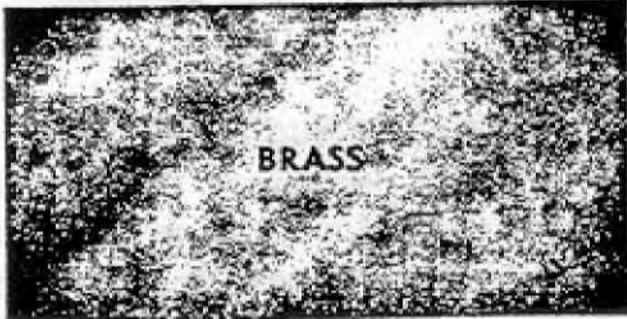

CARDBOARD



CHIPBOARD



EXPLOSIVE D



COPPER



FELT



ILLUMINANT COMPOSITION



RA PD 15129

Explanatory Color Chart (for Sectioned Views)

GENERAL

INCENDIARY MIXTURE



MUSTARD GAS

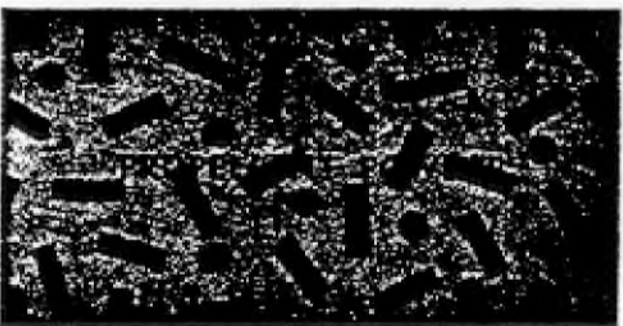
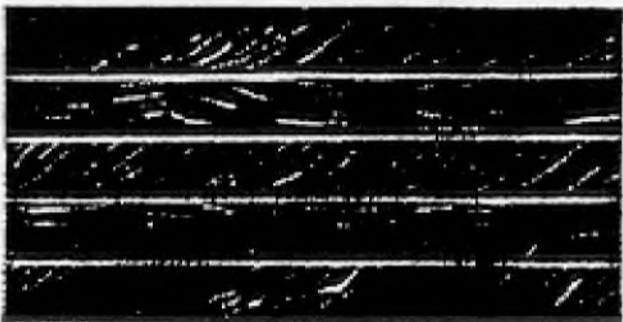

TNT

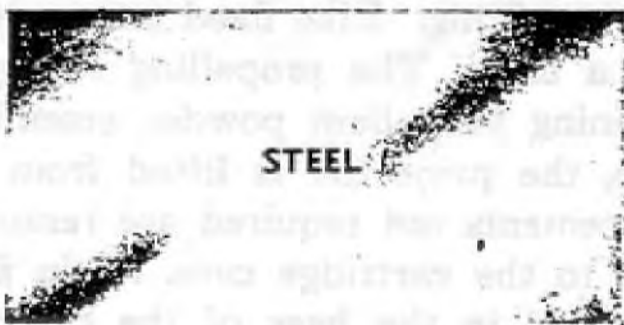

STEEL

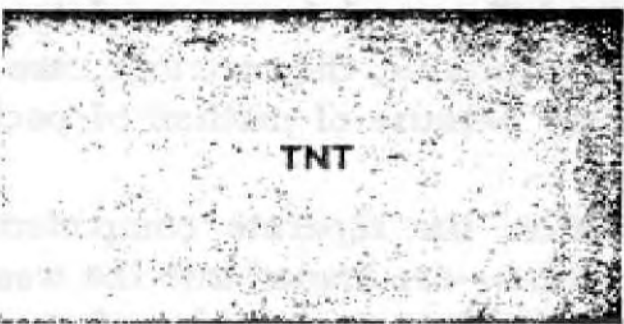

LEAD AZIDE

PLASTER OF PARIS

PRIMER MIXTURE
OR
FULMINATE OF MERCURY

SMOKE PRODUCING AGENT



TRACER COMPOSITE

RA PD 15130

Explanatory Color Chart (for Sectioned Views) — Continued

ARTILLERY AMMUNITION

Section II

GENERAL DISCUSSION

4. DEFINITIONS.

a. *Ammunition* is materiel intended to be expended in combat or simulated combat conditions. *Artillery ammunition* includes all ammunition, except rockets, used in weapons of caliber greater than 0.60 inch. Included in the discussion of artillery ammunition in this manual is a special group known as trench-mortar ammunition.

b. A *round*, or *complete round*, of artillery ammunition comprises all of the components necessary to fire the weapon once. This includes the following: First, a *projectile*; second, a *propelling charge* to drive the projectile out of the weapon; third, a *primer* to initiate the burning of the propelling charge; and fourth, a *fuze* assembled to the projectile to explode it at the time and under the conditions desired. Dependent on the manner in which these components are assembled for firing, complete rounds of artillery ammunition are known as *fixed*, *semifixed*, and *separate-loading*. See figure 1 for these types of ammunition and for terms applied to their components.

c. In *fixed ammunition*, the propelling charge is fixed, that is, not adjustable, and the components are loaded into the weapon in one operation. As usually designed, the propelling charge is assembled loosely in the cartridge case which is crimped rigidly to the projectile. The primer is fitted in the base of the cartridge case. A round of fixed ammunition may also be termed a *cartridge*.

d. *Semifixed ammunition* is characterized by the loose fit of the cartridge case over the projectile so that the propelling charge may be accessible for adjustment for zone firing. Like fixed ammunition, it is loaded into the weapon as a unit. The propelling charge is divided into sections, each containing propellant powder assembled in a bag. To adjust the charge, the projectile is lifted from the cartridge case, the sections or increments not required are removed, and the projectile is reassembled to the cartridge case. As in fixed ammunition, the primer is assembled in the base of the cartridge case. The 105-mm howitzer H.E., A.T. round is a special type in that the charge is fixed, that is, not adjustable, the cartridge case and projectile not being crimped together because of method of packing and shipping.

e. In *separate-loading ammunition*, the separate components—projectile, propelling charge, and primer—are loaded into the weapon separately. First, the projectile is inserted into the breech and rammed home so that the rotating band seats in the forcing cone; second, the propelling charge in one or more cylindrical cloth bags is placed in the powder chamber immediately to the rear of the projectile;

GENERAL

- A-FUZE
- B-BOOSTER
- C-FUZE WELL LINER
- D-SHELL
- E-OGIVE
- F-BOURRELET
- G-BURSTING CHARGE
- H-ROTATING BAND
- I-CRIMP
- J-BASE COVER
- K-CARTRIDGE CASE
- L-PROPELLING CHARGE
- M-PRIMER
- N-LIFTING PLUG
- O-GROMMET
- P-COTTER PIN WITH PULL RING
- Q-IGNITER

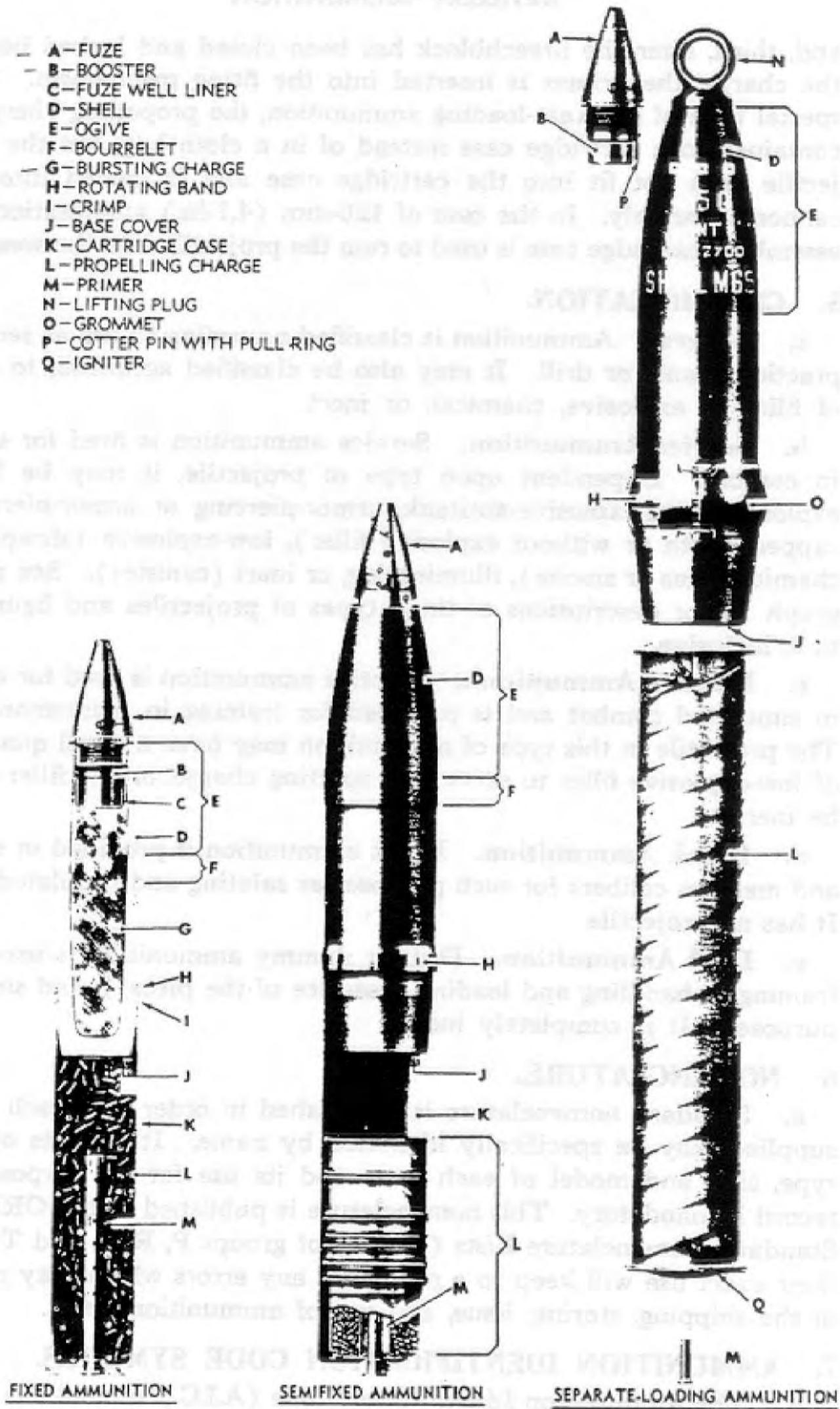

FIXED AMMUNITION

SEMIFIXED AMMUNITION

SEPARATE-LOADING AMMUNITION

RA PD 80671

Figure 1 - Ammunition Terms - Complete Rounds

ARTILLERY AMMUNITION

and, third, after the breechblock has been closed and locked behind the charge, the primer is inserted into the firing mechanism. In a special type of separate-loading ammunition, the propelling charge is contained in a cartridge case instead of in a cloth bag, but the projectile does not fit into the cartridge case and is loaded into the cannon separately. In the case of 120-mm (4.7-in.) ammunition the assembled cartridge case is used to ram the projectile into the weapon.

5. CLASSIFICATION.

a. **General.** Ammunition is classified according to use as service, practice, blank, or drill. It may also be classified according to type of filler as explosive, chemical, or inert.

b. **Service Ammunition.** Service ammunition is fired for effect in combat. Dependent upon type of projectile, it may be high-explosive, high-explosive-antitank, armor-piercing or armor-piercing-capped (with or without explosive filler), low-explosive (shrapnel), chemical (gas or smoke), illuminating, or inert (canister). See paragraph 14 for descriptions of these types of projectiles and figures 2 to 5, inclusive.

c. **Practice Ammunition.** Practice ammunition is fired for effect in simulated combat and is provided for training in marksmanship. The projectile in this type of ammunition may have a small quantity of low-explosive filler to serve as a spotting charge, or the filler may be inert.

d. **Blank Ammunition.** Blank ammunition is provided in small and medium calibers for such purposes as saluting and simulated fire. It has no projectile.

e. **Drill Ammunition.** Drill or dummy ammunition is used for training in handling and loading ("service of the piece"), and similar purposes. It is completely inert.

6. NOMENCLATURE.

a. Standard nomenclature is established in order that each item supplied may be specifically identified by name. It consists of the type, size, and model of each item, and its use for all purposes of record is mandatory. This nomenclature is published in the ORD 11 Standard Nomenclature Lists (SNL's) of groups P, R, S, and T, and their exact use will keep to a minimum any errors which may result in the shipping, storing, issue, and use of ammunition items.

7. AMMUNITION IDENTIFICATION CODE SYMBOLS.

a. The Ammunition Identification Code (A.I.C.) symbol has been established to facilitate the supply of ammunition in the field. Code symbols assigned to each item of ammunition in a specific packing are to be used in messages, requisitions, and records. These code symbols are published in ORD 11 SNL's of groups P, R, S, and T.

GENERAL

- A - { A.P.C., WITH
EXPLOSIVE FILLER
- B - { A.P.C., WITHOUT
EXPLOSIVE FILLER
- C - A.P., SOLID

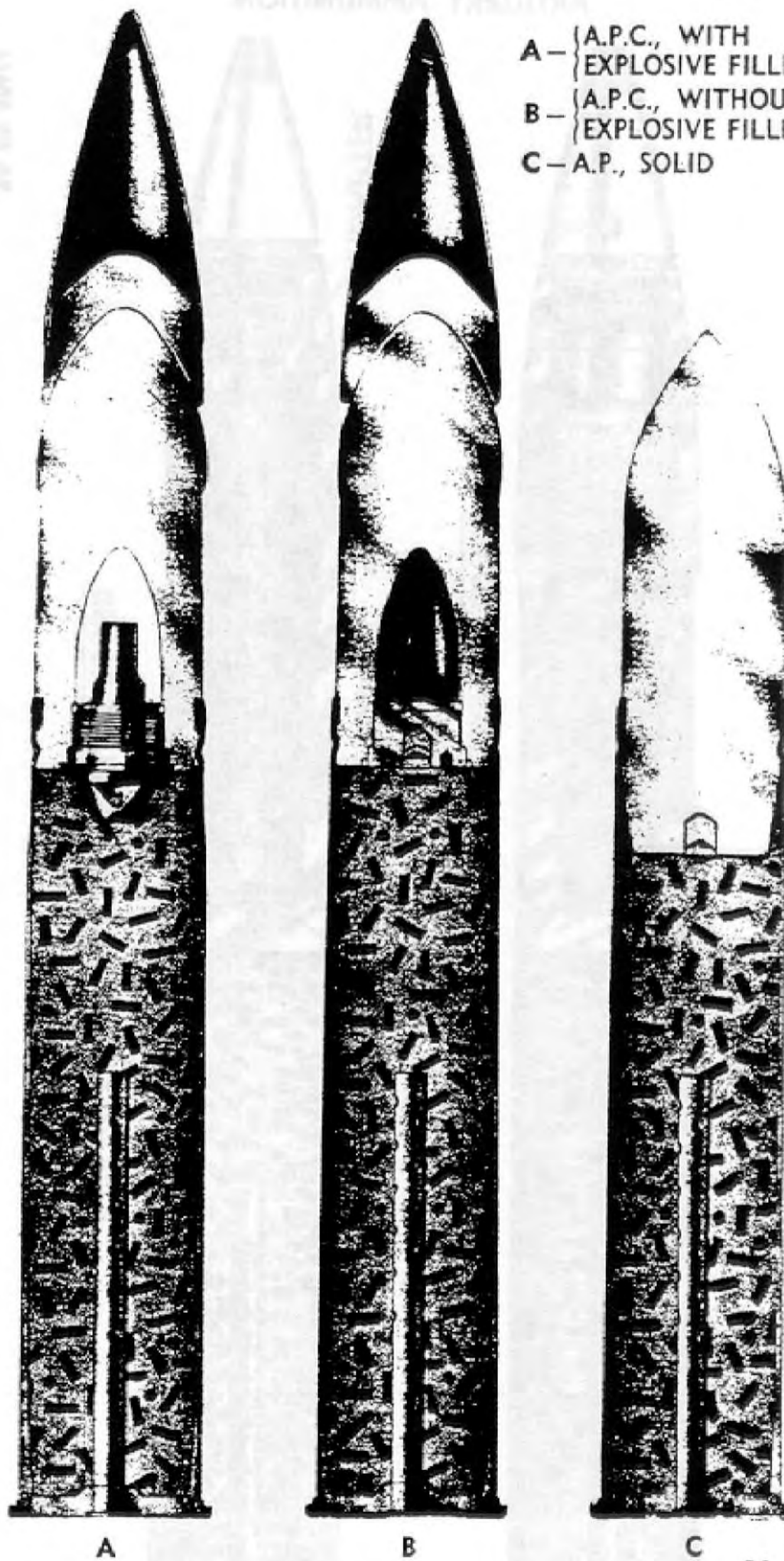

A

B

C

RA PD 80673

Figure 2—Typical Armor-piercing and Armor-piercing-capped Complete Rounds

ARTILLERY AMMUNITION

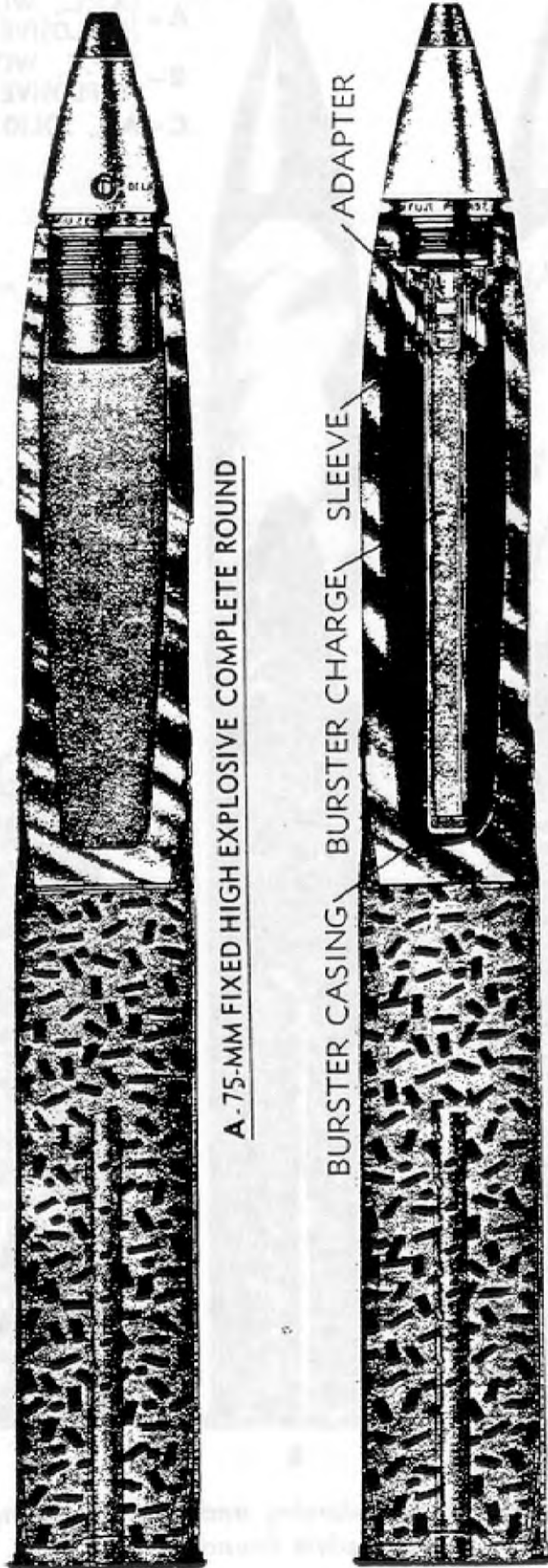

A. 75-MM FIXED HIGH EXPLOSIVE COMPLETE ROUND

B. 75-MM FIXED CHEMICAL COMPLETE ROUND

RA PD 80674

Figure 3 — Typical High-explosive and Chemical Complete Rounds

GENERAL

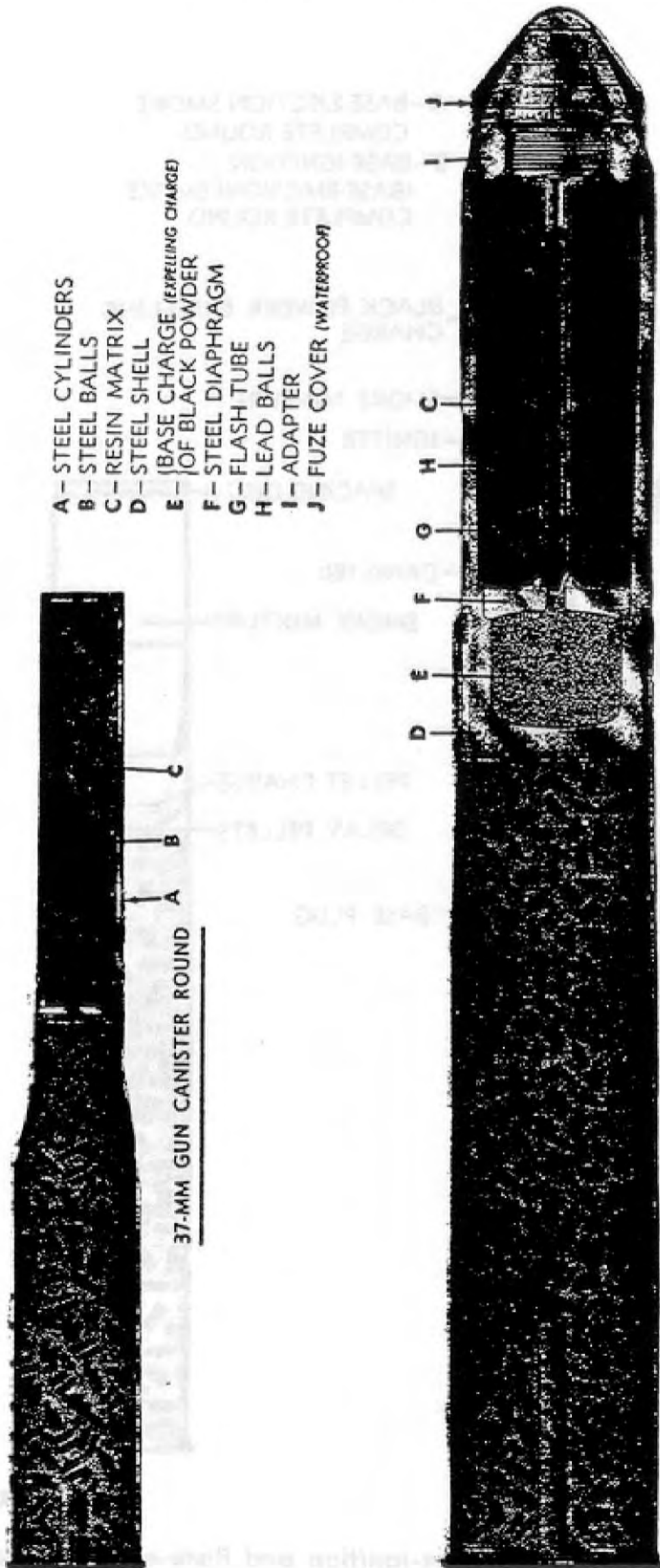

RA PD 80675

Figure 4 - Typical Complete Rounds of Canister and Shrapnel

ARTILLERY AMMUNITION

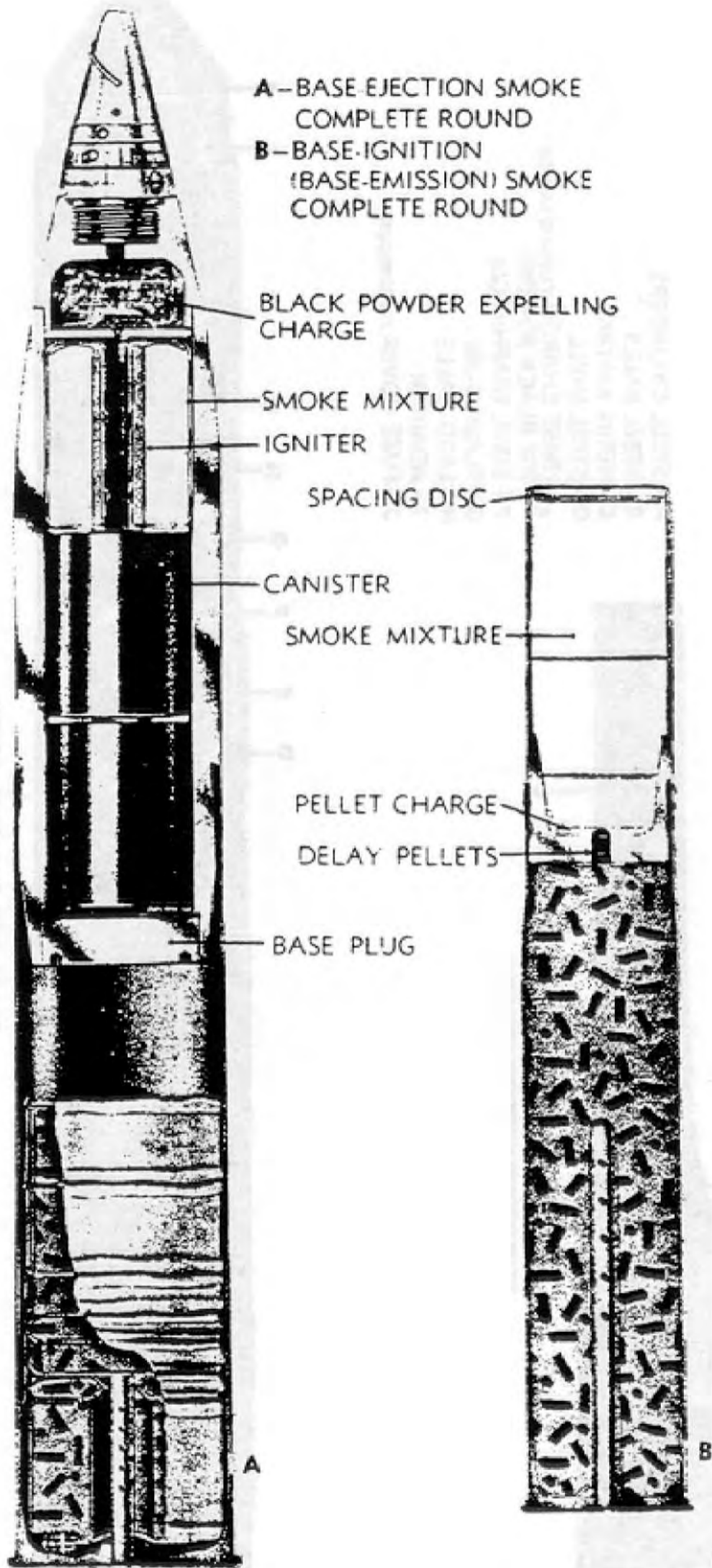

RA PD 80676

Figure 5 - Typical Base-ignition and Base-ejection Smoke Complete Rounds

GENERAL

8. GRADES OF AIRCRAFT AMMUNITION.

a. A system of grading has been established for aircraft artillery ammunition. The purpose of grading is to provide for higher performance by aircraft ammunition than is required of ammunition acceptable for use in ground guns. These grades are applicable to ammunition for use in 20-mm guns M1, AN-M2, M3, and Br. H.S./A/; 37-mm guns AN-M9, AN-M4, and M10; and 75-mm guns M4, AN-M5, M5A1, and T13E1. The grades are as follows:

Grade AIR—for use in any situation.

Grade NA—for use in any situation except air combat
(primarily for training).

b. Steel case rounds or resized case rounds will not be used in aircraft weapons.

9. EXPLOSIVES IN AMMUNITION.

a. **General.** The characteristics of various types of explosives are given in TM 4-205, Coast artillery ammunition; TM 9-1900, Ammunition, general; and TM 9-2900, Military explosives.

b. **Classification.** For military purposes, explosives are divided into two basic groups: Propellants (or low explosives) and high explosives. One of the chief differences between these two groups is in the nature of the characteristic reactions. The propellant is considered to react by burning, the rate of which depends upon such factors as pressure, grain form, composition, etc. The high explosive, on the other hand, is used for its detonating properties which are visualized as resulting from an explosion wave traveling through the high-explosive charge at an extremely high velocity (22,000 to 27,500 ft/sec). The velocity of detonation of a particular high explosive is directly proportional to its density.

c. **Propellants.** Propellants are used to propel the projectile out of the weapon at a prescribed velocity. Those currently used have a nitrocellulose base and are commonly known as smokeless powders. These powders are distinguished by such terms as straight nitrocellulose (NC), or pyro powder; double-base powder containing nitroglycerin (NG) and nitrocellulose. They may be flashless-nonhygroscopic (FNH); or simply nonhygroscopic (NH), depending upon their flash properties in a particular weapon. Black powder (or gunpowder) has been almost completely superseded as a propellant by smokeless powder. The usual form of smokeless powder in artillery ammunition is a cylindrical grain with one or more perforations (ch. 3, sec. II).

d. **High Explosives.** High explosives, because of their extremely rapid rate of detonation, have a powerful disruptive action. This action, or shattering power, is known as "brisance" and varies for different explosives. The high explosives more sensitive to impact

ARTILLERY AMMUNITION

FOR
SUPERQUICK
ACTION

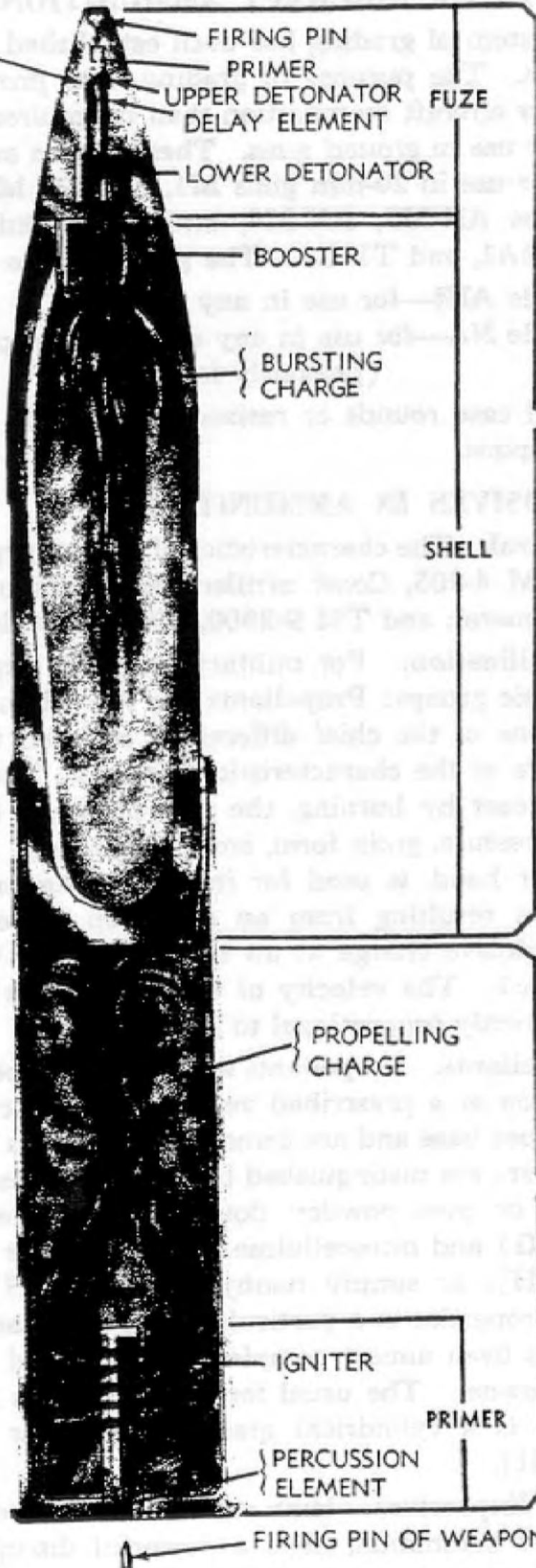

FIRING PIN
PRIMER
UPPER DETONATOR
DELAY ELEMENT
LOWER DETONATOR

FUZE

BOOSTER

BURSTING
CHARGE

BURSTING
CHARGE
EXPLOSIVE
TRAIN
(UPON IMPACT)

SHELL

PROPELLING
CHARGE

PROPELLING
CHARGE
EXPLOSIVE
TRAIN
(UPON FIRING)

IGNITER

PRIMER

PERCUSSION
ELEMENT

FIRING PIN OF WEAPON

RA PD 80672

Figure 6 — Explosive Trains — Artillery Ammunition

GENERAL

are used as initiators in primers or detonators, whereas the high explosives less sensitive to impact are used as bursting charges in shell. TNT and Composition B are the standard bursting charges in the United States, and amatol is the substitute explosive. Tetryl has more brisance than TNT but is also more sensitive; hence, it is used only as a bursting charge for small projectiles, of 20-mm, 37-mm, and 40-mm caliber, and as a booster in other calibers to initiate the detonation of TNT or explosive D. Explosive D is the high explosive least sensitive to impact and therefore is used as the bursting charge in armor-piercing projectiles where severe impact is expected. For details and descriptions of explosives, see TM 9-1900 and TM 9-2900.

e. **Explosive Train.** The arrangement of a series of explosives beginning with a small amount of sensitive explosive, and ending with a large amount of comparatively insensitive explosive, is termed an explosive train. In general, there are two such trains: The propelling charge explosive train and the bursting charge explosive train. These two trains are illustrated in figure 6 for a complete round of fixed artillery ammunition.

10. CHEMICAL FILLERS.

a. Some shell contain a chemical agent. A chemical agent is a substance which, by its ordinary and direct chemical action and in concentrations attainable in the field, produces a toxic or an irritating (harassing) physiological effect, a screening smoke, an incendiary action, or any combination of these. The most common gas used as a chemical filler is mustard gas, denoted by the Chemical Warfare Service symbol "H." This is a *persistent* gas; that is, it remains effective at the point of release for more than 10 minutes. The most commonly used smoke filler is white phosphorus (WP) which, in addition to producing a dense white smoke, also has an incendiary action. Phosphorus is a solid which melts at 110° F. A substitute for phosphorus is FS smoke. This is a sulfur trioxide-chlorosulfonic acid mixture; no mask is required for the FS smoke, the smoke being harmless except in very heavy concentrations. In base-ejection and base-ignition smoke shell, HC smoke is used. This is a hexachlorethane-zinc mixture for which no protection of personnel or materiel is required. Further information on chemical filler will be found in TM 9-1900, TM 3-315, and the Ordnance Safety Manual, O.O. Form No. 7224.

11. IDENTIFICATION.

a. **General.** Ammunition is completely identified, except as to grade, by painting and marking (which includes the ammunition lot number) on original packing containers. Once removed from its packing, ammunition may be identified by painting and marking on

ARTILLERY AMMUNITION

the ammunition items. Other essential information may also be obtained from the marking on ammunition items. The muzzle velocity of projectiles may be obtained from the firing tables and ammunition data cards; in case of some rounds of smaller caliber, the muzzle velocity also appears on the packing box.

b. Mark or Model. To identify a particular design, a model designation is assigned at the time the model is classified as an adopted type. This model designation becomes an essential part of the nomenclature and is included in the marking of the item. Prior to the World War, the year in which the design was adopted, preceded by an M, was used as the model designation, for example M1914. From World War I to 1 July 1925, it was the practice to assign mark numbers, that is, the word "Mark," abbreviated "Mk.," followed by a roman numeral. The modification was indicated by the addition of MI to the mark number, the second by MII, etc. The present system of model designation consists of the letter "M" followed by an arabic numeral, for example, "M1." Modifications are indicated by adding the letter "A" and the appropriate arabic numeral. Thus, "M1A1" indicates the first modification of an item for which the original model designation was "M1." Wherever a "B" suffix appears in a model designation it indicates an item of alternative (or substitute) design, material, or manufacture.

c. Ammunition Lot Number. At the time of manufacture every item of ammunition is assigned a lot number. Where the size of the item permits, it is stamped on the item itself to insure permanency of this means of identification. In addition to this lot number, there is assigned to each complete round of fixed and semifixed ammunition an *ammunition lot number* which serves to identify the conditions under which the round was assembled and the components used in the assembly. This ammunition lot number is marked on every complete round of fixed and semifixed ammunition (except where the item is too small) and on all packing containers. It is required for all purposes of record, including reports on condition, functioning, and accidents, in which the ammunition is involved. As far as practicable, all complete rounds of any particular ammunition lot are made up of components selected from the same lot. To obtain the greatest accuracy in any firing, successive rounds should be from the same ammunition lot whenever practicable.

d. Painting and Marking.

(1) **PAINING.** Ammunition is painted primarily to prevent rust. Secondary purposes are to provide, by the color, a ready means of identification, and, by the use of lusterless paint, for camouflage. The color scheme is as follows:¹

¹--An exception to the basic color scheme is the case of 20-mm projectiles. The high explosive-incendiary projectile has a yellow body and red ogive.

GENERAL

High-explosive	Olive-drab; marking in yellow
Armor-piercing containing high-explosive	Olive-drab; marking in yellow
Armor-piercing without explosive	Black; marking in white
Low-explosive	Red; marking in black
Chemical	Gray; one green band indicates non-persistent toxic gas; two green bands indicate persistent toxic gas; two red bands indicate persistent harassing agent; and one yellow band indicates smoke. Marking on the ammunition is in the same color as the band.
Practice	Blue; marking in white ²
Dummy or drill (inert)	Black; marking in white ³

(2) **MARKING.** The components of artillery rounds are marked as follows:

(a) *Projectiles* (figs. 7, 8, and 9):⁴

1. *Stenciled on the body:*

Ammunition Identification Code (A.I.C.) symbol on separate-loading shell.

Caliber and type of cannon in which fired ("75 H", etc.)⁵

Kind of filler ("TNT," "WP SMOKE," "H GAS," etc.)

Type and model of projectile ("SHELL M60," "PROJ. A.P.C. M61," etc.)

The word "TRACER" when projectile contains a tracer.

Lot number of loaded projectile. For fixed and semifixed rounds, the lot number is stenciled below the rotating band, in which position it is covered by the neck of the cartridge case.⁶

Ammunition lot number, in the case of 20-mm, 37-mm, and 40-mm projectiles only.

Weight zone (crosses or squares) or weight to nearest pound of loaded projectile. Exceptions are armor-piercing projectiles which are components of fixed rounds and base-ignition and base-ejection smoke shell.

¹—There are on hand some target-practice projectiles of larger caliber which have been painted black. It is contemplated that when replacement or repainting is required, they will be painted blue in agreement with the basic color scheme.

²—Nonferrous metal parts or assemblies (such as of brass or bronze) are not painted.

³—In addition to the identification listed, chemical shell also are marked with color bands indicating the type of filler; subparagraph d (1), above.

⁴—Navy projectiles are marked in accordance with Navy practice.

⁵—Shrapnel for 155-mm gun or howitzer may be found marked either "155-mm G" or "155-mm H." These items are identical with shrapnel properly marked "155-mm GH."

⁶—In older types and lots, the lot number of loaded projectile may not be below the rotating band.

ARTILLERY AMMUNITION

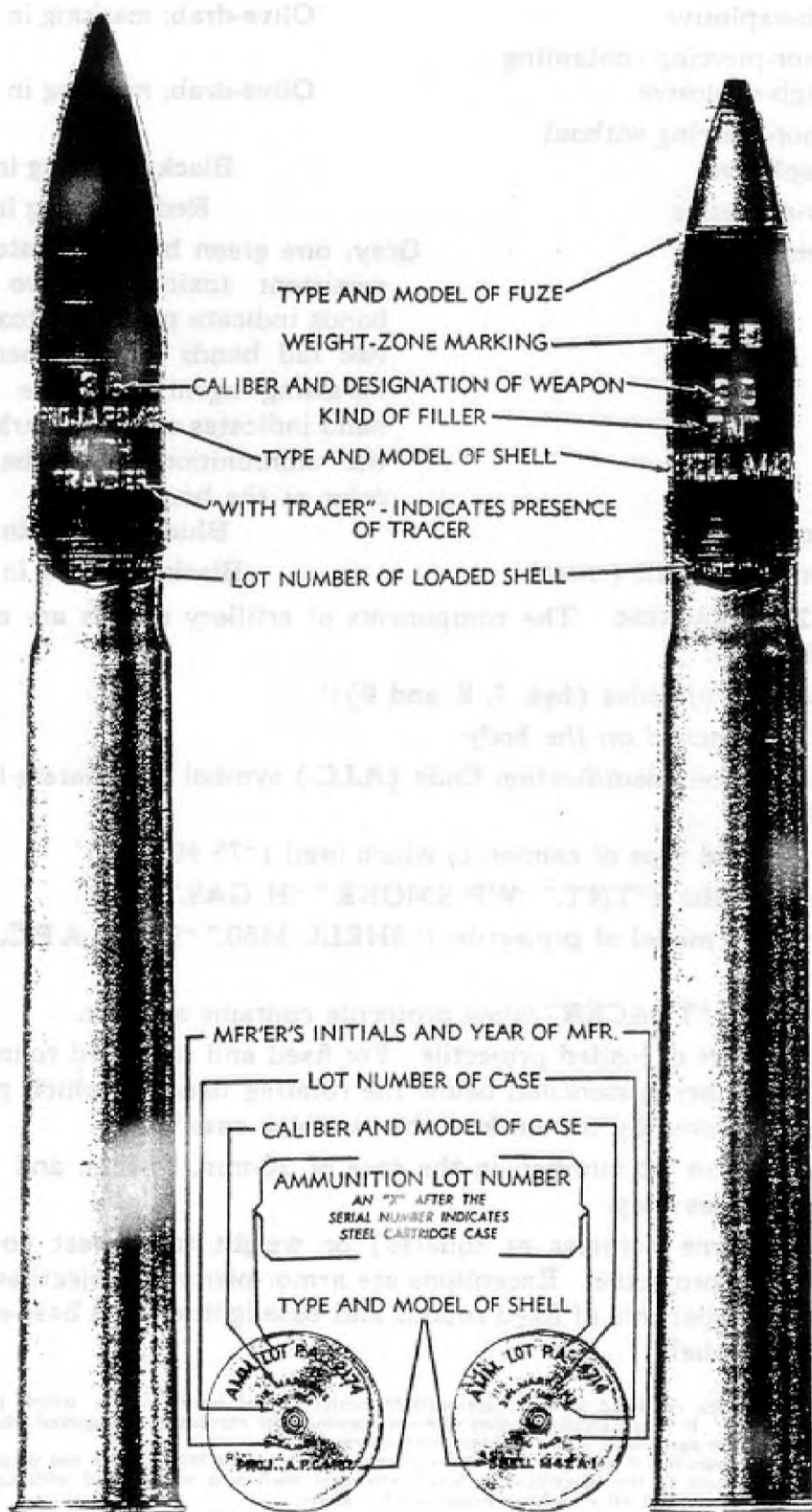

RA PD 80678

Figure 7 — Typical Marking of Fixed Ammunition

GENERAL

- A — WEIGHT ZONE MARKING
- B — WEIGHT TO NEAREST LB.
- C — CALIBER AND TYPE OF WEAPON
- D — KIND OF FILLER
- E — LOT NUMBER OF LOADED SHELL
- F — TYPE AND MODEL OF SHELL

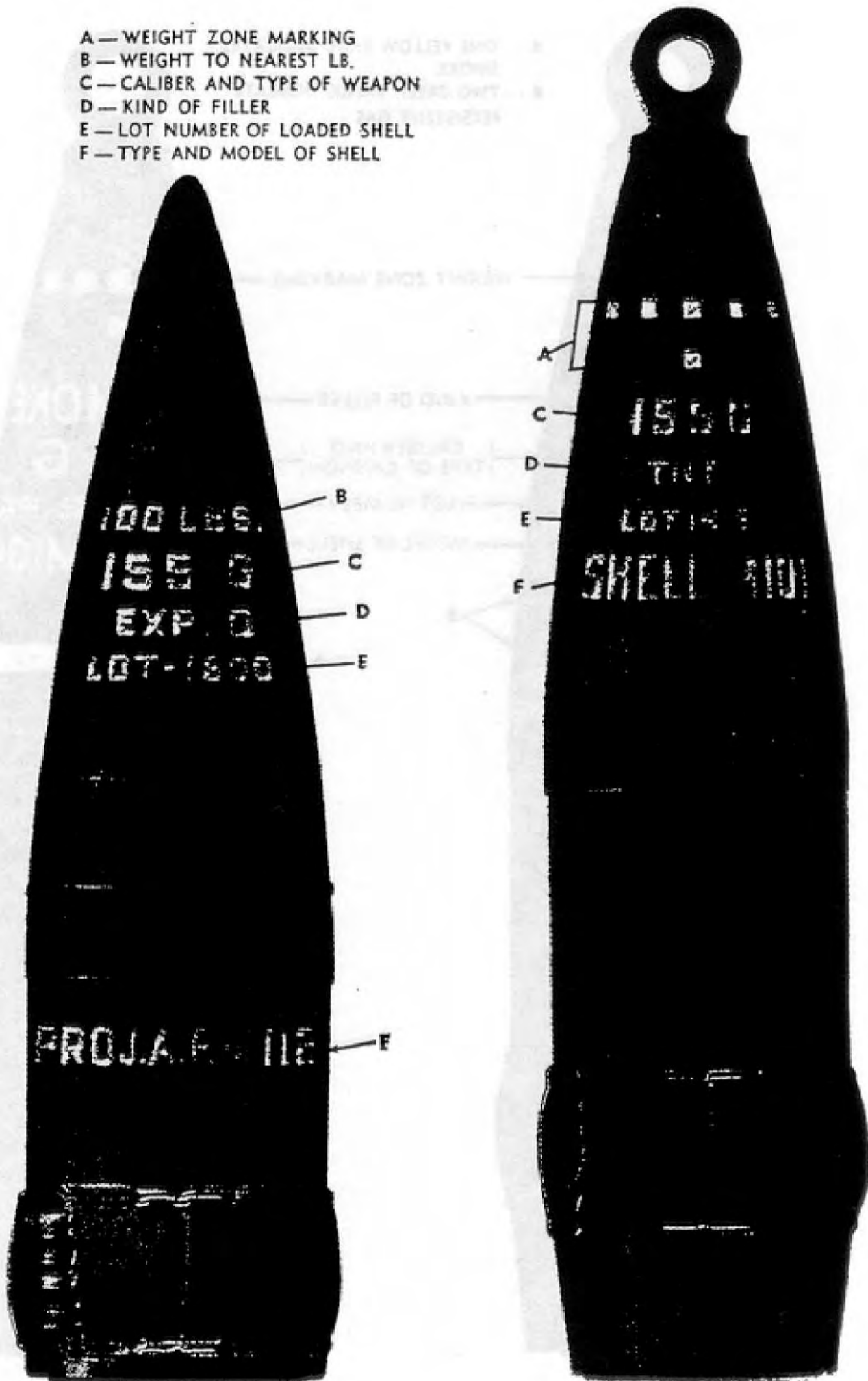

RA PD 80680

Figure 8 — Typical Marking of Separate-loading High-explosive and Armor-piercing Projectiles (Early Type Grommet Fastening Shown)

ARTILLERY AMMUNITION

- A ... ONE YELLOW BAND INDICATES SMOKE
- B ... TWO GREEN BANDS INDICATE PERSISTENT GAS

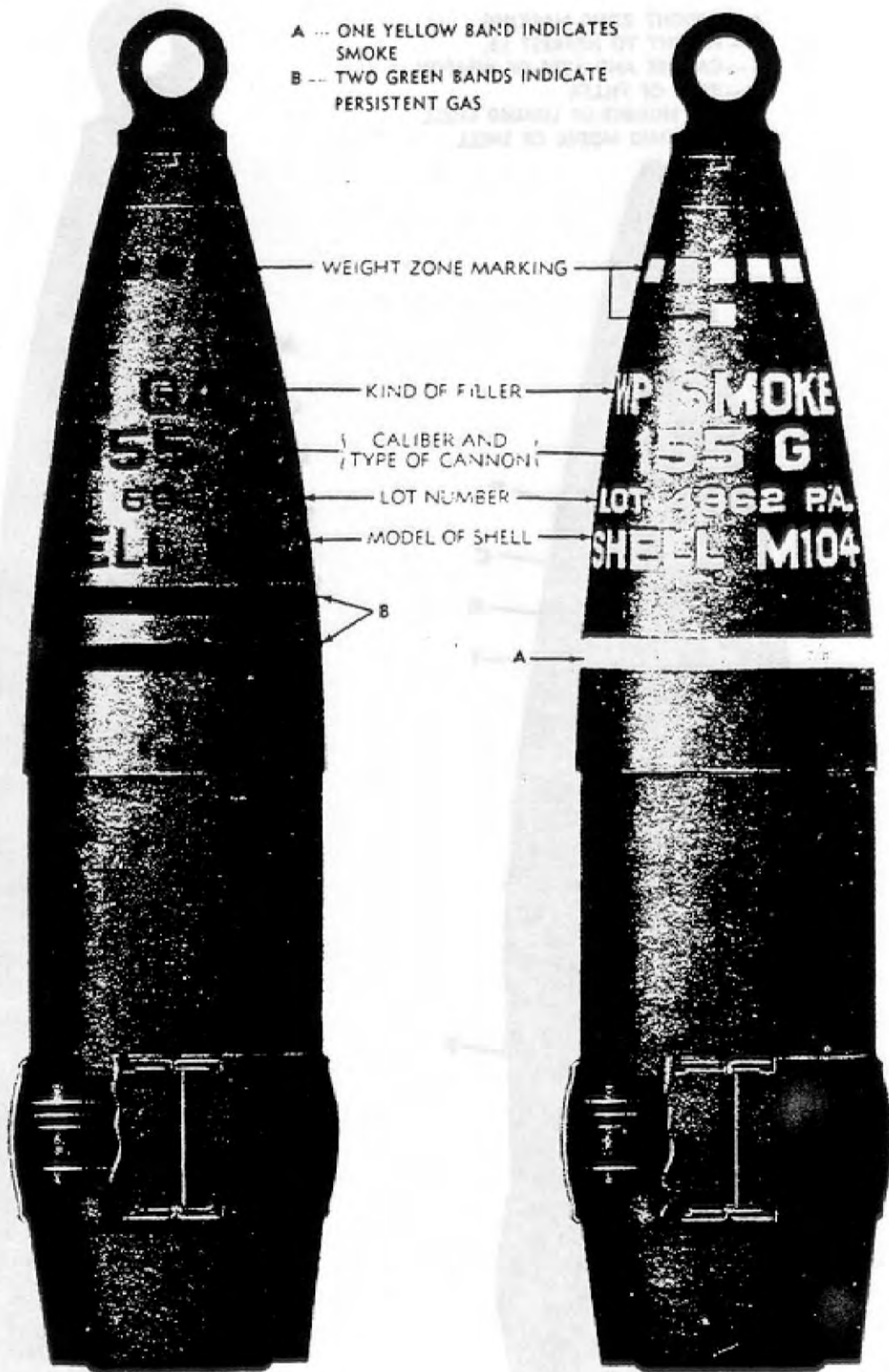

RA PD 80681

Figure 9 - Typical Marking of Separate-loading Chemical Projectiles
(Early Type Grommet Fastening Shown)

GENERAL

- A - 2 DIAMETRAL STRIPES AT RIGHT ANGLES AND "REDUCED" INDICATE REDUCED CHARGE
- B - 2 BANDS AND "REDUCED" INDICATE REDUCED CHARGE
- C - 1 DIAMETRAL STRIPE AND "NORMAL" INDICATE NORMAL CHARGE
- D - 1 BAND AND "NORMAL" INDICATE NORMAL CHARGE
- E - "SUPER" INDICATES SUPERCHARGE
- F - AMMUNITION LOT NUMBER AND LOADER'S INITIALS
- G - MANUFACTURER'S INITIALS AND YEAR OF MANUFACTURE
- H - CALIBER AND MODEL OF CARTRIDGE CASE
- I - MODEL OF SHELL
- J - WEIGHT-ZONE MARKING
- K - KIND OF FILLER
- L - CALIBER AND TYPE OF CANNON

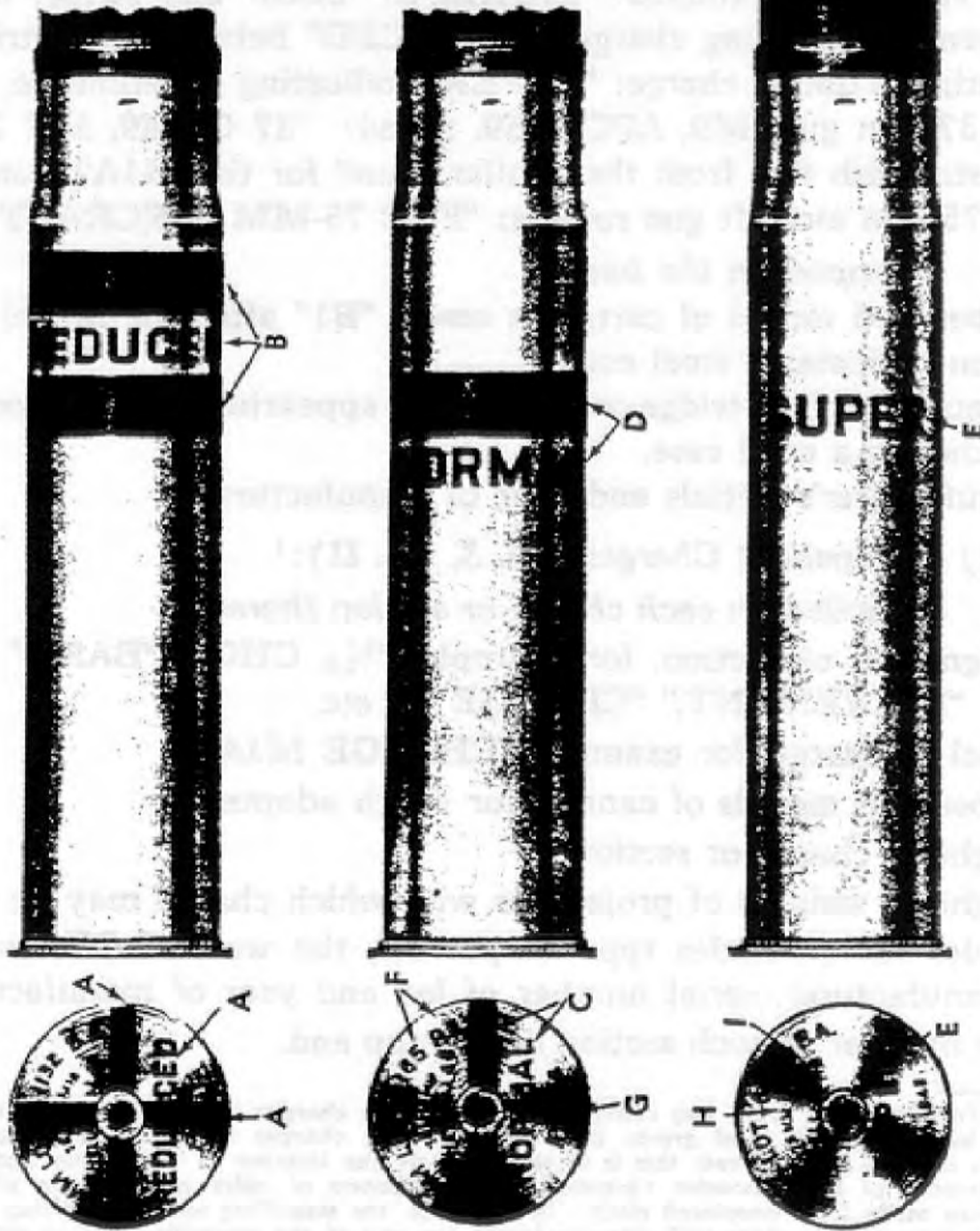

RA PD 80679

Figure 10 - Marking of 75-mm Complete Rounds Indicating Reduced, Normal, and Super Charges

ARTILLERY AMMUNITION

2. *Stamped on or forward of the rotating band:*

Lot number of empty shell.

Manufacturer's initials or symbol.

Caliber and model of shell.

Year of manufacture.

(b) *Cartridge Case (figs. 7 and 10):*1. *Stenciled on the base:*

Ammunition lot number and loader's initials. For 37-mm and 40-mm rounds, this ammunition lot number appears on the projectile instead of the base of the cartridge case.

Type and model of shell.

For 75-mm gun rounds: "NORMAL" below one diametral stripe, indicating normal propelling charge; "REDUCED" and two diametral stripes at right angles, indicating reduced charge; "SUPER" indicating supercharge.

2. *Stenciled on the side of the cartridge case:*

For 75-mm gun rounds: "NORMAL" below one stripe, indicating normal propelling charge; "REDUCED" between two stripes indicating reduced charge; "SUPER" indicating supercharge.

For 37-mm gun, M9, APC M59, round: "37 G, M9, MV 2,800" to distinguish this from the similar round for the M1A2 gun.

For 75-mm aircraft gun rounds: "FOR 75-MM AIRCRAFT GUNS."

3. *Stamped on the base:*

Caliber and model of cartridge case. "B1" after the model designation indicates a steel case.

Lot number of cartridge case. An "X" appearing after the lot number indicates a steel case.

Manufacturer's initials and year of manufacture.

(c) *Propelling Charges (ch. 3, sec. II):¹*1. *Stenciled on each charge or section thereof:*

Designation of section, for example, " $\frac{1}{16}$ CHG.," "BASE," "INCR." or "INCREMENT," "CHARGE 2," etc.

Model of charge, for example, "CHARGE M1A1."

Caliber and models of cannon for which adapted.

Weight of charge or section.

Weight or weights of projectiles with which charge may be used.

Powder lot (includes type of powder, the word "LOT," initials of manufacturer, serial number of lot, and year of manufacture).

Zone number of each section on the top end.

¹—To distinguish green bag charges from white bag charges, the cartridge bag cloth for the green bag charges is dyed green; that for white bag charges is white. The cloth used for igniters is dyed a bright red; this is to show clearly the location of the igniter and to indicate the presence of black powder (low-explosive). Igniters of older manufacture will be found in service made from uncolored cloth. In this case, the stenciling and the quilting which holds the black powder in place will serve to locate the end of the propelling charge which contains the igniter.

GENERAL

2. *Stenciled on igniter:*

Weight, grade, and kind of igniter powder.
"IGNITER."

Caliber and models of cannon in which fired.

Month and year of loading.

(d) *Fuzes (Stamped on the Body):*

Type and model of fuze.

Manufacturer's initials.

Lot number of fuze and year of manufacture.

Action of fuze, for example, "DELAY" and length of delay in seconds, "SQ" (superquick), or time in seconds on a graduated time ring.

(e) *Primers (Stamped on the Base):*

Loader's initials, lot number, and year of loading.

Model designation.

(3) WEIGHT OR WEIGHT-ZONE MARKINGS.

(a) In the manufacture of shell containing explosives or chemical agents, variations in weight occur. Ballistic corrections are provided in firing tables for these variations in weight. For most separate-loading projectiles of medium and large caliber, the weight to the nearest pound is stenciled on each projectile. For fixed and semi-fixed shell and for certain medium caliber separate-loading projectiles, shell of one lot number falling within a certain range of weights are considered to be in a *weight zone*. The weight zone of the projectile is indicated by crosses on 75-mm projectiles, and by squares with a prick punch in the center of each on projectiles of 76-mm caliber and over, in the same color as the original markings. One, two, three, or more are used, depending on the weight of the projectile. Weight zones lighter than that of one cross are indicated by one "L" or more, as required. The following crosses or squares indicate "standard" or "normal" weight, that is, the range of weights for which no corrections in range tables are required.

Caliber of Projectile	"Standard" or "Normal" Weight Zone
75-mm	2 crosses
3-in., 76-mm	1 square
90-mm, 105-mm, 4.5-in., 6-in.....	2 squares
120-mm (4.7-in.), 155-mm, 8-in. how., 240-mm how.	4 squares
8-in. gun, 10-in. and above.....	None (weight to nearest pound used)

(b) Small-caliber projectiles; trench-mortar rounds; canister, high-explosive-antitank, armor-piercing, base-ejection smoke, and base-ignition smoke projectiles do not require weight-zone markings. Armor-piercing projectiles, 6" caliber and above, have weights to the nearest pound.

ARTILLERY AMMUNITION

12. CARE, HANDLING, AND PRESERVATION.

a. Ammunition is packed to withstand conditions ordinarily encountered in the field, moisture-resistant containers and suitable packing boxes or crates being used to provide the desired protection for shipment and storage. Care must be observed to keep packing boxes from becoming broken or damaged. All broken boxes must be repaired immediately and careful attention given to the transfer of all markings to the new parts of the box. When the packing box contains a metal liner, the liner should be air-tested and sealed provided equipment for this work is available. This air-testing is also applicable to cartridge-storage cases for propelling charges.

b. Since explosives are adversely affected by moisture and high temperature, due consideration should be given to the following:

(1) Do not break the moisture-resistant seal until ammunition is to be used. Ammunition removed from the airtight container, particularly in damp climates, is apt to corrode, thereby causing the ammunition to become unserviceable.

(2) Protect the ammunition, particularly fuzes, from sources of high temperatures, including the direct rays of the sun. More uniform firing is obtained if the rounds are at the same temperature.

c. Ammunition and ammunition components should be protected from mud, sand, dirt, and water. Wet or dirty ammunition should be wiped off at once, and any verdigris or light corrosion removed. Ammunition should not be polished, however, to make it look better or brighter.

d. Explosive ammunition, or components containing explosives, *must* be handled with appropriate care at all times. The explosive elements in primers and fuzes are particularly sensitive to shock and high temperature. The adoption of high explosives such as composition B, pentolite, and tetrytol makes it even more necessary to follow the precautions prescribed for handling ammunition as stated in TM 9-1900.

e. Ammunition, or components of ammunition, prepared for firing but not fired will be returned to their original condition and packings, and appropriately marked. Such ammunition will be used first in subsequent firings in order that stocks of opened packings may be kept at a minimum.

f. Do not attempt to disassemble any fuze. Any alteration of loaded ammunition except by the technical service concerned and under the supervision of a commissioned officer of that service is hazardous and is therefore prohibited (AR 750-10, par. 2 e, 22 Jan 44).

g. Do not remove protection or safety devices from fuzes until just before use.

GENERAL

h. Cartridge cases are easily dented and should be protected from hard knocks and blows. A dented cartridge case may result in loss of obturation, jamming in the chamber, and difficulties in extraction.

i. Do not remove the eyebolt-lifting plug from unfuzed projectiles until the fuze is to be assembled thereto. The plug is provided to keep the fuze opening free of foreign matter as well as for convenience in handling. When separate-loading projectiles are stored in the field, frequent inspection of the plugs must be made for evidence of corrosion. At the first sign of corrosion, the threads must be coated with a thin film of light, rust-preventive compound, to prevent the plug from sticking or "freezing" in the projectile.

CAUTION: *This lubrication should be done sparingly.*

j. Blank ammunition with loose or broken closing cup will not be used or fired but will be reported to the Ordnance officer for disposition.

k. Do not handle duds. Because their fuzes are armed, and hence extremely dangerous, duds will not be moved or turned, but will be destroyed in place in accordance with TM 9-1900.

l. Precautions in handling, including procedures to be taken in case of misfires, will be found in TM 9-1900 and in the various Technical Manuals and Field Manuals on the weapon.

13. STORAGE PRECAUTIONS.

a. When necessary to leave ammunition in the open, raise it on dunnage at least 6 inches from the ground and cover it with a double thickness of tarpaulin. Whenever possible, dunnage should be used between each row to permit full air circulation. Suitable trenches should be dug to prevent water from flowing under the pile. Tarpaulin should be arranged so as to permit free circulation of air through the pile. The tarpaulin should be kept at least 6 inches from the pile on top, ends, and sides.

b. Detonating fuzes will be stored and transported separate from other explosive ammunition.

c. Shells containing phosphorus, or rounds having phosphorus filled shell, should preferably be stored or transported on their bases. Should such ammunition be stored or transported on their sides and the temperature reaches the neighborhood of 110° F., the melting point of phosphorus, this filler may flow to one side of the shell and thereby cause erratic ballistics.

d. Fires involving fuzed ammunition can generally be fought for approximately the first 10 minutes of the fire. This may allow sufficient time in which to bring the fire under control.

e. For further storage precautions, see TM 9-1900, TM 4-295, and the Ordnance Safety Manual, O O Form No. 7224.

ARTILLERY AMMUNITION

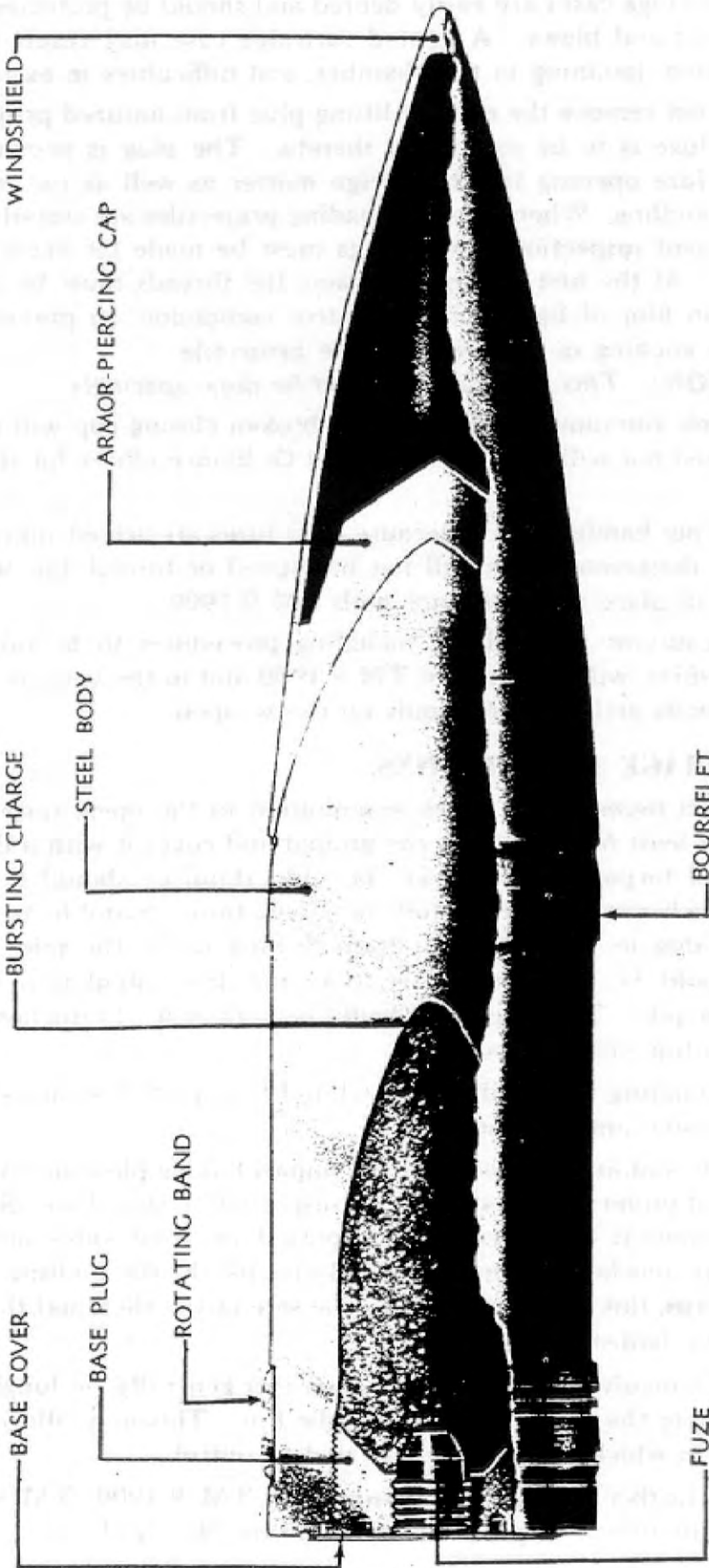

RA PD 4034A

Figure 11 — Typical Armor-piercing Projectile Showing Parts

GENERAL

14. DISCUSSION OF PROJECTILES.

a. **General.** An artillery projectile may be either solid or hollow. When hollow, the projectile may be empty or it may be partly or completely filled with explosive, and have a fuze for the purpose of detonating the explosive. Service types of projectiles are mentioned in paragraph 5 b. These types are described more fully in this paragraph. With the exception of canister, base-ignition smoke shell, and proof projectiles, artillery projectiles, although differing in characteristic details, are of the same general shape, in that they have a cylindrical body and an ogival head. The projectiles vary in length from 2 to 6 calibers. Their principal characteristic differences are in:

- (1) Location of fuzes—point or base.
- (2) Radius of ogive—smaller for low-velocity, larger for high-velocity projectiles.
- (3) Rotating band—narrow for low-velocity, wide for high-velocity projectiles.
- (4) Base—tapering ("boat-tailed") or cylindrical ("square" base).
- (5) Armor-piercing-cap—only for certain armor-piercing projectiles.
- (6) Windshield, ballistic cap, or false ogive—when required for improved ballistics.

b. **Components of Projectiles.** A typical projectile with principal parts named is shown in figure 11. These parts are described briefly below. Additional information will be found in TM 9-1900.

(1) **LOCATION OF FUZES.** High-explosive shell generally require point-detonating fuzes or time fuzes located in the nose of the shell. The high-explosive shell shipped unfuzed are fitted with eyebolt-lifting plugs (ch. 3, sec. V) to protect the fuze hole threads and to provide for ease in handling. Armor-piercing shell require base-detonating fuzes with either delay or nondelay action.

(2) **OGIVE.** The curved portion of the projectile from the point to the bourrelet, is called the ogive. Since armor-piercing projectiles have a short radius of ogive for purposes of penetration, a ballistic cap, often called a false ogive or windshield, is placed over the armor-piercing head to increase the ability to overcome air resistance.

(3) **BOURRELET.** The bourrelet is the accurately machined surface, of slightly larger diameter than the body, which bears on the lands of the bore. It centers the projectile in the bore and guides it in its travel through the bore. Generally, it is at the forward end of the body, but in the case of the 4.5-inch projectile it extends from the ogive to the boat-tailed base. In addition, some projectiles of large caliber have a front and rear bourrelet.

ARTILLERY AMMUNITION

(4) **BODY.** While applicable to the entire projectile, the term "body" is used to designate the cylindrical portion of the projectile between the bourrelet and the rotating band.

(5) **BURSTING CHARGE.** The high explosives fill the entire cavity in the shell except for space into which the booster or the fuze fits. In the case of chemical shell the bursting charge of tetryl is contained in a narrow cylindrical burster tube fitted in the center of the shell. This burster for chemical shell ruptures the shell sufficiently to allow the chemical filler to escape without excess dispersion. The percentage of explosive in shell varies with the type of shell and the following figures are generally applicable:

Type of Shell	Percent by Weight of High Explosive (Approx)
H.E. shell, gun or howitzer	7.5—18
H.E. shell, mortar:	
Light	12—18
Heavy	30—40
A.P. shell	0.9—1.4
Chemical shell	0.34—0.55

(6) **ROTATING BAND.** The rotating band is a cylindrical ring of copper or gilding metal pressed into a knurled or roughened groove near the base of the projectile. It affords a snug seat for the projectile in the forcing cone and centers the base in the bore. As the projectile moves forward, the soft rotating band is engraved by the lands of the bore. Because of compression of the band, excess metal flows toward the rear. This flow of metal is taken up by cannelures, or grooves, cut in the rotating band. Since the rifling of the weapon has a helical twist, rotation is imparted to the moving projectile by the engraved rotating band. In addition, the rotating band prevents the escape of the propellant gases forward of the projectile by completely filling the grooves of the rifling.

(7) **TYPE OF BASE.** When the surface to the rear of the rotating band is cylindrical, the projectile is said to have a "square" base; when tapered or conical, it is known as "boat-tailed." From a velocity of 2,500 feet per second to velocities below that of sound, the boat-tail decreases the retardation due to air resistance, by reducing the vacuum-forming eddy currents of air in the wake of the projectile, increasing the range. Accordingly, the boat-tailing is effective in low-velocity weapons and in high-velocity weapons at velocities of 2,500 feet per second or less. The taper of boat-tailed bases varies from 5 to 9 degrees.

(8) **BASE PLUG.** To facilitate manufacture, armor-piercing projectiles are closed at the base with a heavy steel plug. In the larger

GENERAL

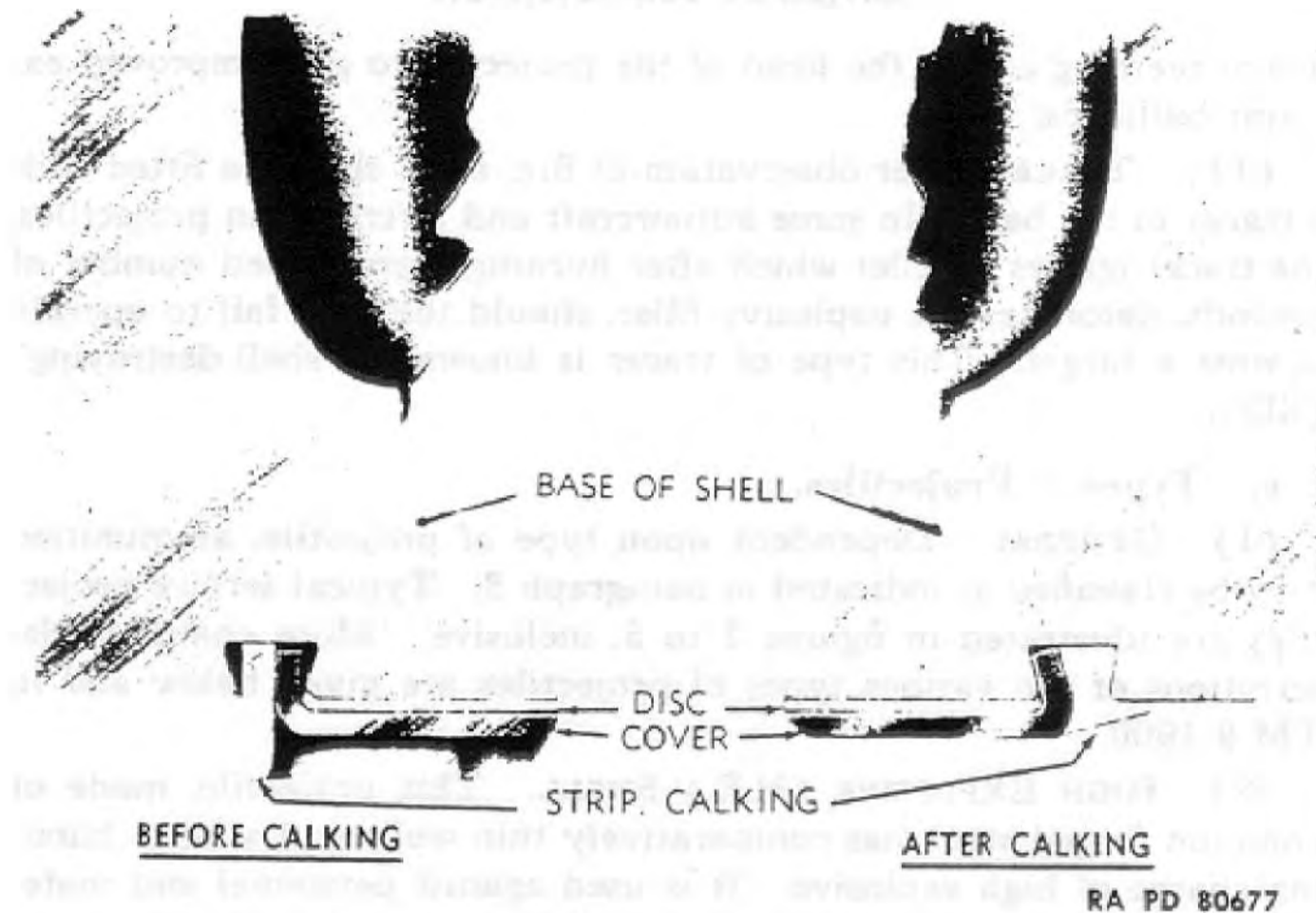

RA PD 80677

Figure 12 — Calked Type of Base Cover for Shell With Explosive Filler

calibers. the base plug also provides a seat for the fuze plug and fuze. In the smaller calibers. if an explosive charge is loaded in the cavity of the projectile. the base plug is replaced by a base fuze. The tracer element. in the smaller calibers. is contained in the base of the projectile. in a base plug. or in the base fuze.

(9) **BASE COVER.** The 20-mm projectiles and projectiles of 75-mm or larger caliber containing high explosive are provided with a base cover to prevent the hot gases of the propelling charge from coming in contact with the explosive filler of the projectile through joints or possible flaws in the metal of the base. Small and medium caliber armor-piercing projectiles with high-explosive filler and base fuzes are not ordinarily provided with base covers. Base covers may be crimped, calked, or welded to the base of the projectile (fig. 12).

(10) **ARMOR-PIERCING CAP.** Some armor-piercing projectiles are fitted with an armor-piercing cap for use especially in penetrating face-hardened armor plate. The cap is made of forged alloy steel. heat-treated to have a hard face and relatively soft but tough core. On impact, the hardened face of the cap destroys the hardened face of the armor plate while the softer core of the cap protects the hardened point of the projectile by distributing the impact stresses over a large area of the head. See also subparagraph c (4). below, describing armor-piercing projectiles.

(11) **WINDSHIELD.** The windshield, also known as the false ogive or ballistic cap. is made of steel or aluminum and is secured to the

ARTILLERY AMMUNITION

armor-piercing cap or the head of the projectile to give improved exterior ballistics.

(12) **TRACER.** For observation of fire, some shell are fitted with a tracer in the base. In some antiaircraft and aircraft gun projectiles, the tracer ignites a pellet which after burning a prescribed number of seconds, detonates the explosive filler, should the fuze fail to operate against a target. This type of tracer is known as "shell-destroying" (SD).

c. Types of Projectiles.

(1) **GENERAL.** Dependent upon type of projectile, ammunition may be classified as indicated in paragraph 5. Typical service projectiles are illustrated in figures 2 to 5, inclusive. More complete descriptions of the various types of projectiles are given below and in TM 9-1900.

(2) **HIGH EXPLOSIVE (H.E.) SHELL.** This projectile, made of common forged steel, has comparatively thin walls and a large bursting charge of high explosive. It is used against personnel and materiel targets, producing blast effect and fragmentation at the target. It may be fitted with either a time or impact fuze, according to type of action desired.

(3) **HIGH-EXPLOSIVE-ANTITANK (H.E., A.T.) SHELL.** This is a special type of high-explosive shell for use against armored or concrete targets. Its effect is dependent upon the type and shape of its high-explosive charge. It blasts a hole in the target. It has a conical windshield which crushes on the target, and a base-detonating fuze having nondelay action.

(4) **ARMOR-PIERCING (A.P. OR A.P.C.) PROJECTILE.** Armor-piercing projectiles are made of heat-treated high carbon alloy steel. The head is very hard for penetration of armor and the body is tough so that it will withstand the strains imposed by the twisting action of the projectile at angles of impact oblique to normal. To aid in overcoming face-hardened armor plate, an armor-piercing cap (subpar. b (10), above) is attached to the head of the projectile. These armor-piercing projectiles have thick walls and generally a small cavity which may be either empty or filled with explosive D and fitted with a base-detonating fuze having a delay action. A steel or aluminum windshield is generally attached to the body or to the armor-piercing cap by screw threads or crimping. A tracer may be present in the base plug or in the base end of the fuze.

(5) **CHEMICAL SHELL.** There are three general types of chemical shell. The burster, the base-ejection, and the base-ignition (base-emission) types. The burster type is very similar to high-explosive shell, except for type of filler (par. 10), and the absence of a base cover. A large booster charge, termed a burster (subpar. b (5),

GENERAL

above), is used to break the shell body and aid in dispersion of the chemical filler. In older types of chemical shell, the nose is fitted with tapered threads to form a gastight joint with the adapter. Modern types use standard threads with silver soldering for the adapter and a force fit for the burster casing. Base-ejection shells do not have a burster, but have an expelling charge of black powder, adjacent to the time fuze, which ignites and blows the three or four smoke canisters out through the base of the shell. In the base-ignition smoke shell, the smoke filler is ignited through a hole in the base by the propelling charge. Shells of older manufacture have a low-melting fusible metal plug in this base hole, whereas shells of new manufacture have delay pellets.

(6) **ILLUMINATING SHELL.** These shells contain parachute and illuminant assemblies which are ejected by an expelling charge adjacent to the time fuze. The illuminant burns lighting up a target area.

(7) **CANISTER.** Canister consists of a light metal cylindrical case, filled with steel balls, containing no explosives. It is fired point-blank for effect against personnel. The case breaks upon leaving the muzzle of the cannon, allowing the balls to scatter with shotgun effect.

(8) **SHRAPNEL.** Shrapnel are point-fuzed with a combination time and superquick or an AA. time fuze. An expelling charge of black powder is assembled in the base. A central flash tube connects the fuze and base charge. When the time fuze has burned its predetermined time, the magazine charge flashes through the central tube to ignite the base charge. This results in the ejection of the steel diaphragm, balls, head, and fuze from the case at a velocity of about 350 feet per second added to that of the shrapnel at time of burst. The case is not ruptured. The balls are projected forward in the form of a cone, due to rotational velocity. Shrapnel are authorized only for training purposes.

(9) **TARGET-PRACTICE PROJECTILES.** Target-practice projectiles, generally made of cast iron, are provided for target practice. These projectiles have the same dimensions, weight, and center of gravity, as the service projectiles they simulate. Some target-practice projectiles must be sand-loaded to bring them up to standard weight. Target-practice shells, including those used in subcaliber firings, sometimes contain a black powder spotting charge.

(10) **DUMMY PROJECTILES.** Drill or dummy (inert) projectiles are used with fixed, semifixed, and separate-loading drill rounds for training purposes. Those which are part of fixed and semifixed rounds (drill cartridges) are usually inert service projectiles, with or without modifications. Separate-loading dummy projectiles are of two types: sliding-ring type and internal-plunger type. In the sliding-ring type, a rear ring on a cylindrical sliding assembly simulates the rotating band.

ARTILLERY AMMUNITION

After the rear band is seated in the forcing cone of the bore, the dummy projectile can be pulled sharply to the rear for a short distance by means of an extractor inserted in the base end of the dummy projectile. In the internal-plunger type, an internal plunger, held to the rear by a spring, moves forward against the spring when the projectile is rammed home. The plunger then snaps back loosening the projectile in its seat so that it can be extracted more easily.

d. Armor-piercing Data.

(1) The penetration data of specific projectiles are given in chapter 2. Certain general armor-piercing data for projectiles are given herein. *Penetration* generally refers to the piercing of armor plate, whereas *perforation* indicates complete penetration of the projectile through one side and out of the other side of the plate.

(2) The angle of impact is important in penetration. Once the perforation is known at normal impact, the perforation at any angle can be estimated as follows:

Angle (deg)	Percentage Lost in Perforation	Angle (deg)	Percentage Lost in Perforation
0	0	25	16
5	2½	30	20
10	5	35	27
15	8	40	34
20	13	45	41

(3) Approximate penetration for different caliber armor-piercing projectiles is given in Table 1, below.

TABLE 1 — ARMOR PENETRATION TABLE

Caliber	Approx. Inches of Penetration of Armor Plate at 1,000 Yards (Normal Impact)		Caliber	Approx. Inches of Penetration of Armor Plate at 1,000 Yards (Normal Impact)	
	Homogeneous Plate	Face-hardened Plate		Homogeneous Plate	Face-hardened Plate
20-mm A.P.	0.9	0.6	75-mm H.E., A.T...	3½*	—
37-mm AA., A.P....	0.7	0.7	76-mm A.P.C.	4.5	1.7
37-mm A.T., A.P.C.	2.3	2.1	3-inch A.P.C.	4.5	4.7
40-mm A.P.	1.8	1.7	90-mm A.P.C.	5.5	6.0
57-mm A.P.C.	3.6	3.7	105-mm H.E., A.T.	4.0*	—
75-mm A.P.C.	2.8	3.4	155-mm A.P.	7.5	—

*—At any range.

GENERAL

15. BLANK AMMUNITION.

a. **General.** Blank ammunition is made up for cannon of calibers up to and including 105-mm for practice purposes in maneuvers, in firing the morning and evening gun, and for saluting purposes.

b. **Complete Round.** A complete round of blank ammunition consists of a black powder charge contained in either a loose-fitting cloth bag which sags around the primer or in one or two compressed cylindrical pellets wrapped in cellophane fitting around the primer, assembled in a brass cartridge case. A chipboard closing cup is inserted in the mouth of the case and sealed to hold the charge in place and to prevent powder from leaking out. A 10-gage blank cartridge, with a suitable adapter made from a service cartridge case, is used for blank firing of 37-mm weapons.

16. PACKING AND MARKING FOR SHIPMENT.

a. **General.** Moisture-resistant containers are used for practically all ammunition, except separate-loading projectiles and primers. These packing containers are marked to furnish all essential information. Specific packing data for each ammunition item will be found in ORD 11 Standard Nomenclature Lists.

b. **Packing.** Separate-loading projectiles do not require any outer packings; they are shipped unfuzed with an eyebolt-lifting plug in the nose and a grommet to protect the rotating band (ch. 3, sec. V). Exceptions are those projectiles having a windshield and dummy projectiles which are shipped in a crate (fig. 21). Separate-loading primers are packed 50 to a sealed metal can (fig. 13), and these cans are packed in a wooden box. In the smaller calibers, other components and rounds of artillery ammunition are packed in a slip-cover fiber container of the mailing tube type. For further protection, rounds assembled with point-fuzed projectiles may have U-shaped packing stops fitted into the fuze wrench slots. These must be removed before firing. All fiber containers are packed in wooden boxes or in bundles of three containers. For typical packing boxes, see figures 14, 15, and 22, and for fiber containers, including the inverted 105-mm type, see figure 16. Some of these packing boxes have a carriage bolt and rod holding and reinforcing the two ends of the box. Bundle packings are illustrated in figures 17 and 18. Bundles are crated for over-sea shipments as shown in figure 19. In addition to bundle packing, separate-loading propelling charges are packed in hermetically sealed metal cartridge-storage cases (fig. 20). An igniter-protector cap, made of cloth or paper, serves as protection to the igniter end of propelling charges as shipped. Metal containers are the latest type of packing for single rounds of artillery ammunition and one, four, or eight rounds of trench-mortar ammunition. Rounds for the 105-mm howitzer, 60-mm and 81-mm mortars are packed in standard fiber con-

ARTILLERY AMMUNITION

tainers prior to packing in the metal container. Eight 60-mm mortar rounds, four light 81-mm mortar rounds, or one heavy 81-mm mortar round are placed in one metal container. The metal containers are cylindrical, made of steel, and sealed against moisture by a rubber gasket in the sealing cover. A screw and pressure plate cover assembly hooks under a locking ring on the metal container and provides pressure over the sealing cover and gasket.

c. **Sealing.** Each container, after the contents are properly packed, is sealed in some manner which will indicate whether or not the container has been tampered with. Where metal strapping is used around boxes, paper seals are not necessary and are no longer used.

d. **Marking for Shipment.**

(1) **GENERAL.** Ammunition items are marked as described in paragraph 11. Packing containers are marked in accordance with Army Regulations, specifications, and I.C.C. regulations.

(2) Each package of supplies turned over for shipment on a Government bill of lading is marked with the following:

(a) Name and address of destination or port officer (or code marking) preceded by word "To."*

(b) Name and address of ultimate consignee, preceded by word "For."*

(c) List and description of contents.

(d) Ammunition code symbol, published in ORD 11 SNL's.

(e) Gross weight in pounds, displacement in cubic feet.

(f) The number of the package or shipping ticket.*

(g) The letters "U.S." in several conspicuous places.

(h) Order number or contract number.

(i) Ordnance insignia.

(j) Name or designation of consignor preceded by the word "From."*

(k) Lot number.

(l) Month and year packed.

(m) Inspector's stamp.

(3) The adhesive sealing strips on fiber containers are in the same color as ammunition item, in accordance with basic color scheme. Thus, blank ammunition has sealing strips in red, to indicate low explosive (black powder). It will be noted, however, that for rounds with high-explosive projectiles, the strips are yellow with black marking.

(4) Wooden packing boxes are painted or stained brown; markings in yellow.

(5) Metal containers are painted olive drab; markings in yellow.

(6) Containers for green bag propelling charge, white bag pro-

*—May be omitted on individual packages in carload shipments of packages of standard weights and dimensions containing standard quantities.

GENERAL

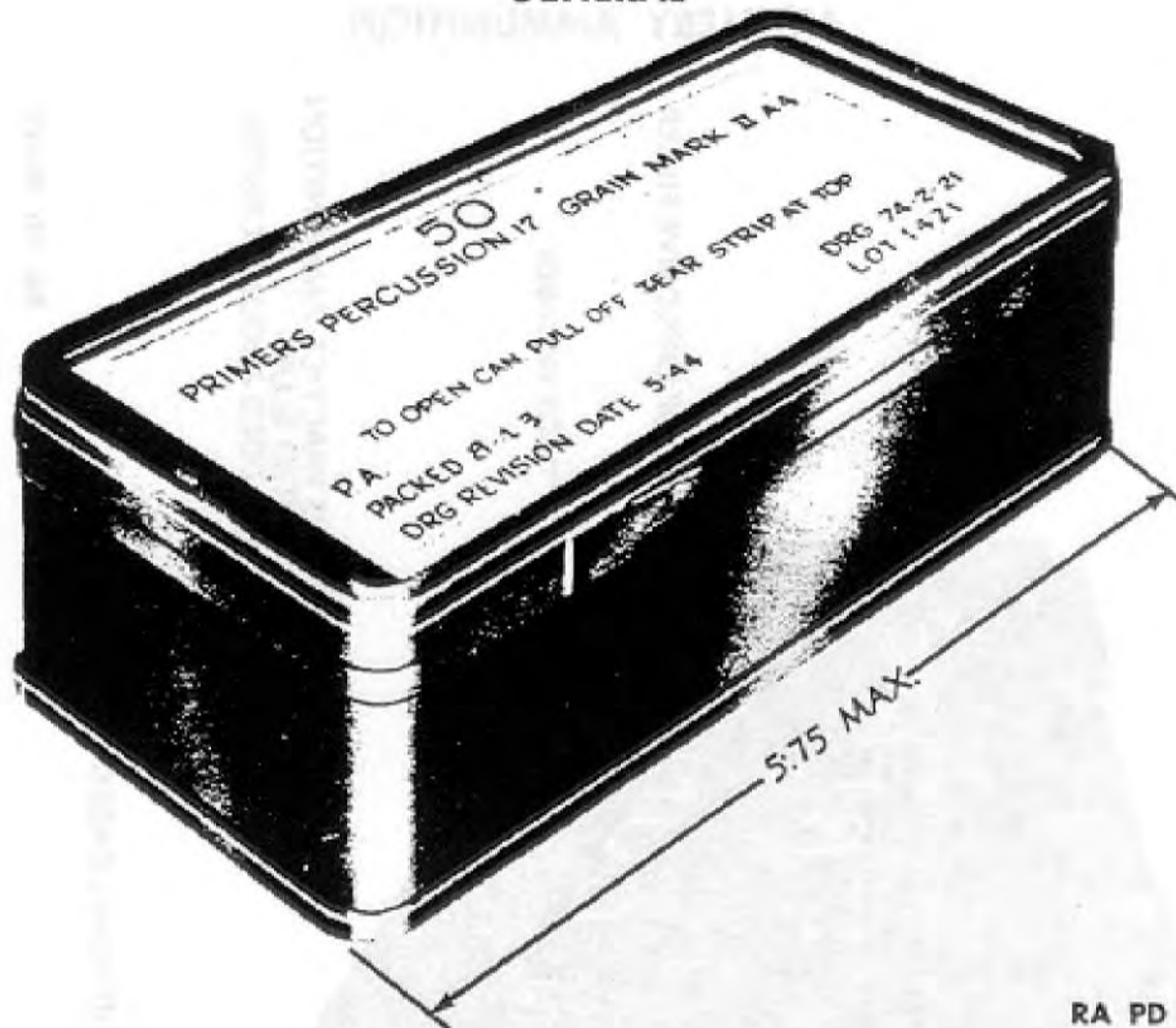

RA PD 26818

Figure 13 — Metal Container for Primers

PELLING charge, or section of propelling charge containing the black powder igniter, are painted with green, white, and red stripes, respectively.

(7) The muzzle velocity of rounds of smaller caliber is indicated on the packing box.

(8) To distinguish rounds assembled with brass cartridge cases from those with steel cartridge cases, the words "steel case" are marked on those boxes containing steel case rounds.

(9) Linen data tags, containing pertinent information, are attached to separate-loading propelling charges. Ammunition data cards for other ammunition accompany shipping tickets for ammunition packings. Firing table cards are inclosed in the packings of trench-mortar complete rounds.

17. FIELD REPORT OF ACCIDENTS.

a. When an accident occurs during training practice, procedure prescribed in AR 750-10 will be observed by the Ordnance officer under whose supervision the ammunition is maintained or issued. Where practicable, reports covering malfunctions of ammunition in combat will be made to the Chief of Ordnance, giving the type of malfunction, type of ammunition, type of weapon, the lot number of the complete rounds of separate-loading components, and conditions under which fired.

ARTILLERY AMMUNITION

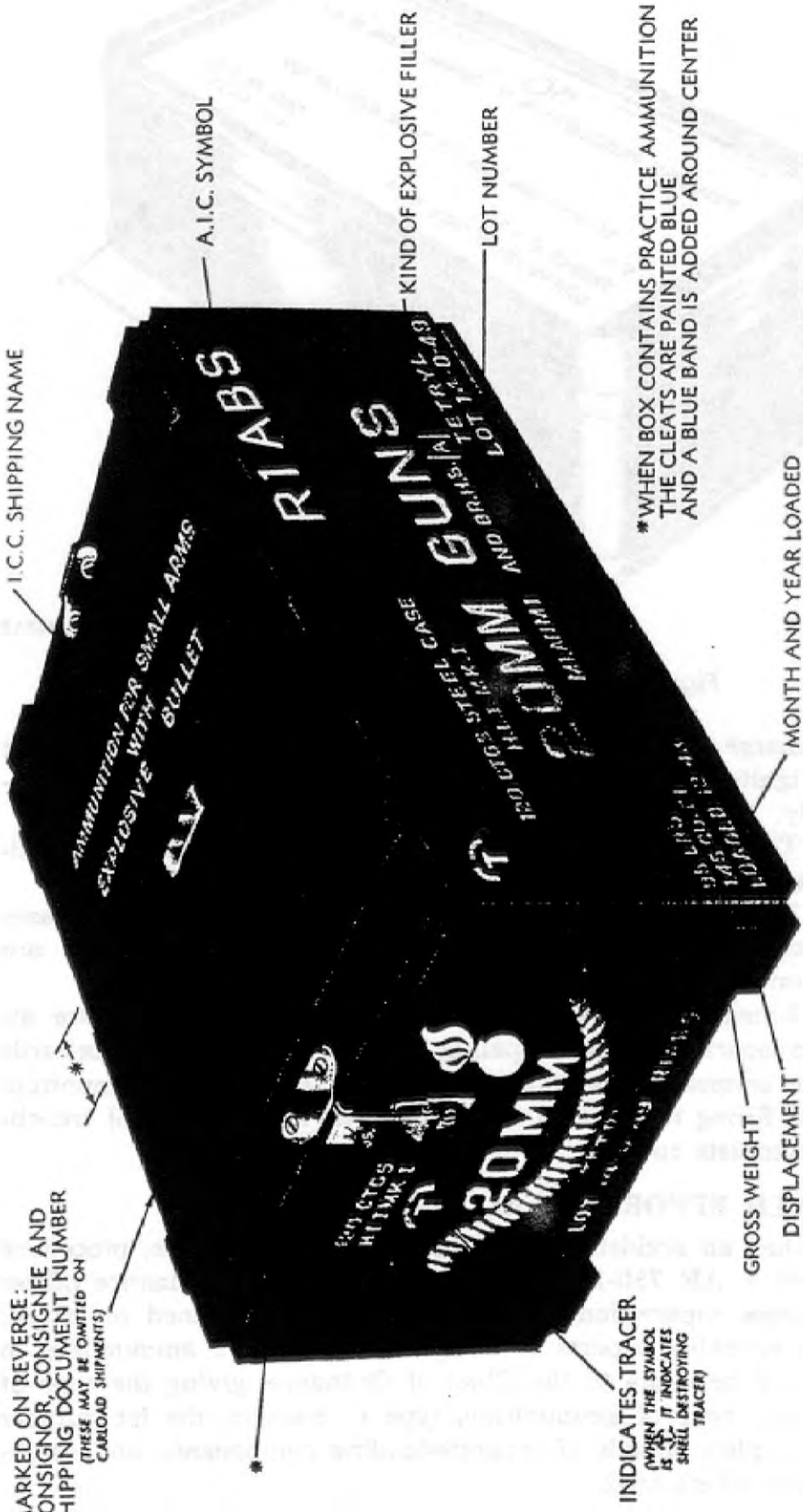

I.C.C. SHIPPING NAME

A.I.C. SYMBOL

KIND OF EXPLOSIVE FILLER

LOT NUMBER

*WHEN BOX CONTAINS PRACTICE AMMUNITION THE CLEATS ARE PAINTED BLUE AND A BLUE BAND IS ADDED AROUND CENTER

RA PD 80682

MARKED ON REVERSE:
CONSIGNOR, CONSIGNEE AND
SHIPPING DOCUMENT NUMBER
(THESE MAY BE OMITTED ON
CARLOAD SHIPMENTS)

INDICATES TRACER
(WHEN THE SYMBOL
IS IT INDICATES
SHELL DESTROYING
TRACER)

GROSS WEIGHT
DISPLACEMENT

MONTH AND YEAR LOADED

Figure 14 — Typical Packing Box for Small Caliber Fixed Ammunition

GENERAL

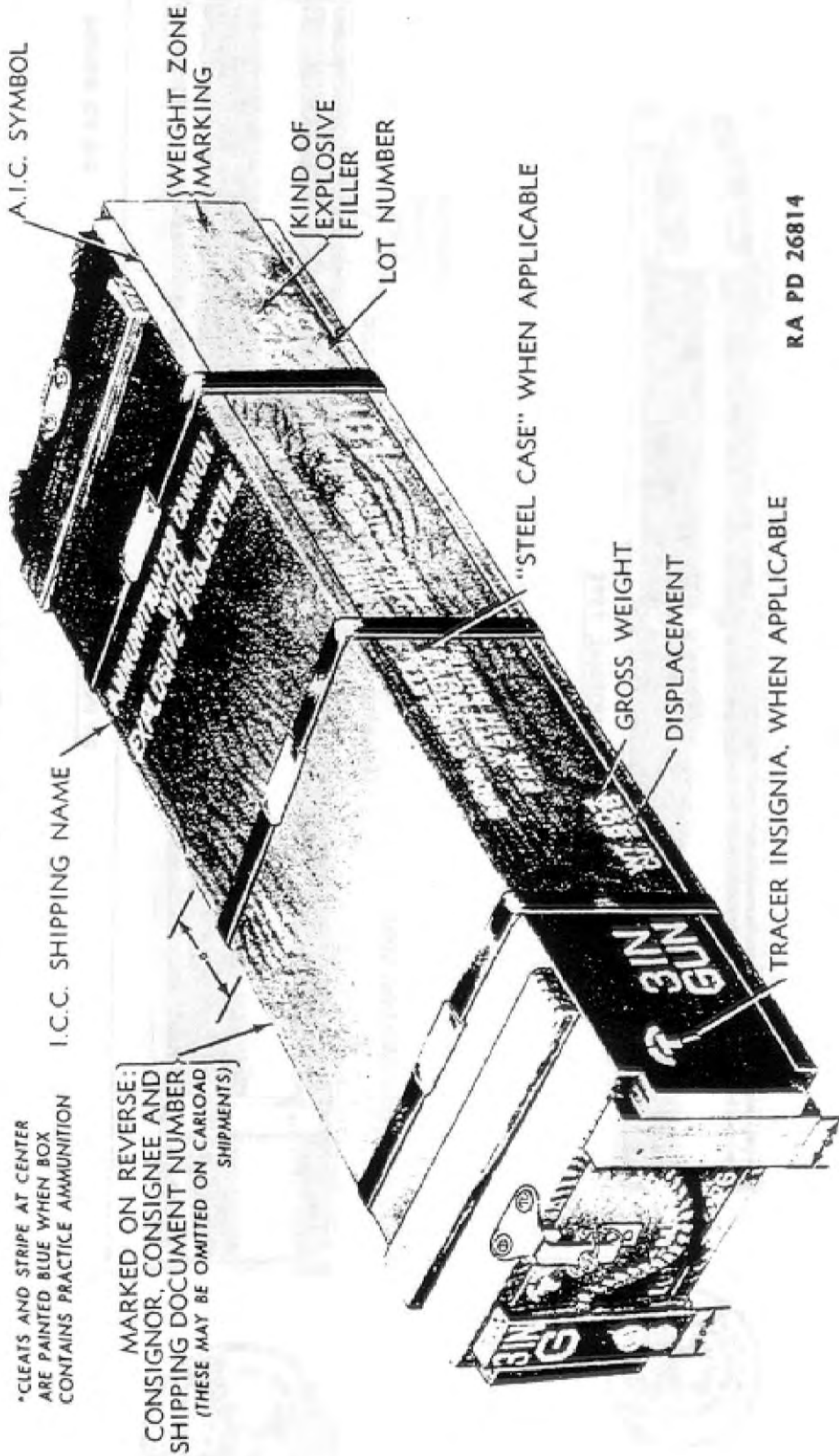

RA PD 26814

Figure 15 - Typical 2-round Packing Box

ARTILLERY AMMUNITION

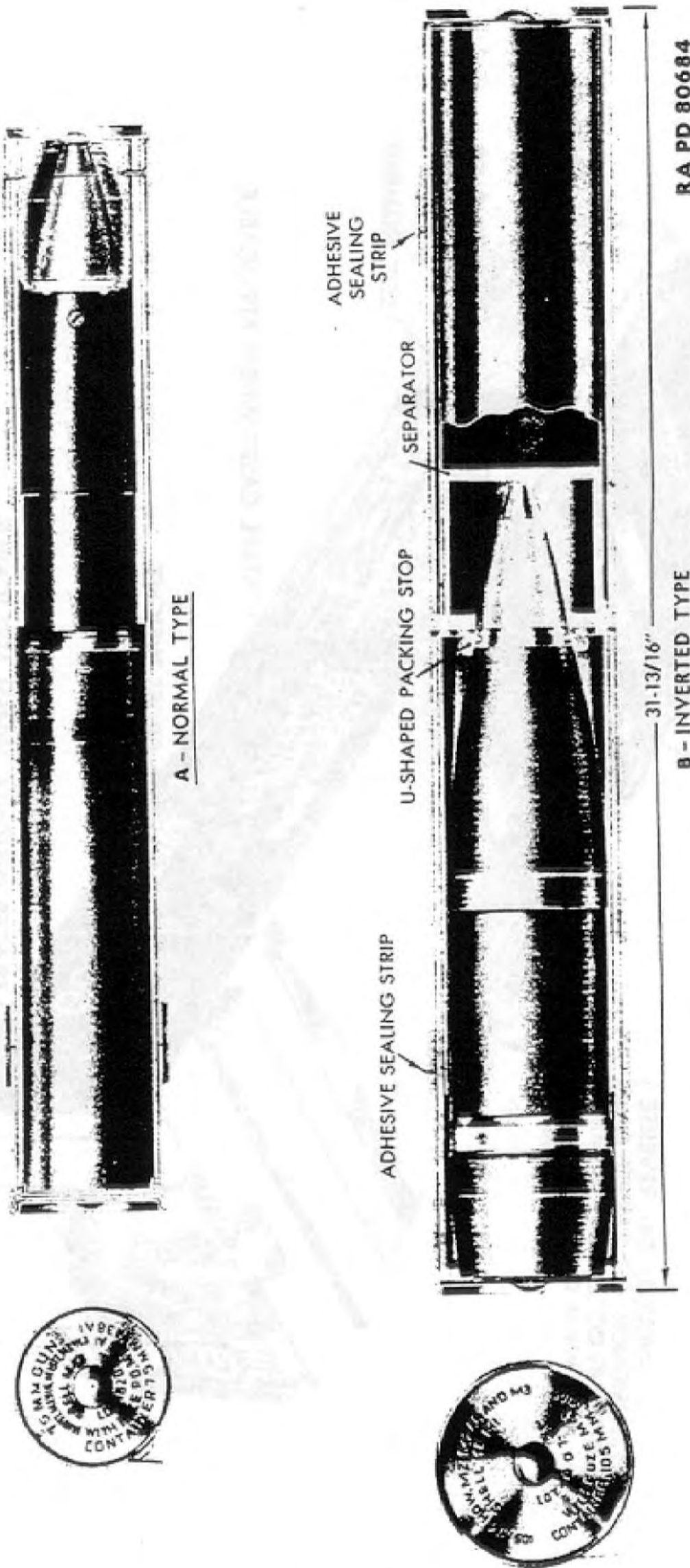

Figure 16 - Fiber Containers

GENERAL

RA PD 80685



Figure 17 — Typical Bundle Packing for Complete Rounds

ARTILLERY AMMUNITION

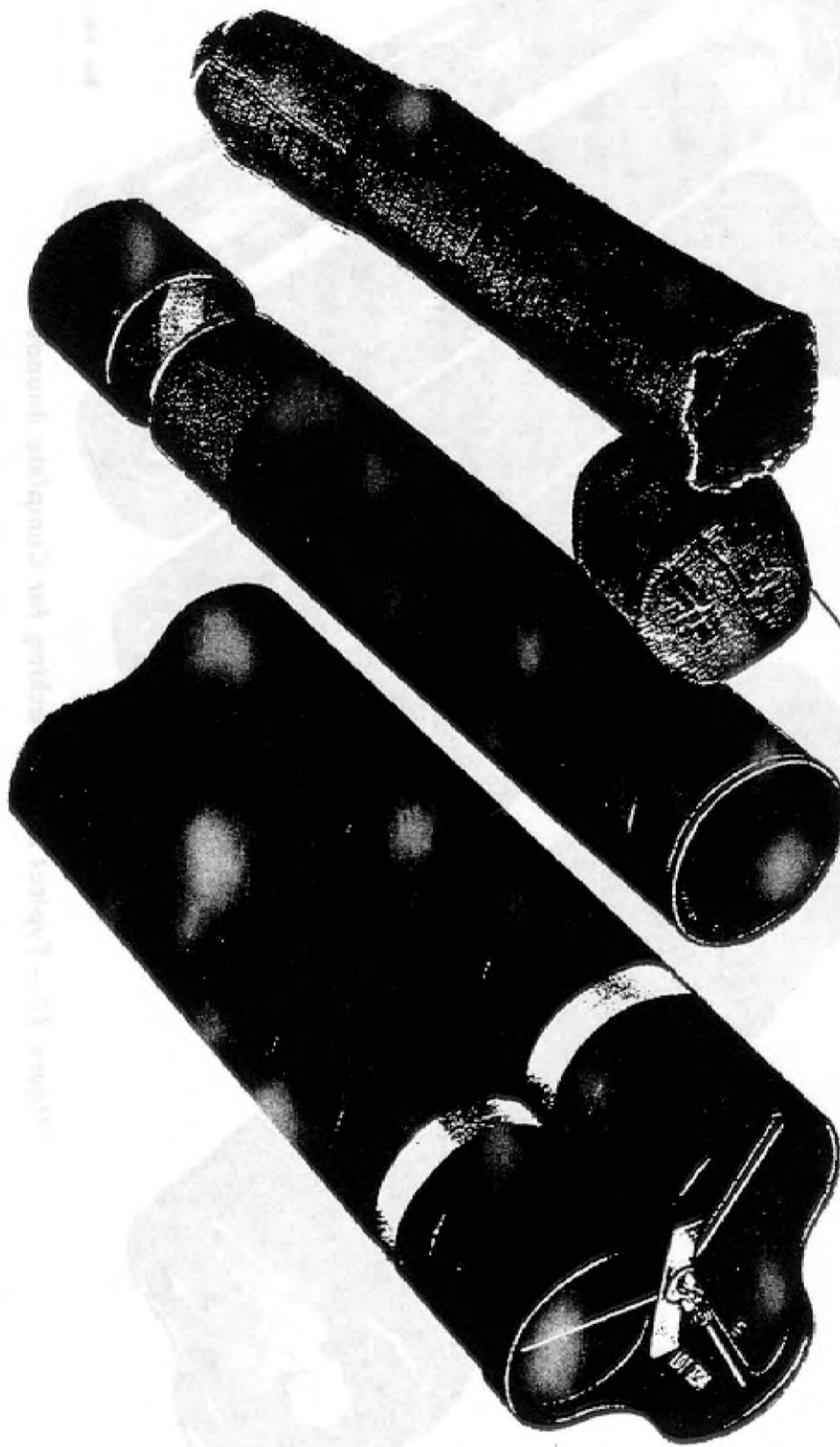

IGNITER PROTECTOR CAP

RA PD 80686

Figure 18 — Typical Bundle Packing for Separate-loading Propelling Charges

GENERAL

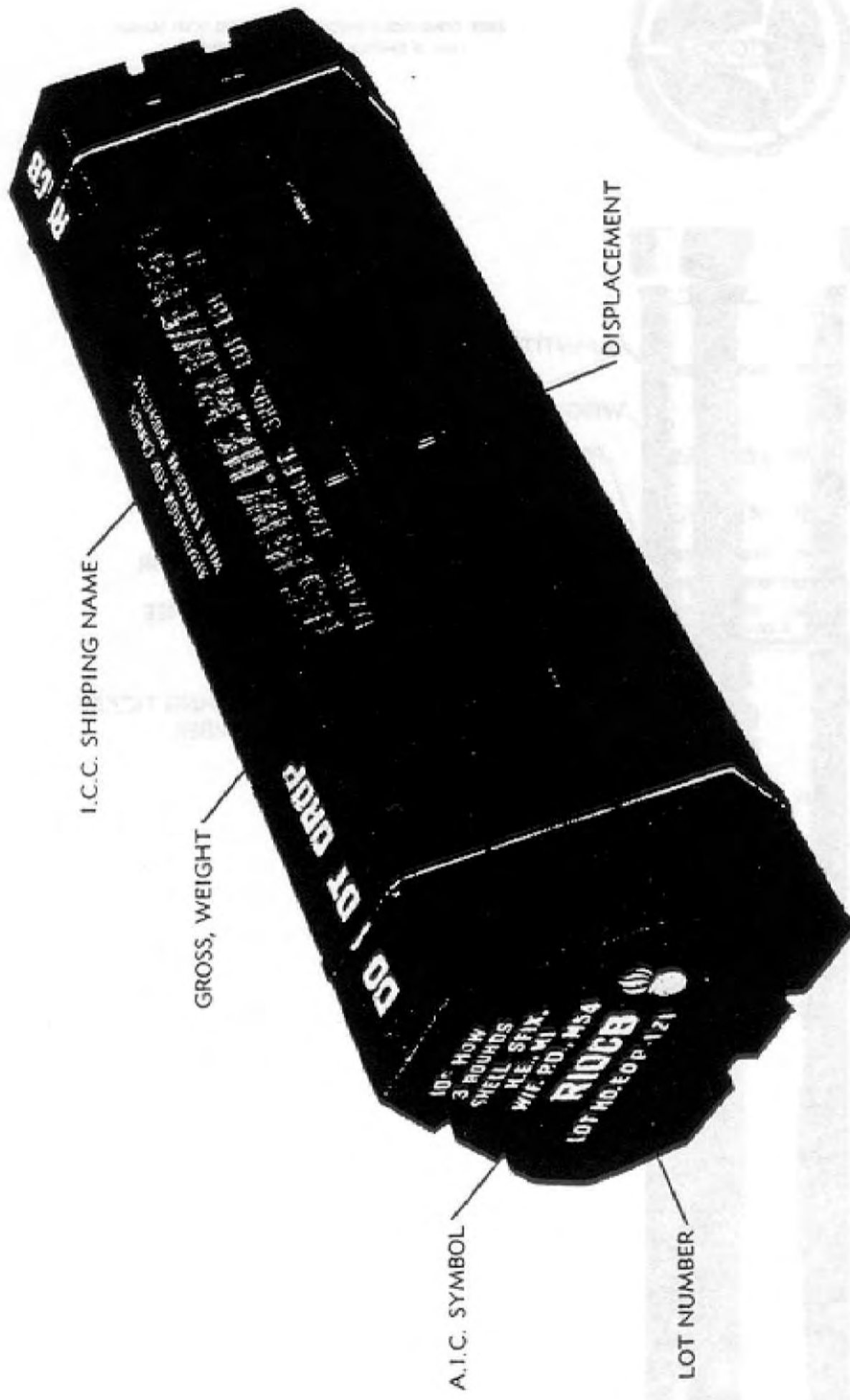

I.C.C. SHIPPING NAME

GROSS WEIGHT

DISPLACEMENT

A.I.C. SYMBOL

LOT NUMBER

RA PD 80687

Figure 19 — One-bundle Crate for Oversea Shipments

ARTILLERY AMMUNITION



NOTE: CONSIGNOR, CONSIGNEE, AND SHIPPING TICKET NUMBER
MAY BE OMITTED ON CARLOAD SHIPMENTS

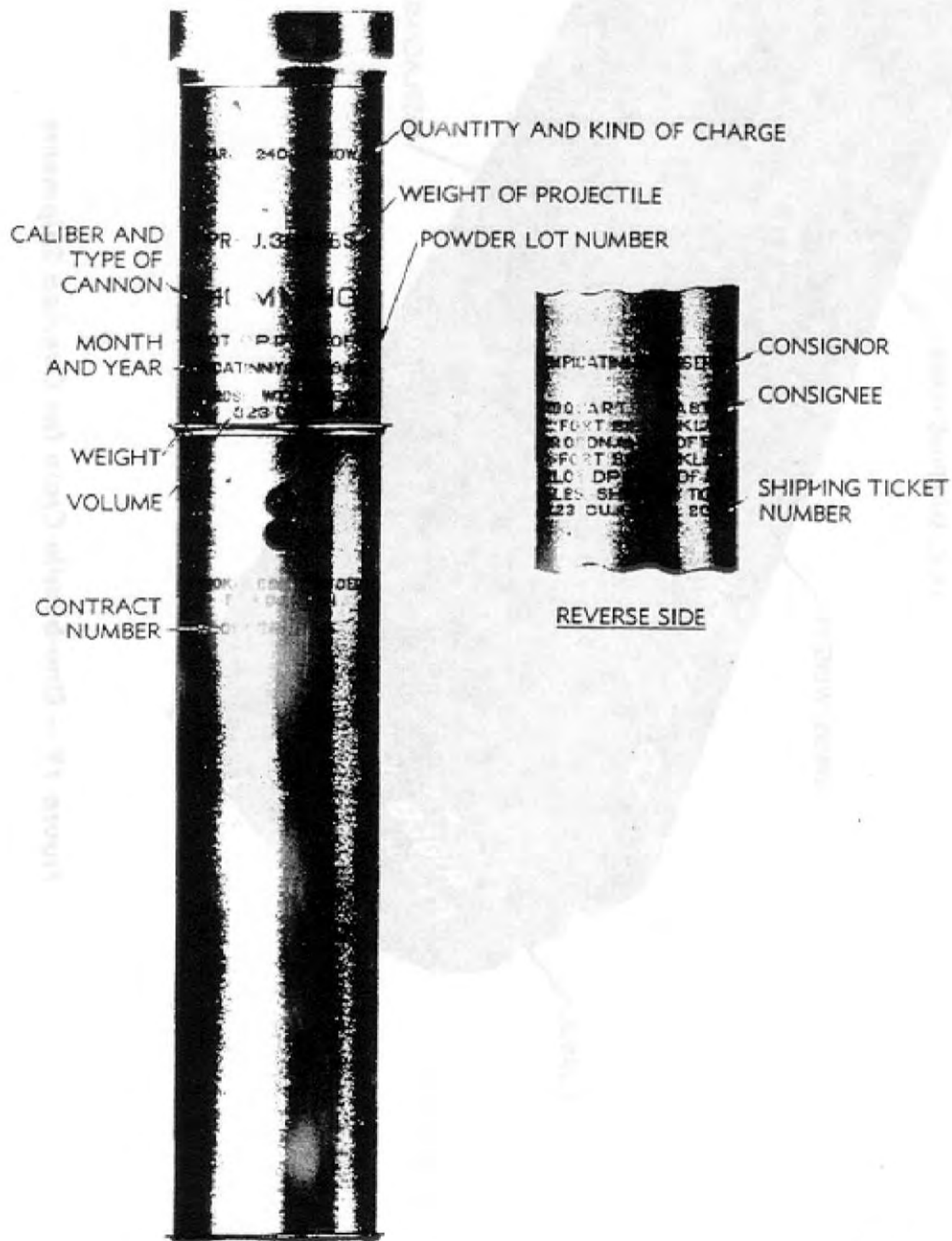

RA PD 53905

Figure 20 — Typical Cartridge-storage Case

GENERAL



RA PD 80691

Figure 21 — Crate for Separate-loading Projectiles

ARTILLERY AMMUNITION

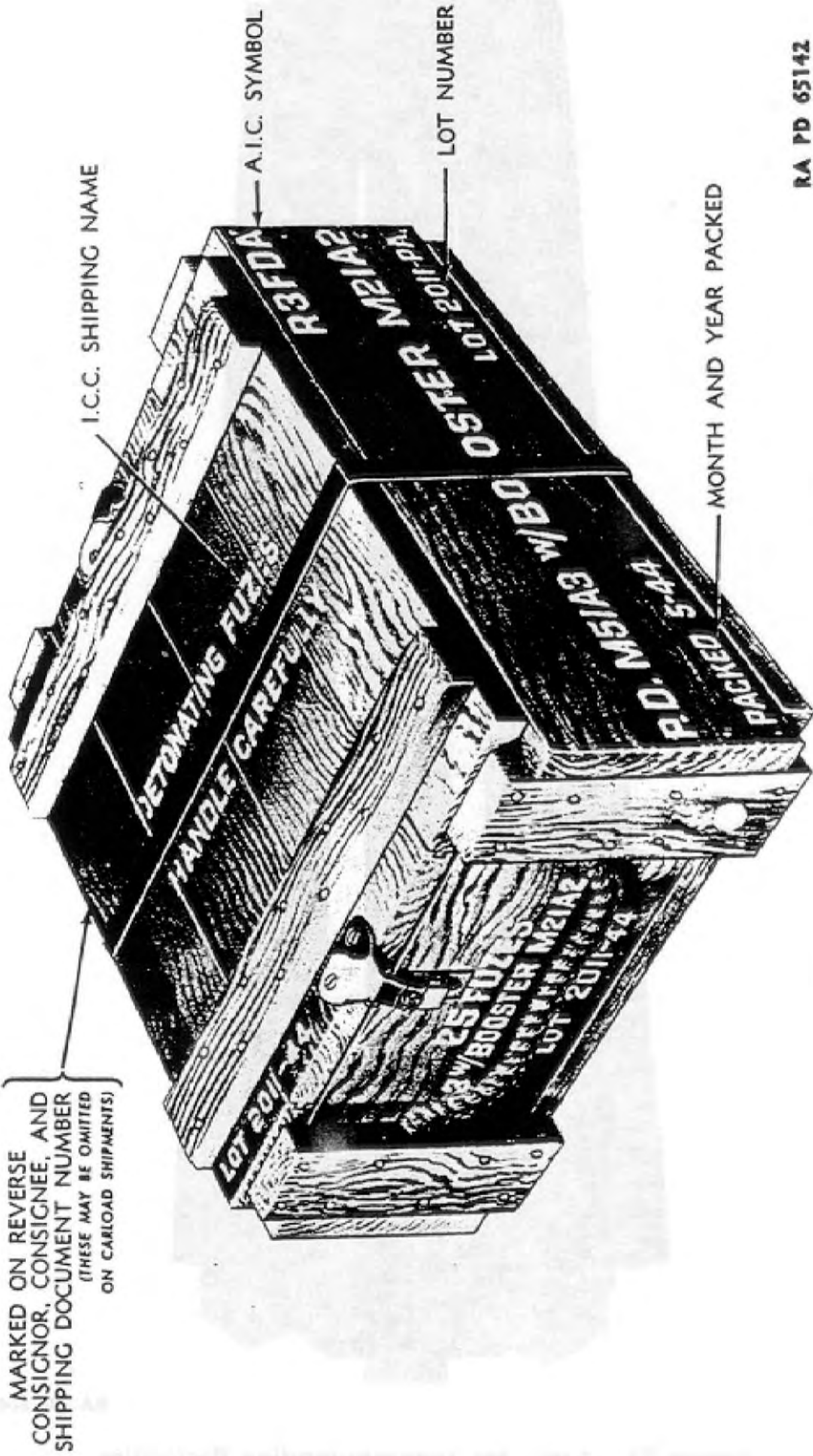

RA PD 65142

Figure 22 — Typical Packing Box for Fuzes

CHAPTER 2

**FIXED AND SEMIFIXED ROUNDS AND
SEPARATE-LOADING PROJECTILES**

Section I**AMMUNITION FOR 20-MM GUNS****18. GENERAL.**

a. **General Discussion.** The present 20-mm Guns M1, AN-M2, M3, and Br. H.S./A/ (British Hispano-Suiza, Aircraft) are automatic aircraft cannon for use against ground targets and other aircraft. There are several types of these guns, dependent upon the type of adapter used. However, since they are similarly chambered it is possible to use the same ammunition. Ammunition manufactured in the U.S. must be proof-fired in British guns to determine whether the lot develops sufficiently low chamber pressure for acceptance for firing in British weapons. If the ammunition is accepted by both U.S. and British services, the words "COMMON AMMN" are marked or printed on the packing boxes. The ammunition is fed into the guns by means of link belts (fig. 23) or a 60-round drum-type magazine. High explosive-incendiary (HE-I), armor-piercing with tracer (AP-T), incendiary, practice, ball, and drill ammunition types are provided for the guns, all issued in the form of fixed complete rounds known as cartridges. There are two sets of 20-mm rounds. Rounds of older manufacture are the HE-I Mk. I, w/FUZE, P.D., 253 Mk. II-III; AP-T, M75; and ball (figs. 24, 25, and 26). The exterior ballistics of the projectiles of these rounds differ from each other because of differences in weight and shape. The recent rounds, developed to have matched ballistics, are the AP-T, T9E5 (M95); incendiary, T18 (M96); HE-I, T23 (M97), w/FUZE, P.D., T71E4 (M75); and practice, T24 (M99) (figs. 27, 28, 29, and 30). The shape, length, and weight of these rounds are approximately the same, and all have a purple annulus about the primer at the head of the cartridge case. The trajectories of these new rounds cross at 1,000 yards, at which range the time of flight for each projectile is approximately 1.66 seconds when fired from a stationary weapon with a muzzle velocity of 2,800 feet per second. The incendiary cartridge is slightly lighter in weight than the other projectiles, hence has a muzzle velocity of 2,840 feet per second.

b. **Identification.** Painting and marking of 20-mm cartridges for purposes of identification differ from the basic color scheme prescribed in TM 9-1900 but all essential information is provided. The HE-I

ARTILLERY AMMUNITION

projectile has a yellow ogive and a red body; the AP-T, ball, and practice projectiles are painted black; the incendiary projectile is painted gray with the tip painted blue. See figures 24 to 31, inclusive.

c. **Fuzes.** The HE-I round, Mk. I, is fitted with FUZE, P. D., 253 Mk. III or Mk. II. These point detonating fuzes of British origin are direct-action superquick types and are not boresafe. The HE-I round, T23 (M97) is fitted with FUZE, P.D., T71E4 (M75), similar in internal details, but not in shape, to the Mk. III Fuze. See chapter 3, section I, for a complete description of these fuzes.

d. **Cartridge Cases.** The standard cartridge case is the M21A1, weighing approximately 0.205 pound; the substitute standard is the M21A1B1. The M21A1B1 is a steel case with a deeper extracting groove machined in the head, and is about 0.017 pound lighter than the standard M21A1 Brass Case. Rounds assembled with steel cases are only for ground and target use within continental U.S. The earlier standard M21 Case is no longer manufactured. It differs from the M21A1 in that the primer recess is adapted to hold the M37 (Berdan) Primer. The anvil is not present in this type of primer but is instead a component of the cartridge case. Also, the M21 has several flash vents instead of the single vent found in the M21A1 Case.

e. **Primers.** The M36-type Primer, containing a 2.1-grain charge of primer mixture, is standard for the 20-mm ammunition (ch. 3, sec. III).

f. **Disintegrating Belt Links.** These links, center and end, are considered as ammunition components similar to small-arms ammunition links (fig. 23). They are stored, issued, and reviewed in ORD 11 SNL R-1. They are issued when right- or left-hand Feed Mechanisms M1, M1A1, and T15 are required, except the M7 Link which is issued for the M2 Feed Mechanism. Their nomenclatures and piece marks are as follows:

LINK, disintegrating belt, 20-mm, M7

LINK, disintegrating belt, 20-mm, M3, C70661

LINK, end, disintegrating belt, 20-mm, M4, B163774

LINK, end, disintegrating belt, 20-mm, M5 (alternative), B163775

19. COMPLETE ROUND TABLE.

a. Data concerning the 20-mm complete rounds and components therefor are given in table 8, chapter 5.

20. PACKING AND SHIPPING DATA.

a. Data concerning 20-mm rounds are given in ORD 11 SNL's R-1 and R-6.

FIXED AND SEMIFIXED ROUNDS AND SEPARATE-LOADING PROJECTILES

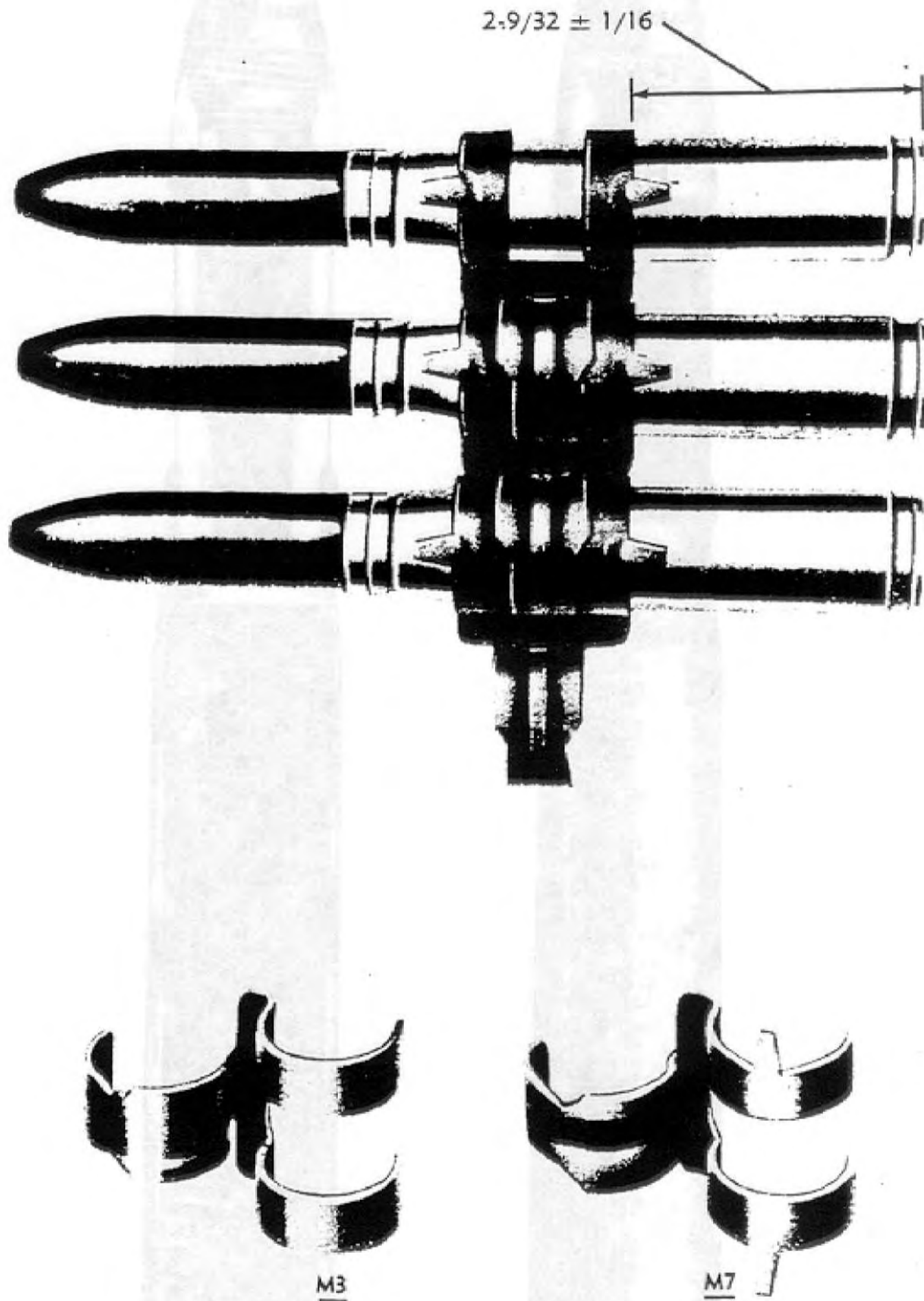

RA PD 26815

Figure 23 — 20-mm Cartridges in Link Belt and 20-mm Links

ARTILLERY AMMUNITION

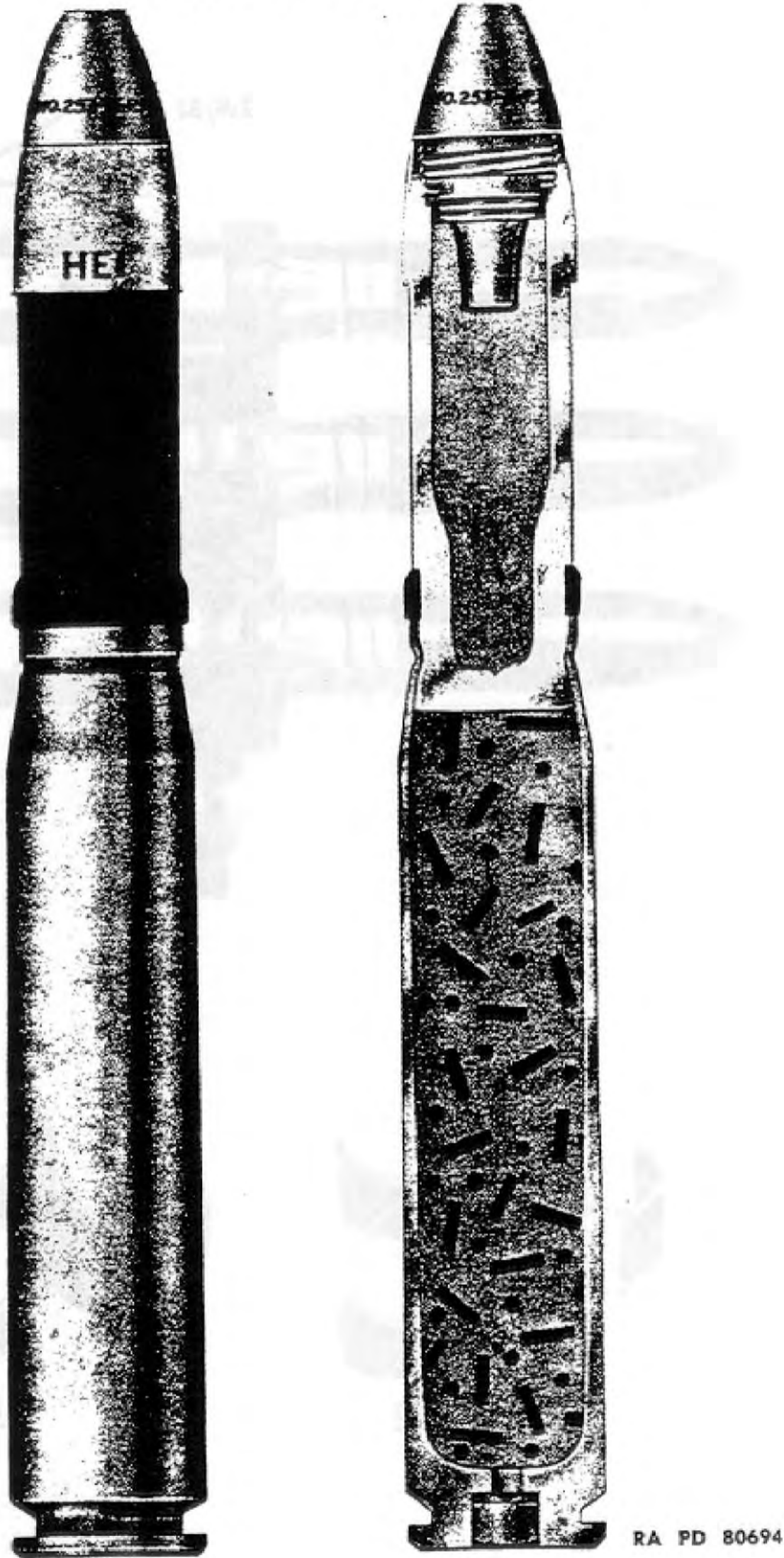

RA PD 80694

Figure 24 — CARTRIDGE, HE-I, Mk. I, w/FUZE, P. D., 253 Mk. II-III,
20-mm Guns, M1, AN-M2, M3, and Br. H.S./A/

FIXED AND SEMIFIXED ROUNDS AND SEPARATE-LOADING PROJECTILES

21. CARTRIDGE, HE-I, MK. I, W/FUZE, P. D., 253 MK. II-III, 20-MM GUNS, M1, AN-M2, M3, AND BR. H.S./A/ (fig. 24), is for use against aircraft and light materiel targets, functioning with both explosive and incendiary effect. The explosive filler is tetryl and the incendiary mixture is located in the base of the shell. After the shell penetrates the target, the high-explosive filler is detonated, the shell is shattered, and the incendiary composition is ignited. Its fuze is an instantaneous percussion fuze of the impact type. The thickness of the base is only 0.15 inch and a base cover is present for additional protection.

DATA

Weight of complete round.....	0.57 lb	Width of rotating band.....	0.203 in.
Length of complete round.....	7.19 in.	Type of base.....	Square
Length of fuzed projectile.....	3.22 in.	Radius of ogive.....	3.27 cal.
Length of cartridge case.....	4.34 in.	Muzzle velocity.....	2,800 ft per sec
Maximum range.....	5,100 yd		



RA PD 80695

Figure 25 — CARTRIDGE, AP-T, M75, 20-mm Guns, M1, AN-M2, M3, and Br. H.S./A/

22. CARTRIDGE, AP-T, M75, 20-MM GUNS, M1, AN-M2, M3, AND BR. H.S./A/ (fig. 25), is for use against armored targets. The projectile is a solid steel shot, turned from cold-drawn steel bar stock. The base of the projectile contains a red tracer composition which is sealed in by means of a metal closing cup. When ignited, the tracer burns for about 4 seconds, equivalent to a range of about 3,000 yards.

DATA

Weight of complete round.....	0.639 lb	Radius of ogive.....	2.39 cal.
Length of complete round.....	7.22 in.	Muzzle velocity.....	2,615 ft per sec
Length of projectile.....	3.25 in.	Maximum range.....	6,300 yd
Length of cartridge case.....	4.34 in.	Penetration (in. at 0-deg obliquity of face-hardened plate at 1,000 yd).....	0.6
Width of rotating band.....	0.203 in.		
Type of base.....	Square		

ARTILLERY AMMUNITION

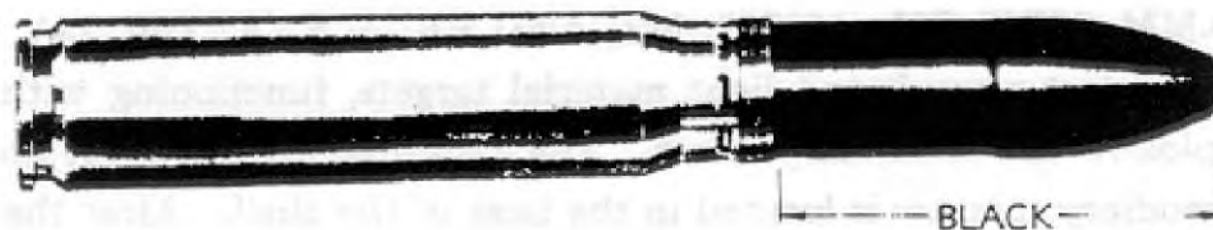

RA PD 80696

Figure 26 — CARTRIDGE, Ball, 20-mm Guns, M1, AN-M2, M3, and Br. H.S./A/

23. CARTRIDGE, BALL, 20-MM GUNS, M1, AN-M2, M3, AND BR. H.S./A/ (fig. 26), is for service firing against personnel and light materiel targets, for practice, and for proof-firing. The projectile is similar in shape and ballistic properties to the HE-I projectile, but is hollow and contains no explosive or tracer. It is rolled from steel bar stock. A steel closing disk with a 45-degree chamfer is fitted into the recesses in the base of projectile.

DATA

Weight of complete round.....	0.56 lb	Width of rotating band.....	0.203 in.
Length of complete round.....	7.23 in.	Type of base.....	Square
Length of projectile.....	3.31 in.	Radius of ogive.....	3.27 cal.
Length of cartridge case.....	4.34 in.	Muzzle velocity	2,850 ft per sec
Maximum range.....	6,000 yd		



RA PD 65139

Figure 27 — CARTRIDGE, AP-T, T9E5 (M95), 20-mm Guns, M1, AN-M2, M3, and Br. H.S./A/

24. CARTRIDGE, AP-T, T9E5 (M95), 20-MM GUNS, M1, AN-M2, M3, AND BR. H.S./A/ (fig. 27), is for use against armored targets. The projectile is a solid shot made from bar or forged steel. A drawn steel windshield is crimped into rolled or stamped grooves in the projectile body, the portion of the windshield over the crimping acting as the bourrelet of the projectile. The base of the projectile contains a red tracer composition, sealed in by means of a

FIXED AND SEMIFIXED ROUNDS AND SEPARATE-LOADING PROJECTILES

metal closing cup. The tracer burns for about 2.25 seconds, equivalent to a range of about 1,400 yards.

DATA

Weight of complete round.....	0.57 lb	Muzzle velocity	2,800 ft per sec
Length of complete round.....	7.22 in.	Maximum range	5,900 yd
Length of projectile.....	3.27 in.	Penetration (in. at 0-deg obliquity of face-hardened plate at 400 yd).....	3/4
Length of cartridge case.....	4.34 in.	Penetration (in. at 0-deg obliquity of homogeneous plate at 400 yd).....	7/8
Width of rotating band.....	0.203 in.		
Type of base.....	Square		
Radius of ogive.....	2.3 cal.		

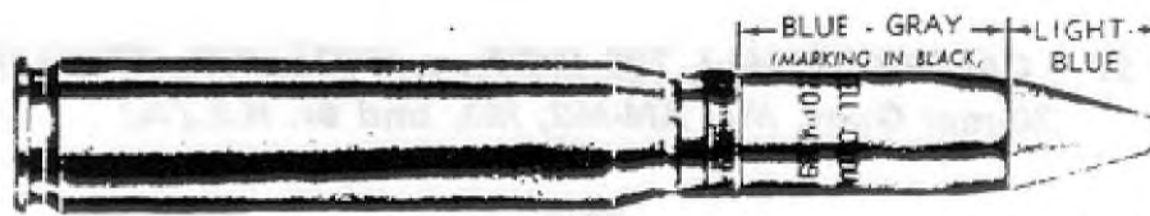

RA PD 65138

Figure 28 – CARTRIDGE, Incendiary, T18 (M96), 20-mm Guns, M1, AN-M2, M3, and Br. H.S./A/

25. **CARTRIDGE, INCENDIARY, T18 (M96), 20-MM GUNS, M1, AN-M2, M3, AND BR. H.S./A/** (fig. 28), is for use against aircraft, functioning with incendiary effect, similar to cal. .50 incendiary cartridges. The body is made of cold-drawn steel. The nose, threaded to screw into body, is made of a die-cast zinc alloy; it is painted light blue for identification similar to small-arms cartridges. Both the body and nose are filled with incendiary materiel. This round does not require a fuze, as functioning is initiated by impact of nose upon target.

DATA

Weight of complete round.....	0.55 lb	Width of rotating band.....	0.203 in.
Length of complete round.....	7.20 in.	Type of base.....	Square
Length of projectile.....	3.245 in.	Radius of ogive.....	2.54 cal.
Length of cartridge case.....	4.34 in.	Muzzle velocity	2,840 ft per sec
		Maximum range	5,700 yd

26. **CARTRIDGE, HE-I, T23 (M97), W/FUZE, P. D., T71E4 (M95), 20-MM GUNS, M1, AN-M2, M3, AND BR. H.S./A/** (fig. 29), is for use against aircraft and light materiel targets, functioning with both explosive and incendiary effect. The explosive filler is tetryl and the incendiary mixture is located in the base of the shell. After the shell penetrates the target, its filler is detonated, the shell shattered, and the incendiary composition ignited. Its fuze is an instantaneous

ARTILLERY AMMUNITION

percussion fuze of the impact type. The thickness of the base is approximately 0.2 inch, and a base cover is welded thereon for additional protection. This cartridge differs basically from the HE-I cartridge, described in paragraph 21, by having a pointed fuze.

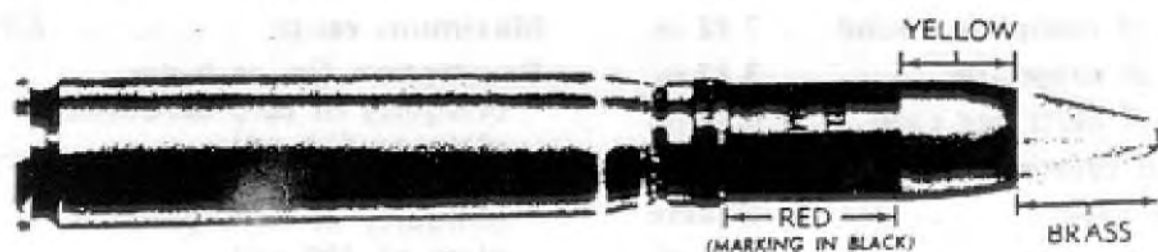

RA PD 65137

Figure 29 — CARTRIDGE, HE-I, T23 (M97), w/FUZE, P.D., T71E4 (M75), 20-mm Guns, M1, AN-M2, M3, and Br. H.S./A/

DATA

Weight of complete round.....	0.57 lb	Width of rotating band.....	0.203 in.
Length of complete round	7.22 in.	Type of base.....	Square
Length of fuzed projectile	3.28 in.	Radius of ogive.....	2.54 cal.
Length of cartridge case.....	4.34 in.	Muzzle velocity	2,800 ft per sec
Maximum range	5,750 yd		



RA PD 65136

Figure 30 — CARTRIDGE, Practice, T24 (M99), 20-mm Guns, M1, AN-M2, M3, and Br. H.S./A/

27. CARTRIDGE, PRACTICE, T24 (M99), 20-MM GUNS, M1, AN-M2, M3, AND BR. H.S./A/ (fig. 30), is for practice firing. The projectile is similar in shape and ballistic properties to the T18 (M96) Incendiary Projectile but is hollow and contains no explosive. The nose consists of a zinc die casting as in the T18 (M96) Incendiary but its weight is adjusted to give the projectile a weight of 2,000 grains (0.29 lb). The projectile body is made of cold-drawn steel.

DATA

Weight of complete round.....	0.57 lb	Width of rotating band.....	0.203 in.
Length of complete round	7.22 in.	Type of base.....	Square
Length of projectile.....	3.27 in.	Radius of ogive.....	2.54 cal.
Length of cartridge case.....	4.34 in.	Muzzle velocity	2,800 ft per sec
Maximum range	5,750 yd		

FIXED AND SEMIFIXED ROUNDS AND SEPARATE-LOADING PROJECTILES



Figure 31 — CARTRIDGE, Drill, M18A1, 20-mm Auto. Guns, M1, AN-M2, and Br. H.S./A/

28. CARTRIDGE, DRILL, M18A1, 20-MM GUNS, M1, AN-M2, AND BR. H.S./A/ (fig. 25), is a completely inert assembly intended to provide a simulated service cartridge for drill purposes and for testing feed mechanism of the weapon. The service projectile and cartridge case are simulated by a 1-piece casing made of steel, cold-drawn to size, shape, and weight. The base is threaded to hold a steel base plug, flanged to provide an extractor groove like that on service ammunition. Alternative manufacturing designs for this drill cartridge have a steel body plug secured in the nose of the cartridge. Weight is 0.57 pound; length is 7.20 inches.

29. CARTRIDGE, DRILL, M18, 20-MM GUNS, M1, AN-M2, AND BR. H.S./A/, differs from the M18A1 Drill Cartridge (par. 28) in minor internal details of the body and the base plug.

FIXED AND SEMIFIXED ROUNDS AND SEPARATE-LOADING PROJECTILES

- A - MK.II A1, PRACTICE ROUND FOR 37-MM GUN SUBCALIBER, M1916,
- B - M56 H.E. ROUND FOR 37-MM GUNS, M4 AND M10
- C - M56 H.E. ROUND FOR 37-MM GUNS, M1A2 AND M9
- D - M63 H.E. ROUND FOR 37-MM GUNS
M3, M3A1, M5, M5A1, AND M6

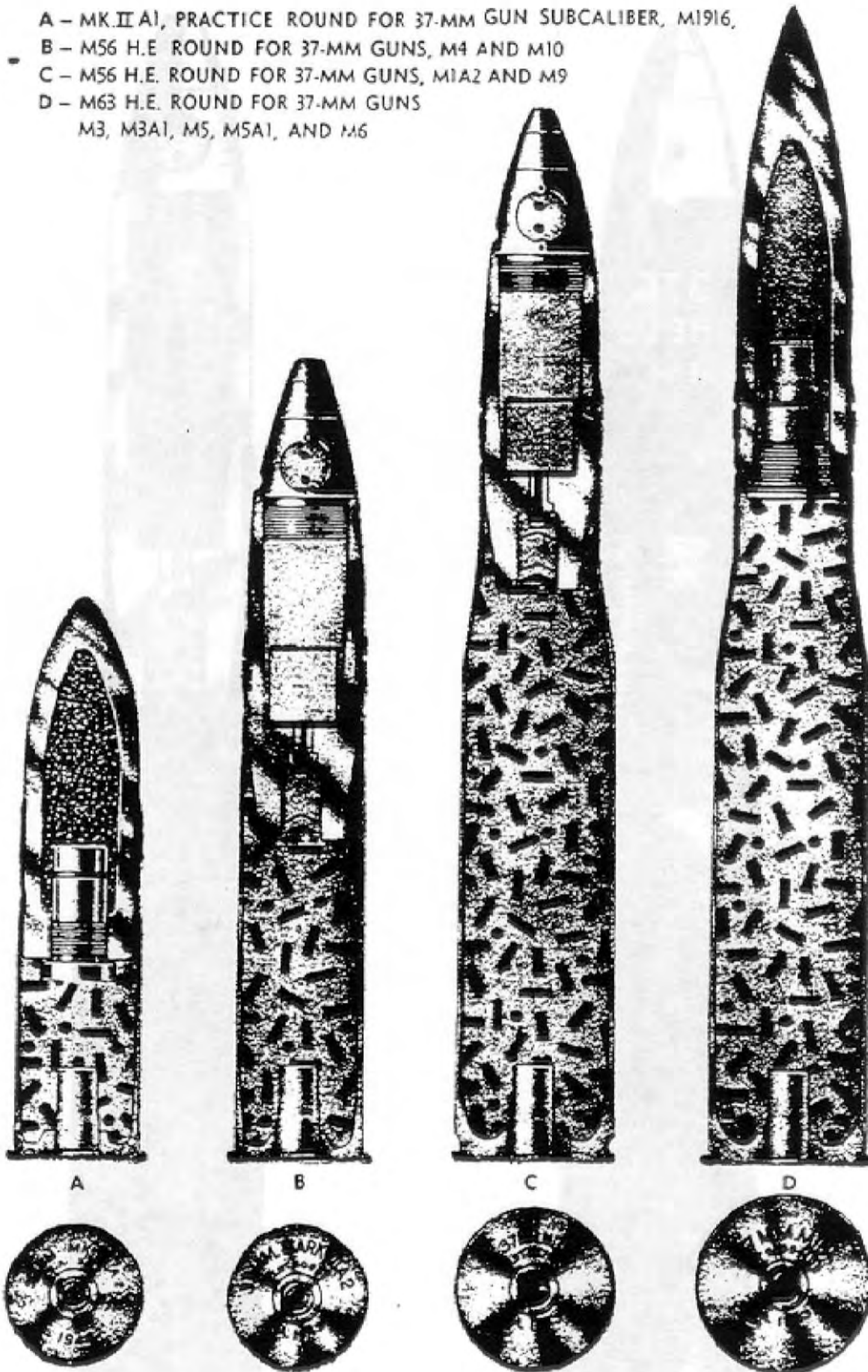

RA PD 80699

Figure 32 - Comparison of 37-mm Ammunition

ARTILLERY AMMUNITION

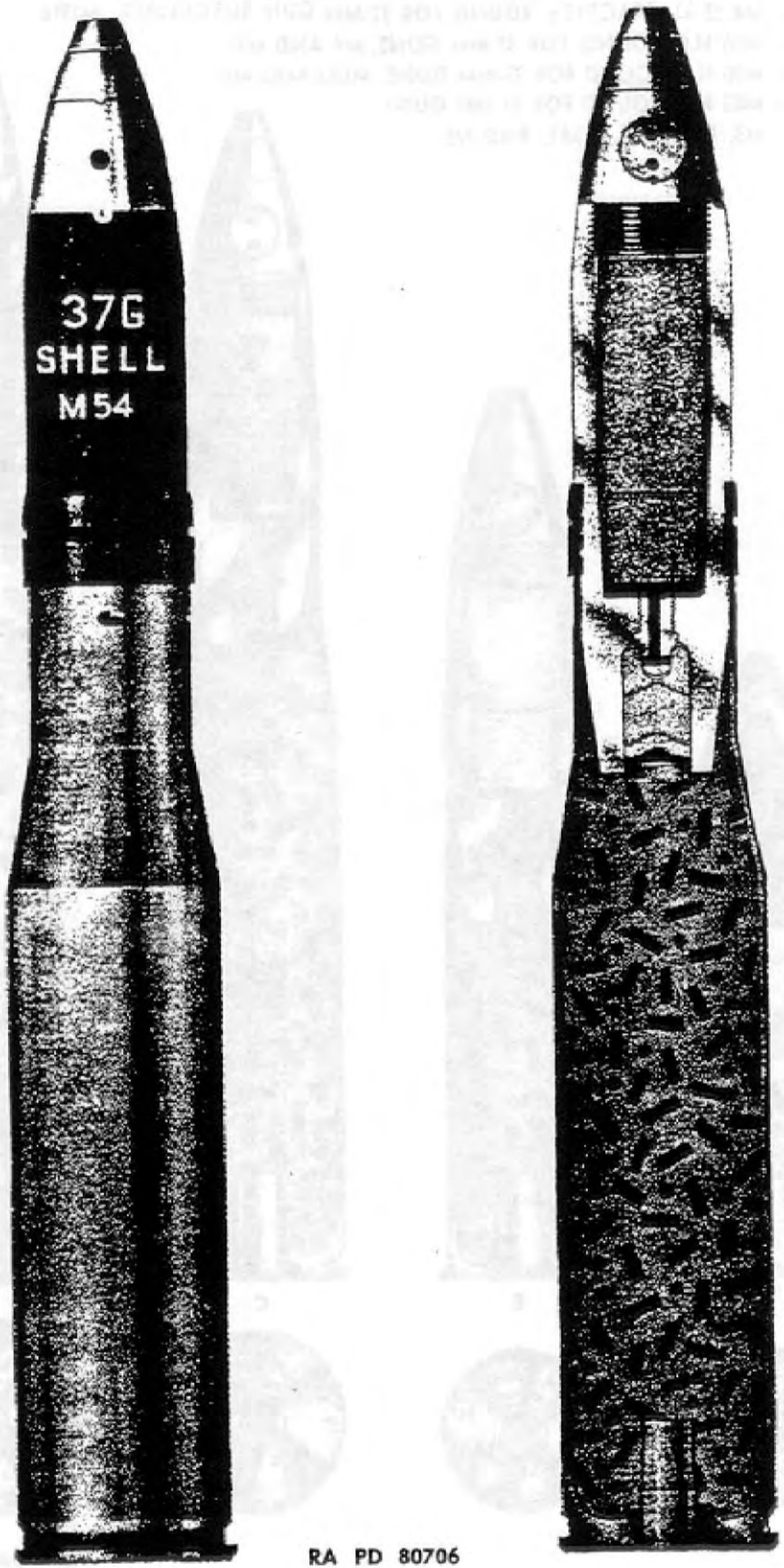

RA PD 80706

Figure 33 — SHELL, Fixed, H.E., M54, w/TRACER, SD, and FUZE, P.D., M56, 37-mm Auto. Guns, M1A2 and AN-M9

FIXED AND SEMIFIXED ROUNDS AND SEPARATE-LOADING PROJECTILES

33. SHELL, FIXED, H. E., M54, W/TRACER, SD, AND FUZE, P. D., M56, 37-MM AUTO. GUNS, M1A2 AND AN-M9 (fig. 33), is provided for use in the M1A2 and AN-M9 Guns for firing against aircraft, hence is fitted with a supersensitive type fuze. The same shell and fuze are also used with the AN-M4 and M10 Aircraft Guns. However, when fired from the M1A2 and AN-M9 Guns, the round is assembled with the M17 Cartridge Case, or for the M1A2 Gun only, with the M17B1 (steel) Cartridge Case. The projectile consists of a relatively thin-welded shell body, a tetryl bursting charge, FUZE, P.D., M56, and a shell-destroying tracer. The nose is threaded to receive the fuze and the "boat-tailed" base is threaded to receive a tracer assembly containing a relay housing, an igniter charge, and a relay igniting charge. These charges connect the tracer with a black powder pellet in the base end of the bursting charge cavity. The tracer burns for about 8 seconds, equivalent to about 3,500 yards, whereupon the relay pellet is ignited and causes the bursting charge to detonate if prior functioning has not been caused by impact.

DATA

Weight of complete round.....	2.62 lb	Type of base.....	Boat-tailed
Length of complete round	12.81 in.	Degree of taper base.....	9 deg 15 min
Length of fuzed projectile	5.87 in.	Radius of ogive.....	4.34 cal.
Length of cartridge case.....	8.75 in.	Muzzle velocity	2,600 ft per sec
Width of rotating band.....	0.74 in.	Maximum range	3,500 yd*



Figure 34 – SHOT, Fixed, A.P., M74, w/TRACER, 37-mm Auto. Gun, M1A2

34. SHOT, FIXED, A. P., M74, W/TRACER, 37-MM AUTO. GUN, M1A2 (fig. 34), has the same shot as that used in the corresponding round for M3, M3A1, M5, M5A1, and M6 Guns (par. 43). However, when fired from the M1A2 Gun, it is assembled with the M17 Cartridge Case, which has an extractor groove. The tracer burns for 2,000 yards.

DATA

Weight of complete round.....	3.07 lb	Radius of ogive.....	1.52 cal.
Length of complete round	13.01 in.	Muzzle velocity	2,050 ft per sec
Length of projectile.....	4.84 in.	Maximum range	7,290 yd
Length of cartridge case.....	8.75 in.	Penetration (in. at 0-deg	
Width of rotating band.....	0.74 in.	obliquity of homogeneous	
Type of base.....	Square	plate at 1,000 yd).....	1.2

*—Limited by shell-destroying tracer. Theoretical maximum is 8,875 yards, horizontal, and 6,200 yards, vertical.

ARTILLERY AMMUNITION

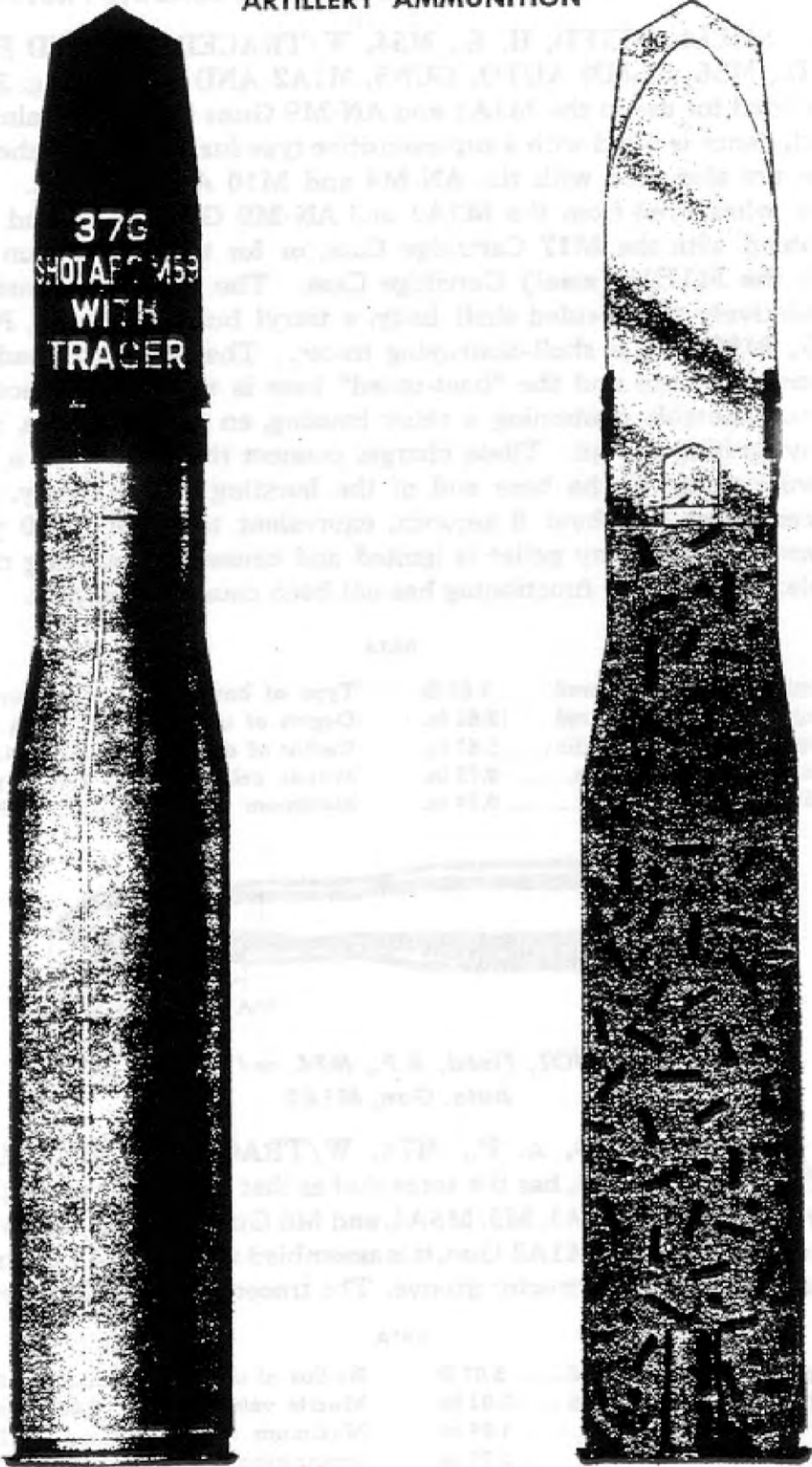

RA PD 80707

Figure 35 — SHOT, Fixed, A.P.C., M59, w/TRACER, 37-mm
Auto. Gun, M1A2

FIXED AND SEMIFIXED ROUNDS AND SEPARATE-LOADING PROJECTILES

35. SHOT, FIXED, A.P.C., M59, W/TRACER, 37-MM AUTO. GUN, M1A2 (fig. 35), has been adapted from the M51 Projectile (par. 42) to provide armor-piercing ammunition for the 37-mm Automatic Gun M1A2, and more recently for the AN-M9 Gun. The projectile body, armor-piercing cap, and tracer are similar to the corresponding parts of the M51 Armor-piercing Projectile, but the windshield is omitted. This gives the M59 Shot a blunt flat-nosed appearance, in contrast to the long tapered shape of the M51 Shot. Penetrating qualities are not affected, so that both projectiles are about equally effective against the same types of armor plate. However, the effective range is less than that of the M51 Shot.

DATA

Weight of complete round.....	3.12 lb	Width of rotating band.....	0.74 in.
Length of complete round	12.76 in.	Type of base.....	Square
Length of projectile	4.59 in.	Muzzle velocity	2,050 ft per sec*
Length of cartridge case.....	8.75 in.	Maximum range	5,790 yd*
Penetration (in. at 0-deg obliquity of face-hardened plate at 1,000 yd).....	0.7*		

*Data for M1A2 Gun. Muzzle velocity for AN-M9 Gun is 2,800 feet per second.

36. SHOT, FIXED, A.P.C., M59, W/TRACER, 37-MM AUTO. GUN, M9 (fig. 35), differs from the round described in paragraph 35 only in the propelling charge (hence the muzzle velocity) and the marking on the cartridge case, which is as follow: "37G, M9, MV 2800." See table 8, chapter 5, complete round table for ammunition for 37-mm guns, for further details. Armor penetration for this projectile in the AN-M9 Gun will be much greater than when fired in the M1A2 due to the greater muzzle velocity to which should be added the velocity of the airplane.

37. SHOT, FIXED, A.P.C., M59A1, W/TRACER, 37-MM AUTO. GUN, M1A2, differs from the round described in paragraph 35 only in the method of attaching the armor-piercing cap to the propectile body, which is by means of a 360-degree crimp.

38. SHOT, FIXED, A.P.C., M59A1, W/TRACER, 37-MM AUTO. GUN, M9, differs from the round described in paragraph 36 only in the method of attaching the armor-piercing cap to the projectile body, which is by means of a 360-degree crimp.

ARTILLERY AMMUNITION

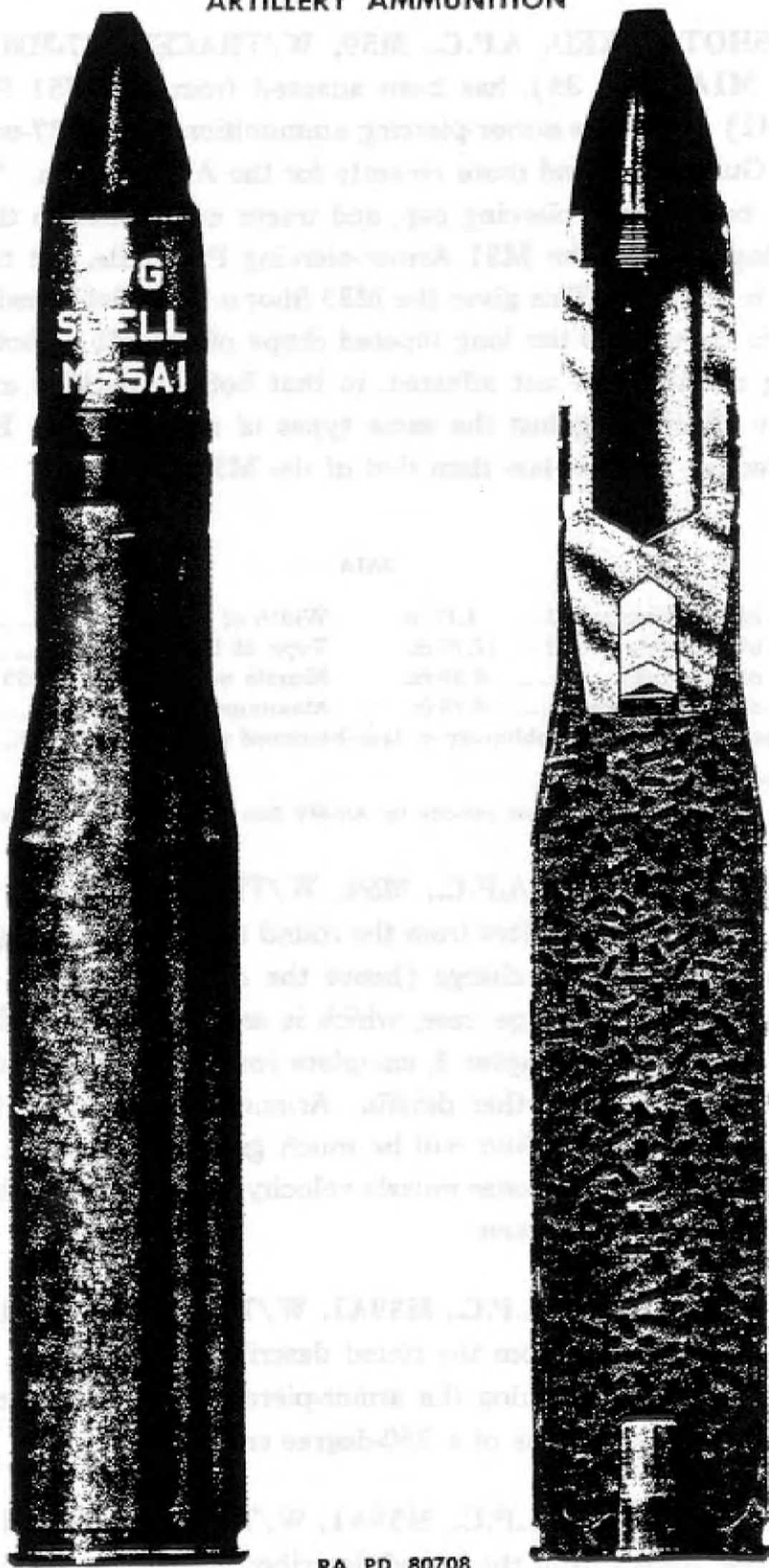

RA PD 80708

Figure 36 — SHELL, Fixed, Practice, M55A1, w/TRACER, and FUZE, Dummy, M50, 37-mm Auto. Guns, M1A2 and AN-M9

FIXED AND SEMIFIXED ROUNDS AND SEPARATE-LOADING PROJECTILES

39. SHELL, FIXED, PRACTICE, M55A1, W/TRACER, AND FUZE, DUMMY, M50, 37-MM AUTO. GUNS, M1A2 AND AN-M9 (fig. 36), provides practice ammunition for the M1A2 and AN-M9 Guns with about the same ballistic characteristics as the high-explosive Service Round M54 (par. 33). The M17 Cartridge Case and a service primer and propelling charge are used. The projectile is similar in contour to, and of the same weight as the M54 Shell, but has no bursting charge and is fitted with a dummy fuze. In addition, the shell-destroying tracer of the service round is replaced by a composition for tracing purposes only. The tracer, consisting of a red tracer composition and an igniter composition, burns for about 8 seconds, or 3,500 yards. **FUZE, dummy, M50**, simulates the M56 Service Fuze but has no explosive elements.

DATA

Weight of complete round.....	2.63 lb	Width of rotating band.....	0.74 in.
Length of complete round	12.81 in.	Type of base	Boat-tailed
Length of fuzed projectile	5.87 in.	Degree of taper of base..	9 deg 15 min
Length of cartridge case.....	8.75 in.	Muzzle velocity	2,600 ft per sec
Maximum range	8,875 yd	(Horizontal; vertical range is 6,200 yd)	



Figure 37 — SHOT, Fixed, A.P., M80, w/TRACER, 37-mm Auto. Gun, AN-M9

40. SHOT, FIXED, A.P., M80, W/TRACER, 37-MM AUTO. GUN, AN-M9 (fig. 37), is used in rounds to be fired from the AN-M4 as well as the AN-M9 Aircraft Gun. When to be fired from the AN-M9 Gun, the round is assembled with the grooved M17 Brass Cartridge Case. The shot is of the same general design as the M74 Shot used with the M1A2 Gun (par. 34) but is shorter and lighter. The body is of the uncapped monobloc type, with the nose formed to a relatively short ogive. The base contains a tracer composition for observation purposes which burns for 2,000 yards of flight.

DATA

Weight of complete round.....	3.15 lb	Width of rotating band.....	0.74 in.
Length of complete round	12.40 in.	Type of base.....	Square
Length of projectile.....	4.23 in.	Radius of ogive.....	1.62 cal.
Length of cartridge case.....	8.75 in.	Muzzle velocity	3,050 ft per sec
Penetration (in. at 0-deg obliquity of homogeneous plate at 1,000 yd).....	2.1		

ARTILLERY AMMUNITION

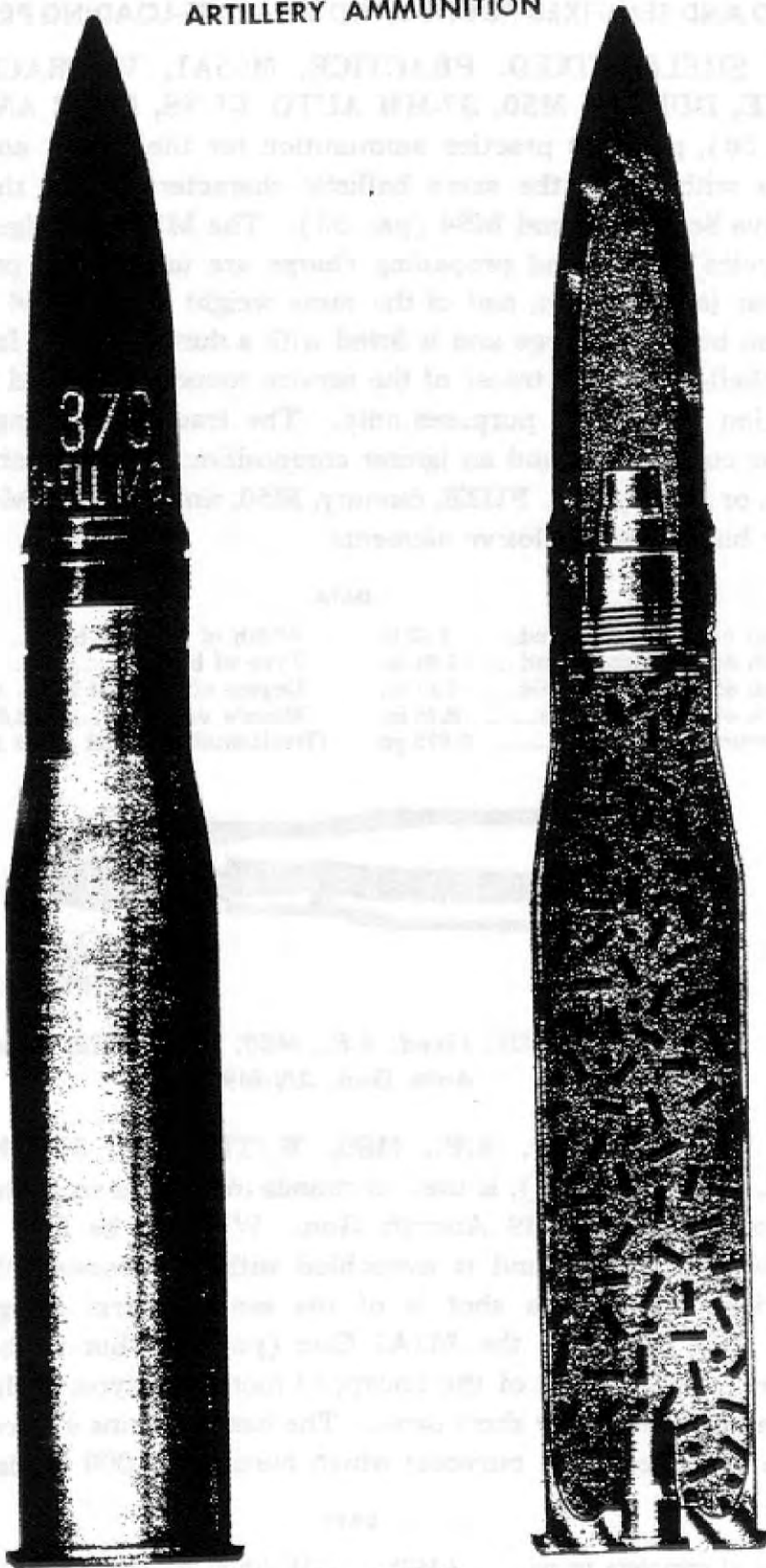

RA PD 80711

Figure 38 — SHELL, Fixed, H.E., M63, w/FUZE, B.D., M58, 37-mm
Guns, M3, M3A1, M5, M5A1, and M6

FIXED AND SEMIFIXED ROUNDS AND SEPARATE-LOADING PROJECTILES

41. **SHELL, FIXED, H.E., M63, W/FUZE, B.D., M58, 37-MM GUNS, M3, M3A1, M5, M5A1, AND M6** (fig. 38), is for use with 37-mm tank and antitank guns when fragmentation and blast effect are desired. The shell body is a relatively heavy steel casing. The nose is solid and formed to a long ogive. The base is "square" and threaded to receive the M58 Base Fuze which functions with nondelay action. This construction provides a maximum distribution of metal forward of the TNT bursting charge and for some penetration before detonation, increasing the effectiveness against targets such as sheltered or entrenched personnel, trucks, and light-armored vehicles. The round is assembled with both brass and steel cartridge cases. Present muzzle velocity is 2,600 feet per second, but rounds of earlier manufacture may be found which are loaded to give 2,700 feet per second muzzle velocity.

DATA

Weight of complete round.....	3.08 lb	Muzzle velocity:
Length of complete round....	14.09 in.	In M3, M3A1, and
Length of fuzed projectile.....	6.02 in.	M6 Guns 2,600 ft per sec
Length of cartridge case.....	8.75 in.	In M5 and M5A1
Width of rotating band.....	0.74 in.	Guns 2,565 ft per sec
Type of base.....	Square	Approximate maximum range:
Radius of ogive.....	8.97 cal	In M3, M3A1, and M6
		Guns 9,500 yd
		In M5 and M5A1 Guns... 9,425 yd



RA PD 80712

Figure 39 — SHOT, Fixed, A.P.C., M51, w/TRACER, 37-mm Guns, M3, M3A1, M5, M5A1, and M6

42. **SHOT, FIXED, A.P.C., M51, W/TRACER, 37-MM GUNS, M3, M3A1, M5, M5A1, AND M6** (fig. 39), is provided for use in 37-mm tank and antitank guns against light armor and similar materiel targets. The shot depends for its effect upon the force of its impact and penetration; the use of an armor-piercing cap especially adapts it for combating face-hardened plate. Three types of projectile—M51, M51B1 and M51B2—have been manufactured for the round. The M51B1 differs from the alternative M51B2 in that the armor-piercing cap is pointed, whereas the cap of the M51B2 is rounded at the front end. The M51, an earlier design, has a pointed cap, but differs from both the M51B1 and M51B2 in that the tracer cavity is closed by a steel washer crimped to the base of the projectile. The tracer cavities of the M51B1 and M51B2 are closed by a metal

ARTILLERY AMMUNITION

disk. In other respects, construction is similar, the projectile being made up of a hard steel core or body, the softer steel armor-piercing cap, and a light-weight windshield or false ogive which is crimped or screwed onto the armor-piercing cap. There is no bursting charge, the projectile being solid except for the small cavity in the base. This holds a red tracer composition which burns for approximately 3 seconds, equivalent to about 2,300 yards.

DATA

Weight of complete round.....	3.41 lb	Maximum range (at 45 deg elevation):
Length of complete round	14.53 in.	In M3, M3A1, and
Length of projectile.....	6.36 in.	M6 Guns 12,850 yd
Length of cartridge case.....	8.75 in.	In M5 and M5A1 Guns.... 12,725 yd
Width of rotating band.....	0.74 in.	Penetration (in. at 0-deg
Type of base.....	Square	obliquity of face-hardened
Radius of ogive (false ogive)	8.96 cal.	plate at 1,000 yd)..... 2.1
Muzzle velocity:		Penetration (in. at 0-deg
In M3, M3A1, and		obliquity of homogeneous
M6 Guns 2,900 ft per sec*		plate at 1,000 yd)..... 2.3
In M5 and M5A1		
Guns 2,855 ft per sec*		

*—For rounds with brass cartridge cases: 2,800 feet per second for rounds with steel cases. Rounds of earlier manufacture have muzzle velocity of 2,600 feet per second. Identification provided by marking on packing boxes.

43. SHOT, FIXED, A.P., M74, W/TRACER, 37-MM GUNS, M3, M3A1, M5, M5A1, AND M6, has same projectile as that of corresponding round for M1A2 Automatic Gun (par. 34). However, when to be fired from the tank and antitank guns, the projectile is assembled with the M16 Cartridge Case, which has extractor rim instead of extractor groove. The projectile is of the monobloc type, the body being of solid steel except for tracer cavity in base. Like most uncapped armor-piercing projectiles, the nose is formed to a relatively blunt point. While capable of adequate performance against homogeneous plate, this shot has been found to be less effective than the capped projectile against face-hardened plate of the type now being encountered in the field and is now used for service firing only in certain theaters of operation. The tracer burns for 2,000 yards.

DATA

Weight of complete round.....	3.07 lb	Maximum range (at 45 deg):
Length of complete round	13.01 in.	In M3, M3A1, and
Length of projectile.....	4.84 in.	M6 Guns 8,725 yd
Length of cartridge case.....	8.75 in.	In M5 and M5A1 Guns.... 8,625 yd
Width of rotating band.....	0.74 in.	Penetration (in. at 0-deg
Type of base.....	Square	obliquity of face-hardened
Radius of ogive.....	1.52 cal.	plate at 1,000 yd)..... 1.5
Muzzle velocity:		Penetration (in. at 0-deg
In M3, M3A1, and		obliquity of homogeneous
M6 Guns 2,900 ft per sec		Plate at 1,000 yd)..... 2.0
In M5 and M5A1		
Guns 2,855 ft per sec		

FIXED AND SEMIFIXED ROUNDS AND SEPARATE-LOADING PROJECTILES



Figure 40 — CANISTER, Fixed, M2, 37-mm Guns, M3, M3A1, M5, M5A1, and M6

44. CANISTER, FIXED, M2, 37-MM GUNS, M3, M3A1, M5, M5A1, AND M6 (fig. 40), is provided for 37-mm tank and antitank guns for effect against personnel. It is assembled with the M16 Cartridge Case. The canister consists of a terneplate cylinder sealed by a metal disk at each end and beaded near the base to insure firm seating in the cartridge case. The filler consists of 122 steel balls, each about $\frac{3}{8}$ -inch diameter, imbedded in a resinous matrix or binding material. There is no bursting charge or fuze. The case is ruptured by the shock of discharge and bursts within 100 feet of the muzzle of the gun, projecting the balls forward in a cone-shaped pattern at a velocity closely equal to that at the muzzle. This canister ammunition is effective against unsheltered personnel up to around 150 to 200 yards. Ability to penetrate materiel is limited.

DATA

Weight of complete round.....	3.31 lb	Length of canister.....	6.36 in.
Length of complete round	14.53 in.	Length of cartridge case.....	8.75 in.
Muzzle velocity	2,500 ft per sec		

45. SHOT, FIXED, T.P., M51A1, W/TRACER, 37-MM GUNS, M3, M3A1, M5, AND M6, has the same components as used for the M51A2 Target-practice Round described in paragraph 46, except that the windshield is omitted. As a result, the projectile has a blunt flat-nosed appearance, in contract to the long ogival nose of the M51A2.

DATA

Weight of complete round.....	3.34 lb	Muzzle velocity:	
Length of complete round	12.62 in.	In M3, M3A1, and	
Length of projectile.....	4.45 in.	M6 Guns	2,600 ft per sec†
Length of cartridge case.....	8.75 in.	In M5 and M5A1	
Width of rotating band.....	0.74 in.	Guns	2,550 ft per sec
Type of base.....	Square	Maximum range:	
Radius of ogive.....	8.96 cal.*	In M3, M3A1, and	
		M6 Guns	5,525 yd

*—For approximately 1.57 inches forward of the bourrelet, at which point the nose ends in a flat fronted surface approximately 1.1 inches in diameter.

†—Authorized velocity is 2,450 feet per second, but no rounds have been manufactured with this velocity.

ARTILLERY AMMUNITION



RA PD 80713

Figure 41 — SHOT, Fixed, T.P., M51A2, w/TRACER, 37-mm Guns, M3, M3A1, M5, M5A1, and M6

46. SHOT, FIXED, T.P., M51A2, W/TRACER, 37-MM GUNS, M3, M3A1, M5, M5A1, AND M6 (fig. 41), simulates SHOT, fixed, A.P.C., M51, w/TRACER, for practice firing from tank and antitank guns. Components are the same as for the service round (par. 42), except that the projectile body is a solid slug having the same over-all dimensions as combined body and armor-piercing cap of service shot.

DATA

Weight of complete round.....	3.39 lb	Muzzle velocity:	
Length of complete round....	14.53 in.	In M3, M3A1, and	
Length of projectile	6.21 in.	M6 Guns	2,600 ft per sec
Length of cartridge case.....	8.75 in.	In M5 and M5A1	
Width of rotating band.....	0.74 in.	Guns	2,550 ft per sec
Type of base.....	Square	Maximum range (at 45 deg):	
Radius of ogive (false ogive)..	8.96 cal.	In M3, M3A1, and	
		M6 Guns	12,050 yd
		In M5 and M5A1 Guns....	11,900 yd



RA PD 80717

OLIVE DRAB
(MARKING IN YELLOW)

Figure 42 — SHELL, Fixed, H.E., M54, w/TRACER, SD, and FUZE, P.D., M56, 37-mm Auto. Guns, AN-M4 and M10 (Aircraft)

47. SHELL, FIXED, H.E., M54, W/TRACER, SD., AND FUZE, P.D., M56, 37-MM AUTO. GUNS, AN-M4 AND M10 (AIRCRAFT) (fig. 42), has the same shell as used in rounds for M1A2 and AN-M9 Automatic Guns described (par. 33), and is adapted for use in the AN-M4 Aircraft Gun by assembling it with the Mk. IIIA2 (brass), or Mk. IIIA2B1 (steel) Cartridge Case. Because of lower muzzle velocity, the shell-destroying element operates at about 2,000 yards.

DATA

Weight of complete round.....	1.93 lb	Width of rotating band.....	0.74 in.
Length of complete round.....	9.75 in.	Type of base.....	Bob-tailed
Length of fuzed projectile	5.87 in.	Degree of taper.....	9 deg 15 min
Length of cartridge case.....	5.69 in.	Radius of ogive.....	4.34 cal.
Muzzle velocity	2,000 ft per sec		

FIXED AND SEMIFIXED ROUNDS AND SEPARATE-LOADING PROJECTILES



Figure 43 — SHOT, Fixed, A.P., M80, w/TRACER, 37-mm Auto. Guns, AN-M4 and M10 (Aircraft)

48. SHOT, FIXED, A.P., M80, W/TRACER, 37-MM AUTO. GUNS, AN-M4 AND M10 (AIRCRAFT) (fig. 43), is the same as that for the Automatic Gun AN-M9, except for the cartridge case. For the AN-M4 and M10 Guns the Mk. IIIA2, or alternative Steel Case Mk. IIIA2B1, loaded with a smaller propelling charge, is used in the round.

DATA

Weight of complete round.....	2.25 lb	Muzzle velocity	1,825 ft per sec*
Length of complete round	9.34 in.	Maximum range	6,700 yd
Length of projectile	4.23 in.	Penetration (in. at 0-deg	
Length of cartridge case.....	5.69 in.	obliquity of face-hardened	
Width of rotating band.....	0.74 in.	plate at 1,000 yd).....	0.6
Type of base.....	Square	Penetration (in. at 0-deg	
Radius of ogive.....	1.62 cal.	obliquity of homogeneous	
		plate at 1,000 yd).....	0.8

*—Rounds of older manufacture have muzzle velocity of 1,650 feet per second.



Figure 44 — SHELL, Fixed, Practice, M55A1, w/TRACER and FUZE, Dummy, M50, 37-mm Auto. Guns, AN-M4 and M10 (Aircraft)

49. SHELL, FIXED, PRACTICE, M55A1, W/TRACER, AND FUZE, DUMMY, M50, 37-MM AUTO. GUNS, AN-M4 AND M10 (AIRCRAFT) (fig. 44), differs from that described in paragraph 39 only in that the Mk. IIIA2 or alternative steel Cartridge Case Mk. IIIA2B1, and a smaller propelling charge are used. It provides practice ammunition for the AN-M4 and M10 Guns with ballistic properties similar to those of the M54 H.E. Round.

DATA

Weight of complete round.....	1.93 lb	Width of rotating band.....	0.74 in.
Length of complete round	9.75 in.	Type of base.....	Boat-tailed
Length of fuzed projectile	5.87 in.	Degree of taper.....	9 deg 15 min
Length of cartridge case.....	5.69 in.	Radius of ogive.....	4.34 cal.
	Muzzle velocity		2,000 ft per sec

ARTILLERY AMMUNITION

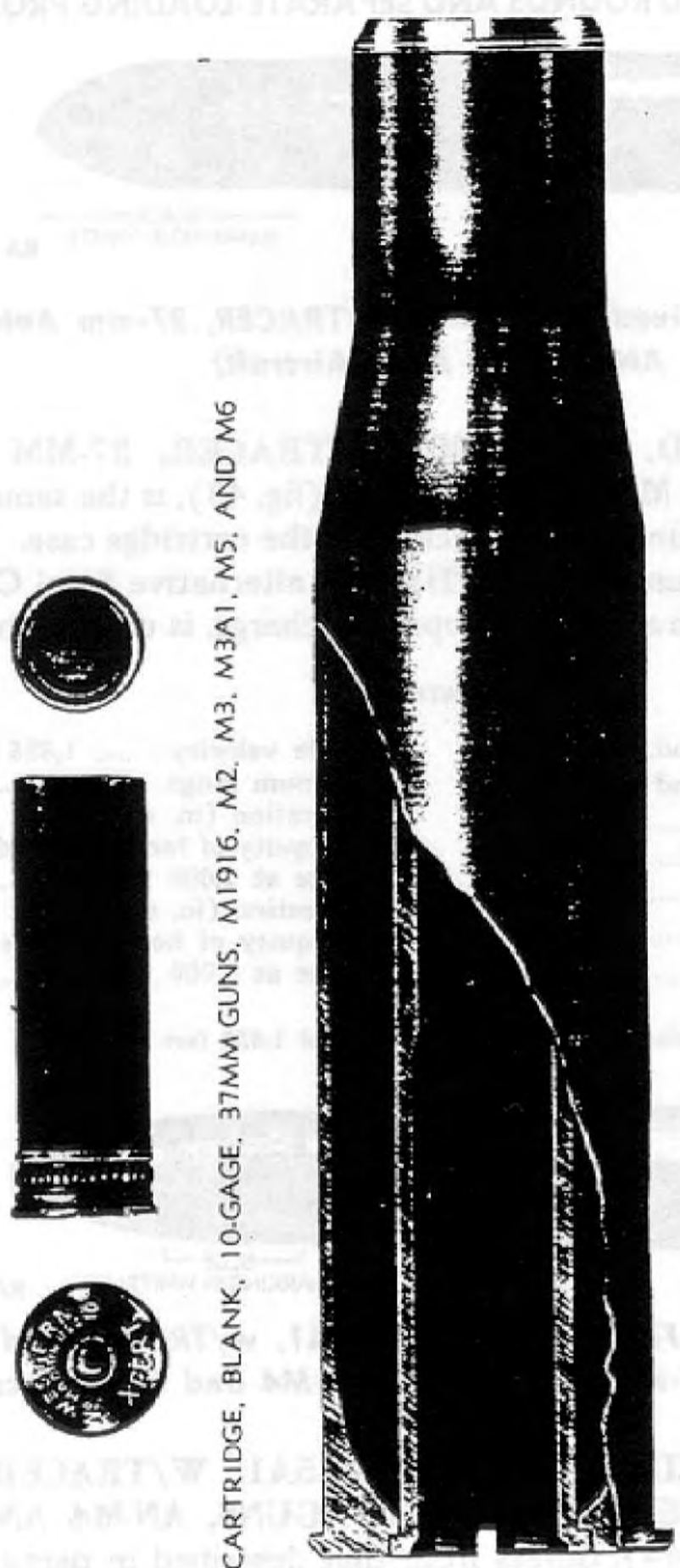

CARTRIDGE, BLANK, 10-GAGE, 37MM GUNS, M1916, M2, M3, M3A1, M5, AND M6

ADAPTER, M2, 37MM GUNS, M3, M3A1, M5 AND M6

RA PD 69048

Figure 45 — Adapter and Blank Cartridge for 37-mm Gun



FIXED AND SEMIFIXED ROUNDS AND SEPARATE-LOADING PROJECTILES

50. CARTRIDGE, BLANK, 10-GAGE, 37-MM GUNS, M1916, M3, M3A1, M5, AND M6 (fig. 45), consists of a commercial 10-gage blank shotgun shell loaded with 8 grains of black powder and containing dry felt wads. For firing with the M1916 Gun, the blank cartridge is used with ADAPTER, M1; in the M3, M3A1, M5, M5A1, and M6 Guns, the cartridge is used with ADAPTER, M2.

a. Both adapters are made up of three parts—a modified service cartridge case; a liner of steel tubing which extends through the cartridge case and acts as a seat for the blank cartridge; and an aluminum or steel bushing. The bushing serves to seat the liner firmly in position and to protect the neck of the cartridge case during handling and loading into the gun as well as to protect gun parts from damage during firing.

b. The M16 Cartridge Case is used to make up ADAPTER, M2, the primer hole being enlarged to seat the liner. This liner extends through the cartridge to a distance just short of the mouth of the case. The front end is threaded and screws into the steel bushing. When fully seated, this bushing protrudes approximately one-quarter inch beyond the cartridge case mouth.

c. A modified Mk. IA2 Cartridge Case is used to make up the M1 Adapter. In this adapter, the bushing extends approximately 1 $\frac{3}{4}$ inches beyond the cartridge case mouth, hence, when this ammunition is loaded into the gun, it extends into the bore of the gun for approximately that distance. In firing with either the M1 or the M2 Adapter, the percussion element of the blank shotgun cartridge serves as the primer.

DATA

	M1916 Gun	M3, M3A1, M5 and M5A1, and M6 Guns
Weight of adapter, w/o cartridge.....	0.87 lb	2.00 lb
Weight of adapter, w/ cartridge.....	0.91 lb	2.04 lb
Length of adapter.....	6.00 in.	9.00 in.
Length of cartridge case.....	3.64 in.	8.75 in.
Length of blank cartridge.....	2.85 in.	2.85 in.

ARTILLERY AMMUNITION

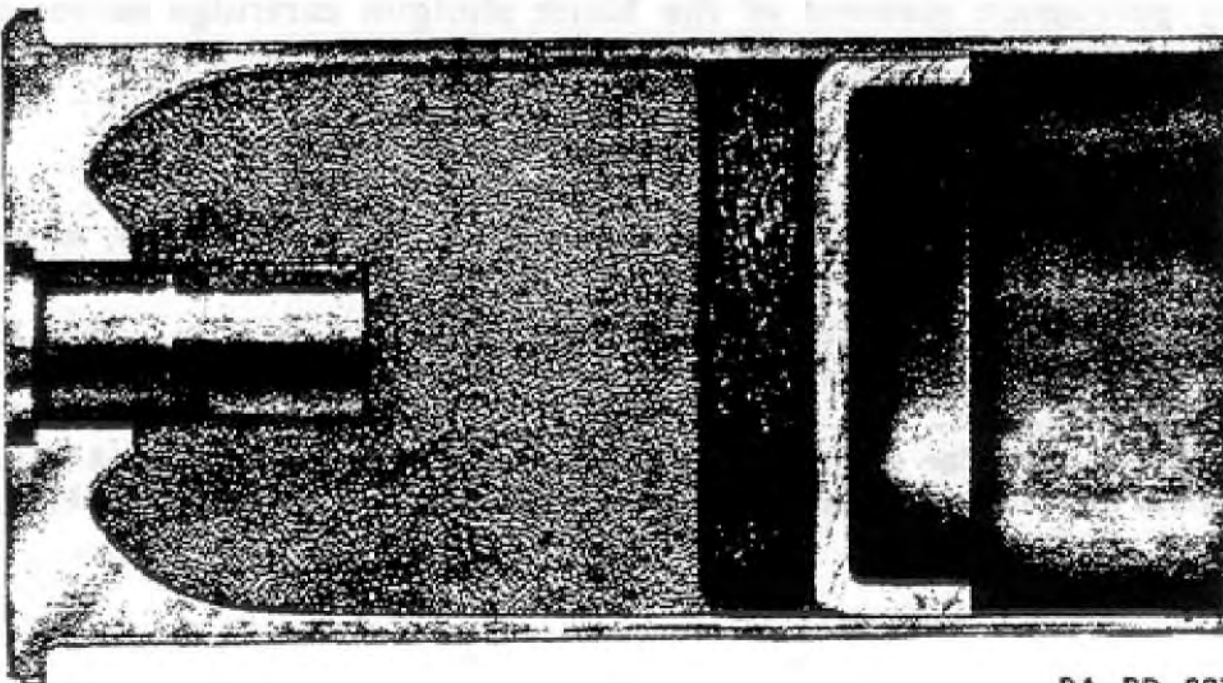
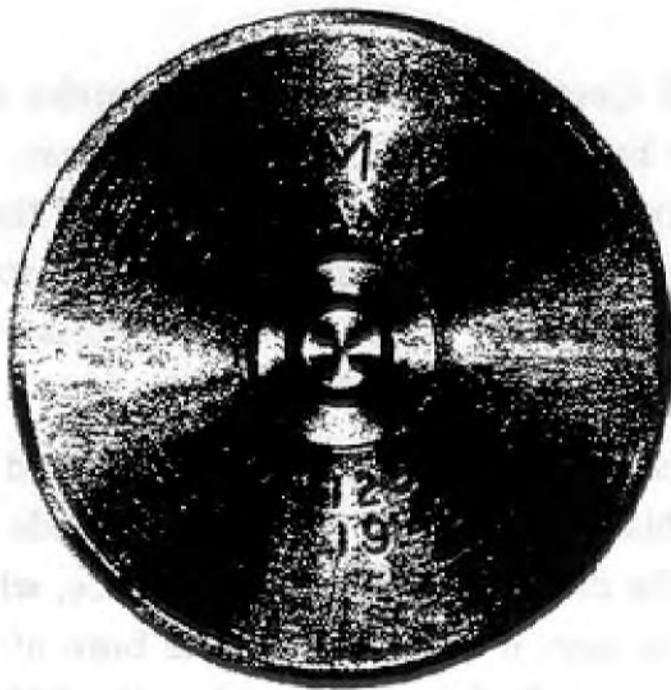
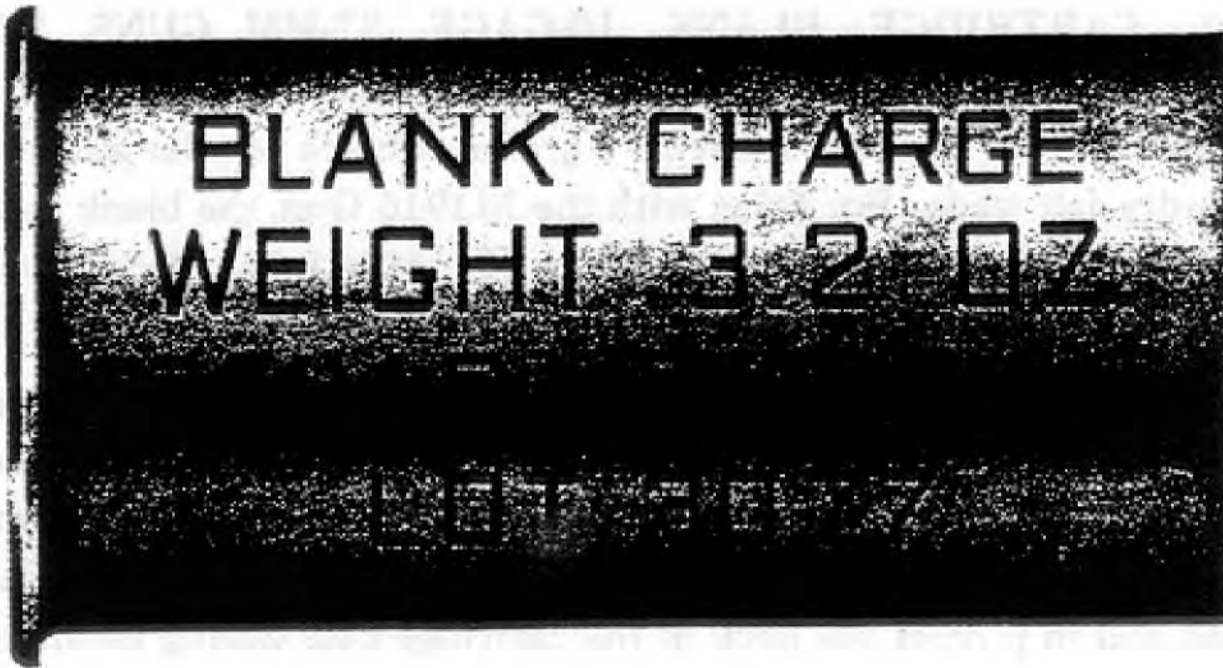

RA PD 80715

Figure 46 – AMMUNITION, Blank, 37-mm Guns, M3, M3A1, M5, M5A1, and M6

FIXED AND SEMIFIXED ROUNDS AND SEPARATE-LOADING PROJECTILES

51. AMMUNITION, BLANK, 37-MM GUNS, M3, M3A1, M5, M5A1, AND M6 (fig. 46), is for simulated fire and for saluting purposes. It consists of a brass or steel cartridge case, 4 inches long, which contains a service primer and a 3.2-ounce charge of loose black powder. The powder charge is held in position around the primer by a closing cup made up of a felt inner padding and a thin pulp-board front surface. The closing cup is sealed in position with Pettman cement about five-eighths inch from the front of the cartridge case.

52. CARTRIDGE, DRILL, M21, W/FUZE, DUMMY, M50B2, 37-MM AUTO. GUNS, M1A2 AND AN-M9, simulates the M54 H.E. Round for M1A2 and AN-M9 Guns. It consists of the steel Cartridge Case M17B1, assembled with an M54 Shell and an M50B2 (1-piece, steel) Dummy Fuze. The shell and case are held together by means of a steel retaining rod, one end of which is inserted into the enlarged tracer cavity in the base of the shell. The other end is screwed into a cartridge case plug assembly which takes the place of the primer. This plug assembly is inserted with a force fit in the primer hole. A copper plug is assembled in the base of the plug assembly so that the firing pin of the weapon will not be injured in simulated firings.

DATA

Weight of complete round.....	2.67 lb	Width of rotating band.....	0.74 in.
Length of complete round	12.81 in.	Type of base	Boat-tailed
Length of fuzeed projectile.....	5.87 in.	Degree of taper of base..	9 deg 15 min
Length of cartridge case.....	8.75 in.	Radius of ogive.....	4.34 cal.

53. CARTRIDGE, DRILL, M23 (T31), 37-MM AUTO. GUNS, AN-M4 AND M10 (AIRCRAFT), simulates the M54 H.E. Round for the 37-mm AN-M4 and M10 Guns. It consists of a 1-piece malleable iron body which simulates the fuze, shell, and cartridge case of the M54 Round and a steel base which is screwed into the body. The base contains a copper plug held therein by a steel spring, steel washer, and cotter pin. The plug is made of copper so that the firing pin of the weapon will not be injured during simulated firings. Weight of complete round is 1.93 pounds; length of complete round is 9.75 inches.

54. CARTRIDGE, DRILL, M13, 37-MM GUNS, M3, M3A1, M5, M5A1, AND M6 (fig. 47), is a completely inert cartridge which simulates the M51 Service Round for use in drill. It consists of a modified M51 or M51A2 Target-practice Projectile (which in turn closely resembles the M51 A.P.C. Service Projectile for these guns), an M16 Cartridge Case, and a steel retaining bar with a nail-like head and a threaded forepart. The retaining bar extends the length of the car-

ARTILLERY AMMUNITION



Figure 47 — CARTRIDGE, Drill, M13, 37-mm Guns, M3, M3A1, M5, M5A1, and M6

tridge case and screws into the base of the projectile when the drill cartridge is assembled. The projectile is modified for this purpose by lengthening the tracer cavity of the target-practice projectile to approximately 2 inches and threading the drilled hole.

DATA

Weight of complete round.....	3.20 lb	Length of cartridge case.....	8.75 in.
Length of complete round	14.54 in.	Width of rotating band.....	0.74 in.
Length of projectile.....	6.21 in.	Type of base.....	Square
Radius of ogive (false ogive).....	8.96 cal.		

55. CARTRIDGE, DRILL, M___, (T5), 37-MM GUNS, M3, M3A1, M5, M5A1, AND M6, simulates the M63 H.E. Round. It consists of the M63 Shell with an adapter screwed into its base, the M16 Cartridge Case, and a steel retaining rod. The retaining rod has a rim at one end to seat it in the primer hole of the case, and is threaded at the other end to be screwed into the adapter of the shell. A copper plug is held in place in the base of the retaining rod by a plug pin so that the firing pin of the weapon will not be injured in simulated firings. A half-inch hole is drilled into the side of the cartridge case for purposes of identification.

DATA

Weight of complete round.....	3.20 lb	Length of cartridge case.....	8.75 in.
Length of complete round	14.09 in.	Width of rotating band.....	0.74 in.
Length of projectile.....	6.02 in.	Type of base.....	Square
Radius of ogive.....	8.97 cal.		

FIXED AND SEMIFIXED ROUNDS AND SEPARATE-LOADING PROJECTILES

Section III

AMMUNITION FOR 40-MM GUNS**56. GENERAL.**

a. **General Discussion.** Sometimes referred to as the "Bofors" gun, GUN, automatic, 40-mm, M1, is primarily a rapid-fire automatic gun for anti-aircraft defense, but can be set for a single shot. The gun is fed by an automatic mechanism into which 4-round charger clips are loaded by hand. Use of the word "cartridge" to indicate a complete round of 40-mm fixed ammunition resulted from a joint agreement of the U.S. Army, the U.S. Navy and the British.

b. **Interchangeability.** Since the M1 Gun is basically the same as Navy and British 40-mm guns, the ammunition may be interchanged.

c. **Identification.** Rounds of Army procurement are painted and marked for identification in accordance with basic color scheme prescribed in TM 9-1900 and in figures 48, 49, and 50. In other cases, painting and marking may follow practices of other services.

d. **Fuzes.** Four models of supersensitive point-detonating fuzes have been used with 40-mm high-explosive shell—FUZE, P. D., Mk. 27 (Navy), FUZE, P.D., M71, FUZE, P.D., M64A1, and FUZE, P. D., 251, Mk. I (ch. 3, sec. I, and par. 61).

e. **Cartridge Cases.** CASE, cartridge, 40-mm, M25, or M25B1, is used with 40-mm ammunition of Army procurement. The M25B1 Case, made of steel, differs from the M25 in having a thinner head and primer seat, and weighs approximately 0.31 pound less. Ammunition of Navy design will have the Mk. 2 or Mk. 2-Mod. 1 Brass Case or the Mk. 3 Steel Case; the brass case weighs 1.89 pounds and the steel case weighs 0.36 pound less. Ammunition of British design will have the M22 Case, which differs from the American standard case in that the primer hole is threaded to fit the British primer.

f. **Primers.** PRIMER, percussion, 55-grain, M38A1, is standard for rounds of Army procurement, but the earlier standard 20-grain M23A1 Primer may still be found in rounds of less recent manufacture. Alternative primers are the Mk. 22 Navy Primer and the M38B2 Percussion Primer. Rounds with CASE, cartridge, 40-mm, M22, and those manufactured according to British design, will have PRIMER, percussion, Q.F. cartridges, No. 12, Mk. II/L. For descriptions of these primers see chapter 3, section III.

57. COMPLETE ROUND TABLE.

a. Data concerning the 40-mm complete rounds and components thereof are given in table 10, chapter 5.

58. PACKING AND SHIPPING DATA.

a. Packing and shipping data are given in ORD 11 SNL's P-5 and P-8.

ARTILLERY AMMUNITION

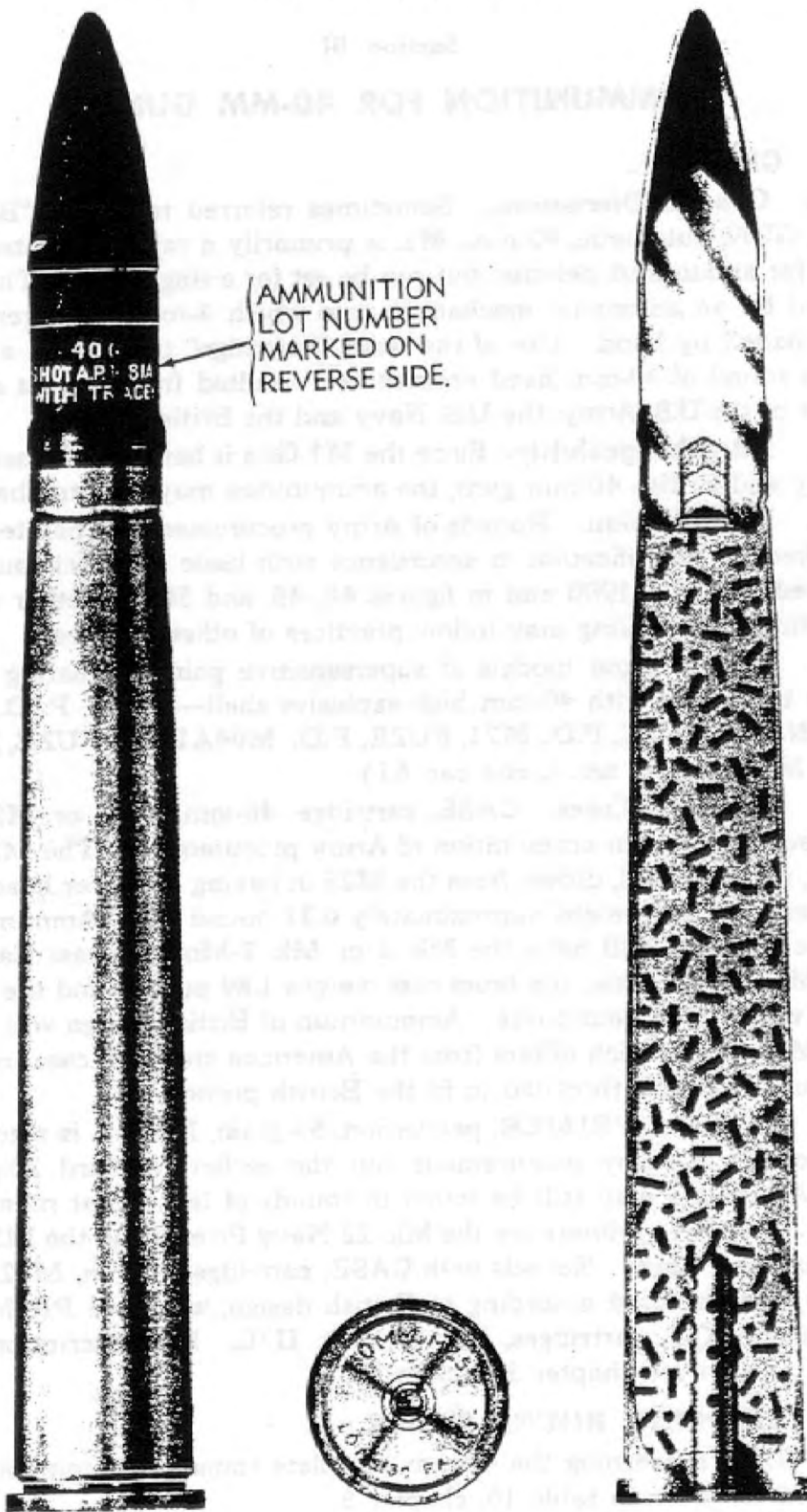

RA PD 80721

Figure 48 - CARTRIDGE, AP-T, M81A1, 40-mm AA. Guns

FIXED AND SEMIFIXED ROUNDS AND SEPARATE-LOADING PROJECTILES

59. CARTRIDGE, AP-T, M81A1, 40-MM AA. GUNS (fig. 48), is provided for the 40-mm guns for firing against armored targets. The projectile is a monobloc type, of solid steel. A tracer cavity in the base holds a red tracer composition. The nose of the body proper is shaped to a relatively blunt ogive. However, a long false ogive is provided, for better ballistics, by securing a light-weight windshield or false ogive to the shot body by a 360-degree crimp just forward of the bourrelet. The M81A1 Shot has no armor-piercing cap. The length of trace is 12 seconds.

DATA

Weight of complete round.....	4.57 lb	Muzzle velocity	2,870 ft per sec
Length of complete round	17.62 in.	Maximum range	9,475 yd
Length of projectile.....	6.19 in.	Penetration (in. at 0-deg	
Length of cartridge case.....	12.24 in.	obliquity of face-hardened	
Width of rotating band.....	0.64 in.	plate at 1,000 yd.....	1.7
Type of base.....	Square	Penetration (in. at 0-deg	
Radius of ogive.....	5.78 cal.	obliquity of homogeneous	
		plate at 1,000 yd.....	1.8

60. CARTRIDGE, AP-T, M81, 40-MM AA. GUNS, is an earlier design of armor-piercing shot which is identical with that described in paragraph 59 except that the windshield is secured to the body of the shot by means of an adapter. For data refer to paragraph 59.

61. CARTRIDGE, H.E., MK. I (NAVY), W/FUZE, MK. 27 (NAVY), 40-MM AA. GUNS, has a shell very similar to the Mk. II Shell (described in par. 62) used with rounds of Army manufacture, and functions like it. For Navy procurement, the shell is fuzed with the Mk. 27 Navy Fuze and Cartridge Case Mk. 1 or Mk. 2. Standard Navy primer is the Mk. 22, a press-in type; earlier standard was the Mk. 21* which screwed into the base of the cartridge case. The Shell-destroying Tracer Mk. 8 or Mk. 10 may be assembled in the base of the shell.

DATA

Weight of complete round.....	4.60 lb	Width of rotating band.....	0.60 in.
Length of complete round	17.60 in.	Type of base	Boat-tailed
Length of fuzed projectile	7.10 in.	Muzzle velocity	2,800 ft per sec
Length of cartridge case.....	12.24 in.	Maximum range	10,800 yd

*—Rounds assembled with the Mk. 21 Primer have been declared unsafe to fire.

ARTILLERY AMMUNITION



RA PD 80722

Figure 49 — CARTRIDGE, HE-T (SD, Mk. 11 or Mk. 11-Mod. 2), Mk. II, w/FUZE, P.D., Mk. 27.(Navy), 40-mm AA. Guns

FIXED AND SEMIFIXED ROUNDS AND SEPARATE-LOADING PROJECTILES

62. **CARTRIDGE, HE-T (SD, MK. 11 OR MK. 11-MOD. 2), MK. II, W/FUZE, P.D., MK. 27 (NAVY), 40-MM AA. GUNS (fig. 49),** consists of the M25 brass or M25B1 alternative steel Cartridge Case with the M38A1 Primer and an FNH powder charge crimped rigidly to a Mk. II High-explosive Shell fitted with the Mk. 27 supersensitive Fuze. The Mk. II Shell consists of three principal parts—a hollow steel casing containing a high-explosive bursting charge of pressed TNT, the point-detonating fuze, and a shell-destroying (SD) tracer. The nose of the shell is conical, with a 7-degree 45-minute taper, and is cut and threaded internally to receive the fuze. The base is boat-tailed (conical) with an 8-degree 15-minute taper, and is threaded internally to accommodate the shell-destroying Tracer Assembly Mk. 11 or Mk. 11-Mod. 2, of Navy origin, which protrudes beyond the base of the shell for approximately 0.56 inch. The tracer consists of an igniting charge, a red tracer composition, and a relay igniting charge of black powder. The red tracer composition burns with a visible trace for 9 to 12 seconds, equivalent to a range of 4,300 to 5,200 yards. As the tracer burns out, the relay igniting charge is ignited, detonating the bursting charge of the shell unless prior detonation has been caused by functioning of the fuze. The Mk. 11 and Mk. 11-Mod. 2 Tracers are similar to the M3 Tracer except for details of the relay igniting assembly.

DATA

Weight of complete round.....	4.70 lb	Type of base.....	Boat-tailed
Length of complete round ..	17.60 in.	Degree of taper.....	8 deg 15 min
Length of fuzed projectile....	7.64 in.	Muzzle velocity	2,870 ft per sec
Length of cartridge case.....	12.24 in.	Maximum range, horizontal	5,200 yd*
Width of rotating band.....	0.64 in.	Maximum range, vertical....	5,100 yd*

*—Limited by shell-destroying tracer. Theoretical maximum: 10,850 yards, horizontal, and 7,625 yards, vertical.

63. **CARTRIDGE, HE-T (SD), MK. II, OF EARLIER MANUFACTURE** are listed in ORD 11 SNL P-5 and their data presented in table 9, chapter 5, and the subparagraphs below. The standard Mk. II HE-T Round is described in paragraph 62.

a. The first rounds used in 40-mm guns were adapted from British ammunition. These Mk. II Shell are loaded with TNT and fitted with the TRACER and IGNITER, shell, No. 12, Mk. I/L/, internal. The fuze used is the No. 251 Mk. I, which was replaced by the

ARTILLERY AMMUNITION

M64A1, this fuze in turn being replaced by the Mk. 27 (Navy) Fuze. The muzzle velocity of these rounds is 2,870 feet per second. The No. 12 tracer, of British origin, consists of a primer, an igniting charge, a red tracer composition, and a relay igniting charge. The primer strikes a firing pin by set-back upon firing, igniting the red tracer composition. This burns for about 9 seconds, equivalent to a range of about 3,500 to 4,000 yards. As the tracer burns out, the relay igniting charge is ignited, detonating the bursting charge of the shell unless prior detonation has been caused by functioning of the fuze. Weights of these complete rounds are approximately 4.82 pounds. Length of the projectile with the No. 12 tracer is 7.08 inches.

b. The muzzle velocity of the Mk. II HE-T Rounds was reduced from 2,870 feet per second to 2,700 feet per second. Rounds manufactured with this velocity contained the No. 12 tracer and the M64A1, Mk. 27, and M71 Fuzes.

c. An improved tracer, TRACER, SD, M3, of American manufacture was adopted to replace the No. 12 tracer. The M3 Tracer differs from the No. 12 in that the primer and firing pin are omitted, the powder train consisting of an igniter charge, three charges of red tracer composition pressed at various loads in a steel body, and a relay igniting charge. The body is threaded externally to screw into the base of the shell. Unlike the tracer No. 12, which is flush with the rear surface of the shell when fully inserted, the M3 Tracer protrudes for about 0.75 inch. The bursting charge used in shell with the M3 Tracer is tetryl in preliminary design shell, and explosive D in the base and tetryl in the rest of shell of subsequent manufacture. A black powder wafer is also loaded in the base of the shell adjacent to the tracer relay charge to cause detonation of the bursting charge. The M3 Tracer has a burning time of 12 to 14 seconds, corresponding to a maximum horizontal range of 6,000 yards and a maximum vertical range of 5,750 yards (based on 2,870 ft per sec muzzle velocity). Rounds manufactured with the M3 Tracer have the Mk. 27 and M64A1 Fuzes. The Mk. 27 fuzed shell have a muzzle velocity of 2,700 feet per second, but shell fuzed with the M64A1 have been manufactured with both the 2,700 and 2,870 feet per second muzzle velocity. Weights of these complete rounds are approximately 4.82 pounds. Length of the fuzed projectile with the M3 Tracer is 7.88 inches. Maximum horizontal range is 6,000 yards and maximum vertical range is 5,750.

FIXED AND SEMIFIXED ROUNDS AND SEPARATE-LOADING PROJECTILES

d. The next development was an improved tracer, the M3A1. Details of these rounds with the M3A1 are the same as described in subparagraph c, above, except that only the muzzle velocity of 2,700 feet per second is applicable. Rounds with the M3A1 Tracer are also assembled with the Mk. 27 and M64A1 Fuzes. The TRACER, SD, M3A1, differs from the M3 in having an initiator and the same tracer and igniter composition as in the Mk. 11 Navy tracer.

e. The earlier types described in subparagraphs a to d, above, are superseded by the present standard round, described in paragraph 62, which has the Mk. 11 or Mk. 11-Mod. 2 tracer and the muzzle velocity of 2,870 feet per second. Rounds with these tracers are assembled with the Mk. 27 and M71 Fuzes, and the bursting charge is pressed TNT.

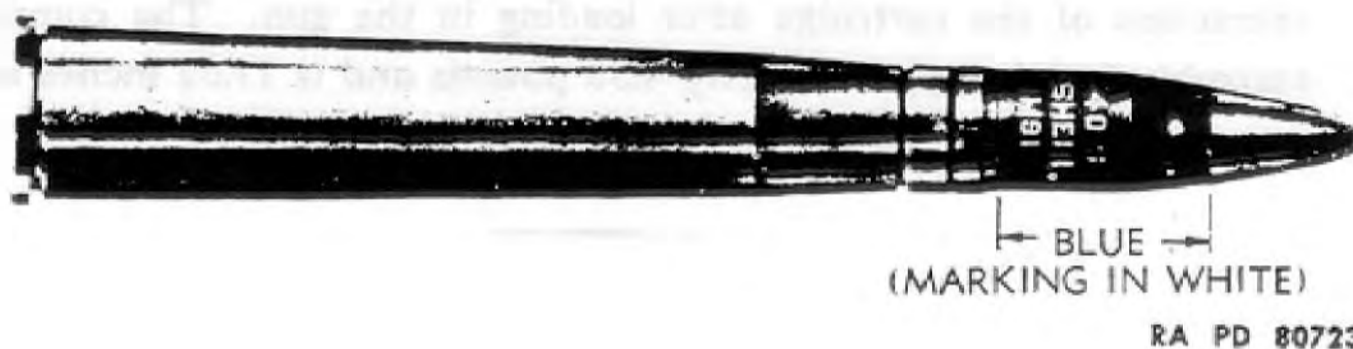

Figure 50 - CARTRIDGE, TP-T, M91, w/FUZE, Dummy or Inert, M___, 40-mm AA. Guns

64. CARTRIDGE, TP-T, M91, W/FUZE, DUMMY OR INERT, M___, 40-MM AA. GUNS (fig. 50), has a projectile which resembles the high-explosive shell in the Mk. II Cartridge but has a solid base except for a small tracer cavity. The shell-destroying tracer is replaced in the practice projectile by a burning composition for observation only, and the bursting charge cavity is empty. The shell may be fitted with FUZE, dummy, M69, or M69B1, which simulates the supersensitive point-detonating fuzes or may be an inert service fuze unserviceable for high-explosive loading.

DATA

Weight of complete round.....	4.72 lb	Type of base.....	Boat-tailed
Length of complete round	17.60 in.	Degree of taper.....	8 deg 15 min
Length of fuzed projectile	7.08 in.	Muzzle velocity	2,870 ft per sec
Length of cartridge case.....	12.24 in.	Maximum range, horizontal	10,850 yd
Width of rotating band.....	0.64 in.	Maximum range, vertical.....	7,625 yd

ARTILLERY AMMUNITION

65. CARTRIDGE, HE-T, MK. II, INERT LOADED, W/FUZE, DUMMY OR INERT, M___, 40-MM AA. GUNS, is an alternative practice round to CARTRIDGE, TP-T, M91, w/FUZE, dummy or inert, M___, 40-mm AA. Guns. It consists of a service cartridge case, primer, and propelling charge; an inert-loaded Mk. II High-explosive Shell; and an inert fuze. FUZE, dummy, M69 or M69B1, or an inert service fuze (the M71 or Mk. 27 (Navy)) may be assembled to the shell.

66. CARTRIDGE, DRILL, M17, 40-MM GUNS, is a completely inert assembly for drill purposes. The iron body is shaped in the general form of a service projectile and a fixed cartridge case. The nose end of the assembly may be left open and threaded to hold an iron plug resembling a service fuze, or the body and nose may be made in one piece. The base end of the body is closed by an iron base plate which screws into the body and has a flange to provide for extraction of the cartridge after loading in the gun. The complete assembly weighs approximately 4.53 pounds and is 17.62 inches long.

FIXED AND SEMIFIXED ROUNDS AND SEPARATE-LOADING PROJECTILES

Section IV

AMMUNITION FOR 2-INCH MORTARS

67. GENERAL.

a. **General Discussion.** The 2-inch Mortar M3 is the same as the 2-inch British Bomb Thrower Mk. I. It is used on tanks to project smoke bombs. Variation in range is obtained by the use of a gas regulator on the mortar which governs the escape of part of the propellant gases through an exhaust pipe.

b. **Identification.** The smoke bomb is not painted in accordance with the basic color scheme as prescribed in TM 9-1900. It differs in appearance from other mortar ammunition, being cylindrical in shape and having a flattened head (fig. 51). The head is unpainted and the body is painted green. A 1/2-inch red stripe is painted around the body at a distance of 1/2-inch from the head. The fin assembly is unpainted, except for the opposite side of the vane bearing the markings, which is painted red.

c. **Primer and Ignition Cartridge.** A 28-gage blank cartridge containing 18 grains of trench mortar powder is fitted into the fin assembly and is secured therein by a knurled zinc alloy cap which screws onto the end of the fin assembly. This cap has a hole in its center to allow the firing pin to strike the primer of the blank cartridge. No other propellant is used.

68. PACKING AND SHIPPING DATA.

a. Two rounds are packed in a fiber container, three containers are strapped together to form a "carrier" assembly, and three carriers (18 rounds) are packed in a steel Ammunition Box, B167, Mk. I. The fiber containers hold two rounds, separated by a wood or fiber disk; tinned metal ends hold the rounds in the container. In the carrier, wood spacers hold the containers and banding together, and a handle of cotton webbing is secured by brass links and the banding (figs. 52, 53, and 54). Dimensions and weights of packings are given in TM 9-293 and ORD 11 SNL R-4.

ARTILLERY AMMUNITION

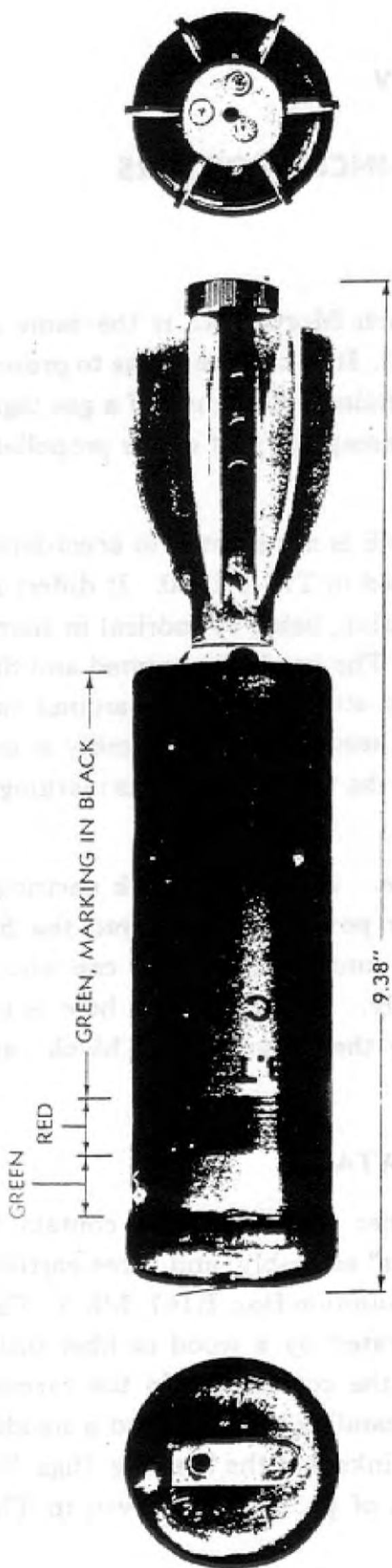

RA PD 69121

Figure 51 — BOMB, Smoke, Mk. 1/L, 2" Mortar, M3, Complete Round

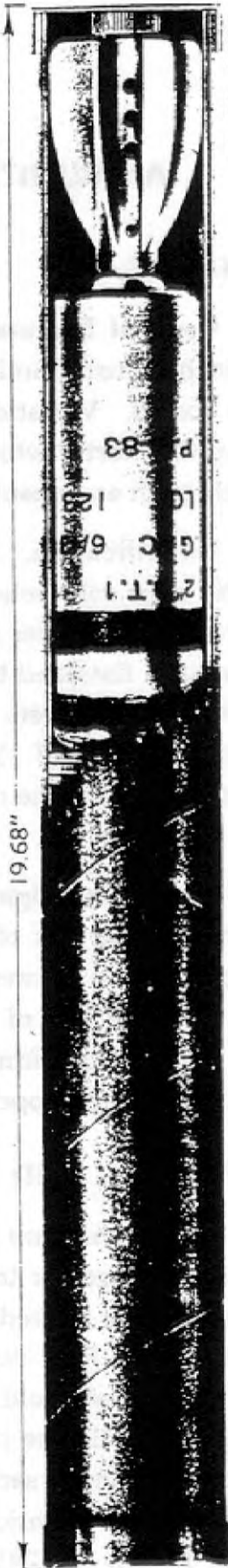

RA PD 64435

Figure 52 — Fiber Container for Two BOMB, Smoke, Mk. 1/L, 2" Mortar, M3, Complete Round

FIXED AND SEMIFIXED ROUNDS AND SEPARATE-LOADING PROJECTILES

69. BOMB, SMOKE, MK. 1/L, 2" MORTAR, M3 COMPLETE ROUND (fig. 51), consists of a steel cylinder approximately 5.8 inches long, which contains the smoke filler. The head of the cylinder has a slightly larger diameter than the body, and serves as the front bourrelet. The base end of the cylinder is crimped over a tinned steel adapter and a thin diaphragm of tinned brass. The adapter has a threaded projection onto which the fin assembly of zinc alloy is screwed. A set screw secures the fin assembly to the adapter. The fins, in addition to serving as a stabilizer in flight, also serve to center the round in the mortar, hence act as a rear bourrelet. A metal lifting strap, spot-welded to the head of the bomb, aids in removing a round placed in the mortar, should it be desired not to fire it. Upon pulling the trigger, the firing pin strikes the primer of the blank cartridge in the base of the fin initiating the burning of the propellant powder. The hot gases formed are emitted through the holes in the fin assembly, after burning through the paper walls of the blank cartridge. In addition to propelling the round in the barrel forward, the hot gases break through the thin brass diaphragm held in place by the adapter, and ignite the smoke filler in the steel cylinder.

DATA

Weight of complete round.....	2 1/8 lb	Range:	
Length of complete round.....	9.38 in.	Short	20 yd
Weight of round as fired		Medium	60 yd
(approx)	2.0 lb	Long	120 yd

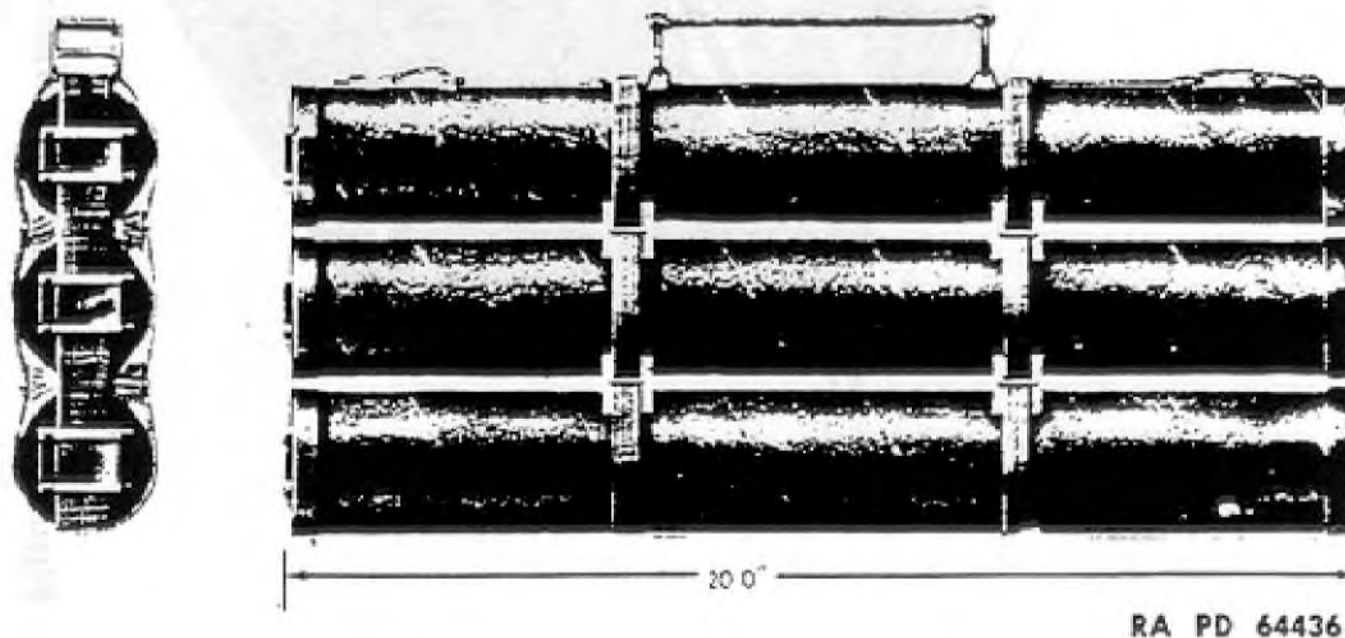
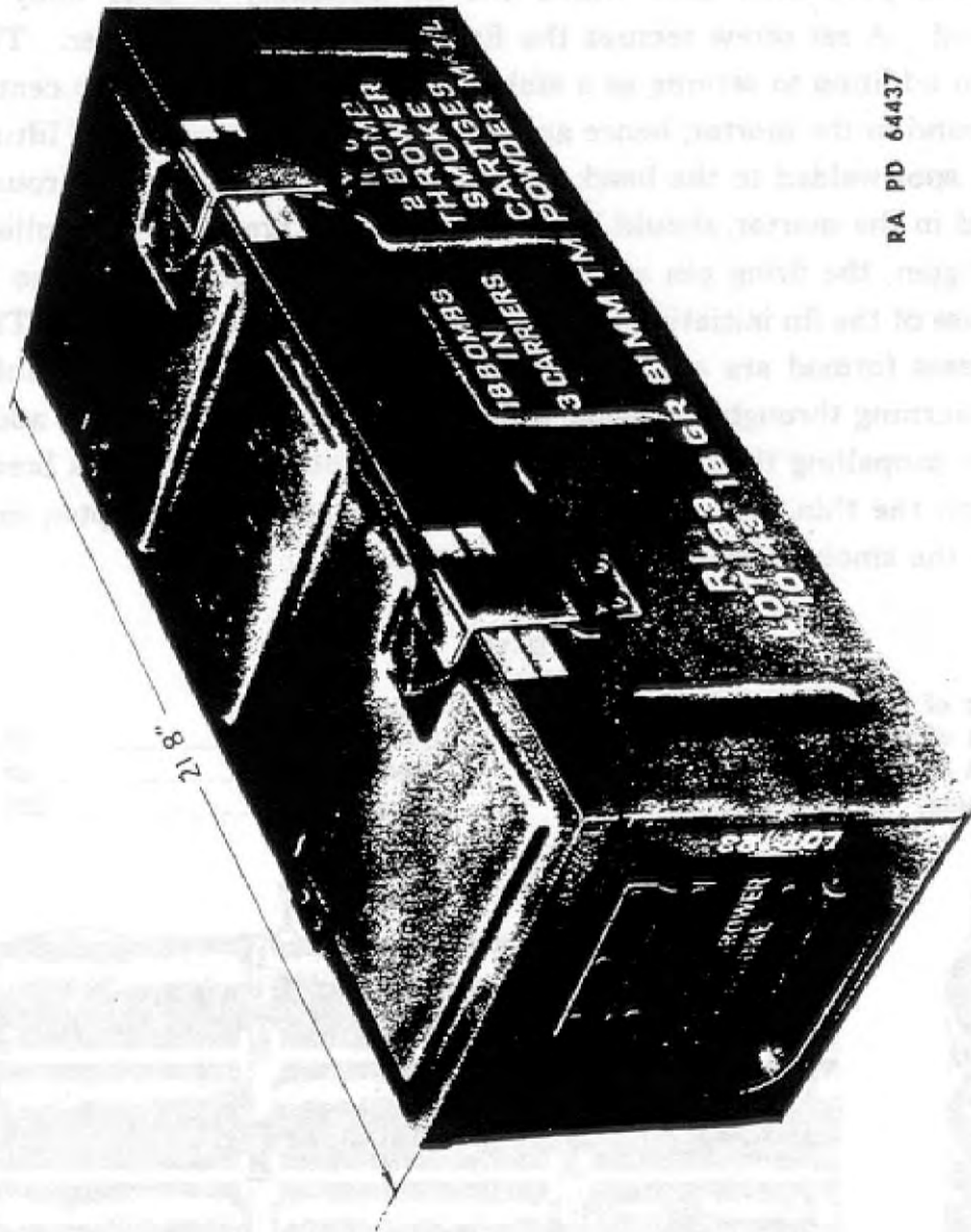

Figure 53 – CARRIER, Ammunition, for Three Containers for BOMB, Smoke, Mk. 1/L, 2" Mortar, M3, Complete Round

ARTILLERY AMMUNITION



RA PD 64437

Figure 54 — BOX, Ammunition, B-167, Mk. 1/L, for Three Carriers (18 Rounds) for BOMB, Smoke, Mk. 1/L, 2" Mortar, M3, Complete Round

FIXED AND SEMIFIXED ROUNDS AND SEPARATE-LOADING PROJECTILES

Section V

AMMUNITION FOR 57-MM GUNS

70. GENERAL.

a. **General Discussion.** All 57-mm guns now in use are primarily antitank weapons. Various types of mounts are in use, and the British 6 Pr. 7 Cwt. gun is further distinguished from American makes by a shorter, stubbier barrel. However, all present types are chambered alike and therefore fire the same ammunition. The 57-mm ammunition is in the form of complete fixed rounds, known as "cartridges." Ammunition with explosive filler is fuzeed as shipped.

b. **Identification.** Painting and marking for identification is in accordance with the basic scheme as prescribed in TM 9-1900. Typical painting and marking on the rounds are illustrated in figures 55 and 56.

c. **Fuzes.** FUZE, B.D., M72, is used with loaded armor-piercing-capped (APC-T) projectiles. This fuze functions with delay action and has a tracer in its base which operates independently of the fuze mechanism. The other authorized projectiles do not require a fuze (ch. 3, sec. I).

d. **Cartridge Cases.** CASE, cartridge, 57-mm, M23A2, is the standard cartridge case for 57-mm ammunition. Substitute standard is CASE, cartridge, 57-mm, M23A2B1. The M23A2B1 is a steel case with a slightly thinner head and primer seat than the standard brass case, and weighs approximately 0.26 pound less.

e. **Primers.** PRIMER, percussion, 100-grain, M1B1A2, is the standard primer for ammunition in this caliber. PRIMER, percussion, 100-grain, M1A2, is an alternative primer (ch. 3, sec. III).

71. COMPLETE ROUND TABLE.

a. Data concerning the 57-mm complete rounds, and components thereof, are given in table 11, chapter 5.

72. PACKING AND SHIPPING DATA.

a. Packing and shipping data on 57-mm rounds are given in ORD 11 SNL's R-1 and R-6.

ARTILLERY AMMUNITION

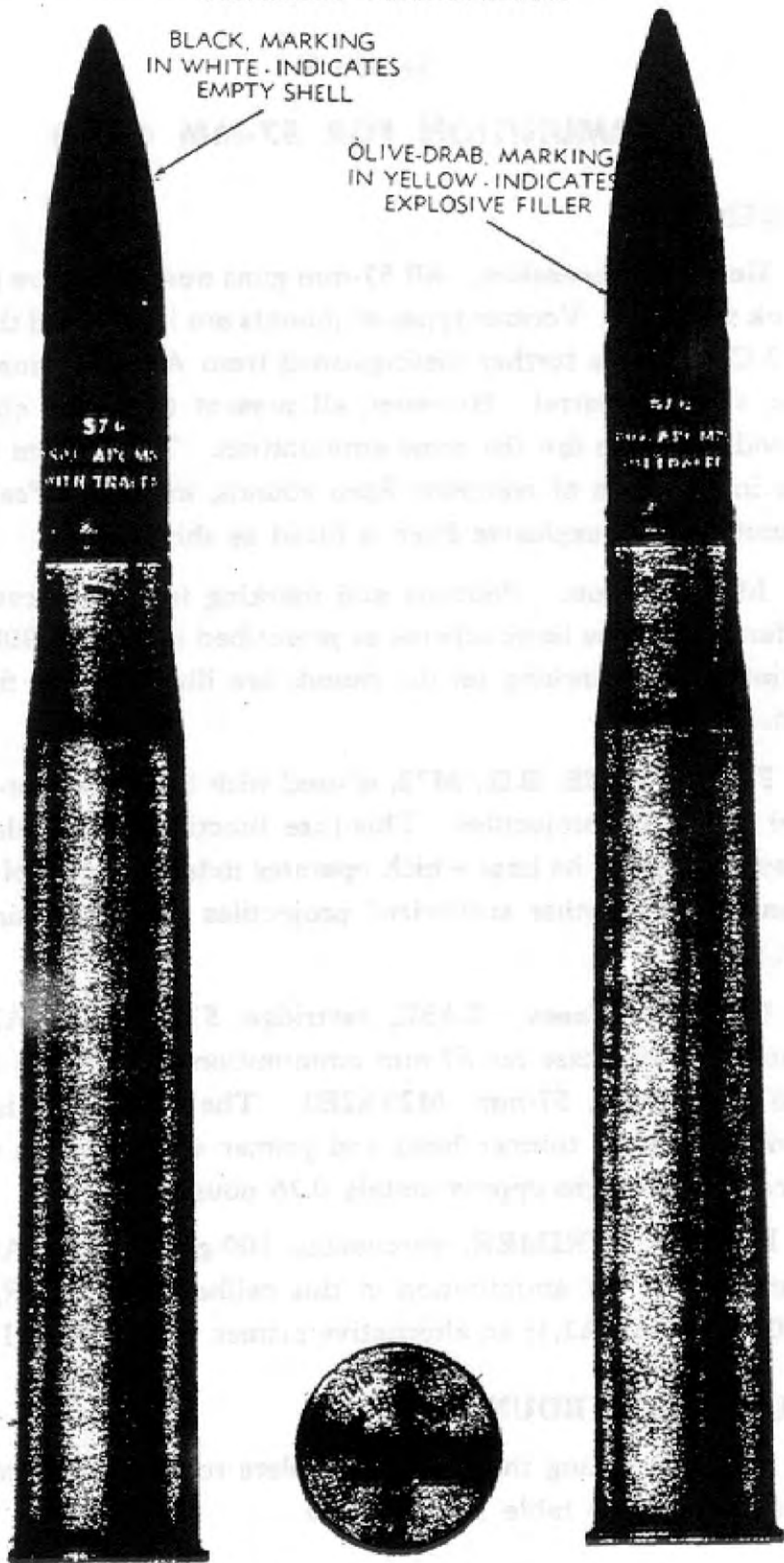

RA PD 80724

Figure 55 — Complete Rounds of 57-mm Armor-piercing-capped Ammunition

FIXED AND SEMIFIXED ROUNDS AND SEPARATE-LOADING PROJECTILES

73. CARTRIDGE, APC-T, M86, W/FUZE, B.D., M72, 57-MM GUNS, M1 AND 6 PR. 7 CWT. (BRITISH) (fig. 55), is provided for use against armor-protected targets. The complete round consists of the standard (or alternative steel) cartridge case, primer and propelling charge, assembled to a loaded armor-piercing-capped projectile. Construction of the projectile is similar to that of corresponding armor-piercing-capped projectiles in other calibers. The body is of hardened steel, and has a square base and an ogival nose. A face-hardened softer steel cap is sweated to the nose to increase the effectiveness against face-hardened plate. For better ballistics, a light-weight ogival ballistic cap or windshield is secured to the cap by crimping or by means of a threaded adapter. An M72 Base-detonating Fuze is fitted to the base to explode the small high-explosive charge of explosive D. The fuze has incorporated in it the M17 Detonator Assembly which detonates the explosive D and tetryl pellet bursting charge. The fuze functions with delay action and has a tracer in its base which operates independently of the fuze mechanism. The tracer burns for approximately 4.5 seconds after being ignited by the propelling charge, providing a visible trace for observation purposes over a range of about 3,000 yards.

DATA

Weight of complete round.....	13.88 lb	Muzzle velocity	2,700 ft per sec*
Length of complete round	26.72 in.	Maximum range	13,555 yd
Length of projectile		Penetration (in. at 0-deg	
(capped)	10.31 in.	obliquity of face-hardened	
Length of cartridge case.....	17.40 in.	plate at 1,000 yd).....	3.7
Width of rotating band.....	0.79 in.	Penetration (in. at 0-deg	
Type of base.....	Square	obliquity of homogeneous	
Radius of ogive.....	7.21 cal.	plate at 1,000 yd).....	3.6

*—Muzzle velocity in the British 6 Pr. Mk. III Gun is 2,580 feet per second.

74. CARTRIDGE, APC-T, M86, 57-MM GUNS, M1 AND 6 PR. 7 CWT. (BRITISH) (fig. 55), is assembled with an earlier type of M86 Projectile which has been superseded for manufacture by the loaded and fuzed projectile. In this projectile, the bursting charge cavity is left empty, hence there is no blast effect at the target. The base hole is closed by a steel plug which contains a tracer similar to that in the fuze of the standard projectile.

DATA

Weight of complete round.....	12.99 lb	Width of rotating band.....	0.79 in.
Length of complete round	26.72 in.	Type of base.....	Square
Length of projectile.....	10.31 in.	Radius of ogive.....	7.21 cal.
Length of cartridge case.....	17.40 in.	Muzzle velocity	2 700 ft per sec*
	Maximum range		13,555 yd

*—Muzzle velocity in the British 6 Pr. Mk. III Gun is 2,580 feet per second.

ARTILLERY AMMUNITION



Figure 56 — CARTRIDGE, AP-T, M70, 57-mm Guns, M1 and 6 Pr. 7 Cwt. (British)

75. CARTRIDGE, AP-T, M70, 57-MM GUNS, M1 AND 6 PR. 7 CWT. (BRITISH) (fig. 56), like the armor-piercing-capped round, is intended for firing against armor-protected targets. Components assembled in the round are the same as for the M86, except for the projectile. The M70 Shot is a solid slug of hardened steel with a square base and a short ogival nose, and is inert except for a tracer held in a small cavity in the base. The tracer consists of three pellets of red tracer composition (73 grains) and one pellet of igniter charge, pressed into the cavity and sealed against moisture by a metal disk. Upon being ignited by the propelling charge, when the round is fired the composition burns for about 4.5 seconds, giving a visible trace for observation purposes over a range of about 2,600 yards. Since there is no armor-piercing cap, the projectile is not as well adapted for defeating face-hardened plate as the M86. However, it is at least equally as effective against homogeneous plate.

DATA

Weight of complete round.....	12.92 lb	Muzzle velocity	2,950 ft per sec†
Length of complete round	23.22 in.	Maximum range	9,275 yd*
Length of projectile.....	6.81 in.	Penetration (in. at 0-deg	
Length of cartridge case.....	17.40 in.	obliquity of face-hardened	
Width of rotating band.....	0.79 in.	plate at 1,000 yd).....	2.7*
Type of base.....	Square	Penetration (in. at 0-deg	
Radius of ogive.....	1.40 cal.	obliquity of homogeneous	
		plate at 1,000 yd).....	3.4*

*—Data for projectile with muzzle velocity of 2,950 feet per second. Rounds of older manufacture had a muzzle velocity of 2,800 feet per second.

†—Muzzle velocity in the British 6 Pr. Mk. III Gun is 2,830 feet per second; muzzle velocity of older rounds, having 2,800 feet per second velocity in U. S. guns, is 2,700 feet per second in the British 6 Pr. Mk. III Gun.

FIXED AND SEMIFIXED ROUNDS AND SEPARATE-LOADING PROJECTILES

Section VI

AMMUNITION FOR 60-MM MORTARS**76. GENERAL.**

a. **General Discussion.** The 60-mm and 81-mm mortars are used primarily in missions where high angles of fire are needed to drop shells behind hills, into trenches, and placements, or on similarly protected targets. MORTAR, 60-mm, M2, is the standard small caliber mortar, the M1 being limited standard. The ammunition falls within the classification of semifixed ammunition since the propelling charges are in increments permitting adjustment for zone fire. All rounds are issued in the form of fuzed complete rounds. A complete round consists of a fuzed projectile with a fin assembly, a propelling charge comprising a number of increments and an ignition cartridge, and a primer. The rounds need no preparation for firing, once removed from wrappings, other than the adjustment of the propelling charge as described in subparagraph d, below.

b. **Identification.** The characteristic shape resulting from the use of a fin to obtain the desired stability in flight serves to distinguish mortar ammunition from other artillery types. Painting and marking provides for complete identification of the round, and the components thereof, in accordance with the basic principles prescribed in TM 9-1900 (figs. 57, 58, 59, and 60).

c. **Fuzes.** Two types of point-detonating fuzes are used with mortar ammunition—"time" and "impact." FUZE, P.D., M52, M52B1, or M52B2 is used with the high-explosive round for the 60-mm mortars. They are single-action fuzes providing for superquick action. The only difference between these fuzes is in the kind of material used in making up the head and body; the M52 has an aluminum head and body, whereas the M52B1 has a plastic head and body; the M52B2 has a plastic head and aluminum body. The time fuze, FUZE, time (fixed), M65, is fitted to the 60-mm illuminating shell. This is a fixed powder-train time fuze which has a time delay of approximately 15 seconds (ch. 3 sec. I).

d. **Propelling Charges.** The Ignition Cartridge M5A1 serves as the propelling charge for the extremely short ranges. For longer ranges, the M3 and M3A1 Propelling Charges are provided. These charges are divided into removable parts or increments to provide for zone firing. To prepare the charges for firing inner zones, it is only necessary to remove those increments not required, according to the appropriate firing tables. The increments consist of stitched

ARTILLERY AMMUNITION

bundles of sheet powder having a hole in the center of each increment. Each of the M3A1 Increments is sealed in a cellophane bag; the M3 is not sealed in cellophane bags. Four such increments or bundles, and the ignition cartridge, comprise a full charge for all 60-mm mortar rounds, one increment being fitted into each of the spaces within the blades of the fin. The early practice was to place the increments between the fins, but this has been discontinued.

e. **Primers and Ignition Cartridges.** For all current manufacture, PRIMER, percussion, M32, is used in conjunction with CARTRIDGE, ignition, M5A1, to ignite the M3 and M3A1 Propelling Charge Increments. An M4 Propelling Charge was formerly used with the M83 Illuminating Shell, but has been replaced by the M3 Propelling Charge for the M83A1 Shell. The ignition cartridge also acts as the propelling charge for the extremely short ranges. The older M5 Ignition Cartridge will be used only until it can be replaced by the M5A1. Rounds with the M5 Cartridge will not be fired over the heads of friendly troops. When used in training, regulations of AR 750-10 must be followed, and in addition positive protection must be given to mortar crew members and personnel in the danger area. The M32 Primer and the M5 Cartridge together replaced the M4 Ignition Cartridge, which included both the primer and the ignition charge, except for the Training Projectile, M69. For description of M32 Primer, see chapter 3, section III.

f. **Fins.** Prior to 1944, propellant increments were placed *between* the fin blades. This has resulted in some instances in the loss of fins in flight causing erratic trajectories and dangerously short ranges. To overcome this, the present practice is to place the increments *within* the blades of the fins. In the new production of 60-mm mortar ammunition, the increment holder has been redesigned so that the increments will be placed within the fins. Also, the web between the fin blades has been increased from 38 to 52 degrees.

77. COMPLETE ROUND TABLE.

a. Data concerning the complete rounds of 60-mm ammunition, and components thereof, are given in table 12, chapter 5.

78. PACKING AND SHIPPING DATA.

a. Packing and shipping data on the rounds are given in ORD 11 SNL R-4.

FIXED AND SEMIFIXED ROUNDS AND SEPARATE-LOADING PROJECTILES

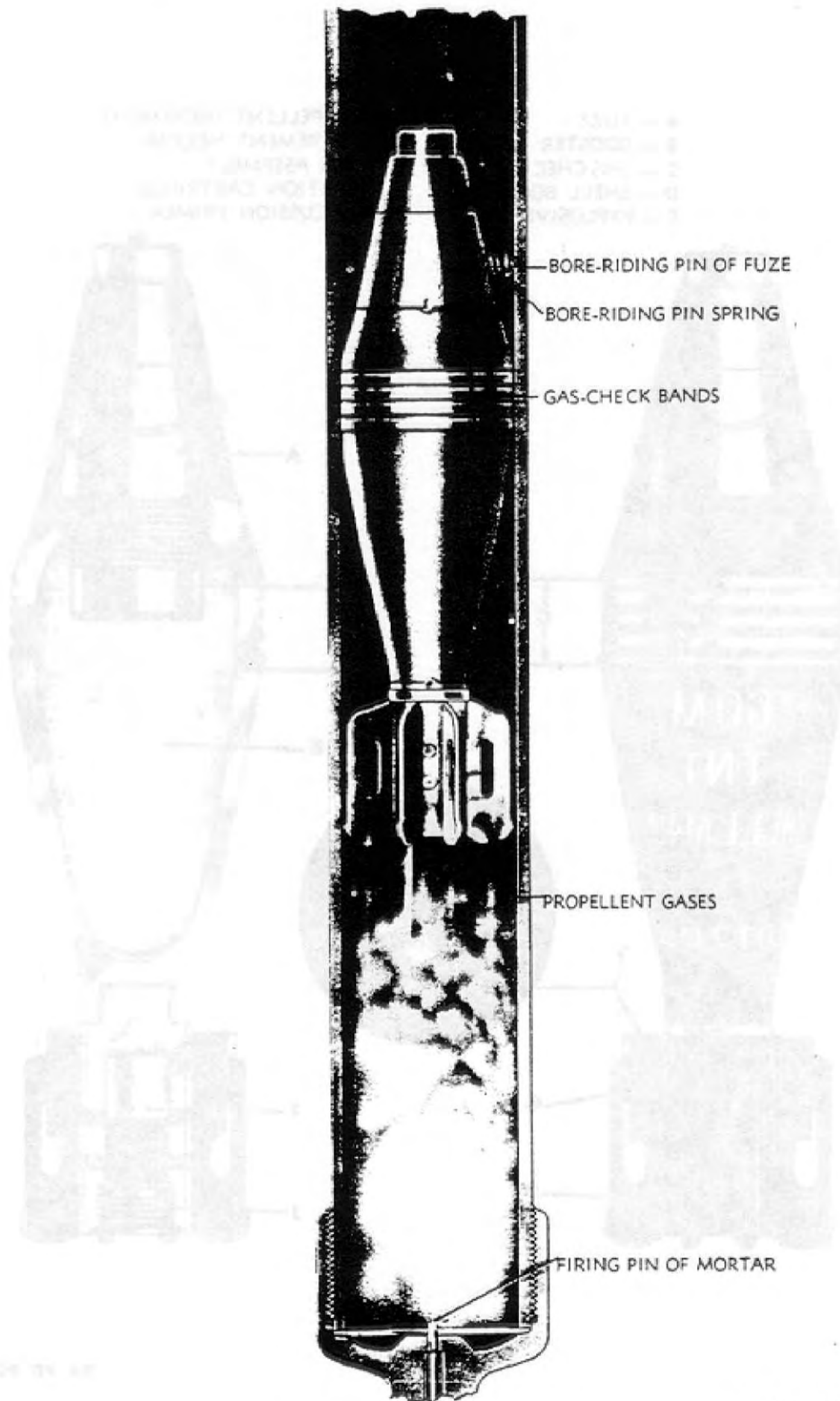
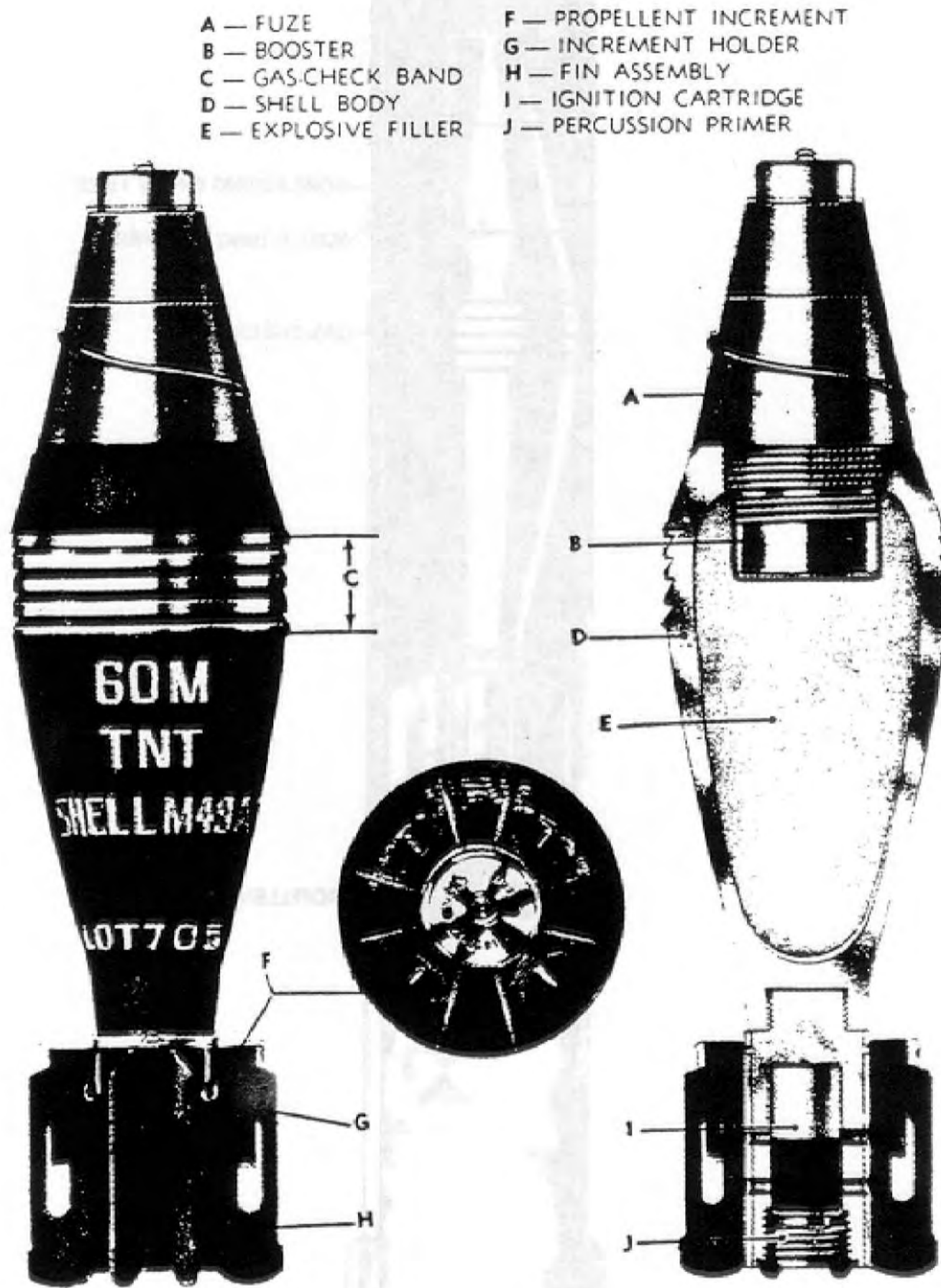

Figure 56A — 60-mm Mortar Shell Being Fired

RA PD 65179

ARTILLERY AMMUNITION



RA PD 80729

Figure 57 — SHELL, H.E., M49A2, w/FUZE, P.D., M52, 60-mm Mortars, M1 and M2, Complete Round

FIXED AND SEMIFIXED ROUNDS AND SEPARATE-LOADING PROJECTILES

79. SHELL, H.E., M49A2, W/FUZE, P.D., M52, 60-MM MORTARS, M1 AND M2, COMPLETE ROUND (fig. 57), is the only high-explosive round provided for the 60-mm mortars. A complete round consists of six components—the M49A2 High-explosive Shell, an M52 Fuze, a fin assembly, an M3 or M3A1 (4-increment) Propelling Charge, an M5A1 Ignition Cartridge, and an M32 Primer. All are issued and shipped assembled in a complete round which is ready for firing except for adjustment of the propelling charge. The shell body consists of a thin-walled cast or forged steel casing formed in a pear or tear-drop shape and threaded at both ends, at the narrow base end to hold the fin assembly and at the nose end to hold the M52 Fuze with its booster. The TNT shell filler is shaped at the forward end to provide a suitable well for the booster. The fin assembly consists of a 2½-inch long steel cylinder to which is welded four double-bladed fins. The hollow shaft is threaded externally at the fore end to screw into the shell base, where it is staked in position. The rear is threaded internally to hold the M32 Primer. This primer, which consists of a threaded head containing the percussion element and a short housing holding the primer mixture, is screwed into the shaft after insertion of the ignition cartridge. The M5A1 Ignition Cartridge is a cartridge paper tube approximately 5/8 inch in diameter, closed at both ends by a chipboard disk, and holding 40 grains of propelling powder. This charge provides the propelling charge for the short ranges. For the longer ranges, the increments of the M3 or M3A1 (cellophane-wrapped), Propelling Charge are provided in addition to the ignition cartridge. As shipped, each increment is inserted in one of the four spaces within the fins and held in position there by the spring clip of the increment holder. Any or all of the increments may be removed as required.

DATA

	With M52 or M52B2 Fuze	With M52B1 (Plastic) Fuze
Weight of complete round	2.96 lb	2.80 lb
Length of complete round	9.54 in.	9.54 in.
Muzzle velocity	518 ft per sec*	535 ft per sec*
Maximum range (at 45 deg).....	1,984 yd*	2,017 yd*

*—For charge 4 (cartridge plus 4 increments). Corresponding data for other charges are:

	Muzzle Velocity		Maximum Range	
	w/M52 or M52B2	w/M52B1	w/M52 or M52B2	w/M52B1
Charge 0 (Ignition Cartridge M5A1 only)	189	195	332	373
Charge 1 (Cartridge and 1 increment)....	292	301	784	816
Charge 2 (Cartridge plus 2 increments)..	377	389	1,204	1,244
Charge 3 (Cartridge plus 3 increments)..	449	463	1,594	1,630

ARTILLERY AMMUNITION

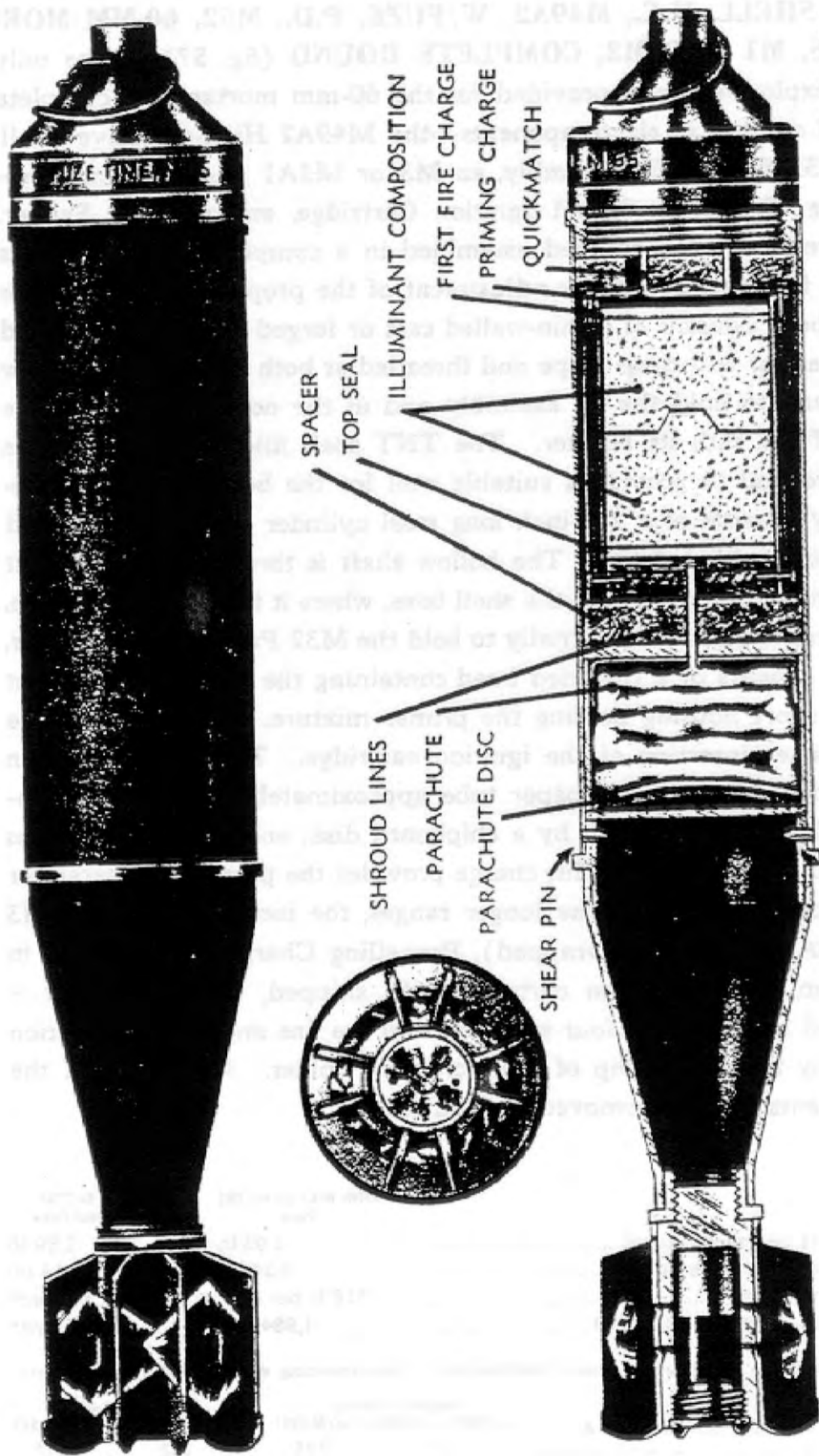

RA PD 80728

Figure 58 — SHELL, Illuminating, M83A1, w/FUZE, Time (Fixed), M65,
60-mm Mortars, M1 and M2, Complete Round

FIXED AND SEMIFIXED ROUNDS AND SEPARATE-LOADING PROJECTILES

80. SHELL, ILLUMINATING, M83A1, W/FUZE, TIME (FIXED), M65, 60-MM MORTARS, M1 AND M2, COMPLETE ROUND (fig. 58), is intended for use in night missions requiring illumination for purposes of observation. The complete round consists of six components—the M83A1 Shell, an M65 Time Fuze, a fin assembly, an M3 or M3A1 (cellophane-wrapped) Propelling Charge, an M5A1 Ignition Cartridge, and an M32 Primer. These components are assembled into the complete round, before shipment, in the same manner as the M49A2 High-explosive Round. The fin assembly, primer, and ignition cartridge are the same, and function alike, in both types of round. The M83A1 Shell supersedes the M83 which was used with the M4 Propelling Charge the increments of which consisted of 28 grains of powder each, as compared with the M3 Increments which weigh 35 grains each. The M83A1 Shell is made up of four major parts: a body tube assembly, illuminant assembly, a parachute assembly, and a tail assembly. The body assembly is a thin-walled steel tubing to the front end of which is welded a steel adapter or collar threaded internally to seat the fuze. The base end is closed by the tail assembly. The tail assembly is a light-weight metal cone fitted at the front end with a coupling or collar which is inserted in the body tube and held in position there by four equally spaced shear pins. The base end of the cone is fitted with an adapter which holds the fins, ignition cartridge, and primer. The illuminant assembly consists of a quick match, a black powder priming or expelling charge, a first-fire composition, and the main charge of illuminant composition held in a boxboard casing. This casing is attached to the parachute by a suspension wire 18 inches long. In functioning, the fuze ignites the quick match (after approx 15 sec), the quick match in turn igniting the black powder charge. This charge expels the parachute and illuminant charge assemblies from the shell, at the same time igniting the illuminant charge. The illuminant composition burns for at least 25 seconds, with a minimum candlepower of 145,000 candles when the standard composition is used, and of 110,000 candles when the substitute composition is used. It drops at the rate of 10 feet per second.

DATA

Weight of complete round	3.77 lb	Maximum range (at 45 deg):
Length of complete round....	14.28 in.	Horizontal
Length of projectile, w/fin....	14.28 in.	Height of burst

*—For charge 4 (ignition cartridge plus 4 increments).

ARTILLERY AMMUNITION

- A — BOOSTER
- B — BLACK POWDER
- C — INERT FILLER

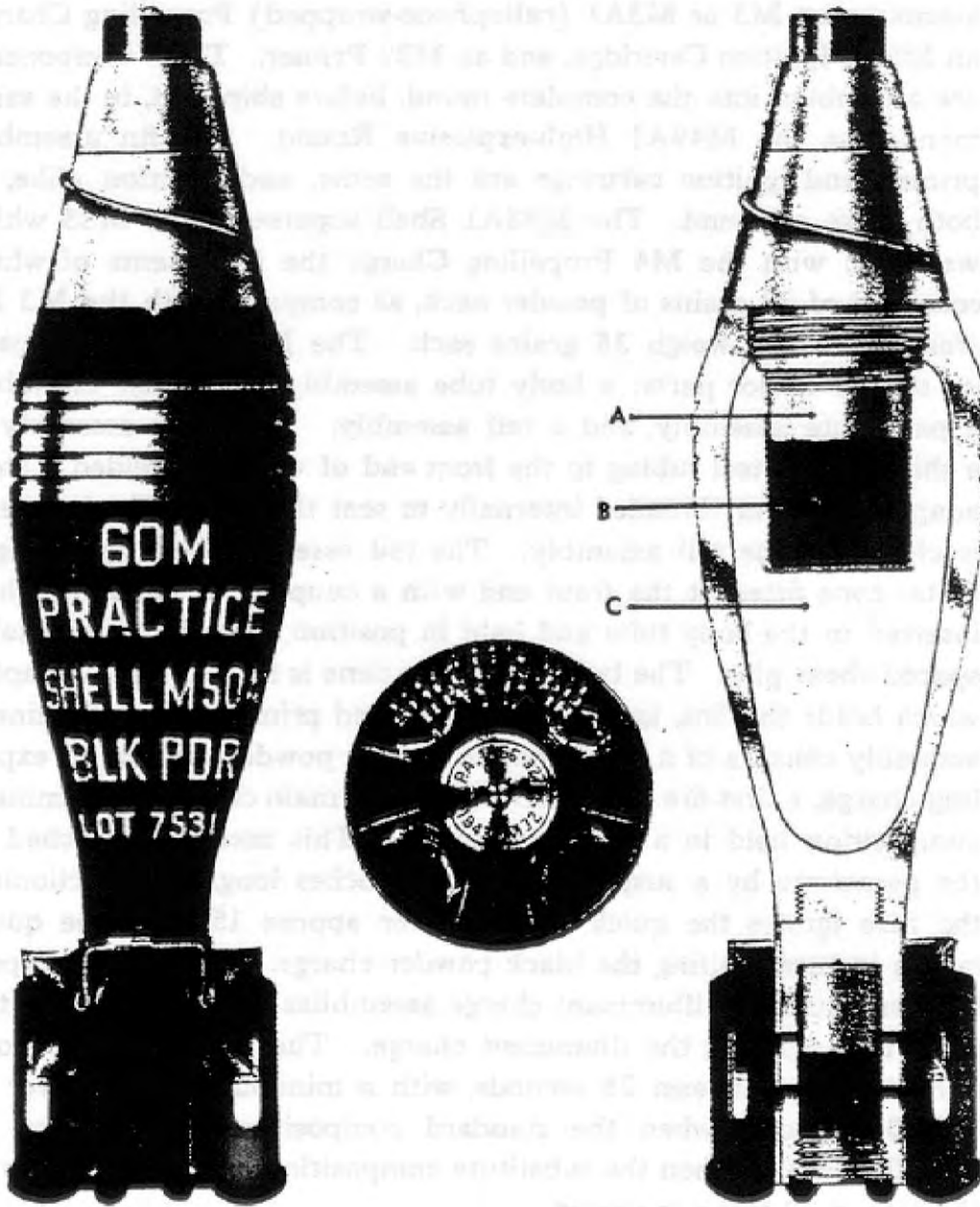

RA PD 80727

Figure 59 — SHELL, Practice, M50A2, w/FUZE, P.D., M52, 60-mm Mortars, M1 and M2, Complete Round

FIXED AND SEMIFIXED ROUNDS AND SEPARATE-LOADING PROJECTILES

81. SHELL, PRACTICE, M50A2, W/FUZE, P.D., M52, 60-MM MORTARS, M1 and M2, COMPLETE ROUND (fig. 59), is a practice round provided for the 60-mm mortars by adapting service items for this purpose. Components of the M50A2 Practice Round are the same as are used in the M49A2 Service Round except for the high-explosive shell filler. The M50A2 Projectile has a filler of inert material (plaster of paris and stearic acid) and a black powder pellet (0.05 lb) loaded adjacent to the booster of the M52 Fuze. The M52 Fuze is a superquick fuze and shell is functioned before penetration occurs. The black powder pellet and booster charge provide a spotting charge for observation purposes. The shell is loaded to the same weight as the service round, thereby providing for the same ballistic values.

DATA

	With M52 or M52B2 Fuze	With M52B1 (Plastic) Fuze
Weight of complete round.....	2.96 lb	2.80 lb
Length of complete round.....	9.54 in.	9.54 in.
Muzzle velocity	518 ft per sec*	535 ft per sec*
Maximum range (at 45 deg).....	1,984 yd*	2,017 yd*

*—For charge 4 (cartridge plus 4 increments). Corresponding data for other charges are:

	Muzzle Velocity		Maximum Range	
	w/M52 or M52B2	w/M52B1	w/M52 or M52B2	w/M52B1
Charge 0 (Ignition Cartridge M5A1 only)	189	195	332	373
Charge 1 (Cartridge and 1 increment)....	292	301	784	816
Charge 2 (Cartridge plus 2 increments)..	377	389	1,204	1,244
Charge 3 (Cartridge plus 3 increments)..	449	463	1,594	1,630

82. SHELL, PRACTICE, M50A1, W/FUZE, P.D., M52, 60-MM MORTARS, M1 AND M2, COMPLETE ROUND, is limited standard for practice purposes, having been superseded by the M50A2 Round. The shell is basically the same as the current standard but contains a somewhat smaller black powder pellet (0.04 lb). Other differences are in respect to the ignition cartridge and manner of assembling the M3 Propellant Charge to the fin. The fin assembly is adapted for the M4 Cartridge which includes the primer. The propelling charge increments are held in position on the fin by inserting two corners of the bundles in the slots in the blades.

ARTILLERY AMMUNITION

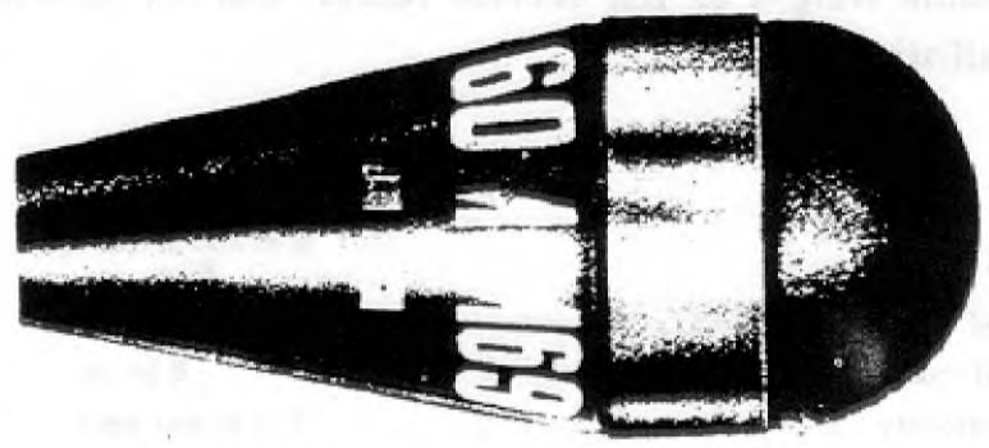
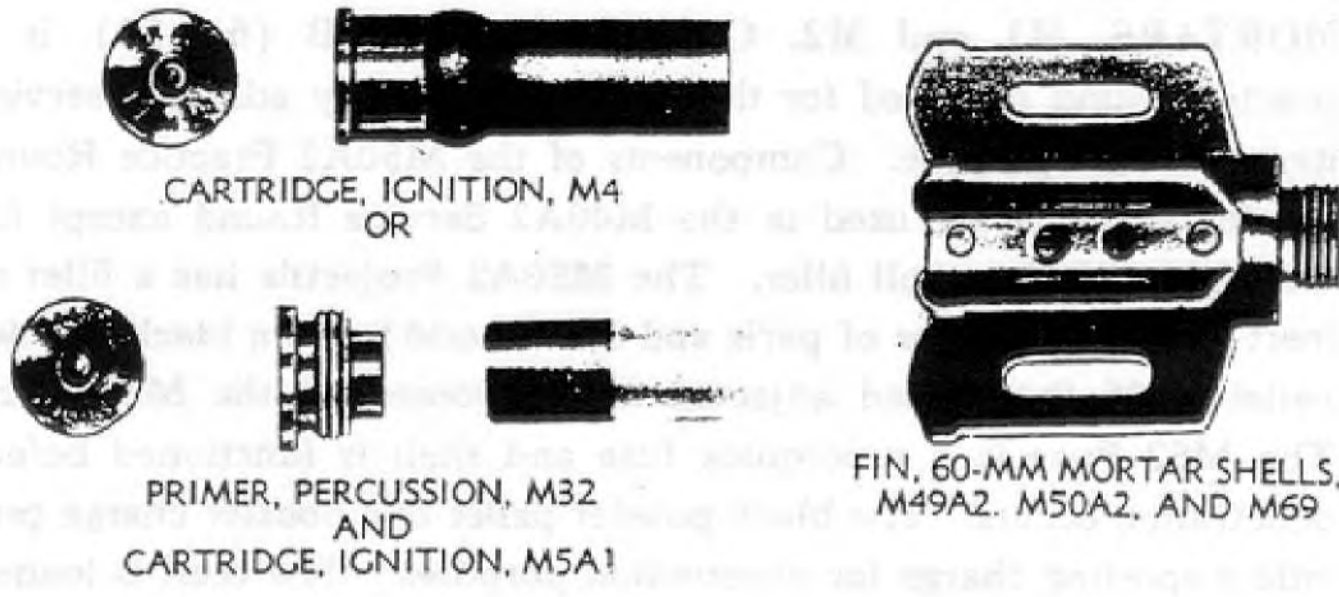

SHELL, TRAINING, M69, 60-MM MORTARS,
M1 AND M2, W/O FIN, IGNITION CARTRIDGE
AND PRIMER

A — COMPONENTS

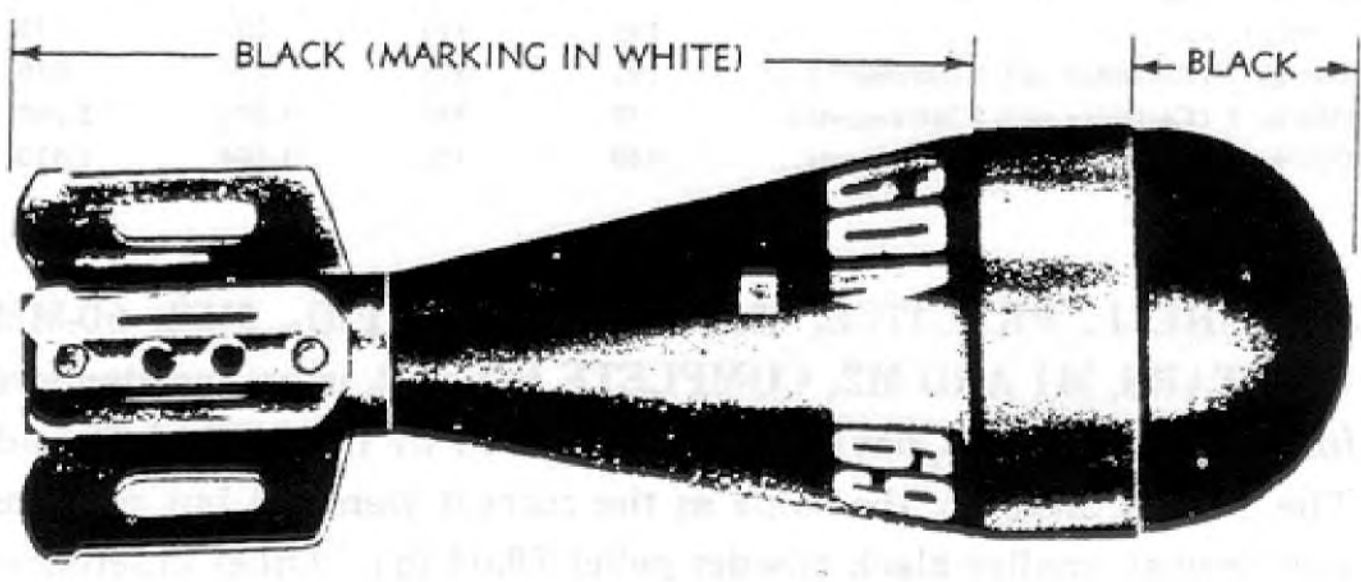

B — ASSEMBLED

RA PD 26817

Figure 60 — SHELL, Training, M69, 60-mm Mortars, M1 and M2

FIXED AND SEMIFIXED ROUNDS AND SEPARATE-LOADING PROJECTILES

83. SHELL, TRAINING, M69, 60-MM MORTARS, W/O FIN, IGNITION CARTRIDGE, AND PRIMER (fig. 60), is a training round provided for drill in loading and firing the mortar. The projectile differs from that in the practice ammunition in that it is completely inert and has no fuze. It consists of a solid cast-iron body of pear or tear-drop shape, drilled at the base end to hold a service-type fin assembly. No propelling charge increments are provided for the round, but the M4 Ignition Cartridge, or if not available the combination of the M5A1 Ignition Cartridge and M32 Percussion Primer is issued for use in firing the projectile. Unlike the other ammunition for the mortar, the three components are issued and shipped separately, to facilitate replacement of damaged or worn out parts and the procurement of additional ignition cartridges. Ten training shells and accessories are packed in an equipment training kit for field use.

DATA

Weight of complete round.....	4.53 lb	Length of shell, w/o fin.....	5.54
Weight of shell, w/o fin.....	4.07	Muzzle velocity	152.5 ft per sec
Length of complete round....	7.70 in.	Maximum range (at 45 deg)....	235 yd

ARTILLERY AMMUNITION

Section VII

AMMUNITION FOR 75-MM GUNS

84. GENERAL.

a. **General Discussion.** In addition to being a field piece, the 75-mm gun is also used, in modified form, as a tank, antitank, and aircraft weapon. All types of guns are chambered alike so that they are capable of firing the same ammunition, although certain rounds are not universally used, for tactical reasons. Ammunition in this caliber is of the fixed type but falls into one of three general design groups. Each can be readily distinguished by appearance as well as marking. Shell of recent design are characterized by a long ogival nose, the streamlined effect of which is continued by the length of the fuze. Standard shell in this group are shipped with fuzes already assembled. Shell of the second group, those of earlier design, are characterized by a short ogival nose terminating in an adapter which holds the cigar-like fuze provided for these shell. These rounds are shipped unfuzed, the fuze being added in the field. The third group consists of the recently manufactured base-ignition smoke shell. This shell is cylindrical in shape and does not have a fuze.

b. **Identification.** Shell of current manufacture are painted and marked as prescribed in TM 9-1900 and illustrated in figures 61 to 73, inclusive. For 75-mm gun high-explosive ammunition, markings to indicate weight zones are in the form of crosses. Since super-charge, normal, and reduced propelling charges are used with 75-mm high-explosive ammunition, special marking on the side and base of the cartridge case will signify the particular type of propelling charge used (fig. 10). Armor-piercing and base-ignition smoke rounds have no marking to indicate the type of propelling charge for these rounds. Shell of older manufacture may still be found with markings in accordance with earlier practice. The earlier marking includes, in addition to that under present practice, the word "FLASHLESS" when the propelling charge is of flashless (FNH) powder; caliber and type of cannon; and the muzzle velocity in feet per second (enclosed in a black rectangle on normal charge rounds). These markings are placed on the side of the cartridge case. A reduced propelling charge

FIXED AND SEMIFIXED ROUNDS AND SEPARATE-LOADING PROJECTILES

is indicated in the usual way. A supercharge is indicated by the word "SUPERCHARGE" in red or black. Absence of such markings signifies a normal charge.

c. **Fuzes.** High-explosive shell of recent design are fitted for shipment with one of three types of fuze: selective superquick or delay (FUZE, P.D., M48, M48A1, or M48A2, SQ & 0.15-sec. delay, or M48A2, SQ & 0.05-sec. delay); selective time or superquick (FUZE, TSQ, M54); or a single-action superquick type (FUZE, P.D., M57). Shell of earlier design are adapted for two or more types of single-action fuzes in order to provide, by selective assembly in the field, for alternative superquick or delay functioning. Armor-piercing projectiles containing a high-explosive filler are fitted with the delay-action base fuze, FUZE, B.D., M66A1. FUZE, combination, 21-sec., M1907M, is used with shrapnel to provide for both time and percussion functioning with these rounds. Fuzes for practice and drill ammunition are either dummy fuzes which resemble corresponding service types, or inert service fuzes (ch. 3, sec. I).

d. **Cartridge Case.** CASE, cartridge, 75-mm, M18, made of brass, is standard for all 75-mm gun ammunition. CASE, cartridge, 75-mm, M18B1, made of steel is substitute standard, except for aircraft use. The latter has a thinner head and primer seat, and is approximately 0.22 pound lighter than the standard M18 Brass Case.

e. **Primers.** Three types of primers are used with 75-mm ammunition. For rounds loaded with a supercharge of propelling powder, modifications of the M31 Primer are assembled to the cartridge case. This primer contains 150 grains of black powder. For other rounds, except shrapnel, the 65-grain M22 Primer is standard. Shrapnel has either the 49-grain Mk. I or 100-grain M1B1 Primer (ch. 3, sec. III).

85. COMPLETE ROUND TABLE.

a. Data concerning complete rounds for 75-mm guns, and components thereof, are given in table 13, chapter 5.

86. PACKING AND SHIPPING DATA.

a. Packing and shipping data for 75-mm gun ammunition are given in ORD 11 SNL's R-1 and R-6.

ARTILLERY AMMUNITION



Figure 61 — PROJECTILE, Fixed, A.P.C., M61A1, w/FUZE, B.D., M66A1, and TRACER, 75-mm Gun

RA PD 80731

FIXED AND SEMIFIXED ROUNDS AND SEPARATE-LOADING PROJECTILES

87. PROJECTILE, FIXED, A.P.C., M61A1, W/FUZE, B.D., M66A1, AND TRACER, 75-MM GUN (fig. 61), is authorized for use in all 75-mm guns. The complete round consists of a brass or steel cartridge case containing a 2-pound (supercharge) propelling charge and M31 Primer (or modifications) crimped to a fuzeed projectile. The projectile is intended to give both penetration and explosive effect against armored targets. It is effective against medium tank fronts up to about 1,000 yards, and against the sides up to about 3,000 yards. The projectile consists of three parts: a steel body which contains a small charge of explosive D; a steel armor-piercing cap; and a light-weight steel or aluminum ballistic cap or windshield. The base is drilled and threaded to accommodate the base fuze, FUZE, B.D., M66A1. This fuze functions with delay action, providing an opportunity for penetration before detonation occurs. The base of the fuze protrudes about three-quarters of an inch beyond the rear of the projectile. This portion of the fuze contains a red tracer composition which operates independent of the fuze mechanism. When the tracer is ignited by the flame of the propelling charge upon firing, it burns for approximately 3 seconds, thereby providing a visible trace during 1,800 yards of flight for observation purposes. When fired in the 75-mm Aircraft Guns, M4, AN-M5, M5A1, and T13E1, this round produces a flash; it will be issued for aircraft guns only until the new aircraft round, described in paragraph 88, is available for issue.

DATA

Weight of complete round	19.92 lb	Radius of ogive (false ogive)	7.17 cal.
Length of complete round....	26.29 in.	Muzzle velocity	2,030 ft per sec*
Length of projectile	13.22 in.	Maximum range	13,870 yd*
Length of cartridge case.....	13.82 in.	Penetration (in. at 0-deg obliquity of face-hardened plate at 1,000 yd)	3.4†
Width of rotating band	0.49 in.	Penetration (in. at 0-deg obliquity of homogeneous plate at 1,000 yd)....	2.8‡
Type of base	Square		

*—In M3 Guns; muzzle velocity in M1916, M1917 and M2 Guns, 1,930 feet per second. in M1897A4 Guns, 2,000 feet per second.

†—In M3 Guns; in M2, M1916, and M1917 Guns, 3.1 inches; in M1897A4 Guns, 3.3 inches.

‡—In M3 Guns; in M2, M1916, and M1917 Guns, 2.6 inches; in M1897A4 Guns, 2.7 inches.

88. PROJECTILE, FIXED, A.P.C., M61A1, FLASHLESS, W/FUZE, B.D., M66A1, AND TRACER, 75-MM AIRCRAFT GUNS, is the same as that described in paragraph 87, except that 1 percent potassium sulfate has been added to the propelling charge powder to make it flashless when fired in the 75-mm aircraft guns and use of steel cases is prohibited. The data in paragraph 87 for the M3 Guns is applicable to this round.

ARTILLERY AMMUNITION

89. PROJECTILE, FIXED, A.P.C., M61, W/FUZE, B.D., M66A1, AND TRACER, 75-MM GUN, is the same as that described in paragraph 87, except for the method of crimping the steel windshield to the armor-piercing cap of the projectile. In the M61A1, a 360-degree roll crimp is used near the end of the windshield, whereas in the M61, the end of the windshield is crimped into a groove. The data in paragraph 87 is applicable to this round.

90. PROJECTILE, FIXED, A.P.C., M61, FLASHLESS, W/FUZE, B.D., M66A1, AND TRACER, 75-MM GUN, is the same as that described in paragraph 88 except for the method of crimping the steel windshield to the armor-piercing cap of the projectile. In the M61A1, a 360-degree roll crimp is used near the end of the windshield, whereas in the M61 the end of the windshield is crimped into a groove. The data in paragraph 87 for the M3 Guns is applicable to this round.



RA PD 80732

Figure 62 — PROJECTILE, Fixed, A.P.C., M61, w/TRACER, 75-mm Gun

91. PROJECTILE FIXED, A.P.C., M61, W/TRACER, 75-MM GUN (fig. 62), an unfuzed round, has been superseded by the M61 Round with explosive and fuze described in paragraph 89. Components of both rounds are alike except for the projectile. In the unfuzed projectile, the bursting charge cavity is left empty and the base is closed by a steel plug which contains the tracer composition.

DATA

Weight of complete round.....	19.36 lb	Radius of ogive (false ogive)..	7.17 cal.
Length of complete round.....	26.29 in.	Muzzle velocity	2,030 ft per sec*
Length of projectile	13.22 in.	Maximum range	13,870 yd*
Length of cartridge case.....	13.82 in.	Penetration (in. at 0-deg obliquity	
Width of rotating band.....	0.49 in.	of face-hardened plate at 1,000	
Type of base	Square	yd)	3.4†
Penetration (in. at 0-deg obliquity of homogeneous plate at 1,000 yd)....	2.8‡		

*—In M3 Guns; muzzle velocity in M1916, M1917 and M2 Guns, 1,930 feet per second, in M1897A4 Guns, 2,000 feet per second.

†—In M3 Guns; in M2, M1916, and M1917 Guns, 3.1 inches; in M1897A4 Guns, 3.3 inches.

‡—In M3 Guns; in M2, M1916, and M1917 Guns, 2.6 inches; in M1897A4 Guns, 2.7 inches.

FIXED AND SEMIFIXED ROUNDS AND SEPARATE-LOADING PROJECTILES



Figure 63 — SHOT, Fixed, A.P., M72, w/TRACER, 75-mm Gun

92. SHOT, FIXED, A.P., M72, W/TRACER, 75-MM GUN (fig. 63), formerly issued as a substitute for the M61 A.P.C. Round, is now limited standard. It may be issued and used for target practice as well as for service use. The projectile is of the monobloc type, without armor-piercing cap or ballistic cap, and is solid except for a small tracer cavity in the base. This holds a red tracer composition which provides a 3-second trace for observation purposes. The body has the typically blunt appearance of this type of projectile, the nose being formed to a short ogive of 1.64-caliber radius. The shot is suitable for use against homogeneous plate but because it has no armor-piercing cap is less effective than A.P.C. rounds against face-hardened armor plate. When fired in the 75-mm Aircraft Guns M4, AN-M5, M5A1, and T13E1, this round produces a flash; it will only be issued for aircraft guns until the new aircraft round, described in paragraph 93, is available for issue.

DATA

Weight of complete round	18.80 lb	Muzzle velocity	2,030 ft per sec*
Length of complete round	20.81 in.	Maximum range	10,650 yd*
Length of projectile	9.21 in.	Penetration (in. at 0-deg obliquity of face-hardened plate at 1,000 yd)	2.6†
Length of cartridge case	13.82 in.	Penetration (in. at 0-deg obliquity of homogeneous plate at 1,000 yd)	3.1‡
Width of rotating band.....	0.49 in.		
Type of base	Boat-tailed		
Degree of taper	9 deg 15 min		
Radius of ogive.....	1.64 cal.		

*—In M3 Guns; in M2, M1916, and M1917 Guns, 1,930 feet per second; in M1897A4 Guns, 2,000 feet per second.

†—In M3 Guns; in M2, M1916, and M1917 Guns, 2.3 inches; in M1897A4 Guns, 2.5 inches.

‡—In M3 Guns; in M2, M1916, and M1917 Guns, 2.9 inches; in M1897A4 Guns, 3.0 inches.

93. SHOT, FIXED, A.P., M72, FLASHLESS, W/TRACER, 75-MM AIRCRAFT GUNS, is the same as that described in paragraph 92, except that 1 percent potassium sulfate has been added to the propelling charge powder to make it flashless when fired in the 75-mm aircraft guns and use of steel cases is prohibited. The data in paragraph 92 for the M3 Guns is applicable to this round.

ARTILLERY AMMUNITION

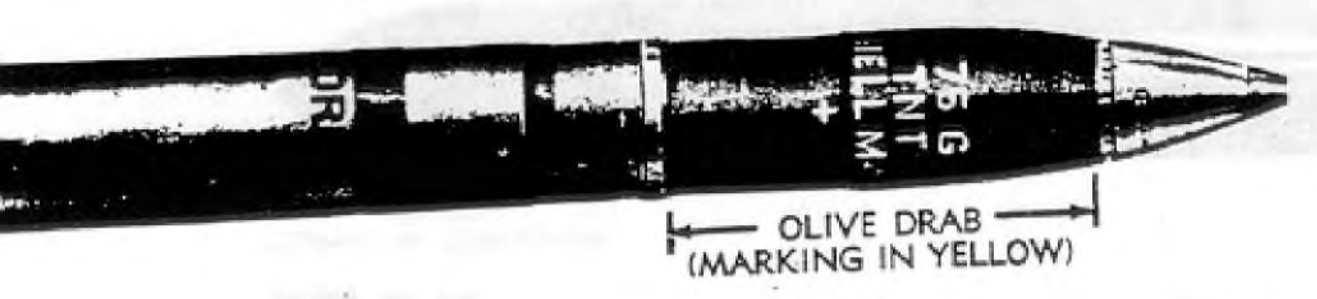

RA PD 80733

Figure 64 — SHELL, Fixed, H.E., M48, Normal Charge, w/FUZE, P.D., M48A2, SQ & 0.15-sec. Delay, 75-mm Gun

SHELL, FIXED, H.E., M48, NORMAL CHARGE, W/FUZE, P.D., M48A2, SQ & 0.15-SEC. DELAY, 75-MM GUN (fig. 64), is the M48 Projectile which is also assembled with other types of charges, and in rounds having super and reduced propelling charges as well as the normal charge. The shell body is a relatively thin-walled forged-steel cylinder. A streamlined effect is obtained by boat-tailing the base to a 9-degree 15-minute taper and forming the nose to a long ogive of approximately $7\frac{1}{2}$ -caliber radius. The bursting charge of TNT or 50-50 amatol is loaded so as to provide a well at the forward end of the charge to accommodate BOOSTER, M20A1 or M24. The booster is a manufacturing component of the loaded shell, being inserted during manufacture and permanently staked in position by a set screw. The booster is threaded to permit assembly with any of the authorized fuzes. All fuzes used with this shell are alike in contour and weight, but vary as to the manner of functioning. As assembled with the M48A2 Fuze, the shell may be fired for fragmentation and blast effect with either superquick action, giving a surface burst, or with a delay of 0.15 seconds, for high-burst ranging or to permit partial penetration before detonation. Rounds of older manufacture may be assembled with M48A1, or M48 Fuzes. The 75-grain M22 Percussion Primer is used with the normal charge round.

DATA

Weight of complete round	18.80 lb	Type of base	Boat-tailed
Length of complete round	26.6 in.	Degree of taper	9 deg 15 min
Length of fuze projectile	15.00 in.	Radius of ogive	7.51 cal.
Length of cartridge case	13.82 in.	Muzzle velocity	1,515 ft per sec*
Width of rotating band.....	0.49 in.	Maximum range (at 44 deg).....	11,195 yd*

*—In M3 Guns; in M1916-17 and M2 Guns, 1,470 feet per second; in M1897A4 Guns, 1,500 feet per second.

95. SHELL, FIXED, H.E., M48, SUPERCHARGE, W/FUZE, P.D., M48A2, SQ & 0.05-SEC. DELAY, 75-MM GUN, differs from that in paragraph 94 in that it has a supercharge of FNH propelling powder and uses the 150-grain M31 Primer. Due to the larger

FIXED AND SEMIFIXED ROUNDS AND SEPARATE-LOADING PROJECTILES

powder charge, the complete round is somewhat heavier, weighing 19.56 pounds. Muzzle velocity with this charge is 1,885 feet per second for M1916-17 and M2 Guns; 1,974 feet per second for M3 Guns; 1,950 feet per second in the M1897A4 Guns. Maximum range is approximately 13,600 yards at a 44-degree elevation in M3 Guns. Rounds of older manufacture may be assembled with M48A1 or M48 Fuzes. In all other respects, description and data given in paragraph 94 apply to this round.

96. **SHELL, FIXED, H.E., M48, REDUCED CHARGE, W/FUZE, P.D., M48A2, SQ & 0.15-SEC. DELAY, 75-MM GUN**, has the same shell, fuze, and cartridge case as the round described in paragraph 94. However, the cartridge case contains a reduced charge (0.56 lb) of propelling powder and the 75-grain M22 Primer. Rounds with this weight of propelling charge weigh approximately 18.24 pounds and have a muzzle velocity of 926 feet per second in M1916-17 and M2 Guns; 960 feet per second in M3 Guns; and 950 feet per second in M1897A4 Guns. Maximum range is 6,960 yards in M3 Guns. Rounds of older manufacture may be assembled with M48A1 or M48 Fuzes. Other description and data given in paragraph 94 apply to this round.

97. **SHELL, FIXED, H.E., M48, NORMAL CHARGE, W/FUZE, TSQ, M54, 75-MM GUN**, has components similar to those described in paragraph 94 except for the fuze. **FUZE, TSQ, M54**, is a combination time and superquick fuze which can be set for functioning up to 25 seconds. The superquick action is always operative after firing and will function on impact unless prior functioning has been caused by the time action. The shell can be fired, therefore, for time fire for effect or for surface burst on impact, and might be used for high-burst ranging. Data given in paragraph 94 is also applicable to this round.

98. **SHELL, FIXED H.E., M48, SUPERCHARGE, W/FUZE, TSQ, M54, 75-MM GUN**, has a propelling charge similar to that described in paragraph 95 and also uses the 150-grain M31 Primer. Data given in that paragraph and in paragraph 94 apply equally to this round. The fuze is the same as that for the round in paragraph 97.

99. **SHELL, FIXED, H.E., M48, REDUCED CHARGE, W/FUZE, TSQ, M54, 75-MM GUN**, has the same fuze as that described in paragraph 97, but is loaded with a reduced propelling charge similar to that in the M48 Round with M48A2 Fuze (par. 96). Description and data in that paragraph and in paragraph 94 apply to this round.

ARTILLERY AMMUNITION

100. SHELL, FIXED, H.E., M48, SUPERCHARGE, W/FUZE, P.D., M57, 75-MM GUNS, M4, AN-M5, AND M5A1, is provided for the 75-mm Aircraft Guns M4, AN-M5, and M5A1. It is similar to the corresponding rounds authorized for the other 75-mm guns. However, it is fitted with a single-action superquick Fuze M57. When fired in the 75-mm aircraft guns, this round produces a flash; it will only be issued for aircraft guns until the new aircraft round, described in paragraph 101, is available for issue.

101. SHELL, FIXED, H.E., M48, SUPERCHARGE, FLASH-LESS, W/FUZE, P.D., M57, 75-MM AIRCRAFT GUNS, is the same as that described in paragraph 100, except that 1 percent potassium sulfate has been added to the propelling charge powder to make it flashless when fired in the 75-mm aircraft guns.

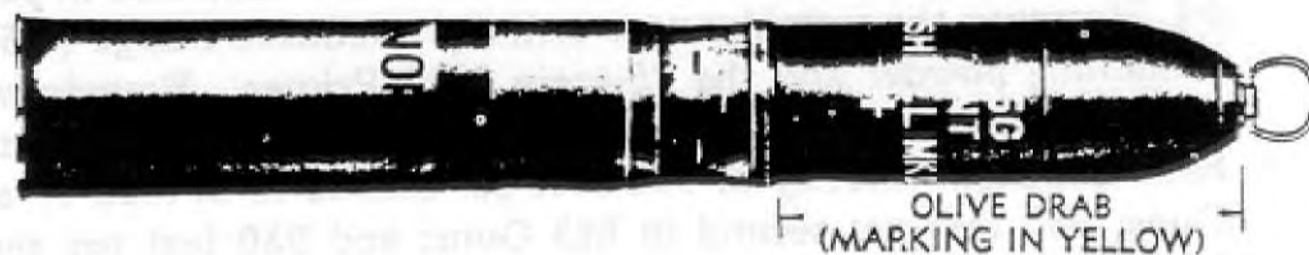

RA PD 80736

Figure 65 — SHELL, Fixed, H.E., Mk. I, Flashless, Unfuzed, 75-mm Gun (Adapted for FUZE, P.D., M46 or M47)

102. SHELL, FIXED, H.E., MK. I, FLASHLESS, UNFUZED, 75-MM GUN (ADAPTED FOR FUZE, P.D., M46 OR M47) (fig. 65), has a shell of early design which no longer is manufactured and will be available as a substitute for the round with the M48 Shell in field, antitank, and tank guns only until the present supply is exhausted. The Mk. I Shell has a somewhat larger high-explosive filler than the M48, but less effective ballistic qualities. The base is square and the nose is shaped in a short ogive which ends about $2\frac{3}{4}$ inches in front of the bourrelet. At this point, the nose is cut, machined, and threaded internally to hold an adapter and booster assembly. This assembly is screwed into the shell during manufacture, the booster seating in a narrow well in the shell bursting charge. The booster charge in turn is covered by a steel or brass casing which forms a socket or seat for the fuze. The rounds are shipped unfuzed, the adapter being closed by a plug which is removed just prior to fuzing. Selective quick or delay functioning is provided for by making two or more single-action fuzes available for separate issue, for assembling to the shell as required in the field. Like the M48, the Mk. I Shell

FIXED AND SEMIFIXED ROUNDS AND SEPARATE-LOADING PROJECTILES

has been assembled in several types of rounds. In this round, the M18 or M18B1 Cartridge Case is fitted with the 75-grain M22 Primer (or modifications) as loaded with 1.35 pounds (a normal charge) of flashless propelling powder. The M46 and M47 Fuzes are authorized for use with the round.

DATA

Weight of complete round..	16.04 lb*	Width of rotating band.....	0.49 in.
Length of complete round ..	22.60 in.*	Type of base	Square
Length of projectile	10.49 in.*	Radius of ogive	1.49 cal.
Length of cartridge case	13.82 in.	Muzzle velocity	1,722 ft per sec†
	Maximum range (at 42 deg).....		8,865 yd†

*—For unfuzed rounds; fuze weights are: M47, 0.74 pound; M46, 0.77 pound.
†—For M2, M1916, and M1917 Guns; muzzle velocity in M1897A4 Guns is 1,784 feet per second; in M3 Guns, 1,814 feet per second.

103. SHELL, FIXED, H.E., MK. I, FLASHLESS, REDUCED CHARGE, UNFUZED, 75-MM GUN (ADAPTED FOR FUZE, P.D., M46 OR M47), has the same shell, cartridge case, and primer as for the round described in paragraph 102. However, the propellant consists of a reduced charge (0.56 lb) of flashless powder. Muzzle velocity of the round is 1,075 feet per second in M2, M1916, and M1917 Guns; 1,115 feet per second in M1897A4 Guns; and 1,135 feet per second in M3 Guns. Maximum range is 6,570 yards in M2, M1916, and M1917 Guns. Weight of the round is 15.25 pounds; other data given in paragraph 102 apply also to this round.

104. SHELL, FIXED, H.E., MK. I, UNFUZED, 75-MM GUNS (ADAPTED FOR FUZE, P.D., M46 OR M47), is similar to the round described in paragraph 102 except that the propelling powder is not flashless. Otherwise the description and data given in that paragraph apply equally to this round.

105. SHELL, FIXED, H.E., MK. I, REDUCED CHARGE, UNFUZED, 75-MM GUN (ADAPTED FOR FUZE, P.D., M46 OR M47), is the same as that described in paragraph 103, except that the propelling charge is not flashless. The description and data therein apply equally to this round.

106. SHELL, FIXED, SMOKE, HC, B.I., M89, 75-MM GUNS, M2 AND M3 (fig. 66), is provided for the 75-mm tank guns, for screening purposes which cannot be adequately provided for by the Mk. II Smoke Shell. Components of the complete round consist of the M18 or M18B1 Cartridge Case, the 150-grain M31 Primer (or modifications) and a canister-like projectile. No fuze is required, the filler being ignited by the propelling charge upon firing. The round is intended for firing at low velocities; hence, only 0.1625 pound of

ARTILLERY AMMUNITION

propelling powder is used. The body of the projectile is a thin-walled steel tubing welded at one end to a cup-shaped steel base, and closed after loading at the forward end by a steel disk. The shell base is drilled to hold a soft lead plug and a steel cap. The shell consists of three charges of HC (hexachlorethane-zinc) mixture, loaded in varying amounts and at different pressures. The filler is



RA PD 80734

Figure 66 - SHELL, Fixed, Smoke, HC, B.I., M89, 75-mm Guns, M2 and M3

designed to burn freely for approximately 2 minutes. Ignition is begun when the round is fired, by the flash of the propelling charge. This ignites a pellet which burns slowly. As it burns out, the pellet ignites the first HC charge, whereupon smoke begins to issue from the base of the shell. Muzzle velocity of the round is around 850 feet per second, the range at 12-degree elevation is about 1,500 yards. Although the projectile rotates during its travel, there is some wobbling and tumbling in flight.

DATA

Weight of complete round	9.83 lb	Type of base	Square
Length of complete round	20.26 in.	Muzzle velocity (approx)	850 ft per sec
Length of projectile	7.49 in.	Maximum range (at 12 deg) (approx)	1,500 yd
Length of cartridge case	13.82 in.		
Width of rotating band.....	0.49 in.		

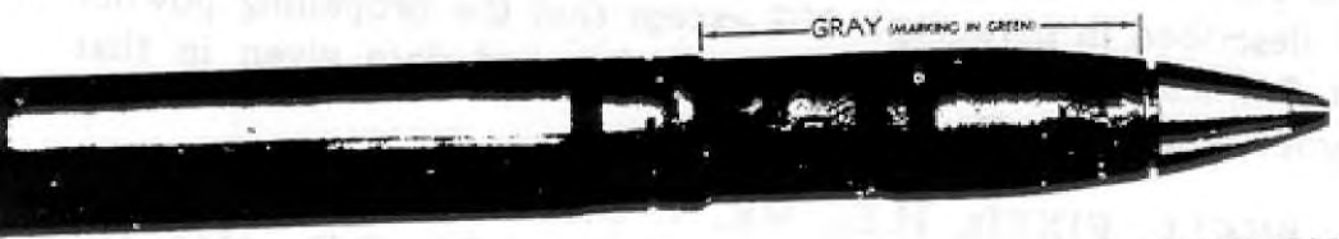

RA PD 65141

Figure 67 - SHELL, Fixed, Smoke, Phosphorus, WP, M64, w/FUZE, P.D., M57, 75-mm Gun

07. SHELL, FIXED, SMOKE, PHOSPHORUS, WP, M64, w/FUZE, P.D., M57, 75-MM GUN (fig. 67), is a standard round for 75-mm Guns M1897, M2, and M3 for screening and incendiary purposes. It is also effective against personnel. It will not be used in the M1916 and M1917 Guns. Components are M18 or M18B1 Cartridge Case, the M31A2 150-grain Primer, an FNH propelling charge

FIXED AND SEMIFIXED ROUNDS AND SEPARATE-LOADING PROJECTILES

and the M64 Projectile, which is also used in 75-mm howitzers, fuzed with the M57 Superquick Fuze. The projectile is a modification of the M48 High-explosive Shell, the nose being cut and threaded to hold an adapter which screws into the body. The adapter serves three purposes: to provide a tight seal for the chemical contents of the shell; to hold the fuze; and to provide a seat for the forward end of the burster. BURSTER, M6, is a thin-walled steel tubular casing extending nearly the length of the filler cavity. The burster contains a detonator relay chain and a burster charge (CHARGE, burster, M8) of high explosive to rupture shell and disperse chemical contents.

DATA

Weight of complete round	20.26 lb	Type of base	Boat-tailed
Length of complete round	26.6 in.	Degree of taper	9 deg 15 min
Length of fuzed projectile	15.00 in.	Radius of ogive	7.51 cal.
Length of cartridge case	13.82 in.	Muzzle velocity	1,980 ft per sec
Width of rotating band	0.49 in.	Maximum range	13,860 yd

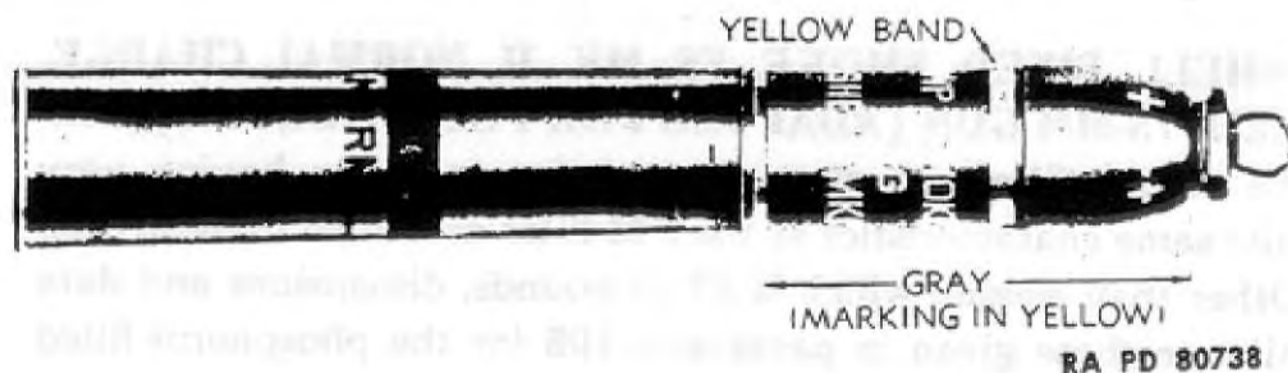

Figure 68 — SHELL, Fixed, Smoke, Phosphorus, WP, Mk. II, Normal Charge, Unfuzed, 75-mm Gun (Adapted for FUZE, P.D., M46)

108. SHELL, FIXED, SMOKE, PHOSPHORUS, WP, MK. II, NORMAL CHARGE, UNFUZED, 75-MM GUN (ADAPTED FOR FUZE, P.D., M46) (fig. 68), is now limited standard, having been superseded by the M64 WP Shell as standard. The components are the M18 or M18B1 Cartridge Case, the 75-grain M22 Primer (or modifications), a normal (1.35-lb) charge of FNH propelling powder, and a projectile fuzed, in the field, with a single-action superquick Fuze M46. The projectile closely resembles the Mk. I High-explosive Shell in appearance but has an adapter which has a pipe thread in order to insure a tight seal. The shell is a burster type, that is, has a small high-explosive charge for bursting the shell and scattering the chemical contents. This charge is held in the booster casing which is an integral part of the adapter, the adapter in turn being a manufacturing component of the shell. The M46 Fuze, issued

ARTILLERY AMMUNITION

Separately for assembly in the field, is a superquick type of fuze. This type is used in order to provide for bursting before penetration and thereby insure the most effective distribution of smoke. White phosphorus is a solid smoke producer, and also has an incendiary effect.

DATA

Weight of complete round..	16.40 lb*	Width of rotating band.....	0.49 in.
Length of complete round ..	23.59 in.*	Type of base	Square
Length of projectile	11.30 in.*	Radius of ogive	1.49 cal.
Length of cartridge case	13.82 in.	Muzzle velocity	1,722 ft per sec†
	Maximum range (at 42 deg).....		8,600 yd†

*Data for unfuzed rounds; fuze weight for M46 is 0.77 pound.
†In M2, M1916, and M1917 Guns; muzzle velocity in M1897A4 Guns, 1,784 feet per second; in M3 Guns, 1,815 feet per second.

9. SHELL, FIXED, SMOKE, FM, MK. II, NORMAL CHARGE, UNFUZED, 75-MM GUN (ADAPTED FOR FUZE, P.D., M46), is identical with that described in paragraph 108 except for the type of chemical filler. FM is a liquid which is atomized by detonation at the time of bursting of the shell and thereupon hydrolyzes, forming a smoke.

10. SHELL, FIXED, SMOKE, FS, MK. II, NORMAL CHARGE, UNFUZED, 75-MM GUN (ADAPTED FOR FUZE, P.D., M46), contains FS smoke filler, an atomizing smoke producer having very nearly the same characteristics as the FM filler described in paragraph 108.

Other than weight, which is 17.18 pounds, dimensions and data are similar to those given in paragraph 108 for the phosphorus-filled shell.



PD 80737
Figure 69 — SHELL, Fixed, Gas, Persistent, H, Mk. II, Normal Charge, Unfuzed, 75-mm Gun (Adapted for FUZE, P.D., M46)

11. SHELL, FIXED, GAS, PERSISTENT, H, MK. II, NORMAL CHARGE, UNFUZED, 75-MM GUN (ADAPTED FOR FUZE, P.D., M46) (fig. 69), contains the chemical filler, H, or mustard gas, a persistent type vesicant. Other components are similar to those described in paragraph 108. Weight of the complete round is approximately 15.91 pounds.

FIXED AND SEMIFIXED ROUNDS AND SEPARATE-LOADING PROJECTILES

112. SHELL, FIXED, GAS, PERSISTENT, NC, MK. II, NORMAL CHARGE, UNFUZED, 75-MM GUN (ADAPTED FOR FUZE, P.D., M46), is similar to that described in paragraph 108 except for the NC filler.

113. SHELL, FIXED, GAS, PERSISTENT, CNS, M64, W/FUZE, P.D., M57, 75-MM GUN, is identical with the round described in paragraph 107 except for the chemical filler which is a solution of chloracetophenone (CN) and chlorpicrin (PS) in chloroform. Other than weight, the dimensions and data are similar to those given in paragraph 107 for the phosphorus-filled shell.

114. SHELL, FIXED, PRACTICE, INERT LOADED, M48, NORMAL CHARGE, W/FUZE, INERT, P.D., M48A1, 75-MM GUN, is standard for 75-mm subcaliber guns. The projectile is similar to the service shell described in paragraph 94, which it is intended to simulate, but is loaded with inert material to the required weight and fuzed with an inert fuze. Either FUZE, dummy, M73, or an inert service fuze may be assembled to the round as shipped. A service cartridge case with a service primer and normal charge of FNH powder are used to complete the round. Dimensions and other data given in paragraph 94 apply equally to this round.

115. SHELL, FIXED, PRACTICE, INERT LOADED, MK. I, W/FUZE, INERT, P.D., MK. IV OR M47, 75-MM GUN, is an earlier type round for subcaliber use. It is made up of a service cartridge case, primer and propelling charge (normal charge), together with unserviceable components of the Mk. I High-explosive Shell described in paragraph 102. All explosive elements are omitted in the projectile, the bursting charge cavity being loaded with 1.83 pounds of sand. The Mk. III Adapter is used, with the booster omitted. An inert Mk. IV or M47 Point-detonating Fuze is assembled to the projectile as shipped. Data in paragraph 102 are applicable to practice round except as to weight, which is approximately 16.15 pounds.

116. SHRAPNEL, FIXED, MK. I, 75-MM GUN (fig. 70), is no longer manufactured, since there is no present requirement for shrapnel. Stocks on hand will be issued for training purposes. Issue will be 90 percent grade IIR (unrenovated), for impact fire, and 10 percent grade I—ammunition in over-all sound condition—for high-burst ranging. Grade IIR shrapnel is safe for impact fire but cannot be used for adjusted fire due to deterioration of the time action of the fuze. The complete round consists of the M18 or M18B1 Cartridge Case, the Mk. I Primer (49-grain), a nitrocellulose propelling charge (nonflashless), and a fuzed projectile. FUZE, combination, 21-sec.,

ARTILLERY AMMUNITION

M1907M, is always assembled to the round as shipped. The cavity of the shell is loaded with approximately 270 lead balls held in a resinous matrix which also serves to produce a white smoke for observation and adjustment of fire. See chapter 1, paragraph 14 c (8).



- RED (MARKING IN BLACK) -

RA PD 80735

Figure 70 — SHRAPNEL, Fixed, Mk. I, 75-mm Gun

DATA

Weight of complete round	20.62 lb	Width of rotating band	0.49 in.
Length of complete round	23.45 in.	Type of base	Square
Length of fuze projectile	11.23 in.	Muzzle velocity	1,755 ft per sec*
Length of cartridge case	13.82 in.	Maximum range (at 43 deg 40 min).....	9,760 yd*

*—Data given is for M1897 Guns. Muzzle velocity in M1916 and M1917 Guns is 1,693 feet per second; maximum range is about 9,655 yards (at 42 deg 30 min).

117. **SHRAPNEL, FIXED, MK. I, FLASHLESS, 75-MM GUN**, is the same as that described in paragraph 116, except for the propelling charge and primer, and is used for the same purposes. The propellant of this round is flashless (FNH) powder. The 100-grain M1B1A1 Primer is used to ignite the propelling charge. Data given in paragraph 116 are applicable to this round.

118. **AMMUNITION, BLANK (SINGLE PELLET CHARGE), 75-MM GUNS, M1897-16-17, 75-MM HOW., M1 AND M1A1, AND 3" FIELD GUNS, M1902-04-05** (fig. 72), is provided for saluting purposes and simulated firing and consists of an M9A1 Cartridge Case containing an M1B1A1 (100-grain) Primer and a single pellet of black powder weighing 0.43 pound. The M9A1 Cartridge Case may be a service (M18) case cut to a 7.25-inch length (about 60 percent of the service length). The black powder charge is pressed and formed to required size, with a hole through its center for inserting the primer. The pellet is wrapped in cellophane for protection and is held firmly in position against the cartridge case base by a chipboard tube which in turn is held in position by a closing cup assembly. The closing cup is inserted and cemented in position about 2¾ inches from the cartridge case mouth with Pittman cement. Rounds with a damaged or loose closing cup should never be fired. The complete round weighs 2.68 pounds and is 7.25 inches in length.

FIXED AND SEMIFIXED ROUNDS AND SEPARATE-LOADING PROJECTILES

119. **AMMUNITION, BLANK (DOUBLE PELLET CHARGE), 75-MM GUNS, M1897-16-17, 75-MM HOW., M1 AND M1A1, AND 3" FIELD GUNS, M1902-04-05** (fig. 73), consists of the same components as used for the round described in paragraph 118, except for the black powder charge. The charge in this ammunition is in the form of two pellets weighing in all 0.87 pound. The complete round weighs 3.07 pounds and is 7.25 inches in length.

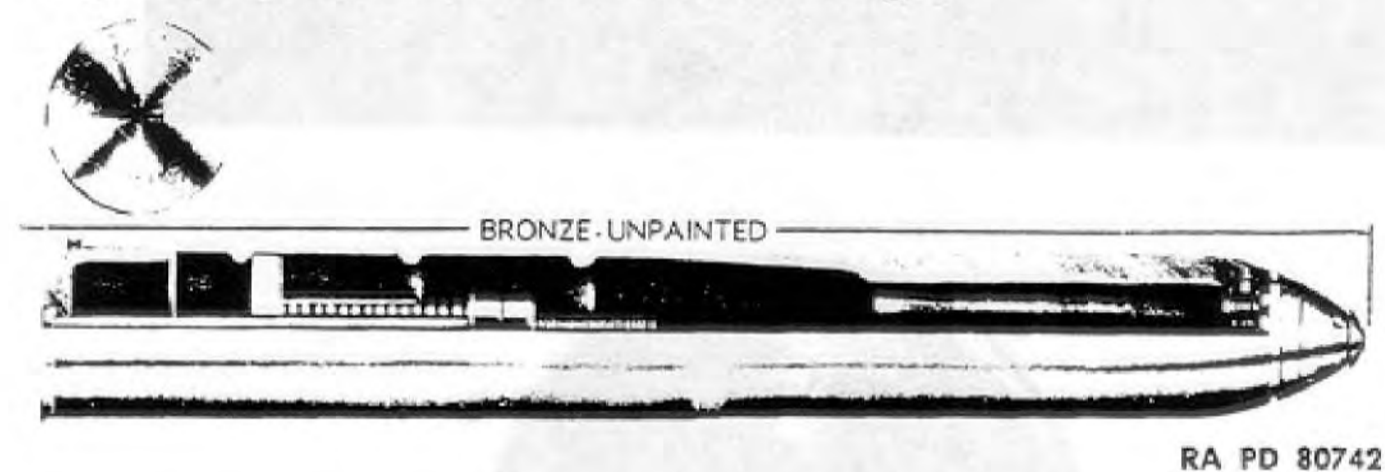

Figure 71 — CARTRIDGE, Drill, M7, 75-mm Guns, M1897-16-17, M2, M3, and T6

120. **CARTRIDGE, DRILL, M7, 75-MM GUNS, M1897-16-17, M2, M3, AND T6** (fig. 71), is a completely inert 1-piece assembly provided for the 75-mm field, antitank, and tank guns for simulating the handling of service ammunition during training of gun crews. The cartridge case and projectile of a service round are simulated by a formed 1-piece unit made of bronze and steel. The cartridge case base is a sliding fit, held in normal closed position by a steel rod and spring. The cartridge may be fitted with an inert 21-second Combination Fuze M1907M, or may be adapted for the inert M46 or M47 or similar inert fuzes by use of a Mk. III Adapter. The ammunition is packed either as a complete round with the 21-second Combination Fuze M1907M, or as a drill cartridge kit containing three cartridges, the various types of inert service fuzes, and spare parts. See ORD 11.SNL R-6 for list of contents. The fuzed round is approximately 23.42 inches long and weighs 20.38 pounds.

121. **CARTRIDGE, DRILL, M16, W/FUZE, DUMMY, M59, 75-MM GUN**, is functionally similar to that described in paragraph 120 and is also fitted with a sliding-type spring-held base. The body is made of bronze (M16) or malleable iron (M16B1) and is fitted with FUZE, dummy, M59. This fuze simulates the selective-type M48 and M48A1 Fuzes. The fuzed round is 26.25 inches long and weighs 18.75 pounds.

ARTILLERY AMMUNITION



RA PD 80740

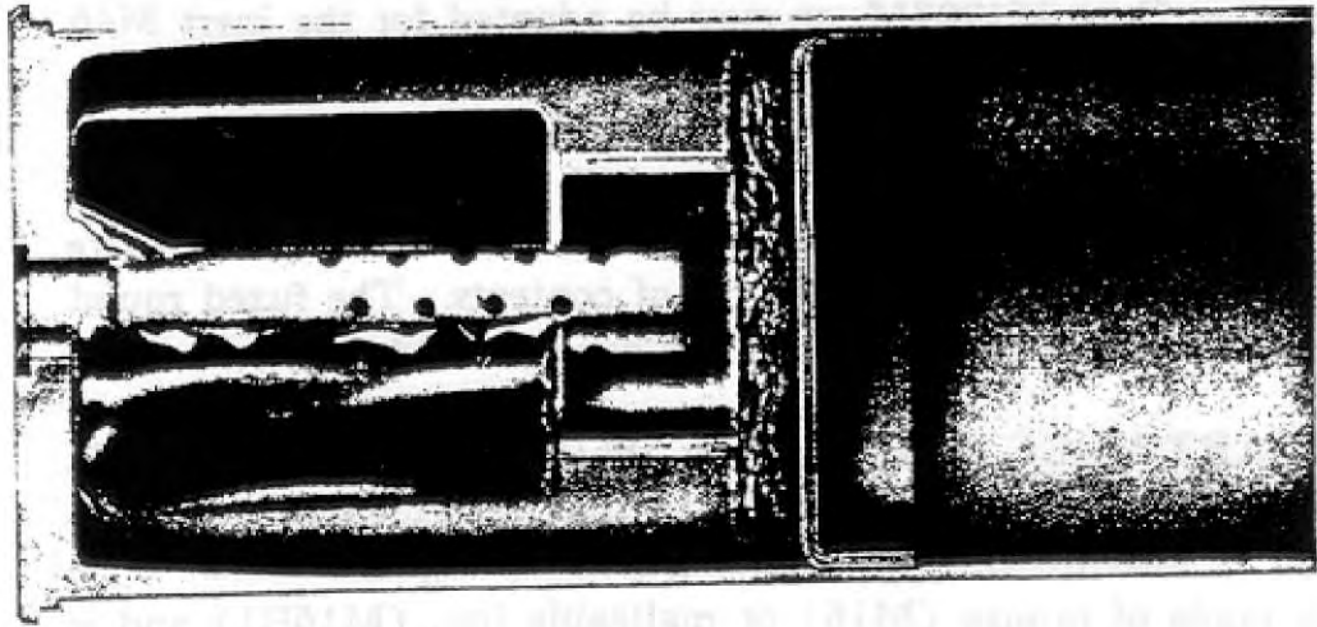
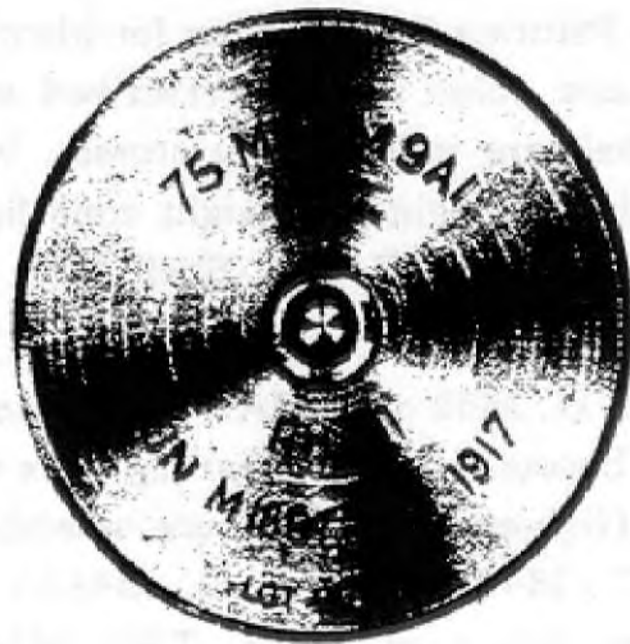
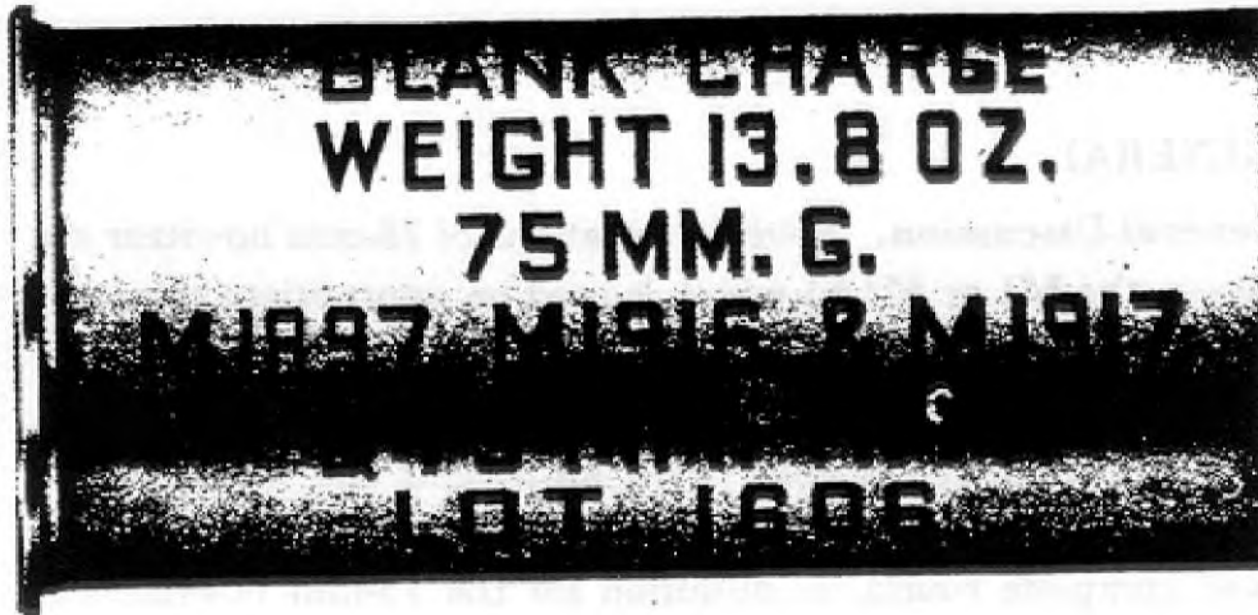

Figure 72 — AMMUNITION, Blank (Single Pellet Charge), 75-mm Guns,
M1897-16-17 and 3" Field Guns, M1902-04-05

FIXED AND SEMIFIXED ROUNDS AND SEPARATE-LOADING PROJECTILES



RA PD 80741

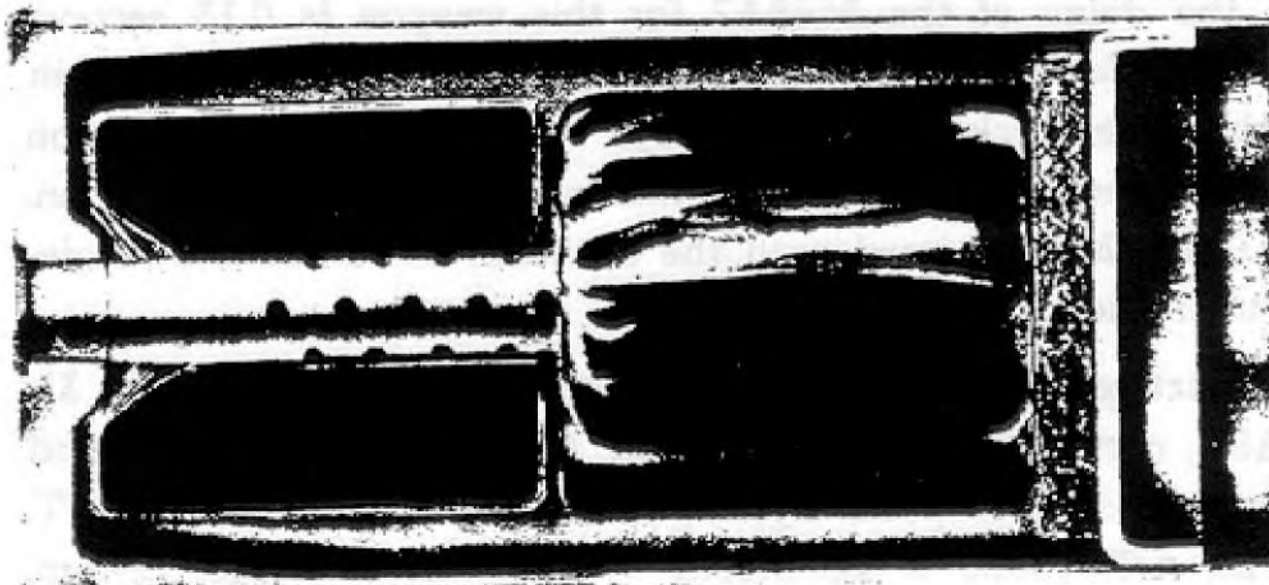

Figure 73 — AMMUNITION, Blank (Double Pellet Charge), 75-mm Guns, M1897-16-17, 75-mm How., M1 and M1A1, and 3" Field Guns, M1902-04-05

ARTILLERY AMMUNITION

Section VIII

AMMUNITION FOR 75-MM HOWITZERS

122. GENERAL.

a. **General Discussion.** Several variations of 75-mm howitzer are now in use — the M1 or M1A1 which is used on appropriate carriages for field, pack and airborne artillery, and the M2 and M3 which are mounted in combat vehicles for tank support and antitank defense. Since the chamber design is alike in all, all models and modifications fire the same ammunition. Except for one round which is issued as a fuze fixed complete round, ammunition for the 75-mm howitzers is in the form of fuze rounds of semifixed ammunition, permitting the adjustment of the propelling charge for zone firing.

b. **Identification.** Painting and marking for identification are in accordance with the basic color scheme prescribed in TM 9-1900. Weight zones of the shell are indicated by crosses; two crosses signify "normal" or "standard" weight. A weight zone lighter than one cross is indicated by "L." The H.E., A.T. Shell M66, does not have weight zone markings.

c. **Fuzes.** FUZE, B. D., M62 or M62A1, is fitted to the H.E., A.T. Shell M66. These are boresafe base-detonating fuzes which function with nondelay action. High-explosive shell are assembled as shipped with either FUZE, P. D., M48; FUZE, P. D., M48A1; FUZE, P. D., M48A2, SQ & 0.15 sec delay; or FUZE, TSQ, M54. The M48, M48A1, and M48A2 Fuzes are selective superquick-delay types. The M48A1 has a 0.15-second delay whereas the delay of the M48 is 0.05 second; the delay of the M48A2 for this weapon is 0.15 second. FUZE, TSQ, M54, is a combination time and superquick type in which the superquick action is always operative. It will function on impact unless prior functioning has been caused by time action. FUZE, P. D., M57, is used with the chemical shell. It is a single-action superquick type (ch. 3, sec. I).

d. **Cartridge Cases.** CASE, cartridge, 75-mm, M5A1 (type I), and CASE, cartridge, 75-mm, M5A1B1 (type I), are standard and substitute standard, respectively, for all rounds except the H.E., A.T. The H.E., A.T. round is assembled with CASE, cartridge, 75-mm, M5A1, (type II), the standard case, or the substitute standard CASE,

FIXED AND SEMIFIXED ROUNDS AND SEPARATE-LOADING PROJECTILES

cartridge, 75-mm, M5A1B1 (type II). The type I case has a slightly larger mouth and a less sharp taper at the shoulder than the type II to provide a free fit when assembling the round. This is not necessary with the type II case which is crimped rigidly to the projectile when the round is assembled. All standard cases are made of brass. The substitute cases are made of steel, have thinner heads and primer seats, and are about 0.27 pound lighter than the standard brass case.

e. **Propelling Charges.** The fixed H.E., A.T. round has a non-adjustable propelling charge which is loaded loosely in the cartridge case. Propelling charges of all other rounds are divided into sections to permit adjusting for zone firing. The full charge consists of four sections—a base charge and three increments. Each is assembled in a cloth bag on which is marked the number of the charge. The base charge (charge 1) is tied to a retainer in the bottom of the cartridge case. The first increment, which is marked charge 2, is tied to the base section with a long twine. The other increments, in numerical order, are tied to each other with short twine. This permits withdrawal of the sections, except the base section, to the mouth of the cartridge case where those increments not required may be removed by cutting or breaking the twine. The increments to be used are then readily assembled in the cartridge case in numerical order, with the increment having the number corresponding to the charge to be fired uppermost. The increments are of unequal weights, hence are not interchangeable. All sections up to and including the number of the charge to be fired are required to fire the charge called for. Thus, to fire charge 3, the base charge (marked "1") and the increments marked "2" and "3," in numerical order, must be used.

f. **Primer.** PRIMER, percussion, 100-grain, M1B1A2, is standard for all 75-mm howitzer ammunition. Alternative is PRIMER, percussion, 100-grain, M1A2 (ch. 3, sec. III).

123. COMPLETE ROUND TABLE.

a. Data concerning the complete rounds of 75-mm howitzer ammunition, and components thereof, are given in table 14, chapter 5.

124. PACKING AND SHIPPING DATA.

a. Packing and shipping data for the ammunition are given in ORD 11 SNL's R-1, R-5, and R-6.

ARTILLERY AMMUNITION



RA PD 80744

Figure 74 — SHELL, Semifixed, H.E., M48, w/FUZE, TSQ, M54, 75-mm How., M1, M1A1, M2, and M3

125. SHELL, SEMIFIXED, H. E., M48, W/FUZE, TSQ, M54, 75-MM HOW., M1, M1A1, M2, AND M3 (fig. 74), is issued to provide a high-explosive ammunition for fragmentation and blast effect against personnel and light materiel targets. The selective time-superquick fuze fitted to the projectile permits firing for either high-burst bursting or for surface burst on impact. The projectile is identical with that in the corresponding round for 75-mm guns, described in paragraphs 97, 98, and 99. However, because of differences in chambering in the cannon, the two rounds differ materially in respects other than the projectile and are not interchangeable. The 75-mm howitzer cartridge case is 3.13 inches shorter than the case for the 75-mm gun, making the complete round shorter to approximately the same extent. Also, whereas the propelling charge for the gun consists of a non-adjustable charge loaded loosely in the cartridge case crimped permanently to the projectile, the howitzer charge is in four sections in a cartridge case having a free fit for adjustment for zone firing.

DATA

Weight of complete round	18.24 lb	Type of base	Boat-tailed
Length of complete round	23.48 in.	Degree of taper	9 deg 15 min
Length of fuzed projectile	15.00 in.	Radius of ogive.....	7.51 cal.
Length of cartridge case	10.69 in.	Muzzle velocity	1,250 ft per sec*
Width of rotating band	0.49 in.	Maximum range	
		(at 43 deg 30 min)	9,610 yd*

*—Charge 4 (full charge) propelling charge, in M1 and M1A1 Howitzers. Corresponding data for other charges are:

	Muzzle Velocity	Maximum Range
Charge 3	950 ft per sec	6,930 yd (at 43 deg)
Charge 2	810 ft per sec	5,360 yd (at 43 deg 35 min)
Charge 1	700 ft per sec	4,190 yd (at 43 deg 35 min)

126. SHELL, SEMIFIXED, H. E., M48, W/FUZE, P. D., M48A2, M48A1, M48A3, Q & 0.15-SEC. DELAY, 75-MM HOW., M1, M1A1, M2, AND M3, except for the fuze, is similar to that described in paragraph 125. Data given therein applies equally to this round. FUZE, P. D., M48A2, is a selective superquick-delay type, with a delay of 0.15 second. Its use adapts the shell for firing with either surface or cochet burst. Rounds of earlier manufacture may be fitted with the M48A1 Fuze (0.15 sec delay) or the M48 (0.05 sec delay) of 0.05 second.

FIXED AND SEMIFIXED ROUNDS AND SEPARATE-LOADING PROJECTILES



RA PD 80745

Figure 75 — SHELL, Semifixed, H.E., M41A1, w/FUZE, P.D., M48A2, SQ & 0.15-sec. Delay, 75-mm How., M1, M1A1, M2, and M3

127. SHELL, SEMIFIXED, H. E., M41A1, W/FUZE, P. D., M48A2, SQ & 0.15-SEC. DELAY, 75-MM HOW., M1, M1A1, M2, AND M3 (fig. 75), is a substitute standard for the M48 in the 75-mm howitzers, and is issued with the same types of fuzes. Other components also are the same except for the projectile. Like the M48, the M41A1 Shell is a streamlined boat-tailed type. However, both the base and the nose ogive taper somewhat less sharply in the case of the M41A1, and its over-all length is approximately 1½ inches less. The bursting charge is slightly smaller—approximately 1.11 pounds of TNT, or alternative high explosive, as against 1.49 pounds for the M48 Filler. As a result, the loaded fuzed M41A1 Shell is approximately 0.85 pound lighter than the M48 Shell. The propelling charge is adjusted so as to give about the same muzzle velocities and maximum ranges as for the standard rounds. As assembled with the M48A2 Superquick-delay (0.15-sec) Fuze, the round is a substitute for the M48 Round described in paragraph 126. Rounds of earlier manufacture may be assembled with the M48A1 Fuze having a 0.015-second delay or the M48 Fuze having a 0.05-second delay.

DATA

Weight of complete round	17.40 lb	Degree of taper	7 deg 45 min
Length of complete round	21.98 in.	Radius of ogive	6.24 cal.
Length of fuzed projectile	12.69 in.	Muzzle velocity	1,270 ft per sec*
Length of cartridge case	10.69 in.	Maximum range	
Width of rotating band	0.49 in.	(at 43 deg 45 min)	9,650 yd*
Type of base	Boat-tailed		

*—Charge 4 (full charge). Corresponding data for other charges are:

	Muzzle Velocity	Maximum Range
Charge 3	965 ft per sec	7,075 yd (42 deg 45 min)
Charge 2	820 ft per sec	5,470 yd (43 deg 40 min)
Charge 1	705 ft per sec	4,250 yd (43 deg 9 min)

128. SHELL, SEMIFIXED, H. E., M41A1, W/FUZE, TSQ, M54, 75-MM HOW., M1, M1A1, M2, AND M3, except for the fuze, is assembled from the same components as used with the round described in paragraph 127. Data given in paragraph 127 is applicable to this round. The fuze assembled to this shell is the same as that for the M48 Round in paragraph 125, for which this round is a substitute.

ARTILLERY AMMUNITION



RA PD 80743

Figure 76 — SHELL, Fixed, H.E., A.T., M66, w/FUZE, B.D., M62 or M62A1, 75-mm How., M1, M1A1, M2, and M3

FIXED AND SEMIFIXED ROUNDS AND SEPARATE-LOADING PROJECTILES

129. SHELL, FIXED, H. E., A.T., M66, W/FUZE, B. D., M62, OR M62A1, 75-MM HOW., M1, M1A1, M2, AND M3 (fig. 76), is provided for the 75-mm howitzers for use against tanks and other heavy materiel. The effect of the projectile is obtained by the force of the detonation of its high-explosive filler rather than from striking velocity. The construction of the shell differs materially, therefore, from the standard types of armor-piercing projectile. The shell body is a thin-walled casing containing a shaped high-explosive filler and closed off at the forward end by a ballistic cap in the form of a thin steel cone. The base is boat-tailed and fitted with a base-detonating fuze which functions with nondelay action. The cartridge case is the type II M5A1 or M5A1B1. The type II case was designed especially for this round, to provide a case with a smaller neck and mouth suitable for crimping to the projectile. The case is fitted with the standard M1B1A2 Primer and has a nonadjustable propelling charge of FNH powder.

DATA

Weight of complete round	16.30 lb	Degree of taper	9 deg 15 min
Length of complete round	23.47 in.	Degree of nose taper	22 deg 50 min
Length of fuzed projectile	15.00 in	Muzzle velocity	
Length of cartridge case	10.69 in.	(approx)	1,000 ft per sec
Width of rotating band	0.49 in.	Range (at 9 deg 35 min).....	3,000 yd
Type of base	Boat-tailed	Maximum range	7,000 yd
Penetration (in. of plate, at any range) (approx)		3 ⁵ / ₈	



RA PD 80747

Figure 77 — SHELL, Semifixed, Smoke, Phosphorus, WP, M64, w/FUZE, P.D., M57, 75-mm How., M1, M1A1, M2, and M3

130. SHELL, SEMIFIXED, SMOKE, PHOSPHORUS, WP, M64, W/FUZE, P. D., M57, 75-MM HOW., M1, M1A1, M2, AND M3 (fig. 77), is standard for 75-mm howitzers for screening and incendiary purposes. It is also effective against personnel. Cartridge case, primer, and propelling charge are the standard components also used with the high-explosive and antitank rounds. The projectile is a modification of the M48 High-explosive Shell (par 125), the nose being cut and threaded to hold an adapter which screws into the body. The adapter serves three purposes: to provide a tight seal for the chemical

ARTILLERY AMMUNITION

contents of the shell; to hold the fuze; and to provide a seat for the forward end of the burster. BURSTER, M6, is a thin-walled steel tubular casing extending nearly the length of the filler cavity. The burster contains a detonator relay chain and a burster charge (CHARGE, burster, M8) of high explosive to rupture the shell and disperse the chemical contents. FUZE, P. D., M57, a single-action superquick type, is used with the 75-mm howitzer chemical shell to provide for functioning before penetration, thereby giving the most effective distribution of the filler. White phosphorus is a smoke-producing chemical which also has an incendiary effect.

DATA

Weight of complete round ... 18.89 lb	Type of base Boat-tailed
Length of complete round 23.49 in.	Degree of taper 9 deg 15 min
Length of fuzeed projectile 15.00 in.	Radius of ogive 7.51 cal.
Length of cartridge case 10.69 in.	Muzzle velocity 1,250 ft per sec*
Width of rotating band..... 0.49 in.	Maximum range (at 44 deg) 9,610 yd*

*—Charge 4 (full charge), in M1 and M1A1 Howitzers.

31. SHELL, SEMIFIXED, SMOKE, FS, M64, W/FUZE, P. D., M57, 75-MM HOW., M1, M1A1, M2, AND M3, contains FS filler, a liquid smoke-producer functioning very much like white phosphorus. When filled with FS, the complete round weighs approximately 19.05 pounds. In other respects it is similar to the round described in paragraph 130, and data given therein apply equally to this round.

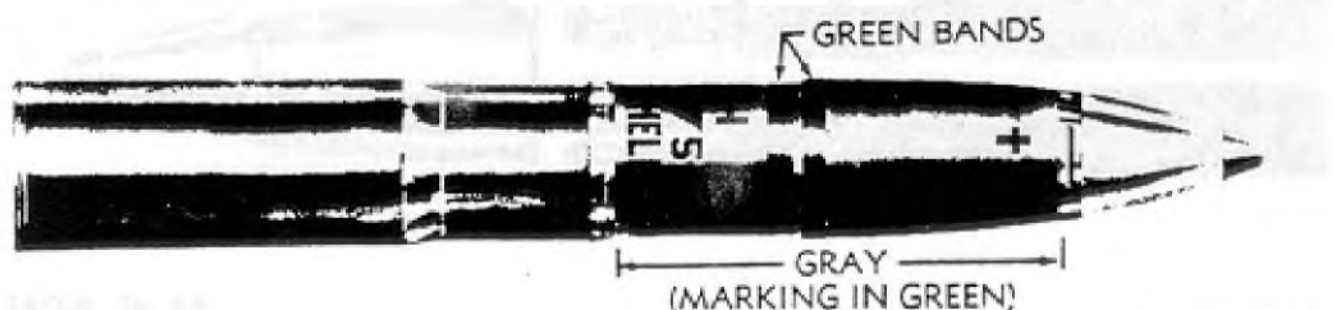

RA PD 80746

Figure 78 — SHELL, Semifixed, Gas, Persistent, H, M64, w/FUZE, P.D., M57, 75-mm How., M1 and M1A1

32. SHELL, SEMIFIXED, GAS, PERSISTENT, H, M64, W/FUZE, P. D., M57, 75-MM HOW., M1 AND M1A1 (fig. 78), is similar to the phosphorus and FS filled smoke shell, but the filler consists of mustard gas (H), a persistent liquid vesicant. The complete round weighs 18.58 pounds. Otherwise, the data given in paragraph 130 also apply to this round.

FIXED AND SEMIFIXED ROUNDS AND SEPARATE-LOADING PROJECTILES

133. AMMUNITION, BLANK (DOUBLE PELLET CHARGE), 75-MM GUNS, M1897-16-17, 75-MM HOW., M1 AND M1A1, AND 3" FIELD GUNS, M1902-04-05, is described in paragraph 119, and illustrated in figure 73.

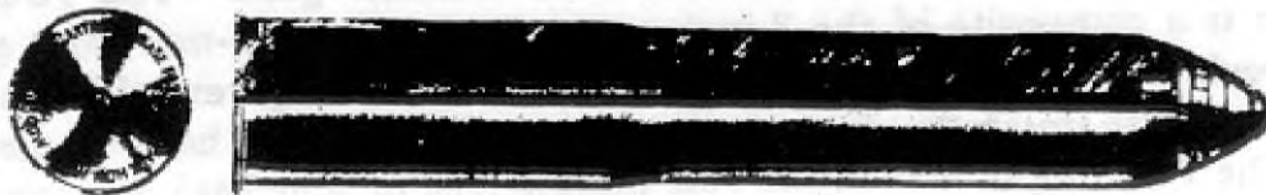

RA PD 80748

Figure 79 — CARTRIDGE, Drill, M2A2, 75-mm How., M1, M1A1, M2, and M3

134. CARTRIDGE, DRILL, M2A2, 75-MM HOW., M1, M1A1, M2, AND M3 (fig. 79), is a completely inert cartridge for use in training in handling and in loading the cannon. The round is a 1-piece bronze assembly with a detachable base. It is fitted with an inert 21-second Combination Fuze M1907M, which is made up of burned-out or rejected fuze parts.

135. CARTRIDGE, DRILL, M19, W/FUZE, DUMMY, M59, 75-MM HOW., M1, M1A1, M2, AND M3, simulates the M48 Service Round for use in training. Like the M2A2 Drill Cartridge, it is of 1-piece with a detachable base and nose cut and threaded to hold a simulated point fuze. However, the assembly is a malleable iron casting and is fitted with FUZE, dummy, M59. The M59 Fuze simulates the M48 selective type and has a similar setting pin arrangement.

ARTILLERY AMMUNITION

Section IX

AMMUNITION FOR 76-MM GUNS

136. GENERAL.

a. **General Discussion.** The 76-mm Guns M1, M1A1, and M1A2 are lightweight high-velocity tank and antitank guns. The 76-mm gun is a composite of the 3-inch gun tube, and the 75-mm tank gun breech ring and mechanism. Characteristics which govern the design of shell are much the same as for the 3-inch gun (the base diameter of the 76-mm gun actually is 76.2 millimeters, or 3 inches), and corresponding rounds for the two guns use the same shells. However, the *complete rounds are not interchangeable*, since the chamber of the 76-mm gun is smaller and requires a shorter cartridge case as well as a different weight of propelling powder. As a result, 76-mm rounds are uniformly smaller and lighter than the 3-inch. All 76-mm ammunition is issued in the form of fixed complete rounds. Rounds requiring fuzes are fuzed as shipped. The rounds described in this section are those containing FNH powder (subpars. e and f, below). Unless "reduced charge" appears in the nomenclature of an item, then the round has a normal charge.

b. **Identification.** Painting and marking for identification is in accordance with the basic color scheme as prescribed in TM 9-1900. The marking on the shell clearly identifies the round from the corresponding one for the 3-inch gun since it includes the caliber as well as type of cannon, for example, "76 G - TNT - SHELL M42A1" when to be assembled in the 76-mm round, and "3 G - TNT - SHELL M42A1" when for the 3-inch gun.

c. **Fuzes.** FUZE, B.D., M66A1, a base-detonating fuze which functions with delay action, is fitted in the base of 76-mm armor-piercing-capped projectiles when these projectiles are loaded with high explosive. This fuze is not considered to be boresafe. High-explosive shell are fitted with either FUZE, P.D., M48A2, SQ and 0.05-sec. delay; FUZE, P.D., M48A1; or FUZE, P.D., 48 (ch. 3, sec. I).

d. **Cartridge Cases.** CASE, cartridge, 76-mm, M26, is standard for 76-mm ammunition. This is a brass case, 21.3 inches long, weighing 5.28 pounds. Substitute standard is CASE, cartridge, 76-mm, M26B1, a steel case with a thinner head and primer seat than the standard brass case, and approximately 0.50 pound lighter.

e. **Propellent Powder.** Formerly, FNH powder was standard for use in 76-mm guns. Because of the smoke produced, recent rounds contain the FNH, M1, Powder without potassium sulfate, making an

FIXED AND SEMIFIXED ROUNDS AND SEPARATE-LOADING PROJECTILES

NH type powder. These rounds are flashing but have less smoke. Rounds of new manufacture also have PRIMER, percussion, 225-grain, M40 (T27), in addition to the NH powder.

f. **Primers.** PRIMER, percussion, 300-grain, M28A2, is standard for 76-mm gun ammunition. An alternative is PRIMER, percussion, 300-grain, M28B1A1. PRIMER, percussion, 260-grain, M40 (T27), is a new primer used with NH powder charges. It is 19 inches long, as compared to the M28A2 which is 10 inches long, and is open at the end.

137. COMPLETE ROUND TABLE.

a. Data concerning the 76-mm complete rounds, and components thereof, are given in table 15, chapter 5.

138. PACKING AND SHIPPING DATA.

a. Packing and shipping data for the 76-mm ammunition are given in ORD 11 SNL's R-1 and R-6.

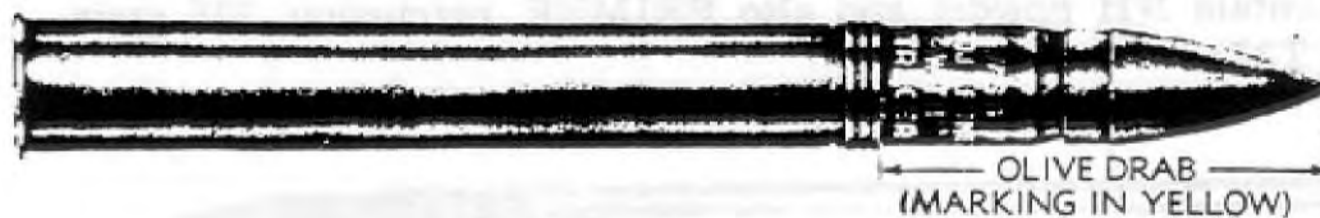

RA PD 80749

Figure 80 — PROJECTILE, Fixed, A.P.C., M62A1, w/FUZE, B.D., M66A1, and TRACER, 76-mm Guns, M1, M1A1, and M1A2

139. PROJECTILE, FIXED, A.P.C., M62A1, W/FUZE, B.D., M66A1, AND TRACER, 76-MM GUNS, M1, M1A1, and M1A2 (fig. 80), is intended for use against armored targets. The projectile is the armor-piercing-capped type which relies on striking power for penetration, and is loaded and fuzeed for blast effect behind the plate. The body of the projectile is solid except for a relatively small cavity at the rear which holds the high-explosive charge of explosive D. The nose of the body is fitted with an armor-piercing cap, increasing the effectiveness of the projectile against face-hardened armor. A ballistic cap or windshield is permanently fixed to the armor-piercing cap. The windshield is a hollow thin-walled steel ogival cap which gives a streamlined effect to the forepart of the round. The base is square, and is drilled and threaded to hold the Base-detonating Fuze M66A1. This fuze is a nonboresafe type which functions with delay action, thereby providing for penetration before detonation of the explosive filler. The boat-tailed rear portion of the fuze housing holds a tracer which operates independent of the fuze mechanism. After its ignition by the

ARTILLERY AMMUNITION

propelling charge when the round is fired, the tracer composition burns for approximately 3 seconds, giving a visible trace for observation purposes. Due to the greater muzzle velocity, the round is effective at greater ranges than the corresponding round for 75-mm guns. Rounds of new manufacture contain NH powder and also PRIMER, percussion, 225-grain, M40 (T27).

DATA

Weight of complete round	24.80 lb	Radius of ogive (false ogive)	7.05 cal.
Length of complete round	33.80 in.	Muzzle velocity	2,600 ft per sec
Length of fuzeed projectile	9.79 in.	Maximum range	16,100 yd
Length of cartridge case	21.30 in.	Penetration (in. at 0-deg obliquity	
Width of rotating band.....	1.02 in.	of face-hardened plate at 1,000	
Type of base	Square	yd)	4.7
Penetration (in. at 0-deg obliquity of homogeneous plate at 1,000 yd).....			4.5

140. **PROJECTILE, FIXED, A.P.C., M62, W/FUZE, B.D., M66A1, AND TRACER, 76-MM GUNS,** is similar to the M62A1 Round described in paragraph 139 except for the method of crimping the steel windshield to the armor-piercing cap of the projectile. In the M62A1, the windshield is roll-crimped near the end of the windshield, whereas in the M62, the end of the windshield is crimped into a groove in the armor-piercing cap. Rounds of recent manufacture may contain NH powder and also PRIMER, percussion, 225 grain, M40 (T27).

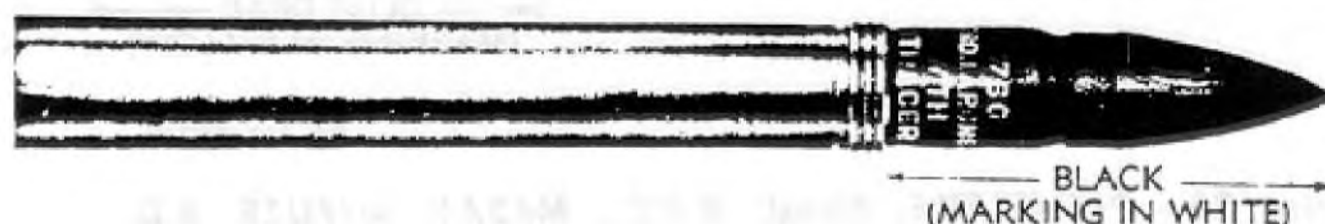

RA PD 80750

Figure 81 — **PROJECTILE, Fixed, A.P.C., M62, w/TRACER, 76-mm Guns, M1, M1A1, and M1A2**

141. **PROJECTILE, FIXED, A.P.C., M62, W/TRACER, 76-MM GUNS, M1, M1A1, AND M1A2** (fig. 81), is an earlier type of armor-piercing round which has been superseded for current manufacture by the loaded and fuzeed rounds described in paragraphs 139 and 140. Components are the same as those in the current standard round but cavity in the base of the projectile is empty. A steel plug in the base holds a tracer like that in the fuze of the loaded round. Because of the difference in loading, the projectile and complete round weigh approximately 0.50 pound less than the loaded projectile and round. The length of the projectile is 8.94 inches; otherwise, data in paragraph 139 are applicable.

FIXED AND SEMIFIXED ROUNDS AND SEPARATE-LOADING PROJECTILES

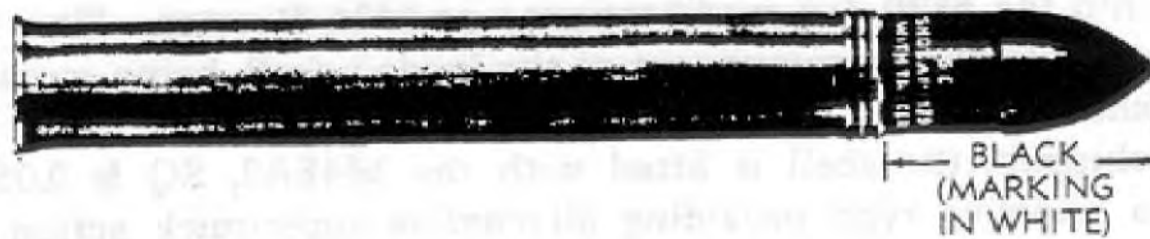

RA PD 80752

Figure 82 — SHOT, Fixed, A.P., M79, w/TRACER, 76-mm Guns, M1, M1A1, and M1A2

142. SHOT, FIXED, A.P., M79, W/TRACER, 76-MM GUNS, M1, M1A1, AND M1A2 (fig. 82), is substitute standard for the armor-piercing-capped round (par. 139). Rounds are the same for both types of round except for the projectile. The M79 Shot is essentially a steel slug with a rounded nose. A small cavity in the base holds a red tracer composition similar to that in the loaded A.P.C. projectile, giving a visible trace for observation for the first 3 seconds of flight. The shot has neither ballistic nor armor-piercing cap. It is not as well adapted, therefore, for combating face-hardened types of armor, but will perform adequately against homogeneous plate.

DATA

Weight of complete round	24.24 lb	Radius of ogive	1.68 cal.
Length of complete round	29.76 in.	Muzzle velocity	2,600 ft per sec
Length of projectile	9.22 in.	Maximum range	12,770 yd
Length of cartridge case	21.30 in.	Penetration (in. at 0-deg obliquity	
Width of rotating band.....	1.02 in.	of face-hardened plate at 1,000	
Type of base	Square	yd)	3.0
Penetration (in. at 0-deg obliquity of homogeneous plate at 1,000 yd).....			4.5

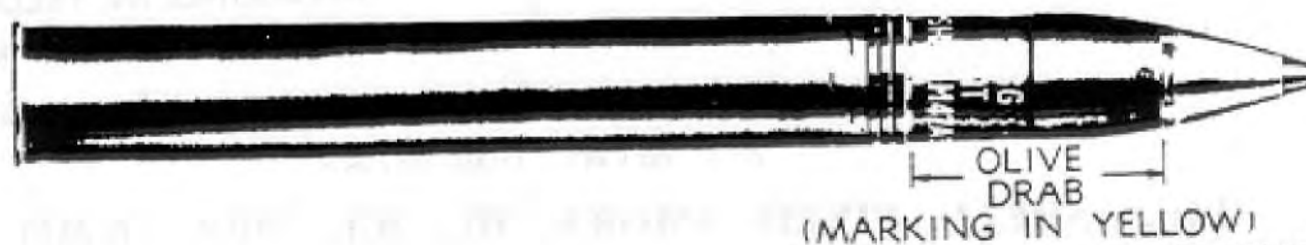

RA PD 80751

Figure 83 — SHELL, Fixed, H.E., M42A1, w/FUZE, P.D., M48A2, SQ & 0.05-sec. Delay, 76-mm Guns, M1, M1A1, and M1A2

143. SHELL, FIXED, H.E., M42A1, W/FUZE, P.D., M48A2, SQ & 0.05-SEC. DELAY, 76-MM GUNS, M1, M1A1, AND M1A2 (fig. 83), provides for fragmentation and blast effect at the target for use against personnel and light materiel. The complete assembly consists of the standard cartridge case and primer, a 3.75-pound propelling charge (FNH), and a fuzed high-explosive shell. The shell body is a relatively thin-walled forged steel casing having an explosive

ARTILLERY AMMUNITION

charge cavity extending almost the full length of the body and closed at the front end, after loading, with a bakelite fuze well cup. The fuze well cup prevents broken bits of explosive charge from falling into the M20 (or modifications) or M24 Booster. This booster is a manufacturing component of the loaded shell, being screwed into the shell nose and permanently locked in position by a set screw. As shipped, the shell is fitted with the M48A2, SQ & 0.05-sec. delay, a selective type providing alternative superquick action for surface burst on impact, or delay action for penetration at target. Rounds of older manufacture may be fuzed with the M48A1 having a 0.15-second delay or the M48 having a 0.05-second delay. Newer rounds may contain NH powder which will be indicated in nomenclature.

DATA

Weight of complete round	22.23 lb	Width of rotating band	1.02 in.
Length of complete round	32.29 in.	Type of base	Square
Length of fuzed projectile	12.36 in.	Radius of ogive	7.05 cal.
Length of cartridge case	21.30 in.	Muzzle velocity	2,700 ft per sec
Maximum range	14,200 yd		

144. SHELL, FIXED, H.E., M42A1, REDUCED CHARGE, W/FUZE, P.D., M48A2, SQ & 0.15-SEC. DELAY, 76-MM GUNS, M1, M1A1, AND M1A2, is similar to that described in paragraph 143, except for the reduced charge and the longer delay action of the fuze (0.15 sec). Rounds may also be assembled with NH powder. Weight of complete round is 19.62 pounds, muzzle velocity is 1,550 feet per second, and maximum range is 8,805 yards. Otherwise, data in paragraph 143 are applicable.



Figure 84 — SHELL, Fixed, Smoke, HC, B.I., M88, 76-mm Guns, M1, M1A1, and M1A2

145. SHELL, FIXED, SMOKE, HC, B.I., M88, 76-MM GUNS, M1, M1A1, AND M1A2 (fig. 84), is a low-velocity chemical round for screening purposes. It is constructed along the same lines as the corresponding round for 75-mm guns, and functions in the same manner. Rounds of recent manufacture may contain NH powder. For details on construction and functioning, see paragraph 106.

DATA

Weight of complete round	13.43 lb	Width of rotating band	0.49 in.
Length of complete round	28.56 in.	Type of base	Square
Length of projectile	8.02 in.	Muzzle velocity (appr.)..	900 ft per sec
Length of cartridge case	21.30 in.	Maximum range (at 12 deg)	2,000 yd

FIXED AND SEMIFIXED ROUNDS AND SEPARATE-LOADING PROJECTILES

146. CARTRIDGE, DRILL, M20, W/FUZE, DUMMY, M59, 76-MM GUNS, M1 AND M1A1. The M20 and M20B1 Drill Cartridges simulate the 76-mm complete round assembled with SHELL, H.E., M42A1, w/FUZE, P.D., M48, and PROJECTILE, A.P.C., M62 and M62A1. The M20B1 Drill Cartridge body is hollow and manufactured from malleable iron, while the M20 Body is made of bronze. A copper base center pin, fitted in the center of the base, simulates the primer. FUZE, dummy, M59, simulates FUZE, P.D., M48, and modifications. The weight of the drill cartridge is 24.80 pounds and its length is 33.80 inches.

ARTILLERY AMMUNITION

Section X

AMMUNITION FOR 3-INCH GUNS

147. GENERAL.

a. **General Discussion.** Considering chamber dimensions, there are two general types of 3-inch guns: 3-inch antiaircraft guns in fixed emplacements ("fixed" guns) and the 3-inch (15-pdr.) Seacoast Gun M1903; and 3-inch antiaircraft guns on mobile mounts ("mobile" guns), 3-inch tank and antitank guns, and the 3-inch (15-pdr.) Seacoast Gun M1902MI. The first group includes the 3-inch AA. Guns M1917 and modifications, the M1925 and modifications, and the M2 and M4. Guns in the second group are the 3-inch AA. Guns M1918 and modifications, the M3, and the 3-inch Tank and Antitank Guns M5, M6, and M7. In addition there are the 3-inch Field Guns M1902, M1904, and M1905, which have been rechambered to take 75-mm blank ammunition; these guns are used for saluting purposes only. For all other guns in this caliber, service, practice, blank, and drill rounds are provided, all being issued in the form of fixed rounds. Most 3-inch high-explosive shell are used interchangeably, with appropriate fuzes, in both types of gun. However, because the larger chamber in the fixed-type gun requires a large cartridge case for ammunition to be fired from these guns, *complete rounds are not interchangeable* (fig. 85). Rounds also differ as to the type of propelling powder. Some 3-inch projectiles are also used in 76-mm ammunition. Differences in characteristics and means of distinguishing such rounds are discussed in chapter 2, section IX.

b. **Identification.** Painting and marking for identification are in accordance with the basic scheme described in TM 9-1900.

c. **Fuzes.** All 3-inch rounds requiring fuzes are shipped with fuzes assembled. Various types are provided, depending on the purpose for which the round is intended. High-explosive rounds intended for anti-aircraft fire are fuzed with the M43 Mechanical Time Fuze (or modifications), which provides a time setting up to 30 seconds. This fuze has no impact element. High-explosive rounds to be fired against ground targets are fitted with a selective-type point-detonating Fuze M48A2, M48A1, or M48, which provide alternative superquick or delay (0.05 or 0.15 sec.) action upon impact. Models containing the shorter delay are used with rounds other than reduced-charge rounds; the latter are fitted with the longer delay fuzes. Loaded armor-piercing projectiles are fitted with the Base-detonating Fuze M66A1, giving delay action. Shrapnel for the fixed guns is fitted with the Mk. IIIA1 or Mk. IIIA2 AA. Fuze. As a rule, shrapnel rounds for the mobile

FIXED AND SEMIFIXED ROUNDS AND SEPARATE-LOADING PROJECTILES

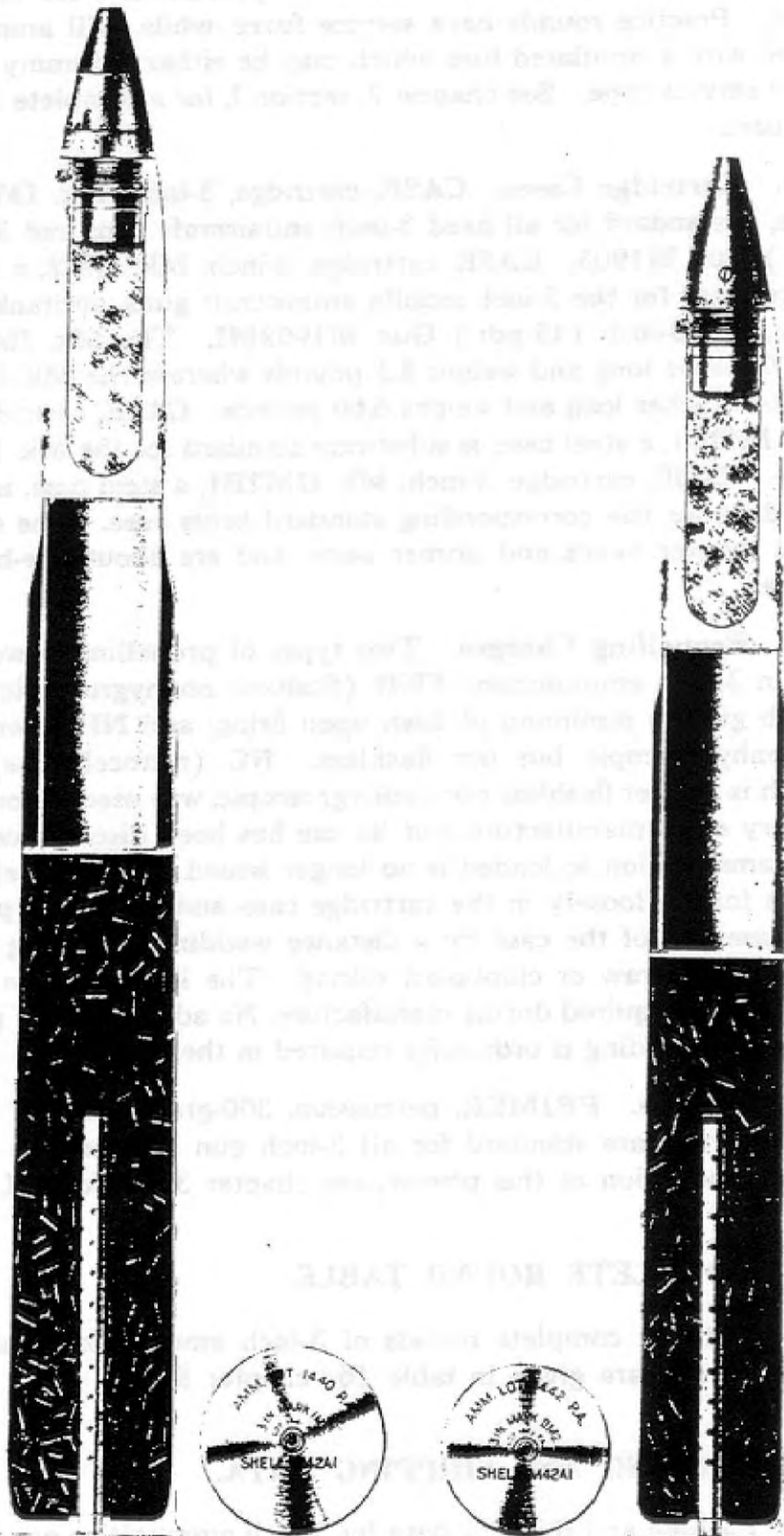

RA PD 80753

Figure 85 — Comparison of 3-inch Gun Ammunition

ARTILLERY AMMUNITION

guns also are assembled with the Mk. III-type fuze. However, rounds with the M1907M Combination Time-percussion Fuze are in existence. Practice rounds have service fuzes, while drill ammunition is fitted with a simulated fuze which may be either a dummy fuze or an inert service type. See chapter 3, section I, for a complete description of fuzes.

d. **Cartridge Cases.** CASE, cartridge, 3-inch, Mk. IM2, a brass case, is standard for all fixed 3-inch antiaircraft guns and 3-inch (15-pdr.) Gun M1903. CASE, cartridge, 3-inch, Mk. IIM2, a brass case, is standard for the 3-inch mobile antiaircraft guns, antitank and tank guns, and 3-inch (15-pdr.) Gun M1902MI. The Mk. IM2 Case is 26.70 inches long and weighs 8.5 pounds whereas the Mk. IIM2 Case is 23.08 inches long and weighs 6.66 pounds. CASE, cartridge, 3-inch, Mk. IM2B1, a steel case, is substitute standard for the Mk. IM2 Brass Case. CASE, cartridge, 3-inch, Mk. IIM2B1, a steel case, is alternate standard for the corresponding standard brass case. The steel cases have thinner heads and primer seats, and are about one-half pound lighter.

e. **Propelling Charges.** Two types of propelling powder are in use in 3-inch ammunition: FNH (flashless nonhygroscopic) powder, which gives a minimum of flash upon firing; and NH powder, which is nonhygroscopic but not flashless. NC (nitrocellulose) powder, which is neither flashless nor nonhygroscopic, was used in some rounds of very early manufacture, but its use has been discontinued, and 3-inch ammunition so loaded is no longer issued. The propellant powder is loaded loosely in the cartridge case and is held in position at the base end of the case by a distance wadding consisting of a split disk and a straw or chipboard tubing. The length of the tubing is adjusted as required during manufacture. No adjustment of propelling charge or wadding is ordinarily required in the field.

f. **Primers.** PRIMER, percussion, 300-grain, M28, or modifications thereof, are standard for all 3-inch gun ammunition. For detailed description of this primer, see chapter 3, section III.

148. COMPLETE ROUND TABLE.

a. Data on complete rounds of 3-inch ammunition, and components thereof, are given in table 16, chapter 5.

149. PACKING AND SHIPPING DATA.

a. Packing and shipping data for 3-inch ammunition are published in ORD 11 SNL's P-5, P-6, P-7, P-8, R-1, R-5, and R-6.

FIXED AND SEMIFIXED ROUNDS AND SEPARATE-LOADING PROJECTILES

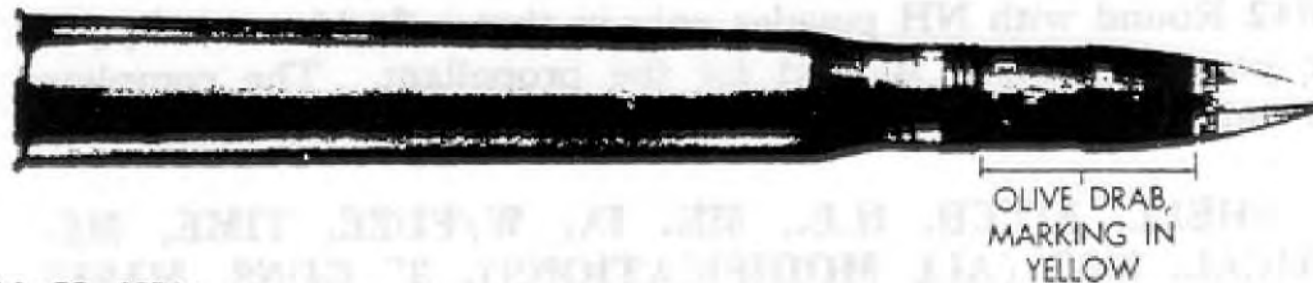

RA PD 80754

Figure 86 — SHELL, Fixed, H.E., M42A1, NH, w/FUZE, Time Mechanical, M43 (All Modifications), 3" Guns, M1917 (All Models), M1925MI-25MIA1, M2, and M4

150. SHELL, FIXED, H.E., M42A1, NH, W/FUZE, TIME, MECHANICAL, M43 (ALL MODIFICATIONS), 3" GUNS, M1917 (ALL MODELS), M1925MI-25MIA1, M2, and M4 (fig. 86), has identical shell and shell loading as those of the high-explosive round for the 76-mm gun (par. 143), including the M20-type booster. The round is shipped fitted with an M43 Fuze or modifications, a mechanical time fuze without impact element. For firing from the fixed 3-inch guns, the Mk. IM2 or Mk. IM2B1 Cartridge Case, an M28 Primer (or modification), and a 4.87-pound charge of nonhygroscopic (NH) propellant powder is used. As a result, the complete round is longer and heavier than the corresponding rounds for both the mobile 3-inch and the 76-mm guns.

DATA

Weight of complete round.....	26.76 lb	Radius of ogive.....	7.05 cal.
Length of complete round.....	37.67 in.	Muzzle velocity	2,800 ft per sec
Length of fuzeed projectile.....	12.36 in.	Maximum range:	
Length of cartridge case	26.70 in.	Vertical height	
Width of rotating band.....	1.02 in.	(at 79 deg 42 min).....	9,800 yd*
Type of base	Square	Horizontal range	
		(at 20 deg 30 min).....	11,200 yd*

*—Limited by maximum fuze time setting; theoretical maximum horizontal range of shell is 15,100 yards.

151. SHELL, FIXED, H.E., M42, NH, W/FUZE, TIME, MECHANICAL, M43 (ALL MODIFICATIONS), 3" GUNS, M1917 (ALL MODELS), M1925MI-M25MIA1, M2, AND M4, has the same projectile as that described in paragraphs 150 and 148, except for a slight difference in the shape of the bursting charge cavity, and a small difference in shell weight as a result. The base end of the charge cavity in the M42 Shell is nearly square; this was modified to a smooth curve and the shell thereby became the M42A1. The complete round weighs 26.70 pounds (against 26.76 for the M42A1 Round); in all other respects, data given in paragraph 150 are applicable to this round.

ARTILLERY AMMUNITION

152. SHELL, FIXED, H.E., M42, FLASHLESS, W/FUZE, TIME MECHANICAL, M43 (ALL MODIFICATIONS), 3" GUNS, M1917 (ALL MODELS), M1925MI-25MIA1, M2, AND M4, differs from the M42 Round with NH powder only in that a flashless nonhygroscopic powder (FNH) is used for the propellant. The complete round weighs 26.70 pounds; other data are given in paragraph 150.

153. SHELL, FIXED, H.E., MK. IX, W/FUZE, TIME, MECHANICAL, M43 (ALL MODIFICATIONS), 3" GUNS, M1917 (ALL MODELS), M1925MI-25MIA1, M2, AND M4, is a limited standard round, very similar in appearance to the M42A1 Round (par. 150) and is fitted with the same type of fuze. The round consists, in addition to the Mk. IX Shell, of the Mk. IM2 or Mk. IM2B1 Cartridge Case with an M28 Primer or modifications thereof, and a 1.87-pound propelling charge of NH powder. The Mk. IX Shell resembles the M42A1 and M42 Shell, the latter being, in fact, a modification of the older design. However, the nose of the Mk. IX is cut and threaded so that an M23 Booster can be fitted to the shell by means of an adapter for use with the M43 Fuzes. The adapter is a threaded plug-like assembly formed to continue the ogival contour of the shell nose. The booster is a brass assembly holding a small booster charge of tetryl and fitted with an interrupter arrangement for more safety. Due to the different booster, the Mk. IX Shell has a slightly larger TNT bursting charge than the M42A1 Shell.

DATA

Weight of complete round.....	26.68 lb	Width of rotating band.....	1.02 in.
Length of complete round.....	37.57 in.	Type of base	Square
Length of fuzed projectile.....	12.03 in.	Radius of ogive.....	7.05 cal.
Length of cartridge case.....	26.70 in.	Muzzle velocity	2,800 ft per sec
Maximum range (at 45 deg).....	12,100 yd*		

*—Actual range limited by fuze time setting.

154. SHELL, FIXED, PRACTICE, M42B2, W/FUZE, TIME, MECHANICAL, M43 (ALL MODIFICATIONS), 3" GUNS, M1917 (ALL MODELS), M1925MI-25MIA1, M2, AND M4 (fig. 87), closely simulates the service high-explosive rounds in appearance and ballistic characteristics for practice purposes. All components with the exception of the bursting charge of the shell are service items, including a full service propelling charge of NH powder. The shell charge consists of two black powder pellets (0.125 lb each) loaded in the fore part of the charge cavity adjacent to the fuze cup well. The M20 or M20A1 Booster is inserted during manufacture and staked in position. The loaded round is shipped fitted with an M43 Service Fuze (or modifications). The black powder charge serves as a spotting charge for observation and adjustment of fire.

FIXED AND SEMIFIXED ROUNDS AND SEPARATE-LOADING PROJECTILES

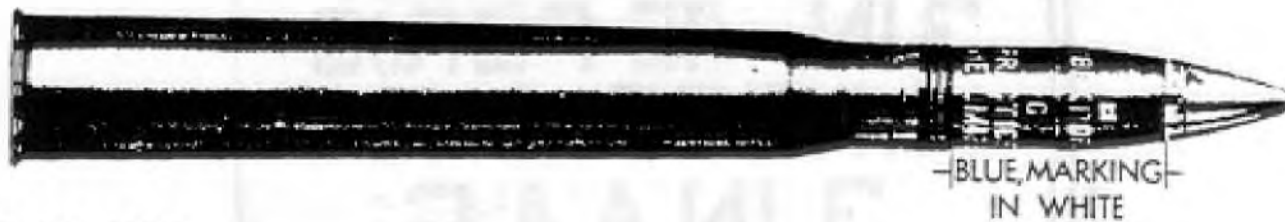

RA PD 80757

Figure 87 — SHELL, Fixed, Practice, M42B2, w/FUZE, Time, Mechanical, M43 (All Modifications), 3" Guns, M1917 (All Models), M1925MI-25MIA1, M2, and M4

DATA

Weight of complete round.....	26.79 lb	Width of rotating band:.....	1.02 in.
Length of complete round.....	37.72 in.	Type of base.....	Square
Length of fuzed projectile.....	12.20 in.	Radius of ogive.....	7.05 cal.
Length of cartridge case.....	26.70 in.	Muzzle velocity	2,800 ft per sec
	Maximum range (at 45 deg).....		12,100 yd*

*—Actual maximum range within limits of maximum fuze setting is: horizontal—11,200 yards at 20 degrees 30 minutes elevation; vertical—9,800 yards at 79 degrees 42 minutes elevation.



RA PD 80756

Figure 88 — SHRAPNEL, Fixed, Mk. I, 3" Guns, M1917 (All Models), M1925MI-25MIA1, M2, and M4

155. SHRAPNEL, FIXED, MK. I, 3" GUNS, M1917 (ALL MODELS, M1925MI-25MIA1, M2 and M4 (fig. 88), is no longer manufactured for 3-inch guns; the supply on hand will be issued for target practice only. A complete round consists of the Mk. IA1 Cartridge Case (a brass case which has been superseded as standard by the Mk. IM2), the M28 Primer, an NH powder propelling charge, and a fuzed projectile. The projectile, similar in construction to that for 75-mm guns, is adapted to seat Mk. III-type 21-second fuzes. The cavity is loaded with lead balls to weight (approx 253 balls).

DATA

Weight of complete round.....	29.38 lb	Width of rotating band:.....	0.55 in.
Length of complete round.....	36.99 in.	Type of base.....	Square
Length of fuzed projectile.....	11.55 in.	Radius of ogive.....	7.00 cal.
Length of cartridge case.....	27.15 in.	Muzzle velocity	2,600 ft per sec
	Maximum range (at 45 deg).....		12,600 yd*

*—Actual maximum range within limits of maximum fuze setting is: horizontal—7,575 yards at 16 degrees 54 minutes; vertical—8,300 yards at 79 degrees.

ARTILLERY AMMUNITION

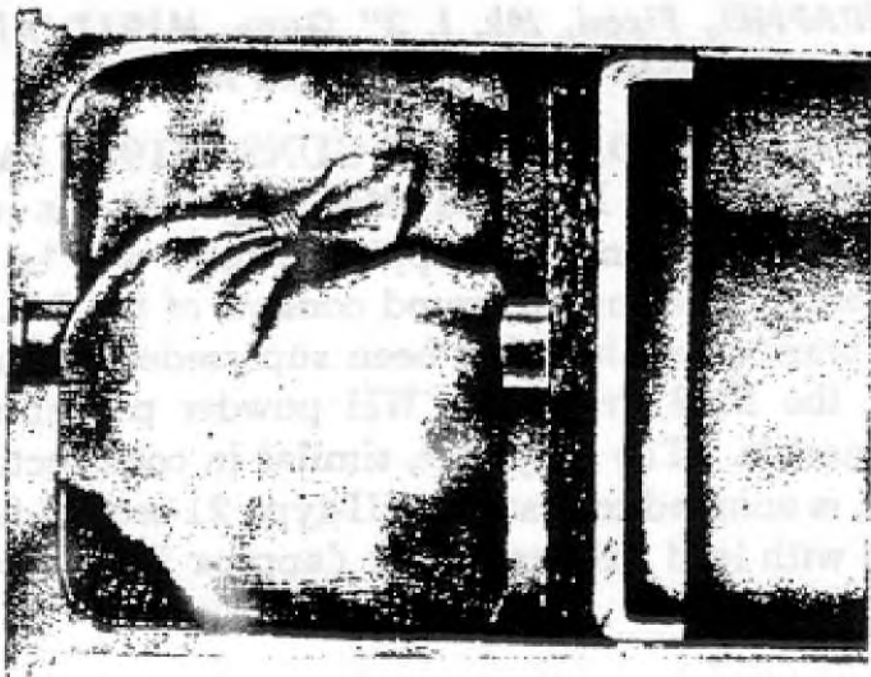
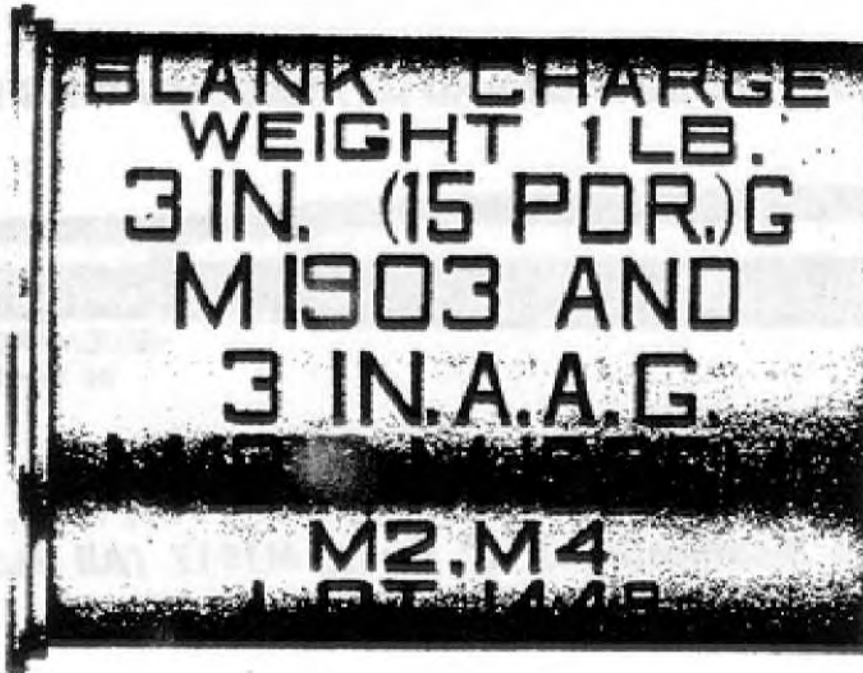

RA PD 80758

Figure 89 — AMMUNITION, Blank, 3" (15-pdr.) Gun, M1903, and 3" Guns, M1917 (All Models), M1925MI-25MIA1, M2, and M4

FIXED AND SEMIFIXED ROUNDS AND SEPARATE-LOADING PROJECTILES

156. **AMMUNITION, BLANK. 3" (15-PDR.) GUN, M1903, AND 3" GUNS, M1917 (ALL MODELS), M1925MI-25MIA1, M2, AND M4** (fig. 89), is authorized for saluting purposes and simulated firing during maneuvers. The complete round consists of the M12 Cartridge Case, containing a 100-grain M1B1A1 Primer and a 1-pound black powder charge. The case is closed at the forward end with a chipboard or pulpboard closing cup which serves both to hold the powder charge in position and to protect it against moisture and foreign matter. The powder charge may be either sodium nitrate composition (commercial blasting powder) or potassium nitrate composition (Army black powder). When the first-mentioned is used, the closing cup has a 0.5-inch felt pad cemented to its inner surface; when potassium nitrate is used, the pad is omitted. The round is similar to that provided for mobile 3-inch guns, differing only with respect to the cartridge case. The M12 is 6 inches long whereas the M13, used with the mobile guns, is 6.625 inches long.

DATA

Weight of complete round..... 4.47 lb Length of complete round..... 6.00 in.
Length of cartridge case..... 6.00 in.

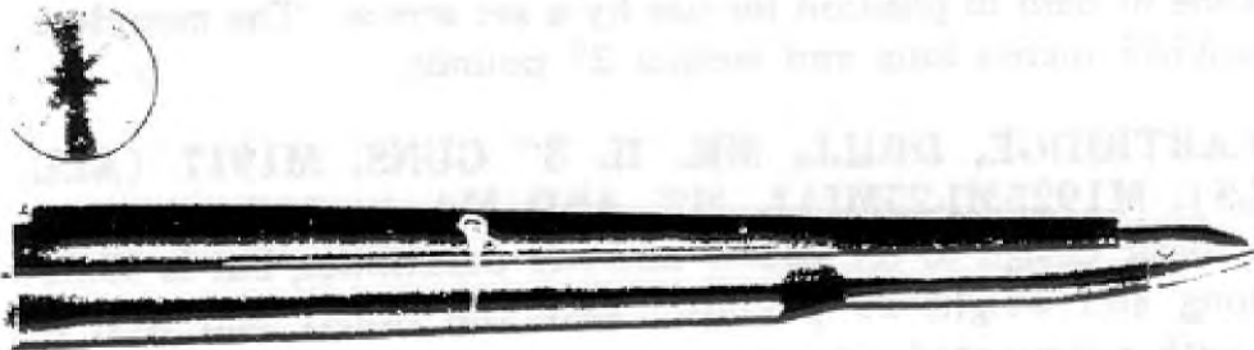

RA PD 80759

Figure 90 — CARTRIDGE, Drill, M9, w/FUZE, Dummy, M59, 3" Guns, M1917 (All Models), M1925MI-25MIA1, M2, and M4, or 3" (15-pdr.) Gun, M1903

157. **CARTRIDGE, DRILL, M9, W/FUZE, DUMMY, M59, 3" GUNS, M1917 (ALL MODELS), M1925MI-25MIA1, M2, AND M4, OR 3" (15-PDR.) GUN, M1903** (fig. 90), is provided for use in training in loading the gun and setting the fuze. It is a 1-piece assembly made up of a body formed to resemble a cartridge case and affixed projectile, closed at the rear with a removable and replaceable base plate and fuzed at the nose with an M59 Dummy Fuze. This drill cartridge may also be designated M9B1. The M9 Drill Cartridge is constructed of bronze and has a base plate which may be manganese bronze or naval brass. The M9B1 has a malleable

ARTILLERY AMMUNITION

Iron body closed by a steel base plate. The M59 Dummy Fuze is an inert steel assembly simulating the selective superquick-delay service fuze, and has a selective setting screw similar to that on the M48. The two cartridges can be distinguished by their painting and marking; the M9 will be so stamped on the base and will be unpainted, whereas the M9B1 will also be stamped on base and be painted black. The complete round weighs 26.76 pounds and is 37.56 inches long.

58. CARTRIDGE, DRILL, M9, W/FUZE, DUMMY, 21-SEC., M42A1, 3" GUNS, M1917 (ALL MODELS), M1925MI-25MIA1, M2, AND M4, OR 3" (15-PDR.) GUN, M1903, except for the fuze, the same as that described in paragraph 157. The M42A1 Fuze is intended to simulate a service time fuze and is of bronze casting or machined naval brass. The contour is stubbier than that of thereamlined M59 Dummy Fuze. As a result, the complete round is shorter, being 35.53 inches long and weighs 27 pounds.

59. CARTRIDGE, DRILL, M3A1, W/FUZE, DUMMY, 21-SEC., M42A1, 3" GUNS, M1917 (ALL MODELS), M1925MI-25MIA1, M2, AND M4, OR 3" (15-PDR.) GUN, M1903, is very similar to the M9 Cartridge with 21-second Dummy Fuze M42A1, differing principally in that the base plate does not screw in place but is a simple slide fit held in position for use by a set screw. The complete round is 35.55 inches long and weighs 27 pounds.

60. CARTRIDGE, DRILL, MK. II, 3" GUNS, M1917 (ALL MODELS), M1925MI-25MIA1, M2, AND M4, is similar in purpose and basic design to the M3A1 and M9 assemblies, but is 39.20 inches long and weighs 29 pounds. Like the M3A1 and M9, it is fitted with a simulated time fuze.

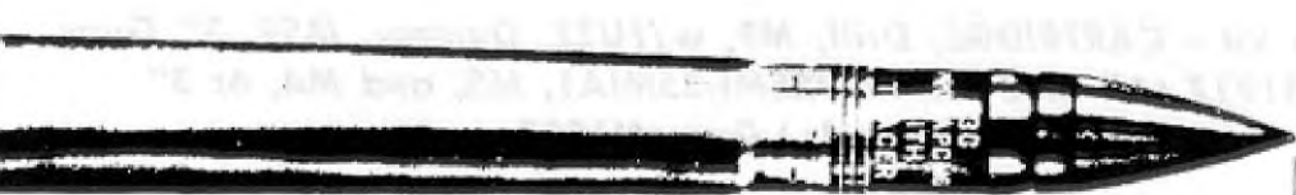

PD 80760

OLIVE DRAB
(MARKING IN YELLOW)

Figure 91 — PROJECTILE, Fixed, A.P.C., M62A1, w/FUZE, B.D., M66A1, and TRACER, 3" Guns, M1918 (All Models), M3, M5, M6, and M7

61. PROJECTILE, FIXED, A.P.C., M62A1, W/FUZE, B.D., M66A1, AND TRACER, 3" GUNS, M1918 (ALL MODELS), M3, M5, M6, AND M7 (fig. 91), has a projectile identical with that used in the corresponding round for the 76-mm gun (par. 139), and it is intended for use against armor plate, particularly face-hard-

FIXED AND SEMIFIXED ROUNDS AND SEPARATE-LOADING PROJECTILES

ened types. The body is solid except for a small cavity in the rear which holds a high-explosive charge. The nose of the body is fitted with an armor-piercing cap to which is affixed a light-weight steel or aluminum ballistic cap or windshield. The base is square (cylindrical behind the rotating band) and threaded to hold the M66A1 Base Fuze. This fuze, a delay-action type, contains a tracer which, operating independent of the fuze mechanism, provides a 3-second trace for observation purposes. Other components consist of the standard M28 Primer, the Mk. IIM2 Cartridge Case, and a 4.87-pound propelling charge of FNH powder. The round is approximately 1¾ inches longer than the corresponding 76-mm round.

DATA

Weight of complete round.....	27.24 lb	Radius of ogive (false ogive)...	7.05 cal.
Length of complete round.....	35.59 in.	Muzzle velocity	2,600 ft per sec*
Length of fuzed projectile.....	9.79 in.	Maximum range (at 45 deg)...	16,000 yd
Length of cartridge case.....	23.08 in.	Penetration (in. at 0-deg obliquity	
Width of rotating band.....	1.02 in.	of face-hardened plate at 1,000	
Type of base.....	Square	yd)	4.7†
		Penetration (in. at 0-deg obliquity of homogeneous plate at 1,000 yd)....	4.7††

*—In M3, M5, M6, and M7 Guns. In M1918 Guns, 2,400 feet per second.
 †—In M3, M5, M6, and M7 Guns. In M1918 Guns, 3.9 inches.
 ††—In M3, M5, M6, and M7 Guns. In M1918 Guns, 4.1 inches.

162. PROJECTILE, FIXED, A.P.C., M62, W/FUZE, B.D., M66A1, AND TRACER, 3" GUNS, M1918 (ALL MODELS), M3, M5, M6, AND M7, is the same as that described in paragraph 161 except for the method of crimping the steel windshield to the armor-piercing cap of the projectile. In the M62A1, a 360-degree roll crimp is used near the end of the windshield, whereas in the M62, the end of the windshield is crimped into the groove. Also, the steel windshield of the M62A1 is slightly heavier, the added weight being offset by a corresponding decrease in weight elsewhere. Data given in paragraph 161 are also applicable to this round.

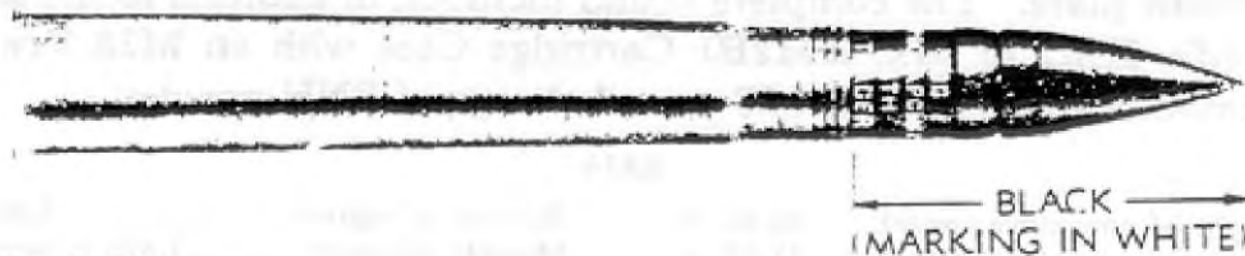

RA PD 80761

Figure 92 — PROJECTILE, Fixed, A.P.C., M62, w/TRACER, 3" Guns, M1918 (All Models), M3, M5, M6, and M7

163. PROJECTILE, FIXED, A.P.C., M62, W/TRACER, 3" GUNS, M1918 (ALL MODELS), M3, M5, M6, AND M7 (fig. 92), has been superseded for current manufacture by the round having the loaded and fuzed type projectile. Other components of the round

ARTILLERY AMMUNITION

are the same as in the round described in paragraph 161 but the projectile cavity is empty and the fuze hole is plugged with a steel plug. This plug holds a tracer which functions like that in fuzeed projectile.

DATA

Weight of complete round.....	26.71 lb	Radius of ogive (false ogive)..	7.05 cal.
Length of complete round.....	35.54 in.	Muzzle velocity	2,600 ft per sec*
Length of projectile.....	8.94 in.	Maximum range (at 45 deg)..	16,000 yd
Length of cartridge case.....	23.08 in.	Penetration (in. at 0-deg obliquity	
Width of rotating band.....	1.02 in.	of face-hardened plate at 1,000	
Type of base.....	Square	yd)	4.7†
Penetration (in. at 0-deg obliquity of homogeneous plate at 1,000 yd)....	4.5††		

*—In M3, M5, M6, and M7 Guns. In M1918 Guns, 2,400 feet per second.

†—In M3, M5, M6, and M7 Guns. In M1918 Guns, 3.9 inches.

††—In M3, M5, M6, and M7 Guns. In M1918 Guns, 4.1 inches.

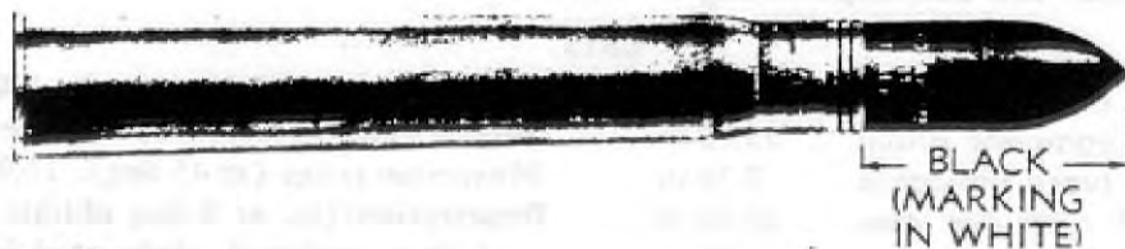

A PD 80763

Figure 93 — SHOT, Fixed, A.P., M79, w/TRACER, 3" Guns, M1918 (All Models), M3, M5, M6, and M7

164. SHOT, FIXED, A.P., M79, W/TRACER, 3" GUNS, M1918 (ALL MODELS), M3, M5, M6, AND M7 (fig. 93), is available both as a substitute for capped armor-piercing rounds for service use, and for target-practice purposes. The M79 Shot is essentially a steel plug formed at the forward end to a relatively blunt nose. There is no armor-piercing cap or ballistic windshield. There is no bursting charge or charge cavity, the body being solid except for a small cavity in the base which holds a red tracer. This tracer is similar to that in the fuzeed M62 or M62A1 Projectiles and burns for the first 3 seconds of flight. The shot is not as well adapted for combatting face-hardened plate as the capped type, but performs satisfactorily against homogeneous plate. The complete round includes, in addition to the shot, the Mk. IIM2 or Mk. IIM2B1 Cartridge Case with an M28 Primer (or modifications) and a 4.38-pound charge of FNH powder.

DATA

Weight of complete round.....	26.56 lb	Radius of ogive.....	1.68 cal.
Length of complete round.....	31.57 in.	Muzzle velocity	2,600 ft per sec*
Length of projectile.....	9.22 in.	Maximum range	12,770 yd
Length of cartridge case.....	23.08 in.	Penetration (in. at 0-deg obliquity	
Width of rotating band.....	1.02 in.	of face-hardened plate at 1,000	
Type of base.....	Square	yd)	3.1†
Penetration (in. at 0-deg obliquity of homogeneous plate at 1,000 yd)....	4.5††		

*—In M3, M5, M6, and M7 Guns. In M1918 Guns, 2,400 feet per second.

†—In M3, M5, M6, and M7 Guns. In M1918 Guns, 2.7 inches

††—In M3, M5, M6, and M7 Guns. In M1918 Guns, 4.0 inches.

FIXED AND SEMIFIXED ROUNDS AND SEPARATE-LOADING PROJECTILES



RA PD 80762

Figure 94 — SHELL, Fixed, H.E., M42A1, NH, w/FUZE, Time, Mechanical, M43 (All Modifications), 3" Guns, M1918 (All Models), and M3

165. SHELL, FIXED, H.E., M42A1, NH, W/FUZE, TIME, MECHANICAL, M43 (ALL MODIFICATIONS), 3" GUNS, M1918 (ALL MODELS), AND M3 (fig. 94), has the same components as the corresponding round for fixed 3-inch guns, described in paragraph 150, except for the cartridge case. For the mobile guns, the round is assembled with the Mk. IIM2 or Mk. IIM2B1 Case, making a slightly shorter and lighter round. The shell in this round is also used in the corresponding 76-mm round (par. 143) but the complete assembly differs both as to cartridge case and fuze.

DATA

Weight of complete round.....	24.91 lb	Width of rotating band.....	1.02 in.
Length of complete round.....	34.05 in.	Type of base.....	Square
Length of fuzed projectile.....	12.36 in.	Radius of ogive.....	7.05 cal.
Length of cartridge case.....	23.08 in.	Muzzle velocity	2,600 ft per sec*
	Maximum range (at 45 deg).....		13,800 yd†

*—In M1918 Guns; in M3 Guns, 2,800 feet per second.
†—In M1918 Guns; in M3 Guns, 14,780 yards.

166. SHELL, FIXED, H.E., M42, NH, W/FUZE, TIME, MECHANICAL, M43 (ALL MODIFICATIONS), 3" GUNS, M1918 (ALL MODELS), AND M3, is similar to that for fixed 3-inch guns described in paragraph 151 except that the shorter and lighter Mk. IIM2 (or Mk. IIM2B1) Cartridge Case is used. Like the assembly for the fixed guns, this round is intended primarily for antiaircraft firing, being adapted for the purpose by fuzing with M43 Mechanical Time Fuze.

DATA

Weight of complete round.....	24.85 lb	Width of rotating band.....	1.02 in.
Length of complete round.....	34.05 in.	Type of base.....	Square
Length of fuzed projectile.....	12.36 in.	Radius of ogive.....	7.05 cal.
Length of cartridge case.....	23.08 in.	Muzzle velocity	2,600 ft per sec*
	Maximum range (at 45 deg).....		13,800 yd†

*—In M1918 Guns; in M3 Guns, 2,800 feet per second.
†—In M1918 Guns; in M3 Guns, 14,780 yards.

167. SHELL, FIXED, H.E., MK. IX, W/FUZE, TIME, MECHANICAL, M43 (ALL MODIFICATIONS), 3" GUNS, M1918 (ALL MODELS), AND M3, is similar to the corresponding round for 3-inch fixed guns, described in paragraph 153, except for the cartridge case. For the mobile guns, the round is assembled with the Mk.

TM 9-1901
167-169

ARTILLERY AMMUNITION

IIM2 or Mk. IIM2B1 Case, making a shorter and lighter round. The Mk. IX Shell resembles the M42A1 and M42 Shell, but differs in that the nose is cut and drilled for the M23 Booster and an adapter which permits use of the M43 Fuzes with the shell. The adapter is shaped to continue the ogival contour of the shell nose. The booster is a brass assembly holding a small booster charge of tetryl and is fitted with an interrupter arrangement providing boresafety. Because of the differences between the M23 and M20 Boosters, the Mk. IX Shell has a slightly larger TNT bursting charge than the standard M42A1 Shell.

DATA

Weight of complete round.....	24.84 lb	Width of rotating band.....	1.02 in.
Length of complete round.....	33.95 in.	Type of base.....	Square
Length of fuzed projectile....	12.32 in.	Radius of ogive.....	7.05 cal.
Length of cartridge case.....	23.08 in.	Muzzle velocity	2,600 ft per sec*
Maximum range (at 45 deg).....		11,000 yd†	

*—In the M1918 Guns; in M3 Guns, 2,800 feet per second.

†—In M1918 Guns; in M3 Guns, 11,800 feet per second.

168. SHELL, FIXED, H.E., M42A1, W/FUZE, P.D., M48A2, SQ & 0.05-SEC. DELAY, 3" (15-PDR.) GUN, M1902MI, AND 3" GUNS, M5, M6, AND M7, has the same projectile as that in the rounds for 3-inch antiaircraft guns (pars. 150 and 165), and that in 76-mm rounds described in paragraph 143. For use in tank and antitank guns, and the 3-inch (15-pdr.) Gun M1902MI, the shell is assembled with the Mk. IIM2 or Mk. IIM2B1 Cartridge Case, and is adapted for firing against ground targets by fuzing with the M48-type impact fuze. Standard fuze for the round is the M48A2, with 0.05-second delay. Rounds of earlier manufacture with M48 or M48A1 Fuzes may be encountered, as well as rounds of more recent assembly which are fitted with modified M48A1 Fuzes having 0.05-second delay instead of the original 0.15-second delay.

DATA

Weight of complete round.....	24.91 lb	Width of rotating band.....	1.02 in.
Length of complete round.....	34.05 in.	Type of base.....	Square
Length of fuzed projectile.....	12.36 in.	Radius of ogive.....	7.05 cal.
Length of cartridge case.....	23.08 in.	Muzzle velocity	2,800 ft per sec
Maximum range.....		14,780 yd	

169. SHELL, FIXED, H.E., M42A1, REDUCED CHARGE, W/FUZE, P.D., M48A2, SQ & 0.15-SEC. DELAY, 3" (15-PDR.) GUN, M1902MI, AND 3" GUNS, M5, M6, AND M7, has the same components as used for the round described in paragraph 168, except for the propelling charge and fuze. Instead of a full propelling charge for 2,800 feet per second muzzle velocity, a reduced charge giving approximately 1,550 feet per second velocity is used. The standard

FIXED AND SEMIFIXED ROUNDS AND SEPARATE-LOADING PROJECTILES

fuze for rounds with this velocity is the M48A2 with 0.15-second delay, but rounds with the M48A1 which also has an 0.15-second delay element may be encountered.

DATA

Weight of complete round.....	21.13 lb	Width of rotating band.....	1.02 in.
Length of complete round.....	34.05 in.	Type of base.....	Square
Length of fuzed projectile.....	12.36 in.	Radius of ogive.....	7.05 cal.
Length of cartridge case.....	23.08 in.	Muzzle velocity	1,550 ft per sec
	Maximum range		8,805 yd

170. SHELL, FIXED, M42, W/FUZE, P.D., M48, 3" (15-PDR.) GUN, M1902MI, AND 3" GUNS, M5, M6, AND M7. has a shell similar to that described in paragraph 151 but is fuzed with the impact type of fuze for firing against ground targets from tank and anti-tank guns and for firing from the 3-inch Seacoast Gun M1902MI. Like the M42A1 Round described in paragraph 168, this round is used with an M48-type fuze having a short delay (0.05 sec); however, other components are the same. Except that the complete round weighs 24.85 pounds, data given in paragraph 168 are applicable.

171. SHELL, FIXED, PRACTICE, M42B2, W/FUZE, TIME, MECHANICAL, M43 (ALL MODIFICATIONS), 3" GUNS, M1918 (ALL MODELS), AND M3, provides practice ammunition for the mobile antiaircraft guns similar to the service AA. rounds. Like the M42B2 Practice Round for the fixed 3-inch AA. guns (par. 154), which has the same projectile but is assembled with the longer, heavier, Mk. IM2 Cartridge Case, all components are service items except for the bursting charge of the shell. This charge consists of two black powder pellets (0.125 lb each), the remainder of the charge cavity being filled with inert material to the required weight. The black powder charge serves as a spotting charge for observation and adjustment of fire.

DATA

Weight of complete round.....	24.94 lb	Width of rotating band.....	1.02 in.
Length of complete round.....	34.05 in.	Type of base.....	Square
Length of fuzed projectile.....	12.20 in.	Radius of ogive.....	7.05 cal.
Length of cartridge case.....	23.08 in.	Muzzle velocity	2,800 ft per sec
	Maximum range (at 45 deg).....		14,780 yd*

*—Actual range limited by fuze time setting.

172. SHRAPNEL, FIXED, MK. I, 3" GUNS, M1918 (ALL MODELS), AND M3, for the mobile antiaircraft guns, is essentially the same as that for the fixed 3-inch guns described in paragraph 155, and like that round, will be issued for target practice only until present supplies are exhausted. The projectile is identical with that in the fixed gun round and functions in the same manner. However, to adapt it for firing from the smaller chamber of the mobile cannon, the

ARTILLERY AMMUNITION

projectile is assembled to the short Mk. IIA1 Cartridge Case. The case is fitted with the standard M28 Primer (modifications) and is loaded with a 4.62-pound charge of NH powder.

DATA

Weight of complete round.....	27.19 lb	Width of rotating band.....	0.55 in.
Length of complete round.....	33.49 in.	Type of base.....	Square
Length of fuzeed projectile.....	11.55 in.	Radius of ogive.....	7.00 cal.
Length of cartridge case.....	27.15 in.	Muzzle velocity	2,600 ft per sec*
	Maximum range (at 45 deg).....		12,600 yd†

*—In M3 Guns; in M1918 Guns, 2,400 feet per second.

†—Actual range limited by fuze time setting. In M1918 Guns, 7,840 yards.



RA PD 80765

Figure 95 — AMMUNITION, Blank, 3" (15-pdr.) Gun, M1902MI, and 3" Guns, M1918 (All Models), and M3

173. **AMMUNITION, BLANK, 3" (15-PDR.) GUN, M1902MI, AND 3" GUNS, M1918 (ALL MODELS), AND M3** (fig. 95), is very similar to the blank ammunition provided for the fixed 3-inch guns, the principal difference being in the cartridge case. For the mobile guns, the M13 Cartridge Case is used. This case is 6.625 inches long whereas the M12 Case for the fixed guns is 6 inches. Other components are the same, and consist of M1B1A1 Primer and a 1-pound charge which may be either sodium nitrate or potassium nitrate composition. With the first-mentioned charge, a closing cup with a felt inner wad or pad is used to close the mouth of the case. With the potassium nitrate charge, the belt wad is unnecessary and is omitted. Weight of complete round is 4.21 pounds.

174. **CARTRIDGE, DRILL, M4A1, W/FUZE, DUMMY, 21-SEC., M42A1, 3" GUNS, M1918 (ALL MODELS), AND M3, OR 3" (15-PDR.) GUN, M1902MI**, is a completely inert bronze cartridge provided for drill with the mobile antiaircraft guns and the 15-pdr. Seacoast Gun M1902MI in loading the piece and setting the fuze. The 1-piece cartridge is fitted to a bronze or brass plate which

FIXED AND SEMIFIXED ROUNDS AND SEPARATE-LOADING PROJECTILES

is locked in position by a set screw. FUZE, dummy, 21-sec., M42A1, is assembled to the cartridge nose, giving a simulated service time fuze. Both the base and the fuze are replaceable if damaged in handling. The complete assembly is 31.90 inches long and weighs approximately 24 pounds.

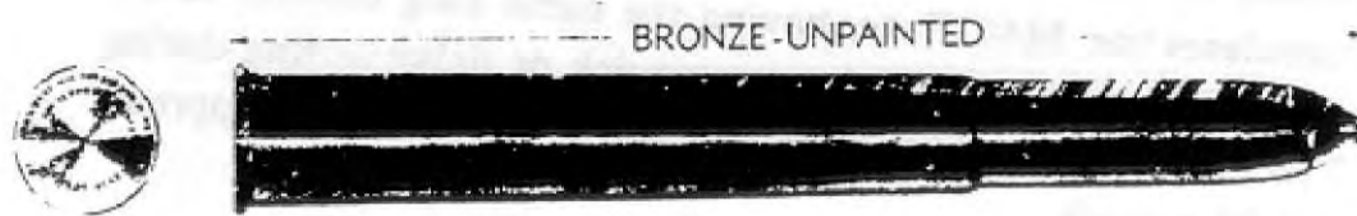

RA PD 80766

Figure 96 — CARTRIDGE, Drill, M10, w/FUZE, 21-sec., M42A1, 3" Guns, M1918 (All Models), and M3, or 3" (15-pdr.) Gun, M1902MI

175. CARTRIDGE, DRILL, M10, W/FUZE, DUMMY, 21-SEC., M42A1, 3" GUNS, M1918 (ALL MODELS), AND M3, OR 3" (15-PDR.) GUN, M1902MI (fig. 96), is similar in size and appearance to older M4A1 design described in paragraph 174. The principal difference is that M10 Cartridge is screwed on to a steel base plate, whereas in the M4A1, the bronze or brass plate is a slide fit. The complete assembly is 31.9 inches long and weighs 24.5 pounds.

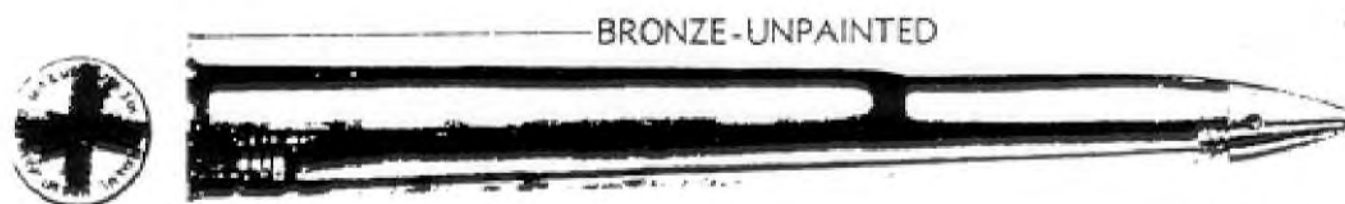

RA PD 80767

Figure 97 — CARTRIDGE, Drill, M15, w/FUZE, Dummy, M59, 3" Guns, M1918 (All Models), M1, M3, M5, M6, and M7 or 3" (15-pdr.) Gun, M1902MI

176. CARTRIDGE, DRILL, M15, W/FUZE, DUMMY, M59. 3" GUNS, M1918 (ALL MODELS), M3, M5, M6, AND M7. OR 3" (15-PDR.) GUN, M1902MI (fig. 97), may also be designated M15B1. Both types are functionally alike and are provided for use in training in loading the gun and in setting the fuze. However, the M15B1 is made of malleable iron and steel, whereas the M15 is made of bronze and brass parts. The assemblies differ from earlier drill cartridges in that the cartridge is fitted at the base end

FIXED AND SEMIFIXED ROUNDS AND SEPARATE-LOADING PROJECTILES

Section XI

AMMUNITION FOR 81-MM MORTARS

177. GENERAL.

a. **General Discussion.** The 81-mm Mortar M1 is a refinement of the 3-inch trench mortar, which no longer is manufactured. The 81-mm mortar, like the 60-mm, is a smooth-bore, muzzle-loading weapon for high-angle fire. It is mounted on tripod mounts for ground placement or for use from motor vehicles, and is employed primarily for infantry and cavalry support. With high-explosive ammunition, a plunging type of fire is obtained. Light and heavy types of explosive rounds are provided for the weapon, together with several chemical rounds for screening purposes and suitable practice and training ammunition. The 81-mm rounds are considered to be "semi-fixed," that is, the propelling charges are adjustable and the round is loaded into the weapon in one operation. All service and practice ammunition is issued and shipped in the form of fuzed complete rounds. The ammunition may be adapted for firing from the Mk. I, IA1, or IA2, 3-inch Mortar by properly reducing the propelling charges.

b. **Identification.** The use of a fin to provide stability of flight to the projectile in place of rotational forces gives a characteristic appearance to the round which serves to distinguish mortar rounds from other artillery types. Complete identification is provided for by painting and marking in accordance with the basic scheme as prescribed in TM 9-1900.

c. **Fuzes.** Service and practice 81-mm rounds are fuzed with point-detonating fuzes. The fuzes in use are: FUZE, P.D., M52; FUZE, P.D., M53; FUZE, P.D., M45; and FUZE, TSQ, M77 (T88). FUZE, P.D., M45, is limited standard, and is assembled only to shell of earlier design. This is a selective superquick and short delay (0.1-sec) fuze. FUZE, P.D., M52, and FUZE, P.D., M53, are single-action types, the M52 providing for superquick action and the M53 having an 0.1-second delay element. The M77 is a combination time and superquick fuze for use with M56 and M57 Shell. Until the M77 Fuze becomes available for use with the M56 Shell, the M52 Fuze is to be issued (ch. 3, sec. I).

d. **Propelling Charges.** Propellant Increments M1 and M2 are now provided for 81-mm mortar ammunition. The M1 Charge is similar to the M3 and M4 Charges for the 60-mm mortar rounds

AMMUNITION FOR 81-MM MORTARS

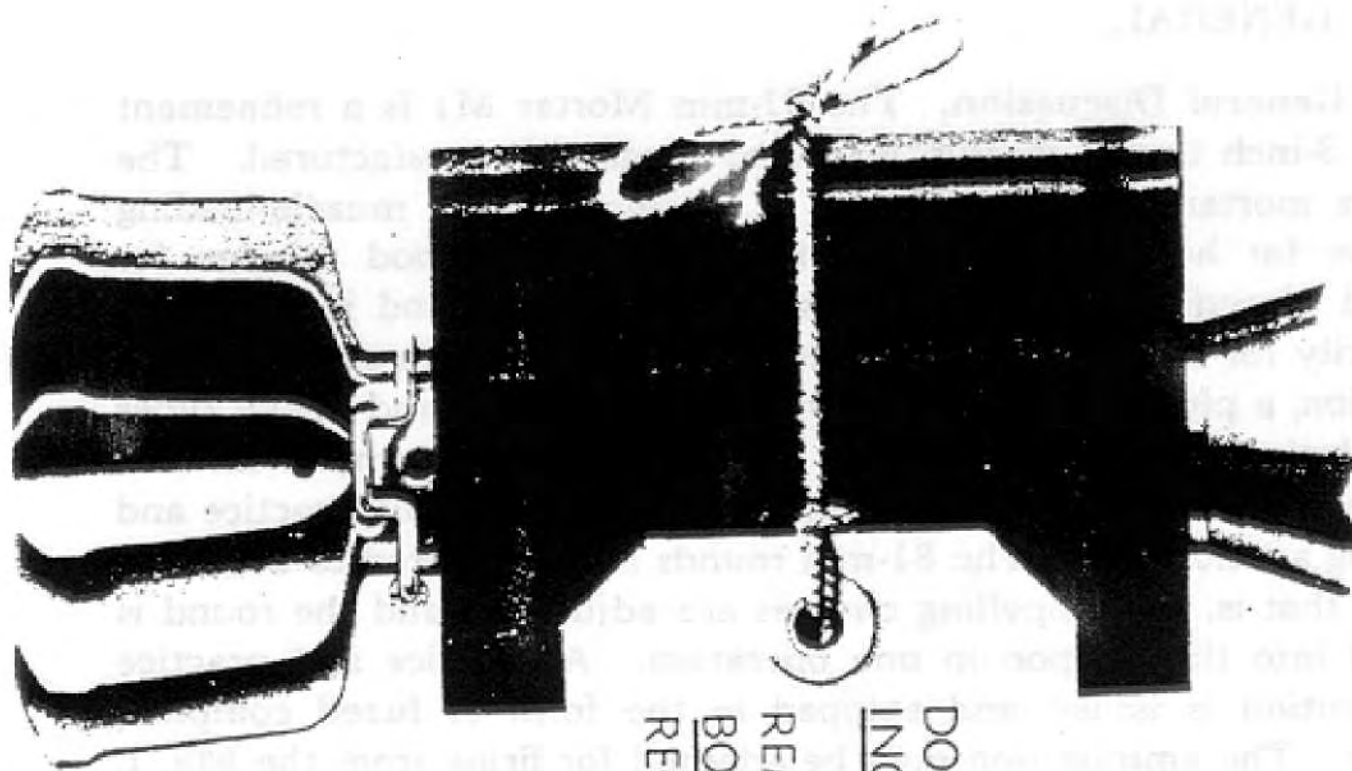

WARNING!
 DO NOT FIRE ROUND WITH
INCREMENTS IN BAGS.
 REMOVE INCREMENTS FROM
BOTH BAGS AND ASSEMBLE
REQUIRED NUMBER TO SHELL.

RA PD 65150

Figure 98 — Method of Shipping M2 Increments for 81-mm Shell, M56 and M57

FIXED AND SEMIFIXED ROUNDS AND SEPARATE-LOADING PROJECTILES

and assembled in the same manner to the fin assembly. The M1A1 Increments are the same as M1 Increments but are shipped in individual cellophane bags for protection against moisture. A full charge consists of six increments for the High-explosive, and Practice Rounds M43A1, and of four increments for the High-explosive M45 and M45B1 Rounds and the Practice M44 Rounds. Not more than four increments are to be used in firing from the 3-inch trench mortars. The M2 Charge or increment differs from the other trench-mortar increments in that it has a slit from the center hole to one edge to provide for seating on the fin shaft of the M56 High-explosive and M57 Chemical Shell. Four increments comprise a full charge and not more than three are to be used in 3-inch trench mortar firing. For protection in shipment, four M2 Increments are packed in a foil-cell asphalt paper bag, containing an inner cellophane bag, and this asphalt bag with increments is wrapped around the fin shaft (fig. 98). The increments must be removed from *both* bags before firing. The M2A1 Increments consist of the same propelling charge as the M2 but of different design and are individually cellophane-wrapped. The M2A1 Increments are held around the fin shaft by the M3 Holder. An older type of charge consists of loose powder held in a celluloid container, four containers making a full charge. All increments of all types of charges are removable as required for zone firing. In case all the increments are removed from a round for firing Charge O, the Ignition Cartridge M6, or the older M3, serves solely as the propellant. For the heavy High-explosive Rounds M56 and M45B1, and Chemical Round M57, the minimum charge used is charge 1, that is, ignition cartridge plus one increment.

e. **Primers and Ignition Cartridges.** For all current manufacture, PRIMER, percussion, M33 or M34, is used in conjunction with CARTRIDGE, ignition, M6, to ignite the propelling increments. The M6 Cartridge and M33 and M34 Primers have replaced the M3 Cartridge which included the primer, except for the Training Projectile, M68. However, the M3 may still be found in older assemblies (ch. 3, sec. III).

178. COMPLETE ROUND TABLE.

a. Data concerning the complete rounds of 81-mm mortar ammunition, and components thereof, are given in table 17, chapter 5.

179. PACKING AND SHIPPING DATA.

a. Packing and shipping data for the rounds are given in ORD 11 SNL R-4.

ARTILLERY AMMUNITION

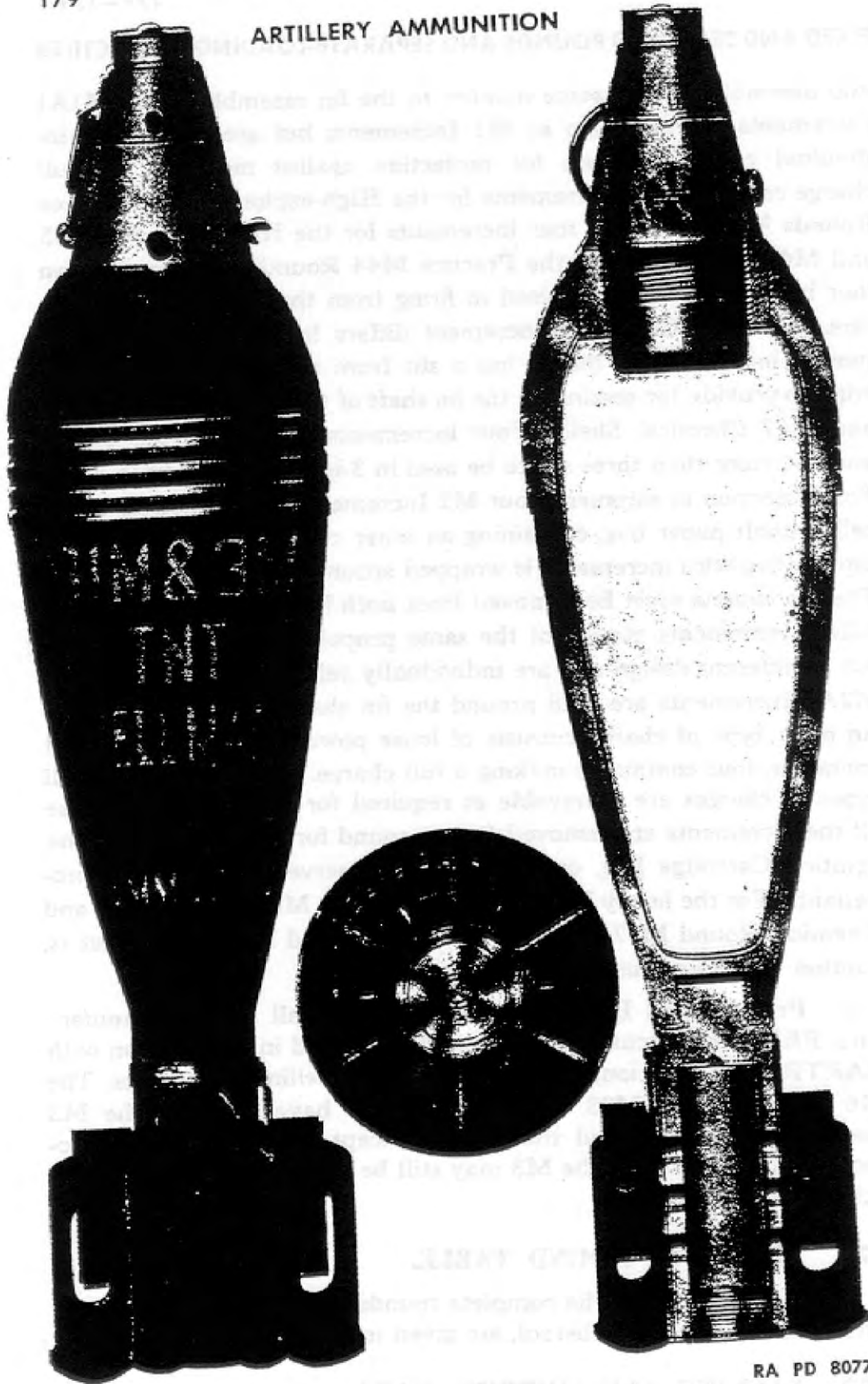

RA PD 80770

Figure 99 — SHELL, H.E., M43A1, w/FUZE, P.D., M52, 81-mm Mortar, Complete Round

FIXED AND SEMIFIXED ROUNDS AND SEPARATE-LOADING PROJECTILES

180. SHELL, H.E., M43A1, W/FUZE, P.D., M52, 81-MM MORTAR, COMPLETE ROUND (fig. 99), is a light-weight round provided for fragmentation and blast effect. The complete round is made up of six components: the M43A1 Shell, an M52 Superquick Fuze, a fin assembly, an M1 Propellant Charge, an M6 Ignition Cartridge, and an M33 Percussion Primer. The shell consists of a thin-walled egg-shaped steel casing holding a 1.23-pound high-explosive charge. The shell casing is cut and threaded at the nose end to fit an adapter into which the M52 Fuze with its booster is screwed after the shell is loaded, the bursting charge being shaped at the free end to provide a suitable well for the booster. The base of the shell is drilled and threaded to hold the fin assembly. The fin assembly consists of three double-bladed fins welded to a cylindrical shaft. The shaft is drilled and threaded internally at the rear to hold the igniter cartridge and the primer, the latter holding the cartridge in position. The shaft is threaded at the front end to screw into the base of the shell. Vents in the shaft provide for transmission of the cartridge flash to the propellant increments and facilitate burning and disintegration of the cartridge and case. The propellant increments are pushed into the spaces between the fin blades and held there by a spring clip arrangement which permits easy removal as desired. The M43A1 Round may be adapted for the 3-inch trench mortar by reducing the outer zone propelling charge from six to four increments. With the M52 Fuze, the shell functions with superquick action and before any appreciable penetration of the target.

DATA

Weight of complete round.....	7.10 lb	Length of projectile, w/fin....	13.27 in.
Length of complete round.....	13.27 in.	Muzzle velocity	700 ft per sec*
		Maximum range	3,290 yd*

*—For six increments (full charge). Corresponding data for other charges are:

	Muzzle Velocity (ft per sec)	Maximum Range (yd)
Charge 0 (ignition cartridge only)	235	541
Charge 1 (ignition cartridge plus one increment).....	332	1,020
Charge 2 (ignition cartridge plus two increments).....	419	1,502
Charge 3 (ignition cartridge plus three increments).....	449	2,042
Charge 4 (ignition cartridge plus four increments).....	572	2,517
Charge 5 (ignition cartridge plus five increments).....	638	2,963

ARTILLERY AMMUNITION

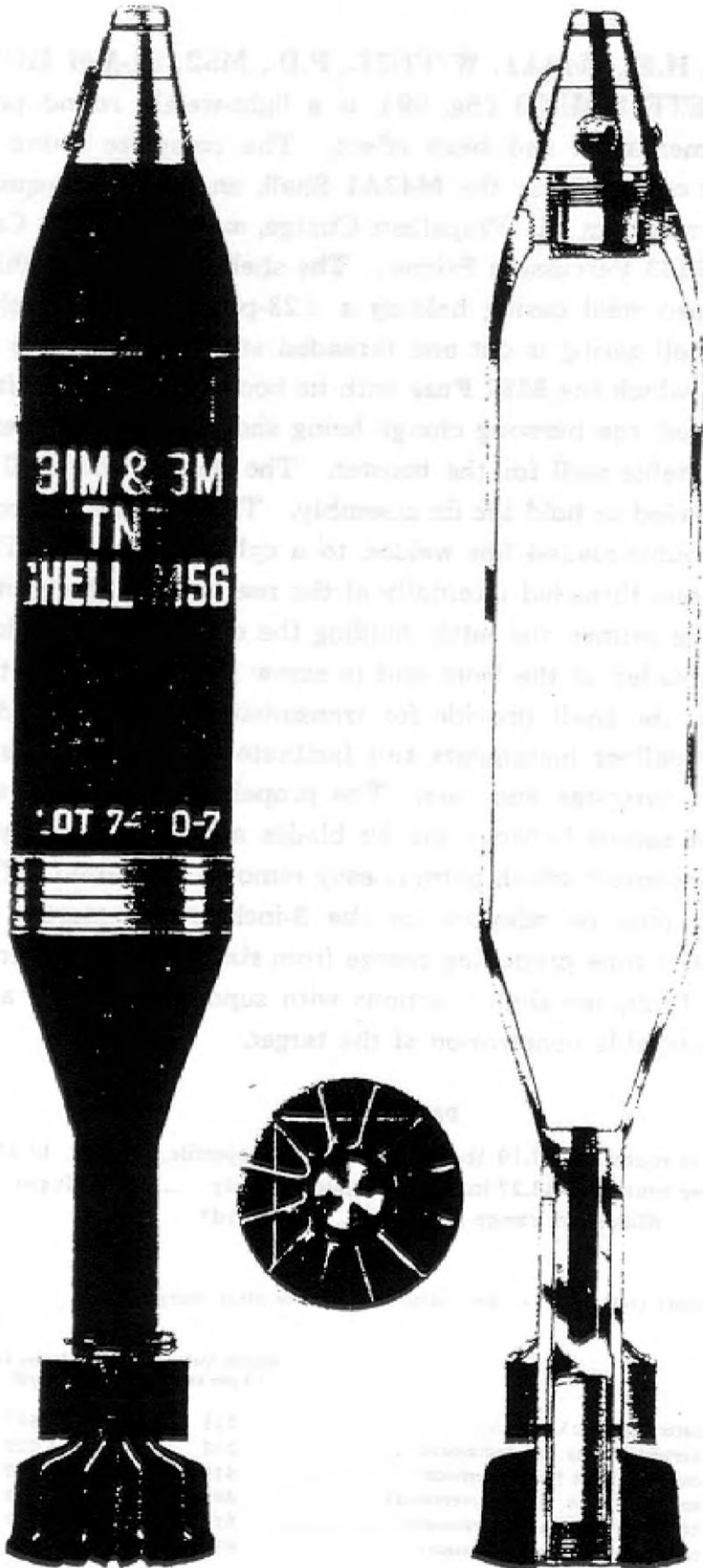

RA PD 80771

Figure 100 -- SHELL, H.E., M56, w/FUZE, P.D., M53, 81-mm Mortar, Complete Round

FIXED AND SEMIFIXED ROUNDS AND SEPARATE-LOADING PROJECTILES

181. SHELL, H.E., M56, W/FUZE, P.D., M53, 81-MM MORTAR, COMPLETE ROUND (fig. 100), is the heavy type of the two current standard rounds for fragmentation and blast effect. The complete round consists of six components: the M56 Shell, an M53 Short-delay Fuze, a fin assembly, an M2 Propelling Charge, an M6 Ignition Cartridge, and an M34 Percussion Primer. Rounds of future manufacture will also be assembled with FUZE, TSQ, M77. Until the M77 Fuze is available, the FUZE, P.D., M52, will be issued. The projectile is made up of a 4.3-pound high-explosive charge (TNT or an alternative) held in a thin-walled shell made of steel tubing. The shell casing is formed to a long cylindrical shape with a long tapered (boat-tailed) base and a short ogival nose. The nose is threaded to hold an adapter into which the fuze with its booster is screwed and staked after the shell is loaded. The tapered base is drilled and threaded to hold the fin assembly. The fin assembly is an aluminum alloy die casting with 12 blades seated on a hollow cylindrical shaft. The shaft acts as a sleeve for a steel liner which is threaded at the front end to screw into the shell base. The rear of the liner is hollow and holds the ignition cartridge and primer, the latter screwing in and holding the cartridge in position. The shaft is vented to permit transmission of the ignition of the flash cartridge to the propelling increments. The M2 Propelling Charge comprises four increments or bundles of propelling powder in the form of square flakes or sheets. The flakes have a hole through the center and a slit from center to edge to permit seating on, and removal from, the fin shaft. The increments are held against the front edges of the fin blades by a spring clip arrangement. See figure 98 for method of shipping M2 Increments. The M2A1 Increments (cellophane-wrapped) are held flat around the fin shaft by means of the Holder M3. The M56 Round may be adapted for firing from the 3-inch trench mortar by reducing the outer zone propelling charge from four to three increments.

DATA

Weight of complete round.....	10.82 lb	Length of projectile, w/fin....	22.89 in.
Length of complete round.....	22.89 in.	Muzzle velocity	583 ft per sec*
		Maximum range	2,560 yd*

*—For four increments (full charge). Corresponding data for other charges are:

	Muzzle Velocity (ft per sec)	Maximum Range (yd)
Charge 1	306	875
Charge 2	412	1,474
Charge 3	502	2,046

ARTILLERY AMMUNITION



RA PD 80772

Figure 101 — SHELL, Smoke, Phosphorus, WP, M57, w/FUZE, P.D., M52, 81-mm Mortar, Complete Round

FIXED AND SEMIFIXED ROUNDS AND SEPARATE-LOADING PROJECTILES

182. SHELL, SMOKE, PHOSPHORUS, WP, M57, W/FUZE, P.D., M52, 81-MM MORTAR, COMPLETE ROUND (fig. 101), is assembled from the same components as are used with the M56 High-explosive Round (par. 181) but is loaded with a phosphorus filler for screening purposes. To adapt the M57 Shell for this filler, the nose of the shell casing is fitted with a special adapter. This serves to provide the tight seal necessary with chemical loading and also acts as the seat for the burster assembly. The burster consists of a thin-walled tubing filled with a small charge of tetryl. This assembly extends from the nose longitudinally through the chemical filler for about three-quarters the length of the cavity. Its function is to burst the shell casing and scatter the chemical contents. The superquick type of fuze is fitted to the shell to provide for burst before penetration. White phosphorus burns with a dense smoke and has an incendiary effect. For firing the 3-inch trench mortar, the maximum charge is reduced from four to three increments.

DATA

Weight of complete round.... 11.61 lb* Length of projectile, w fin... 22.89 in.
Length of complete round..... 22.89 in. Muzzle velocity 560 ft per sec
Maximum range..... 2,466 yd†

*—Weight with M52B2 Fuze (plastic head) is 11.57 pounds.

†—For four increments (full charge). Corresponding data for other charges are:

	Muzzle Velocity (ft per sec)	Maximum Range (yd)
Charge 1	297	833
Charge 2	399	1,409
Charge 3	484	1,952

183. SHELL, SMOKE, FS, M57, W/FUZE, P.D., M52, 81-MM MORTAR, COMPLETE ROUND, is assembled from the same components as are used with the M56 High-explosive Round (par. 181), but is loaded with FS, a liquid smoke-producer which functions very much like white phosphorus, but lacks the incendiary effect. It differs from that described in paragraph 182 only with respect to the kind of chemical filler.

DATA

Weight of complete round.... 12.11 lb* Length of projectile, w fin... 22.89 in.
Length of complete round..... 22.89 in. Muzzle velocity 544 ft per sec†
Maximum range 2,431 yd†

*—Weight with M52B2 Fuze (plastic head) is 12.07 pounds.

†—For four increments (full charge). Corresponding data for other charges are:

	Muzzle Velocity (ft per sec)	Maximum Range (yd)
Charge 1	291	808
Charge 2	390	1,374
Charge 3	472	1,916

ARTILLERY AMMUNITION

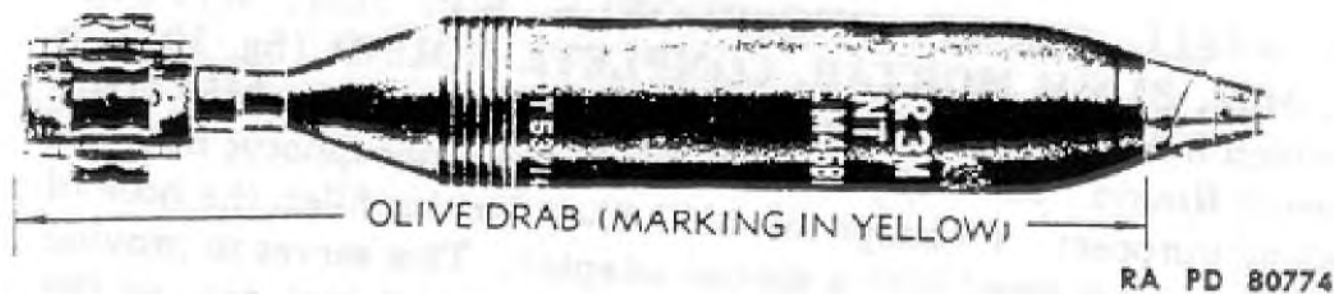

Figure 102 — SHELL, H.E., M45B1, w/FUZE, P.D., M53, 81-mm Mortar, Complete Round

184. SHELL, H.E., M45B1, W/FUZE, P.D., M53, 81-MM MORTAR, COMPLETE ROUND (fig. 102), is an earlier design which is no longer being manufactured. The round is essentially the same as the current standard rounds and intended for the same purposes. However, the M45B1 Shell is longer and heavier than the shell now being manufactured but contains less explosive in relation to the total weight of the loaded shell. The fin assembly consists of a short shaft with four supports to which are spring-hinged four slightly arched leaves. These are held in a closed position by shear pins prior to firing, and are released and open to form stabilizing vanes during flight. In the closed position, the leaves provide a shallow cup-like seat for the propelling charge. The charge used consists of loose powder grains held on a celluloid container. Four of these comprise a full charge. The M3 Ignition Cartridge, which includes the primer, is assembled to this round, being seated as in other rounds, in a hole in the shaft beneath the fin. The shaft is vented to permit the flash from the cartridge to reach the propellant increments. The short-delay type of fuze is used with this round. This ammunition can be fired from the 3-inch trench mortar, without adjustments.

DATA

Weight of complete round.....	15.15 lb	Length of projectile, w/fin....	23.62 in.
Length of complete round.....	23.62 in.	Muzzle velocity	380 ft per sec*
	Maximum range		1,275 yd*

*—For four increments (full charge). Corresponding data for other charges are:

	Muzzle Velocity (ft per sec)	Maximum Range (yd)
Charge 1	216	446
Charge 2	276	715
Charge 3	330	986

185. SHELL, H.E., M45, W/FUZE, P.D., M45, 81-MM MORTAR, COMPLETE ROUND, differs principally from the M45B1, described in paragraph 184, with respect to the fuze. FUZE, P.D., M45, is a selective type providing for superquick or short-delay (0.1-sec) functioning. Because of the difference in the fuze, the complete round weighs slightly less than the M45B1 (15.10 lb), and is slightly shorter (23.59 in.).

FIXED AND SEMIFIXED ROUNDS AND SEPARATE-LOADING PROJECTILES



RA PD 80776

Figure 103 — SHELL, Practice, M44, w/FUZE, P.D., M52, 81-mm Mortar, Complete Round

186. SHELL, PRACTICE, M44, W/FUZE, P.D., M52, 81-MM MORTAR, COMPLETE ROUND (fig. 103), simulates the M43A1 High-explosive Round for use in practice. When loaded and fuze, the cast-iron projectile weighs the same as the service shell. However, the shell loading consists of 0.2 pound of black powder together with sufficient inert material to give the required shell weight. Since ballistic and other characteristics are the same as for the M43A1 Service Round, data given in paragraph 180 also are applicable to the M44 Round.



RA PD 80775

Figure 104 — SHELL, Practice, M43A1, w/FUZE, P.D., M52, 81-mm Mortar, Complete Round

187. SHELL, PRACTICE, M43A1, W/FUZE, P.D., M52, 81-MM MORTAR, COMPLETE ROUND (fig. 104), is an alternative practice round to the M44. It is an adaptation of the M43A1 Service Round (par. 180) for practice purposes, accomplished by changing the shell filler. All other components are the same as for the service round, and construction and assembly of these in the round are the same. For practice purposes, the shell cavity is filled with an inert material (plaster of paris and stearic acid) except for a 0.06-pound black powder pellet. The black powder is loaded at the front end of the cavity, adjacent to the rear wall of the booster casing when the fuze is assembled to the shell. The fuze booster and black powder pellet provide a spotting charge for observation of fire. Ballistic properties are the same as for the M43A1 Service Round and data given in paragraph 180 are applicable to the practice round.

ARTILLERY AMMUNITION

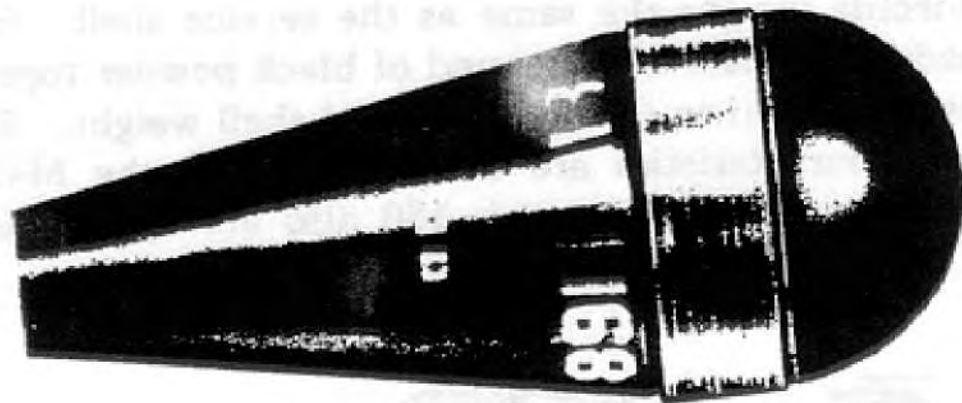
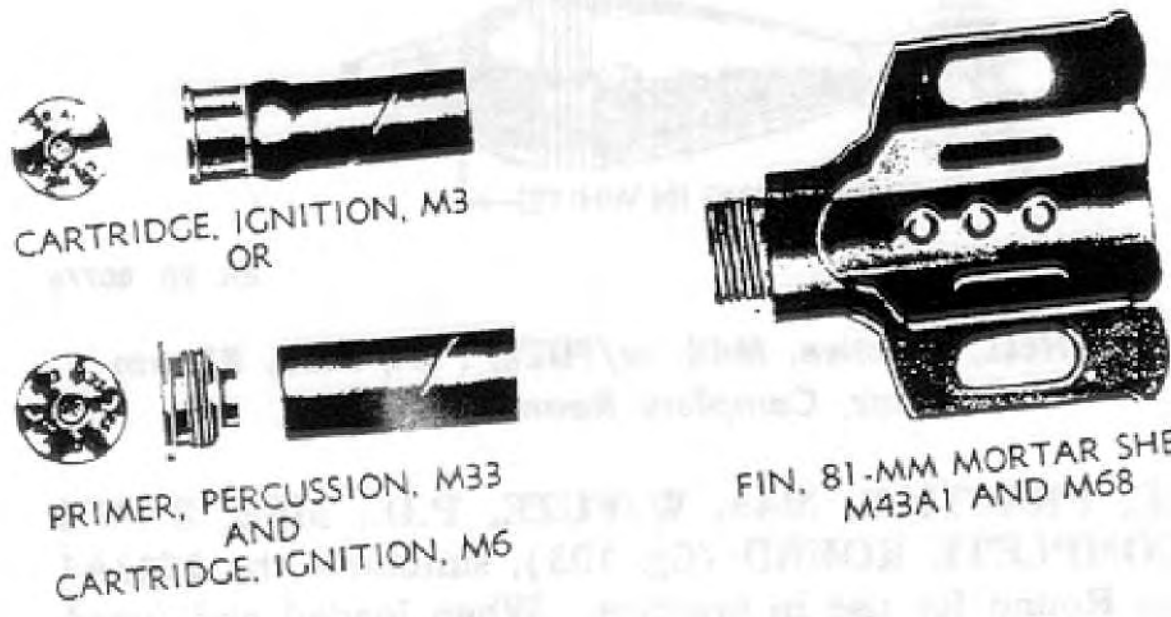

SHELL, TRAINING, M68, 81-MM MORTAR W/O FIN,
IGNITION CARTRIDGE AND PRIMER

A — COMPONENTS

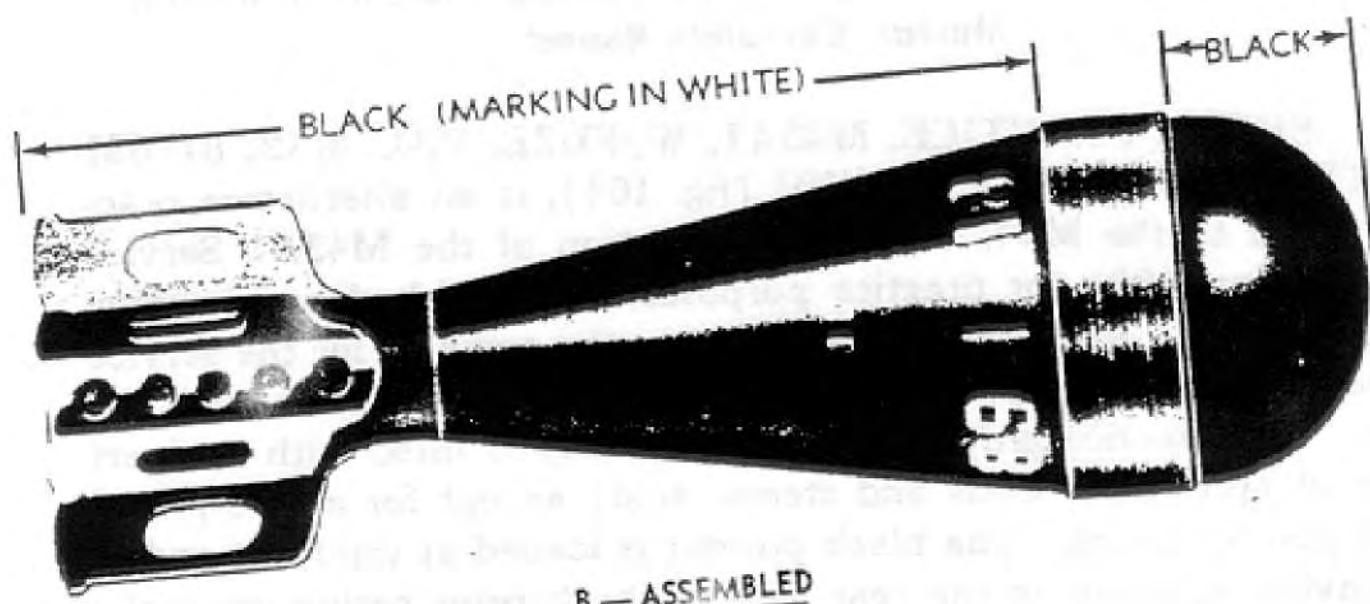

B — ASSEMBLED

RA PD 26816

Figure 105 — SHELL, Training, M68, 81-mm Mortar

FIXED AND SEMIFIXED ROUNDS AND SEPARATE-LOADING PROJECTILES

188. SHELL, PRACTICE, M43, W/FUZE, P.D., M52, 81-MM MORTAR, COMPLETE ROUND, an earlier design of practice round, is essentially the same as the M43A1 described in paragraph 187. However, a somewhat smaller (0.04 lb) black powder pellet is loaded in the shell and the propelling increments are held in position by inserting two corners of each bundle in the slots of the fin blades. Ballistic properties are similar to those of the M43A1 Practice and Service Rounds. Data given in paragraph 180 are applicable to this round.

189. SHELL, TRAINING, M68, 81-MM MORTAR, W/O FIN, IGNITION CARTRIDGE, AND PRIMER (fig. 105), is provided for drill in loading and firing the mortar. The projectile is completely inert and has no fuze, consisting of a cast-iron body shaped to a pear or tear-drop contour, and drilled at the narrow base to hold a service-type fin assembly similar to that on the M43A1 Projectiles. No propellant increments are issued or used, but the M3 Ignition Cartridge, or if this is not available the combination of the M33 Ignition Cartridge and M6 Percussion Primer, is issued for use in firing the projectile. The four components are issued separately to facilitate replacement of damaged or worn-out parts and the procurement of extra ignition cartridges. A training kit used in the field holds 10 training shell and accessories, including a ground hook used in the recovery of fired training shell.

DATA

Weight of complete round.....	10.82 lb	Length of projectile	7.92 in.
Length of complete round.....	11.08 in.	Muzzle velocity	172.8 ft per sec
Weight of projectile	9.8 lb	Maximum range	306 yd

ARTILLERY AMMUNITION

Section XII

AMMUNITION FOR 90-MM GUNS

190. GENERAL.

a. **General.** Originally intended for antiaircraft defense, the 90-mm gun has since been adapted, by the use of various types of mounts, for use also against ground and water-borne targets. Of the several models of 90-mm guns now in use, all have the same type of chamber and can fire the same ammunition. The ammunition is of the fixed type, that is the rounds have propelling charges which are not adjustable and are loaded into the cannon in one operation. Armor-piercing, high-explosive, practice, blank, and drill rounds are provided. Rounds requiring fuzes are shipped with fuzes assembled. Once removed from packing materials, the rounds require only adjustment of the fuzes to be ready for firing.

b. **Identification.** Painting and marking for identification is in accordance with the basic color scheme as prescribed in TM 9-1900.

c. **Fuzes.** Shell for antiaircraft use are fitted with the M43 Mechanical Time Fuze (all modifications), which permits adjustment of setting to 30 seconds but has no impact element. Shell for ground fire or anti-motor-torpedo-boat defense are shipped fuzed with M48 series fuzes. These provide for selective superquick or delay setting, for surface burst or for detonation after penetration or upon ricochet with either 0.05-second or 0.15-second delay. The modification, M48A2, is manufactured with either delay, depending on the lot. The M48 and M48A1 Fuzes are manufactured with 0.05-second and 0.15-second delay, respectively, but some M48A1 Fuzes modified to have 0.05-second delay elements are in existence. Fuzes with 0.15-second delay are used in anti-motor-torpedo-boat firing, while models with the short (0.05-sec) delay are used against ground targets. Loaded armor-piercing projectiles are fitted with FUZE, B.D., M68, a base-detonating fuze which functions with delay action. Practice and drill rounds are fitted with either dummy or inert service fuzes. For a complete description of fuzes, see chapter 3, section I.

d. **Cartridge Cases.** CASE, cartridge, 90-mm, M19, made of brass, is standard for all ammunition except blank. Substitute standard is CASE, cartridge, 90-mm, M19B1. The M19B1 is a steel case weighing 10.1 pounds whereas the brass case weighs 11 pounds. CASE, cartridge, M27 or M27B1, is used with 90-mm blank ammunition.

FIXED AND SEMIFIXED ROUNDS AND SEPARATE-LOADING PROJECTILES

e. NH (nonhygroscopic, flashing) propellant powder has been established as standard for all 90-mm ammunition except time-fuzed rounds, which, for AA. fire, will be loaded with FNH (flashless nonhygroscopic) powder. Impact-fuzed rounds with FNH powder are to be reserved for target-practice firing insofar as is practicable. Time-fuzed NH rounds will be used for daytime fire or for practice until supplies are exhausted and replaced by rounds with the standard propellant.

f. **Primers.** PRIMER, percussion, 300-grain, M28A2, is standard for all ammunition for 90-mm guns except blank ammunition. Alternative primer is PRIMER, percussion, 300-grain, M28B2 (steel). Rounds of earlier manufacture may have PRIMER, percussion, 300-grain, M28A1 or M28B1A1. PRIMER, percussion, 100-grain, M1B1A2, is used with blank ammunition (ch. 3, sec. III).

191. COMPLETE ROUND TABLE.

a. Data concerning complete rounds for 90-mm guns, and components thereof, are given in table 18, chapter 5.

192. PACKING AND SHIPPING DATA.

a. Packing and shipping data for 90-mm ammunition are given in ORD 11 SNL's P-5, P-7, and P-8.

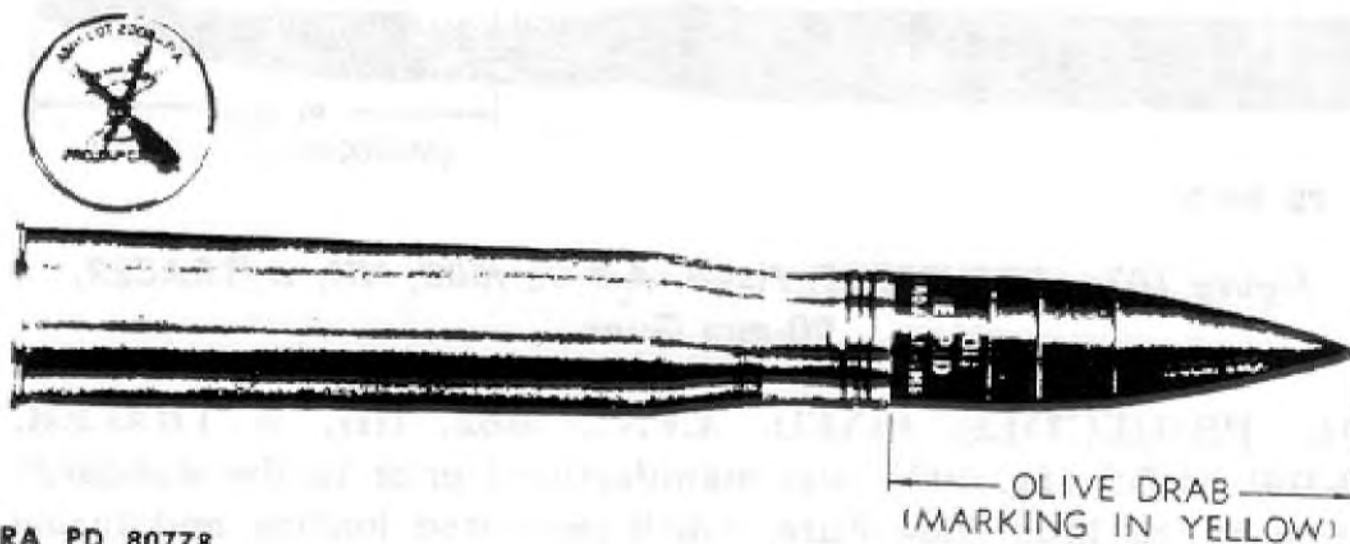

RA PD 80778

Figure 106 — PROJECTILE, Fixed, A.P.C., M82, NH, w/FUZE, B.D., M68, and TRACER, 90-mm Guns

193. PROJECTILE, FIXED, A.P.C., M82, NH, W/FUZE, B.D., M68, AND TRACER, 90-MM GUNS (fig. 106), is provided for 90-mm guns for use against ground targets, particularly armored materiel. The projectile, which has been manufactured both with and without a high-explosive charge (par. 194) is similar to other standard types especially adapted for combating face-hardened armor. The body proper is made of hard steel, with a square base and a nose

ARTILLERY AMMUNITION

shaped to a relatively short ogive. The nose is sweated to a softer steel cap, on which in turn is screwed a light-weight steel ballistic cap or windshield. The rear portion of the body contains a small cavity which, in the loaded projectile, holds a small charge of explosive D. The base hole is threaded to receive the M68 Base-detonating Fuze. This fuze, a simple inertia type, functions with delay action. The rear housing of the fuze extends approximately $\frac{3}{4}$ inch beyond the rear surface of the projectile base. This portion of the fuze contains a red tracer for observation purposes. Operating independent of the fuze mechanism, the tracer composition is ignited by the propelling charge when the round is fired. It burns with a visible tracer for about 3 seconds, equivalent to a range of about 2,400 yards.

DATA

Weight of complete round.....	42.75 lb	Radius of ogive (false ogive) ..	9.09 cal.
Length of complete round.....	38.24 in.	Muzzle velocity	2,650 ft per sec
Length of fuzed projectile.....	16.19 in.	Maximum range	13,540 yd
Length of cartridge case.....	23.70 in.	Penetration (in. at 0-deg obliquity	
Width of rotating band.....	1.20 in.	of face-hardened plate at 1,000	
Type of base.....	Square	yd)	6.0
		Penetration (in. at 0-deg obliquity of homogeneous plate at 1,000 yd)....	5.5



RA PD 80779

Figure 107 — PROJECTILE, Fixed, A.P.C., M82, NH, w/TRACER, 90-mm Guns

194. PROJECTILE, FIXED, A.P.C., M82, NH, W/TRACER, 90-MM GUNS (fig. 107), was manufactured prior to the standardization of the M68 Base Fuze, which permitted loading and fuzing the projectile for blast as well as penetrating effect. In this round, the projectile bursting charge cavity is left empty. The base hole is plugged with a steel plug which contains a tracer similar to that in the fuze of the loaded projectile. Weight of the complete round is 42.04 pounds; over-all length of the projectile is 15.49 inches, 0.70 inch less than the fuzed projectile due to the omission of the fuze, otherwise, the data in paragraph 193 is applicable to this round.

195. SHOT, FIXED, A.P., M77, NH, W/TRACER, 90-MM GUNS (fig. 108), has the same components, other than the projectile, as the M82 Armor-piercing-capped Round, and is used for the same purpose. The shot is a solid steel slug similar in contour to the body of the

FIXED AND SEMIFIXED ROUNDS AND SEPARATE-LOADING PROJECTILES

M82 Projectile but lacking the armor-piercing cap and ballistic windshield of the standard projectile and without explosive. The base is drilled to provide a small cavity for holding a red tracer. The tracer is similar to that in the loaded and fuzed round and burns for approximately 3 seconds.



RA PD 80782

Figure 108 — SHOT, Fixed, A.P., M77, NH, w/TRACER, 90-mm Guns

DATA

Weight of complete round.....	42.04 lb	Radius of ogive	1.51 cal.
Length of complete round.....	32.75 in.	Muzzle velocity	2,700 ft per sec
Length of projectile.....	10.00 in.	Maximum range	12,790 yd
Length of cartridge case.....	23.70 in.	Penetration (in. at 0-deg obliquity	
Width of rotating band.....	1.20 in.	of face-hardened plate at 1,000	
Type of base.....	Square	yd)	4.5
		Penetration (in. at 0-deg obliquity of homogeneous plate at 1,000 yd)....	5.5

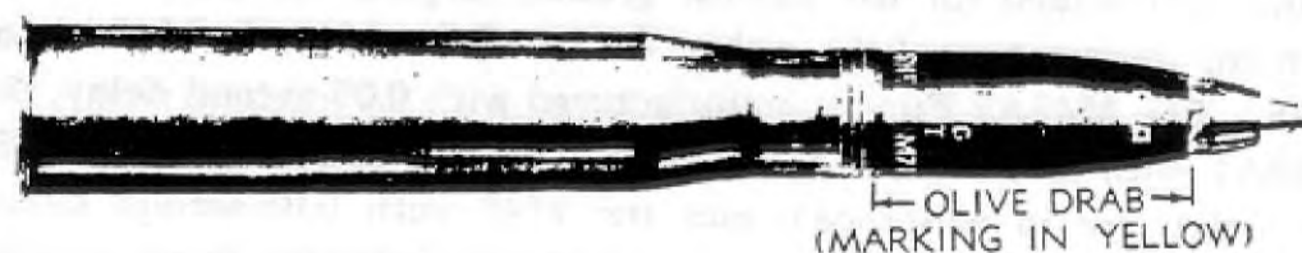

RA PD 80781

Figure 109 — SHELL, Fixed, H.E., M71, w/FUZE, Time, Mechanical, M43 (All Modifications), 90-mm Guns

196. SHELL, FIXED, H.E., M71, W/FUZE, TIME, MECHANICAL, M43 (ALL MODIFICATIONS), 90-MM GUNS (fig. 109), consists of a hollowed steel casing containing a high-explosive filler and a booster, and fitted with a point fuze. The bursting charge cavity tapers in conical fashion over the lower half of the cavity and is hemispherical at the bottom. The result is a relatively small cavity, with comparatively thick walls, for a high-explosive shell. The base is boat-tailed and the nose formed to a long ogive, the sweep of which is continued by the contour of the fuze. When to be fired against aircraft, the projectile is fitted with the M43 Mechanical Time Fuze. This fuze gives selective time setting up to 30 seconds but has no impact element. To obtain the desired fragmentation and blast effect, the shell is loaded with TNT; an alternative high-explosive is 50-50

TM 9-1901
196-199

ARTILLERY AMMUNITION

amatol. The high-explosive charge is shaped at the front end to provide for a booster well. When 50-50 amatol is used, an additional booster is provided by surrounding the booster well with TNT. BOOSTER, M20A1, is a manufacturing component of the shell, being inserted after loading and staked permanently in position.

DATA

Weight of complete round.....	42.04 lb	Degree of taper.....	7 deg 15 min
Length of complete round.....	37.44 in.	Radius of ogive	9.01 cal.
Length of fuzeed projectile.....	16.37 in.	Muzzle velocity	2,700 ft per sec
Length of cartridge case.....	23.70 in.	Maximum range	
Width of rotating band.....	1.20 in.	(at 45 deg).....	19,560 yd*†
Type of base	Boat-tailed		

*—Effective maximum range limited by fuze time limits to around 13,000 yards.

†—Range shown in horizontal range; maximum vertical height is about 12,000 yards.

197. SHELL, FIXED, H.E., M71, NH, W/FUZE, P.D., M48A2, SQ & 0.05-SEC. DELAY, 90-MM GUNS, has the same components as the round described in paragraph 196, except for the fuze. Since this round is intended for use against ground targets, the shell is fuzeed with an impact type fuze, either FUZE, P.D., M48A2, M48A1, or M48. The M48A2 Fuze is manufactured with 0.05-second delay, the M48A1 with 0.15-second delay (although modified fuzes with 0.05-sec delay are in existence), and the M48 with 0.05-second delay. The short-delay models are prescribed for batteries firing against ground targets. As loaded with a 7.31-pound propelling charge of NH powder, the projectile has a muzzle velocity of 2,700 feet per second and a maximum range of approximately 19,500 yards (at approx 45 deg 45 min). Other data is the same as that given in paragraph 196 for the time-fuzed AA. round.

198. SHELL, FIXED, H.E., M71, NH, W/FUZE, P.D., M48A2, SQ & 0.15-SEC. DELAY, 90-MM GUNS, is exactly the same as the M71 Round described in paragraph 197 except for the delay element in the fuze. The data described in paragraphs 196 and 197 are applicable. This long-delay fuze (0.15-sec delay) is for use in rounds to be fired in anti-motor-torpedo-batteries.

199. SHELL, FIXED, PRACTICE, INERT LOADED, M71, NH, W/FUZE, DUMMY OR INERT, M73, 90-MM GUNS, is provided for training in marksmanship in anti-motor-torpedo-boat firing. It differs from the M71 Service Round in that the shell is loaded with inert material and fuzeed with an inert service M48A1 Fuze or FUZE, dummy, M73. Data for the practice round is the same as that for the M71 Round given in paragraphs 197 and 196.

FIXED AND SEMIFIXED ROUNDS AND SEPARATE-LOADING PROJECTILES

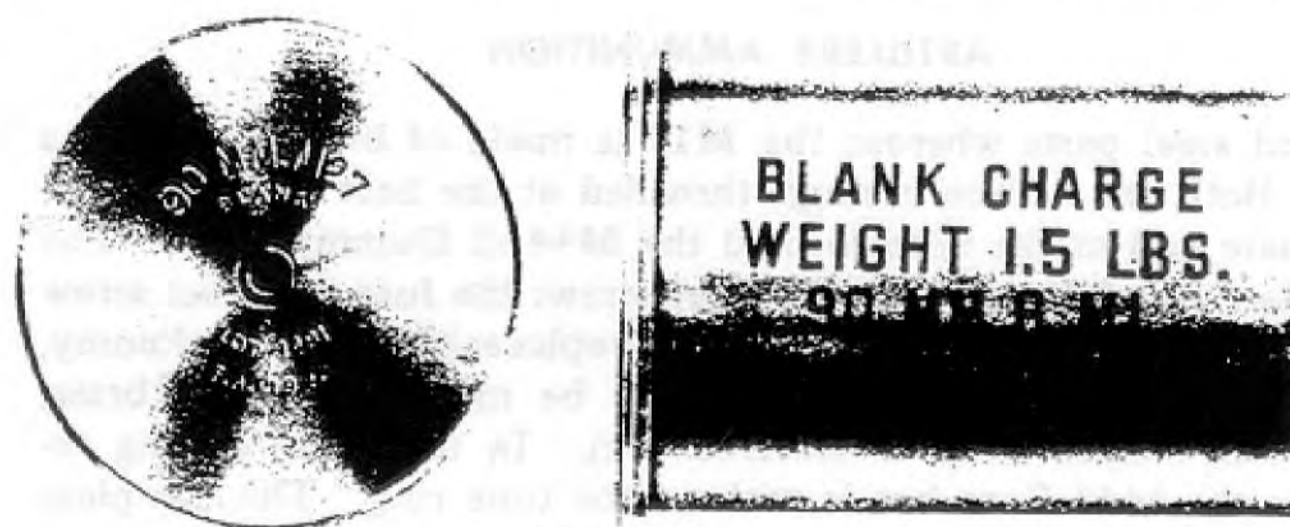

RA PD 80783

Figure 110 — AMMUNITION, Blank, 90-mm Guns

200. AMMUNITION, BLANK, 90-MM GUNS (fig. 110), consists of the M27 or M27B1 (steel) Cartridge Case, similar to a service case but shortened to 7.25 inches; a 100-grain M1B1A2 Primer or alternative PRIMER, percussion, 100-grain, M1A2; and a 1.5-pound charge of black powder (sodium nitrate). The round is constructed like other standard types of blank ammunition, the blank charge being held in a cotton bag which is so loaded into the cartridge case as to surround the primer. The charge is held firmly in position at the base of the case by a closing cup assembly. For 90-mm blank ammunition, the closing cup assembly consists of two pulpboard disks glued one to each surface of a felt disk or wad. The assembly is inserted into the case and glued securely in position about 2.42 inches from the mouth of the case. Weight of complete round is 8.23 pounds and length is 7.27 inches.



RA PD 80784

Figure 111 — CARTRIDGE, Drill, M12, w/FUZE, Dummy, M44A2, 90-mm Guns

201. CARTRIDGE, DRILL, M12, W/FUZE, DUMMY, M44A2, 90-MM GUNS (fig. 111), may be stamped either M12 or M12B1. Both are functionally alike and completely inert. However, the M12B1, which is being manufactured at present, is made of malleable

ARTILLERY AMMUNITION

iron and steel parts whereas the M12 is made of bronze and brass parts. Both are 1-piece castings threaded at the base to receive the base plate and at the nose to hold the M44A2 Dummy Fuze. The base plate is held in position by a set screw; the fuze, by a set screw and shoe arrangement. Both parts are replaceable. FUZE, dummy, M44A2, used with this cartridge, may be made of bronze, brass, aluminum, copper alloy or sintered iron. In form, the casting resembles the M43 Fuze but is without the time ring. The complete assembly weighs 39.15 pounds, and is 37.44 inches long. This drill cartridge is not used in the 90-mm M2 Gun which has a power-operated rammer.

201. ARTILLERY AMMUNITION. BLANK CARTRIDGE (Fig. 111) consists of the M12 or M12B1 (steel) Cartridge Case similar to a service cartridge, but threaded at the base to receive the M44A2 Dummy Fuze and a 1-piece casting of bronze or steel (shoe and set screw). The fuze is connected to the case by a shoe and set screw. The blank cartridge case is held in a carrier which is so loaded into the cartridge case as to surround the fuze. The carrier is held firmly in position in the case by a locking cup assembly. For 90-mm blank ammunition, the locking cup assembly consists of two polygonal disks, the outer one of a flat disk of steel. The assembly is in contact with the case and fuze assembly so that about 2.43 inches from the mouth of the case. The fuze is weighed about 2.33 pounds and weighs 2.77 pounds.



FIGURE 111. BLANK CARTRIDGE. (Fig. 111) consists of the M12 or M12B1 (steel) Cartridge Case similar to a service cartridge, but threaded at the base to receive the M44A2 Dummy Fuze and a 1-piece casting of bronze or steel (shoe and set screw). The fuze is connected to the case by a shoe and set screw. The blank cartridge case is held in a carrier which is so loaded into the cartridge case as to surround the fuze. The carrier is held firmly in position in the case by a locking cup assembly. For 90-mm blank ammunition, the locking cup assembly consists of two polygonal disks, the outer one of a flat disk of steel. The assembly is in contact with the case and fuze assembly so that about 2.43 inches from the mouth of the case. The fuze is weighed about 2.33 pounds and weighs 2.77 pounds.

FIXED AND SEMIFIXED ROUNDS AND SEPARATE-LOADING PROJECTILES

Section XIII

AMMUNITION FOR 105-MM HOWITZERS

202. GENERAL.

a. **General Discussion.** Two distinct types of 105-mm howitzer are now in use—the M2, M2A1, and M4 type and the M3 type. The M2 and M2A1 are the basic models making up the traditional light field howitzer mounted on split-trail type carriage. These models also are used as assault artillery by the armored forces. The M4 Howitzer is mounted in the medium tanks. The M3 is basically of the same design, being a stripped-down and shortened light-weight M2A1 Howitzer for infantry and air-borne service. Except that ammunition for the M3 model has a smaller quicker-burning propelling charge, rounds provided for the 105-mm howitzers are alike. All rounds are classified as semifixed ammunition, and all have adjustable propelling charges for zone firing, with one exception. The H.E., A.T. round is a special type in that the charge is fixed, that is, not adjustable, the cartridge case and projectile not being crimped together because of the method of packing and shipment. Standard projectiles are shipped with fuzes assembled.

b. **Identification.** Painting and marking for identification is in accordance with the basic scheme as prescribed in TM 9-1900. Rounds for the M2, M2A1, and M4 Howitzers may be readily identified from those for the M3 by the marking on the packing containers, and on the round itself, since the designation of the cannon is marked on containers and on base of cartridge case of each round (fig. 112).

c. **Fuzes.** FUZE, B.D., M62, or M62A1, is assembled in the base of the H.E., A.T. Shell M67. These are boresafe base-detonating fuzes which function with nondelay action. High-explosive shell are assembled as shipped with either FUZE, P.D., M48, M48A1, M48A2, or FUZE, TSQ, M54. The M48, M48A1, and M48A2 Fuzes are selective superquick-delay types. They function alike except for differences in the length of delay (0.05 sec in the M48, 0.15 sec in the M48A1 although modified fuzes with 0.05-sec delay are in existence, and 0.05 sec or 0.15 sec in the M48A2, depending on the lot). FUZE, TSQ, M54, is a combination time and superquick type in which the superquick action is always operative. It will function on impact unless prior functioning has been caused by time action. FUZE, P.D., M57, a single-action superquick type, is used with the chemical shell. This fuze is used in order to give surface bursts, and thereby, the most effective dissemination of the smoke or gas filler of the shell. For a complete description of the fuzes, see chapter 3, section I.

ARTILLERY AMMUNITION

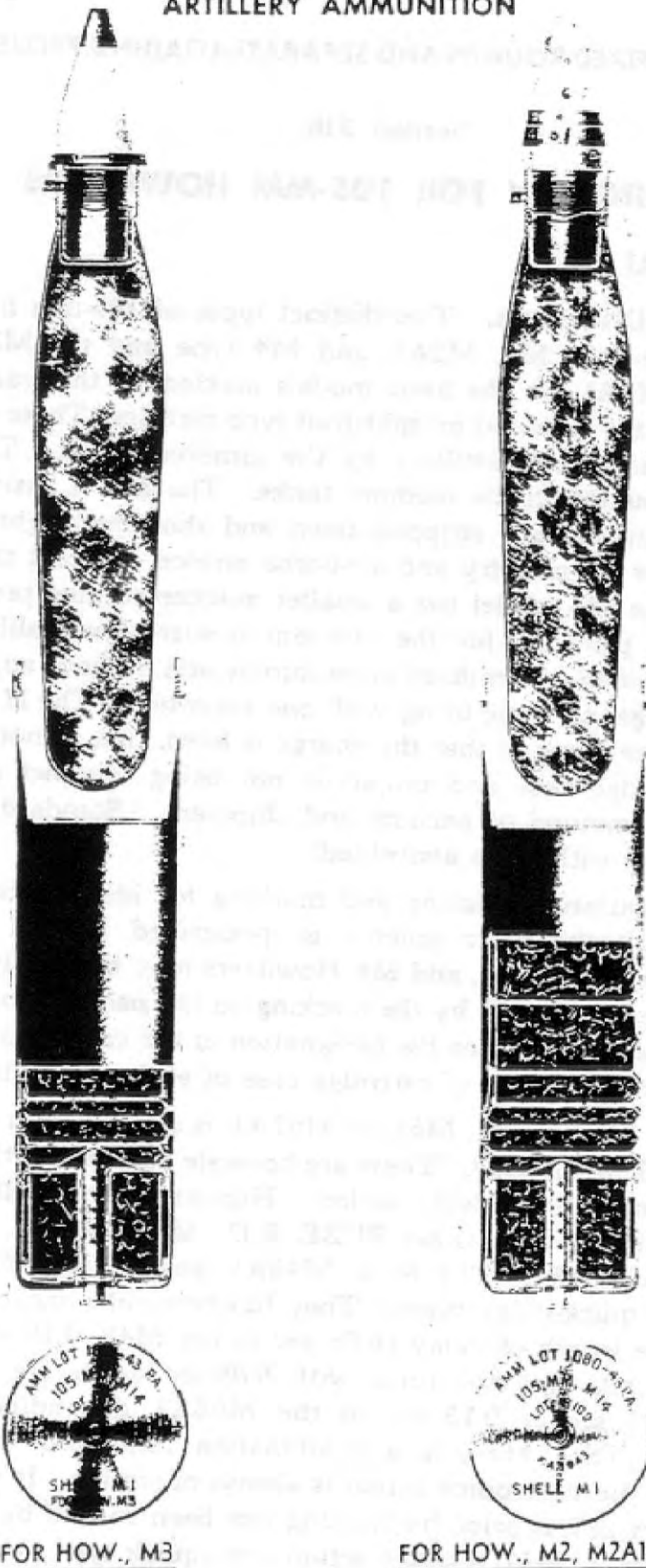

FOR HOW., M3

FOR HOW., M2, M2A1, AND M4

RA PD 80785

Figure 112 – Comparison of 105-mm Howitzer Complete Rounds

FIXED AND SEMIFIXED ROUNDS AND SEPARATE-LOADING PROJECTILES

d. **Cartridge Cases.** CASE, cartridge, 105-mm, M14, made of brass, is standard for all 105-mm howitzer ammunition. Substitute standard is the M14B1 Cartridge Case which is made of steel and weighs approximately 0.5 pound less than the standard brass case due to a thinner head and primer seat. Prior to the change in cartridge case for the H.E., A.T. shell from a crimped case to the removable type, two types of cartridge case were made (type I and type II). Type II had a mouth with a slightly smaller diameter, to adapt it for crimping to the H.E., A.T. shell. However, all cases now used are type I, that is, the free-fit or removable type.

e. **Propelling Charges.** Although assembled with removable cartridge case, the H.E., A.T. round has a fixed (nonadjustable) propelling charge. Propelling charges of all other rounds are divided into parts to permit adjusting for zone firing. For rounds to be fired from the M2, M2A1, and M4 Howitzers, the full (outer zone) charge consists of seven sections, a base charge and six increments, providing for seven zones of fire. For the M3 Howitzer, the full charge consists of five sections, a base charge and four increments, for five zones of fire. The powder for each section is assembled in a cloth bag on which is marked the number of the charge. The base charge (charge 1) is tied to a retainer in the bottom of the cartridge case. The first increment, or second section (charge 2) is tied to the base increment by a long twine. The other increments, in numerical order, are tied to each other with a short twine. This permits withdrawal of the increments, except the base charge, to the mouth of the cartridge case where those increments not required for the particular inner zone to be fired may be removed by cutting or breaking the twine. The increments to be used are then readily reassembled in the cartridge case in numerical order, the increment the number of which corresponds to the zone to be fired being uppermost. All increments up to and including the number of the charge to be fired are required to fire the charge called for. Thus, to fire charge 3 the base charge (marked "1") and increments marked "2" and "3," in numerical order, must be used. The sections are of unequal weight and, hence, are not interchangeable. Propelling charges for the M2, M2A1, and M4 Howitzers are not directly interchangeable with those for the M3 Weapon since the latter consists of a quicker-burning powder. However, the high-explosive rounds may be used interchangeably as outlined in paragraph f, below.

CAUTION: *For the M3 Howitzer, zone 5 charge will not be fired above a 45-degree elevation except in case of emergency. Zones 1, 2, 3, and 4 charges may be fired up to elevation of 65 degrees.*

f. **Interchangeability.** By applying suitable corrections for the resultant velocities listed below, the M1 High-explosive Rounds for

ARTILLERY AMMUNITION

the M3 Howitzer may be fired with full charge, or any part thereof, in the M2, M2A1, and M4 Howitzers. Conversely, M1 H.E. Rounds for the M2 and M2A1 Weapons may be fired in the M3 Howitzer, *but*, due to poor obturation, low pressures, and excessive muzzle flash, *only with charges 1 through 3, and then only in cases of extreme emergency.* Suitable corrections for the resultant different velocities must be made. Muzzle velocities and maximum range obtained with interchanged rounds are:

M1 Round for M3 Howitzer When Fired in M2 and M2A1 Howitzers			M1 Round for M2, M2A1, and M4 Howitzers When Fired in the M3 Howitzer		
Charge	Muzzle Velocity (ft per sec)	Maximum Range (yd)	Charge	Muzzle Velocity (ft per sec)	Maximum Range (yd)
1	695	4,293 (at 43° 36')	1	605	3,357 (at 43° 28')
2	755	4,974 (at 43° 38')	2	660	3,920 (at 43° 27')
3	825	5,711 (at 43° 24')	3	730	4,690 (at 43° 11')
4	925	7,050 (at 43° 24')			
5	1,080	8,967 (at 43° 14')			

g. **Primer.** PRIMER, percussion, 100-grain, M1B1A2, is used with all rounds except the H.E., A.T. Round M67, which uses the 300-grain Primer M28A2. Alternative primers for the M1B1A2 are 100-grain M1, M1A1, M1B1, or M1B1A1 Primers (ch. 3, sec. III).

203. COMPLETE ROUND TABLE.

a. Data concerning the complete rounds of 105-mm howitzer ammunition, and components thereof, are given in table 19, chapter 5.

204. PACKING AND SHIPPING DATA.

a. Packing and shipping data for the ammunition described in this section are published in ORD 11 SNL's R-1, R-5, and R-6.

205. SHELL, SEMIFIXED, H.E., M1, W/FUZE, P.D., M48A2, SQ & 0.15-SEC. DELAY, 105-MM HOW., M2, M2A1, AND M4 (fig. 113), consists of the M14 or M14B1 Cartridge Case fitted with the standard primer and an FNH propelling charge (seven increments), assembled with free fit to the fuzed M1 Projectile. The M1 Projectile is similar to other standard high-explosive shell of modern design. The body is a relatively thin-walled steel shell with boat-tailed base and a nose formed to a long ogive and threaded to hold a point fuze. The fuze contour continues the long sweep of the shell nose, maintaining the streamlined effect throughout the assembly. The bursting charge is TNT—or the alternative 50-50 amatol—formed at the front end to provide a well for the booster. When

FIXED AND SEMIFIXED ROUNDS AND SEPARATE-LOADING PROJECTILES

50-50 amatol is loaded in the cavity, a booster surround consisting of a small amount of TNT is used. BOOSTER, M20A1, is a standard manufacturing component of the M1 Shell, being inserted after

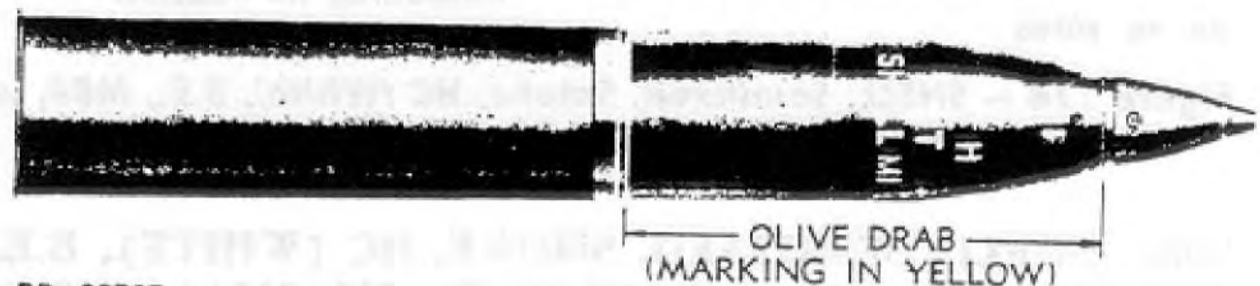

RA PD 80787

Figure 113 – SHELL, Semifixed, H.E., M1, w/FUZE, P.D., M48A2, SQ & 0.15-sec. Delay, 105-mm How., M2, M2A1, and M4

the shell is loaded and secured permanently in position by a set screw. As fuzed with FUZE, P.D., M48A2 (or M48A1 in the case of rounds of earlier manufacture), giving selective superquick or delay (0.15-sec) setting, the shell is adapted for firing for fragmentation and blast effect with surface burst, or after penetration or on ricochet.

DATA

Weight of complete round.....	42.07 lb	Type of base	Boat-tailed
Length of complete round.....	31.07 in.	Degree of taper	9 deg 15 min
Length of fuzed projectile.....	19.63 in.	Radius of ogive	6.02 cal.
Length of cartridge case.....	14.64 in.	Muzzle velocity	1,550 ft per sec*†
Width of rotating band.....	0.81 in.	Maximum range (at 44 deg)	12,205 yd*†

*—When fired in the M2, M2A1, and M4 Howitzers. For muzzle velocity and range data when this round is fired in the M3 Howitzer, see paragraph 202 f.
†—With full charge (charge 7); corresponding data for other charges are:

	Muzzle Velocity	Maximum Range
Charge 1	650 ft per sec	3,825 yd (at 48°38')
Charge 2	710 ft per sec	4,475 yd (at 43°38')
Charge 3	780 ft per sec	5,280 yd (at 43°24')
Charge 4	875 ft per sec	6,430 yd (at 43°24')
Charge 5	1,020 ft per sec	8,295 yd (at 43°14')
Charge 6	1,235 ft per sec	10,150 yd (at 43°17')

206. SHELL, SEMIFIXED, H.E., M1, W/FUZE, P.D., M48, 105-MM HOW., M2, M2A1, AND M4, is the same as the round with M48A1 or M48A2 Fuze described in paragraph 205, except that FUZE, P.D., M48 has an 0.05-second delay element incorporated in its delay action train.

207. SHELL, SEMIFIXED, H.E., M1, W/FUZE, TSQ, M54, 105-MM HOW., M2 AND M2A1, differs from those described in paragraph 205 only with respect to the fuze. FUZE, TSQ, M54, provides alternative setting for superquick action or over any time up to 25 seconds after firing the round. The superquick action is always operative, providing for detonation of the shell bursting charge should prior action not be caused by the time train. This fuze adapts the shell for time fire or high-burst ranging.

ARTILLERY AMMUNITION

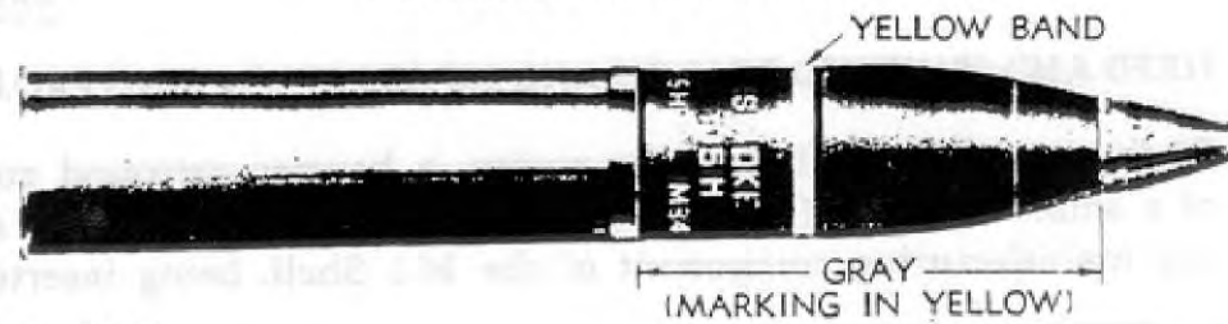

RA PD 80788

Figure 114 — SHELL, Semifixed, Smoke, HC (White), B.E., M84, w/FUZE, TSQ, M54, 105-mm How., M2, M2A1, and M4

208. SHELL, SEMIFIXED, SMOKE, HC (WHITE), B.E., M84, W/FUZE, TSQ, M54, 105-MM HOW., M2, M2A1, AND M4 (fig. 114), is assembled with one of the several new types of smoke shell intended to overcome certain deficiencies of the bursting type smoke shell. It is a base-ejection shell consisting essentially of a drawn steel tubing containing a small black powder expelling charge at the nose end and three canisters of HC smoke mixture (fig. 5). The shell casing, like that of the M60 Chemical Shell, resembles the high-explosive shell in outward appearance, being boat-tailed and having the nose formed to the same long ogive. Internal construction differs in that the cavity is cylindrical in shape and extends the full length of the shell. Both ends are threaded, the rear to hold a base plug and the front to hold the M54 Fuze. An expelling charge (0.14 lb) of black powder is loaded in the front end of the cavity. The remainder of the cavity holds three canisters of HC smoke mixture. A baffle plate separates the black powder charge and the smoke filler, but transmission of the flash and explosive action of the black powder is provided for by a flash tube which extends through the doughnut-shaped smoke canisters. In functioning, the black powder ignites the smoke filler and at the same time expels the canisters through the base end of the shell. Time of action is governed by the fuze, which provides for time setting up to 25 seconds or action on impact. Air burst does not materially alter the path of flight since the expelled canisters continue approximately along the original trajectory and land close to the shell body. The smoke filler will burn for approximately 3 minutes after reaching the ground. Maximum emission of smoke from the canisters occurs in about 2 minutes although an effective smoke develops in about 1 minute. The M84 Shell is fired with the standard semifixed propelling charge for the Howitzers, M2, M2A1, and M4.

DATA

Weight of complete round.....	41.94 lb	Type of base	Boat-tailed
Length of complete round.....	30.49 in.	Degree of taper	9 deg 15 min
Length of fuzed projectile.....	18.84 in.	Radius of ogive	6.02 cal.
Length of cartridge case.....	14.64 in.	Muzzle velocity	1,550 ft per sec
Width of rotating band.....	0.81 in.	Maximum range	12,205 yd

FIXED AND SEMIFIXED ROUNDS AND SEPARATE-LOADING PROJECTILES

209. SHELL, SEMIFIXED, SMOKE (COLORED), B.E., M84, W/FUZE, TSQ, M54, 105-MM HOW., M2 AND M2A1 (W/GREEN, RED, VIOLET, OR YELLOW SMOKE FILLER), in addition to the white-smoke B.E. shell (par. 208), have been standardized for use in the 105-mm field howitzers for target and battery identification purposes. Characteristics are similar to those for the white-smoke shell with the exception of the differences in color of smoke and some slight variations in weight due to different densities of the fillers. Like the white-smoke shell, the colored-smoke projectiles are intended for firing with the standard propelling charge and other components for the weapons. Complete round weights are: green or violet, 39.57 pounds; red, 39.77 pounds; yellow, 39.37 pounds.

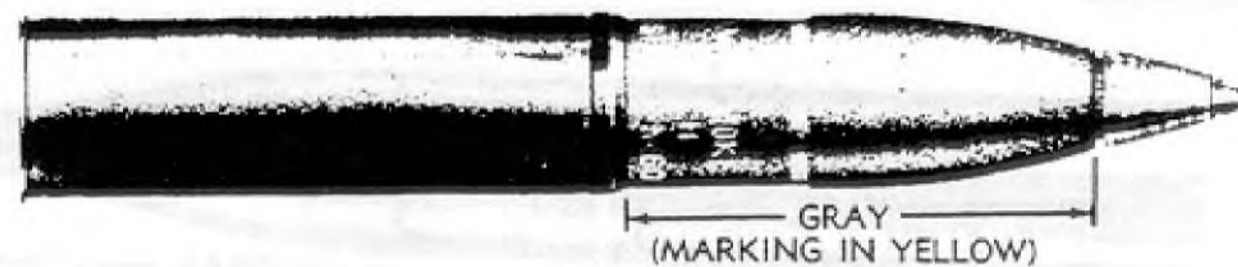

RA PD 80789

Figure 115 — SHELL, Semifixed, Smoke, Phosphorus, WP, M60, w/FUZE, P.D., M57, 105-mm How., M2, and M2A1

210. SHELL, SEMIFIXED, SMOKE, PHOSPHORUS, WP, M60, W/FUZE, P.D., M57, 105-MM HOW., M2 AND M2A1 (fig. 115), is assembled with the M60 Smoke Shell which resembles the high-explosive shell in outward appearance. The shell is boat-tailed and the nose is ogival and threaded to take an adapter. The adapter serves three purposes: it provides a tight seal for the chemical contents of the shell; it holds the fuze and booster; and it provides a seat for the forward end of BURSTER, M5, a thin-walled steel tube extending from the adapter to the rear of the shell cavity. It contains a detonator relay chain and a burster charge to rupture the shell casing and disperse the chemical contents. FUZE, P.D., M57, is used with the projectile, in conjunction with BOOSTER, M22, to provide for superquick action and functioning of the shell before any appreciable penetration has taken place. White phosphorus is a smoke-producing chemical which also has an incendiary effect.

DATA

Weight of complete round.....	43.77 lb	Degree of taper	9 deg 15 min
Length of complete round....	31.08 in.	Radius of ogive.....	6.02 cal.
Length of fuze projectile.....	19.46 in.	Muzzle velocity	1,550 ft per sec*
Length of cartridge case.....	14.64 in.	Maximum range	
Width of rotating band.....	0.81 in.	(at 44 deg)	12,150 yd*
Type of base	Boat-tailed	*—Full charge (charge 7).	

ARTILLERY AMMUNITION

211. SHELL, SEMIFIXED, SMOKE, FS, M60, W/FUZE, P.D., M57, 105-MM HOW., M2 AND M2A1, contains the chemical filler FS, a liquid smoke producer which functions very much like white phosphorus. When filled with FS, the complete round weighs approximately 44.28 pounds. In other respects it is similar to the round described in paragraph 210. Data given therein apply equally to this round.

212. SHELL, SEMIFIXED, GAS, PERSISTENT, H, M60, W/FUZE, P.D., M57, 105-MM HOW., M2 AND M2A1, is similar to the phosphorus and FS filled shell rounds, but the filler consists of mustard gas, a persistent liquid vesicant. The complete round weighs 42.84 pounds. Otherwise, data given in paragraph 210 also apply to this round.

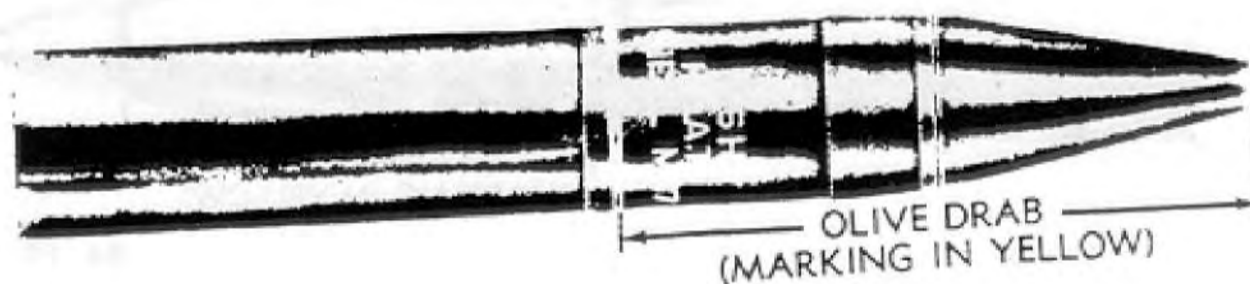

RA PD 80786

Figure 116 - SHELL, Semifixed, H.E., A.T., M67, w/FUZE, B.D., M62 or M62A1, 105-mm How., M2, M2A1, and M4

213. SHELL, SEMIFIXED, H.E., A.T., M67, W/FUZE, B.D., M62, OR M62A1, 105-MM HOW., M2, M2A1, AND M4 (fig. 116), is similar in all respects except size to the H.E., A.T. round for the 75-mm howitzers. Like that round, it provides an effective ammunition for the howitzers against tanks. The effect of the projectile is produced by the force of detonation of the high-explosive filler rather than by striking velocity. The construction of the shell differs materially from standard armor-piercing types. The shell body is a relatively thin-walled casing containing a shaped high-explosive filler and closed off at the forward end by a ballistic cap in the form of a thin steel cone. The ballistic cap is attached to an ogive and union assembly which provides sufficient "stand-off" from the target after the ballistic cap crushes on impact with the target. The base is boat-tailed and fitted with a base-detonating fuze which functions with nondelay action. A standard cartridge case and the M28A2 300-grain Primer are used with the projectile. However, the propelling charge consists of 1.60 pounds of flashless powder (little more

FIXED AND SEMIFIXED ROUNDS AND SEPARATE-LOADING PROJECTILES

than half the full charge used with semifixed rounds) in a cloth bag, and is not intended to be adjustable, the cartridge case being a loose fit on the projectile only for shipping and storage purposes.

DATA

Weight of complete round.....	36.85 lb	Type of base	Boat-tailed
Length of complete round.....	31.05 in.	Degree of taper	9 deg 15 min
Length of fuzeed projectile.....	19.43 in.	Degree of nose taper.....	21 deg 30 min
Length of cartridge case.....	14.64 in.	Muzzle velocity	1,250 ft per sec
Width of rotating band.....	0.81 in.	Maximum range	8,590 yd
		Penetration (at any range)	4.0 in.

214. SHELL, SEMIFIXED, EMPTY, FOR SAND LOADING, M1, W/FUZE, INERT, P.D., M48, 105-MM HOW., M2, M2A1, AND M4. provides practice ammunition for the howitzer, and consists of service case, primer, and propelling charge and an inert projectile. The projectile is an M1 Shell with the bursting charge cavity left empty, for loading with inert material in the field. An inert service fuze is used with the round. Ballistically the projectile is the same as the service round described in paragraph 205 and data therein are applicable to the practice round.

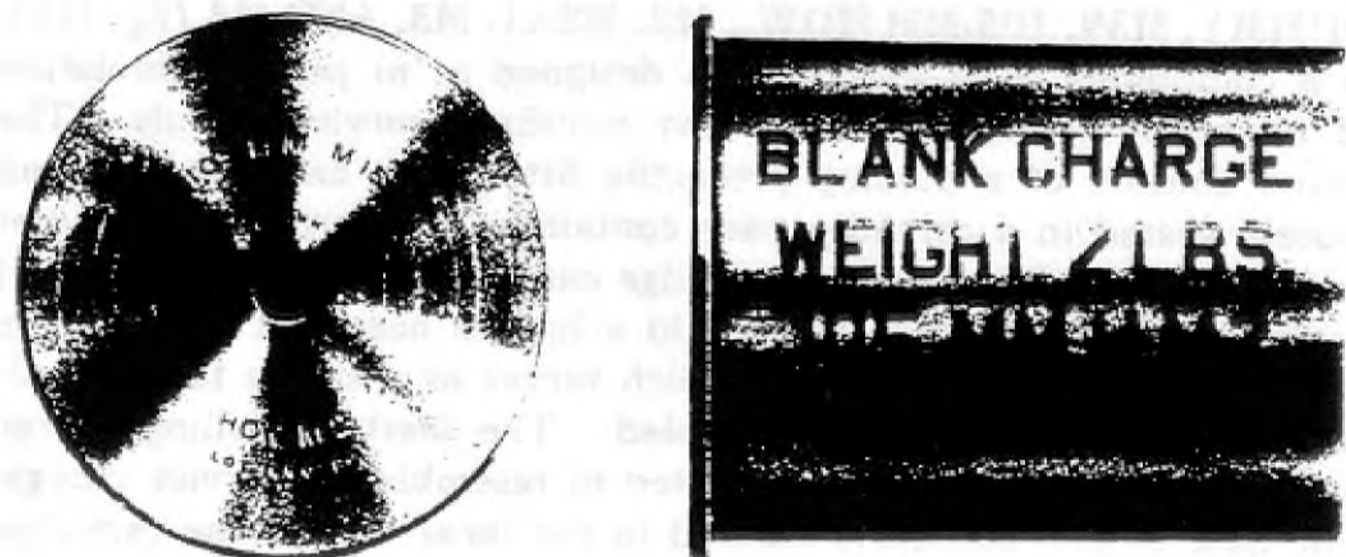

RA PD 80790

Figure 117 – AMMUNITION, Blank (1.5-lb. or 2-lb. Charge), 105-mm How., M2, M2A1, M3. and M4

215. AMMUNITION, BLANK (1.5- OR 2-LB. CHARGE), 105-MM HOW., M2, M2A1, M3, AND M4 (fig. 117), is provided for the 105-mm howitzers for salutes and simulated fire and consists of the M15 Cartridge Case, which is essentially the service case cut down to a 6-inch length, a 49-grain primer, and a black powder charge. Construction is similar to other standard blank rounds. The powder charge is loaded in a cotton bag wrapped about the primer and held in position by a closing cup assembly. Standard powder is sodium nitrate composition but potassium nitrate may be used as an alternative. When sodium nitrate is used, the charge weighs 2 pounds and

ARTILLERY AMMUNITION

the closing cup assembly includes a felt wad cemented to the inner surface of a pulpboard disk. The assembly is inserted and cemented in position about 0.5 inch from the cartridge case mouth. When potassium nitrate is used, the charge weighs 1.5 pounds. The felt wad is omitted from the closing cup, which is inserted about 1 inch in the cartridge case and cemented in position at that point. Weight of complete round is 6.23 pounds and length is 6.00 inches.



Figure 118 — CARTRIDGE, Drill, Semifixed, M14, w/FUZE, Dummy, M59, 105-mm How., M2, M2A1, M3, and M4

216. CARTRIDGE, DRILL, SEMIFIXED, M14, W/FUZE, DUMMY, M59, 105-MM HOW., M2, M2A1, M3, AND M4 (fig. 118), is a completely inert assembly so designed as to permit simulation of all adjustments required in the semifixed service rounds. The round consists of a dummy projectile fitted with an inert fuze and loosely seated in a cartridge case containing an inert service primer and propelling charge. The cartridge case is a cadmium-plated steel tubing threaded at the rear to hold a bronze base and fitted at the front end with a bronze collar which serves as a sleeve for the projectile when the round is assembled. The inert propelling charge consists of seven sections constructed to resemble the service charge. The base or first section is secured to the inner face of the cartridge case base; the second section is attached to the base section by a 16-inch sash chain or, more recently, by twine. Each additional section is attached to the one preceding by snaps, if the chain is used, or by twine. The arrangement permits withdrawal of all sections, except the base, to the mouth of the case where adjustments of the charge can be made. As shipped with the 7-section charge, the round simulates the service ammunition for the M2, M2A1, and M4 Howitzers, but can be adapted for M3 Howitzer drill by removing the top two sections (numbered 6 and 7). The dummy projectile is a hollow bronze casting with an open base to facilitate extraction from the howitzer. As fitted with FUZE, dummy, M59, the round provides for

FIXED AND SEMIFIXED ROUNDS AND SEPARATE-LOADING PROJECTILES

drill in setting the M48-type fuzes since this dummy fuze has a setting pin arrangement like that of the M48 Fuze. The complete round weighs 41.35 pounds and is 31.07 inches long.

217. CARTRIDGE, DRILL, SEMIFIXED, M14, W/FUZE, INERT, TSQ, M54, 105-MM HOW., M2, M2A1, M3, AND M4, is the same as the drill cartridge described in paragraph 216 except that the fuze is an inert M54 Fuze made up of a burned out service fuze or of rejected parts. This fuze provides for drill in time setting.

218. SHELL, SEMIFIXED, H.E., M1, W/FUZE, P.D., M48A2, SQ & 0.15-SEC. DELAY, 105-MM HOW., M3, differs from the corresponding round for the M2, M2A1, and M4 models (par. 205) only with respect to the propelling charge. For the M3 Weapon and its mount, a lighter charge, five increments of quick-burning powder, is used to obtain the desired muzzle velocity.

DATA

Weight of complete round.....	40.46 lb	Type of base	Boat-tailed
Length of complete round.....	31.07 in.	Degree of taper	9 deg 15 min
Length of fuzed projectile.....	19.63 in.	Radius of ogive	6.02 cal.
Length of cartridge case.....	14.64 in.	Muzzle velocity	1,020 ft per sec*†
Width of rotating band.....	0.81 in.	Maximum range (at 42 deg 53 min)	8,295 yd*†

*—When fired from the M3 Howitzer. For conditions under which this round may be fired in M2 and M2A1 Howitzers, and resultant muzzle velocities and range data, see paragraph 205 f of this section.

†—With full charge (charge 5); corresponding data for other charges are:

	Muzzle Velocity	Maximum Range
Charge 1	650 ft per sec	3,825 yd (at 43°28')
Charge 2	710 ft per sec	4,475 yd (at 43°27')
Charge 3	780 ft per sec	5,280 yd (at 43°11')
Charge 4	875 ft per sec	6,430 yd (at 43° 8')

219. SHELL, SEMIFIXED, H.E., M1, W/FUZE, P.D., M48, 105-MM HOW., M3, is the same as that described in paragraph 218 except for the fuze. The M48 Fuze has an 0.05-second delay action incorporated in the delay action train whereas the M48A1 and M48A2 used with howitzer shell, have 0.15-second delay. Data and other information given in paragraph 218 apply to this round also.

220. SHELL, SEMIFIXED, H.E., A.T., M67, W/FUZE, B.D., M62 OR M62A1, 105-MM HOW., M3, has the same components as the corresponding round for the M2, M2A1, and M4 Howitzers except that a lighter (1.40-lb) nonadjustable propelling charge is used to obtain the 1,020 feet per second muzzle velocity when fired from the M3 Howitzer. Range is 8,490 yards at a 45-degree elevation. Other applicable data are given in paragraph 213.

ARTILLERY AMMUNITION

221. SHELL, SEMIFIXED, HC, B.E., M84, W/FUZE, P.D., M54, 105-MM HOW., M3, is similar to the corresponding one for the M2, M2A1, and M4 Howitzers with the exception of the propelling charge. For the M3 Howitzer, the lighter 5-increment charge is used to provide the desired muzzle velocity. For a more complete description of other components, see paragraph 208.

DATA

Weight of complete round.....	40.32 lb	Type of base	Boat-tailed
Length of complete round.....	30.49 in.	Degree of taper	9 deg 15 min
Length of fuzeed projectile.....	18.84 in.	Radius of ogive	6.02 cal.
Length of cartridge case.....	14.64 in.	Muzzle velocity	1,020 ft per sec
Width of rotating band.....	0.81 in.	Maximum range	8,295 yd

222. SHELL, SEMIFIXED, SMOKE, PHOSPHORUS, WP, M60, W/FUZE, P.D., M57, 105-MM HOW., M3, is the same as the phosphorus-filled assembly described in paragraph 210, except that the 5-increment propelling charge is used when the round is fired from the M3 Howitzer.

DATA

Weight of complete round.....	41.83 lb	Type of base	Boat-tailed
Length of complete round.....	31.08 in.	Degree of taper	9 deg 15 min
Length of fuzeed projectile.....	19.46 in.	Radius of ogive	6.02 cal.
Length of cartridge case.....	14.64 in.	Muzzle velocity	1,020 ft per sec
Width of rotating band.....	0.81 in.	Maximum range	8,295 yd

223. SHELL, SEMIFIXED, SMOKE, FS, M60, W/FUZE, P.D., M57, 105-MM HOW., M3, differs from the phosphorus-filled round in the type of chemical filler. When filled with the FS smoke producer, the complete round weighs 42.32 pounds. In other respects, data given for the phosphorus-filled round (par. 222) are applicable to this round also.

FIXED AND SEMIFIXED ROUNDS AND SEPARATE-LOADING PROJECTILES

Section XIV

AMMUNITION FOR 105-MM GUNS

224. GENERAL.

a. **General Discussion.** GUN, AA., 105-mm, M3, is the standard antiaircraft gun in this caliber. At present it is used exclusively for antiaircraft defense from the fixed pedestal-type mount, no mobile mounts having been authorized for the gun. It is a semiautomatic type equipped with a rammer mechanism to facilitate rapid loading at all angles of elevation. Ejection of the cartridge case after firing is automatic, during counterrecoil of the gun. Since it is a single purpose weapon, only high-explosive ammunition with a mechanical time fuze is issued for service use, together with appropriate practice and drill rounds. All of the ammunition is fixed, that is, has a non-adjustable propelling charge in a cartridge case which is crimped rigidly to the projectile. All rounds are fuzed as shipped and require only proper setting of the fuze to be ready for firing.

b. **Identification.** Painting and marking for identification is in accordance with the basic scheme as prescribed in TM 9-1900.

c. **Fuzes.** Standard fuze for service and practice 105-mm ammunition is the M43 Mechanical Time Fuze (all modifications). This fuze provides for time setting up to 30 seconds. It has no impact element, thereby minimizing danger to friendly personnel and materiel in the event of a failure in the time train. Substitute standard rounds (M38) are fuzed with the M2 Mechanical Time Fuze. The M2 Fuze also provides time setting up to 30 seconds but has a booster as an integral part whereas the M43 is used in conjunction with the M20 Booster which is a component of the shell (ch. 3, sec. I).

d. **Cartridge Cases.** CASE, cartridge, 105-mm, M6, is standard for the 105-mm gun. This is a brass case drilled in the base to seat the 300-grain M28 type primer. A flange at the head adapts the case for automatic ejection from the gun. The propelling charge is loaded loosely in the case and is held in position around the primer by a distance wad and igniter assembly. The distance wad consists of a strawboard or chipboard cylinder closed at both ends which is adjusted in manufacture for variations in the amount of propelling powder by bending the end disks or by changing the length of the cylinder.

ARTILLERY AMMUNITION

e. **Primers.** PRIMER, percussion, 300-grain, M28A2, is standard for 105-mm gun ammunition but earlier modifications may be found in rounds of less recent manufacture. An alternative is PRIMER, percussion, 300-grain, M28B1. The M21 Primer—a 330-grain type—was formerly used with the M38 Round (ch. 3, sec. III).

225. COMPLETE ROUND TABLE.

a. Data concerning the complete rounds of 105-mm gun ammunition, and components thereof, are given in table 20, chapter 5.

226. PACKING AND SHIPPING DATA.

a. Packing and shipping data for the ammunition are published in ORD 11 SNL's P-5 and P-8.



RA PD 80792

Figure 119 — SHELL, Fixed, H.E., M38A1, w/FUZE, Time, Mechanical, M43 (All Modifications), 105-mm Gun, M3

227. SHELL, FIXED, H. E., M38A1, W/FUZE, TIME, MECHANICAL, M43 (ALL MODIFICATIONS), 105-MM GUN, M3 (fig. 119), is intended for fragmentation and blast effect against aircraft targets. Components consist of: the M6 Cartridge Case; the M28 type primer; a loosely loaded propelling charge held in position by a distance wad and igniter assembly; and a fuzed M38A1 Projectile. The M38A1 Shell is similar to other modern high-explosive shell, the body being a thin-walled forged-steel casing with tapered (boat-tailed) base and a long ogival nose. Standard bursting charge is TNT but 50-50 amatol also may be used, as an alternative. Both charges are shaped at the front end to provide a booster well; when 50-50 amatol is loaded in the shell a booster surround of TNT is used. BOOSTER, M20A1, is a standard manufacturing component of the shell, being inserted and locked permanently in position by a set screw after the

FIXED AND SEMIFIXED ROUNDS AND SEPARATE-LOADING PROJECTILES

shell is loaded. FUZE, time, mechanical, M43 (all modifications), adapts the round for antiaircraft fire; it provides time setting up to 30 seconds but has no impact element, thereby minimizing danger to friendly personnel and materiel on ground impact in the event of time train failure.

DATA

Weight of complete round.....	63.73 lb	Degree of taper	7 deg 15 min
Length of complete round.....	45.31 in.	Radius of ogive.....	8.37 cal.
Length of fuzeed projectile.....	18.00 in.	Muzzle velocity	2,800 ft per sec
Length of cartridge case.....	30.37 in.	Maximum range (at 45 deg):	
Width of rotating band.....	1.42 in.	Horizontal range	20,000 yd*
Type of base	Boat-tailed	Vertical height	14,000 yd*

*—Actual maximum range as limited by time setting of fuze is: horizontal, 13,000 yards; vertical, 12,000 yards.

228. SHELL, FIXED, H. E., M38, FLASHLESS, W/FUZE, TIME, MECHANICAL, M2, 105-MM GUN, M3, is essentially the same as the M38A1 Round with M43 Fuze. The chief difference is in the shell loading which does not require a provision for the booster in the M38 Shell since the Mechanical Time Fuze M2 has the booster as an integral part. The round is limited standard for the M3 Gun, for the same purposes as the standard M38A1, and will be issued only to the extent of stocks on hand.

229. SHELL, FIXED, PRACTICE, M38A1, W/FUZE, TIME, MECHANICAL, M43 (ALL MODIFICATIONS), 105-MM GUN, M3 is provided for the 105-mm gun by adapting the service round for the purpose. Service components are used with the exception of the shell loading. For the practice ammunition, a small charge of black powder (0.80 lb) is loaded in the bursting charge cavity adjacent to the booster well cup. The remainder of the cavity is filled with an inert material (plaster of paris and stearic acid). The black powder charge is used in conjunction with the M20A1 Booster to provide a spotting charge for observation purposes when firing in target practice. Ballistic data are the same as that given for the service round in paragraph 227.

230. SHELL, FIXED, PRACTICE, M38, W/FUZE, TIME, MECHANICAL, M2, 105-MM GUN, M3, is an adaptation of the M38 Service Round for practice purposes. The loading is essentially the same as that for the practice M38A1 Round described in paragraph 229 except that the booster is an integral part of the M2 Fuze whereas in the M38A1, the booster is a manufacturing component of the shell. The round is limited standard, having been superseded for manufacture by the M38A1.

ARTILLERY AMMUNITION

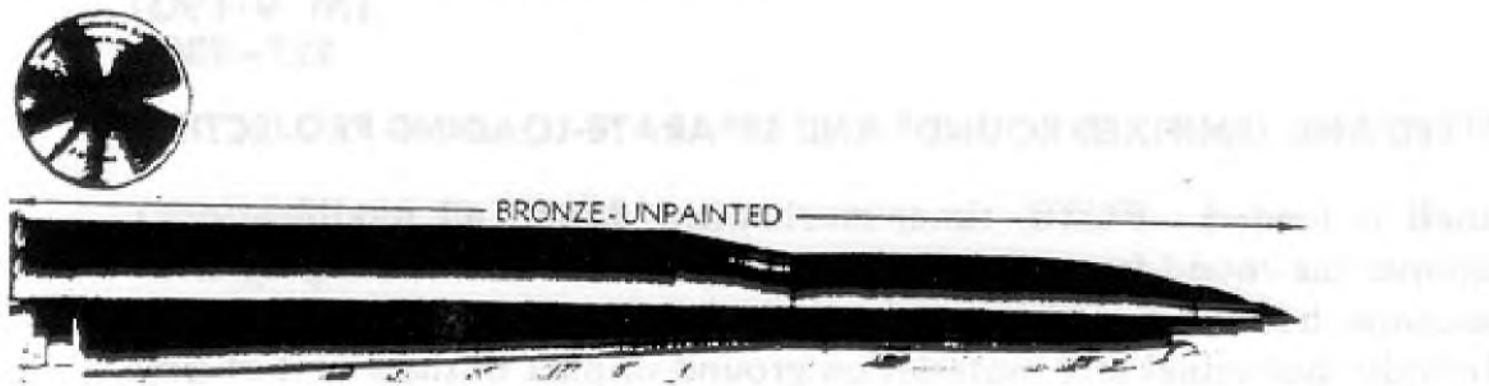

RA PD 80793

Figure 120 — CARTRIDGE, Drill, M11, w/FUZE, Dummy, T23,
105-mm Gun, M3

231. CARTRIDGE, DRILL, M11, W/FUZE, DUMMY, T23, 105-MM GUN, M3 (fig. 120), is used to simulate service ammunition for drill in handling and in loading the gun. Construction is similar to that of drill ammunition for the 3-inch and 90-mm guns, the cartridge consisting of three replaceable parts: a 1-piece casting formed to resemble a projectile and affixed cartridge case; a flanged base plate; and a dummy fuze. The T23 Dummy Fuze is a hollow bronze casting of the same general size and contour as the service fuzes. The cartridge is 45.20 inches long and weighs 63.55 pounds when assembled.

232. CARTRIDGE, DRILL, M8, W/FUZE, DUMMY, M44A2 OR T23, 105-MM GUN, M3, resembles the M11 Drill Cartridge externally, being of the same size, shape, and weight. However, the base plate is a "slide" fit in the cartridge case. During loading and handling, the base is held in closed position by a rod and spring assembly, but when being extracted from the gun it moves rearward within the limits allowed by the spring. This device makes manual extraction easier and reduces wear and tear on the flange. The cartridge was originally fitted with the M44 Dummy Fuze; cartridges of more recent manufacture have been fitted with the T23 Dummy Fuze. Both are hollow bronze castings, and of the same shape except that the M44 is squared off at the nose whereas the T23 is shaped to a full point.

FIXED AND SEMIFIXED ROUNDS AND SEPARATE-LOADING PROJECTILES

Section XV

AMMUNITION FOR 4.5-INCH GUNS

233. GENERAL.

a. The 4.5-inch Gun M1 is a standard field weapon used for shelling targets to a maximum range of 21,000 yards. The projectiles authorized for this gun are classified as to type as high-explosive and dummy. The separate-loading complete round consists of the loaded and fuzed High-explosive Shell M65 with either the normal Propelling Charge M7 or the Supercharge M8, and PRIMER, percussion, 17-grain, Mk. IIA4, which is seated in the base of the obturator spindle. The propelling charge fits against the face of the obturator spindle.

b. **Identification.** The ammunition and ammunition components are completely identified by means of the painting and marking as illustrated in figures 121 and 122, and in accordance with basic color scheme as prescribed in TM 9-1900.

c. **Fuzes.** See chapter 3, section I.

d. **Propelling Charges.** See chapter 3, section II.

e. **Primers.** See chapter 3, section III.

234. COMPLETE ROUND TABLE.

a. Data concerning the 4.5-inch complete round and components therefore are given in table 21, chapter 5.

235. PACKING AND SHIPPING DATA.

a. Data concerning the 4.5-inch rounds are given in ORD 11 SNL's R-2 and R-6.



RA PD 80794

Figure 121 - SHELL, H.E., M65, Unfuzed, 4.5" Gun, M1

236. SHELL, H.E., M65, UNFUZED, 4.5" GUN, M1 (fig. 121), is for use primarily against personnel and heavy materiel targets. The M51 type and M67 type fuzes for which it is adapted have the booster permanently assembled to the fuze at the time of manufac-

ARTILLERY AMMUNITION

ture, both elements being handled thereafter as a single unit in shipment and assembly to the projectile. The rotating band, either of copper or gilding metal, is located 3.5 inches in front of the base end and has a single cannellure or groove. A steel base plate is set into the base end flush with the surface. The conventional type of welded base plate is also authorized. This base cover prevents gas from the propelling charge from reaching the bursting charge of the projectile through possible defects or flaws in the base.

DATA

Length of projectile.....	21.92 in.*	Degree of taper	7.5 deg
Width of rotating band.....	1.72 in.	Radius of ogive	10 cal.
Type of base ,	Boat-tailed	Muzzle velocity (supercharge)	2,275 ft per sec†
Maximum range (supercharge).....	21,125 yd††		

*—As shipped with eyebolt-lifting plug.
†—Normal charge—1,820 feet per second.
††—Normal charge—16,650 yards.

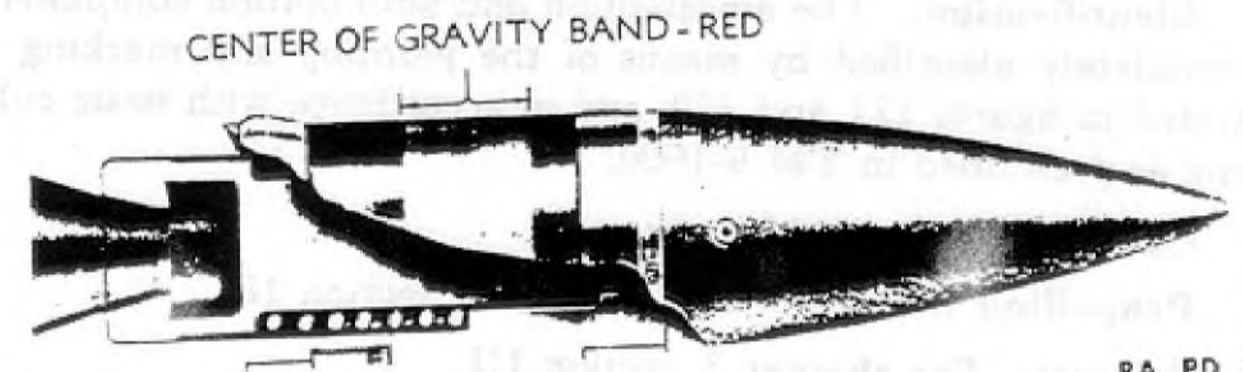

RA PD 80795

Figure 122 — PROJECTILE, Dummy, M8, 4.5" Gun, M1

237. PROJECTILE, DUMMY, M8, 4.5" GUN, M1 (fig. 122), is similar in make-up to the M65 Shell. However, unlike the service projectile, the nose is not cut away to provide a fuze hole. The projectile body has three main parts, an ogival cap, body, and base, each screwing into the next neighboring part when assembled. The rotating band and bourrelet of the service shell are simulated by bronze bands. The several parts are replaceable. The projectile is 22.51 inches long.

FIXED AND SEMIFIXED ROUNDS AND SEPARATE-LOADING PROJECTILES

Section XVI

AMMUNITION FOR 120-MM (4.7-INCH) GUNS

238. GENERAL.

a. The 120-mm (4.7-in.) Gun M1 is an antiaircraft weapon intended for protection of large rear areas against fast flying bombers at altitudes of approximately 30,000 feet. The complete round may be considered as a special case of separate-loading ammunition. The projectile and the cartridge case assembly are packed and shipped separately. Unlike the usual separate-loading ammunition, a cartridge case, fitted with a closing plug, protects the nonadjustable propelling charge against moisture and foreign matter, and also prevents the loss of powder. In firing, the projectile and the cartridge case are loaded into the chamber, and the shell is rammed home by the cartridge case, which is in turn rammed home by the power rammer.

b. **Identification.** The 120-mm complete round is identified by means of the painting and marking as illustrated in figure 123 and in accordance with basic color scheme as prescribed in TM 9-1900.

c. **Fuze.** See chapter 3, section I.

d. **Cartridge Case.** The Cartridge Case M24 is the conventional hollow metal cylinder used in semifixed and fixed ammunition, but is sealed by a closing Plug M2, made of Palmatex which is pressed in the mouth and permanently glued thereto. The M1 Plug is made of cork. A protruding portion provides protection for the cartridge case mouth. The propelling charge is made up of 24 pounds of non-hygroscopic (NH) powder, loosely loaded in the cartridge case. Since PRIMER, percussion, 100-grain, M1B1A2, does not insure complete burning of the propelling charge, an igniter of black powder is attached to the primer.

e. **Primers.** See chapter 3, section III.

239. COMPLETE ROUND TABLE.

a. Data concerning the 120-mm complete round and components therefor are given in table 22, chapter 5.

240. PACKING AND SHIPPING DATA.

a. Data concerning the 120-mm rounds are given in ORD 11 SNL's P-5 and P-8.

FIXED AND SEMIFIXED ROUNDS AND SEPARATE-LOADING PROJECTILES

241. SHELL, H.E., M73, W/FUZE, TIME, MECHANICAL, M61A1, 120-MM GUN, M1 (ANTIAIRCRAFT), is the only shell fired from the 120-mm Gun M1 (antiaircraft). The projectile has two bourrelets, one (front bourrelet) approximately at the center of the projectile and the other (rear bourrelet) just to the rear of the rotating band. The rotating band, made of gilding metal, is located 3.56 inches from the base end. The fuze is a mechanical clockwork fuze of the type designed for use with antiaircraft ammunition. The projectile is fitted with a base cover which prevents the hot gases generated by the burning propelling charge from coming in contact with the bursting charge through possible flaws in the base.

DATA

Weight of loaded projectile.....	50 lb	Degree of taper.....	7.5 deg
Weight of loaded charge and cartridge case	50 lb	Radius of ogive (conical end)	5.77 cal.
Length of projectile	24.06 in.*	Muzzle velocity	3,100 ft per sec
Length of cartridge case.....	32.80 in.	Maximum range:	
Width of rotating band.....	2.25 in.	Horizontal	28,250 yd
Type of base	Boat-tailed	Vertical	19,151 yd

* — As shipped with fuze assembled.

242. SHELL, H.E., M73, W/FUZE, TIME, MECHANICAL, M61, 120-MM GUN, M1, is an earlier item of manufacture and differs from the shell described in paragraph 241 by having the M61 Fuze instead of the M61A1 Fuze.

243. PROJECTILE, DUMMY, M (T5), W/FUZE, DUMMY, M , 120-MM GUN, M1, is similar to the M73 Shell. The principal parts are the shell body assembly and the dummy fuze assembly. The shell body assembly consists of an M73 Shell body, the rotating band of which is machined flush with the surface of the shell, and which contains an inert filler. The dummy fuze assembly is screwed into the shell body. The projectile is 24.12 inches long.

ARTILLERY AMMUNITION

Section XVII

AMMUNITION FOR 155-MM HOWITZERS

244. GENERAL.

a. The 155-mm howitzers are relatively short-barrelled weapons. The HOWITZERS, 155-mm, M1917, M1918, and modifications, being chambered alike, fire ammunition of the same designation. The HOWITZER, 155-mm, M1, is chambered differently from these howitzers, and the ammunition standard for use in these two types of howitzers is *not* interchangeable. (See subparagraph f, below, for interchangeability of limited standard rounds.) The standard service projectiles for the 155-mm Howitzers, M1917A1-17A2-18 have rotating bands which are 0.60 inch wide, whereas those for the 155-mm Howitzer M1 have rotating bands which are 1.02 inches wide. Standard projectiles for use in the 155-mm Howitzer M1 may also be identified by a groove immediately to the rear of the rotating band. In addition, the standard propelling charges for the 155-mm Howitzers M1917A1-17A2-18 differ from those used in the 155-mm Howitzer M1.

b. **Identification.** Ammunition and ammunition components are completely identified by means of painting and marking on the items themselves, and as described in subparagraph a, above.

c. **Fuzes.** See chapter 3, section I.

d. **Propelling Charges.** See chapter 3, section II.

e. **Primer.** See chapter 3, section III.

f. **Interchangeability.**

(1) The following table shows shell for the 155-mm Howitzers M1917A1-17A2-18, and fuzes that may be used therewith, that are authorized as limited standard for firing in the 155-mm Howitzer M1: with Propelling Charges M1A1 (green bag), and M2 or M2A1 (white bag), for the 155-mm Howitzers M1917A1-17A2-18, or M3 (green bag) and M4* or M4A1* (white bag) for the 155-mm Howitzer M1 (See FT 155-V-2, C-1). The 17-grain Mk. IIA4 Primer is used with these rounds.

 * To be fired only in extreme emergency with the shell indicated.

SHELL, H.E., M102 SHELL, H.E., Mk. IA1	FUZE, P.D., M51 series, w/BOOSTER, M20 or M21 series* FUZE, TSQ, M55 series, w BOOSTER, M21 Series† FUZE, time, mechanical, M67 series, w BOOSTER, M21 series‡
---	---

FIXED AND SEMIFIXED ROUNDS AND SEPARATE-LOADING PROJECTILES

SHELL, gas, CNS, Mk. IIA1-Mod. 1	FUZE, P.D., M51 series, w/BOOSTER, M20 or M21 series*
SHELL, gas, H, M105	
SHELL, gas, H, Mk. IIA1	
SHELL, gas, H, Mk. IIA1-Mod. 1	
SHELL, smoke, FS, M105	
SHELL, smoke, FS, Mk. IIA1	
SHELL, smoke, WP, M105	
SHELL, smoke, WP, Mk. IIA1	

*—FUZE, P.D., M51 or M51A1, w/BOOSTER, M21 or M21A1—emergency combat only; w/BOOSTER, M20A1—for practice, also service until later models available.

†—FUZE, TSQ, M55, w/BOOSTER, M21; M55A1, w/BOOSTER, M21A1; M55A2, w/BOOSTER, M21A2; or M55A3, w/BOOSTER, M21A4.

‡—FUZE, time, mechanical, M67 or M67A1, w/BOOSTER, M21A1; M67A2, w/BOOSTER, M21A2; or M67A3, w/BOOSTER, M21A4.

(2) CHARGE, propelling, M1A1 (green bag), and CHARGE, propelling, M2 or M2A1 (white bag), for the 155-mm Howitzers M1917A1-17A2-18, are authorized for use as limited standard in the 155-mm Howitzer M1 with the following shell. The 17-grain Mk. IIA4 Primer is used with these rounds.

SHELL, H.E., M107	FUZE, P.D., M51 series, w/BOOSTER, M20 or M21 series* FUZE, time, mechanical, M67 series, w/BOOSTER, M21 series† FUZE, nose, C.P., T105, w/BOOSTER, T1
SHELL, gas, persistent, CNS, M110 SHELL, gas, persistent, H, M110 SHELL, smoke, FS, M110 SHELL, smoke, WP, M110	FUZE, P.D., M51 series, w/BOOSTER, M20 or M21 series*

*—FUZE, P.D., M51 or M51A1, w/BOOSTER, M21 or M21A1—emergency combat only; w/BOOSTER, M20A1—for practice, also service until later models available.

†—FUZE, time, mechanical, M67 or M67A1, w/BOOSTER, M21A1; M67A2, w/BOOSTER, M21A2; or M67A3, w/BOOSTER, M21A4.

245. COMPLETE ROUND TABLE.

a. Data concerning the complete rounds for the 155-mm Howitzers M1917A1-17A2-18, and M1, and components therefor are given in table 23, chapter 5.

246. PACKING AND SHIPPING DATA.

a. Data concerning the 155-mm Howitzers M1917A1-17A2-18, and M1, are given in ORD 11 SNL's R-2 and R-6.

247. SHELL, H.E., M107, UNFUZED, 155-MM HOW., M1 (fig. 124), is similar to other standard high-explosive shell of modern design. The body is a relatively thin-walled steel shell with a nose formed to a long ogive and threaded to hold a point fuze. The burst-

ARTILLERY AMMUNITION

ing charge is TNT or amatol, formed at the front end to provide a well for the booster. When amatol is loaded in the cavity, a booster surround consisting of 0.2 pound of cast TNT is used. The projectile has a single rotating band located about 3.5 inches in front of the base. A steel base plate welded to the base end of the projectile prevents gas from the propelling charge from reaching the bursting charge of the projectile through possible flaws in the base.

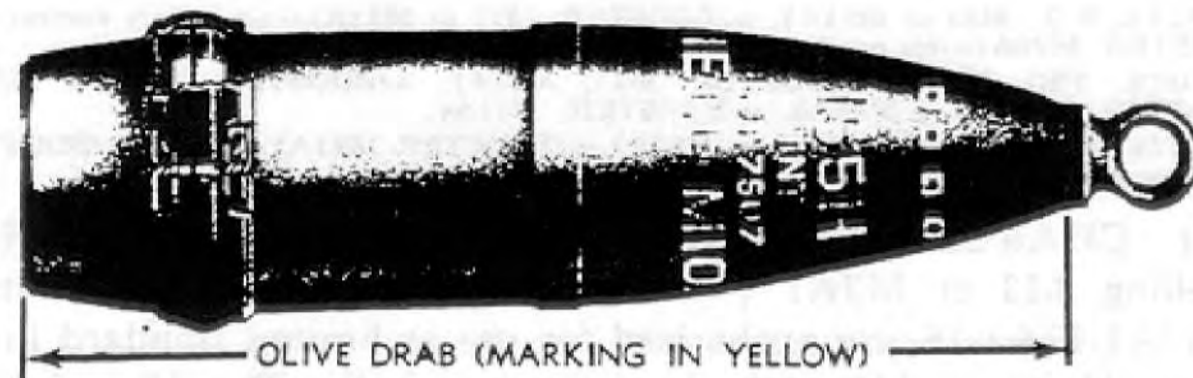

RA PD 80797

Figure 124 - SHELL, H.E., M107, Unfuzed, 155-mm How., M1 (Early Type Grommet Fastening Shown)

DATA

Length of projectile*	26.82 in.	Radius of ogive (conical end)	10.75 cal.
Width of rotating band	1.02 in.	Muzzle velocity (M4 or M4A1 Charge)	1,850 ft per sec
Type of base	Boat-tailed	Maximum range, (at 45-deg 17-min)	16,355 yd
Degree of taper	8.5 deg		

*—With eyebolt-lifting plug.



RA PD 80798

Figure 125 - SHELL, Gas, Persistent, H, M110, Unfuzed, 155-mm How., M1 (Early Type Grommet Fastening Shown)

248. SHELL, M110, GAS AND SMOKE, have approximately the same ballistic shape and external dimensions as the M107 Shell described in paragraph 247. The M110 H Gas Shell is shown in figure 125. The explosive charge of the burster, which is contained in a cardboard or thin aluminum casing, is held in place in the casing

FIXED AND SEMIFIXED ROUNDS AND SEPARATE-LOADING PROJECTILES

by the fuze well cup. One end of the burster casing is fastened to an adapter in the nose cavity. The shell is adapted for the P.D. M51 Fuze and modifications. The various types of gas and smoke shell using the M110 Shell body and bursters are:

- SHELL, smoke, phosphorus, WP, M110, unfuzed, 155mm how., M1
- SHELL, smoke, FS, M110, unfuzed, 155-mm how., M1
- SHELL, gas, persistent, H, M110, unfuzed, 155-mm how., M1
- SHELL, gas, persistent, CNS, M110, unfuzed, 155-mm how., M1

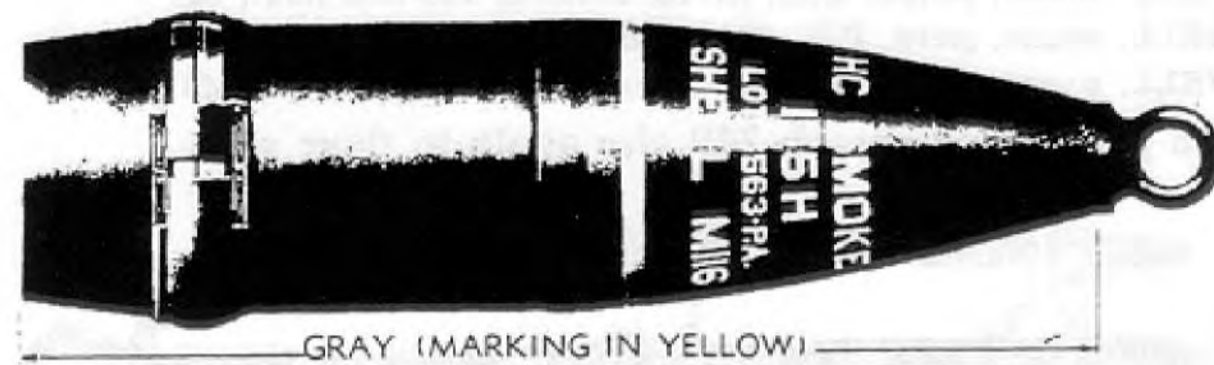

RA PD 80799

Figure 126 – SHELL, Smoke, HC, B.E., M116, Unfuzed, 155-mm How., M1 (Early Type Grommet Fastening Shown)

249. SHELL, SMOKE, HC, B.E., M116, UNFUZED, 155-MM HOW., M1 (fig. 126), is standard for use in the M1 Howitzer. It is a base-ejection type of smoke shell, with the nose in two sections. An expelling charge of black powder backed up by a baffle plate is located in the front end of the shell cavity. The remainder of the cavity holds four canisters of smoke mixture, one behind the other, and the forward canister is conical to conform with the taper of the cavity. A hole passes through the baffle plate and the longitudinal axis of each canister thus forming a flash tube. The base of the projectile is closed by a base plug which, in the functioning of the shell, is blown out, as are the four smoke canisters. The smoke filler will burn for approximately 4 minutes after reaching the ground. Maximum emission of smoke occurs in about 1 minute although an effective smoke develops in 30 seconds. The smoke cloud emitted from each canister is approximately two or three times greater in volume than that from a canister of 105-mm B.E. smoke.

DATA

Length of projectile ^a	26.41 in.	Degree of taper.....	8.5 deg
Width of rotating band.....	1.02 in.	Radius of ogive.....	10.75 cal.
Type of base.....	Boat-tailed	Muzzle velocity (M4 or	
Maximum range.....	16,200 yd	M4A1 Charge).....	1,850 ft per sec

^a—With eyebolt-lifting plug.

ARTILLERY AMMUNITION

250. SHELL, SMOKE (COLORED), B.E., M116, UNFUZED, 155-MM HOW., M1, is the standard for use in the M1 Howitzer. It is similar to the M116 White Smoke B.E. Shell described in paragraph 249 except for the red, yellow, green, or violet smoke filler. The colored smoke mixture burns for approximately 3 minutes after reaching the ground. Maximum emission of smoke occurs for about 2 minutes, although an effective smoke develops in about 1 minute. Nomenclature for the shell is as follows:

- SHELL, smoke, red, B.E., M116, unfuzed, 155-mm how., M1
 - SHELL, smoke, yellow, B.E., M116, unfuzed, 155-mm how., M1
 - SHELL, smoke, green, B.E., M116, unfuzed, 155-mm how., M1
 - SHELL, smoke, violet, B.E., M116, unfuzed, 155-mm how., M1
- Data given in paragraph 249 also apply to these shell.

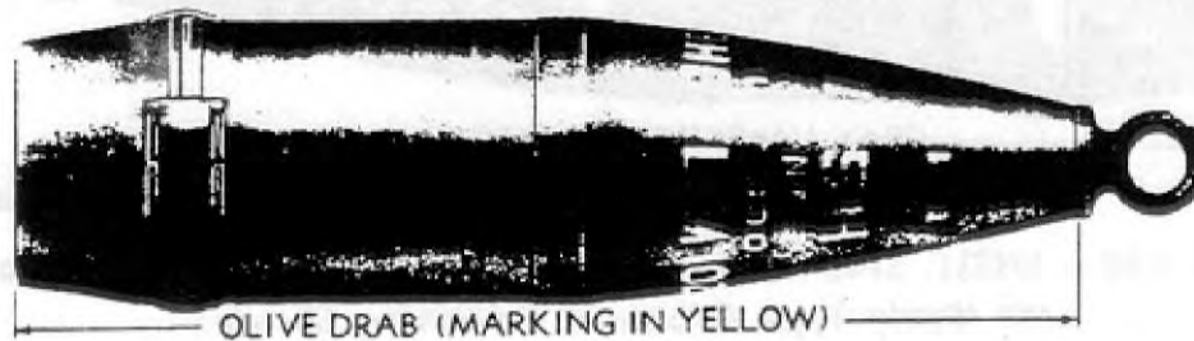

RA PD 80800

Figure 127 — SHELL, H.E., M102, Unfuzed, 155-mm How., M1917-17A1-18 (Early Type Grommet Fastening Shown)

251. SHELL, H. E., M102, UNFUZED, 155-MM HOW., M1917A1-17A2-18 (fig. 127), is similar to the M107 Shell described in paragraph 247, differing chiefly in that it has the narrower rotating band. See paragraph 244 f for interchangeability.

DATA

Length of projectile ^a	26.82 in.	Degree of taper.....	8.5 deg
Width of rotating band.....	0.60 in.	Radius of ogive.....	10.75 cal.
Type of base.....	Boat-tailed	Muzzle velocity (M2 or M2A1 Charge)	1,480 ft per sec
		Maximum range (at 44-deg 15-min).....	12,775 yd

^a—With eyebolt-lifting plug.

252. SHELL, H.E., MK. IA1, UNFUZED, 155-MM HOW., M1917A1-17A2-18 (fig. 128), is similar to the M107 Shell described in paragraph 247, differing chiefly in that it has the narrower rotating band and in the angle of taper of the boat-tailed base, which is one-half degree less. The length of ogive is approximately the same for the M102 and Mk. IA1 Shell when the adapter is assembled to the Mk. IA1 Shell. See paragraph 244 f for interchangeability.

FIXED AND SEMIFIXED ROUNDS AND SEPARATE-LOADING PROJECTILES



RA PD 80801

Figure 128 — SHELL, H.E., Mk. IA1, Unfuzed, 155-mm How., M1917A1-17A2-18

DATA

Length of projectile*.....	26.88 in.	Radius of ogive.....	10.75 cal.
Width of rotating band.....	0.60 in.	Muzzle velocity (M2 or	
Type of base.....	Boat-tailed	M2A1 Charge)	1,478 ft per sec
Degree of taper.....	8 deg	Maximum range	12,400 yd

*—With eyebolt-lifting plug.



RA PD 80804

Figure 129 — SHELL, Gas, Persistent, H, M105, Unfuzed, 155-mm How., M1917A1-17A2-18

253. SHELL, M105, GAS AND SMOKE, which supersede the Mk. IIA1 Shell, are similar to the M110 Gas and Smoke Shell described in paragraph 248. The shell are adapted for the P.D. M51 Fuze and modifications. The M105 H Gas Shell is shown in figure 129. The types of gas and smoke shell using M105 body are:

- SHELL, gas, persistent, H, M105, unfuzed, 155-mm how., M1917A1-17A2-18
- SHELL, smoke, FS, M105, unfuzed, 155-mm how., M1917A1-17A2-18
- SHELL, smoke, phosphorus, WP, M105, 155-mm how., M1917A1-17A2-18

DATA

Length of projectile*.....	26.78 in.	Radius of ogive.....	10.75 cal.
Width of rotating band.....	0.60 in.	Muzzle velocity (M2 or	
Type of base.....	Boat-tailed	M2A1 Charge)	1,476 ft per sec
Degree of taper.....	8.5 deg	Maximum range	12,775 yd

*—With eyebolt-lifting plug.

ARTILLERY AMMUNITION

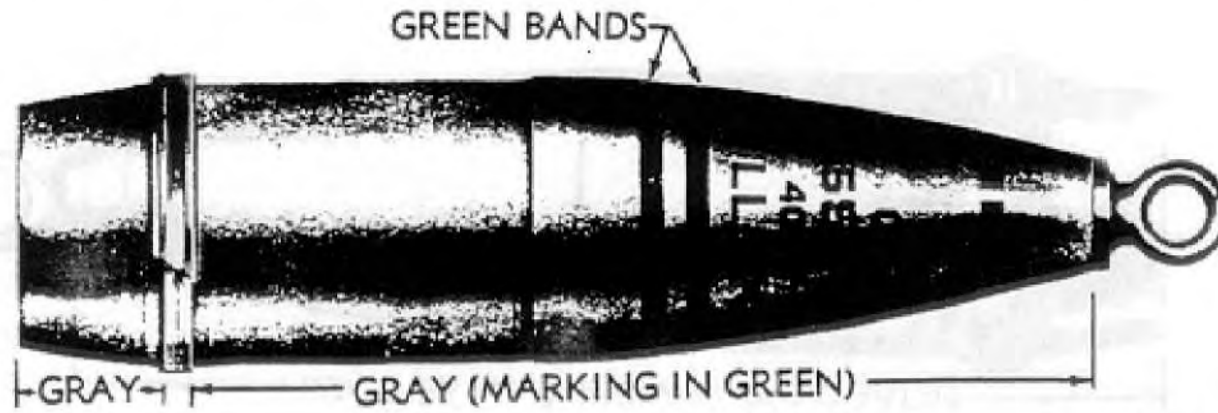

RA PD 80805

Figure 130 - SHELL, Gas, Persistent, H, Mk. IIA1, Unfuzed, 155-mm How., M1917A1-17A2-18

254. SHELL, MK. IIA1, GAS AND SMOKE, are limited standard chemical shell and are modifications of the Mk. II Shell (par. 256) in that it has a Burster M1 extending from the nose to the base of the shell, and uses the P.D. M51 Fuze and modifications. The Mk. IIA1 H Gas Shell is shown in figure 130. The various types of gas and smoke shell using the Mk. IIA1 Shell body and M1 Burster are:

SHELL, gas, persistent, H, Mk. IIA1, unfuzed, 155-mm how., M1917A1-17A2-18

SHELL, smoke, FS, Mk. IIA1, unfuzed, 155-mm how., M1917A1-17A2-18

SHELL, smoke, phosphorus, WP, Mk. IIA1, unfuzed, 155-mm how., M1917A1-17A2-18

DATA

Length of projectile*.....	26.82 in.	Radius of ogive.....	10.75 cal.
Width of rotating band.....	0.60 in.	Muzzle velocity (M2 or	
Type of base.....	Boat-tailed	M2A1 Charge)	1,476 ft per sec
Degree of taper.....	8 deg	Maximum range ..	12,400 yd

*—With eyebolt-lifting plug.



RA PD 80806

Figure 131 - SHELL, Gas, Persistent, H, Mk. IIA1-Mod. 1, Unfuzed 155-mm How., M1917A1-17A2-18

255. SHELL, MK. IIA1-MOD. 1, GAS, is a modification of the Mk. VII Projectile for the 155-mm Guns M1917-17A1-18MI. The modification consists of machining down the forward rotating band

FIXED AND SEMIFIXED ROUNDS AND SEPARATE-LOADING PROJECTILES

to the diameter of the shell body. Dimensions and data are the same as for the Mk. IIA1 Shell described in paragraph 254. The two types of gas shell using the Mk. IIA1 Shell body are:

SHELL, gas, persistent, CNS, Mk. IIA1-Mod. 1, unfuzed, 155-mm how., M1917A1-17A2-18

SHELL, gas, persistent, H, Mk. IIA1-Mod. 1, unfuzed, 155-mm how., M1917A1-17A2-18 (fig. 131)

256. SHELL, MK. II, GAS AND SMOKE, are adapted for the P.D. M46 Fuze. They have tapered or pipe threads, and do not contain a base cover. The adapter-booster is tightly screwed into place, forming a gastight seal for the filler. The various types are:

SHELL, gas, persistent, H, Mk. II, unfuzed, 155-mm how., M1917A1-17A2-18

SHELL, smoke, FM, Mk. II, unfuzed, 155-mm how., M1917A1-17A2-18

SHELL, smoke, FS, Mk. II, unfuzed, 155-mm how., M1917A1-17A2-18

SHELL, smoke, phosphorus, WP, Mk. II, 155-mm how., M1917A1-17A2-18

DATA

Length of projectile*.....	26.14 in.	Radius of ogive	10.8 cal.
Width of rotating band.....	0.60 in.	Muzzle velocity (M2 or	
Type of base	Boat-tailed	M2A1 Charge)	1,480 ft per sec
Degree of taper.....	8 deg	Maximum range	12,295 yd

*—With eyebolt-lifting plug.

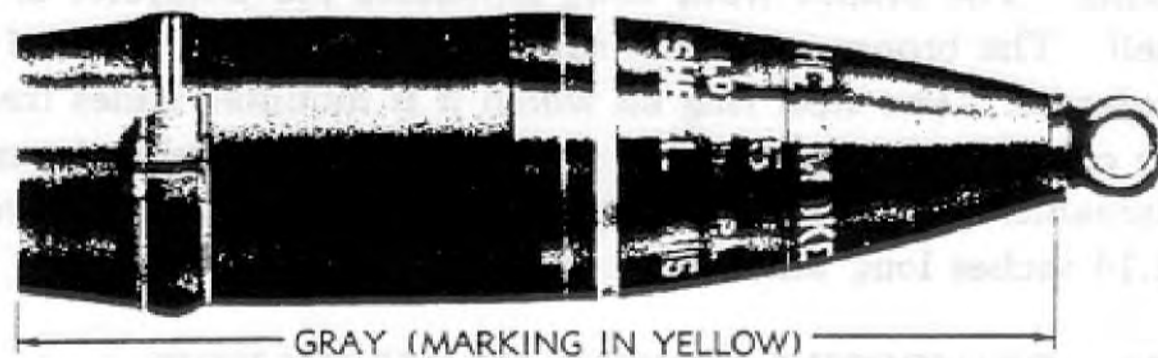

RA PD 80807

Figure 132 — SHELL, Smoke, HC, B.E., M115, Unfuzed, 155-mm How., M1917A1-17A2-18 (Early Type Grommet Fastening Shown)

257. SHELL, SMOKE, HC, B.E., M115, UNFUZED, 155-MM HOW., M1917A1-17A2-18 (fig. 132), is standard for M1917A1-17A2-18 Howitzers. It is similar to M116 Shell (par. 249).

DATA

Length of projectile*.....	26.41 in.	Radius of ogive	10.78 cal.
Width of rotating band.....	0.60 in.	Muzzle velocity (M2 or	
Type of base	Boat-tailed	M2A1 Charge)	1,476 ft per sec
Degree of taper	8.5-deg	Maximum range	12,400 yd

*—With eyebolt-lifting plug.

ARTILLERY AMMUNITION

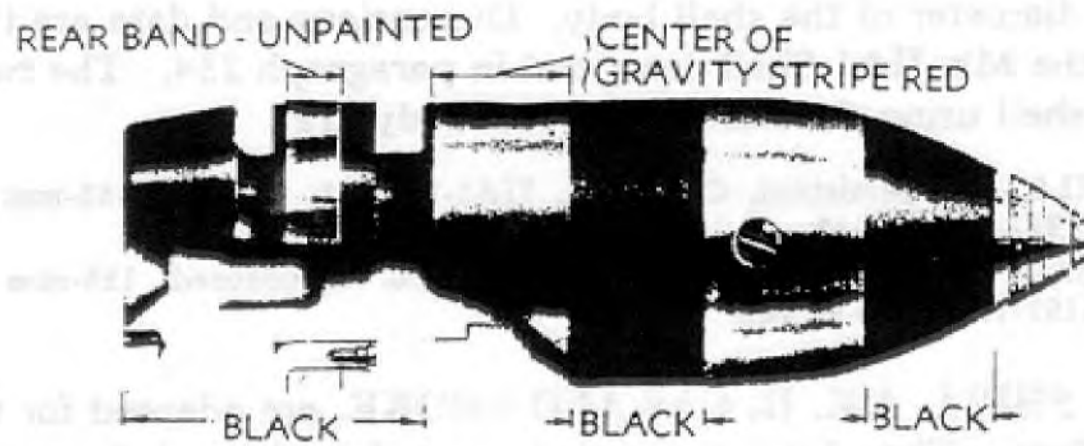

RA PD 80810

Figure 133 — PROJECTILE, Dummy, 95-lb., Mk. I, 155-mm How.

258. PROJECTILE, DUMMY, 95-LB., MK. I, 155-MM HOW. (fig. 133), is provided for training in the service of the 155-mm gun as well as the howitzer. However, when used with the howitzer, the projectile is fitted with a rotating band having a maximum diameter of 6.1 inches; when used with the gun the band has a diameter of 6.5 inches. The principal parts of this dummy projectile are a cast-iron body, a steel base, a bronze front band, and a steel rear ring on which is mounted a bronze band. The cast-iron body is ogival in shape and screws onto the steel base at about the center of gravity of the projectile. The bronze front band simulates the bourrelet of a service shell. The bronze rear band simulates the rotating band of a service projectile. The steel ring on which it is mounted slides freely along the cylindrical portion of the steel base. The individual parts are replaceable. With the 45-second inert M1907M Fuze, the projectile is 21.14 inches long and weighs 95 pounds.

259. PROJECTILE, DUMMY, M7, 155-MM HOW., is also intended for training in the service of the 155-mm gun as well as the howitzer. It is of the type having a fully enclosed spring-cushioned plunger, which kicks the projectile loose from the forcing cone of the gun on the rebound upon ramming. It has a malleable iron cap, steel body, bronze front band, steel base, and bronze rear band. The bronze front band simulates the bourrelet of a service projectile. The bronze rear band simulates the rotating band of a service projectile. The several parts are replaceable. The projectile is 27.56 inches long.

NOTE: Projectiles of earlier manufacture are for use in the 155-mm gun only, because of the greater diameter of the rear band (6.3 in.).

FIXED AND SEMIFIXED ROUNDS AND SEPARATE-LOADING PROJECTILES

Section XVIII

AMMUNITION FOR 155-MM GUNS

260. GENERAL.

a. The 155-mm Guns M1917-17A1-18MI, M1, and M1A1, being chambered alike, fire the same projectiles. The projectiles for these guns are of two general design types, those of earlier design distinguished by two narrow rotating bands, each approximately 0.6 inch wide, and those of current design which have a broad rotating band approximately 2 inches wide. Only those of current design are authorized for use in the 155-mm Guns M1 and M1A1. However, there are certain cases of emergency interchangeability, which may be followed only in accordance with specific regulations permitting same. Although projectiles for the 155-mm guns and the 155-mm howitzers are of the same size and shape, they are readily distinguished by the marking as well as by the rotating bands. The howitzer projectiles have rotating bands 0.6 inch or 1.02 inches wide; the gun projectiles have two bands, 0.6 inch wide, or one band 2 inches wide.

b. **Identification.** The ammunition, including components, for the 155-mm guns, is completely identified by the painting and marking on the items themselves.

c. **Fuzes.** See chapter 3, section I.

d. **Propelling Charges.** The propelling charge for the 155-mm Guns M1 and M1A1 is of the base and increment type, approximately 6½ inches in diameter. This charge should not be confused with the 155-mm gun Propelling Charge M1917-17A1-18MI, which is of approximately the same over-all length, but somewhat smaller in diameter (approx 5¾ in.). The FLASH REDUCER, M1, is for use with the propelling charges for 155-mm guns. It greatly reduces the flash and is primarily intended for night firing (ch. 3, sec. II).

e. **Primers.** See chapter 3, section III.

f. **Interchangeability.**

(1) The H.E. M101 and H.E. Mk. IIIA1 Shell are authorized for emergency use in the 155-mm Guns M1 and M1A1 with the propelling charge intended for the M1917-17A1-18MI Guns (full charge only).

(2) The H.E. Mk. IIIA1 Shell is authorized for emergency use in the 155-mm Guns M1 and M1A1 with the propelling charge standard for these weapons (base section only, or in case of extreme emergency, the full charge).

ARTILLERY AMMUNITION

261. COMPLETE ROUND TABLE.

a. Data concerning complete rounds for 155-mm Guns M1917-17A1, 18MI, M1, and M1A1, are given in table 24, chapter 5.

262. PACKING AND SHIPPING DATA.

a. Packing and shipping data concerning 155-mm gun rounds are given in ORD 11 SNL's P-1, P-2, and P-8.

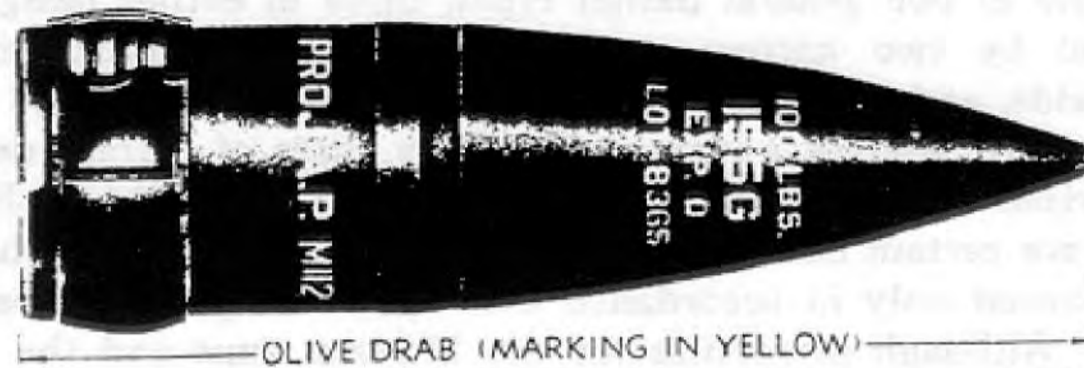

Figure 134 — PROJECTILE, A.P., 100-lb., M112, w/FUZE, B.D., M60, 155-mm Guns, M1917-17A1-18MI, M1, and M1A1

263. PROJECTILE, A.P., 100-LB., M112, W/FUZE, B.D., M60, 155-MM GUNS, M1917-17A1-18MI, M1, AND M1A1 (fig. 134), is intended for use against armored targets, concrete emplacements, and similar targets. It consists of a hardened steel body which contains a cavity in the base filled with explosive D, a base-detonating fuze with delay action, and a ballistic cap or windshield. A base cover is fitted over the fuze in the base of the projectile.

DATA

Length of projectile.....	23.62 in.	Maximum range,	
Width of rotating band.....	2.00 in.	supercharge.....	24,075*; 19,200 yd†
Type of base	Square	Penetration (in. at 0-deg	
Radius of ogive	10.70 cal.	obliquity of homogeneous	
Muzzle velocity (super-		plate at 1,000 yd).....	7.5*
charge)	2,740*; 2,360 ft per sec†	Penetration (in. of reinforced	
		concrete at 1,000 yd).....	60

*—In M1 and M1A1 Guns.

†—In M1917-17A1-18 MI Guns.

264. SHELL, H.E., M101, UNFUZED, 155-MM GUNS, M1917-17A1-18MI, M1, AND M1A1 (fig. 135), was developed from the Mk. IIIA1 Shell described in paragraph 265, differing chiefly in that it has a single wide rotating band, and the angle of taper of the boat-tailed base is 0.5 degree greater. The rear of the rotating band is located approximately 3.48 inches forward of the base. The shell is adapted for either the P.D. M51 Fuze and modifications, or the M67 Mechanical Time Fuze and modifications.

FIXED AND SEMIFIXED ROUNDS AND SEPARATE-LOADING PROJECTILES

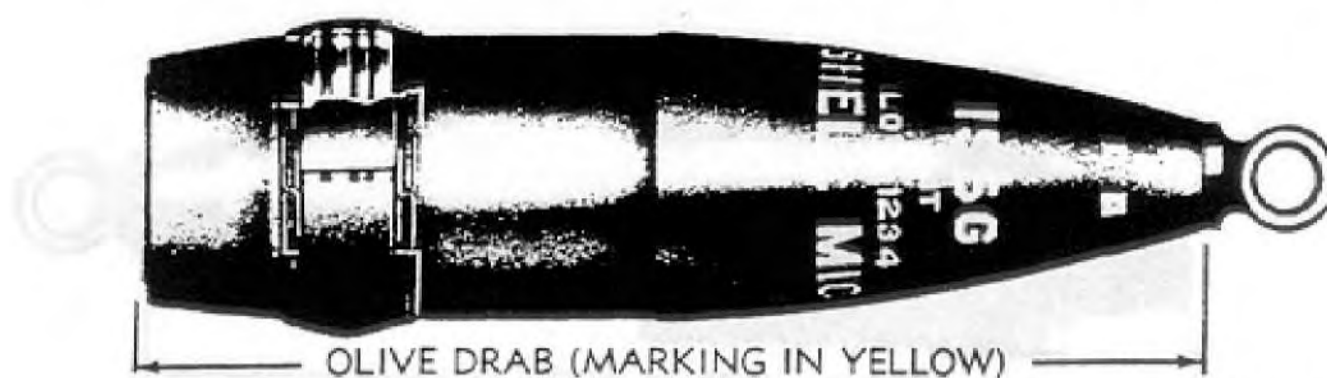

RA PD 80812

Figure 135 — SHELL, H.E., M1G1, Unfuzed, 155-mm Guns, M1917-17A1-18MI, M1, and M1A1 (Early Type Grommet Fastening Shown)

DATA

Length of projectile*.....	26.88 in.	Maximum charge, M1917-17A1-18 Guns	2,410 ft per sec
Width of rotating band.....	2.00 in.	Maximum range:	
Type of base.....	Boat-tailed	M1A1 Gun (at 46 deg	
Degree of taper.....	8.5 deg	49 min)	25,715 yd
Radius of ogive.....	10.75 cal.	M1917-17A1-18 Guns (at 35	
Muzzle velocity:		deg 24 min).....	20,100 yd
Maximum charge, M1 and			
M1A1 Guns	2,800 ft per sec		

*—With eyebolt-lifting plug.



RA PD 80813

Figure 136 — SHELL, H.E., Mk. IIIA1, Unfuzed, 155-mm Guns, M1917-17A1-18MI

265. SHELL, H.E., MK. IIIA1, UNFUZED, 155-MM GUNS, M1917-17A1-18MI (fig. 136), being of earlier design than projectiles for 155-mm Guns M1 and M1A1, is distinguished by two narrow rotating bands. It is a modification of the earlier Mk. III Projectile, the nose being adapted to the new type fuzes. This modification of ogive and use of a standard contour fuze improve the ballistic characteristics.

DATA

Length of projectile*.....	26.88 in.	Muzzle velocity, super-	
Width of rotating bands		charge	2,410*; 2,800 ft per sec††
(two each)	0.59 in.	Maximum range, supercharge:	
Type of base.....	8 deg —boat-tailed	(35 deg 22 min).....	19,100 yd†
Radius of ogive	10.75 cal.	(35 deg)	22,450 yd††

*—With eyebolt-lifting plug. †—In M1917-17A1-18MI Guns. ††—In M1 and M1A1 Guns.

ARTILLERY AMMUNITION

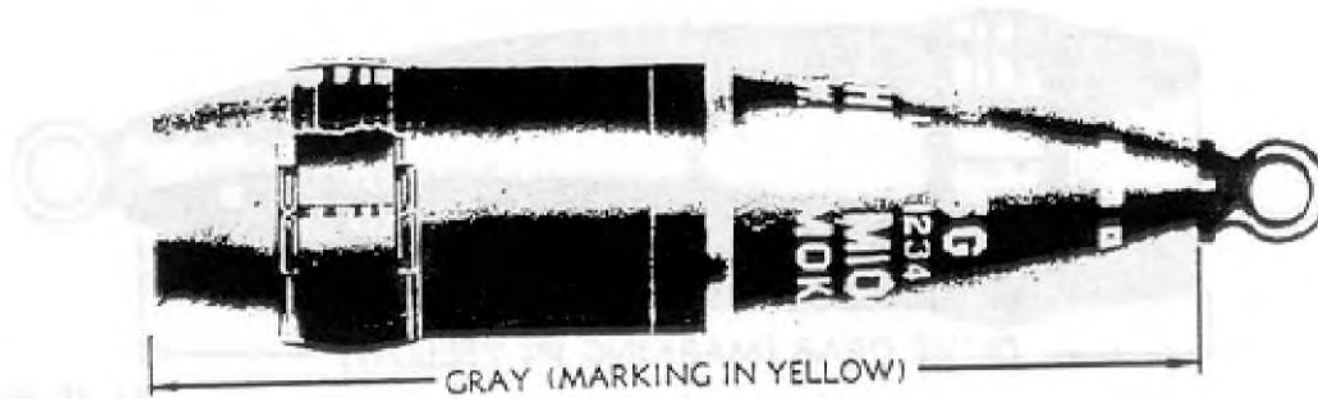

Figure 137 — SHELL, Smoke, Phosphorus, WP, M104, Unfuzed, 155-mm Guns, M1917-17A1-18MI, M1, and M1A1 (Early Type Grommet Shown)

266. SHELL, M104, GAS AND SMOKE, have the same contour as the H.E. M101 Shell described in paragraph 264. The M104 WP Phosphorus Smoke Shell is shown in figure 137. The explosive charge of the burster which is contained in a cardboard or thin aluminum casing, is held in place in the casing by the fuze well cup. One end of the burster casing is fastened to an adapter in the nose cavity. The shell is adapted for the P.D. M51 Fuze and modifications. The various types of gas and smoke shell using the M104 body and burster are:

- SHELL, gas, persistent, H, M104, unfuzed, 155-mm guns, M1917-17A1-18MI, M1, and M1A1
- SHELL, smoke, FS, H104, unfuzed, 155-mm guns, M1917-17A1-18MI, and M1A1
- SHELL, smoke, phosphorus, WP, M104, unfuzed, 155-mm guns, M1917-17A1-18MI, M1, and M1A1

DATA

Length of projectile*.....	26.78 in.	Muzzle velocity, supercharge:	
Width of rotating band.....	2.00 in.		2,410†; 2,800 feet per sec††
Type of base.....	Boat-tailed	Maximum range, supercharge:	
Degree of taper.....	8.5 deg		(at 35 deg 15 min)..... 20,247 yd†
Radius of ogive.....	10.75 cal.		(at 46 deg 45 min)..... 25,940 yd††

*—With eyebolt-lifting plug. †—In M1917-17A1-18MI Guns. ††—In M1 and M1A1 Guns.

267. SHELL, MK. VIIA1, GAS AND SMOKE, are modifications of the Mk. VII Shell described in paragraph 268, the adapter being changed to take the P.D. M51 Fuze, or modifications. The Mk. VIIA1 H Gas Shell is shown in figure 138. The various types of gas and smoke shell using the Mk. VIIA1 Shell body are:

- SHELL, gas, persistent, H, Mk. VIIA1, unfuzed, 155-mm guns, M1917-17A1-18MI
- SHELL, smoke, FS, Mk. VIIA1, unfuzed, 155-mm guns, M1917-17A1-18MI
- SHELL, smoke, phosphorus, WP, Mk. VIIA1, unfuzed, 155-mm guns, M1917-17A1-18MI

FIXED AND SEMIFIXED ROUNDS AND SEPARATE-LOADING PROJECTILES



RA PD 80816

Figure 138 — SHELL, Gas, Persistent, H, Mk. VIIA1, Unfuzed, 155-mm Guns, M1917-17A1-18MI (Early Type Grommet Fastening Shown)

DATA

Length of projectile*	26.82 in.	Degree of taper	8 deg
Width of rotating band (two each)	0.59 in.	Radius of ogive	10.75 cal.
Type of base	Boat-tailed	Muzzle velocity, supercharge	2,385 ft per sec
Maximum range, supercharge (at 34 deg 15 min).....			20,247 yd

*—With eyebolt-lifting plug.

268. SHELL, MK. VII, GAS AND SMOKE, are adapted for the P.D. M46 Fuze. They have tapered or pipe threads, and do not have a base cover. The adapter-boosters are tightly screwed into place, forming a gastight seal for the filler. The two types of gas and smoke shell using the Mk. VII Shell body are:

SHELL, gas, persistent, H, Mk. VII, unfuzed, 155-mm guns, M1917-17A1-18MI

SHELL, smoke, phosphorus, WP, Mk. VII, unfuzed, 155-mm guns, M1917-17A1-18MI

DATA

Length of projectile*	26.82 in.	Radius of ogive	10.75 cal.
Width of rotating band	2.00 in.	Muzzle velocity, supercharge	2,410 ft per sec
Type of base	Boat-tailed	Maximum range	17,900 yd
Degree of taper	8 deg		

*—With eyebolt-lifting plug.

269. SHELL, TARGET-PRACTICE, FOR SAND LOADING, UNFUZED, 155-MM GUNS, M1917-17A1-18MI, M1, AND M1A1, consists of a M101 Shell body, inert adapter-boosters, and inert fuze. Shell is shipped empty and sand-loaded to weight at point of use.

270. PROJECTILE, DUMMY, 95-LB., MK. I, 155-MM GUNS, is provided for training in the service of the 155-mm howitzer as well as the gun. However, when used with the gun, the projectile is fitted with a rotating band having a maximum diameter of 6.5 inches; when used with the howitzer the band has a diameter of 6.1 inches. For further details, see paragraph 258 and figure 133.

ARTILLERY AMMUNITION

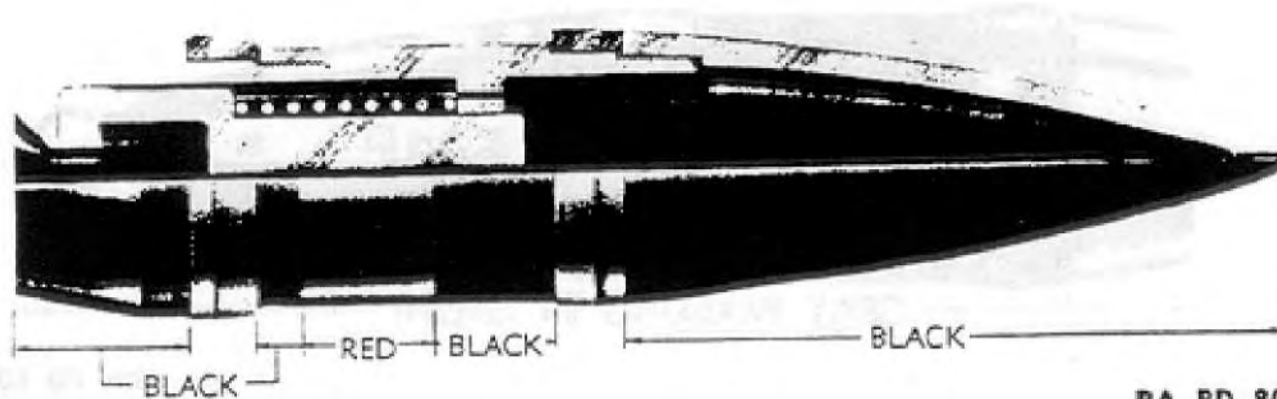

RA PD 80818

Figure 139 — PROJECTILE, Dummy, 95-lb., M7, 155-mm Gun or How.

271. PROJECTILE, DUMMY, 95-LB., M7, 155-MM GUN OR HOW. (fig. 139), is intended for practice in loading and handling of the 155-mm howitzer, as well as the gun. It is of the type having a fully enclosed spring-cushioned plunger, which kicks the projectile loose from the forcing cone of the gun on the rebound upon ramming. It has a malleable iron cap, steel body, bronze front band, steel base, and bronze rear band. The bronze front band simulates the bourrelet of a service projectile. The bronze rear band simulates the rotating band of a service projectile. The several parts are replaceable. The projectile is 27.56 inches long.

FIXED AND SEMIFIXED ROUNDS AND SEPARATE-LOADING PROJECTILES

Section XIX

AMMUNITION FOR 8-INCH HOWITZERS

272. GENERAL.

a. Two models of high-explosive projectiles are authorized for use in the 8-inch Howitzer M1; a dummy projectile is used in training in service of the piece. In one model of service projectile, the surface to the rear of the rotating band is conical (boat-tailed); in the other, the surface to the rear of the rotating band is cylindrical (square).

b. Identification. The ammunition, including components, is completely identified by means of the painting and marking on the items themselves.

c. Fuzes. See chapter 3, section I.

d. Propelling Charges. See chapter 3, section II.

e. Primers. See chapter 3, section III.

273. COMPLETE ROUND TABLE.

a. Data concerning complete rounds for the 8-inch howitzer and components therefor are given in table 25, chapter 5.

274. PACKING AND SHIPPING DATA.

a. Data concerning rounds for the 8-inch howitzer are given in ORD 11 SNL's P-1, P-2, and P-8.

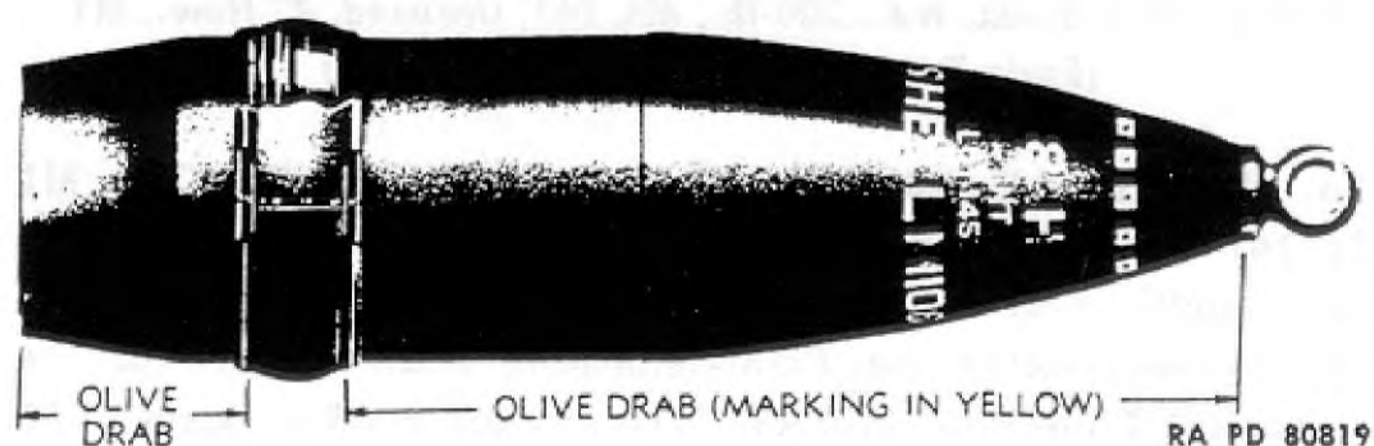

Figure 140 - SHELL, H.E., 200-lb., M106, Unfuzed, 8" How., M1
(Early Type Grommet Fastening Shown)

275. SHELL, H.E., 200-LB., M106; UNFUZED, 8" HOW., M1 (fig. 140), is standard for use in the M1 Howitzer. The rotating band, made of copper or gilding metal, is located 6.06 inches from the base end and has two cannelures or grooves. A molded plastic fuze well cup is assembled in the booster capacity. The projectile

ARTILLERY AMMUNITION

is fitted with a base cover which may consist either of a lead disk and copper cup assembly, secured to the base by means of a lead calking strip, or of a steel plate which is welded to the base. This base cover prevents the hot gases from the propelling charge from reaching the bursting charge of the projectile through possible defects or flaws in the base.

DATA

Length of projectile*	35.14 in.	Radius of ogive	8.0 cal.
Width of rotating band	2.02 in.	Muzzle velocity (M2 Charge, zone VIII)	1,950 ft per sec
Type of base	Boat-tailed		
Degree of taper	9.25 deg		
	Maximum range (at 45 deg 30 min) (M2 Charge)		18,510 yd

*—With eyebolt-lifting plug.



RA PD 80820

Figure 141 — SHELL, H.E., 200-lb., Mk. IA1, Unfuzed, 8" How., M1 (Early Type Grommet Fastening Shown)

276. SHELL, H.E., 200-LB., MK. IA1, UNFUZED, 8" HOW., M1 (fig. 141), is authorized for limited use in the 8-inch Howitzer M1. It is a modification of the Mk. I High-explosive Shell used in 8-inch guns, to take either the Point-detonating Fuze M51A4, or the Mechanical Time Fuze M67A3. The rotating band is located 1.02 inches from base end of projectile. It is fitted with a base cover.

DATA

Length of projectile*	31.10 in.	Radius of ogive	4.0 cal.
Width of rotating band	2.02 in.	Muzzle velocity (M1 Charge, zone V)	1,339 ft per sec
Type of base	Square		
	Maximum range (at 43 deg 35 min) (M1 Charge)		11,170 yd

*—With eyebolt-lifting plug.

FIXED AND SEMIFIXED ROUNDS AND SEPARATE-LOADING PROJECTILES

277. **PROJECTILE, DUMMY, 200-LB., 8" HOW.**, simulates the H.E. M106 Shell. It is of the conventional type having a fully enclosed spring-cushioned plunger, which kicks the projectile loose from the forcing cone of the gun on the rebound upon ramming. It has an ogival bronze cap, a steel body, and a steel base, each screwing into the next neighboring part when assembled. The rotating band and bourrelet of the service shell are simulated by bronze bands. The several parts are replaceable. Projectile is 34.40 inches long.

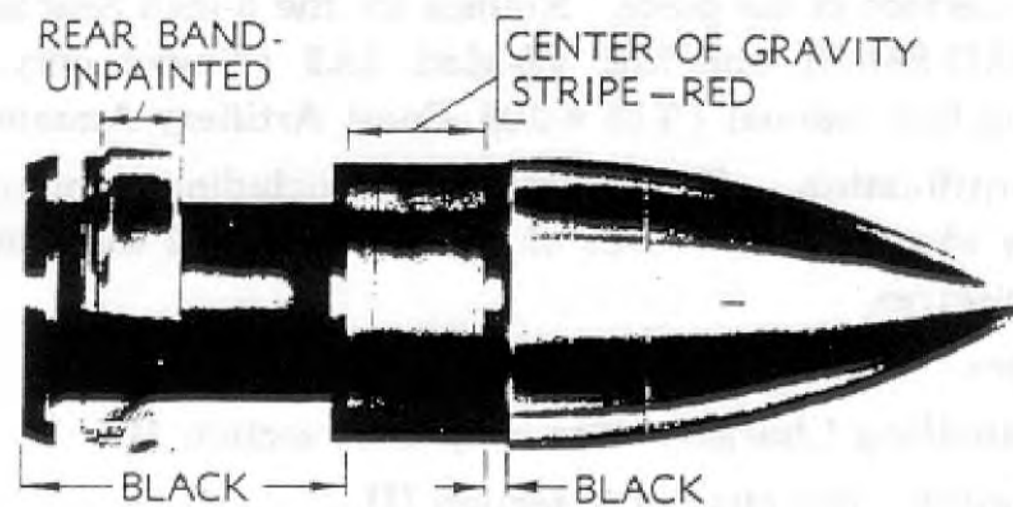

RA PD 80821

Figure 142 – PROJECTILE, Dummy, 200-lb., Mk. IA1, 8" Guns or How.

278. **PROJECTILE, DUMMY, 200-LB., MK. IA1, 8" GUNS OR HOW.** (fig. 142), is provided for training in the service of the 8-inch gun as well as the howitzer. It is a modification of the Mk. I Dummy Projectile described in paragraph 279, and differs in the details of the rear ring and the distance which it slides on the cylindrical portion of the base.

279. **PROJECTILE, DUMMY, 200-LB., MK. I, 8" GUNS OR HOW.**, is an earlier design of the dummy projectile described in paragraph 278. Its principal parts are a bronze cap, a steel body, bronze front band, steel base, and a steel rear ring with bronze rear band. The bronze cap is ogival in-shape and is attached to the forward end of the body. The bronze front band simulates the bourrelet of a service projectile. The steel rear ring is mounted on the cylindrical portion of the base and can slide freely upon it. The bronze rear band mounted on the rear ring simulates the rotating band of the service projectiles. The several parts are replaceable. The projectile is 29 inches long.

ARTILLERY AMMUNITION

Section XX

AMMUNITION FOR 8-INCH GUNS

280. GENERAL.

a. The 8-inch Field Gun M1 is a long-barrelled weapon. It is manually operated and uses separate-loading ammunition. The projectiles authorized for use in this weapon comprise a high-explosive type fitted with a point-detonating fuze, and a dummy type used for training in service of the piece. Rounds for the 8-inch Seacoast Guns, M1888-88MI-88MI, and Mk. VI-Mod. 3A2 (Navy) only, are not discussed in this manual (TM 4-205, Coast Artillery Ammunition).

b. **Identification.** The ammunition, including components, is completely identified by means of the painting and marking on the items themselves.

c. **Fuzes.** See chapter 3, section I.

d. **Propelling Charges.** See chapter 3, section II.

e. **Primers.** See chapter 3, section III.

281. COMPLETE ROUND TABLE.

a. Data concerning 8-inch complete rounds and components therefor are given in table 26, chapter 5.

282. PACKING AND SHIPPING DATA.

a. Data concerning 8-inch rounds are given in ORD 11 SNL's P-1, P-2, and P-8.

283. SHELL, H.E., 240-LB., M103, W/FUZE, P.D., M51A1-MOD. 3, W/BOOSTER, M20A1, OR M51A3-MOD. 3, W/BOOSTER, M21A2, 8" GUNS, MK. VI-MOD. 3A2 (NAVY), MK. IX-MOD. 2 (NAVY), AND M1 (fig. 143), is fitted with a false ogive (windshield). The shell has two bourrelets of 7.990 inches diameter; one (front bourrelet) is just to the rear of the windshield; the other (rear bourrelet) is at the rear of the projectile body. The rotating band, 3.3 inches wide, is located approximately 6 inches forward of the base and within the rear bourrelet. This shell contains a filler of 21 pounds of TNT. A base cover is calked or welded to the base of the shell. The **FUZE**, time, mechanical, M67, and modifications, is authorized for use with this shell when fired from the 8-inch Gun M1 and is assembled in place of the M51A1 Mod. 3, or M51A3-Mod. 3 Fuze, at point of use.

FIXED AND SEMIFIXED ROUNDS AND SEPARATE-LOADING PROJECTILES

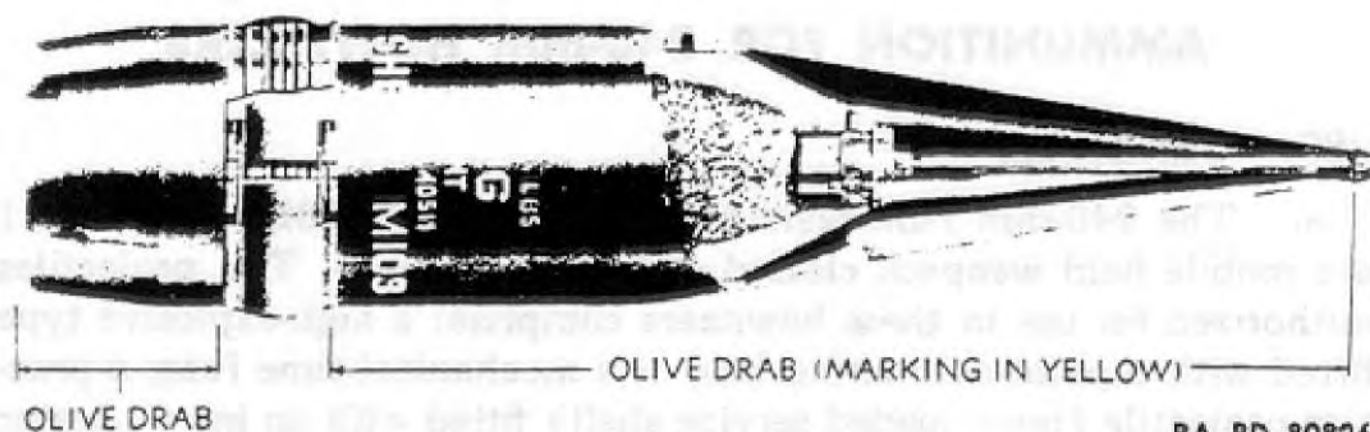

Figure 143 — SHELL, H.E., 240-lb., M103, w/FUZE, P.D., M51A1-Mod. 3, w/BOOSTER, M20A1, or M51A3-Mod. 3, w/BOOSTER, M21A2, 8" Guns, Mk. VI-Mod. 3A2 (Navy), Mk. IX-Mod. 2 (Navy), and M1

DATA

Length of projectile	40.95 in.	Ogive	Conical
Width of rotating band	3.31 in.	Muzzle velocity	
Type of base	Boat-tailed	(supercharge)	2,850 ft per sec
Degree of taper	6 deg	Maximum range	35,635 yd

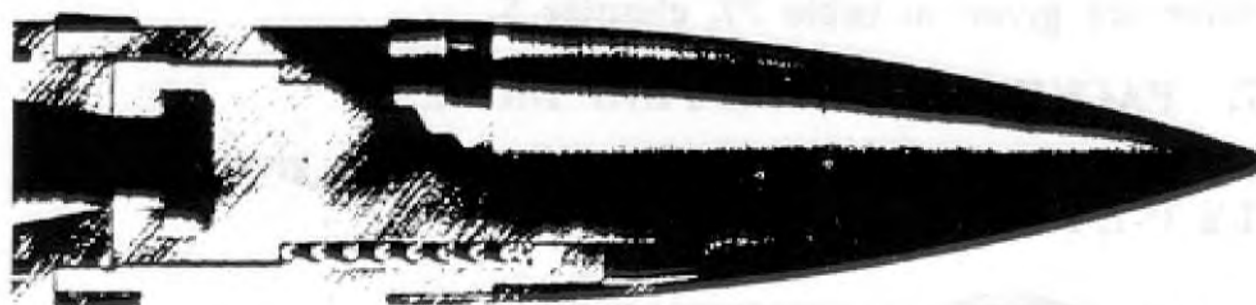

Figure 144 — PROJECTILE, Dummy, 240-lb., M13, 8" Gun

284. PROJECTILE, DUMMY, 240-LB., M13, 8" GUN, M1 (fig. 144) simulates the H.E. Shell, M103 described in paragraph 283, and is intended for training in service of the piece. It is 35.90 inches long and is of the type having a fully enclosed spring-cushioned plunger, which loosens the projectile in the forcing cone of the gun on rebound resulting from ramming. It has a malleable iron cap, steel body, bronze front band, steel base, and bronze rear band. The iron cap is ogival in shape and is attached to the forward end of the body. The bronze front band simulates the bourrelet of a service projectile. The bronze rear band simulates the rotating band of the service projectile. The several parts are replaceable.

ARTILLERY AMMUNITION

Section XXI

AMMUNITION FOR 240-MM HOWITZERS

285. GENERAL.

a. The 240-mm Howitzers M1918-18A1-18MI-18MIA1 and M1 are mobile field weapons classed as heavy artillery. The projectiles authorized for use in these howitzers comprise: a high-explosive type fitted with a point-detonating fuze or a mechanical time fuze; a practice projectile (inert loaded service shell) fitted with an inert adapter and fuze; and a dummy type used for training in service of the piece.

b. **Identification.** The ammunition, including components, is completely identified by the painting and marking on the items themselves.

c. **Fuzes.** See chapter 3, section I.

d. **Propelling Charges.** See chapter 3, section II.

e. **Primers.** See chapter 3, section III.

286. COMPLETE ROUND TABLE.

a. Data concerning 240-mm complete rounds and components therefor are given in table 27, chapter 5.

287. PACKING AND SHIPPING DATA.

a. Data concerning the 240-mm rounds are given in ORD 11 SNL's P-1, P-2, and P-8.

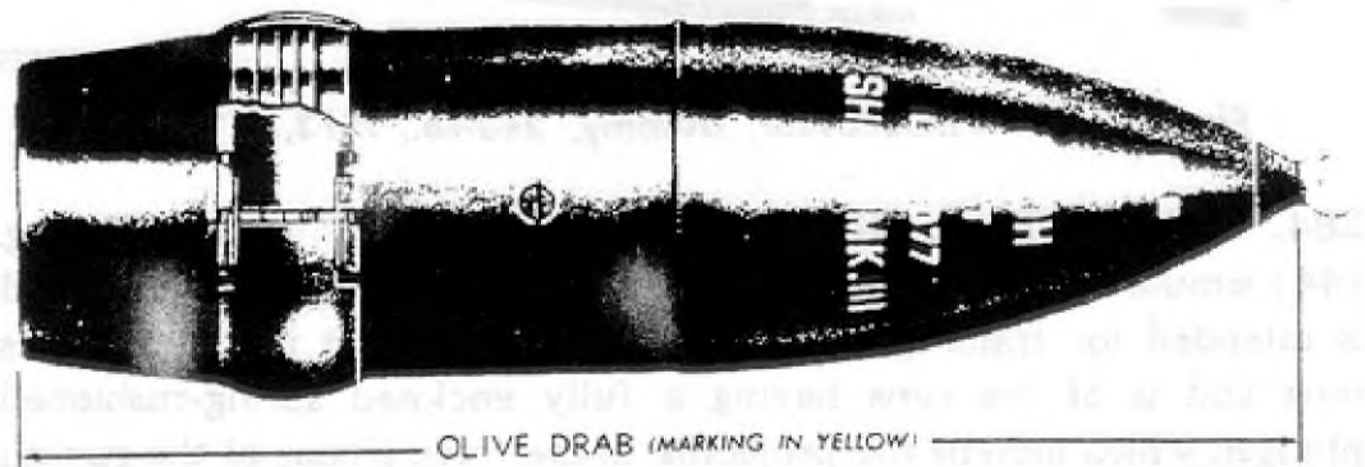

Figure 145 - SHELL, H.E., Mk. III, Unfuzed, 240-mm How.,
M1918-18A1-18MI-18MIA1

288. SHELL, H.E., MK. III, UNFUZED, 240-MM HOW., M1918-18A1-18MI-18MIA1 (fig. 145), is intended for use with the M46 or M47 Point-detonating Fuze. As shipped, the projectile is unfuzed and is fitted with the Mk. IIA Adapter-booster, and a lifting plug. The

FIXED AND SEMIFIXED ROUNDS AND SEPARATE-LOADING PROJECTILES

rotating band, made of gilding metal or copper, has two cannelures or grooves; it is located 6.05 inches from the base end of the projectile. The base cover consists of a lead disk and copper cup assembly secured to the base by means of a lead calking strip.

DATA

Length of projectile*	37.20 in.	Radius of ogive	4.5 cal.
Width of rotating band	2.02 in.	Muzzle velocity (max)..	1,700 ft per sec
Type of base	Boat-tailed	Maximum range	
Degree of taper	7 deg	(at 45 deg 10 min).....	16,390 yd

*—With eyebolt-lifting plug.

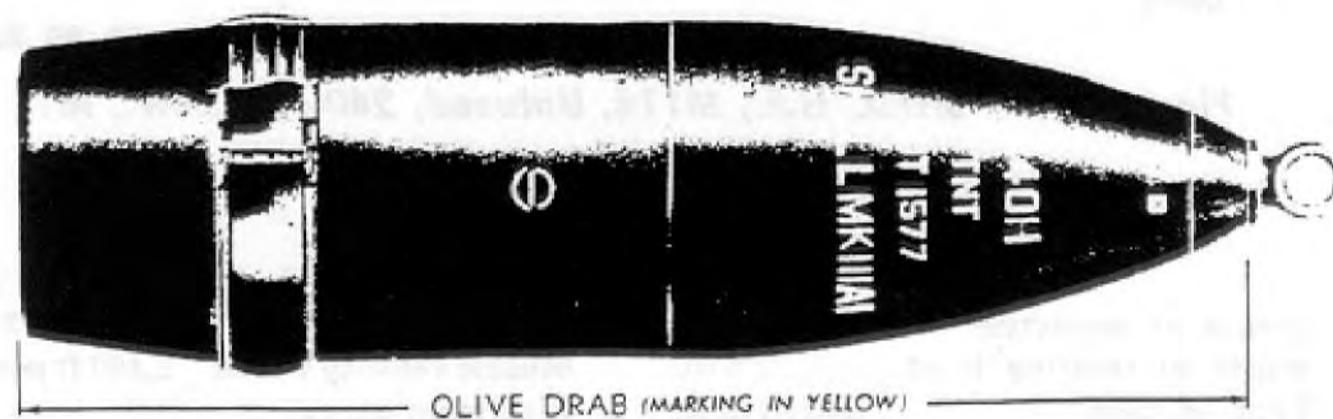

Figure 146 — SHELL, H.E., Mk. IIIA1, Unfuzed, 240-mm How., M1918-18A1-18MI-18MIA1

289. SHELL, H.E., MK. IIIA1, UNFUZED, 240-MM HOW., M1918-18A1-18MI-18MIA1 (fig. 146), is intended for use with the M51 Point-detonating Fuze or modifications, or the M67 Mechanical Time Fuze or modifications. This projectile utilizes the same shell body as the Mk. III (par. 288) but employs a modified nose bushing. All other characteristics are the same as the Mk. III except the over-all length which is 37.22 inches.

290. SHELL, EMPTY, FOR SAND LOADING, 345-LB., Mk. III, UNFUZED, 240-MM HOW., M1918-18A1-18MI-18MIA1, used for target-practice firings, is the Mk. III High-explosive Shell with its bursting charge replaced by an equivalent weight of inert filler, in this case, sand. Projectile is adapted for inert Point-detonating Fuze M47.

291. SHELL, H.E., M114, UNFUZED, 240-MM HOW., M1 (fig. 147), is the standard high-explosive round for the M1 Howitzer. The rotating band, made of copper or gilding metal, has three cannelures or grooves; it is located 6.58 inches from the base end of the projectile. This projectile is fitted with a base cover to prevent hot gases

ARTILLERY AMMUNITION

generated by the burning propelling charge from reaching the bursting charge through possible defects or flaws in the base. The base cover consists of a lead disk and copper cup assembly or a steel cup secured to the base by means of a lead calking strip.

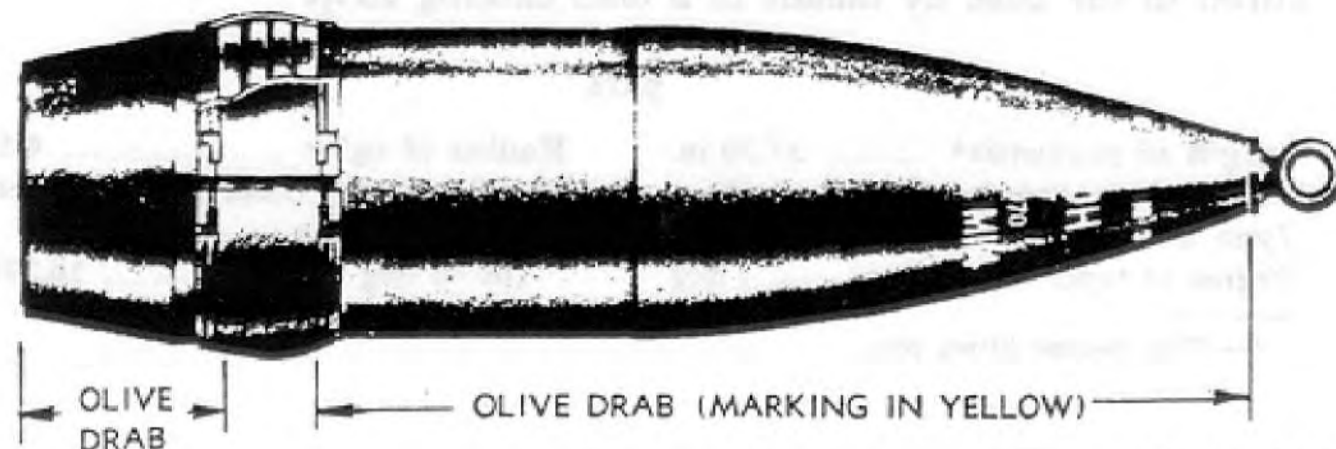

Figure 147 - SHELL, H.E., M114, Unfuzed, 240-mm How., M1

DATA

Length of projectile*	41.74 in.	Radius of ogive	8 cal.
Width of rotating ¹ band.....	2.5 in.	Muzzle velocity (max) ..	2,300 ft per sec
Type of base	Boat-tailed	Maximum range	
Degree of taper	8.5 deg	(at 46 deg 30 min).....	25,255 yd

*—With eyebolt-lifting plug.

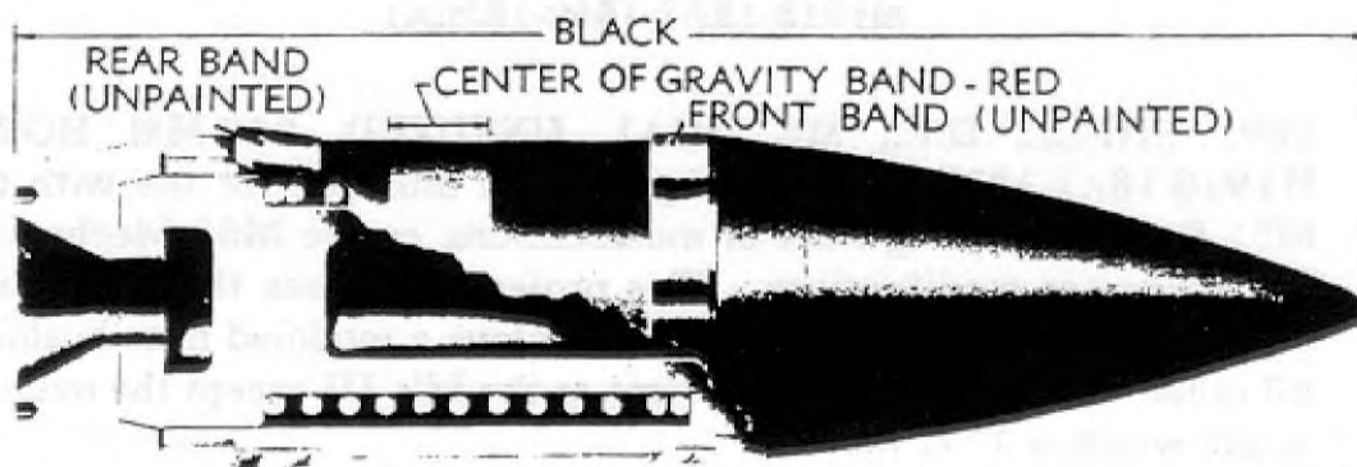

Figure 148 - PROJECTILE, Dummy, 360-lb., M12, 240-mm How., M1918-18A1-18MI-18MIA1, and M1

292. PROJECTILE, DUMMY, 360-LB., M12, 240-MM HOW., M1918-18A1-18MI-18MIA1, AND M1 (fig. 148), is intended for training in service of the piece. It is 40.45 inches long and is of the type having a fully enclosed spring-cushioned plunger, which loosens the projectile in the forcing cone of the gun on rebound of the plunger due to ramming. It has a malleable iron cap, a steel body, bronze front band, steel base, and steel rear ring with bronze rear band. The iron

FIXED AND SEMIFIXED ROUNDS AND SEPARATE-LOADING PROJECTILES

cap is ogival in shape and is attached to the forward end of the body. The bronze front band simulates the bourrelet of a service projectile. The bronze rear band mounted on the rear ring simulates the rotating band of the service projectile. The several parts are replaceable.

293. PROJECTILE, DUMMY, 356-LB., MK. I, 240-MM HOW., M1918-18A1-18MI-18MIA1, AND M1, is intended for training in service of the piece. Its principal parts are a bronze cap, a steel body, bronze front band, and a sliding steel rear ring with bronze rear band. The bronze cap is ogival in shape and is attached to the forward end of the body. The bronze front band simulates the bourrelet of a service projectile. The steel rear ring is mounted on the undercut cylindrical portion of the body and can slide freely upon it. The bronze rear band, mounted on the rear ring, simulates the rotating band of the service projectiles. The several parts are replaceable. The projectile is 35.9 inches long.

ARTILLERY AMMUNITION

Section XXII

AMMUNITION FOR SUBCALIBER WEAPONS

294. GENERAL.

a. Subcaliber ammunition is intended for use in subcaliber guns for training personnel in target practice. For small caliber weapons, interior type subcaliber guns are provided which fire small-arms ammunition, such as cal. .22 and cal. .30 cartridges. Cal. .30 and cal. .50 cartridges are also used in machine guns on exterior subcaliber mounts on the 37-mm Antiaircraft Gun M1A2, and on medium caliber antitank weapons. For the remaining medium and heavy weapons, the 37-mm Subcaliber Guns M12, M13, M14, and M1916 and modifications are used on appropriate subcaliber mounts. See table 2 for a list of weapons and their subcaliber weapons and ammunition. This section deals primarily with ammunition for the 37-mm Subcaliber Guns M12, M13, M14, and M1916. Also described in this section is the Field Artillery Trainer M3, which, although not subcaliber equipment, simulates field artillery firings.

b. **Identification.** The 37-mm subcaliber rounds are completely identified by means of the painting and marking on the items themselves.

c. **Fuzes.** See chapter 3, section I.

d. **Cartridge Cases.** The standard 37-mm cartridge case for ammunition used in 37-mm Subcaliber Gun M1916 is the Mk. IA2. The Mk. IA2B1 Case is a steel case alternate and is 0.02 pound lighter than the Mk. IA2 Case, which is made of drawn brass.

e. **Primers.** See chapter 3, section III.

295. COMPLETE ROUND TABLE.

a. Data concerning the 37-mm subcaliber rounds are given in table 28, chapter 5.

296. PACKING AND SHIPPING DATA.

a. Data concerning the 37-mm subcaliber rounds are given in ORD 11 SNL R-1.

FIXED AND SEMIFIXED ROUNDS AND SEPARATE-LOADING PROJECTILES

TABLE 2
SUBCALIBER MATERIEL AND AMMUNITION

Weapon and Mount	Subcaliber Weapon and Mount	Subcaliber Ammunition
37-mm guns, M3, M3A1, on CARRIAGE, gun, 37-mm, M4	RIFLE, subcaliber, cal. .22, M2A1	CARTRIDGE, ball, cal. .22, long rifle
CARRIAGE, gun, 37-mm, M4A1	MOUNT, subcaliber, cal. .22-.30, M6*	
CARRIAGE, motor, 37-mm gun, M6	MOUNT, subcaliber, cal. .22-.30, M7*	
57-mm gun M1, on CARRIAGE, gun, 57-mm, M1A3	MOUNT, subcaliber, cal. .22-.30, M7A1*	
37-mm gun, M6, in light, medium, and heavy tanks	MOUNT, subcaliber, cal. .22-.30, M14*	
37-mm guns, M3, M3A1, on CARRIAGE, gun, 37-mm, M4	RIFLE, subcaliber, cal. .22, M5	
CARRIAGE, gun, 37-mm, M4A1	MOUNT, subcaliber*	
CARRIAGE, motor, 37-mm gun, M6	RIFLE, subcaliber, cal. .30, M1903A2	CARTRIDGE, ball, cal. .30, M2
57-mm gun, M1, on CARRIAGE, 57-mm, M1A3	MOUNT, subcaliber, cal. .22-.30, M6	CARTRIDGE, ball, cal. .30, M1
37-mm auto. gun, M1A2, on CARRIAGE, automatic, 37-mm, M3	MOUNT, subcaliber, cal. .22-.30, M7*	
76-mm gun, M1, M1A1, M1A2, on CARRIAGE, motor, 76-mm gun, M18	MOUNT, subcaliber, cal. .22-.30, M7A1*	
3-inch gun, M7, on CARRIAGE, motor, 3-inch gun, M10, M10A1	MOUNT, subcaliber, cal. .22-.30, M14*	
3-inch gun, M5, on CARRIAGE, gun, 3-inch, M1	GUN, machine, cal. .30, Browning, M1917A1	
	MOUNT, subcaliber, cal. .30, M8†	
	GUN, machine, cal. .50, Browning, M2, HB (flexi- ble)	CARTRIDGE, ball, cal. .50, M2
	MOUNT, subcaliber, cal. .50, M10†	
	MOUNT, subcaliber, cal. .50, M9†	
	MOUNT, subcaliber, cal. .50, M12†	

ARTILLERY AMMUNITION

Weapon and Mount	Subcaliber Weapon and Mount	Subcaliber Ammunition
75-mm gun, M1917, on CARRIAGE, gun, 75-mm, M1917A1	GUN, subcaliber, 37-mm, M1916A1 MOUNT, subcaliber (in- terior type)*	SHELL, fixed, prac- tice, M92, w/ FUZE, P.D., M74, 37-mm sub-caliber guns, M12, M13, M14, and M1916††
75-mm gun, M1897, on CARRIAGE, gun, 75-mm, M1897MIA2, M1897A4 CARRIAGE, gun, 75-mm, M2, M2A1, M2A2, M2A3	GUN, 37-mm, M1916 MOUNT, subcaliber, 37- mm, M2† MOUNT, subcaliber, 37- mm, M7†	SHELL, fixed, prac- tice, M63-Mod. 1, w/FUZE, base, practice, M58, 37- mm subcaliber guns, M12, M13, M14, and M1916††
CARRIAGE, gun, 75-mm, M1897MI, M1897A4	MOUNT, subcaliber, 37- mm, M8†	SHELL, fixed, prac- tice, Mk. IIA1, w/FUZE, base, practice, M38, 37- mm subcaliber gun, M1916†† §
75-mm gun, M1916, on CARRIAGE, gun, 75-mm, M1916A1	MOUNT, subcaliber, 37- mm, M9†	
75-mm how., M1, M1A1, on CARRIAGE, how., 75-mm, M1, M2A1, M3, M3A2, M3A3	MOUNT, subcaliber, 37- mm, M5†	
105-mm how., M2, M2A1, on CARRIAGE, how., 105- mm, M2, M2A1, M2A2, and CARRIAGE, mo- tor, 105-mm how., M7....	MOUNT, subcaliber, 37- mm, M16†	
4.5-inch gun, M1, on CARRIAGE, gun, 4.5- inch, M1	MOUNT, subcaliber, 37- mm, M13A1†	
155-mm how., M1, on CARRIAGE, how., 155- mm, M1	MOUNT, subcaliber, 37- mm, M13A1†	
155-mm how., M1917-17A1- 18, on CARRIAGE, how., 155- mm, M1917A4 or M1918A3	MOUNT, subcaliber, 37- mm, M4†	
155-mm gun, M1917-17A1- 18MI, on CARRIAGE, gun, 155- mm, M1917-17A1- M1918-18A1, M2, M3....	MOUNT, subcaliber, 37- mm, M1†	
155-mm gun, M1, M1A1, on CARRIAGE, gun, 155- mm, M1	MOUNT, subcaliber, 37- mm, M10†	
8-inch how., M1, on CARRIAGE, how., 8-inch, M1	MOUNT, subcaliber, 37- mm, M10†	

FIXED AND SEMIFIXED ROUNDS AND SEPARATE-LOADING PROJECTILES

Weapon and Mount	Subcaliber Weapon and Mount	Subcaliber Ammunition
75-mm how., M1, M1A1, on CARRIAGE, how., 75-mm, M1A1 75-mm how., M2 and M3, on CARRIAGE, motor, 75-mm how., M8	GUN, subcaliber, 37-mm, M12*	SHELL, fixed, practice, M92, w/FUZE, P.D., M74, 37-mm subcaliber guns, M12, M13, M14, and M1916††
105-mm how., M2, M2A1, on CARRIAGE, how., 105-mm, M2A2 105-mm, how., M3, on CARRIAGE, how., 105-mm, M3, M3A1 105-mm how., M4, on CARRIAGE, motor, 105-mm how., T76, M7 medium tanks, M4, M4A3	GUN, subcaliber, 37-mm, M13*	SHELL, fixed, practice, M63-Mod. 1, w/FUZE, base, practice, M58, 37-mm subcaliber guns, M12, M13, M14, and M1916††
90-mm gun, M1, on CARRIAGE, gun, 90-mm, M3	GUN, subcaliber, 37-mm, M14*	SHELL, fixed, practice, Mk. IIA1, w/FUZE, base, practice, M38, 37-mm subcaliber gun, M1916†† §
76-mm gun, M1A1, M1A2, on CARRIAGE, motor, 76-mm gun, M18	GUN, subcaliber, 37-mm, T34*	
3-inch gun, M5, on CARRIAGE, gun, 3-inch, M1, M1A1, M6	GUN, subcaliber, 37-mm, T36*	

*—Interior mount. †—Exterior mount. ††—Also assembled with "steel case".
§—This round is not to be fired over the heads of troops, and no personnel in the vicinity of the gun are to be forward of a line perpendicular to the muzzle.

297. CARTRIDGE, BALL, CAL. .22, LONG RIFLE (fig. 149). The muzzle velocity of the 40-grain lead bullet is 1,130 feet per second and the maximum range is 1,350 yards.

298. CARTRIDGE, BALL, CAL. .30, M2 (fig. 149). Weight of the complete cartridge is 396 grains. Muzzle velocity of the 150-grain bullet is 2,760 feet per second and maximum range is 4,700 yards.

299. CARTRIDGE, BALL, CAL. .30, M1, is used in the same weapon and for the same purpose as CARTRIDGE, ball, cal. .30, M2, described in paragraph 298. The weight of the complete cartridge is 420 grains. Muzzle velocity of the 174-grain bullet is 2,647 feet per second and the maximum range is 4,950 yards.

300. CARTRIDGE, BALL, CAL. .50, M2 (fig. 149), is for use with the Browning Machine Gun, cal. .50, M2, HB (flexible), on subcaliber mounts on medium caliber antitank guns. Muzzle velocity of 698-grain bullet is 2,935 feet per second in a 45-inch barrel, and maximum range is 7,600 yards.

ARTILLERY AMMUNITION

- A — CARTRIDGE, BALL, CAL. .22, LONG RIFLE
- B — CARTRIDGE, BALL, CAL. .30, M2
- C — CARTRIDGE, BALL, CAL. .50, M2

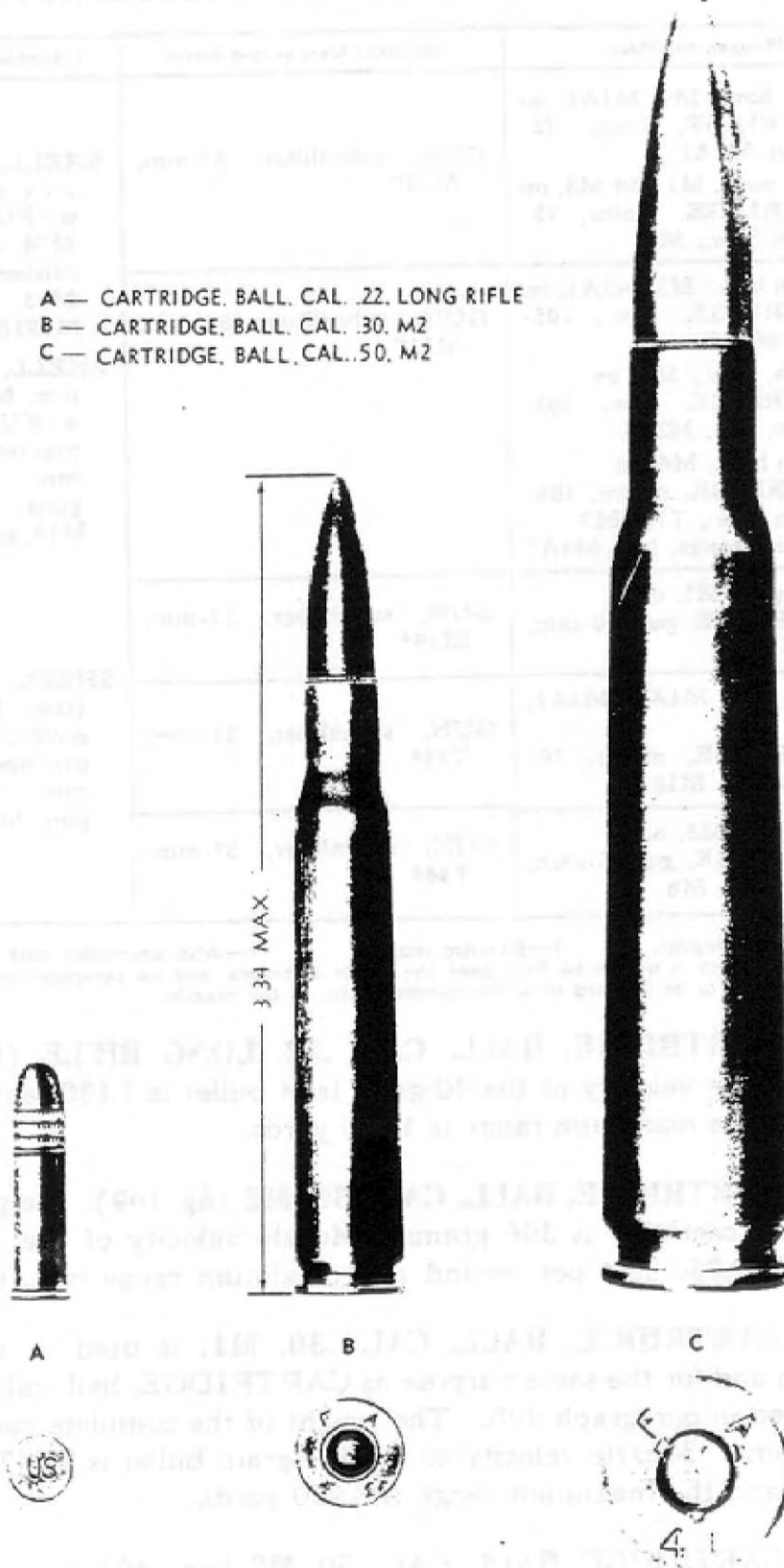

RA PD 80834

Figure 149 — Cal. .22, cal. .30, and cal. .50 Subcaliber Ammunition

FIXED AND SEMIFIXED ROUNDS AND SEPARATE-LOADING PROJECTILES

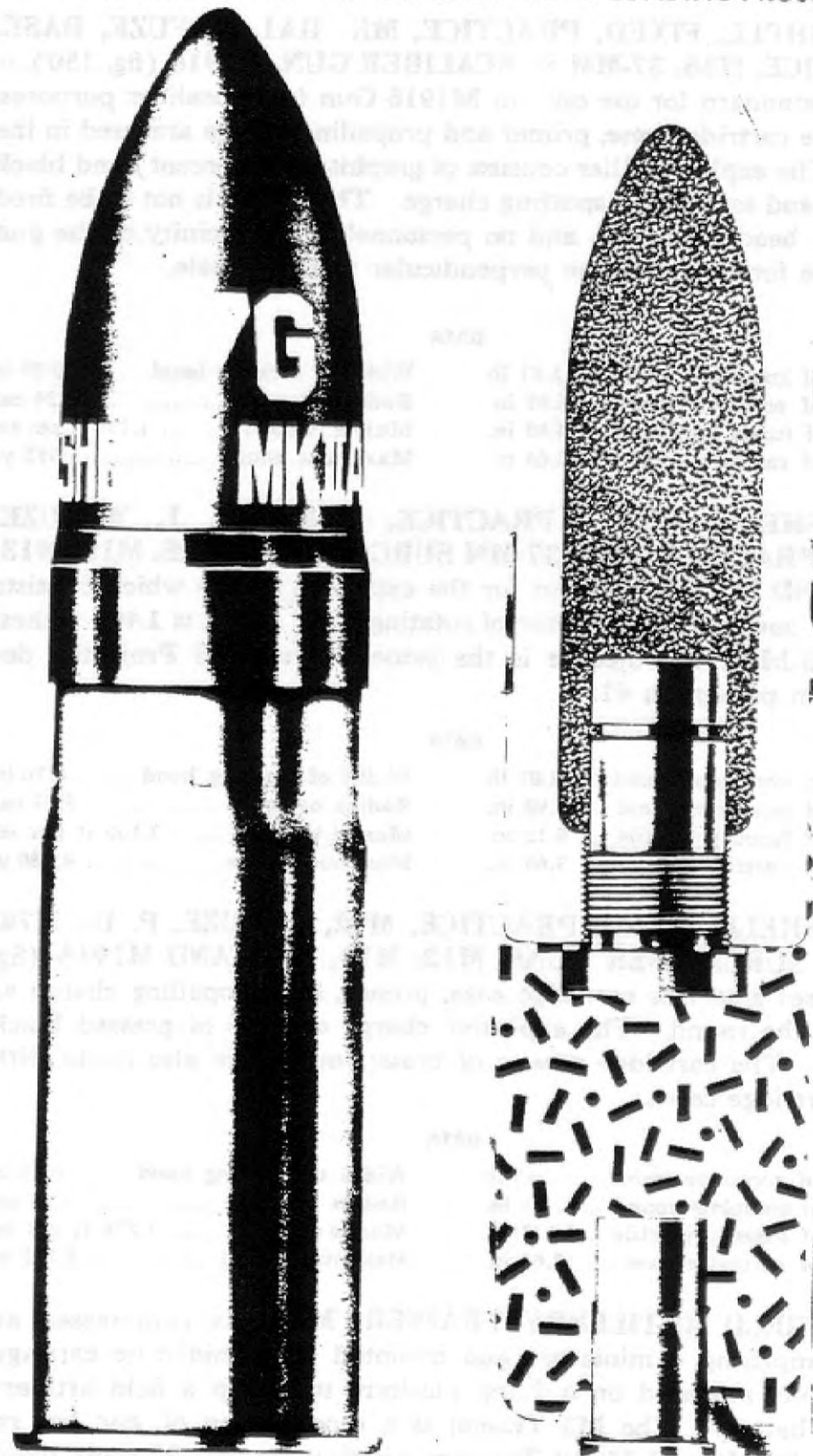

RA PD 80700

Figure 150 — SHELL, Fixed, Practice, Mk. IIA1, w/FUZE, Base, Practice, M38, 37-mm Subcaliber Gun, M1916

ARTILLERY AMMUNITION

301. SHELL, FIXED, PRACTICE, MK. II A1, W/FUZE, BASE, PRACTICE, M38, 37-MM SUBCALIBER GUN, M1916 (fig. 150), is limited standard for use only in M1916 Gun for subcaliber purposes. A service cartridge case, primer and propelling charge are used in the round. The explosive filler consists of graphite (15 percent) and black powder and serves as a spotting charge. This round is not to be fired over the heads of troops, and no personnel in the vicinity of the gun are to be forward of a line perpendicular to the muzzle.

DATA

Weight of complete round	1.61 lb	Width of rotating band.....	0.74 in.
Length of complete round....	6.92 in.	Radius of ogive	2.24 cal.
Length of fuzeed projectile	4.60 in.	Muzzle velocity	1,276 ft per sec
Length of cartridge case.....	3.64 in.	Maximum range	4,915 yd

302. SHELL, FIXED, PRACTICE, M63-MOD. 1, W/FUZE, BASE, PRACTICE, M58, 37-MM SUBCALIBER GUNS, M12, M13, M14, AND M1916. Except for the explosive charge which consists of black powder and diameter of rotating band which is 1.491 inches, the M63-Mod. 1 Projectile is the same as the M63 Projectile described in paragraph 41.

DATA

Weight of complete round	2.01 lb	Width of rotating band	0.76 in.
Length of complete round	8.98 in.	Radius of ogive	8.97 cal.
Length of fuzeed projectile	6.15 in.	Muzzle velocity	1,100 ft per sec
Length of cartridge case.....	3.64 in.	Maximum range	4,980 yd

303. SHELL, FIXED, PRACTICE, M92, W/FUZE, P. D., M74, 37-MM SUBCALIBER GUNS, M12, M13, M14, AND M1916 (fig. 151), uses a service cartridge case, primer, and propelling charge as used in the round. The explosive charge consists of pressed black powder. The cartridge case is of brass; rounds are also made with steel cartridge cases.

DATA

Weight of complete round	1.65 lb	Width of rotating band	0.74 in.
Length of complete round	7.21 in.	Radius of ogive	2.24 cal.
Length of fuzeed projectile ..	4.175 in.	Muzzle velocity	1,276 ft per sec
Length of cartridge case	3.64 in.	Maximum range	5,165 yd

304. FIELD ARTILLERY TRAINER, M3, is a compressed air unit comprising a miniature gun mounted on a miniature carriage. Four units mounted on a firing platform make up a field artillery trainer battery. The M3 Trainer is a modification of, and has replaced, the M2 and M2A1 Trainers, which use a cal. .22 short blank cartridge as propellant. The projectile is a 1-inch commercial steel ball weighing approximately 1,024 grains. The range is 90 yards.

FIXED AND SEMIFIXED ROUNDS AND SEPARATE-LOADING PROJECTILES



RA PD 80888

Figure 151 — SHELL, Fixed, Practice, M92, w/FUZE, P.D., M74,
37-mm Subcaliber Guns, M12, M13, M14, and M1916

CHAPTER 3

**FUZES, PROPELLING CHARGES, PRIMERS, AND
OTHER COMPONENTS**

Section I

FUZES

305. GENERAL.

a. **Definition.** A fuze is a mechanical device used with a projectile to explode it at the time and under the circumstances desired. The descriptions of specific fuzes are arranged in this section as follows: First, base fuzes; second, point fuzes; third, dummy fuzes; and thence, numerically within each of these groups.

b. **Classification.** Artillery fuzes are classified according to their location on the projectile, as "base" or "point." They are also classified, according to the method of functioning as "time" or "impact," or may be a combination of these. Time fuzes contain a graduated time element in the form of a compressed black powder train or a mechanism similar to clockwork, which may be set to a predetermined time prior to firing. Impact fuzes are classified according to the quickness of action after impact, as superquick, instantaneous, nondelay, or delay. It will be noted that the time of action for impact fuzes is measured from the instant of *impact*, whereas for time fuzes the time of action is measured from the instant of *firing*. An impact fuze which is intended to function on impact with a very light material target, such as an airplane wing, is called "supersensitive."

c. **Description.** In general, modern fuzes consist of a connected series (train) of small explosive charges together with a striker or firing-pin device for initiating the action of the first charge in the train. The mechanism and explosive elements are held in a body or housing. In the case of modern point-detonating fuzes, the housing is shaped for best ballistics. In impact fuzes now in use, the explosive train

FUZES, PROPELLING CHARGES, PRIMERS, AND OTHER COMPONENTS

usually consists of a very small highly sensitive explosive charge of primer mixture followed by a larger less sensitive explosive charge such as mercury fulminate or lead azide, in turn followed by a still larger and still less sensitive explosive charge such as tetryl. Such charges function by successive *detonation*—hence the prevalent term “detonating fuzes.” Explosive trains of detonating fuzes will, however, include a black powder charge at a suitable point in the train when it is intended to provide for delay action. Black powder is used exclusively in the time train of powder-train time fuzes, and for the magazine charge of both powder-train and mechanical types of time fuze. Black powder, being a low explosive, differs in manner of functioning from high-explosive charges used in fuzes in that it produces its effect by *ignition*. In the functioning of a fuze, each charge by its action initiates that of the next charge in the train, the final charge in the fuze causing the detonation of the booster which in turn detonates the bursting charge of the shell (fig. 6).

d. **Boresafety.** To prevent accidental arming during handling and shipping, safety devices such as a safety wire or a cotter pin are used when required. In certain types of fuzes, the mechanisms are so arranged that the fuzes are said to be “boresafe” (detonator safe). A boresafe fuze is one in which the explosive train is so interrupted that prior to firing and while the projectile is still in the bore of the weapon, premature explosion of the shell is prevented should any of the more sensitive elements, primer and/or detonator, malfunction.

e. **Fuze Setters.** For accurate and rapid setting, time fuzes require a fuze setter suitably graduated to suit the requirements of the fuze. A number of models of fuze setters have been standardized, ranging from simple hand types to full automatic types operating in conjunction with a power rammer. Most fuze setters are constructed for a particular fuze or type of fuze, but certain models are adapted for several fuzes. Models of fuze setters now in use are listed in table 3, pages 222-223, together with the fuzes and ammunition for which intended, and additional pertinent data.

f. **Packing and Shipping Data.** Packing and shipping data for separately issued fuzes are given in ORD 11 SNL R-3.

ARTILLERY AMMUNITION

TABLE 3
FUZE SETTERS*

Fuze Setter Model	Fuzes for Which Adapted	Ammunition With Which Used	Type of Fuze Setter	Type of Operation		Range of Scale (s)
				Adjusting	Setting	
M1912	FUZE, combination, 21-sec., M1907M	SHRAPNEL, fixed, Mk. I, 75-mm gun	Hand	Manual	Manual	0-21 sec. 6,000 yd
M1916	FUZE, combination, 21-sec., M1907M	SHRAPNEL, fixed, Mk. I, 75-mm gun	Hand	Manual	Manual	0-21 sec. 6,600 yd
M1916A1	FUZE, time, 21-sec., A.A., Mk. IIIA1, Mk. IIIA2	SHELL, fixed, H.E., M42; SHELL, fixed, H.E., Mk. IX; SHRAPNEL, fixed, Mk. I; 3" guns, M1917 (all mods.), M1925MI-25MIA1, M2, and M4 SHELL, fixed, H.E., Mk. IX; SHRAPNEL, fixed, Mk. I; 3" guns, M1918 (all mods.), and M3	Bracket	Manual	Manual	0-21.2 sec.
M8	FUZE, time, mechanical, M43 (all mods.) FUZE, time, 21-sec., A.A., Mk. IIIA1, Mk. IIIA2 FUZE, dummy, M42A1	All 3-inch gun service, practice and drill; ammunition with the M43 and Mk. III Fuzes, or modifications thereof, or with the M42A1 Dummy Fuze.	Electrical indicating	Electrical	Manual	0-30 sec.†§ 0-30 sec.††§
M9	FUZE, time, mechanical, M2	SHELL, fixed, H.E., M38, flashless, 105-mm gun, M3	Electrical indicating	Electrical	Manual	0-30 sec.
M10	FUZE, time, mechanical, M43 (all mods.)	SHELL, fixed, H.E., M38A1, 105-mm gun, M3 SHELL, fixed, H.E. (ammunition), M38A1, 105-mm gun, M3 SHELL, fixed, practice, M38A1, 105-mm gun, M3	Electrical indicating	Electrical	Manual	0-30 sec.
M13	FUZE, time, mechanical, M43 (all mods.) FUZE, dummy, M44A2	SHELL, fixed, H.E., M58, 90-mm guns SHELL, fixed, H.E. (ammunition), M58, 90-mm guns SHELL, fixed, H.E., M71, 90-mm guns CARTRIDGE, drill, M12, 90-mm guns	Electrical indicating	Electrical	Manual	0-30 sec.

FUZES, PROPELLING CHARGES, PRIMERS, AND OTHER COMPONENTS

TABLE 3 (Contd.)
FUZE SETTERS* (Contd.)

Fuze Setter Model	Fuzes for Which Adapted	Ammunition With Which Used	Type of Fuze Setter	Type of Operation		Range of Scale (s)
				Adjusting	Setting	
M14†	FUZE, TSQ, M54 FUZE, TSQ, M55, M55A1, M55A2 FUZE, time, mechanical, M67, M67A1, M67A2 FUZE, TSQ, M77	Projectiles of all calibers with the M54, M55, M55A1, M55A2, M67, M67A1, M67A2, or M77 Fuzes	Hand (Wrench type)	None	Manual	No graduations or calibrations
M15	FUZE, TSQ, M54	SHELL, semifixed, H.E., M48, charge 3, 75-mm howitzer	Hand	Manual	Manual	9-25 sec. 0-6000 yd
M17	FUZE, TSQ, M54	SHELL, semifixed, H.E., M1, charge 5, 105-mm how., M2	Hand	Manual	Manual	0-25 sec. 0-6500 yd
M19	FUZE, time, mechanical, M61, M61A1	SHELL, H.E., M73, 120-mm gun, M1	Combination setter and rammer	Electrical	Electrical	None, preset by signals fed from remote-control director
M20	FUZE, time, mechanical, M43 (all mods.)	SHELL, fixed, H.E., M71, 90-mm gun, M1	Combination setter and rammer	Electrical	Electrical	None, preset by signals fed from remote-control director
M22	FUZE, TSQ, M54 FUZE, TSQ, M55, M55A1, M55A2 FUZE, time, mechanical, M67, M67A1, M67A2 FUZE, TSQ, M88 (T77)	All projectiles of all calibers with M54, M55, M55A1, M55A2, M67, M67A1, M67A2, or M88 Fuzes	Hand	Manual	Manual	0-75 sec.
M23	FUZE, time, mechanical, M67, M67A1, M67A2	All projectiles of all calibers with M67 or M67A1 Fuze	Hand	Manual	Manual	0-75 sec.

*—In addition to fuze setters listed, WRENCH, fuze, M7A1, is provided for tightening the M51, M55, and M67 type fuzes in the projectile, and for interchanging fuzes. The screwdriver portion of the wrench is used for setting the fuze.

†—For M43 Fuze (all modifications).

††—For Mk. IIIA1 and Mk. IIIA2 AA. Fuzes.

§—Either scale for service fuzes may be used for drill with M42A1 Dummy Fuze.

¶—M14 Setter can also be used for emergency purpose with, FUZE, time, mechanical, M43 (all modifications).

ARTILLERY AMMUNITION

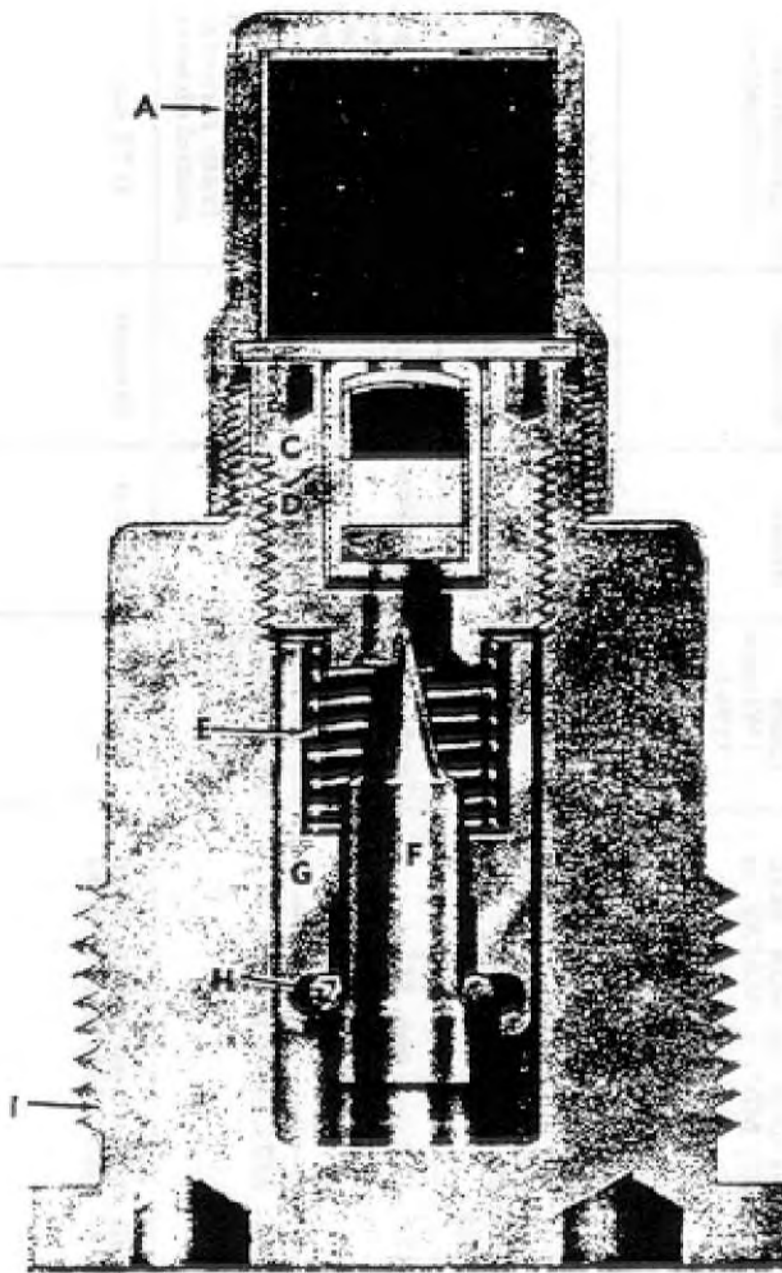

RA PD 80839

RA PD 80839

Figure 152 — FUZE, B.D., M58

FUZES, PROPELLING CHARGES, PRIMERS, AND OTHER COMPONENTS

306. FUZE, BASE, PRACTICE, M38.

a. **Description and Functioning.** Used with the Mk. IIA1 Practice Shell for subcaliber firing with Gun, M1916. With this shell, a booster is unnecessary. The fuze has the same internal mechanism as the M58 Base Fuze described in paragraph 307 and illustrated in figure 152.

b. **Data.** Over-all length, 1.5 inches; weight 0.125 pound; thread size, 0.72-18NS-1.

307. FUZE, B.D., M58.

a. **General.** This fuze (fig. 152) is used with the M63 H.E. Shell for 37-mm Guns, M3, M3A1, and M6.

b. **Data.** Over-all length, 2.02 inches; weight, 0.30 pound; thread size, 1.02-18NS-3 LH.

c. **Description.** The fuze consists of: a brass or steel body (I) containing the firing pin (F) and sleeve (G) assembly; a brass detonator holder (C) which holds the primer mixture and intermediate detonating charges (D); and a brass or steel closing cup (A). The closing cup holds the booster pellet (B), the final charge in the fuze explosive train. These components are assembled as illustrated in figure 152. There are no boresafety arrangements or external safety devices, the striker being held in the unarmed position prior to firing by a resistance ring (H) which holds the firing pin at the rear of the sleeve and away from the detonator.

d. **Functioning.** Upon firing, set-back forces the ring back over the shoulder of the firing pin and into the groove near the flat end of the firing pin, locking the pin in a more forward position in the sleeve. During the flight of the projectile, the combined pin sleeve assembly is held to the rear by its spring. Upon impact, the pin-sleeve assembly moves forward against the restraint of the spring and the firing pin strikes the primer, initiating the explosive train.

308. FUZE, BASE, PRACTICE, M58.

a. **Description and Functioning.** The M58 Practice Fuze is the M58 Service Fuze with the booster omitted and, except for this difference, it functions like the service model. The practice fuze is used with M63-Mod. 1 Practice Shell for subcaliber purposes for 37-mm Gun M1916. With this shell a booster is unnecessary, since flash of detonator charge is sufficient to ignite black powder shell filler.

b. **Data.** Over-all length 1.6 inches; weight, 0.29 pound; thread size, 1.02-18NS-3 LH.

ARTILLERY AMMUNITION

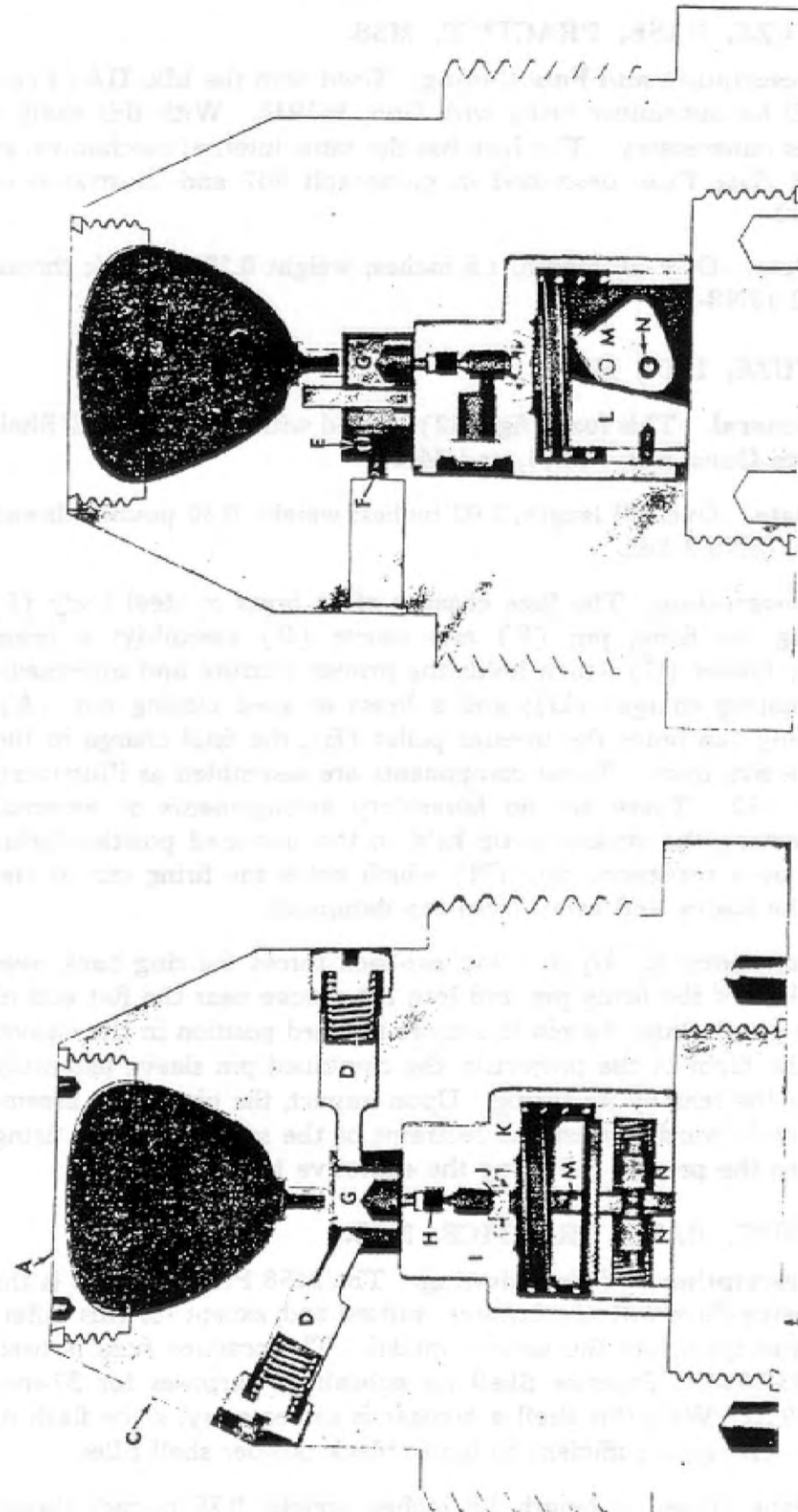

RA PD 80840

Figure 153 — FUZE, B.D., M60

FUZES, PROPELLING CHARGES, PRIMERS, AND OTHER COMPONENTS

309. FUZE, B.D., M60.

a. **General.** The M60 (fig. 153) is a base-detonating fuze which functions with delay action.

b. **Data.** Over-all length, 4.28 inches; weight, 9.22 pounds; thread size, 3.6-6NS-2 LH.

c. **Description.** It is made up of a steel body (C) which holds a Semple (rotor-type) firing pin (M) and plunger (L) assembly, a delay-charge holder (I), and a rotor assembly (G). The delay-charge holder contains the primer (J) and a black powder delay pellet (H). The rotor assembly contains a detonator composed of lead azide and tetryl. The front end of the fuze body is drilled to hold the tetryl booster pellet (B). After loading, the fuze is closed at the base end by a steel plug (O), and at the front end by a closing screw (A) which seals the booster cavity. The components are assembled in the fuze as illustrated in figure 153. Boresafety is provided for by the arrangement of the rotor assembly, which keeps the detonator out of alinement with the primer and delay element until sufficient centrifugal force is exerted on the rotor to turn it approximately 90 degrees.

d. **Functioning.** Prior to firing, the rotor is held in out-of-alinement in the unarmed position by two spring-held pins (D). After firing, under the action of centrifugal force these pins move outward against the resistance of their springs, allowing the rotor to swing into the armed position. A stop pin (E) halts the rotation of the rotor when it reaches the alined or armed position, whereupon a rotor lock pin normally located in a recess in the rotor becomes alined with a hole (F) provided in the fuze body and partly engages therein. This locks the rotor in the armed position. Prior to firing, the firing pin also is held in an unarmed position in the plunger by two spring-held pins (N). These move outward in the same manner as the rotor pins upon sufficient centrifugal force, permitting the firing pin to swing into the armed position by its own weight. Both the rotor and the firing pin arm when the fuze revolves at the rate of 1,450 or more revolutions per minute, but must not arm at 1,150 revolutions per minute. The plunger spring (K) holds the firing pin to the rear and away from primer, during the flight of the projectile. Upon impact, the plunger overcomes the resistance of the spring, carrying the firing pin forward against the primer. The action of the primer mixture ignites the delay pellet, which burns for a prescribed time (approx 0.04 to 0.06 sec) and then initiates the action of the detonating elements of the explosive train. The final charge (the booster pellet) in turn causes the detonation of the shell bursting charge.

ARTILLERY AMMUNITION

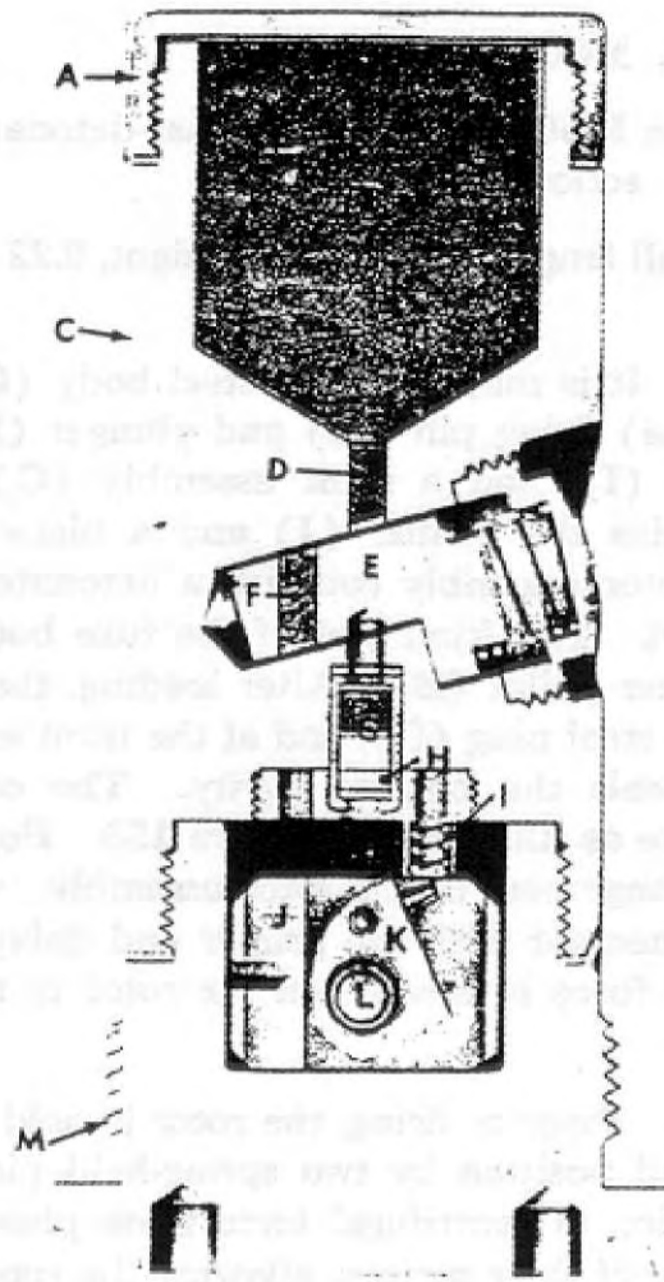

RA PD 80841

Figure 154 - FUZE, B.D., M62A1

FUZES, PROPELLING CHARGES, PRIMERS, AND OTHER COMPONENTS

310. FUZE, B.D., M62A1 AND M62.

a. **General.** FUZE, B.D., M62A1 (fig. 154) is a nondelay base-detonating fuze provided for use with 75-mm and 105-mm H.E., A.T. projectiles. The M62A1 differs from the earlier M62 Fuze in the firing pin plunger assembly. In the M62A1, a steel plunger housing has been added and a larger coil restraining spring is used to hold this housing and firing pin assembly. See figure 153 for details of the M62A1 Fuze firing pin plunger assembly, the spring (K) in figure 153 being the type of spring used. Figure 154 shows the M62 type of restraining spring (I) and plunger assembly (J).

b. **Data.** Over-all length, 3.54 inches, weight, 1.28 pounds; thread size, 1.5-12NS-1 LH.

c. **Description.** The fuze consists of three parts: A steel head (M), a steel body (C), and a brass booster cup (A). The head holds a Semple firing-pin (K) and percussion plunger (J) assembly similar to that in the M60 Fuze (par. 309). The body contains a primer (H), intermediate detonating charges (G), a slider assembly (E) with a slider charge (F), a booster pellet (B), and a booster lead (D). The booster cup, made of brass, seals the booster pellet in its cavity in the fuze body when screwed to the body. Boresafety is provided for by the slider detonator assembly.

d. **Functioning.** The firing pin (K), as in the M60 Fuze, is held in the unarmed position in the percussion plunger by spring-held safety pins (L) which release the firing pin under the action of centrifugal force. The percussion plunger assembly will not arm at 1,700 revolutions or less per minute. The slider assembly is normally positioned under spring pressure in its recess in the fuze body so that the slider charge of the slider is out of alinement with the other explosive elements. When sufficient centrifugal force has been set up, the slider overcomes the resistance of the spring and moves outward, bringing the slider charge into alinement. The slider will not arm when the fuze revolves at 2,400 revolutions or less per minute, but must arm at 3,600 revolutions per minute. Upon firing and after sufficient rotational force has been created, the firing pin and slider move into the armed position. However, the percussion plunger assembly is held to the rear during the flight of the projectile by two restraining springs (I) in the M62 Fuze. For type of restraining spring in the M62A1, see figure 153, letter (K). Upon impact, the plunger overcomes the resistance of the springs and carries the firing pin forward against the primer, initiating the action of the explosive train. The booster pellet in its turn causes detonation of the shell bursting charge.

ARTILLERY AMMUNITION

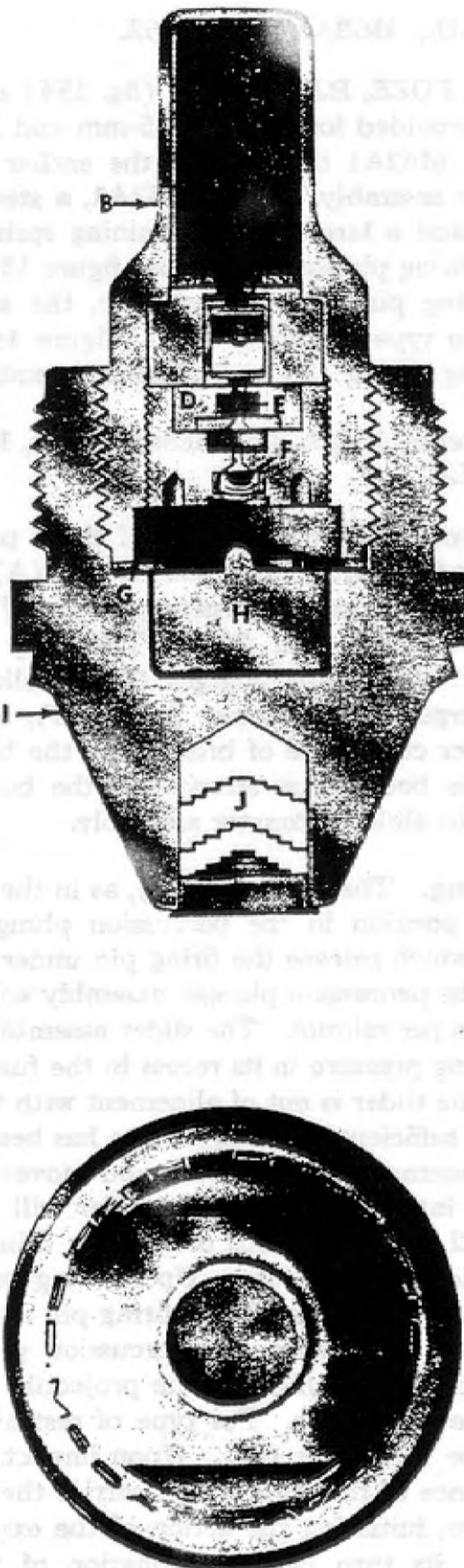

Figure 155 — FUZE, B.D., M66A1

RA PD 80842

FUZES, PROPELLING CHARGES, PRIMERS, AND OTHER COMPONENTS

311. FUZE, B.D., M66A1.

a. **General.** The M66A1 (fig. 155) is a delay-action base-detonating fuze which is provided for use with the M61 and M61A1 (75-mm) and M62 and M62A1 (3-in.) Armor-piercing-capped Projectiles. It is a simple inertia-type fuze, without boresafety provision, in which the firing pin (H) is held at rest by a soft steel washer (G) prior to impact at the target. Upon impact, the weight of the firing pin forces it past the washer.

b. **Data.** Over-all length, 3.458 inches; weight 1 pound; thread size, 1.65-10NS-1 LH.

c. **Description.** The fuze is made up of three parts: A body assembly (I), a detonator-booster assembly (B), and a primer holder assembly (D). The body assembly contains the firing pin and, in a cavity in the boat-tailed rear portion, a red tracer composition (J) which operates independent of the fuze mechanism. The detonator-booster assembly holds a tetryl booster pellet (A) and the intermediate detonating charges of lead azide and tetryl (C). The primer holder assembly contains the primer, PRIMER, No. 26 (F), and a black powder delay pellet (E).

d. **Functioning.** The tracer composition is ignited by the flash of the propelling charge, and burns thereafter for a prescribed time (about 3 sec), providing a visible trace. The firing pin remains at rest upon firing and during the flight of the projectile. Upon impact, the forward force of the firing pin breaks the soft brass washer, and the point of the pin strikes the primer. Action of the primer ignites the delay pellet. After burning a prescribed time (0.01 sec), the black powder pellet initiates detonation of the detonating elements in the explosive train. The final charge (the booster pellet) in turn causes the filler of the projectile to explode.

312. FUZE, B.D., M68.

a. **Description.** Except that the diameter of the body is larger, the construction and functioning of the M68 (fig. 156) are identical with those of the M66A1 (compare with fig. 155). The M68 is 2.00 inches in diameter across the threaded part of the body, whereas the diameter of the M66A1 is 1.65 inches, the increased thread diameter being necessary to adapt it for the larger 90-mm projectile.

b. **Data.** Over-all length, 3.458 inches; weight 1.56 pounds; thread size, 2.00-10NS-1 LH.

ARTILLERY AMMUNITION

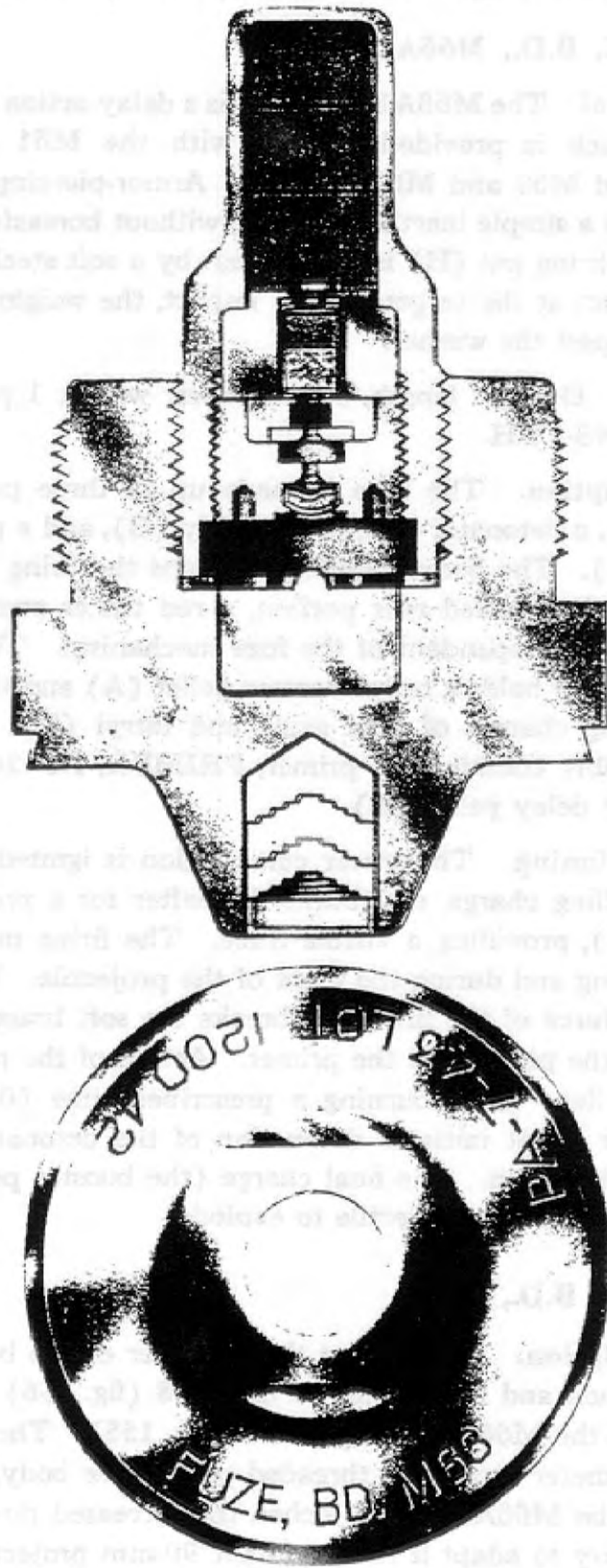
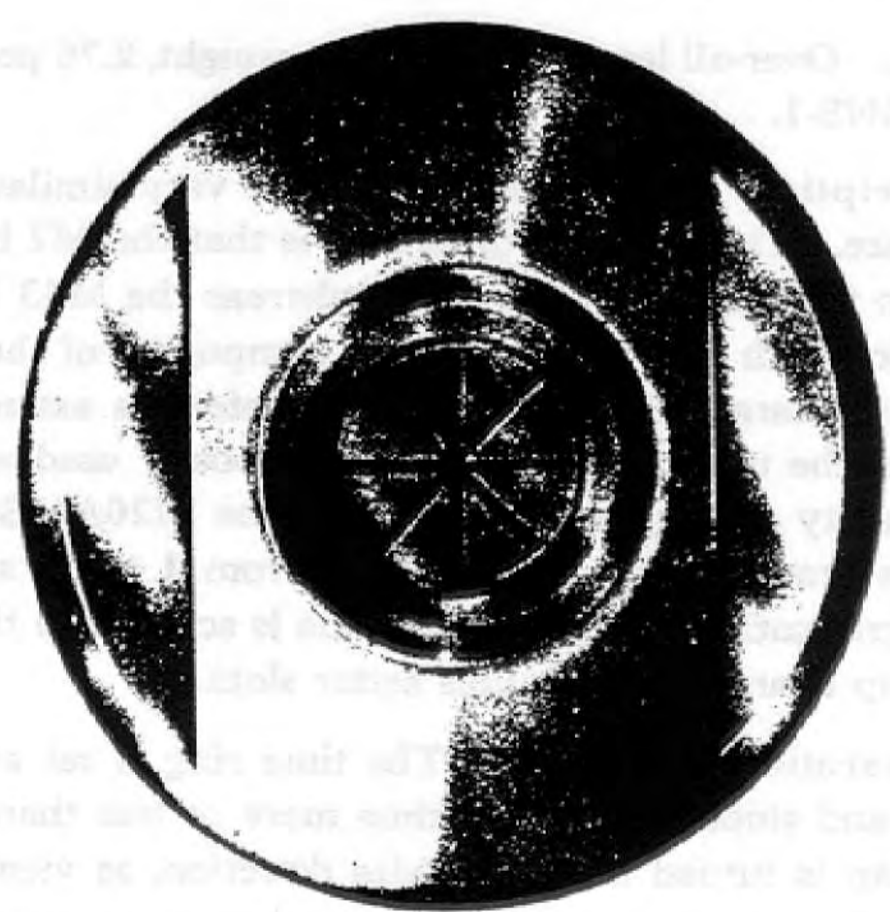
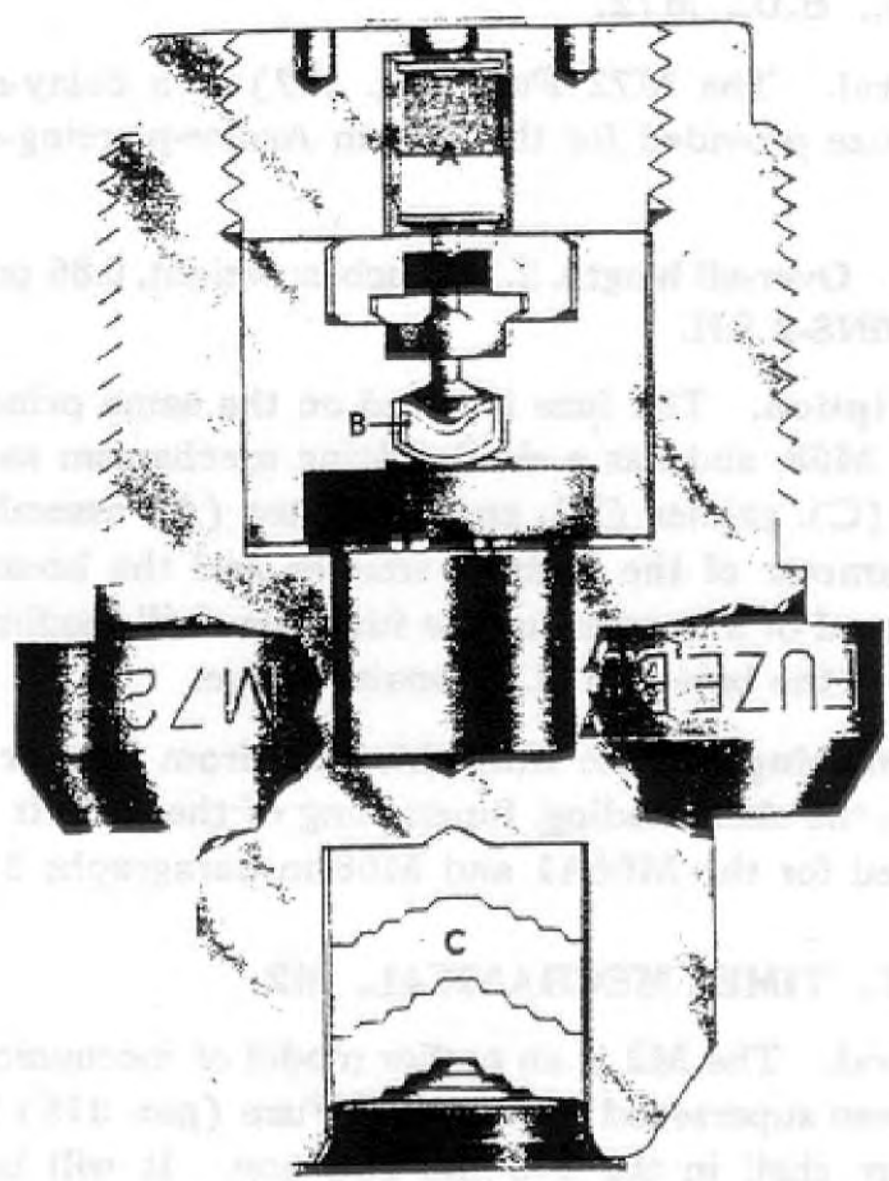

Figure 156 — FUZE, B.D., M68

FUZES, PROPELLING CHARGES, PRIMERS, AND OTHER COMPONENTS



RA PD 80844

Figure 157 — FUZE, B.D., M72

ARTILLERY AMMUNITION

313. FUZE, B.D., M72.

a. **General.** The M72 Fuze (fig. 157) is a delay-action, base-detonating fuze provided for the 57-mm Armor-piercing-capped Projectile M86.

b. **Data.** Over-all length, 2.167 inches; weight, 0.86 pound; thread size, 1.375-10NS-2 LH.

c. **Description.** The fuze is based on the same principles as the M66A1 and M68, and has a similar firing mechanism as well as the same tracer (C), primer (B), and detonator (A) assemblies. However, the diameter of the body is smaller and the booster pellet is omitted; instead of a booster for the fuze, the shell loading includes a tetryl pellet at the base end of the main charge.

d. **Functioning.** Aside from this shift from booster in the fuze to a pellet in the shell loading, functioning of the M72 is the same as that described for the M66A1 and M68 in paragraphs 311 and 312.

314. FUZE, TIME, MECHANICAL, M2.

a. **General.** The M2 is an earlier model of mechanical time fuze which has been superseded by the M43 Fuze (par. 315) for use with high-explosive shell in the 105-mm AA. gun. It will be used only with the 105-mm AA. M38 Shell until stocks on hand are exhausted.

b. **Data.** Over-all length, 5.75 inches; weight, 2.76 pounds; thread size, 2.20-16NS-1.

c. **Description.** Action and design are very similar to those of the M43 Fuze. The principal difference is that the M2 has a booster screwed into the base end of the fuze whereas the M43 Fuze is used in conjunction with a booster which is a component of the shell. The M2 also has a larger thread size and therefore is assembled to the shell without the use of an adapter. The booster used with the fuze has a boresafety arrangement like that of the M20A1 Booster. The fuze body is graduated for time settings from 1 to 30 seconds, with 0.2-second graduations, and a register line is scribed on the surface of the lower cap near one of the fuze setter slots.

d. **Preparation for Firing.** The time ring is set at 15 seconds for storage and shipment. For a time more or less than 15 seconds, the lower cap is turned in a clockwise direction, as viewed from the point of the fuze, to increase the time setting; or counterclockwise to decrease the time setting.

FUZES, PROPELLING CHARGES, PRIMERS, AND OTHER COMPONENTS

315. FUZE, TIME, MECHANICAL, M43 (ALL MODIFICATIONS).

a. **General.** The M43 Fuze (figs. 158 and 159) is a mechanical time type, and has the streamlined contour which is characteristic of modern design fuzes. It provides for time setting to 30 seconds. There is no impact element. The fuze is especially adapted for anti-aircraft use with medium caliber shell fitted with a suitable booster (the M20 type). A number of models have been manufactured, all based on the same principles but incorporating improvements and refinements since the original design. Differences in the various models are described in subparagraph g, below; basic features are described in the following subparagraphs:

b. **Data.** Length, visible, 3.74 inches, over-all, 4.55 inches; weight, 1.41 pounds; thread size, 1.7-14NS-1.

c. **External Details.** The fuze body is in three parts: an upper cap (A), a movable lower cap (C), and a fixed base (O). The lower cap holds the setting pin (B), and a hammer (D) device which releases the timing disk (G) upon firing. The lower cap and base house the other mechanical parts and explosive elements. The upper cap is staked to the lower cap and turns as a unit with it during fuze setting. The base is engraved circumferentially with 0.2-second graduations up to 30 seconds, full seconds being numbered. A safety line with "S" below it is also stamped on the base, and indicates a point in the setting at which the fuze cannot function. As shipped, the fuze is set "safe," that is with "S" line alined with the register line of the lower cap. Timing is regulated by the angular distance which the timing disk must turn before the firing arm is released for functioning. This distance is increased or decreased by turning the lower cap counterclockwise as viewed from the point of fuze to increase the time, and clockwise to reduce it. The desired time has been set when the register line on the lower cap is alined with the appropriate graduation on the base. The lower cap may be turned in either direction and through the zero and safety graduations. Two setting grooves, one each in the lower cap and base, are provided for fuze setting.

d. **Internal Details.** The driving mechanism is based on the same principles as clockwork but differs in that it is driven by a pair of weighted gear segments actuated by centrifugal force. Also, the escapement (R) beats at a much higher frequency and makes use of a straight spring (Q). A timing disk with protruding lug and a

FUZES, PROPELLING CHARGES, PRIMERS, AND OTHER COMPONENTS

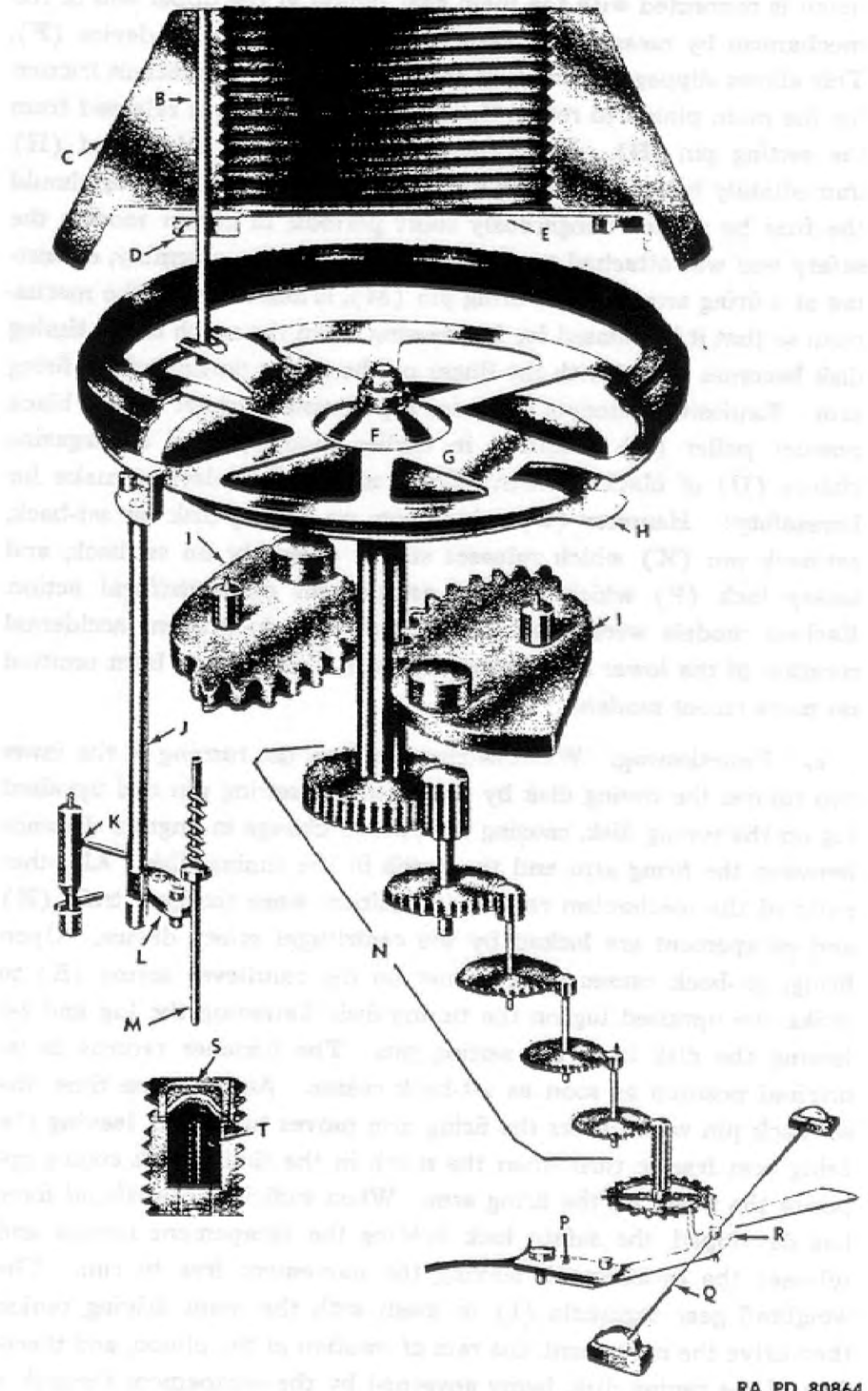

RA PD 80864

Figure 159 — Mechanism of FUZE, Time, Mechanical, M43A4

ARTILLERY AMMUNITION

notch is connected with the main gear pinion at the upper end of the mechanism by means of a washer and Belleville spring device (F). This allows slippage during fuze setting but provides sufficient friction for the main pinion to rotate the disk when the disk is released from the setting pin (B). In recent models there is a safety leaf (H) immediately below the timing disk which prevents functioning should the fuze be set for dangerously short periods; in earlier models the safety leaf was attached to the hammer. A striker assembly, consisting of a firing arm (J) and firing pin (M), is assembled in the mechanism so that it is released for functioning when the notch in the timing disk becomes aligned with the finger on the upper portion of the firing arm. Explosive elements comprise a percussion primer (S), a black powder pellet (T) (omitted in earlier models), and a magazine charge (U) of black powder. Three main safety devices make for boresafety: Hammer (D) which acts on timing disk on set-back, set-back pin (K) which releases striker assembly on set-back, and safety lock (P) which releases escapement on centrifugal action. Earliest models were fitted with a pull wire to prevent accidental rotation of the lower cap during shipment, but this has been omitted on more recent models.

e. **Functioning.** When setting the fuze, the turning of the lower cap rotates the timing disk by means of the setting pin and upraised lug on the timing disk, causing the desired change in angular distance between the firing arm and the notch in the timing disk. All other parts of the mechanism remain in position, since the gear train (N) and escapement are locked by the centrifugal safety device. Upon firing, set-back causes the hammer on the cantilever spring (E) to strike the upraised lug on the timing disk, flattening the lug and releasing the disk from the setting pin. The hammer returns to its original position as soon as set-back ceases. At the same time, the set-back pin which locks the firing arm moves backward, leaving the firing arm free to turn when the notch in the timing disk comes opposite the finger on the firing arm. When sufficient centrifugal force has developed, the safety lock holding the escapement rotates and releases the escapement, leaving the movement free to run. The weighted gear segments (I) in mesh with the main driving pinion then drive the movement, the rate of rotation of the pinion, and therefore of the timing disk, being governed by the escapement through a

FUZES, PROPELLING CHARGES, PRIMERS, AND OTHER COMPONENTS

series of gears. When the notch in the timing disk reaches the finger of the firing arm, the firing arm turns, permitting the firing pin safety plate (L) to swing from under the firing-pin flange, and allowing the firing pin to strike the primer under the action of its spring. This initiates the action of the powder train, which action is transmitted to the shell booster and bursting charge.

f. Preparation for Firing. The Fuze is set by means of a fuze setter, the lower cap being turned in a counterclockwise direction as viewed from the point of the fuze to increase the setting, and clockwise to reduce it. In the case of early M43A1 Fuzes, it is necessary to remove the pull wire before setting the fuze. This can be done readily by pulling the end of the wire from the hole in the lower cap and sliding the wire off the end of the fuze.

g. Modifications. There are several modifications of the M43 Fuze, and these differ as follows: The change from the M43A1 to the M43A2 consisted of a bevel in the shoulder so that the fuze could be screwed into the M23 Booster. The change from the M43A2 to M43A3 resulted from a change in the method of regulating the movements. The change from the M43A3 to M43A4 resulted from the decrease in minimum functioning time from 1.67 seconds to 0.6 second. The change from the M43A4 to the M43A5 resulted from a redesign of the body and cap, using steel in place of brass and aluminum. Since safe setting and torque required to turn the lower cap may be critical, these data are presented for the various modifications, as follows:

Modification	Safe Setting Limits (sec.)	Torque required To Turn Lower Cap (in.-lb)
M43A5	0.6 or less	80 to 100
M43A4*	0.6 or less	80 to 100
M43A3	1.67 or less	80 to 100
M43A2	1.67 or less	60 to 80
M43A1 (late)†	1.67 or less	60 to 80
M43A1 (early)††	1.4 or less	40 to 60

*—Upper cap painted red.

†—Fuzes of later manufacture without pull wire.

††—Fuzes of earlier manufacture with pull wire.

ARTILLERY AMMUNITION

RA PD 80849

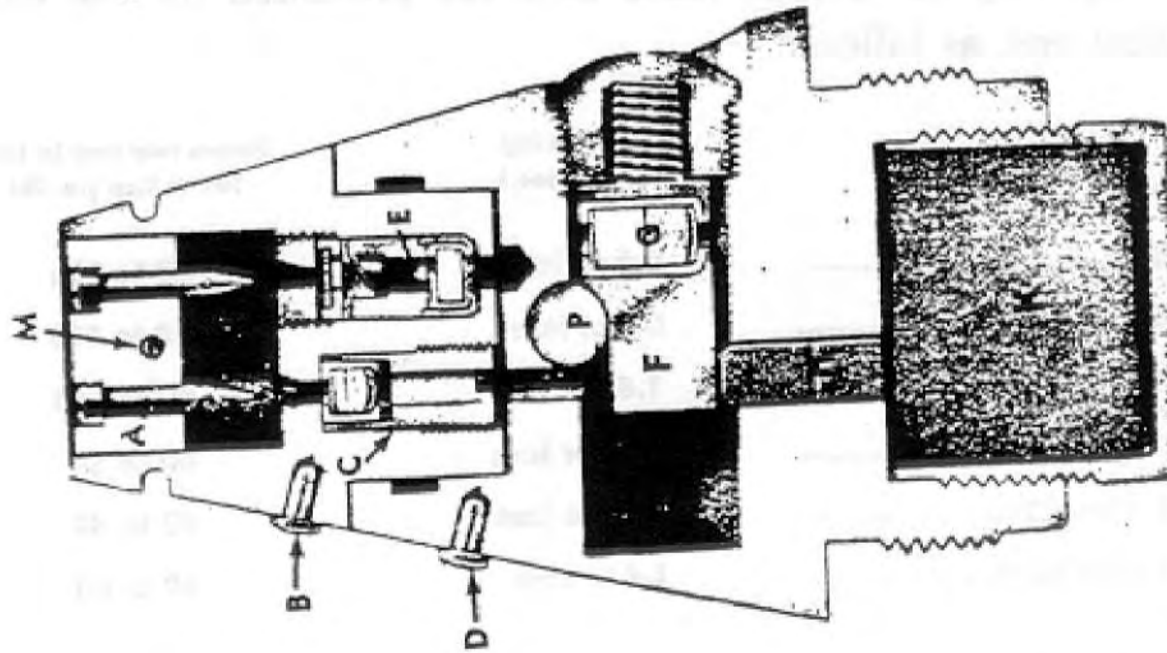
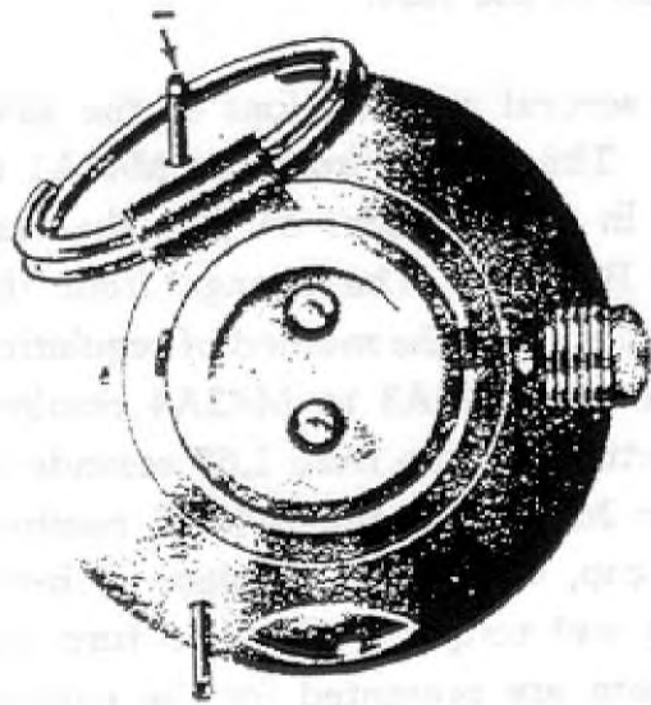
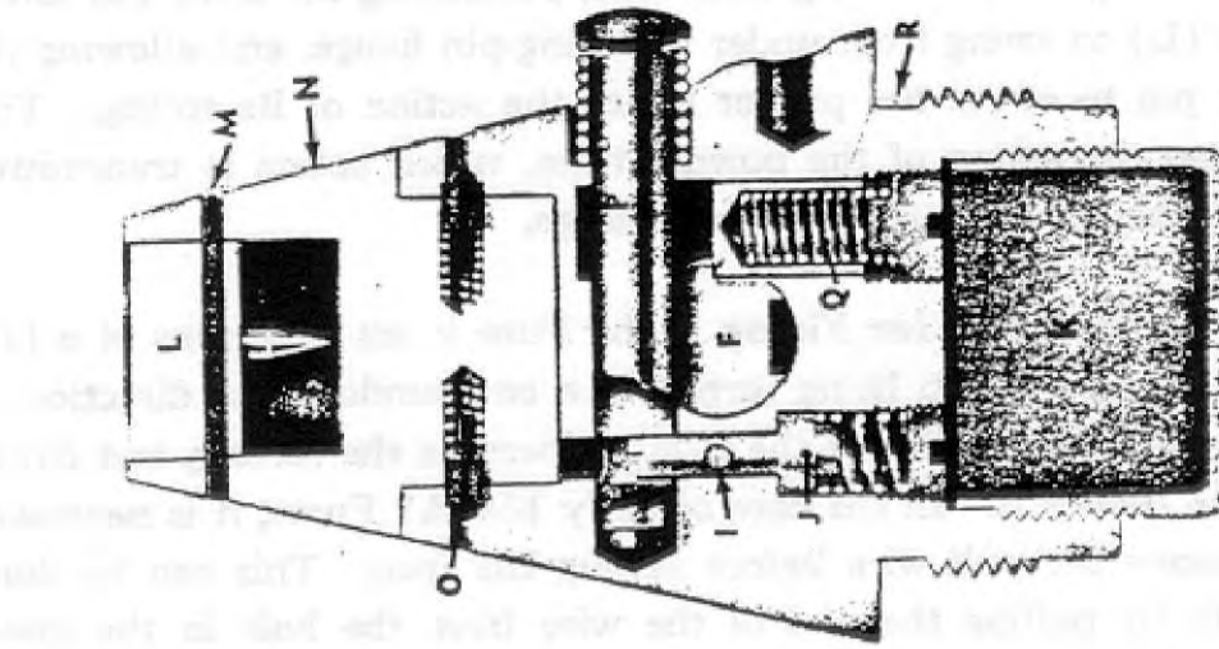

Figure 160 — FUZE, P.D., M45

FUZES, PROPELLING CHARGES, PRIMERS, AND OTHER COMPONENTS

316. FUZE, P.D., M45.

a. **General.** The M45 Fuze (fig. 160) is a selective superquick or delay (0.1-sec) point-detonating fuze especially adapted for use with 3-inch and 81-mm mortars. It is no longer standard for manufacture, having been superseded by single-action types, but will be issued with M45 Mortar shell until stocks are exhausted.

b. **Data.** Length, visible, 3.34 inches, over-all, 3.46 inches; weight, 0.5 pound; thread size, 1-5-12NF-1.

c. **Description.** As shown in figure 160, the fuze is essentially two separate assemblies, one consisting of the delay-action train (E) which includes a black powder delay pellet and a relay charge, and the other the superquick action (C). Each is initiated by its own firing pin (A). Since both firing pins are seated in the same striker (L) in the head assembly (N), they function simultaneously on impact. However, depending on the action selected, only the superquick or the delay action is transmitted through the detonating charges, booster lead (H) and booster (K) to the shell bursting charge, the other being interrupted and dissipated in a recess in the fuze body (R). Provision is made for boresafety by a slider-type interrupter (F) which normally holds the intermediate detonating charge (G) out of alignment with other elements in the train. The interrupter is held in the unarmed position, prior to firing, by a safety pin (P). This pin in turn is held in locked position by a set-back pin (J). Positive protection against arming is provided during shipment by a safety cotter pin (I) with ring which prevents the set-back pin from moving. To reduce the possibility of accidental withdrawal of the cotter pin, the ring is held against the head of the fuze by adhesive tape. A brass striker pin (M) holds the striker at rest during normal handling; this wire is sheared upon impact, releasing the firing pins for functioning.

d. **Setting.** Selective action is obtained by turning the fuze head. For superquick action, the knurled button SQ (B) on the head must be brought in line with the reference point (knurled button (D) and engraved line) on the body. For delay action, the letter "D" indicating delay must be aligned with the common reference point on the body. Two concealed spring-actuated pins (O) aid in locating the exact alignment and hold the head in the set position for firing. The fuze is set for superquick action as shipped. The setting may be changed at will and can be done in the dark by noting the relative positions of the reference points, but all adjustments should be made *before* removing the cotter pin.

e. **Functioning.** Upon firing, set-back causes the set-back pin to move backward against the resistance of its spring, disengaging the

ARTILLERY AMMUNITION

safety pin. The safety pin is held in the fuze by the inside wall of the mortar tube. As the shell emerges from the mortar tube, the freed safety pin is ejected from the fuze under action of a compressed spring. This releases the slider of the interrupter, which is then forced inward by its spring, bringing the intermediate detonating charges in line. The slider is then locked in the armed position by the spring-actuated slider lock (Q). Force of impact shears striker pin, releasing both firing pins which are driven into their respective primers, whereupon action of the primer in the armed explosive train is transmitted through the succeeding charges to the shell bursting charge.

f. **Preparation for Firing.** When superquick is desired, it is only necessary to remove the adhesive tape and the cotter pin, since the fuze is set for superquick action as shipped. For delay action, the fuze must be set as described above, *before* removing the cotter pin.

317. FUZE, P.D., M46.

a. **General.** The M46 (fig. 161) is a superquick point-detonating fuze. It is a modification of the Mk. III and M35 Fuzes and has replaced these fuzes for use in 75-mm, 155-mm and larger caliber shell fitted with suitable adapters (the Mk. III or Mk. IIIAM2; ch. 3, sec. IV).

b. **Data.** Length, visible, 3.01 inches, over-all, 5.66 inches; weight, 0.72 pound; thread size, approximately 12.7 threads per inch, Löwenherz.

c. **Description.** As shown in figure 161, the fuze incorporates a head (B) assembly in which the firing pin (D) is supported at a safe distance from the upper detonator (E) by a gilding metal cup (C). The walls of the cup are sufficiently strong to support the pin against ordinary knocks during handling and against initial set-back caused by firing, but collapses readily upon nose impact with any type of target at comparatively low velocities. Partial boresafety is provided for by an interrupter (G) in the body (J) which, in the unarmed position, closes the passage (F) between the upper (E) and lower (M) detonators. The interrupter is a plunger type, in which a steel plug or plunger (I) is normally held at rest across the fuze passage by a spring (H) but moves outward against this resistance when sufficient centrifugal force has been created by rotation of the shell. The head of the M46 Fuze is painted white to aid in distinguishing it from the M47, which is similar in appearance but has a delay element. The head of the M47 is painted black.

d. **Functioning.** Upon firing, no immediate action takes place, the firing pin being held at rest by the gliding metal cup, and the interrupted plunger being restrained by set-back and its spring. Upon

FUZES, PROPELLING CHARGES, PRIMERS, AND OTHER COMPONENTS

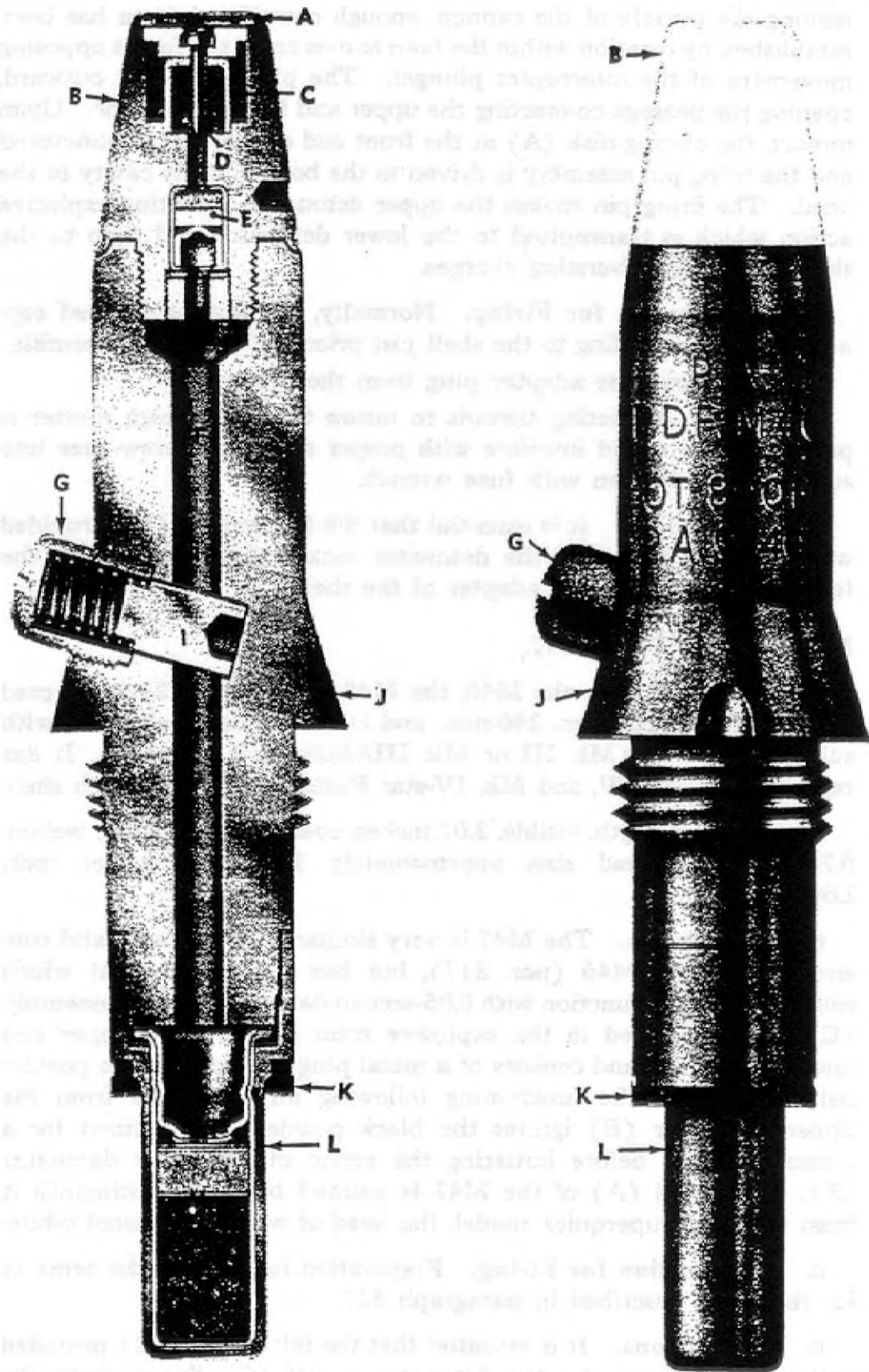

Figure 161 — FUZE, P.D., M46

ARTILLERY AMMUNITION

leaving the muzzle of the cannon, enough centrifugal force has been established by rotation within the bore to overcome the forces opposing movement of the interrupter plunger. The plunger moves outward, opening the passage connecting the upper and lower detonator. Upon impact, the closing disk (A) at the front end of the fuze is punctured and the firing pin assembly is driven to the bottom of its cavity in the head. The firing pin strikes the upper detonator, initiating explosive action which is transmitted to the lower detonator and then to the shell booster and bursting charges.

e. **Preparation for Firing.** Normally, the fuze is shipped separately, for assembling to the shell just prior to firing. To assemble:

- (1) Remove the adapter plug from the projectile.
- (2) After inspecting threads to insure that no foreign matter is present which would interfere with proper assembly, screw fuze into adapter, then tighten with fuze wrench.

f. **Precautions.** It is essential that the felt washer (K) provided with the fuze be under the detonator socket (L) flange when the fuze is assembled to the adapter of the shell.

318. FUZE, P.D., M47.

a. **General.** Like the M46, the M47 Fuze (fig. 162) is adapted for the 75-mm, 155-mm, 240-mm, and larger caliber shell fitted with suitable adapters (Mk. III or Mk. IIIAM2; ch. 3, sec. IV). It has replaced the Mk. IV, and Mk. IV-star Fuzes for use with such shell.

b. **Data.** Length, visible, 3.01 inches, over-all, 5.66 inches; weight, 0.74 pound; thread size, approximately 12.7 threads per inch, Löwenherz.

c. **Description.** The M47 is very similar in appearance and construction to the M46 (par. 317), but has a delay element which causes the fuze to function with 0.05-second delay. The delay assembly (C) is incorporated in the explosive train between the upper and lower detonators, and consists of a metal plug holding a black powder pellet (D). In the functioning following impact, flame from the upper detonator (B) ignites the black powder, which burns for a prescribed time before initiating the action of the lower detonator (F). The head (A) of the M47 is painted black, to distinguish it from the M46 superquick model, the head of which is painted white.

d. **Preparation for Firing.** Preparation for firing is the same as for the M46, described in paragraph 317.

e. **Precautions.** It is essential that the felt washer (E) provided with the fuze be under the detonator socket (G) flange when the fuze is assembled to the adapter of the shell.

FUZES, PROPELLING CHARGES, PRIMERS, AND OTHER COMPONENTS

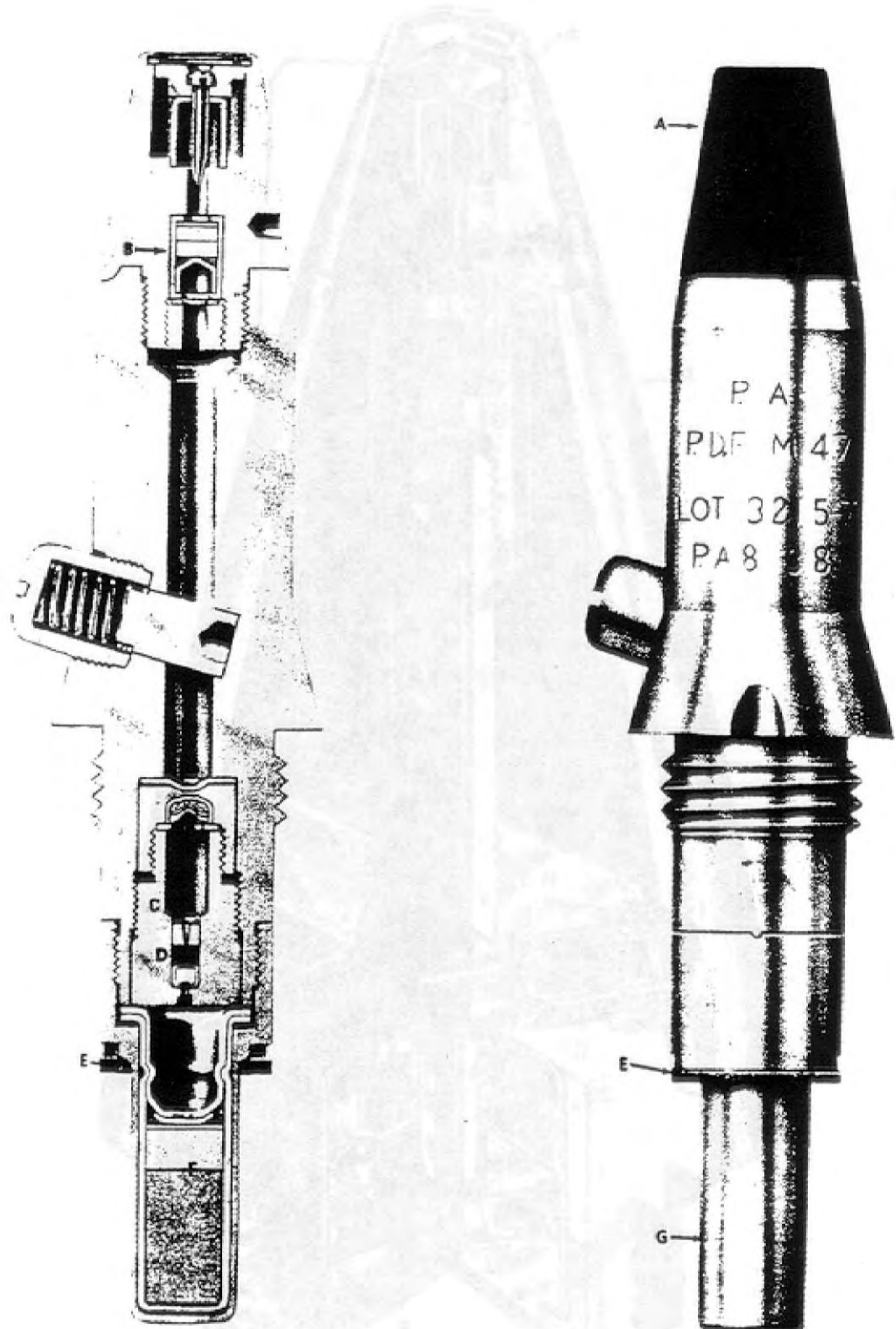

RA PD 80851

Figure 162 — FUZE, P.D., M47

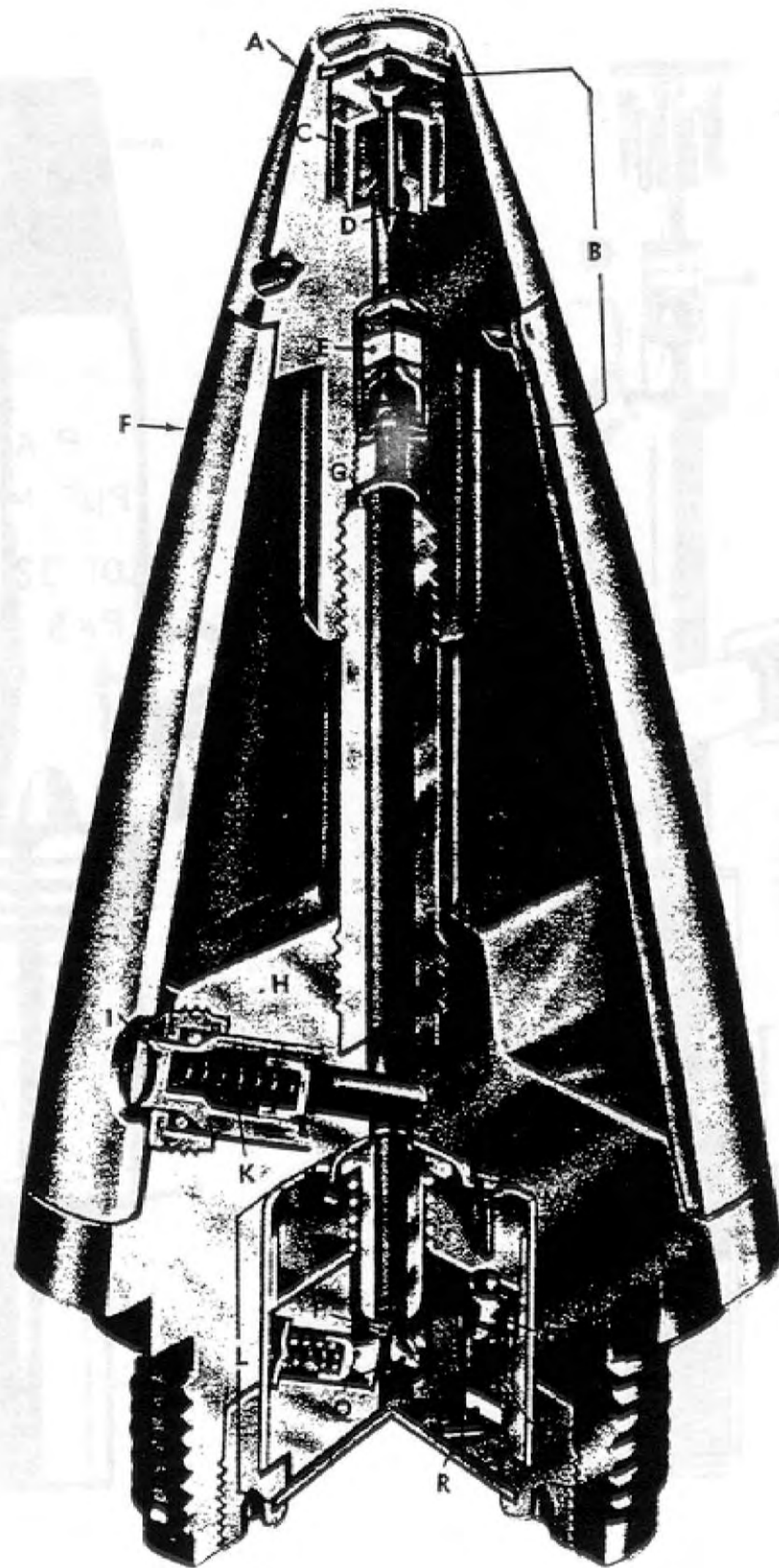

RA PD 80852

Figure 163 — FUZE, P.D., M48A2

FUZES, PROPELLING CHARGES, PRIMERS, AND OTHER COMPONENTS

319. FUZE, P.D., M48A2, M48A1, AND M48.

a. **General.** The M48A2 (fig. 163) is a selective superquick or delay fuze. Either action can be obtained, prior to firing, by turning a setting screw in the side of the fuze. The M48A2 Fuze has two models, one having a delay of 0.05 second, the other a delay of 0.15 second; the time of delay is stamped on the fuze body. The M48A1 Fuze was originally fitted with the 0.15-second delay, whereas the M48 Fuze has the 0.05-second delay. The M48A1 Fuze differs from the M48A2 in that the firing pin in the delay-action assembly is not secured against movement to the rear. This is also true of the M48 Fuze, which differs, in addition, in not having a centrifugal lock (P) to hold the centrifugal delay plungers (Q) apart at low velocities. The fuzes are adapted for use in conjunction with the M20 Booster (or modification) which is made a manufacturing component of the shell. Some M48A1 Fuzes modified to have 0.05-second delay elements are in existence.

b. **Data.** Length, visible, 3.74 inches, over-all, 4.55 inches; weight, 1.41 pounds; thread size, 1.7-14NS-1.

c. **Description.** The fuze consists of a head (A) which holds a superquick action (B), and a body (H) which houses a delay assembly (L) and a selective setting device. These main assemblies are connected by a tube (G) which holds the parts firmly in position, and are further supported by a thin-walled ogive (F) shaped to continue the sweep of the ogive of the shell. The superquick action comprises a firing pin (D) supported by a gilding metal cup (C), and a detonator (E). The firing pin support is strong enough to withstand ordinary blows on the firing pin as well as set-back forces upon firing, but collapses under the force of impact at the target. The delay assembly is an inertia plunger type and includes a firing pin (M), primer (N), black powder delay pellet (O), and a detonating relay charge (R).

d. **Setting.** The setting device is an eccentrically positioned plunger (J) and plunger spring (K), the functioning of which is regulated by a setting sleeve (I). The head of the sleeve is slotted to facilitate turning when adjusting the setting. To enable exact alinement, two register lines and the marking "S.Q." and "DELAY" are stamped on the ogive of the fuze. When the slot in the sleeve head is alined with the "S.Q." line (parallel to the fuze axis), or within 15 degrees either side, the sleeve, which is thicker on one side than on the other, is turned so that it does not interfere with movement of the plunger. The plunger is free, therefore, to move outward under centrifugal force, and thereby open the passage for superquick action. When the slot is alined with the "DELAY" line (at right angles to

ARTILLERY AMMUNITION

the fuze axis) or within 15 degrees either side, a section on the setting sleeve rests against the plunger, securing it in the lower extremity of the recess, across the superquick passage.

e. **Safety Devices.** Boresafe superquick action is provided by the plunger (J). Boresafe delay action is provided by the M20 type booster.

f. **Functioning.** No action takes place upon firing until sufficient rotational speed has been established to overcome the resistance of springs and set-back force on the several safety devices. When set for superquick action, after projectile leaves the muzzle of the weapon, centrifugal force causes the plunger (J) to move outward opening the passage. At the same time, the plunger pins (Q) locking the delay assembly in unarmed position also move outward, releasing that assembly in preparation for impact. In the M48A1 and M48A2 Fuzes, the plunger-pin lock (P) then swings on its pivot under centrifugal force, placing an arm against the inner end of each plunger pin and thereby preventing the return of the pins to the unarmed position. In the M48, rotational force is relied on to hold the pins in the armed position. Upon impact, the firing pin of the superquick action is driven against the detonator, initiating the superquick action. Inertia causes the delay action plunger to move forward, driving the primer against the delay action firing pin and initiating the delay action. In normal functioning with superquick action, the delay action has no effect since the superquick train will have caused the shell to explode before the delay train can burn for its prescribed time. However, should the superquick action fail, the shell will function with delay action rather than become a dud. When set for delay action, the plunger which interrupts the superquick passage is restrained from moving. Upon impact, the superquick firing pin and detonator function but the effect is prevented from being transmitted to the shell.

g. **Preparation for Firing.** The fuze need only be adjusted for the desired action, as described above. The setting can be adjusted at will, prior to firing, with a screwdriver or similar instrument. The adjustment can be made in the dark by noting the position of the slot, parallel to the fuze axis (or within 15 deg either side) for superquick ("S.Q.") action, and at right angles thereto (or within 15 deg either side) for delay ("DELAY") action.

320. FUZE, P.D., M51A3, W/BOOSTER, M21A2.

a. **Description.** The M51A3 Fuze (fig. 164) is essentially the M48A2 (par. 318) with the M21A2 Booster (ch. 3, sec. IV) attached. FUZE, P.D., M51A3, w/BOOSTER, M21A2, replaces FUZE, P.D., M51, w/BOOSTER, M21, and FUZE, P.D., M51A1, w/BOOSTER, M21A1, which must be drop-tested prior to use. The M51A3 Fuze

FUZES, PROPELLING CHARGES, PRIMERS, AND OTHER COMPONENTS



RA PD 65134

Figure 164 — FUZE, P.D., M51A3, w/BOOSTER, M21A2

ARTILLERY AMMUNITION

and Booster assembly does not require a drop test before issue or use. The M51 and M51A1 Fuzes have a 0.05-second delay, whereas the M51A3 has a 0.15-second delay. The M51A3 Fuze and Booster assembly differs from the M51A1 Fuze and Booster assembly in two respects: first, the firing pin in the M51A3 Fuze delay assembly is secured against movement either forward or backward; second, the BOOSTER, M21A2, has a 2-piece set-back pin. These two features are not present in the M51A1 Fuze and M21A1 Booster assembly. The only difference between the M51A1 and the M51 Fuzes is with respect to the booster. The M51A1 is assembled with the M21A1 Booster, which has a 1/4-inch flash hole in the rotor cover, whereas the M51 is assembled with the M21 Booster, which has a 1/8-inch flash hole. Some M51 and M51A1 Fuzes have been assembled with M20A1 Boosters so that the Fuze and Booster assembly will not arm on ramming. The M20A1 Booster is used since it has the centrifugal pin set-back pin which the M21 and M21A1 Boosters do not have.

b. **Data.** Length, visible, 3.74 inches, over-all, 5.93 inches (including booster); weight, 2.15 pounds (including booster); thread size, of fuze, 1.7-14NS-1, of booster, 2-12NS-1.

c. **Functioning.** Except for the differences noted in subparagraph a, above, functioning of the M51 Fuze and modifications is the same as described for the M48 Fuzes in paragraph 319. For details of the M21A1 and M21 Boosters, see chapter 3, section IV.

d. **Preparation for Firing.** Unlike the M48 type fuzes, the M51 type fuzes with booster assemblies are usually shipped separately, and must be assembled in the field just prior to firing. To assemble the fuze to the projectile:

- (1) Remove the lifting plug from the projectile.
- (2) Inspect threads to insure that no foreign material is present which would interfere with proper assembly.
- (3) Remove the safety (cotter) pin (C) from the booster.
- (4) Screw fuze with booster into the fuze hole by hand. Then tighten with fuze wrench.
- (5) The fuze is then ready for setting. This is done in the same manner as for the M48 type fuzes (par. 319).

e. **Drop Test for M51 and M51A1 Fuzes.** Each fuze with booster in its fiber container, with point of fuze down, is dropped from a height of 2 feet through an improvised chute so that it will land squarely on a solid piece of wood. This is intended to fire the delay elements of any fuzes which may have become armed during transit. Use of a barricade is recommended. The letters "DT" stenciled on the cover end of each fuze with booster container indicates that drop-testing has been done.

FUZES, PROPELLING CHARGES, PRIMERS, AND OTHER COMPONENTS

f. Limitations and Precautions.

(1) An appreciable percentage of duds may be expected when firing FUZE, P.D., M51A3, w/BOOSTER, M21A2, in low zones of fire of howitzers. This is due to the nonarming of the M21A2 Booster at the low velocities in the zones. These limitations apply particularly in those listed below:

155-mm Howitzers M1917A1, M1917A2, and M1918.. Zones 1 and 2
155-mm Howitzer M1 Zone 1
8-inch howitzer Zones 1 and 2

(2) FUZE, P.D., M51, w/BOOSTER M21, and FUZE, P.D., M51A1, w/BOOSTER, M21A1, must be drop-tested prior to issue. *These fuzes are authorized for emergency combat use only.*

(3) FUZE, P.D., M51, w/BOOSTER, M20A1, and FUZE, P.D., M51A1, w/BOOSTER, M20A1, may not arm in low zones of fire in howitzers, particularly when firing charges 1 and 2 in 155-mm Howitzer M1, and in 8-inch Howitzer M1, and when firing charges 1, 2, and 3, in 155-mm Howitzer M1918. It is recommended that for these fuze and booster assemblies double drop test be performed at the gun position.

321. FUZE, P.D., M51A3-MOD. 3, W/BOOSTER, M21A2, AND M51A1-MOD. 3, W/BOOSTER, M20A1.

a. **General.** The M51A3-Mod. 3, and M51A1-Mod. 3, are modifications of the M51A3 and M51A1 Fuzes, respectively, to adapt this fuze for use with the M103 8-inch High-explosive Shell. The principal differences are that the ogive is omitted from the modified fuze and the flash tube is replaced by a longer tube so that the fuze can be assembled within the windshield of the M103 Shell. All M103 8-inch Shell have been refuzed with the M51A1-Mod. 3 Fuze; future production will be the M51A3-Mod. 3 Fuze.

b. **Data.** Weight, 2.47 pounds; thread size, 1.7-14NS-1.

c. **Description.** Since the fuze can not be reset by means of the setting screw when assembled to the shell, the setting screw in the fuze body (not visible when the fuze is assembled to the shell) is always set for superquick action, so that the superquick is always free to arm under centrifugal force. Selective delay (0.05 sec) or superquick action is provided for by use of one of two heads provided with the fuze. One head is inert; the other contains the superquick action consisting of a striker and firing-pin assembly, and a detonator. When delay action is required, the inert head is used. When superquick action is required, the inert head is unscrewed from the shell and replaced by the superquick action. As shipped assembled to the 8-inch M103 High-explosive Shell, the fuze is fitted with the inert head (for delay action). The two heads are distinguished by differences in the end—

ARTILLERY AMMUNITION

the inert head is solid brass, whereas the superquick head is closed by an aluminum disk, crimped in place. For shipment separately from the shell, the flash-tube hole in the body is closed by a body closing plug which is removed when the flash tube is to be assembled to the fuze. The appearance of the fuze when assembled to the shell is shown in figure 143; the mechanism is shown in the illustration of the M48A2 Fuze (fig. 163).

d. Alternative Fuze. A retaining screw, packed in the box with the projectile, is intended for use only with the inert head when this fuze is replaced by a time fuze. The time fuze does not have an extended flash tube, hence the retaining screw is necessary to secure the head to the windshield of the shell.

e. Preparation for Firing. Since the fuze is shipped arranged for delay action, the projectile is fired as shipped when delay action is required. To obtain superquick action:

- (1) Unscrew the delay head from the point of the projectile with the fuze wrench provided for this purpose.
- (2) Assemble superquick head in place of the delay head and tighten with the fuze wrench.

322. FUZE, P.D., M52, M52B1 AND M52B2.

a. General. The M52B1 and M52B2 are manufactured alternatives of the M52 (fig. 165). Whereas the M52 has an aluminum head and body, the M52B1 is made of plastic materials while the M52B2 has a plastic head and an aluminum body. In other respects the fuzes are identical. All models are standard for 60-mm and 81-mm mortar shell, having replaced the M45 Selective-action Fuze for current manufacture.

b. Data. Length, visible, 3.36 inches, over-all, 3.47 inches; weight, M52, 0.45 pound, M52B1, 0.29 pound; thread size, 1.5-12NF-1.

c. Description. The fuze is a single-action superquick type with a direct-action firing device. It consists of two major parts: a head (D) which holds the firing pin assembly; and a body (L) which contains a slider mechanism (F), a detonator (I), a booster lead-in (J), and a tetryl booster pellet (K) in a booster cup (O) screwed into the base of the fuze body. The firing pin assembly consists of a firing pin (C) secured to a cup-shaped striker (A). The striker is supported by a spring (B) which holds the firing pin at a safe distance from the detonator during the flight of the projectile. The entire firing pin assembly is held within the fuze head by a pin (E) near the pointed end of the firing pin. Boresafety is provided for by means of a slider-type interrupter which, in the unarmed position, holds the detonator out of alignment with the firing pin and the booster lead-in. The slider is locked in the unarmed position by a safety pin (G);

FUZES, PROPELLING CHARGES, PRIMERS, AND OTHER COMPONENTS

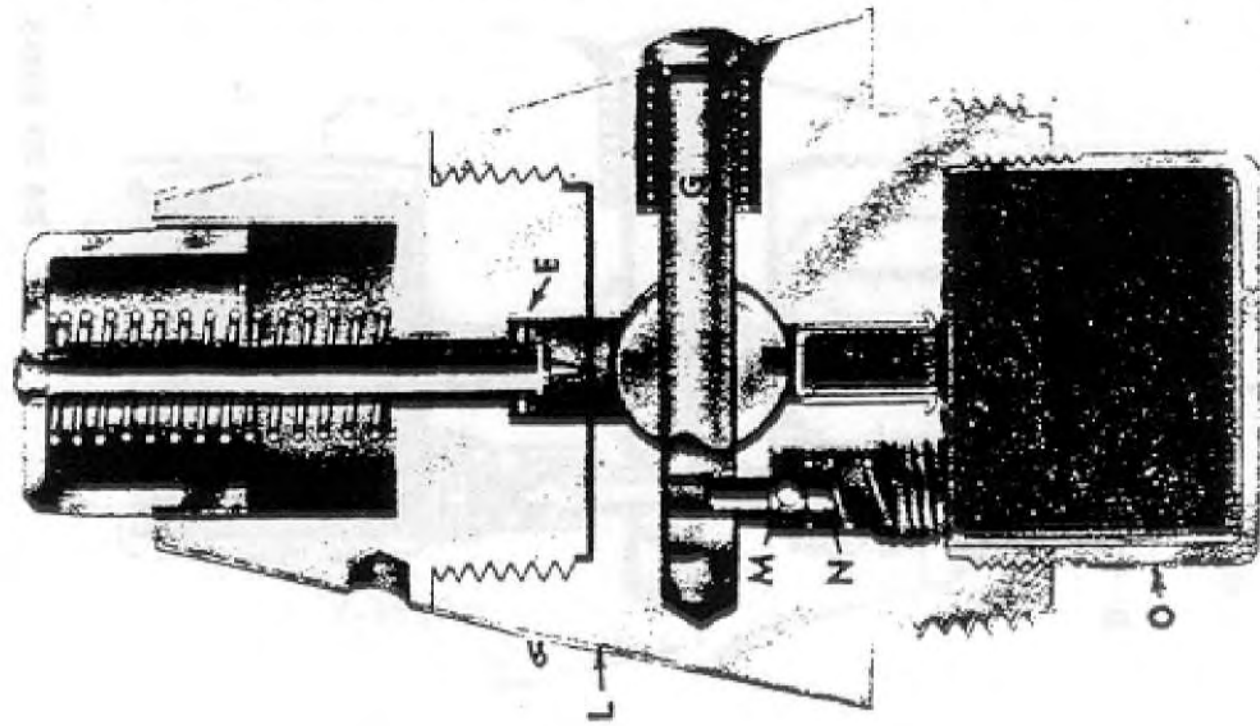

RA PD 80854

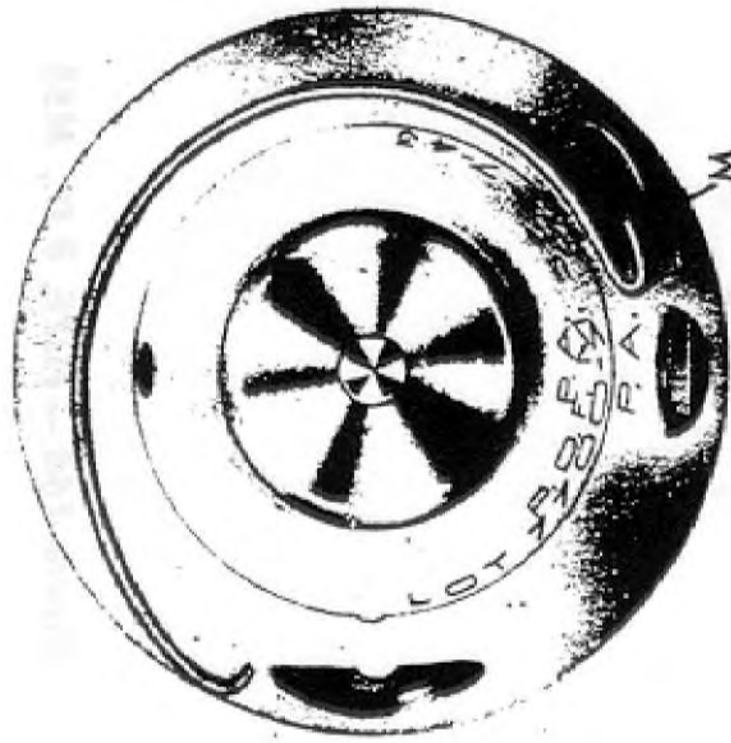
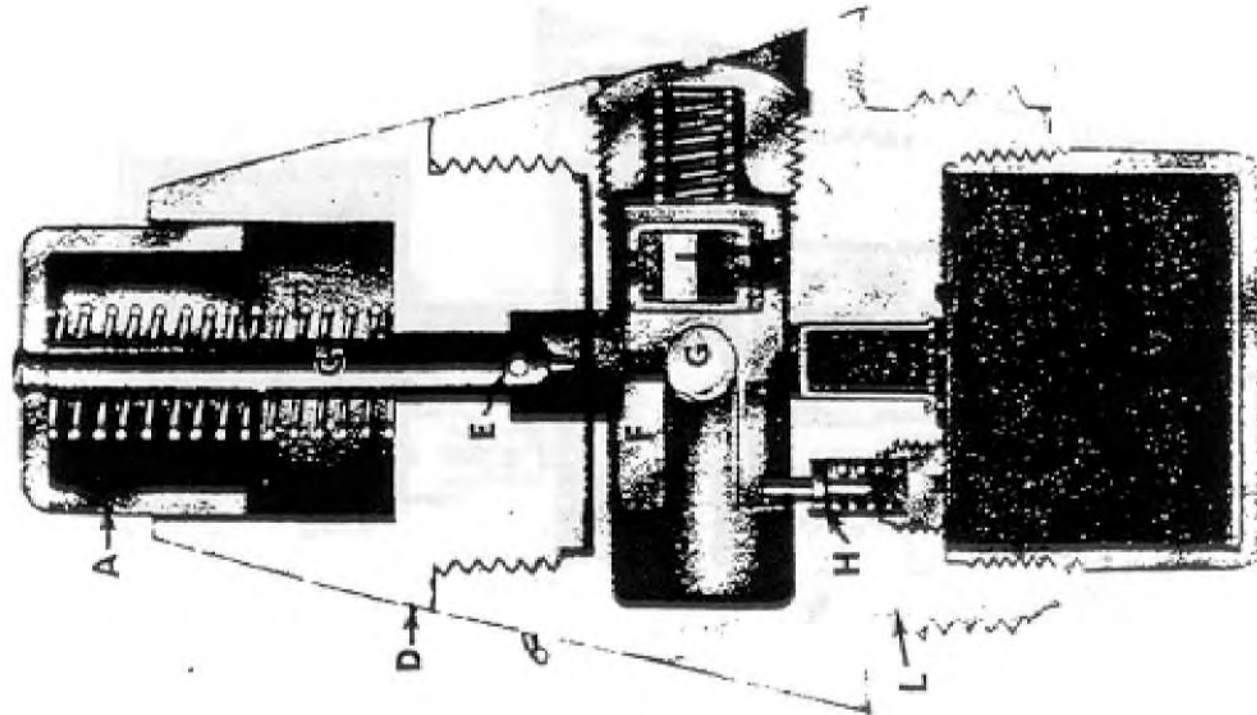
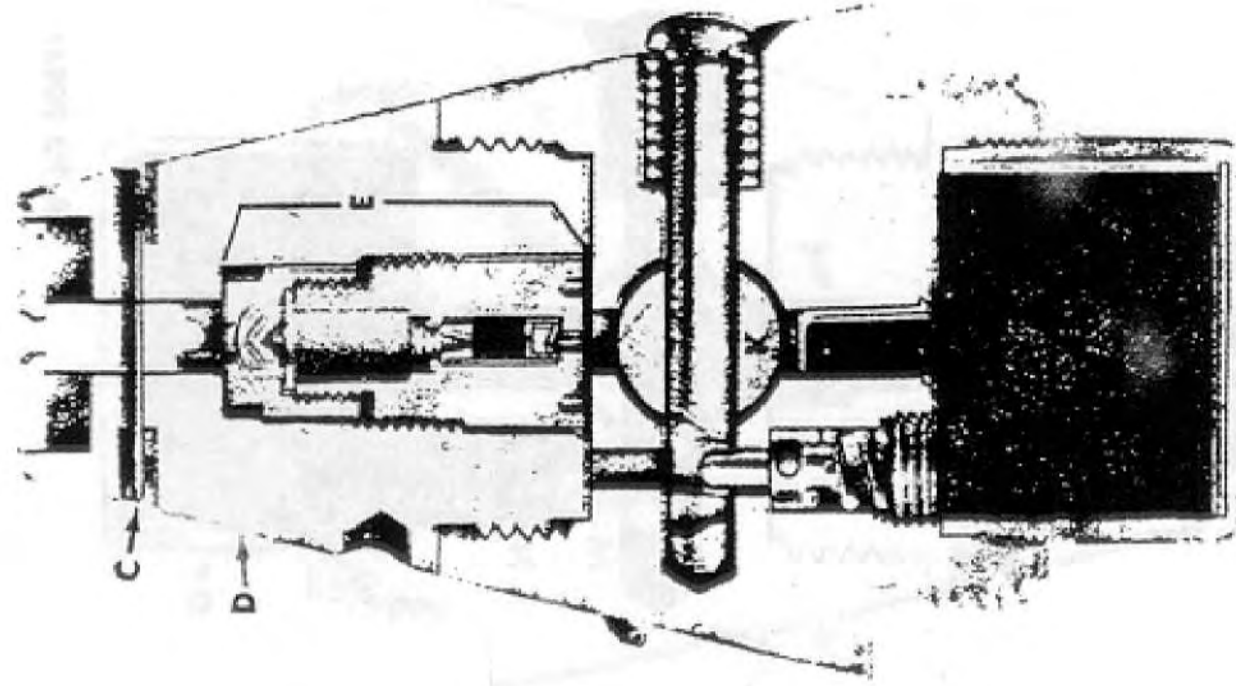

Figure 165 — FUZE, P.D., M52



ARTILLERY AMMUNITION



RA PD 80855

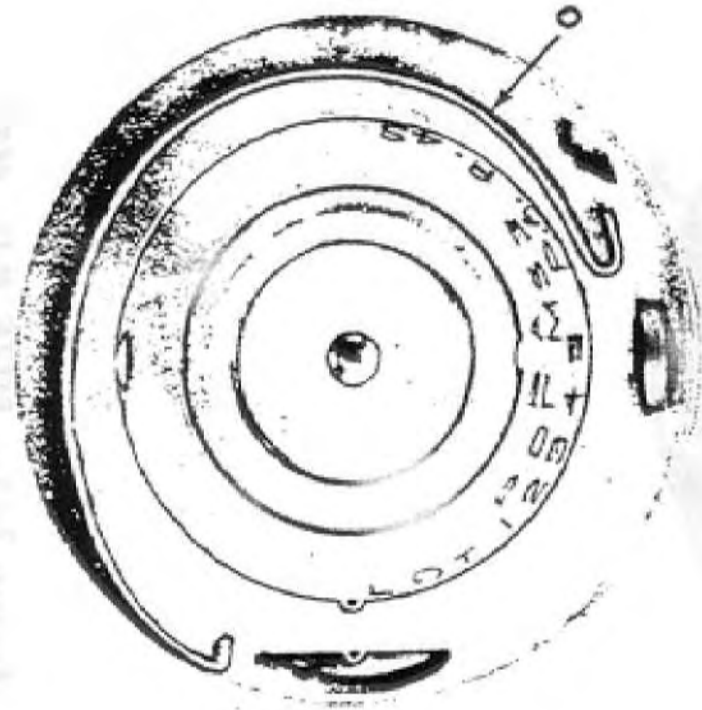
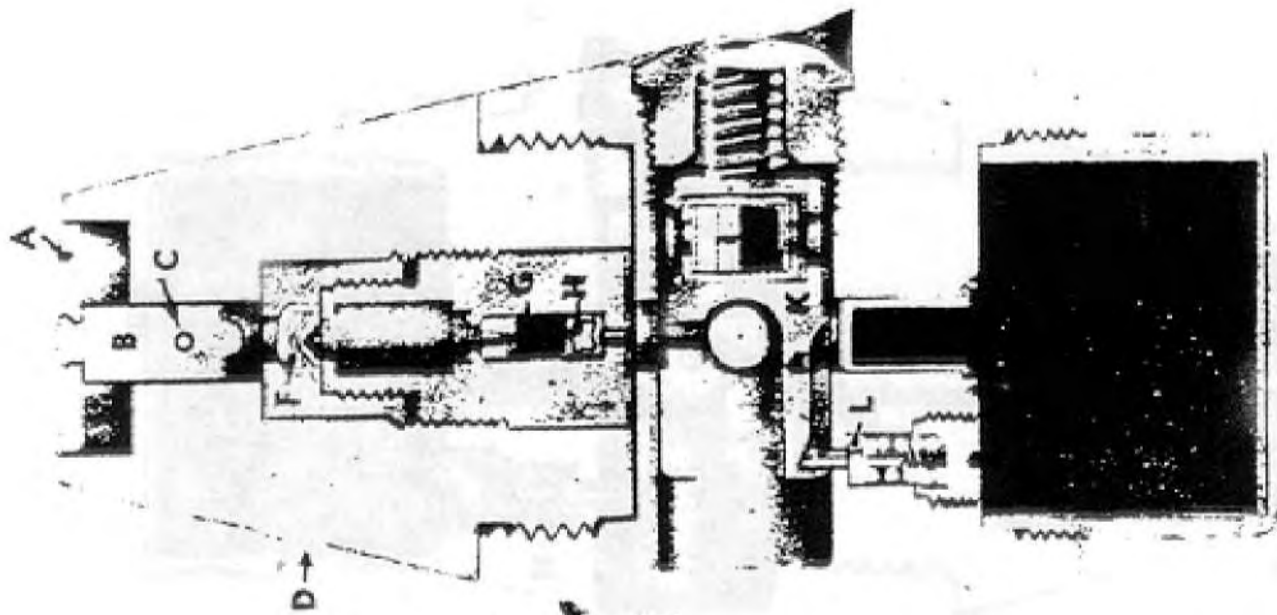

Figure 166 — FUZE, P.D., M53



FUZES, PROPELLING CHARGES, PRIMERS, AND OTHER COMPONENTS

the safety pin in turn is held in locking position by a set-back pin (N). Positive safety during shipment and handling is provided by a safety wire (M) which prevents the set-back pin from moving. This safety wire must be removed before firing.

d. **Functioning.** Upon firing, after removing the safety wire, set-back causes the set-back pin to move backward against the resistance of the spring. This releases the safety pin which, after the shell has emerged from the mortar tube, is ejected from the fuze by its spring, bringing the detonator into the alined (armed) position. While the shell is in the mortar, the safety pin is kept in the fuze by the inner wall of the mortar tube. The slider is locked in the armed position by the spring-activated locking pin (H). Upon impact, the striker is driven inward, compressing its spring and carrying the firing pin against the detonator. Action of the detonator is transmitted through the booster lead-in to the tetryl booster pellet and, thereby, to the bursting charge of the shell.

e. **Preparation for Firing.** The fuze requires no preparation for firing other than removing the safety wire. This should be done just before firing, and at no other time.

323. FUZE, P.D., M53.

a. **General.** The M53 Fuze (fig. 166) is standard for use with 81-mm high-explosive ammunition when delayed functioning is desired. It replaces the M45 Selective-action Fuze for such purposes.

b. **Data.** Length, visible, 3.36 inches, over-all, 3.47 inches; weight, 0.54 pound; thread size, 1.5-12NF-1.

c. **Description.** The fuze is a single-action type with a direct-action firing device. The body and mechanism therein are identical with that of the M52 Mortar Fuze (fig. 170). However, the head (D) is fitted with a delay assembly (E), and a short plug-type firing pin (B) with a nipple at one end and riveted at the other end to a thin aluminum-alloy disk (A) which forms the striker. Normally, the firing pin is held at rest by a shear wire (C). This wire is sufficiently strong to withstand ordinary blows and the set-back created upon firing, but is sheared or bent upon impact at the target, allowing the nipple of the firing pin to come into contact with a primer (F) in the delay assembly. The delay assembly consists of the primer, a black powder delay pellet (G) which is loaded to cause the fuze to function with 0.1-second delay, and a relay charge (H) of lead azide.

d. **Functioning.** Upon impact the firing pin is driven against the primer. Action of the latter ignites the black powder. After burning for the prescribed time, action of the lead azide is initiated. The detonator (I) in the slider (K) of the interrupter having been

ARTILLERY AMMUNITION

brought into alinement in the same manner as in the M52 Fuze (par. 356) and locked in the armed position by the lock pin (L), action of the relay charge is transmitted to the detonator and, thereby, to the booster lead (M) and booster charge (N). The booster charge in turn causes the shell to explode.

e. **Preparation for Firing.** There is no preparation other than removing the safety wire (O). This should be done just before firing, and at no other time.

324. FUZE, TSQ, M54.

a. **General.** The M54 (fig. 167) is a selective superquick or time-action (to 25 sec) type. The fuze is usually used in conjunction with the M20 type booster, which is made a manufacturing component of the shell when the fuze is to be assembled thereto. The M54 is of the same size, shape, and weight as the M48, which is used with shell in the same calibers for impact functioning, and has the same ballistic values.

b. **Data.** Length, visible, 3.76 inches, over-all, 4.57 inches; weight, 1.42 pounds; thread size, 1.7-14NS-1.

c. **Description.** The fuze consists of three major parts: a closing cap or head (A) containing the superquick impact elements (B, C, E) and the time-action plunger (F); two time-train rings, one fixed (K) to the body and the other movable (P); and a body (R) containing a time-action striker (H) and primer (I), a magazine charge (T), and an interrupter (S). The superquick action is identical in construction and functioning with that in the M48 Fuze except that the interrupter incorporated in the body of the fuze has no setting sleeve, being automatic and always operative regardless of fuze setting. Hence, the fuze will function on impact unless prior functioning has been caused by the time action. The time action is typical of powder-train types and is initiated upon firing by the time-action plunger under set-back. The fixed upper and moveable lower time rings have a tunnel-shaped slot or groove in their lower surfaces which is filled with compressed black powder (N). One end of the lower-ring powder train is connected by a pellet (O) to the upper-ring train; one end of the upper train is connected by a pellet (L) to the time-action primer. Movement of the lower ring in relation to the fixed upper ring and a pellet (Q) in the body determines the time of functioning. Counterclockwise turning of the lower ring (viewed from the point of the fuze) lengthens the time by increasing the amount of powder which must burn in the upper and lower rings before the flame reaches the pellet in the body and is transmitted

ARTILLERY AMMUNITION
FUZES, PROPELLING CHARGES, PRIMERS, AND OTHER COMPONENTS

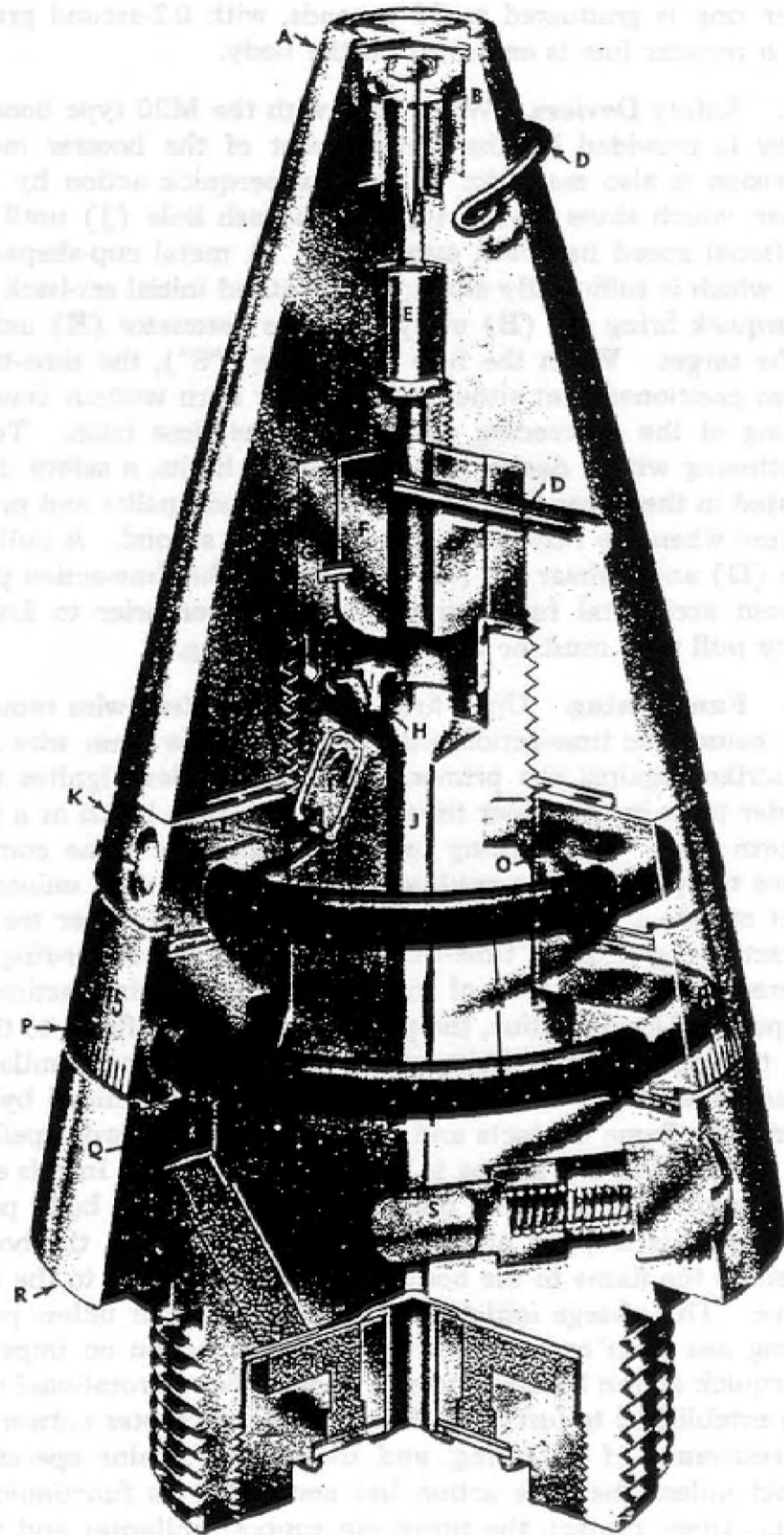

Figure 167 — FUZE, TSQ, M54

RA PD 80856

ARTILLERY AMMUNITION

thereby to the body and magazine charges. For setting purposes, the lower ring is graduated to 25 seconds, with 0.2-second graduations, and a register line is engraved on the body.

d. **Safety Devices.** When used with the M20 type booster, bore-safety is provided by the arrangement of the booster mechanism. Provision is also made for boresafe superquick action by the interrupter, which shuts off the superquick flash hole (J) until sufficient rotational speed has been established. A metal cup-shaped support (C) which is sufficiently strong to withstand initial set-back holds the superquick firing pin (B) away from the detonator (E) until impact at the target. When the fuze is set safe ("S"), the time-train rings are so positioned that either or both may burn without causing functioning of the succeeding elements in the time train. To prevent functioning within dangerously short time limits, a safety disk incorporated in the lower time ring covers the body pellet and prevents its ignition when the fuze is set at less than 0.4 second. A pull (safety) wire (D) and a shear pin (G) are fitted in the time-action plunger to prevent accidental functioning of the plunger prior to firing. The safety pull wire must be removed before firing.

e. **Functioning.** Upon firing, with the safety wire removed, set-back causes the time-action plunger to shear the shear wire and force the striker against the primer. The primer flash ignites the black powder train in the upper time ring, which then burns at a relatively uniform rate. The burning progresses until the flame contacts and ignites the pellet of the graduated (lower) time ring, unless the fuze is set at safe ("S"). In this event, flame of the upper train cannot contact the graduated time-ring pellet since the lower-ring pellet is covered by the solid part of the upper ring, and time action stops at this point. Upon ignition, the pellet transmits the flame to the graduated time-ring powder train, which burns in manner similar to that of the upper ring. After burning for a time determined by the fuze setting, the flame contacts and ignites the black powder pellet in the fuze body unless the setting is less than 0.4 second. In this event, the flame is interrupted before making contact with the body pellet, and time action is stopped at this point. When ignited, the body pellet transmits the flame to the body charge and, thereby, to the magazine charge. This charge initiates action of the booster unless prior functioning has been caused by the superquick action on impact. This superquick action becomes armed when sufficient rotational speed has been established to force the slider of the interrupter outward against the resistance of its spring, and thereafter remains operative until impact unless the time action has completed its functioning during flight. Upon impact, the firing pin support collapses and the firing pin strikes the superquick detonator. Action of the detonator is trans-

FUZES, PROPELLING CHARGES, PRIMERS, AND OTHER COMPONENTS

mitted directly to the shell booster through the uninterrupted flash hole. The fuze will function on impact, therefore, with superquick action, when the time setting is set for a time greater than the time of flight or otherwise fails to complete its functioning. The gases formed by the burning of the powder train escape through the closing disk (M).

f. **Preparation for Firing.** Prior to firing, with either superquick or time setting, the safety pull wire must be removed from the fuze (pull free end of wire off fuze and out of hole). If superquick action is required, the graduated time ring can be left as shipped set at safe ("S") or be set for a time greater than the time of flight. If time action is required, the graduated time ring is set for the required time of burning by means of a fuze setter.

325. FUZE, TSQ, M55A2, W/BOOSTER, M21A2.

a. **Description.** The M55A2, M55A1, and M55 Fuzes (fig. 168) are identical in every respect with M54 Fuze (par. 324) except that BOOSTER M21A2, M21A1, M21, respectively, is a manufacturing component of the fuze. The only difference between the M55A2, M55A1, and M55 Fuzes is in the booster with which each is assembled. See chapter 3, section IV for a description of the boosters.

b. **Data.** Length, visible, 3.76 inches, over-all, 5.95 inches (including booster); weight 2.16 pounds (including booster); thread size, of fuze, 1.7-14NS-1, of booster, 2-12NS-1.

c. **Preparation for Firing.** The fuzes are shipped separately from the shell with which they are used, for assembling to the projectile in the field. This is done by:

- (1) Removing the shipping plug from the projectile.
- (2) Examining all threads to insure that no foreign matter is present which may interfere with proper assembly.
- (3) Screwing the fuze with booster into the fuze hole by hand, then tightening with a fuze wrench.
- (4) Removing safety pin (C) from the booster.
- (5) When thus assembled to the projectile, the fuze is set for the required action as described in paragraph 324 for the M54 Fuze.

326. FUZE, P.D., M56.

a. **General.** The M56 Fuze (fig. 169) is known as a supersensitive type because its mechanism is arranged to function on light impact. It is used with 37-mm high-explosive shell in both antiaircraft and aircraft guns.

ARTILLERY AMMUNITION

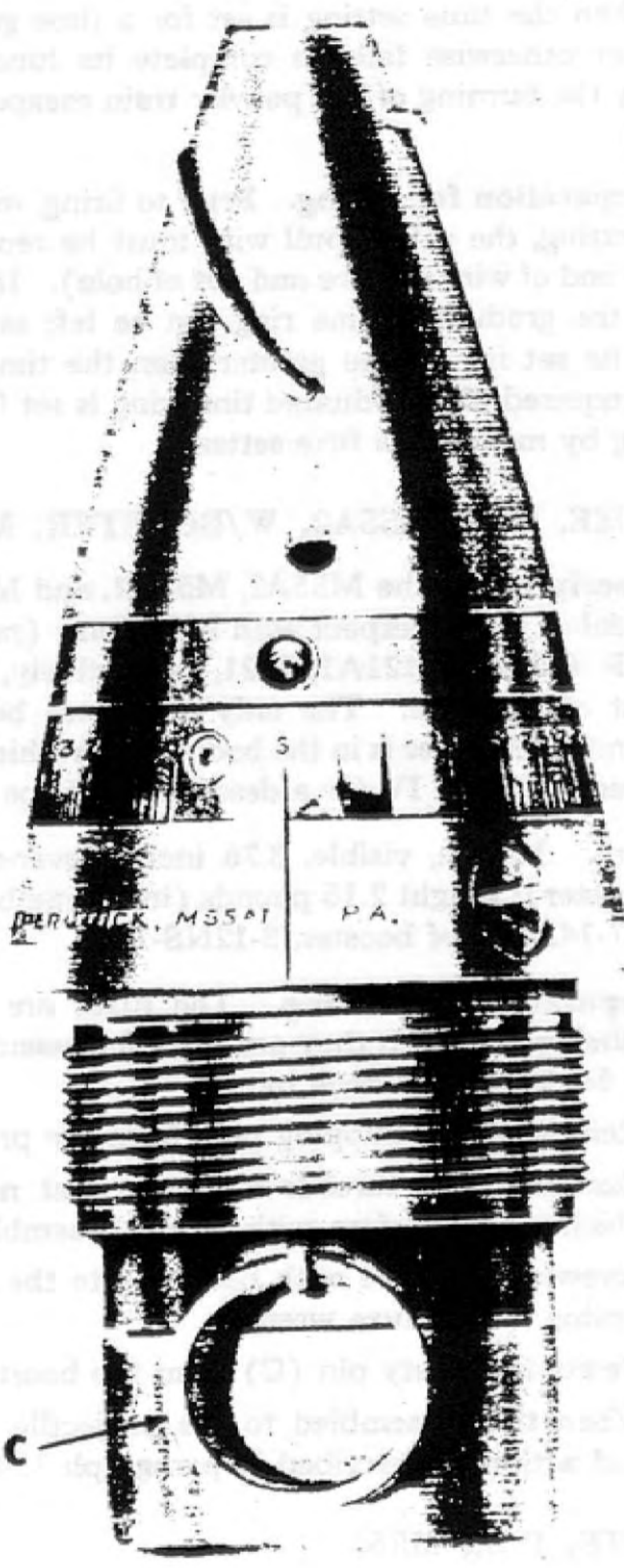

RA PD 80857

Figure 168 — FUZE, TSQ, M55A2, w/BOOSTER, M21A2

FUZES, PROPELLING CHARGES, PRIMERS, AND OTHER COMPONENTS

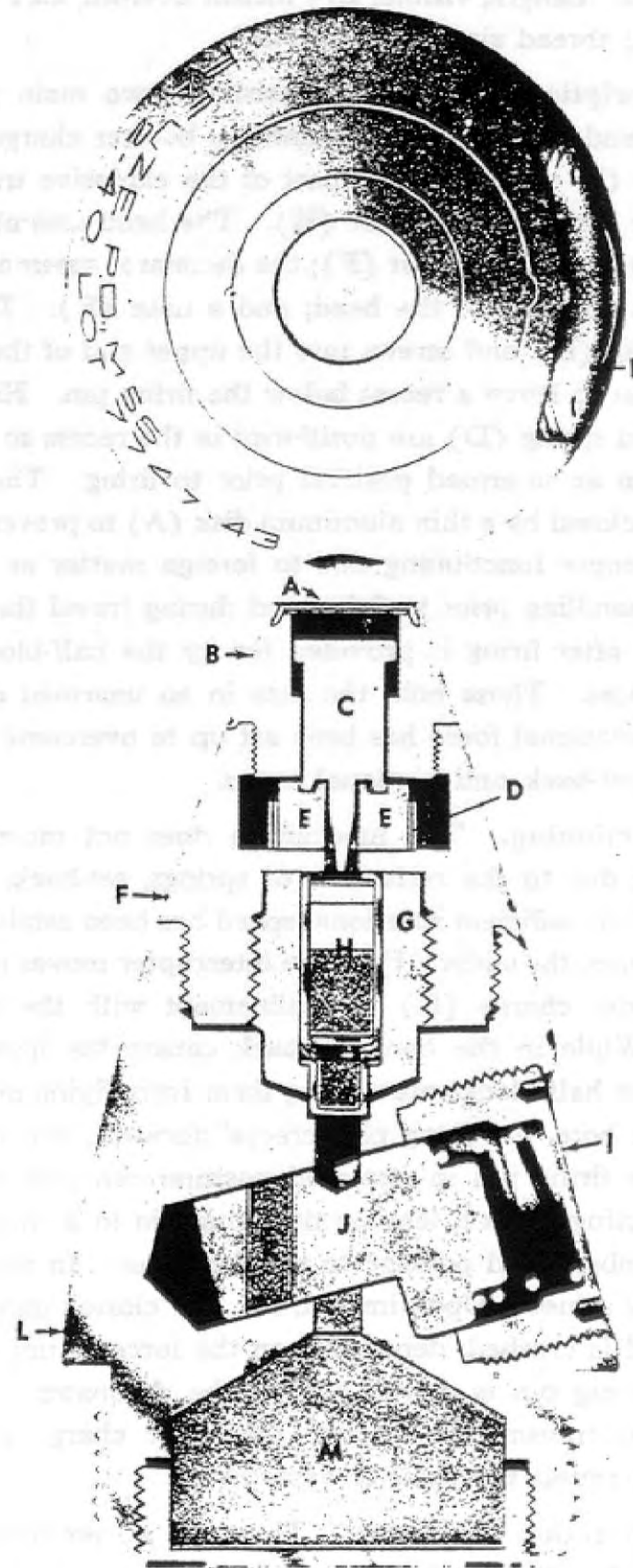

Figure 169 — FUZE, P.D., M56

RA PD 80858

ARTILLERY AMMUNITION

b. **Data.** Length, visible, 1.74 inches, over-all, 2.21 inches; weight, 0.17 pound; thread size, 1.125-20-NS-1.

c. **Description.** The fuze consists of two main parts: a head assembly; and a body (L) containing a booster charge (M) and an interrupter (I) which holds a part of the explosive train connecting the booster with the detonator (H). The head assembly is made in three parts: the head proper (F); the detonator assembly (G), which screws into the base of the head; and a nose (E). The nose holds the firing pin (C), and screws into the upper end of the head in such a manner as to leave a recess below the firing pin. Half-blocks (E) and a coiled spring (D) are positioned in the recess so as to hold the firing pin in an unarmed position prior to firing. The front end of the nose is closed by a thin aluminum disk (A) to prevent interference with the proper functioning due to foreign matter or air resistance. Safety in handling prior to firing and during travel through the bore of the gun after firing is provided for by the half-blocks and interrupter devices. These hold the fuze in an unarmed condition until sufficient rotational force has been set up to overcome the resistance of springs, set-back, and frictional forces.

d. **Functioning.** The mechanism does not move immediately after firing due to the resistance of springs, set-back, and frictional forces. When sufficient rotational speed has been established to offset the resistances, the slider (J) of the interrupter moves outward, bringing the slider charge (K) into alinement with the detonator and booster. While in the bore, set-back causes the firing pin to seat firmly in the half-blocks preventing them from flying outward. Upon leaving the bore, the firing pin "creeps" forward, and the half-blocks holding the firing pin in unarmed position can now move outward under centrifugal force, leaving the firing pin in a "floating" position with an unobstructed passage to the detonator. In this position, the fuze is fully armed. Upon impact, the thin closing disk is perforated, or the head is crushed, depending on the force of impact. In either case, the firing pin is driven against the detonator. Action of the detonator is transmitted through the slider charge to the booster, which then causes the shell to explode.

e. **Preparation for Firing.** There are no preparations.

CAUTION: *Fuzes with perforated or imperfect closing disks will not be fired.*

FUZES, PROPELLING CHARGES, PRIMERS, AND OTHER COMPONENTS

327. FUZE, P.D., M57.

a. **General.** The M57 Fuze (fig. 170) is essentially the M48 Fuze modified to a single-action superquick type by omitting the delay element, and is of the same size, shape, and weight. The conversion provides a more suitable fuze for use with chemical shell, where surface burst on impact is desirable for the most effective results. The M57 is used primarily with 75-mm howitzer chemical shell, and in conjunction with the M22 Booster in 105-mm howitzer chemical shell. See chapter 3, section IV for boosters. The booster is a manufacturing component of the shell.

b. **Data.** Length, visible, 3.74 inches, over-all, 5.93 inches (including booster); weight, 2.14 pounds; thread size, of fuze, 1.7-14NS-1, of booster, 2-12NS-1.

c. **Description.** The superquick element (A) is identical in construction and functioning to the M48A2 (par. 319) except that there is no setting sleeve on the centrifugal interrupter (B) and there is no delay assembly.

d. **Functioning.** For details on functioning, see paragraph 319.

e. **Preparation for Firing.** There are no preparations.

328. FUZE, TIME, MECHANICAL, M61 AND M61A1.

a. **Description.** The M61A1 (fig. 171) is essentially the M43A4 Fuze with an extended conical nose. The long pointed shape is required to adapt the fuze to the sweep of the 120-mm Antiaircraft Shell M73, for which the fuze is provided. Aside from the difference in contour, the M61A1 and M43A4 are like in construction and in functioning (see par. 315 for details of arrangement and functioning), including safety devices and the minimum safe setting time of 0.6 second, as well as the torque required to turn the movable cap. Similarly, the M61 is the same as the M43A3 except for the difference in shape and weight.

b. **Data.** Length, visible, 6.867 inches, over-all, 7.677 inches; weight, 1.62 pounds; thread size, 1.7-14NS-1.

c. **Preparation for Firing.** The fuze is prepared for firing in the same manner as described for the M43 Fuzes in paragraph 315.

ARTILLERY AMMUNITION

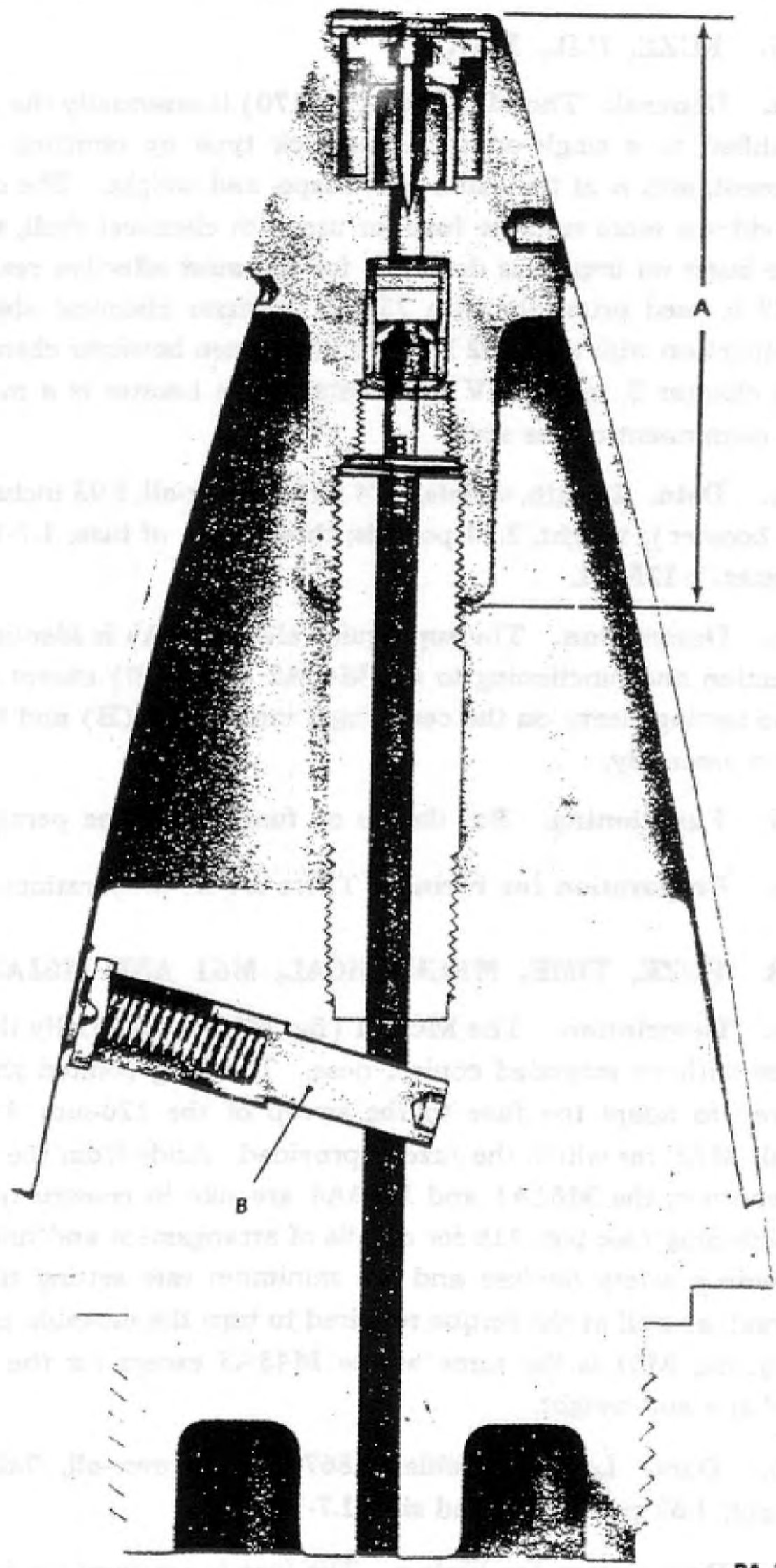

RA PD 80859

Figure 170 — FUZE, P.D., M57

FUZES, PROPELLING CHARGES, PRIMERS, AND OTHER COMPONENTS

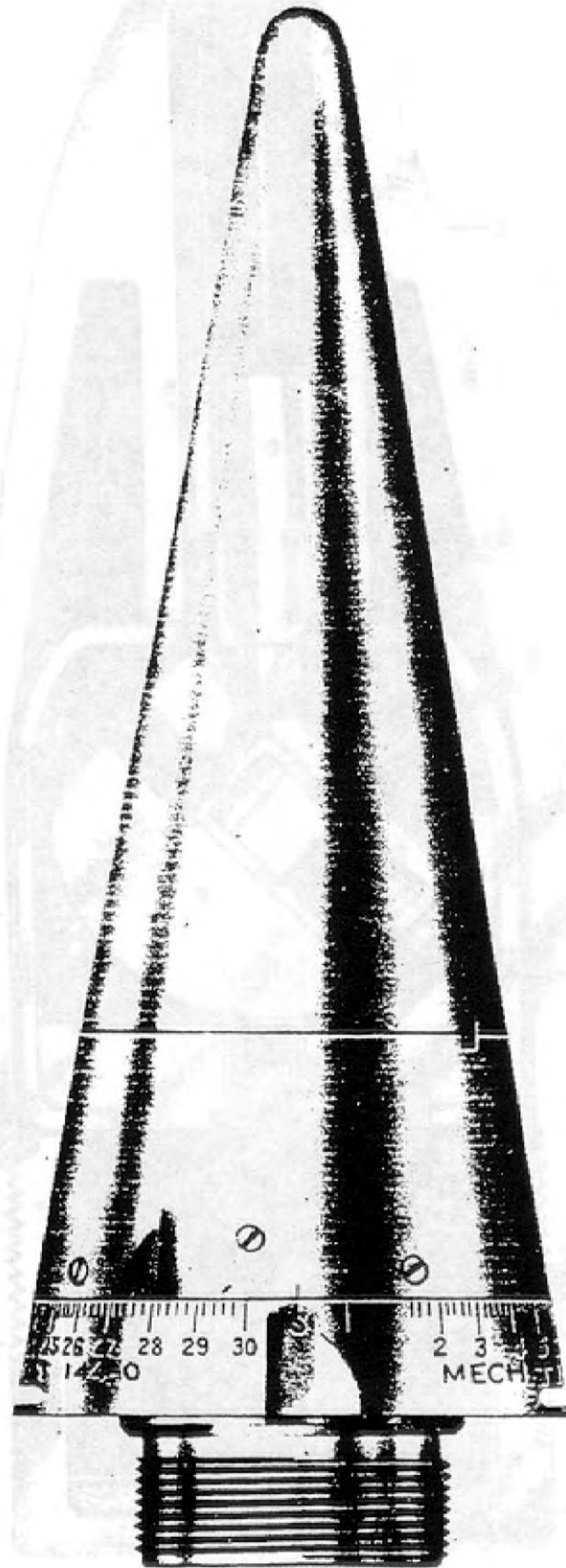

RA PD 80860

Figure 171 — FUZE, Time, Mechanical, M61A1

ARTILLERY AMMUNITION

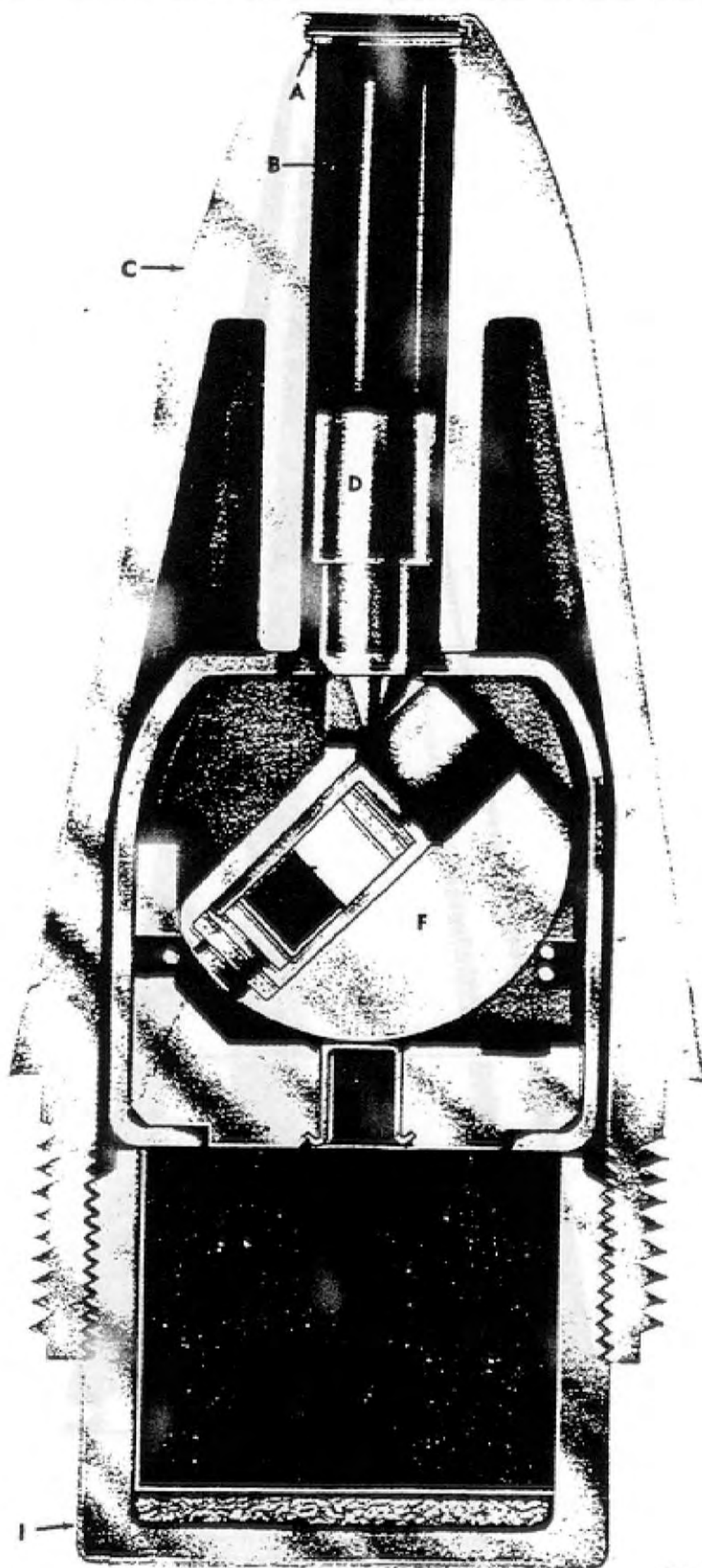

RA PD 80861

Figure 172 - FUZE, P.D., M64A1

FUZES, PROPELLING CHARGES, PRIMERS, AND OTHER COMPONENTS**329. FUZE, P.D., M64A1.**

a. **General.** The M64A1 Fuze (fig. 172) is a single-action fuze intended to function with superquick action on light impact. The fuze has been superseded as standard for 40-mm antiaircraft shell by the Mk. 27 (Navy) and M71 Fuzes, which it resembles, but will be used until present stocks are exhausted.

b. **Data.** Length, visible, 1.91 inches, over-all, 2.82 inches; weight, 0.25 pound; thread size, 1.18-14NS-2.

c. **Description.** The fuze consists of a die-cast aluminum-alloy body (C) holding a firing pin (D) and a striker or plunger (B) in the forepart, and a rotor device in the rear portion. A booster cup (I) with tetryl booster pellet (H), screwed into the base end of the fuze, completes the assembly. The firing pin and the striker are in a "floating" position in a long narrow recess. The recess is closed at the front by a thin aluminum disk (A) which prevents the entry of foreign matter into the fuze and also shuts off air resistance during flight. The front end of the rotor (F) confines the firing pin and striker within their recess so long as the rotor is in the unarmed position. In the unarmed position, the rotor also holds the detonator (E) out of alignment with the booster. The rotor is locked in this position by two centrifugally operated lock pins which are held in the locking position by a spring.

d. **Functioning.** After firing, upon the development of sufficient centrifugal force (rotational speeds between 10,000 and 20,000 rev per min), the pins move outward against the resistance of the spring. The rotor then swings into armed position, bringing the detonator into alignment and leaving the firing pin free to contact the detonator upon impact. Upon impact, the striker is driven inward, forcing the firing pin against the detonator. Action of the detonator is transmitted through the booster lead (G) to the booster pellet and then to the shell bursting charge, causing the shell to explode.

e. **Preparation for Firing.** There are no preparations.

330. FUZE, TIME (FIXED), M65.

a. **General.** The M65 Fuze (fig. 173) is a simple time fuze used with the 60-mm Illuminating Shell M83, to obtain the delay in functioning required for the most effective illumination. It differs from the adjustable powder-train types in that the burning time is fixed at 15 seconds, and therefore does not have a movable time ring or require adjustment. This delay permits the round to be at its optimum range and height before the illuminant begins to burn.

b. **Data.** Length, visible, 1.875 inches, over-all, 2.53 inches; thread size, 2-20NS-1.

ARTILLERY AMMUNITION

c. **Description.** The time train is a powder-train type consisting of a primer (E), quick match (F), a time-ring charge (H) loaded for a prescribed time of burning, a body pellet (I), and an expelling charge (K). Powder elements other than the quick match and time-ring charge are held in a die-cast body. The quick match and time-ring charge are assembled in the time ring (G), which is essentially a large washer grooved and drilled to hold the charges. A head (D) seating the striker (C) screws on to a threaded neck on the body (J), holding the time ring securely in a fixed position. A safety (cotter) pin (A) and a shear wire (B) pass through the head and the striker. The cotter pin provides positive safety during handling prior to firing. The shear wire holds the striker at rest until broken or bent by set-back forces on firing.

d. **Functioning.** Upon firing, set-back causes the striker to move rearward with sufficient force to shear or bend the shear wire and strike the primer. The flame from the primer ignites the quick match, which, in turn, ignites the time-ring charge. After the flame of the time-ring charge has completed its circle about the time ring, it ignites the body pellet. The body pellet then ignites the expelling charge. Flame from the latter passes through the apertures in the expelling charge retainer disk (L), igniting the illuminant of the shell.

e. **Preparation for Firing.** There is no preparation except the removal of the safety (cotter) pin, just prior to firing.

331. FUZE, TIME, MECHANICAL, M67A2, W/BOOSTER, M21A2.

a. **General.** The M67A2 Fuze (fig. 174) is a mechanical time fuze used with high-explosive shell in calibers from 4.5-inch to 240-mm (field weapons only). Due to its longer time range, the fuze also has replaced the M55, M55A1, and M55A2 Fuzes for use for high-burst ranging.

b. **Data.** Length, visible, 3.74 inches, over-all, 5.93 inches (including booster); weight, 2.14 pounds (including booster), thread size, 2-12NS-1.

c. **Description.** The M67A2 Fuze has the same size, weight, and shape as the M43, and like it, has no impact element. The time action is based on the same clockwork principle, and functions similarly except that escapement and gears of the M67A2 are set to give a functioning time up to 75 seconds, and the safety leaf prevents functioning when the fuze is set for less than 1.5 seconds. The setting register (B) is engraved with 0.5-second graduations up to 75 seconds, a zero line (C), and a safety (S) line (D). The fuze is set safe as shipped. A safety wire (A) extends through the fuze body and the firing pin, pro-

ARTILLERY AMMUNITION

viding positive safety during the handling prior to firing. This wire must be removed when preparing the fuze for firing.

d. **Preparation for Firing.** To assemble the fuze and booster assembly to the projectile:

- (1) Remove the shipping plug from the projectile.
- (2) Inspect the fuze hole threads to make certain that no foreign matter is present which may interfere with proper assembly.
- (3) Remove safety (cotter) pin (E) from booster.
- (4) Screw the fuze and booster assembly into the projectile by hand and tighten with the fuze wrench.
- (5) When the fuze is assembled to the projectile, it is only necessary to remove the safety wire (A) (pull end of wire from hole and slip the wire off the head) and then set the fuze for the desired time of action by means of the fuze setter, to complete the preparation for firing.

332. FUZE, P.D., M71.

a. **General.** The M71 (fig. 175) is a relatively recent type of superquick fuze. It has been adopted as an alternative fuze for the Mk. 27 (Navy) Fuze in 40-mm ammunition.

b. **Data.** Length, visible, 1.900 inches; over-all length 2.45 inches; weight, 0.22 pound; thread size 1.18-14NS-2RH.

c. **Description and Functioning.** The fuze is essentially a Simple-design rotor mechanism housed in the Mk. 27 (Navy) Fuze body (C). In outward appearance, it resembles the Mk. 27 Fuze illustrated in figure 181, having the same body (C), booster housing (I), and booster charge (K). However, internally the two fuzes are different in a number of respects. The M71 Fuze mechanism consists of: a firing pin (B) and firing-pin head (A), and a rotor (H) containing the detonator (F) and the set-back pin (E). The rotor is a cylindrical type (as contrasted to the disk or wafer type as in the Mk. 27 Fuze) of a length about 1½ times the diameter. A rotor housing (D) holds the rotor and the end of the firing pin in position. The detonator is inserted diametrically across the axis of the rotor, and normally is held out of alinement with respect to the firing pin and booster lead (J) by the set-back pin. The ends of the rotor are slotted (G) in such a manner as to cause unbalance in the rotor. Upon firing and after the set-back pin has moved rearward to release the rotor, the rotor rotates to bring the detonator into alinement with the firing pin and booster (K) when centrifugal force has become great enough to overcome friction caused by set-back force. This same principle is applied in the M74 Fuze described in paragraph 333 and illustrated in figure 176.

d. **Preparation for Firing.** There is no preparation for firing.

FUZES, PROPELLING CHARGES, PRIMERS, AND OTHER COMPONENTS

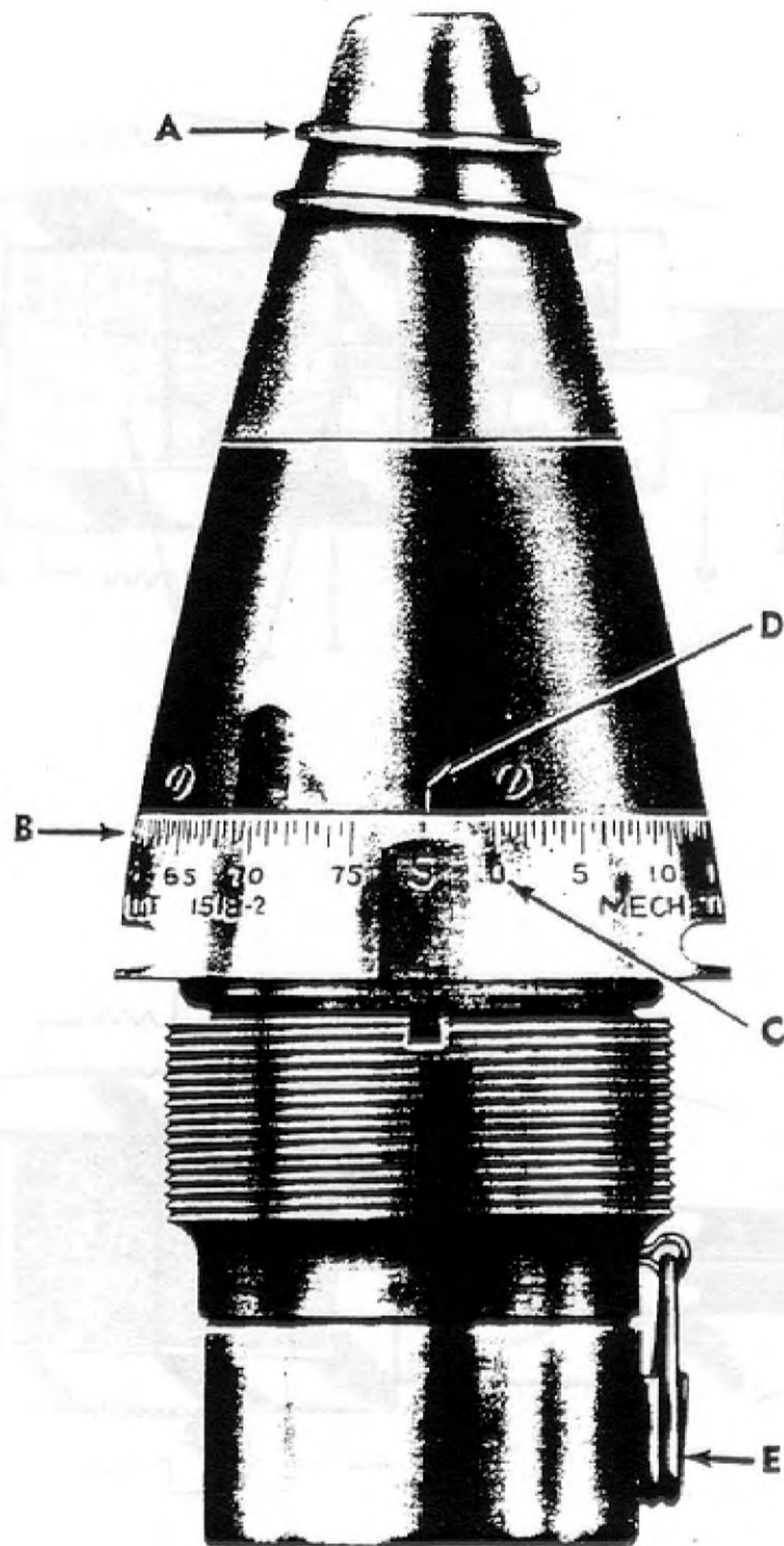

RA PD 80863

Figure 174 — FUZE, Time, Mechanical, M67A2, w/BOOSTER, M21A2

ARTILLERY AMMUNITION

RA PD 65130

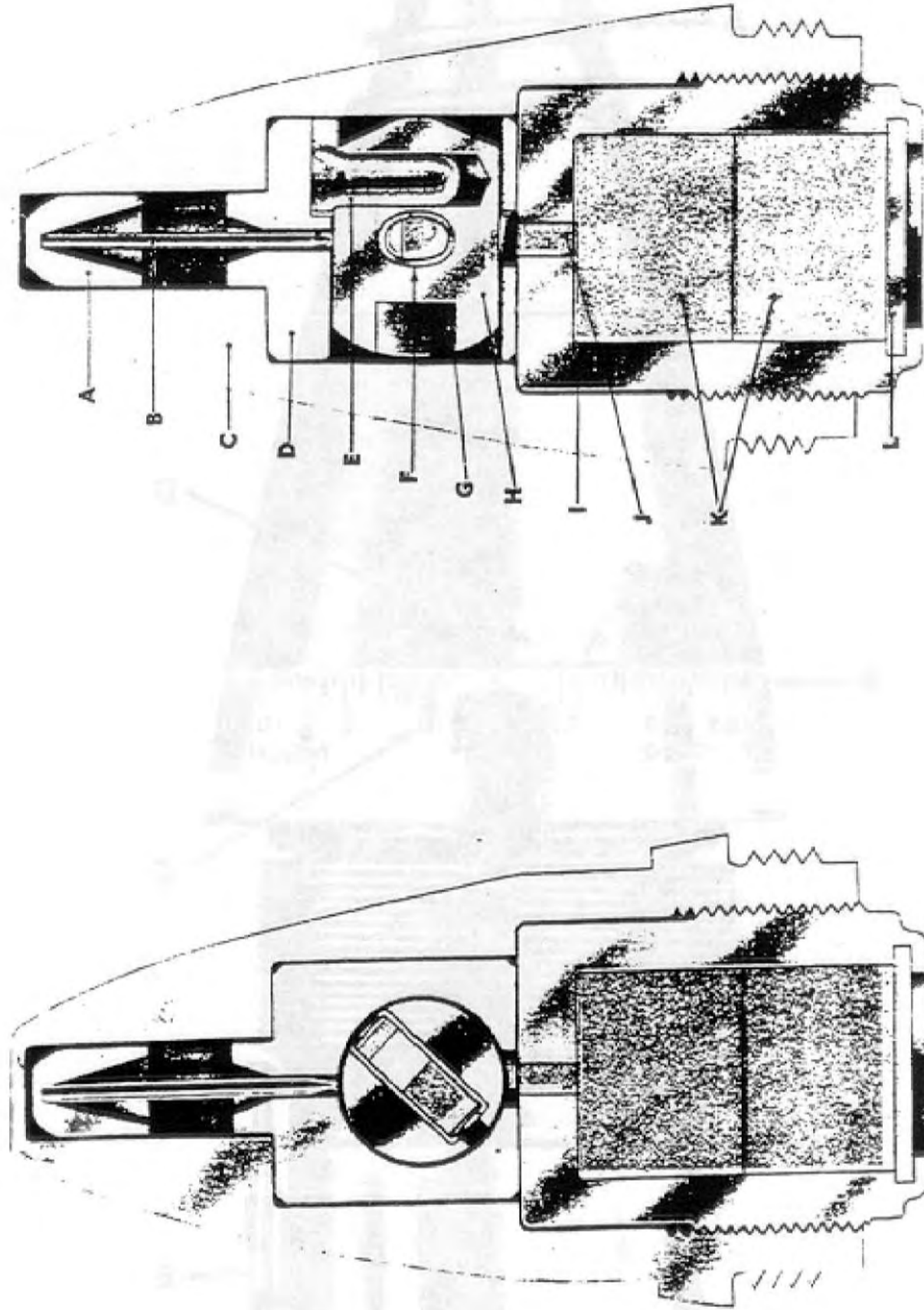

Figure 175 — FUZE, P.D., M71

FUZES, PROPELLING CHARGES, PRIMERS, AND OTHER COMPONENTS

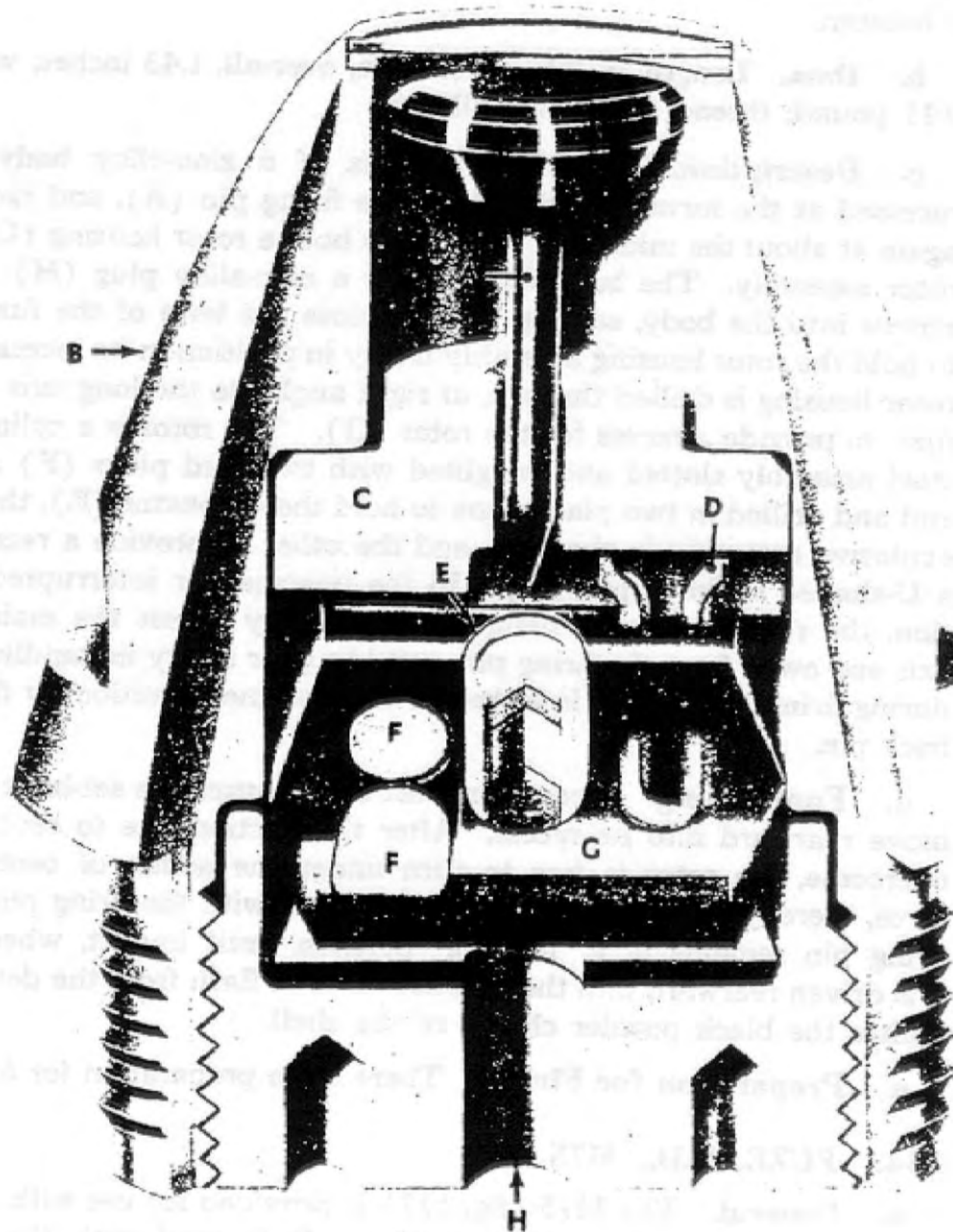

Figure 176 — FUZE, P.D., M74

ARTILLERY AMMUNITION

333. FUZE, P.D., M74.

a. **General.** The M74 (fig. 176) is a relatively recent model point fuze containing a direct-action firing pin and a Semple-type rotor. The fuze is provided for use with the M92 Practice Shell in the 37-mm Subcaliber Guns, M12, M13, M14, and M1916. It is used to ignite the black powder spotting charge of the shell and does not require or have a booster.

b. **Data.** Length, visible, 0.965 inch, over-all, 1.43 inches; weight, 0.21 pound; thread size 1.125-20NS-1.

c. **Description.** The fuze consists of a zinc-alloy body (B) recessed at the forward end to hold the firing pin (A), and recessed again at about the middle of the fuze to hold a rotor housing (C) and rotor assembly. The base is closed by a zinc-alloy plug (H) which screws into the body, serving both to close the base of the fuze and to hold the rotor housing assembly firmly in position in its recess. The rotor housing is drilled through, at right angles to the long axis of the fuze, to provide a recess for the rotor (G). The rotor is a cylindrical steel assembly slotted and weighted with two lead plugs (F) at one end and drilled in two places, one to hold the detonator (E), the only explosive assembly in the fuze, and the other to provide a recess for a U-shaped set-back pin (D). In the unarmed or interrupted position, the rotor holds the detonator diagonally across the main fuze axis and away from the firing pin, providing for safety in handling and during firing. The rotor is locked in the unarmed position by the set-back pin.

d. **Functioning.** Upon firing, set-back causes the set-back pin to move rearward into its recess. After the friction due to set-back is overcome, the rotor is free to turn under the action of centrifugal force, thereby bringing the detonator in line with the firing pin. The firing pin remains in a "floating" position until impact, whereupon it is driven rearward into the detonator. The flash from the detonator ignites the black powder charge of the shell.

e. **Preparation for Firing.** There is no preparation for firing.

334. FUZE, P.D., M75.

a. **General.** The M75 (fig. 177) is provided for use with 20-mm high-explosive-incendiary ammunition. It is used with the recent matched-ballistic shell, whereas FUZE, P.D., 253 Mk. II-III (par. 340), which it resembles, is used with older shell. It is a single-action type intended to function with instantaneous percussion action on impact with light materiel surfaces. Like the 253 Mk. II-III Fuzes, its design differs from the ordinary in that functioning is initiated on impact by the set-forward force of the detonator charge or by pieces of

FUZES, PROPELLING CHARGES, PRIMERS, AND OTHER COMPONENTS

RA PD 65131

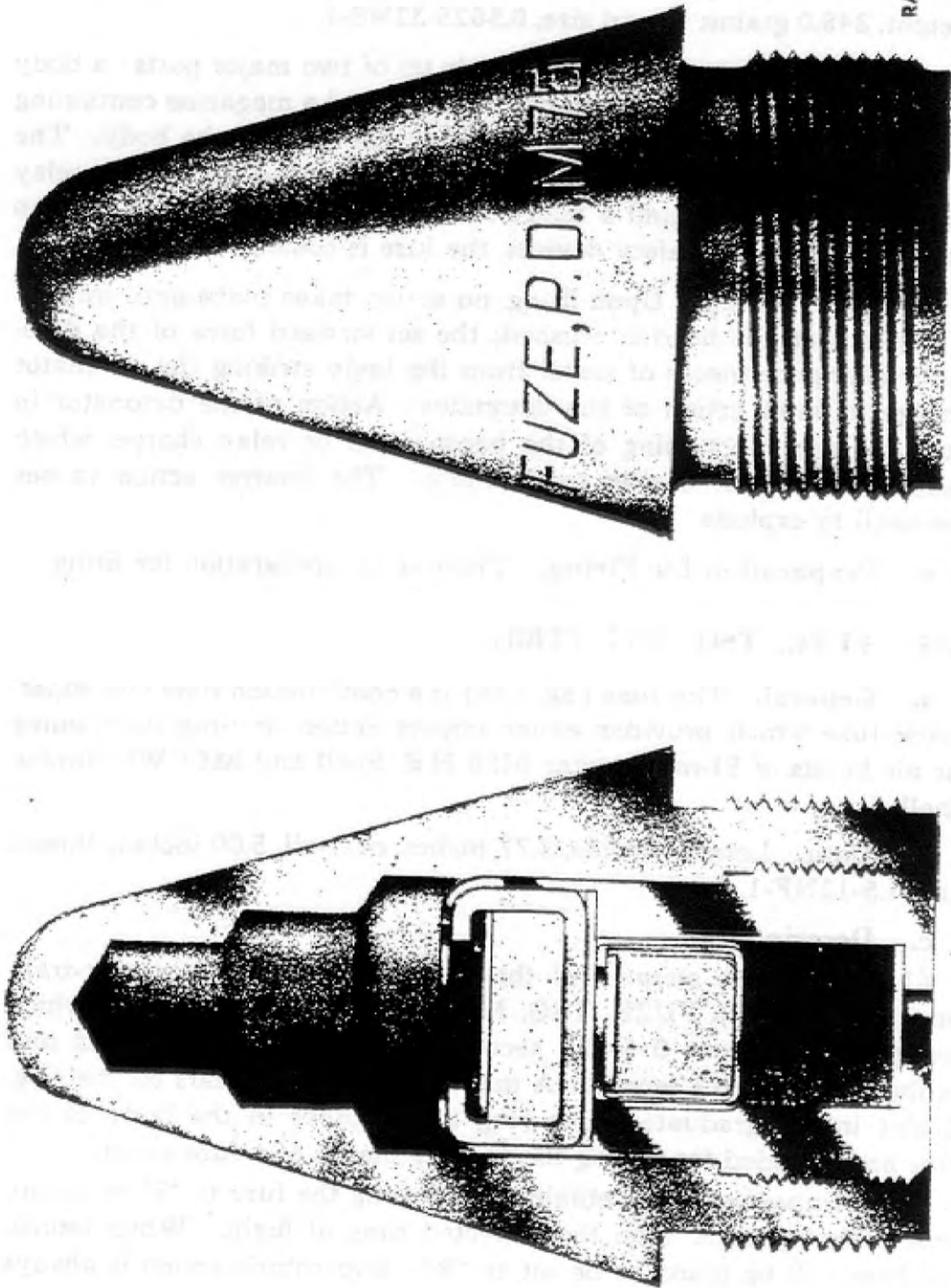

Figure 177 — FUZE, P.D., M75

ARTILLERY AMMUNITION

metal from the body striking the detonator charge. Hence the striker or firing pin mechanism usually found in point-detonating fuzes is omitted in this design.

b. **Data.** Length, visible, 0.84 inch; overall length, 1.20 inches; weight, 348.0 grains; thread size, 0.5625-32NS-1.

c. **Description.** The fuze is made up of two major parts: a body with an air space in the forepart of the fuze, and a magazine containing the explosive train which is screwed into the base of the body. The explosive train consists of a mercury fulminate detonator, a relay charge of lead azide, and a tetryl booster charge. Since there are no interrupter or other safety devices, the fuze is considered nonboresafe.

d. **Functioning.** Upon firing, no action takes place until impact. Upon impact, the head is crushed; the set-forward force of the detonator charge or pieces of metal from the body striking the detonator charge initiates action of the detonator. Action of the detonator in turn initiates functioning of the booster cap or relay charge, which causes the booster charge to detonate. The booster action causes the shell to explode.

e. **Preparation for Firing.** There is no preparation for firing.

335. FUZE, TSQ, M77 (T88).

a. **General.** This fuze (fig. 178) is a combination time and superquick fuze which provides either impact action or time functioning for air bursts of 81-mm mortar M56 H.E. Shell and M57 WP Smoke Shell.

b. **Data.** Length, visible, 3.77 inches, over-all, 5.00 inches; thread size, 1.5-12NF-1.

c. **Description.**

(1) The time element of this fuze consists of the powder-train time rings used in FUZE, TSQ, M54 (fig. 172 and par. 324) which are graduated from 0 to 25 seconds; numbered every second and calibrated every 0.2 second. A marking "S" also appears on the ring. A slot in the graduated time ring and another in the body of the fuze are provided for setting the fuze by means of a fuze setter.

(2) Impact action is obtained by setting the fuze to "S" or to any time setting greater than the expected time of flight. When issued, the fuze will be found to be set to "S." Superquick action is always obtained when functioned by impact.

(3) The safety elements incorporated in this fuze consist of a bore-riding safety (H) pin similar to that in the M52 and M53 Point-detonating Fuzes and a shear pin (D) which supports the time-action

FUZES, PROPELLING CHARGES, PRIMERS, AND OTHER COMPONENTS

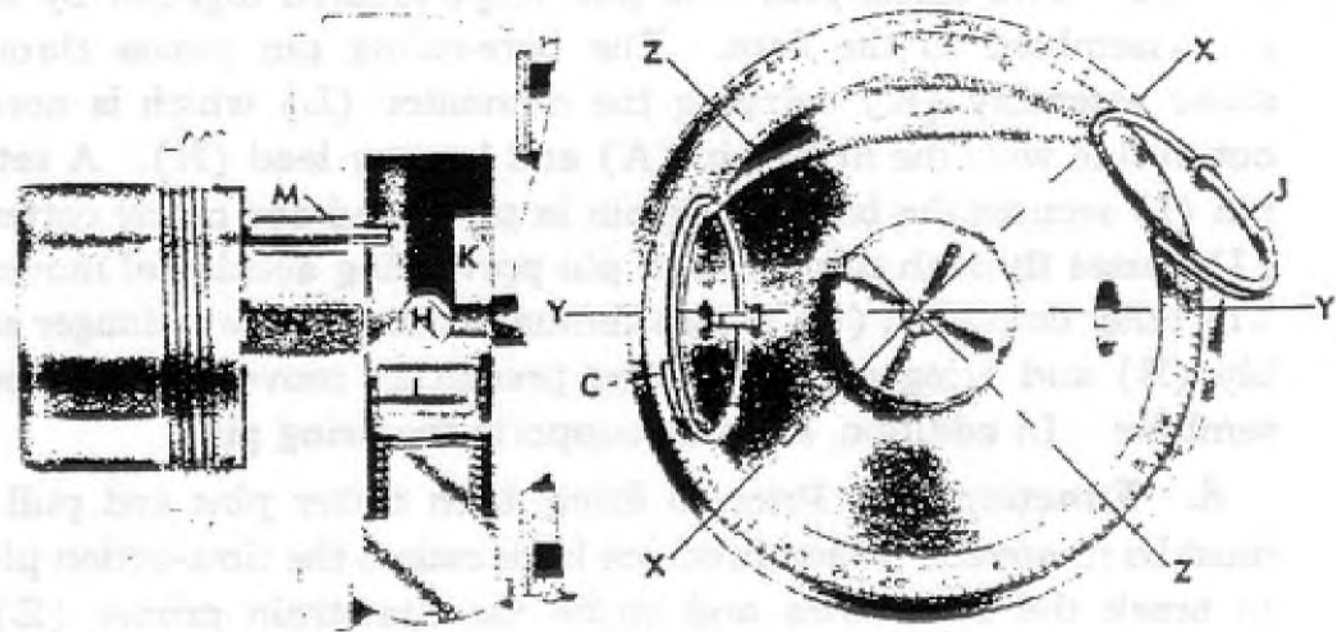

SECTION X-X

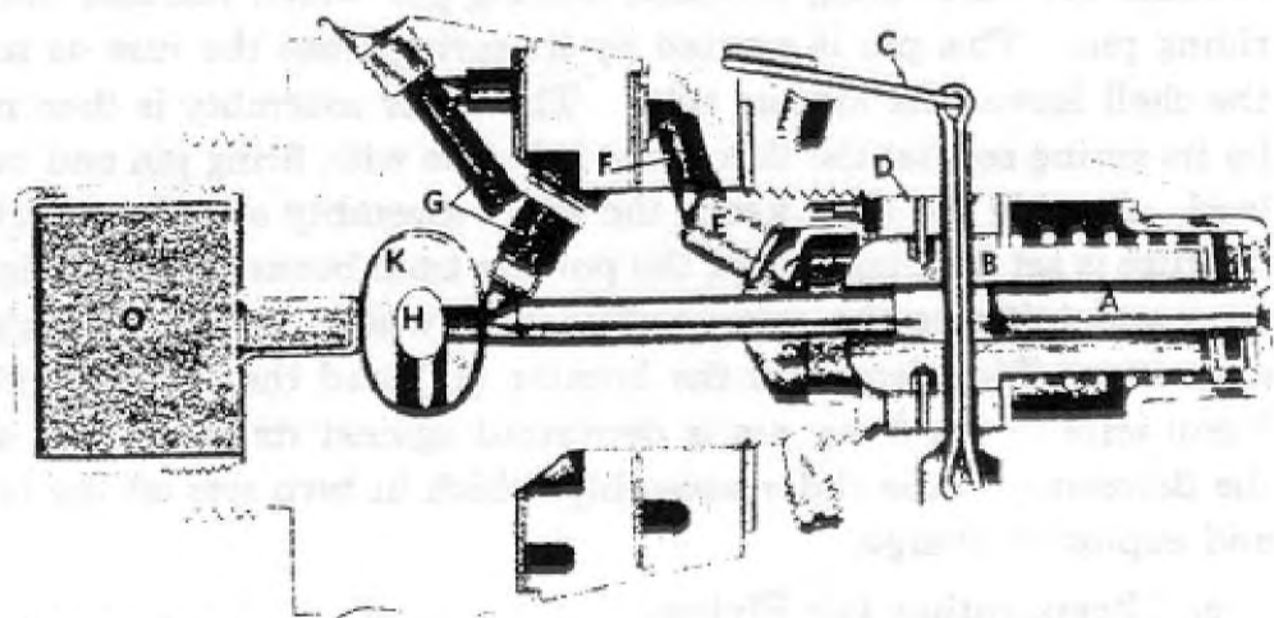

SECTION Y-Y

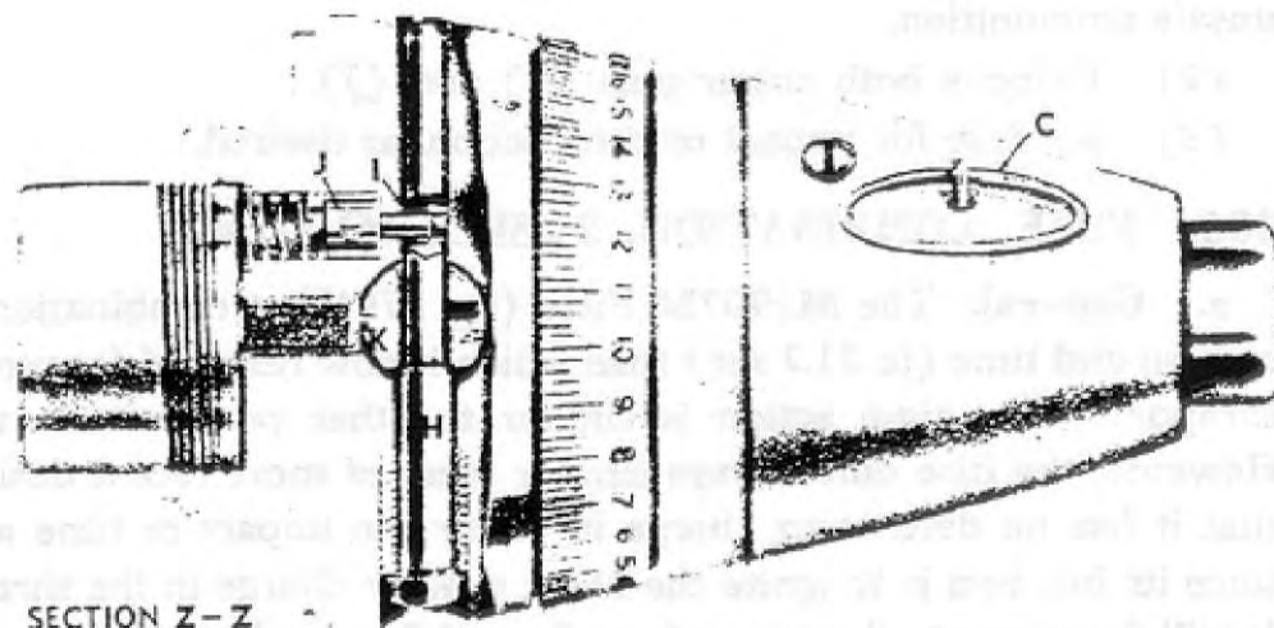

SECTION Z-Z

RA PD 65178

Figure 178 — FUZE, TSQ., M77 (T88)

ARTILLERY AMMUNITION

plunger. Two cotter pins with pull rings, secured together by a cord, are assembled to the fuze. The bore-riding pin passes through a slider assembly (K) carrying the detonator (L) which is normally out of line with the firing pin (A) and booster lead (N). A set-back pin (I) secures the bore-riding pin in place and one of the cotter pins (J) passes through this set-back pin preventing accidental movement. The other cotter pin (C) passes through both the delay plunger assembly (B) and firing pin preventing premature movement of these assemblies. In addition, a spring supports the firing pin.

d. **Functioning.** Prior to firing, both cotter pins and pull rings must be removed. When fired, set-back causes the time-action plunger to break the shear wire and strike the time-train primer (E) and ignite the time train, through the pellet (F) provided a time setting of 0.8 second or more has been made. At the same time, set-back retracts the bore-riding set-back locking pin which releases the bore-riding pin. This pin is ejected by its spring from the fuze as soon as the shell leaves the mortar tube. The slider assembly is then moved by its spring so that the detonator is in line with firing pin and booster lead. A guide pin (M) keeps the slider assembly aligned properly. If the fuze is set for time action, the powder train burns for the designated time and initiates the relay pellets (G) which, in turn, initiate the detonator. This detonates the booster (O) and the explosive charge. Upon impact, the firing pin is depressed against its spring and strikes the detonator in the slider assembly, which in turn sets off the booster and explosive charge.

e. **Preparation for Firing.**

- (1) Examine fuze for the bore-riding pin (H). If not present, dispose of the rounds in accordance with regulations for disposal of unsafe ammunition.
- (2) Remove both cotter pins (C) and (J).
- (3) Set fuze for impact or time action, as desired.

336. FUZE, COMBINATION, 21-SEC., M1907M.

a. **General.** The M1907M Fuze (fig. 179)* is a combination percussion and time (to 21.2 sec) fuze which is now reserved for use with shrapnel. The time action is similar to other powder-train types. However, the fuze differs from similar fuzes of more recent design in that it has no detonating charge in either the impact or time action since its function is to ignite the black powder charge in the shrapnel. It will function at all settings from 0 to 21.2 seconds, a canister effect being obtained with shrapnel when the zero setting is used. The fuze

FUZES, PROPELLING CHARGES, PRIMERS, AND OTHER COMPONENTS

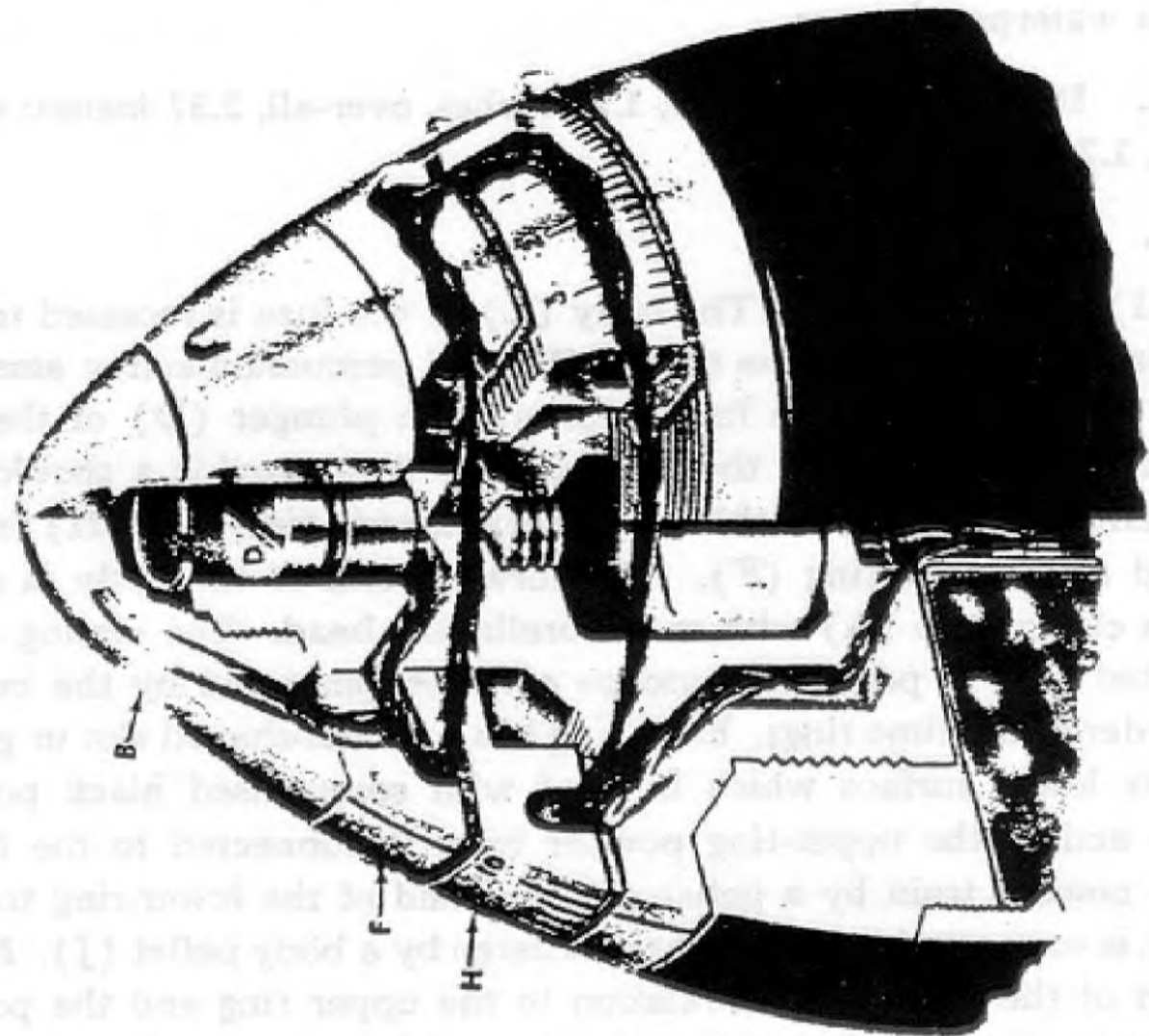

RA PD 80866

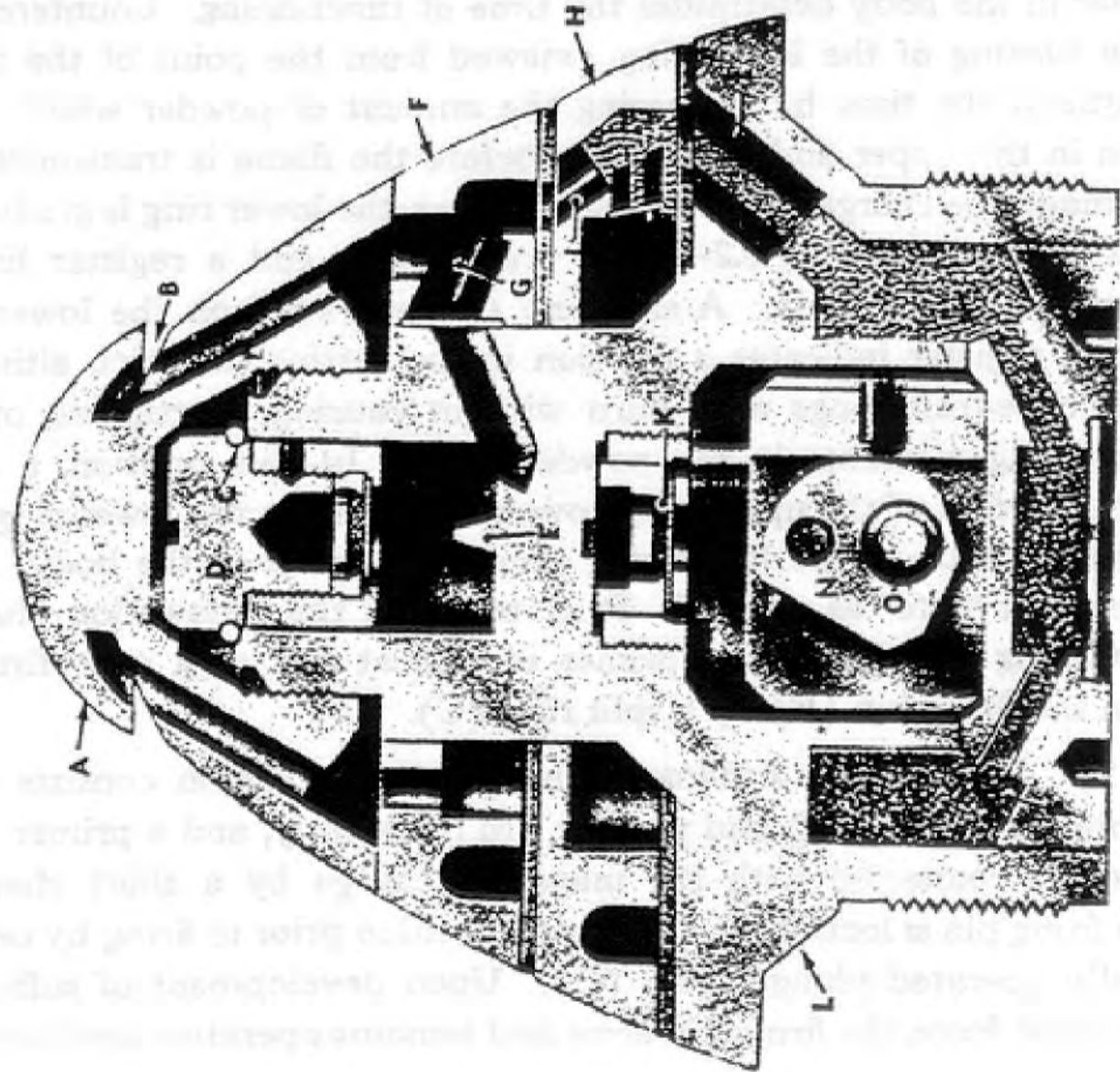

Figure 179 — FUZE, Combination, 21-sec., M1907M

ARTILLERY AMMUNITION

is assembled to the round as shipped and is protected during shipment by a waterproof cover.

b. **Data.** Length, visible, 1.75 inches, over-all, 2.57 inches; thread size, 1.7-14NS-1.

c. **Description.**

(1) **TIME ACTION.** The body (L) of the fuze is recessed to hold a black powder magazine charge (P) and percussion-action assembly, and to provide a guide for the concussion plunger (D) of the time action. The outside of the body is shaped to provide a shoulder on which is seated the movable lower (graduated) time ring (H) and the fixed upper time ring (F). The forward end of the body is closed by a closing cap (A) with an umbrella-like head. The closing cap is vented (B) to permit the escape of gases generated by the burning powder of the time rings. Each ring has a tunnel-shaped slot or groove in its lower surface which is filled with compressed black powder. One end of the upper-ring powder train is connected to the lower-ring powder train by a pellet (I); one end of the lower-ring train in turn, is connected to the magazine charge by a body pellet (J). Movement of the lower ring in relation to the upper ring and the powder pellet in the body determines the time of functioning. Counterclockwise turning of the lower ring (viewed from the point of the fuze) lengthens the time by increasing the amount of powder which must burn in the upper and lower rings before the flame is transmitted to the magazine charge. For setting purposes, the lower ring is graduated to 21.2 seconds, with 0.2-second graduations, and a register line is engraved on the body. A safe line (S) engraved on the lower-ring setting register indicates a position in the setting in which either or both time-train rings may burn without causing functioning of the succeeding elements in the powder train. In this position, a solid metal portion of the upper ring covers the pellet in the lower ring and a solid portion of the lower ring covers the pellet in the body. The fuze is set "safe" as shipped. Prior to firing; the time-action plunger containing the time-action primer is held at rest at a safe distance from the firing pin (E) by a split ring (C).

(2) **PERCUSSION ACTION.** The percussion action consists of a Simple firing-pin (N) and plunger (M) assembly, and a primer (K) which is connected with the magazine charge by a short channel. The firing pin is locked in an unarmed position prior to firing by centrifugally operated plunger pins (O). Upon development of sufficient rotational force, the firing pin arms and remains operative until impact

FUZES, PROPELLING CHARGES, PRIMERS, AND OTHER COMPONENTS

unless prior functioning of the magazine charge has been caused by the time action. The fuze can be set for percussion action by leaving the fuze set "safe" as shipped or by setting for a time greater than the time of flight.

d. Functioning.

(1) **TIME ACTION.** Upon firing, set-back forces the time-action plunger rearward through the split ring, bringing the time-action primer against the firing pin. The flame from the primer passes through the hole in the body and ignites the powder pellet (G) in the fixed upper time ring. The flame from this ring ignites the pellet in the lower ring unless the fuze is set "safe," in which event the time action becomes a "dud" at this point. When set for other than "safe," the time of burning in the upper ring before ignition of the powder pellet in the lower ring is determined by the time setting. In the case of zero setting, the flame from the pellet in the upper ring is transmitted directly to the pellet in the lower ring and body and, thereby, to the magazine charge. With this setting, the shrapnel functions within 50 to 75 feet of the muzzle of the gun, with an effect similar to that of canister. With time setting greater than zero, the pellet of the lower ring is so moved in relation to the pellet of the upper ring that the powder train of the upper ring must burn until the pellet in the lower ring is reached. The powder train of the lower ring, in turn, must burn until the flame reaches the pellet in the body. The body pellet then ignites the magazine charge, unless prior functioning has been caused by impact and action of the percussion assembly.

(2) **PERCUSSION ACTION.** The percussion action becomes armed shortly after firing, when centrifugal force causes the spring-restrained plunger pins to move outward and release the firing pin. Upon impact, the plunger is driven forward against the percussion primer, initiating the primer and, thereby, the magazine charge unless functioning has been caused by the time action.

e. Preparation for Firing. The waterproof protective covering must be removed before setting or firing the fuze. For percussion action, the fuze may be left as shipped, set at "safe," or set for a time greater than the expected time of flight. For time action, the graduated time-train ring is set for the required time by means of a fuze setter.

f. Precautions. The fuze should be protected at all times from moisture. While the fuze is covered by a waterproof cover, and the powder trains are covered by waxed paper, short exposure in damp places will allow moisture to enter. Absorption of moisture by the powder will greatly alter the time of burning.

ARTILLERY AMMUNITION

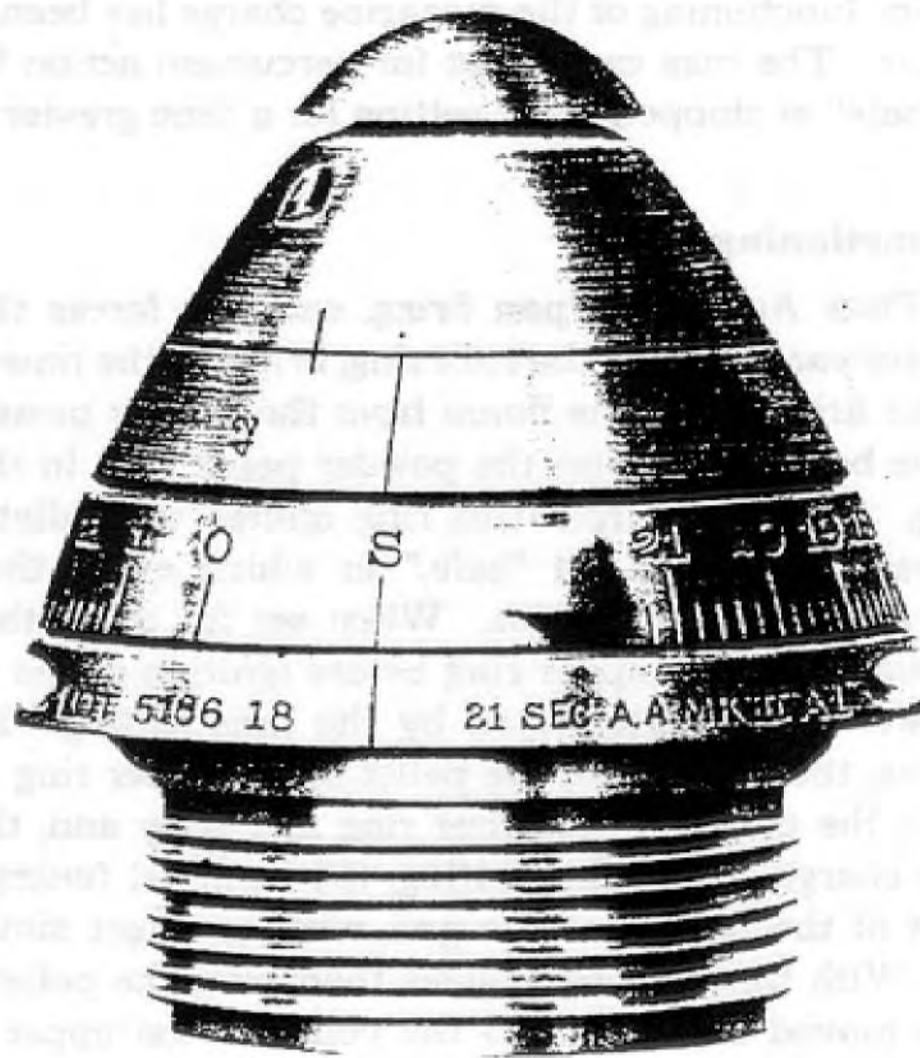

RA PD 80871

Figure 180 — FUZE, Time, 21-sec., AA., Mk. IIIA1

337. FUZE, TIME, 21-SEC., AA., MK. IIIA1, AND MK. IIIA2.

a. **General.** The Mk. III type fuze (fig. 180) is an early design of antiaircraft fuze providing for time action to 21 seconds. It is a redesign of the 21-second Combination Fuze M1907M (par. 336 and fig. 178) eliminating the percussion element.

b. **Data.** Length, visible, 1.75 inches, over-all, 2.75 inches; weight, 1.25 pounds; thread size, 1.7-14NS-1.

c. **Description.** The original model Mk. III was modified later to strengthen the nose end of the fuze for greater protection against accidental functioning due to blows during handling, and thereby became the Mk. IIIA1. A second modification, designated Mk. IIIA2, reduced the magazine charge to 20 grains of black powder to permit the fuze to be used in conjunction with the M20 Booster. Due to the large magazine charge (95 grains of black powder), the earlier models cannot be used with the M20 Booster. The Mk. IIIA1 and Mk. IIIA2 Fuzes are standard for use with 3-inch antiaircraft shrapnel. Prior to the changes necessitating new model designations, the Mk. III was modified by strengthening the setting lug on the body, to eliminate

FUZES, PROPELLING CHARGES, PRIMERS, AND OTHER COMPONENTS

shearing of this lug when setting the fuze by means of automatic continuous-type setters. Fuzes thus modified are designated Mk. IIIM1. Except for the differences outlined above, the modifications of this fuze are alike in construction and functioning. In outward appearance, the fuze closely resembles the M1907M Fuze from which it is adapted, and has the same powder-train type of time action. For complete description of the time action, see paragraph 336.

d. Functioning. Except that there is no percussion action, the fuze functions as described for the M1907M in paragraph 336.

e. Preparation for Firing. Like the M1907M, the Mk. III Fuzes are protected during shipment by a waterproof protective covering. This cover must be removed before setting the fuze. The fuze is set for the required time by means of a fuze setter.

f. Precautions. The fuze should be protected at all times from moisture. While the fuze is shielded by a waterproof cover and the powder trains are covered by waxed paper, short exposure in damp places will allow moisture to enter. Absorption of moisture by the powder will greatly alter the time of burning. Each fuze should be tested, before use, for indications of extreme exterior corrosion. If the fuze shows any appreciable stains around the time ring, the entire round will be classed as unserviceable.

338. FUZE, P.D., MK. 27 (NAVY).

a. General. The Mk. 27 (fig. 181) is a point-detonating fuze of Navy origin which has been standardized for Army procurement for use with 40-mm high-explosive ammunition. It closely resembles in external appearance, the alternative Fuze M71, and the limited standard fuzes (the M64A1 and the British 251, Mk. I), for the same ammunition, and, like them, is a single-action superquick type constructed to function on light impact.

b. Data. Length, visible, 1.900 inches, over-all, 2.45 inches; weight, 0.22 pound; thread size, 1.18-14NS-2.

c. Description. The fuze mechanism consists of a firing pin (I), a striker (K), and a rotor assembly (F) holding a wafer-shaped rotor (C). The explosive train consists of a lead azide prime-detonator (D), a tetryl booster lead (B), and a tetryl booster charge (A). The fuze is made up of two major parts: a body (J) recessed to hold the firing pin with its striker, and the rotor assembly; and a base plug which holds the booster lead and booster charge. The base plug also serves to seat the rotor assembly securely in its recess when the fuze is assembled. The rotor is so seated in the rotor assembly that it can revolve only on an axis perpendicular to the major axis of the fuze, and normally holds the primer detonator out of alinement with both

ARTILLERY AMMUNITION

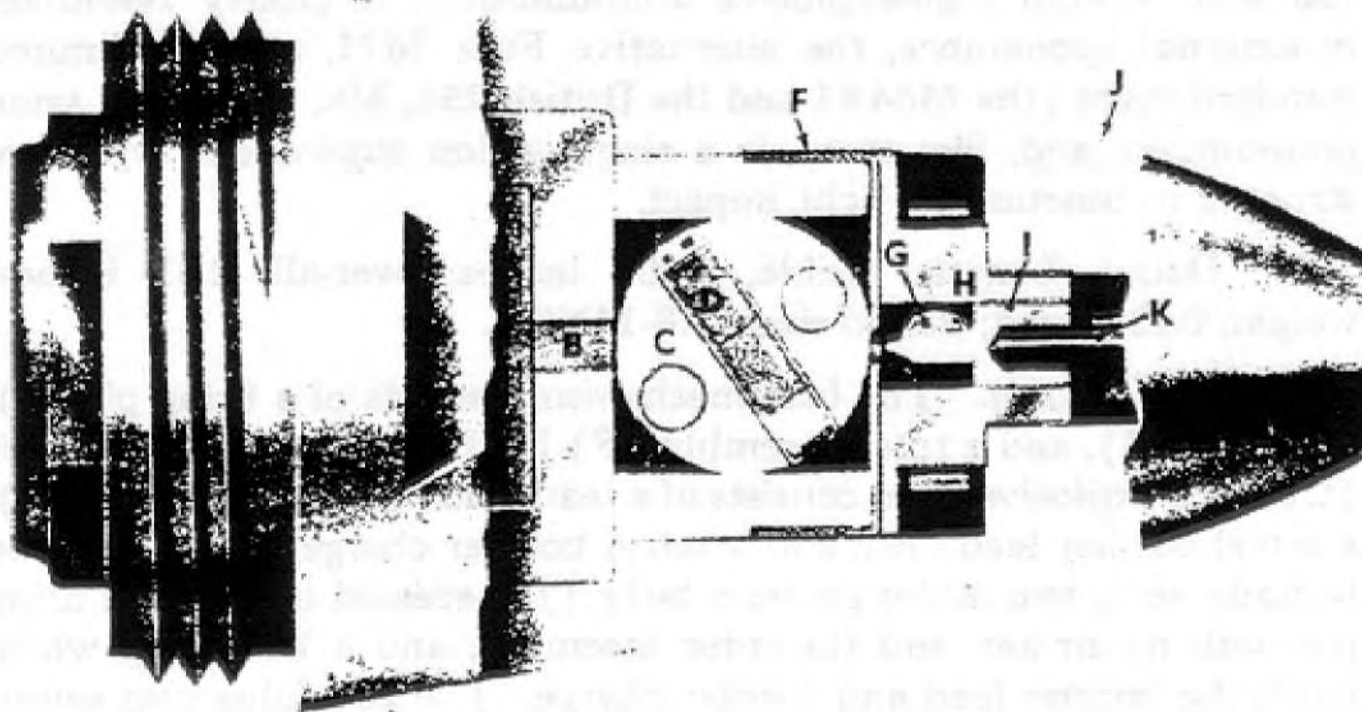
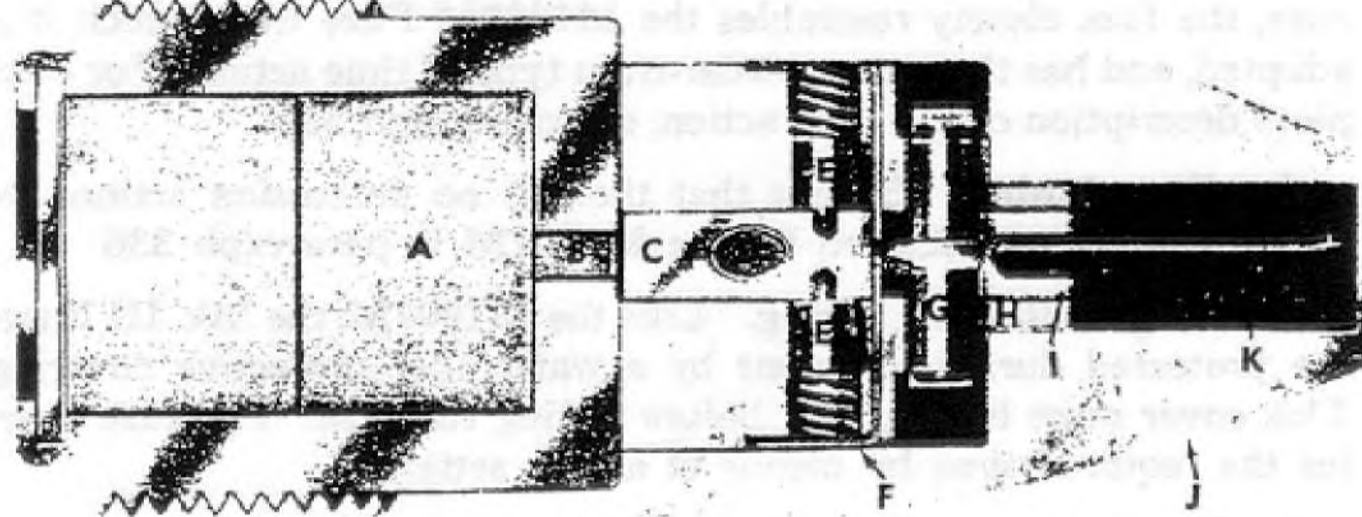

RA PD 80873

Figure 181 — FUZE, P.D., Mk. 27 (Navy)

FUZES, PROPELLING CHARGES, PRIMERS, AND OTHER COMPONENTS

the booster and the firing pin. Two centrifugally actuated plunger pins (E) under spring tension lock the rotor in the interrupted or unarmed position until a prescribed minimum centrifugal force has been established. A bushing (H) in the forward end of the rotor assembly recess forms a seat for the firing pin. A peg-like striker is secured to the forward end of the firing pin and occupies a narrow recess extending almost to the front end of the fuze, providing for increased sensitivity on impact. The firing pin is supported by two spring-held plunger pins (G) until sufficient centrifugal force has been established after firing to overcome the resistance of the plunger springs.

d. **Functioning.** No action takes place upon firing until a prescribed centrifugal force has been set up by rotation of the projectile in its travel, whereupon, the plunger pins holding the rotor and those supporting the firing pin move outward. Upon release from its pins, the rotor revolves, bringing the primer-detonator into alignment with the firing pin and the booster. Upon the outward movement of its plunger pins, the firing pin has an unobstructed passage to the primer-detonator, but tends to remain at the forward end of the fuze until impact, due to creep action. On impact, the front of the fuze is perforated or crushed, forcing the striker inward and driving the firing pin against the primer. Action of the primer is transmitted through the successive elements of the explosive train, whereupon functioning of the booster causes the shell to explode.

e. **Preparation for Firing.** There is no preparation for firing.

339. FUZE, P.D., 251, MK. I.

a. **General.** This single-action superquick fuze (fig. 182) of British origin is limited standard for use with 40-mm ammunition. It closely resembles the Mk. 27 model in general appearance and, like it, is constructed so as to function on light impact. However, the mechanism is considerably more complicated.

b. **Data.** Length, visible, 1.89 inches, over-all, 2.76 inches; weight, 0.219 pound; thread size, 1.18-14NS-2.

c. **Description.** The fuze is made up of two major parts, a head (A) and nose (I) assembly, and a body (M) closed at the base end by a booster cup (S) holding a tetryl booster charge (R). The head is drilled and threaded internally to hold a primer plug (J) with the primer (K), and striker guide (H), a bushing which serves as a guide for the firing pin (G). Forward of the firing pin is a plastic striker (B); the lower end is seated in the striker guide, in contact with the firing pin, and the upper end occupies a recess in the nose of the fuze. About the neck of the striker guide is an arming sleeve (E). In normal position, this sleeve retains three steel balls (F) in holes drilled through in the neck of the striker guide. In this position the

ARTILLERY AMMUNITION

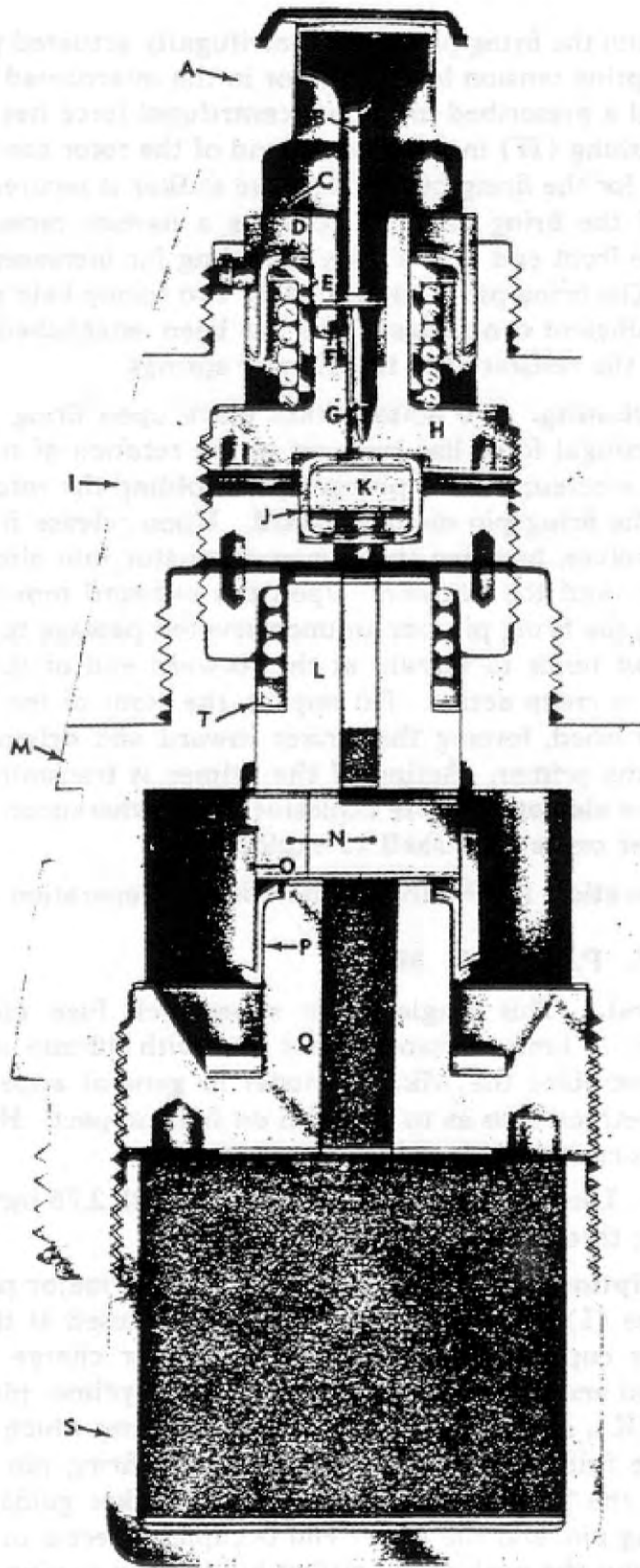

RA PD 80874

Figure 182 — FUZE, P.D., 251, Mk. I

FUZES, PROPELLING CHARGES, PRIMERS, AND OTHER COMPONENTS

balls nestle under a flange on the firing pin, holding it away from the primer. The arming sleeve is under the tension of a compressed spring but is prevented from moving by a ferrule (C) and stirrup (D). A detonator holder (L) screwed into the rear of the head and nose assembly, and a relay-charge holder (Q) screwed into the rear of the body just forward of the booster, hold a series of small high-explosive charges making up the middle portion of the fuze explosive train. Between the detonator holder and the relay-charge holder is a shutter (N) composed of two parts. In closed position, this shutter interrupts the explosive train and prevents premature action of the primer or upper detonator from detonating the relay charge and booster. The shutter is held in a closed position prior to firing by a ferrule (O) and stirrup (P) similar to that controlling the arming sleeve and firing-pin.

d. Functioning. Upon firing, set-back causes the ferrule and stirrup in the head to move rearward. Upon return, after set-back ceases, the bottom edge of the stirrup is deformed, thereby releasing the arming sleeve, which is forced forward by its spring and un.masks the three holes in the striker guide. The shutter ferrule also moves rearward, thereby releasing the shutter. Upon development of sufficient centrifugal force, the three balls fly outward and release the firing pin, while the two parts of the shutter separate and fly outward. Thus released, the detonator holder moves rearward under compulsion of its spring, bringing all elements of the explosive train into alignment. The detonator holder is held in the armed position by the locking collar (T), which consists of a 2-sectioned brass washer. This washer spreads, after movement to the rear, into grooves. On impact, the striker is forced inward, driving the firing pin into the primer. Action of the primer is transmitted through the detonator and relay charges to the booster which in turn causes the shell to explode.

e. Preparation for Firing. There is no preparation for firing.

340. FUZE, P.D., 253 MK. II-III.

a. General. This fuze (fig. 183) is provided for use with 20-mm high-explosive-incendiary ammunition. It is a single-action type intended to function with instantaneous percussion action on impact with light materiel surfaces. The design differs from the ordinary in that functioning is initiated on impact by the set-forward force of the detonator charge or by pieces of metal from the body striking the detonator charge. Hence, the striker or firing-pin mechanism usually found in point-detonating fuzes is omitted in this design.

b. Data. Length, visible, 0.60 inch, over-all 1.41 inches; weight, 0.058 pound; thread size, 0.625-36NS-2.

c. Description. The fuze is made up of two major parts: a brass body (G) with an air chamber (F) in the forepart of the fuze; and a

ARTILLERY AMMUNITION

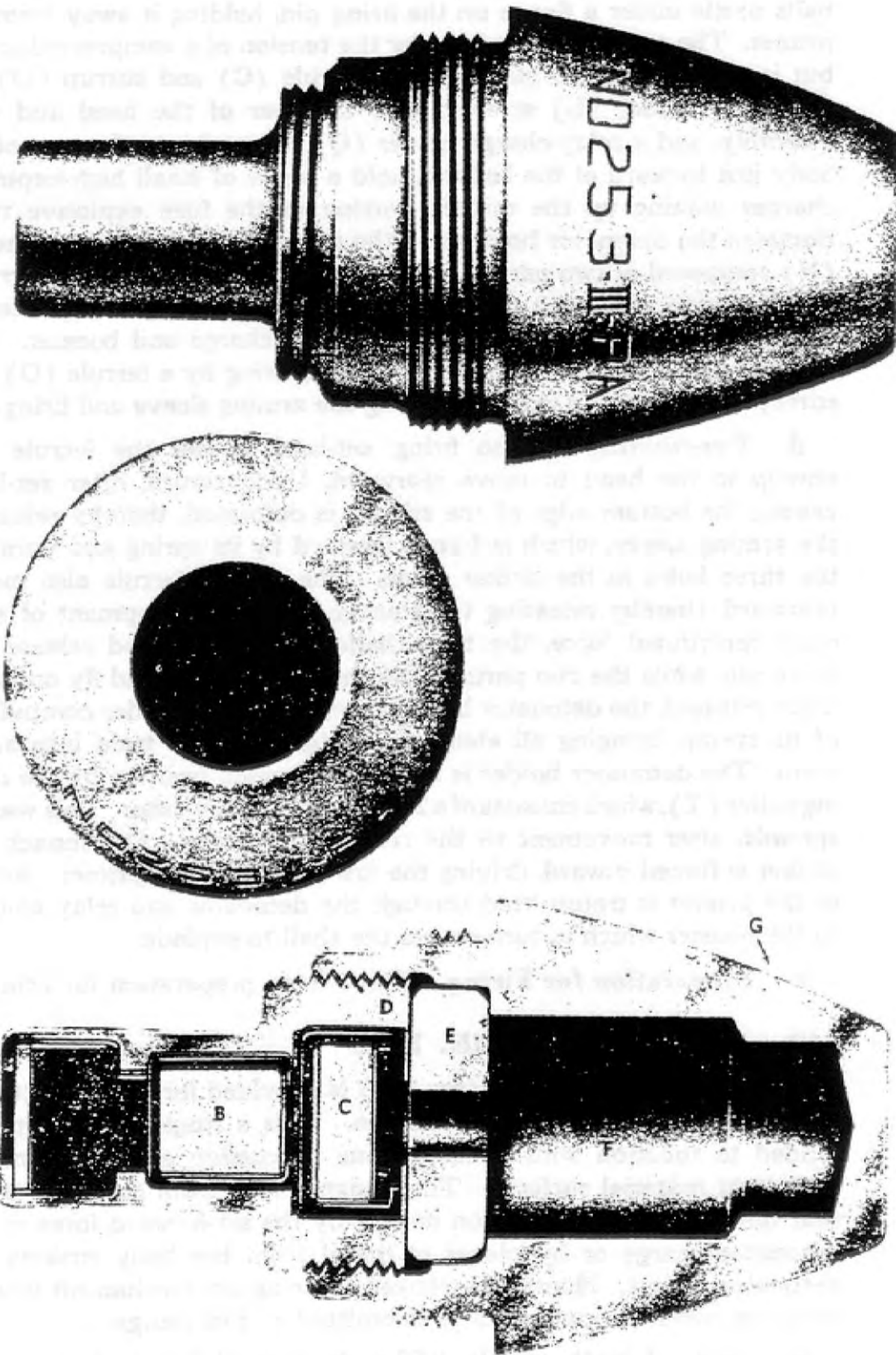

RA PD 80876

Figure 183 — FUZE, P.D., 253 Mk. III

FUZES, PROPELLING CHARGES, PRIMERS, AND OTHER COMPONENTS.

brass magazine (D) containing the explosive train and threaded externally at the front end to screw into the threaded base end of the body. The explosive train consists of a mercury fulminate detonator (C), a booster cup (relay) charge (B) of mercury fulminate, and a tetryl booster charge (A). The magazine is covered by a thin brass disk (E) which separates the detonator from the air column. In the original model, Mk. I, this disk was solid but in the Mk. II and Mk. III a small hole is drilled through the center to increase the sensitivity of the fuze. In the Mk. II Fuze, the cavity in the body was closed at the front end by a thin brass disk; in the Mk. III Fuze, the nose is solid across this area, providing approximately the same thickness of frontal closure as was provided formerly by the disk. Except for these changes, the models are alike. Since there are no interrupters or other safety devices, the fuze is considered nonboresafe.

d. **Functioning.** Upon firing, no action takes place until impact. Upon impact, the head is crushed; the set-forward force of the detonator charge or pieces of metal from the body striking the detonator charge initiates action of the detonator which detonates, in turn, the relay charge, booster and shell.

e. **Preparation for Firing.** There is no preparation for firing.

341. DUMMY FUZES.

a. **General.** Dummy fuzes (figs. 184, 185, and 186) are provided for use with ammunition, such as target-practice and drill, which does not require a normal full-functioning fuze. Fuzes may be especially manufactured for the purpose (dummy fuzes), or may be assembled from burned out or rejected parts of service fuzes (inert fuzes). Whether assembled from service parts or especially manufactured for the purpose, the assemblies are completely inert. In general, the fuzes are intended to simulate a specific model, or one type of service fuze. Contour and weight of the service fuze which is being simulated are closely approximated in the dummy fuze in order to provide about the same ballistic values for use with practice ammunition, and to give the proper "feel" when used with drill ammunition. This policy also permits the use of drill ammunition in conjunction with fuze setters for training in preparing ammunition for firing and in servicing the piece. Most dummy fuzes are extremely simple in construction but essential features of the simulated service fuze are incorporated in some types. An instance is FUZE, dummy, M59, which has a setting screw and registration similar to that in FUZE, P.D., M48, M48A1, and M48A2.

b. **Data.** Dummy fuzes now in use are listed in table 4, chapter 5, together with essential information thereon, and are illustrated in figures 184 to 186, inclusive.

ARTILLERY AMMUNITION

TABLE 4
DUMMY FUZE CHART

Fuze	Materials Used in Construction	Length (in.)		Wt.	Thread Size	Interchangeability ^a	Ammunition With Which Used	Service Fuze Simulated
		Over-all	Visible					
FUZE, dummy, 21-sec., M42A1	Manganese bronze; or naval brass	2.57	1.72	1.25	1.7-14NS-1	*	M3A1 and M9 Drill Cartridges for 3-inch Guns M1917 (all mods.), M1925MI-25M1A1, M2, and M4, or 3-inch (15-pdr.) Gun M1903 M4A1 and M10 Drill Cartridges for 3-inch Guns M1918 (all mods.), M1, M3, M5, M6, and M7, or 3-inch 15-pdr.) Gun M1902MI	FUZE, time, 21-sec., AA., Mk. III, Mk. IIIA1, Mk. IIIA2 ^a
FUZE, dummy, M44A2	Manganese bronze; or naval brass; or aluminum; or copper-silicon alloy; or sintered iron	4.53	3.72	1.90	1.7-14NS-1	+	M12 Drill Cartridge for 90-mm Guns M1, M1A1, and M2 M71 Practice Round for 90-mm Guns M1, M1A1, and M2 ^a M8 Drill Cartridge for 105-mm Gun M3	FUZE, time, mechanical, M43 (all mods.), w/o Booster ^a
FUZE, dummy, T23	Manganese bronze; or naval brass; or copper-silicon alloy	4.46	3.65	1.95	1.7-14NS-1	+	M11 Drill Cartridge for 105-mm Gun M3 M8 Drill Cartridge for 105-mm Gun M3	FUZE, time, mechanical, M2, w/o graduated time ring
FUZE, dummy, M50; manufacturing alternatives, M50B1, M50B2	M50—plastic M50B1—steel (1-piece) M50B2—steel (ogive crimped to threaded base)	2.18	1.74	2.56	1.125-20NS-1	•	M21 Drill Cartridge for 37-mm Guns M1A2 and M9 M55A1 Practice Round for 37-mm Guns M1A2, M4, and M9	FUZE, P. D., M56

FUZES, PROPELLING CHARGES, PRIMERS, AND OTHER COMPONENTS

TABLE 4 (Contd.)
DUMMY FUZE CHART (Contd.)

Fuze	Materials Used in Construction	Length (in.)		Wt.	Thread Size	Inter-changeability ¹	Ammunition With Which Used	Service Fuze Simulated
		Over-all	Visible					
FUZE, dummy, M59	Steel	4.55	3.75	1.4	1.7-14NS-1	††	M9 Drill Cartridge for 3-inch Guns M1917 (all mods.), M1925M1-25M1A1, M2, and M4, or 3-inch (15-pdr.) Gun M1903 M14 Drill Cartridge for 105-mm How. M2 and M2A1 M15 Drill Cartridge for 3-inch Guns M1918 (all mods.), M1, M3, M5, M6, and M7, or 3-inch (15-pdr.) Gun M1920M1 M16 Drill Cartridge for 75-mm Guns M1897-16-17 M19 Drill Cartridge for 75-mm How. M1, M1A2, M2, and M3 M20 Drill Cartridge for 76-mm Guns M1, M1A2, and M2 M71 Practice Round for 90-mm Guns M1, M1A1, and M2 ³	FUZE, P. D., M48, M48A1, M48A2 (including selective setting screw and registration), w/o Booster
FUZE, dummy, M69; manufac-turing alterna-tive, M69B1	M69—plastic; or aluminum alloy M69B1—steel	2.375	1.90	0.225	1.18-14NS-1	*	M91 Practice Round for 40-mm AA. Gun M1 Mk. II inert-loaded HE-T Round for 40-mm AA. Gun M1	FUZE, P. D., Mk. 27 (Navy)
FUZE, dummy, M73	Steel	4.96	3.77	2.15	2-12NS-1	*	M71 Practice Round for 90-mm Guns M1, M1A1, and M2, M48 Sand-loaded Practice Round for 75-mm Guns ²	FUZE, P. D., M48, M48A1, M48A2, w/Booster

¹—Interchangeability:

*—These fuzes are adaptable for use only in the ammunition for which they are authorized.

†—FUZE, dummy, M44A2, and FUZE, dummy, T23, may be used interchangeably in drill except when the drill cartridge is to be used in conjunction with automatic fuze setters.

††—FUZE, dummy, M59, may also be used as a replacement for the FUZE, dummy, M73, in the M48 Sand-loaded Round for 75-mm guns when an inert M20 or M20A1 Booster is used in conjunction with the M59 Fuze. The M59 Fuze is threaded to suit the internal threading of the M20 or M20A1 Booster; the booster is threaded externally to suit the nose threads of the M48 Practice Shell.

²—Also simulates FUZE, combination, 21-sec., M1907M.

³—FUZE, dummy, M44A2, and FUZE, dummy, M59, are alternative fuzes for FUZE, dummy, M73, for use with the M71 Practice Round.

⁴—FUZE, dummy, M73, is standard for this round. For alternatives, see footnote 3.

⁵—FUZE, dummy, M73, is an alternative fuze for the inert P. D., M48 Fuze for use with this round.

⁶—FUZE, dummy, M44A2, also simulates FUZE, P. D., M48, M48A1, M48A2, with respect to contour, and may be used interchangeably with FUZE, dummy, M59, when the differences in weight do not affect the desired results.

ARTILLERY AMMUNITION

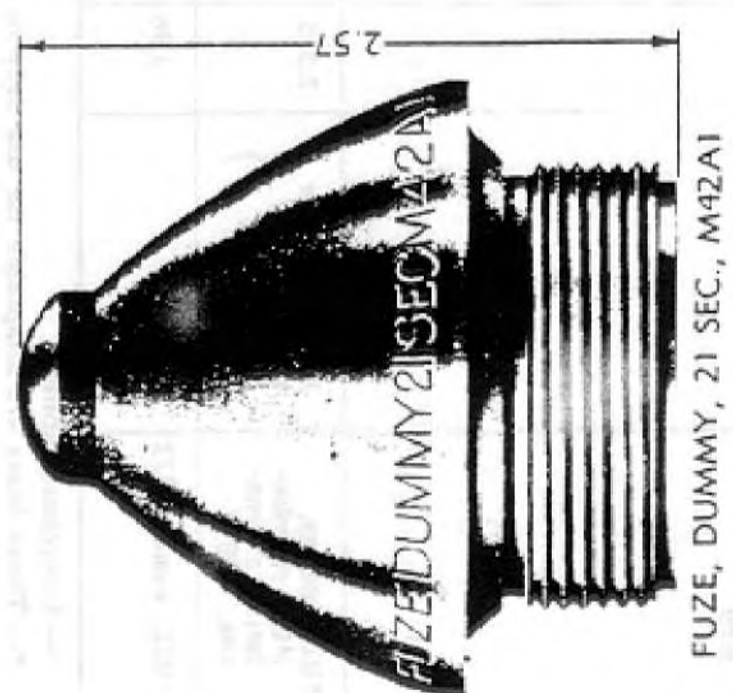
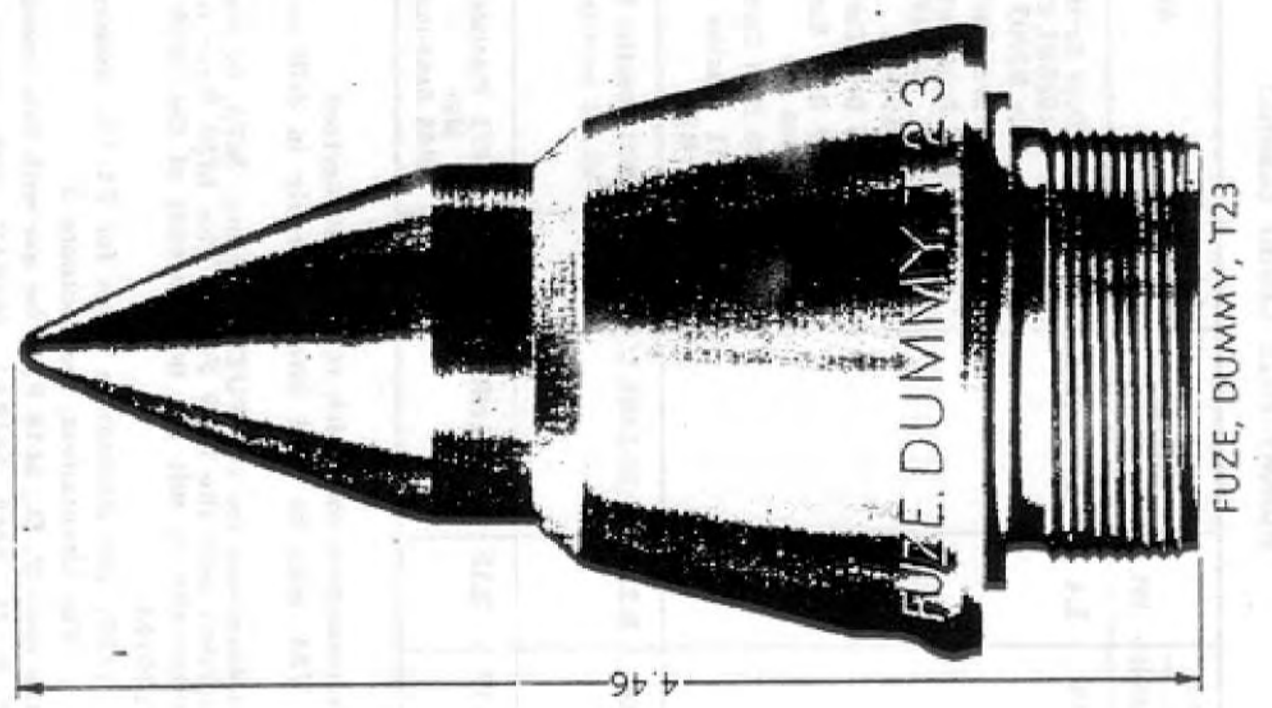

RA PD 80865

FUZE, DUMMY, T23

FUZE, DUMMY, 21 SEC., M42A1

FUZES, PROPELLING CHARGES, PRIMERS, AND OTHER COMPONENTS

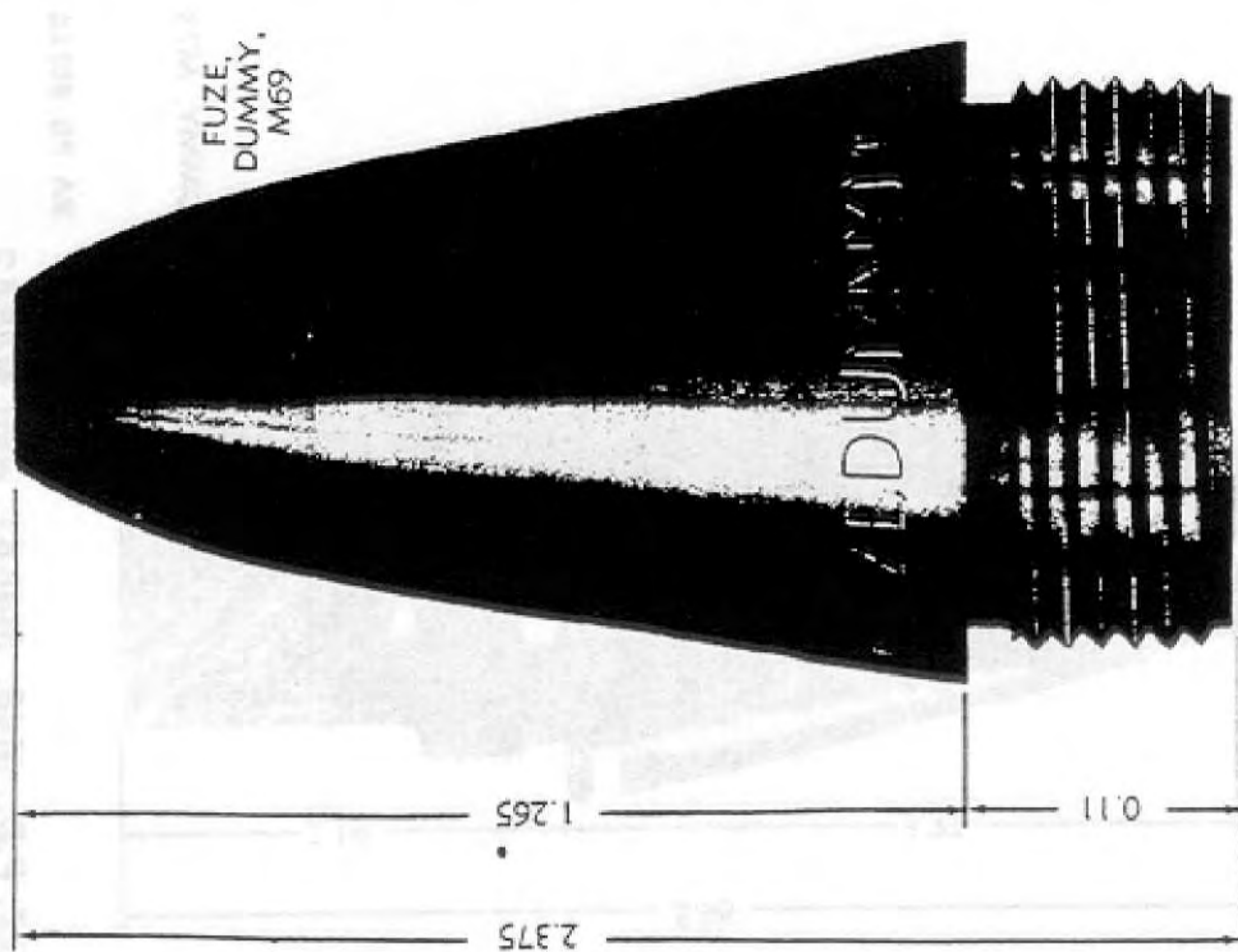

RA PD 80701

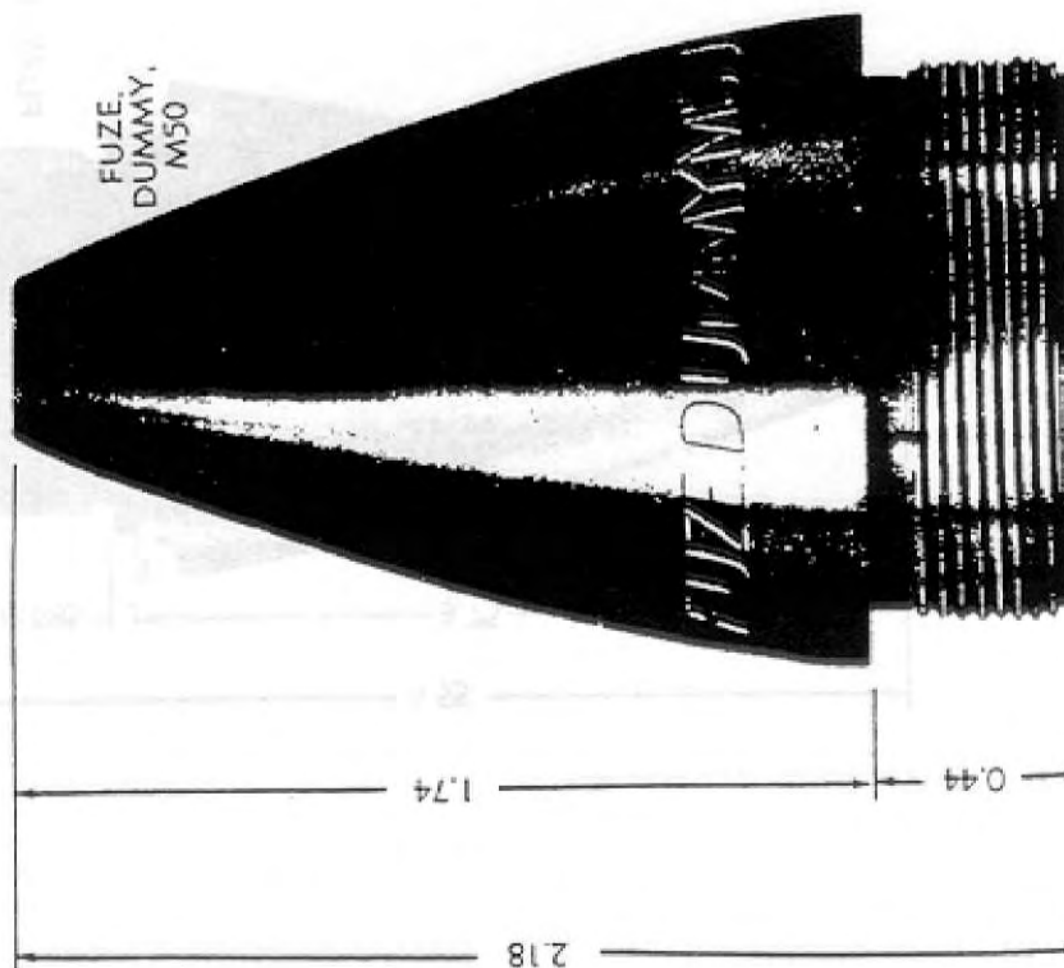

293

Figure 185 — Dummy Fuzes (Continued) — Simulated Smaller Caliber Fuzes

ARTILLERY AMMUNITION

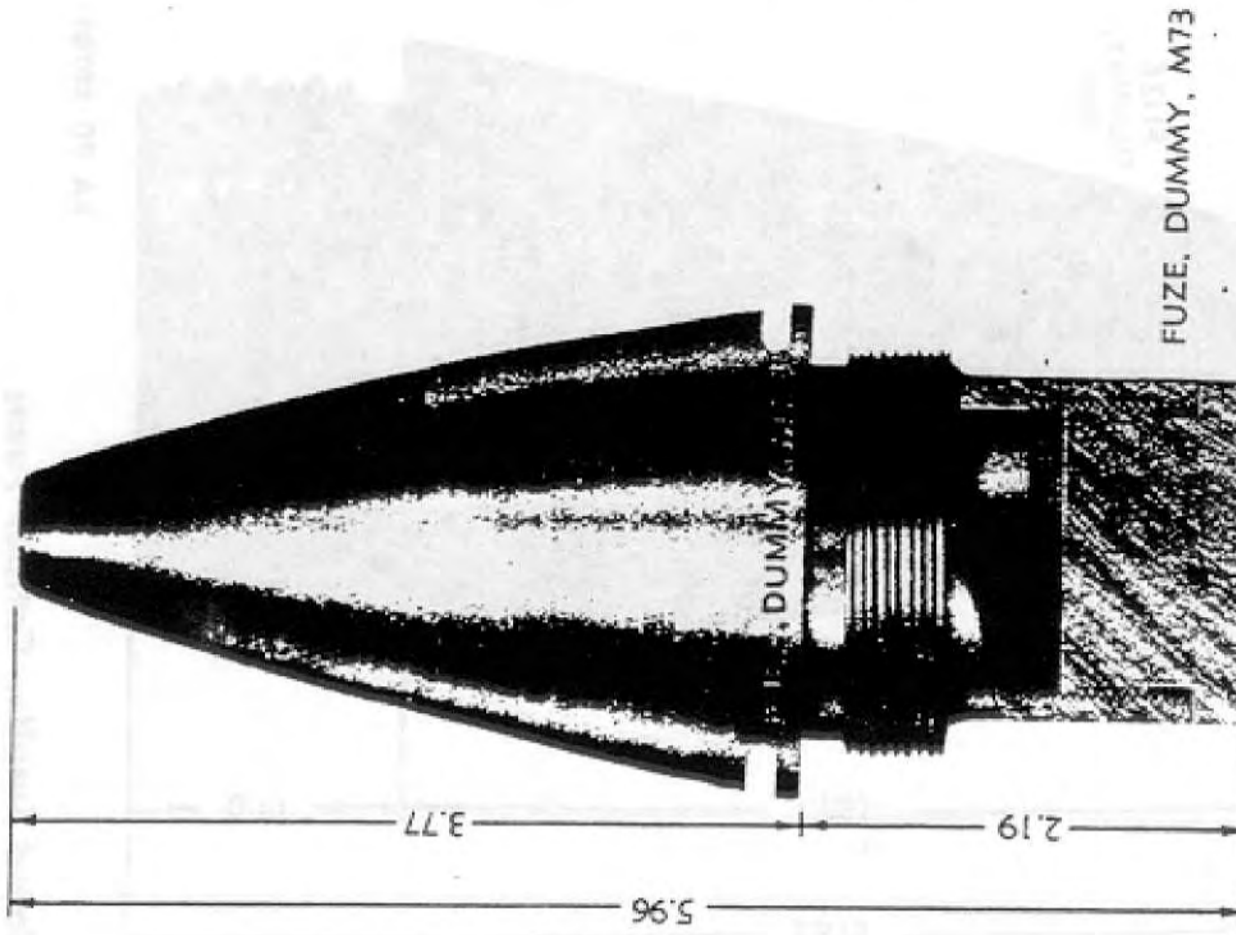

RA PD 80768

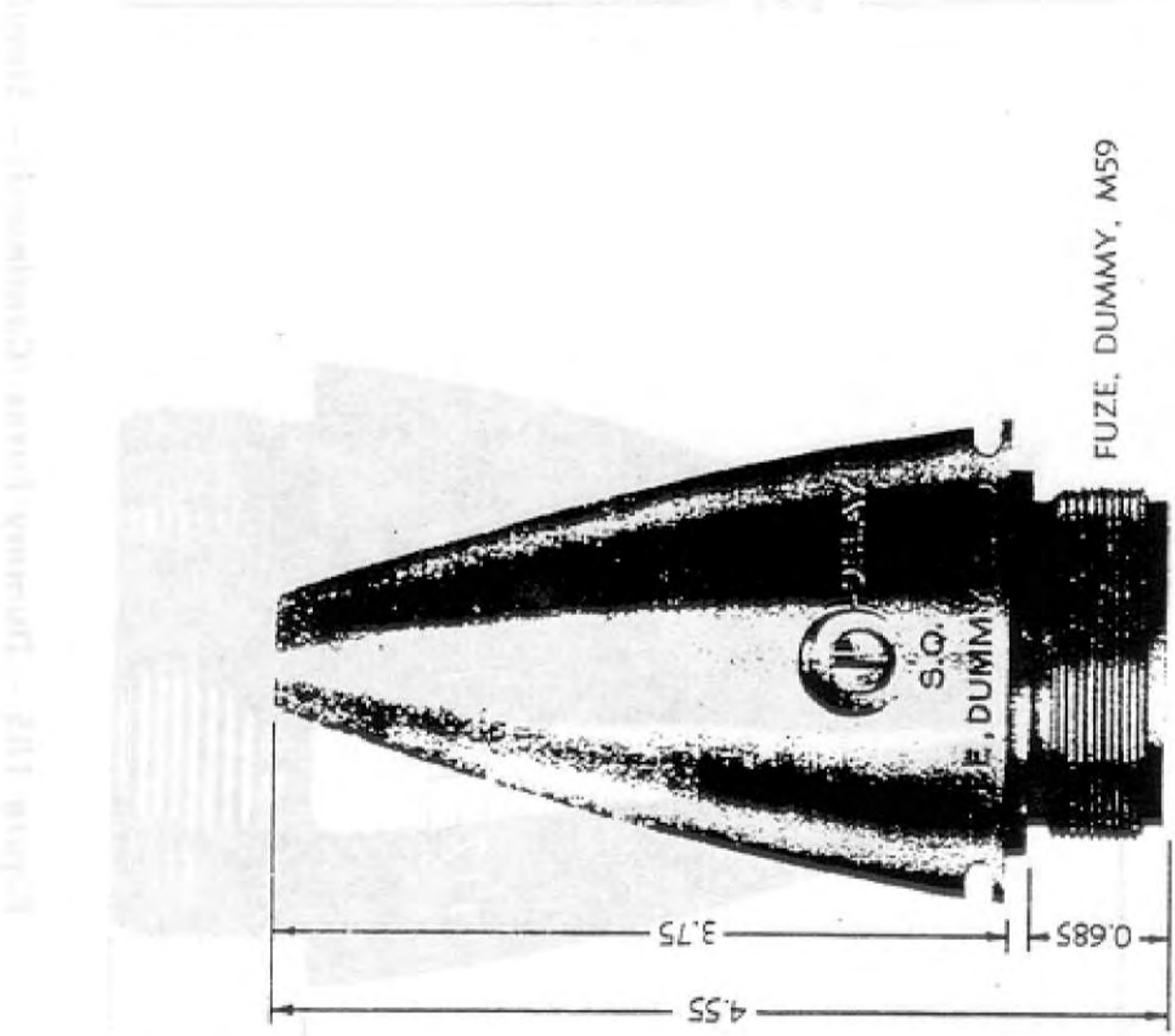

Figure 186 — Dummy Fuzes (Continued) -- Simulated FUZE, P.D., M48, M48A1, and M48A2

FUZES, PROPELLING CHARGES, PRIMERS, AND OTHER COMPONENTS

Section II

PROPELLING CHARGES

342. GENERAL.

a. In general, propelling charges consist of a charge of smokeless powder, with an igniter charge of black powder assembled in a suitable container. In fixed and semifixed rounds, the igniter charge is present in a tube attached to the percussion element of the primer. See chapter 3, section III, for a description of artillery primers. In separate-loading rounds, the igniter charge is assembled in an igniter bag sewed to the base end of the propelling charge bag and in some cases forms a core running through the center of the propelling charge bag. See paragraph 9 c for a brief listing of different types of propellant powders. Either NH (nonhygroscopic) or FNH (flashless nonhygroscopic) powder is used. Whether a propellant is flashless or not in a given weapon is dependent upon the composition and weight of the powder charge, the length of bore of the gun, the weight of the projectile and, in aircraft weapons, upon the altitude and velocity of the aircraft. Nitrocellulose powder (NC) may be used as a substitute standard for the FNH and NH powders. The same FNH powder may be flashless in one weapon and yet not completely flashless in another. When FNH powder is used in weapons in which flash occurs it is termed NH powder. For types of powder grains, see figures 187 and 188.

b. Fixed and Semifixed Charges.

(1) CARTRIDGE CASE. A cartridge case, made of drawn brass or steel serves as the container for the propelling charge in the case of fixed and semifixed artillery ammunition. It has a profile and size to conform to the powder chamber of the weapon for which the case is intended. The head of the case is relatively thick and has a flange to permit mechanical extraction and to seat the round in the gun. Those rounds used in automatic guns have cartridge cases with extracting grooves instead of a flange or rim. The cartridge case holds the primer, propelling charge, and the projectile so that the assembly can be inserted into the weapon in one operation. A secondary function is to provide for obturation. The use of steel for artillery cartridge cases has been discontinued, with the exception that steel cases are standard for use in 3-inch Guns M1902MI, M1918, M3, M5, M6, and M7.

(2) PROPELLING CHARGE IN FIXED AMMUNITION. The propelling charge in a round of fixed ammunition is packed loosely in the cartridge case. In some instances where the charge is not large enough to fill the case completely, a distance wadding, usually a

ARTILLERY AMMUNITION

cardboard disk and cylinder, is inserted in the neck of the cartridge case, between the powder charge and the base of the projectile. In some cases, a black powder charge is attached to the distance wadding to supplement the primer ignition.

(3) **PROPELLING CHARGE IN SEMIFIXED AMMUNITION.** The propelling charge in a round of semifixed ammunition is packed in cartridge bags. Since the cartridge case is loosely fitted to the projectile, some of the increments of the charge may be removed prior to firing to provide for zone firing.

c. Trench-mortar Propelling Charges.

(1) The propelling charges for trench-mortar ammunition are divided into removable parts or increments to provide for zone firing. The increments consist of stitched bundles of sheet powder having a hole in the center of each increment. In addition, the M2 Increment for 81-mm mortar ammunition has a slit from the center hole to one edge to provide for seating on the fin shaft of the M56 H. E. and M57 Chemical Shell. The present practice is that each increment is sealed in a cellophane bag and "A1" is added to the model of the powder, for example M1A1, M2A1, and M3A1. An older type of charge consists of loose powder held in a celluloid container. One increment is fitted into each of the spaces within the blades of the fin.

(2) In case all the increments are removed from a round for firing charge O, an ignition cartridge serves solely as the propellant.

d. 120-mm Propelling Charge. This ammunition is unique since it is the only existing separate-loading propelling charge contained in a cartridge case. The charge consists of NH Powder M1, loosely loaded in a brass cartridge case which is closed by a plug made of palmetto pulp or cork. An igniter is placed around the primer to insure proper ignition.

e. Separate-loading Charges.

(1) Cartridge bags form a suitable and convenient means of containing the smokeless powder charge in separate-loading ammunition. Cartridge bag cloth was formerly made of silk. Bags made of cotton or rayon are now used almost universally to replace silk. Only certain ash-free grades of these fabrics are suitable, however, for otherwise there might be smoldering fragments in the bore of the cannon after firing. This would be particularly undesirable, as the products of combustion of smokeless powder are inflammable when mixed with the requisite amount of air, thus resulting in a reignition of gases known as a "flare-back." Cartridge-igniter pads are made of silk and the cloth is similar to cartridge bag cloth except that it is more closely woven to prevent the black ignition powder from sifting through.

FUZES, PROPELLING CHARGES, PRIMERS, AND OTHER COMPONENTS

(2) Stacked charges are composed of grains placed end to end throughout the length of the charge, instead of being arranged at random. The stacked charge is more rigid, maintains its original dimensions more closely when loaded into the gun, and can be made with smaller diameter because of the reduced space required.

(3) Separate-loading propelling charges are divided into single-section and multisection charges. In the single-section charge, the propellant powder is contained in a single bag, tightly laced or wrapped to give the charge rigidity. The igniting charge is divided into three parts, each in its own bag, two end pads and a core which extends axially through the center of the charge and connects the igniter pads sewed to each end. This type of igniter is termed a "core igniter."

(4) Multisection charges are subdivided into "base and increment," "equal section," and "unequal section" types.

(a) The "base and increment" type of propelling charge consists of a base section or charge and one or more increments. The increments may be of equal or unequal weights but usually weigh less than the base section. With some types, one igniter pad is attached to the base end of the base section only, while other types have a core-type igniter in the base section and sometimes in one or more increments as well.

(b) The "equal section" charge is also known as an "aliquot part" charge. As the name implies, these charges are divided into a given number of equal sections. In those designs in which the igniter pad is separate, tying straps are provided for attaching the igniter to the propellant charges. In other designs, the igniting charge is divided into parts, there being an igniter pad attached to the base end of each section.

(5) In certain cases, two types of propelling charge are provided for one howitzer—one for inner, the other for outer zones of fire. The cloth of the bags for the inner zones is dyed green to distinguish that charge from the other type which is assembled in undyed (white) bags. Accordingly, these two types of charge are called "green bag" and "white bag" charges.

(6) A FLASH REDUCER, M1, is for use with the propelling charges for the 155-mm guns. It greatly reduces the flash and is primarily intended for night firing.

(7) Separate-loading propelling charge data are given in table 5, chapter 5.

343. PACKING AND SHIPPING DATA.

a. Data concerning separate-loading propelling charges are given in ORD 11 Standard Nomenclature Lists.

ARTILLERY AMMUNITION

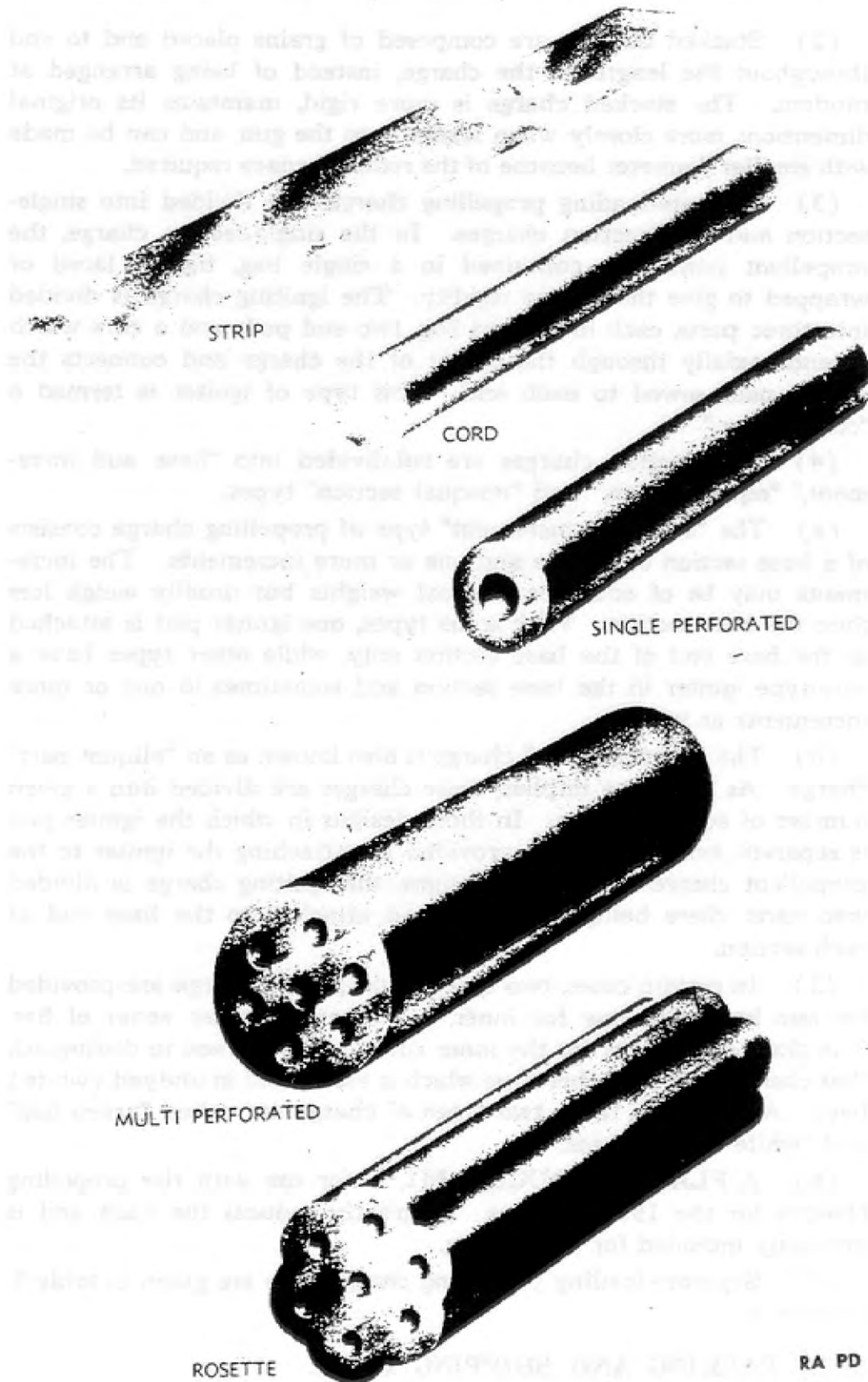

RA PD 80877

Figure 187 - Types of Powder Grains

FUZES, PROPELLING CHARGES, PRIMERS, AND OTHER COMPONENTS

The fuze is a device which is used to initiate the explosion of the projectile at a certain distance from the muzzle of the gun.

The propelling charge is a substance which is used to propel the projectile through the barrel of the gun.

The primer is a small explosive charge which is used to initiate the explosion of the propelling charge.

The fuze is a device which is used to initiate the explosion of the projectile at a certain distance from the muzzle of the gun.

The propelling charge is a substance which is used to propel the projectile through the barrel of the gun.

The primer is a small explosive charge which is used to initiate the explosion of the propelling charge.

The fuze is a device which is used to initiate the explosion of the projectile at a certain distance from the muzzle of the gun.

The propelling charge is a substance which is used to propel the projectile through the barrel of the gun.

The primer is a small explosive charge which is used to initiate the explosion of the propelling charge.

The fuze is a device which is used to initiate the explosion of the projectile at a certain distance from the muzzle of the gun.

The propelling charge is a substance which is used to propel the projectile through the barrel of the gun.

The primer is a small explosive charge which is used to initiate the explosion of the propelling charge.

The fuze is a device which is used to initiate the explosion of the projectile at a certain distance from the muzzle of the gun.

The propelling charge is a substance which is used to propel the projectile through the barrel of the gun.

The primer is a small explosive charge which is used to initiate the explosion of the propelling charge.

The fuze is a device which is used to initiate the explosion of the projectile at a certain distance from the muzzle of the gun.

The propelling charge is a substance which is used to propel the projectile through the barrel of the gun.

The primer is a small explosive charge which is used to initiate the explosion of the propelling charge.

The fuze is a device which is used to initiate the explosion of the projectile at a certain distance from the muzzle of the gun.

The propelling charge is a substance which is used to propel the projectile through the barrel of the gun.

The primer is a small explosive charge which is used to initiate the explosion of the propelling charge.

The fuze is a device which is used to initiate the explosion of the projectile at a certain distance from the muzzle of the gun.

The propelling charge is a substance which is used to propel the projectile through the barrel of the gun.

The primer is a small explosive charge which is used to initiate the explosion of the propelling charge.

The fuze is a device which is used to initiate the explosion of the projectile at a certain distance from the muzzle of the gun.

RA PD 80878



Figure 188 - Comparison of Powder Grains

ARTILLERY AMMUNITION

344. CHARGE, PROPELLING, FOR 20-MM GUNS.

a. Ammunition for 20-mm guns is of the fixed type. FNH powder, type II, is the standard propellant for loading in 20-mm ammunition; it is composed of single perforated grains.

345. CHARGE, PROPELLING, FOR 37-MM GUNS.

a. Ammunition for 37-mm guns is of the fixed type. The weight of powder charge varies from one-half to 9 ounces of powder, depending on the model of the gun. For some guns, single-perforated grains are used; for others, multiperforated grains. FNH powder is the standard propellant for loading in these weapons.

346. CHARGE, PROPELLING, FOR 40-MM GUNS.

a. Ammunition for 40-mm guns is of the fixed type. Type I FNH powder is the propellant.

347. CHARGE, PROPELLING, FOR 57-MM GUNS.

a. Ammunition for 57-mm guns is of the fixed type. Smokeless powder of the NH type is the propellant.

TABLE 5
SEPARATE-LOADING PROPELLING CHARGE DATA

Nomenclature	Maximum Length (in.)	Maximum Diameter (in.)	Maximum Weight (approx) (lb)
CHARGE, propelling, M7 (normal), 4.5" gun, M1	22.8	3.9	6.5
CHARGE, propelling, M8 (super), 4.5" gun, M1....	22.8	4.9	11.2
CHARGE, propelling, dummy, M6, 4.5" gun, M1..	22.8	4.9	11.9
CHARGE, propelling, 120-mm gun, M1.....			49.71*
CHARGE, propelling, dummy, M___ (T2), 120-mm Gun, M1			49.71
CHARGE, propelling, M3 (green bag), 155-mm how., M1	16.	5.	5.94
CHARGE, propelling, M4 (white bag), 155-mm how., M1	21.	5.8	13.87
CHARGE, propelling, M4A1 (white bag), 155-mm how., M1	21.	5.8	13.91
CHARGE, propelling, M1A1 (green bag), 155-mm how., M1917A1-17A2-18	11.	5.	4.22
CHARGE, propelling, M2 (white bag), 155-mm how., M1917A1-17A2-18	11.	6.	8.64
CHARGE, propelling, M2A1 (white bag), 155-mm how., M1917A1-17A2-18	11.	6.	8.64
CHARGE, propelling, dummy (base and 6 increments), M2, 155-mm how., M1917A1-17A2-18, and M1	11.	6.	7.37
CHARGE, propelling, dummy (base and 6 increments), Mk. I, 155-mm how., M1917A1-17A2-18, and M1	12.5	6.	8.0

*—Propellant, NH powder, M1, loaded loosely in CASE, cartridge, M24.

FUZES, PROPELLING CHARGES, PRIMERS, AND OTHER COMPONENTS

TABLE 5 (Contd.)
SEPARATE-LOADING PROPELLING CHARGE DATA

Nomenclature	Maximum Length (in.)	Maximum Diameter (in.)	Maximum Weight (approx) (lb)
CHARGE, propelling, NH powder, 155-mm gun, M1 and MA1	37.4	6.5	32.23
CHARGE, propelling, NH powder, 155-mm guns, M1917-17A1-18MI	37.	5.8	26.17
CHARGE, propelling, dummy (21-lb., base with 5½-lb. increment), Mk. I, 155-mm guns, M1917-17A1-18MI, M1, and M1A1	37.	5.8	26.5
CHARGE, propelling, M1 (green bag), 8" how., M1	21.	6.5	13.9
CHARGE, propelling, M2 (white bag), 8" how., M1	24.	7.75	29.90
CHARGE, propelling, dummy, M4, base and increment, 8" how., M1	24.	7.75	28.75
CHARGE, propelling, base and increment, NH powder, M9 (green bag), 8" gun, M1.....	50.5	8.2	76.0
CHARGE, propelling, base and increment, NH powder, M10 (white bag), 8" gun, M1.....	55.5	9.0	106.1
CHARGE, propelling, dummy, M7, base and increment, 8" gun, M1.....			
CHARGE, propelling, base and 3 increments, FNH powder, 240-mm how., M1.....	50.	8.4	80.0
CHARGE, propelling, dummy, base and 3 increments, M12, 240-mm how., M1.....	50.0	8.4	80.0
CHARGE, propelling, 4 one-fifth and 2 one-tenth sections, Mk. I, NH powder, 240-mm how., M1918-18A1-18MI-18MIA1, 345-lb. proj.	20.75	9.025	37.3
CHARGE, propelling, 4 one-fifth and 2 one-tenth sections, Mk. I, 240-mm how., M1918-18A1-18MI-18MIA1, 345-lb. proj.	20.75	9.025	37.3
CHARGE, propelling, 5 equal sections, Mk. I, NH powder, 240-mm how., M1918-18A1-18MI-18MIA1, 345-lb. proj.	20.75	9.025	37.3
CHARGE, propelling, 5 equal sections, Mk. I, 240-mm how., M1918-18A1-18MI-18MIA1, 345-lb. proj.	20.75	9.025	37.3
CHARGE, propelling, dummy, 5 sections (7½ lbs. each), 240-mm how., M1918-18A1-18MI-18MIA1	20.75	8.75	38.0

348. CHARGE, PROPELLING, FOR 60-MM MORTARS, M1, AND M2.

a. The propelling charge for 60-mm mortars consists of an ignition cartridge and four increments. The Ignition Cartridge M5A1 serves as the propelling charge for extremely short ranges. Increments provided for zone firing consist of stitched bundles of sheet powder, each having a hole in the center. See chapter 2, section VI.

349. CHARGES, PROPELLING, FOR 75-MM GUNS.

a. Ammunition for 75-mm guns is of the fixed type. The propelling charge consists of FNH Powder M1. The grains are type I and are approximately 0.40 inch in length and 0.12 inch in diameter.

ARTILLERY AMMUNITION

Three weights of charge are used. The propelling charge weighing 0.56 pound is referred to as the reduced charge. This type of charge is used with high-explosive and chemical shell. The propelling charge weighing 1.13 pounds is called the normal charge. It is intended for normal firing and normal muzzle velocities. The charge weighing 2.0 pounds is called the supercharge, and is intended for extreme velocities and ranges. Approximately this same weight of charge is also used with armor-piercing projectiles. The propellant for rounds to be fired in 75-mm aircraft guns consists of FNH Powder M1, to which has been added 1 percent potassium sulfate, for complete elimination of muzzle flash at all altitudes.

350. CHARGES, PROPELLING, FOR 75-MM HOWITZERS, M1, M1A1, M2, AND M3.

a. Ammunition for the 75-mm Howitzers M1, M1A1, M2, and M3, is of the fixed and semifixed type. In the case of the fixed type, the charge, consisting of double base FNH powder, is poured loosely in the cartridge case. In the case of the semifixed rounds, the propelling charge (single base FNH powder) consists of a base section, which is secured to the base of the cartridge case, and three increments. Each of the increments is connected in sequence by means of a string to the base charge (ch. 2, sec. VIII).

351. CHARGES, PROPELLING, FOR 76-MM GUN, M1.

a. Ammunition for the 76-mm Gun M1, is of the fixed type. The propellant consists of FNH powder.

352. CHARGES, PROPELLING, FOR 3-INCH GUNS.

a. Ammunition for 3-inch guns is of the fixed type. Two types of propelling powder are used: FNH (flashless nonhygroscopic) powder; NH powder, which is nonhygroscopic but not flashless. Since the propelling charge does not completely fill the cartridge case, a distance wad, in the form of a cardboard cylinder with a disk at each end and held in place by a piece of cord, is contained in the neck of the cartridge case. The grains are approximately 0.6 inch long and 0.28 inch in diameter.

353. CHARGES, PROPELLING, FOR 81-MM MORTARS.

a. These propelling charges consist of an ignition cartridge and propellant increments of stitched sheet powder similar to those used for the 60-mm mortar. An older type of charge consists of loose powder held in a celluloid container. Four or six increments comprise a full charge. All increments of all types of charges are removable as required for zone firing (ch. 2, sec. XI).

FUZES, PROPELLING CHARGES, PRIMERS, AND OTHER COMPONENTS**354. CHARGES, PROPELLING, FOR 90-MM GUNS.**

a. Ammunition for 90-mm guns is of the fixed type. A propelling charge of smokeless powder is held loosely in the cartridge case without the assistance of a distance wad. The charge is NH powder in rounds used against ground targets and FNH in antiaircraft rounds.

355. CHARGES, PROPELLING, FOR 105-MM HOWITZERS.

a. The propelling charge for all semifixed ammunition for 105-mm howitzers is divided into parts to provide for zone firing. The smokeless powder used is FNH. For the M2, M2A1, and M4 Howitzers, the full (outer zone) charge consists of a base charge and six increments, thereby providing for seven zones of fire with the regular M1 High-explosive Projectile. The powder for each increment is assembled in a cloth bag, on which is marked the number of the increment. The increments are of unequal weight and are, therefore, not interchangeable. For the M3 Howitzers, the charge consists of a base charge and four increments providing for five zones of fire. The M3 Howitzer charge has a quicker burning powder than the charge for the M2, M2A1, and M4 Howitzers.

b. Although assembled with removable projectile, the H.E., A.T. round has a fixed (nonadjustable) propelling charge in a single cloth bag (ch. 2, sec. XIII).

356. CHARGES, PROPELLING, FOR 105-MM GUNS.

a. Ammunition for 105-mm guns is of the fixed type. The propelling charge for these rounds consists of either NH or FNH smokeless powder. The charge is poured loosely into the cartridge case and is held in the vicinity of the primer by a distance wad and igniter assembly (ch. 2, sec. XIV).

357. CHARGES, PROPELLING, FOR 4.5" GUN, M1.

a. Two types of service propelling charges are authorized for the 4.5" Gun M1, a single-section type, known as the normal charge (M7), designed for firing at reduced velocity (1,820 ft per sec), and a base-and-increment type (M8), known as the supercharge, for firing at full velocity (2,275 ft per sec). Neither section of the base and increment charge can be used in conjunction with the single-section charge as the single-section charge contains a powder with a faster burning rate. The base section of the base and increment charge can be used for firing at the reduced velocity. However, a greater dispersion in range due

ARTILLERY AMMUNITION

to deviation in velocity may result as compared with that obtained when the single-section charge is used for firing inner zones.

(1) **CHARGE, PROPELLING, M7 (NORMAL), 4.5" GUN, M1** (fig. 1). This is a single-section charge made up of FNH Smokeless Powder M1, loaded in a cartridge cloth bag. The loaded section is wrapped in silk or cotton cloth strapping wound in spiral fashion over the entire length of the assembly, giving the desired rigidity to the charge. At the rear or breech end of the charge is fastened an igniter assembly of 5 ounces of black powder held in a cartridge igniter cloth bag. The maximum diameter is 3.9 inches, as compared with 4.9 inches for the M8 (super) Charge.

(2) **CHARGE, PROPELLING, M8 (SUPER), 4.5" GUN, M1**. This charge is made up of NH Smokeless Powder M1, is in two sections, a base charge and an increment section. Each charge, base and increment, is loaded in a cartridge cloth bag which is wrapped in silk or cotton cloth strapping wound in spiral fashion around the section. Four tying straps fastened to the front end of the base section provide the means of securing the increment section to the base. One igniter assembly of 5 ounces of black powder in a cartridge igniter cloth bag, is stitched to the rear or base end of the base charge.

(3) **CHARGE, PROPELLING, DUMMY, M6, 4.5" GUN, M1**. This charge simulates the base-and-increment (M8) service charge and has approximately the same dimensions. The charge consists of two sections made up of lead-weighted wood cylinders encased in cotton duck cloth. Four tying straps secure the increment section to the base.

358. CHARGE, PROPELLING, FOR 120-MM (4.7") GUN, M1.

a. The propelling charge for the 120-mm Gun M1 is made up of approximately 24 pounds of NH Smokeless Powder M1, loaded loosely in the CASE, cartridge, M24. In the mouth of the case is a plug made of Palmatex or cork, which extends 1.80 inches beyond the cartridge case when shellacked in place. Due to the large quantity of propellant powder used, an igniter charge of 8 ounces of black powder is placed around the M1B1A2 Primer to help ignite the NH powder. This igniter is contained in a cartridge cloth bag which has a hole in the center through which the primer projects (ch. 2, sec. XVI, and fig. 123).

b. **CHARGE, Propelling, Dummy, M—(T2), 120-mm Gun, M1**. This charge simulates the service charge. It consists of an inert filler, loaded loosely in the service cartridge case, and held in place by a wood plug.

FUZES, PROPELLING CHARGES, PRIMERS, AND OTHER COMPONENTS

359. CHARGES, PROPELLING, FOR 155-MM HOWITZERS, M1917A1-17A2-18, AND M1 (figs. 189 and 190).

a. Propelling charges for the 155-mm howitzers are divided into increments of unequal size to provide complete coverage for zone firings. The charges consist of FNH Smokeless Powder M1 in cloth bags to which is attached the igniter charge of black powder, contained in an igniter cloth bag. One igniter pad is sewed to the rear (breech end) of the base section. Four tying straps sewed to the base section provide a means whereby the increments are attached thereto.

(1) 155-MM HOWITZERS M1917A1-17A2-18. For use in this howitzer, there is one type of charge, the M1A1, green bag (B, fig. 189) designed for accurate firings in zones 1 to 5 exclusively. For this howitzer, there are also two other types of charge, the M2, white bag, and the M2A1, white bag (A, fig. 193). These two types are designed for firings in the outer zones: the M2 in zones 5, 6, and 7 only; and the M2A1 in zones 3, 4, 5, 6, and 7. The M1A1 Charge (base and four increments) is loaded into green bags for identification, whereas the M2 (base and two increments) and the M2A1 (base and four increments) are loaded in the normal white-colored bags. For further data, see table 5, chapter 5.

(2) 155-MM HOWITZER M1. The designs of propelling charge for this howitzer are quite similar to those for the 155-mm howitzer, M1917A1-17A2-18. Thus there is one charge, the M3, green bag (A, fig. 192), designed for accurate firings in zones 1 to 5 exclusively. This charge consists of a base charge and four increments. And there are two types of charge designed for outer zone firings. These are the M4, white bag (zones 5, 6, and 7), and the M4A1, white bag (B, fig. 193) (zones 3, 4, 5, 6, and 7). The M4 (white bag) consists of a base charge and two increments; the M4A1 (white bag) consists of a base charge and four increments. For further data, see table 5, chapter 5.

(3) PRECAUTIONS.

(a) As noted above, the green bag and the white bag charges are quite different in design and in the type of powder loaded in each. Therefore, sections of green bag charges will never be mixed or used with sections of the white bag charges, and the use of charges having increments of more than one color is definitely prohibited.

(b) In general, propelling charges are not interchangeable between the two types of howitzers covered above. However, there are

ARTILLERY AMMUNITION

RA PD 80879

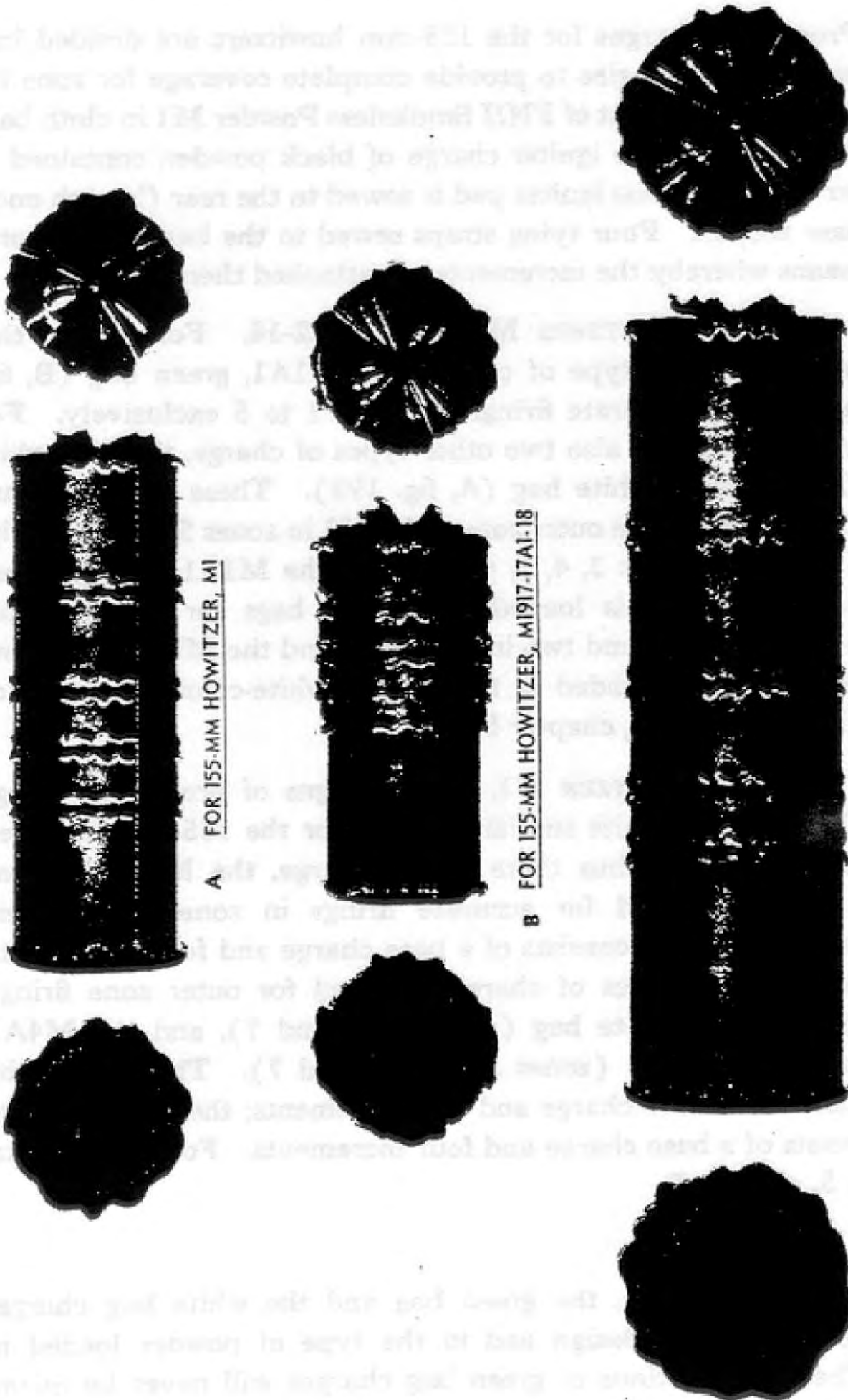

A FOR 155-MM HOWITZER, MI

B FOR 155-MM HOWITZER, MI917-17A1-18

C FOR 8" HOWITZER, MI

Figure 189 — Separate-loading Green Bag Propelling Charges for Howitzers

FUZES, PROPELLING CHARGES, PRIMERS, AND OTHER COMPONENTS

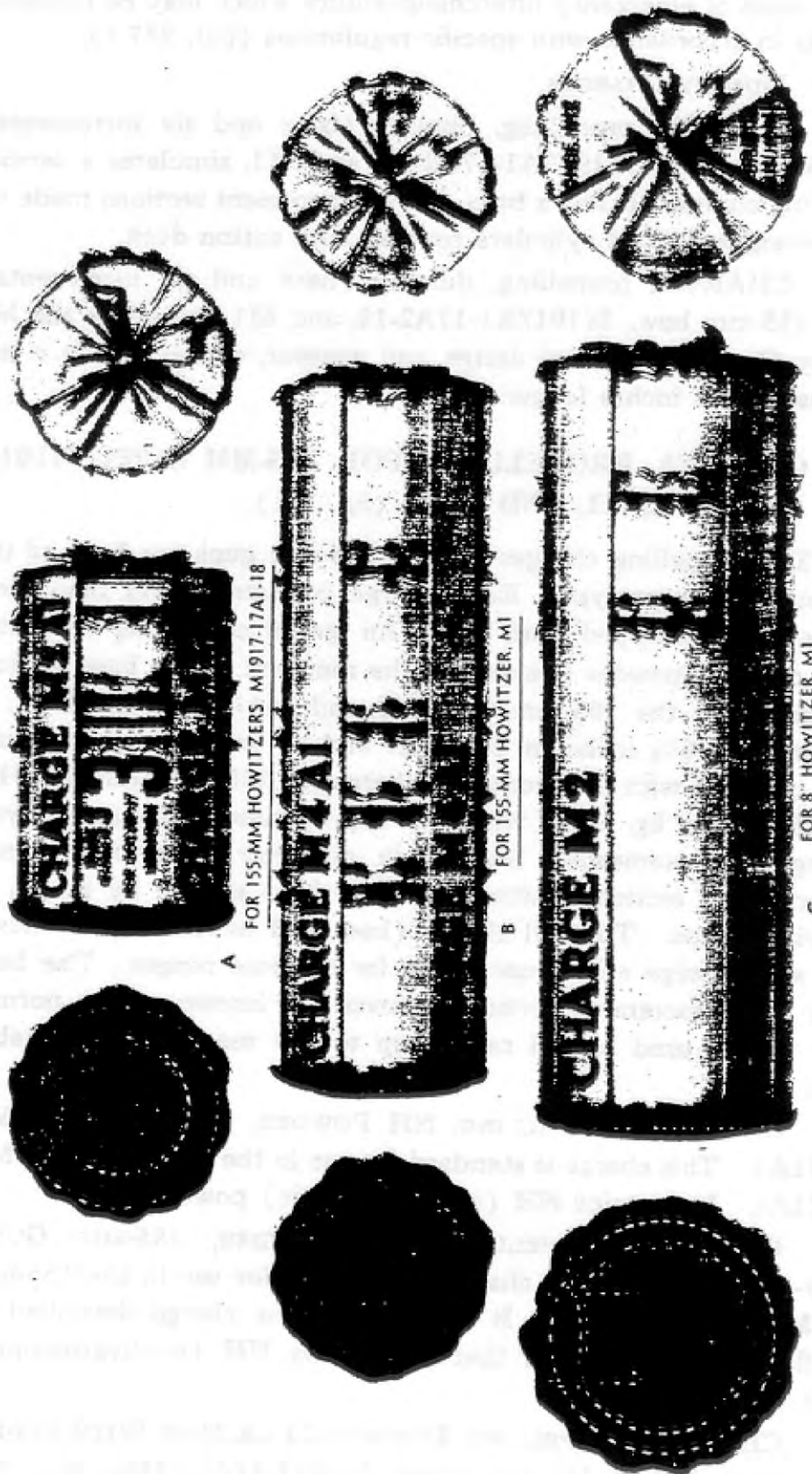

RA PD 80880

Figure 190 — Separate-loading White Bag Propelling Charges for Howitzers

ARTILLERY AMMUNITION

certain cases of emergency interchangeability which may be followed, but only in accordance with specific regulations (par. 247 f).

(4) DUMMY CHARGES.

(a) CHARGE, propelling, dummy (base and six increments), M2, 155-mm how., M1917A1-17A2-18, and M1, simulates a service propelling charge. It has a base and six increment sections made up of lead-weighted wood cylinders covered with cotton duck.

(b) CHARGE, propelling, dummy (base and six increments), Mk. I, 155-mm how., M1917A1-17A2-18, and M1, resembles the M2 Dummy Charge in general design and contour, except that it is approximately 1.5 inches longer.

360. CHARGES, PROPELLING, FOR 155-MM GUNS, M1917-17A1-18MI, M1, AND M1A1 (fig. 191).

a. The propelling charges for the 155-mm guns are both of the base and increment type. Each charge consists of NH Smokeless Powder M1 in wrapped cloth bags. An igniter containing an igniter charge of black powder is sewed to the rear end of the base section. The charge for the 155-mm Gun M1 and M1A1 (B, fig. 194), is approximately 6½ inches in diameter and 37 inches long; it should not be confused with the propelling charge for 155-mm Guns M1917-17A1-18MI (A, fig. 194) which is approximately the same overall length but somewhat smaller in diameter (approx 5.8 in.). The increment section is attached to the base section by means of four tying straps. The full charge (base and increment) is known as the supercharge and is used only for extreme ranges. The base section only (increment section removed) is known as the normal charge and is used for all ranges up to the maximum obtainable with it.

(1) CHARGE, PROPELLING, NH POWDER, 155-MM GUNS, M1 AND M1A1. This charge is standard for use in the 155-mm Guns M1 and M1A1. It contains NH (nonhygroscopic) powder.

(2) CHARGE, PROPELLING, NH POWDER, 155-MM GUNS, M1917-17A1-18MI. This charge is standard for use in the 155-mm Guns M1917-17A1-18MI. It differs from the charge described in the following paragraph in that it contains NH (nonhygroscopic) powder.

(3) CHARGE, PROPELLING, DUMMY (21-LB. BASE WITH 5½-LB. INCREMENT), MK. I, 155-MM GUNS, M1917-17A1-18MI, M1, AND M1A1. This dummy propelling charge simulates service charge in

FUZES, PROPELLING CHARGES, PRIMERS, AND OTHER COMPONENTS

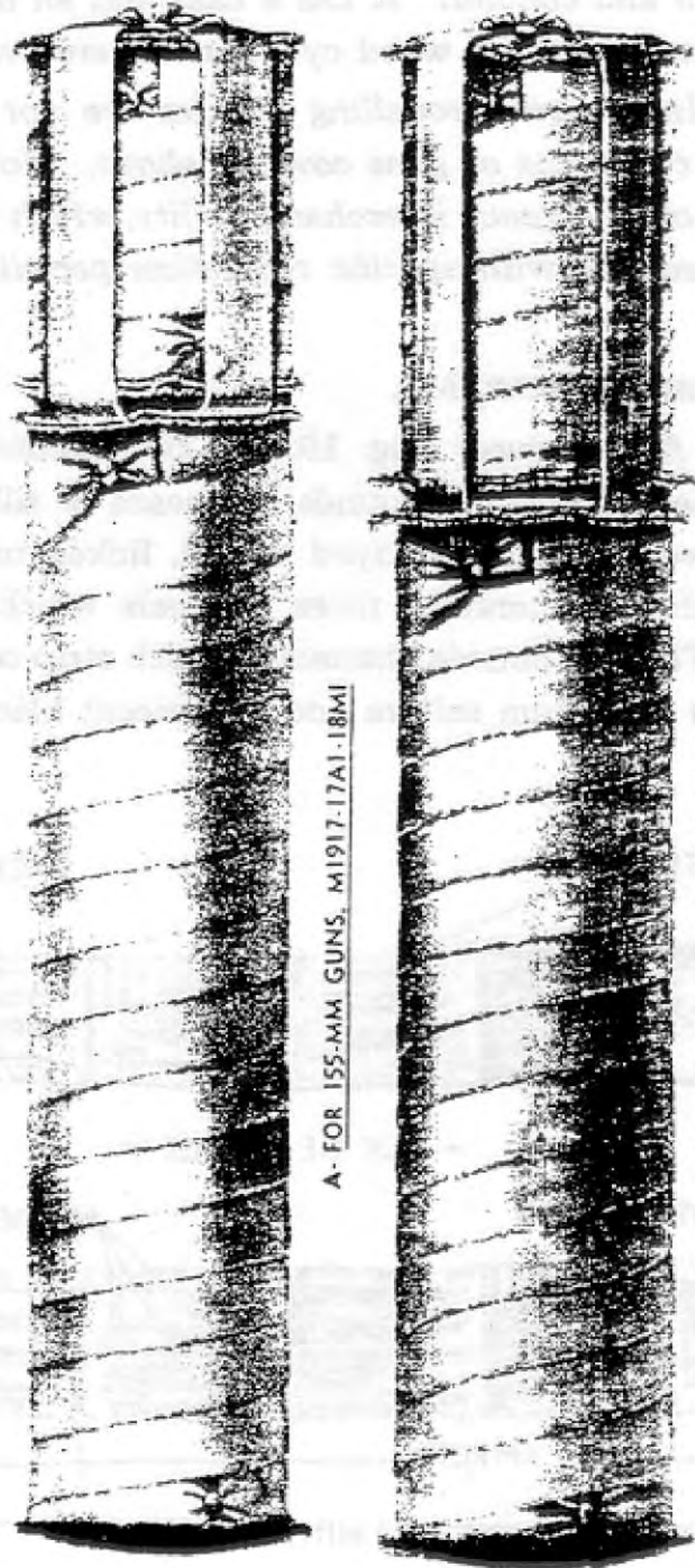

A - FOR 155-MM GUNS, M1917-17A1-18M1

B FOR 155-MM GUNS, M1 AND M1A1

RA PD 80881

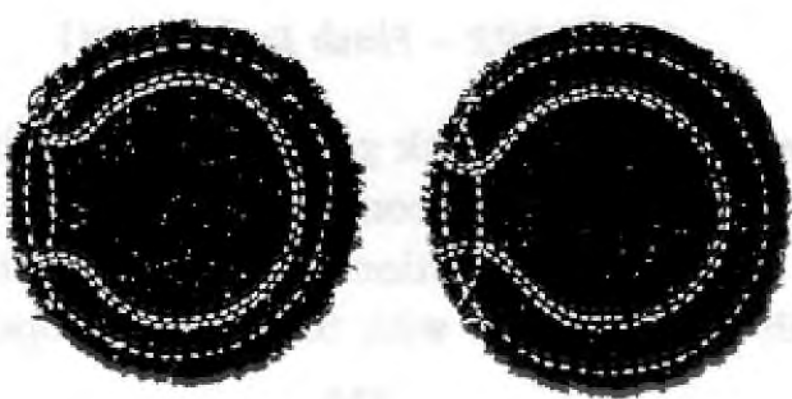

Figure 191 — Separate-loading Propelling Charges for 155-mm Guns

ARTILLERY AMMUNITION

general design and contour. It has a base and an increment section made up of lead-weighted wood cylinders covered with cotton duck.

NOTE: In general, propelling charges are not interchangeable between the two types of guns covered above. However, there are certain cases of emergency interchangeability, which may be followed only in accordance with specific regulation permitting same (par. 260 f).

(4) FLASH REDUCER, M1.

(a) This flash reducer (fig. 192) is tied around the propelling charges of the 155-mm gun rounds by means of silk tie strings. It consists of two cotton strips, dyed scarlet, linked together with silk strings. Each strip contains three channels which are filled with chemicals. The two outside channels of each strip contain a mixture of 60 percent potassium sulfate and 40 percent black powder. The

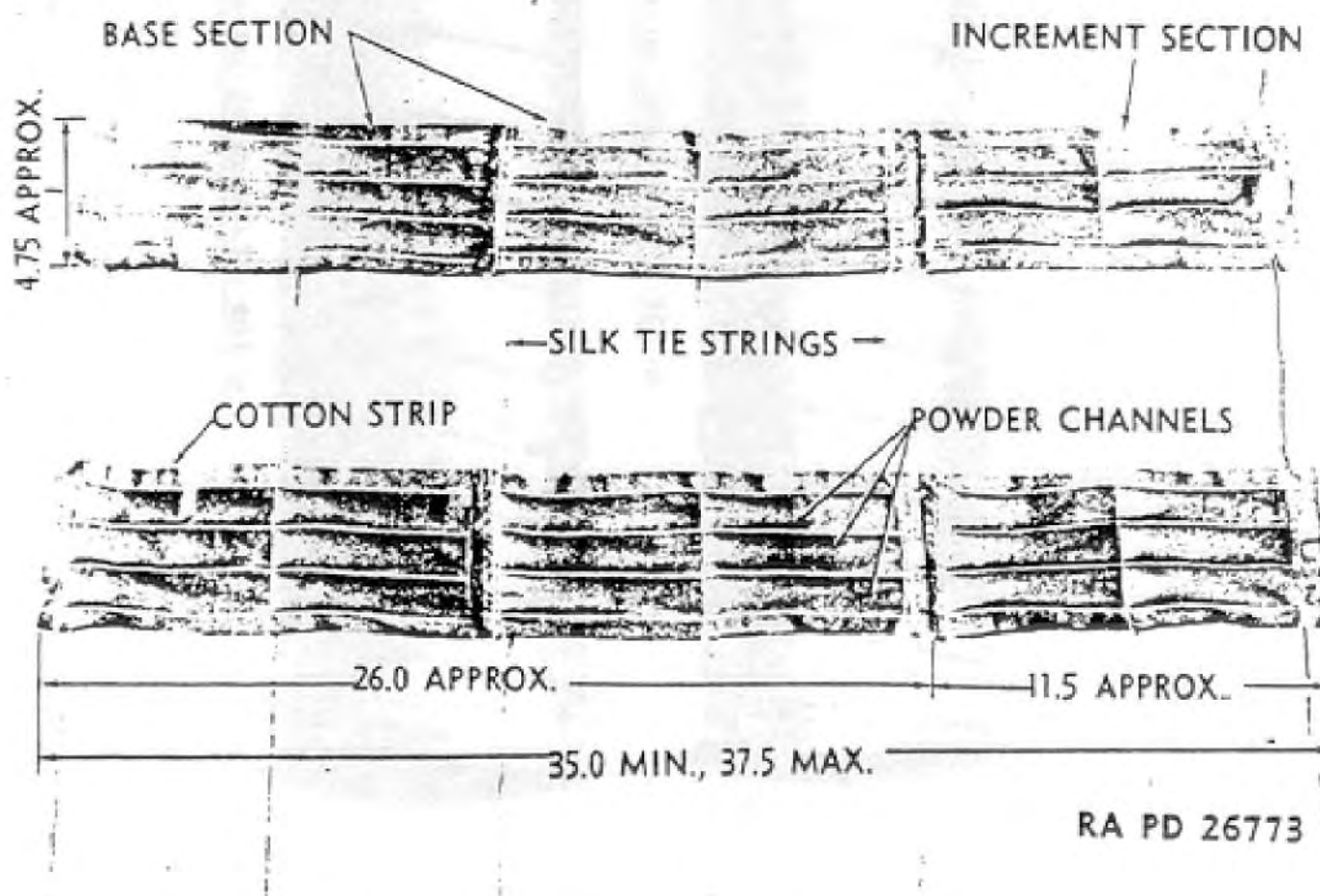

Figure 192 — Flash Reducer, M1

center channel contains all black powder. Each strip is divided into two sections, the base section containing the upper and lower base charges, and the increment section containing the increment charge. When using the flash reducer with the normal propelling charge, the

FUZES, PROPELLING CHARGES, PRIMERS, AND OTHER COMPONENTS

increment section of each strip is removed and discarded. When using the supercharge, both base and increment sections are used.

(b) *Ballistic Correction.* The effect of the use of the flash reducer is to increase the muzzle velocity: by approximately 10 feet per second for the supercharge in the 155-mm Guns M1 and M1A1; by approximately 15 feet per second for the normal charge and 35 feet per second for the supercharge, in the 155-mm Guns M1917-17A1-18M1. *This correction must be applied when computing range data.*

(c) *Precaution.* The FLASH REDUCER, M1, should be handled in the same manner as any other explosive charge.

361. CHARGES, PROPELLING, FOR 8" HOW., M1.

a. The service propelling charges for the 8-inch Howitzer M1 are divided into unequal increments to provide for zone firing. The charge consists of FNH Smokeless Powder M1 in cloth bags to which the igniter charge of 5 ounces of black powder in the form of an igniter pad is rigidly attached. The igniter pad is sewed to the rear (breech end) of the base section. Four tying straps sewed to the base section provide a means whereby the increments are attached thereto. There are two types of propelling charge for the 8-inch Howitzer M1.

b. The CHARGE, propelling, M1 (green bag), 8-inch, how., M1 (C, fig. 192), consists of five increments designed for accurate firings in zones 1 to 5, inclusive. It is assembled in cartridge bags of green cloth. It is commonly referred to as the "green bag" charge to distinguish it from the CHARGE, propelling, M2 (white bag), 8-inch how., M1 (C, fig. 193). The "white bag" charge consists of a large base section and two increments, assembled in cartridge bags of white cloth, and designed for zones of fire 5 to 7, inclusive. Sections of the green bag charge will never be mixed with sections of the white bag charge, as the latter contains powder of a slower burning type. The use of charges having zone increments of more than one color is, therefore, definitely prohibited. The maximum diameter of the M1 Charge is 6.5 inches as compared to 7.75 inches for the M2 Charge.

c. The CHARGE, propelling, dummy, M4, base and increment, 8-inch how., M1, simulates the white bag service charge. It consists of a base charge and two increment sections. The fillers for the sections consist of blocks of wood, each of which is drilled, counter-bored, and weighted with lead to produce the desired weight.

ARTILLERY AMMUNITION

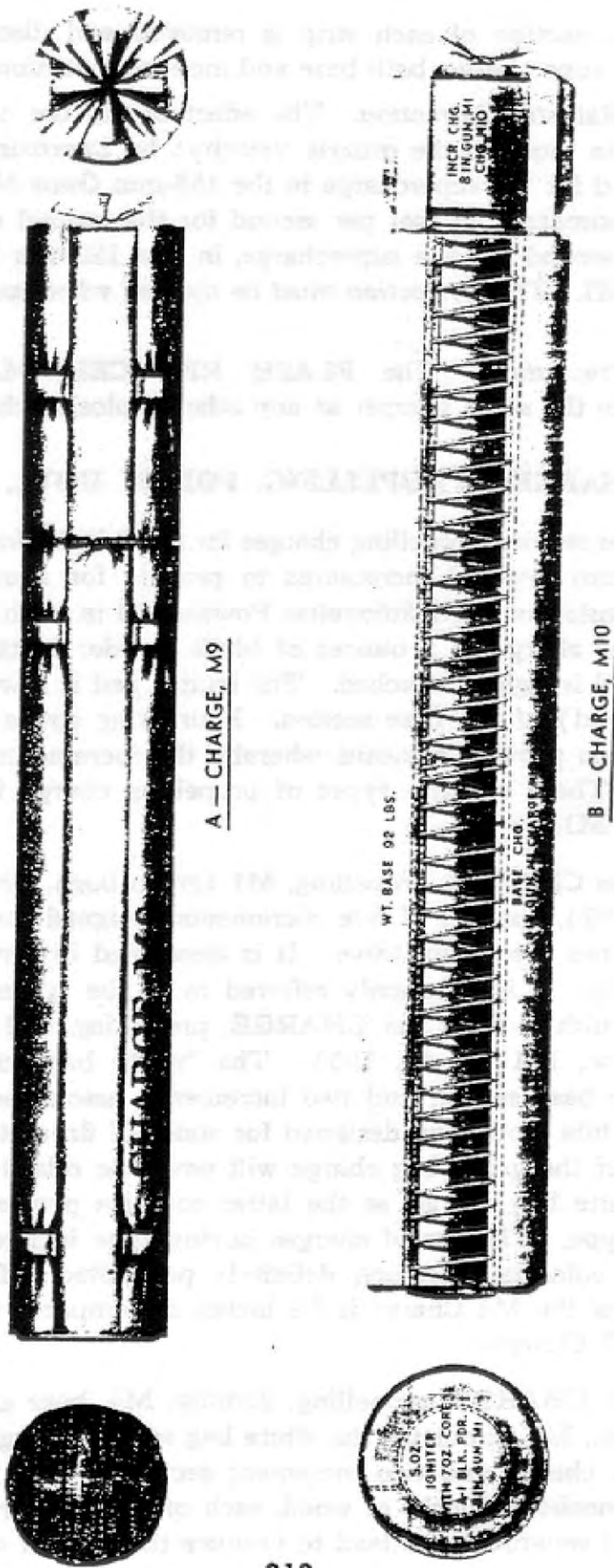

RA PD 65135

Figure 193 — Separate-loading Propelling Charges for 8-inch Gun M1

FUZES, PROPELLING CHARGES, PRIMERS, AND OTHER COMPONENTS

362. CHARGES, PROPELLING, FOR 8-INCH GUN, M1.

a. Propelling charges for the 8-inch Gun M1 are of the base and increment type. The service charges consist of NH Smokeless Powder M1 in two bags each. Two types of charge are provided for use at different velocity levels. The grains are approximately 1.3 inches long and 0.55 inch wide. The base section is fitted with a black powder igniter.

(1) CHARGE, PROPELLING, BASE AND INCREMENT, NH POWDER, M9 (GREEN BAG), 8" GUN, M1 (A, fig. 193). The full charge (2,600 ft per sec) is used for medium range firing, and the base charge is used by itself for firing in the lower ranges. An igniting charge of 8 ounces of black powder is contained in an igniter pad sewed to an end of the base charge. This pad is equipped with four tying straps which are passed through loops on the sides of the base and increment, and are tied over the increment. At the junction of the base and increment a cord is tied around the four tying straps to increase the rigidity of the charge.

(2) CHARGE, PROPELLING, BASE AND INCREMENT, M10, (WHITE BAG), 8" GUN, M1 (B, fig. 193). The full charge (2,850 ft per sec) is used for extreme range firings only, and the base charge (2,600 ft per sec) is used by itself for medium range firing. This charge as a whole is designed primarily for use only at extreme ranges, the M9 green bag type described above being preferred even at medium ranges because of improved accuracy as compared with the M10. The igniting charge and the general design of this base-and-increment type charge are quite similar to that of the M9, except for the large size, particularly the greater diameter.

(3) CHARGE, PROPELLING, DUMMY, M7, BASE AND INCREMENT, 8" GUN, M1. This dummy charge simulates the service charge in size, weight, and general appearance; it is provided for training in handling and loading of the piece.

363. CHARGES, PROPELLING, FOR 240-MM HOW., M1 (fig. 194).

a. The propelling charges used in this weapon are of the base and increment type. The service charge consists of FNH Smokeless Powder M1 in cloth bags. The CHARGE, propelling, base and 3 increments, FNH powder, 240-mm how., M1, is composed of a base section and three unequally sized increments and is approximately

ARTILLERY AMMUNITION

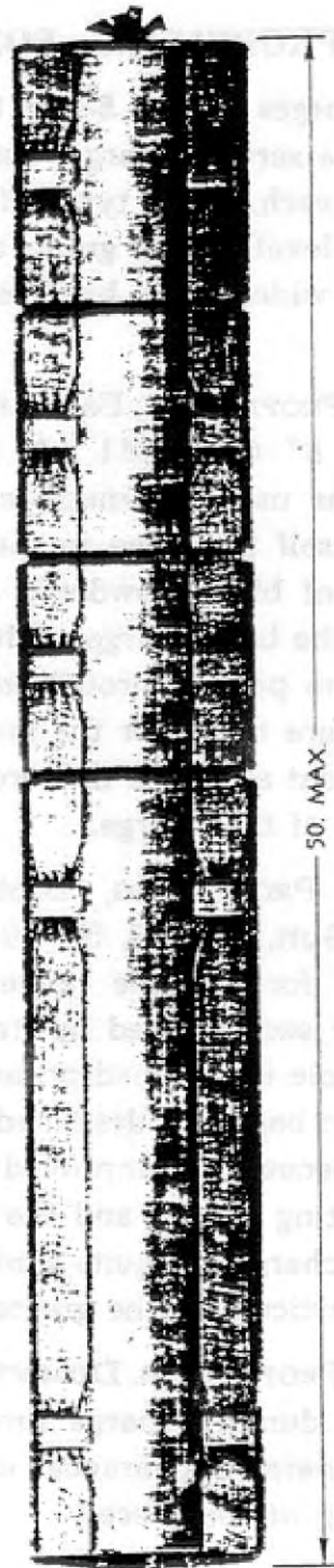

RA PD 53903

Figure 194 — Separate-loading Propelling Charges for 240-mm Howitzer M1

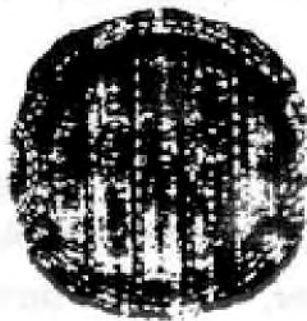

FUZES, PROPELLING CHARGES, PRIMERS, AND OTHER COMPONENTS

8.4 inches in diameter. The full charge is used for maximum range firing and less than a full charge for firing in the lower ranges. An igniter charge of 8 ounces of black powder in the form of an igniter pad is sewed to the end of the base section. This charge is equipped with four tying straps which are passed through loops on the side of the base and increments and are tied over the last increment thus securing all sections together. At each junction of two sections, a cord is tied around the four tying straps to increase the rigidity of the charge.

b. **CHARGE, Propelling, Dummy, Base and 3 Increments, M12, 240-mm How., M1.** This charge simulates the service charge described above. The filler for the base and three increments consists of cylindrical wood blocks which are drilled, counterbored, and weighted with lead to produce the desired weight. A cotton webbing handle is secured to the igniter end of the propelling charge to aid in extraction from the chamber of the cannon.

364. **CHARGES, PROPELLING, FOR 240-MM HOW., M1918-18A1-18MI-18MIA1.**

a. The propelling charges used in this weapon are of the equal section and unequal section types. An igniter charge of 5 ounces of black powder in the form of an igniter pad is used with both types of charges. This pad is equipped with four tying straps which tie around the entire charge, thus securing the igniter and all sections together. Two igniters are furnished with each full charge in order that sections left over from firings of less than a full charge may be used in subsequent firings.

b. **CHARGE, Propelling, Four One-fifth and Two One-tenth Sections, Mk. I, NH Powder, 240-mm How., M1918-18A1-18MI-18MIA1; 345-lb. Proj.** This unequal section type charge (fig. 195) consists of six sections, each section being a fractional portion of a full charge, in this case, four one-fifth sections and two one-tenth sections.

c. **CHARGE, Propelling, Four One-Fifth and Two One-tenth Sections, Mk. I, 240-mm How., M1918-18A1-18MI-18MIA1, 345-lb. Proj.** This propelling charge is identical with the propelling charge described in subparagraph b, above, with the one exception that the charge is of nitrocellulose (NC) powder.

d. **CHARGE, Propelling, Five Equal Sections, Mk. I NH Powder, 240-mm How., M1918-18A1-18MI-18MIA1, 345-lb. Proj.** This propelling charge is of the equal section type, the complete

ARTILLERY AMMUNITION

RA PD 53894

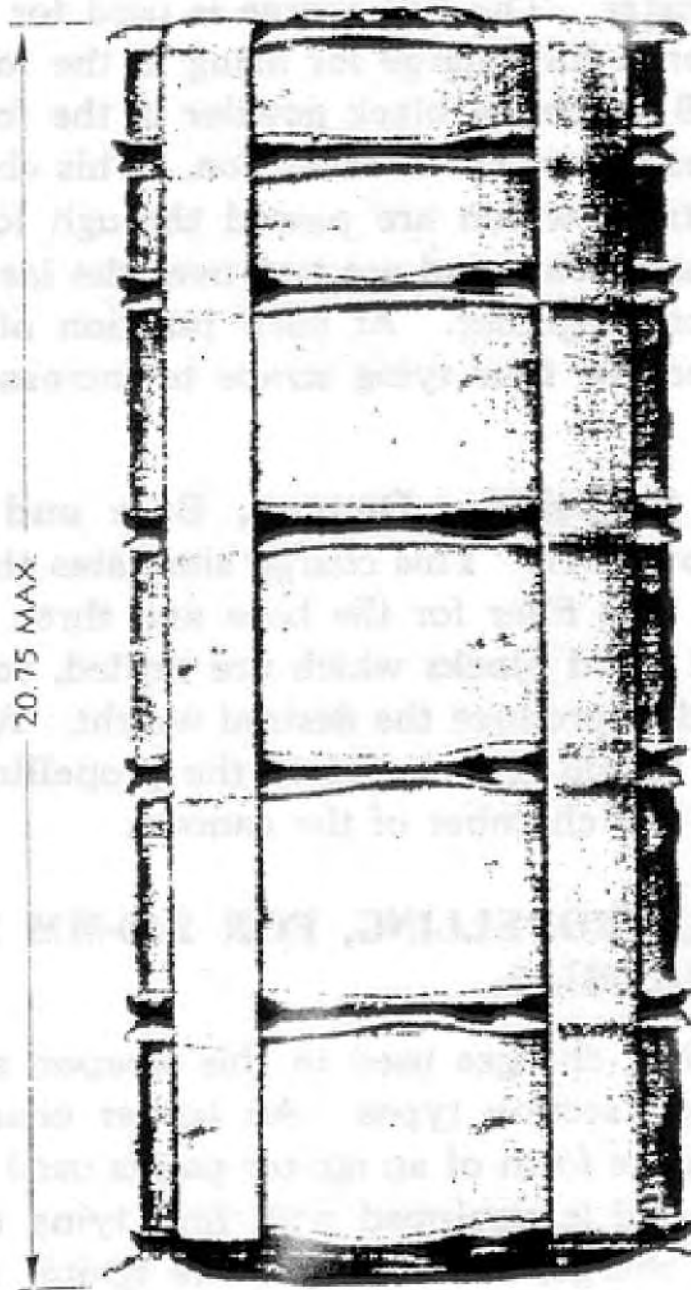

Figure 195 — Separate-loading Propelling Charge for 240-mm Howitzers M1918-18A1-18MI-18MIA1

FUZES, PROPELLING CHARGES, PRIMERS, AND OTHER COMPONENTS

charge being divided into five equal sections. In all other respects this propelling charge is identical with propelling charge described in subparagraph b, above.

e. **CHARGE, Propelling, Five Equal Sections, Mk. I, 240-mm How., M1918-18A1-18MI-18MIA1, 345-lb. Proj.** This propelling charge is identical with propelling charge described in subparagraph d, above, with the exception that the charge is of nitrocellulose (NC) powder.

f. **CHARGE, Propelling, Dummy, 5 Section (7½ lbs. Each), 240-mm How., M1918-18A1-18MI-18MIA1, and M1.** This charge simulates the service charge. Fillers for the sections consist of blocks of wood, each of which is drilled, counterbored, and weighted with lead to produce the desired weight. A cotton webbing handle is secured to the igniter end of the propelling charge to aid in extraction from the chamber of the cannon.

Item No.	Weight (lb.)	Volume (cu in.)	Material	Description
1	7.5	100	Wood	Block for propelling charge section
2	7.5	100	Wood	Block for propelling charge section
3	7.5	100	Wood	Block for propelling charge section
4	7.5	100	Wood	Block for propelling charge section
5	7.5	100	Wood	Block for propelling charge section
6	7.5	100	Wood	Block for propelling charge section
7	7.5	100	Wood	Block for propelling charge section
8	7.5	100	Wood	Block for propelling charge section
9	7.5	100	Wood	Block for propelling charge section
10	7.5	100	Wood	Block for propelling charge section
11	7.5	100	Wood	Block for propelling charge section
12	7.5	100	Wood	Block for propelling charge section
13	7.5	100	Wood	Block for propelling charge section
14	7.5	100	Wood	Block for propelling charge section
15	7.5	100	Wood	Block for propelling charge section
16	7.5	100	Wood	Block for propelling charge section
17	7.5	100	Wood	Block for propelling charge section
18	7.5	100	Wood	Block for propelling charge section
19	7.5	100	Wood	Block for propelling charge section
20	7.5	100	Wood	Block for propelling charge section

ARTILLERY AMMUNITION

Section III

PRIMERS

365. GENERAL.

a. A primer is the component used to initiate the ignition of a propelling charge. Artillery primers consist essentially of a small quantity of sensitive explosive and a charge of black powder encased in a metal container. In the case of fixed and semifixed ammunition, the primer is in the form of a tube with provision for its being forced into the base of the cartridge case. In trench-mortar ammunition, the percussion primer and ignition cartridge (containing a special ignition powder charge) are separate items. In the case of separate-loading ammunition, the primer is intended for insertion into the breechblock and (excepting those for seacoast use), is fired by percussion. Cannon primers described in this manual include only percussion primers. For other types of primers, see TM 9-1900 and TM 4-205. Primers are illustrated in figures 196 to 200, inclusive.

b. **Percussion Primer.** This type of primer, fired by a blow of the firing pin, is used in all service fixed and semifixed ammunition, and in separate-loading ammunition used by mobile artillery. Primers used in cartridge cases contain sufficient black powder to ignite the smokeless powder in the cartridge case. Those used with separate-loading charges contain only enough black powder to ignite black powder igniter attached to propelling charge.

c. **Primer and Ignition Cartridge Data.** See table 6 below.

TABLE 6

Primers and Ignition Cartridges	Total Length (in.)	Diameter		Total Weight (Grains)
		Head (in.)	Body (in.)	
PRIMER, percussion, M36A1	0.25	0.332 (of cup)	—	25.65
PRIMER, percussion, 20-grain, M23A2 ..	1.15	0.62	0.555	345.0
PRIMER, percussion, Q.F. cartridges No. 12, Mk. II/L/	2.62	0.795	0.53	1 LB.
PRIMER, percussion, 65-grain, M22A3 ..	7.68	0.62	0.544	1693.2
PRIMER, percussion, 100-grain, M1B1A2	3.71	0.62	0.544	872.5
PRIMER, percussion, 55-grain, M38A2 ..	2.84	0.62	0.544	682.5
PRIMER, percussion, 150-grain, M31A2..	7.68	0.62	0.544	1782.2
PRIMER, percussion, 300-grain, M28A2..	10.26	0.62	0.544	2316.2
PRIMER, percussion, 225-grain, M40(T27)	19.	0.62	0.544	4800.0
CARTRIDGE, ignition, M3	2.64	0.889	0.79	—
CARTRIDGE, ignition, M4	1.75	0.728	0.65	—
PRIMER, percussion, M32	0.516	0.82	0.47	345.0
PRIMER, percussion, M33	0.586	1.00	0.56	542.78
PRIMER, percussion, M34	0.761	1.00	0.56	737.45
PRIMER, percussion, 17-grain, Mk. IIA4	1.595	0.515	0.348	198.05
CARTRIDGE, ignition, M5A1	1.58	—	0.65	82.2
CARTRIDGE, ignition, M6	2.13	—	0.796	—

FUZES, PROPELLING CHARGES, PRIMERS, AND OTHER COMPONENTS

366. PACKING AND SHIPPING DATA.

a. Data concerning separate-loading primers are given in ORD 11 SNL R-3.

367. PRIMER, PERCUSSION, M36A1 (fig. 196), weighing 25.65 grains, is the standard primer for assembly in the 20-mm Cartridge Case M21A1, and the substitute standard Case M21A1B1 (steel). It is the type of primer having an anvil as an integral part. The PRIMER, M36A1, consists of a brass primer cup, a foiling paper cover, and a primer mixture charge. The primer cup is made of cartridge brass and weighs 18.53 grains. The anvil, made of strip cartridge brass, is shaped in the form of a cone. The thickness of the anvil is 0.665 inch and its weight 4.95 grains. The foiling paper cover is placed over the priming charge after being coated with a special shellac varnish applied to the side that will be placed next to the primer mixture charge. The primer mixture charge, weighing 2.10 grains, is pressed into the cup. The cover is pressed over the charge and the anvil assembled with its apex pointing into the recess formed in the charge. The charge is designated as No. 90A primer mixture.

368. PRIMER, PERCUSSION, 20-GRAIN, M23A2 (fig. 196), is standard for assembly with the three authorized rounds of ammunition fired from the 37-mm Gun M1916, and the Target-practice Round, M51A1, M51A2 for the 37-mm Gun M3. The primer is made of brass, weighs 345 grains, and is held in the case by means of a force fit between the walls of the primer pocket. The primer consists of an anvil, body, percussion element, primer charge, cover, battery cup, primer cup, closing disk, and firing plug. The anvil is formed and shaped in the same manner as the anvil for the PRIMER, percussion, M36A1, described in paragraph 367. It is made of brass and weighs approximately 5.8 grains. The body, made of brass, is machined so as to provide a series of chambers into which are fitted the various functioning assemblies; the firing plug assembly, the percussion assembly, and the primer charge assembly. The chamber containing the primer charge assembly communicates with the chamber containing the percussion element assembly through a cylindrical port designated as the flash vent. The percussion element consists of one grain of No. 70 primer mixture in pellet form. The primer charge consists of 20 grains of black powder. The cover, made of foiling paper is coated and assembled in the same manner as the cover in the M36A1 Primer described in paragraph 367. The battery cup, made of cartridge brass and tubular in shape, is assembled after the

ARTILLERY AMMUNITION

firing plug. The primer cup is similar in construction and function to the cup in the M36A1 Primer. The closing disk, of onionskin paper, is placed over the primer charge. After it is placed, the void space of the primer charge recess is filled with molten beeswax. The firing plug, made of commercial brass rod, has a knob on its under side that acts as the firing pin. This knob strikes the primer cup.

369. PRIMER, PERCUSSION, Q.F. CARTRIDGES, NO. 12, Mk. II/L/ (fig. 196), is a British type primer used with ammunition for 40-mm antiaircraft guns. This primer is screwed into the base of the cartridge case. It is made of brass, and consists of a primer body, charge holder, percussion element assembly, tapered plug and closing plug. The primer charge of 65 grains of black powder is contained in the charge holder, which is screwed into the primer body. The anvil is screwed into the primer body behind the percussion element assembly; the closing plug is in turn screwed into the primer body behind the anvil.

370. PRIMER, PERCUSSION, 65-GRAIN, M22A3 (fig. 197), is assembled in fixed 75-mm high-explosive rounds using reduced and normal propelling charges. The charge is held in the end of the primer tube adjacent to the primer head by means of a cardboard cup. The empty portion of the tube has many small vents and is lined on the inside with a paper liner. This liner prevents the grains of propellant powder from entering the upper end of the primer tube and supports the black powder charge retainer cup. The M22A3 Primer employs the same head assembly as the 20-grain M23A2 Primer described in paragraph 368. A body of brass tubing is screwed to the head and is closed at the other end by a threaded brass plug. The M22A3 Primer differs from the M22A2 Primer which it supersedes, in that it has a firing plug with a boss, which increases the length of the plug to 0.225 inch.

371. PRIMER, PERCUSSION, 100-GRAIN, M1B1A2 (fig. 196), is used with ammunition for 57-mm and 3-inch guns, and 75-mm and 105-mm howitzers. It consists of a brass tube that screws onto the primer head. The other end of the tube is closed by a plug which is rolled crimped in place after being screwed in. The head is similar to that of the 65-grain M22A3 Primer described in paragraph 370. The black powder charge completely fills the case and ignites the propellant charge through the vents in the body of the primer. An alternate primer is the PRIMER, percussion, 100-grain, M1A2, which differs from the M1B1A2 Primer in the design of the brass tube.

FUZES, PROPELLING CHARGES, PRIMERS, AND OTHER COMPONENTS

372. PRIMER, PERCUSSION, 55-GRAIN, M38A2 (fig. 196), supersedes the 20-grain M23A2 Primer (par. 368) for use with 37-mm ammunition. It is also standard for use with 40-mm rounds of Army procurement. This primer is similar in construction to the M1B1A2 Primer described in paragraph 371. The 55-grain primer charge fills the primer body and ignites the propellant charge through the vents in the body of the primer.

373. PRIMER, PERCUSSION, 150-GRAIN, M31A2 (fig. 197), is used with some rounds of 75-mm high-explosive shell requiring a primer of higher black powder capacity than the 75-grain M22A3, or the 100-grain, M1B1A1. Similarly, the larger black powder charge is used in igniting the propellant of 75-mm armor-piercing shot. The M31A2 Primer is similar to the M22A3 Primer described in paragraph 370 except for the amount of black powder charge.

374. PRIMER, PERCUSSION, 300-GRAIN, M28A2 (fig. 197), is standard for use with 76-mm ammunition, and 3-inch, 90-mm and 105-mm antiaircraft ammunition. It is also used with the M67 H.E., A.T. Shell in the 105-mm Howitzers M2, M2A1, M3, and M4. The function of the M28A2 Primer is identical with the 20-grain M23A2 Primer described in paragraph 368. It is similar in construction to the 100-grain M1B1A2 Primer, described in paragraph 371, except for the length of the tube. It contains more powder. Alternative primer is the PRIMER, percussion, 300-grain, M28B2 (steel). Rounds of earlier manufacture may have the PRIMER percussion, 300-grain, M28A1 or M28A1B1.

375. PRIMER, PERCUSSION, 225-GRAIN, M40 (T27), used with ammunition for 76-mm guns, is similar to, but longer than, the M28A2 Primer, described in paragraph 374. It consists of a brass head with increased thread area, in combination with a brass primer body. The primer has an open end without the usual metal plug.

376. CARTRIDGE, IGNITION, M3 (fig. 198), is assembled with the 81-mm High-explosive M45 Shell. It is also issued for use with the 81-mm M68 Training Shell. The cartridge consists of a body assembly, a commercial primer, and a powder charge. The body assembly is essentially a shotgun shell, made of paper and having a brass inner and outer base. The body is commercial cartridge paper, reinforced at one end by the brass base. The commercial primer is

ARTILLERY AMMUNITION

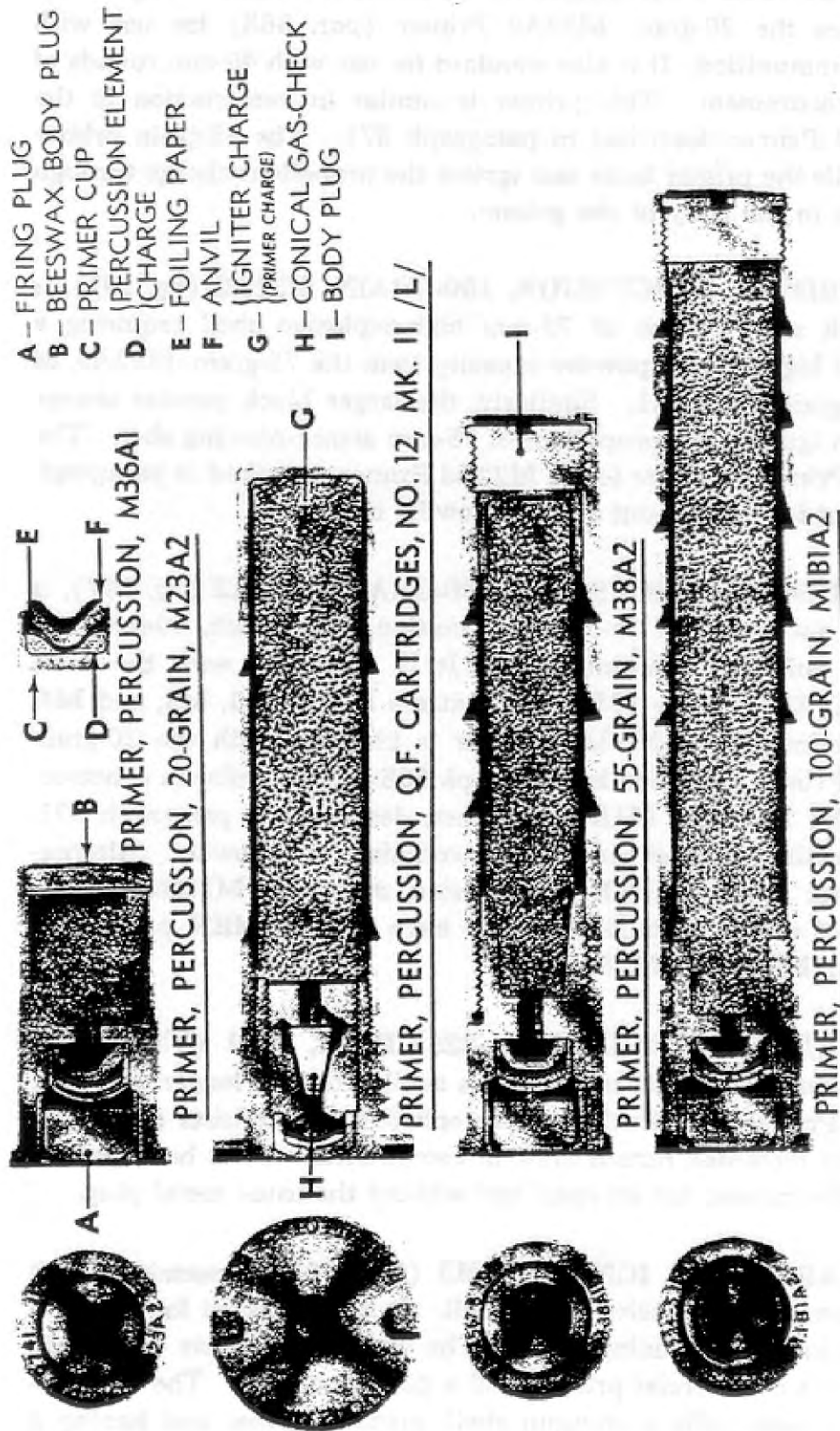

RA PD 80872

Figure 196 — Percussion Primers for Fixed and Semifixed Ammunition

FUZES, PROPELLING CHARGES, PRIMERS, AND OTHER COMPONENTS

- A - FIRING PLUG
- B - PRIMER CUP
- C - PERCUSSION ELEMENT CHARGE
- D - ANVIL
- E - PRIMER CHARGE (IGNITER CHARGE)
- F - DIAPHRAGM
- G - FOILING PAPER
- H - BODY
- I - BODY VENT
- J - BODY PLUG



PRIMER, PERCUSSION, 75-GRAIN, M2ZA3

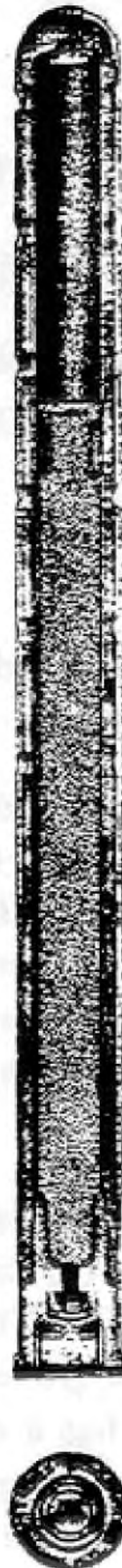

PRIMER, PERCUSSION, 150-GRAIN, M3IAZ



PRIMER, PERCUSSION, 300-GRAIN, M28AZ

RA PD 80883

Figure 197 - Percussion Primers for Fixed and Semixed Ammunition (Continued)

ARTILLERY AMMUNITION

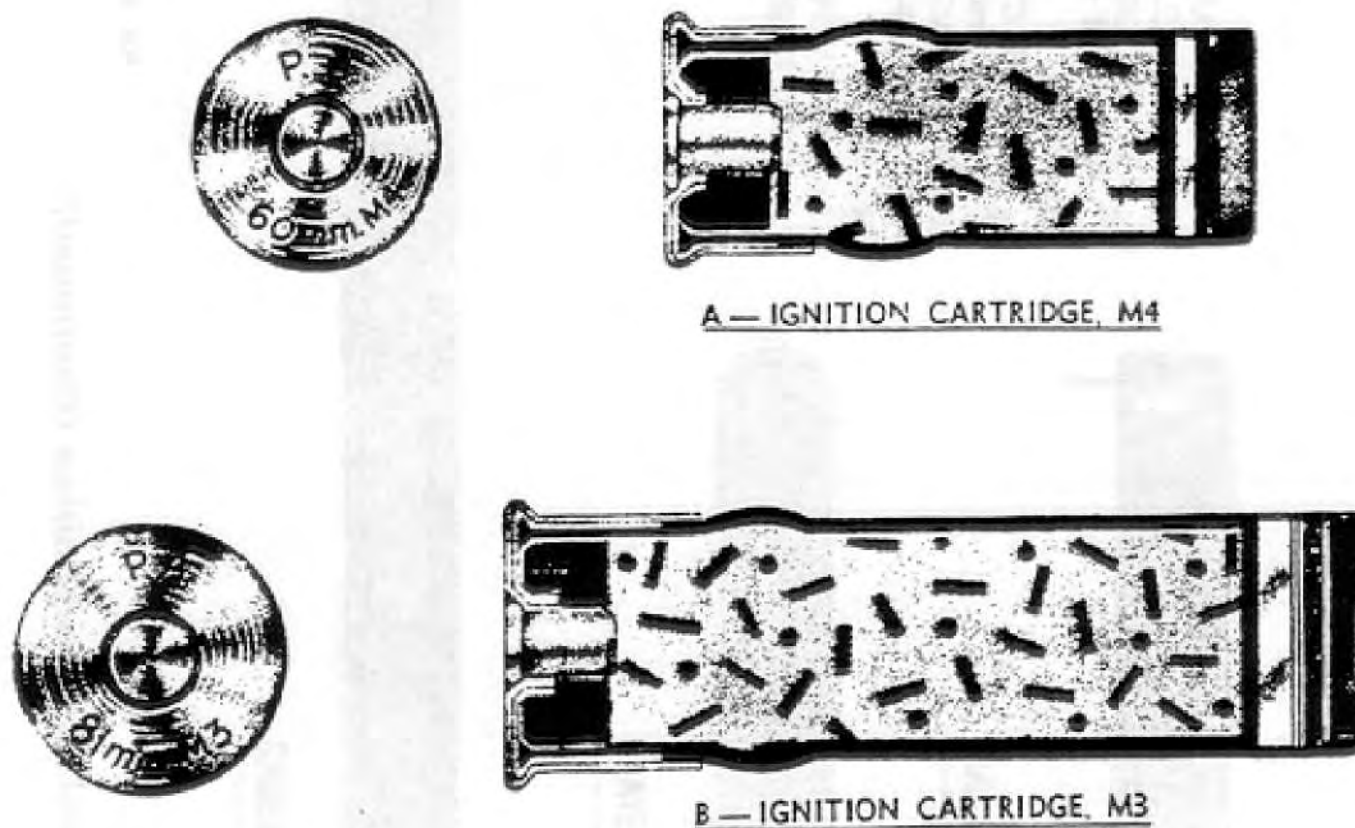

RA PD 65128

Figure 198 — The M3 and M4 Ignition Cartridges for Use With Mortar Ammunition.

inserted in the holes in the brass bases and is firmly held in position by means of a compressed paper wad that is crimped to the base and into which the primer is force fitted. After the powder charge is loaded, a series of three wads is inserted at the opposite end and the rim of the cylinder roll crimped to hold the wads in place. The complete assembly is then dipped in molten paraffin. The charge is 120 grains of propellant powder.

377. CARTRIDGE, IGNITION, M4 (fig. 198), is the propellant for the 60-mm M69 Training Shell. It is almost identical with the M3 Cartridge described in paragraph 376. The M3 Cartridge is larger. The outer wad of the M3 is made of greaseproof felt and has a bond paper disk on both faces; the M4 has a chipboard outer wad with a disk on its outer face only. The charge of the M4 Cartridge is 47 grains of commercial powder, known as Special Infallible Powder.

FUZES, PROPELLING CHARGES, PRIMERS, AND OTHER COMPONENTS

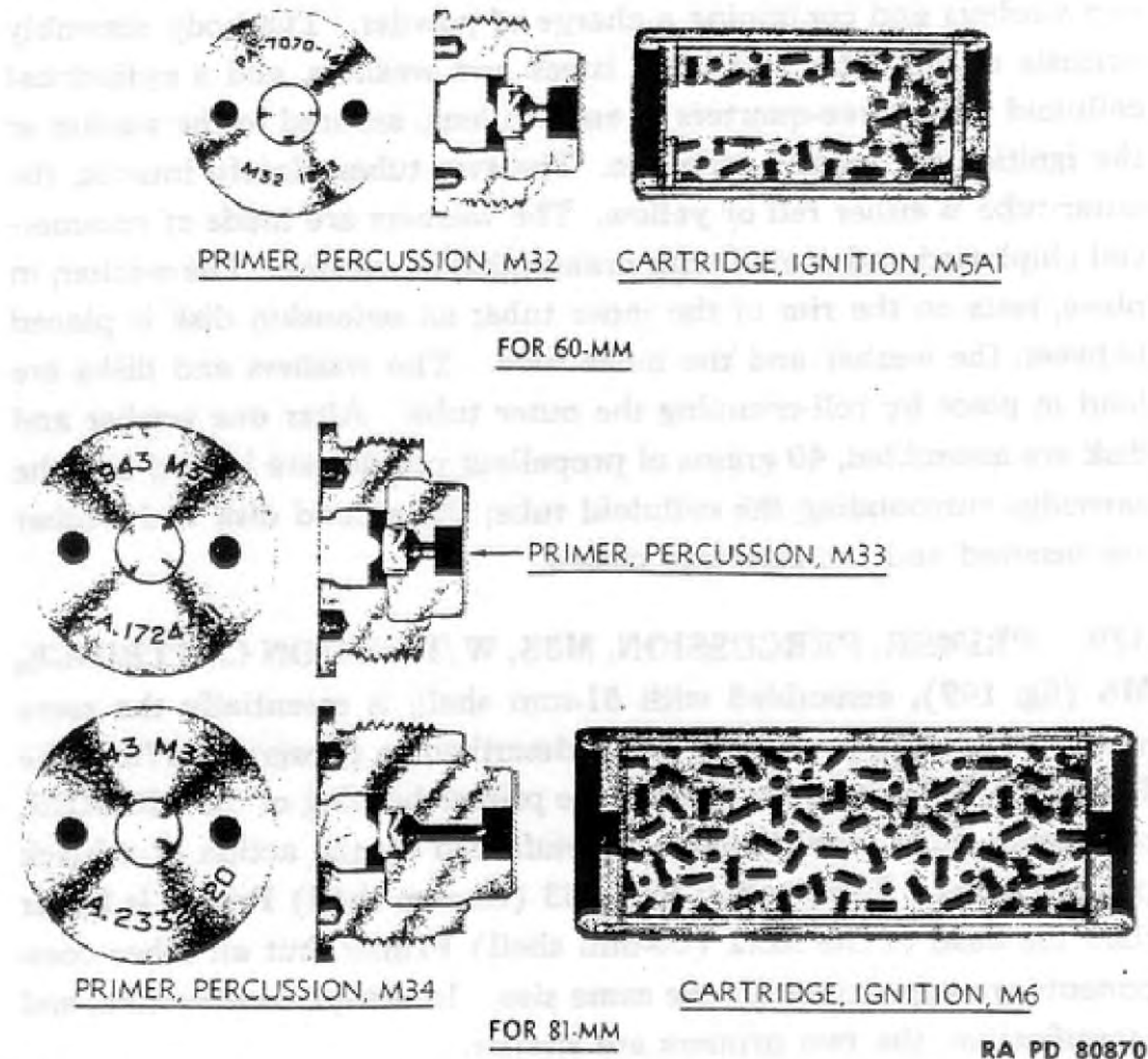

Figure 199 — Primers and Ignition Cartridges for Use With Mortar Ammunition

378. **PRIMER, PERCUSSION, M32, W/IGNITION CARTRIDGE, M5A1** (fig. 199), for use with 60-mm Shell M49A2, M50A2, M83A1, and M69 Training Shell, consists of a housing for a second primer (PRIMER, M35), a black powder pellet, and a head containing a firing plug. The head is made of steel and is threaded to fit in the fin assembly after the M5A1 Ignition Cartridge is inserted. A firing plug, made of brass, increases the area against which the firing pin may strike. The housing is made of steel and contains the PRIMER, M35, and a black powder pellet. This pellet, weighing 1.65 grains, amplifies the flame of the primer. This primer consists of a cup, the priming mixture, a disk of shellacked foiling paper, and an anvil. The metal parts are made of cartridge brass. The charge is a pellet of No. 70 primer mixture weighing 0.37 grain. The CARTRIDGE, ignition, M5A1, is a double paper tube enclosed at both ends by disks

ARTILLERY AMMUNITION

and washers and containing a charge of powder. The body assembly consists of the outer and inner tubes and washers, and a cylindrical celluloid tube, three-quarters of an inch long, secured to the washer at the ignition end of the cartridge. The two tubes closely interfit; the outer tube is either red or yellow. The washers are made of commercial chipboard and coated with orange shellac varnish. The washer, in place, rests on the rim of the inner tube; an onionskin disk is placed between the washer and the inner tube. The washers and disks are held in place by roll-crimping the outer tube. After one washer and disk are assembled, 40 grains of propellant powder are loaded into the cartridge surrounding the celluloid tube; the second disk and washer are inserted and the cartridge closed.

379. PRIMER, PERCUSSION, M33, W/IGNITION CARTRIDGE, M6 (fig. 199), assembled with 81-mm shell, is essentially the same as the **PRIMER, percussion M32**, described in paragraph 378. The **PRIMER, M35**, is housed within the primer housing of the **PRIMER, percussion, M33**, and its flame is reinforced by the action of a black powder pellet. The head of the **M33 (81-mm shell) Primer** is larger than the head of the **M32 (60-mm shell) Primer**, but all other components are approximately the same size. In action, construction, and identification, the two primers are similar.

380. PRIMER, PERCUSSION, M34, W/IGNITION CARTRIDGE, M6 (fig. 199), is standard for assembly with the 81-mm M56 Shell. It resembles in general appearance the **PRIMER, M32**, described in paragraph 378. The **M34 (81-mm) Primer** houses the **M35 Primer** as does the **M32 (60-mm)**. The major changes are in size. The over-all dimensions of the **M34** are: head—1.0 inch in diameter (**M32—0.82 in.**), 0.6 inch deep (**M32—0.57 in.**); primer housing—0.56 inch in diameter (**M32—0.50 in.**), 0.40 inch deep (**M32—0.26 in.**); disk—0.50 inch in diameter (**M32—0.44 in.**); firing plug—0.257 inch thick (**M32—0.227 in.**). All other general dimensions of the **M34 Primer** are the same as the **M32**. The black powder pellet in both primers has the same weight. The action of the two is identical. The **Ignition Cartridge M6** is, except for size, exactly the same as the **M5A1 Ignition Cartridge**, described in paragraph 378. It is 2.23 inches long after the ends are crimped, 0.795 inch in diameter, and has a 120-grain propellant powder charge.

FUZES, PROPELLING CHARGES, PRIMERS, AND OTHER COMPONENTS



RA PD 65129

Figure 200 — PRIMER, percussion, 17-grain, Mk. IIA4

381. **PRIMER, PERCUSSION, 17-GRAIN, MK. IIA4** (fig. 200), is used in ammunition for the 4.5-inch gun, 155-mm howitzers, 155-mm guns, 8-inch howitzer, 8-inch gun, and 240-mm howitzers. The primer is made of brass and consists of the body, percussion element assembly, conical gas check, closing disks, and the primer charge. The small charge (17-grains) of black powder contained in this primer is sufficient to ignite the igniter pad attached to the propelling charge. The firing pin of the gun strikes the primer cup directly. The conical gas check consists of a copper cone, and a brass plug. The cone is forced to the rear by the burning gas of the propelling charge and thus provides for obturation. The primer charge is held in place by the closing disk and beeswax, and sealed with shellac varnish. **PRIMER, percussion, 18-grain, Mk. IIA3**, and **PRIMER, percussion, 21-grain, Mk. II, Mk. IIA, and Mk. IIA1**, may be used until present stocks are exhausted. However, the **PRIMER, percussion, 21-grain Mk. IIA1**, is restricted to use in 155-mm howitzers only.

Section IV

BOOSTERS, ADAPTER-BOOSTERS, AND BURSTERS**382. BOOSTERS.**

a. **General.** Since the bursting charges of high-explosive shell are relatively insensitive to shock, a comparatively large detonating charge is necessary to insure a high-order detonation of the bursting charge. The use of more sensitive explosives, such as mercury fulminate or lead azide, in the quantities required for the purpose would create excessive hazards in handling and firing. Therefore, such explosives are used only in small amounts as initiating and intermediate detonating charges. A separate charge of somewhat less sensitivity (usually tetryl) is provided for detonating the high-explosive charge of the shell, and because its function is to increase or "boost" the effectiveness of the explosive train, this charge is known as a booster charge. The booster charge may be incorporated within the fuze itself, or may be encased in a thin casing of metal or plastic which is screwed permanently to and handled as a unit with the fuze, or inserted in the shell during manufacture. The assembled casing with booster charge is known as a booster. Some types are provided with a boresafety mechanism; these boosters usually contain one or more other charges in addition to the booster charge, such as an intermediate detonator or a lead charge. Types now in use are described below.

b. BOOSTER, M20, and M20A1.

(1) **GENERAL.** The M20 Booster and modification, M20A1, are used in conjunction with point fuzes, both impact and time types, to effect the functioning of fixed and semifixed high-explosive projectiles. The M20A1 differs from the M20 only in that it has a larger flash hole in the rotor cover; in other respects, construction and functioning are the same. The booster can be used in projectiles having a threaded fuze hole with a 2-inch diameter, 12 threads per inch, and with all fuzes having a threaded base 1.7 inches in diameter, 14 threads per inch, subject to certain conditions. When the booster is used with a powder train time fuze, the black powder magazine charge of the fuze should not exceed 20 grains. If a larger charge is used, a low-order detonation of the projectile may occur if the magazine charge of the time fuze should be ignited prematurely. For certainty of functioning, the booster should be fired only under conditions providing a setback force greater than 0.25 per grain. The M20 and M20A1 are used only in fixed and semifixed ammunition of 75-mm to 4.7-inch caliber and in the 8-inch High-explosive Shell M103, which are issued and shipped with the fuze assembled. The booster is handled as a manufacturing component of the projectile.

FUZES, PROPELLING CHARGES, PRIMERS, AND OTHER COMPONENTS

(2) **DESCRIPTION.** The following description is also applicable to the M21 and M21A1 Boosters with the exceptions cited in subparagraph c, below. The letters in parentheses herein refer to figure 201. The booster is made up of two major parts, a booster cup (N) which contains a tetryl booster charge (O) and screws onto a threaded brass body (A) containing a tetryl booster lead (M) and a rotor assembly. The rotor assembly is made up of a rotor (H) containing a lead azide-tetryl detonator (G), a centrifugally actuated pin (K), a centrifugal pin lock pin (P) which operates under set-back, a rotor stop pin (F), a rotor lock pin (I), and a rotor lock pin lock (J). The rotor is so seated on its pivot pin (L) that the detonator is normally out of alinement with other explosive elements in the booster and the assembled fuze. The center of gravity of the rotor assembly is off the centerline of the pivot center so that the assembly will rotate under centrifugal force. The rotor is locked in the unarmed position prior to firing by the spring-held centrifugal pin. The centrifugal pin in turn is held in the locking position by the centrifugal pin lock pin. The function of the rotor stop pin is to stop the rotor assembly when it has rotated to alined or armed position. The boresafety mechanism is covered at the forward end of the booster by a thin brass cover (D) which has a flash hole to permit the transmission of the fuze action to the detonator in the rotor of the booster. In the M20 Booster, this flash hole is one-eighth inch in diameter, in the M20A1 Booster, the diameter is increased to one-quarter inch to insure that the detonator will function properly. The flash-hole is covered by a thin disk of onionskin (E) paper to prevent foreign matter from entering the booster.

(3) **FUNCTIONING.** Upon firing, set-back forces the centrifugal pin lock pin rearward against its spring, freeing the centrifugal pin. When the projectile reaches the required rotational velocity, the centrifugal pin moves outward against its spring. This releases the rotor which then rotates to the alined or armed position, whereupon the rotor lock pin moves outward under centrifugal force from its cavity in the rotor and into the hole in the booster body. Creep force causes the rotor lock pin lock to move forward into the space behind the rotor lock pin, preventing the rotor lock pin from returning to its original position. Thus the booster is locked in the armed position throughout the flight of the projectile. Action of the detonator is initiated by the detonating elements, or magazine charge (in time fuzes), of the fuze. Explosion of the detonator is transmitted through the booster lead to the booster charge. The booster charge in turn detonates the high-explosive charge of the projectile.

(4) **PREPARATION FOR FIRING.** There is no preparation for firing.

ARTILLERY AMMUNITION

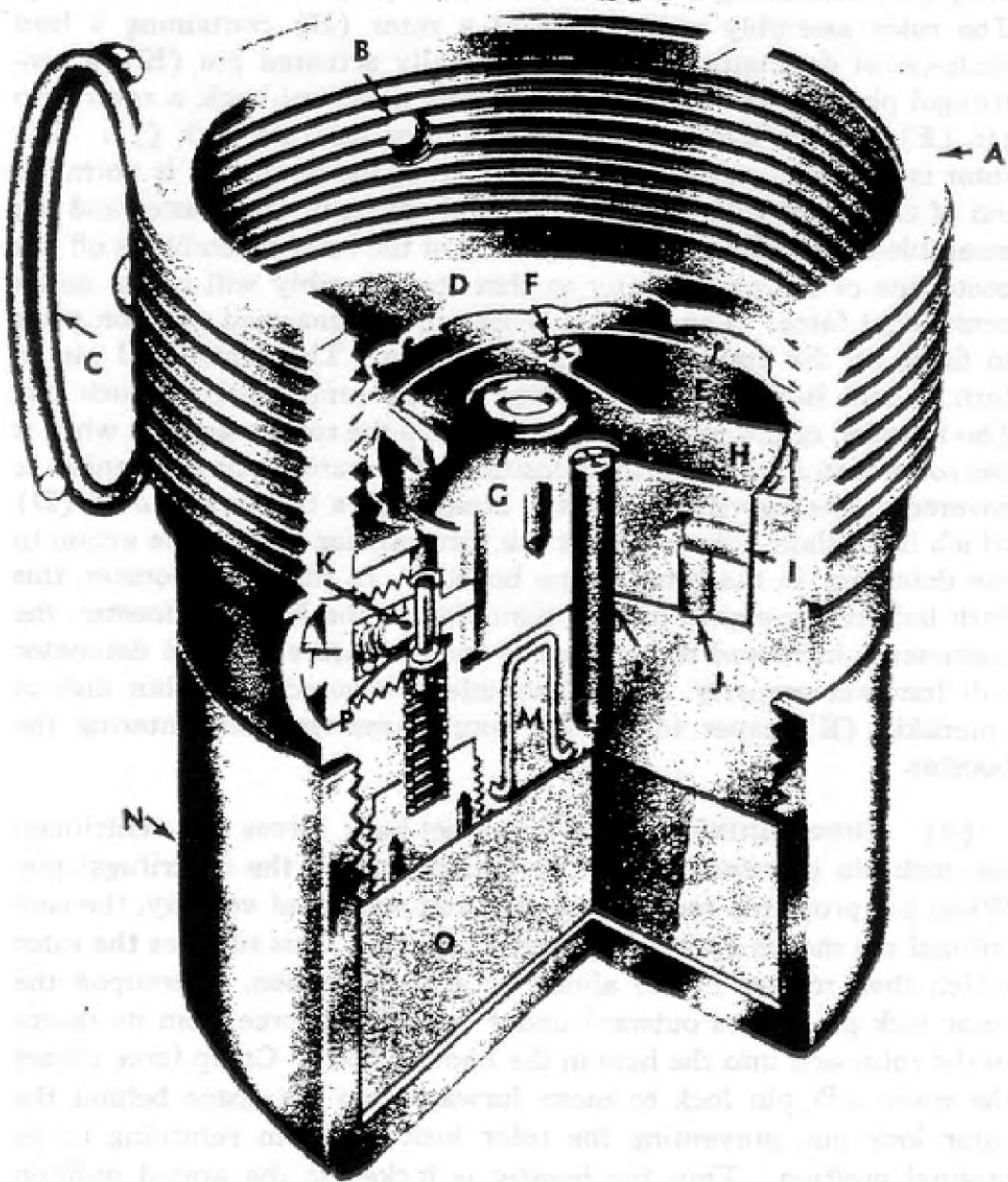

RA PD 80886

Figure 201 — BOOSTER, M21A2

FUZES, PROPELLING CHARGES, PRIMERS, AND OTHER COMPONENTS

c. BOOSTER, M21, M21A1, M21A2, and M21A4 (fig. 201).

(1) **GENERAL.** The M21, M21A1, M21A2, and M21A4 are companion boosters to the M20-series fuzes. Upon standardization, the M21 replaced the M20 for use with separately issued point fuzes, and to date this booster or a modification thereof has been used with such fuzes in projectiles of separate-loading ammunition of 4.5-inch caliber and larger. However, the boosters will fit any projectile with a threaded fuze hole with a 2-inch diameter, 12 threads per inch, and receive all fuzes having a threaded base 1.7 inches in diameter, 14 threads per inch. In normal use, the booster is assembled to the fuze during manufacture, the fuze and booster being handled thereafter as a unit, although the booster can be used in place of the M20 Boosters as a component of the shell. The M21A4 Booster has become standard for use in all fixed, semifixed, or separate-loading shell. A small hole (B) is drilled in the threaded upper portion of the booster to accommodate a set screw for securing the fuze to the booster. The set screw is staked in position after assembly.

(2) **DESCRIPTION.** In basic respects, construction and functioning are the same as for the M20 Boosters, described in subparagraph h, above. However, M21 Boosters are fitted with a safety (cotter) pin with pull ring (C) which holds the rotor in the unarmed position prior to assembling the fuze with booster to the projectile. The M21 and M21A1 Boosters differ from the M20 designs also in that the centrifugal pin lock pin (P) is omitted. The only difference between the M21 and M21A1 models is in the size of the flash-hole in the rotor cover. In the M21A1, the flash-hole has a one-quarter inch diameter, as compared with one-eighth inch in the M21. In the M21A2, a 2-piece centrifugal pin lock pin making use of a ball and socket joint to permit some "play" is incorporated in the booster. In the M21A4, the most recent production model, the centrifugal pin screw was shortened and the centrifugal pin lock removing pin was replaced by a single-piece type like that in the M20A1 Booster.

(3) **PREPARATION FOR FIRING.** The safety (cotter) pin must be removed before inserting the fuze and booster assembly into the shell.

ARTILLERY AMMUNITION

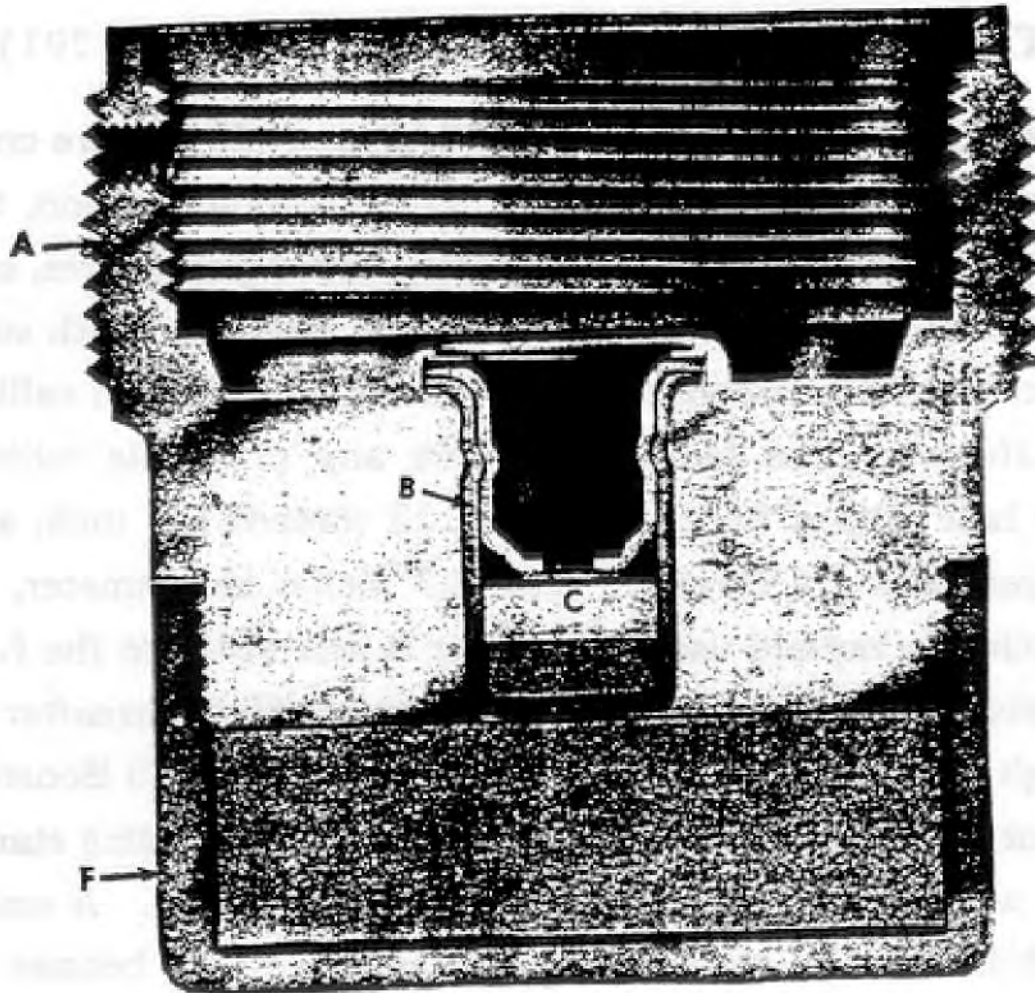

RA PD 80869

Figure 202 — BOOSTER, M22

FUZES, PROPELLING CHARGES, PRIMERS, AND OTHER COMPONENTS

d. **BOOSTER, M22** (fig. 202). The M22 Booster is used in conjunction with the M57 Superquick Fuze in 105-mm howitzer chemical shell to explode the shell burster charge. In outward respects, the booster is very similar to the M20 and M21 Boosters, and has the same threading. Internally the booster differs in that the rotor assembly is omitted, the body (A) being solid except for a drill hole through the center. This seats a detonator assembly (B) containing two pellets, one lead azide (C) and the other tetryl (D). The booster charge (E) is contained in a booster cup (F) screwed on the base end of the booster. Due to the omission of the rotor, the booster is not boresafe. There is a small threaded drill hole in the threaded upper part of the body similar to that in the M21-series boosters. However, unlike the M21's, the booster is handled as a manufacturing component of the shell, being screwed into the adapter of the projectile and locked in position by a set screw. The fuze is then screwed into the booster and secured in position by staking to the projectile.

e. **BOOSTER, M23**. The M23 Booster has superseded the older Navy Mk. XVII Booster as standard for SHELL, fixed, H.E., Mk. IX, for 3-inch antiaircraft guns. The thread diameter is 1.375 inches, the same as for the earlier Mk. XVII design, but a somewhat finer thread is used on the M23 (20NS-2 L.H. vs. 18NS-1 L.H.). The relatively small diameter is necessary since the Mk. IX Shell is fitted with an adapter which reduces the diameter of the fuze hole of the shell from 2.2 inches to 1.7 inches. This permits fuzing with modern-type fuzes such as the FUZE, time, mechanical, M43, and modification, currently standard for the shell. Since the Mk. IX Shell is limited standard, it is probable that this booster will be in use only until the present supply of shell is exhausted.

f. **BOOSTER, M24**. The M24 Booster has been standardized as an alternate for all modifications of the M20 and M21 Boosters, for all purposes for which these are authorized. The M24 Booster (fig. 203) consists of the body (A), which is threaded internally to take standard fuzes, and externally to fit in adapters or shell threads. The flash-hole (B) opens into the rotor chamber. The rotor (C) contains the detonator (D) and holds it out of line until the fuze arms. The rotor is held in unarmed position by the centrifugal rotor stop (H) which rides on a guide pin (I) and is held engaged to the rotor

ARTILLERY AMMUNITION

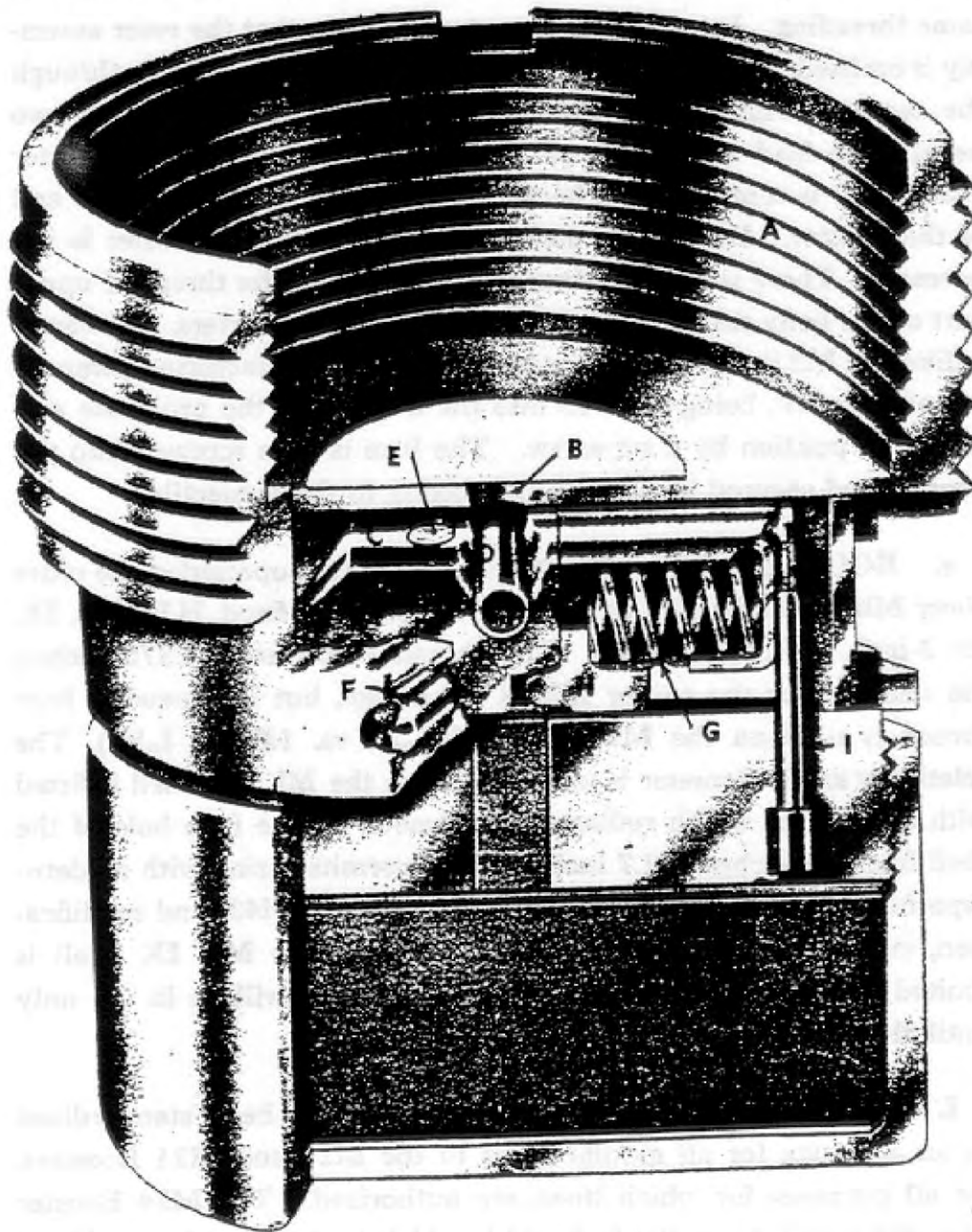

RA PD 65177

Figure 203 — BOOSTER, M24

FUZES, PROPELLING CHARGES, PRIMERS, AND OTHER COMPONENTS

by the centrifugal spring (G). The rotor chamber is closed by a plate (J). On firing the shell, centrifugal force causes the rotor stop to move outward against the spring and release the rotor which turns so that the detonator is alined with the flash-hole and the booster lead (K). On reaching this position, the rotor is locked in place by the lock pin (E) which enters the lock pin cavity as far as the closing plug (F). The booster charge (L) consists of a tetryl pellet. As a manufacturing modification, the booster body may be made of drawn brass with a brass insert. This modification is designated M24B1.

383. BURSTERS.

a. **General.** In chemical shell, the function of the explosive charge is to burst the shell casing and disperse the chemical contents. Hence, when used in chemical shell, the charges are generally known as burster charges, and the assembly as a burster. The burster, like the booster charge for high-explosive shell, consists essentially of a high-explosive charge in a suitable thin-walled container. Some early designs were similar to boosters, but modern types consist of a long assembly extending the length of the shell cavity. This insures a complete rupture of the shell and effective dispersion of the chemical filler.

b. **BURSTER, M8.** This burster is used in the M6 Burster casing in conjunction with a detonator assembly to rupture the casing and disperse the chemical filler of the M64 Chemical Shell for 75-mm howitzers. It extends the full length of the shell cavity. The burster casing is a press fit in the shell adapter and the burster charge is a loose fit in the casing. The burster consists of a 1-ounce tetryl charge loaded under pressure in an aluminum-alloy tubing approximately one-half inch in diameter and 7.9 inches long. The M6 Burster casing is made up of a seamless steel tubing seated at the forward end in a steel sleeve. The tubing is approximately $1\frac{3}{8}$ inches longer than the burster to allow space forward of the burster charge for the detonator assembly. An intermediate detonator is required for proper functioning of the burster charge since the M57 Fuze, which is standard for the M64 Shell, has no booster charge in its explosive train. The detonator assembly is held in position against the front end of the burster by a washer and spring clip.

c. **BURSTER, M1.** This burster is used in the M2 Burster casing with the 3-inch and 81-mm Mortar Chemical Shell M57. The assembly resembles that used with 75-mm howitzer shell (subpar. b, above) but differs in that the burster charge is smaller, and that no intermediate detonating charges are necessary. The M1 Burster consists of approximately 0.6 ounce of tetryl loaded under pressure in an

ARTILLERY AMMUNITION

aluminum-alloy tubing 0.39 inch in diameter and 9.82 inches long. The M2 Burster casing is made up of a seamless steel tubing with internal dimensions approximately the same as the external measurements of the burster, seated at the forward end in a steel sleeve. The assembly is constructed so as to be a press fit in the adapter of the M57 Shell, and extends approximately three-quarters of the length of the shell cavity. Action of the burster is initiated by the M52 Fuze, which has a booster assembled thereto.

d. **BURSTER, M5.** This burster is used in the M5 Burster casing with the M60 Chemical Shell for 105-mm howitzers. The assembly is essentially the same as the M1 Burster in the M2 Casing, described in subparagraph c, above, in construction and manner of functioning but differs in various details. The M5 Burster charge is somewhat heavier, weighing approximately 3 ounces. The charge is loaded in an aluminum tube 12.42 inches long; the over-all length of the assembly is 12.62 inches and extends the full length of the shell cavity. The burster assembly has no auxiliary charges; however, the M22 Booster is a manufacturing component of the M60 Shell for use with the M57 Fuze, which is standard for this shell.

e. **BURSTER, M6.** This burster is used in the M1 Burster casing with the Mk. VIIA1 Chemical Shell for 155-mm guns. The assembly also is standard for the Mk. IIA1, Mk. IIA1-Mod. 1, and the Chemical Shell M105 and M110 for 155-mm howitzers. These shell are adapted for the M51 Fuze or modifications, which are issued with an M21-series booster assembled to the fuze. In construction and functioning, the burster assembly is basically the same as those described in the preceding paragraphs; differences are chiefly with respect to size and weight of the charge. The M6 Burster charge consists of approximately 5.8 ounces of tetryl or tetryl and TNT mixture, a relatively heavy charge being necessary due to the large size of the shell as compared with those with which the other assemblies of this type are used. The assembly is 20.67 inches long and extends the full length of the shell cavity.

384. ADAPTERS AND ADAPTER-BOOSTERS.

a. **Adapters.** The openings in the nose of most modern projectiles are threaded to conform to the requirements of the fuzes. With this and the greater standardization of fuze threading, interchangeability is obtained without modifications. However, in chemical shell, and in many high-explosive shell of earlier design, openings in the nose are considerably larger than required by the fuzes, in order to facilitate manufacture and loading of the projectiles. For such shell, a suitably threaded metal bushing, called an adapter, is necessary to

FUZES, PROPELLING CHARGES, PRIMERS, AND OTHER COMPONENTS

reduce the size of the opening to conform to the threaded portion of the fuze. Interchangeability is obtained by using the appropriately sized adapter required for different fuzes and projectiles. In chemical shell, the adapter has an additional function, that of providing a gas-tight seal for the chemical filler, hence, threads of adapters for older chemical shell have tapered (pipe) threads. Modern chemical shell have standard machine threads, gastightness being obtained by other means, such as sealing.

b. **Adapter-boosters.** In some cases, the booster or burster has been combined with the adapter, the two assemblies thereafter being handled as a unit. Such combinations are known as adapter-boosters. Assemblies of this kind are no longer widely used, due to the greater standardization in fuze and fuze-hole sizes and the use, in more recent chemical shell design, of a separate burster and adapter. Adapter-boosters now in use, chiefly in shell of relatively early design, are described below and illustrated in figure 204.

c. **ADAPTER-BOOSTER, Mk. III** (fig. 204). The Mk. III Adapter-booster is used in the Mk. I High-explosive Shell for 75-mm guns to adapt the shell for use with the M46 and M47 Fuzes and to provide the necessary booster charge to supplement the detonator charges of those fuzes. The booster consists of a thin-walled tubular steel casing (B) approximately 1 1/8 inches in diameter and 3 1/2 inches long (over-all) containing a 1-ounce booster charge (A) of tetryl in the form of four pellets. The booster is permanently assembled to the adapter (E) during manufacture by screwing the loaded casing into the base end of the steel adapter after first coating the booster threads with glue. A cup-shaped brass fuze socket (C) closes the front end of the booster and protects the booster charge against moisture; one or more felt washers (D) are placed under the flange of the fuze socket to insure a tight fit upon assembly. A felt washer is fitted around the booster and secured to the base of the adapter to provide a tight seating when the adapter-booster is assembled in the shell. The adapter is threaded externally with 1.5-12NS-1 threads to suit the nose opening of the shell, and is drilled and threaded internally with Löwenherz threads (major diam, 0.9275 in., 12.7 threads per in.) to receive the M46 and M47 Fuzes. As the fuzes are not assembled to the shell until just prior to firing, an adapter plug (F) with ring is fitted to the adapter for protection against entrance of foreign matter during shipment and storage.

d. **ADAPTER-BOOSTER, Mk. IIAM2.** The Mk. IIAM2 Adapter-booster is used with Mk. III High-explosive Shell for 155-mm guns. It adapts the shell for use with the M46 and M47 Fuzes. The assembly is essentially the same as the Mk. III Adapter-booster described above, and performs the same functions. However, the

ARTILLERY AMMUNITION

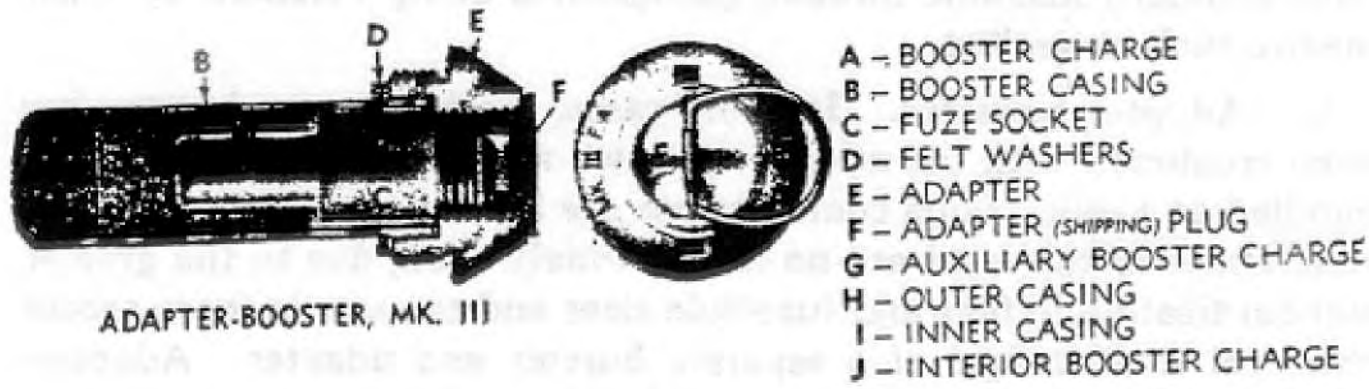

ADAPTER-BOOSTER, MK. III

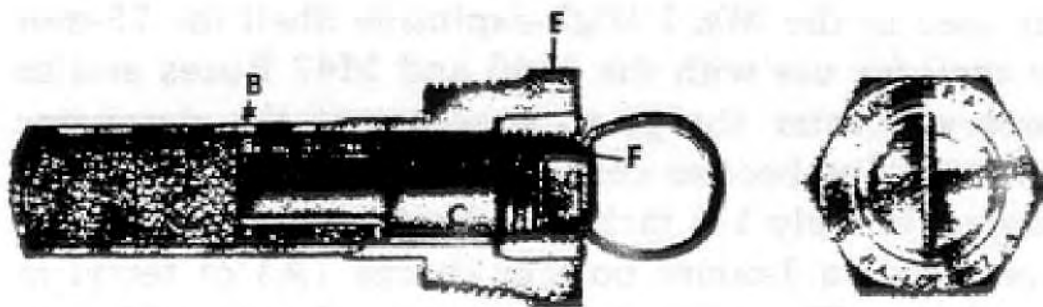

ADAPTER-BOOSTER, MK IVMI

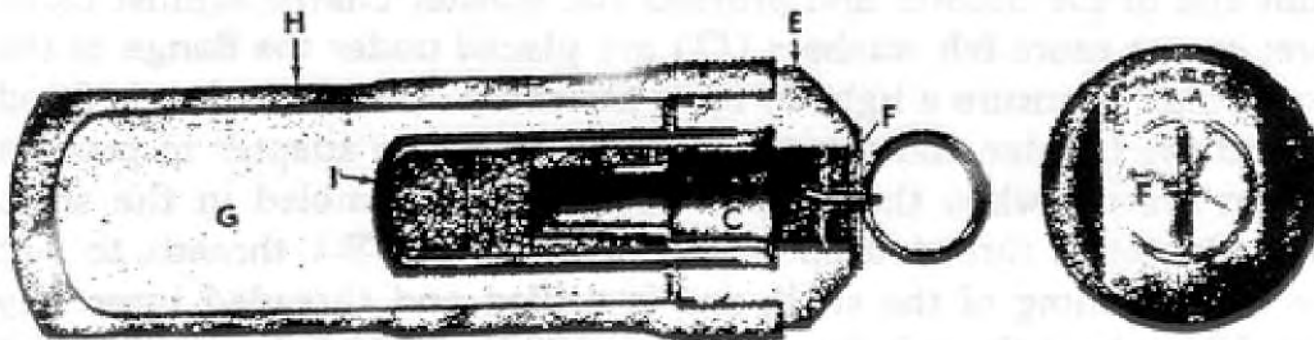

ADAPTER-BOOSTER, MK. VIB

RA PD 80887

Figure 204 - Adapter-boosters

FUZES, PROPELLING CHARGES, PRIMERS, AND OTHER COMPONENTS

adapter has a larger diameter and is threaded with 2.5-8NS-1 threads to suit the opening in the nose of the 155-mm shell. Like the Mk. III Adapter-booster, the Mk. IIIAM2 is fitted with a plug (an eyebolt-lifting plug) to prevent the entrance of foreign matter and to facilitate handling during shipment and storage.

e. **ADAPTER-BOOSTER, Mk. IVMI** (fig. 204). The Mk. IVMI Adapter-booster has superseded the Mk. IVB, an earlier type very similar to the Mk. IVMI, as standard for the Mk. II Chemical Shell for 75-mm guns. The Mk. IVMI has a hexagonal head whereas the Mk. IVB has an octagonal head. Although termed an adapter-booster, the function of the explosive charge contained in the assembly is to rupture the Mk. II Shell casing and disperse the chemical filler. The booster, or burster charge (A) is held in a thin-walled tubular steel casing (B) which is welded to the steel adapter (E). Since the adapter must provide a gastight seal for the chemical filler of the shell as well as a seat for the fuze, the external threads are tapered (pipe threads). The adapter is drilled and threaded internally at the front end with 1.233-16NS-1 threads to receive a steel bushing which seats the fuze. The bushing has Löwenherz threads (major diam, 0.9275 in., 12.7 threads per in.) to suit the M46 Fuze, which is standard for the Mk. II Shell. A cup-shaped brass fuze socket (C), pressed into the assembly after the burster charge has been loaded and held in position by the bushing, protects the burster charge against moisture. As the fuze is not assembled to the shell until just prior to firing, an adapter plug with ring (F) is screwed into the adapter to prevent entrance of foreign matter.

f. **ADAPTER-BOOSTER, Mk. IVB**. The Mk. IVB is an earlier type of adapter-booster for the Mk. II Chemical Shell for 75-mm guns. It has been superseded as standard by the Mk. IVMI, to which it is very similar, but may still be found in Mk. II Shell of earlier manufacture. The Mk. IVB has an octagonal head as compared with the hexagonally headed Mk. IVMI.

g. **ADAPTER-BOOSTER, Mk. VIB** (fig. 204). The Mk. VIB Adapter-booster is used with Mk. II Chemical Shell for 155-mm howitzers and Mk. VII Chemical Shell for 155-mm guns. The assembly serves three purposes: to provide an explosive charge capable of rupturing the shell casing and scattering the chemical filler; to provide a gastight seal for the shell; and to adapt the shell for use with the M46 Fuze. Because of the relatively large chemical filler in the 155-mm shell, a larger explosive charge is required to burst the shell and disperse the contents than in the case of the 75-mm shell, which uses the Mk. IVMI Adapter-booster. Hence, an auxiliary booster charge (G) is used in the Mk. VIB assembly. The interior charge of tetryl (J) is held in a thin-walled tubular casing (I) which screws

ARTILLERY AMMUNITION

in the adapter (E). The adapter with interior booster screws into a larger outer tubular casing (H) which holds the 0.56-pound auxiliary booster, or burster, charge of TNT. The outer booster casing is threaded externally at the front end with tapered (pipe) threads to provide the required gastight fit in the nose opening of the shell. The adapter is threaded internally with the Löwenherz threads (major diam, 0.9275 in., 12.7 threads per in.) As the fuze is not assembled to the shell until just prior to firing, an adapter plug (F) is fitted in the adapter for protection against foreign matter and easier handling during shipment and storage.

the 75-mm gun. The Mk IVB has an auxiliary booster, or burster, charge of TNT. The outer booster casing is threaded externally at the front end with tapered (pipe) threads to provide the required gastight fit in the nose opening of the shell. The adapter is threaded internally with the Löwenherz threads (major diam, 0.9275 in., 12.7 threads per in.) As the fuze is not assembled to the shell until just prior to firing, an adapter plug with ring (F) is screwed into the adapter to prevent entrance of foreign matter.

1. ADAPTER-BOOSTER, MK IVB. The Mk IVB is an adapter-booster for the Mk II Chemical Shell for 75-mm gun. It is based upon the adapter-booster for the Mk IV shell of earlier construction. The Mk IVB has an auxiliary booster charge of TNT. The outer booster casing is threaded externally at the front end with tapered (pipe) threads to provide the required gastight fit in the nose opening of the shell. The adapter is threaded internally with the Löwenherz threads (major diam, 0.9275 in., 12.7 threads per in.) As the fuze is not assembled to the shell until just prior to firing, an adapter plug with ring (F) is screwed into the adapter to prevent entrance of foreign matter.

2. ADAPTER-BOOSTER, MK VII. The Mk VII adapter-booster is used with Mk II Chemical Shell for 155-mm gun and Mk VII Chemical Shell for 155-mm gun. The adapter-booster provides an auxiliary booster charge of TNT. The outer booster casing is threaded externally at the front end with tapered (pipe) threads to provide the required gastight fit in the nose opening of the shell. The adapter is threaded internally with the Löwenherz threads (major diam, 0.9275 in., 12.7 threads per in.) As the fuze is not assembled to the shell until just prior to firing, an adapter plug with ring (F) is screwed into the adapter to prevent entrance of foreign matter.

FUZES, PROPELLING CHARGES, PRIMERS, AND OTHER COMPONENTS

Section V

EYEBOLT-LIFTING PLUGS AND GROMMETS

385. EYEBOLT-LIFTING PLUGS.

a. Complete rounds or separate-loading projectiles which are issued and shipped unfuzed are fitted with a suitable plug to protect against the entrance of foreign matter into the fuze hole during shipment, storage, and handling. For unfuzed fixed and semifixed ammunition, which normally is packed in individual sealed containers, the plug consists of a felt washer with a brass ring attached to the outer

TABLE 7
TYPES OF EYEBOLT-LIFTING PLUGS

Type of Plug	Ammunition With Which Used	Thread Size	Over-all Length (in.)	Diameter of Eyebolt (in.)	Weight (lb)
Type "A"	Mk. III High-explosive Shell for 155-mm Guns M1917-17A-18MI Mk. VII Chemical Shell for 155-mm Gun M1918MI	0.9225-12.7-Löwenherz	2.60	2.00	0.25
Type "F"	Mk. I and Mk. IV High-explosive Shell for 155-mm Howitzers M114 High-explosive Shell for 240-mm Howitzer M1	0.9225-12.7-Löwenherz	3.52	2.00	0.7
Type "G"	M65 High-explosive Shell for 4.5-inch gun M107 and Mk. IA1 High-explosive Shell for 155-mm howitzers M105, M115, M116, Mk. IIA1, Mk. IIA1-Mod. 1 and Mk. IA1 Chemical Shell for 155-mm howitzers M104 Chemical, and M101 and Mk. IIIA1 High-explosive Shell for 155-mm Guns M1917-17A1-18MI, M1, and M1A1 Mk. VIIA1 Chemical Shell for 155-mm Guns, M1917-17A1-18MI	2-12NS-1	3.825	2.25	1.75
Type "H"	SHELL, empty, for sand loading, 95-lb., Mk. I, 155-mm how., M1917-19A1-18 SHELL, empty, for sand loading, 95-lb., Mk. III, 155-mm guns M1917-17A1-18MI	2.5-8NF-1	3.625	2.25	2.25

surface for easier removal when fuzing the projectile. For unfuzed separate-loading projectiles which, generally, are shipped without packing, the plug is a screw-in type made of steel or malleable iron, with an eyebolt on the outer surface to facilitate handling. Several types of such eyebolt-lifting plugs are provided, the essential difference between the types being with respect to the size and type of threads. Types most generally encountered in the field, and characteristic thereof, are given in table 7. See also figure 205.

386. GROMMETS.

a. **Types.** To provide the necessary protection for the relatively fragile rotating bands, projectiles shipped without packing are fitted with a grommet or ring of suitable material. Several types have been manufactured, the earliest of which is a rope grommet cut to required length and looped at both ends. When one grommet is required, it is placed directly over or in front of the rotating band or, in the case of double-banded shell, between the bands. Two grommets are required for overseas shipments, placed one behind and one in front of the band. Rope grommets are secured in position by hemp twine drawn tightly through the two end loops and secured by a slipknot. A more recent type consists of a split ring of thin steel faced on the inner surface by a fiber liner of approximately one-eighth inch thickness. This grommet is designed to cover the entire rotating band and to seat on the projectile without pressure on the band. It is secured in position by soft wire drawn tightly through the notches provided in the rim for the purpose, as described in subparagraph b (2), below, and illustrated in figure 206. A less widely used third type (the rubber grommet), designed for use with 155-mm shell, is similar to the fiber-steel grommet in that it covers the entire rotating band. However, it is made up of a steel core with a rubber cushioning faced on the end and lower surfaces with cotton sheeting (fig. 207).

b. **Method of Securing Metal-fiber Grommets.** Metal fiber grommets should be assembled to the projectile as follows:

(1) Make a hairpin bend in the tying wire 2 inches from end (A). Slip end (A) into the tying slot (D) moving the end inside of the metal grommet toward tying slot (C) as far as the hairpin bend will allow it to go.

(2) Weave the long end (B) from tying slot (D) outside of the metal grommet, passing the wire through the metal jacket opening, between the grommet and the shell, then through tying slot (C).

(3) Press the metal grommet as tight to the shell as possible and, while holding in place, pull the wire tight with pliers and bend the

FUZES, PROPELLING CHARGES, PRIMERS, AND OTHER COMPONENTS

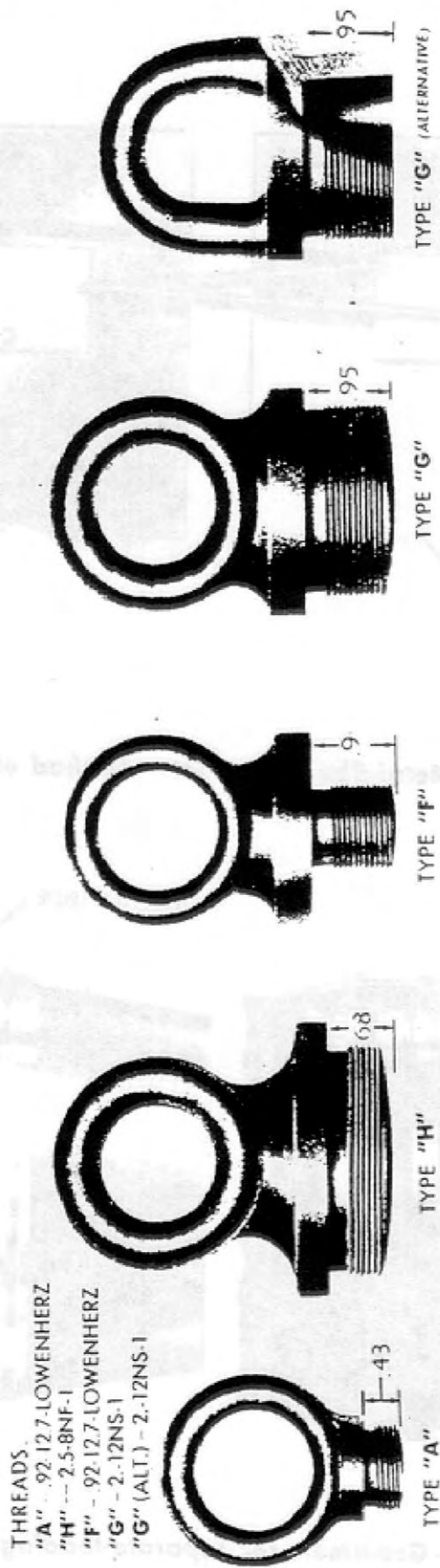

RA PD 80690

Figure 205 — Eyebolt-lifting Plugs for Separate-loading Projectiles

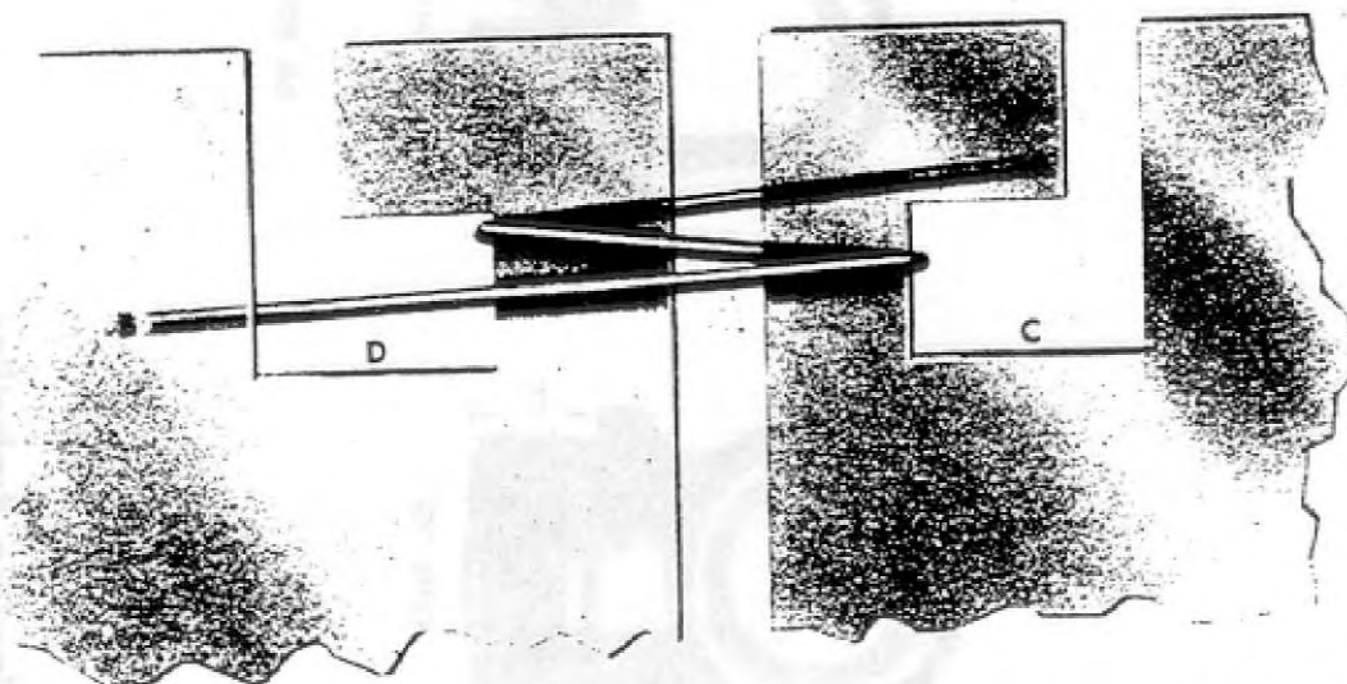

RA PD 65133

Figure 206 — Metal-fiber Grommet — Method of Assembly

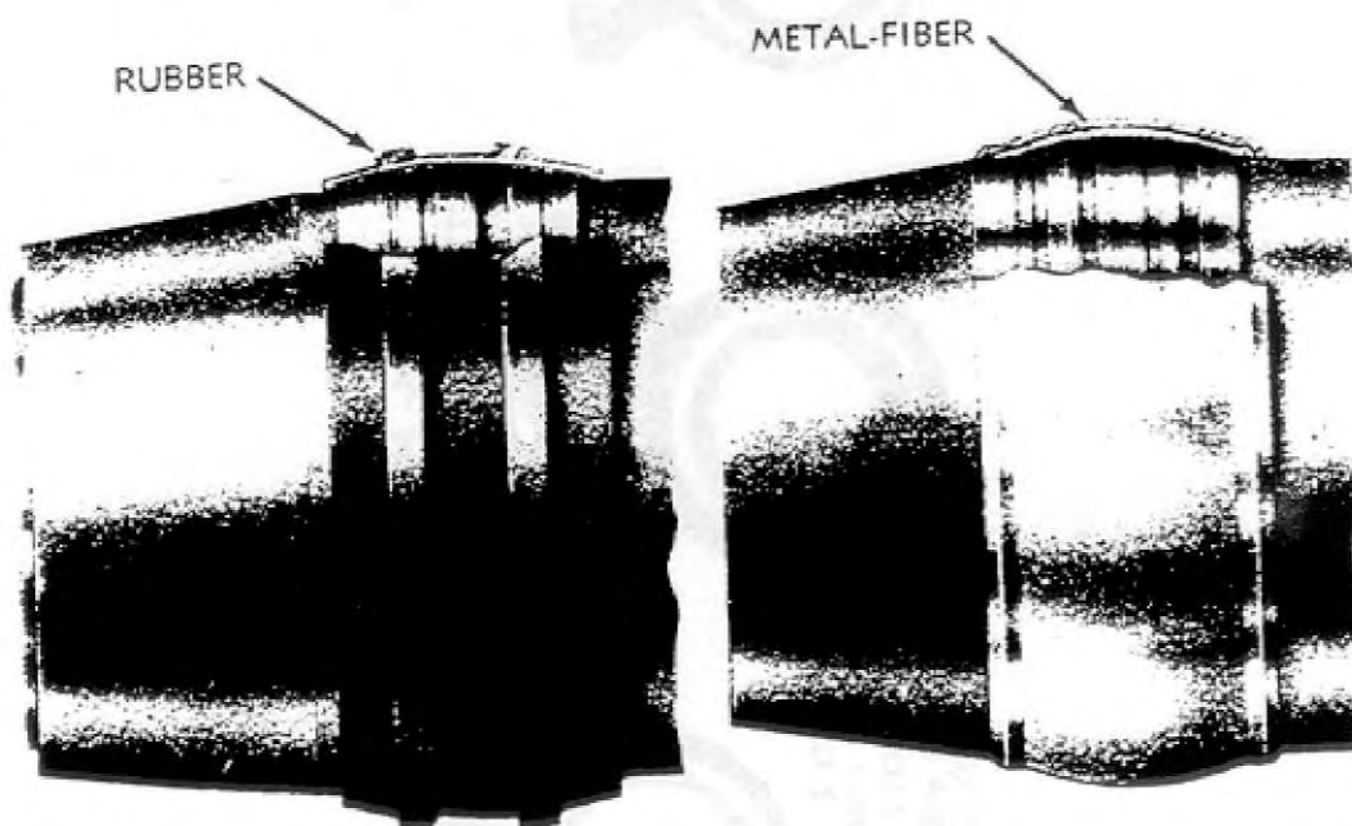

RA PD 80689

Figure 207 — Grommets for Separate-loading Projectiles

FUZES, PROPELLING CHARGES, PRIMERS, AND OTHER COMPONENTS

wire toward the tying slot (D). While holding the wire tight, tap the bend lightly with a hammer so that it will have the smallest possible radius.

(4) Push the end (B) through tying slot (D) between the shell and the grommet as far as it will go.

(5) It is most essential that the band be held as tight to the shell as possible during the wire-tying operation. It is recommended that a suitable jig be improvised locally to hold the band firmly to the shell during the above operation.

ARTILLERY AMMUNITION

CHAPTER 4

**DESTRUCTION OF AMMUNITION UPON IMMINENCE
OF CAPTURE IN COMBAT ZONE**

387. GENERAL.

a. When immediate capture of ammunition is threatened by a turn of events in the combat zone and when the ammunition cannot be evacuated, it will be as completely destroyed or damaged as available time, equipment, materials, and personnel will permit.

b. The destruction of ammunition will be accomplished only on authority delegated by the division or higher commander.

c. The methods used will require imagination, initiative, and ingenuity, and should be the simplest which will accomplish the desired purpose.

388. METHODS.

a. Ammunition can be destroyed most quickly by detonation or burning.

(1) **DETONATION.** Unpacked high-explosive rounds, separate-loading high-explosive shell, and high capacity items such as antitank mines, bangalore torpedoes, bursters or caps, packed or unpacked, may be destroyed by placing them in contact in piles and detonating them with a charge of TNT, using with blasting cap and sufficient safety fuse to permit reaching cover at 200 yards. About 1 pound of TNT per 100 pounds of ammunition as packed, should be sufficient.

(2) **BURNING.** All other types of ammunition such as packed high-explosive rounds and propelling charges, small-arms ammunition, grenades, pyrotechnics, etc., packed or unpacked, can most rapidly be destroyed by burning. The ammunition may be piled in the containers (except small-arms cartridges which should be broken out) with all available inflammable material as wood, rags, brush, and cans or drums of gasoline. The gasoline should be poured over the pile and ignited from cover. Rounds that come through the fire unexploded will be in the nature of duds, that is, in a condition dangerous to handle.

INDEX TO COMPLETE ROUND TABLES*

349	TABLE 8	30-mm Gun Ammunition
350	9	37-mm Gun Ammunition
352	10	40-mm Gun Ammunition
354	11	57-mm Gun Ammunition
355	12	60-mm Rocket Ammunition
356	13	75-mm Gun Ammunition
358	14	75-mm Howitzer Ammunition
359	15	75-mm Gun Ammunition
360	16	81-mm Gun Ammunition
362	17	81-mm Rocket Ammunition
364	18	90-mm Gun Ammunition
365	19	COMPLETE ROUND TABLES
367	20	105-mm Gun Ammunition
368	21	105-mm Gun Ammunition
369	22	120-mm (4.2-inch) Gun Ammunition
370	23	155-mm Howitzer Ammunition
372	24	155-mm Gun Ammunition
373	25	8-inch Howitzer Ammunition
375	26	8-inch Gun Ammunition
377	27	140-mm Howitzer Ammunition
378	28	160-mm Howitzer Ammunition

CHAPTER 5

COMPLETE ROUND TABLES

* These tables are to be used in connection with the ammunition section in Chapter 2 and are to be read in conjunction with the complete round tables in Chapter 5.

ARTILLERY AMMUNITION

INDEX TO COMPLETE ROUND TABLES*

	Page
TABLE 8. 20-mm Gun Ammunition	349
9. 37-mm Gun Ammunition	350
10. 40-mm Gun Ammunition	352
11. 57-mm Gun Ammunition	354
12. 60-mm Mortar Ammunition	355
13. 75-mm Gun Ammunition	356
14. 75-mm Howitzer Ammunition	358
15. 76-mm Gun Ammunition	359
16. 3-inch Gun Ammunition	360
17. 81-mm Mortar Ammunition	363
18. 90-mm Gun Ammunition	364
19. 105-mm Howitzer Ammunition	365
20. 105-mm Gun Ammunition	367
21. 4.5-inch Gun Ammunition	368
22. 120-mm (4.7-inch) Gun Ammunition	369
23. 155-mm Howitzer Ammunition	370
24. 155-mm Gun Ammunition	373
25. 8-inch Howitzer Ammunition	375
26. 8-inch Gun Ammunition	376
27. 240-mm Howitzer Ammunition	377
28. 37-mm Subcaliber Ammunition	378

* These tables are to be used in conjunction with the ammunition sections in Chapter 2 and are not to be confused with official Complete Round Charts, Form No. 5981.

TABLE 8
COMPLETE ROUND TABLE FOR AMMUNITION FOR 20-MM GUNS

(This table is not to be confused with official Complete Round Charts, Form No. 5981.)

Note References	Designation of Cannon	PROJECTILE				FUZE		Cartridge Case ¹	PROPELLING CHARGE		PRIMER			
		Kind	Type	Model	Weight as Fired (lb.)	Type and Model	Action		Kind	Weight (lb.)	Model	Type		
													Kind	Model
Service Ammunition														
—	A	CARTRIDGE	HE-I	Mk. I	0.025	Tetryl ²	0.29	P.D., Mk. II or III	S.Q.	M21A1	FNH, I.M.R. 4879	0.07	M36	2.1-gr. perc.
—	A	CARTRIDGE	AP-T	M75	—	None	0.37	None	—	M21A1	FNH, I.M.R. 4879	0.07	M36	2.1-gr. perc.
—	A	CARTRIDGE	AP-T	T9E5(M95)	—	None	0.29	None	—	M21A1	FNH, I.M.R. 4879	0.07	M36A1	2.1-gr. perc.
—	A	CARTRIDGE	HE-I	T23 (M97)	0.017	Tetryl ²	0.29	P.D., T71E4 (M75)	S.Q.	M21A1	FNH, I.M.R. 4879	0.07	M36A1	2.1-gr. perc.
—	A	CARTRIDGE	Incendiary	T18 (M96)	Incendiary mixture	0.020	0.27	None	—	M21A1	FNH, I.M.R. 4879	0.07	M36A1	2.1-gr. perc.
Practice Ammunition														
—	A	CARTRIDGE	Ball	—	—	None	0.28	None	—	M21A1	FNH, I.M.R. 4879	0.07	M36	2.1-gr. perc.
—	A	CARTRIDGE	Practice	T24 (M99)	—	None	0.29	None	—	M21A1	FNH, I.M.R. 4879	0.07	M36A1	2.1-gr. perc.
Drill Ammunition														
—	A	CARTRIDGE	Drill	M18A1	—	None	—	None	—	—	None	—	None	—
—	A	CARTRIDGE	Drill	M18	—	None	—	None	—	—	None	—	None	—

AP-T—armor-piercing-tracer gr.—grain
 FNH—flashless nonhygroscopic HE-I—high-explosive-incendiary
 A—20-mm guns, M1, AN-M2, M3, and Br. H.S./A/ (Aircraft).
 1—M21A1 (brass) is standard cartridge case. Rounds may also be assembled with steel cartridge case, M21A1B1, weighing 0.017 lb. less than brass case and are restricted to ground and training use only within continental U. S.
 2—Plus incendiary composition.
 P.D.—point-detonating perc.—percussion S.Q.—superquick

TABLE 9
COMPLETE ROUND TABLE FOR AMMUNITION FOR 37-MM GUNS
 (This table is not to be confused with official Complete Round Charts, Form No. 5981.)

Note Refer-ences	Designation of Cannon	PROJECTILE				FUZE			PROPELLING CHARGE			PRIMER		
		Kind	Type	Model	Filler		Type and Model	Action	Cartridge Case	Kind	Weight (Lb.)		Model	
					Kind	Weight (Lb.)								Weight as Fired (Lb.)
Service Ammunition														
2, 3	M1A2 and AN-M9	SHELL	H.E.	M54	Tetryl	0.10	1.34	P.D., M56	Supersensitive	M17	FNH, M1	0.38	M38A2	55-gr. perc.
2, 4	M1A2	SHOT	A.P.C.	M59A1	None	—	1.91	None	—	M17	FNH, M1	0.31	M38A2	55-gr. perc.
4	AN-M9	SHOT	A.P.C.	M59A1	None	—	1.91	None	—	M17	FNH, M5	0.52	M38A2	55-gr. perc.
3, 4	M1A2	SHOT	A.P.C.	M59	None	—	1.91	None	—	M17	FNH, M1	0.31	M38A2	55-gr. perc.
4	AN-M9	SHOT	A.P.C.	M59	None	—	1.91	None	—	M17	FNH, M5	0.52	M38A2	55-gr. perc.
3, 4, 5	M1A2	SHOT	A.P.	M74	None	—	1.92	None	—	M17	FNH, M1	0.25	M38A2	55-gr. perc.
4, 5	AN-M9	SHOT	A.P.	M80	None	—	1.66	None	—	M17	FNH	0.56	M38A2	55-gr. perc.
6	M3, M3A1, M5, M5A1, M6	CANISTER	—	M2	Steel balls	122 balls	1.89	None	—	M16	FNH, M1	0.48	M38A2	55-gr. perc.
6, 8	M3, M3A1, M5, M5A1, M6	SHELL	H.E.	M63	TNT	0.085	1.61	B.D., M58	Nondelay	M16	FNH, M1	0.44	M38A2	55-gr. perc.
4, 6	M3, M3A1, M5, M5A1, M6	SHOT	A.P.	M74	None	—	1.92	None	—	M16	FNH, M1 or M5	0.44	M38A2	55-gr. perc.
4, 6, 7, 9	M3, M3A1, M5, M5A1, M6	SHOT	A.P.C.	M51	None	—	1.92	None	—	M16	FNH, M1 or M5	0.15	M38A2	55-gr. perc.
2, 6	AN-M4, M10	SHELL	H.E.	M54	Tetryl	0.10	1.34	P.D., M56	Supersensitive	Mk. IIIA2	FNH, M2	0.16	M38A2	55-gr. perc.
4, 6	AN-M4, M10	SHOT	A.P.	M80	None	—	1.66	None	—	Mk. IIIA2	FNH, M2	0.14	M38A2	55-gr. perc.
Practice Ammunition														
3, 4	M1A2 and AN-M9	SHELL	Practice	M55A1	None	—	1.34	Dummy, M50	Inert	M17	FNH, M1 or M2	0.38	M38A2	55-gr. perc.
4, 6	M3, M3A1, M5, M5A1, M6	SHOT	T.P.	M51A2	None	—	1.92	None	—	M16	FNH, M1	0.44	M23A1	20-gr. perc.
4, 6	M3, M3A1, M5, M5A1, M6	SHOT	T.P.	M51A1	None	—	1.92	None	—	M16	FNH, M1	0.44	M23A1	20-gr. perc.
4, 6	AN-M4, M10	SHELL	Practice	M55A1	None	—	1.34	Dummy, M50	Inert	Mk. IIIA2	FNH, M2	0.15	M38A2	55-gr. perc.
Blank Ammunition														
10	M3, M3A1, M5, M5A1, M6	AMMUNITION	Blank	No projectile	—	—	—	—	—	M28	Blk. Pwdr.	0.20	M23A2	20-gr. perc.
10	M1916, M3, M3A1, M5, M5A1, M6	CARTRIDGE	Blank, 10-gage	No projectile	—	—	—	—	—	Commercial type shotgun cartridge	—	—	—	—

TABLE 9 (Contd.)
COMPLETE ROUND TABLE FOR AMMUNITION FOR 37-MM GUNS (Contd.)

Note References	Designation of Cannon	PROJECTILE				FUZE		Cartridge Case	PROPELLING CHARGE		PRIMER	
		Kind	Type	Model	Weight as Fired (Lb.)	Type and Model	Action		Kind	Weight (Lb.)	Model	Type
		Drill Ammunition										
	M1A2 and AN-M9	CARTRIDGE	Drill	M21	None	—	Dummy, M50B2	Inert	M17B1	None	None	None
11	M3, M3A1, M5, M5A1, M6	CARTRIDGE	Drill	M13	None	—	None	—	M16	None	None	None
11	M3, M3A1, M5, M5A1, M6	CARTRIDGE	Drill	M—(T5)	None	—	None	—	M16	None	None	None
11	AN-M4, M10	CARTRIDGE	Drill	M23(T31)	None	—	None	—	None	None	None	None

A.P.—armor-piercing
A.P.C.—armor-piercing-capped
B.D.—base-detonating
Blk. pwdr.—black powder
F.N.H.—flashless nonhygroscopic
H.E.—high-explosive
P.D.—point-detonating
perc.—percussion
T.P.—target practice

1—PRIMER, percussion, 55-grain, M38, and modifications now standard for 37-mm ammunition, superseding M23 and modifications for future manufacture.
2—Shell has a shell-destroying tracer.
3—Alternative rounds also assembled with steel cartridge case for M1A2 gun only.
4—Projectile contains a tracer.
5—Some projectiles have been manufactured which do not contain a tracer.
6—Alternative rounds also assembled with steel cartridge case which weighs 0.22-lb. less than standard brass case.
7—Propelling charge shown is for rounds of 2600 f/s muzzle velocity. Rounds of current manufacture to have 2900 f/s muzzle velocity when assembled with brass cartridge cases.
8—Rounds of current manufacture have 2600 f/s muzzle velocity. Rounds of older manufacture have 2700 f/s muzzle velocity.
9—Projectile may be marked M51, M51B1 or M51B2. Rounds are identical in functioning the B1 and B2 designations signifying manufacturing alternatives. For restrictions on shipments, see SNL R-1.
10—For use with ADAPTER, M1, 37-mm gun, M1916, and ADAPTER, M2, 37-mm gun, M3, M3A1, M5, and M6, when the cartridge is used with the guns specified.
11—Assembled from inert service components. For positive identification, holes are drilled in the cartridge cases. Cartridges not so drilled will not be used for drill purposes.

TABLE 10
COMPLETE ROUND TABLE FOR AMMUNITION FOR 40-MM GUNS¹
 (This table is not to be confused with Official Complete Round Charts, Form No. 5981)

Note References	Designation of Cannon	PROJECTILE				FUZE		SD Tracer ²	Cartridge Case	PROPELLING CHARGE		PRIMER	
		Kind	Type	Model	Kind	Weight (lb.)	Action			Kind	Weight (lb.)	Model ³	Type
4	M1	CARTRIDGE	AP-T	M81A1	None	—	1.96	None	—	FNH	0.72	M38A1	55-gr. perc.
4	M1	CARTRIDGE	AP-T	M81	None	—	1.96	None	—	FNH	0.72	M38A1	55-gr. perc.
—	M1	CARTRIDGE	HE	Mk. I (Navy)	TNT	0.1	2.0	P.D., Mk. 27	S.Q.	FNH, M1	0.66	Mk. 22	64-gr. perc.
4	M1	CARTRIDGE	HE-T	Mk. II	TNT	0.15	1.93	P.D., No. 251, Mk. I	S.Q.	FNH	0.72	M38A1	55-gr. perc.
4	M1	CARTRIDGE	HE-T	Mk. II	TNT	0.14	1.96	P.D., M64A1	S.Q.	FNH	0.72	M38A1	55-gr. perc.
4	M1	CARTRIDGE	HE-T	Mk. II	TNT	0.168	1.93	P.D., Mk. 27	S.Q.	FNH	0.72	M38A1	55-gr. perc.
5	M1	CARTRIDGE	HE-T	Mk. II	TNT	0.14	1.96	P.D., M64A1	S.Q.	FNH	0.68	M38A1	55-gr. perc.
5	M1	CARTRIDGE	HE-T	Mk. II	TNT	0.168	1.93	P.D., Mk. 27	S.Q.	FNH	0.68	M38A1	55-gr. perc.
5	M1	CARTRIDGE	HE-T	Mk. II	TNT	0.168	1.93	P.D., M71	S.Q.	FNH	0.68	M38A1	55-gr. perc.
5	M1	CARTRIDGE	HE-T	Mk. II	Tetryl ⁴	0.05	2.06	P.D., Mk. 27	S.Q.	FNH	0.68	M38A1	55-gr. perc.
5	M1	CARTRIDGE	HE-T	Mk. II	Tetryl ⁴	0.05	2.06	P.D., M64A1	S.Q.	FNH	0.68	M38A1	55-gr. perc.
4	M1	CARTRIDGE	HE-T	Mk. II	Tetryl ⁴	0.05	2.06	P.D., M64A1	S.Q.	FNH	0.72	M38A1	55-gr. perc.
5	M1	CARTRIDGE	HE-T	Mk. II	Tetryl ⁴	0.05	2.06	P.D., Mk. 27	S.Q.	FNH	0.68	M38A1	55-gr. perc.
5	M1	CARTRIDGE	HE-T	Mk. II	Tetryl ⁴	0.05	2.06	P.D., M64A1	S.Q.	FNH	0.68	M38A1	55-gr. perc.
4	M1	CARTRIDGE	HE-T	Mk. II	TNT	0.07	1.99	P.D., Mk. 27	S.Q.	FNH	0.72	M38A1	55-gr. perc.
4	M1	CARTRIDGE	HE-T	Mk. II	TNT	0.07	1.99	P.D., M71	S.Q.	FNH	0.72	M38A1	55-gr. perc.

Service Ammunition

TABLE 10 (Contd.)
 COMPLETE ROUND TABLE FOR AMMUNITION FOR 40-MM GUNS¹ (Contd.)

Note References	Designation of Cannon	PROJECTILE			FUZE		SD Tracer ²	Cartridge Case	PROPELLING CHARGE		PRIMER			
		Kind	Type	Model	Kind	Weight (Lb.)			Model	Type	Kind	Weight (Lb.)	Model	Type
4	M1	CARTRIDGE	TP-T	M91	None	—	1.96	Dummy, M69 ³	—	M25	FNH	0.72	M38A1	55-gr. perc.
4	M1	CARTRIDGE	HE-T	Mk. II	Inert loaded	—	1.99	Dummy, M69 ³	—	M25	FNH	0.72	M38A1	55-gr. perc.
7	M1	CARTRIDGE	Drill	M17	None	—	—	None	—	None	None	—	None	—

Practice Ammunition

Drill Ammunition

AP-T—armor-piercing-tracer
 FNH—flashless nonhydroscopic
 gr.—grain
 *—Tracer for observation purposes only.
 †—Or Mk. II-Mod. 2 SD Tracer.
 ‡—Or M69B1 dummy fuze or an inert service fuze.
 1—Data in this table is based on standard components. Rounds may be found which have been assembled from similar components procured from other services. Interchanged components can be identified by the marking.
 2—M25, a brass case, is standard. Substitute standard is M25B1, a steel case.
 3—M38A1 primer is standard for American manufacture, superseding M23A1 which may still be found in rounds of earlier manufacture. M38B2 and Mk. 22 (Navy) are alternatives.
 4—Muzzle velocity, 2,870 f/s.
 5—Muzzle velocity 2,700 f/s.
 6—Or tetryl and explosive D. Includes black powder pellet.
 7—One-piece simulating cartridge case, projectile and fuze.

TABLE 11
COMPLETE ROUND TABLE FOR AMMUNITION FOR 57-MM GUNS

(This table is not to be confused with official Complete Round Charts, Form No. 5981.)

Note Refer- ences	Designation of Cannon	PROJECTILE				FUZE		Car- tridge Case ¹	PROPELLING CHARGE		PRIMER			
		Kind	Type	Model	Weight as Fired (lb.)	Type and Model	Action		Kind	Weight (lb.)	Model ²	Type		
													Kind	Weight (lb.)
3	M1, 6 Pr. 7 Cwt.	CARTRIDGE	APC-T	M86	Exp. D	0.094	7.27	B.D., M72	Delay	M23A2	NH, M1	2.43	M1B1A2	100-gr. perc.
4	M1, 6 Pr. 7 Cwt.	CARTRIDGE	APC-T	M86	None	—	6.71	None	—	M23A2	NH, M1	2.25	M1B1A2	100-gr. perc.
4	M1, 6 Pr. 7 Cwt.	CARTRIDGE	AP-T	M70	None	—	6.28	None	—	M23A2	NH, M1	2.62*	M1B1A2	100-gr. perc.

Service Ammunition

AP-T—armor-piercing tracer
APC-T—armor-piercing-capped tracer
Exp. D—explosive D
B.D.—base detonating
NH—nonhydroscopic
gr.—grain
perc.—percussion

1—M23A2 is standard. Substitute standard is CASE, cartridge, 57-mm, M23A2B1, a steel case.
2—M1B1A2 is standard primer. Alternative is: PRIMER, percussion, 100-grain, M1A2.
3—Fuse, B.D., M72, contains a tracer, burning time approximately 4.5 seconds in flight.
4—Projectile contains a tracer, burning time approximately 4.5 seconds in flight.
*—Weight of charge for production of muzzle velocity of 2,950 f/s. Weight of charge for round with muzzle velocity of 2,800 f/s is 2.25 lbs.

TABLE 12
COMPLETE ROUND TABLE FOR AMMUNITION FOR 60-MM MORTARS

(This table is not to be confused with official Complete Round Charts, Form No. 5981.)

Note Refer-ences	Designation of Weapon	PROJECTILE			FUZE		PROPELLING CHARGE		PRIMER		IGNITION CARTRIDGE				
		Kind	Type	Model	Kind	Weight as Fired (lb.)	Type and Model	Action	Model	Weight (Grains)	Model	Type	Model	Weight of Charge (Grains)	
Service Ammunition															
1	M1, M2	SHELL	H.E.	M49A2	TNT	0.34	2.952 [†]	P.D., M52	Superquick	M3	140.	M32	1.65-gr. perc.	M5A1	40.
1	M1, M2	SHELL	ILL'G	M83A1	△	0.49	3.75	Time (fixed), M65	15-sec.	M3	140.	M32	1.65-gr. perc.	M5A1	40.
Practice Ammunition															
2	M1, M2	SHELL	PRACTICE	M50A2	(Inert Material)	0.29	2.96 [‡]	P.D., M52	Superquick	M3	140.	M32	1.65-gr. perc.	M5A1	40.
2, 3	M1, M2	SHELL	PRACTICE	M50A1		0.37	2.96	P.D., M52	Superquick	M3	140.	—	—	M4	47.
Training Ammunition															
2, 4	M1, M2	SHELL	TRAINING	M69	None	—	4.53	None	—	None	—	—	—	M4	47.

gr.—grain H.E.—high-explosive Blk. pdr.—black powder I.L.G.—illuminating P.D.—point-detonating sec.—seconds TNT—trinitrotoluene

△—Standard illuminating composition (barium nitrate and aluminum), plus a priming and first-fire charge.
 †—Weight with M52B1 (plastic) fuze is 2.78 pounds.
 ‡—Full charge consists of 4 increments or bundles weighing 35 grains each.
 1—In addition to inert filler, there is a black powder charge of 0.05 lb.
 2—M4 ignition cartridge includes a commercial-type primer.
 4—If the M4 ignition cartridge is not available, the combination of M32 percussion primer and M5A1 ignition cartridge may be used.

TABLE 13
COMPLETE ROUND TABLE FOR AMMUNITION FOR 75-MM GUNS
 (This table is not to be confused with official Complete Round Charts, Form No. 5981.)

Note References	Designation of Cannon	PROJECTILE				FUZE			Booster, Adapter, Booster, or Burstur	Cartridge Case ¹	PROPELLING CHARGE		PRIMER		
		Kind	Type	Model	Kind	Model	Type and Model	Action			Kind	Weight (lb.)	Model	Type	
															Weight as Fired (lb.)
7, 8	A, B, C	PROJECTILE	A.P.C.	M61A1	Exp. D	0.144	14.96	B.D., M66A1	Delay	None	M18	FNH, M1 (super)	2.00	M31A2	150-gr. perc.
7	B	PROJECTILE	A.P.C.	M61A1	Exp. D	0.144	14.96	B.D., M66A1	Delay	None	M18	FNH ² (super)	2.00	M31A2	150-gr. perc.
7, 8	A, B, C	PROJECTILE	A.P.C.	M61	Exp. D	0.144	14.96	B.D., M66A1	Delay	None	M18	FNH, M1 (super)	2.00	M31A2	150-gr. perc.
8, 9	A, B, C	PROJECTILE	A.P.C.	M61	None	—	14.40	None	—	None	M18	FNH, M1 (super)	2.00	M31A2	150-gr. perc.
7	B	PROJECTILE	A.P.C.	M61	Exp. D	0.144	14.96	B.D., M66A1	Delay	None	M18	FNH ² (super)	2.00	M31A2	150-gr. perc.
8, 9	B	PROJECTILE	A.P.C.	M61	None	—	14.40	None	—	None	M18	FNH ² (super)	2.00	M31A2	150-gr. perc.
—	A, C	SHELL	Gas	M64	CNS	1.10	15.01	P.D., M57	SQ	M6	M18	FNH	2.00	M31A2	150-gr. perc.
—	A	SHELL	Gas	Mk. II	NC	—	—	P.D., M46	SQ	Mk. IVM1	M18	FNH, M1 (normal)	1.35	M22A1	75-gr. perc.
—	A	SHELL	Gas	Mk. II	H	1.33	12.33	P.D., M46	SQ	Mk. IVM1	M18	FNH, M1 (normal)	1.35	M22A2	75-gr. perc.
—	A	SHELL	H.E.	M48	TNT	1.47	14.70	P.D., M48A2 ³	SQ & 0.15-sec. Delay	M20A1 ⁴	M18	FNH, M2 (reduced)	0.59	M22A3	75-gr. perc.
—	A, C	SHELL	H.E.	M48	TNT	1.47	14.70	P.D., M48A2 ³	SQ & 0.15-sec. Delay	M20A1 ⁴	M18	FNH, M1 (normal)	1.15	M22A3	75-gr. perc.
—	A, C	SHELL	H.E.	M48	TNT	1.47	14.70	P.D., M48A2 ³	SQ & 0.05-sec. Delay	M20A1 ⁴	M18	FNH, M1 (super)	2.00	M31A2	150-gr. perc.
—	A	SHELL	H.E.	M48	TNT	1.47	14.70	TSQ, M54	Time & SQ	M20A1 ⁴	M18	FNH, M2 (reduced)	0.59	M22A3	75-gr. perc.
—	A	SHELL	H.E.	M48	TNT	1.47	14.70	TSQ, M54	Time & SQ	M20A1 ⁴	M18	FNH, M1 (normal)	1.15	M22A3	75-gr. perc.
—	A	SHELL	H.E.	M48	TNT	1.47	14.70	TSQ, M54	Time & SQ	M20A1 ⁴	M18	FNH, M1 (super)	2.00	M31A2	150-gr. perc.
8	B	SHELL	H.E.	M48	TNT	1.47	14.70	P.D., M57	SQ	M20A1 ⁴	M18	FNH (super)	2.00	M31A2	150-gr. perc.
—	B	SHELL	H.E.	M48	TNT	1.47	14.70	P.D., M57	SQ	M20A1 ⁴	M18	FNH ² (super)	1.93	M34A2	150-gr. perc.
—	A, C	SHELL	H.E.	Mk. I	TNT	1.64	12.44 ⁵	P.D., M46 or M47 ⁶	SQ or Delay ⁶	Mk. III	M18	FNH, M2 (reduced)	0.56	M22A2	75-gr. perc.
—	A, C	SHELL	H.E.	Mk. I	TNT	1.64	12.44 ⁵	P.D., M46 or M47 ⁶	SQ or Delay ⁶	Mk. III	M18	FNH, M1 (normal)	1.35	M22A2	75-gr. perc.
—	A, C	SHELL	H.E.	Mk. I	TNT	1.64	12.44 ⁵	P.D., M46 or M47 ⁶	SQ or Delay ⁶	Mk. III	M18	NC, M2 (reduced)	0.56	M22A2	75-gr. perc.
—	A, C	SHELL	H.E.	Mk. I	TNT	1.64	12.44 ⁵	P.D., M46 or M47 ⁶	SQ or Delay ⁶	Mk. III	M18	NC, M1 (normal)	1.35	M22A2	75-gr. perc.
—	A	SHELL	Smoke	Mk. II	FM	1.68	12.69	P.D., M46	SQ	Mk. IVM1	M18	FNH, M1 (normal)	1.35	M22A2	75-gr. perc.
—	A	SHELL	Smoke	Mk. II	FS	1.90	12.90	P.D., M46	SQ	Mk. IVM1	M18	FNH, M1 (normal)	1.35	M22A2	75-gr. perc.

TABLE 13 (Contd.)
COMPLETE ROUND TABLE FOR AMMUNITION FOR 75-MM GUNS (Contd.)

Note Refer- ences	Design- ation of Cannon	PROJECTILE			FUZE		Booster, Adapter, Booster, or Burstor	Cart- ridge Case	PROPELLING CHARGE		PRIMER			
		Kind	Type	Model	Kind	Weight (Lb.)			Kind	Weight (Lb.)	Model	Type		
	A, C	SHELL	Smoke	Mk. 11	WP	1.81	P.D., M46	SQ	Mk. 1VM1	M18	FNH, M1 (normal)	1.35	M22A1	75-gr. perc.
	D	SHELL	Smoke	M64	WP	1.34	P.D., M57	SQ	M6	M18	FNH	2.00	M31A2	150-gr. perc.
	C	SHELL	Smoke, B.I.	M89	HC	3.03	None	—	None	M18	FNH, M2	0.219	M31A2	150-gr. perc.
8, 9, 10	A, B, C	SHOT	A.P.	M72	None	—	None	—	None	M18	FNH, M1 (super)	1.90	M31A2	150-gr. perc.
9, 10	B	SHOT	A.P.	M72	None	—	None	—	None	M18	FNH ² (super)	1.90	M31A2	150-gr. perc.
10	A	SHRAPNEL	—	Mk. 1	270 lead balls	15.98	Comb., 21-sec., M1907M	Time & perc.	None	M18	NC	1.60	Mk. 1	49-gr. perc.
10	A	SHRAPNEL	—	Mk. 1	270 lead balls	15.98	Comb., 21-sec., M1907M	Time & perc.	None	M18	FNH	1.72	M1B1	100-gr. perc.
	A, C	AMMUNITION	Blank	No projectile	—	—	—	—	—	M9A1	Single pellet	0.43	M1B1A2	100-gr. perc.
	A, C	AMMUNITION	Blank	No projectile	—	—	—	—	—	M9A1	Double pellet	0.87	M1B1A2	100-gr. perc.

Service Ammunition (Contd.)

Blank Ammunition

Drill Ammunition

	A, C	CARTRIDGE	Drill	M7	None	—	Inert, comb. 21-sec., M1907M	Inert	None	—	None	—	None	—
	A, B, C	CARTRIDGE	Drill	M16	None	—	Dummy, M59	Inert	None	—	None	—	None	—

A.P.C.—armor-piercing-capped
 A.P.—armor-piercing
 B.D.—base detonating
 P.D.—point detonating
 TSQ—time and superquick
 SQ—superquick
 H.E.—high-explosive
 Exp. D—explosive D
 CNS—chloroacetophenone and chlorpicrin
 in chloroform
 NC (filler)—chlorpicrin-stannic chloride
 H—mustard gas
 FM—titanium tetrachloride
 FS—chlorosulfonic acid-sulfur trioxide mixture
 HC—hexachlorethane-zinc mixture
 WP—white phosphorus
 B.I.—base-ignition
 FNH—flashless nonhygroscopic
 NC (propelling charge)—nitrocellulose
 gr.—grain
 perc.—percussion

A—M1897, M1916, and M1917 guns. C—M2, M3, and T7 guns.
 B—M4, AN-M5, M5A1, and T13E1 guns. D—M1897, M2, M3, and T7 guns, only.
 1—Substitute standard is the M18B1 (steel case) which weighs approximately 0.22 pound less than the standard brass case. The M18B1 steel case will not be used in the M4, AN-M5, M5A1, and T13E1 aircraft guns.
 2—Contains 1% potassium sulfate for use in aircraft guns.
 3—FUZE, P.D., M48A2, is standard and has either 0.05-second or 0.15-second delay as indicated in table. Rounds may also be assembled with the M48 (0.05-second delay) or M48A1 (0.15-second delay) fuze. Time fuzes may also be found which are modified to have different delays than indicated herein.
 4—Other boosters may be M20, or M21A4.
 5—Weight with M46 fuze. With M47 fuze the weight is 12.41.
 6—Unfuzed as shipped. Fitted with adapter closing plug. The M46 has superquick action and M47 is a delay fuze.
 7—Fuze contains a tracer for observation purposes.
 8—This round is not flashless in the 75-mm aircraft guns, M4, AN-M5, M5A1, and T13E1, and will only be issued for these guns until the flashless aircraft rounds are available.
 9—Projectile contains a tracer for observation purposes.
 10—Issued for training (target-practice).

TABLE 14
COMPLETE ROUND TABLE FOR AMMUNITION FOR 75-MM HOWITZERS

(This table is not to be confused with official Complete Round Charts, Form No. 5981.)

Note Refer-ences	Designation of Cannon	PROJECTILE				FUZE			Booster, Adapter-Booster, or Burstler	Car-tridge Case*	PROPELLING CHARGE		PRIMER ^a	
		Kind	Type	Model	Kind	Weight (Lb.)	Type and Model	Action			Kind	Weight (Lb.)	Model	Type
Service Ammunition														
1	M1, M1A1, M2, M3	SHELL	H.E., A.T.	M66	Pentolite	1.00	B.D., M62 or M62A1	Nondelay	None	M5A1	FNH, M2	1.04	M1B1A2	100-gr. perc.
1-3	M1, M1A1, M2, M3	SHELL	H.E.	M48	TNT	1.49	P.D., M48A2 ³	S.Q. & 0.15-sec. Delay	M20A1	M5A1	FNH, M1	1.06	M1B1A2	100-gr. perc.
1-3	M1, M1A1, M2, M3	SHELL	H.E.	M48	TNT	1.49	TSQ., M54	Time & S.Q.	M20A1	M5A1	FNH, M1	1.06	M1B1A2	100-gr. perc.
3	M1, M1A1, M2, M3	SHELL	H.E.	M41A1	TNT	1.11	P.D., M48A ³	S.Q. & 0.15-sec. Delay	M20	M5A1	FNH, M1	1.04	M1B1A1	100-gr. perc.
3	M1, M1A1, M2, M3	SHELL	H.E.	M41A1	TNT	1.11	TSQ., M54	Time & S.Q.	M20	M5A1	FNH, M1	1.04	M1B1A1	100-gr. perc.
1-4	M1, M1A1, M2, M3	SHELL	Smoke	M64	WP	1.35	P.D., M57	S.Q.	M6	M5A1	FNH, M1	1.04	M1B1A2	100-gr. perc.
1-4	M1, M1A1,	SHELL	Gas	M64	H	1.04	P.D., M57	S.Q.	M6	M5A1	FNH, M1	1.04	M1B1A2	100-gr. perc.
4	M1, M1A1, M2, M3	SHELL	Smoke	M64	FS	1.51	P.D., M57	S.Q.	M6	M5A1	FNH, M1	1.04	M1B1A2	100-gr. perc.
Blank Ammunition														
2	M1, M1A1, M2, M3	No projectile								M9A1	Double Pel-let Charge	0.87	M1B1A1	100-gr. perc.
Drill Ammunition														
—	M1, M1A1, M2, M3	CARTRIDGE	Drill	M2A2	None	—	Inert, combi-nation, 21-sec., M1907M	Inert	—	—	—	—	—	—
—	M1, M1A1, M2, M3	CARTRIDGE	Drill	M19	None	—	Dummy, M59	Inert	—	—	—	—	—	—

B.D.—base-detonating
FNH—flashless nonhydroscopic
gr.—grain
H.E.—high-explosive
H.E., A.T.—high-explosive-antitank

S.Q.—superquick
TSQ—time and superquick

*—CARTRIDGE, case, 75-mm; M5A1 (Type I) used with all rounds, except H.E., A.T. round which uses M5A1 (Type II) case.
^a—Alternative: PRIMER, percussion, 100-grain, M1A2.
¹—These rounds are also assembled with CASE, cartridge, M5A1B1 (Type I or Type II), a steel case which weighs 0.27 lb. less than standard brass case.
²—Charge is a black powder charge.
³—BOOSTER, M20A1, or BOOSTER, M20.
⁴—Burstler, M6, with Burstler Charge, M8.
⁵—Rounds of earlier manufacture may have M48 or M48A1 fuzes.

TABLE 15
COMPLETE ROUND TABLE FOR AMMUNITION FOR 76-MM GUNS
(This table is not to be confused with official Complete Round Charts, Form No. 5981.)

Note References	Designation of Cannon	PROJECTILE				FUZE		Booster, Adapter-Booster, or Burstler	Cartridge Case	PROPELLING CHARGE		PRIMER			
		Kind	Type	Model	Kind	Weight as Fired (Lb.)	Type and Model			Action	Kind	Weight (Lb.)	Model	Type	
															Kind
Service Ammunition															
3, 7, 8	M1, M1A1, M1A2	PROJECTILE	A.P.C.	M62A1	Exp. D	0.144	15.44	B.D., M66A1	Delay	—	M26	FNH, M1	3.75	M28A2	300-gr. perc.
3, 7, 8	M1, M1A1, M1A2	PROJECTILE	A.P.C.	M62	Exp. D	0.144	15.44	B.D., M66A1	Delay	—	M26	FNH, M1	3.75	M28A2	300-gr. perc.
4	M1, M1A1, M1A2	PROJECTILE	A.P.C.	M62	None	—	15.11	None	—	—	M26	FNH, M1	3.75	M28A2	300-gr. perc.
4	M1, M1A1, M1A2	SHOT	A.P.	M79	None	—	15.00	None	—	—	M26	FNH, M1	3.75	M28A2	300-gr. perc.
7	M1, M1A1, M1A2	SHELL	H.F.	M42A1	TNT	0.86	12.87	P.D., M48A2 ¹	SQ & 0.05-sec. Delay	M20A1	M26	FNH, M1	3.75	M28A2	300-gr. perc.
5, 7	M1, M1A1, M1A2	SHELL	H.E.	M42A1	TNT	0.86	12.87	P.D., M48A2	SQ & 0.15-sec. Delay	M20A1	M26	FNH, M1	1.14 ²	M28A2	300-gr. perc.
7	M1, M1A1, M1A2	SHELL	Smoke, B.J.	M88	HC	3.147	7.38	None	—	—	M26	FNH, M2	0.219	M28A2	300-gr. perc.
Drill Ammunition															
6	M1, M1A1, M1A2	CARTRIDGE	Drill	M20	None	—	—	Dummy, M59	—	—	—	None	—	None	—

A.P.—armor-piercing
 A.P.C.—armor-piercing-capped
 B.D.—base detonating
 H.F.—high-explosive
 B.J.—base-ignition (base-emission)
 Exp. D—explosive D
 HC—hexachlorethane-zinc mixture
 P.D.—point-detonating
 sec.—second
 SQ—superquick
 FNH—flashing nonhygroscopic gr.—grain perc.—percussion

1—Alternative is: PRIMER, percussion, 300-grain, M28B1A1.
 2—Rounds of earlier manufacture assembled with FUZE, P.D., M48A1, having a delay of 0.15 second and FUZE, P.D., M48, having a delay of 0.05 second. Some M48A1 fuzes have been renovated to have an 0.05-second delay.
 3—Fuze contains a tracer.
 4—Tracer in base of projectile.
 5—This round assembled with a reduced charge of propellant.
 6—Cartridge case and projectile simulated by a one-piece assembly. Body made of bronze. The M20B1 drill cartridge has body made of malleable iron.
 7—Rounds of recent manufacture contain NH propellant powder.
 8—Rounds of recent manufacture contain both NH propellant powder and PRIMER, percussion, 260-grain, M40 (T27).

TABLE 16
COMPLETE ROUND TABLE FOR AMMUNITION FOR 3-INCH GUNS

(This table is not to be confused with official Complete Round Charts, Form No. 5981.)

Note References	Designation of Cannon	PROJECTILE				FUZE		Booster, Adapter-Booster, or Bursting	Cartridge Case	PROPELLING CHARGE		PRIMER			
		Kind	Type	Model	Filler		Type and Model			Action	Kind	Weight (lb.)	Model**	Type	
					Kind	Weight (lb.)									Weight as Fired (lb.)
—	M1917*-25°, M2, M4	SHELL	H.E.	M42	TNT	0.86	12.81	M43f	Timef. to 30 sec.	M20A1††	Mk. IM2†	FNH, M1	4.87	M28	300-gr. perc.
—	M1917*-25°, M2, M4	SHELL	H.E.	M42	TNT	0.86	12.81	M43f	Timef. to 30 sec.	M20A1††	Mk. IM2†	NH, M1	4.87	M28	300-gr. perc.
—	M1917*-25°, M2, M4	SHELL	H.E.	M42A1	TNT	0.86	12.87	M43f	Timef. to 30 sec.	M20A1††	Mk. IM2†	NH	4.87	M28	300-gr. perc.
—	M1917*-25°, M2, M4	SHELL	H.E.	Mk. IX	TNT	0.89	12.80	M43f	Timef. to 30 sec.	M23	Mk. IM2	NH	4.87	M28	300-gr. perc.
—	M1917*-25°, M2, M4	SHRAPNEL	—	Mk. I	Lead balls	253 balls	15.25	Mk. IIIA2f#	Timef. to 21 sec.	None	Mk. IA1	NH, M1	5.00	M28	300-gr. perc.
—	M1918°, M3, M5, M6, M7	PROJECTILE	A.P.C.	M62A1	Exp. D	0.144	15.44	B.D., M66A1	Delay	None	Mk. IIM2†	FNH, M1	4.87	M28	300-gr. perc.
—	M1918°, M3, M5, M6, M7	PROJECTILE	A.P.C.	M62	Exp. D	0.144	15.44	B.D., M66A1	Delay	None	Mk. IIM2†	FNH, M1	4.87	M28	300-gr. perc.
—	M1918°, M3, M5, M6, M7	PROJECTILE	A.P.C.	M62	None	—	14.91	None	—	None	Mk. IIM2†	FNH, M1	4.87	M28	300-gr. perc.
—	M1918°, M3, M5, M6, M7	SHOT	A.P.	M79	None	—	15.00	None	—	None	Mk. IIM2†	FNH, M1	4.38	M28	300-gr. perc.
—	M1918°, M3	SHELL	H.E.	M42	TNT	0.86	12.81	M43f	Timef. to 30 sec.	M20A1††	Mk. IIM2†	NH, M1	4.87	M28	300-gr. perc.
—	M1918°, M3	SHELL	H.E.	M42A1	TNT	0.86	12.87	M43f	Timef. to 30 sec.	M20A1††	Mk. IIM2†	NH	4.87	M28	300-gr. perc.

Service Ammunition

TABLE 16 (Contd.)
COMPLETE ROUND TABLE FOR AMMUNITION FOR 3-INCH GUNS (Contd.)

Note Refer- ences	Designation of Cannon	PROJECTILE				FUZE			Booster, Adapter- Booster, or Burstor	Car- tridge Case	PROPELLING CHARGE		PRIMER		
		Kind	Type	Model	Kind	Model	Weight as Fired (Lb.)	Type and Model			Action	Kind	Weight (Lb.)	Model**	Type
Service Ammunition (Contd.)															
—	M1918°, M3	SHELL	H.E.	Mk. IX	TNT	0.91	12.80	M43f	Timeff. to 30 sec.	Mk. IIM2†	NH	4.87	M28	300-gr. perc.	
—	M1918°, M3	SHRAPNEL	—	Mk. I	Lead balls	253 balls	15.25	Mk. IIIA2ff	Timeff. to 21 sec.	Mk. IIA1	NH, M1	4.62	M28	300-gr. perc.	
—	M1902MI, M5, M6, M7	SHELL	H.E.	M42	TNT	0.86	12.81	P.D., M48*	SQ & delay	Mk. IIM2†	FNH, M1	4.87	M28	300-gr. perc.	
—	M1902MI, M5, M6, M7	SHELL	H.E.	M42A1	TNT	0.86	12.87	P.D., M48A2*	SQ & delay*	Mk. IIM2†	FNH	4.87	M28	300-gr. perc.	
—	M1902MI, M5, M6, M7	SHELL	H.E.	M42A1	TNT	0.86	12.87	P.D., M48A2*	SQ & delay*	Mk. IIM2†	FNH	■	M28	300-gr. perc.	
Practice Ammunition															
—	M1917°-25°, M2, M4	SHELL	Practice	M42B2	Blk. Pwdr.	0.25	12.90	M43f	Timeff. to 30 sec.	Mk. I12	NH	4.87	M28	300-gr. perc.	
—	M1918°, M3	SHELL	Practice	M42B2	Blk. Pwdr.	0.25	12.90	M43f	Timeff. to 30 sec.	Mk. IIM2	NH	4.87	M28	300-gr. perc.	
Blank Ammunition															
—	M1903, M1917°- 25M1°, M2, M4	NONE	—	—	—	—	—	—	—	M12	Blk. Pwdr.	1.00	M1B1A1	100-gr. perc.	
—	M1902MI, M1918°, M3	NONE	—	—	—	—	—	—	—	M13	Blk. Pwdr.	1.00	M1B1A1	100-gr. perc.	
—	M1902-04-05	NONE	—	—	—	—	—	—	—	M9A1	Single Pel- let Charge	0.43	M1B1A1	100-gr. perc.	
—	M1902-04-05	NONE	—	—	—	—	—	—	—	M9A1	Double Pel- let Charge	0.87	M1B1A1	100-gr. perc.	

TABLE 16 (Contd.)
COMPLETE ROUND TABLE FOR AMMUNITION FOR 3-INCH GUNS (Contd.)

Note References	Designation of Cannon	PROJECTILE					FUZE			Booster, Adapter, Booster, or Bursting	PROPELLING CHARGE		PRIMER	
		Kind	Type	Model	Filter		Type and Model	Action	Cartridge Case		Kind	Weight (lb.)	Model**	Type
					Weight as Fired (lb.)	Weight (lb.)								
	M1917*-25°, M2, M4	CARTRIDGE	Drill	Mk. II	—	—	Dummy, M42	Inert	—	—	—	—		
	M1903, M1917*-25°, M2, M4	CARTRIDGE	Drill	M3A1	—	—	Dummy, M42A1	Inert	—	—	—	—		
	M1903, M1917*-25°, M2, M4	CARTRIDGE	Drill	M9	—	—	Dummy, M59	Inert	—	—	—	—		
	M1903, M1917*-25°, M2, M4	CARTRIDGE	Drill	M9	—	—	Dummy, M42A1	Inert	—	—	—	—		
	M1902M1, M1918°, M3	CARTRIDGE	Drill	M4A1	—	—	Dummy, M42A1	Inert	—	—	—	—		
	M1902M1, M1918°, M3	CARTRIDGE	Drill	M10	—	—	Dummy, M42A1	Inert	—	—	—	—		
	M1902M1, M1918°, M3, M5, M6, M7	CARTRIDGE	Drill	M15	—	—	Dummy, M59	Inert	—	—	—	—		

Drill Ammunition

A.P.—armor-piercing
A.F.C.—armor-piercing-capped
B.D.—base-detonating
Blk. Pwd.—black powder
gr.—grain
H.E.—high-explosive

NC—nitrocellulose
NH—nonhygroscopic
perc.—percussion

S.Q.—superquick
T.N.T.—trinitrotoluene
T.P.—target practice

F.N.H.—flashless nonhygroscopic
P.D.—point-detonating

**—Or modifications M28A1 or M28A2.
*—M1917A2, M1917A3, M1917M1A2, M1917M1A3, M1917M11.
^—M1925M1 and M1925M1A1.
#—FUZE, time, mechanical, M43 (all modifications); mechanical time type.
†—BOOSTER, M20, or modification, M20A1; or BOOSTER, M24.
‡—Substitute cartridge case is the Mk. IM2B1.
§—FUZE, time, 21-sec., A.A. Mk. III, Mk. IIIA1, Mk. IIIA2; powder train type.
||—M1918M1, M1918A1, M1918M1A1.
‡—Alternate cartridge case is the Mk. IIM2B1.
A.—FUZE, P.D., M48A2, most recent modification, may have 0.05-second or 0.15-second delay, depending on the lot. Earlier models M48A1 and M48 originally were manufactured with 0.15-second and 0.05-second delay, respectively. However, modified fuses which have the other than original delay are in existence.
■—Reduced charge; cartridge case is marked "REDUCED" to identify the type of propelling charge.

TABLE 17
COMPLETE ROUND TABLE FOR AMMUNITION FOR 81-MM MORTAR

(This table is not to be confused with official Complete Round Charts, Form No. 5981)

Note Refer-ences	Designation of Cannon	PROJECTILE			FUZE		Booster, Adapter-Booster, or Burst	PROPELLING CHARGE		PRIMER		IGNITION CARTRIDGE			
		Kind	Type	Model	Kind	Weight as fired (Lb.)		Type and Model	Action	Kind†	Weight (Lb.)	Model	Type	Model	Weight of Charge (Grains)
	M1	SHELL	H.E.	M43A1	TNT	1.23	6.92‡	P.D., M52 S.Q.‡		M1A1	0.10†	M33	1.65-gr. perc.	M6	120.
4	M1	SHELL	H.E.	M56	TNT	4.30	10.66	P.D., M53 Delay (0.1-sec.)		M2A1	0.12*	M34	1.65-gr. perc.	M6	120.
1	M1	SHELL	H.E.	M45	TNT	4.48	15.01	P.D., M45 S.Q. & Delay (0.1-sec.)		Dr. 71-12-14	0.06‡	—	—	M3	120.
1	M1	SHELL	H.E.	M45B1	TNT	4.48	15.05	P.D., M53 Delay (0.1-sec.)		M1A1	0.07‡	—	—	M3	120.
2, 5	M1	SHELL	Chemical	M57	WP smoke	4.09	11.45	P.D., M52 S.Q.		M2 (M1)	0.12*	M34	1.65-gr. perc.	M6	120.
2, 5	M1	SHELL	Chemical	M57	FS smoke	4.59	11.95	P.D., M52 S.Q.		M2 (M1)	0.12*	M34	1.65-gr. perc.	M6	120.
Service Ammunition															
	M1	SHELL	Practice	M44	△	1.25	6.97	P.D., M52 S.Q.		M1A1	0.10†	M33	1.65-gr. perc.	M6	120.
	M1	SHELL	Practice	M43A1	△	1.25	6.97	P.D., M52 S.Q.		M1A1	0.10†	M33	1.65-gr. perc.	M6	120.
1	M1	SHELL	Practice	M43	△	1.11	6.92	P.D., M52 S.Q.		M1A1	0.10†	—	—	M3	120.
Drill Ammunition															
1, 3	M1	SHELL	Training	M68	None	—	10.82	None		—	—	—	—	M3	120.

gr.—grain H.E.—high-explosive P.D.—point-detonating perc.—percussion sec.—second S.Q.—superquick TNT—trinitrotoluene
 *—Total weight of 4 increments (full charge). Not more than 3 increments will be used in the 3" trench mortars.
 †—Inert material together with black powder pellet; weight shown is combined weight. Weight of black powder charge in M43A1 shell is 0.05 lb., in M44 shell, 0.19 lb.
 ‡—M3 ignition cartridge includes primer.
 §—M2 burster casing, containing M1 burster charge.
 ¶—Projectile weight shown includes projectile, fuze and ignition cartridge.
 ††—Rounds of future manufacture will also be assembled with FUZE, TSQ, M88.
 †††—Rounds of future manufacture will also be assembled with FUZE, TSQ, M88.
 ††††—Total weight of 6 increments (full charge). Not more than 4 increments will be used on the 3" trench mortars.
 †††††—Total weight of 4 increments (full charge) for use in both 81-mm and 3" trench mortars.
 ††††††—Weight is 6.81 lb. when M52B1, all plastic fuze, is used.
 †††††††—The M1A1 and M2A1 increments are cellophane-wrapped. Rounds of older manufacture may be assembled with the M1 and M2 increments which are not cellophane-wrapped.

TABLE 18
COMPLETE ROUND TABLE FOR AMMUNITION FOR 90-MM GUNS
(This table is not to be confused with official Complete Round Charts, Form No. 5981.)

Note References	Designation of Cannon	PROJECTILE				FUZE		Booster,* Adapter-Booster, or Bursting	PROPELLING CHARGE		PRIMER				
		Kind	Type	Model	Filler		Type and Model		Action	Cartridge Case	Kind ^Δ	Weight (Lb.)	Model	Type	
					Kind	Weight (Lb.)									Weight as Fired (Lb.)
Service Ammunition															
1, 2	M1, M1A1, M2, M3	PROJECTILE	A.P.C.	M82	Exp. D	0.44	24.11	B.D., M98	Delay	—	M19	NH, M1	7.31	M28A2	300-gr. perc.
3	M1, M1A1, M2, M3	PROJECTILE	A.P.C.	M62	None	—	23.40	None	—	—	M19	NH, M1	7.31	M28A2	300-gr. perc.
1	M1, M1A1, M2, M3	SHELL	H.E.	M71	TNT	2.04	23.29	M.T., M43†	Time to 30 sec.	M20A1	M19	FNH, M1	7.31	M28A2	300-gr. perc.
1	M1, M1A1, M2, M3	SHELL	H.E.	M71	TNT	2.04	23.29	P.D., M48A2	S.Q. & Del.**	M20A1	M19	NH, M1	7.31	M28A2	300-gr. perc.
3	M1, M1A1, M2, M3	SHOT	A.P.	M77	None	—	23.40	None	—	—	M19	NH, M1	7.31	M28A2	300-gr. perc.
Practice Ammunition															
—	M1, M1A1, M2, M3	SHELL	Practice	M71	Inert	2.04	23.40	†	Inert	—	M19	NH, M1	7.31	M28A2	300-gr. perc.
Blank Ammunition															
—	M1, M1A1, M2, M3	NONE	—	—	—	—	—	—	—	—	M27	Blk. Powder	1.50	M1B1A2	100-gr. perc.
Drill Ammunition															
4	M1, M1A1, M3	CARTRIDGE	Drill	M12	None	—	—	Dummy, M44A2	Inert	None	—	None	—	None	—

A.P.—armor-piercing
A.P.C.—armor-piercing-capped

*—Alternative is BOOSTER, M24.

Δ—Standard propellant powder; rounds with non-standard type may be encountered.

†—Alternative primer: PRIMER, percussion, 300-grain, M28B2 (steel). Rounds of earlier manufacture may have PRIMER, percussion, 300-grain, M28A1 or M28B1A1.

‡—All modifications.

**—Fuse, P.D., M48A2, may have 0.05-second or 0.15-second delay, depending on lot. Rounds of earlier assembly were fused with M48 or M48A1 fuses, with 0.05-second and 0.15-second delay, respectively. Rounds with modified fuses having other than original delay may be encountered.

1—FUZE, inert, P.D., M48A1; or FUZE, dummy, M73.

2—Rounds also assembled with steel cartridge case, CASE, cartridge, 90-mm, M19B1. This case is approximately 0.90 pound lighter than the standard brass case.

3—Fuse contains tracer.

4—Projectile contains tracer.

5—M12 is a bronze assembly. M12B1 is of malleable iron and steel (standard for current manufacture).

NH—nonhygroscopic
P.D.—point-detonating
perc.—percussion

H.E.—high-explosive
M.T.—mechanical time

B.D.—base-detonating
gr.—grain

TABLE 19
COMPLETE ROUND TABLE FOR AMMUNITION FOR 105-MM HOWITZERS
 (This table is not to be confused with official Complete Round Charts, Form No. 5981.)

Note References	Designation of Cannon	PROJECTILE				FUZE		Booster, Adapter, Booster, or Burst	Cartridge Case	PROPELLING CHARGE		PRIMER		
		Kind	Type	Model	Kind	Weight (lb.)	Action			Kind	Weight (lb.)	Model	Type	
														Weight as Fired (lb.)
		Kind		Weight (lb.)		Weight (lb.)								
1, 2, 3, 9	M2, M2A1, M4	SHELL	H.E.	M1	TNT	4.80	33.00	P.D., M48A2	SQ & Delay	M14	FNH, M1	3.04	M1B1A2	100-gr. perc.
2, 3, 9	M2, M2A1	SHELL	H.E.	M1	TNT	4.80	33.00	TSQ, M54	SQ & Time	M14	FNH, M1	3.04	M1B1A2	100-gr. perc.
2, 3, 4	M2, M2A1, M4	SHELL	Chem., B.E.	M84	HC smoke	7.50	32.87	TSQ, M54	SQ & Time	M14	FNH, M1	3.04	M1B1A2	100-gr. perc.
2, 3, 4, 5	M2, M2A1	SHELL	Chem., B.E.	M84	Colored HC smoke	See note 5	See note 5	TSQ, M54	SQ & Time	M14	FNH, M1	3.04	M1B1A2	100-gr. perc.
2, 3, 6	M2, M2A1	SHELL	Chemical	M60	FS smoke	4.61	34.82	P.D., M57	SQ	M14	FNH, M1	3.04	M1B1A2	100-gr. perc.
2, 3, 6	M2, M2A1	SHELL	Chemical	M60	WP smoke	4.10	34.31	P.D., M57	SQ	M14	FNH, M1	3.04	M1B1A2	100-gr. perc.
2, 3, 6	M2, M2A1	SHELL	Chemical	M60	H gas	3.17	33.38	P.D., M57	SQ	M14	FNH, M1	3.04	M1B1A2	100-gr. perc.
2	M2, M2A1, M4	SHELL	H.E., A.T.	M67	Pentolite	2.93	29.22	B.D., M62 or M62A1	Nondelay	M14	FNH, M1	1.60	M28A2	300-gr. perc.
1, 2, 9	M3	SHELL	H.E.	M1	TNT	4.80	33.00	P.D., M48A2	SQ & Delay	M14	FNH, M1	1.43	M1B1A2	100-gr. perc.
2	M3	SHELL	H.E., A.T.	M67	Pentolite	2.93	29.22	B.D., M62 or M62A1	Nondelay	M14	FNH, M1	1.40	M28A2	300-gr. perc.
2, 3, 4	M3	SHELL	Chem., B.E.	M84	HC smoke	7.50	32.87	TSQ, M54	SQ & Time	M14	FNH, M1	1.43	M1B1A2	100-gr. perc.
2, 3, 6	M3	SHELL	Chemical	M60	WP smoke	4.06	34.31	P.D., M57	SQ	M14	FNH, M1	1.43	M1B1A2	100-gr. perc.

Service Ammunition

TABLE 20
COMPLETE ROUND TABLE FOR AMMUNITION FOR 105-MM GUN M3

(This table is not to be confused with official Complete Round Charts, Form No. 5981.)

Note Refer-ences	Desig-nation of Cannon	PROJECTILE				FUZE		Booster ^a Adapter-Booster, or Burst	PROPELLING CHARGE		PRIMER				
		Kind	Type	Model	Kind	Weight (lb.)	Type and Model		Action	Car-tridge Case	Kind	Weight (lb.)	Model ^b	Type	
															Weight as Fired (lb.)
Service Ammunition															
1	M3	SHELL	H.E.	M38A1	TNT	3.53	32.77	M.T., M43†	Time, to 30-sec.	M20A1	M6	FNH, M1	11.00	M28A1	300-gr. perc.
—	M3	SHELL	H.E.	M38	TNT	3.56	32.83	M.T., M2	Time, to 30-sec.	—	M6	FNH, M1	11.00	M28	300-gr. perc.
Practice Ammunition															
2	M3	SHELL	Practice	M38A1	Blk. Pwdr.	0.28	32.77	M.T., M43†	Time, to 30-sec.	M20A1	M6	FNH, M1	11.00	M28A2	300-gr. perc.
3	M3	SHELL	Practice	M38	Blk. Pwdr.		31.63	M.T., M2	Time, to 30-sec.	—	M6	FNH, M1	9.78	M21	330-gr. perc.
Drill Ammunition															
4	M3	CARTRIDGE	Drill	M11	—	—	—	Dummy, T23	Inert	—	—	—	—	—	—
4	M3	CARTRIDGE	Drill	M8	—	—	—	Dummy, M44A2 or T23	Inert	—	—	—	—	—	—

Blk. Pwdr.—black powder
FNH—flashless nonhygroscopic

gr.—grain
H.E.—high-explosive
M.T.—mechanical time
perc.—percussion
TNT—trinitrotoluene

^a—Alternative is BOOSTER, M24.
^b—Alternative: PRIMER, percussion, 300-grain, M28B1—Current standard is M28A2.
†—All modifications.
‡—Alternative shell loading: 50-50 Amatol, weight 3.41 lbs.
§—Shell loading: Black powder as shown, together with approximately 3.03 lbs. of inert material.
¶—Shell loading: Black powder as shown, together with approximately — lbs. of inert material.
⌞—Cartridge case and projectile are a single unit.

TABLE 21
COMPLETE ROUND TABLE FOR AMMUNITION FOR 4.5-INCH GUN M1
 (This table is not to be confused with official Complete Round Charts, Form No. 5981.)

Note References	Designation of Cannon	PROJECTILE						FUZE		Booster, Adapter-Booster, or Bursting	PROPELLING CHARGE		PRIMER	
		Kind	Type	Model	Filler		Weight as Fired (lb.)	Type and Model	Action		Kind	Weight (lb.)	Model ¹	Type
					Kind	Weight (lb.)								
	M1	SHELL	H.E.	M65	TNT	4.49	54.90	P.D., M51A4* SQ or DEL	M21A4 ^f	M7 or M8**	11.2	Mk. IIA4	perc. 17-gr.	
	M1	SHELL	H.E.	M65	TNT	4.49	54.90	M67A3 ^a	M21A4 ^f	M7 or M8**	11.2	Mk. IIA4	perc. 17-gr.	
	M1	DUMMY	DRILL	M8	None	—	55.0	None	—	M6	11.9	Mk. IIA4	perc. 17-gr.	

Service Ammunition

Dummy Ammunition

DEL—delay

gr.—grain

*—FUZE, P.D., M51, w/BOOSTER, M20A1 or M21; M51A1, w/BOOSTER, M20A1 or M21; M51A3, w/BOOSTER, M21A2; or M51A4, w/BOOSTER, M21A4, may be used. Note: The following limitations apply to the M51 fuze, and modifications:
 FUZE, P.D., M51 or M51A1, w/BOOSTER, M20A1, for service use until a sufficient supply of M51A3 fuzes, with M21A2 booster, or M51A4 fuzes, with M21A4 boosters are available then for practice.

**—The M7 normal charge contains FNH, M1, smokeless powder; the M8 supercharge contains NH, M1, powder.
^f—As issued, the booster is assembled to the fuze.
^a—For high burst range fire; replaces the FUZE, TSQ, M55, w/BOOSTER, M21, and modifications. FUZE, time, mechanical, M67, or M67A1, w/BOOSTER, M21A1; M67A2, w/BOOSTER, M21A2; or M67A4, w/BOOSTER, M21A4, may be used.

¹—Other primers which may be used if PRIMER, percussion, 17-grain, Mk. IIA4, is not available are: PRIMER, percussion, 18-grain, Mk. IIA3, or PRIMER, percussion, 21-grain, Mk. II, IIA, or Mk. IIA1.

TABLE 22
COMPLETE ROUND TABLE FOR AMMUNITION FOR 120-MM (4.7-INCH) GUN M1

(This table is not to be confused with official Complete Round Charts, Form No. 5981.)

Note References	Designation of Cannon	PROJECTILE						FUZE		Booster, Adapter, Booster, or Burst	Cartridge Case	PROPELLING CHARGE		PRIMER	
		Kind	Type	Model	Filler		Weight as Fired (lb.)	Type and Model	Action			Kind	Weight (lb.)	Model	Type
					Kind	Weight (lb.)									
Service Ammunition															
—	M1	SHELL	H.E.	M73	TNT	5.24	50	MT M61A1†	Time (30-sec.)	M24°	NH, M1*	23.62	M1B1A2	100-gr. pero.	
Dummy Ammunition															
—	M1	DUMMY	DRILL	M—(T5)	None	—	50	M—	—	None	M—(T2)	24.70	M1B1A2 (Inert)	100-gr. pero.	

H.E.—high-explosive
 MT—mechanical time
 gr.—grain
 perc.—percussion
 NH—nonhygroscopic

°—With Cork Plug, M1, or Palmatex plug, M2.
 *—CHARGE, propelling in CASE, cartridge, M24.
 †—With wooden plug.
 ‡—Alternative is BOOSTER, M24.
 ††—Rounds of earlier manufacture assembled with the M61 mechanical time fuse.

TABLE 23
COMPLETE ROUND TABLE FOR AMMUNITION FOR 155-MM HOWITZER MODELS, M1917A1-17A2-18, AND M1
 (This table is not to be confused with official Complete Round Charts, Form No. 5981.)

Note Refer-ences	Designation of Cannon	PROJECTILE				FUZE			Booster, Adapter-Booster, or Burst	PROPELLING CHARGE		PRIMER		
		Kind	Type	Model	Filler		Type and Model	Action		Kind†††	Weight (Lb.)	Model‡	Type	
					Kind	Weight (Lb.)								Weight as Fired (Lb.)
	M1917A1-17A2-18	SHELL	H.E.	Mk. IA1*	TNT	15.21	95.70	P.D., M51A4†	S.Q. or Del.	M21A4‡	{ M1A1 M2A1 }	{ 4.22 8.64 }	Mk. IIA4	17-gr. perc.
	M1917A1-17A2-18	SHELL	H.E.	Mk. IA1*	TNT	15.21	95.70	M55A3	T.S.Q.	M21A4‡	{ M1A1 M2A1 }	{ 4.22 8.64 }	Mk. IIA4	17-gr. perc.
	M1	SHELL	H.E.	Mk. IA1	TNT	15.21	95.70	M67A3	M.T.	M21A4‡	{ M1A1 M2A1 }	{ 4.22 8.64 }	Mk. IIA4	17-gr. perc.
	M1917A1-17A2-18	SHELL	H.E.	M102*	TNT	15.56	95.08	P.D., M51A4†	S.Q. or Del.	M21A4‡	{ M1A1 M2A1 }	{ 4.22 8.64 }	Mk. IIA4	17-gr. perc.
	M1917A1-17A2-18	SHELL	H.E.	M102*	TNT	15.56	95.08	M55A3*	T.S.Q.	M21A4‡	{ M1A1 M2A1 }	{ 4.22 8.64 }	Mk. IIA4	17-gr. perc.
	M1	SHELL	H.E.	M102	TNT	15.56	95.08	M67A3	M.T.	M21A4‡	{ M1A1 M2A1 }	{ 4.22 8.64 }	Mk. IIA4	17-gr. perc.
	M1	SHELL	H.E.	M107‡	TNT††	15.13††	95.00	P.D., M51A4†	S.Q. or Del.	M21A4‡	{ M3 M4A1 }	{ 5.94 13.91 }	Mk. IIA4	17-gr. perc.
	M1	SHELL	H.E.	M107‡	TNT††	15.13††	95.00	M67A3*	M.T.	M21A4‡	{ M3 M4A1 }	{ 5.94 13.91 }	Mk. IIA4	17-gr. perc.
	M1	SHELL	H.E.	M107‡	TNT††	15.13††	95.00	C.P. nose, T105	S.Q. or Del.	T1	{ M3 M4A1 }	{ 5.94 13.91 }	Mk. IIA4	17-gr. perc.
	M1917A1-17A2-18	SHELL	SMOKE	Mk. II	WP	15.54	98.82	P.D., M46	S.Q.	Mk. VIB	{ M1A1 M2A1 }	{ 4.22 8.64 }	Mk. IIA4	17-gr. perc.
	M1917A1-17A2-18	SHELL	SMOKE	Mk. II	FS	16.25	99.50	P.D., M46	S.Q.	Mk. VIB	{ M1A1 M2A1 }	{ 4.22 8.64 }	Mk. IIA4	17-gr. perc.
	M1917A1-17A2-18	SHELL	GAŠ	Mk. II	H	11.41	94.66	P.D., M46	S.Q.	Mk. VIB	{ M1A1 M2A1 }	{ 4.22 8.64 }	Mk. IIA4	17-gr. perc.
	M1917A1-17A2-18	SHELL	SMOKE	Mk. II	FM	14.13	96.13	P.D., M46	S.Q.	Mk. VIB	{ M1A1 M2A1 }	{ 4.22 8.64 }	Mk. IIA4	17-gr. perc.
	M1917A1-17A2-18	SHELL	SMOKE	Mk. IIA1*	WP	14.80	97.95	P.D., M51A4†	S.Q. or Del.	M6	{ M1A1 M2A1 }	{ 4.22 8.64 }	Mk. IIA4	17-gr. perc.
	M1917A1-17A2-18	SHELL	SMOKE	Mk. IIA1*	FS	16.23	100.02	P.D., M51A4†	S.Q. or Del.	M6	{ M1A1 M2A1 }	{ 4.22 8.64 }	Mk. IIA4	17-gr. perc.

Service Ammunition

TABLE 23 (Contd.)
 COMPLETE ROUND TABLE FOR AMMUNITION FOR 155-MM HOWITZER MODELS, M1917A1-17A2-18, AND M1
 (Contd.)

Note Refer- ences	Designation of Cannon	PROJECTILE				FUZE			Booster, Adapter- Booster, or Burstor	PROPELLING CHARGE		PRIMER		
		Kind†††	Type	Model	Filler		Type and Model	Action		Kind**‡	Weight (lb.)	Model‡	Type	
					Kind	Weight (lb.)								Weight as Fired (lb.)
Service Ammunition (Contd.)														
—	M1917A1-17A2-18	SHELL	GAS	Mk. IIA1*	H	11.40	95.79	P.D., M51A4†	S.Q. or Del.	M6	{ M1A1 M2A1 }	{ 4.22 8.64 }	Mk. IIA4	17-gr. perc.
—	M1917A1-17A2-18	SHELL	GAS	Mk. IIA1- Mod. 1*	CNS	13.93		P.D., M51A4†	S.Q. or Del.	M6	{ M1A1 M2A1 }	{ 4.22 8.64 }	Mk. IIA4	17-gr. perc.
—	M1917A1-17A2-18	SHELL	GAS	Mk. IIA1- Mod. 1*	H	11.80	97.09	P.D., M51A4†	S.Q. or Del.	M6	{ M1A1 M2A1 }	{ 4.22 8.64 }	Mk. IIA4	17-gr. perc.
—	M1917A1-17A2-18	SHELL	SMOKE	M105*	WP	15.60	98.96	P.D., M51A4†	S.Q. or Del.	M6	{ M1A1 M2A1 }	{ 4.22 8.64 }	Mk. IIA4	17-gr. perc.
—	M1917A1-17A2-18	SHELL	SMOKE	M105*	FS	16.90	100.32	P.D., M51A4†	S.Q. or Del.	M6	{ M1A1 M2A1 }	{ 4.22 8.64 }	Mk. IIA4	17-gr. perc.
—	M1917A1-17A2-18	SHELL	GAS	M105*	H	11.70	95.07	P.D., M51A4†	S.Q. or Del.	M6	{ M1A1 M2A1 }	{ 4.22 8.64 }	Mk. IIA4	17-gr. perc.
—	M1	SHELL	GAS	M110f	CNS	13.81		P.D., M51A4†	S.Q. or Del.	M6	{ M1A1 M2A1 }	{ 4.22 8.64 }	Mk. IIA4	17-gr. perc.
—	M1	SHELL	GAS	M110f	H	11.70	95.20	P.D., M51A4†	S.Q. or Del.	M6	{ M3 M4A1 }	{ 5.94 13.91 }	Mk. IIA4	17-gr. perc.
—	M1	SHELL	SMOKE	M110f	FS	16.90	99.40	P.D., M51A4†	S.Q. or Del.	M6	{ M3 M4A1 }	{ 5.94 13.91 }	Mk. IIA4	17-gr. perc.
—	M1	SHELL	SMOKE	M110f	WP	15.60	98.40	P.D., M51A4†	S.Q. or Del.	M6	{ M3 M4A1 }	{ 5.94 13.91 }	Mk. IIA4	17-gr. perc.
—	M1917A1-17A2-18	SHELL	B.E. SMOKE	M115	HC	25.84	94.88	TSQ, M54	T. & S.Q.	Blk. Pwdr.	{ M1A1 M2A1 }	{ 4.22 8.64 }	Mk. IIA4	17-gr. perc.
—	M1	SHELL	B.E. SMOKE	M116	HC	25.84	95.10	TSQ, M54	T. & S.Q.	Blk. Pwdr.	{ M3 M4A1 }	{ 5.94 13.91 }	Mk. IIA4	17-gr. perc.
—	M1	SHELL	B.E. SMOKE	M116	RED			TSQ, M54	T. & S.Q.	Blk. Pwdr.	{ M3 M4A1 }	{ 5.94 13.91 }	Mk. IIA4	17-gr. perc.
—	M1	SHELL	B.E. SMOKE	M116	YELLOW			TSQ, M54	T. & S.Q.	Blk. Pwdr.	{ M3 M4A1 }	{ 5.94 13.91 }	Mk. IIA4	17-gr. perc.
—	M1	SHELL	B.E. SMOKE	M116	GREEN			TSQ, M54	T. & S.Q.	Blk. Pwdr.	{ M3 M4A1 }	{ 5.94 13.91 }	Mk. IIA4	17-gr. perc.
—	M1	SHELL	B.E. SMOKE	M116	VIOLET			TSQ, M54	T. & S.Q.	Blk. Pwdr.	{ M3 M4A1 }	{ 5.94 13.91 }	Mk. IIA4	17-gr. perc.

TABLE 23 (Contd.)
 COMPLETE ROUND TABLE FOR AMMUNITION FOR 155-MM HOWITZER MODELS, M1917A1-17A2-18, AND M1
 (Contd.)

Note Refer- ences	Designation of Cannon	PROJECTILE					FUZE		Booster, Adapter- Booster, or Burstler	PROPELLING CHARGE		PRIMER	
		Kind	Type	Model	Filler		Type and Model	Action		Kind	Weight (lb.)	Model†	Type
					Kind	Weight (lb.)							
—	All models	DUMMY	DRILL	Mk. I	None	—	45-sec., M1907M	Inert	—	{ M2 Mk. I }	{ 7.37 8.0 }	Mk. IIA4	17-gr. perc.
—	All models	DUMMY	DRILL	M7	None	—	None	—	—	{ M2 Mk. I }	{ 7.37 8.0 }	Mk. IIA4	17-gr. perc.

Dummy Ammunition

S.Q.—superquick
 TSQ (T. & S.Q.)—time and superquick
 WP—white phosphorus

H.E.—high-explosive
 H—mustard gas
 M.T.—mechanical time
 P.D.—point-detonating

Del.—delay
 FM—titanium tetrachloride
 FS—sulfur trioxide—chlorosulfonic acid solution
 HC—hexachlorethane—zinc mixture

B.E.—base-ejection
 CNS—chloracetophenone solution
 C.P.—concrete piercing

*—Limited standard for use in 155-mm howitzer, M1, with CHARGE, propelling, M3 (green bag), 155-mm how., M1; CHARGE, propelling, M4 (white bag), 155-mm how., M1; CHARGE, propelling, M4A1 (white bag), 155-mm how., M1; CHARGE, propelling, M2A1 (green bag), 155-mm how., M1917A1-17A2-18; CHARGE, propelling, M2A1 (white bag), 155-mm how., M1917A1-17A2-18.

†—Other P.D. M51 fuses on hand are: FUZE, P.D., M51, w/BOOSTER, M20A1 or M21; M51A1, w/BOOSTER, M20A1 or M21A1; or M51A3, w/BOOSTER, M21A2.

‡—Other TSQ M55 fuses on hand are: FUZE, TSQ, M55, w/BOOSTER, M21A1; or M55A2, w/BOOSTER, M21A2.
 Note: The following limitations apply to the M51 fuse, and modifications.
 FUZE, P.D., M51 or M51A1, w/BOOSTER, M20A1, for service use until a sufficient supply of M51A3 fuses with M21A2 boosters, or M51A4 fuses with M21A4 boosters are available; then for practice.
 FUZE, P.D., M51, w/BOOSTER, M21, or FUZE, P.D., M51A1, w/BOOSTER, M21A1, for emergency combat use only; must be drop-tested prior to use.
 An appreciable percentage of duds may be expected when firing FUZE, P.D., M51A3, w/BOOSTER, M21A2, in zones 1 and 2 of the 155-mm how., M1917A1-17A2-18, and zone 1 of the 155-mm how., M1.

§—As issued, the booster is assembled to the fuze.
 ¶—Other primers which may be used if PRIMER, Mk. IIA1, is restricted to use in 155-mm howitzers only. PRIMER, Mk. II and Mk. IIA, may be used in all authorized cannon but should be reserved where practicable for issue for cannon other than 155-mm howitzers.

||—Alternatives: Amatol, 50-50, 14.19 lbs., Amatol 90-20, 13.36 lbs.
 ††—Standard charges are listed. Other charges for the 155-mm how., M1917A1-17A2-18 are: CHARGE, propelling, M2 (white bag), 155-mm how., M1, for zones 5 to 7 inclusive.

‡‡—Standard charges for the 155-mm how., M1, is: CHARGE, propelling, M4 (white bag), 155-mm how., M1, for zones 5 to 7 inclusive.

TABLE 24
COMPLETE ROUND TABLE FOR AMMUNITION FOR 155-MM GUNS, M1917-17A1-18M1, M1, AND M1A1
 (This table is not to be confused with official Complete Round Charts, Form No. 5981.)

Note References	Designation of Cannon	PROJECTILE					FUZE			Booster, Adapter-Booster, or Burst	PROPELLING CHARGE		PRIMER ^a	
		Kind	Type	Model	Filler		Type and Model	Action	Kind ^f		Weight (lb.)	Model	Type	
					Kind	Weight (lb.)								Weight as Fired (lb.)
—	All models	PROJECTILE	A.P.	M112	Exp. D	1.44	100.00	B.D., M60	Del	—	M1917-18, M1 and M1A1*	26.17	Mk. IIA4	17-gr. perc.
—	All models	PROJECTILE	A.P.	M112	Exp. D	1.44	100.00	B.D., M60	Del	—	M1 and M1A1	32.23	Mk. IIA4	17-gr. perc.
—	All models	SHELL	H.E.	Mk. IIIA1	TNT	15.21	96.08	P.D., M51A4°	SQ or Del	M21A4	M1917-18, M1 and M1A1*	26.17	Mk. IIA4	17-gr. perc.
—	All models	SHELL	H.E.	Mk. IIIA1	TNT	15.21	96.08	P.D., M51A4°	SQ or Del	M21A4	M1 and M1A1#	32.23	Mk. IIA4	17-gr. perc.
—	All models	SHELL	H.E.	Mk. IIIA1	TNT	15.21	96.08	M67A4†	M.T.	M21A4	M1917-18, M1 and M1A1*	26.17	Mk. IIA4	17-gr. perc.
—	All models	SHELL	H.E.	Mk. IIIA1	TNT	15.21	96.08	M67A4†	M.T.	M21A4	M1 and M1A1†	32.23	Mk. IIA4	17-gr. perc.
—	All models	SHELL	H.E.	M101	TNT	15.56	94.69	P.D., M51A4°	SQ or Del	M21A4	M1917-18, M1 and M1A1*	26.17	Mk. IIA4	17-gr. perc.
—	All models	SHELL	H.E.	M101	TNT	15.56	94.69	P.D., M51A4°	SQ or Del	M21A4	M1 and M1A1	32.23	Mk. IIA4	17-gr. perc.
—	All models	SHELL	H.E.	M101	TNT	15.56	94.69	M67A4†	M.T.	M21A4	M1917-18, M1 and M1A1*	26.17	Mk. IIA4	17-gr. perc.
—	All models	SHELL	H.E.	M101	TNT	15.56	94.69	M67A4†	M.T.	M21A4	M1 and M1A1	32.23	Mk. IIA4	17-gr. perc.
—	All models	SHELL	GAS	M104	H	11.70	94.43	P.D., M51A4°	SQ or Del	M6	M1917-18, M1 and M1A1*	26.17	Mk. IIA4	17-gr. perc.
—	All models	SHELL	GAS	M104	H	11.70	94.42	P.D., M51A4°	SQ or Del	M6	M1 and M1A1	32.23	Mk. IIA4	17-gr. perc.
—	All models	SHELL	SMOKE	M104	FS	16.90	99.71	P.D., M51A4°	SQ or Del	M6	M1917-18, M1 and M1A1*	26.17	Mk. IIA4	17-gr. perc.
—	All models	SHELL	SMOKE	M104	FS	16.90	99.71	P.D., M51A4°	SQ or Del	M6	M1 and M1A1	32.23	Mk. IIA4	17-gr. perc.
—	All models	SHELL	SMOKE	M104	WP	15.60	98.42	P.D., M51A4°	SQ or Del	M6	M1917-18, M1 and M1A1*	26.17	Mk. IIA4	17-gr. perc.
—	All models	SHELL	SMOKE	M104	WP	15.60	98.42	P.D., M51A4°	SQ or Del	M6	M1 and M1A1	32.23	Mk. IIA4	17-gr. perc.

Service Ammunition

TABLE 24 (Contd.)
 COMPLETE ROUND TABLE FOR AMMUNITION FOR 155-MM GUNS, M1917-17A1-18MI, M1, AND M1A1 (Contd.)

Note References	Designation of Cannon	PROJECTILE					FUZE			Booster, Adapter, Booster, or Burst	PROPELLING CHARGE		PRIMER ^a	
		Kind	Type	Model	Filler		Type and Model	Action	Kind ^b		Weight (lb.)	Model	Type	
					Kind	Weight (lb.)								Weight as Fired (lb.)
Service Ammunition (Contd.)														
—	M1917-17A1-18MI	SHELL	GAS	Mk. VIIA1	H	11.40	94.88	P.D., M51A4°	SQ or Del	M6	M1917-18, M1 and M1A1	26.17	Mk. IIA4	17-gr. perc.
—	M1917-17A1-18MI	SHELL	SMOKE	Mk. VIIA1	FS	16.23	99.71	P.D., M51A4°	SQ or Del	M6	M1917-18, M1 and M1A1	26.17	Mk. IIA4	17-gr. perc.
—	M1917-17A1-18MI	SHELL	SMOKE	Mk. VIIA1	WP	14.80	98.28	P.D., M51A4°	SQ or Del	M6	M1917-18, M1 and M1A1	26.17	Mk. IIA4	17-gr. perc.
—	M1917-17A1-18MI	SHELL	SMOKE	Mk. VII	H	11.41	93.49	P.D., M46	SQ	Mk. VIB	M1917-18, M1 and M1A1	26.17	Mk. IIA4	17-gr. perc.
—	M1917-17A1-18MI	SHELL	SMOKE	Mk. VII	WP	15.54	97.62	P.D., M46	SQ	Mk. VIB	M1917-18, M1 and M1A1	26.17	Mk. IIA4	17-gr. perc.
—	All models	SHELL	EMPTY	Target practice	†	—	95.00	P.D., inert, M51 or M67 series	SQ or Del or M.T.	††	M1917-18, M1 and M1A1*	26.17	Mk. IIA4	17-gr. perc.
—	All models	SHELL	EMPTY	Target practice	†	—	95.00	P.D., inert, M51 or M67 series	SQ or Del or M.T.	††	M1 and M1A1	32.23	Mk. IIA4	17-gr. perc.
Dummy Ammunition														
—	All models	DUMMY	DRILL	Mk. I	—	—	95.00	—	—	—	Mk. I dummy	26.5	Mk. IIA4	17-gr. perc.
—	All models	DUMMY	DRILL	M7	—	—	95.00	—	—	—	Mk. I dummy	26.5	Mk. IIA4	17-gr. perc.

A.P.—armor-piercing
 B.D.—base-detonating
 H.E.—high-explosive
 Del—delay
 FS—sulfur trioxide-chlorosulfonic acid solution
 †—Propellant powder for these standard charges is NH, M1.
 ‡—Other primers which may be used if PRIMER, percussion, 17-grain, Mk. IIA4 is not available, are: PRIMER, percussion, 18-grain, Mk. IIA3; or PRIMER, percussion, 21-grain, Mk. II or IIA.
 °—Authorized for emergency use only, in 155-mm guns, M1 and M1A1, and then only as a full charge.
 *—Other P.D. M51 fuses on hand are: FUZE, P.D., M51, w/BOOSTER, M20A1 or M21; M51A1, w/BOOSTER, M20A1 or M21A1; or M51A3, w/BOOSTER, M21A2.
 NOTE: The following limitations apply to the M51 fuse, and modifications:
 FUZE, P.D., M51 or M51A1, w/BOOSTER, M20A1, for service use until a sufficient supply of M51A3 fuses with M21A2 boosters, or M51A4 fuses, with M21A4 boosters are available; then for practice.
 FUZE, P.D., M51, w/BOOSTER, M21 or M51A1, for emergency combat use only; must be drop-tested prior to use.
 †—Authorized for emergency use. SHELL, H.E., Mk. IIIA1 should be fired with the base section alone. The use of the full charge is restricted to extreme emergency use.
 ‡—Other M67 fuses on hand are: FUZE, time, mechanical, M67 or M67A1, w/BOOSTER, M21A1; or M67A2, w/BOOSTER, M21A2.
 †—To be sand loaded to weight at point of use.
 ††—Inert booster, M20, all mods., or M21, all mods.

TABLE 25
COMPLETE ROUND TABLE FOR AMMUNITION FOR 8-INCH HOWITZER, M1
 (This table is not to be confused with official Complete Round Charts, Form No. 5981.)

Note Refer-ences	Designation of Cannon	PROJECTILE				FUZE		Booster, Adapter-Booster, or Burstler	PROPELLING CHARGE		PRIMER		
		Kind	Type	Model	Filler		Type and Model		Action	Kind*	Weight (lb.)	Model*	Type
					Kind	Weight (lb.)							
Service Ammunition													
—	M1	SHELL	H.E.	Mk. IA1	TNT	30.08	200.00	M21A4°	M1 (green)	13.375	Mk. IIA4	17-gr. perc.	
—	M1	SHELL	H.E.	Mk. IA1	TNT	30.08	200.00	M21A4°	M1 (green)	13.375	Mk. IIA4	17-gr. perc.	
—	M1	SHELL	H.E.	Mk. IA1	TNT	30.08	200.00	M21A4°	M2 (white)	28.25	Mk. IIA4	17-gr. perc.	
—	M1	SHELL	H.E.	M106	TNT	36.98	200.00	M21A4°	M1 (green)	13.375	Mk. IIA4	17-gr. perc.	
—	M1	SHELL	H.E.	M106	TNT	36.98	200.00	M21A4°	M2 (white)	28.25	Mk. IIA4	17-gr. perc.	
—	M1	SHELL	H.E.	M106	TNT	36.98	200.00	M21A4°	M1 (green)	13.375	Mk. IIA4	17-gr. perc.	
—	M1	SHELL	H.E.	M106	TNT	36.98	200.00	M21A4°	M2 (white)	28.25	Mk. IIA4	17-gr. perc.	
Dummy Ammunition													
—	M1	DUMMY	DRILL	M14	None	—	200.00	—	M4, dummy	28.75	Mk. IIA4	17-gr. perc.	
—	M1	DUMMY	DRILL	Mk. I	None	—	200.00	—	M4, dummy	28.75	Mk. IIA4	17-gr. perc.	
—	M1	DUMMY	DRILL	Mk. IA1	None	—	200.00	—	M4, dummy	28.75	Mk. IIA4	17-gr. perc.	

Del.—delay H.E.—high-explosive M.T.—mechanical time P.D.—point-detonating SQ—superquick perc.—percussion

*—Other primers which may be used if PRIMER, percussion, 17-grain, Mk. IIA4 is not available are: PRIMER, percussion, 18-grain, Mk. IIA3; PRIMER, percussion, 21-grain, Mk. II or IIA. Inert primers are used with the dummy projectiles and propelling charges in drill.

°—Other M67 fuzes on hand are: FUZE, time, mechanical, M67 or M67A1, w/BOOSTER, M21A1; or M67A2, w/BOOSTER, M21A2.

•—Other P.D. M51 fuzes on hand are: FUZE, P.D., M51, w/BOOSTER, M20A1 or M21; M51A1, w/BOOSTER, M20A1 or M31A1; or M51A3, w/BOOSTER, M21A2.

NOTE: The following limitations apply to the M51 fuze, and modifications.
 FUZE, P.D., M51 or M51A1, w/BOOSTER, M20A1, for service use until a sufficient supply of M51A3 fuzes with M21A2 boosters or M51A4 fuzes with M21A4 boosters are available; then for practice.
 FUZE, P.D., M51, w/BOOSTER, M21, or M51A1, w/BOOSTER, M21A1, for emergency combat use only; must be drop-tested prior to use.
 An appreciable percentage of duds may be expected when firing FUZE, P.D., M51A3, w/BOOSTER, M21A2 in zones 1 and 2 of the 8-inch how., M1. This is due to the non-arming of the M21A2 booster at the low velocities in these zones.
 •—Both M1 green bag and M2 white bag charges contain FNH, M1, smokeless powder.

TABLE 26
COMPLETE ROUND TABLE FOR AMMUNITION FOR 8-INCH GUN M1

(This table is not to be confused with official Complete Round Charts, Form No. 5981.)

Note Refer- ences	Designation of Cannon	PROJECTILE				FUZE		Booster, Adapter- Booster, or Burstor	PROPELLING CHARGE		PRIMER ^o		
		Kind	Type	Model	Weight as Fired (Lb.)	Type and Model	Action		Kind ^m	Weight (Lb.)	Model	Type	
													Kind
Service Ammunition													
—	M1	SHELL	H.E.	M103	CAST TNT 20.9	240.	P.D., M51A3-Mod. 3*	SQ or Del.	M21A2†	M9	76.0	Mk. IIA4	17-gr. perc.
—	M1	SHELL	H.E.	M103	CAST TNT 20.9	240.	P.D., M51A3-Mod. 3*	SQ or Del.	M21A2†	M10	106.1	Mk. IIA4	17-gr. perc.
1	M1	SHELL	H.E.	M103	CAST TNT 20.9	240.	M67A3*	M.T.	M21A4‡	M9	76.0	Mk. IIA4	17-gr. perc.
1	M1	SHELL	H.E.	M103	CAST TNT 20.9	240.	M67A3*	M.T.	M21A4‡	M10	106.1	Mk. IIA4	17-gr. perc.
Dummy Ammunition													
—	M1	DUMMY DRILL		M13	None	—	None	—	—	DUMMY M7	—	Mk. IIA4	17-gr. perc.

Del.—delay

H.E.—high explosive

S.Q.—superquick

M.T.—mechanical time

P.D.—point-detonating

^o—Other M67 fuses on hand are: FUZE, time, mechanical, M67 or M67A1, w/BOOSTER, M21A1; or M67A2, w/BOOSTER, M21A2.
^a—Inert service primers used with dummy projectiles and propelling charges in drill. In lieu of the Mk. IIA4 primer, PRIMER, percussion, 18-grain, Mk. IIA3; PRIMER, percussion, 21-grain, Mk. II or Mk. IIA, may be used.
^m—The M9 propelling charge contains FNH, M1, smokeless powder; the M10 charge contains NH, M1, smokeless powder.
^{*}—M51A1-Mod. 3 fuze, with M20A1 booster may be on hand.
[†]—As issued, assembled to fuzes.
[‡]—M67 series fuzes are issued separately and are assembled to the projectile at point of use, to form this complete round.

TABLE 27
COMPLETE ROUND TABLE FOR AMMUNITION FOR 240-MM HOWITZERS, M1918-18A1-18MI-18MIA1, AND M1
 (This table is not to be confused with official Complete Round Charts, Form No. 5981.)

Note Refer-ences	Designation of Cannon	PROJECTILE				FUZE				Booster, Adapter-Booster, or Burstler	PROPELLING CHARGE		PRIMER	
		Kind	Type	Model	Weight as Fired (lb.)	Kind	Type and Model	Action	Kind		Weight (lb.)	Model*	Type	
														Kind
Service Ammunition														
—	M1918 ¹	SHELL	H.E.	Mk. III	TNT†	49.79†	345.	P.D., M46.	SQ	Mk. IIA	*	37.30	Mk. IIA4	17-gr. perc.
—	M1918 ¹	SHELL	H.E.	Mk. III	TNT†	49.79†	345.	P.D., M47	Del.	Mk. IIA	*	37.30	Mk. IIA4	17-gr. perc.
—	M1918 ¹	SHELL	H.E.	Mk. IIIA1	TNT†	49.79†	345.	P.D., M51A4 [¶]	SQ or Del.	M21A4*	*	37.30	Mk. IIA4	17-gr. perc.
—	M1918 ¹	SHELL	H.E.	Mk. IIIA1	TNT†	49.79†	345.	M67A3 [♠]	M.T.	M21A4*	*	37.30	Mk. IIA4	17-gr. perc.
—	M1	SHELL	H.E.	M114	TNT*	54.06 [♠]	360.	P.D., M51A4 [¶]	SQ or Del.	M21A4*	M1	78.75	Mk. IIA4	17-gr. perc.
—	M1	SHELL	H.E.	M114	TNT*	54.06 [♠]	360.	M67A3 [♠]	M.T.	M21A4*	M1	78.75	Mk. IIA4	17-gr. perc.
Practice Ammunition														
—	M1918 ¹	SHELL	EMPTY	Mk. III	†	—	345.	P.D., inert, M47	Del.	†	*	37.30	Mk. IIA4	17-gr. perc.
Dummy Ammunition														
—	M1918 ¹	DUMMY	Drill	Mk. I [‡]	None	—	350.	None	—	—	†	37.7	Mk. IIA4	17-gr. perc.
—	M1	DUMMY	Drill	M12 [‡]	None	—	360.	None	—	—	M12	80.0	Mk. IIA4	17-gr. perc.

Del.—delay
 M.T.—mechanical time
 H.E.—high-explosive
 P.D.—point-detonating
 SQ—superquick
 perc.—percussion
 gr.—grain

*—Other primers which may be used if PRIMER, percussion, 17-grain, Mk. IIA4, is not available, are PRIMER, percussion, 19-grain, Mk. IIA3; or PRIMER, percussion, 21-grain, Mk. II or IIA.
 †—Alternatives: Amatol, 50-50, 47.15 lbs., Amstol, 80-20, 44.37 lbs.
 ‡—Alternatives: Amatol, 50-50, 51.12 lbs., Amstol 80-20, 48.57 lbs.
 §—Standard charges are: CHARGE, propelling, 4 one-fifth and 2 one-tenth sections, Mk. I, NH powder, 240-mm how., M1918-18A1-18MI-18MIA1, 345-lb. proj. or CHARGE, propelling, 5 equal sections, Mk. I, NH powder, 240-mm how., M1918-18A1-18MI-18MIA1. Other charges for the 240-mm how., M1918-18A1-18MI-18MIA1 are: CHARGE, propelling, 4 one-fifth and 2 one-tenth sections, Mk. I, 240-mm how., M1918-18A1-18MI-18MIA1, 345-lb. proj.; or CHARGE, propelling, 5 equal sections, Mk. I, 240-mm how., M1918-18A1-18MI-18MIA1.
 ¶—Other P.D. M51 fuzes on hand are: FUZE, P.D., M51, w/BOOSTER, M20A1 or M21; M51A1, w/BOOSTER, M20A1 or M21A1; or M51A3, w/BOOSTER, M21A2.
 NOTE: The following limitations apply to the M51 fuze, and modifications:
 FUZE, P.D., M51 or M51A1, w/BOOSTER, M20A1, for service use until a sufficient supply of M51A3 fuzes with M21A2 boosters or M51A4 fuzes, with M21A4 boosters are available, then for practice.
 FUZE, P.D., M51, w/BOOSTER, M21, or M51A1, w/BOOSTER, M21A1, for emergency combat use only; must be drop-tested prior to use.
 †—As issued, assembled to fuze.
 ‡—Other M67 fuzes on hand are: FUZE, time, mechanical, M67 or M67A1, w/BOOSTER, M21A1; or M67A2, w/BOOSTER, M21A2.
 §—To be used loaded to weight at point of use.
 ¶—Fitted with inert adapter and booster.
 †—CHARGE, propelling, dummy, 5-section (7½-lbs. each), 240-mm how., M1918-18A1-18MI-18MIA1.
 ‡—M1918-18A1-18MI-18MIA1.
 †—PROJECTILE, dummy, 356-lb., Mk. I, 240-mm how., M1918-18A1-18MI-18MIA1, and M1, and PROJECTILE, dummy, 360-lb., M12, 240-mm how., M1918-18A1-18MI-18MIA1 and M1, are interchangeable.

TABLE 28
COMPLETE ROUND TABLE FOR AMMUNITION FOR 37-MM SUBCALIBER GUNS M12, M13, M14, AND M1916
 (This table is not to be confused with official Complete Round Charts, Form No. 5981.)

Note References	Designation of Cannon	PROJECTILE					FUZE			PROPELLING CHARGE		PRIMER	
		Kind	Type	Model	Weight as Fired (Lb.)	Type and Model	Action	Cartridge Case	Kind	Weight (Lb.)	Model	Type	
													Kind
Service Ammunition													
f	M1916	SHELL	Pract.	Mk. IIA1 *	.053	M38	Base, Pract.	Mk. IA2 ^o	FNH	.07	M23A2	perc.	
—	M1916, M12, M13, M14	SHELL	Pract.	M92	BLK. PDR. .086	M74	P.D.	Mk. IA2 ^o	FNH	.07	M38A1	perc.	
—	M1916, M12, M13, M14	SHELL	Pract.	M63-Mod. 1	BLK. PDR. .09	M58	Base, Pract.	Mk. IA2	FNH	.056	M23A2	perc.	

P.D.—point-detonating

FNH—flashes, nonhygroscopic powder

*—Low-explosive charge of graphite (15%) and black powder (85%).

o—Rounds assembled with steel case are substitute standard.

f—Limited standard. May be fired provided personnel observe safety precautions of remaining to the rear of a line perpendicular to muzzle of gun.

CHAPTER 6

REFERENCES

389. PUBLICATIONS INDEXES.

The following publications should be consulted frequently for latest changes or revisions of references given in this chapter and for new publications relating to materiel covered in this manual:

- a. Introduction to Ordnance Catalog (explaining SNL system) ASF Cat.
ORD 1 IOC
 - b. Ordnance Publications for supply Index (index to SNL's) ASF Cat.
Ord 2 OPSI
 - c. Index to Ordnance Publications (listing FM's, TM's, TC's, and TB's of interest to Ordnance personnel, OPSR, FSMWO's, BSD, S of SR's, OSSC's, and OFSB's, and including alphabetical listing of Ordnance major items with publications pertaining thereto) .. OFSB 1-1
 - d. List of Publications for Training (listing MR's, MTP's, FM's, TM's, TR's, TB's, MWO's, SB's, WDLO's, and FT's)..... FM 21-6
 - e. List of Training Films, Film Strips, and Film Bulletins (listing TF's, FS's, and FB's by serial number and subject).... FM 21-7
 - f. Military Training Aids (listing Graphic Training Aids, Models, Devices, and Displays) FM 21-8
390. STANDARD NOMENCLATURE LISTS.
- a. Cleaning, preserving, and lubricating materials; recoil fluids, special oils, and miscellaneous related items..... ASF Cat.
ORD 5 SNL K-1
 - b. Medium and Major Caliber Seacoast Artillery, Including Antiaircraft, Railway, and Heavy Field Artillery.
Ammunition, fixed, including subcaliber ammunition, for harbor defense, heavy field, and railway artillery..... ORD 11 SNL P-6
Ammunition for antiaircraft artillery..... ORD 11 SNL P-5
Ammunition instruction material for anti-aircraft, harbor defense, heavy field, and railway artillery, including complete round data..... ORD 11 SNL P-8

ARTILLERY AMMUNITION

Charges, propelling, separate loading, 6-inch to 240-mm, inclusive, for harbor defense, heavy field, and railway artillery	ORD 11 SNL P-2
Fuzes, primers, blank ammunition, and miscellaneous items for antiaircraft, harbor defense, heavy field, and railway artillery	ORD 11 SNL P-7
Projectiles, separate loading, 6-inch to 240-mm, inclusive, for harbor defense, heavy field, and railway artillery, including complete round data.....	ORD 11 SNL P-1

c. Pack, Light, and Medium Field, Aircraft, Tank, and Antitank Artillery, and Trench-mortar Ammunition.

Ammunition, blank, for pack, light and medium field, tank, and antitank artillery	ORD 11 SNL R-5
Ammunition, fixed and semifixed, including subcaliber, for pack, light and medium field, aircraft, tank, and antitank artillery, including complete round data	ORD 11 SNL R-1
Ammunition instruction material for pack, light and medium field, aircraft, tank, and antitank artillery	ORD 11 SNL R-6
Ammunition, trench mortar, including fuzes, propelling charges and other components	ORD 11 SNL R-4
Projectiles and propelling charges, separate loading, for medium field artillery, including complete round data.....	ORD 11 SNL R-2
Service fuzes and primers for pack, light and medium field, aircraft, tank, and antitank artillery	ORD 11 SNL R-3

391. EXPLANATORY PUBLICATIONS.

a. Ammunition, All Types.

Ammunition condition report.....	O.O. Form No. 7235
Ammunition, general	TM 9-1900
Ammunition: General	WD SB 9-AMM 1
Ammunition: Net prices	WD SB 9-AMM 3
Explosives and demolitions.....	FM 5-25
Military explosives	TM 9-2900

REFERENCES

- Qualification in arms and ammunition training allowances AR 775-10
- Range regulations for firing ammunition for training and practice..... AR 750-10
- Unsafe ammunition WD SB 9-AMM 2
- b. Ammunition, Special Types.**
- Coast artillery ammunition TM 4-205
- Field artillery and field mortar ammunition OFSB 3-3
- Ordnance maintenance: Grenades, hand and rifle TM 9-1985
- Ordnance maintenance: Small-arms ammunition TM 9-1990
- Seacoast and railway artillery ammunition, antiaircraft ammunition, and field artillery ammunition for large calibers, including 155-mm gun and above OFSB 3-2
- c. Cleaning, preserving, lubricating, and welding materials and similar items issued by the Ordnance Department...** TM 9-850
- d. Miscellaneous.**
- 2-inch mortar M3..... TM 9-293
- 75-mm gun and carriage M1917 and modifications TM 9-315
- Decontamination TM 3-220
- Defense against chemical attack FM 21-40
- Destruction of Ordnance materiel in hands of Ordnance troops in event of imminent capture in combat zone..... TC 18, 22 Feb 43
- Field artillery trainer..... TM 6-225
- Inspection of propelling charges and bulk powder OFSB 3-13
- List of publications for training..... FM 21-6
- Military chemistry and chemical agents.. TM 3-215
- Ordnance safety manual..... Form No. O.O. 7224
- Ordnance service in the field..... FM 9-5
- Targets, target materials, and rifle range construction TM 9-855
- e. Prescribed Regulations.**
- List of current and suspended pamphlets AR 1-10
- Supplies: Storage, and issue..... AR 700-10
- 392. FIRING TABLES.**
- a. See FM 21-6, List of Publications for Training.**

ARTILLERY AMMUNITION

INDEX

	Page		Page
A		105-mm howitzers	167
Accidents, field report of.....	33	155-mm howitzers	188
Adapter-boosters		240-mm howitzers	208
Mk. III and Mk. IIIAM2.....	337	2-inch mortars	79
Mk. IVMI, Mk. IVB and Mk.		60-mm mortars	87
VIB	339	81-mm mortars	147
Adapters, description	336	Armor-piercing (A.P. or A.P.C.)	
Ammunition		projectile	28
aircraft artillery	11	B	
blank, for 37-mm guns.....	69	Base (projectile)	
care, handling, and preservation..	22	description	27
classification, nomenclature, and		cover	26
identification code symbols.....	6	plug	26
definitions and general discus-		types	26
sion	4	Body of projectile, definition.....	26
destruction of	346	Bomb, smoke, Mk. I/L, 2" mortar,	
interchangeability	71	M3	81
lot number	14	Boosters	
marking and sealing for shipment		M20 and M20A1.....	328
packing and shipping data.....	32	M21, M21A1, M21A2, and	
storage precautions	79	M21A4	331
Ammunition, blank		M22, M23, and M24.....	333
description	6	Bourrelet (projectile), description..	25
general discussion and complete		Bursters	
round	31	M1 and M8.....	335
used with:		M5 and M6.....	336
3-inch (15-PDR) guns....	137, 144	Bursting charge, description.....	26
75-mm guns		C	
double pellet	113, 123	Canister, description	29
single pellet	112	Canister, fixed, M2	63
90-mm guns	165	Cap, armor-piercing (projectile)....	27
105-mm howitzer	175	Cartridge, APC-T, M86	85
Ammunition for:		Cartridge, APC-T, M86, w/fuze,	
3-inch guns	130	B.D., M72	85
4.5-inch guns	183	Cartridge, AP-T, M70	86
8-inch guns	206	Cartridge, AP-T, M75	47
20-mm guns	43	Cartridge, AP-T, M81, 40-mm A.A.	
37-mm guns		guns	73
regular	52	Cartridge, AP-T, M81A1, 40-mm	
subcaliber	212	A.A. guns	73
40-mm guns	71	Cartridge, AP-T, T9E5 (M95)	48
57-mm guns	83	Cartridge, ball	48
75-mm guns	98	Cartridge, ball, cal. .22, long rifle..	215
76-mm guns	124	Cartridge, ball, cal. .30, M1 and M2	215
105-mm guns	179	Cartridge, ball, cal. .50, M2.....	215
120-mm (4.7-inch) guns.....	185	Cartridge, blank, 10-gage	67
155-mm guns	197		
8-inch howitzers	203		
75-mm howitzers	116		

INDEX

C — Contd.	Page		Page
Cartridge, drill, M2A2	123	Cartridge cases used with ammunition for:	
Cartridge, drill, M3A1	138	guns	
Cartridge, drill, M4A1	144	3-inch	132
Cartridge, drill, M7	113	20-mm	44
Cartridge, drill, M8	182	37-mm	
Cartridge, drill, M9, w/fuze, dummy:		regular	52
M59	137	subcaliber	212
21-sec., M42A1	138	40-mm	71
Cartridge, drill, M10	145	57-mm	83
Cartridge, drill, M11	182	75-mm	99
Cartridge, drill, M12	165	76-mm	124
Cartridge, drill, M13	69	90-mm	160
Cartridge, drill, M15	145	120-mm (4.7-inch)	185
Cartridge, drill, M16	113	howitzers	
Cartridge, drill, M17	78	75-mm	116
Cartridge, drill, M18	51	105-mm	169
Cartridge, drill, M18A1	51	marking	20
Cartridge, drill, M19	123	Charges, propelling data.....	300
Cartridge, drill, M20	129	Charges, propelling, for:	
Cartridge, drill, M21	69	guns	
Cartridge, drill, M23(T31)	69	3-inch	302
Cartridge, drill, M- (T5)	70	4.5-inch	303
Cartridge, drill, Mk. II, 3" guns....	138	8-inch	313
Cartridge, drill, semifixed, M14, w/fuze, dummy, M59, 105-mm howitzers	176	20-mm	300
Cartridge, drill, semifixed, M14, w/fuze, inert, TSQ, M54.....	177	37-mm	300
Cartridge, H.E., Mk. I (Navy).....	73	40-mm	300
Cartridge, HE-I, Mk. I, w/fuze....	47	57-mm	300
Cartridge, HE-I, T23 (M97).....	49	75-mm	301
Cartridge, HE-T (SD), Mk. II.....	75	76-mm	302
Cartridge, HE-T, Mk. II, inert loaded	78	90-mm	303
Cartridge, ignition		105-mm	303
M3	321	120-mm (4.7")	304
M4	324	155-mm	308
Cartridge, incendiary, T18 (M96)..	49	howitzers	
Cartridge, practice, T24 (M99)....	50	8-inch	311
Cartridge, primer and ignition.....	79	75-mm	302
Cartridge, TP-T, M91	77	105-mm	303
		155-mm	305
		240-mm	313, 315
		mortars	
		60-mm	301
		81-mm	302
		Chemical fillers, general discussion	13
		Chemical shell, description.....	28
		Complete round tables	349
		Components (artillery rounds).....	15
		D	
		Drill ammunition, description.....	6
		Dummy projectiles	29

ARTILLERY AMMUNITION

	Page		Page
E			
Explosive train, definition.....	13	Fuze, time, mechanical, M61 and M61A1	263
Explosives, high; and propellants....	11	Fuze, time (fixed), M65.....	267
Eyebolt-lifting plugs	341	Fuze, time, mechanical, M67A2, w/booster, M21A2	268
F			
Field artillery trainer, M3.....	218	Fuze, time, 21-sec., AA., Mk. IIIA1, and Mk. IIIA2	282
Field report of accidents.....	42	Fuze setters	
Fins, changes in	88	description	221
Flash reducer, M1.....	310	table of	222
Fuze, B.D., M58	225	Fuzes	
Fuze, B.D., M60	227	boresafety	221
Fuze, B.D., M62A1 and M62.....	229	definition, description, and classification	220
Fuze, B.D., M66A1	231	location in projectile.....	25
Fuze, B.D., M68	231	painting and marking.....	21
Fuze, B.D., M72	234	Fuzes used with ammunition for:	
Fuze, base, practice, M58 and M38	225	guns	
Fuze, combination, 21-sec., M1907M	278	3-inch	130
Fuze, dummy		4.5-inch	183
description	289	8-inch	206
table of	290	20-mm	44
Fuze, P.D., M45	241	37-mm	
Fuze, P.D., M46	242	regular	52
Fuze, P.D., M47	244	subcaliber	212
Fuze, P.D., M51A3, w/booster, M21A2	248	40-mm	71
Fuze, P.D., M51A3-Mod. 3	251	57-mm	83
Fuze, P.D., M52, M52B1 and M52B2	252	75-mm	99
Fuze, P.D., M53	255	76-mm	124
Fuze, P.D., M56	259	90-mm	160
Fuze, P.D., M57	263	105-mm	179
Fuze, P.D., M64A1	267	155-mm	197
Fuze, P.D., M71	270	howitzers	
Fuze, P.D., M74	274	8-inch	203
Fuze, P.D., M75	274	105-mm	167
Fuze, P.D., Mk. 27 (Navy)	283	155-mm	188
Fuze, P.D., 251, Mk. I	285	240-mm	208
Fuze, P.D., 253 Mk. II-III.....	287	mortars	
Fuze, TSQ, M54	256	60-mm	87
Fuze, TSQ, M55A2, w/booster, M21A2	259	81-mm	147
Fuze, TSQ, M77 (T88)	276	G	
Fuze, time, mechanical, M2	234	Guns (See under Ammunition)	
Fuze, time, mechanical, M43 (all modifications)	235	H	
		High-explosive shells, description.. 28	

ARTILLERY AMMUNITION

P — Contd.	Page	Page	
Primer, percussion, 225-grain, M40 (T27)	321	Projectile, dummy, 240-lb., M13, 8" gun, M1.....	207
Primer, percussion, 260-grain, M40 (T27)	125	Projectile, dummy, 356-lb., Mk. I, 240-mm howitzer	211
Primer, percussion, 300-grain M28	132	Projectile, dummy, 360-lb., M12, 240-mm howitzer	210
M28A2	125, 321	Projectile, dummy, M- (T5), w/fuze, dummy, M-, 120-mm gun, M1	187
M28B1A1	125	Projectile, fixed, A.P.C., M61A1....	101
Primer, percussion, M32, w/igni- tion cartridge, M5A1.....	325	Projectile, fixed, A.P.C., M61.....	102
Primer, percussion, M33, w/igni- tion cartridge, M6.....	326	Projectile, fixed, A.P.C., M62..	126, 139
Primer, percussion, M34, w/igni- tion cartridge, M6.....	326	Projectile, fixed, A.P.C., M62A1	125, 138
Primer, percussion, M36A1.....	319	Projectile, fixed, A.P.C., M82.....	162
Primer, percussion, Q.F. cartridges, No. 12, Mk. II /L/	320	Projectiles data (armor-piercing)	30
Primers used with ammunition for:		description	
guns		armor-piercing	28
3-inch	132	base	27
4.5-inch	183	dummy	29
8-inch	206	general discussion	25
20-mm	44	painting and marking.....	15
37-mm		types of	28
regular	52	Propellant powder	
subcaliber	212	76-mm guns	124
40-mm	71	NH (nonhygroscopic, flashing)....	161
57-mm	83	Propelling charges	
75-mm	99	description	87
76-mm	125	fixed and semifixed	295
90-mm	161	packing and shipping data.....	297
105-mm	180	painting and marking.....	20
155-mm	197	separate-loading data	300
howitzers		trench-mortar, 120-mm, and sep- arate-loading	296
8-inch	203	used with ammunition for:	
75-mm	117	guns	
105-mm	170	3-inch	132
155-mm	188	4.5-inch	183
mortars		8-inch	206
60-mm	88	155-mm	197
81-mm	149	howitzers	
Projectile, A.P., 100 lb, M112.....	198	8-inch	203
Projectile, dummy, M7, 155-mm howitzer	196	75-mm	117
Projectile, dummy, M8, 4.5" gun, M1	184	105-mm	169
Projectile, dummy, 95-lb. M7	202	155-mm	188
Mk. I	196	mortars	
Projectile, dummy, 200-lb.....	205	60-mm	87
		81-mm	147
		(See also Charge, propelling)	

INDEX

R	Page		Page
Rotating band (projectile), description and function.....	26	M63, Mod. 1.....	218
S			
Sealing for shipment.....	32	M71	164
Service ammunition	6	M92	218
Shell, empty, for sand loading, 345-lb., Mk. III	209	Mk. I	111
Shell, fixed, gas, persistent, CNS, M64	111	Mk. IIA1	218
Shell, fixed, gas, persistent, H, Mk. II	110	Shell, fixed, smoke, FM, Mk. II, normal charge, unfuzed, 75-mm gun	109
Shell, fixed, gas, persistent, NC, Mk. II	111	Shell, fixed, smoke, FS, Mk. II, normal charge, unfuzed, 75-mm gun	110
Shell, fixed, H.E.		Shell, fixed, smoke, HC, B.I., M88, 76-mm guns	128
M38, flashless	181	Shell, fixed, smoke, HC, B.I., M89, 75-mm guns	107
M38A1	180	Shell, fixed, smoke, phosphorus, WP, M64	108
M42		Shell, fixed, smoke, phosphorus, WP, Mk. II, normal charge, unfuzed, 75-mm guns.....	109
flashless	134	Shell, H.E., M43A1, w/fuze, P.D., M52	151
w/fuze, P.D., M48.....	143	Shell, H.E., M45, w/fuze, P.D., M45	156
M42, NH	141	Shell, H.E., M45B1, w/fuze, P.D., M53	156
M42A1, w/fuze, P.D., M48A2		Shell, H.E., M49A2, w/fuze, P.D., M52	91
SQ & 0.05-sec. delay.....	127, 142	Shell, H.E., M56, w/fuze, P.D., M53	153
SQ & 0.15-sec. delay.....	128, 142	Shell, H.E., M65, unfuzed, 4.5" gun, M1	183
M42A1, NH	133, 141	Shell, H.E., M73, w/fuze, time, mechanical, M61, 120-mm gun, M1	187
M48		Shell, H.E., M73, w/fuze, time, mechanical, M61A1, 120-mm gun, M1	187
normal charge		Shell, H.E., M101, unfuzed, 155-mm guns	198
w/fuze, P.D., M48A2	104	Shell, H.E., M102, unfuzed, 155-mm howitzers	192
w/fuze, TSQ, M54	105	Shell, H.E., 200-lb., M106, unfuzed, 8" howitzer, M1.....	203
reduced charge	105	Shell, H.E., 240-lb., M103, w/fuze, 8-inch gun	206
supercharge		Shell, H.E., M107, unfuzed, 155-mm how., M1	189
flashless	106		
w/fuze, P.D., M57	106		
w/fuze, P.D., M48A2	104		
w/fuze, TSQ, M54	105		
M54, automatic guns			
37-mm	55		
37-mm (aircraft)	64		
M63	61		
M71			
w/fuze, M43	163		
w/fuze, P.D., M48A2	164		
Shell, fixed, H.E.A.T., M66.....	121		
Shell, fixed, H.E., Mk. I.....	106, 107		
Shell, fixed, H.E., Mk. IX.....	134, 141		
Shell, fixed, practice			
M38	181		
M42B2	134, 143		
M55A1	59		

ARTILLERY AMMUNITION

S — Contd.	Page		Page
Shell, H.E., Mk. IA1		Shell, smoke, FS, M57.....	155
8-inch howitzers	204	Shell, smoke, HC, B.E., M115.....	195
155-mm howitzers	192	Shell, smoke, HC, B.E., M116.....	191
Shell, H.E., Mk. III.....	208	Shell, smoke, phosphorus, WP, M57	155
Shell, H.E., Mk. IIIA1		Shell, target-practice, for sand load-	
155-mm guns	199	ing, unfuzed, 15-mm guns.....	201
240-mm howitzers	209	Shell, training, M68, 81-mm mor-	
Shell, illuminating		tars	159
M83A1 w/fuze	93	Shell, training, M69, 60-mm mor-	
(See also Illuminating shell)		tars	97
Shell, M104, gas and smoke.....	200	Shipment, marking for.....	32
Shell, M105, gas and smoke.....	193	Shot, fixed, A.P., M72, flashless,	
Shell, M110, gas and smoke.....	190	w/tracer, 75-mm aircraft guns..	103
Shell, Mk. II, gas and smoke.....	195	Shot, fixed, A.P., M72, w/tracer,	
Shell, Mk. IIA1, gas and smoke....	194	75-mm gun	103
Shell, Mk. IIA1—Mod. 1, gas.....	194	Shot, fixed, A.P., M74, w/tracer	
Shell, Mk. VII, gas and smoke.....	201	37-mm guns	62
Shell, Mk. VIIA1, gas and smoke..	200	37-mm automatic guns	55
Shell, practice		Shot, fixed, A.P., M77, NH,	
M43	159	w/tracer	162
M43A1 and M44.....	157	Shot, fixed, A.P., M79,	
M50A1 and M50A2.....	95	w/tracer	127, 140
Shell, semifixed, empty, for sand		Shot, fixed, A.P., M80,	
loading	175	w/tracer	59, 65
Shell, semifixed, gas, persistent, H,		Shot, fixed, A.P.C.	
M60	174	M51, w/tracer	61
Shell, semifixed, gas, persistent, H,		M59 and M59A1	57
M64	122	Shot, fixed, T.P.	
Shell, semifixed, HC, B.E., M84....	178	M51A1	63
Shell, semifixed, H.E.,		M51A2	64
M1	170, 171, 177	Shrapnel, description	29
Shell, semifixed, H.E., A.T.,		Shrapnel, fixed, Mk. I	
M67	174, 177	3-inch guns	135, 143
Shell, semifixed, H.E., M41A1.....	119	75-mm guns	111, 112
Shell, semifixed, H.E., M48.....	118	Storage, precautions	23
Shell, semifixed, smoke (colored),		Subcaliber materiel and ammuni-	
B.E., M84	173	tion tables	213
Shell, semifixed, smoke, FS,			
M60	174, 178	T	
Shell, semifixed, smoke, FS, M64..	122	Target-practice projectiles	29
Shell, semifixed, smoke, HC		Tracer (projectile)	
(white), B.E., M84.....	172	description	28
Shell, semifixed, smoke, phos-		painting and marking.....	15
phorus, WP, M60.....	173, 178		
Shell, semifixed, smoke, phos-		W	
phorus, WP, M64.....	121	Weight-zone markings	21
Shell, smoke (colored), B.E., M116	192	Windshield (projectile)	27