

DEPARTMENT OF THE ARMY TECHNICAL MANUAL

DEPARTMENT OF THE AIR FORCE TECHNICAL ORDER

TM 9-1985-6

TO 39B-1A-8

ITALIAN

AND

FRENCH

EXPLOSIVE ORDNANCE

DEPARTMENTS OF THE ARMY AND THE AIR FORCE

MARC 1953

TM 9-1985-6/TO 39B-1A-8

ITALIAN
AND
FRENCH
EXPLOSIVE ORDNANCE



United States Government Printing Office
Washington : 1953

DEPARTMENTS OF THE ARMY
AND THE AIR FORCE

WASHINGTON 25, D. C., 16 March 1953

TM 9-1985-6/TO 39B-1A-8 is published for the information and guidance
of all concerned.

[AG 471 (20 Feb 53)]

BY ORDER OF THE SECRETARIES OF THE ARMY AND THE AIR FORCE:

OFFICIAL:

WM. E. BERGIN
Major General, USA
The Adjutant General

J. LAWTON COLLINS

Chief of Staff, United States Army

OFFICIAL:

K. E. THIEBAUD
Colonel, USAF
Air Adjutant General

HOYT S. VANDENBERG

Chief of Staff, United States Air Force

DISTRIBUTION:

Active Army:

Tech Svc (1) except 3, 5 (5), 9 (10); Tech Svc Bd (2); AFF (2);
OS Maj Comd (5); Base Comd (2); MDW (1); A (2); CHQ (2);
Div (2); Sch (1) except 5 (5), 9 (50); Dep 9 (3); POE (2), OSD
(1); PRGR 9 (3); Ars 9 (1); Proc Dist 9 (1); T/O & E 9-500,
FA, FB, FC, FE, FF (1).

NG: None.

Army Reserve: None.

For explanation of distribution formula, see SR 310-90-1.

TABLE OF CONTENTS

Chapter	Page
1. Italian Bombs.....	1
2. Italian Bomb Fuzes.....	29
3. Italian Projectiles.....	61
4. Italian Projectile Fuzes.....	133
5. Italian Hand and Mortar Grenades.....	155
6. Italian Mines and Traps.....	165
7. Italian Igniters.....	173
8. French Bombs.....	177
9. French Bomb Fuzes.....	189
10. French Mines and Traps.....	206
11. French Igniters.....	211

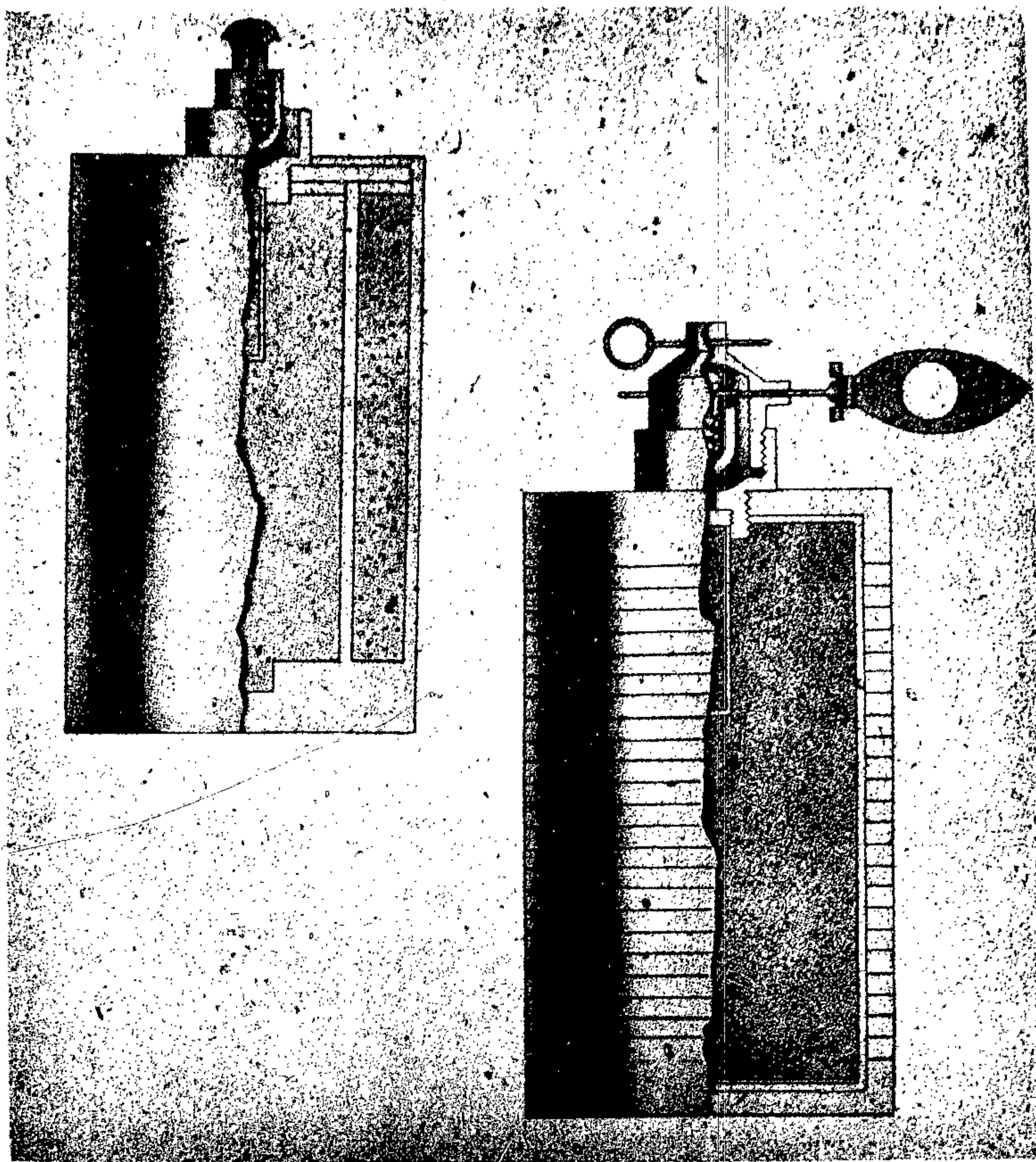

*Figure 1 - 2-kg. Anti-Personnel Bombs
Types F and Mtr.*

Chapter 1

ITALIAN BOMBS

Italian bombs closely resemble Japanese bombs in that they are usually more than one-piece in construction, assembled by screws or rivets, or welded. The Italian bomb is normally filled through the base, which is closed by a base plate attached by screws or rivets. Normally, the tail unit fits over the base plate and is attached to the body or the base plate by screws or rivets, or, in case of the smaller bombs, by welding. The tail units vary considerably in their design, but the tail diameter is usually the same as that of the body of the bomb to which it is attached.

Generally the bombs are of sheet steel, but some are constructed of cast aluminum alloy. In most cases, the filling is cast TNT, but a large number have been found with an alternate filling of Amatol and TNT with aluminum powder. A felt pad in the nose breaks the shock of impact on the explosive filler. The bombs contain a booster, and an initiating charge in the fuze.

Normally the demolition bombs have a mild steel casing, while the armor-piercing bombs use hardened steel. The wall thickness for the 24-kg. or large bombs ranges from $\frac{1}{4}$ in. to $\frac{1}{2}$ in. for light-cased and from $\frac{1}{2}$ in. to $1\frac{1}{2}$ in. for heavy-cased. This thickness varies for each bomb, increasing towards the nose.

Demolition bombs and chemical bombs, 100-kg. or less, usually have provision for tail fuzeing only. The tail fuzes are screwed into the base of the bomb. These tail fuzes usually have very long arming spindles which extend the full length of the tail. The end of the bomb tail is shaped to accommodate the arming vanes of the fuzes. In the case of 20-kg. incendiary bombs, the tail unit is cut to allow the vanes to be situated half-way along the tail in order to insure limited terminal velocity for the vanes. Nose and tail fuzeing is normally used in demolition bombs of 100-kg. or above.

Anti-personnel bombs differ from the demolition bombs in the construction of the outer casing. In one type, the filling is enclosed in a sheet container,

on the outside of which a steel strip is wound spirally. In another type, the filling is contained in a sheet-steel case which is enclosed by a larger container. The space between the two containers is filled with steel fragments embedded in concrete. These anti-personnel bombs are known as Type F and Type Mtr., respectively.

Italian bombs are either painted or galvanized as a precaution against corrosion. The colorings are usually found on the nose and the body. Distinguishing colors are identified as follows:

Type of Bomb	Body	Nose
Fragmentation	blue	red
High explosive	grey	red
Anti-personnel	black or blue	red
Incendiary	reddish brown	red
Gas	bright yellow	red
Practice	grey	grey

2-kg. Anti-Personnel Bombs Types F and Mtr.

Data

	Type F	Type Mtr.
Over-all length	6.0 in.	6.0 in.
Body length	4.5 in.	4.5 in.
Max. diameter	2.75 in.	2.75 in.
Type of filling	TNT	TNT
Weight of filling	0.380 kg.	0.220 kg.
Total weight	1.72 kg.	1.87 kg.

Fuzeing

Tail—Type K

Description

Type F: The bomb consists of a thin steel cylinder surrounded by a tightly coiled spring of rectangular cross section. In certain assemblies of this type, the spring is enclosed by a thin case. The object of the spring is to provide shrapnel effect. In fragmentation, the bomb usually breaks into pieces about 1 in. x 0.2 in. x 0.18 in. The bomb has no tail unit.

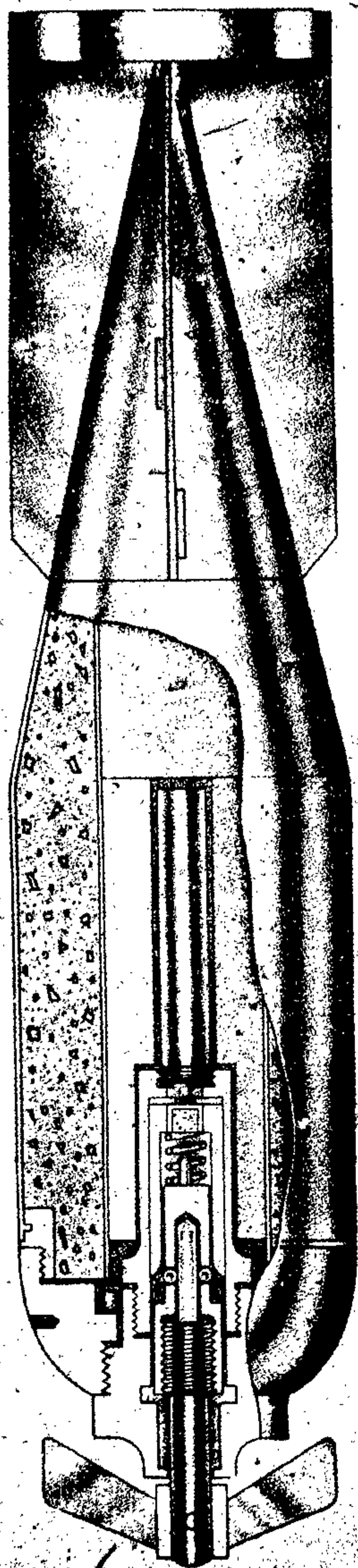

Type Mtr: The bomb consists of two cylinders of sheet metal. The inner cylinder contains the explosives, and the outer cylinder is threaded at the top to take a screwed circular cover. Between the two cylinders are small steel pellets embedded in concrete.

Color and Markings

Over-all color—black

Remarks

1. The bomb may be dropped singly or in containers, e. g. 100 Sp.
2. These bombs are very similar to 1-kg. incendiary bomb and 1-kg. gas bomb.
3. The bomb can also be used as a land mine by use of a pressure igniter.

3-kg. Anti-Personnel Bomb Type Mtr.

Data

Over-all length.....	12.1 in.
Body length.....	8.2 in.
Body diameter.....	2.7 in.
Tail length.....	4.5 in.
Tail width.....	2.7 in.
Type of filling.....	TNT
Weight of filling.....	0.17 kg.
Total weight.....	3 kg.

Fuzing

Nose—Type M

Description

The bomb body is thin sheet steel with a fuze adapter pressed and spot-welded into the nose. A steel central tube, 7.1 in. long and 0.078 in. thick, contains the bursting charge of block TNT, recessed to take the base of the fuze and the detonator. The space between the exploder container and the bomb's outside wall is filled with steel fragments embedded in concrete. The tail is made of thin sheet metal, with four vanes strengthened by a band 0.39 in. in width.

Color and Markings

Over-all—blue or black

Nose—red

Figure 2 — 3-kg. Anti-Personnel Bomb Type Mtr.

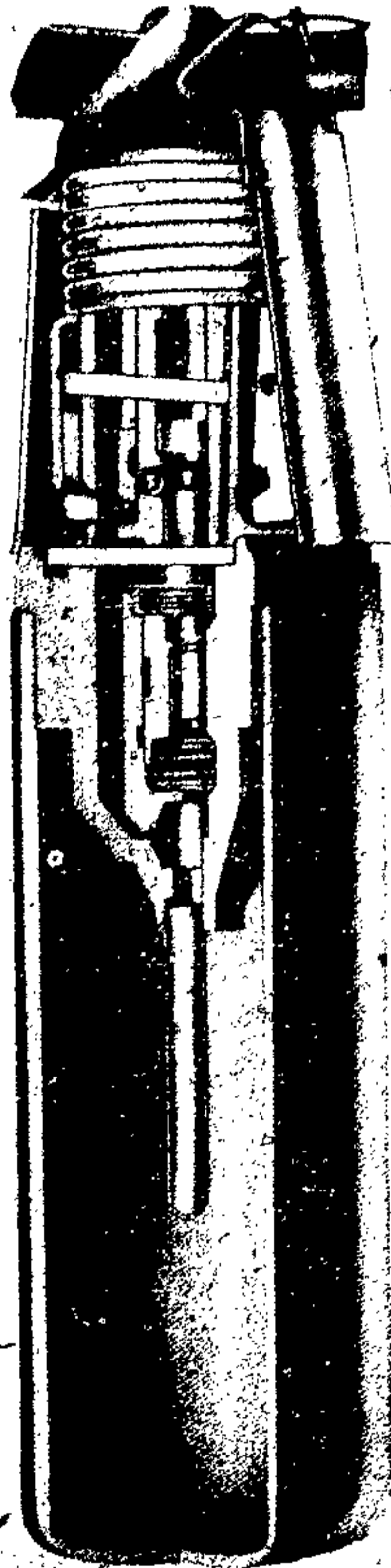

Figure 3 - 4-kg. Anti-Personnel Bomb Manzolini

4-kg. Anti-Personnel Bomb Manzolini (Thermos)

Data

Over-all length.....	12.3 in.
Body length.....	7.3 in.
Body diameter.....	2.75 in.
Wall thickness.....	0.125 in.
Type of filling.....	TNT
Weight of filling.....	0.67 kg.
Total weight.....	3.68 kg.

Fuzing

Manzolini, Type I and II

Description

This bomb, with a steel body and aluminum top,

resembles a thermos bottle. The fuzes (described in the fuze section) are very sensitive. The fragments are lethal to 100 ft., with maximum range of 300 yd.

Color and Markings

Over-all—buff or green

Remarks

1. Bombs fitted with self-destroying mechanism have an aluminum alloy fuze housing (visible where the fuze screws into the bomb).
2. Bomb does not explode on impact, but is designed to explode if moved, and is extremely sensitive to vibration.

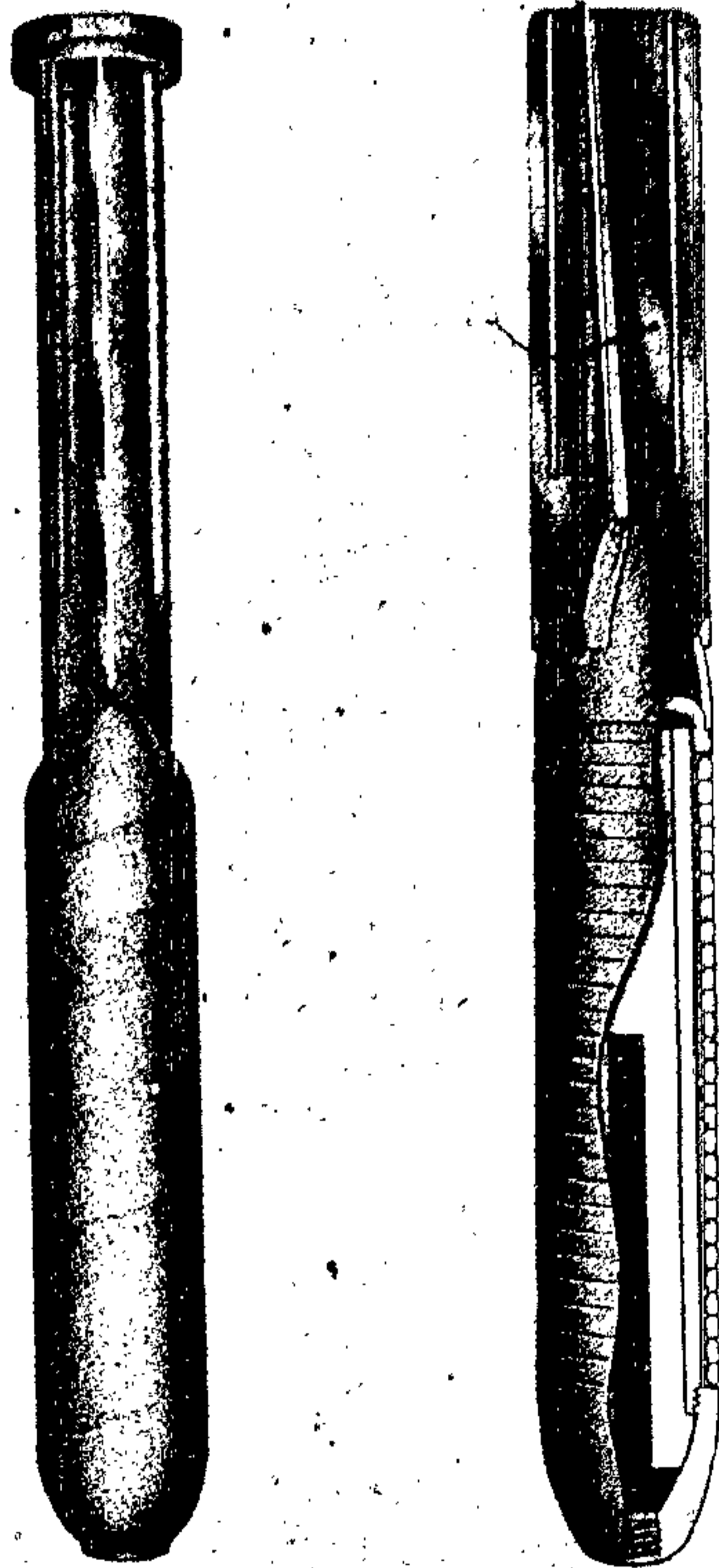

Figure 4 - 12-kg. Anti-Personnel Bombs
Types F and Mtr.

12-kg. Anti-Personnel Bombs Types F and Mtr.

Data

	Type F	Type Mtr.
Over-all length	32.4 in.	32.3 in.
Body length	17.3 in.	16.0 in.
Body diameter	3.5 in.	3.5 in.
Wall thickness	0.2 in.	0.2 in.
Tail length	14.5 in.	16.5 in.
Tail width	3.5 in.	3.5 in.
Type of filling	TNT	TNT
Weight of filling	1.93 kg.	1.90 kg.
Total weight	12.20 kg.	12.88 kg.

Description

Type F: This bomb consists of a steel container around which are wound 25 turns of square steel wire, 0.2 in. thick. The purpose of the wire is to provide shrapnel effect in fragmentation. The tail assembly consists of four stamped sheet-metal vanes which are spot-welded to the base of the bomb.

Type Mtr.: This bomb is very similar to the Type F in appearance, but differs in construction of the body. The body is a double-walled steel cylinder containing steel shrapnel embedded in concrete. In manufacturing the bomb, the concrete-shrapnel filling was poured into the base of the bomb and then the tail unit was screwed into the outer wall of the bomb.

Color and Markings

Type F: Over-all—sky blue; nose—red
Type Mtr.: Over-all—blue or black; nose—red

Fuzing

Type F: Nose—Type F
Type Mtr.: Nose—Type J

14-kg. Fragmentation Bombs Types I and II
Data

	Type I	Type II
Over-all length	22.1 in.	22.1 in.
Body length	13.5 in.	13.5 in.
Body diameter	4.2 in.	4.2 in.
Wall thickness	0.2 in.	0.7 in.
Tail length	6.4 in.	6.4 in.
Tail width	4.2 in.	4.2 in.
Type of filling	TNT	Amatol
Weight of filling	2 kg.	2 kg.
Total weight	14 kg.	14 kg.

Fuzing

Nose—Type I

Description

Type I: The body consists of a tubular steel cylinder on which the cast-steel nose and base sections are threaded. A square steel wire, $\frac{3}{8}$ in. on the side, is helically wound around the body. The nose piece is threaded to receive the fuze. The base has an external recess and extension rod for the tail assembly. The tail section consists of two sheet-steel plates bent to an angle of 90 degrees and held to the extension rod. Four pieces of wood, shaped to form a truncated cone, serve as spacers for the fins. The assembly is held by a steel pressure cap which threads into the extension rod.

Type II: The body is one-piece machined steel with the nose threaded to receive the fuze, and the base recessed with an extension rod for the tail assembly. In all other respects this type is similar to Type I.

Color and Markings

Type I: Over-all—yellow; stenciled in black P30A

IM-4-39

TNT

K

Type II: Over-all—Dark olive green (painted over yellow). Red paint marks diametrically opposite on shoulders of nose and base.

Remarks

Both type resemble the U. S. 30-lb. Fragmentation Bomb Mk 5 in size and appearance.

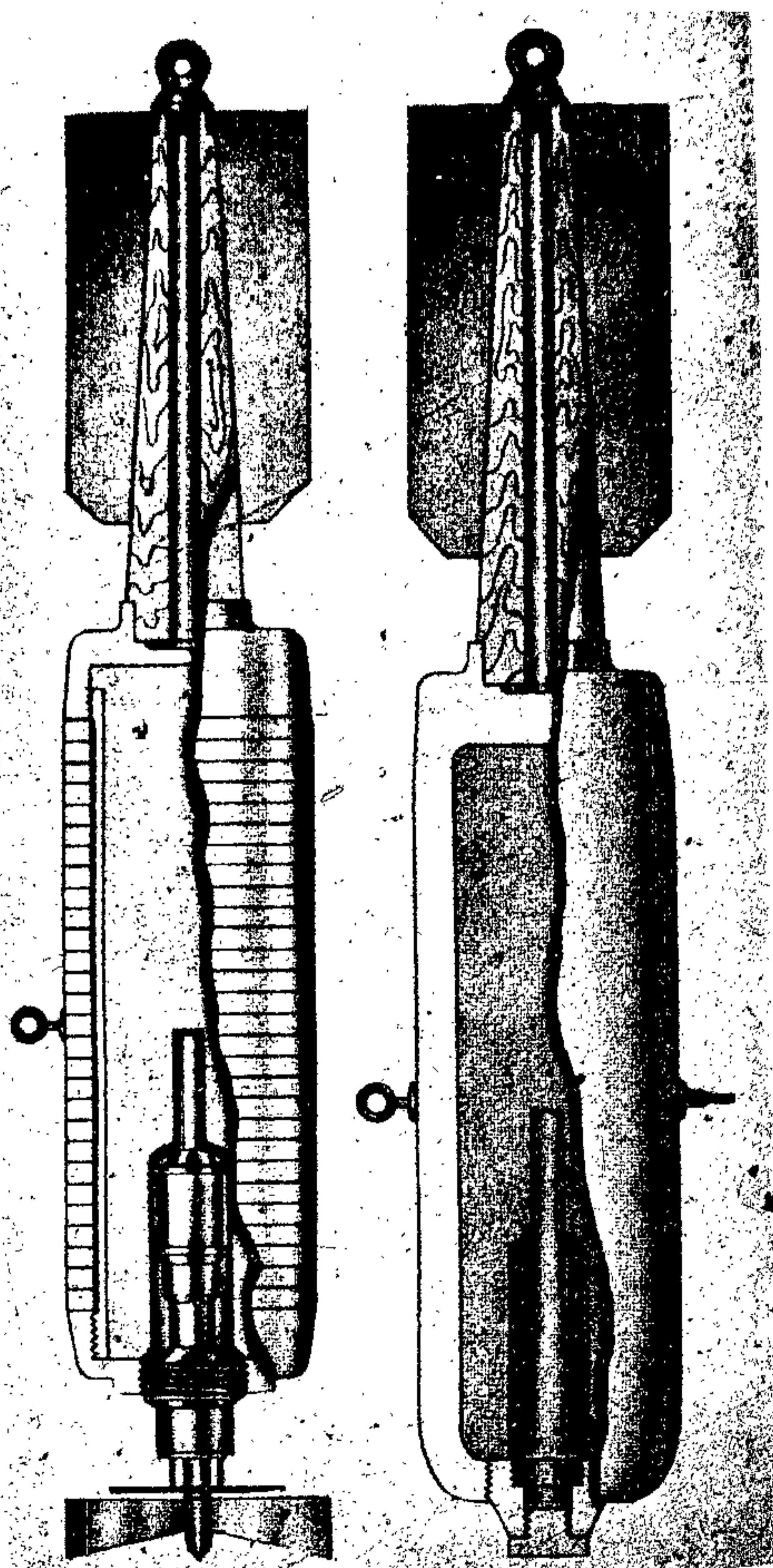

Figure 5 — 14-kg. Fragmentation Bombs
Types I and II

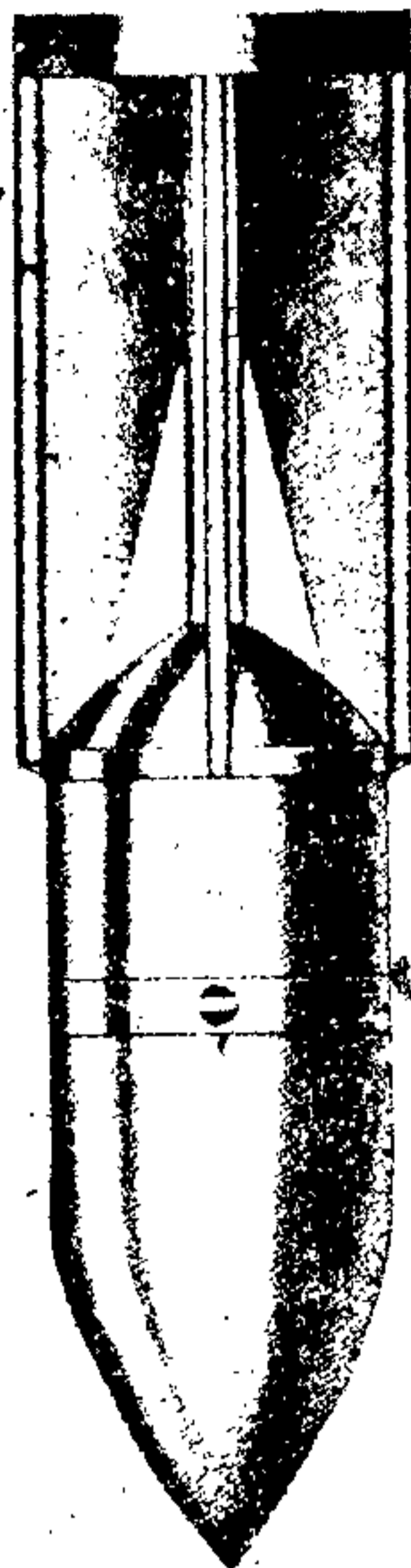

Figure 6 - 24-kg. G.P.-H.E. Bomb

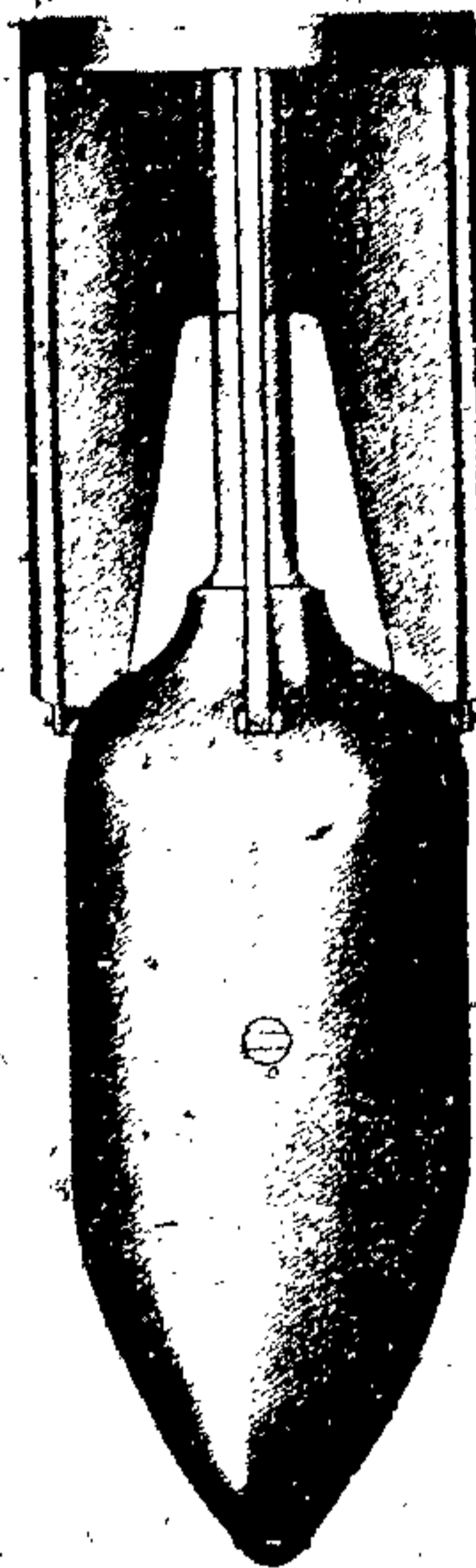

Figure 7 - 40-kg. G.P.-H.E. Bomb

24-kg. G.P.-H.E. Bomb

Data

Over-all length.....	30.5 in.
Body length.....	19.9 in.
Body diameter.....	6.4 in.
Tail length.....	14.8 in.
Tail width.....	6.4 in.
Type of filling.....	TNT
Weight of filling.....	12 kg.
Total weight.....	24 kg.

Fuzing

Tail only—Type N-1

Description

The bomb is light cased, with a steel body and nose in one piece. A sheet-metal tail, including a sheet-metal strengthening band at the end, is attached to bomb by a metal band which is clamped around the body. The suspension band is bolted around the body.

Color and Markings

Over-all—grey; nose—red

Remarks

The bomb was declared obsolete by the Italians before the end of the war.

40-kg. G.P.-H.E. Bomb

Data

Over-all length.....	32.3 in.
Body length.....	19.7 in.
Body diameter.....	9.0 in.
Tail length.....	16.1 in.
Tail width.....	9.0 in.
Type of filling.....	TNT
Weight of filling.....	Unknown
Total weight.....	40 kg.

Fuzing

Tail only—Type N-3

Description

The bomb has a steel body and nose in one piece. The tail is of sheet-metal construction, with a strengthening band at the end. The tail unit is bolted to four square lugs on the body.

Color and Markings

Overall—grey; nose—red

Remarks

This bomb is very similar to 40-kg. gas bomb except for filling.



Figure 8 - 50-kg. G.P.-H.E. Bomb

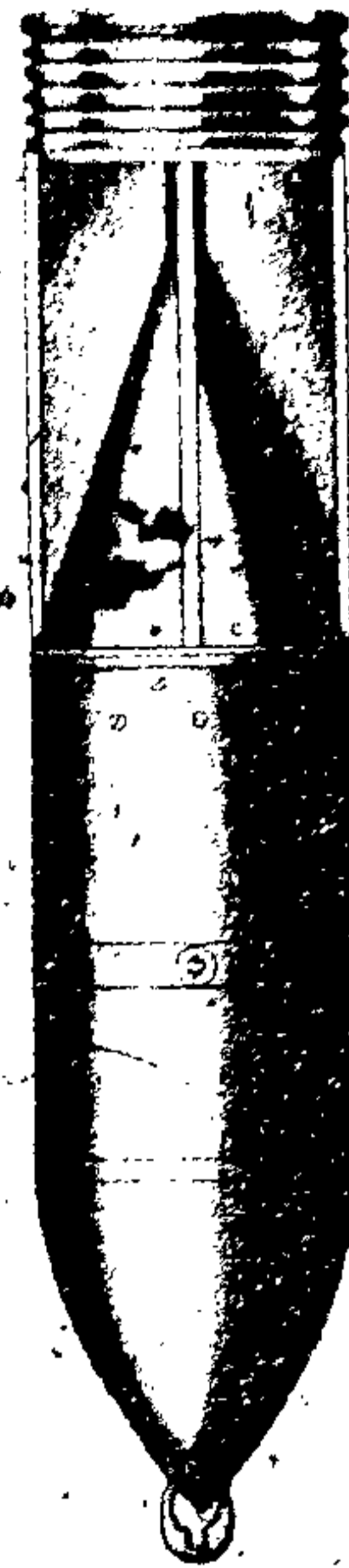

Figure 9 - 100-kg. G.P.-H.E. Bomb

50-kg. G.P.-H.E. Bomb

Data

Over-all length	40.5 in.
Body length	21.7 in.
Body diameter	9.9 in.
Wall thickness	0.25 in.
Tail length	18.4 in.
Tail width	9.9 in.
Type of filling	Amatol
Weight of filling	29.20 kg.
Total weight	59.31 kg.

Fuzing

Tail only—Type C or Y

Description

The bomb body consists of a base section and a nose section, both steel. Screwed into the nose is a pointed steel block, pierced to take a suspension link. The tail is secured to the base plate, which is attached to the casing with one row of screws. The tail assembly consists of four vanes, tail cone, and corrugated strengthening ring, all sheet metal. The bomb can also be suspended horizontally.

Color and Markings

Over-all—dull blue

100-kg. G.P.-H.E. Bomb

Data

Over-all length	51.3 in.	
Body length	32.5 in.	
Body diameter	10.7 in.	
Tail length	22.0 in.	
Tail width	10.7 in.	
Type of filling	TNT	Amatol
Weight of filling	50.6 kg.	49.5 kg.
Total weight	100 kg. (approx.)	

Fuzing

Tail only—Type C-1 or Y-1

Description

The bomb body is a drawn-steel tube to which is riveted a cast-steel nose, pierced to take a suspension link. The base plate is attached to casing with two rows of screws. The tail assembly is sheet metal, consisting of four vanes, cone, and corrugated reinforcing ring, all attached to the bomb base. The bomb can be suspended vertically or horizontally.

Color and Markings

TNT filled: Over-all—grey; nose—red

Amatol filled: Over-all—dull blue; nose—red



Figure 10 - 250-kg. G.P.-H.E. Bomb

250-kg. G.P.-H.E. Bomb

Data

Over-all length	73.8 in.
Body length	35.4 in.
Body diameter	17.6 in.
Tail length	39.4 in.
Tail width	17.6 in.
Type of filling	TNT
Weight of filling	125.7 kg.
Total weight	259.1 kg.

Fuzing

Nose—Type A

Tail—Type O

Description

The bomb casing is a drawn-steel tube with a cast-steel nose riveted to it. The base plate has a double flange and is attached to the casing with a double row of screws. A cast-alloy tail is attached to the upper flange of the base plate with screws. A lug is secured to the body near the center of gravity for horizontal suspension.

Color and Markings

Over-all—grey; nose—red

500-kg. and 800-kg. G.P.-H.E. Bombs

Data

	500 kg.	800 kg.
Over-all length	96.6 in.	127.8 in.
Body length	52.0 in.	77.1 in.
Body diameter	18.0 in.	18 in.
Tail length	35.7 in.	52.8 in.
Tail width	18.0 in.	18 in.
Type of filling	TNT	
Weight of filling	216 kg.	357 kg.
Total weight	508 kg.	821.6 kg.

Fuzing

Nose—Type A

Tail—Type O

Description

The bombs have a steel body and nose cast in one piece, with double-flanged base plate attached by double rows of screws. The cast-alloy tail is attached to the upper flange. The 500-kg. and 800-kg. vary only in length and weight.

Color and Markings

Over-all—grey; nose—red

Remarks

A 630-kg. time bomb has been made from the 800-kg. by reducing the thickness of walls, so as to use a greater explosive charge.



Figure 11 - 500-kg. and 800-kg. G.P.-H.E. Bombs

1,000-kg. G.P. Bomb

Data

Over-all length.....	140 in.
Body length.....	94.5 in.
Body diameter.....	20.5 in.
Wall thickness.....	0.29 in.
Tail length.....	45.5 in.
Tail width.....	28 in.
Type of filling.....	TNT
Weight of filling.....	Unknown
Total weight.....	1000 kg. (approx.)

Fuzing

Nose fuze only—Unknown

Description

The bomb casing is made up of four pieces welded together: (1) the nose; (2) a cylindrical part; (3) a truncated cone; and (4) the conical part to which the tail fins are attached. At about 30 in. from the rear, a steel diaphragm is welded inside the casing to contain the main filling before this point. A steel nose plug carries a steel fuze adapter, and both these have serrated flanges to form seals against rubber packings which are counter-sunk into the relative surfaces on the bomb nose plug, respectively. A steel booster tube, about 1 1/4 in. diameter, runs the length of the bomb; it is inserted from the tail end, where it is screwed into the tail cone, and at the nose end it is located by a sleeve which forms an extension to the fuze adapter. A plug, which is drilled to take the detonator, is screwed into the forward end of the booster tube; there is a felt washer beneath this plug. An internal plug, which is located by grub screws, seals the booster charge at the rear. A steel plug closes the booster tube at the tail end. The booster tube contains penthrite. Around the booster tube and forming a core to the main filling is a tube, 3 in. external diameter, with a bore 2 in. diameter; this is composed of annular rings of compressed TNT about 2 1/4 in. long.

Remarks

A glider attachment was used with this bomb. The controls for the glider contain a gyro unit for azimuth and an air-speed unit to control the dive angle.

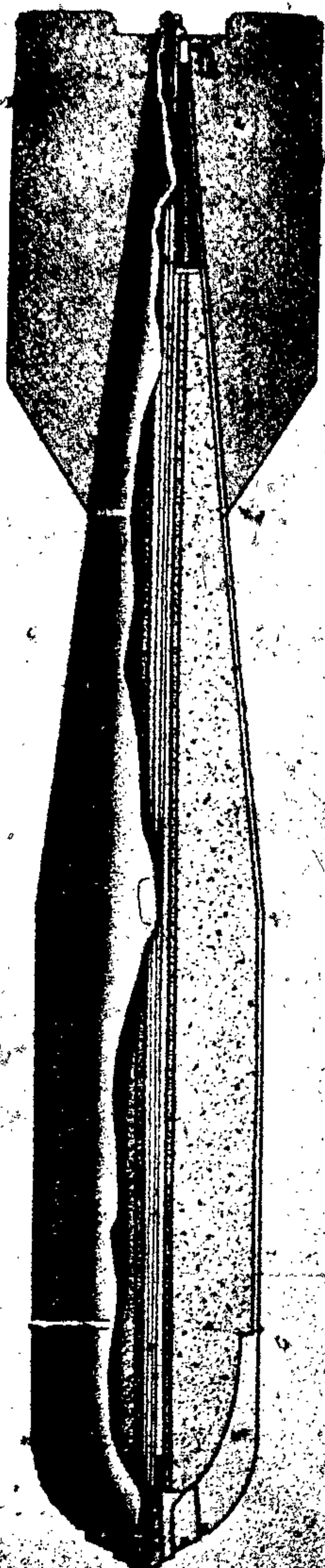

Figure 12 - 1,000-kg. G.P. Bomb

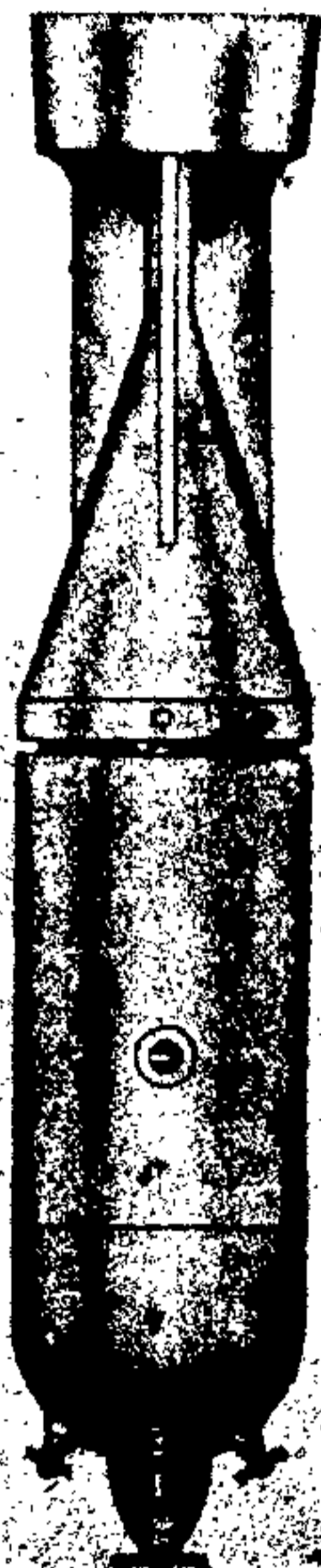

Figure 13 - 500-kg. G.P.-H.E. Bomb

500-kg. G.P.-H.E. Time Bomb

Data

Over-all length	93.7 in.
Body length	50.9 in.
Body diameter	18.1 in.
Wall thickness	0.25 in.
Tail length	43.3 in.
Tail width	18.1 in.
Type of filling	TNT
Weight of filling	247.0 kg.
Total weight	

Fuzing

Nose—Four Type J and one Long-Delay Clockwork Nose

Tail—One Long-Delay Clockwork Tail

Description

Main body and nose are cast in one piece. In the nose is a centrally-located clock work fuze and provision for four additional impact fuzes. If a time fuze is used, impact fuzes can be made inoperative. The cast aluminum-alloy tail is attached to bomb by screws.

Color and Markings

Over-all—grey; nose—red

Remarks

A similar bomb weighing between 800-1000 kg. is thought to have been used by the Italians.

15-kg. S.A.P. Bomb

Data

Over-all length	31.0 in.
Body length	20.7 in.
Body diameter	4.7 in.
Tail length	13.8 in.
Tail width	6.3 in.
Type of filling	TNT
Weight of filling	5.2 kg.
Total weight	15.5 kg.

Fuzing

Tail—Type N

Description

The bomb is thick-walled with a steel body and nose cast in one piece, to which a dome-shaped base is attached. Sheet metal tail fins are attached to a metal band, clamped around the body.

Color and Markings

Over-all—grey; nose—red



Figure 14 - 15-kg. S.A.P. Bomb

31-kg. S.A.P. Bomb

Data

Over-all length.....	31.7 in.
Body length.....	22.5 in.
Body diameter.....	6.4 in.
Tail length.....	12.5 in.
Tail width.....	7.2 in.
Type of filling.....	TNT
Weight of filling.....	10.5 kg.
Total weight.....	31.0 kg. (approx.)

Fuzing

Tail only—Type N-2

Description

The thick-walled steel body has a heavy nose, larger than the rest of the body, welded on. A suspension band is bolted about the body. The sheet-metal tail is attached to a band which clamps around the body.

Color and Markings

Over-all—grey; nose—red

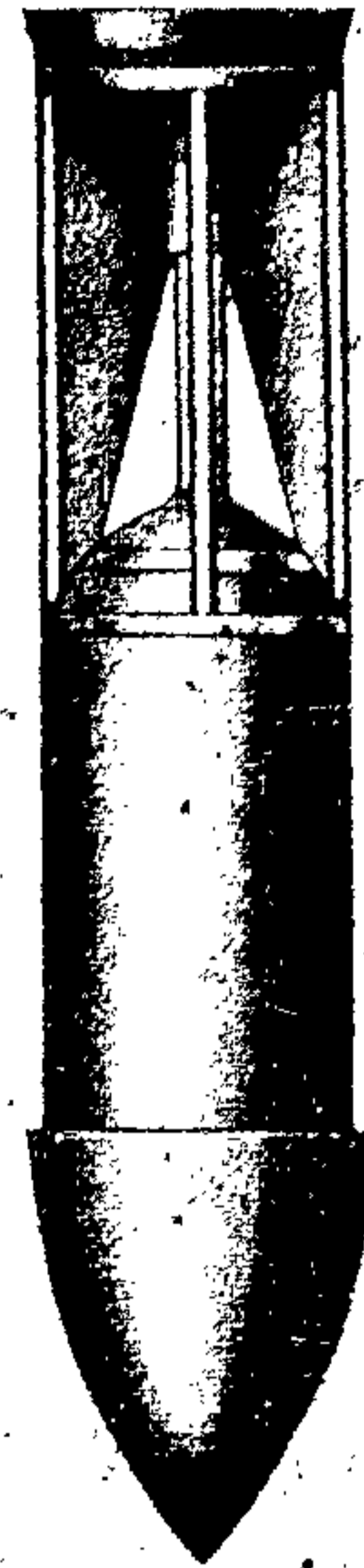

Figure 15 – 31-kg. S.A.P. Bomb

100-kg. S.A.P. Bomb

Data

Over-all length.....	50.5 in.
Body length.....	31.0 in.
Body diameter.....	9.9 in.
Wall thickness.....	0.5 in.
Tail length.....	21.3 in.
Tail width.....	9.9 in.
Type of filling.....	Amatol
Weight of filling.....	27.3 kg.
Total weight.....	109.0 kg.

Fuzing

Tail fuze—Type C-1 or Y-1

Description

The bomb has a single-piece casing with a base plate attached by two rows of screws. A sheet metal tail is attached to base plate by screws.

Color and Markings

Over-all—grey or dull blue; nose—red band

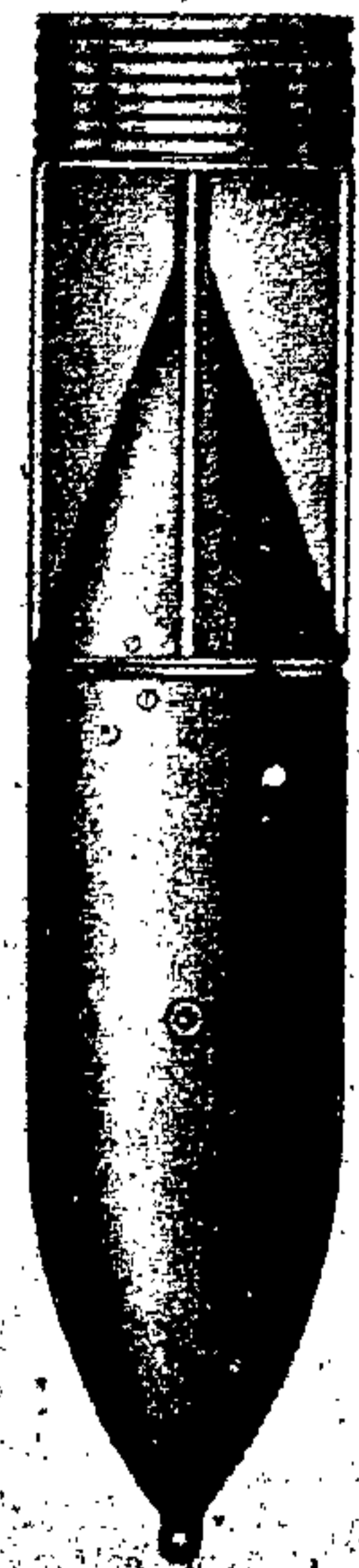

Figure 16 – 100-kg. S.A.P. Bomb



Figure 17 -- 104-kg. S.A.P. Bomb

104-kg. S.A.P. Bomb

Data

Over-all length.....	43.0 in.
Body length.....	28.0 in.
Body diameter.....	10.0 in.
Tail length.....	15 in. (approx.)
Tail width.....	11 in.
Type of filling.....	TNT
Weight of filling.....	30 kg. (approx.)
Total weight.....	104.0 kg.

Fuzing

Tail only—Type C

Description

The steel body and nose are cast in one piece. A dome-shaped base plate receives the sheet-metal tail fins, which are attached to a metal band which clamps around the body.

Color and Markings

Over-all—grey; nose—red

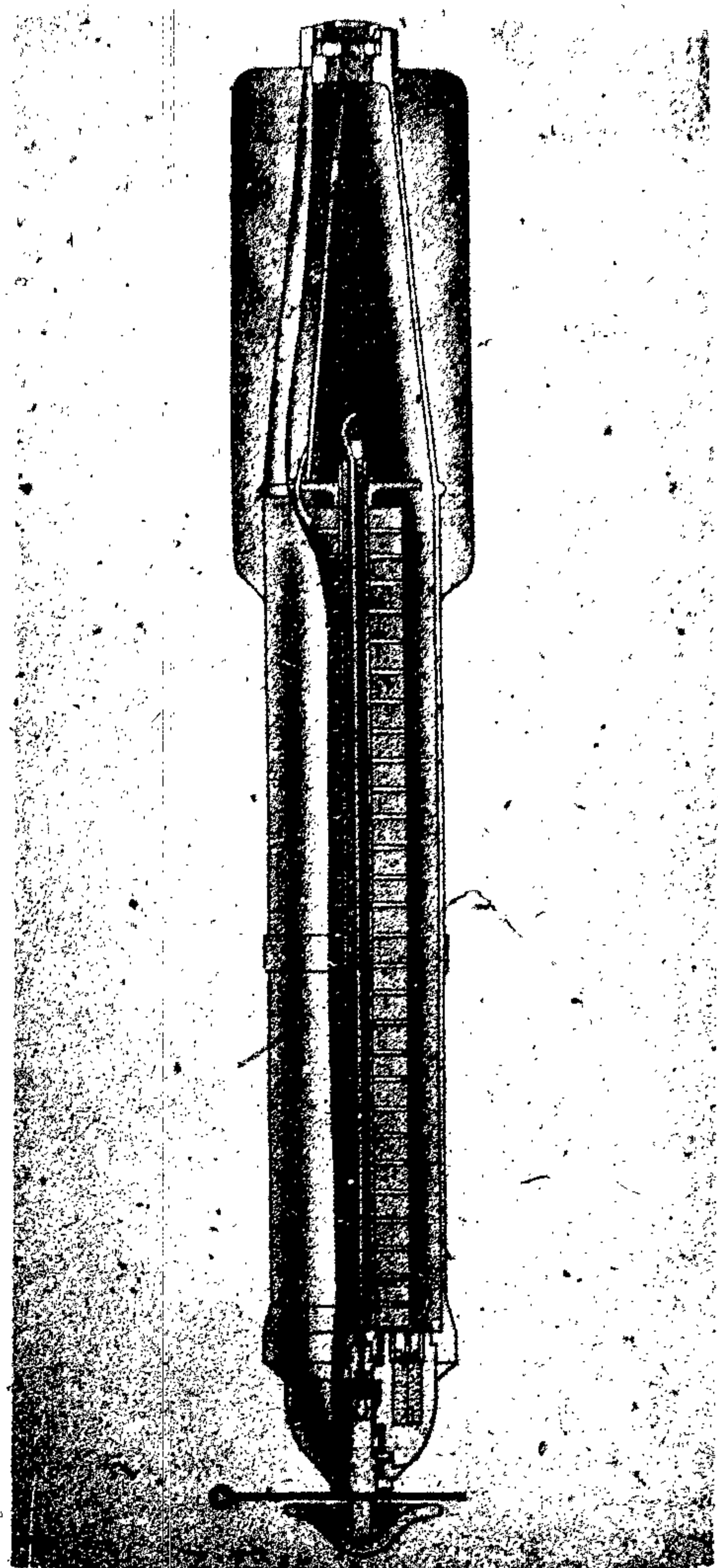

Figure 18 -- 12-kg. Smoke Bomb

12-kg. Smoke Bomb

Data

Over-all length.....	47 in.
Body length.....	33 in.
Body diameter.....	5.2 in.
Wall thickness.....	Unknown
Tail length.....	14 in.

Tail width 7 in.
 Type of filling Smoke composition
 Total weight 28 lb.

Fuzing

Nose only—Special fuze for this bomb

Description

Body is light alloy all-welded construction (including tail unit) with longitudinal seam down the body. Mounted to fuze body, on a central stand, is the smoke-producing composition. There are 26 smoke pellets, each 3 in. diameter and 1 in. thick, made of purple composition, enclosed in a perforated metal container. Between each one and the next, there is a metal spacer. A length of safety fuse leads from fuze to pellets and then to a self-destroying charge in the nose.

Color and Markings

Body—grey; tail—red

0.5-kg. Incendiary Bombs Types IP, IT, and FI

Data

	IP	IT	FI
Over-all length.....	6.1 in.	5.1 in.	4.95 in.
Body length.....	4.5 in.	3.5 in.	3.35 in.
Body diameter.....	2.75 in.	2.5 in.	2.5 in.
Total weight.....	0.5 kg. (approx.)		

Fuzing

All—Type K

Description

Type IP: This bomb consists of a thin mild-steel container of cylindrical shape whose filling consists of cotton wicks soaked in gasoline.

Type IT: Bomb is also of thin sheet mild steel of cylindrical shape; but the main filling is thermite.

Type FI: The casing is of mild steel and somewhat thicker than in the above two cases. The main filling is phosphorus.

Color and Markings

Type IP: Over-all—light green; IP stenciled in black on the body

Type IT: Over-all—dark green; IT stenciled in black on the body

Type FI: Over-all—field grey; FI stenciled in black on the body

Remarks

These bombs are usually dropped in a bomb container.

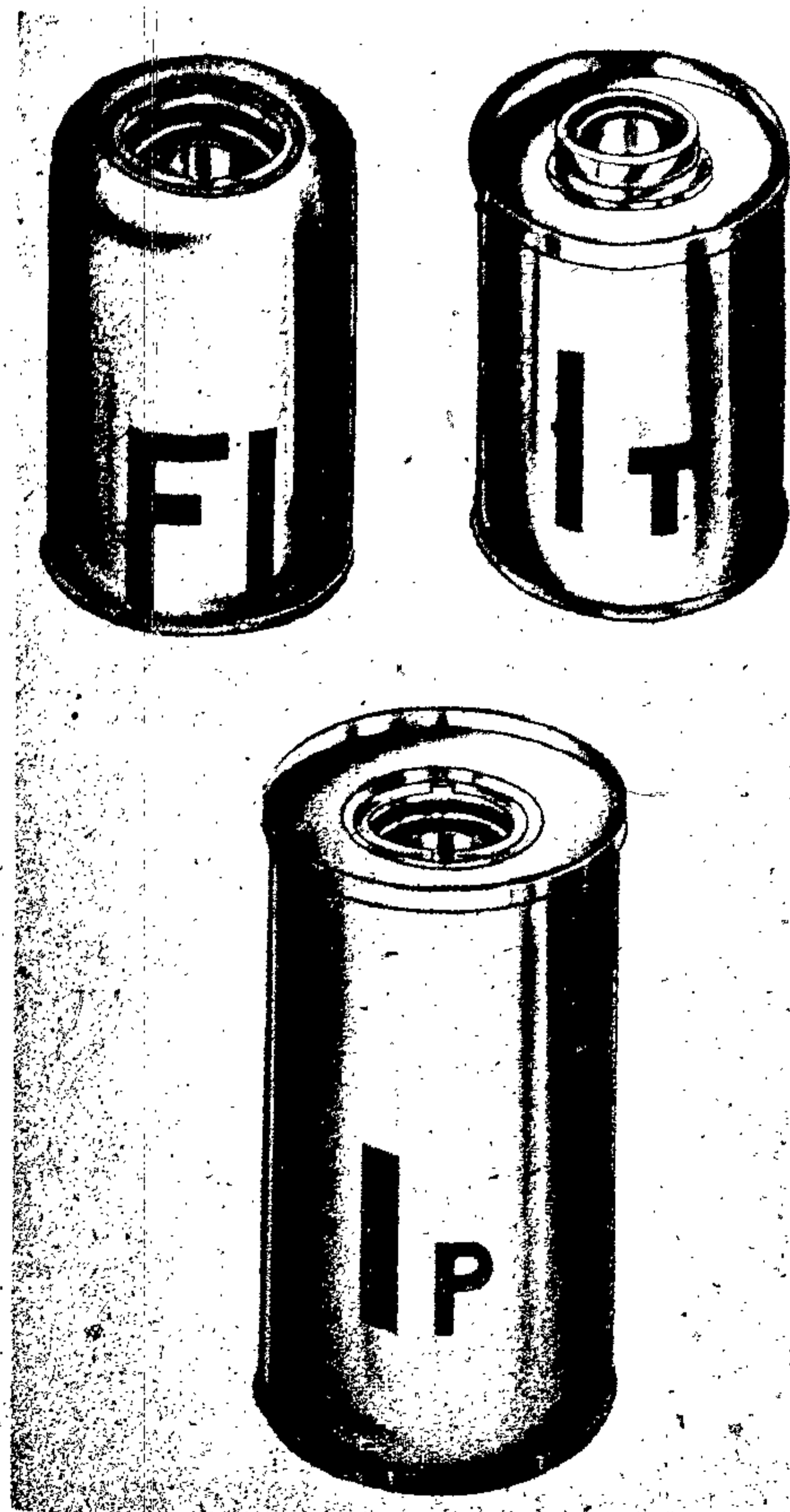

Figure 19 - 0.5-kg. Incendiary Bombs

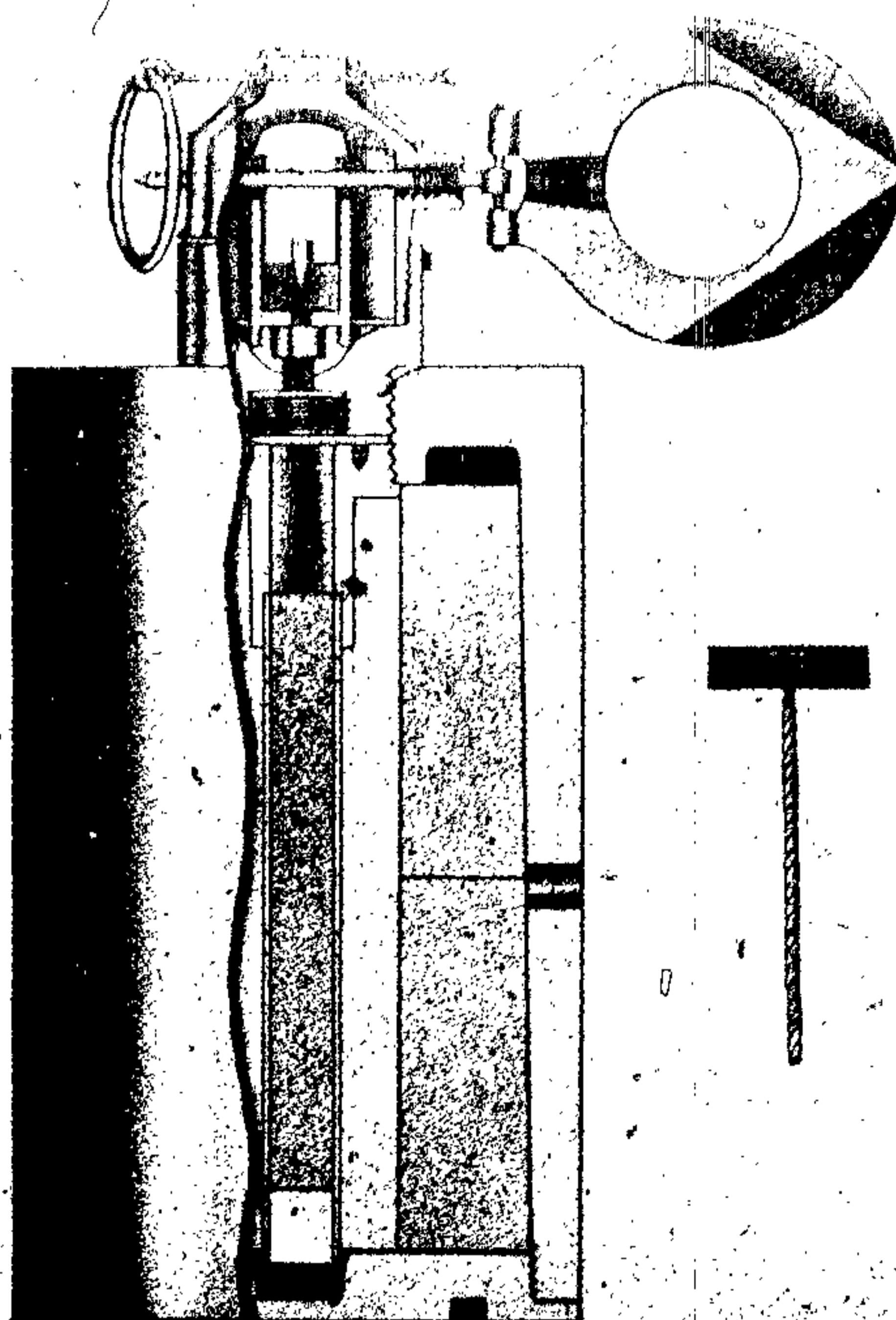

Figure 20 - 1-kg. Incendiary Bomb Type I and Internal Igniter for Type II

1-kg. Incendiary Bombs Types I and II

Data

Types I and II

Over-all length.....	6.1 in.
Body length.....	4.6 in.
Body diameter.....	2.7 in.
Type of filling.....	Magnesium and thermite mix
Weight of filling.....	0.084 magnesium and 0.473 kg. thermite
Total weight.....	1 kg. approx.

Fuzing

Type K

Description

Type I: The bomb is a tail-less cylinder made of electron metal. On the curve surface are three small holes plugged with cork. These act as vent holes when the thermite filling is ignited. The thermite is in the form of a lightly pressed filing, pressed in two halves, with a central cylindrical which is filled with magnesium powder. Below

the fuze is a powder pellet which is separated from the thermite by a paper disc which is glued to a cardboard ring. Through the paper disc is looped a piece of quick-match which extends into the magnesium.

Type II: This type, made of the same material and having the same dimensions as Type I, differs in the internal arrangement for igniting the thermite. In place of the quick-match, a thin aluminum tube is inserted in the magnesium filling. This tube contains a number of holes on its surface covered by thin paper, and is filled with magnesium powder. It is sealed at its lower end by a cork plug.

Color and Markings

Over-all—reddish brown; nose—red

Remarks

1. These bombs can be dropped singly or in a bomb container.
2. These bombs were used also for sabotage work by using the Fuze Type H.

2-kg. Incendiary Bombs Types I and II

Data

	Types I and II
Over-all length.....	12.2 in.
Body length.....	10.6 in.
Body diameter.....	2.7 in.
Wall thickness	
Upper cylinder.....	0.34 in.
Lower cylinder.....	0.06 in.
Type of filling.....	Type I—Thermite and oil Type II—Magnesium, Mercuric oxide, and Nitrobenzene
Weight of filling.....	Type I— 0.339 kg. oil and 0.660 kg. mix Type II—Unknown
Total weight.....	Type I—2.12 kg. Type II—Unknown

Fuzing

Type I and II—Type K

Description.

Type I: The bomb consists of two cylinders screwed together. The upper cylinder is the same as the 1-kg. Incendiary Bomb Type II, except that the base plate is drilled to take four screws which secure the top plate of the lower cylinder to the base plate of the upper cylinder. The lower portion is of sheet steel and contains a high-boiling turpentine oil.

Type II: This bomb is very similar to Type I, except for the filling in both the upper and lower cylinders. The upper part contains magnesium and mercuric oxide powders, and the other contains nitrobenzene.

Color and Markings

Type I: Over-all—grey; nose—red

Type II: Over-all—reddish brown; nose—red

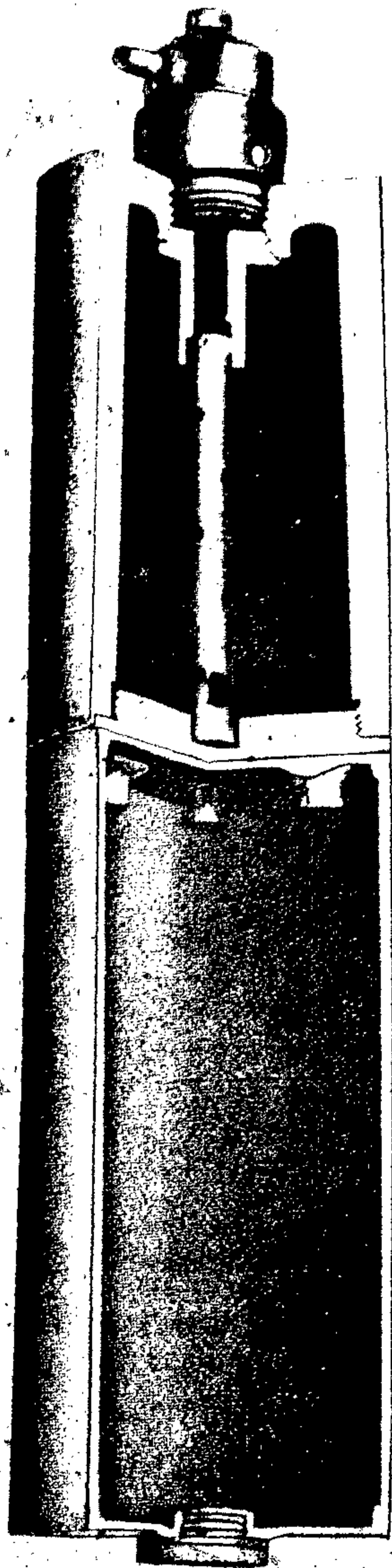

Figure 21 — 2-kg. Incendiary Bomb Type I

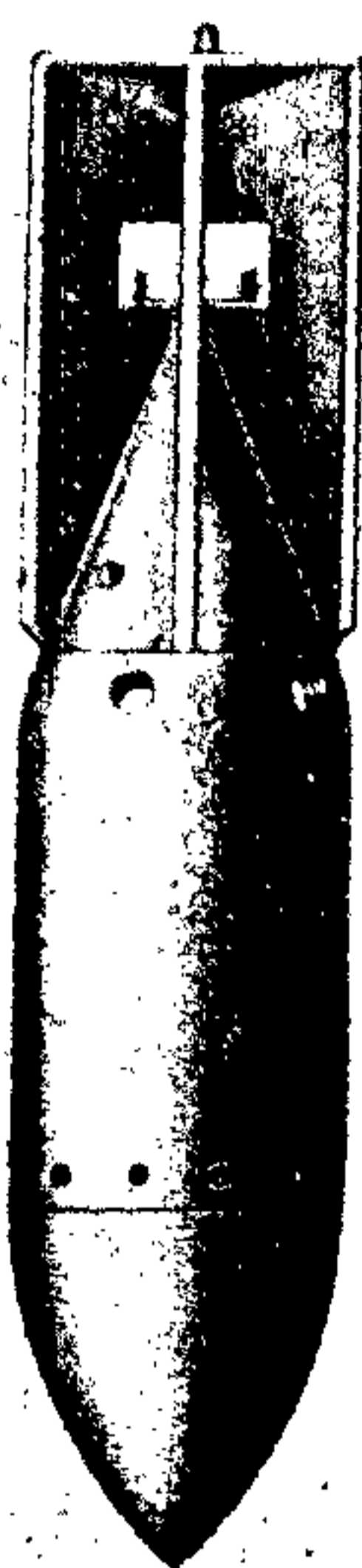

Figure 22.—20-kg. Incendiary Bomb

20-kg. Incendiary Bomb

Data

Over-all length.....	34.0 in.
Body length.....	20.5 in.
Body diameter.....	6.3 in.
Wall thickness.....	0.75 in.
Tail length.....	15.8 in.
Tail width.....	6.3 in.
Type of filling.....	Thermite
Weight of filling.....	10.58 kg.
Total weight.....	20.17 kg.

Fuzing

Tail only—Type E

Description

The bomb consists of nose, body, and tail, all secured by screws. The body is electron; the nose is a steel plug; and the tail is alloy or sheet metal. Fuze vanes halfway along tail length insure limited terminal velocity for the vanes. Five holes at the rear of the bomb casing are closed by cork plugs. The fuze functions on impact; igniter fires thermite; corks blow out and filling burns about three minutes; then casing breaks and burns with a white heat for ten minutes.

Color and Markings

Over-all—reddish brown; nose—red



Figure 23.—70-kg. Incendiary Bomb

70-kg. Incendiary Bomb

Data

Over-all length.....	47.2 in.
Body length.....	23.6 in.
Body diameter.....	9.9 in.
Wall thickness.....	1.0 in.
Tail length.....	24.0 in.
Tail width.....	9.9 in.
Type of filling.....	Thermite
Weight of filling.....	36.6 kg.
Total weight.....	74.5 kg.

Fuzing

Tail only—Type G

Description

Bomb casing is electron metal. The nose is encased in a steel cap 12 in. long and 1/8 in. thick attached to the body by eight screws. The cap insures adequate penetration without damage to the casing. An alloy tail unit is secured to body by eight screws. Vent holes, 1 1/4 in. in diameter, are plugged with cork. The igniter for the thermite filling is magnesium powder in an aluminum tube passing through the center of the tail into the bomb body.

Color and Marking

Over-all—reddish brown; nose—red

100-kg. Special Bomb Combination Anti-Personnel Bomb and Bomb Container

Data

Over-all length	53.2 in.
Body length	29.0 in.
Body diameter	10.7 in.
Wall thickness	0.07 in.
Tail length	20.8 in.
Tail width	10.7 in.
Type of filling	TNT
Total weight	113.0 kg. or 82.1 kg.

Fuzing

Nose—Type X

Tail—Type Z

Description

This is a composite which comprises: (1) 32 small Spezzine bombs; (2) a central bomb; and (3) a nose charge which acts as an anti-personnel bomb. If Spezzine bombs are filled with H. E., the bomb is called 100-kg. Sp. I. In the latter, the 32 small bombs (1 kg. I) may be replaced by 16 (2-kg. I bombs).

Nose fuze (Type X) functions at a preset height and causes the conical nose portion, carrying a length of burning safety fuse and an explosive charge enclosed in concrete, to fall away and explode subsequently; small bombs thus released fall independently. The main body continues its flight, containing the central bomb, which explodes on impact under the action of the tail fuze.

The container part consists of two concentric sheet-steel cylinders, the outer 0.08 in. thick and the inner 0.04 in. thick, held together by four strips and the end plate. The tail is attached to the outer cylinder by four threaded studs; in the inner cylinder is fitted the central bomb, of the "Mitroglia" type. The nose fuze protrudes and is attached by a steel adapter and locking-ball device to the central bomb.

Spezzine bombs are packed, with safety pins removed, in eight columns of four; each column has a conical spring to keep it in compression. Under one spring is a spring-loaded plunger, protruding through the end plate and acting as a safety pin for Fuze Type Z of the central bomb.

Color and Markings

Over-all—reddish brown; nose—red

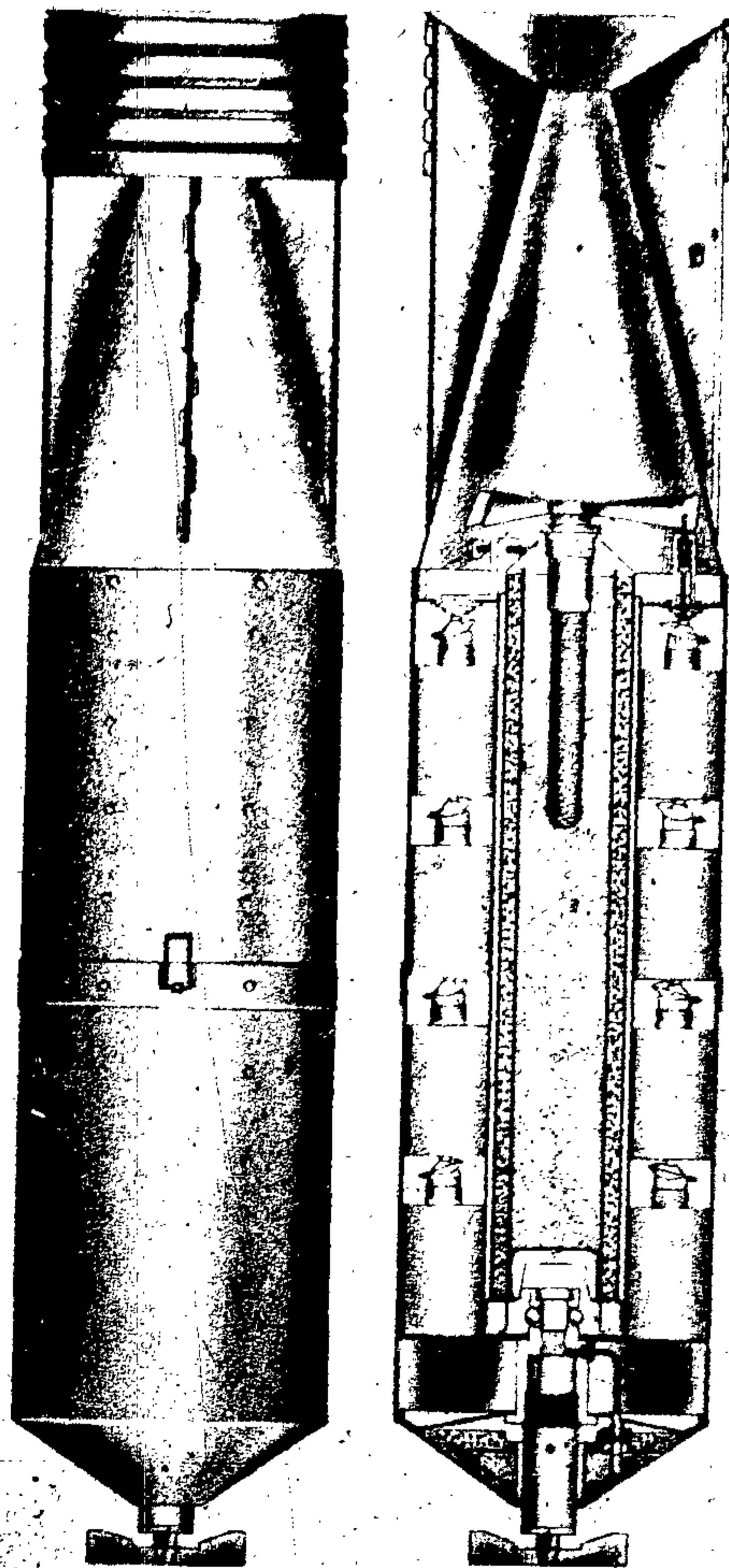

Figure 24 - 100-kg. Special Bomb

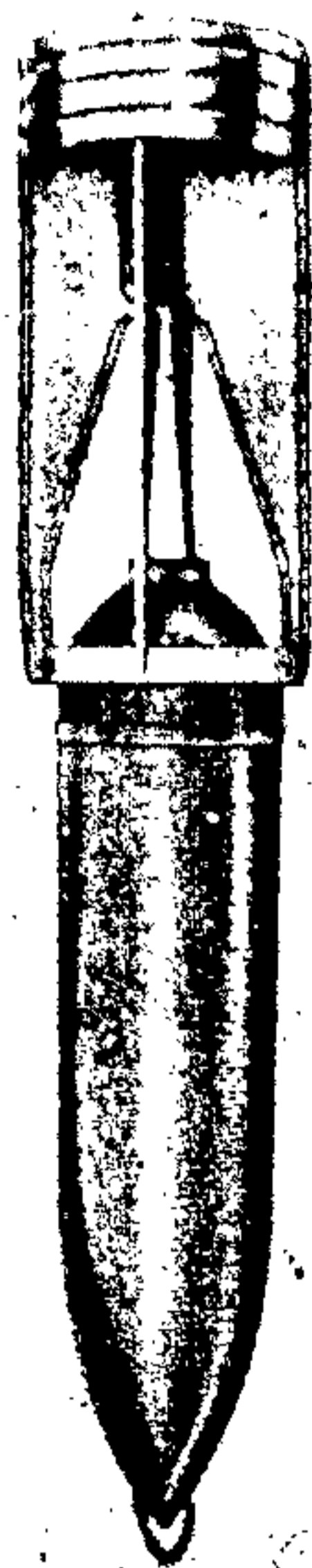

Figure 25 - 15-kg. Gas Bomb

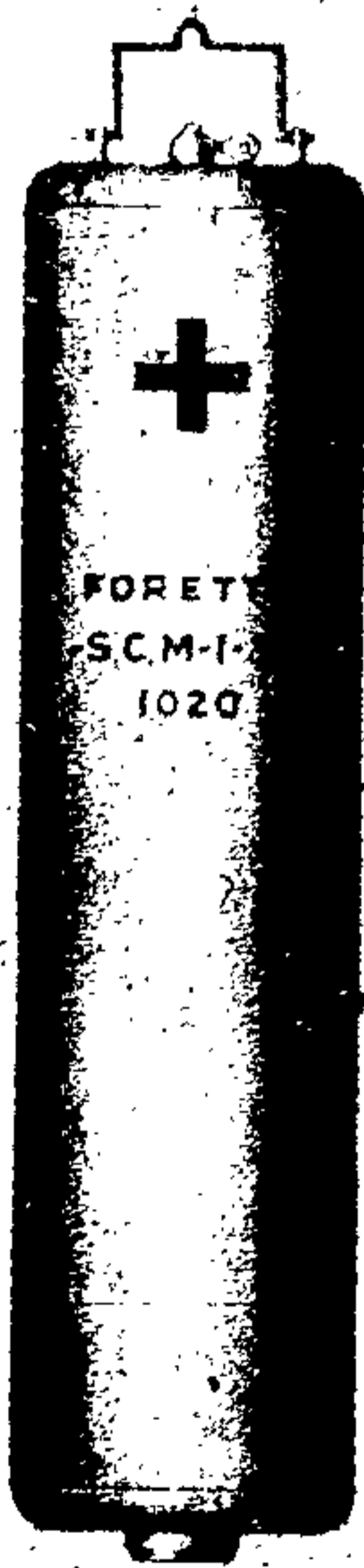

Figure 26 - 25-kg. Gas Bomb (Furretta)

15-kg. Gas Bomb

Data

Over-all length.....	31.0 in.
Body length.....	20.7 in.
Body diameter.....	4.7 in.
Tail length.....	13.8 in.
Tail width.....	6.3 in.
Type of filling.....	Diphenyl Chlorarsine
Weight of filling.....	3.65 kg.
Burster used.....	TNT
Weight of burster.....	1.7 kg.
Total weight.....	16 kg.

Fuzing

Tail fuze—Unknown

Description

The bomb is thick-walled, with a steel body and nose cast in one piece, to which a dome-shaped base is attached. Sheet-metal tail fins are attached to a metal band clamped around the body.

Color and Markings

Over-all—yellow; Geneva cross stenciled on the body

Remarks

This bomb is thought to be the same as the 15-kg. S. A. P. except for filling.

25-kg. Gas Bomb (Furretta)

Data

Over-all length.....	32.7 in.
Body length.....	30 1 in.
Body diameter.....	6.3 in.
Type of filling.....	Lachrymator
Weight of filling.....	10 kg.
Total weight.....	25 kg.

Fuzing

Tail fuze—Type K

Description

The bomb has a blunt nose and parallel sides, but no tail or stabilizing fins. This is a percussion bomb; but it functions as a tear-gas generator. There is no burster charge, but the casing is pierced with small holes through which the lachrymator is emitted.

Color and Markings

Over-all—yellow; Geneva cross in red

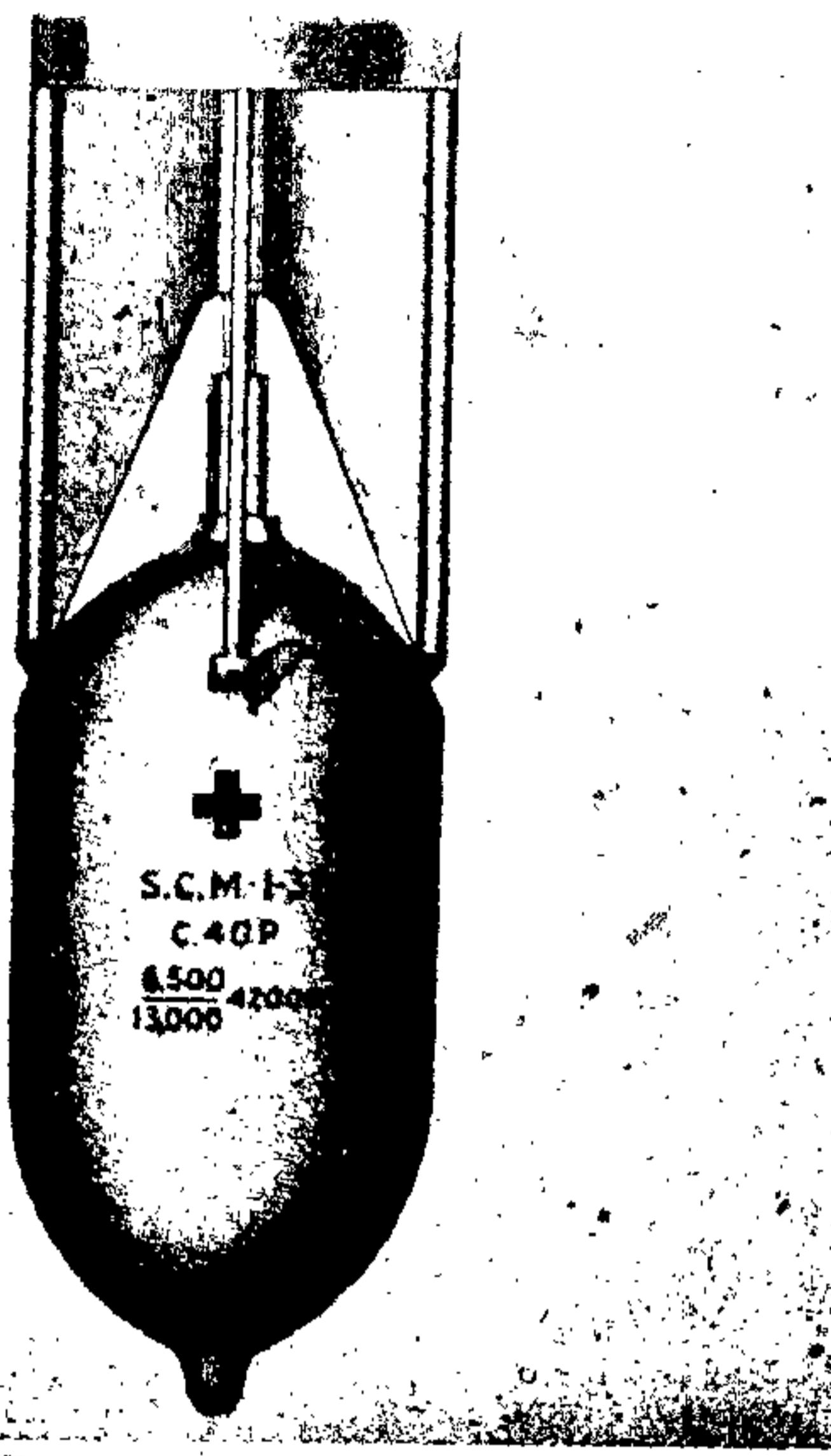

Figure 27 - 40-kg. Gas Bomb C40P

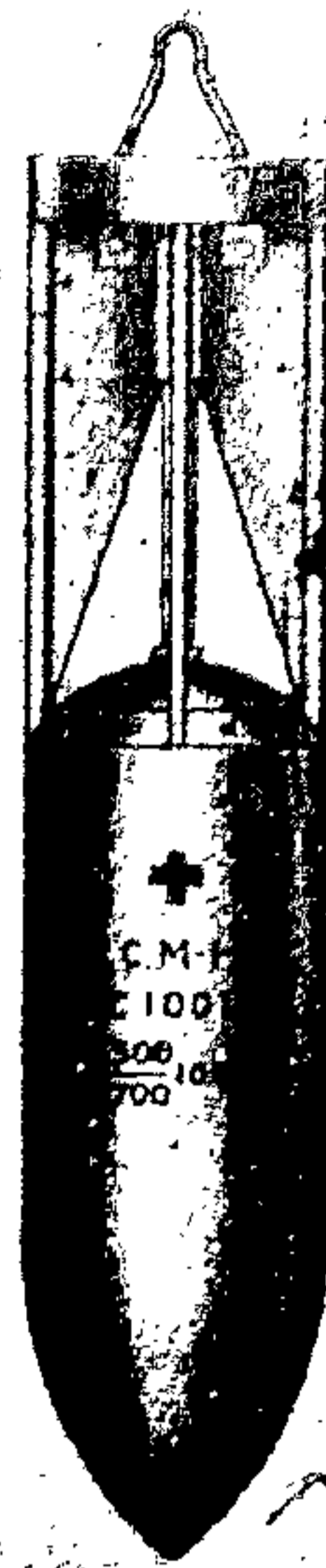

Figure 28 - 100-kg. Gas Bomb

40-kg. Gas Bomb C40P

Data

Over-all length.....	32.3 in.
Body length.....	21.4 in.
Body diameter.....	9.9 in.
Tail length.....	16.1 in.
Tail width.....	9.9 in.
Type of filling..... (A) Diphenyl Chlorarsine (B) Mustard	
Weight of filling..... 6.5 kg.	14.7 kg.
Weight of burster..... 13.0 kg.	0.18 kg.
Total weight.....	47 kg. 40.6 kg.

Fuzing

Tail only—Unknown

Description

This bomb is similar to 40-kg. G. P.-H. E. bomb in size and appearance. The burster tube contains TNT and is about fifteen in. long. Other information is lacking.

Color and Markings

(A) Over-all—yellow; stenciled in black—Geneva cross

(B): Over-all—yellow; nose—red; stenciled in red marking:

N 2228

Lorpo KG 359; Tara KG179

**55-kg. Gas Bomb
100-kg. Gas Bomb (C100P)**

Data

	55-kg.	100-kg.
Over-all length.....	32.3 in.	50.2 kg.
Body length.....		32.5 kg.
Body diameter.....	9.8 in.	10.7 in.
Tail length.....		20.8 in.
Tail width.....		10.7 in.
Type of filling..... Phosgene		Diphenyl Chlorarsine
Weight of filling..... 20 kg.		14.3 kg.
Weight of burster..... 18 kg.		28.7 kg.
Total weight.....	55 kg.	101.9 kg.

Fuzing

55-kg.—Unknown

100-kg.—Tail only; probably C-1 or Y-1

Description

These bombs are similar to same weight G. P.-H. E. bombs. Little information has been found on them.

Color and Markings

55-kg: Overall—yellow; stenciled in white—Geneva cross

100-kg: Overall—yellow; stenciled in black—Geneva cross

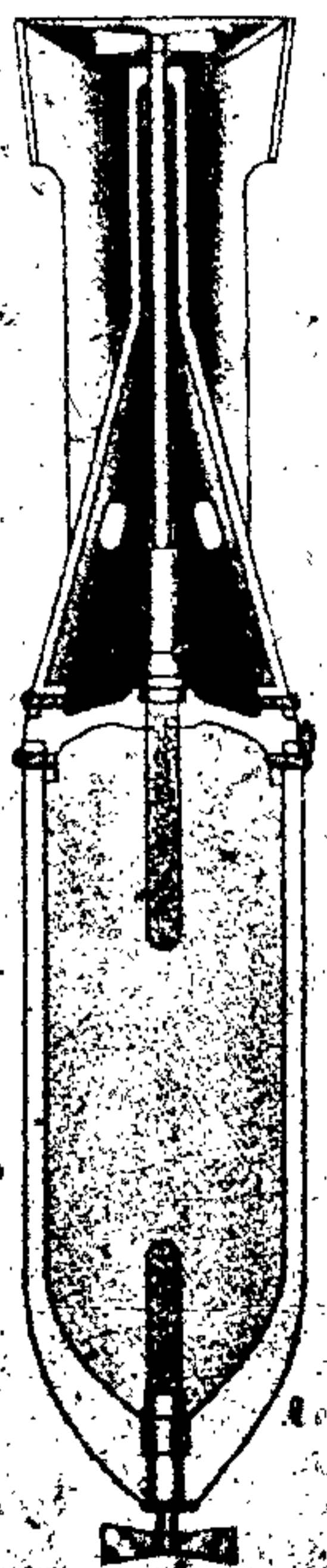
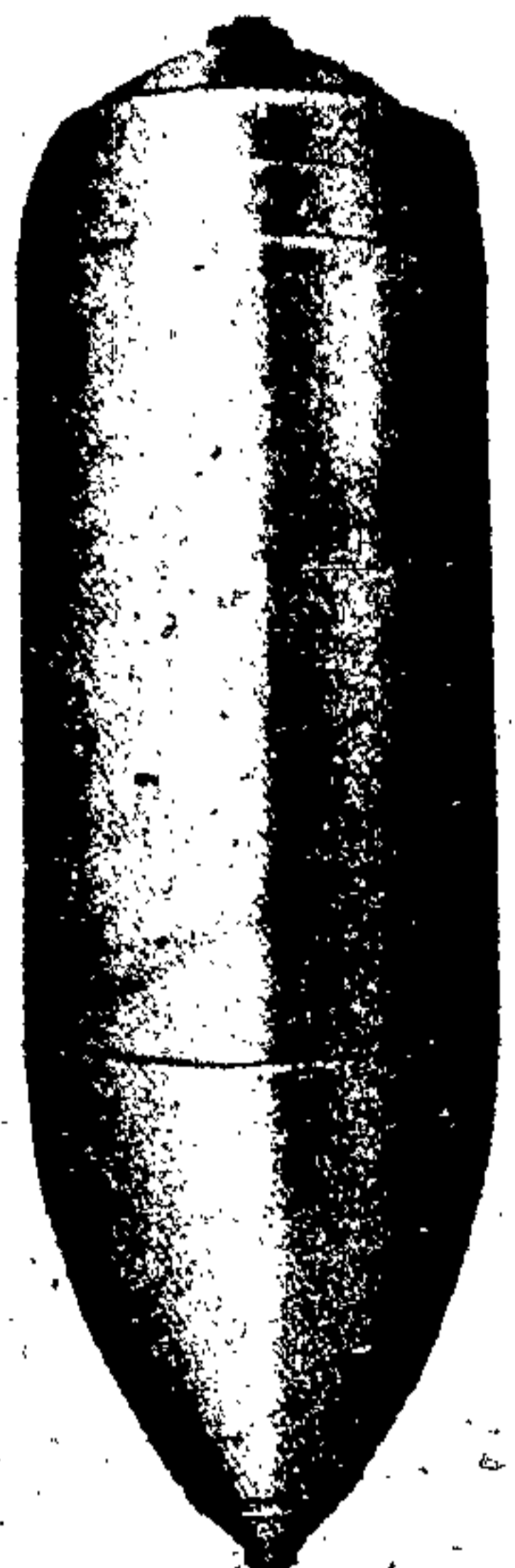

250-kg. and 500-kg. (500T) Gas Bombs

Data

	250-kg.	500-kg.
Over-all length	Unknown	96.6 in.
Body length	57.5 in.	54.3 in.
Body diameter	18.0 in.	18.0 in.
Wall thickness	0.12 in.	0.12 in.
Type of filling	Mustard	Diphenyl Chlorarsine
Weight of filling	214 kg. (approx.)	210 kg.
Total weight	264 kg. (approx.)	298 kg. without tail

Fuzing

250-kg: Nose—Unknown
 500-kg: Nose—Type T

Description

These two bombs are thought to be the same except for the slight differences in length of the body, which could have been measured erratically. Two different illustrations are shown; one is made from recovered bomb and the other is from Italian drawings.

250-kg: The casing is of thin sheet metal and is of welded construction. Inside the body casing is welded a perforated supporting disc which also acts as a baffle for the chemical filling. The tail unit was not recovered, but could take the alloy tail unit which is used in the C500T.

500-kg: Very little is known about this bomb, since it was not used in the war. The bomb is very similar to the 500-kg. General Purpose, except that it has a baffle plate in the center.

Color and Markings

250-kg: Over-all—light blue-grey; nose plug—yellow

500-kg: Over-all—grey; Geneva cross, probably in green, above the lettering S. C. M. F-37 C-500T.

Figure 29 - 250-kg. and 500-kg. (500T) Gas Bombs

5-kg. Vento-Marker**Data**

Over-all length.....	17.4 in.
Body length.....	8.9 in.
Body diameter.....	5.2 in.
Wall thickness.....	0.3 in.
Tail length.....	9.2 in.
Tail width.....	7.0 in.
Type of filling.....	Smoke or Incendiary
Weight of filling.....	Unknown
Total weight.....	5.2 kg.

Fuzing

Nose fuze—Type S

Description

The body consists of a thin metal cylinder liner and outer concrete bomb body, which is reinforced with sheet pellets and wire. The body liner has welded to it: (1) the suspension-lug socket which is internally threaded to receive the horizontal suspension lug; (2) four metal vane supports which have riveted to them four aluminum-alloy vanes; (3) two pairs of diametrically opposite wire guides for the base-plug retaining wire; (4) the ends of a helical reinforcing wire, 16 S. W. G., which is coiled in three turns and passes through the holes provided in the vane support; and (5) the upper end of a second helical reinforcing wire, 8 S. W. G., which is coiled in five turns and is welded at its other end to the fuze pocket. The body-liner closing disc is drilled centrally and has pressed to it the fuze pocket. At the upper end, the liner is closed by a cork plug. This bomb is used in conjunction with chemical bombs. The purpose is to indicate the force and direction of the wind at ground level. Two main fillings are used, a smoke filling for use in the daytime, and an incendiary filling for use at night. The night filling is the 1-kg. Incendiary Bomb Type II. Another modification of this bomb has no body liner but is all concrete and is used for practice.

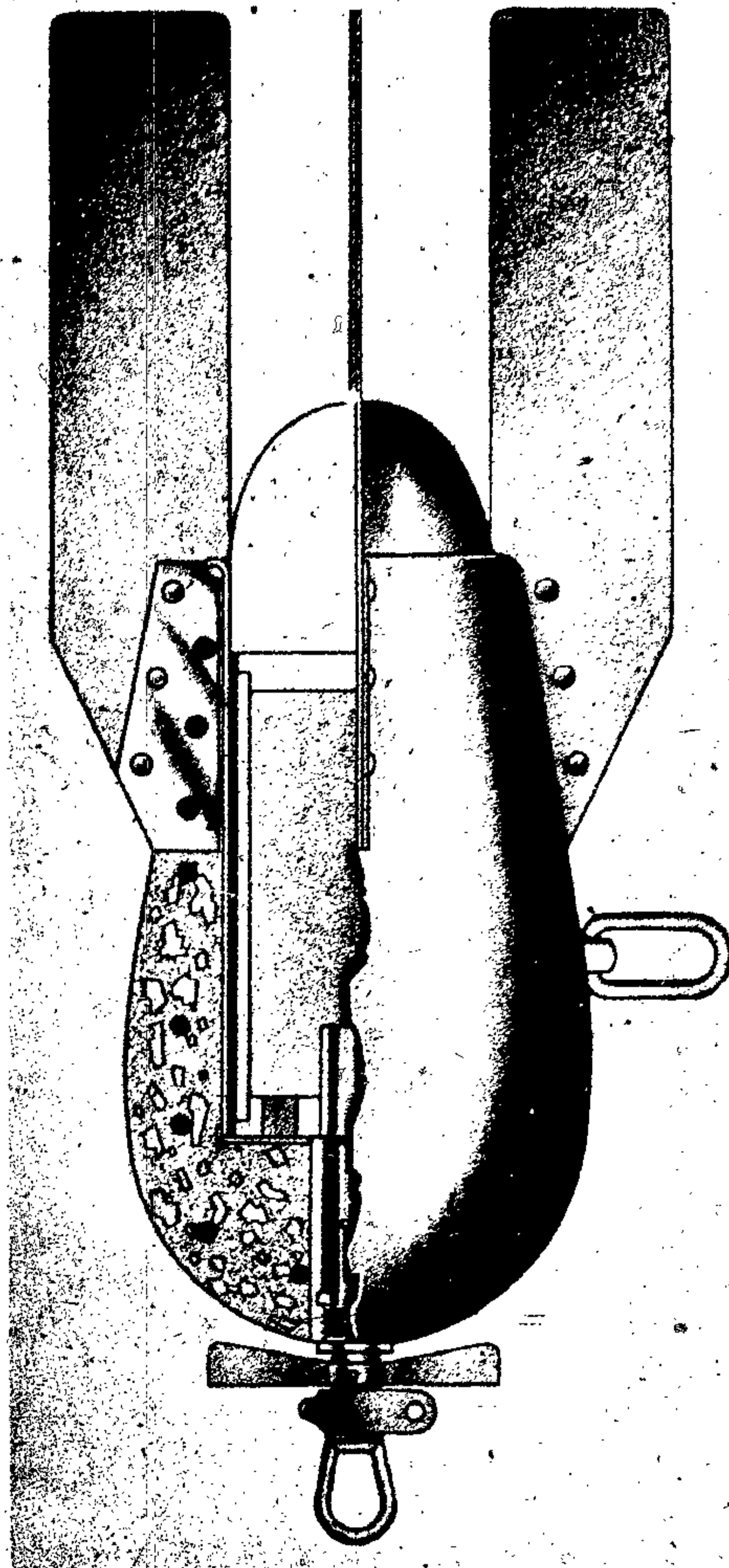
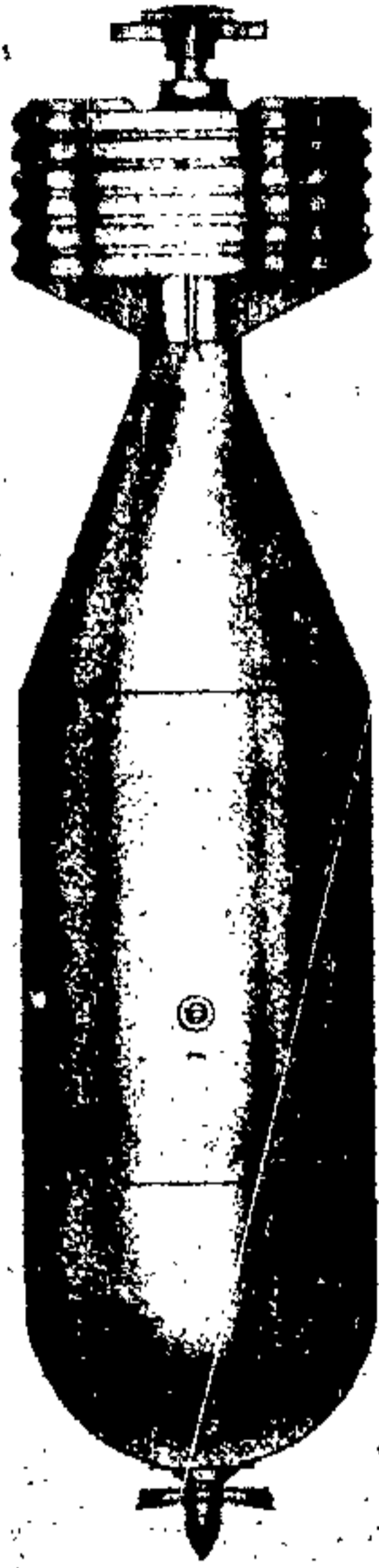

Figure 30 – 5-kg. Vento-Marker



160-kg. (CS) Antisubmarine Bomb

Data

Over-all length.....	69.8 in.
Body length.....	36.2 in.
Body diameter.....	13.3 in.
Wall thickness.....	0.31 in.
Tail length.....	27.2 in.
Tail width.....	15.3 in.
Type of filling.....	TNT
Weight of filling.....	99 kg.
Total weight.....	176 kg.

Fuzing

- Nose fuze—Type B
- Tail fuze—"Grand-daddy"

Description

This bomb has a hemispherical nose. The vanes are short, with a corrugated metal reinforcing ring around the rear of vanes.

Color and Markings

Over-all—grey; nose—red

Figure 31 —160-kg. (CS) Antisubmarine Bomb

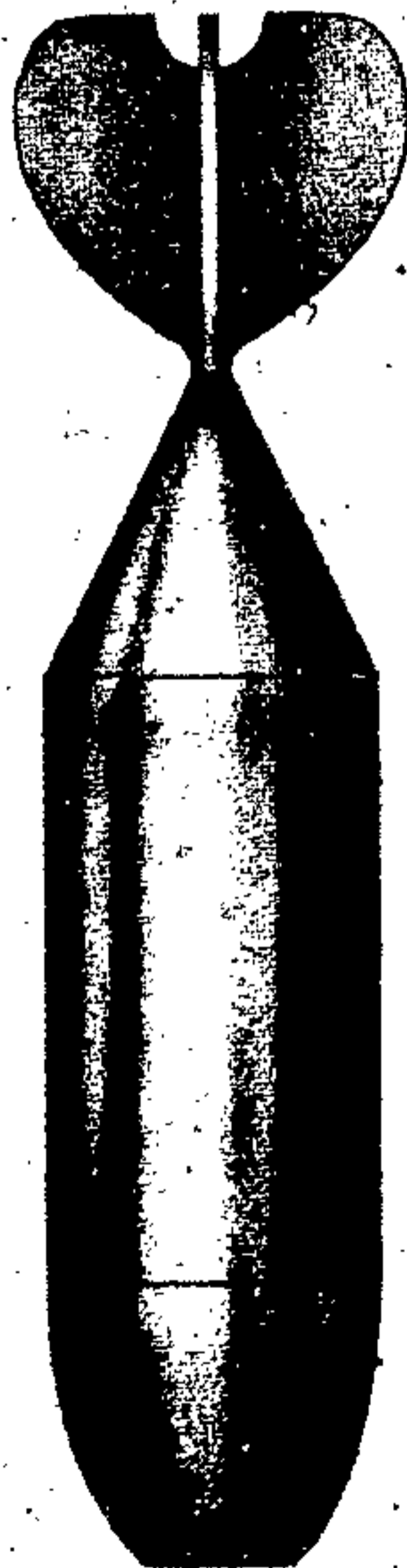

160-kg. H.E. Bomb

Data

Over-all length.....	62.4 in.
Body length.....	50.4 in.
Body diameter.....	12.6 in.
Tail length.....	27.6 in.
Tail width.....	12.6 in.
Type of filling.....	TNT
Weight of filling.....	Unknown
Total weight.....	163.5 kg.

Fuzing

- Nose fuze—Unknown

Description

The bomb has an unusual tail unit. The vanes are short and attached near the end of the tail cone. The nose of the bomb is more hemispherical than other Italian H. E. demolition bombs. It is thought that this bomb was designed for use against submarines.

Color and Markings

Over-all—grey; nose—red

Figure 32 — 160-kg. H.E. Bomb

3-kg. (CV) Antiaircraft Bomb

Data

Over-all length.....	13.5 in.
Body length.....	6.4 in.
Body diameter.....	3.2 in.
Tail length.....	7.0 in.
Tail width.....	3.2 in.
Type of filling.....	Amatol
Weight of filling.....	0.40 kg.
Total weight.....	3.0 kg.

Fuzing

Nose fuze—Type I

Description

The bomb consists of two containers made of mild steel sheet. The space between them is filled with steel pellets embedded in concrete. The nose and the body of the bomb are apparently loaded separately with their filler of concrete and steel. A brown substance, which tops the nose filling, forms a cushion between the concrete filling. It appears to be a waterproof composition, containing a resinous wax.

Color and Markings

Over-all—green; nose—red band



Figure 33 – 3-kg. (CV) Antiaircraft Bomb

20-kg. (CV) Antiaircraft Bomb

Data

Over-all length.....	30.7 in.
Body length.....	15.5 in.
Body diameter.....	5.5 in.
Wall thickness.....	1.1 in.
Tail length.....	18.0 in.
Tail width.....	5.7 in.
Type of filling.....	Unknown
Weight of filling.....	Unknown
Total weight.....	Unknown

Fuzing

Nose fuze—Type 1

Description

The bomb case is loaded with steel pellets embedded in concrete. No further description is available.



Figure 34 – 20-kg. (CV) Antiaircraft Bomb

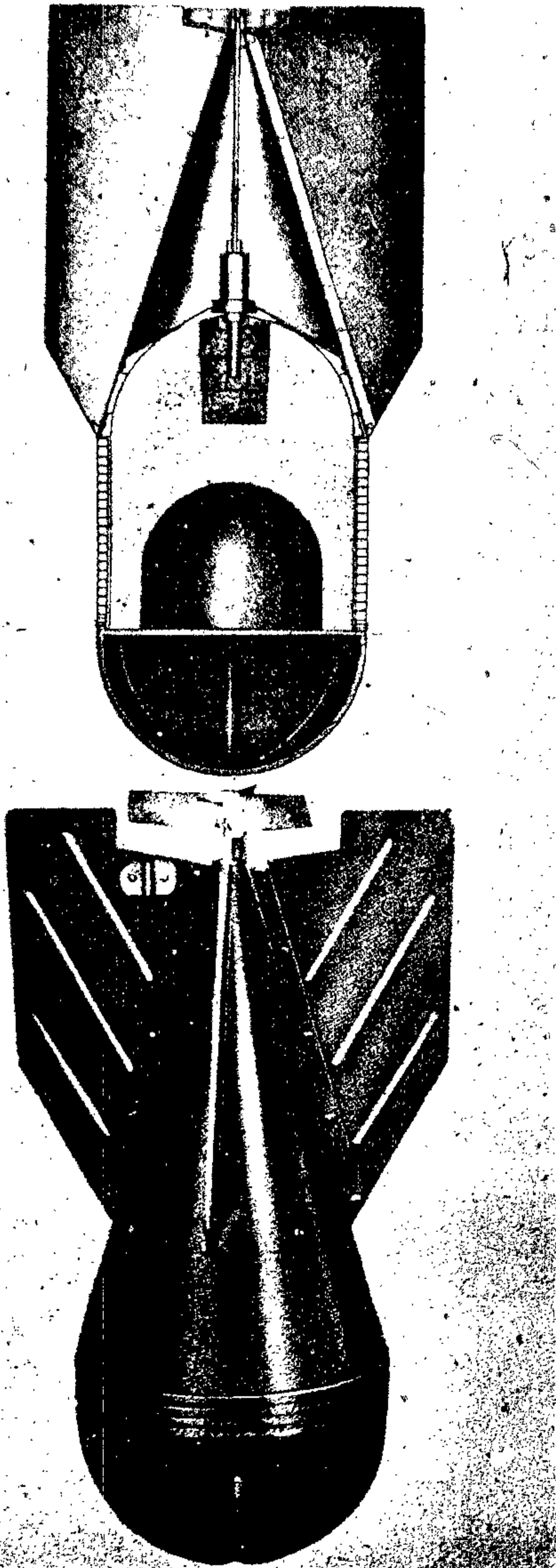

Figure 35 - Hollow-Charge Bombs

3.5-kg., 5-kg., 25-kg., 50-kg., and 100-kg.
Hollow-Charge Bombs

Data

Over-all length	3.5 kg., 15 kg.
Body length	18.8 in.
Body diameter	6.0 in.
Wall thickness	0.06 in.
Tail length	7.7 in.
Tail width	6.0 in.
Type of filling	RDX/TNT
Weight of filling	2.2 kg.
Total weight	3.5 kg. (approx.)

Fuzing

Tail fuze for hollow-charge bombs

Description

All these bombs are very similar in appearance, except the 25-kg. which differs slightly. The 25-kg. has the bomb casing of helically wound steel strips. The 3.5-kg. was the only bomb of this type known to be used or manufactured by the Italians.

This bomb has a dome-shaped nose completely empty of any main filling and threaded at its base to screw over the threaded cone-shaped body. The main filling is 60% RDX, 38% TNT and 2% wax, which is separately cast and is an easy fit in the bomb body.

This main filling has the hollow dome-shaped recess at its base and has fitted to its apex an RDX booster pierced to receive the fuze and its booster. A horizontal suspension lug is riveted to the body, and a safety pin holder is riveted to the tail vane to receive the safety pin of the fuze.

Bomb Container

Data

Over-all length	5 ft. 6 in.
Body length	2 ft. 8½ in.
Body diameter	11 in.
Wall thickness	0.047 in.
Tail length	22.0 in.
Tail width	11 in. (approx.)
Type of filling	40-2 kg. Anti-Personnel F or Mtr. or 40-1 kg. Incendiary or 20-2 kg. Incendiary or 24-4 kg. Anti-Personnel Thermos
Weight (empty)	23 kg.

Description

This is a metal container holding eight columns of anti-personnel or incendiary bombs. The body is cylindrical and is of sheet metal. It contains eight longitudinal tubes which are welded to the after closing plate and the forward closing plate; holes in the latter leave the forward ends of the tubes open. A flap, which is hinged to this plate, partly closes these holes. The container is held closed by a ball locking, the adjustment of which can be observed through the inspection hole. The forward end of the bomb is closed by an aluminum cap held on by three clips. Riveted to the inside of this cap is a plate. Ejector springs are fitted in the after ends of tube.

The tail cone, carrying four fins, is fitted by screws to the body. A corrugated ring strut strengthens the tail fins. Below the drum and situated between each pin of adjacent fins is a drogue of pressed steel. Each of these drogues is connected to its neighbor by a fabric web fixed to the sides of the drogue by rivets.

A fabric-covered elastic strip attached to each case at one end to the drogue, and at the other end to the drum, tends to pull each drogue open. The range of movement of each drogue is limited by the length of a flexible wire cable fixed to the tail cone. Before dropping, these drogues are prevented from opening by a cord or wire which encircles them and passes through a cutter. This clockwork is prevented from running by a safety pin. To the underside of this particular drogue is attached an additional cable which runs through a hole in the tail cone, between the main body and inner tubes, and terminates in a bolt, the withdrawal of which releases the ball locking device. A transit safety pin prevents withdrawal of the bolt.

Operation

On loading into the aircraft, the transit pin is withdrawn. On release, the safety pin in the clockwork is withdrawn. After the preset time, varying between 0 and 20 seconds, the clockwork activates a cutter which severs the restraining wire and so allows the drogues to open. This causes the bolt to be withdrawn. The springs eject the bombs by forcing open the flap which, in turn, throws off the cap by pressing on the plate within the cap.

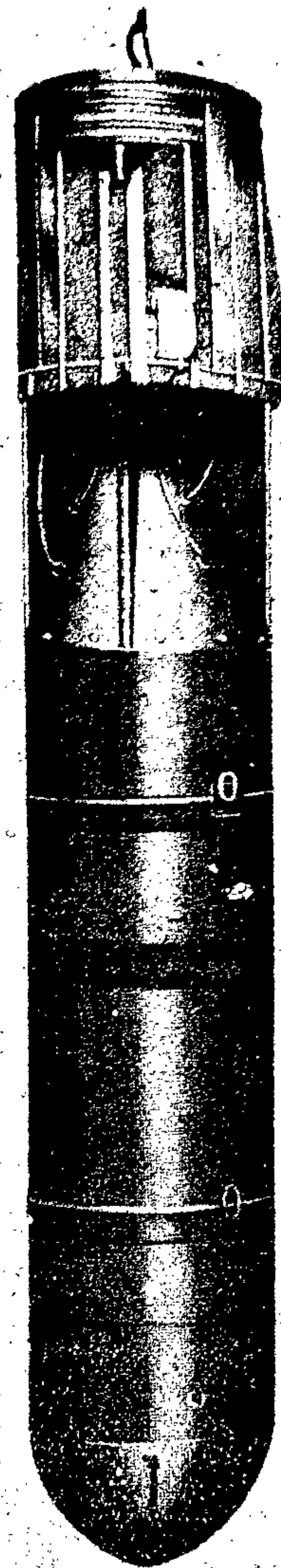

Figure 36 - Bomb Container

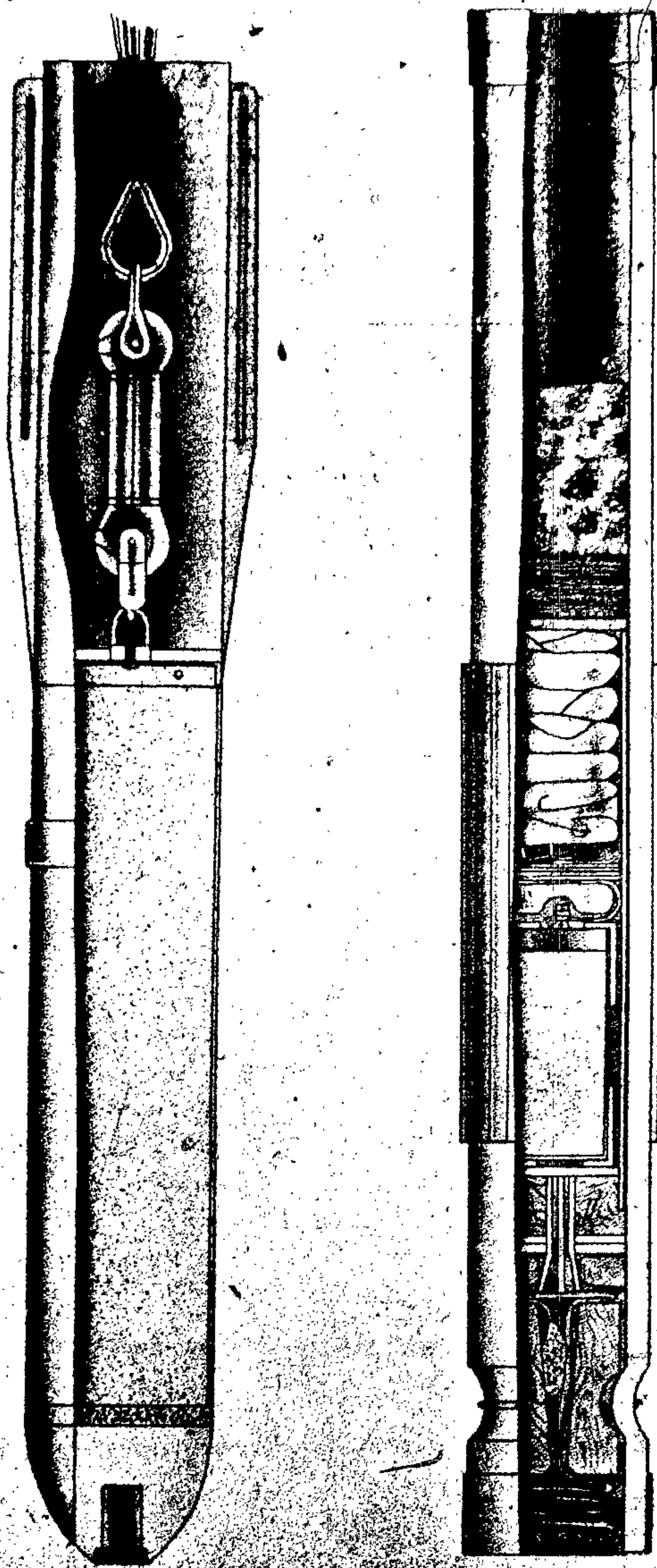

Figure 37 - Parachute Flares

Parachute Flares**Martellona Parachute Flare****Data**

Over-all length	36.9 in.
Flare length	17.0 in.
Body diameter	4.0 in. (approx.)
Tail length	14.2 in.
Type of filling	Magnesium powder
Weight of filling	Unknown
Total weight	Unknown

Fuzing

Nose only—Type L

Description

The bomb consists of a light metal nose, a thin cylindrical body filled with magnesium powder, and a tail unit containing the parachute and release mechanism. The flare is set for height by means of an indicator on the parachute-release mechanism. On release from the plane, the vanes of both the release mechanism and the nose fuze rotate; the fuze arms, and, when the parachute release mechanism functions to cause the parachute to open, the jerk is sufficient to operate the nose fuze. The resultant explosion blows away the light metal nose, with the fuze from the cardboard magnesium container, setting off the ignition powder, which, in turn, ignites the magnesium.

Parachute Flare (Cardboard)**Data**

Over-all length	12.5 in.
Body diameter	1.45 in.
Wall thickness	0.19 in.
Type of filling	Unknown
Weights	Unknown

Fuzing

Friction igniter in nose

Description

This flare is contained in a cardboard tube the same thickness throughout its length. A corrugated cardboard 3.9 inches long surrounds the tube near the center to form a grip. Below the grip the tube is constructed to fit into the groove in the wooden plug at the nose and is held by a wire. The open ends of the tube are sealed by paper gummed over. In central hole of the wooden plug is a friction igniter. This consists of a friction composition attached to the end of a short length of string impregnated with a phosphorus composition. The flare operates by breaking the seal at the nose end and pulling the string, which ignites the friction composition. This, in turn, ignites the safety fuse, which gives approximately two seconds before igniting the powder charge located below the candle. The charge ignites the candle and at the same time ejects the candle and parachute from the tube. The resistance to the expelling charge is provided by a felt washer and waste packing at the top of the tube.

Color and Markings

Over-all—bright red

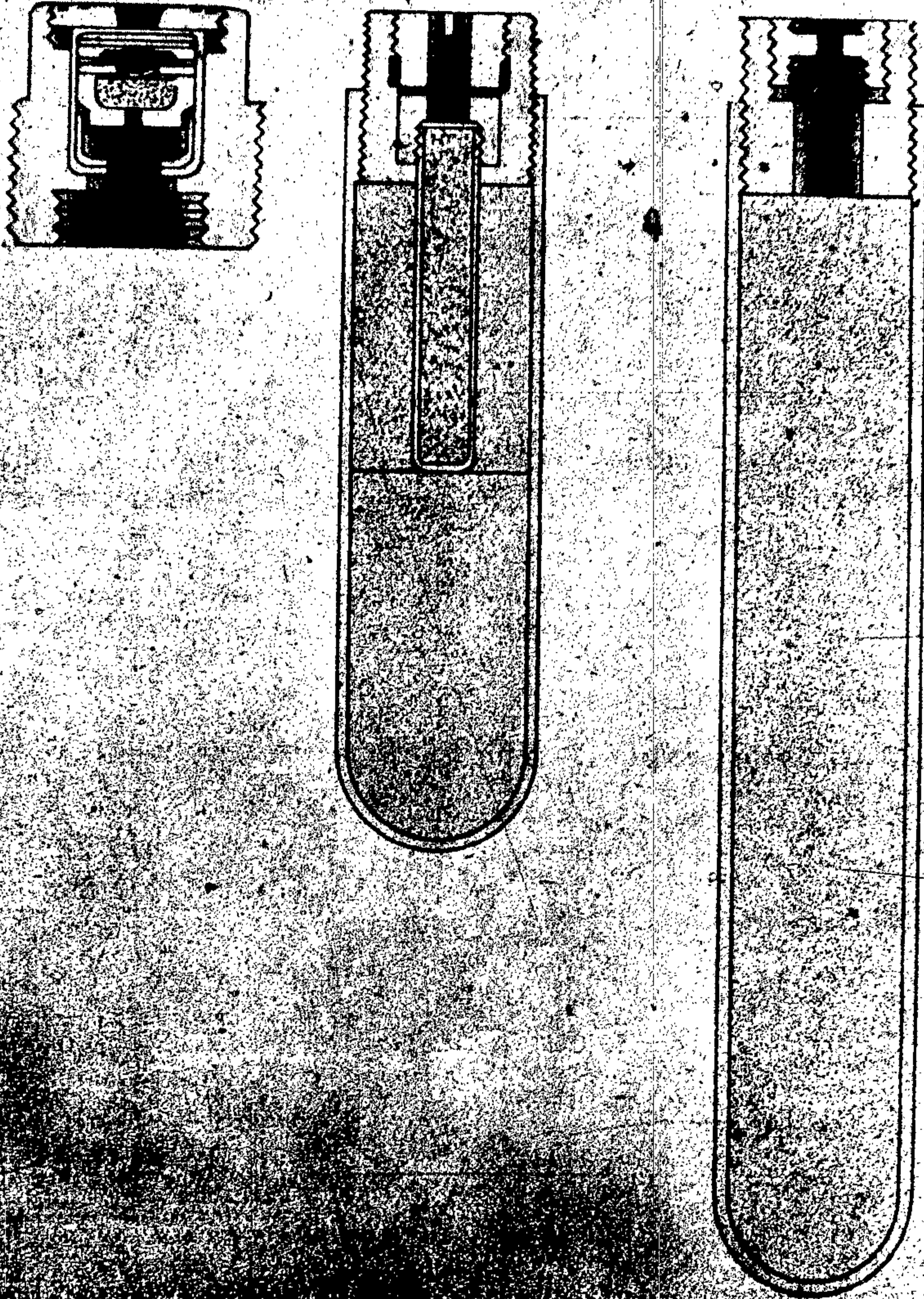

Figure 38 - Bomb Adapters and Boosters

Chapter 2

ITALIAN BOMB FUZES

Italian bomb fuzes are all mechanically operated, except for the time fuzes for the 500-kg. time bomb; and most of the Italian bomb fuzes function upon impact. The principle of arming and functioning is the same for most tail and nose fuzes. Arming takes place during the fall of the bomb and depends upon the rotation of the arming vanes. The primary safety device is always the safety pin, which is withdrawn before the bomb is dropped. The fuze can be handled with relatively little danger when the safety pin is present. Normally, the fuzes are made of brass, steel, or aluminum and are coated with shellac or varnish to resist corrosion.

Tail fuzes are screwed into the base of the bomb and contain a cylindrical steel tube which extends the whole length of the tail. The end of the bomb tail is shaped to accommodate the arming vanes. In most cases the striker is immobilized in the un-armed conditions by steel balls resting against either a groove or a sleeve in the fuze body. The balls either are prevented from moving inwards by an arming spindle, attached directly to vanes which unscrew and rise above the collar into which the spindle screws, or are threaded to a rod or tube attached directly to the vanes. In the latter case, there is no external evidence of arming, since the arming spindle screws either into or onto the tube or rod attached to the arming vanes, and the vanes do not rise as in the case where the arming spindle is attached directly to the vanes.

The striker for many tail fuzes has more than one firing pin in order to insure detonation of the bomb. Where two or more firing pins are used, the striker always has a guide to keep the firing pin and detonator caps in line. In most cases, the striker is held in the armed condition by a creep spring, and the detonator is stationary. These fuzes are operated by the arming spindle, which rises, thus freeing the steel balls, which move inward to free the striker. On impact, the striker overcomes the creep spring and hits the detonator.

Nose fuzes allow a considerably wider variation in operation than do the tail fuzes. Most of the nose fuzes may be divided into two general types: those which are armed by rotation and the subsequently falling away of a vane cap; and those which are armed by the simple rotation of the vanes. In the former case, the absence of the cap indicates arming of the fuze; but, in the latter case, it is more difficult to decide the question of arming.

Most nose fuzes have steel balls which lock either the striker or the sleeve holding the detonator. The functioning in all cases depends on either the cap or the arming spindle, which rises to free the steel balls. These then move either outward or inward to free the detonator sleeve or unlock the striker. In the case where the detonator is movable, a creep spring is incorporated in the design; but, when the striker is movable, a shear washer or a pin is used.

Italian time fuzes are of two types: one for aerial burst, which depends on the certain number of rotations of the vanes for functioning; and the other, a long-delay, which depends on a clockwork for delay, but which arms the same as most other Italian fuzes.

The bases of most Italian fuzes are threaded internally to receive a booster. The normal boosters used were of two types, the long type, 7.5 in. long, and 1.3 in. external diameter; and the short type, 4.8 in. long and also 1.3 in. diameter. The long booster is screw-threaded at the open end to take an adapter and, below the adapter, contains two compressed blocks of TNT; the upper block is recessed to take a booster. The short booster is similar but contains less charge. Different types of adapters are fitted to the booster to give delay action or different length projections of the auxiliary booster which fits into the booster proper. The auxiliary booster is the same for both types and is in an aluminum tube, the top of which is threaded to a steel plug which fits into the adapter. Above the auxiliary booster, the booster lead-in pellet is located and, in some cases, it has a relay or delay powder pellet below it.

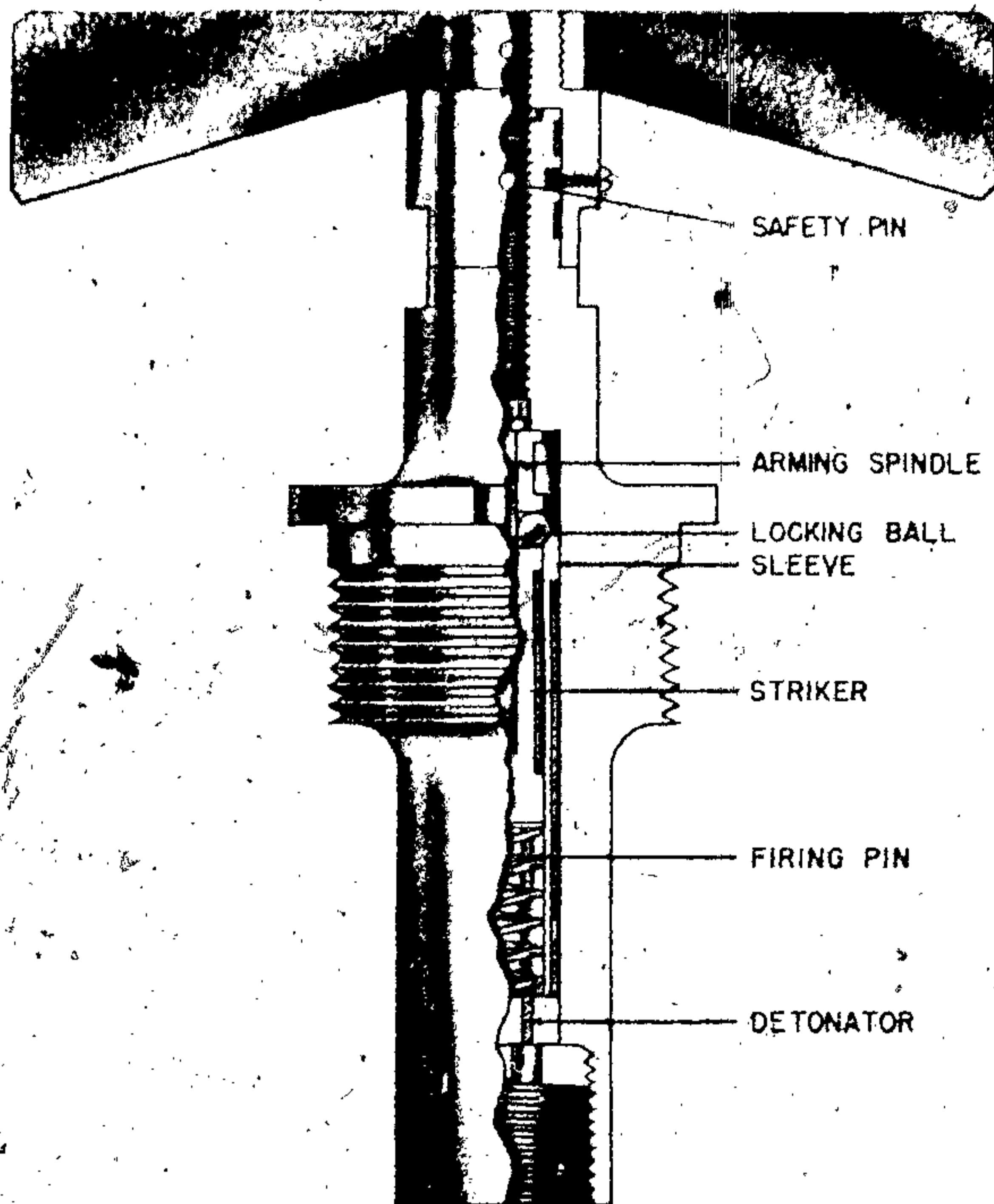

Figure 39 — Type A — Mechanical Impact Nose Fuze

Type A—Mechanical Impact Nose Fuze

Data

Bombs used in.....	250-kg., 500-kg., 800-kg. General Purpose
Fuze found with.....	Tail—Type 0
Material of construction.....	Brass body and vanes
Over-all length.....	7.5 in. (without booster)
Over-all length of vanes.....	6.3 in.
Width of fuze body.....	2.8 in.

Description

The fuze has a main body threaded to fit in to the nose-fuze pocket of the bomb and also internally threaded to take the long-type booster, with a booster lead-in screwed in the upper part. There is an inner sleeve in the main body in which the striker containing the twin firing pins is free to slide. The striker is prevented from moving, in the un-armed condition, by two steel balls resting against

the sleeve and also by the creep spring. An arming spindle prevents the balls from moving in and releasing the striker. The vanes are attached to a collar in which are two pins traveling in annular space. The vanes do not rise during rotation, but the arming spindle rises through the vane collar. The vanes are prevented from rotating by a safety pin through the fuze body and arming spindle.

Operation

When the bomb is dropped, the safety wire withdraws the arming pin. This allows the vanes to rotate, but the pin in the vane collar, which extends into the annular space, prevents the collar from rising. When the arming spindle has withdrawn above the balls, the balls roll inwards, freeing the striker and sleeve. On impact the striker and twin primer cap holder overcome the creep spring; the firing pins hit the twin primers.

The fuze is completely armed when the arming spindle projects 1.5 in. above the vane collar.

Types B and V—Mechanical Impact Nose Fuzes

Data

Bombs used in	
Type B	160-kg. Antisubmarine
Type V	1-kg. and 2-kg. Incendiary
Fuzes used with	Alone
Over-all length	
Type B	8.1 in.
Type V	8.3 in.
Over-all length of vanes	
Type B	7.5 in.
Type V	5.7 in.
Width of fuze body	
Type B	5.5 in.
Type V	2.7 in.

Description

These fuzes have a domeshaped cap of which the vanes are an integral part. The outer shoulder or flange is notched to receive a spanner wrench in tightening the fuze. Beneath this shoulder is the threaded portion of the fuze body which screws into the nose-fuze pocket of the bomb. The striker is threaded at the top to receive the cap. The striker is held in place by a ball race riding in an annular groove in the striker near the top. The striker has two firing pins. The striker is held from the detonators by shear washers and the steel balls; there are no creep springs.

Operation

The safety pin is withdrawn when the bomb is released. The vanes rotate in flight and fall off; the steel balls fall away, thus releasing the striker. Upon impact, the striker is forced down, shearing the shear washer and bringing the firing pins in contact with the detonators, which fire the booster that is internally threaded in the base of the fuze.

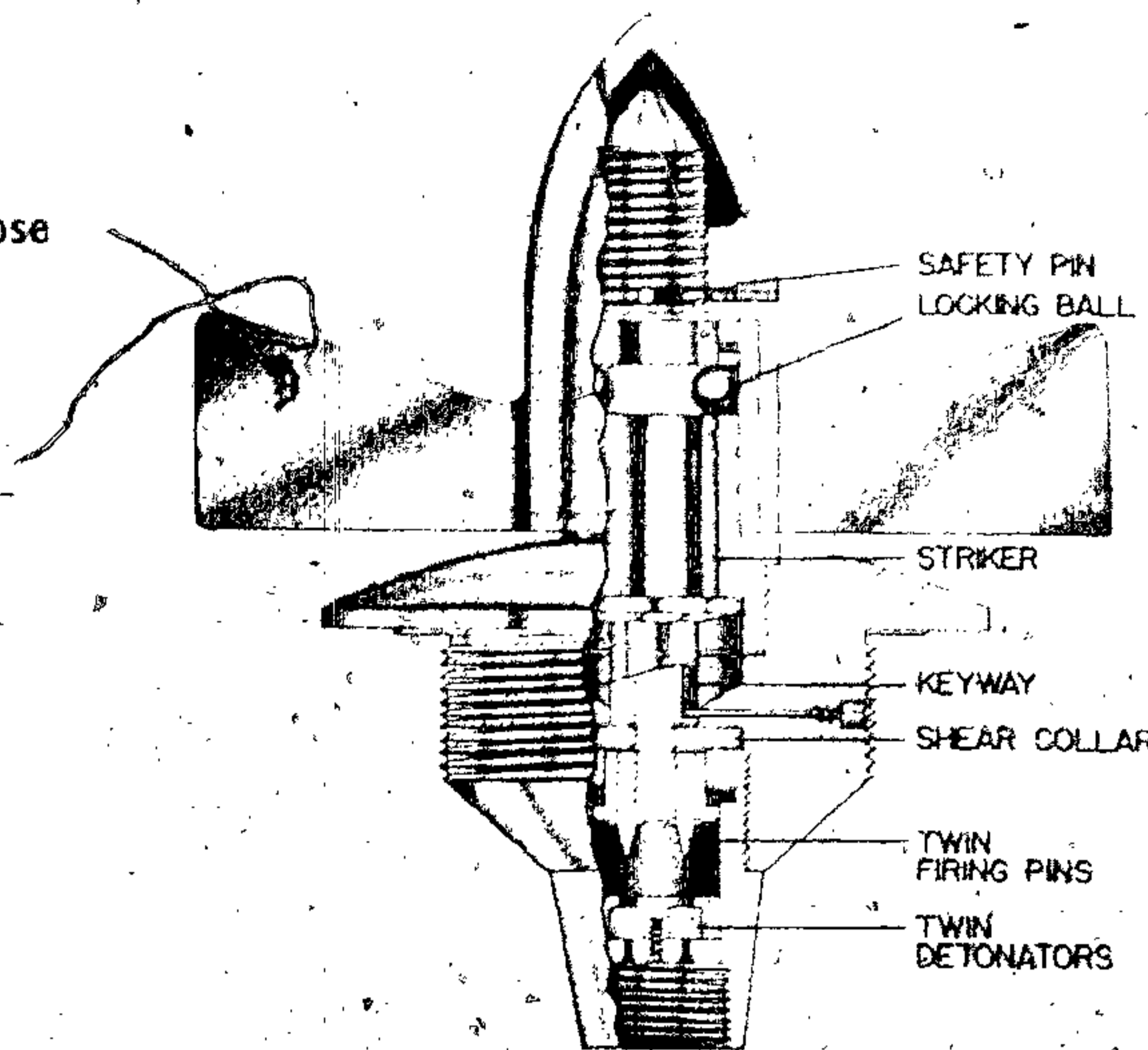

Figure 40 — Type B — Mechanical Impact Nose Fuze

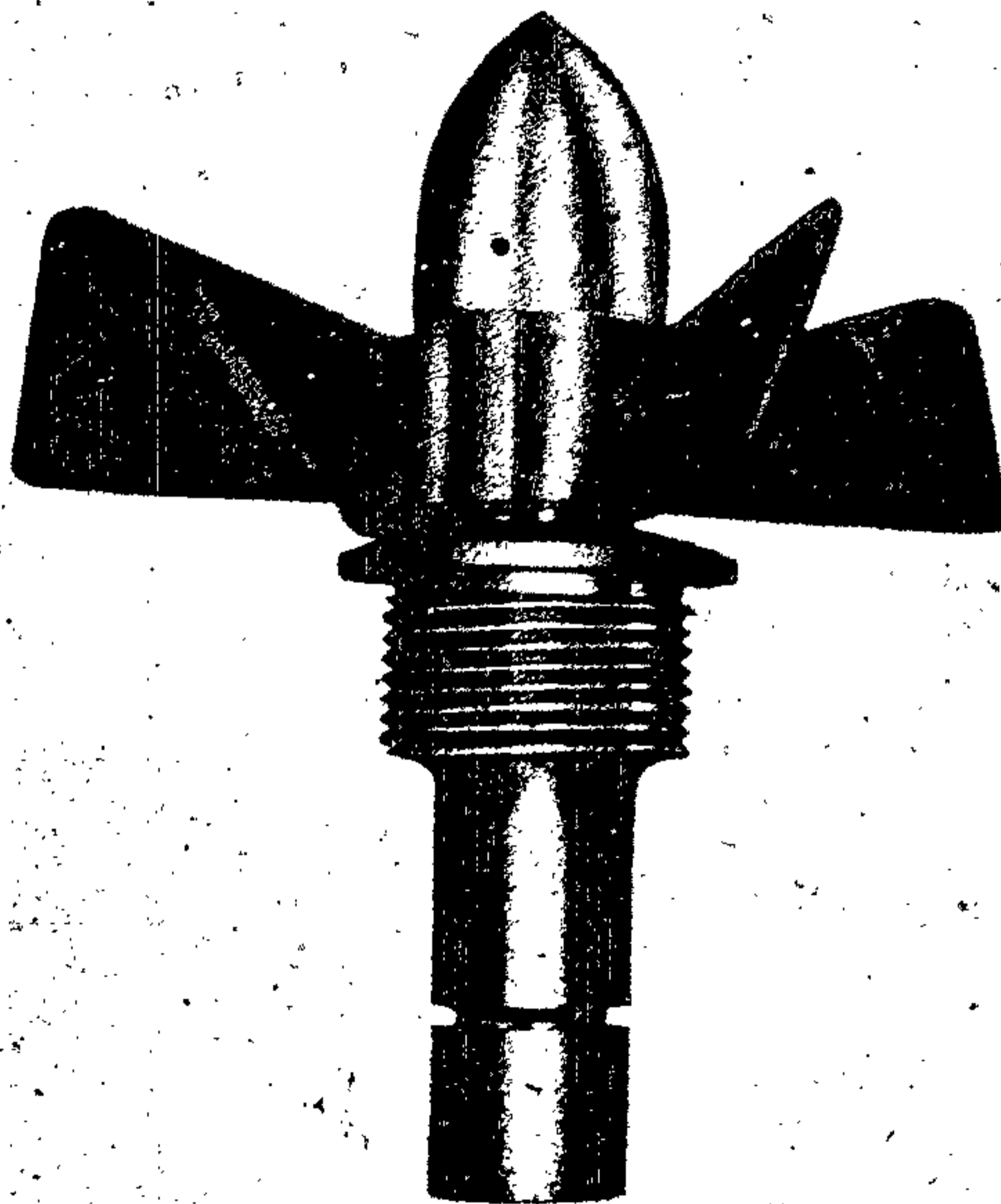

Figure 41 — Type V — Mechanical Impact Nose Fuze

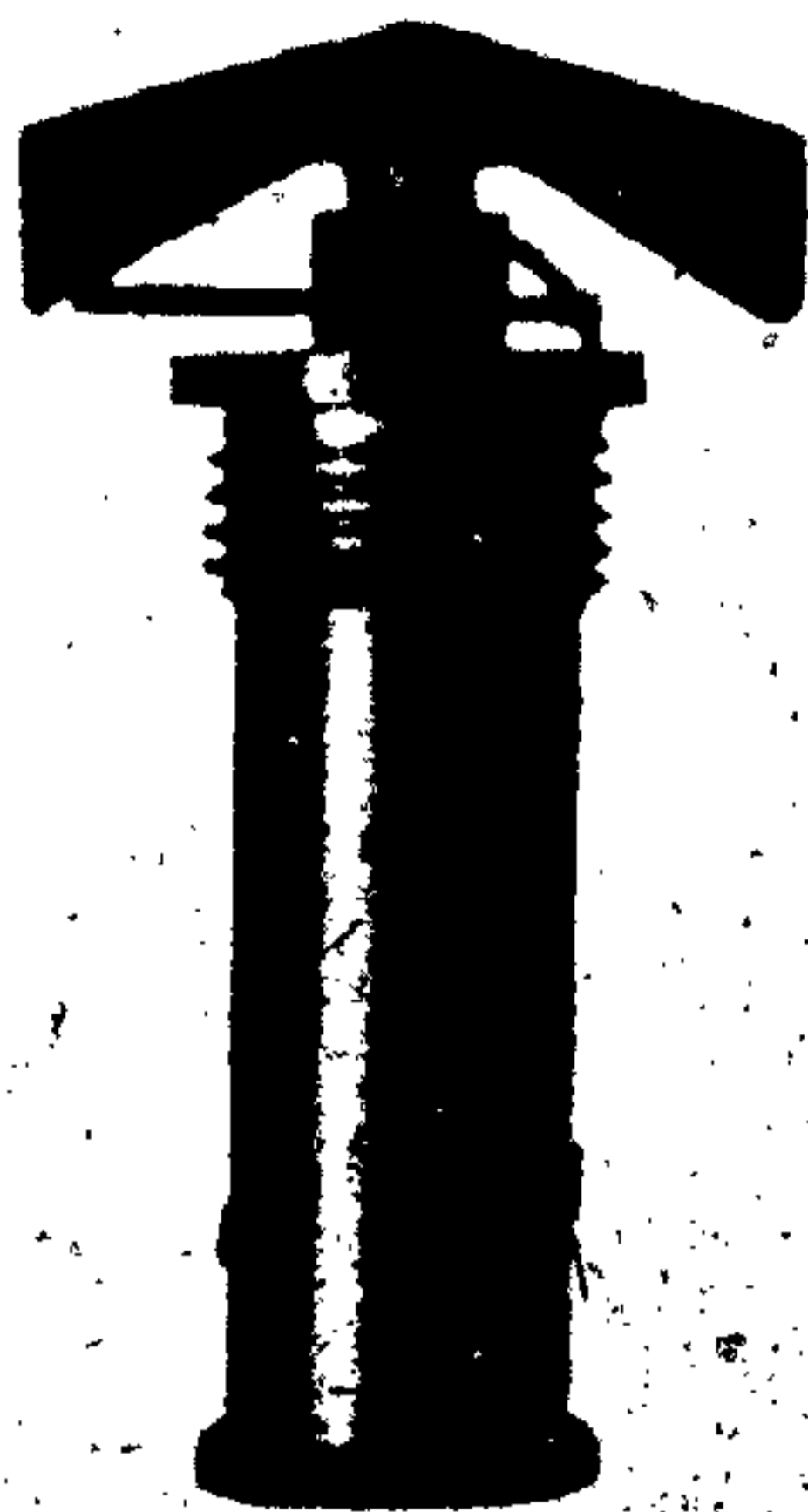

Figure 42 - Type F - Mechanical Impact Nose Fuze

Types F and W—Mechanical Impact Nose Fuzes

Data

Bombs used in	12 kg. Anti-Personnel
Fuzes used with	Alone.
Material of construction	Brass
Over-all length	
Type F	5.6 in.
Type W	5.8 in.
Over-all length of vanes	
Type F	3.3 in.
Type W	3.6 in.
Width of fuze body	1.8 in.
	2.2 in.

Description

These two fuzes are based on the same principle of operation and with few minor variations are similar in appearance. Both fuzes are threaded at the base to receive the long-type boosters; the detonator caps and striker are retained in "All-ways" housings which are free to move. This insures contact of cap and striker, regardless of how the bomb falls. Both fuzes have arming vanes and spindle, which is withdrawn upon the rotation of the vanes, freeing the balls and consequently the striker. The outer shoulder of the Type W Fuze is slightly longer than the Type F.

Beneath the shoulder of each fuze are threads which screw into the nose-fuze pocket. Vanes of the Type F slant down toward the fuze body, whereas vanes on Type W slant away from the fuze body.

Operation

Operation of these two fuzes is the same. Upon being released from the plane, the safety pin is withdrawn; the vane rotates the arming spindle. When the spindle is withdrawn 0.4 in. on the Type F or 0.5 in. on the Type W, steel balls move into the channel, releasing the striker, which then rests on the creep spring. The dome-shaped surface at the end of the striker cavity insures that striker and detonator-cap holder approach each other, regardless of the bomb's position on impact. Upon impact, the detonator cap moves forward, overcoming the creep spring and contacting the striker, detonating booster and

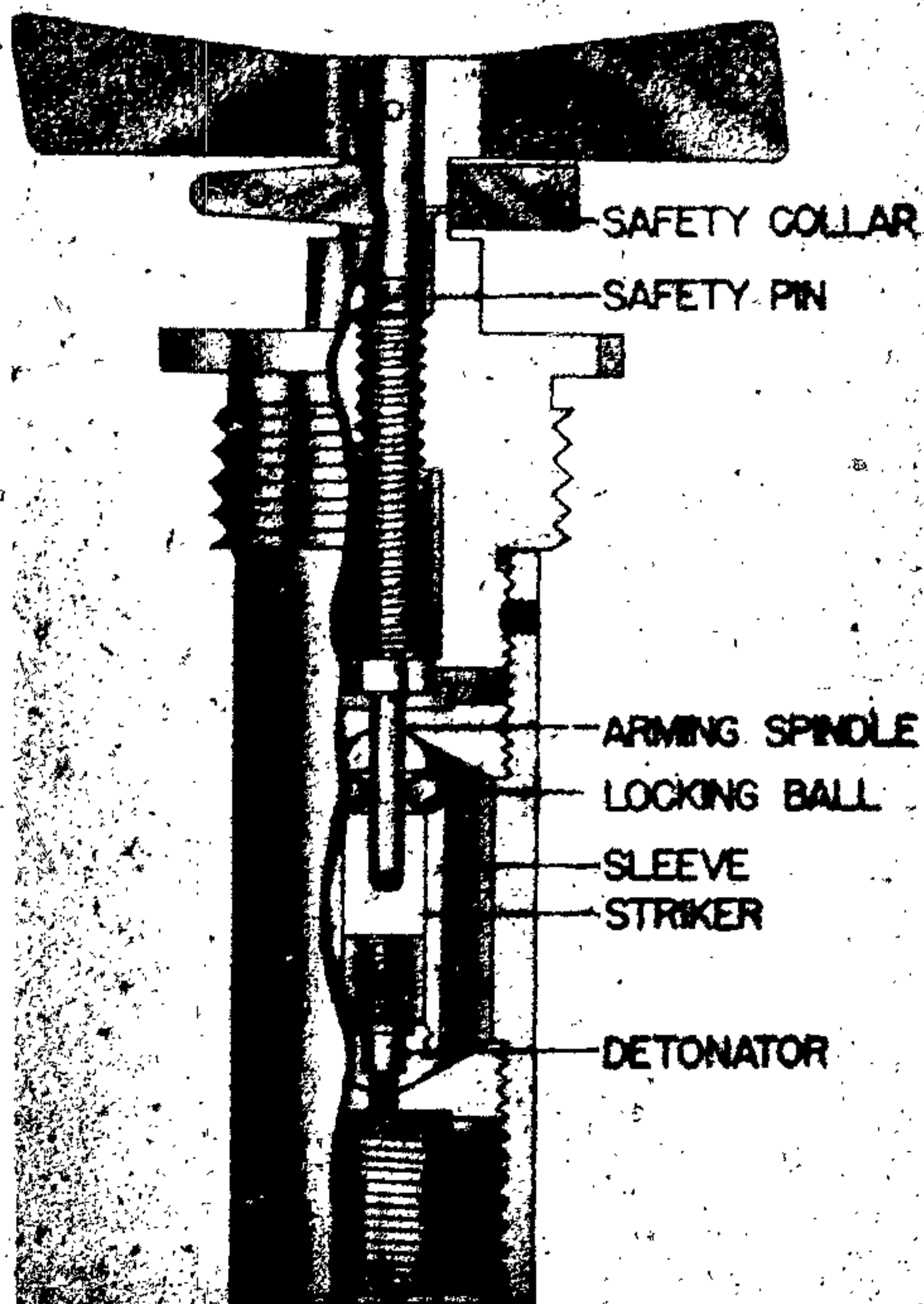

Figure 43 - Type W - Mechanical Impact Nose Fuze

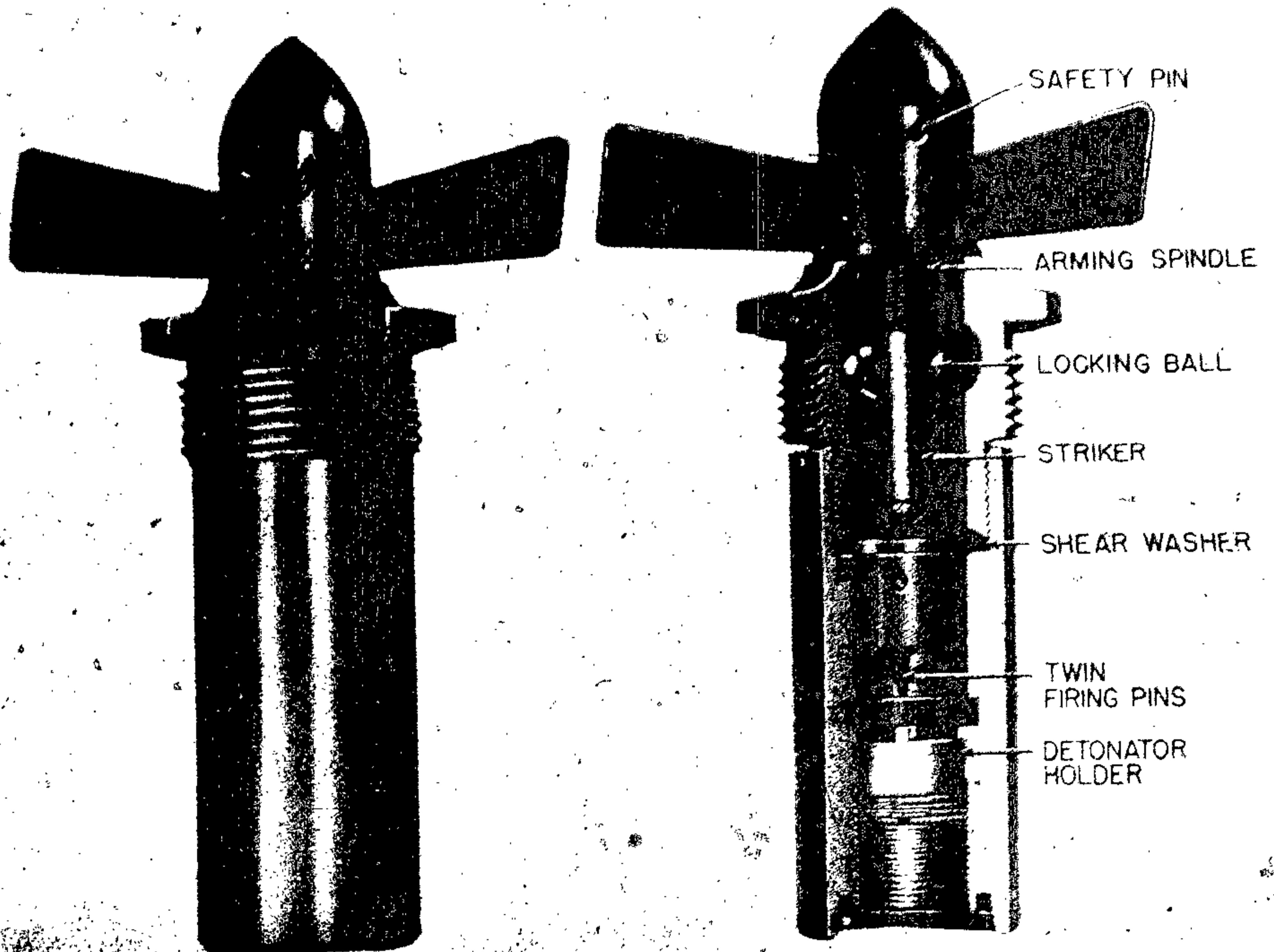

Figure 44 - Type J - Mechanical Impact Nose Fuze

Type J—Mechanical Impact Nose Fuze

Data

Bombs used in.....	500-kg. Time Bomb 12-kg. Anti-Personnel Mtr.
Fuses used with.....	Long-delay nose and Tail clockwork
Material of construction	Steel lower body, striker and shear washer Remainder brass
Over-all length.....	7.8 in. (without booster)
Over-all length of vanes	4.5 in.
Width of fuze body	2.75 in.

Description

The fuze is similar in appearance to Type R. The fuze body is made in two parts: the lower part made of steel and inclosing the twin detonator caps with internal threads to receive the booster and booster lead-ins; the upper part of the fuze

body housing the striker assembly and having a flange above the threads by which the fuze is secured in the bomb. The striker is immobilized by a shear washer and two steel balls located in the channel of the striker and a recess in the body. The arming spindle, which is attached to the arming vanes, prevents the movement of balls until the vanes and cover have rotated to withdraw the spindle past the balls.

Operation

When the bomb falls from the plane, a safety pin which passes through cap and upper part of the fuze is removed, permitting the vanes to rotate and the arming spindle to rise in the striker assembly. When the arming spindle has moved past, the balls roll inward, freeing the striker except for the shear washer. On impact, the head of the striker assembly acts as an anvil and the whole assembly is driven back, shearing the washers, and the firing pins fire the detonators, which in turn fires the explosive train.

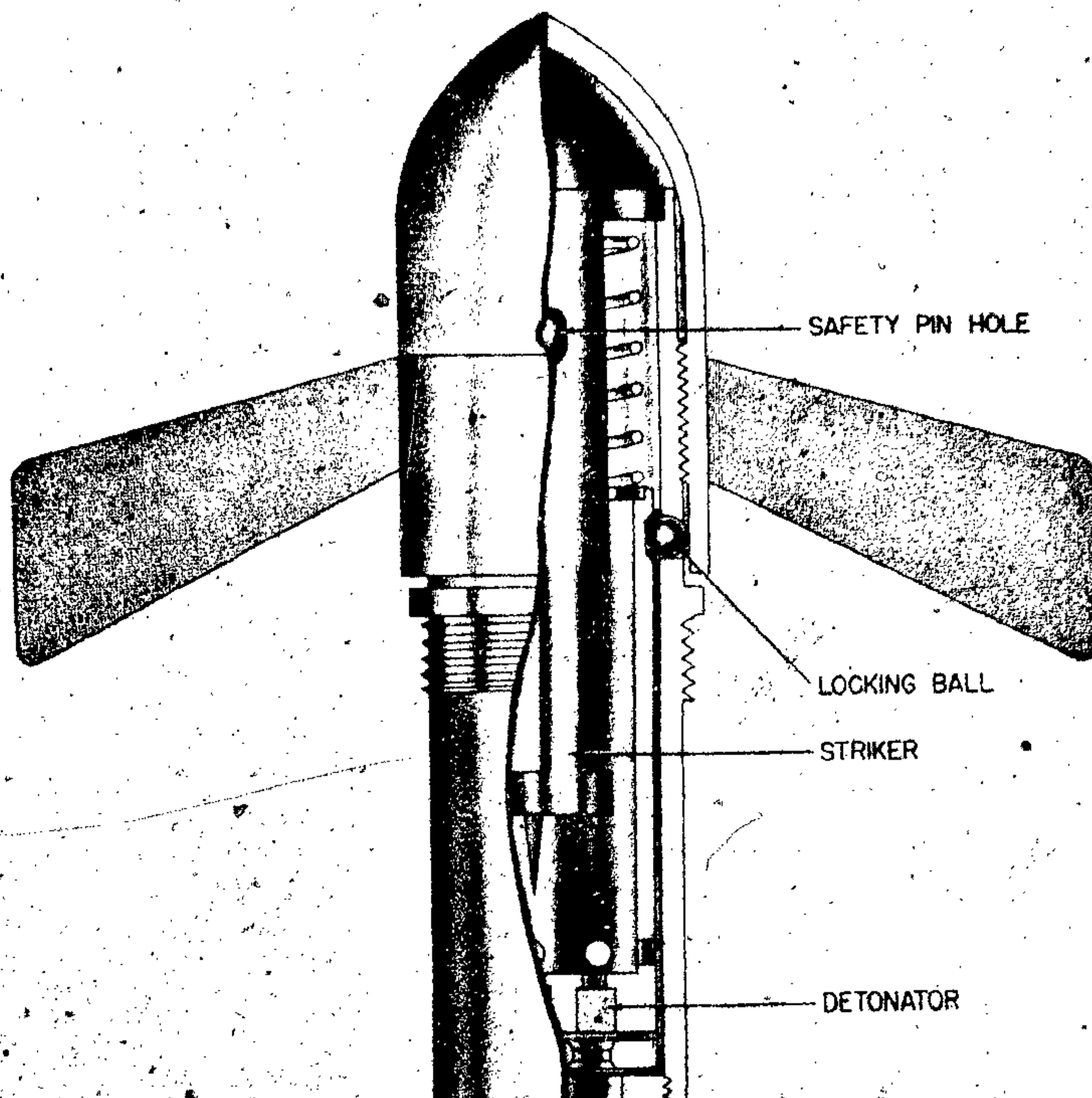

Figure 45 - Type L - Mechanical Impact Nose Fuze

Type L—Mechanical Impact Nose Fuze

Data

Bomb used in	Parachute Flare.
Fuzes used with	Alone
Over-all length	4.3 in.
Over-all length of vanes.....	4.3 in.
Width of fuze body.....	1.2 in.

Description

The fuze body is cylindrical, with a central flange. Below this flange, the cylinder is threaded to screw into the bomb. Above the flange, the cylinder is also threaded to receive a bullet-shaped vane cover in which the vanes are integrally cast. Beneath this cover, is the striker on a plate which screws into the upper part of the cylinder. Inside the base of the cylinder is a tube sliding into the cylinder but prevented from movement by the

light creep spring resting against the top plate of the striker. In the bottom of the tube are twin detonator caps underneath the twin firing pins. Two steel balls are placed in holes in the cylinder, positioned in an annular slot in the tube containing the caps, and prevented from moving outwards by the arming-vane cover. A hole through the striker and vane cover receives the safety pin.

Operation

When the flare is dropped, the safety pin is pulled, allowing the vanes to rotate. After the vanes have made a few rotations, the two steel balls can move out from under the vane cover, freeing the tube except for the creep spring. When the parachute opens, the case receives enough deceleration to cause the sliding tube to set forward, overcoming the spring and impacting the striker. The detonator caps are then fired.

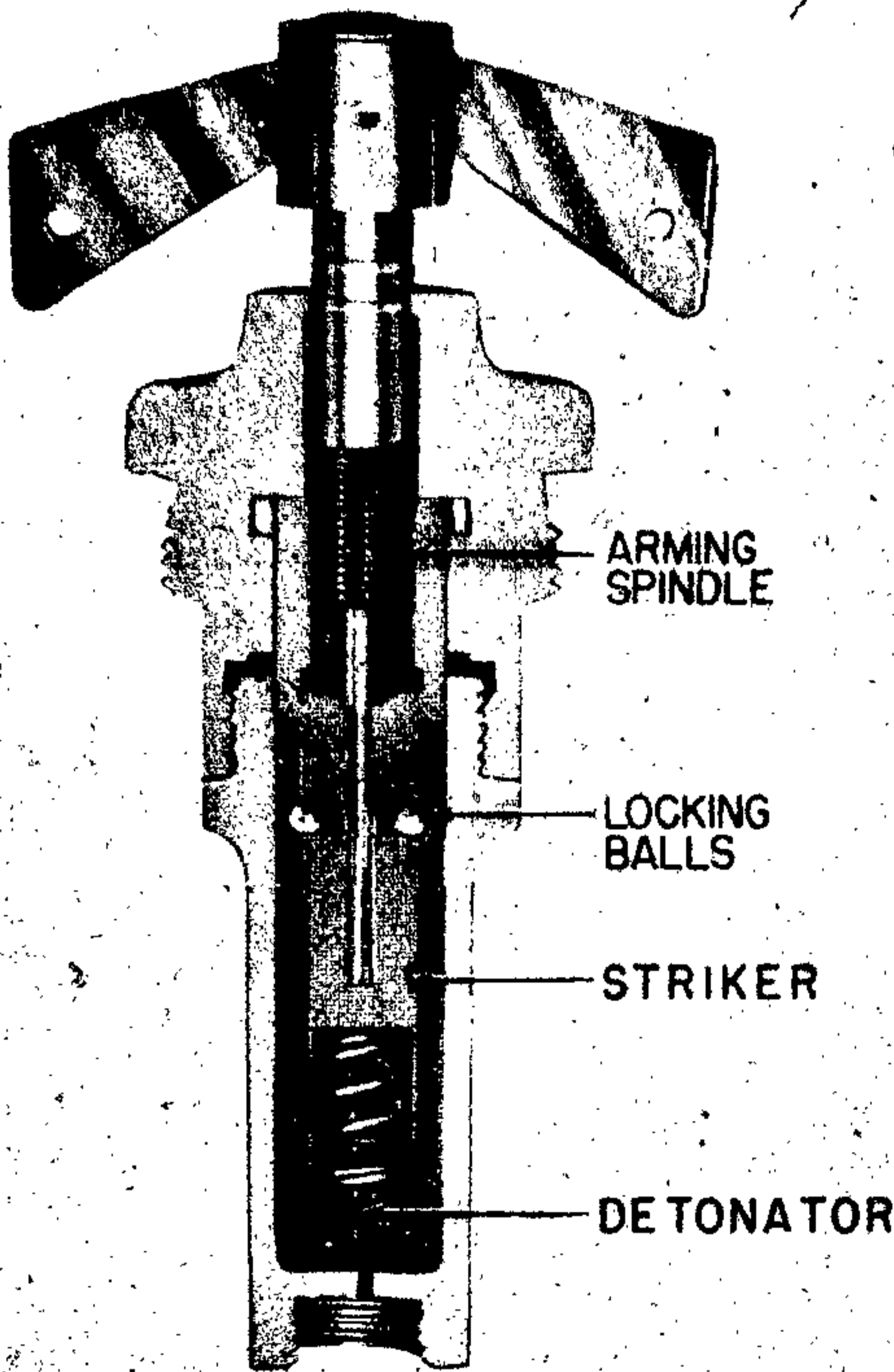

Figure 46 — Type M — Mechanical Impact Nose Fuze

Type M—Mechanical Impact Nose Fuze

Data

Bomb used in..... 3-kg. (Mtr.) Anti-Personnel
 Fuzes used with.... Alone
 Over-all length.... 3.8 in. (without booster)
 Over-all length of 2.3 in.
 vanes
 Width of fuze body 1.6 in.

Description

The fuze body is made in two parts screwed together. The upper part is flanged and threaded to fit into the fuze pocket. A central opening, which has a small flange, receives the threaded arming spindle. This spindle screws into the striker assembly.

In the lower part of the fuze body is a sleeve with a beveled upper edge against which rest the steel balls located in a hole in the striker assembly. In the bottom of the sleeve is the detonator cap,

the sleeve and striker being spaced by a creep spring. The base of the lower part of the fuze is threaded to receive the booster tube. The vanes are secured to the spindle by a pin and prevented from rotating by an arming wire secured to the body and passed through the holes.

Operation

Upon release from the plane, the arming wire is pulled from the vanes, allowing them to rotate. After the arming spindle has withdrawn so that 0.16 in. of the spindle shows below the vanes, the balls will be free to move inwards, freeing the sleeve containing the detonator. Upon impact, the sleeve may be set forward onto the striker, firing the cap. The vanes do not fall away.

Type Q—Mechanical Impact Nose Fuze

Data

Bombs used in..... 2-kg. Anti-Personnel Types
 F and Mtr.

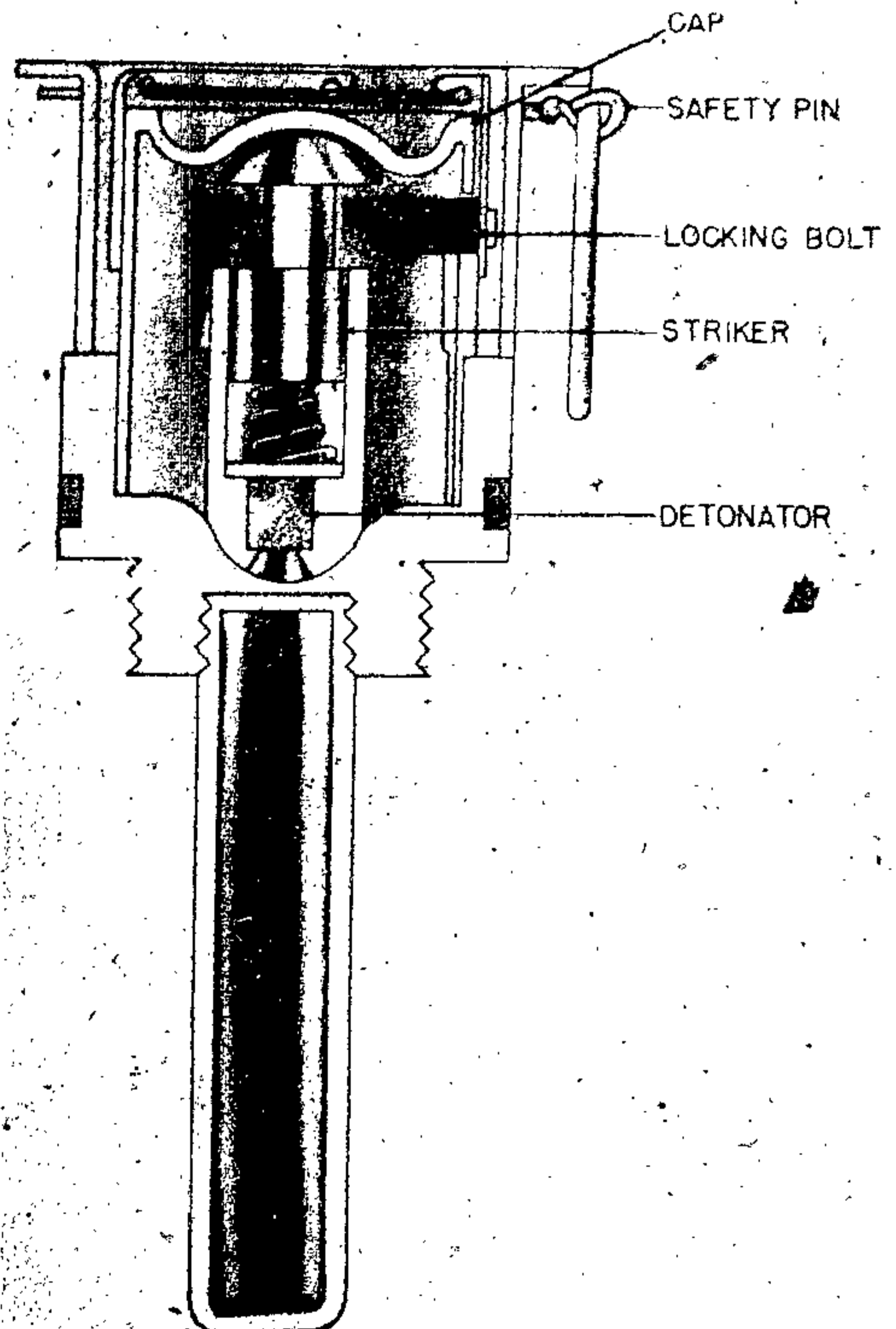
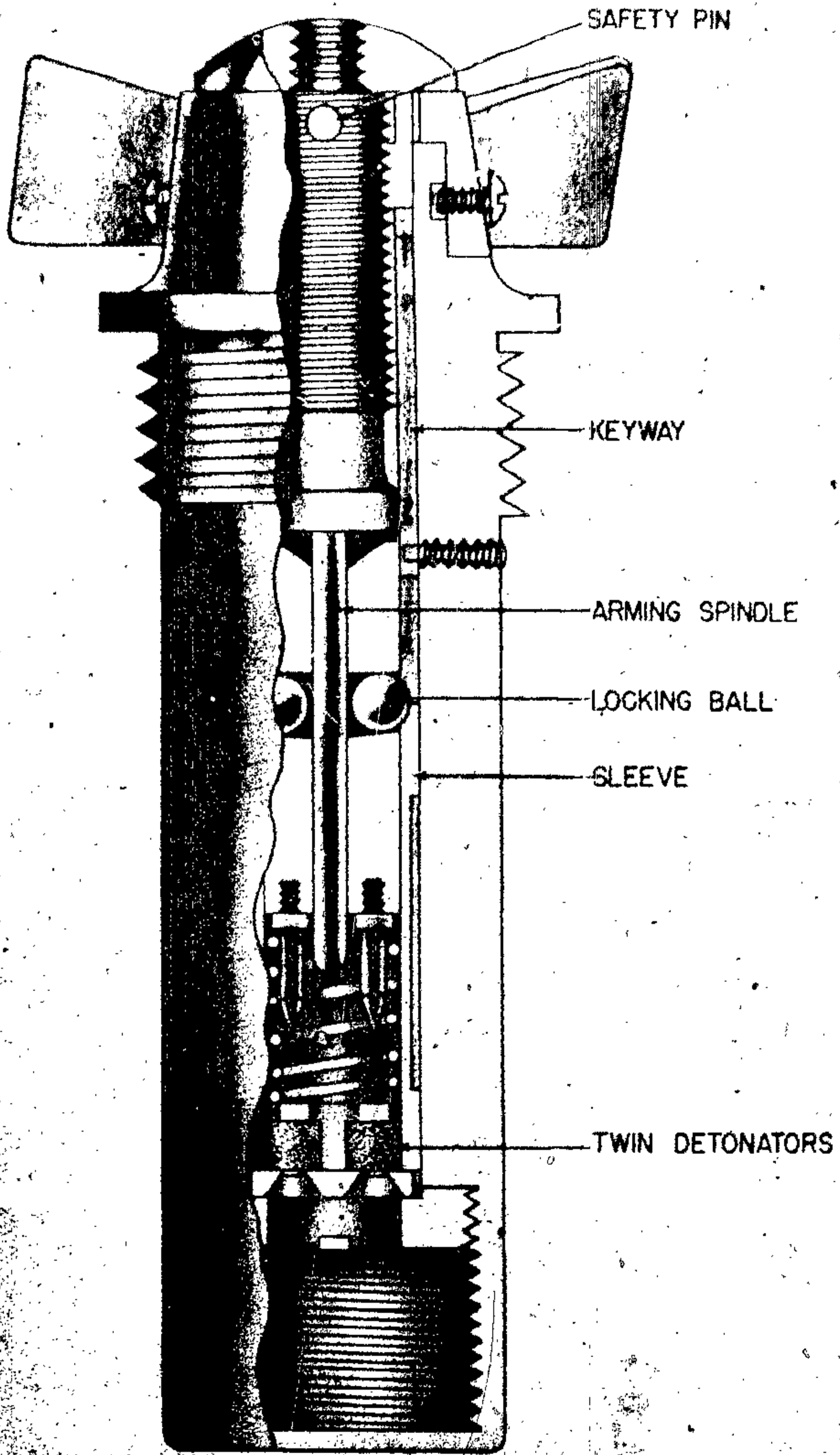

Figure 47 — Type Q — Mechanical Impact Nose Fuze



**Figure 48 - Type R - Mechanical Impact
Nose Fuze**

1-kg. and 2-kg. Intendiary
 Fuzes used with Alone
 Over-all length 1.8 in. (without booster)
 3.7 in. (with booster)
 Width of fuze body . . 1.7 in.

Over-all length 5.8 in. (less booster)
 Over-all length of . . 2.6 in.
 vanes
 Width of fuze body . . 1.9 in.

Description

The fuze has an outer cap which is a push fit over the housing of the fuze. The cap is held in place by the safety pin. The housing contains the striker and primer cap, which are set in a dome-shaped cavity at each end to give an "all-ways" effect. An annular groove at the top of the striker receives three safety bolts. The base of the fuze has internal threads to receive the booster and external threads to screw the fuze into the nose-fuze pocket of the bomb.

Operation

The safety pin is withdrawn upon dropping the bomb, and during flight the cap falls away and releases the safety bolts. The striker is then free to rest on the creep spring. On impact, the striker and detonator cap overcome the creep spring and detonate the bomb. Because this is an "all-ways" assembly, the striker and detonating cap will contact, regardless of the position in which the bomb hits.

Type R—Mechanical Impact Nose Fuze

Data

Bombs used in 12-kg. Anti-Personnel Type
 Mtr.
 Fuzes used with Alone
 Material of Brass arming spindle and
 construction sleeve. Remainder is
 aluminum alloy.

Description

The cylindrical body has external threads beneath the shoulder which screw into the nose-fuze pocket of the bomb. The vanes are attached to a vane hub. Set screws in the hub, which ride in an annular groove in the body, prevent the vanes from coming off in flight. Above the vane cup is a dome-shaped cup threaded to the arming spindle, which in turn is threaded at the top with the vane hub. The firing mechanism consists of a detonator holder with two caps, an inertia striker with two firing pins, and a creep spring set between the detonator cap and the striker. The base of the fuze is threaded to receive the long-type booster.

Operation

The safety pin is removed when the bomb is released. The vanes rotate in flight but do not come off because of the set screws. The arming spindle, being threaded to the vane hub, rises in the channel. When the arming spindle passes the steel balls, they fall inside the channel and the striker and detonator cap are freed. Only the creep spring keeps the firing pins and primers apart. Upon impact, the detonator holder overcomes the creep spring and contacts the firing pins to detonate the bomb.

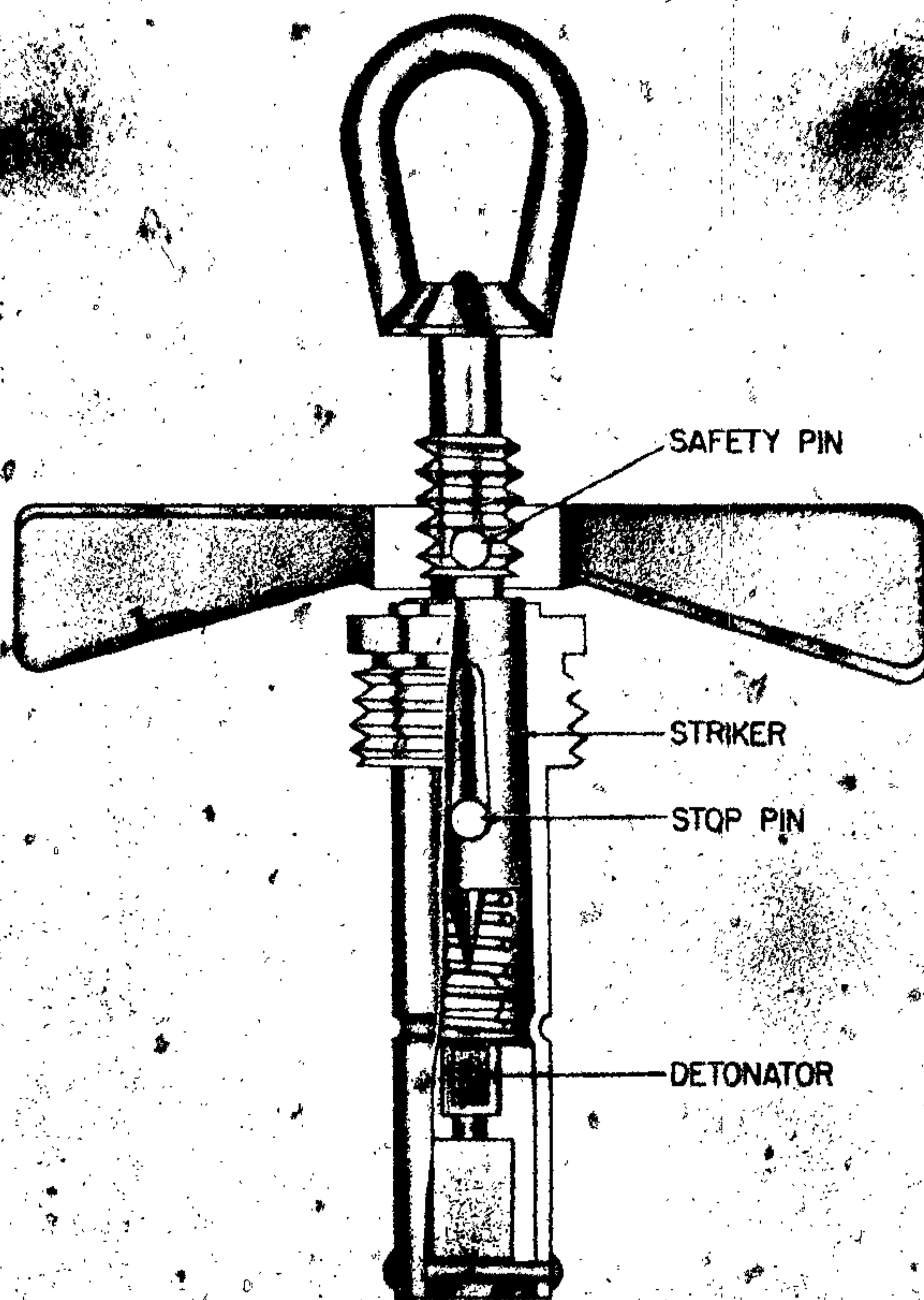

Figure 49 - Type S - Mechanical Impact Nose Fuze

Type S—Mechanical Impact Nose Fuze

Data

Bombs used in.....	Small snoko or Incendiary
Fuze used with.....	Alone
Over-all length.....	4.5 in.
Over-all length of vanes	3.2 in.
Width of fuze body..	0.9 in.

Description

The nose of the fuze consists of a lug which is a part of the striker. The striker is threaded just below the lug in order to receive the arming vanes. The fuze body has a narrow shoulder, immediately beneath which are the threads which screw into

the nose-fuze pocket of the bomb. A stop pin inserted in a channel in the striker prevents the spindle from turning with the arming vanes. The detonator cap is located in the lower part of the fuze body, with another small charge of explosives. A creep spring separates the striker from the detonator.

Operation

The safety pin is withdrawn when the bomb is dropped. The vanes rotate in flight and rise on the striker. The striker then rests on the creep spring. Upon impact, the striker overcomes the creep spring, contacts the primer, and initiates the explosion.

Type U—Mechanical Impact Nose Fuze

Data

Bomb used in 2-kg. Anti-Personnel Type
 F and Mtr.
 1-kg. and 2-kg. Incendiary
 Fuzes used with . . . Alone
 Over-all length 1.8 in. (without booster)
 3.8 in. (with booster)
 Over-all length of . . 1.8 in
 vanes
 Width of fuze body . . 1.0 in.

Description

The fuze is threaded at the base to screw into the nose-fuze pocket of the bomb. The firing assembly consists of a striker, creep spring, and primer. Two steel balls set in the wall of the striker and resting in the wall of the striker sleeve by force of the arming rod, immobilize the striker. The arming spindle is attached to the vanes by a small screw which appears externally in the axis of the vanes. A safety pin prevents the vanes from rotating.

Operation

The safety pin is withdrawn, which allows the vanes to rotate when the bomb is released from the plane. The rotation withdraws the arming spindle from the striker. After the arming spindle has withdrawn a sufficient distance, the balls fall into the channel and release the striker. This action arms the fuze. Upon impact, the striker overcomes the creep spring and contacts the primer detonator.

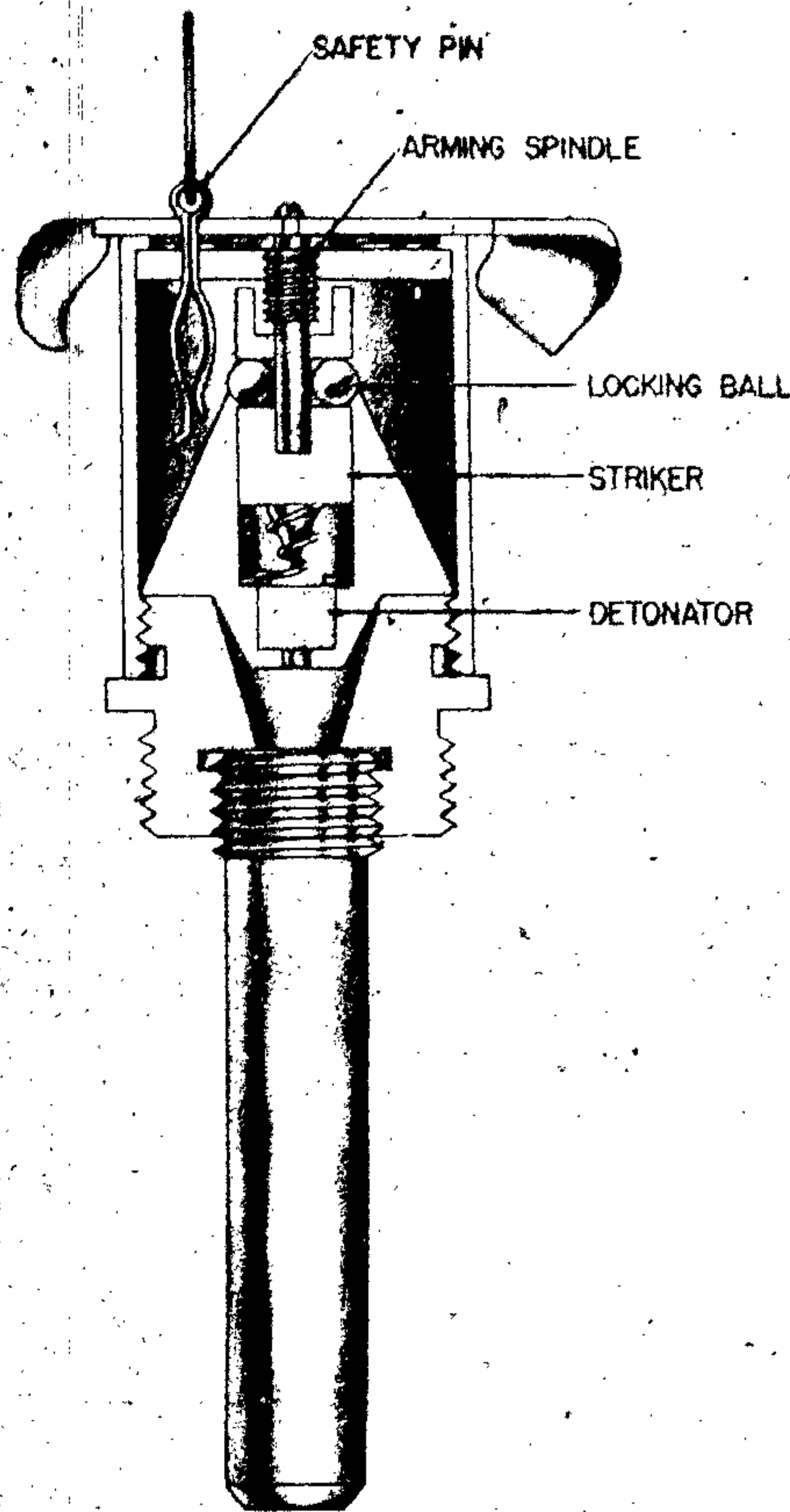

Figure 50 — Type U — Mechanical Impact Nose Fuze

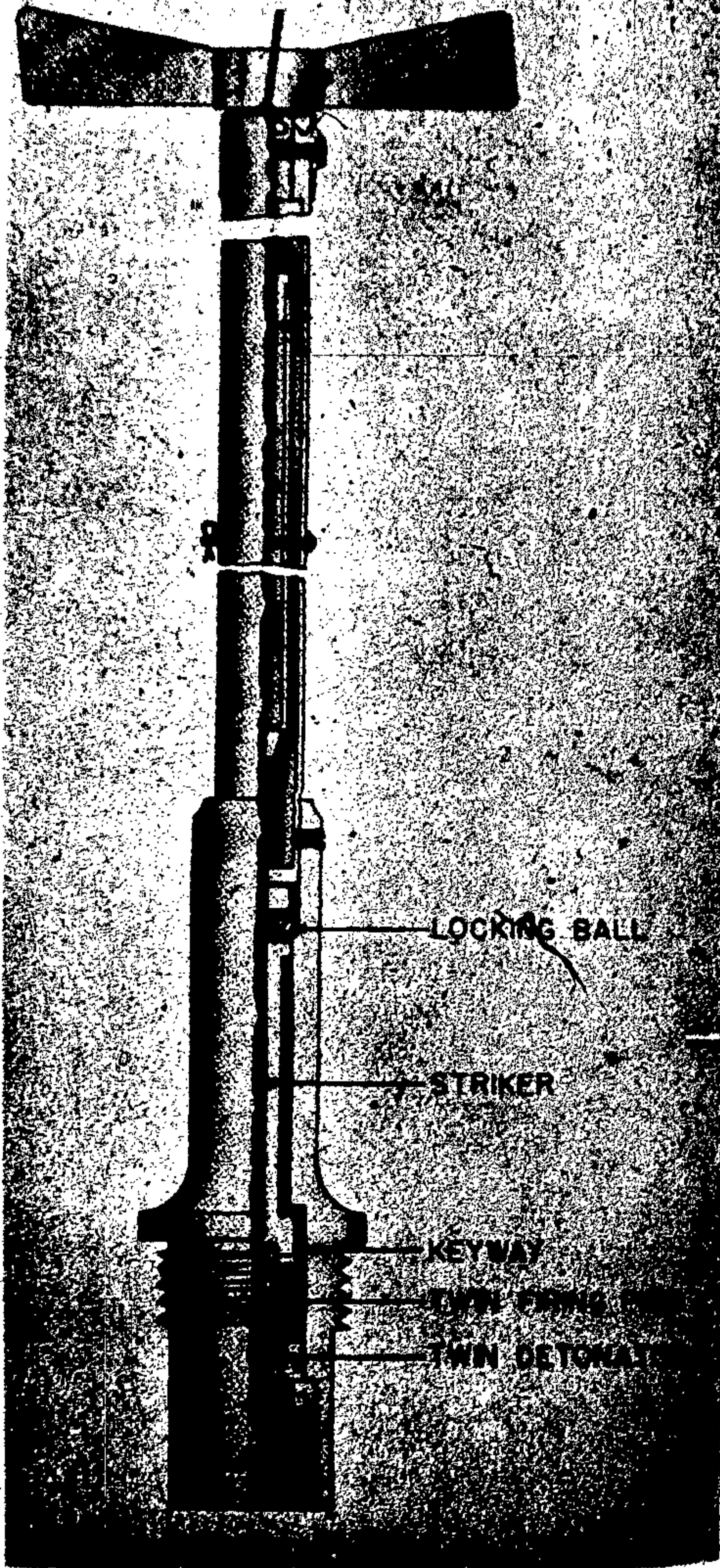

Figure 51 - Types C and C-1 - Mechanical Impact Tail Fuzes

Types C and C-1—Mechanical Impact Tail Fuze

Data

Bombs used in

C—50-kg. and 100-kg. G. P.—H. E. and 100-kg. and 104-kg. S. A. P.

C-1—100-kg. S. A. P.

Fuzes used with Alone

Over-all length
C 15.9 in.

C-1 18.7 in.

Over-all length of vanes 4.9 in.

Width of fuze body 1.85 in.

Description

The C-1 Fuze differs from the C Fuze only in having a longer arming stem case and an opening near the center of the case to permit observation of the progress of arming.

The fuze body is threaded externally to screw into the bomb, and internally to receive the booster. An arming-spindle case is secured to it by a set screw. An inertia striker contains twin firing pins; twin flanges engaging in grooves in the body prevent it from rotating. A creep spring separates the striker and the detonator housing. Two balls are located in the strikers and rest against a shoulder of the fuze body. An arming spindle prevents inward movement of the balls while the spindle is in place in its channel in the striker. The arming spindle is secured to a steel tube, in the upper end of which a threaded brass collar receives the arming screw. A pin through the case prevents the tube from rotating. The upper end of the arming screw is threaded into a brass collar to which vanes are secured by a pin. A U-shaped pin engages in the annular slot to prevent the rise of the vanes on rotation. A safety pin passes through the arming-stem case and collar.

Operation

The safety pin is removed, allowing the vanes to rotate when the bomb is dropped. As the arming screw rotates, the steel tube rises on the screw. When the arming spindle moves past, the steel balls can move in and free the striker. On impact, the striker compresses the creep spring, and the firing pins hit the detonators.

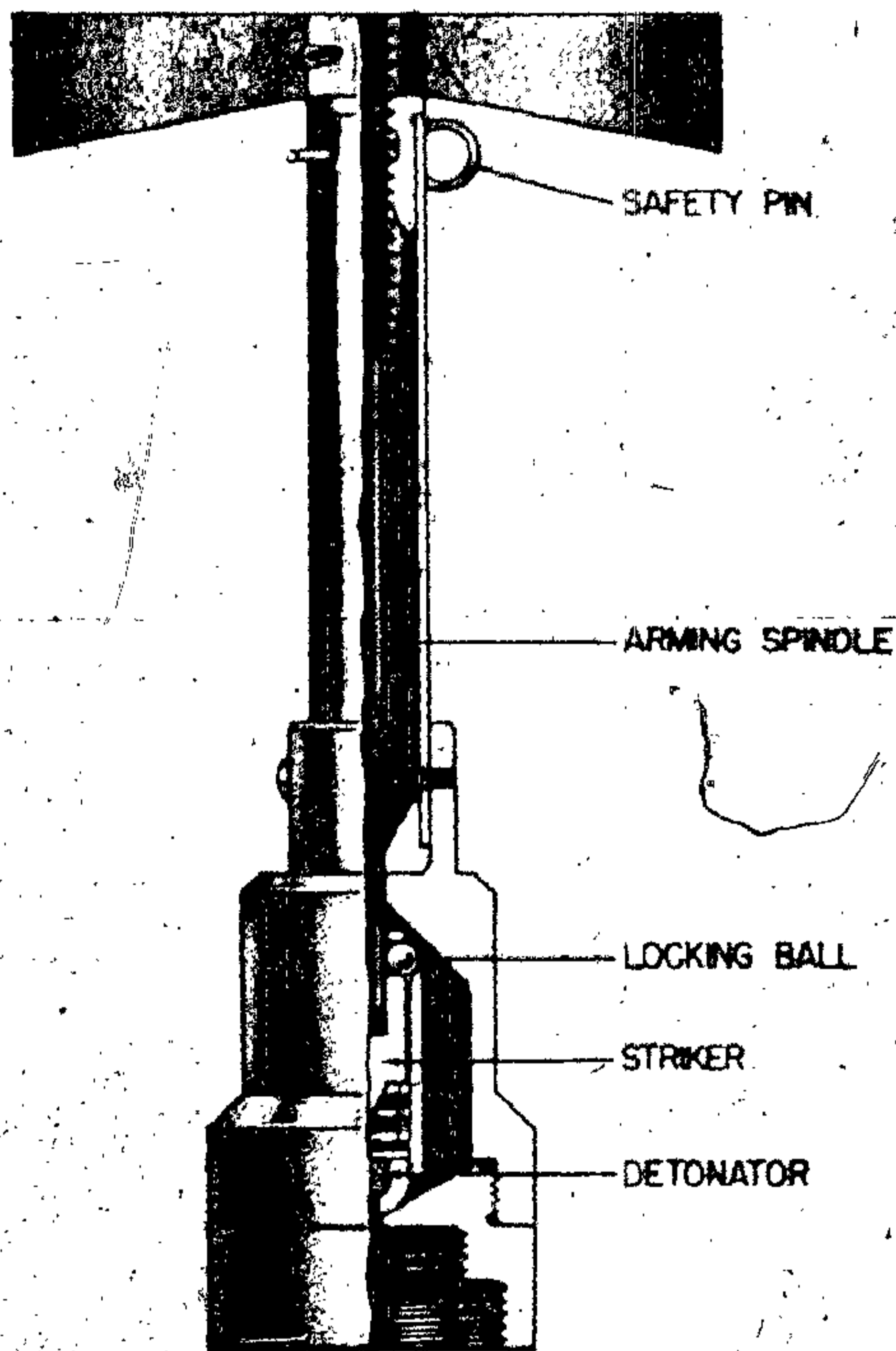

Figure 52 - Type E - Mechanical Impact Tail Fuze

Type E—Mechanical Impact Tail Fuze

Data

Bombs used in.....	20-kg. Incendiary
Fuzes used with.....	Alone
Material of construction...	Steel arming, spindle tube. Remainder is brass.
Over-all length.....	8.4 in.
Over-all length of vanes...	3.5 in.
Width of fuze body.....	2.0 in.

Description

The base of the fuze proper is threaded internally to receive a zinc-alloy adapter. The base of the adapter is threaded externally to screw into the bomb. The top surface of the adapter is curved in order to receive the bottom of the cylinder. The cylinder contains the striker, a creep spring, and

detonator cap. Two steel balls, held in place by the arming rod, immobilize the striker. The arming spindle extends up through the steel shaft and is threaded at the upper end. The vanes are attached to the arming spindle.

Operation

The safety pin is withdrawn. When the bomb is released, the vanes rotate and rise, along with the arming spindle. When the arming rod has risen 0.4 in., the steel balls are released, fall into the channel, and disengage the striker. The striker then rests on the creep spring. Upon impact, the creep spring is overcome; the striker and detonator contact and initiate the explosive train. The striker housing is spherical at the end and rests on the curved surface of the adapter. This assures that the fuze will operate, regardless of the position in which the bomb hits.

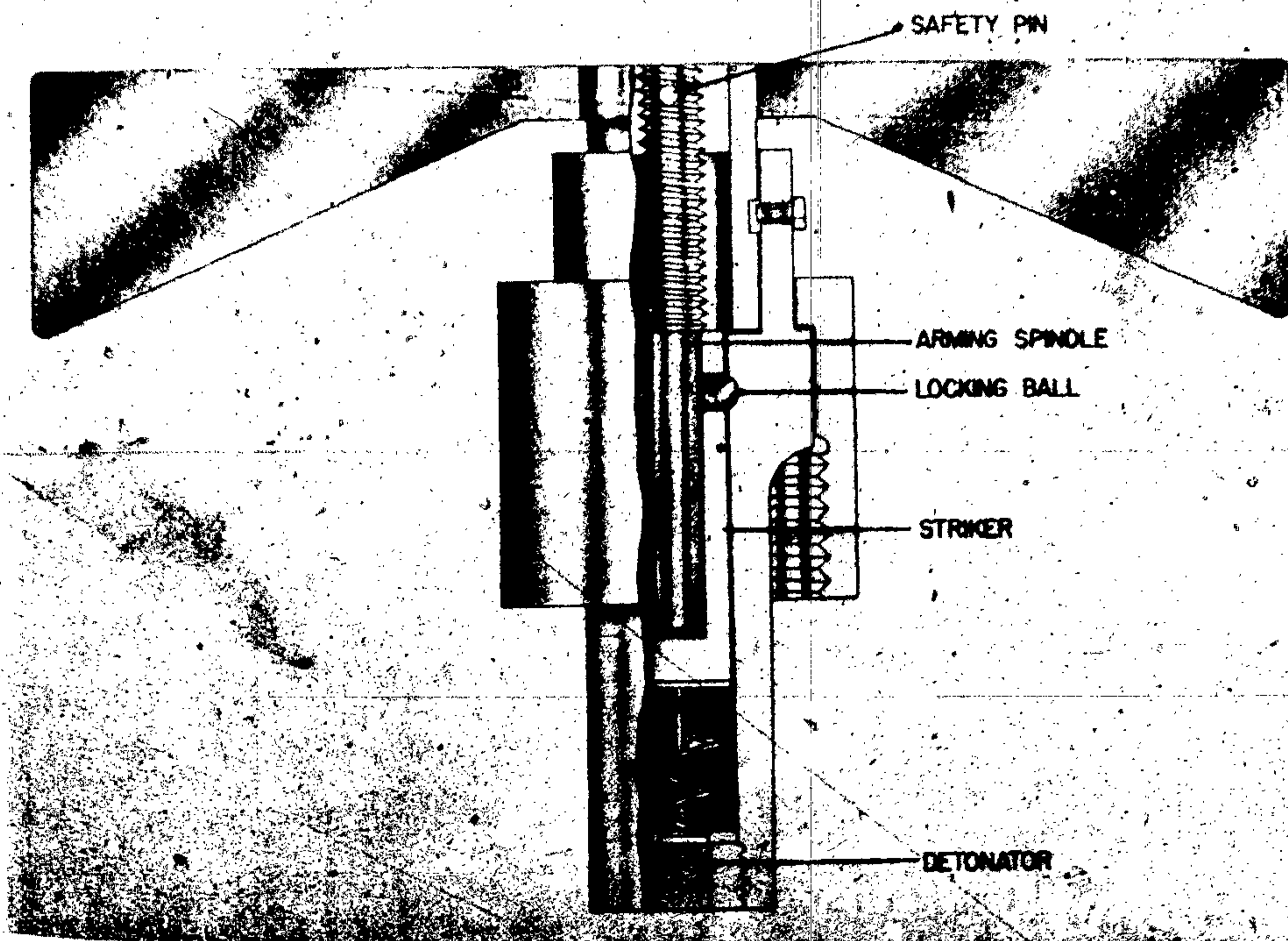

Figure 53 - Type G - Mechanical Impact Tail Fuze

Type G—Mechanical Impact Tail Fuze

Data

Bombs used in.....	70-kg. Incendiary
Fuzes used with.....	Alone
Material of construction.....	Aluminum and brass
Over-all length.....	3.5 in. (less ignition tube)
Over-all length of vanes.....	5.2 in.
Width of fuze body.....	1.5 in.

Description

The fuze consists of a main body over which slips an internally threaded collar used to attach the fuze to the aluminum holder at the end of the ignition tube. Three cast-brass vanes are an integral part of a sleeve which is threaded to hold the arming spindle. A screw engaged in the annular slot prevents longitudinal movement of the sleeve. A safety pin passes through the sleeve and arming

spindle to prevent rotation of the vanes. The arming spindle has a slot in which a screw engages to prevent rotation of the sleeve and arming spindle. The arming spindle moves in a channel in the striker weight, preventing the steel balls from moving in and releasing the striker. A creep spring is placed between the striker point and the primer cap in a fitting, screwed into the base of the fuze body.

Operation

When the bomb is dropped, the safety pin is pulled, allowing the vanes to rotate. As the vanes turn, the arming spindle rises through the sleeve or hub. As soon as the arming spindle rises past the steel balls, the balls roll inward, freeing the striker, which is then kept from the detonator by the creep spring. On impact, the striker compresses the spring and ignites the detonator, which in turn fires the ignition powder in the tube.

Type H—Mechanical Impact Tail Fuze

Data

Bombs used in..... 1-kg. and 2-kg. Incendiary; 2-kg. Anti-Personnel type F and Mtr.
 Fuzes used with..... Alone
 Over-all length..... 5.6 in.
 Width of fuze body..... 2.3 in.

Description

The body is cylindrical and divided into two pieces. The base cover is a push fit over the body. A smaller, threaded cylinder at the front of the fuze serves to affix the fuze to the bomb. There are no arming vanes.

The rear part of the fuze contains 19.4 in. of cord, one end of which is secured to the top of the rear portion and the other looped around the striker in the body portion. The striker arm pivots on a pin and is held by a spring. The body contains the striker, the detonator, and three feet of safety fuse.

Operation

On removal of the safety pin, the cap can be pulled away. To the inside of the cap is attached one end of a piece of cord 6 meters long (19 ft. 4 in.). The other end of the cord is attached by a loop to the striker. When the cord is pulled taut, it pulls the striker to a vertical position, and the loop of the cord slides off the striker. Then the spring takes hold and rotates the striker down to fire the detonator. This ignites a three-foot length of safety fuse, which burns for about 90 seconds and then fires the detonating charge.

Type K—Mechanical Impact Tail Fuze

Data

Bombs used in..... 2-kg. Anti-Personnel Type F and Mtr. 1 and 2-kg. Incendiary
 Fuzes used with..... Alone
 Material of construction..... Steel cap; lower body striker aluminum; vanes, remainder brass
 Over-all length..... 1.8 in. (without booster)
 3.5 in. (with booster)
 Width of fuze body..... 1.4 in.

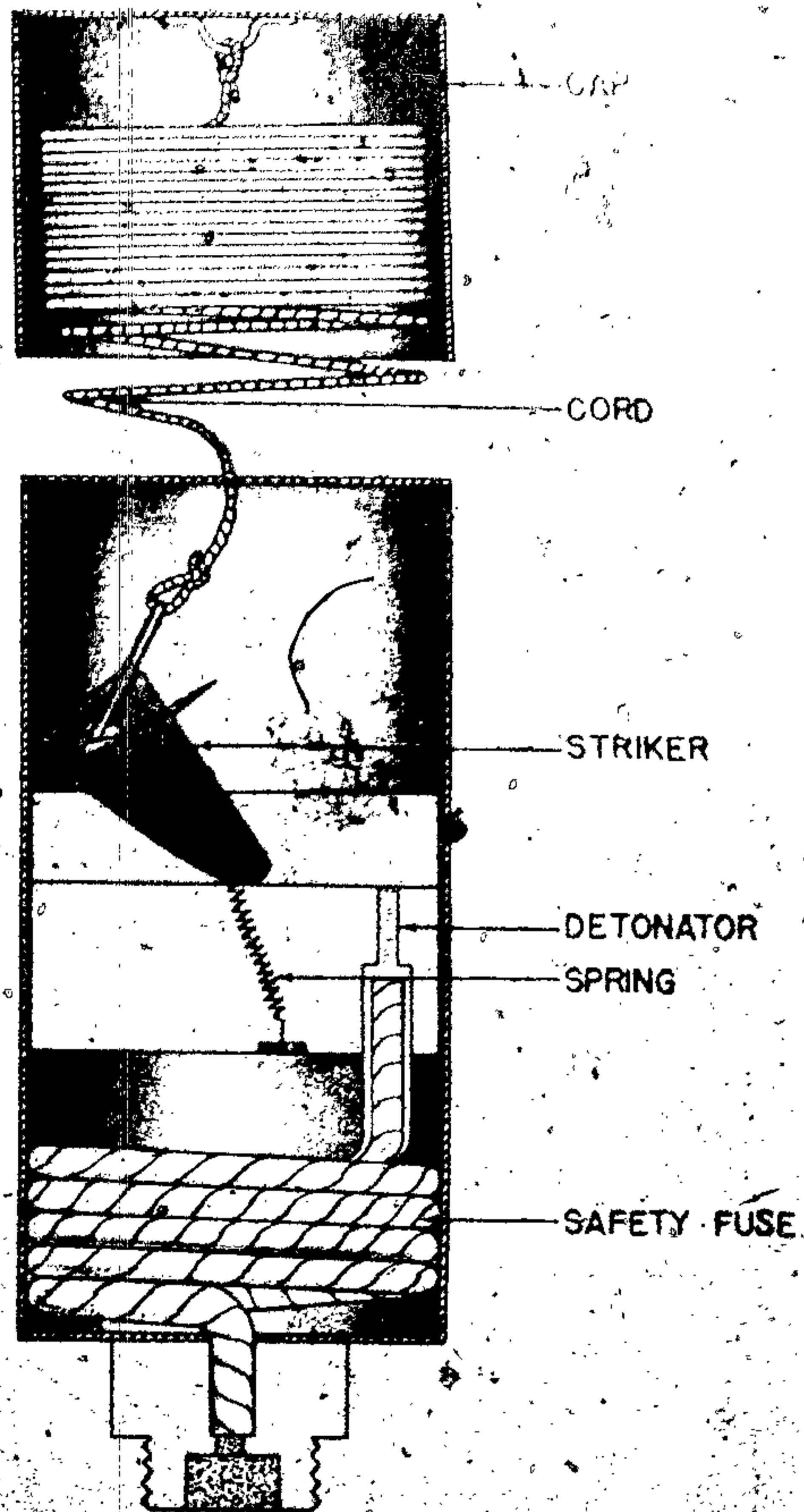

Figure 54 - Type H - Mechanical Impact Tail Fuze

Description

This fuze is divided into two pieces which are threaded together. The upper piece is male threaded. The top of the upper portion is dome-shaped. A hole passes horizontally through the uppermost part of this dome to receive the split pin which holds the vanes in the unarmed position. Protruding from the shoulder of the upper housing is a hollow shaft with internal threads to receive the safety rod. The single arming vane is attached to this rod. The safety rod passes through the striker.

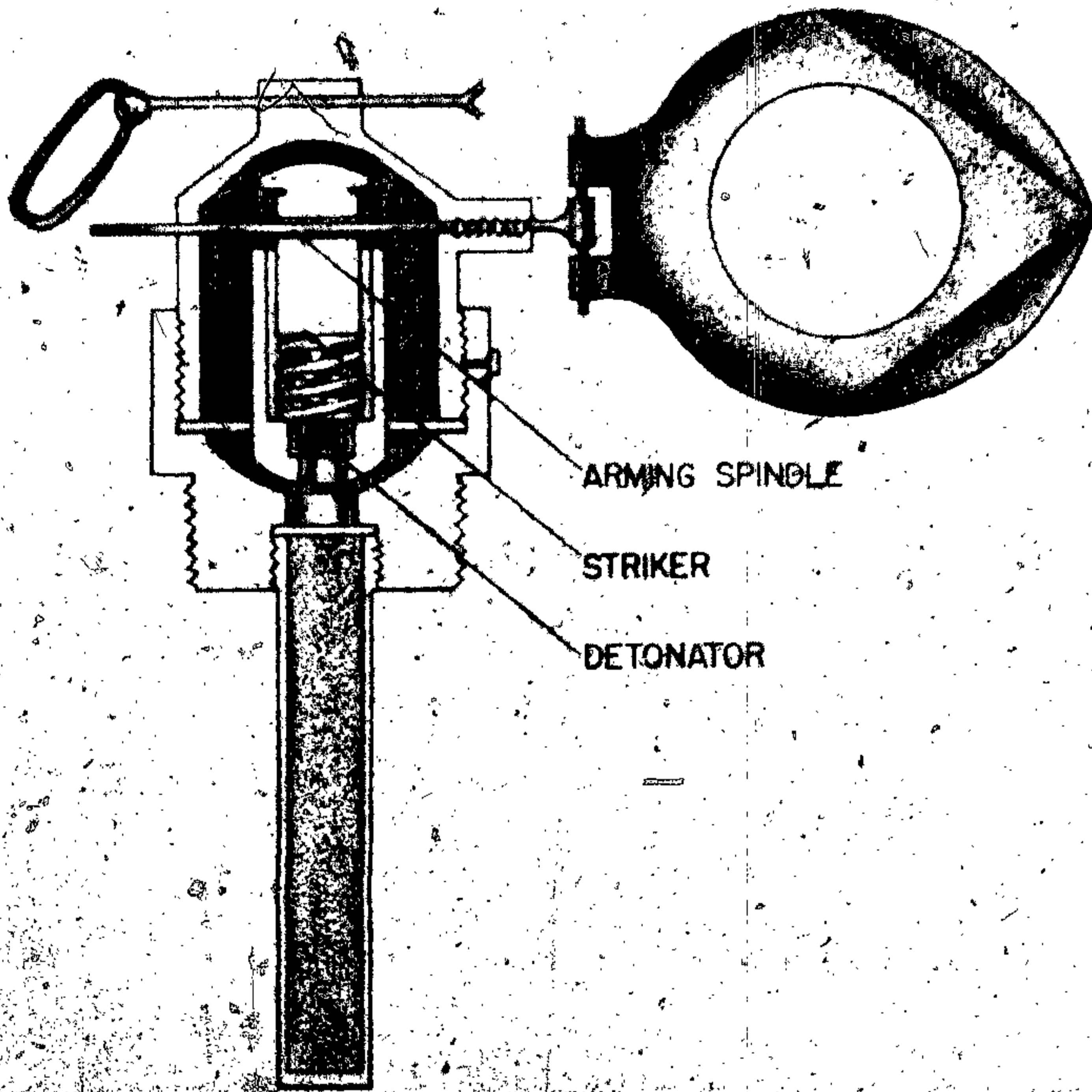

Figure 55 - Type K - Mechanical Impact Tail Fuze

The striker and detonator housing are rounded at the ends to give the effect of an "all-ways" fuze. The striker and primer cap are held apart by a creep spring when the fuze is armed. The base of the lower housing is threaded to receive the booster. The large booster is used.

Operation

The arming vane is folded over the dome of the fuze and secured there by a split pin. Upon the bomb's being released from the plane, the split pin is withdrawn and the vane flies out in the position shown in the drawing. In flight, the vane rotates and unscrews the safety rod, which eventually falls away. This releases the striker, which then rests on the creep spring. Upon impact, the striker and detonator cap overcome the creep spring and make contact. Since this is an "all-ways" arrangement, the fuze will detonate, regardless of the position in which the bomb lands.

Types N, N-1, N-2 and N-3—Mechanical Impact Tail Fuzes

Data

- Bombs used in
 - N—15 kg. S. A. P.
 - N-1—24 kg. G. P.-H. E.
 - N-2—31 kg. S. A. P.
 - N-3—40 kg. G. P.-H. E.
- Fuzes used with _____ Alone
- Over-all length
 - N—Unknown
 - N-1—10.6 in.
 - N-2—11 in.
 - N-3—12.7 in.
- Over-all length of vanes
 - N—Unknown
 - N-1—1.3 in.
 - N-2—2 in.
 - N-3—1.8 in.

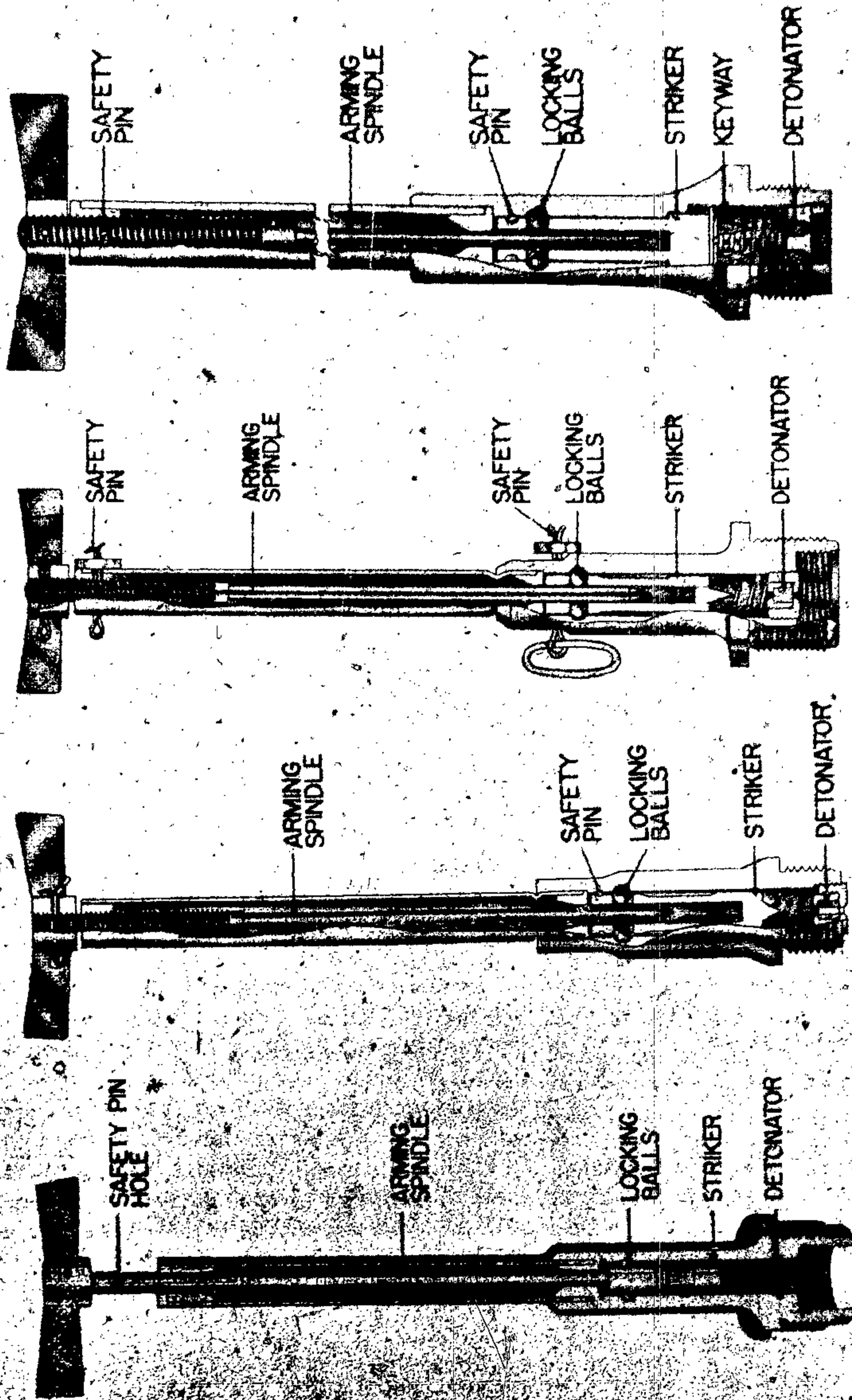

Figure 56 - Types N, N-1, N-2, and N-3 - Mechanical Impact Tail Fuzes

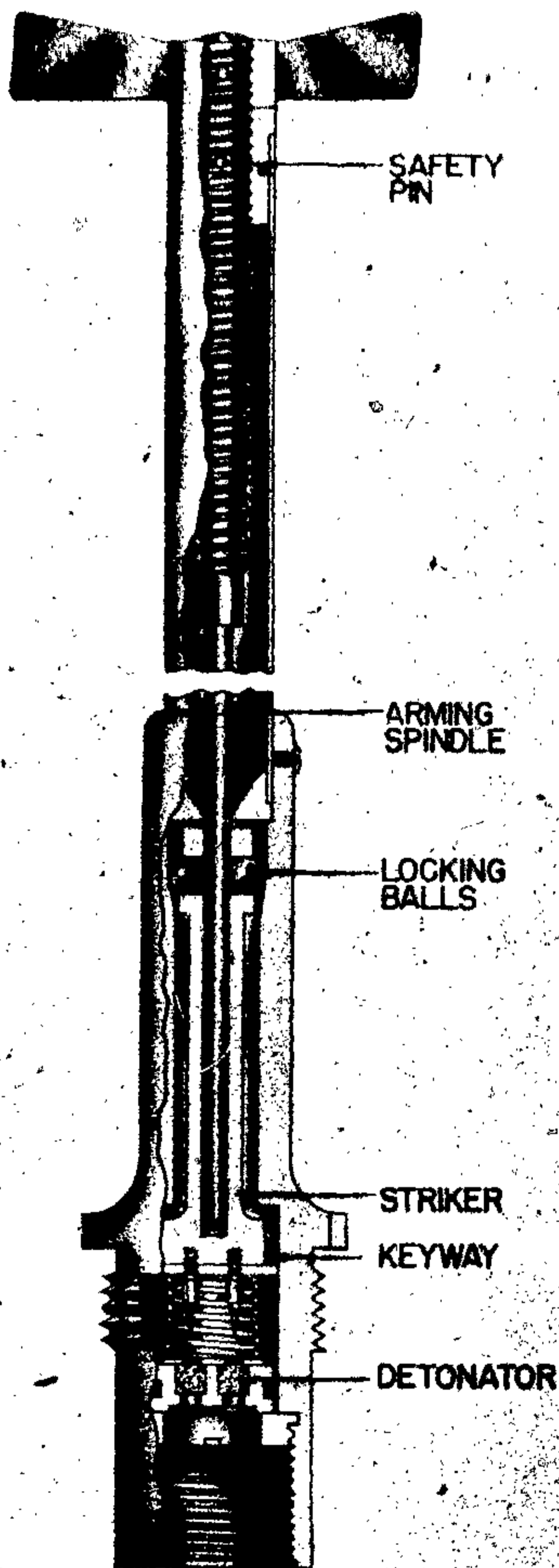

Figure 57 — Types Y and Y-1 — Mechanical Impact Tail Fuzes

Description

These fuzes are nearly similar in outside appearance and have the same type of operation. The type N-3 has a twin firing pin and detonator, the others have only one. The fuzes are mainly brass, except for steel tube locking balls and creep spring. These fuzes have two safety pins. One locks the striker during shipping, and the other passes through

the arming spindle and tube to prevent the vanes from rotating. The two steel balls are prevented from moving inwards by the arming spindle. Type N-3 has a keyway which prevents the striker from turning and keeps the firing pin in line with the detonator.

Operation

The lower safety pin is removed when the bomb is loaded in the plane. When the bomb drops, the upper safety pin is withdrawn, allowing the vanes to rotate. The arming spindle threads through the brass collar and rises past the steel balls. The balls move inwards, freeing the striker, which now rests on the creep spring. On impact, the firing pin or pins hit the detonator or detonators.

Types Y and Y-1—Mechanical Impact Tail Fuzes

Data

Bombs used in	
Y—50-kg. S. A. P. and 100-kg. G. P.-H. E.	
Y-1—100-kg. S. A. P. and 100-kg. G. P.-H. E.	
Fuzes used with	Alone
Over-all length	
Y	16.5 in.
Y-1	20.0 in.
Over-all length of vanes	3.0 in.
Width of fuze body	1.9 in.

Description

These fuzes are very similar to the Type C and Type N fuzes. The only differences in the Y and Y-1 is that the Y-1 has 3.5 in. longer arming spindle and tube. The vanes are secured to the arming spindle by a locking pin. Two screws secure the brass collar to the top of the arming tube. The striker and detonator holder both have two projections which move in the keyway and thus keep the firing pins in line with detonator. A safety pin fits through the brass collar and the arming spindle to prevent the vanes from rotating. Two steel balls in the striker rest against a recess in the fuze body and are prevented from moving inwards by the arming spindle.

Operation

The safety pin is withdrawn when the bomb falls; the vanes rotate and withdraw the arming spindle from the striker. The steel balls move inwards to free the striker, which now is held by a creep spring. On impact, the firing pins hit the detonators.

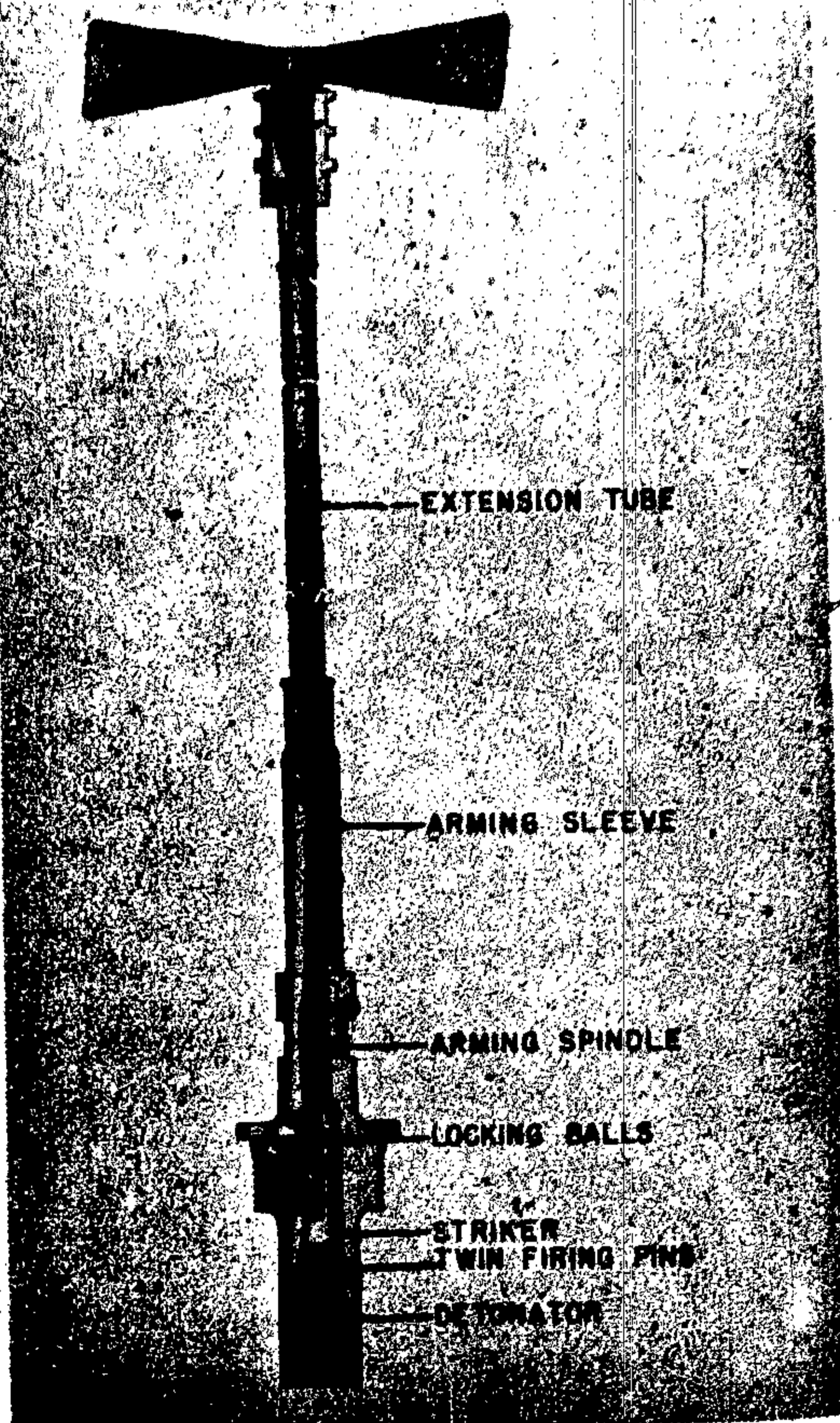

Figure 58 - Type O - Mechanical Impact Tail Fuze

Type O—Mechanical Impact Tail Fuze

Data

Bombs used in.....	250-kg., 500-kg., 800-kg. General Purpose
Fuzes used with.....	Nose—Type A
Material of construction....	Brass
Over-all length.....	7.5 in. (without booster)
Over-all length of vanes....	7.4 in.
Width of fuze body.....	2.8 in.

Description

Type O fuze is the same in construction as Type

A fuze. Actually, Type O is a combination of the fuze arming mechanism and the fuze A, accomplished by removing vanes of the A and screwing in place the arming sleeve. Length of the extension rod may vary to suit the varying lengths of the tail.

Operation

The vanes on the extension arm rotate and withdraw the spindle into the hollow sleeve of the arm. After the spindle is withdrawn, the operation is the same as the Type A, except that on impact the inertia striker overcomes the creep spring and contacts the detonator, setting the explosive train in motion.

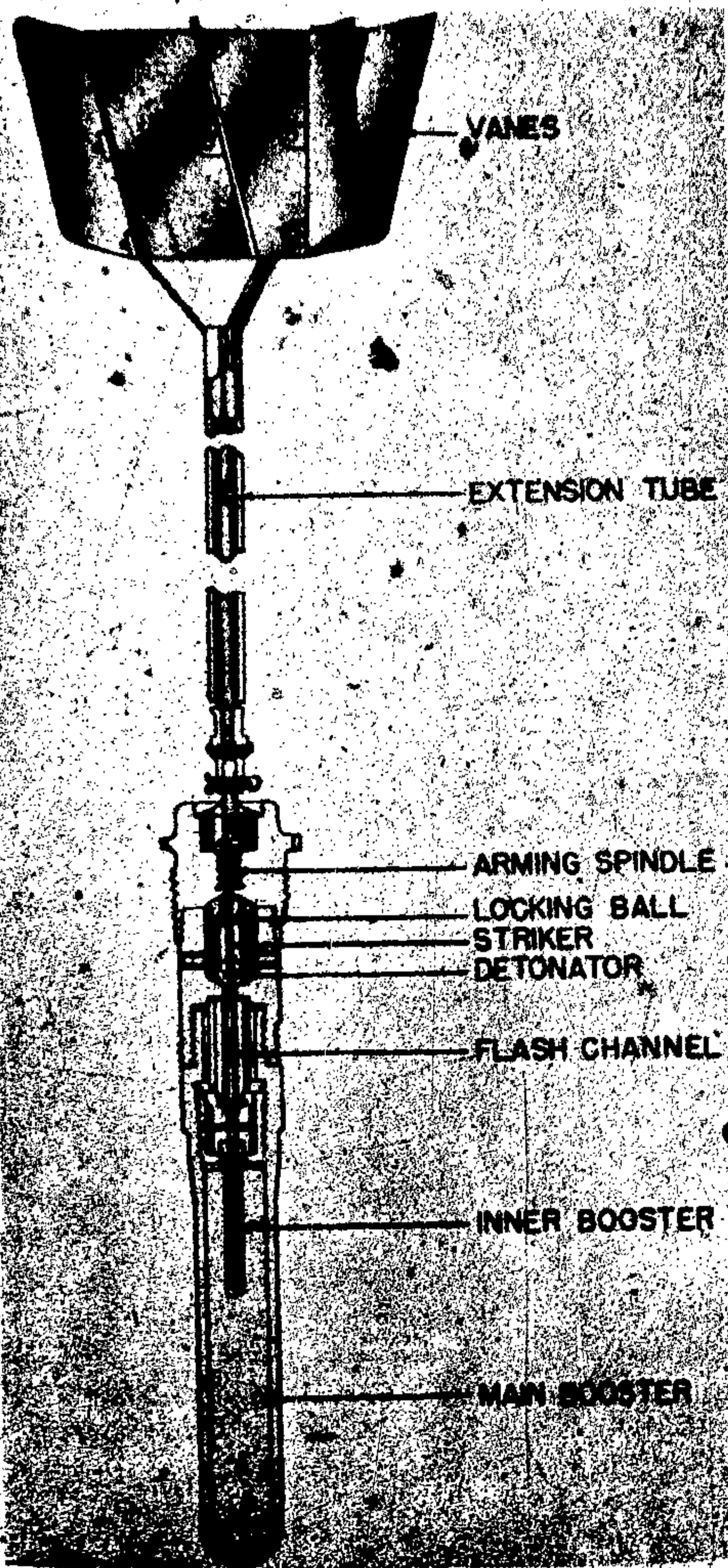

Figure 59 - Type P - Mechanical Impact Tail Fuze

Type P—Mechanical Impact Tail Fuze

Data

Bombs used in	70-kg. Unknown
	Spherical bomb
Fuzes used with	Alone
Over-all length	15.0 in. (less extension and booster)
Over-all length of vanes	8.0 in.
Width of fuze body	2.5 in.

Description

This fuze has a long extension rod with the vanes at the top. The lower end is attached to the arming rod by the split pin. Immediately beneath the shoulder are the threads used to screw the fuze into the bomb. The firing mechanism consists of the detonator, creep spring, and inertia striker. This assembly is housed in a dome-shaped cavity which insures that the fuze will fire, regardless of the position in which the bomb lands. The base of the fuze is internally threaded to receive the housing of the relay element. The base of the relay housing is internally threaded to receive the long Italian booster. The relay housing is internally threaded to receive the booster in the center of the spherical bomb.

Operation

The safety pin is withdrawn when the bomb is released. The vanes rotate in flight and withdraw the arming spindle, which releases the steel balls. These fall into the channel and release the striker mechanism. Upon impact, the striker and the detonator overcome the creep spring and come together.

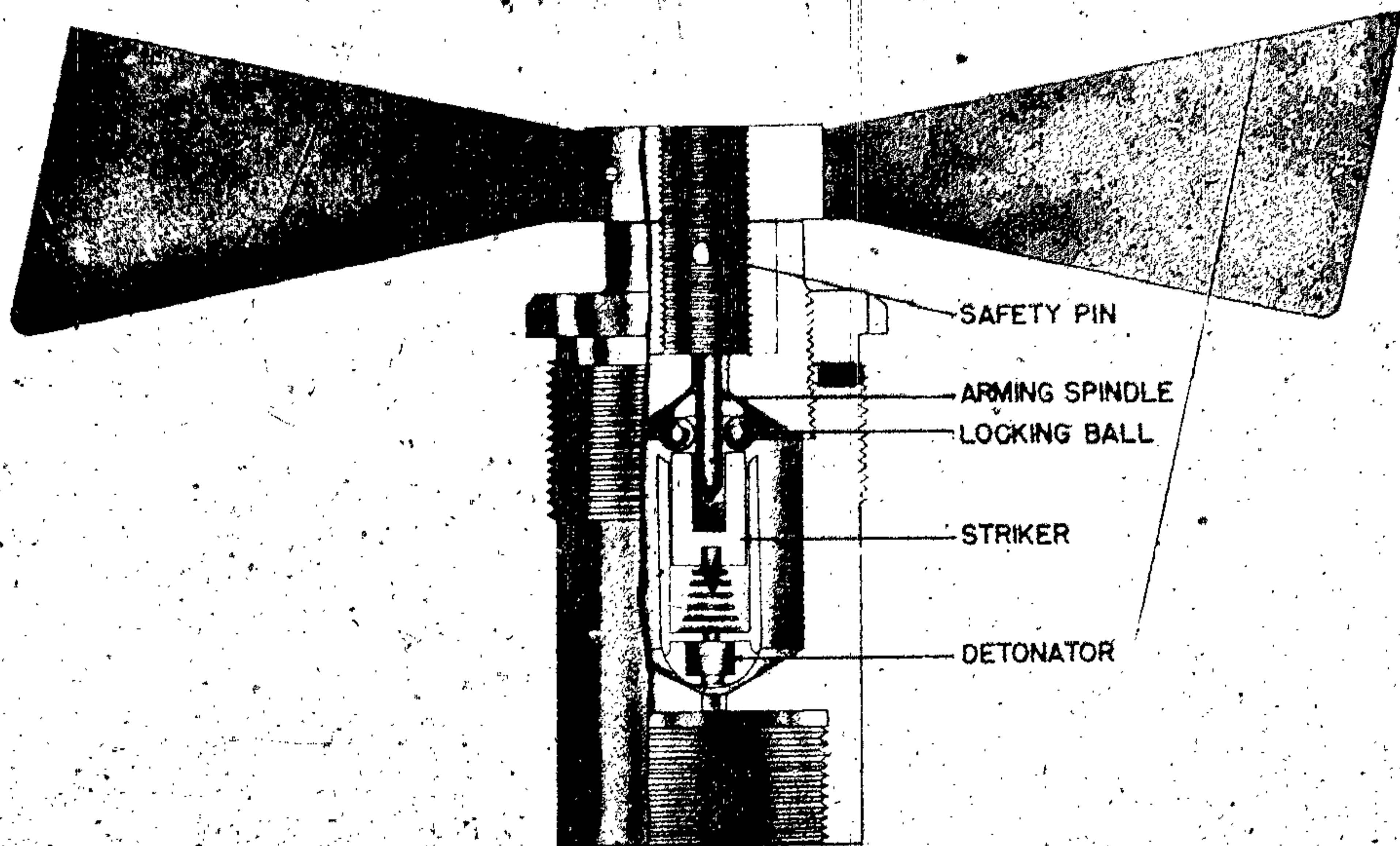

Figure 60 - Type Z - Mechanical Impact Tail Fuze

Type Z—Mechanical Impact Tail Fuze

Data

Bombs used in.....	100-kg. Incendiary container
Fuzes used with.....	Nose—Type X.
Material of construction.....	Aluminum body and vanes; brass fittings
Over-all length.....	4 in. (approx., without booster)
Width of fuze body.....	1.9 in.

Description

The fuze has four large arming vanes attached by two set screws to the threaded portion of the withdrawal rod. The cylindrical body is threaded beneath the shoulder to screw into the base of the bomb. The striker and detonator resemble Types E, F, P, and W, which incorporate the "all-ways" feature with the creep spring. The fuze is internally threaded at the base to receive the long Italian booster.

Operation

The safety pin is removed when the fuze is screwed into the base plate. A spring-loaded stop protrudes

from the base plate to prevent rotation of the vanes. After the aerial burst nose-fuze function, the small bombs are released from the container, and the spring-loaded stop goes forward, freeing the vanes to rotate. The rotating vanes rise above the fuze head, withdrawing the arming spindle, which releases the steel balls. These, in turn, release the striker. Upon impact, the detonator holder and striker are brought together, regardless of the position in which the bomb lands.

Types I and T—Mechanical Time Nose Fuzes

Data

Bombs used in	
Type I.....	3-kg. and 20-kg. Anti-submarine
Type T.....	250-400-kg. Chemical
Fuzes used with.....	Alone
Over-all length.....	
Type I.....	8.0 in.
Type T.....	6.6 in.
Over-all length of vanes	
Type I.....	4.7 in.

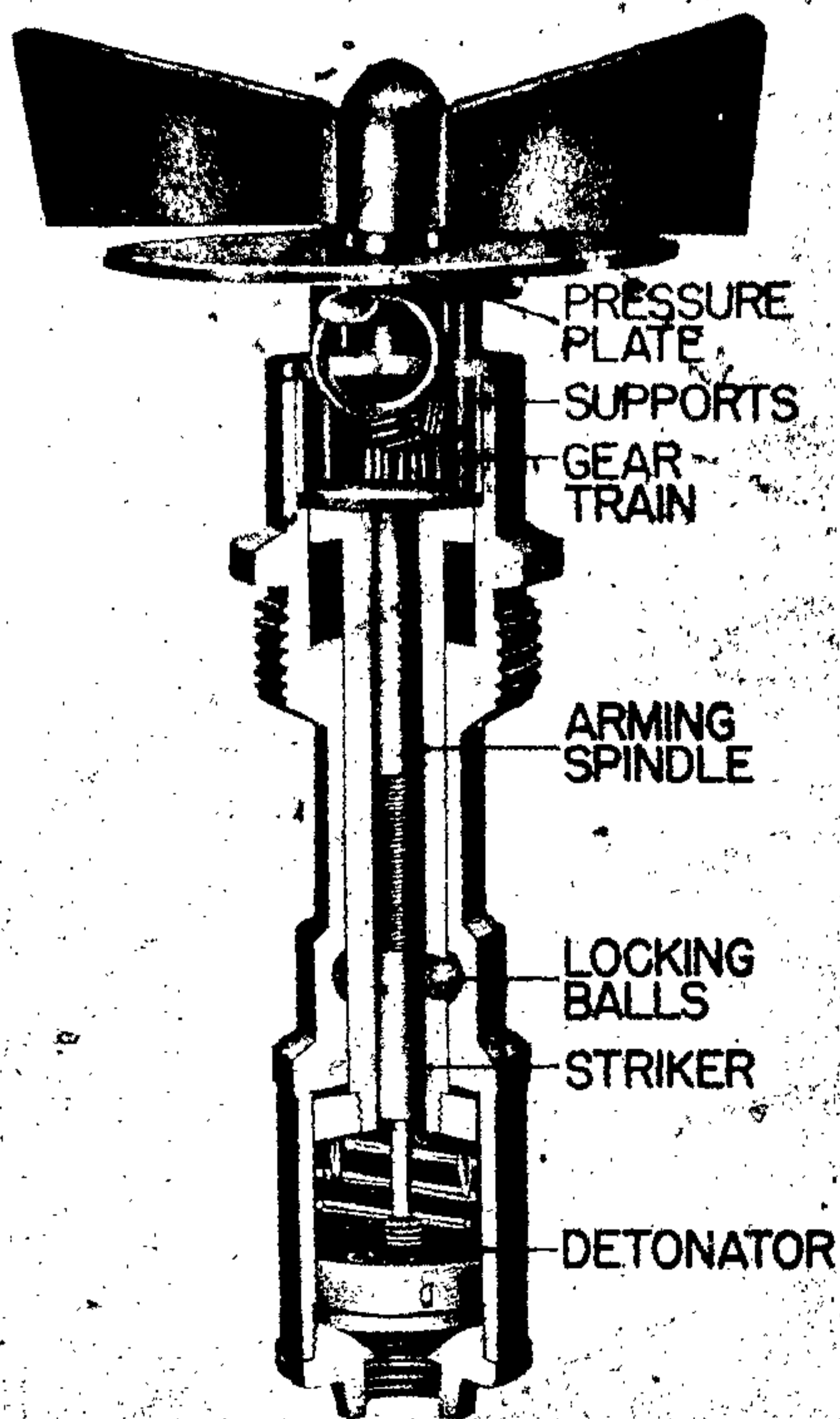

Figure 61 — Type I — Mechanical Time Nose Fuze

Type T	4.2 in.
Width of fuze body	
Type I	1.9 in.
Type T	1.6 in.

Description

The T fuze has not been recovered, as the Italians used no chemical bombs. The internal assembly of the fuze is not known, but it is believed that it is similar to Type I, differing only in the vane assembly. The T fuze has a scale reading from 0 to 6, which are readings in meters of altitude by one-thousands. The scale is set to vary the pitch of the vanes to increase or decrease the time of functioning. Vanes of the I fuze remain at one pitch, but a series of vanes with different pitches is used with the fuze, so that functioning will take place at different altitudes. Both fuzes have an air pressure

plate beneath the vanes. The pressure plate on the I fuze is 2.4 in. in diameter. Vanes are attached to turn the reduction gears which operate the arming spindle.

Operation

Operation of the T fuze is unknown. The operation of the I fuze follows: The safety collar is removed when the bomb is dropped, the vanes rotate; after some 400 revolutions, the gears cause the arming spindle to use in the internally threaded tube. When the arming spindle has withdrawn 1 in., the balls are free to fall into the channel and free the striker, which rests on the creep spring. Air pressure against the pressure plate forces the striker down to contact the primer caps, detonating the bomb and giving aerial burst. If air pressure should fail, then, on impact, the detonator cap and striker would contact, exploding the bomb.

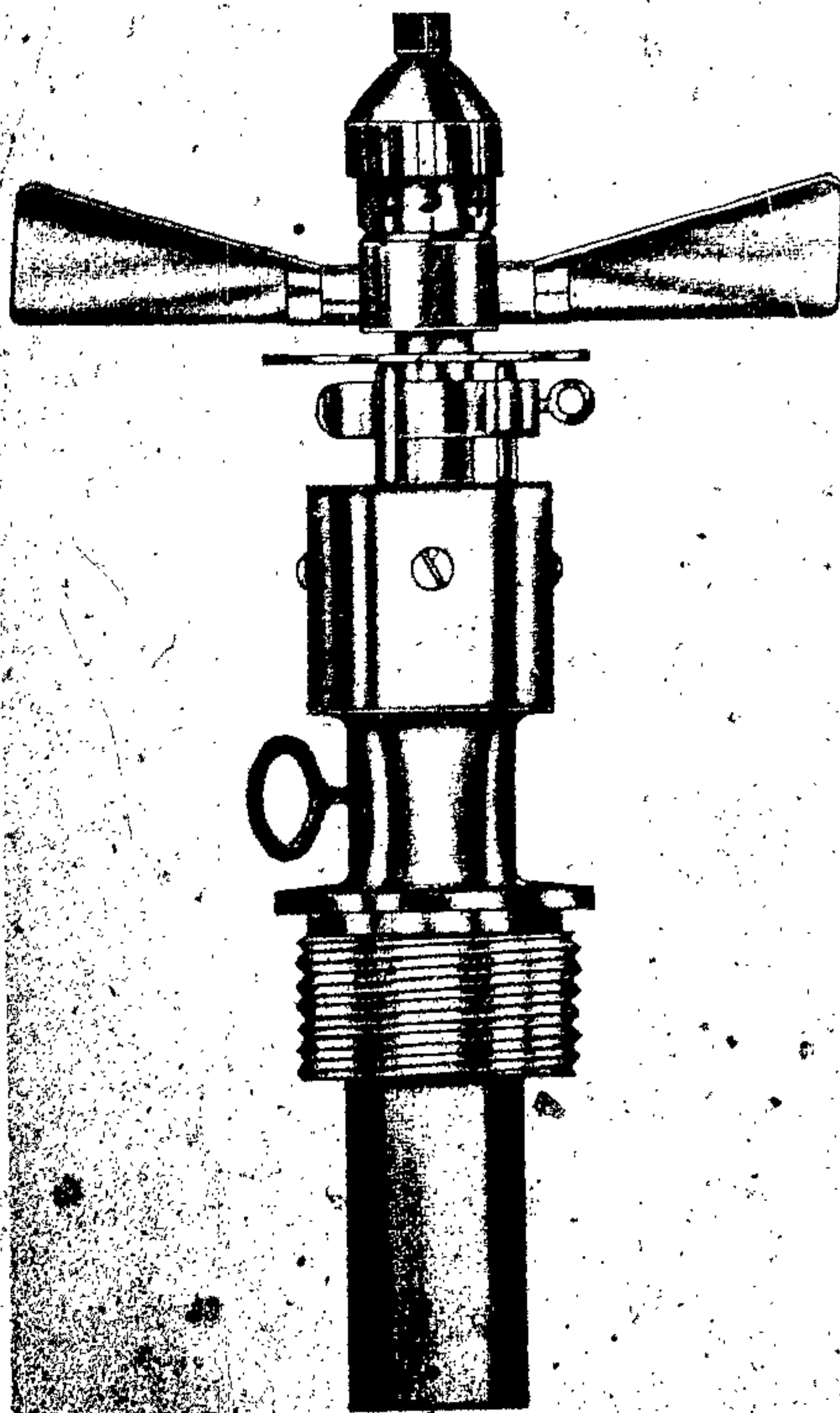

Figure 62 — Type T — Mechanical Time Nose Fuze

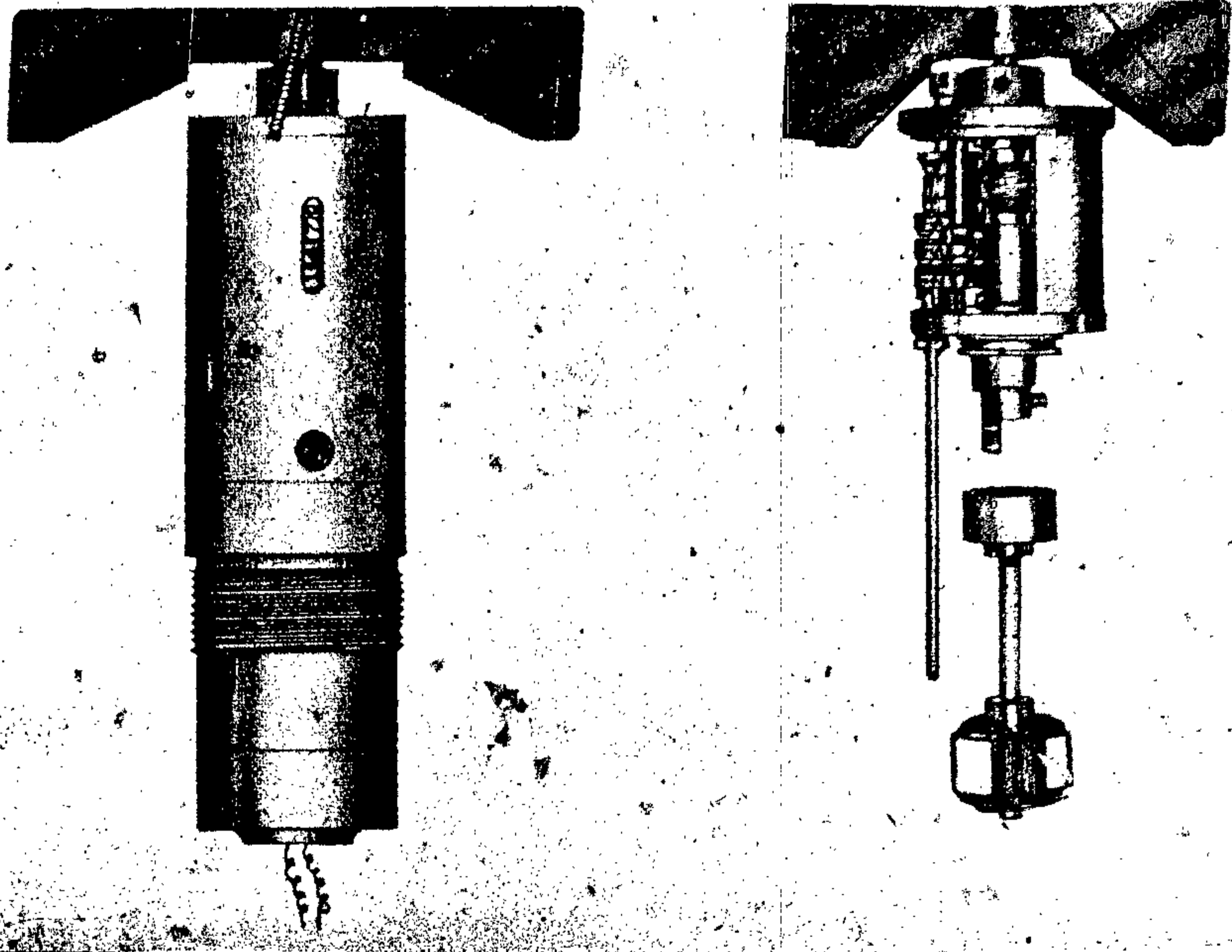

Figure 63 - Type X - Electrical Time Nose Fuze

Type X—Electrical Time Nose Fuze

Data

Bombs used in.....	100-kg. bomb container.
Fuze used with.....	Type Z
Material of construction.....	Aluminum body, cast-iron vanes
Over-all length.....	7.3 in. (without booster)
Over-all length of vanes.....	5.6 in.
Width of fuze body.....	2.0 in.

Description

The exterior of the fuze body is cylindrical, with the lower part recessed and threaded for assembling into the nose of the bomb. The upper part of the body encloses the height meter, gear train, electrical contacts, and central shaft with release pawl. The lower part houses the armature and its shaft. On the upper end of the shaft is mounted the clutch; at the other end, the cap is screwed in. The vanes

are fastened to a spindle rotating in a hub on top of the meter housing. A setting nut is also located on the top of the meter housing and is used to set the height meter. Two insulated wires lead from the base of the fuze to an electric detonator. One lead is connected to the cap, the other to the rod which leads to the contacts in the meter housing.

Operation

Before releasing the bomb, the setting nut is turned until the desired distance of fall (in meters) appears on the meter. When the bomb is released, the vanes are free to rotate and drive the meter through the gear train. After a fall of approximately 30 meters, the vanes have attained a velocity sufficient to rotate the armature, and the release pawl has released the spring detent in the main shaft which engages the clutch. When a reading of zero shows on the meter, the contacts almost touch; and, after a few more rotations, they meet and allow a current to flow through the leads to the electric detonator.

Clockwork Long-Delay Nose Fuze

Data

Bomb used in.....	500-kg. Time Bomb
Fuzes used with.....	Type J and Clockwork
	Long - Delay Tail Fuze
Material of construction	Steel body; brass and copper moving parts
Over-all length.....	16.3 in. (without booster)
Over-all length of vanes	4.6 in.
Width of fuze body.....	5.7 in.

Description

The fuze consists of three parts: a nose unit with arming mechanism; a mid-body with clock-work delay mechanism; and a base with an exploder system. Vanes are secured to the arming spindle, which fits into an inertia striker with twin strikers and two steel balls. A creep spring and sliding detonator holder fit below the striker. Below the detonator are powder pellets and a flat copper plate sealed with a gas-light joint by the raised rig. Attached to the plate is another arming spindle, preventing movement of arming plates by engaging two steel balls. At the base of the clockwork, cushioned by rubber washers, is a timing disc graduated with 48 divisions representing $\frac{1}{8}$ of a day each or 8 days total. The striker is mounted on the timing disc. The clockwork assembly is held under compression by a spring which prevents premature impact of the lower striker and detonator held in a brass fitting in the fuze base.

Operation

When the bomb is dropped, the vanes rotate and withdraw the arming spindle, and the balls roll inward, releasing the sleeve. There is no visual indication of arming, as the vanes merely rotate, prevented from longitudinal movement by the screws. On impact, the detonator holder moves forward to hit the firing pins; the flash in turn ignites the powder pellets. When the pellets burst, the explosion causes the plate to become dome-shaped, forcing the spindle down in the channel and releasing the balls. The spring behind the clockwork presses against the plate, causing the arming rod to release the clockwork, and bringing the lower detonator nearer the striker. When the striker is released after the delay setting of the clockwork has elapsed, it impacts the detonator, setting off the explosive train.

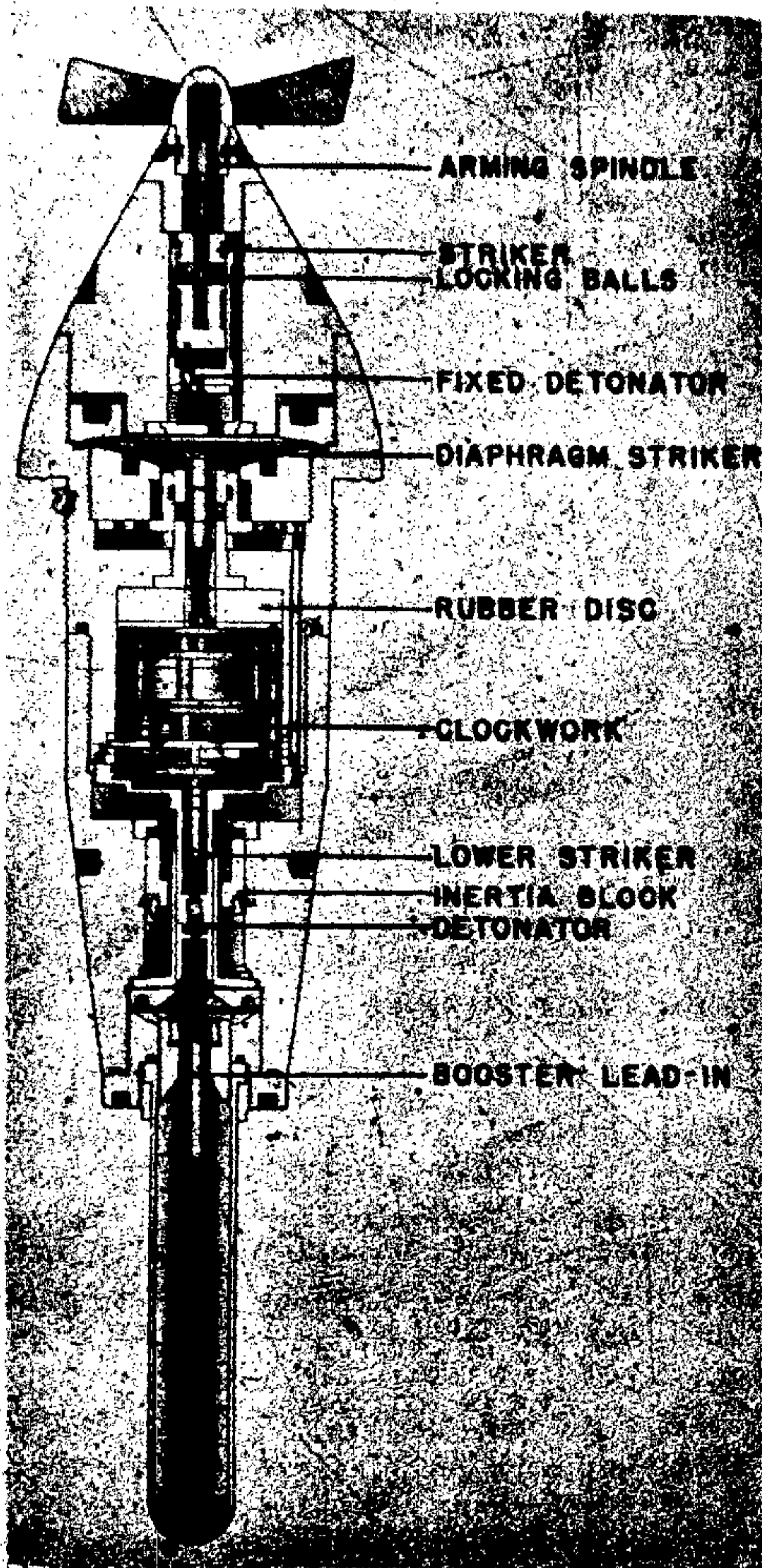

Figure 64 - Clockwork Long-Delay Nose Fuze

Clockwork Long-Delay Tail Fuze

Data

Bombs used in	500-kg. Time Bomb
Fuzes used with	Type J and Clockwork Long-Delay Nose Fuze
Material of construction ..	Steel body, brass and copper moving parts
Over-all length	14.3 in. (less booster and extension)
Over-all length of vanes ..	7.5 in.
Width of body	5.7 in.

Description

The fuze body is of three main parts: the forward portion containing the arming mechanism; the middle portion containing the clockwork delay mechanism; and the lower portion with the exploder system. The vanes are attached to the arming rod extension which fits on the upper portion of the fuze. The rest of the fuze is similar to the Clockwork Long-Delay Nose Fuze, and the operation is similar.

Operation

When the bomb is dropped, the vanes are free to rotate, causing the arming spindle to withdraw from its channel in the inertia striker. There is no visible indication of arming, since the arming spindle does not show. The withdrawal of the arming spindle frees the steel balls and therefore the striker.

On impact, the striker sets forward, compresses the creep spring, and fires the detonator. The flash ignites the powder pellets, causing an explosion which forces the copper disc to assume a domed shape.

At the same time, the arming plate is forced down, causing the rod to move and free the clockwork. The lower striker is also brought closer to the detonator. After the delay time has elapsed, a detent in the clockwork frees the hollow central shaft, which moves upward under a spring load to impact the striker. The detonator is fixed, and the flash passes down the central shaft to the booster.

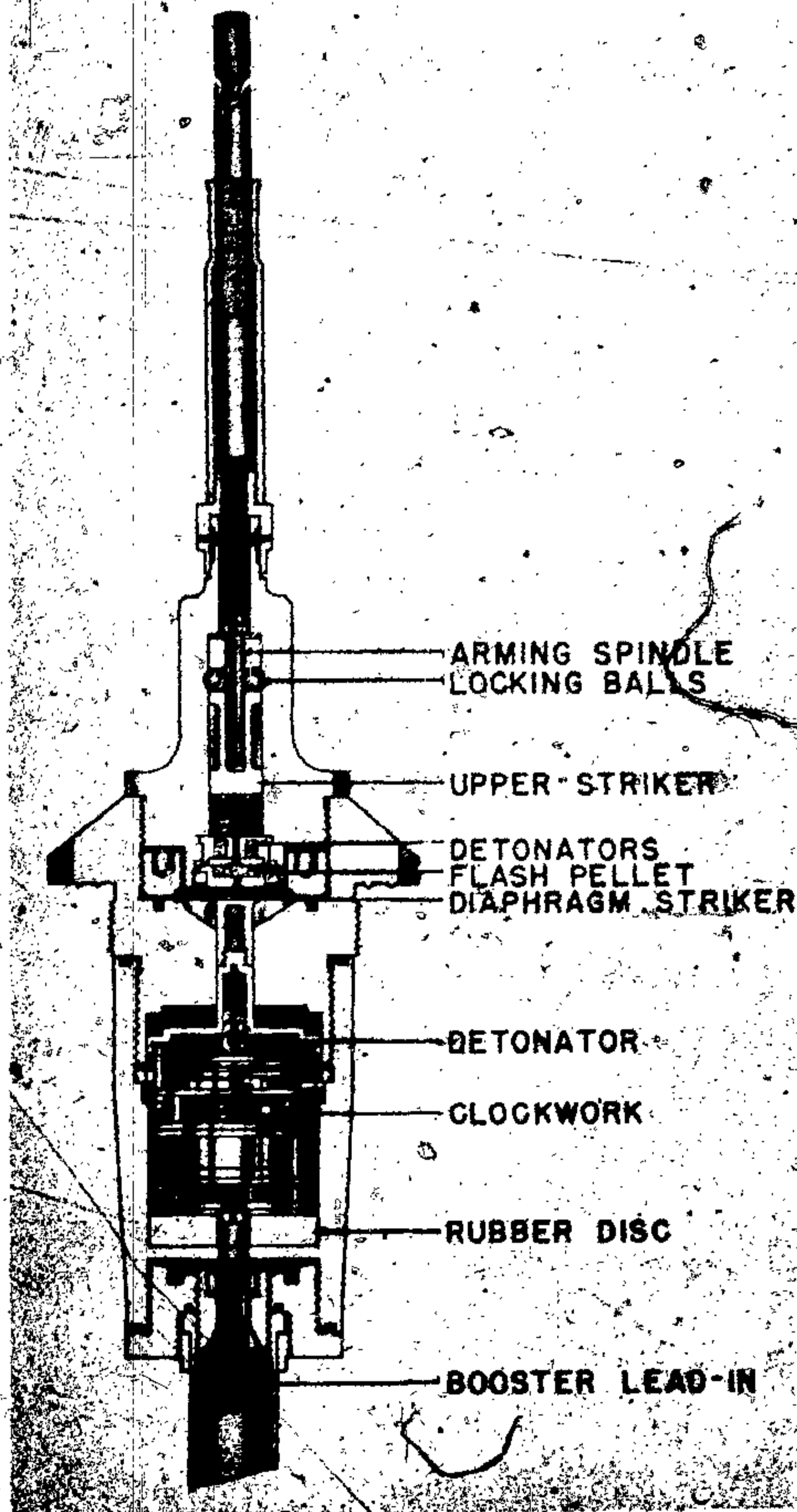

Figure 65 - Clockwork Long-Delay Tail Fuze

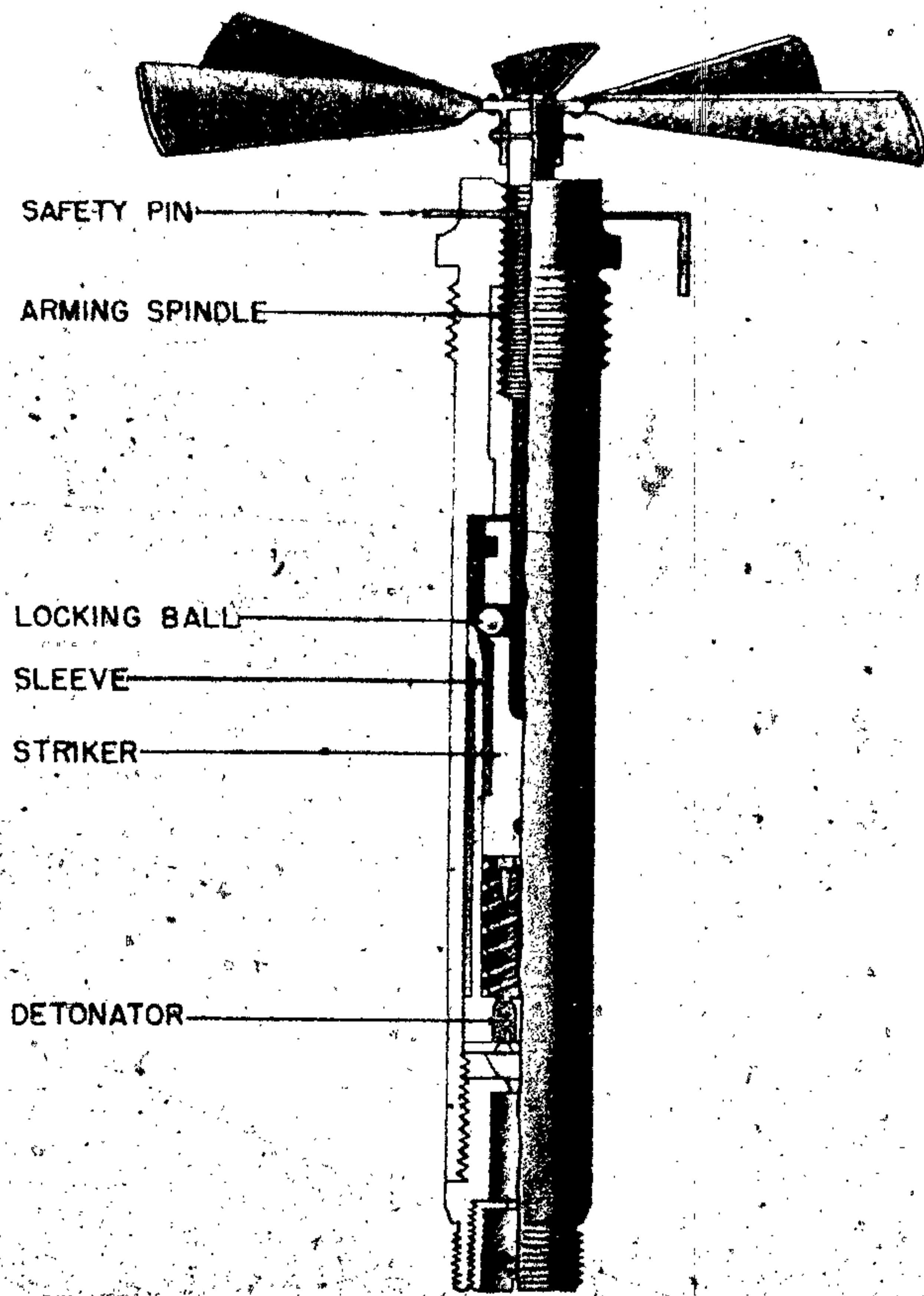

Figure 66 - Type T-2 - Mechanical Impact Tail Fuze

Type T-2—Mechanical Impact Tail Fuze

Data

Bombs used in.....	Unknown
Fuze used with.....	Unknown
Over-all length.....	8.4 in. (without booster)
Over-all length of vanes ..	6.0 in.
Width of fuze body.....	1.1 in.

Description

The fuze consists of a brass body housing, arming spindle, inertia striker, creep spring, and primer caps. Vanes are mounted on the arming spindle,

which is fitted with a safety pin. The arming spindle separates two steel balls within the striker, retaining it in position. The booster is housed in an aluminum tube which is threaded to the fuze.

Operation

The safety pin is removed, and on release vanes rotate in counterclockwise direction, unscrewing the arming spindle from the body. When the arming spindle clears the ball bearings, they fall and free the inertia striker. On impact, the striker compresses the creep spring, and the firing pins puncture the primer caps to initiate an explosive train within the booster.

Type O-2—Mechanical Impact Tail Fuze

Data

Bombs used in	Unknown
Fuzes used with	Unknown
Over-all length	
Short extension rod	31.5 in. (without booster)
Long extension rod	41.5 in. (without booster)
Over-all length of vanes ..	8 in.
Width of fuze body	1.9 in.

Description

The fuze consists of an aluminum body, housing the arming spindle, inertia strikers, creep spring, and detonator caps. The arming spindle is fitted with a safety pin and separates two retaining ball bearings within the striker. The brass arming extension rods are keyed to the fuze body extension.

Operation

The safety pin is removed, and on release the vanes rotate in a counterclockwise direction, turning the fuze body extension. The arming spindle is completely unscrewed from the inertia striker, permitting the ball bearings to come together to free the striker from the body. On impact, the striker compresses the creep spring, and the firing pins puncture the detonator caps to initiate the explosive train.

Tail Fuze for Hollow-Charge Bombs

Data

Bombs used in	Hollow-Charge bombs
Fuze used with	Alone
Over-all length	5.5 in. (without booster or extension flash tube)
Over-all length of vanes ..	Unknown
Width of fuze body	1.8 in.

Description

The body of the fuze is made in three parts. The lowest portion is zinc alloy and screws into the rear end of the bomb from the inside. Into the base of the lower body screws the cap holder containing the detonator. An aluminum collar holding a flanged booster screws onto the cap holder.

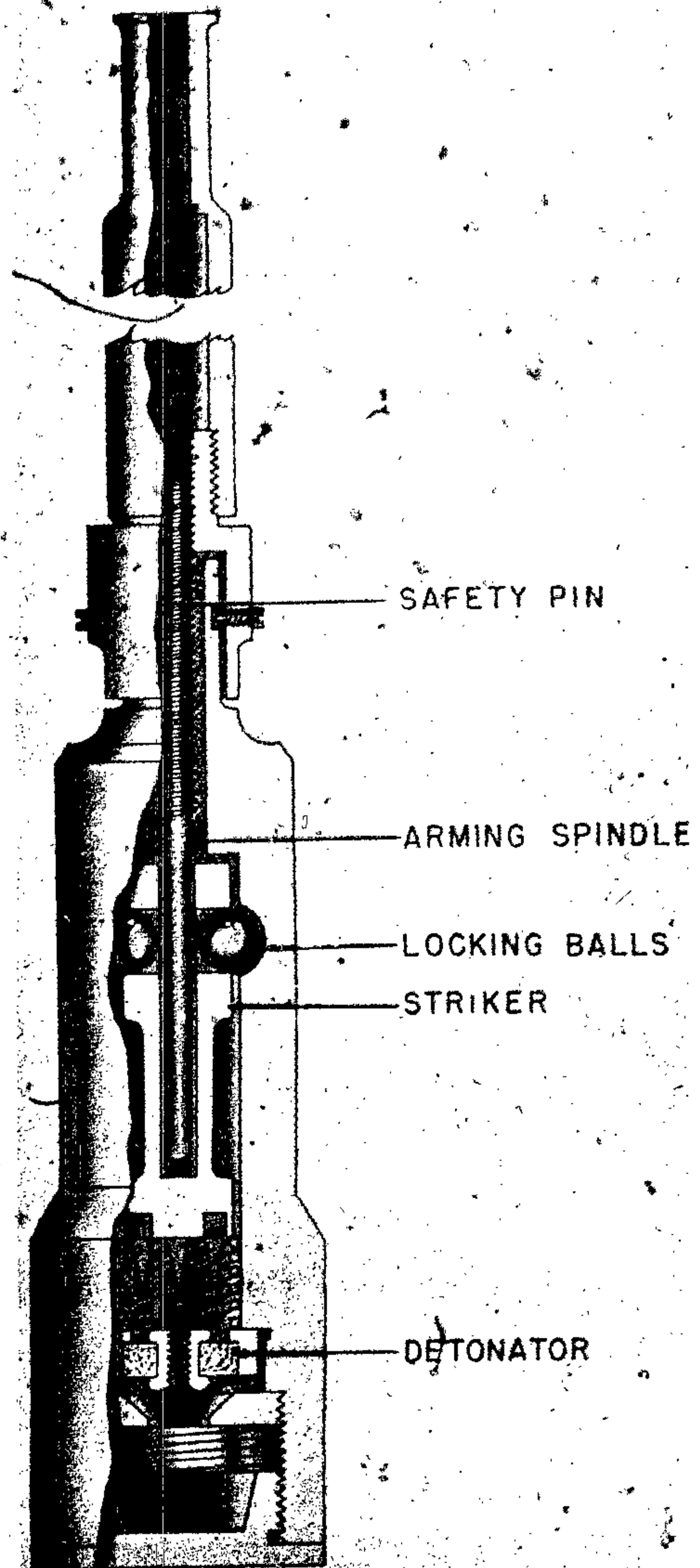

Figure 67 — Type O-2 — Mechanical Impact Tail Fuze

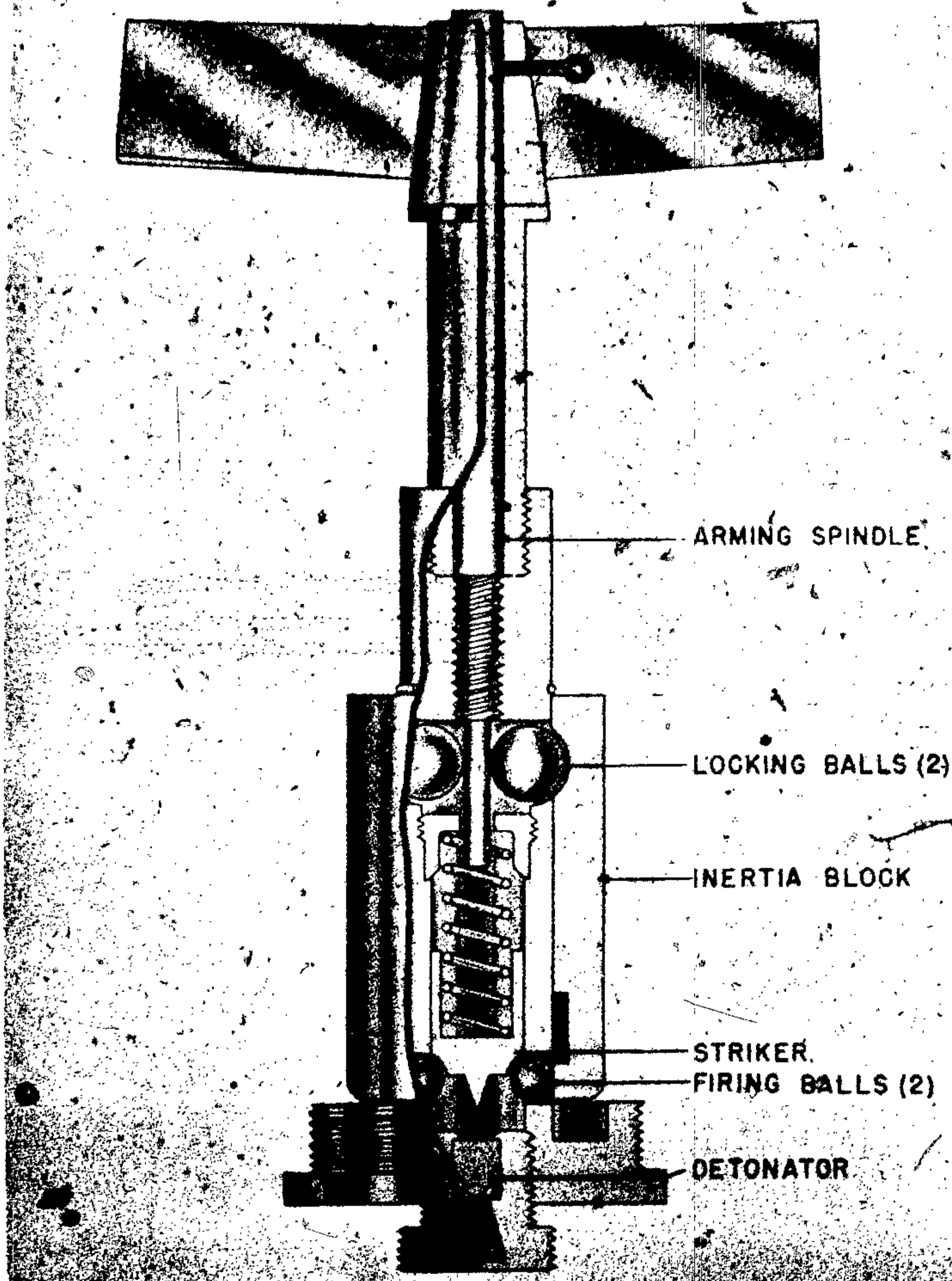

Figure 68 - Tail Fuze for Hollow-Charge Bombs

The central portion of the fuze is of brass and screws into the lower body. It houses the two steel locking balls which, in the unarmed condition of the fuze, project through the lower body into a groove in the heavy arming sleeve. The steel balls are held in the safe position by the arming spindle screwed into the tail of the bomb.

Operation

On release, the safety pin is withdrawn, allowing the vanes to rotate. When the vanes rotate enough to raise the arming spindle 0.5 in., the steel balls move inward, freeing the arming sleeve. On impact, the sleeve sets down into the recess in the base of the fuze and so frees the firing balls. These are pressed outwards into the groove in the arming sleeve, and the striker is thus released.

Hydrostatic Tail Fuze—"Grand-Daddy"

Data

Bomb used in	160-kg. Anti-submarine (O.S.)
Fuzes used with	Alone
Over-all length	33.6 in.
Width of fuze body	2.7 in.
Length of each vane	3.8 in.

Description

The fuze consists of a very long body and three-bladed steel vanes mounted on a brass cylinder which screws internally onto a brass collar. The setting mechanism consists of a setting key which, when rotating, conveys the rotary movement through the worm wheel and gear to the collar, which has the effect of withdrawing the arming spindle from the striker. The long arming spindle is keyed to prevent rotation and is braced along its length. The spindle fits into the striker and prevents the locking balls from moving inwards. The inertia weight fits above the striker and is held by a retaining wedge. The spring is not in compression, except in the armed condition.

Operation

The setting key is turned so that the dial indicates the depth of function, 0-90 meters. The 0-90 meter range corresponds to 0 to $35\frac{1}{2}$ rotations of the vanes, although it is impossible for operation of the fuze at less than 9 meters depth in water.

When the fuze is dropped, the vanes are prevented from rotating during flight through the air by a pressure plate which is held by a shear wire. On impact with water, the shear wire breaks; the vanes force the pressure plate to move up and fall away.

Also on impact, the inertia weight moves forward against the striker spring, and the wedges on the specially shaped base will lodge in the recess provided, thereby preventing the inertial weight retracting and effecting compression of the striker spring.

The vanes rotate during water travel to raise the arming spindle. As the spindle passes the locking balls, the balls move inwards to free the striker, which is then forced into the detonator.

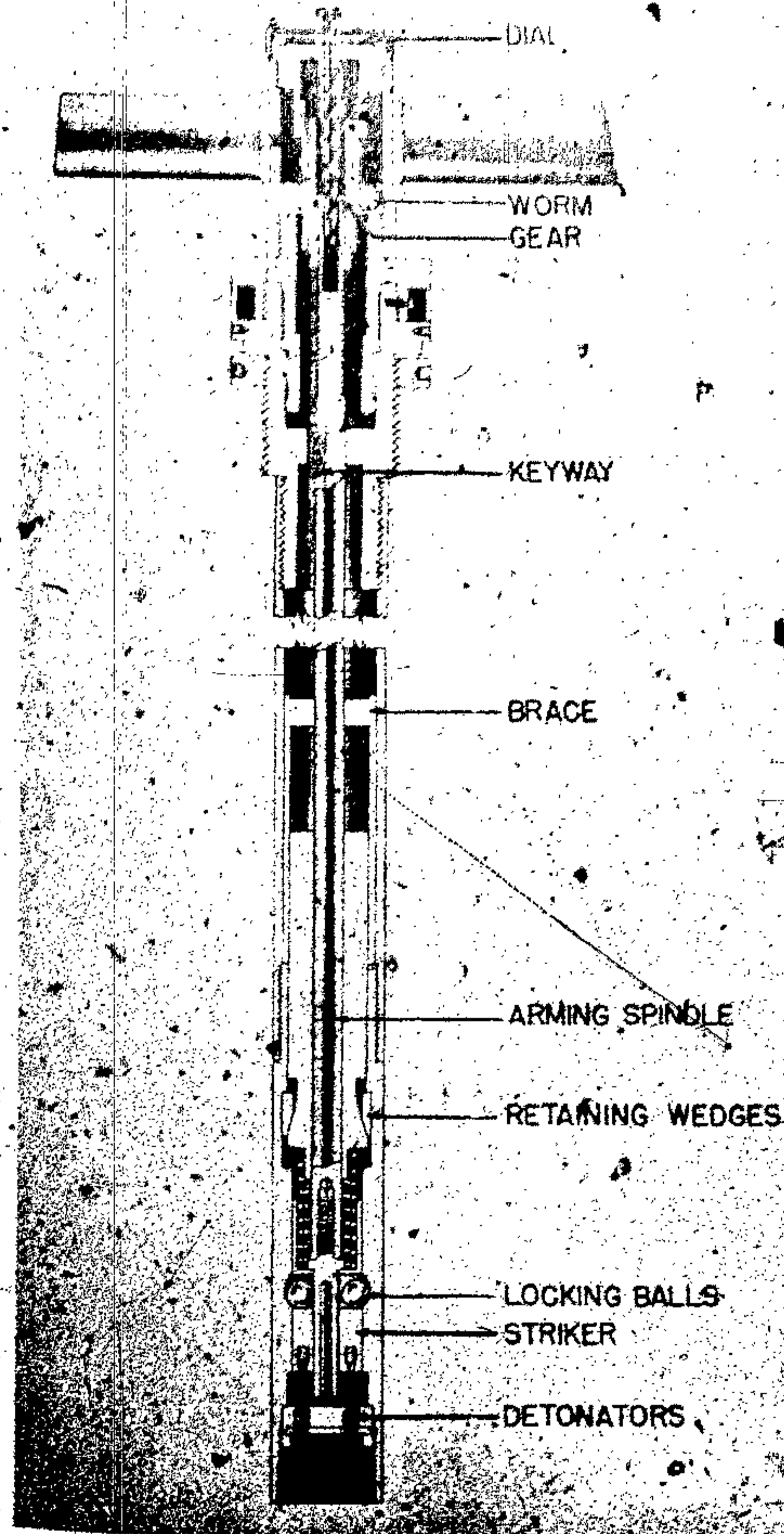

Figure 69 - Hydrostatic Tail Fuze - "Grand-Daddy"

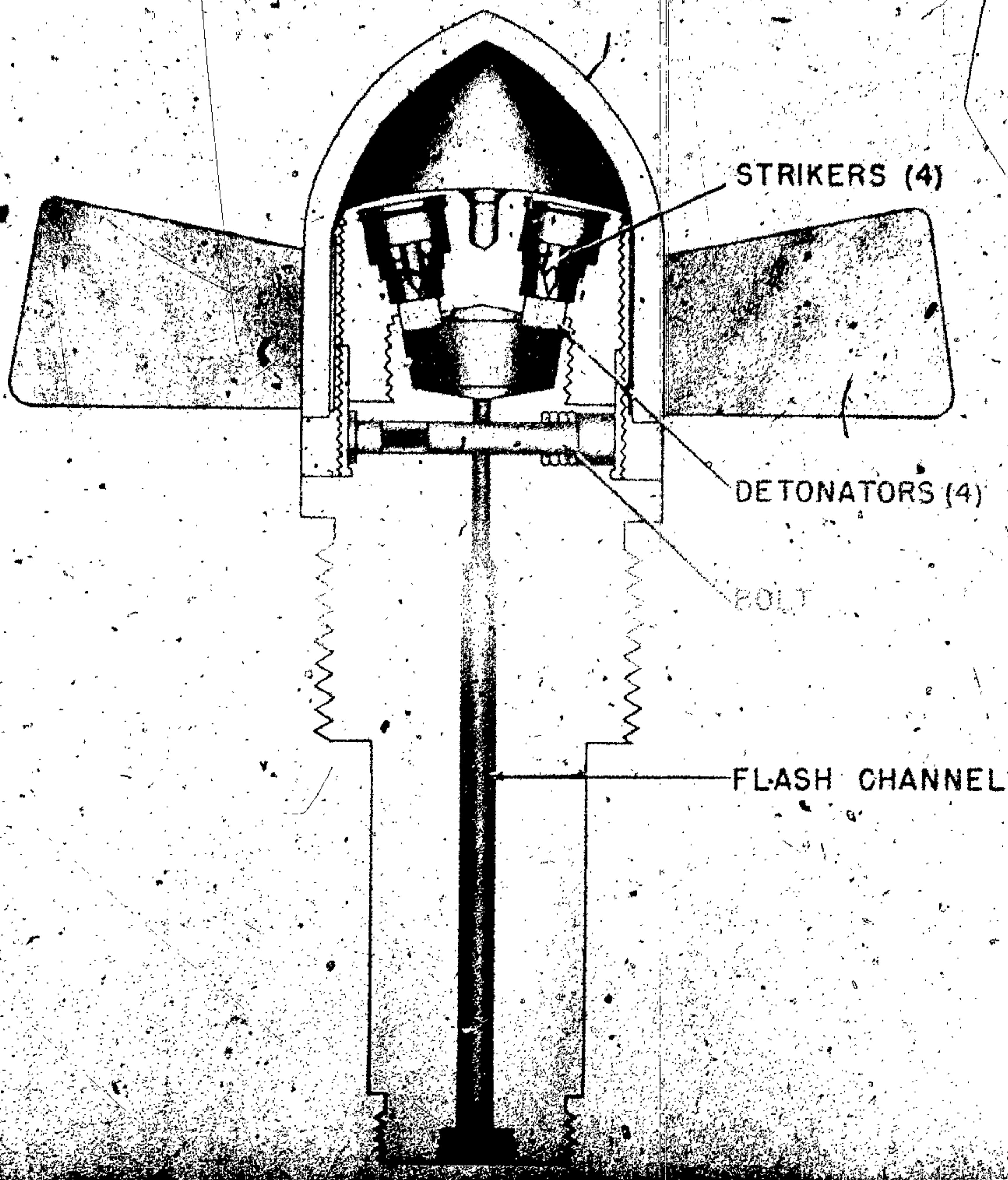

Figure 70 - Mechanical Impact Nose Fuze - "Orphan"

Mechanical Impact Nose Fuze—"Orphan"

Data

Bombs used in.....	135-kg. Bomb
Fuzes used with.....	Unknown
Over-all length.....	7.7 in.
Over-all length of vanes.....	4.7 in.
Width of fuze body.....	2.5 in.

Description

The fuze body is made of aluminum alloy and is threaded at the lower end to take the standard booster. The fuze head, which carries the four strikers and detonators, screws on the body and is protected by the vaned cap. A hole off center, passing through the shoulder and through the fuze body, takes a safety pin to retain the cap. The

head of the fuze has a longitudinal slot in which one arm of the safety bolt is accommodated. The other arm, made of brass, passes through the fuze body and blanks off the flash channel leading to the booster. Four slots for the striker mechanism are equally spaced on the domed head. The striker itself has three equispaced small projections which rest on the shoulder of the slot. The striker also has a small shear wire resting on the detonator's spring. The whole mechanism is similar to the French R. S. A. mechanism, except that the three projections replace the usual shear wire.

Operation

As the bomb is released, the safety pin is withdrawn, allowing the vanes to rotate. The caps thread up and fall away. The safety bolt is then rejected, clearing the flash channel. On impact, one or more of the strikers will be forced inwards. The projections usually break off, and at the same time the fine wire is also sheared. The detonator then is forced into the striker. The flash travels through the flash channel to the booster.

Mechanical Anti-Disturbance Fuze—Manzolini

Data

Bombs used in..... 4-kg. A. R. Anti-Disturbance Bomb
 Fuzes used with..... Alone
 Over-all length..... 7.2 in. (without booster)
 Width of fuze body... 2.6 in.
 Material of construction... Cap is aluminum; the inner parts, brass and steel.

Description and Operation

The sensitive Manzolini Fuze screws into the bomb body and forms the nose of the bomb. It is protected by the aluminum cap, which is retained by the vane cap. This latter screws into the brass adapter in the fuze cover. Two projections on the outer face project through corresponding holes in the cap and prevent the latter from rotating as the vane cap unscrews.

When the vane cap has unscrewed and has fallen away, the fuze cap is released and is forced off the fuze mainly by the rush of air acting on the projections. This is also assisted by the pressure of the strip springs within the cap. Each of the three strips has a brass clay which passes through one of the three equally-spaced holes in the body and

holds the collar in position. A strong spring in the upper part of the fuze presses out the brass claws so that the strip springs bear hard against the cap.

After the cap has been forced off, the pressure of the strong spring on the steel collar, acting on the curved surfaces of the claws, ejects them completely, and the strips fall away. The steel collar then sets down and is pressed hard against the rubber rings, completely masking the fuze and preventing the entrance of sand, grit, or water.

When the bomb strikes the ground, the brass cup-shaped piece and the inertia sleeve set down. The former is cushioned by the spring, while the latter is slit in six places around the upper edge to allow it to pass the slight ridge on the cylinder. The three steel balls, which are equally spaced circumferentially, can then move outwards and free the pistons.

Under the action of the strong spring, the piston rises through the light oil in the chamber. The arming delay thus obtained allows the bomb to come to rest before the fuze is completely armed. Until the piston has moved upwards, the three equally-spaced balls prevent relative movement of the two cylinders.

When the piston has completed its travel, the balls roll inwards and the two cylinders are free to move relative to each other. The fuze is then completely armed. The two spacers at each end of the fuze allow lateral movement of the two cylinders, which results in the cylinders approaching each other.

Thus any jar will overcome the light spring in the base of the fuze and will cause the upper cylinder to move down in the lower cylinder until the three pairs of steel balls come opposite the annular slot into which they then move outwards. This frees the striker which, moving under the compression of its spring, impacts the detonator.

Remarks

A modification includes a device which will cause detonation after lapse of a certain period if the bomb has not already been detonated by vibration or interference. The difference in the piston is 0.6 cm. shorter; the piston travel is shorter; the striker spring is 2 cm. short; and the inertia sleeve is slit in ten pieces instead of six. The device consists of a steel holder in which slides the hollow cylinder. The closed end of the cylinder carries a short projection which passes through and

ITALIAN AND FRENCH EXPLOSIVE ORDNANCE

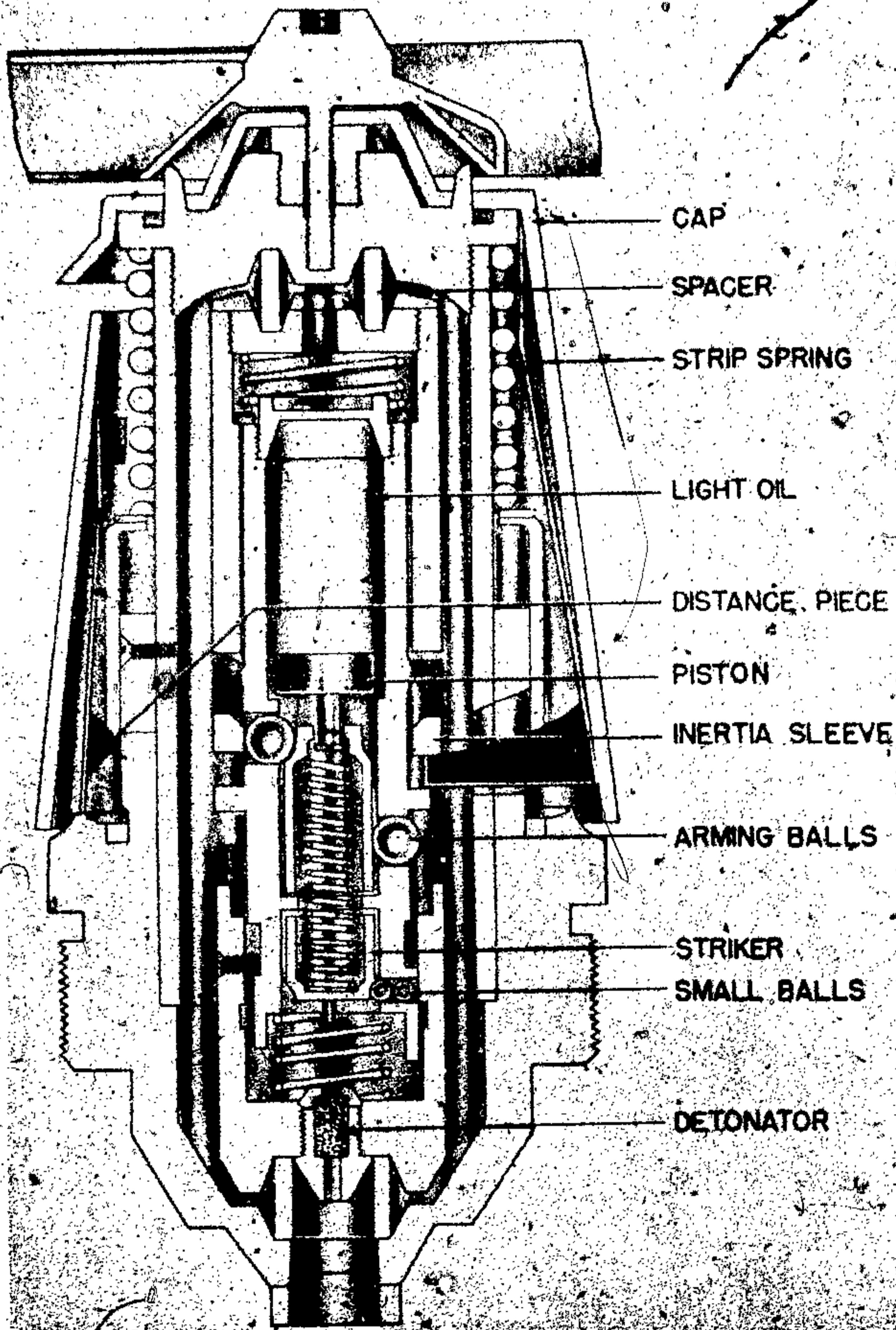

- CAP
- SPACER
- STRIP SPRING
- LIGHT OIL
- DISTANCE PIECE
- PISTON
- INERTIA SLEEVE
- ARMING BALLS
- STRIKER
- SMALL BALLS
- DETONATOR

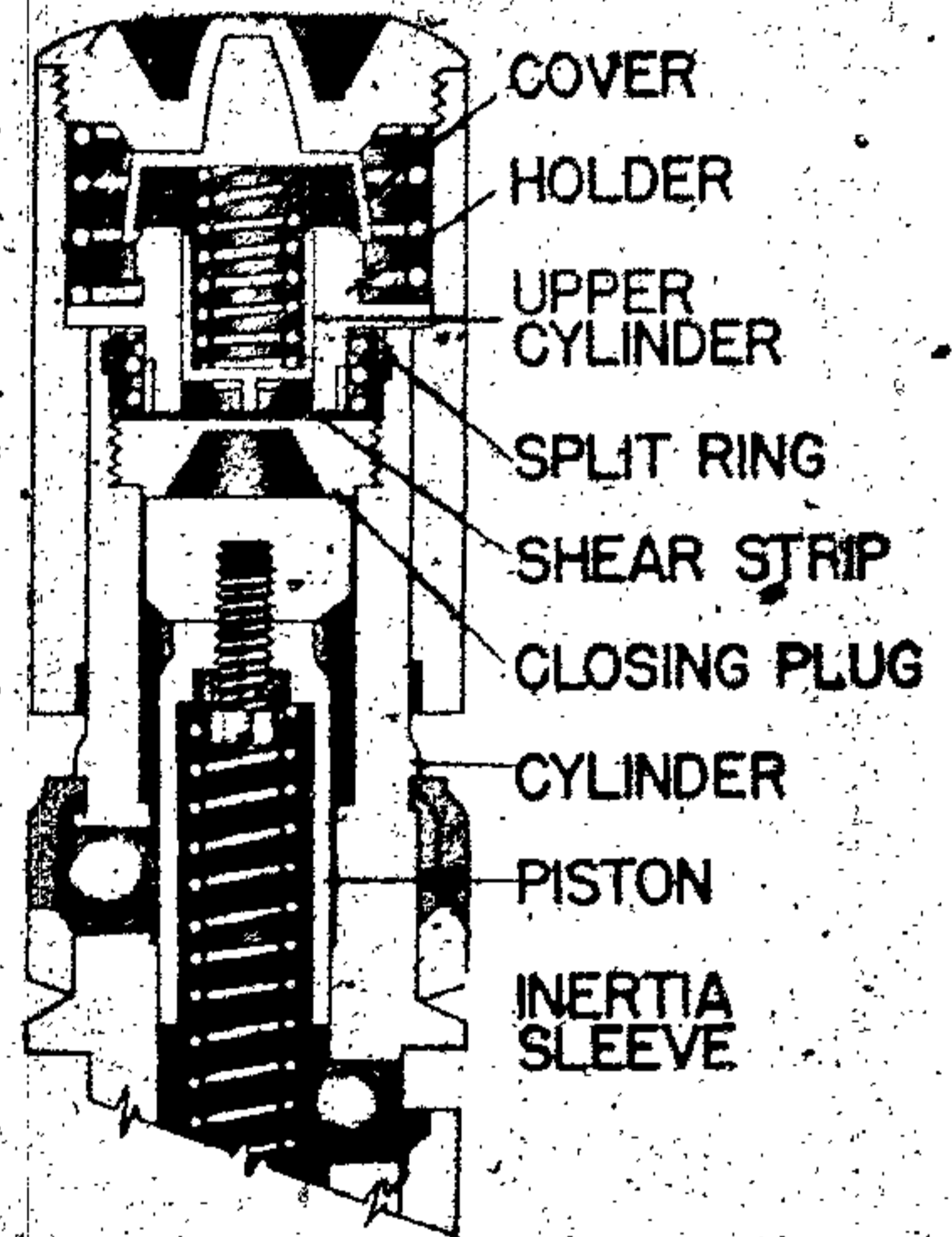

- COVER
- HOLDER
- UPPER CYLINDER
- SPLIT RING
- SHEAR STRIP
- CLOSING PLUG
- CYLINDER
- PISTON
- INERTIA SLEEVE

Figure 71 - "Manzolini", Fuze

locates the aluminum shear strip. Above the holder sits the steel cover, having eight slits in the vertical rim and enclosing the strong steel spring.

The operation of this device proceeds as follows: On impact, the cover sets down and the projection on the rim engages in the annular groove and so locks itself to the holder.

The spring within this enclosure then exerts a pressure on the shear strip through the movable cylinder. At the end of a certain period (60 to 80 hours), the strip shears and, since the projection bears on the plug, an appreciable jerk is communicated to the cylinder to operate the fuze.

Chapter 3

ITALIAN PROJECTILES AND CASES

Introduction

The projectiles used by the Italian army were very similar to French, British, and Japanese in construction and appearance. In some cases, the projectiles were direct copies of British ammunition and used the same fuzeing and filling.

Most field equipment is semi-fixed, with the smaller caliber and antiaircraft guns using fixed ammunition. When the semifixed type of ammunition is used, the propellant charge is divided into a number of parts which are enclosed in silk bags.

The first part is known by the Italians as the "fundamental," and the other part as "augmentive." Igniters of black powder are also included. The complete charge is enclosed in the cartridge case by means of a cardboard closing cup. In the base of the cases are fitted percussion primers of standard design.

In guns using bag ammunition, an igniter, which has an extension piece fitted into the vent hole, is used. For initiation of the charge, the types of tubes used are: friction, percussion, and electric-percussion.

The Italians designated their projectiles by the caliber, the specific equipment in which they were used, and the model numbers of projectiles. In most cases, the model number is thought to have designated the year in which the ammunition was designed.

Types of Projectiles

1. High-Explosive (H. E.)

These are of conventional design and are usually fitted with a point detonating fuze, with a booster charge below the fuze. They most commonly have a shell body of forged steel and a parallel-wall inner cavity. The cavity and exterior are machined over-all. The cavity is threaded internally at the top to receive the nose adapter. The latter is a machined forging, internally threaded at the nose to receive the fuze, and externally threaded at the base for attachment to the shell body.

In the medium caliber shell, the nose, contrary to the usual Italian practice, is sometimes formed by the "bottling" process with the upper portion threaded to take the fuze. Another common method of construction is that which incorporates a shell machined from rolled bar steel and having a parallel-walled cavity of the same diameter as the nose adapter, or, in some cases where there is no adapter, the cavity is the same diameter as the fuze. Some H. E. projectiles were cast and then machined. The base plates of these shells also vary. Some have no base plate, while others have the screwed type, the pressed-in type, or a steel plate soldered to the base of the shell. The majority of the projectiles have one rotating band of pure copper, but a few have two rotating bands.

The booster system is of two types. The first, the old system, consists of a metal tube containing compressed ballistite with a flash hole at each end. This tube fits beneath the nose fuze and has underneath it a larger charge of ballistite, which is also in a metal tube and has a flash hole at the top only.

The latest type of booster system was designated "Detonatore AD Alto Explosivo" by Italians and was given the numbers 1 through 6, and called M35 or M38. It consists of two parts, the upper part which fits immediately below the fuze and consists of an aluminum cylinder with a collar. Inside this is another tube which contains a layer of cyclonite above which is a layer of lead azide. Below this part is the other, which consists of two or more cylinders of TNT wrapped in oiled paper. The upper cylinder has a central cavity to take the upper detonator tube.

2. Hollow-Charge (E. P. and E. P. S.)

A large range of artillery weapons are found to have been equipped with hollow-charge ammunition. Of the type that have been recovered, all show a similarity of design. They appear to be converted H. E. shells.

ITALIAN AND FRENCH EXPLOSIVE ORDNANCE

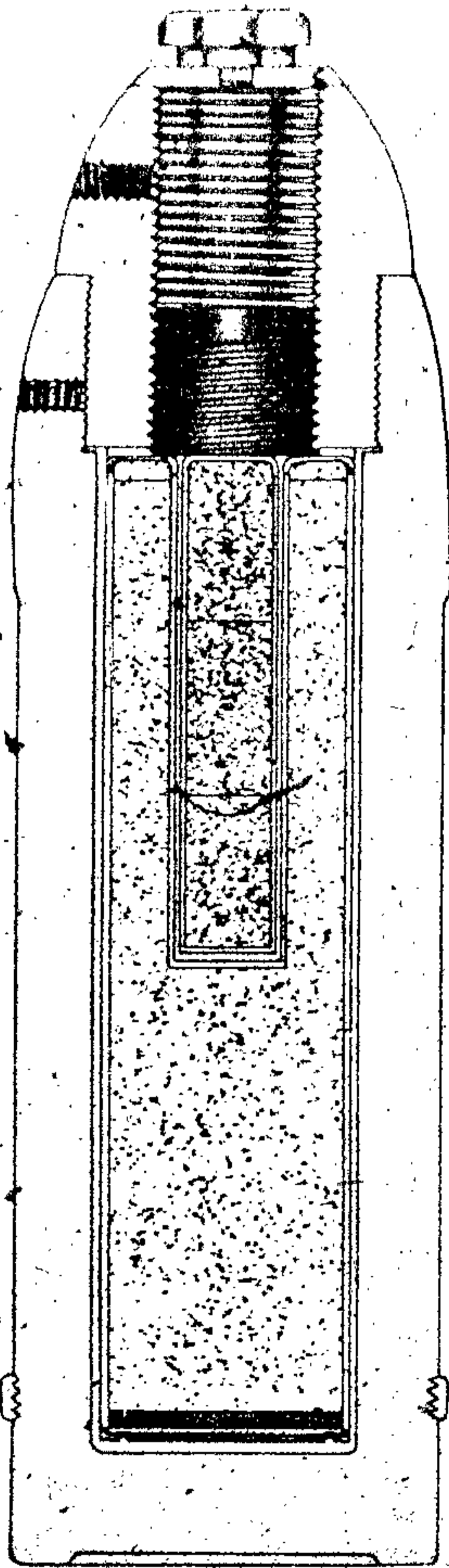

Figure 72 - Example of High-Explosive Shell

The body of the shell is the same as that of the corresponding H. E. shells. The almost hemispherical head is made of light alloy and, to overcome the difficulties in direction of rifling of different equipment, the head is secured to the body by indentation. The nose portion of the shell is hollow and has a cavity liner pressed from 1-mm. steel plate, parabolic in shape.

There are two types of these shells, one using a

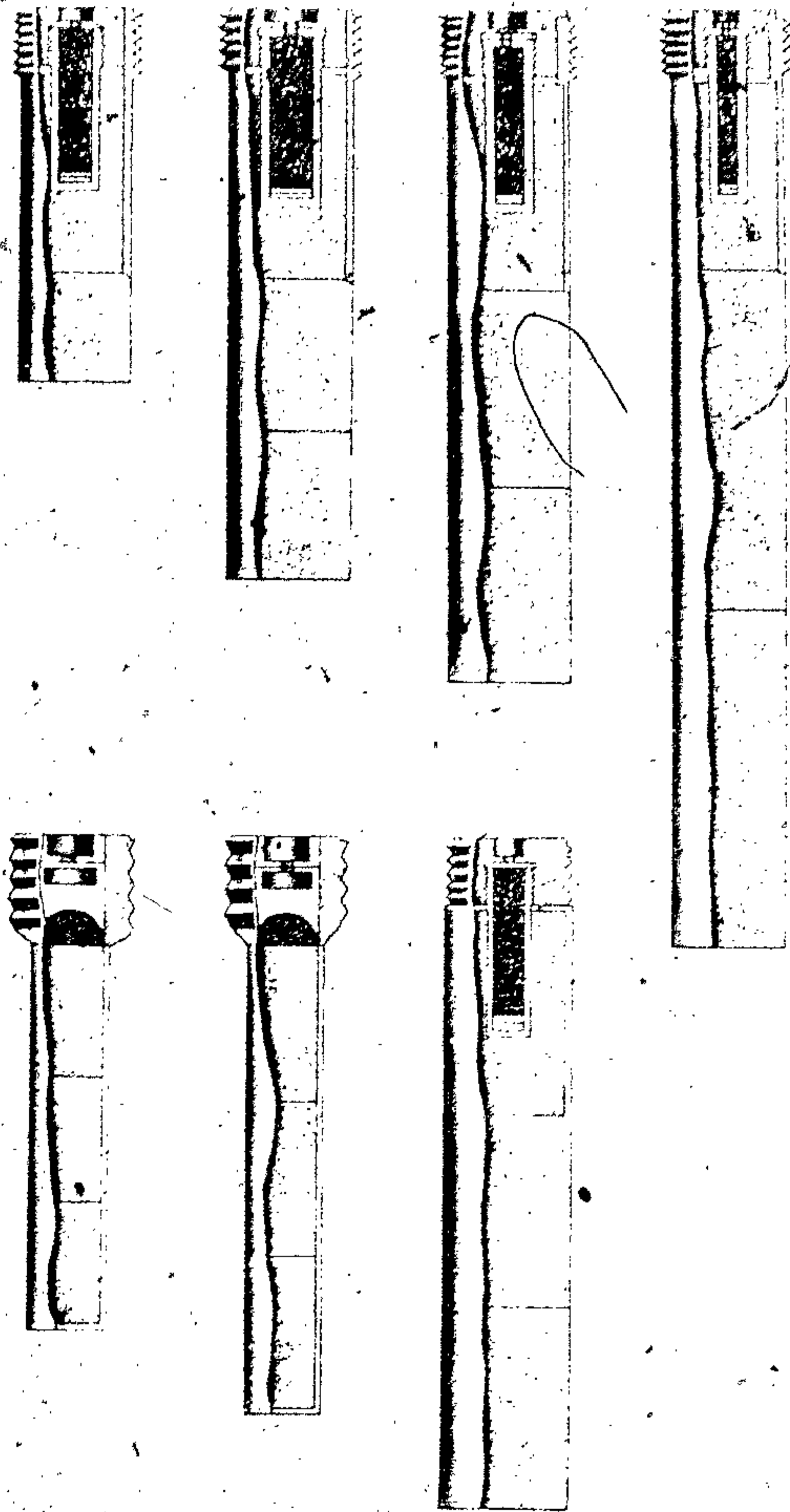

Figure 73 - Typical Italian Boosters

base fuze only. (E. P.), and the other, the latter type (E. P. S.), incorporating a nose fuze with long flash tube leading to the center of the explosive charge. This follows the German design. The rotating band is usually located about $\frac{1}{3}$ the distance from the base of the shell. The explosive filling consists of 58% cyclonite, 40.5 TNT and 1.5% wax. The filling is cast with the fuze and booster assembled in the cavity.

3. Fragmentation

This type is also very similar to the H. E. projectiles, but contains a liner which fits into the internal cavity. In most cases, the combustion type of time nose fuze is used. The shell body is of forged steel with a comparatively thin wall, and is fitted with a copper driving band.

The forward end is screw-threaded internally to receive the adapter. The body contains a fragmentation cylinder machined from grey cast iron, which is grooved along its length and circumferentially on the exterior to assist fragmentation. A channel is formed through the center of the cylinder to accommodate the bursting charge.

Red lead is inserted between the exterior of the cylinder, the wall of the shell, and the fragmentation grooves. The nose adapter is machined from grey cast iron and is screw-threaded internally to two diameters to receive the booster and the fuze, respectively. The exposed portion of the adapter forms the head of the shell and is shaped to form a sloping shoulder with a cylindrical neck. The base of the adapter is recessed to fit over the forward end of the explosive filling. From tests, it has been found that the break-up of the fragmentation cylinder generally follows the line of weakness.

4. Armor-Piercing (A. P.)

Most Italian armor-piercing shells are conventional in design. The shell is generally machined from steel bar stock and then hardened from the rotating band forward. A ballistic cap may or may not be fitted. All but a very few have small explosive filling of TNT and a base fuze.

5. Shrapnel

The later type is designed on conventional lines. It differs from the British type in having gunpowder pellets in the central booster tube. An earlier type had a charge of TNT in the nose. The shell has a nose adapter, a flash tube to the explosive filling located in the base of the cavity, and a diaphragm separating the explosive filling from the shrapnel bullets.

The shell body is forged steel and is machined externally. The explosive cavity and bearing surfaces of the diaphragm are also machined. The nose adapter, which forms a cover for the shrapnel bullets and provides a slot for the flash tube, is machined from bar stock. The flash tube is of brass and fits between slots in the nose adapter

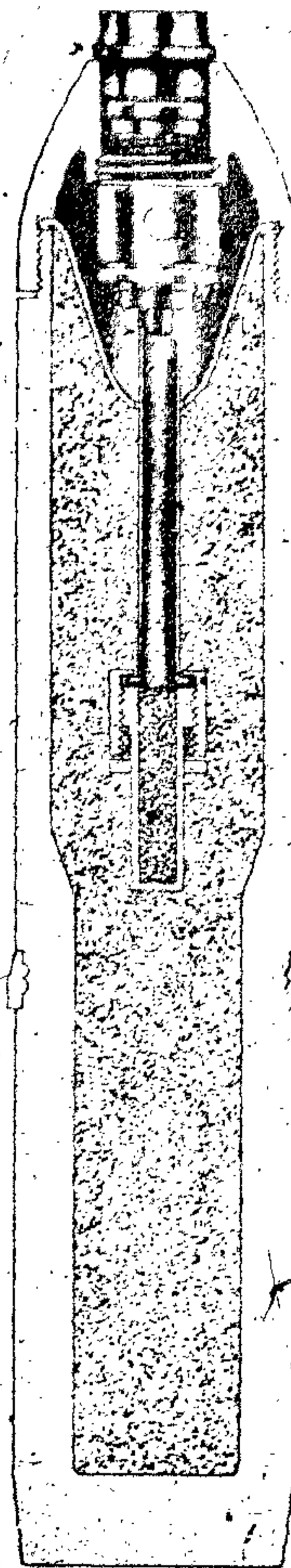

Figure 74 - Typical Hollow-Charge Projectile

and diaphragm. The diaphragm is stamped steel plate. The shrapnel bullets, varying from 100 to 250 in number, are lead-antimony alloy.

6. Aerial Burst or Impact (A. D. E.)

Projectiles designated "A. D. E." are regular High Explosive shells but have the A. D. E. type fuzes, which are time or percussion fuzes.

7. Antiaircraft (A. A.)

These projectiles are H. E. shell with an aerial burst fuze.

ITALIAN AND FRENCH EXPLOSIVE ORDNANCE

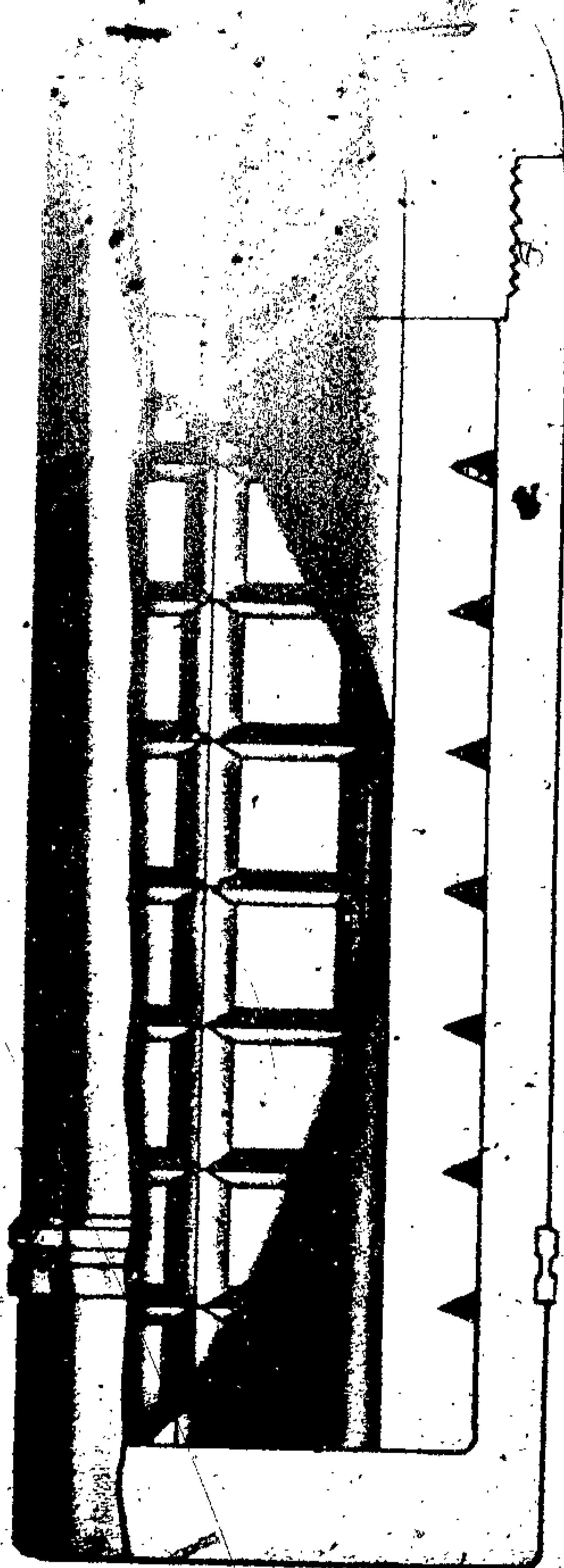

Figure 75 - Typical Fragmentation Projectile

Markings

Before 1931 the following coloring system was used:

Color of Body

Grey	H. E.
White	High capacity H. E.
Blue	Fragmentation
Carmine	Shrapnel

Color of Nose (Ogive same color as body)

Red	Practice shell
-----	-------	----------------

Carmine	Star shell
Black	Tracer

Color of Ogive

Red	H. E. or A. P.
Carmine	Incendiary shell
Black	Smoke shell
Yellow	Chemical shell

Since 1931, the shell body has been zincated, and the ogive and nose painted in distinctive colored bands may be found on the body of the shell. The following coloring scheme was used:

Color of ogive or nose same as before 1931.

Band above the Rotating Band

Green	Steel shell
White	High Capacity H. E.
Red	Shrapnel
Blue	Fragmentation
Black	Practice

Band at Shoulder

Blue	A. A.
------	-------	-------

The stenciling, of which the following are examples, may be found on the body of the projectile.

100/17 Caliber/length of weapon
in calibers

Tritolo Explosive filling

61.000 kg. Weight of Projectile

A. P. VIII 1928 Place and date of filling

Explosive Filling

The following explosive fillings have been found used by the Italians.

Italian Nomenclature

1. Tritolo	TNT	
2. PNP	Ammonium Nitrate	75%
		PETN	20%
		Wax	5%
3. MAT	Picric Acid	60%
		TNT	40%
4. MBT	Picric Acid	
		Dinitrophenol	
5. Pertite	Picric Acid	
6. Schneiderite	Ammonium Nitrate	87%
		Dinitronapthalene	13%
7. Nougat	Ammonium Nitrate	50%
		MST	
		Dinitronapthalene	7%
		TNT	43%
8. Toluolammonal	Ammonium Nitrate	47%
		TNT	30%
		Aluminum	20%
		Carbon	3%

9. MNDT Siperite	Ammonium Nitrate	72.8%
	Dinitronaphthalene	10.5%
	TNT	16.7%
10. Amathol Explosive 60/40	Amathol	
11. Ecrasite	Ammonium Trinitrocresol	
12. Tritolite	TNT	50%
	Cyclonite	50%

Propellants

The composition of the propellants has no outstanding features. Apparently only three types were used in service:

1. A straight ballistite (Ballistite or Bal. containing about 50% nitro-cellulose and 50% nitroglycerine without stabilizer).

2. A modified ballistite (Ballistite Attenuate or Bal. Att.) containing 60% nitro-cellulose, 26% nitroglycerine, and 14% dinitrofluorene as a moderant coating.

3. The so-called "Italian Cordite" which usually bears no markings other than the weapon and propellant sizes. This contains about 72% nitro-cellulose, 24% nitroglycerine, and 4% mineral jelly. In addition, this type of propellant has been found to contain sodium carbonate or bicarbonate, presumably as an additional stabilizer.

In some cases, bags containing potassium chloride have been found included in the charges, presumably as a flash-reducing agent. The shapes encountered have been flat strip, cord, square flake, and tubular cord. An example of marking of the propellant is: "Ballistite Attenuata Piastine—1 x 10 x 220 days CKA VI grs. 570," in a charge of 370 grams of "Ballistite in Attenuata" strip form 1mm x 10 mm x 220 mm for the 75-mm gun.

Naval and Coastal Defense Equipment

The equipment is similar in design as the Army, but different distinctly in markings from Italian field equipment. The following coloring is used:

- H. E. White body with red ogive
 - Star White body with red ogive
 - Practice Yellow with grey and white nose
 - Special light projectiles, as opposed to heavy projectiles, have green bodies and white heads (grey if made of cast iron).
 - Star Green band above rotating band
 - A. P. Blue band above rotating band
 - Practice H. E. Yellow band above rotating band
 - A. P. Shot ... Red band above rotating band
- (Piercing caps—Red, Ballistic caps—Unpainted)

- The markings on the H. E. projectiles are:
 - On the body ... Caliber and type filling
 - On the ogive ... Type, date, place of filling
 - C. L. Tracer fitted
- Star shells have a black triangle on the ogive which may or may not enclose a black disc. This refers to type of star filled.

ITALIAN SMALL-ARM AMMUNITION

General

Italian small-arm ammunition does not have many unusual characteristics and is very similar to British and German ammunition. In some cases the ammunition is interchangeable for use in each country's guns.

The following is a summary of Italian small arms:

6.5-mm Rimless

1. Guns used in Rifle M°91, Carbines M°91, Machine Gun M°30 and M°30, Machine Gun M°14 (Fiat)

2. Types

- a. Ball M°91/95—Round nose
- b. Fragmenting bullet M°91—3 longitudinal striations on the bullet
- c. Fragmenting bullet M°91—2 annular grooves on the bullet
- d. Blank for rifles—Scarlet wooden bullet
- e. Blank for machine gun—Bullet consists of inert black powder which is enclosed in a thin brass jacket
- f. Dumny M°91/95

ITALIAN AND FRENCH EXPLOSIVE ORDNANCE

g. Practice M°91—Bullet consists of a closed jacket of copper-nickel, the upper half filled with lead, the lower half with sand.

h. Practice for Miniature Range M°91—This ammunition consists of a brass cartridge case with a steel tube attached to the base of the case and fitting internally. A lead bullet fits into the top of the steel tube and cartridge fits into the base of the tube.

7.35-mm (Rimless)

1. Guns used in—Rifle M°38
Machine Gun M°38

2. Types—Similar to 6.5-mm

- Ball
- Fragmenting
- Practice—Miniature ranges
- Blanks for rifles
- Blank for machine guns

7.7-mm (Rimmed) (Interchangeable with British 0.303-in.)

1. Guns used in—7.7-mm Aircraft
Machine Gun

2. Types

- Ball
- Tracer—Red tip
- Armor-piercing incendiary (phosphorus)—Blue tip
- Armor-piercing incendiary (thermite)—Green tip

8-mm (Rimmed)

1. Guns used in—8-mm Mannlicher Rifle
8-mm Schwarzlose Machine Gun

2. Types

- Ball
- Blank for Rifle—Reddish orange wooden bullet
- Blank for machine gun—Green wooden bullet

8-mm (Rimless)

1. Guns used in—Machine Guns Fiat M35,
Breder M37 and M38

2. Types

- Ball
- Armor-piercing M37 and M43—M40 has red red tip.
- Blank—Bullet consists of inert black powder enclosed in brass jacket.

12.7-mm (Rimless)

1. Guns used in—12.7-mm Aircraft
Machine Gun

2. Types

- Ball
- Tracer—Red tip
- Armor-piercing—Green tip
- Armor-piercing incendiary (thermite) tracer—White tip
- H. E. Projectile—Red body with nose percussion fuze
- Incendiary (phosphorus)—Blue tip
- Incendiary (thermite) tracer—Blue body with nose percussion fuze similar to German Fuze A.25045
- Incendiary (thermite) tracer—Buff body with nose percussion fuze fitted

13.2-mm (Rimless)

1. Guns used in—13.2-mm Breder Machine Gun

2. Types

- Armor-piercing
 - Armor-piercing/tracer—Red tip
- 14-mm (Similar to British 0.55-in. Anti-tank rifle ammunition)

1. Guns used in—Captured British Anti-tank rifle

2. Types—Armor-piercing

20-mm (Interchangeable with German 2 cm Solothun type of ammunition)

1. Guns used in—20-mm Antiaircraft and Anti-Tank Gun Breder M35

2. Types

- H. E.—Nose percussion fuze and self-destroying tracer
- A.P./H.E./Tracer—Base fuze consisting of a fixed firing pin and primer cap held in position by a shear pin



Figure 76 - 6.5-mm Ball

6.5-mm Ball

Data

Guns used in	Moschetto M°91 Carbine Italian Mannlicher Corcano Rifle
Over-all length of round	76.5 mm
Weight of round	22.67 grams
Length of bullet	30.1 mm
Weight of bullet	10.5 grams
Length of cartridge case	52.2 mm
Weight of propellant	2.3 grams

Remarks

The round consists of a rimless brass case.

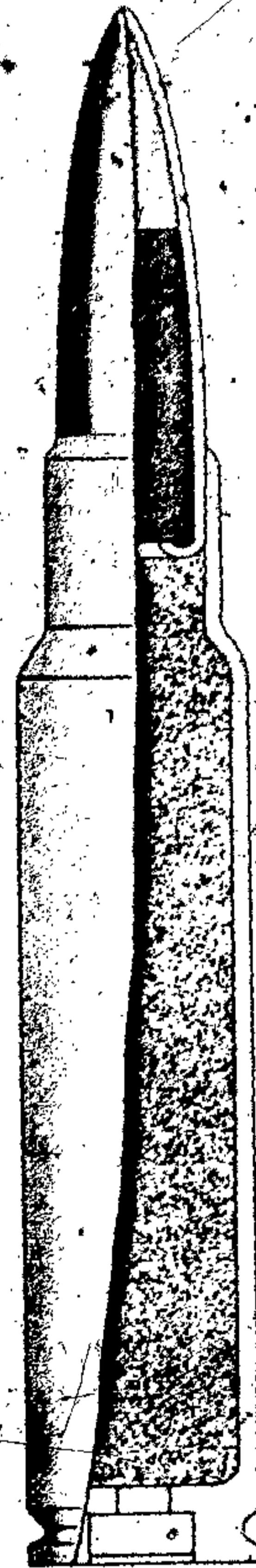

Figure 77 - 7.35-mm Ball

7.35-mm Ball

Data

Gun used in	Fucile M°38 Rifle
Over-all length of round	73.3 mm
Weight of complete round	20.10 grams
Over-all length of bullet	27.4 mm
Weight of bullet	8.32 grams
Length of cartridge case	53.3 mm
Weight of propellant	2.6 grams

Remarks

The round has the marking B. T. M. on the base of the brass cartridge case. The projectile has a nickel-plated steel jacket enclosing an aluminum case and a lead core to rear of the aluminum.

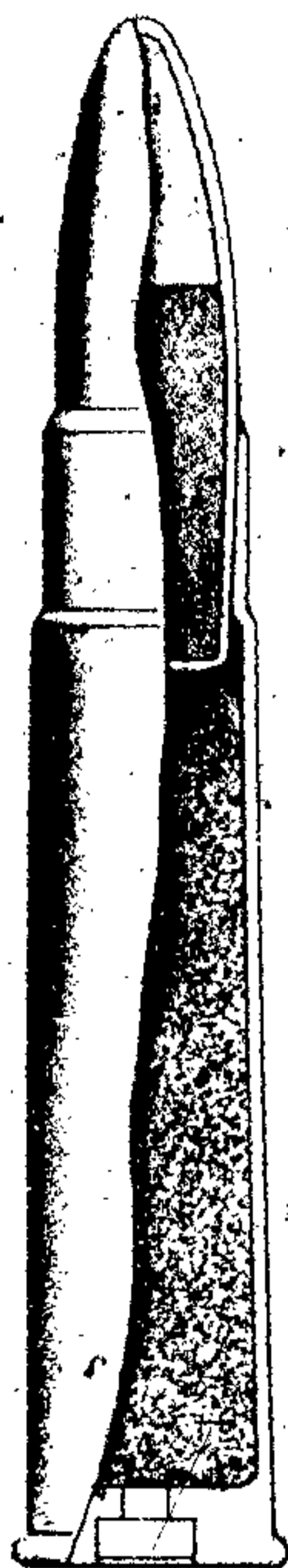

Figure 78 - 7.7-mm Ball

7.7-mm Ball

Data

Gun used in	7.7-mm Aircraft Machine Gun
Over-all length of round	77.5 mm
Weight of round	25.43 grams
Length of bullet	32.9 mm
Length of cartridge case	56 mm
Propellant	2.56 grams

Remarks

This round is interchangeable with the British 0.303-in. and is almost identical to the British Mk VII. The bullet has a copper-nickel plated steel jacket enclosing an aluminum forward core and a lead core in the rear.

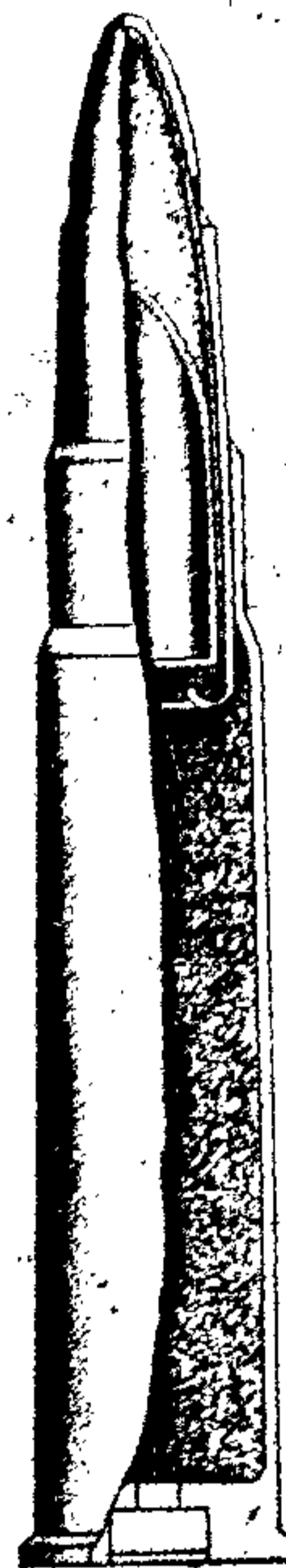

Figure 79 - 7.7-mm A.P.I. Incendiary (Blue Tip)

7.7-mm A.P.I. Incendiary (Blue Tip)

Data

Gun used in	7.7-mm Aircraft Machine Gun
Over-all length of round	77 mm
Total weight of round	23.33 grams
Length of bullet	35 mm
Weight of bullet	9.96 grams
Length of cartridge case	56 mm
Weight of propellant	2.4 grams

Remarks

This round consists of brass cartridge case, a copper cap, and a bullet whose jacket is pierced with four holes on the ogive so that at these points the incendiary composition is protected only by a thin copper sleeve. The jacket is steel plated with either copper-nickel or copper-nickel alloy. A copper sleeve, a steel core in a lead sheath, and the forward nose portion filled with phosphorus are enclosed by the bullet jacket. The four holes on the ogive permit the distribution of the phosphorus on impact.



Figure 80 - 7.7-mm A.P.I. (Green Tip)

7.7-mm A.P.I. (Green Tip)

Data

Gun used in.....	7.7-mm Aircraft Machine Gun
Over-all length of round.....	77 mm
Weight of complete round.....	24.6 grams
Length of bullet.....	35 mm
Weight of bullet.....	10.2 grams
Length of cartridge case.....	56 mm
Weight of propellant.....	2.5 grams

Remarks

This round has a brass cartridge case, and copper-nickel jacketed bullet. The makeup of bullet is very similar to the A. P. I. (blue tip), but the nose is filled with two compositions. In the tip is a small quantity of magnesium potassium chlorate and behind it, surrounding the nose of the steel core, some aluminum-lead oxide. Four holes in ogive permit the mixture to be distributed on impact.

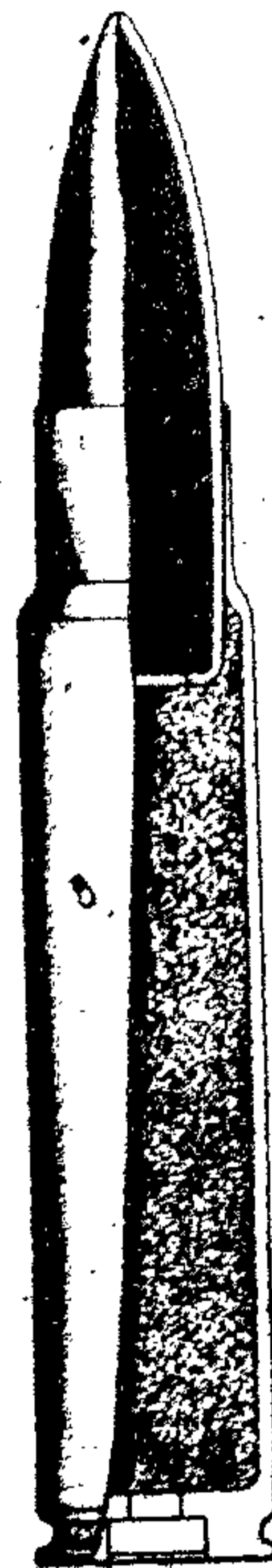

Figure 81 - 8-mm Ball

8-mm Ball

Data

Gun used in.....	8-mm Machine Gun
Over-all length of round.....	80.5 mm
Weight of complete round.....	30.23 grams
Length of bullet.....	34 mm
Weight of bullet.....	13.42 grams
Length of cartridge case.....	59 mm
Weight of propellant.....	3.1 grams

Remarks

This round consists of a brass cartridge case and a bullet which is made up of a lead core enclosed in a plated jacket.

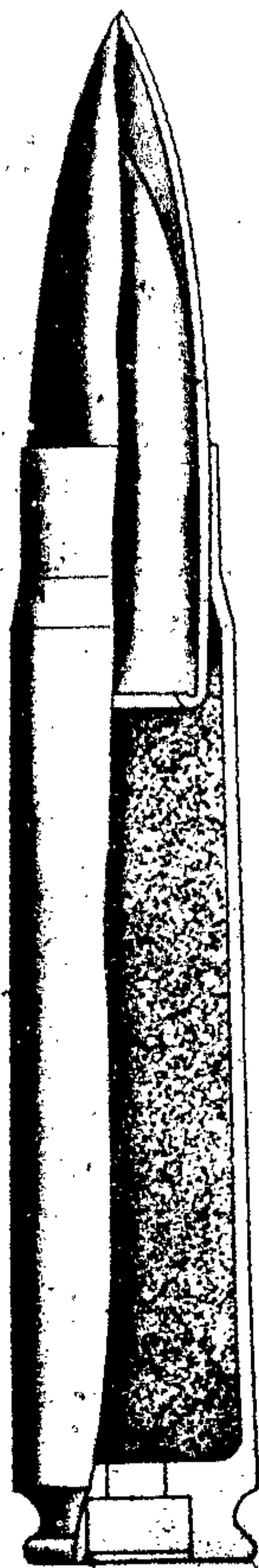

Figure 82 - 8-mm A.P.

8-mm A.P.

Data

Gun used in.....	8-mm Machine Gun.
Over-all length of round	80.3 mm
Weight of complete round	29.34 grams
Length of bullet.....	36.9 mm
Weight of bullet.....	12.57 grams
Length of cartridge case.....	59 mm
Weight of propellant.....	3.08 grams

Remarks

The bullet is made up of a plated steel jacket enclosing a hard steel core with a soft lead point.

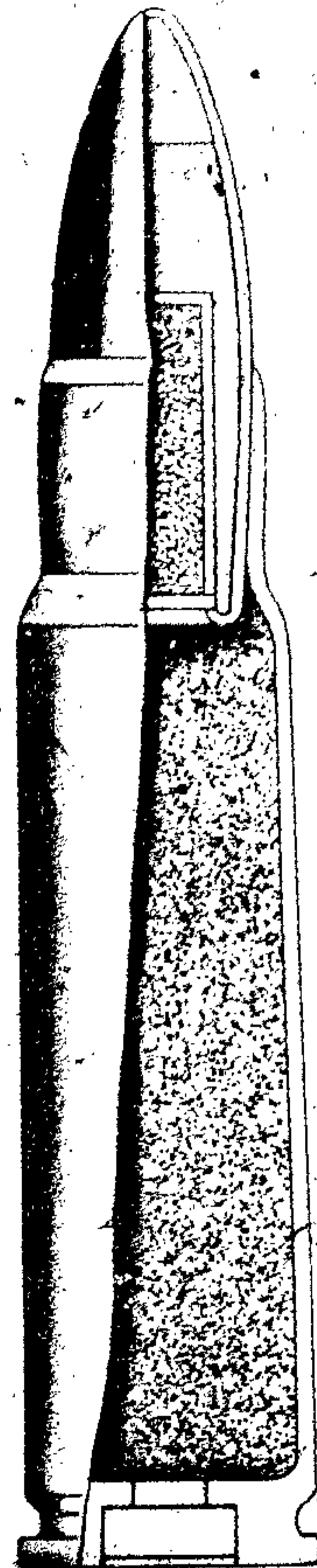

Figure 83 - 12.7-mm Tracer (Red Tip)

12.7-mm Tracer (Red Tip)

Data

Gun used in.....	12.7-mm Aircraft Machine Gun
Over-all length of round	107.25 mm
Weight of complete round	83.60 grams
Length of bullet.....	42.5 mm
Weight of bullet.....	36.35 grams
Length of cartridge case.....	81 mm
Weight of propellant.....	8.1 grams

Remarks

The round has a semirimless brass cartridge case and a bullet with a copper-nickel jacket. The round is the normal tracer type. The bullet has a lead core containing a tracer tube and an aluminum tip. The base is closed by a transparent disc and a brass washer. The color of the tracer is red.

12.7-mm Incendiary (Blue Tip)

Data

Gun used in.....	12.7-mm Aircraft Machine Gun
Over-all length of round....	106.7 mm
Weight of round.....	84.5 grams
Length of bullet.....	44.6 mm
Weight of bullet.....	36.5 grams
Length of cartridge case.....	81 mm
Weight of propellant.....	8.1 grams

Remarks

This bullet consists of a copper-nickel jacket with a copper sleeve container, a brass core, and a lead base plug. The tip of the copper sleeve in front at the brass core is filled with phosphorus, and the rear of the sleeve is sealed to the base of the core with soft solder.

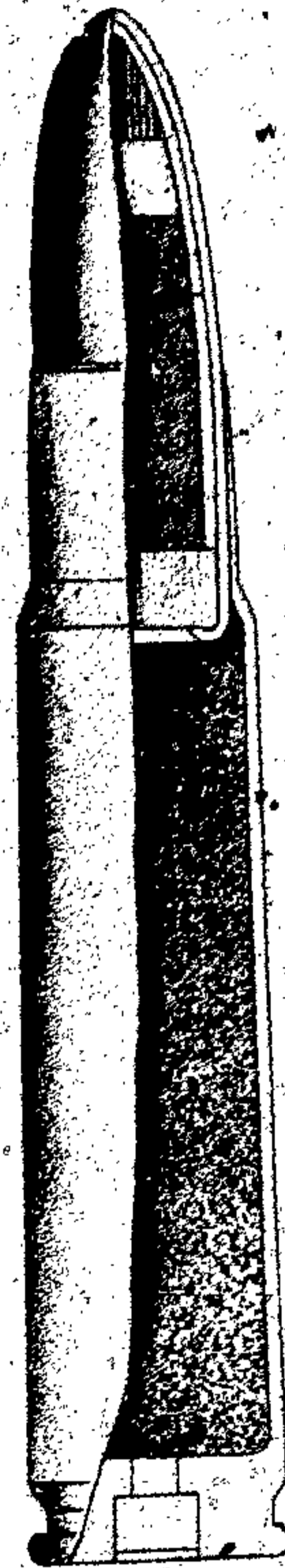

Figure 84 - 12.7-mm Incendiary (Blue Tip)

ITALIAN AND FRENCH EXPLOSIVE ORDNANCE

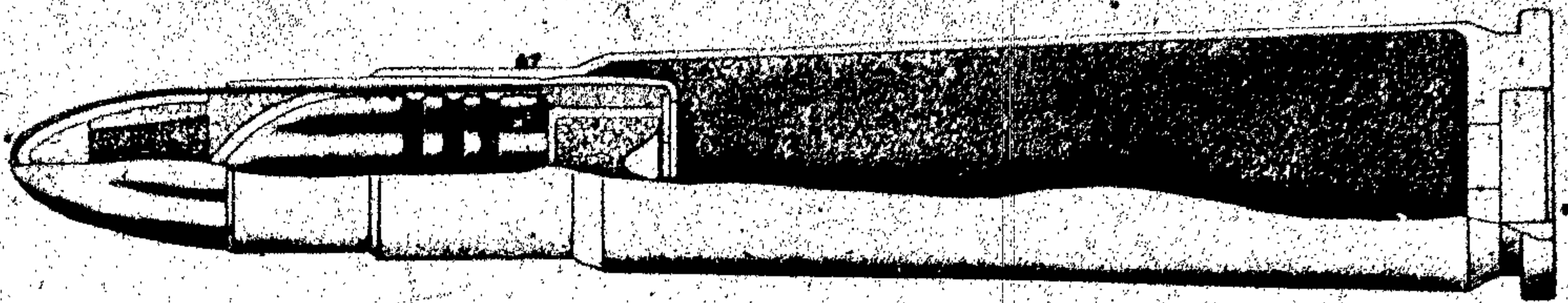

Figure 85 - 12.7-mm A.P.I.T. (White Tip)

12.7-mm A.P.I.T. (White Tip)

Data

Gun used in.....	12.7-mm Aircraft Machine Gun
Over-all length of round.....	107 mm
Weight of complete round.....	83.5 grams
Length of bullet.....	50.6 mm
Weight of bullet.....	36.7 grams
Length of cartridge case.....	81 mm
Weight of propellant.....	7.8 grams

Remarks

The bullet consists of copper-nickel jacket; a

copper sleeve, forming the nose of the bullet; a steel core with a lead bend pressed around its base into cannelures; a lead base plug and tracer tube; a transparent closing disc and brass washer; and a split steel supporting piece in the nose, which possibly acts as a forming anvil. The nose is filled with three compositions: first, in the tip and intimately pressed into the split anvil, a mixture of aluminum-lead oxide; next, a mixture of magnesium-potassium chlorate antimony sulphide; and around the nose of the core, magnesium-lead oxide. The tracer burns a bright red.

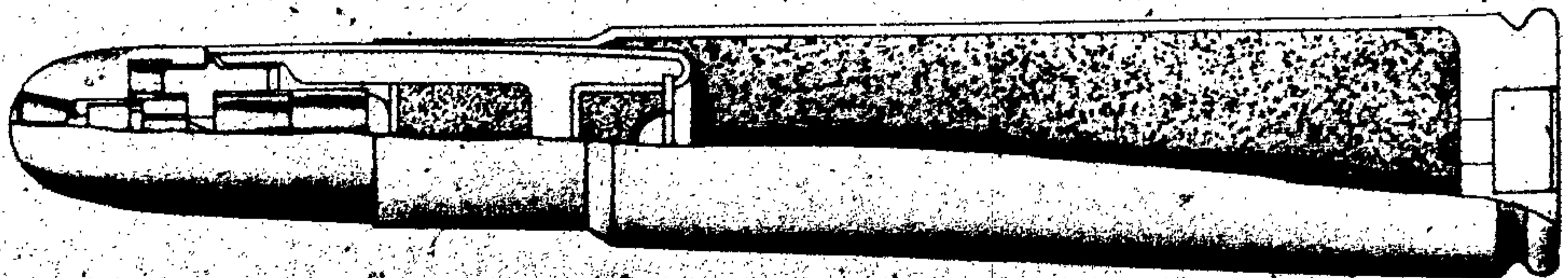

Figure 86 - 12.7-mm H.E.

12.7-mm H.E.

Data

Gun used in.....	12.7-mm Aircraft Machine Gun
Over-all length of round.....	102.5 mm
Weight of complete round.....	84.1 grams
Length of projectile.....	51.3 mm
Weight of projectile.....	37.5 grams
Type of filling.....	Penthrite-wax mixture

Weight of filling.....	0.8 grams
Length of cartridge case.....	81 mm
Weight of propellant.....	8.2 grams

Remarks

The projectile consists of a steel body with a coating of gilding metal in the exterior, which is thickened to form a rotating band. The fuze is similar in action to the German A25045.

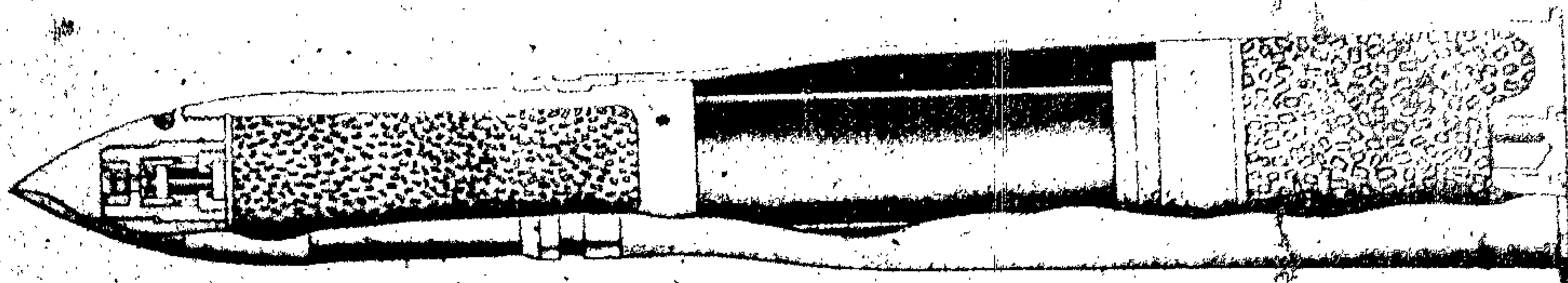

Figure 87 - 37/40-mm H.E.

37/40-mm H.E.

Data

Gun used in.....	37/40-mm Gun
Fuzing.....	Nose Fuze for 37/40 Shell
Over-all length.....	72 mm
Diameter at base.....	36.4 mm (approx.)
Distance base to band.....	18 mm
Width of band.....	22 mm

Diameter at bourrelet.....	36.5 mm
Type of filling.....	Ballistite
Weight of filling.....	41.5 grams
Weight of loaded projectile.....	677 grams
Total length of round.....	328 mm
Weight of complete round.....	2 lb. 13.5 oz.
Weight of propellant.....	112 grams

Remarks

The projectile is closed by a heavy steel pointed nose fitted internally with the fuze.

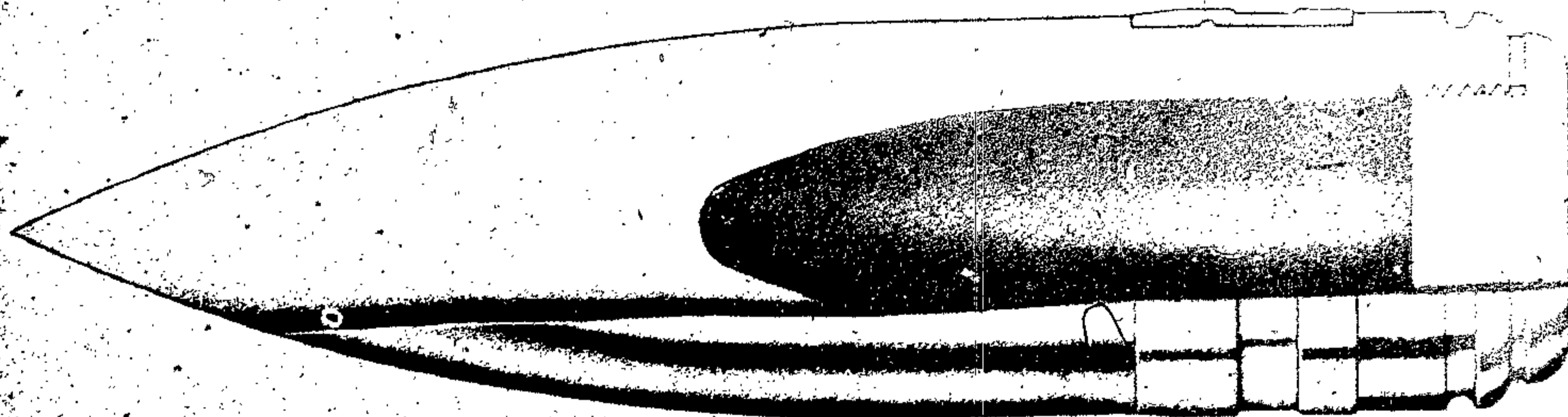

Figure 88 - 37/40-mm H.E./A.P.

37/40-mm H.E./A.P.

Data

Gun used in.....	37/40-mm Gun
Fuzing.....	None
Over-all length.....	138 mm
Diameter at base.....	30 mm
Distance base to band.....	18 mm
Width of band.....	20 mm
Diameter at bourrelet.....	36.4 mm
Type of filling.....	Ballistite

Weight of filling.....	23 grams
Weight of loaded projectile.....	698 grams
Total length of round.....	322 mm
Weight of complete round.....	2 lbs. 14.5 oz.
Weight of propellant.....	112 grams

Remarks

The base of the projectile is closed by a screwed plug, and there is no fuze. It is possible that the filling is intended to ignite by heating effects resulting from shock of impact.

ITALIAN AND FRENCH EXPLOSIVE ORDNANCE

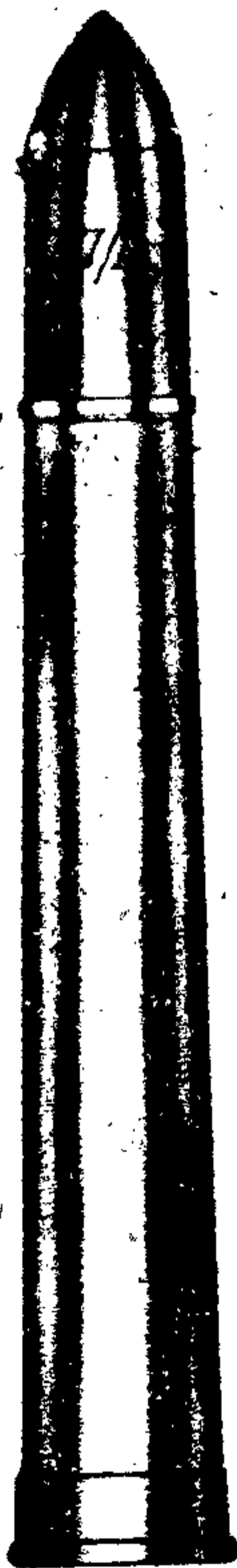

Figure 89 - 37/45-mm A.P.

37/45-mm A.P.

Data	
Gun used in.....	37/45-mm Anti-tank Gun
Fuzing.....	None
Over-all length.....	Unknown
Diameter at base.....	Unknown
Distance base to band.....	Unknown
Width of band.....	Unknown
Diameter at bourrelet.....	Unknown
Weight of loaded projectile.....	0.7 kg.
Total length of round.....	337 kg.
Weight of complete round.....	1.43 kg.
Length of cartridge case.....	202 mm
Weight of propellant.....	0.188 kg.

Remarks

The projectile contains no explosive, but has a tracer.



Figure 90 - 37/54-mm A.A.

37/54-mm A.A.

Data

Guns used in.....	37/54-mm Anti-aircraft Gun
Fuzing.....	Nose fuze for 37/54 Shell
Over-all length.....	Unknown
Diameter at base.....	Unknown
Distance base to band.....	Unknown
Width of band.....	Unknown
Diameter at bourrelet.....	Unknown
Type of filling.....	TNT
Weight of filling.....	0.024 kg.
Weight of loaded projectile.....	0.8 kg.

Remarks

This projectile is a fixed round, packed in a tray for use in the gun. Weight of complete round is 1.59 kg., and over-all length is 14.5 in. The propellant charge weighs 0.2 kg. composed of powder grains 0.65 mm x 7 mm x 185 mm. The projectile is grey-green, with red band below the nose fuze. A tracer is fitted into the base of the projectile.

ITALIAN PROJECTILES



Figure 91 - 40/39-mm A.A.

40/39-mm A.A.

Data	
Gun used in.....	40/39-mm Anti-aircraft Gun
Fuzing.....	Nose Fuze for the 40/39 Shell
Over-all length.....	Unknown
Diameter at base.....	Unknown
Distance base to band.....	Unknown
Width of band.....	Unknown
Diameter at bourrelet.....	Unknown
Type of filling.....	TNT
Weight of filling.....	0.055 kg.

Remarks

This projectile is a fixed round and is packed in a belt for use in the gun. The complete round weighs 1.45 kg. and is 291 mm long. The propellant charge weighs 0.104 kg., composed of powder 2.3 mm x 0.8 mm x 98 mm. The projectile is grey-green in color, with a red band below the nose fuze. A tracer is fitted into the base of the projectile.



Figure 92 - 47/32-mm H.E. M35

47/32-mm H.E. M35

Data	
Gun used in.....	47/32-mm Anti-tank Gun
Fuzing.....	Percussion Nose Fuze M39
Over-all length	
With fuze.....	10.1 in.
Without fuze.....	9.2 in.
Diameter at base.....	Unknown
Distance base to band.....	Unknown
Width of band.....	Unknown
Diameter at bourrelet.....	Unknown
Type of filling.....	TNT
Weight of filling.....	0.15 kg.
Weight of loaded projectile.....	2.37 kg.

Remarks

This projectile is used in a fixed round. The complete round weighs 2.37 kg. The propellant charge weighs 0.052 kg., composed of Italian Type F.C. 4 powder.

The shell is machined from a rolled bar steel and has a parallel-walled cavity the same diameter as the fuze hole. The exterior of the shell is thinly coated with zinc before coloring. There is no base plate. The upper rotating band is more than one third of the length from the base.

ITALIAN AND FRENCH EXPLOSIVE ORDNANCE

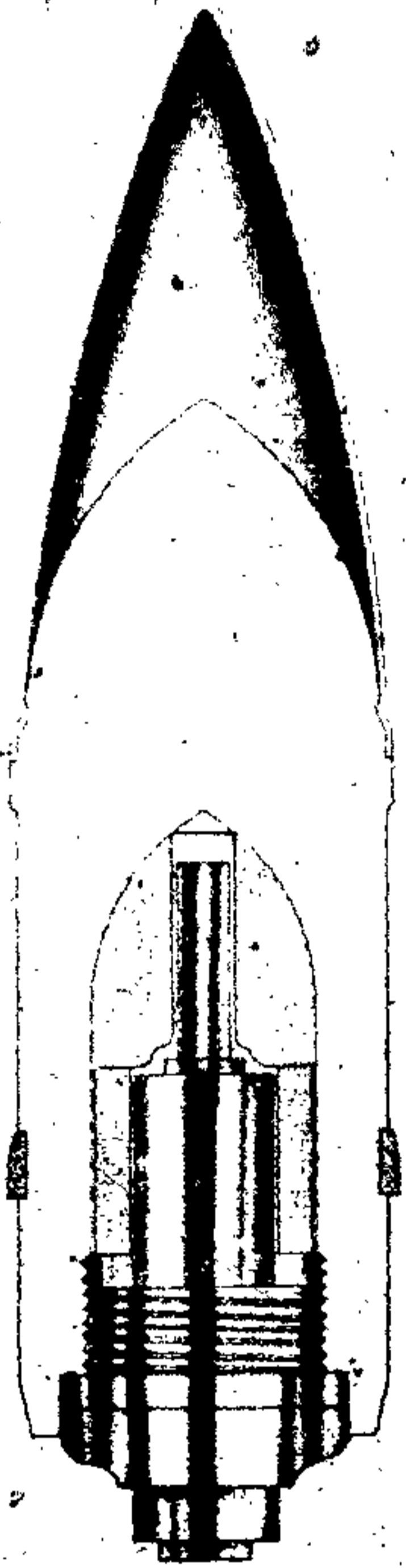

Figure 93 - 47/32-mm A.P. M35 (With Cap)

47/32-mm A.P. M35 (With Cap)

Data

Gun used in.....	47/32-mm Anti-tank Gun
Fuzing.....	Base Fuze MO9
Over-all length (with tracer)	
With cap.....	206 mm
Without cap.....	155 mm
Diameter at base.....	Unknown
Distance base to band.....	50 mm
Width of band.....	8 mm
Diameter at bourrelet.....	Unknown
Type of filling.....	TNT
Weight of filling.....	0.030 kg.
Weight of loaded projectile.....	1.5 kg.
Total length of round.....	355.6
Weight of complete round.....	2.9 kg.

Remarks

A tracer element is fixed to the base of the projectile.

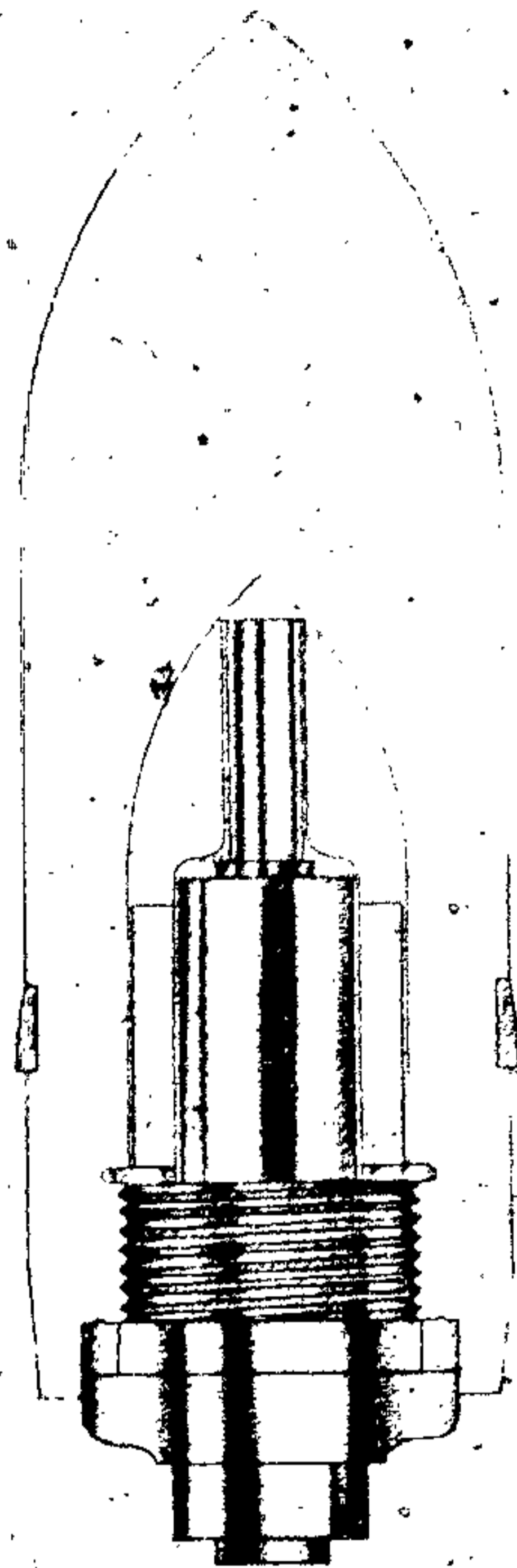

Figure 94 - 47/32-mm A.P. M35 (Without Cap)

47/32-mm A.P. M35 (Without Cap)

Data

Gun used in.....	47/32-mm Anti-tank Gun
Fuzing.....	Base Fuze MO9
Over-all length (with tracer).....	155 mm
Diameter at base.....	Unknown
Distance base to band.....	50 mm
Width of band.....	8 mm
Diameter at bourrelet.....	Unknown
Type of filling.....	TNT
Weight of filling.....	0.030 kg.
Weight of loaded projectile.....	1.5 kg.
Total length of round.....	299.7
Weight of complete round.....	2.9 kg.

Remarks

A tracer element is fixed to the base of the projectile.



Figure 95 - 47/32-mm A.P. M39

47/32-mm A.P. M39

Data

Gun used in.....	47/32-mm Anti-tank Gun
Fuzing.....	Base Fuze MO9
Over-all length.....	Unknown
Diameter at base.....	Unknown
Distance base to band.....	Unknown
Width of band.....	Unknown
Diameter at bourrelet.....	Unknown
Type of filling.....	TNT
Weight of filling.....	0.03 kg.
Weight of loaded projectile.....	1.42 kg.

Remarks

The complete round weighs 2.035 kg. and contains 0.179 kg. propellant powder F. C. 3. A tracer element is fitted into the projectile.

Another version of the M39 has no explosive filling or fuze but contains a tracer element. The round is very similar to the 47/32-mm A. P. M35.

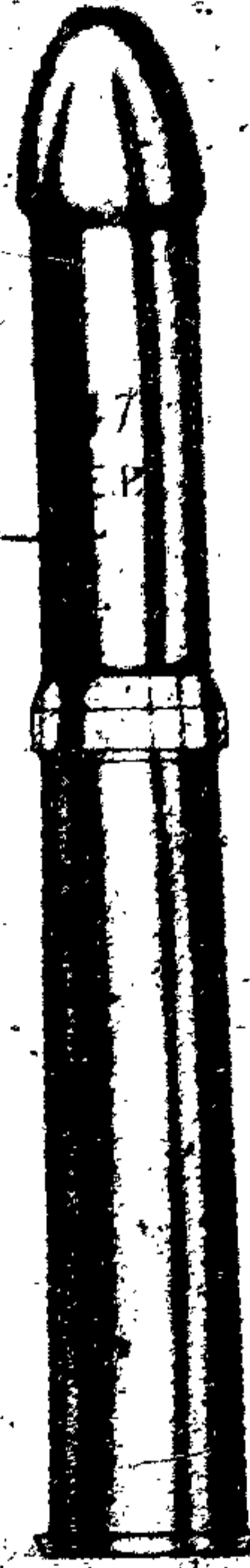

Figure 96 - 47/32-mm E.P. (Hollow-Charge)

47/32-mm E.P. (Hollow Charge)

Data

Gun used in.....	47/32-mm Anti-tank Gun
Fuzing.....	Base Fuze E. P. M41
Over-all length.....	251.5 mm
Diameter at base.....	Unknown
Distance base to band.....	Unknown
Width of band.....	Unknown
Diameter at bourrelet.....	Unknown
Type of filling.....	Tritolite (50% TNT and 50% cyclonite)
Weight of filling.....	Unknown
Weight of loaded projectile.....	1.23 kg.

Remarks

This projectile is used in a fixed round. The propellant charge used is smaller than the other 47/32-mm shells, since a larger portion of the projectile is located in the case.



Figure 97 - 47/32-mm E.P.S. (Hollow-Charge)

47/32-mm E.P.S. (Hollow Charge)

Data	
Gun used in.....	47/32-mm Anti-tank Gun
Fuzing.....	Nose Fuze I. E. P. M.
Over-all length.....	251.5 mm
Diameter at base.....	Unknown
Distance base to band.....	Unknown
Width of band.....	Unknown
Diameter at bourrelet.....	Unknown
Type of filling.....	Unknown
Weight of loaded projectile.....	Unknown
Total length of round.....	Unknown
Weight of complete round.....	Unknown
Length of cartridge case.....	192 mm.

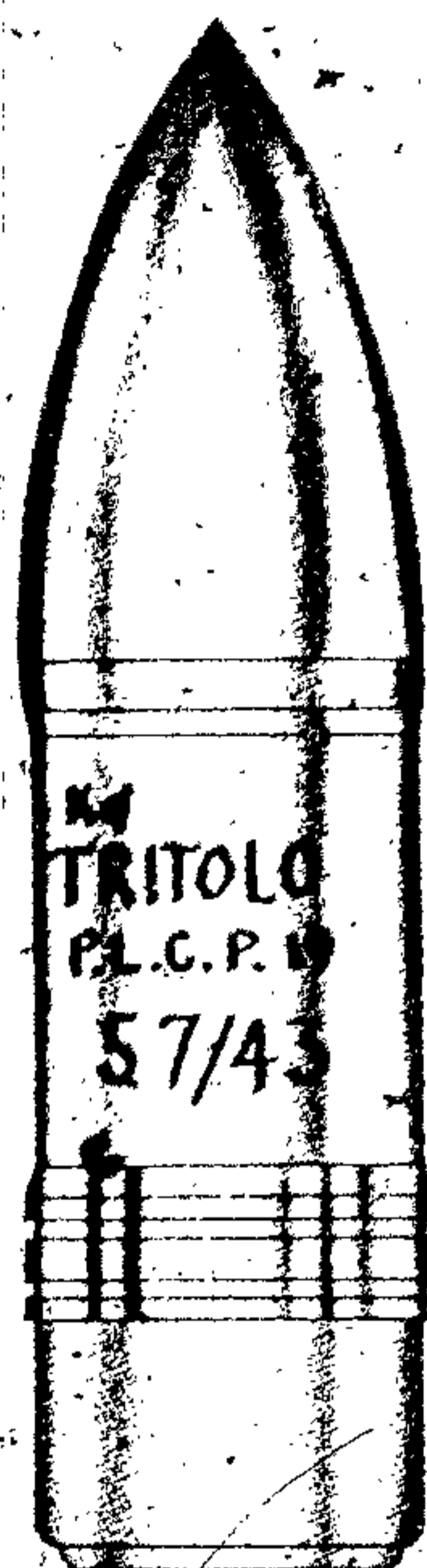

Figure 98.- 57/43-mm A.P. (Without Cap)

57/43-mm A.P. (Without Cap)

Data	
Guns used in.....	57/43-mm Anti-tank Gun
Fuzing.....	Base Percussion Fuze MO9
Over-all length.....	222 mm
Diameter at base.....	Unknown
Distance base to bend.....	36 mm
Width of band.....	Unknown
Diameter at bourrelet.....	Unknown
Type of filling.....	TNT
Weight of filling.....	0.130 kg.
Weight of loaded projectile.....	2.912 kg.

Remarks

This projectile is part of a fixed round which weighs 5.060 kg. and has a propellant charge of ballistite. The propellant weighs 0.460 kg. and is compressed of grains 2 mm x 2 mm x 300 mm.



Figure 99 - 57/43-mm A.P. (With Cap)

57/43-mm A.P. (With-Cap)

Data	
Gun used in.....	57/43-mm Anti-tank Gun
Fuzing.....	Base Percussion Fuze MO9
Over-all length.....	252.5 mm
Diameter at base.....	Unknown
Distance base to band.....	36 mm
Width of band.....	Unknown
Diameter at bourrelet.....	Unknown
Type of filling.....	TNT
Weight of filling.....	105 kg.
Weight of loaded projectile.....	5.083 kg.

Remarks

This projectile is almost identical to the 57-mm. A. P. (without cap) except that a ballistic cap is added. The propellant charge weighs 0.550 kg. and consists of powder C2 in grains 3:3 x 1.1 x 205 and 102 mm.



Figure 100 - 65/17-mm H.E.

65/17-mm H.E.

Data	
Gun used in.....	65/17-mm Mountain Gun
Fuzing.....	Nose Percussion Fuze M10
Over-all length.....	
With fuze.....	244 mm
Without fuze.....	234 mm
Diameter at base.....	64.5 mm
Distance base to band.....	23 mm
Width of band.....	7 mm
Diameter at bourrelet.....	64.7 mm
Type of filling.....	TNT or MNDT
Weight of filling.....	0.23 kg
Weight of loaded projectile.....	4.15 kg.
Total length of round.....	394 mm
Weight of complete round.....	5.00 kg
Booster used.....	No. 5 M38

Remarks

The projectile is thought also to have been fuzed with the Nose Fuze A. D. E. M00, 17. This fuze requires the removal of nose adapter and also changes the length and weight of the projectile.

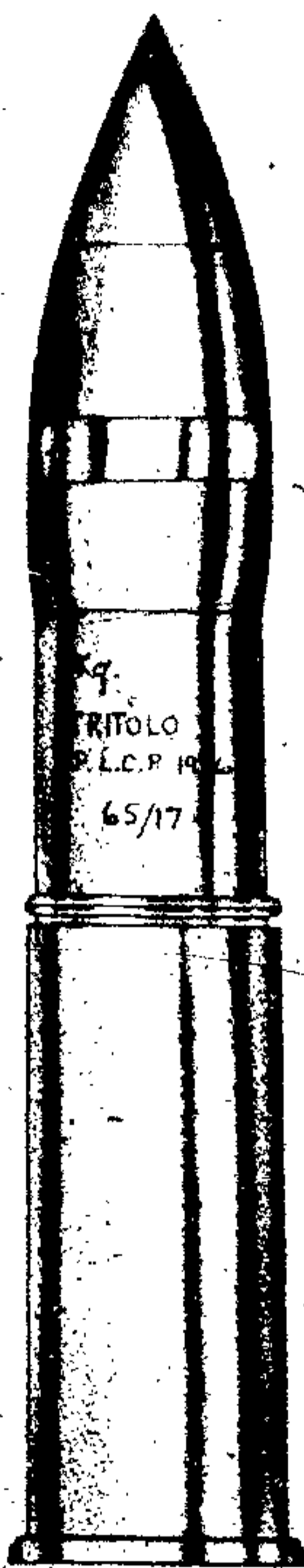

Figure 101 - 65/17-mm A.P.

65/17-mm A.P.

Data	
Gun used in.....	65/17-mm Mountain Gun, Mortar Gun
Fuzing.....	Base Percussion Fuze MO9
Over-all length.....	280 mm
Diameter at base.....	64.5 mm
Distance base to band.....	23 mm
Width of band.....	7 mm
Diameter at bourrelet.....	64.7 mm
Type of filling.....	TNT
Weight of filling.....	0.160 kg.
Weight of loaded projectile.....	4.23 kg.

Remarks

The projectile is part of a fixed round. The propellant charge weighs 5.130 kg.

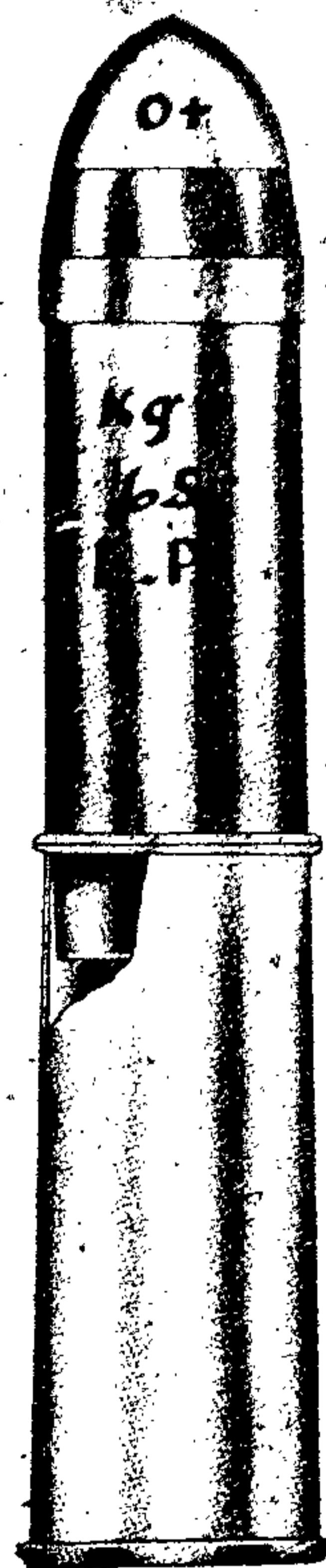

Figure 102 - 65/17-mm E.P. (Hollow-Charge)

65/17-mm E.P. (Hollow-Charge)

Data	
Gun used in.....	65/17-mm Mountain Gun
Fuzing.....	Base Fuze E. P. M41
Over-all length.....	243.4 mm
Diameter at base.....	64.60 mm
Diameter at bourrelet.....	64.70 mm
Type of filling.....	Unknown
Weight of filling.....	Unknown
Weight of loaded projectile.....	Unknown

Remarks

The projectile with its cartridge case makes up a fixed round of ammunition, the length of which is 412.6 mm.

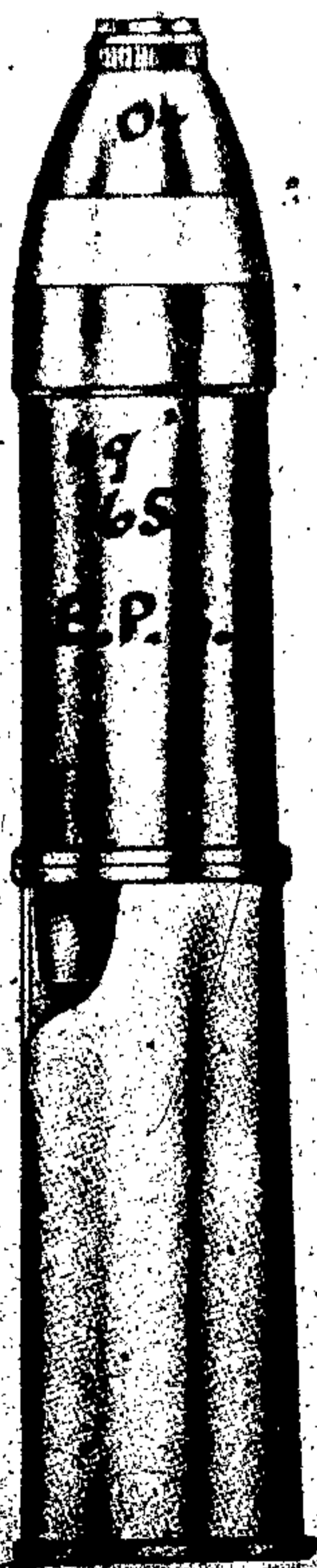

Figure 103 - 65/17-mm E.P.S. (Hollow-Charge)

65/17-mm E.P.S. (Hollow-Charge)

Data	
Gun used in.....	65/17-mm Mountain Gun
Fuzing.....	Nose Fuze I. E. P. M.
Over-all length.....	248.7 mm
Diameter at base.....	64.60 mm
Distance base to band.....	Unknown
Diameter at bourrelet.....	64.70 mm
Type of filling.....	Unknown
Weight of filling.....	Unknown
Weight of loaded projectile.....	Unknown

Remarks

The projectile is used in a fixed round the over-all length of which is 418.2 mm.



Figure 104 - 70/17-mm H.E.

70/15-mm H.E.

Data

Gun used in.....	70/15-mm Pack Gun
Fuzing.....	Nose Percussion Fuze M10 or Nose Fuze M (Guerritore)
Over-all length.....	
-Without fuze.....	229 mm
Diameter at base.....	6.93 (approx.)
Distance base to band.....	Unknown
Width of band.....	Unknown
Diameter at bourrelet.....	69.5 mm
Type of filling.....	TNT
Weight of filling.....	0.275 kg.
Weight of loaded projectile.....	4.75 kg.

ITALIAN AND FRENCH EXPLOSIVE ORDNANCE

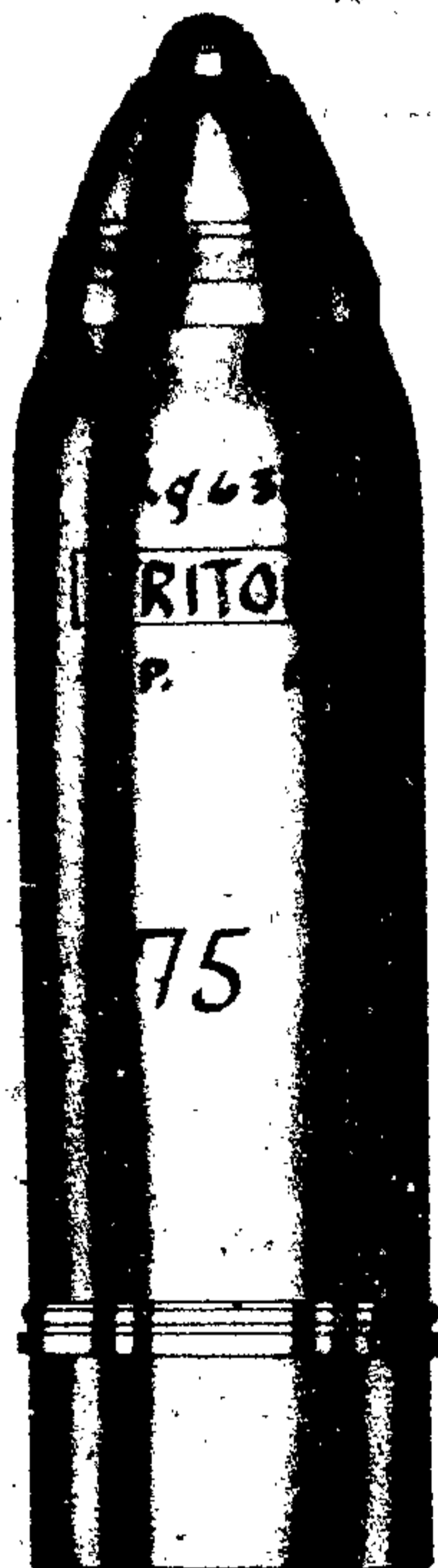

Figure 105 - 75-mm H.E.

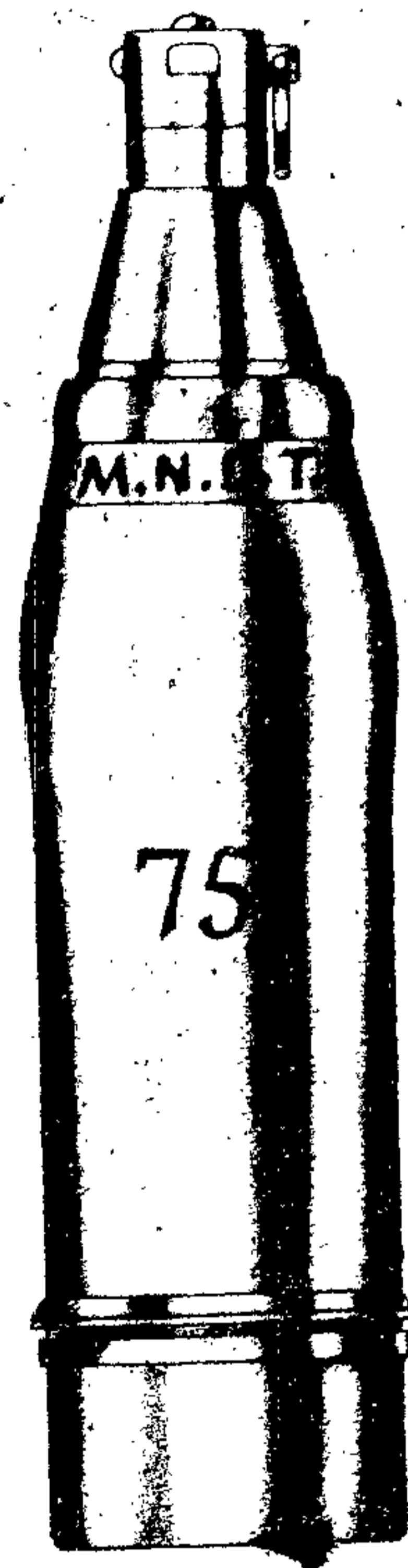

Figure 106 - 75/13-mm H.E. (Light-Case)

75/13-mm H.E.

Data

Gun used in.....	75/13-mm Mountain Gun
Fuzing.....	Nose Percussion M10, I.M35 p. c., I. M38 p.c., or I. M40 p. c.
Over-all length.....	266 mm
Diameter at base.....	74.2 mm
Distance base to band.....	Unknown
Width of band.....	Unknown
Diameter at bourrelet.....	74.6 mm
Type of filling.....	TNT
Weight of filling.....	0.37 kg.
Weight of loaded projectile.....	6.37 kg.

75/13-mm H.E. (Light-Case)

Data

Gun used in.....	75/13-mm Field Gun
Fuzing.....	Nose Percussion, Fuze M (Guerritore) or M10
Over-all length Without fuze.....	276.7 mm
Diameter at base.....	74.2 mm
Distance base to band.....	38 mm
Width of band.....	12 mm
Diameter at bourrelet.....	74.6 mm
Type of filling.....	MNDT or TNT
Weight of filling.....	0.53 kg.
Weight of loaded projectile.....	5.1 kg.
Booster used.....	No. 1 M38

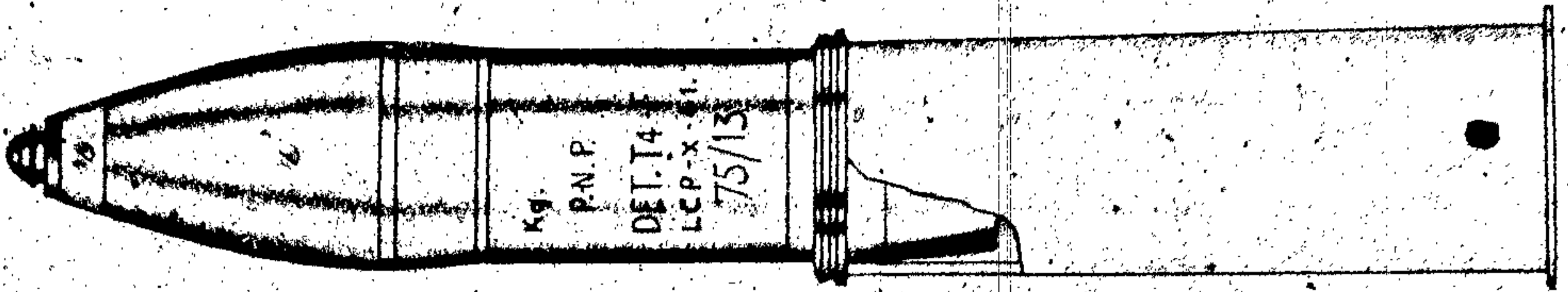

Figure 107 - 75/13-mm H.E. M32

75/13-mm H.E. M32

Data

Guns used in	Assault Guns
Fixed—75/18-mm and 75/34-mm Self-Propelled	
Semifixed—75/27-mm Field Gun	
Fuzing	Nose Percussion Fuze M10
Over-all length	
With fuze	319 mm
Without fuze	305 mm
Diameter at base	64.40 mm

Distance base to band	58 mm
Width of band	9.7 mm
Diameter at bourrelet	74.74 mm
Type of filling	0.6 kg.
Weight of loaded projectile	6.35 kg.
Total length of round	
75/18	479.1 mm
75/34	580.7 mm
Weight of complete round	
75/18	7.725 kg.
75/34	8.52 kg.
Weight of propellant charge	
75/18	0.420 kg. Ballistite
75/34	0.69 kg. F. B1 Powder

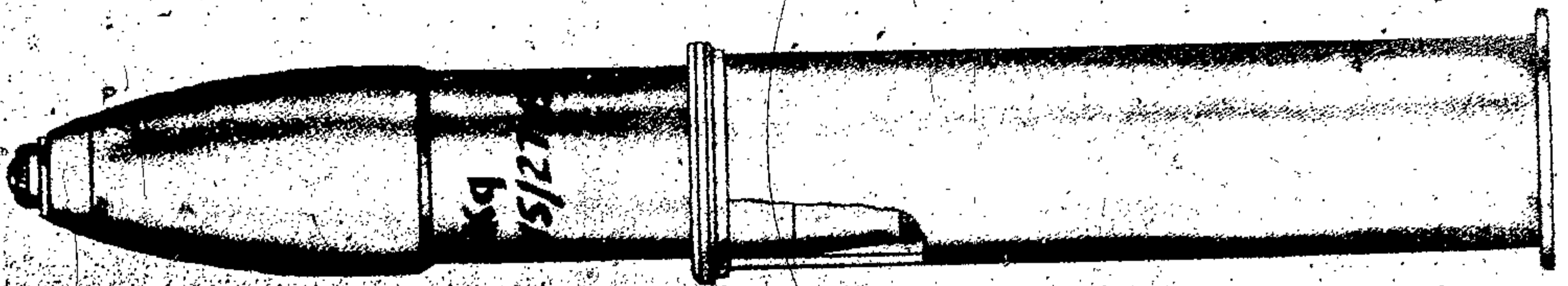

Figure 108 - 75/27-mm H.E. M32

75/27-mm H.E. M32

Data

Guns used in	Assault Gun
Fixed—75/18-mm Self-Propelled	
Semifixed—75/13-mm Mountain Gun	
Fuzing	Nose Percussion Fuze M10 or I. O. M40 p. c.
Over-all length	
With fuze	319 mm
Without fuze	305 mm

Diameter at base	Unknown
Distance base to band	46 mm
Width of band	9.7 mm
Diameter at bourrelet	74.74 mm
Type of filling	TNT
Weight of filling	0.60 kg.
Weight of loaded projectile	6.35 kg.
Total length of round	591.5 mm
Weight of complete round	7.725 kg.
Weight of propellant charge	0.420 kg. Ballistite

ITALIAN AND FRENCH EXPLOSIVE ORDNANCE

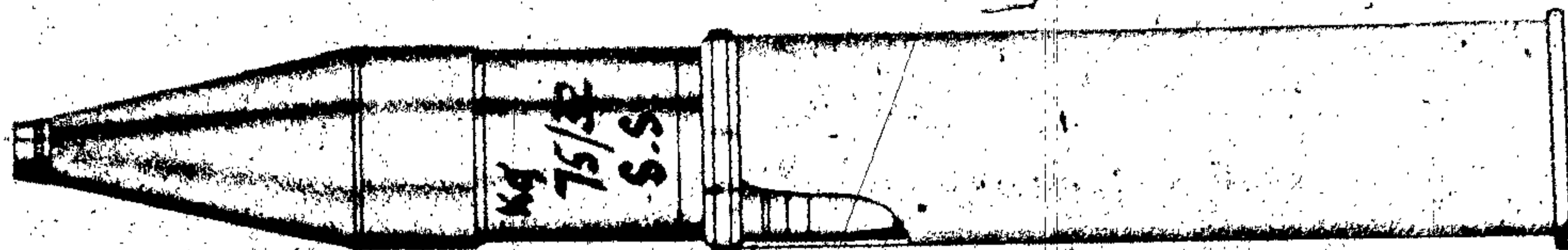

Figure 109 - 75/32-mm H.E.

75/32-mm H.E.

Data

Guns used in

Fixed ammunition—75/34-mm Self-propelled Assault gun

Semifixed ammunition—75/32-mm Field Gun

Fuzing ----- Nose Fuze I. O. M.

.36/40 or Nose

Fuze A. D. E. M36

Over-all length ----- 351 mm

Diameter at base ----- 65.20 mm

Distance base to band ----- 53 mm

Width of band ----- 15 mm

Diameter at bourrelet ----- 74.74 mm

Type of filling ----- Probably TNT

Weight of filling ----- Unknown

Weight of loaded projectile ----- 6.35 kg.

Remarks

The same projectile is used in fixed, or semi-fixed type ammunition. The cartridge case used for fixed round for the 75/34-mm gun is 632.1 mm long and weighs 8.42 kg. The propellant consists of I. B. 1 powder weighing 0.69 kg.



Figure 110 - 75/46-mm H.E. M34

75/46-mm H.E. M34

Data

Gun used in

Fixed ammunition—75/46-mm Antiaircraft Gun

Fuzing ----- Nose Fuze M. T. for 75/46, or M. T. 36 or Time M36

Over-all length ----- Unknown

Diameter at base ----- Unknown

Distance base to band ----- Unknown

Width of bands

1st band ----- 15 mm

2nd band ----- 16 mm

Diameter at bourrelet ----- 74.750

Type of filling ----- TNT

Weight of filling ----- 0.330 kg.

Weight of loaded projectile ----- 6.5 kg.

Booster ----- No. 5 M38

Remarks

The projectile has double rotation, band with a space of 10 mm between them. The complete rounds weigh 10.645 kg. and are 866.7 mm long. The propelling charge is C2 weighing 1.470 kg.

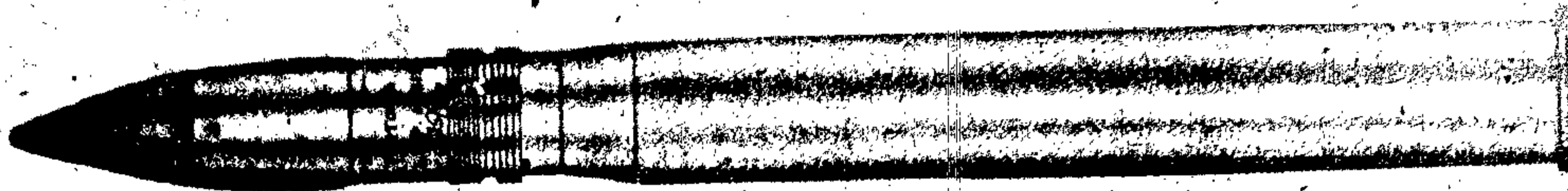

Figure 111 - 75/46-mm H.E. M36

75/46-mm H.E. M36

Data

Gun used in	Fixed ammunition—75/46-mm Antiaircraft Gun
Fuzing	Nose Fuze A. D. E. M36
Over-all length	Unknown
Diameter at base	Unknown
Distance base to band	Unknown
Width of band	
1st Band	15 mm
2nd Band	16 mm
Diameter at bourrelet	74.75 mm

Type of filling	TNT
Weight of filling	0.345 kg.
Weight of loaded projectile	6.355 kg.
Length of complete round	880.4 mm
Length of cartridge case	582.7 mm
Type of propellant	
	1.070 kg. C2 Powder, or
	1.945 kg. N.A.C. Powder, or
	1.605 kg. M.B. Powder
	1.685 kg. F.C4 Powder
	1.617 kg. F. B1 Powder

Remarks

Double rotating band 10 mm apart. Projectile almost identical to 75 H. E. M34.

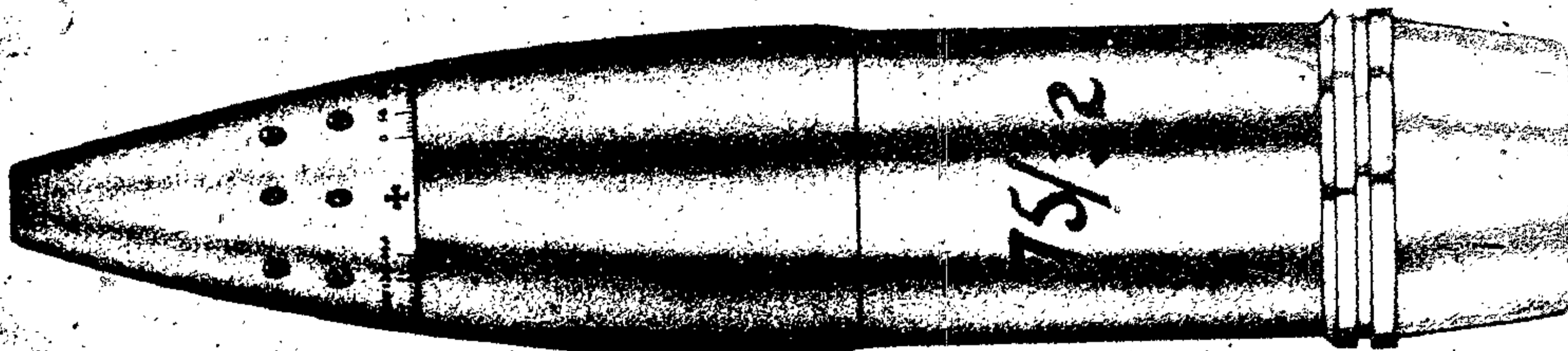

Figure 112 - 75/32-mm A.D.E.-H.E.

75/32-mm A.D.E.-H.E.

Data

Gun used in	Semifixed ammunition—75/32-mm Field Gun
Fuzing	Nose Fuze A. D. E. M36
Over-all length	
With fuze	368 mm
Without fuze	273 mm
Diameter at base	65.20
Distance base to band	42 mm

Width of band	14 mm
Diameter at bourrelet	74.74 mm
Type of filling	Unknown
Weight of filling	0.5 kg.
Weight of loaded projectile	6.3 kg.
Cartridge case	Type for 75/32-mm gun

Remarks

This projectile is called a double-purpose type by the Italians and Germans. It can be set for aerial burst or impact.

ITALIAN AND FRENCH EXPLOSIVE ORDNANCE

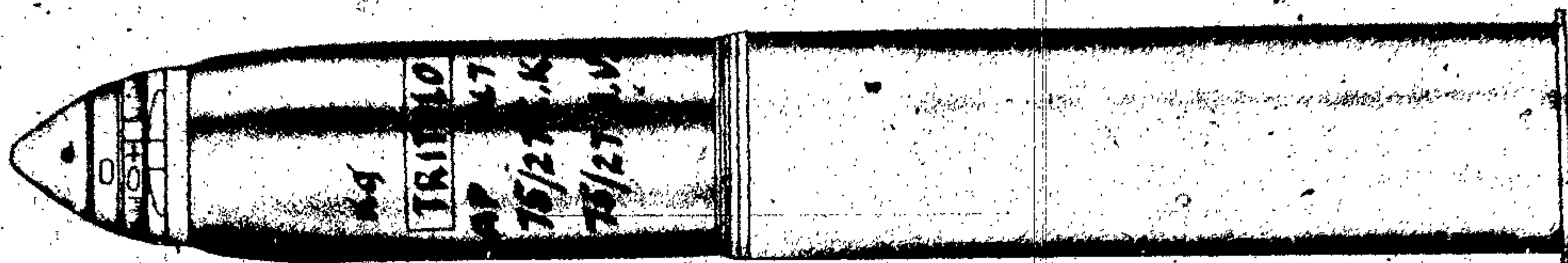

Figure 113 - 75-mm A.A.

75-mm A.A.

Data

Gun used in
Fixed ammunition—75/27-mm antiaircraft
Gun

Fuzing..... Nose Time Fuze
MO6/17

Over-all length..... Unknown

Diameter at base..... Unknown

Distance base to band..... Unknown

Width of band..... Unknown

Diameter at bourrelet..... Unknown

Type of filling..... TNT

Weight of filling..... 0.123 kg.

Weight of loaded projectile..... 6.381 kg.

Length of complete round..... 517 mm

Weight of complete round..... 8.320 kg.

Propellent charge..... 0.570 kg.
Ballistite,
or 0.560 kg.
C2 Powder

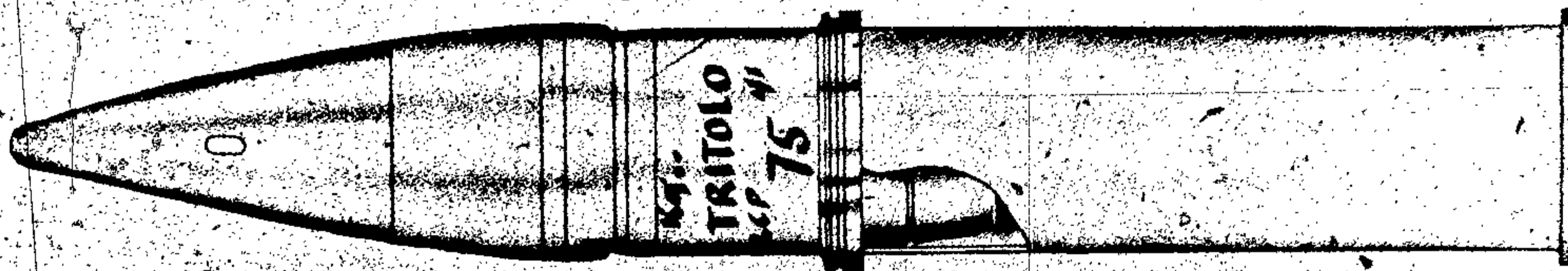

Figure 114 - 75-mm A.P.

75-mm A.P.

Data

Guns used in
Fixed—75/18-mm Self-Propelled Assault Gun
Semifixed—75/13-mm Mountain Howitzer

Fuzing..... Base Fuze
MO9/41 p. c.

Over-all length..... 330 mm

Diameter at base..... Unknown

Distance base to band..... 49.7 mm

Width of band..... 9.7 mm

Diameter at bourrelet..... 74.74 mm

Type of filling..... TNT

Weight of filling..... 0.265 kg

Weight of loaded projectile..... 6.42 kg.

Length of round (fixed)
75/18-mm Self-propelled gun 572.8 mm

Weight of round (fixed)..... 8.080 kg.

Propellent charge (fixed)..... 0.420 kg.
Ballistite

Booster..... No. 5 M38

Remarks

The projectile is fitted with piercing and ballistic caps. The cartridge case for 75/18-mm fixed round is made of steel.

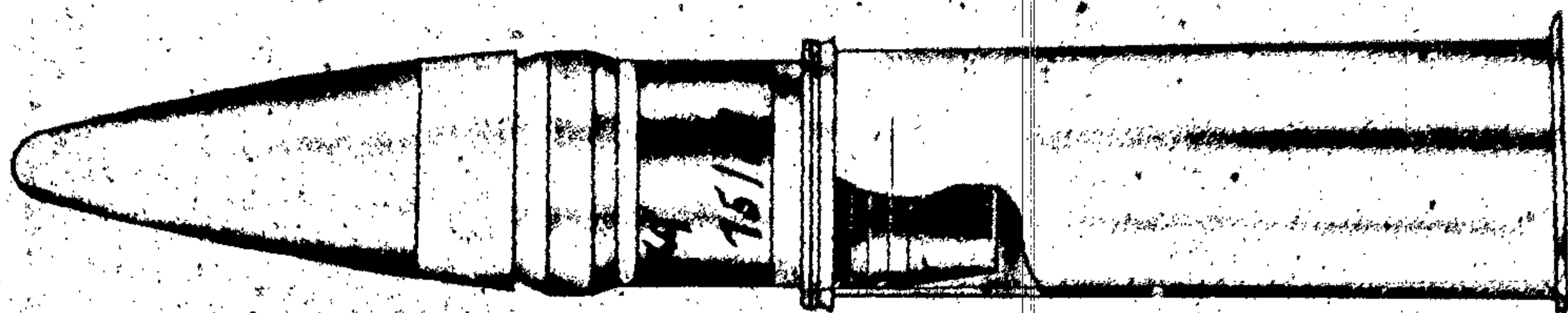

Figure 115 - 75/27-mm A.P.

75/27-mm A.P.

Data

Guns used in
 Fixed—75/18-mm Self-Propelled Assault Gun
 Semifixed—75/27-mm Field Gun

Fuzing ----- Base Fuze
 MO9/41

Over-all length ----- 307 mm

Diameter at base ----- Unknown

Distance base to band ----- 50 mm

Width of band ----- 9.7 mm

Diameter at bourrelet ----- 74.74 mm

Type of filling ----- Probably TNT

Weight of filling ----- 0.27 kg.

Weight of loaded projectile ----- 6.200 kg.

Length of round (fixed)
 75/18-mm ----- 589.5 mm

Weight of round (fixed) ----- 7.880 kg.

Propellant charge (fixed) ----- 0.420 kg.
 Ballistite

Remarks

Cartridge case for 75/18-mm fixed round is steel.

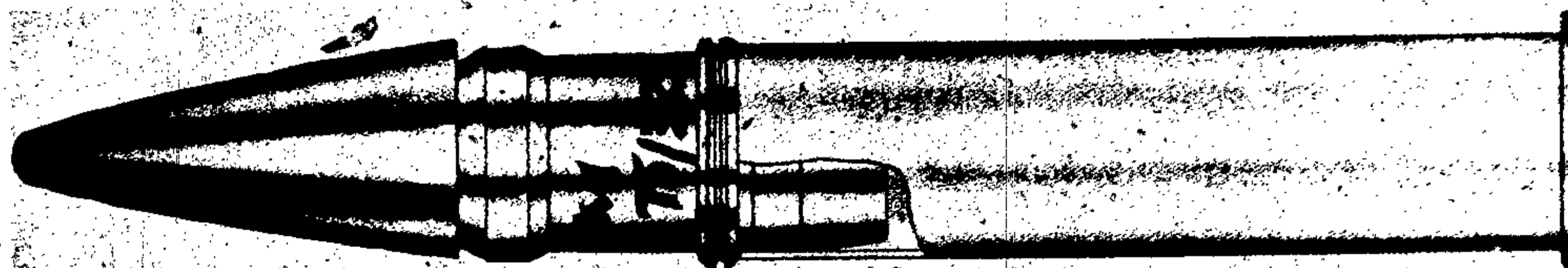

Figure 116 - 75/32-mm A.P.

75/32-mm A.P.

Data

Guns used in
 Fixed—75/34-mm Self-Propelled Assault Gun
 Semifixed—75/32-mm Field Gun

Fuzing ----- Base Fuze MO9/41

Over-all length ----- 307 mm

Diameter at base ----- Unknown

Distance base to band ----- 50 mm

Width of band ----- 15 mm

Diameter at bourrelet ----- 74.74 mm

Type of filling ----- Probably TNT

Weight of filling ----- Unknown

Length of round (fixed) ----- 591.1 mm

Weight of round (fixed) ----- 8.59 kg.

Propellant charge (fixed) ----- 0.85 kg.
 F.B1 Powder

Remarks

Projectile differs very slightly from 75-mm A. P. Type 1 and Type 2.

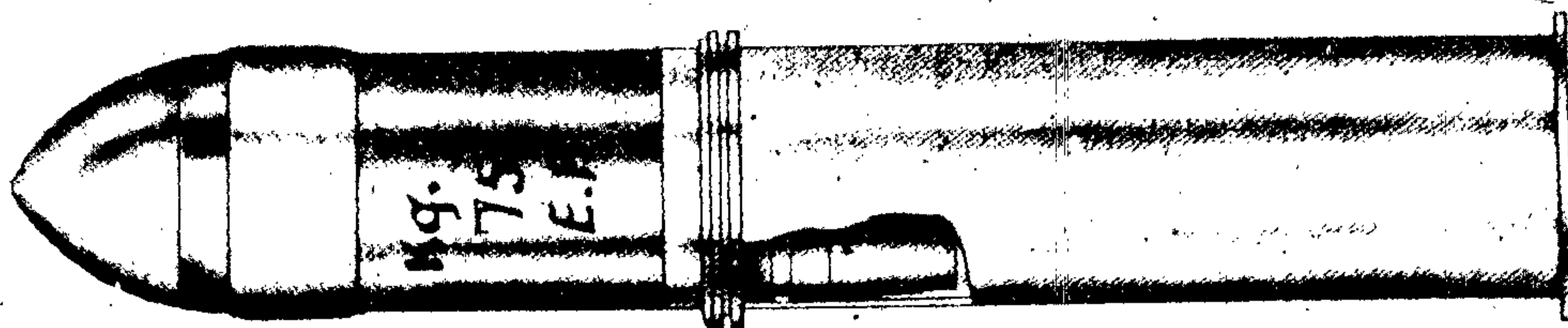

Figure 117 - 75-mm E.P. (Hollow-Charge)

75-mm E.P. (Hollow-Charge)

Data

Guns used in

Fixed—75/18-mm Self-Propelled Assault Gun

Semifixed—75/18-mm Mountain Howitzer

Fuzing..... Base Fuze E. P. M36

Over-all length

With nose cap..... 254 mm

Without nose cap..... 208 mm

Diameter at base..... Unknown

Distance base to band..... 58 mm

Width of band..... 9.7 mm

Diameter at bourrelet..... 74.74 mm

Type of filling..... Unknown

Weight of filling..... Unknown

Weight of loaded projectile..... 4.500 kg.

Length of round (fixed)..... 428.5 mm

Weight of round (fixed)..... 5.870 kg.

Propellent charge (fixed)..... 0.249

Ballistite

Remarks

The semifixed round uses the cartridge case for the 75/18-mm Howitzer. The cartridge case for the fixed round is made of steel.

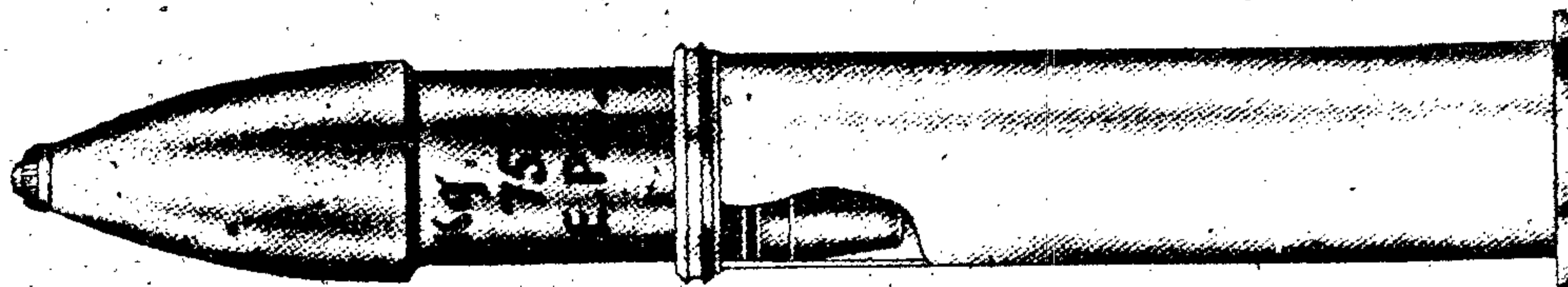

Figure 118 - 75-mm E.P.S. (Hollow-Charge)

75-mm E.P.S. (Hollow-Charge)

Data

Gun used in

Semifixed—75/13-18-27-32-mm Guns

Fixed—Self-Propelled Assault Guns

Fuzing..... Base Fuze

I. E. P. M.

Over-all length

With fuze..... 310 mm

Without fuze..... 302 mm

Diameter at base..... Unknown

Distance base to band..... 58 mm

Width of band..... 9.7 mm

Diameter at bourrelet..... 74.74 mm

Type of filling..... Unknown

Weight of filling..... Unknown

Total length of round

75/13-mm..... 484.5 mm

75/18-mm..... 578.1 mm

Weight of complete round

75/13-mm..... 6.57 kg.

75/18-mm..... 7.37 kg.

Weight of propellant

75/13-mm..... 0.249 kg.

75/18-mm..... 0.690 kg.

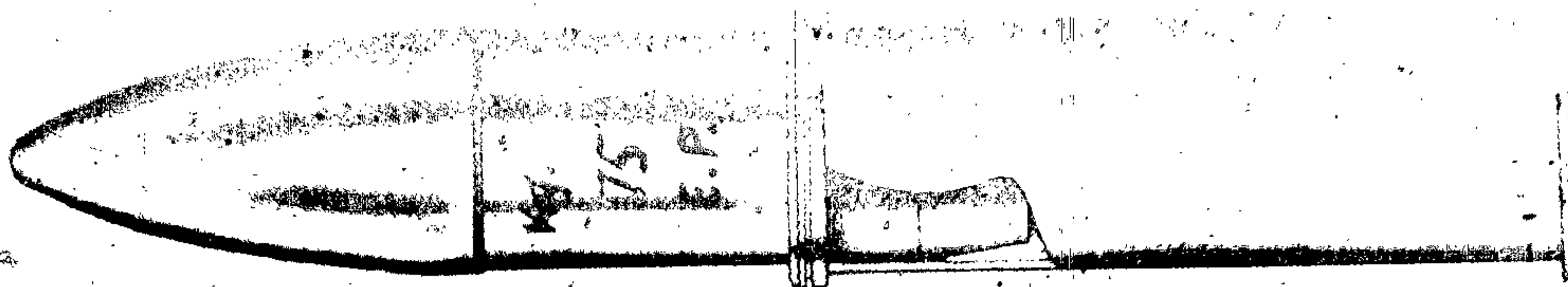

Figure 119 - 75/13-mm E.P. (Hollow-Charge)

75/13-mm E.P. (Hollow-Charge)

Data

Guns used in	
Fixed—75/18-mm Self-Propelled Assault Gun	
Semifixed—75/18-mm Mountain Howitzer	
Fuzing	Base Fuze E. P. M41
Over-all length	307 mm
Diameter at base	Unknown
Distance base to band	58 mm
Width of band	9.7 mm

Diameter at bourrelet	74.74 mm
Type of filling	Probably TNT
Weight of filling	Unknown
Length of round (fixed)	483 mm
Weight of round (fixed)	6.570 kg.
Weight of loaded projectile	5.200 kg
Propellent charge (fixed)	0.249 kg.
	Ballistite

Remarks

The fixed cartridge case is made of steel. The projectile has a nose cap which is 83.5 mm long.

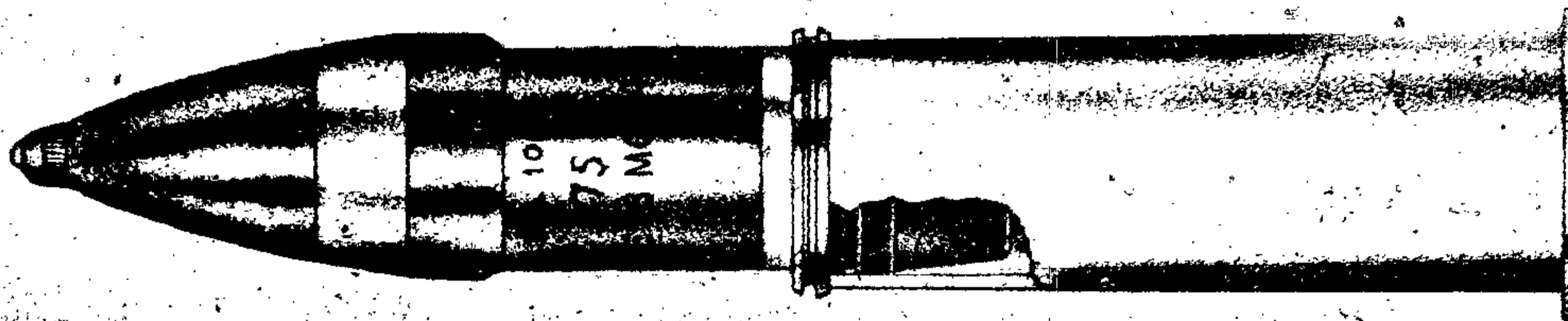

Figure 120 - 75-mm E.P.S. M42 (Hollow-Charge)

75-mm E.P.S. M42 (Hollow-Charge)

Data

Guns used in	
Fixed—75/18-mm Self-Propelled Assault Gun	
75/34-mm Self-Propelled Assault Gun	
Semifixed—75/27-mm Field Gun	
Fuzing	Nose Fuze E. P. S. M42
Over-all length	
With fuze	310 mm
Without fuze	298 mm
Diameter at base	Unknown
Distance base to band	58 mm
Width of band	9.7 mm
Diameter at bourrelet	74.74 mm
Type of filling	Probably TNT

Weight of filling	Unknown
Weight of loaded projectile	5.300 kg.
Length of round (fixed)	
75/18-mm gun	484.5 mm
75/34-mm gun	586.1 mm
Propellent charge (fixed)	
75/18-mm gun	0.249 kg.
	Ballistite
75/34-mm gun	0.690 kg.
	F. B1 Powder
Weight of round (fixed)	
75/18-mm	6.670 kg.
75/34-mm	7.470 kg.

Remarks

The cartridge case in the fixed type of ammunition (75/18-mm) is made of steel. The projectile has a 74-mm cap, which is hollow.

ITALIAN AND FRENCH EXPLOSIVE ORDNANCE

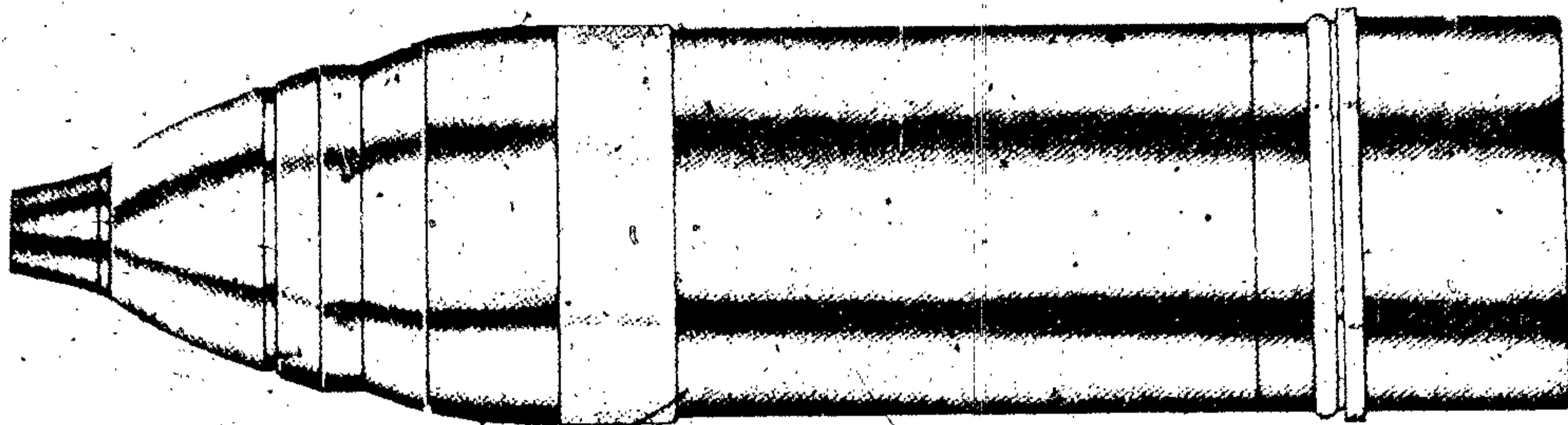

Figure 121—75-mm Incendiary (F/C) and (F.I/C)

75-mm Incendiary (F/C) and F.I/C

Data

Gun used in	75-mm Infantry Gun
Fuzing	Nose Percussion Fuze I. M35; p. c./I. M38, p. c.
Over-all length (without fuze)	
(F/C)	266 mm
(F. I/C)	276.7 mm
Diameter at base	74.2 mm
Distance base to band	38 mm
Width of band	10 mm

Diameter at bourrelet

(F/C)	74.5 mm
(F. I/C)	74.6 mm
Type of filling (F. I/C)	Phosphorus
Weight of filling (F. I/C)	0.70 kg.
Weight of loaded projectile	
(F/C)	6.3 or 6.4 kg
(F. I/C)	5.265 kg.

Remarks

These two projectiles are similar, except for weight and type of incendiary filling.

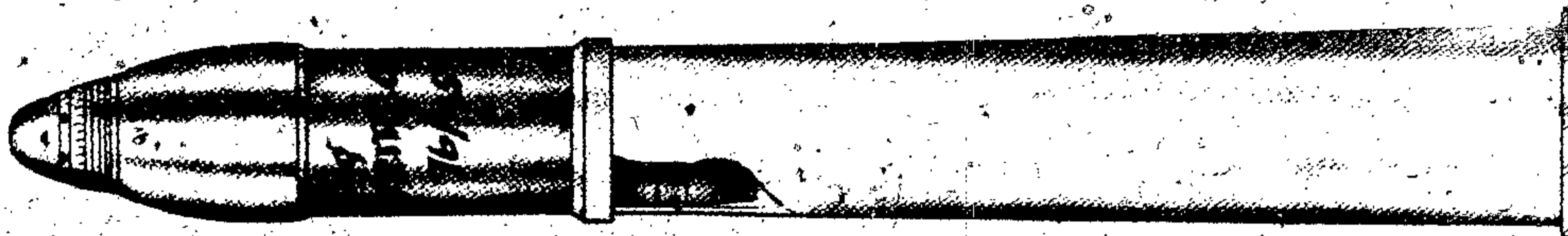

Figure 122—76/40-45-mm H.E.

76/40-45-mm H.E.

Data

Guns used in-as	
Fixed—76/40-mm Antiaircraft Gun	
76/45-mm Antiaircraft Gun	
Fuzing	Nose Time Fuze M900/34
Over-all length	
With nose	309 mm
Diameter at base	75.4 mm
Distance base to band	Unknown
Diameter at bourrelet	75.74 mm

Type of filling	TNT
Weight of filling	0.50 kg.
Weight of loaded projectile	6.050 kg.
Weight of complete round	
76/40-mm	R. C. 9.115 kg.
76/45-mm	9.635 kg.
76/45-mm	R. C. Unknown
76/45-mm	10.328 kg.
Propellent charge	
76/40—Full charge	0.970 kg. Ballistite
76/40—Reduced charge	0.284 kg.
76/45—Full charge	1.620 kg.
76/45—Reduced charge	0.332 kg. Ballistite

ITALIAN PROJECTILES

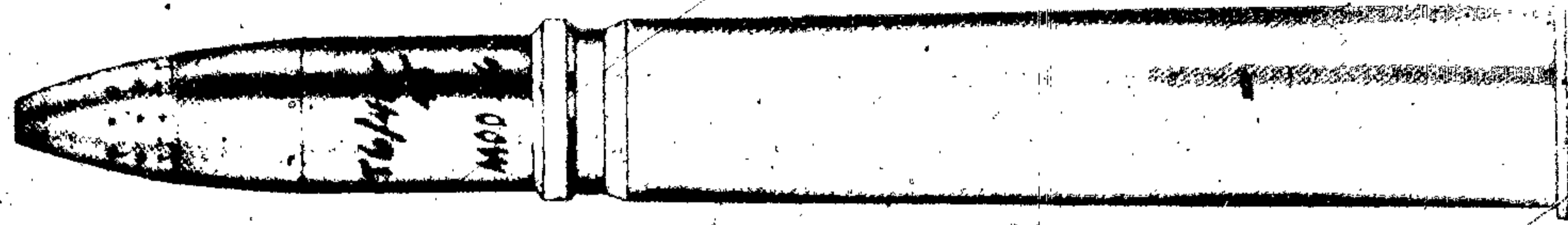

Figure 123 - 76/40-45-mm H.E. M36

76/40-45-mm H.E. M36

Data

Guns used in	
Fixed—76/40-mm Antiaircraft Gun	
76/45-mm Antiaircraft Gun	
Fuzing	Nose Time Fuze
	M36
Over-all length	Unknown
Diameter at base	Unknown
Distance base to band	Unknown
Width of band	17.2 mm
Diameter at bourrelet	75.74 mm

Type of filling	Probably TNT
Weight of filling	0.236 kg.
Weight of loaded projectile	6.215 kg.
Length of complete round	
76/40-mm	736 mm
76/45-mm	992.9 mm
Propellent charge	
76/40-mm	0.970 kg. Ballistite
76/45-mm	1.620 kg.
Booster used	No. 2 M38

Remarks
The ammunition also is made up with reduced propellent charges.

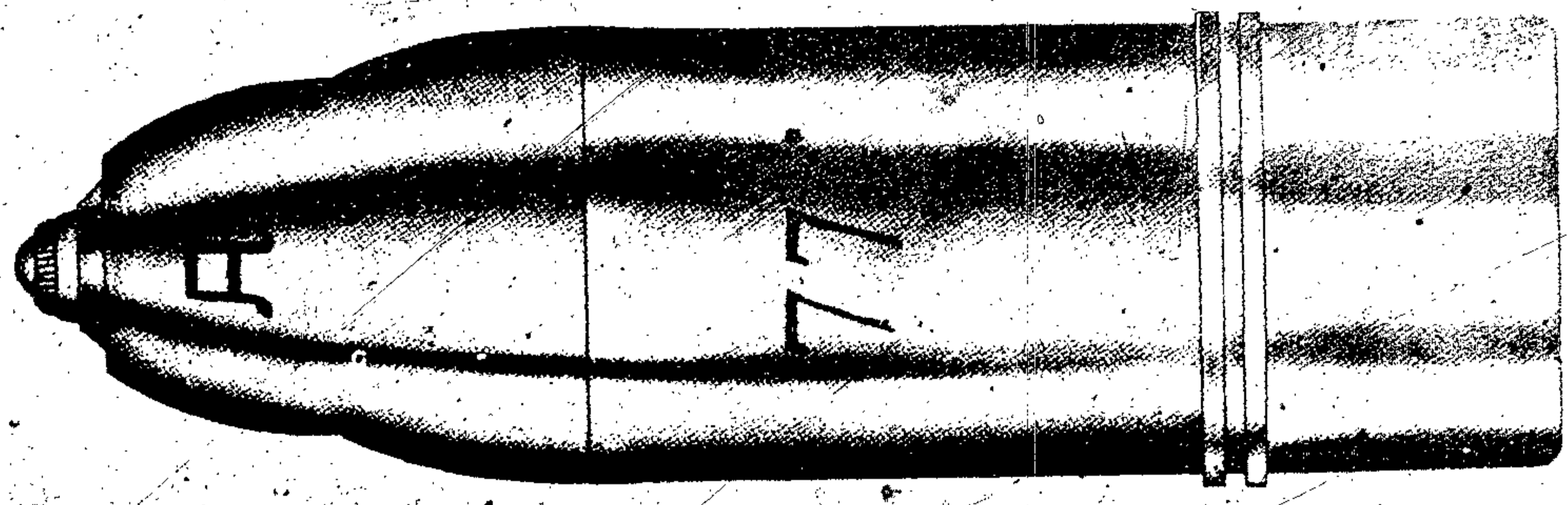

Figure 124 - 77-mm H.E. (Short)

77-mm H. E. (Short)

Data

Gun used in	77/28-mm Field Gun
Fuzing	Nose Percussion Fuze M10, I. M35 p. c., I. M38 p. c., or M (Guerritore)
Over-all length	
With fuze	261 mm

Without fuze	247 mm
Diameter at base	75.8 mm
Distance base to band	49 mm
Width of band	8 mm
Diameter at bourrelet	76.3 mm
Type of filling	Probably TNT
Weight of filling	0.58 kg.
Weight of loaded projectile	4.68 kg.

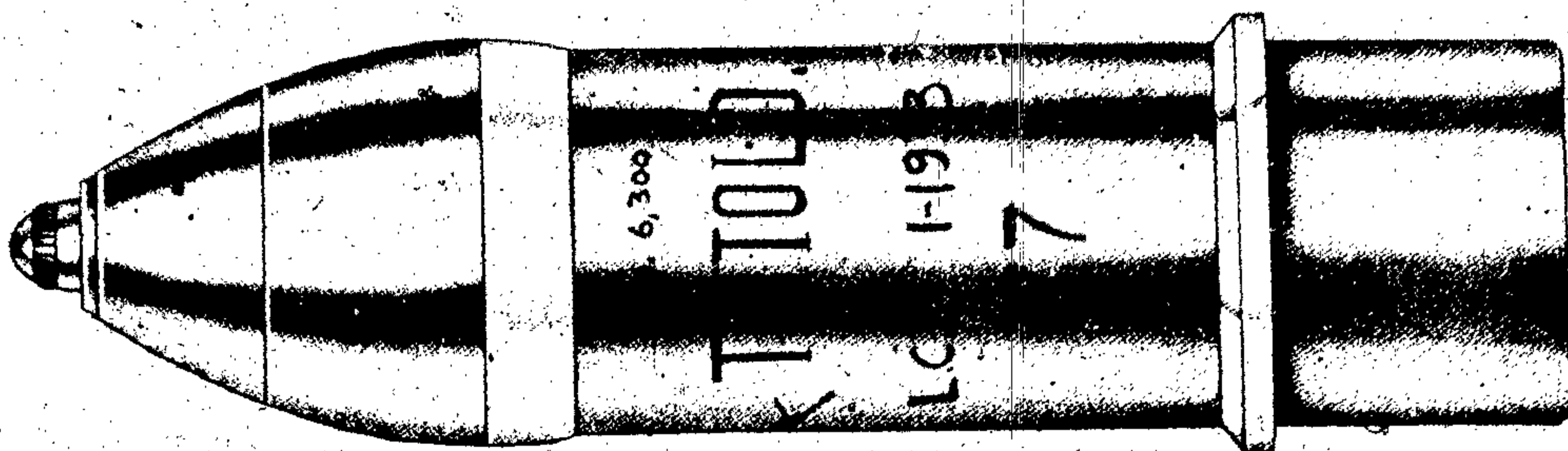

Figure 125 - 77-mm H.E. (Long)

77-mm H.E. (Long)

Data

Gun used in 77/28-mm Field Gun
 Fuzing Nose Percussion
 Fuze M10, or I. M38
 p. c.
 Over-all length
 With fuze 298 mm

Without fuze 281 mm
 Diameter at base 76 mm
 Distance base to band 55 mm
 Width of band 10 mm
 Diameter at bourrelet 76.3 mm
 Type of filling TNT
 Weight of filling 0.695 kg.
 Weight of loaded projectile 6.24 kg.
 Booster used No. 1 M38

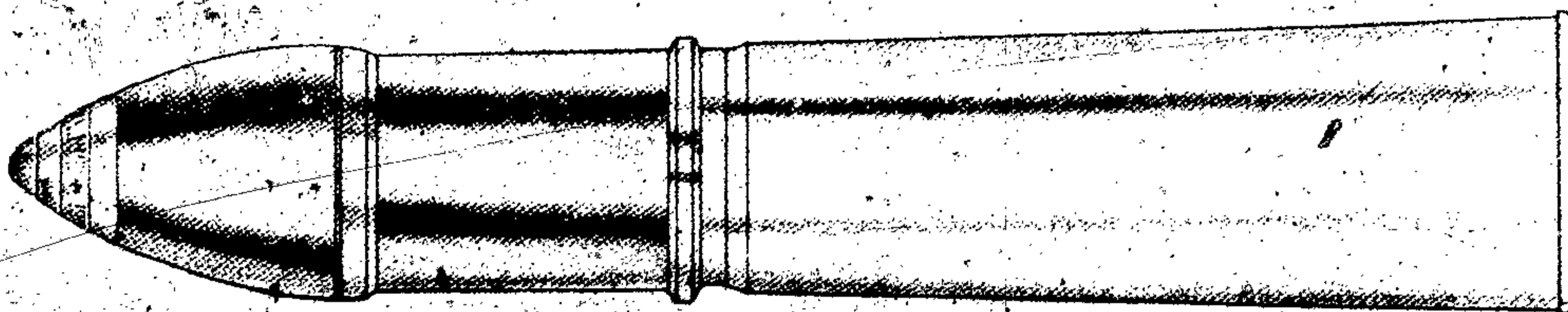

Figure 126 - 77-mm A.A.

77-mm A.A.

Data

Gun used in
 Fixed—77/28-mm Antiaircraft Gun
 Fuzing Nose Time Fuze
 MO6/17
 Over-all length Unknown
 Diameter at base Unknown
 Distance base to band Unknown
 Width of band 8.3 mm

Diameter at bourrelet 76.30 mm
 Type of filling TNT
 Weight of filling 0.220 kg.
 Weight of loaded projectile 5.921 kg.
 Length of complete round 492.5 mm.
 Weight of complete round 8.00 kg.,
 R. C. 7.600 kg.
 Propellant charge
 Full 0.544 kg. C2 or
 C. G. 13
 Reduced 0.150 kg. Ballistite



ITALIAN PROJECTILES

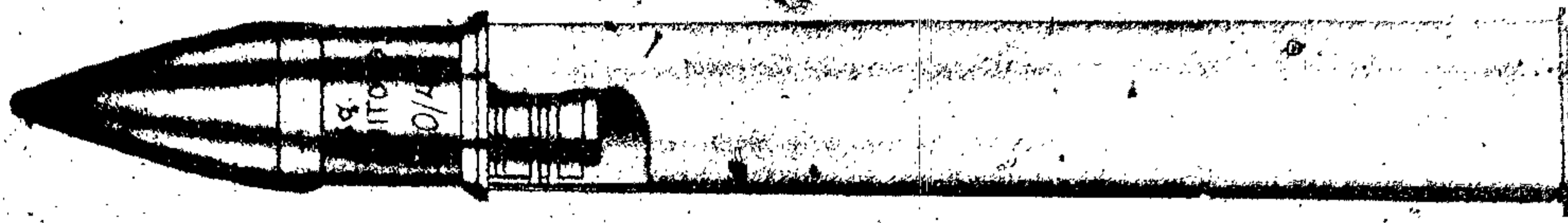

Figure 127 - 90/42-53-mm H.E.

90/42-53-mm H.E.

Data

Gun used in
Fixed—90/53-mm Antiaircraft Gun

Fuzing

Base fuze Unknown

Over-all length 400 mm

Diameter at base Unknown

Distance base to top band ... 88 mm

Width of band Unknown

Diameter of bourrelet 89.7 mm

Type of filling TNT

Weight of filling Unknown

Weight of loaded projectile ... 10.00 kg.

Length of complete round ... 17.4 kg.

Propellent charge 2.620 kg.

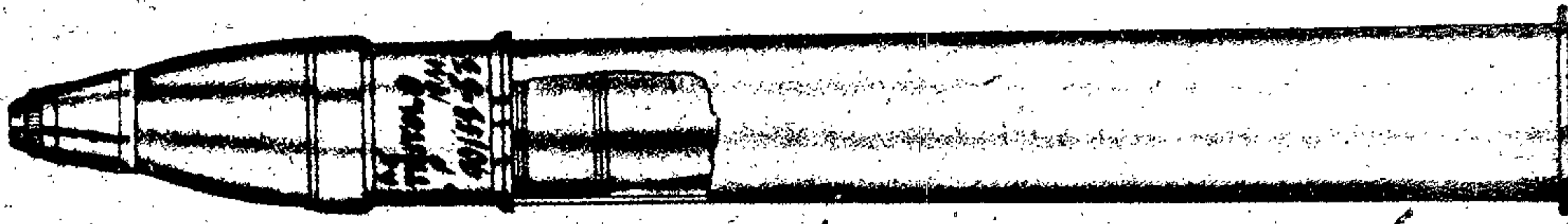

Figure 128 - 90-mm A.A.

90-mm A.A.

Data

Gun used in
Fixed—90/53-mm Antiaircraft Gun

Fuzing

Nose Time Fuze M41 or M. T. 36

Nose Fuze I. O. M40 p. c.

Nose Fuze R40 m. c.

Over-all length without fuze 309 mm

Diameter at base Unknown

Distance base to top band ... 97 mm

Width of band Unknown

Diameter at bourrelet 89.7 mm

Type of filling TNT

Weight of filling 1 kg.

Weight of loaded projectile ... 10.10 kg. to 10.30 kg.

Length of complete round ... 887 mm

Weight of complete round ... 17.050 kg. to 17.913 kg.

Propellent charge 1.465 kg. to 2.650 kg.

Remarks

The weight and length of rounds depend on fuzing. The projectile has a screwed-in base plate and two copper driving bands; one band is covered by the cartridge case.

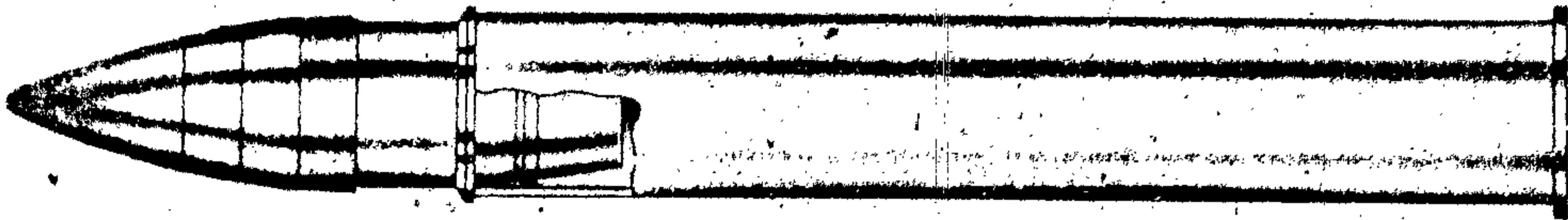

Figure 129 - 90/53-mm A.P.

90/53-mm A.P.

Data		Distance base to 2nd band	97 mm
Gun used in	90/53-mm Antiair- craft Gun	Width of bands	Unknown
Fuzing	Base Fuze M09	Diameter at bourrelet	89.7 mm
Over-all length	407 mm	Type of filling	Probably TNT
Diameter at base	Unknown	Weight of filling	Unknown
Distance base to 1st band	Unknown	Weight of loaded projectile	12.160 kg.
		Total length of round	985 mm
		Weight of complete round	19.6 kg.
		Weight of propellant	2.67 kg.

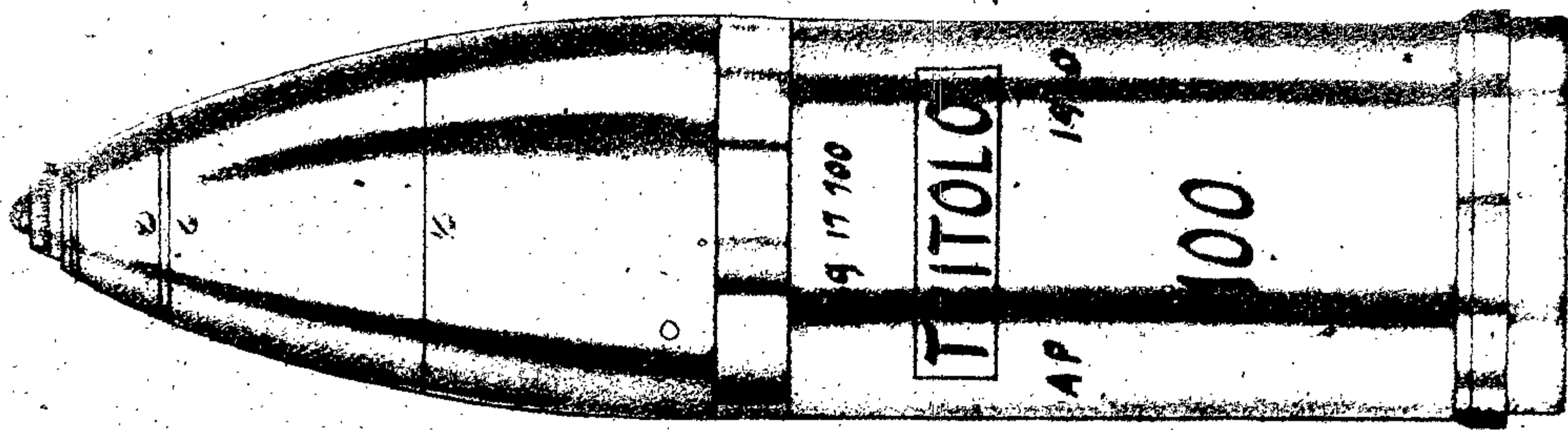

Figure 130 - 100-mm H.E.

100-mm H. E.

Data		Without fuze	372 mm
Gun used in	100/17-mm Light Field Gun	Diameter at base	99 mm
Fuzing	Nose Percussion Fuze M10 or (Guerritore 1. M35, I. M38, or I. M40)	Distance base to band	15 mm
Over-all length	386 mm	Width of band	13 mm
With fuze		Diameter at bourrelet	99.7 mm
		Type of filling	TNT
		Weight of filling	1.285 kg.
		Weight of loaded projectile	12.7 kg.
		Booster used	No. 3 M38

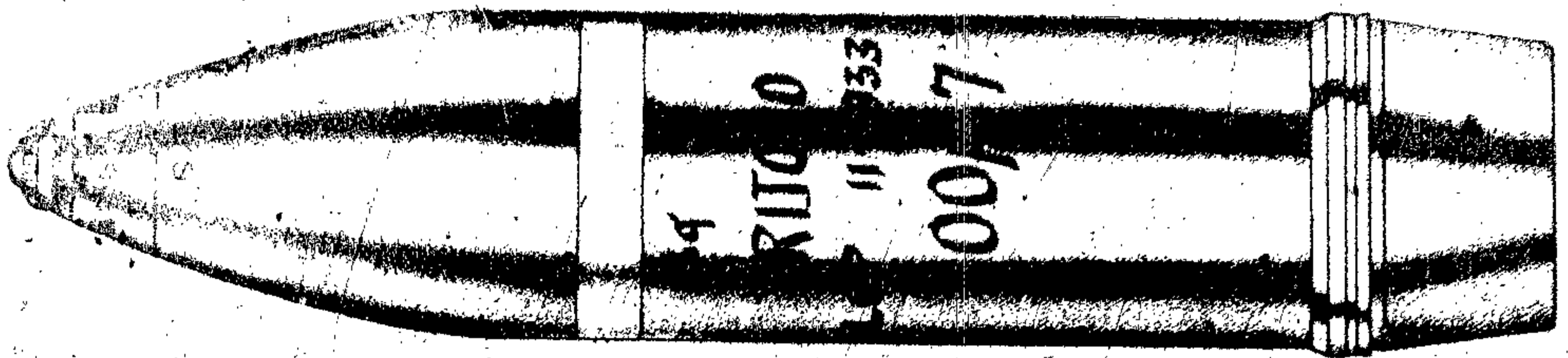

Figure 131 - 100/17-mm H.E. M32

100/17-mm H. E. M32

Data		Without fuze	440 mm
		Diameter at base	86.0 mm
		Distance base to band	55 mm
		Width of band	16 mm
Gun used in	100/17-mm	Diameter at bourrelet	99.70 mm
	Light Field Gun	Type of filling	TNT
Fuzing	Nose Percussion	Weight of filling	2.218 kg.
	Fuze M10	Weight of loaded projectile	13.49 kg.
Over-all length		Booster used	No. 2 M38
With fuze	454 mm		

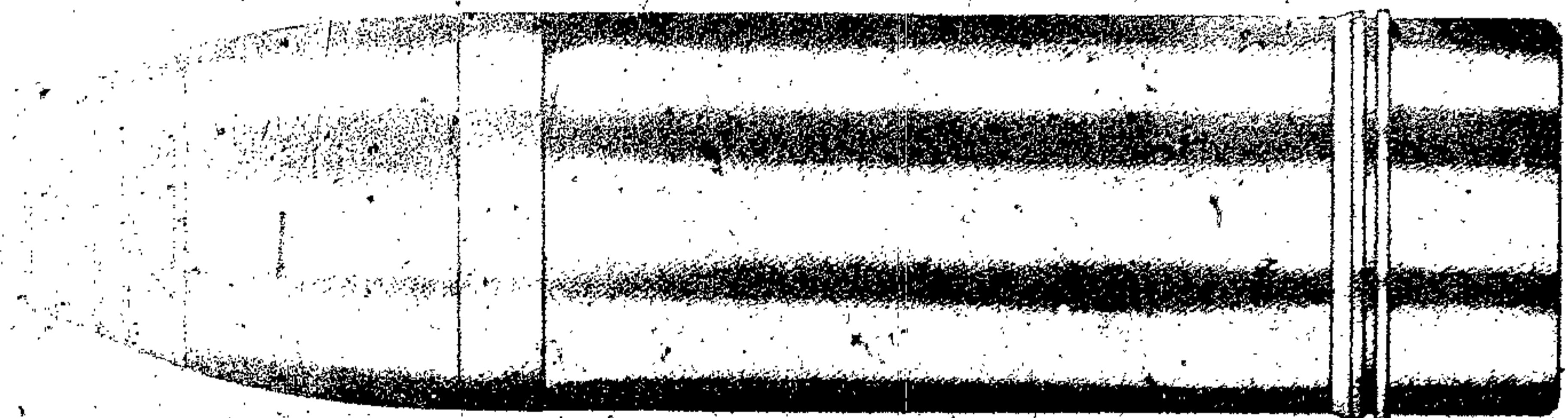

Figure 132 - 100-mm A.D.E.-H.E.

100-mm A.D.E.-H.E.

Data		Distance base to band	40 mm
		Width of band	13 mm
		Diameter of bourrelet	99.70 mm
Gun used in	100/17-mm	Type of filling	TNT, MBT, MAT, or Pertite
	Light Field Gun	Weight of filling	1.312 kg.
Fuzing	Nose Fuze A. D. E. M12	Weight of loaded projectile	12.93 kg.
Over-all length		Booster used	No. 3 M38
With fuze	399 mm		
Without fuze	341 mm		
Diameter at base	99 mm		

Remarks

This projectile is fuzed for aerial burst or impact.

ITALIAN AND FRENCH EXPLOSIVE ORDNANCE

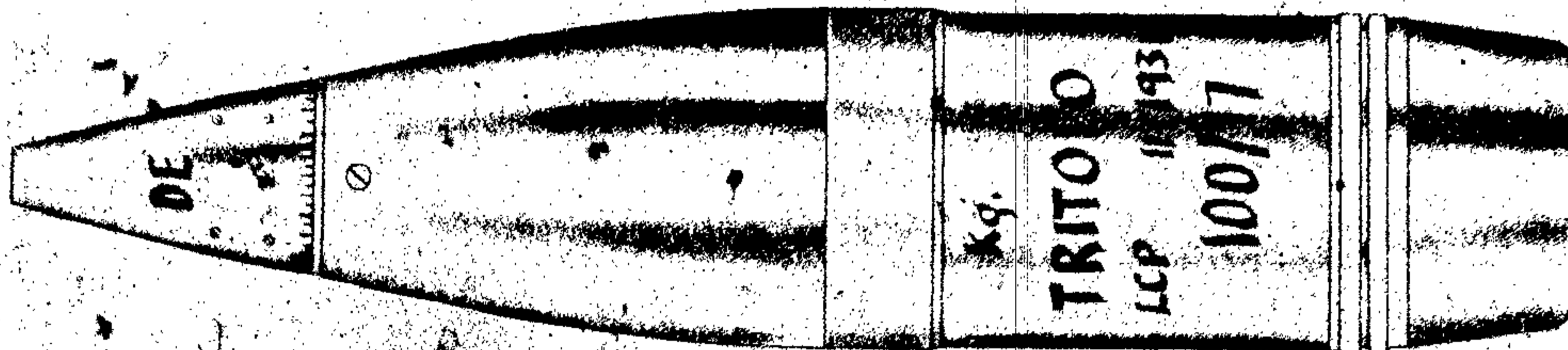

Figure 133 - 100/17-mm A.D.E.-H.E. M36

100/17-mm A.D.E.-H.E. M32 and M36

Data

Gun used in 100/17-mm
Light Field Gun

Fuzing

M32—Nose Fuze A. D. E. M32

M36—Nose Fuze A. D. E. M36

Over-all length

Without fuze 379.7 mm

With fuze

M32—474.7 mm
M36—479.9 mm
Diameter at base Unknown
Distance base to band 55 mm
Width of band 16 mm
Diameter at bourrelet 99.70 mm
Type of filling TNT
Weight of filling 1.570 kg.
Weight of loaded projectile 13.375 kg.
Booster used No. 3 M38

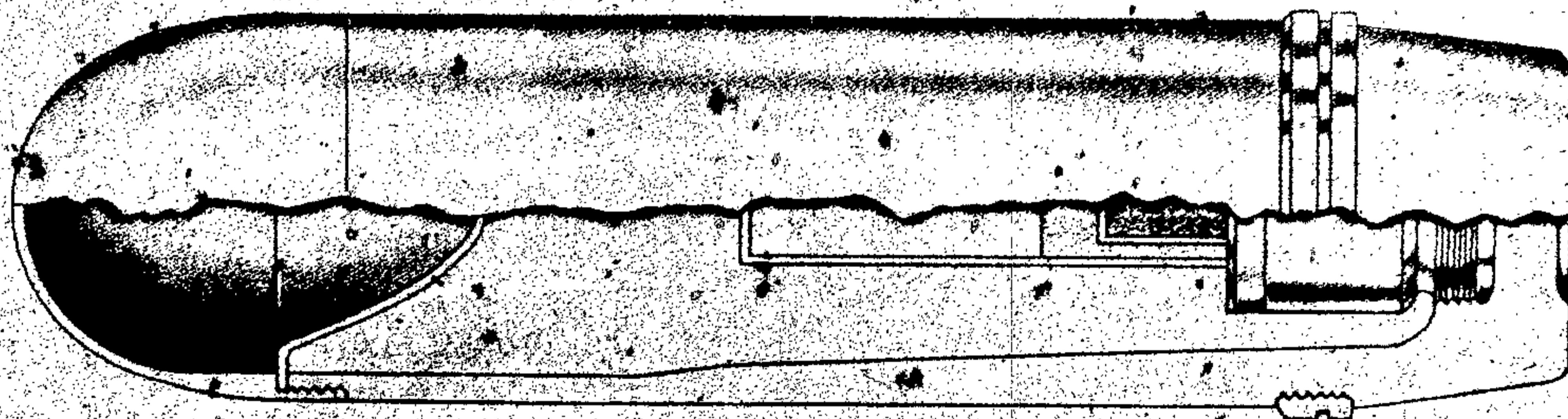

Figure 134 - 100-mm E.P. (Hollow-Charge)

100-mm E.P. (Hollow-Charge)

Data

Gun used in 100/17-mm
Light Field Gun

Fuzing Base Fuze E. P.
M36

Over-all length 377 mm

Diameter at base Unknown
Distance base to band Unknown
Width of band Unknown
Diameter at bourrelet 99.70 mm
Type of filling ROX/TNT
Weight of filling Unknown
Weight of loaded projectile 12.5 kg.

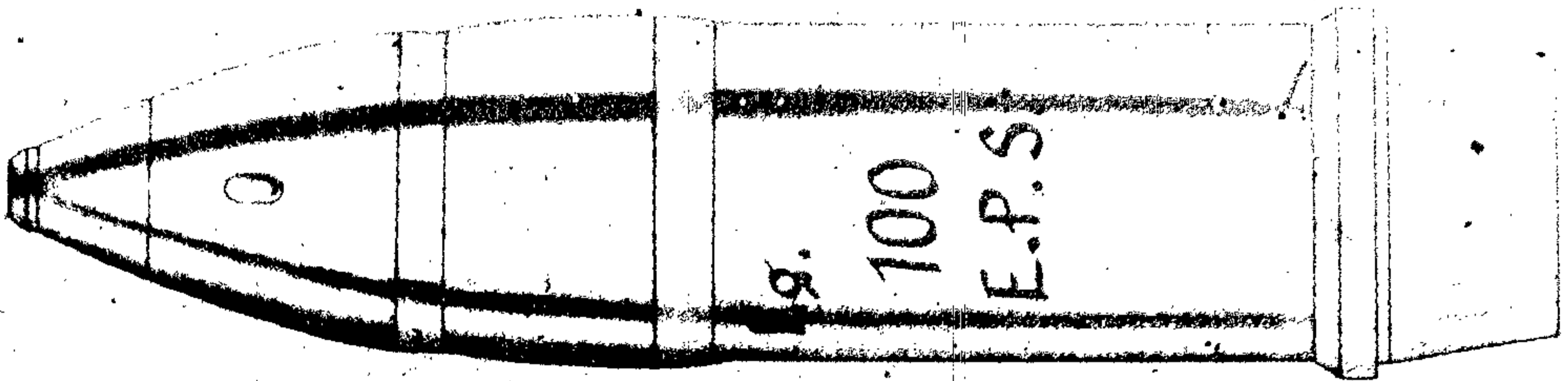

Figure 135 - 100-mm E.P.S. (Hollow-Charge)

100-mm E.P.S. (Hollow-Charge)

Data

Gun used in 100/17-mm
Light Field Gun
Fuzing I. E. P. M.
Over-all length Unknown

Diameter at base Unknown
Distance base to band Unknown
Width of band Unknown
Diameter at bourrelet 99.70 mm
Type of filling Unknown
Weight of filling Unknown
Weight of loaded projectile 12.5 kg.

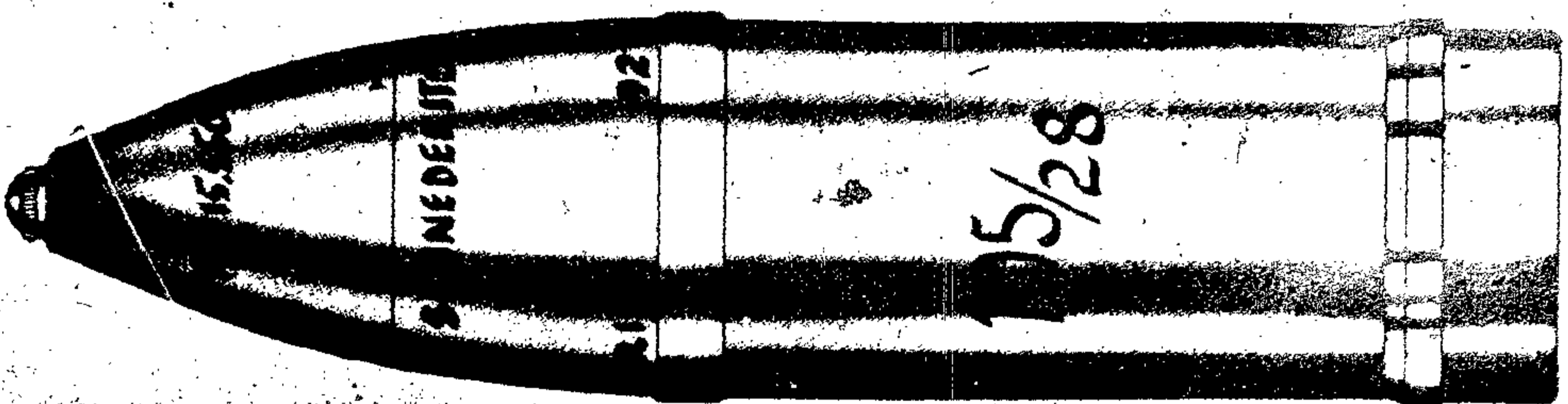

Figure 136 - 105/28-mm H.E.

105/28-mm H.E. (Practice and Incendiary)

Data

105-mm H. E.

Gun used in 105/28 Gun
Fuzing Nose Percussion
M10
Over-all length
With fuze 418.2 mm
Without fuze 404.2 mm
Diameter at base 104.0 mm
Distance base to band 31.5 mm
Width of band 15 mm
Diameter at bourrelet 104.6 mm
Weight of filling 1.24 kg.
Weight of loaded projectile 15.55 kg.

105-mm Practice

Fuzing Nose Percussion
M35 p. e.
Weight of filling 0.300 kg.

105-mm Incendiary

Fuzing Nose Percussion
M35 p. e.
Filling 1.7 kg. Phos-
phorus + 0.090
kg. TNT + 0 kg.
Gasoline +
0.070 kg. TNT

Remarks

The projectiles differ only in filling and fuzing. Another modification is cast in one piece instead of having an adapter.

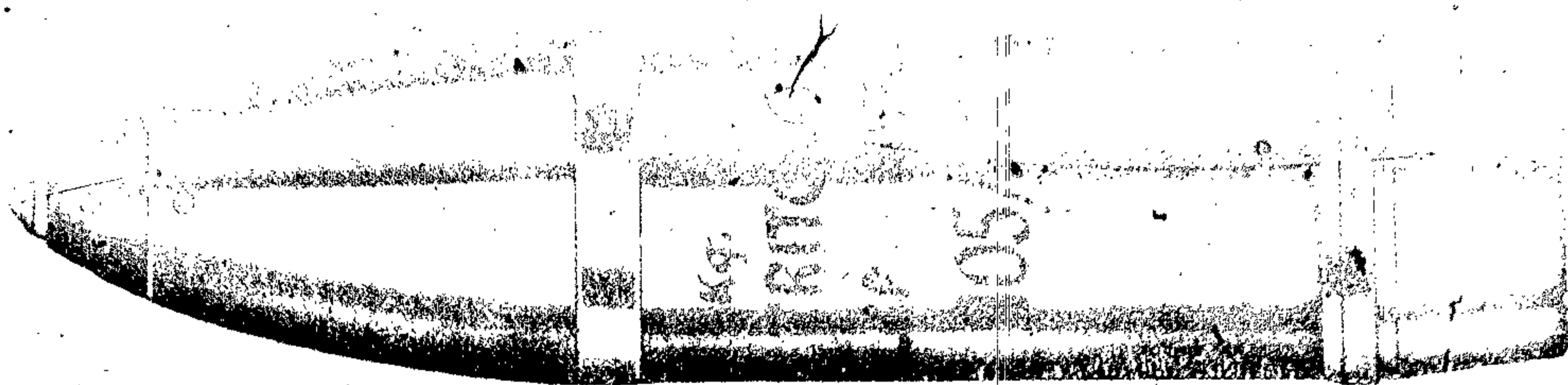

Figure 137 - 105/28-mm H.E. M32

105/28-mm H.E. M32

Data		Without fuze.....	455 mm
Guns used in		Diameter at base.....	90.0 mm
105/14-mm Gun		Distance base to band.....	58 mm
105/28-mm Light Field Gun		Width of band.....	14.8 mm
105/32-mm Gun		Diameter at bourrelet.....	104.60 mm
Fuzing.....	Nose Percussion	Type of filling.....	TNT
	Fuze M10	Weight of filling.....	2.35 kg.
Over-all length		Weight of loaded projectile.....	16.3 kg.
With fuze.....	469.0 mm	Booster used.....	No. 2 M38



Figure 138 - 105/28-mm A.D.E. M32

105/28-mm A.D.E. M32

Data		Without fuze.....	415 mm
Guns used in		Diameter at base.....	Unknown
105/14-mm Light Field Gun		Distance base to band.....	68 mm
105/28-mm Gun		Width of band.....	14.8 mm
105/32-mm Gun		Diameter or bourrelet.....	104.6 mm
Fuzing.....	Nose Fuze A. D.	Type of filling.....	TNT
	E. M32 or A. D.	Weight of filling.....	1.76 kg.
	E. M36	Weight of loaded projectile.....	16.125 kg.
Over-all length		Booster used.....	No. 2 M38
With fuze.....	510 mm		

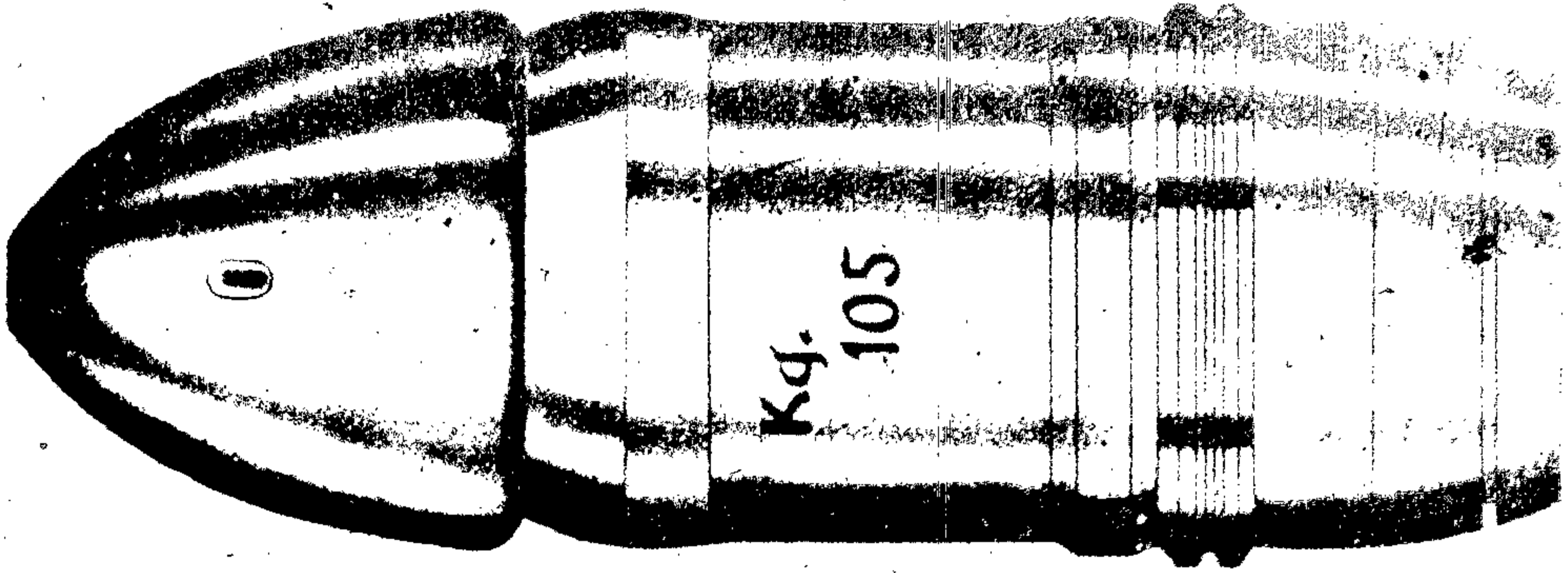

Figure 139 - 105-mm A.P.

105-mm A.P.

Data

Gun used in 105/14-mm
 Light Field Gun
 Fuzing Unknown
 Over-all length 300.5 mm

Diameter at base Unknown
 Distance base to band 59.5 mm
 Width of band 18 mm
 Diameter at bourrelet Unknown
 Type of filling Unknown
 Weight of filling Unknown
 Weight of loaded projectile 15.65 kg

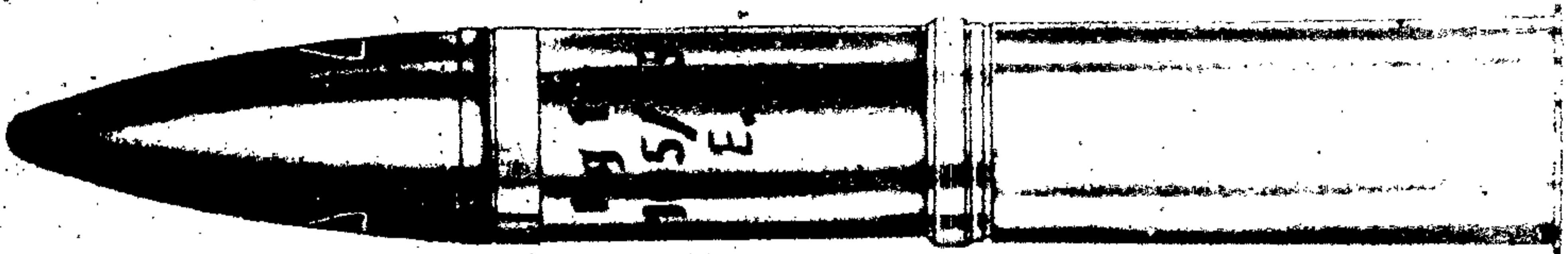

Figure 140 - 105/25-mm E.P. (Hollow-Charge)

105/25-mm E.P. (Hollow-Charge)

Data

Gun used in 105/25-mm Gun
 Fuzing Unknown
 Diameter at base Unknown
 Distance base to band Unknown
 Width of band 18 mm
 Diameter at bourrelet 104.3 mm

Type of filling Unknown
 Weight of filling Unknown
 Weight of loaded projectile 14 kg.

Remarks

Little is known about this projectile except that it is a fixed round and is one of the latest types, since it was used in 1944. The cap is 230 mm long. The rotating band is soft iron instead of copper.

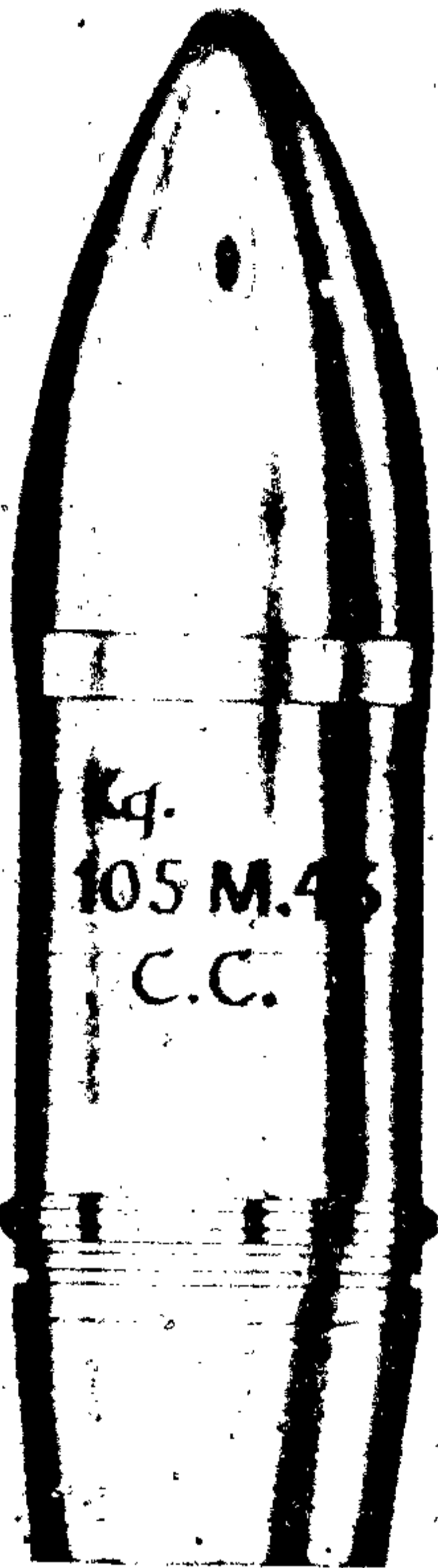

Figure 141 - 105-mm Hollow-Charge M43

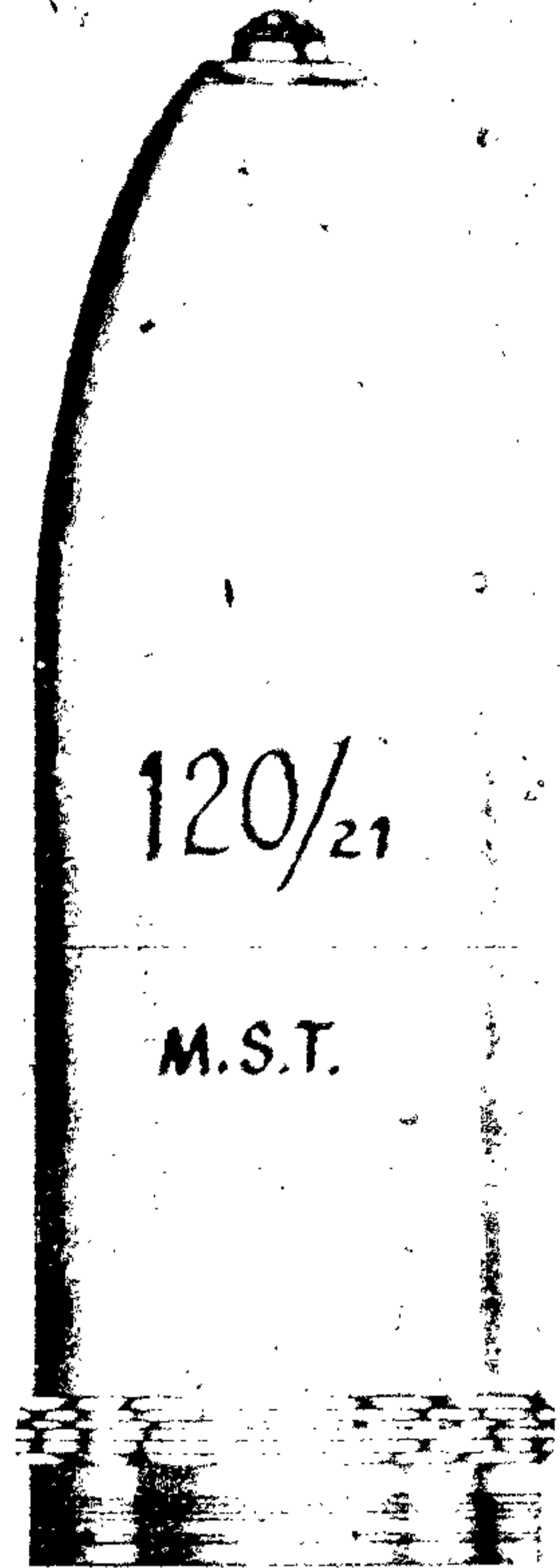

Figure 142 - 120/21-mm H.E.

105-mm (Hollow-Charge) M43

Data

Gun used in.....	105/14-mm Light Field Gun
Fuzing.....	Unknown
Over-all length.....	Unknown
Diameter at base.....	Unknown
Distance base to band.....	Unknown
Width of band.....	Unknown
Diameter at bourrelet.....	Unknown
Type of filling.....	Unknown
Weight of filling.....	Unknown
Weight of loaded projectile.....	14 kg.

Remarks

Little information is available on this projectile, since it was one of the latest designs.

120/21-mm H.E.

Data

Gun used in.....	120/21-mm (Gun
Fuzing.....	Nose Percussion Fuze M17
Over-all length.....	
With fuze.....	355 mm
Without fuze.....	340 mm
Diameter at base.....	123.4 mm
Distance base to band.....	20 mm
Width of band.....	17.1 mm
Diameter at bourrelet.....	119.3 mm
Type of filling.....	MST
Weight of filling.....	2.100 kg.
Weight of loaded projectile.....	16.400 kg.

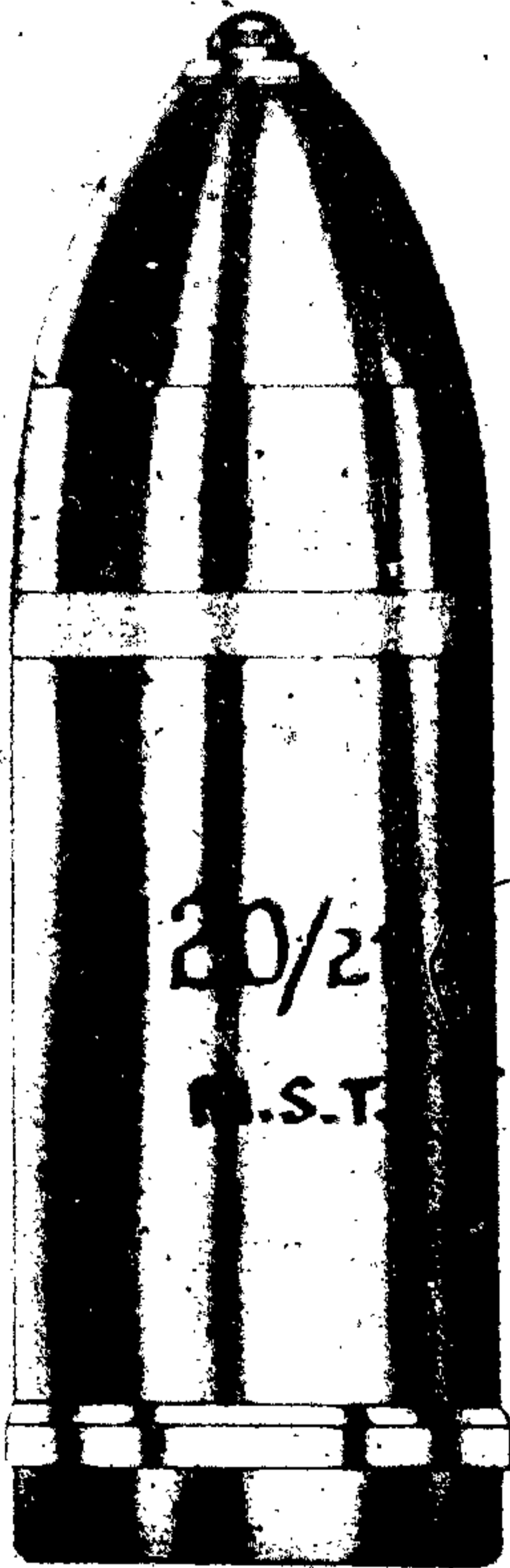

Figure 143 - 120/21-mm H.E. (Cast-Steel)

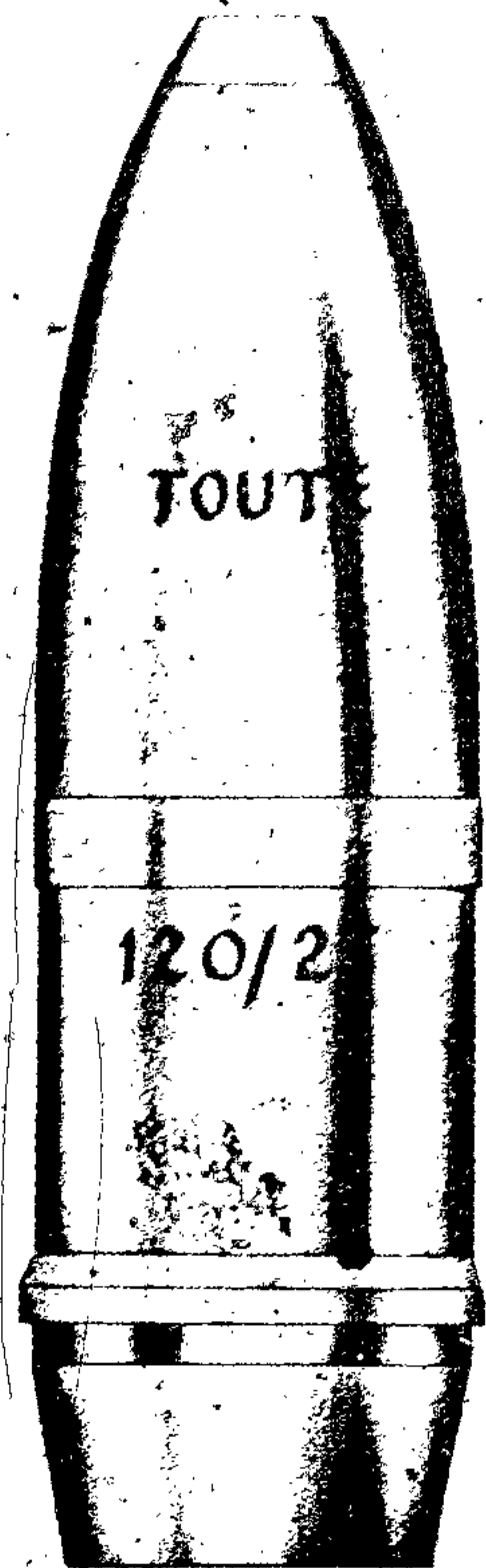

Figure 144 - 120/25-mm H.E. (Short)

120/21-mm H.E. (Cast-Steel)

Data

Gun used in.....	120/21-mm Gun
Fuzing.....	Nose Percussion Fuze M17
Over-all length	
With fuze.....	377 mm
Without fuze.....	362 mm
Diameter at base.....	119 mm
Distance base to band.....	22 mm
Width of band.....	15 mm
Diameter at bourrelet.....	119.5 mm
Type of filling.....	MST
Weight of filling.....	1.290 kg.
Weight of loaded projectile.....	17.800 kg.

Remarks

This projectile is cast steel.

120/25-mm H.E. (Short)

Data

Gun used in.....	120/25-mm Gun
Fuzing.....	Nose percussion Fuze M17
Over-all length	
With fuze.....	432 mm
Without fuze.....	417 mm
Diameter at base.....	Unknown
Distance base to band.....	65 mm
Width of band.....	15 mm
Diameter at bourrelet.....	119.4 mm
Type of filling.....	Tolite
Weight of filling.....	2.550 kg.
Weight of loaded projectile.....	18.700 kg.

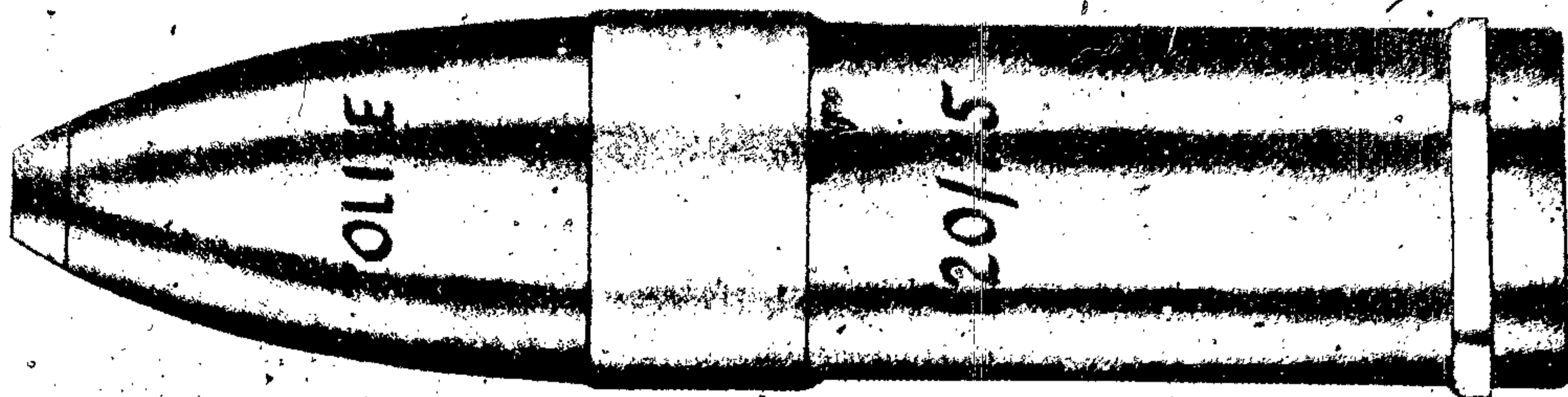

Figure 145 - 120/25-mm H.E. (Long)

120/25-mm H.E. (Long)

Data

Gun used in.....	120/25-mm Gun
Fuzing.....	Nose Percussion Fuze M17
Over-all length	
With fuze.....	503 mm

Without fuze.....	488 mm
Diameter at base.....	122 mm
Distance base to band.....	25 mm
Width of band.....	10 mm
Diameter at bourrelet.....	119.1 mm
Type of filling.....	Tolite
Weight of filling.....	4.275 kg.
Weight of loaded projectile.....	20.350 kg.



Figure 146 - 120/25-mm H.E. (Cast-Steel)

120/25-mm H.E. (Cast-Steel)

Data

Gun used in.....	120/25-mm Gun
Fuzing.....	Nose Percussion Fuze M17
Over-all length	
With fuze.....	421 mm
Without fuze.....	406 mm
Diameter at base.....	Unknown

Distance base to band.....	65 mm
Width of band.....	15 mm
Diameter at bourrelet.....	119.4 mm
Type of filling.....	Pertite
Weight of filling.....	2.080 kg.
Weight of loaded projectile.....	19.200 kg.

Remarks

This projectile is cast steel.

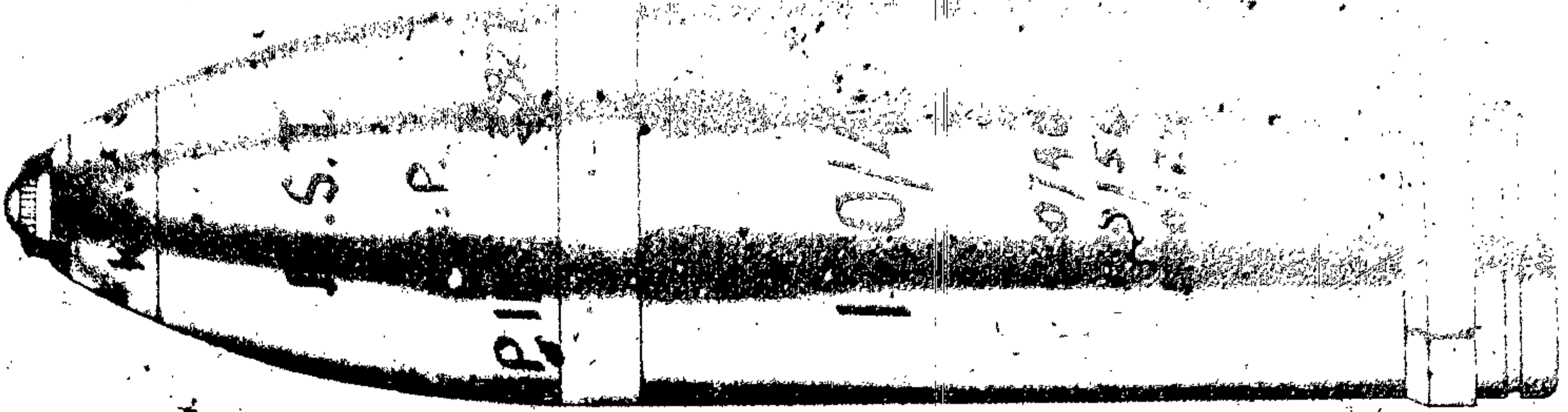

Figure 147-120/40-mm H.E. (Cast-Steel)

120/40-mm H.E. (Cast-Steel)

Data

Guns used in

- 120/40-mm Gun
- 120/50-mm Gun
- 120/25-mm Gun

Fuzing

Nose percussion Fuze M17 or (Guerritore)
M-m. e. g. c.

Over-all length

With fuze 440 mm

Without fuze.....	425 mm
Diameter at base.....	118 mm
Distance base to band.....	25 mm
Width of band.....	20 mm
Diameter of bourrelet.....	119.5 mm
Type of filling.....	MST
Weight of filling.....	1.880 kg.
Weight of loaded projectile.....	24.900 kg.

Remarks

This projectile is cast steel.

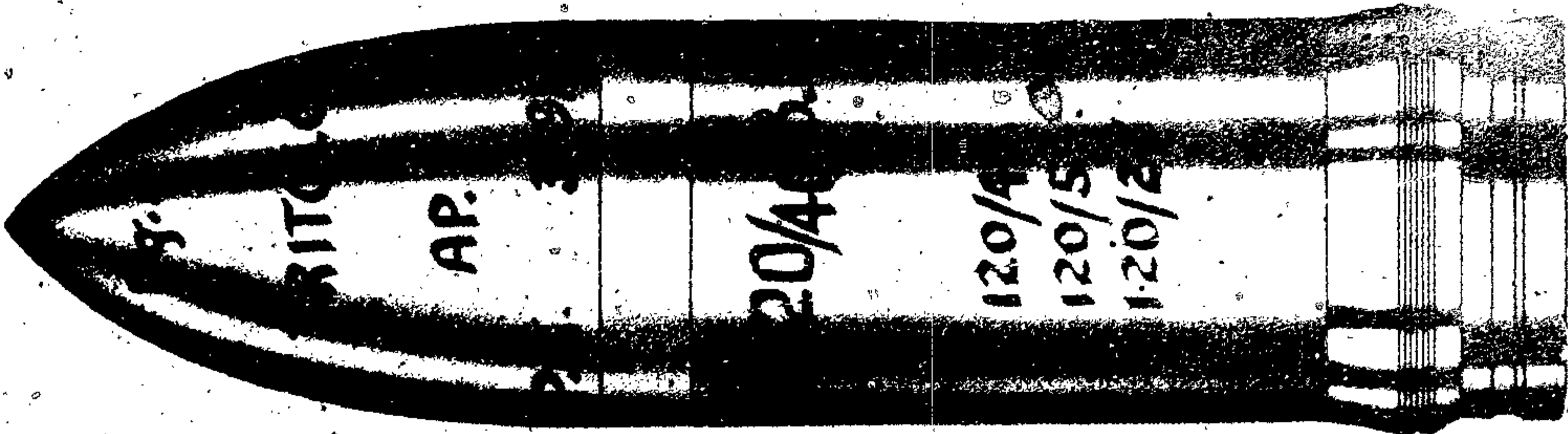

Figure 148 - 120/40-mm H.E. (Base-Fuzed)

120/40-mm H.E. (Base-Fuzed)

Data

Guns used in

- 120/25-mm Gun
- 120/40-mm Gun
- 120/50-mm Gun

Fuzing..... Base Fuze M14

Over-all length.....	463 mm
Diameter at base.....	119 mm
Distance base to band.....	30.5 mm
Width of band.....	38.1 mm
Diameter at bourrelet.....	119.5 mm
Type of filling.....	TNT
Weight of filling.....	1.820 kg.
Weight of loaded projectile.....	23.600 kg.



Figure 149 - 120/45-mm H.E.

120/45-mm H.E.

Data

Gun used in.....	120/45-mm Gun
Fuzing.....	Unknown
Over-all length	
With fuze.....	493 mm
Without fuze.....	440 mm

Diameter at base.....	112 mm
Distance base to band.....	43 mm
Width of band.....	40 mm
Diameter at bourrelet.....	Unknown
Type of filling.....	TNT
Weight of filling.....	2.39 kg.
Weight of loaded projectile.....	Unknown



Figure 150 - 149/12-mm H.E. (Short)

149/12-mm H.E. (Short)

Data

Gun used in.....	149/12-mm Heavy Field Gun
Fuzing	
Nose percussion Fuze M17 or (Guerritore)	
I. M35, I. M38, or I. M40	
Over-all length	
With fuze.....	599 mm
Without fuze.....	584 mm

Diameter at base.....	147.8 mm
Distance base to band.....	38 mm
Width of band.....	15 mm
Diameter at bourrelet.....	148.50 mm
Type of filling.....	TNT or MAT- MBT
Weight of filling.....	6.235 kg. TNT
	3.73 kg. MAT
	302 kg. MBT
Weight of loaded projectile.....	38.9 kg.

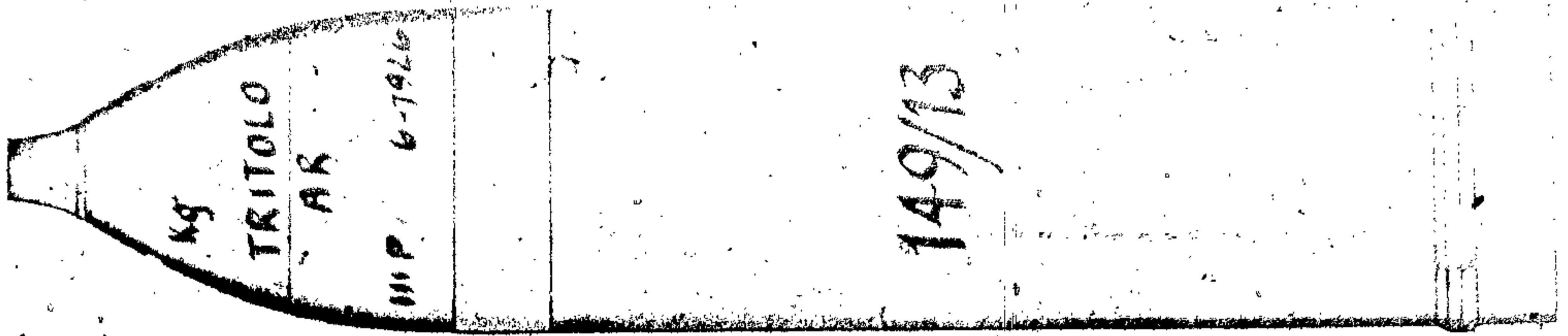

Figure 151 - 149/12-mm H.E.

149/12-13-mm H.E.

Data

Guns used in

- 149/12-mm Heavy Field Howitzer
- 149/13-mm Heavy Field Howitzer

Fuzing ----- Nose Percussion
Fuze M10 or
M17

Over-all length

- With fuze ----- 677.3 mm
- Without fuze ----- 659 mm

Diameter at base -----	147.6 mm
Distance base to band -----	38 mm
Width of band -----	15 mm
Diameter at bourrelet -----	148.50 mm
Type of filling -----	TNT or Pertite
Weight of filling -----	7.525 kg.
Weight of loaded projectile -----	41.11 kg.

Remarks

The projectile for the 149/13-mm gun differs slightly since the rotating band is 152 mm instead of 154 mm for the 149/12-mm gun.

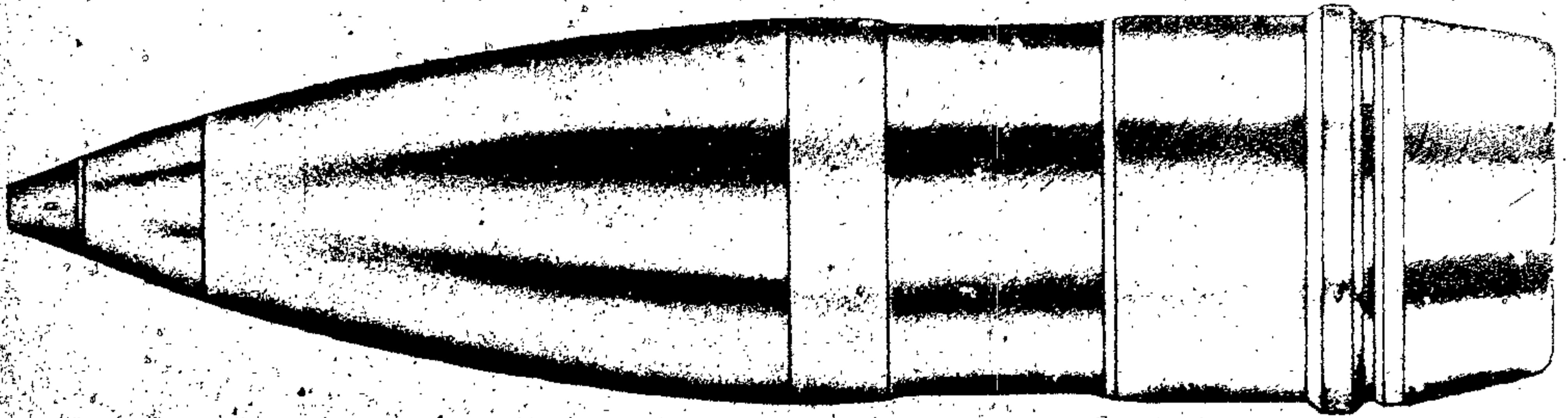

Figure 152 - 149/12-13-mm H. E. (Light)

149/12-13-mm H.E. (Light)

Data

Guns used in

- 149/12-mm Heavy Field Howitzer
- 149/13-mm Heavy Field Howitzer

Fuzing

- Nose percussion Fuze M17 or (Guerritore),
- I. M35, I. M38, I. O. M40

Over-all length

- With fuze ----- 564 mm
- (approx.)

Without fuze -----	533 mm
Diameter at base -----	134.0 mm
Distance base to band -----	76.0 mm
Width of band -----	24.0 mm
Diameter at bourrelet -----	148.6 mm
Type of filling -----	Probably TNT
Weight of filling -----	5.450 kg.
Weight of loaded projectile -----	31.635 kg.

ITALIAN AND FRENCH EXPLOSIVE ORDNANCE

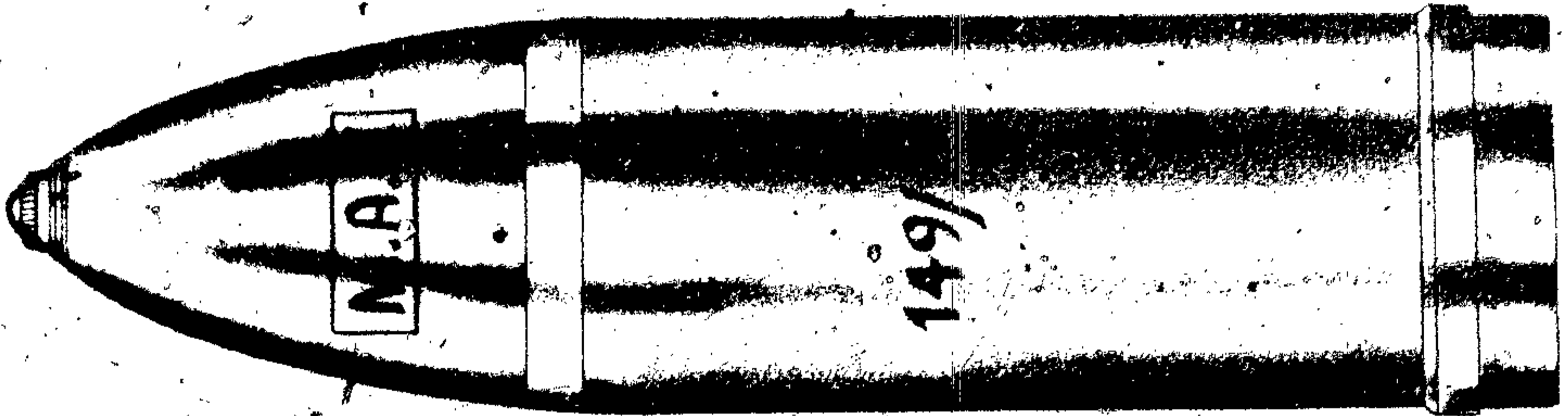

Figure 153 - 149/13-mm H.E.

149/13-mm H.E.

Data

Guns used in	149/13-mm Heavy Field Gun
Fuzing	Nose Percussion Fuze M17
Over-all length	
With fuze	568 mm

Without fuze	552.7 mm
Diameter at base	147.4 mm
Distance base to band	28 mm
Width of band	20 mm
Diameter at bourrelet	148.6 mm
Type of filling	MAT
Weight of filling	5.12 kg
Weight of loaded projectile	40.095 kg.

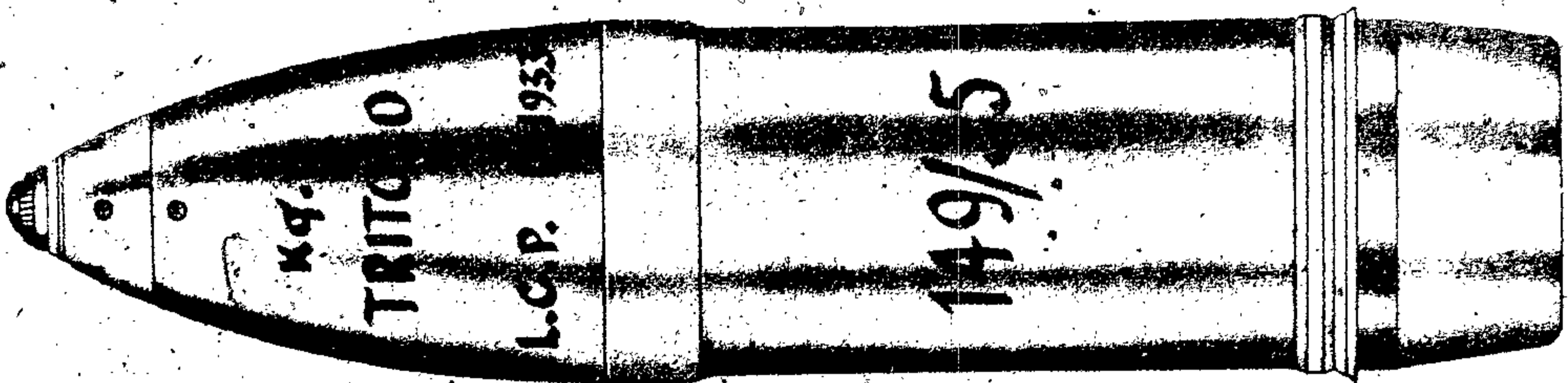

Figure 154 - 149/35-mm H.E. M32

149/13-35-mm H.E. M32 and 149/140-mm H.E. M35

Data

Guns used in	
149/13-mm Heavy Field Gun	
149/40-mm Gun	
149/35-mm Gun	
Fuzing	Nose Percussion Fuze M17
Over-all length	
With fuze	625.3 mm
Without fuze	610 mm

Diameter at base	125 mm
Distance base to band	82 mm
Width of band	16 mm
Diameter at bourrelet	148.6 mm
Type of filling	TNT
Weight of filling	6.327 kg.
Weight of loaded projectile	42.675 kg.

Remarks

The projectiles for the 149/40-mm and 149/35-mm guns differ from the 149/13-mm projectiles in diameter of the rotating band.

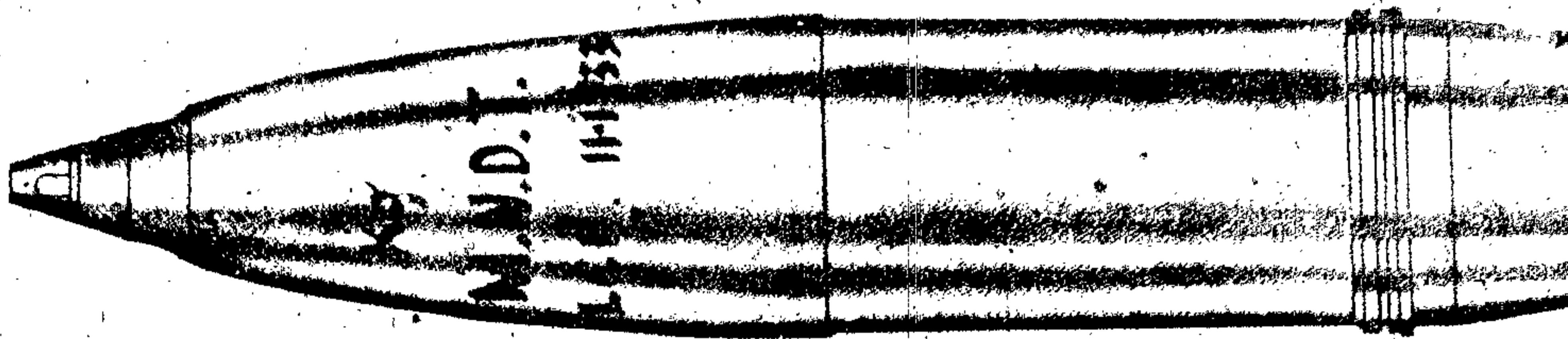

Figure 155 - 149/35-mm H.E. M32/38

149/35-mm H.E. M32/38

Data

Gun used in 149/35-mm Gun
 Fuzing Nose Percussion
 Fuze (Guerritore) I. M38
 M. C.

Over-all length
 With fuze 738 mm

Without fuze 707 mm
 Diameter at base 128 mm
 Distance base to band 82 mm
 Width of band 26 mm
 Diameter at bourrelet 148.6 mm
 Type of filling MBT or MST
 MNBT
 Weight of filling 4.900 kg.
 Weight of loaded projectile 45.950 kg.



Figure 156 - 149/12-35-mm H.E. (Cast-Steel)

149/12-35-mm H.E. (Cast-Steel)

Data

Guns used in
 149/12-mm Heavy Field Howitzer
 149/35-mm Gun
 Fuzing Nose Percussion
 Fuze M17

Over-all length
 With fuze 523.3 mm
 Without fuze 508 mm

Diameter at base 154 mm
 Distance base to band 24 mm
 Width of band 25 mm
 Diameter at bourrelet 148.5 mm
 Type of filling MAT
 Weight of filling 4.75 kg.
 Weight of loaded projectile 38.47 kg.

Remarks

The projectile is made of cast steel.

ITALIAN AND FRENCH EXPLOSIVE ORDNANCE

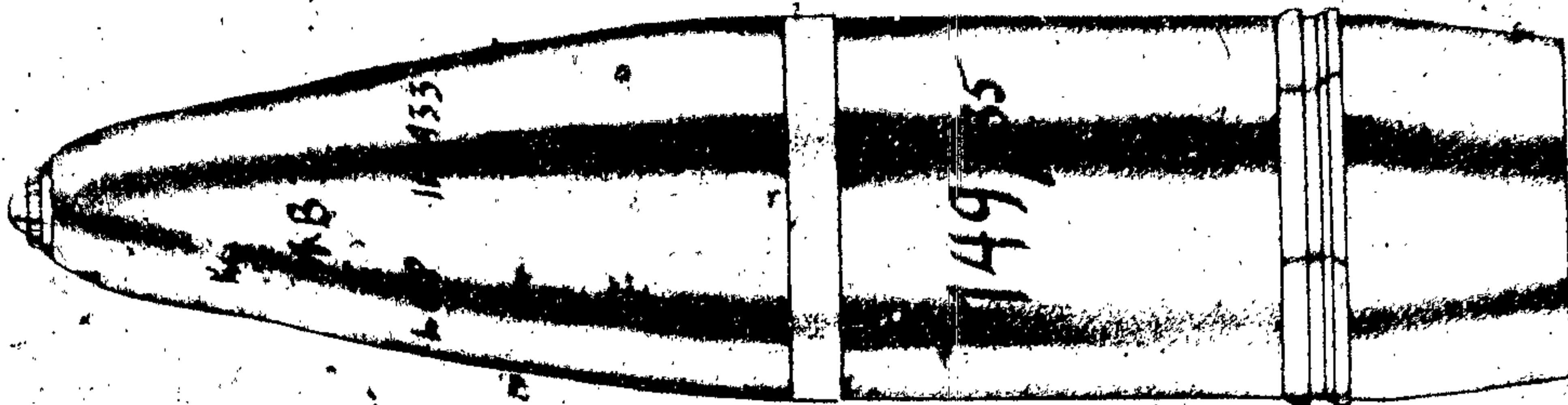

Figure 157 - 149/13-35-mm H.E. (One-Piece)

149/13-35-mm H.E. (One-Piece)

Data

Gun used in.....	149/13-mm and 149/35-mm Guns
Fuzing.....	Nose Percussion Fuze M17 or M (Guerritore)
Over-all length	
With fuze.....	595 mm
Without fuze.....	580 mm
Diameter at base.....	130 mm

Distance base to band.....	86 mm
Width of band.....	25 mm
Diameter at bourrelet.....	148.5 mm
Type of filling.....	MBT or MNDT or MST
Weight of filling.....	6.95 kg., 5.26 kg., or 5.7 kg.
Weight of loaded projectile.....	37.93 kg., 36.24 kg., or 37.1 kg.

Remarks

The weight of this projectile depends upon the type of filling.

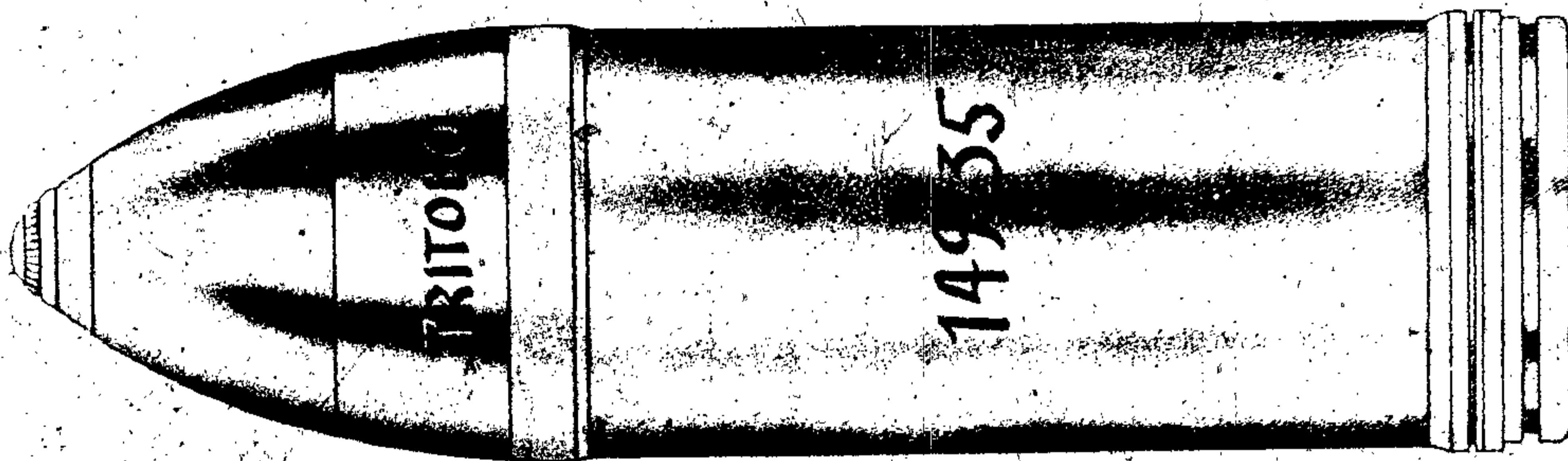

Figure 158 - 149/35-mm H.E. (British)

149/35-mm H.E. (British)

Data

Gun used in.....	149/35-mm Gun
Fuzing.....	Nose Percussion Fuze M17 or M (Guerritore)
Over-all length	
With fuze.....	538.2 mm
Without fuze.....	521.2 mm
Diameter at base.....	148.0 mm

Distance base to band.....	23 mm
Width of band.....	25 mm
Diameter at bourrelet.....	148.5 mm
Type of filling.....	TNT or MST
Weight of filling.....	6.61 kg. or 4.8 kg.
Weight of loaded projectile.....	42.80 kg. or 41.45 kg.

Remarks

This projectile is of British manufacture and has British markings.



Figure 159 - 149/35-mm A.D.E. M32

149/35-mm A.D.E. M32

Data

Gun used in	149/35-mm Gun
Fuzing	Nose Fuze A. D. E. M32
Over-all length	
With fuze	728 mm
Without fuze	614.4 mm

Diameter at base	128 mm
Distance base to band	62 mm
Width of band	25 mm
Diameter at bourrelet	148.6 mm
Type of filling	TNT
Weight of filling	4.90 kg.
Weight of loaded projectile	45.9 kg.

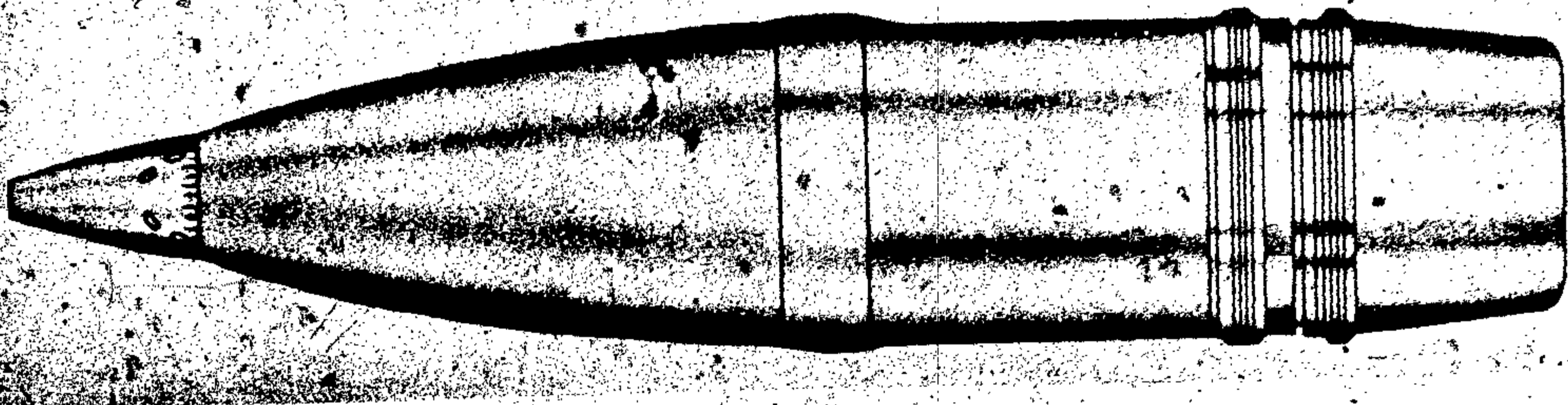

Figure 160 - 149/40-mm A.D.E.-H.E. M35

149/40-mm A.D.E.-H.E. M35

Data

Gun used in	149/50-mm Gun
Fuzing	Nose Fuze A. D. E. M36
Over-all length	
With fuze	745.5 mm
Without fuze	650.5 mm

Diameter at base	129.3 mm
Distance base to band	105 mm
Width of band	22.8 mm
Diameter at bourrelet	148.6 mm
Type of filling	Probably TNT
Weight of filling	6.387 kg.
Weight of loaded projectile	46.200 kg.

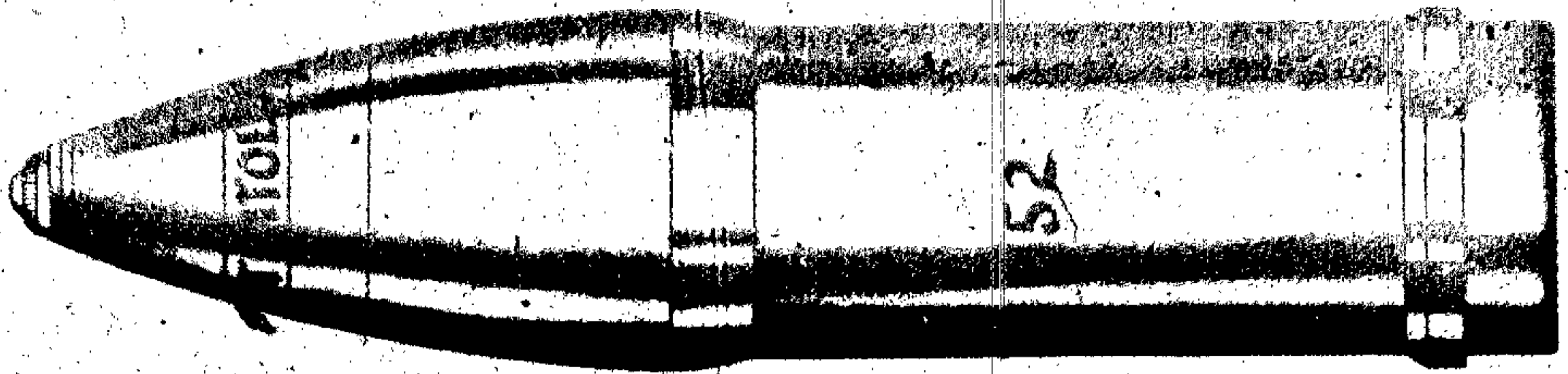

Figure 161 - 152-mm H.E.

152-mm H.E.

Data		Without fuze.....	650 mm
Guns used in.....	152/37-mm Gun, 152/45-mm Gun	Diameter at base.....	151.2 mm
Fuzing.....	Nose Percussion Fuze M17	Distance base to band.....	32 mm
Over-all length		Width of band.....	21.5 mm
With fuze.....	665.3 mm	Diameter at bourrelet.....	151.8 mm
		Type of filling.....	TNT
		Weight of filling.....	5.52 kg.
		Weight of loaded projectile.....	45.9 kg.

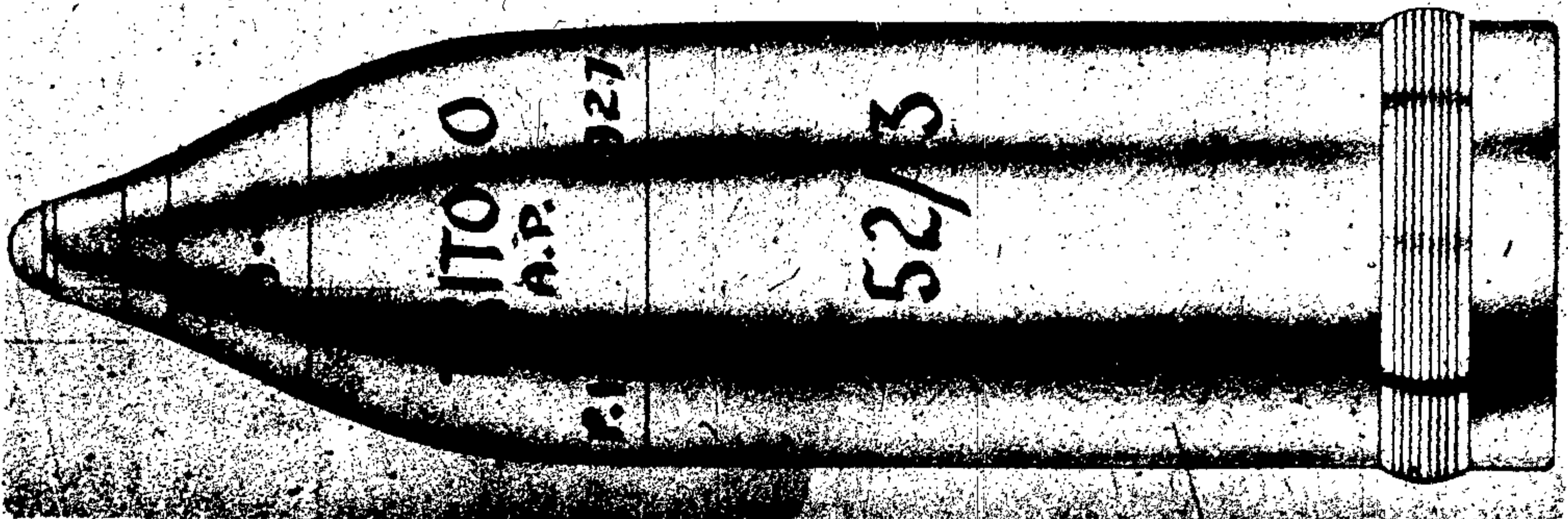

Figure 162 - 152/13-mm H.E. (Short)

152/13-mm H.E. (Short)

Data		Without fuze.....	471.5 mm
Gun used in.....	152/13-mm Heavy Field Howitzer	Diameter at base.....	150.1 mm
Fuzing.....	Nose Percussion Fuzes British Nos. 101, 101E, 106, or 44	Distance base to band.....	31.5 mm
Over-all length		Width of band.....	26.5 mm
With fuze.....	522.5 mm	Diameter at bourrelet.....	151.4 mm
		Type of filling.....	TNT
		Weight of filling.....	5.670 kg.
		Weight of loaded projectile.....	45 kg.
		Remarks	
			The fuze is similar to 152/13-mm (long) and is also British designed.

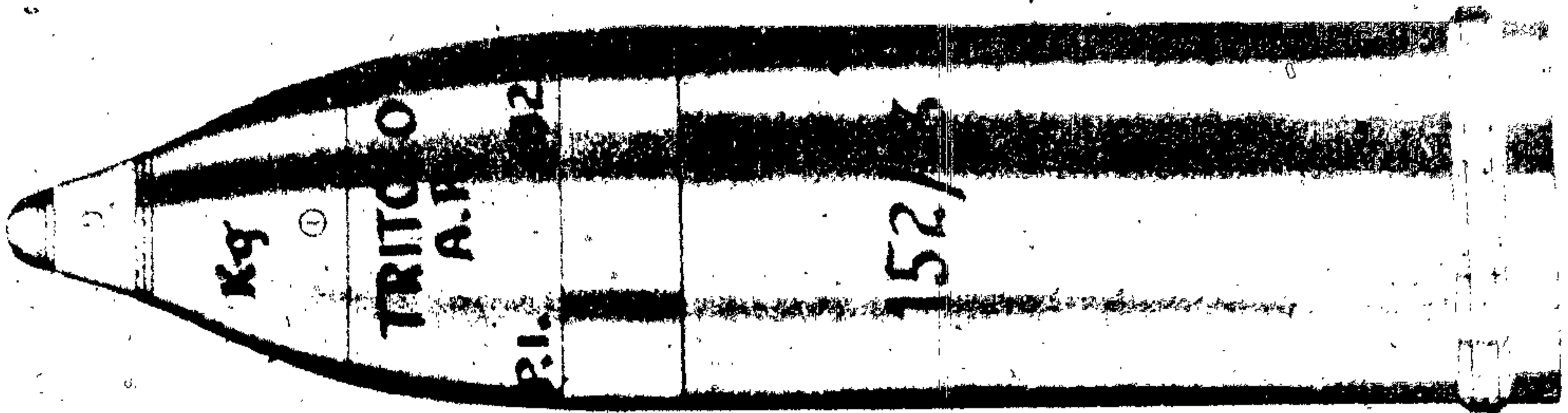

Figure 163 - 152/13-mm H.E. (Long)

153/13-mm H.E. (Long)

Data

Gun used in 152/13-mm
Heavy Field
Howitzer

Fuzing Nose Percussion
Fuzes British
Nos. 100, 101,
101E, 106, or 44

Over-all length
With fuze 582 mm

Without fuze 531 mm

Diameter at base 150.1 mm

Distance base to band 21 mm

Width of band 17 mm

Diameter at bourrelet 152 mm

Type of filling TNT

Weight of filling 3.340 kg.

Weight of loaded projectile 45 kg.

Remarks

This projectile is of British design and uses British fuzes.

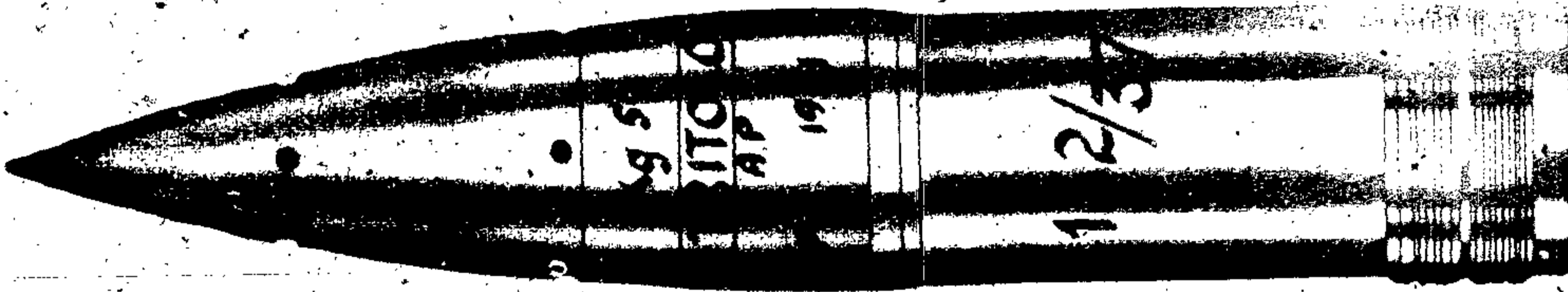

Figure 164 - 152/37-mm H.E.

152/37-mm H.E.

Data

Gun used in 152/37-mm Gun

Fuzing Nose Percussion
Fuze M17
(Guerritore)
I.M35 m. c. or
I.M38 m. c.

Over-all length
With cap 844 mm

Diameter at base 150.9 mm

Distance base to 1st band 25 mm

Distance base to 2nd band 64 mm

Width of 1st band 30 mm

Width of 2nd band 35 mm

Diameter at bourrelet 151.87 mm

Type of filling TNT

Weight of filling 4.68 kg.

Weight of loaded projectile 54.0 kg.

Remarks

The projectile has a ballistic cap and two rotating bands.



Figure 165 - 152/45-50-mm H.E. (Base-Fuzed)

152/45-50-mm H.E. (Base-Fuzed)

Data

Guns used in.....	152/45-mm Gun, 152/50-mm Gun
Fuzing.....	Base Fuze M914
Over-all length.....	599 mm
Diameter at base.....	144.5 mm
Distance base to band.....	35 mm
Width of band.....	65 mm
Diameter at bourrelet.....	Unknown
Type of filling.....	TNT
Weight of filling.....	3.75 kg.
Weight of loaded projectile.....	47 kg.

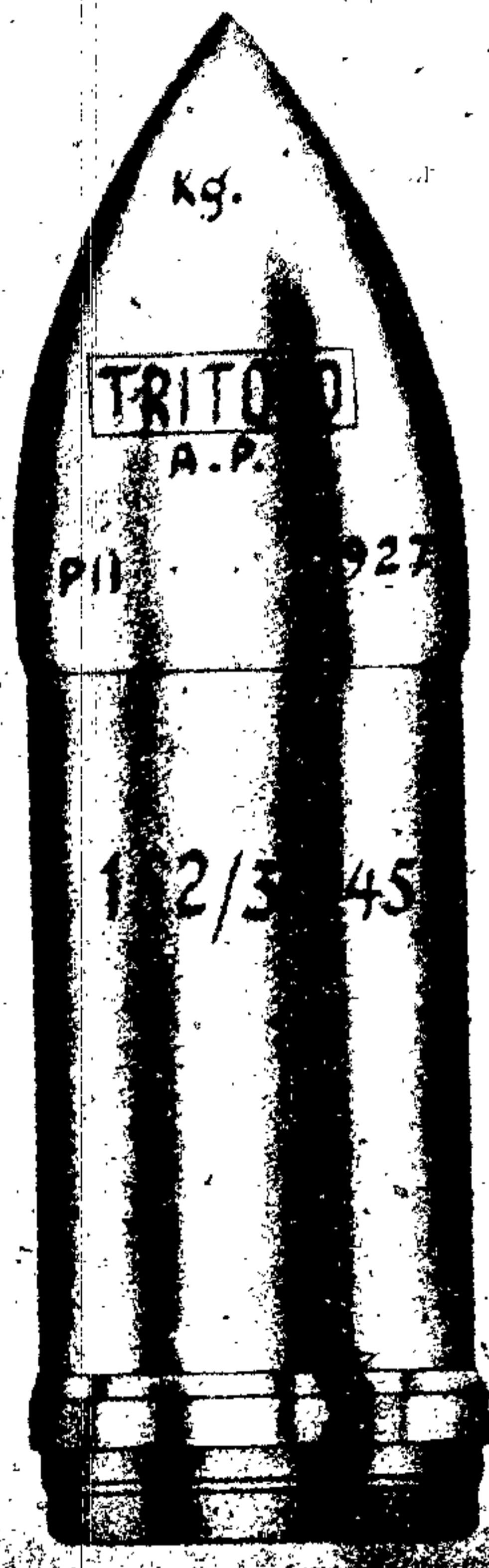

Figure 166 - 152/32-45-mm H.E. (Base-Fuzed)

152/32-45-mm H.E. (Base-Fuzed)

Data

Guns used in.....	152/32-mm Gun, 152/45-mm Gun
Fuzing.....	Base Fuzes M914, M909K25, or M911/917
Over-all length.....	545 mm
Diameter at base.....	150.3 mm
Distance base to band.....	32.4 mm
Width of band.....	25 mm
Diameter at bourrelet.....	Unknown
Type of filling.....	TNT
Weight of filling.....	3.351 kg.
Weight of loaded projectile.....	47 kg.



Figure 167 - 152/37-mm A.P.

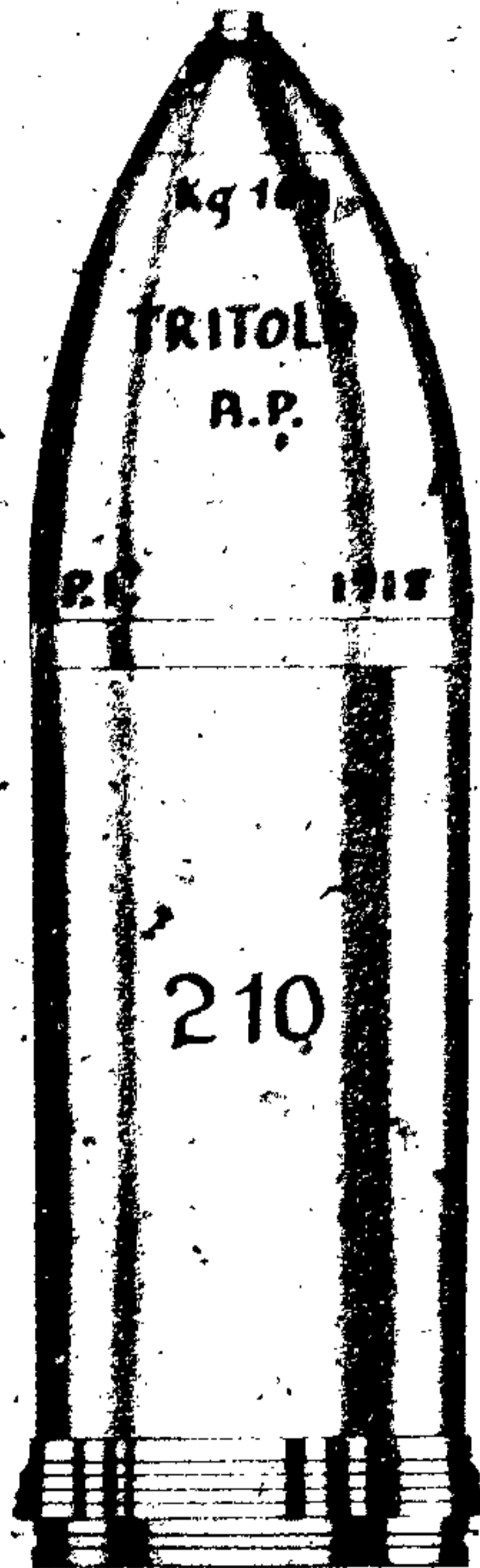

Figure 168 - 210-mm H.E.

152/37-mm A.P.

Data

Gun used in	152/37-mm Gun
Fuzing	Base Fuze M11 K. S. R.
Over-all length	519.6 mm
Diameter at base	151.2 mm
Distance base to 1st band	24 mm
Distance base to 2nd band	63 mm
Width of 1st band	30 mm
Width of 2nd band	35 mm
Diameter at bourrelet	151.8 mm
Type of filling	0.42 kg.
Weight of loaded projectile	52.78 kg.

Remarks

The projectile has a double rotating band and both piercing and ballastic caps.

210-mm H.E.

Data

Guns used in	210/8-mm Field Gun, 210/22-mm Howitzer
Fuzing	Nose Percussion Fuze M17
Over-all length	
With fuze	730.3 mm
Without fuze	712 mm
Diameter at base	Unknown
Distance base to band	25 mm
Width of band	25 mm
Diameter at bourrelet	209.30 mm
Type of filling	TNT or MAT or MBT
Weight of filling	14.125 kg.
Weight of loaded projectile	100.500 kg.
Booster used	No. 4 M38

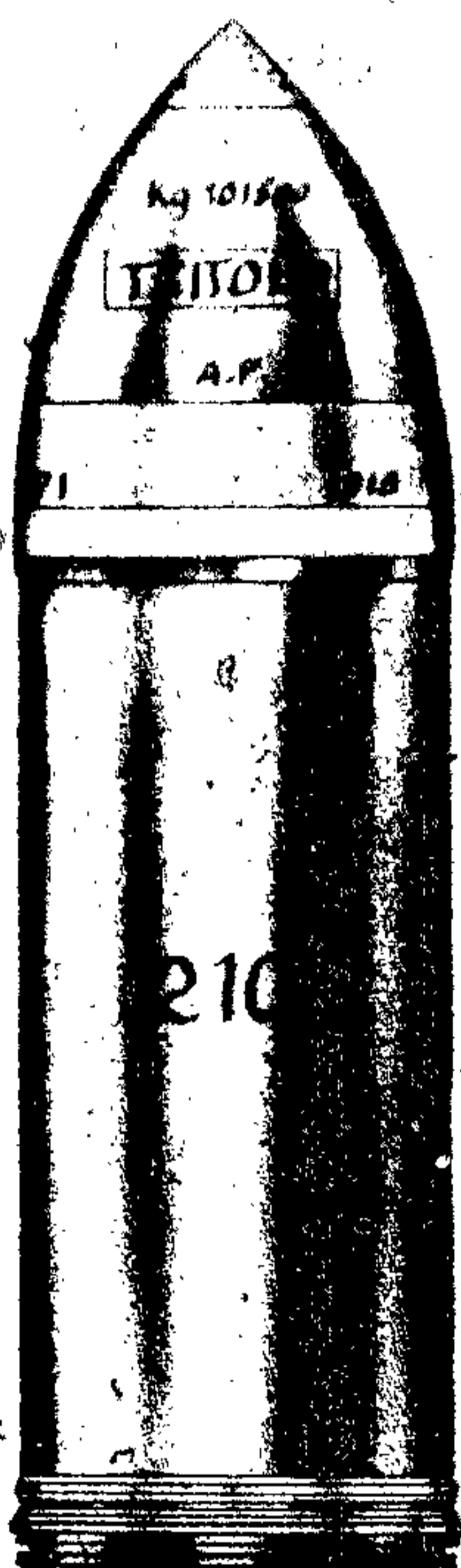

Figure 169 - 210-mm H.E. (Cast-Steel)

210-mm H.E. (Cast-Steel)

Data:	
Gun used in.....	210/8-mm Field Gun
Fuzing.....	Nose Percussion Fuze M17
Over-all length.....	735 mm.
Diameter at base.....	200 mm
Distance base to band.....	14.5 mm
Width of band.....	25 mm
Diameter at bourrelet.....	209.3 mm
Type of filling.....	TNT
Weight of filling.....	11 kg. to 14.70 kg.
Weight of loaded projectile.....	100 kg. to 103.6 kg

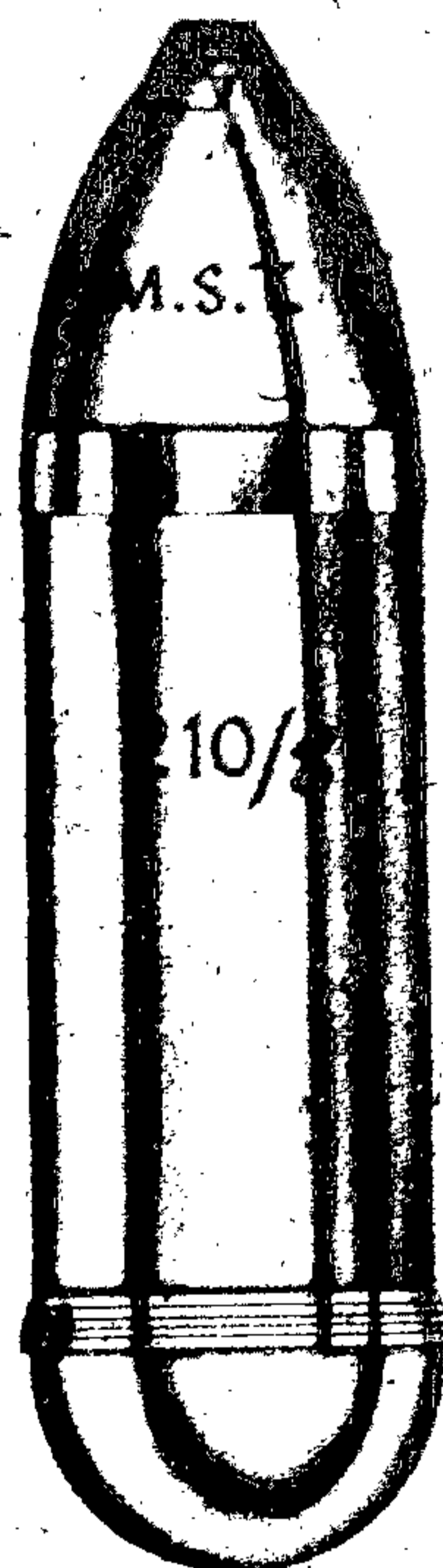

Figure 170 - 210-mm H.E. (Bomba)

210-mm H.E. (Bomba)

Data:	
Gun used in.....	210/8-mm Field Gun
Fuzing.....	Nose Percussion Fuze (Guerritore I. M35 or I. M38)
Over-all length.....	
Without fuze.....	776 mm
Diameter at base.....	208 mm
Distance base to band.....	107.5 mm
Width of band.....	25 mm
Diameter at bourrelet.....	209.5 mm
Type of filling.....	MST
Weight of filling.....	21 kg
Weight of loaded projectile.....	60.5 kg.

Remarks

The projectile has a very unusual round base.



Figure 171 - 210/22-mm H.E. M35

210/22-mm H.E. M35

Data

Gun used in.....	210/22-mm Field Gun
Fuzing.....	Nose Percussion Fuze (Guerritore V. M38)
Over-all length	
With fuze.....	851.2 mm
Without fuze.....	820.2 mm
Diameter at base.....	185 mm
Distance base to band.....	102.5 mm
Width of bourrelet.....	30 mm
Diameter at bourrelet.....	209.4 mm
Type of filling.....	Amatol
Weight of filling.....	18.590 kg.
Weight of loaded projectile.....	101.133 kg.

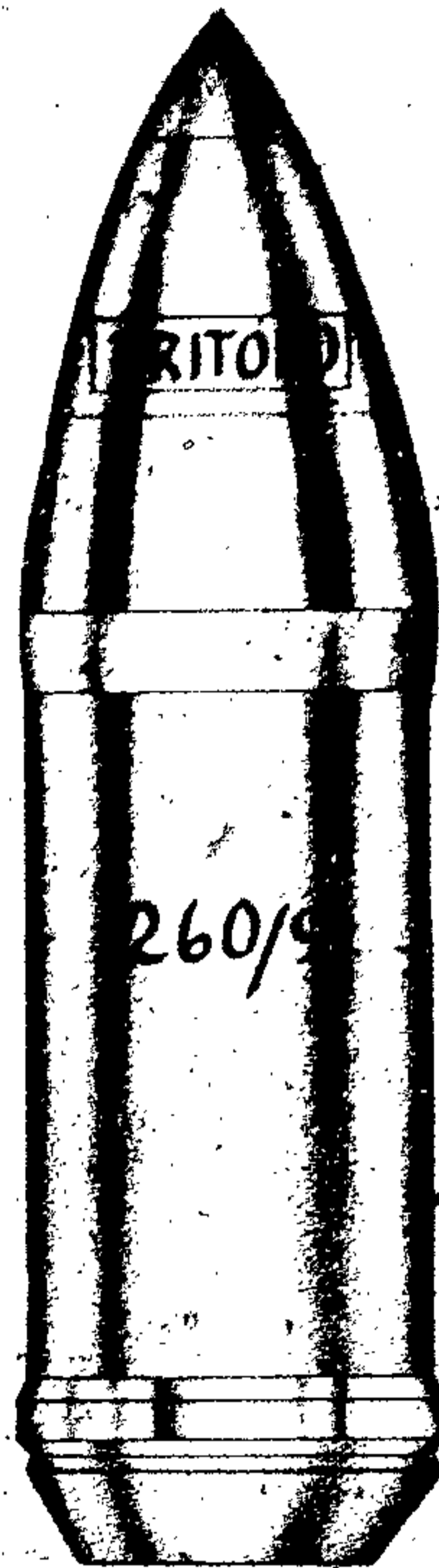

Figure 172 - 260/9-mm H.E.

260/9-mm H.E.

Data

Gun used in.....	260/9-mm Field Gun
Fuzing.....	Nose Percussion Fuze M17
Over-all length with nose plug.....	953 mm
Diameter at base.....	Unknown
Distance base to band.....	73 mm
Width of band.....	34 mm
Diameter at bourrelet.....	Unknown
Type of filling.....	NT
Weight of filling.....	25.940 kg.
Weight of loaded projectile.....	219.100 kg.
Booster.....	No. 4 M38

Remarks

The projectile has a streamlined base. One modification has less wall thickness.

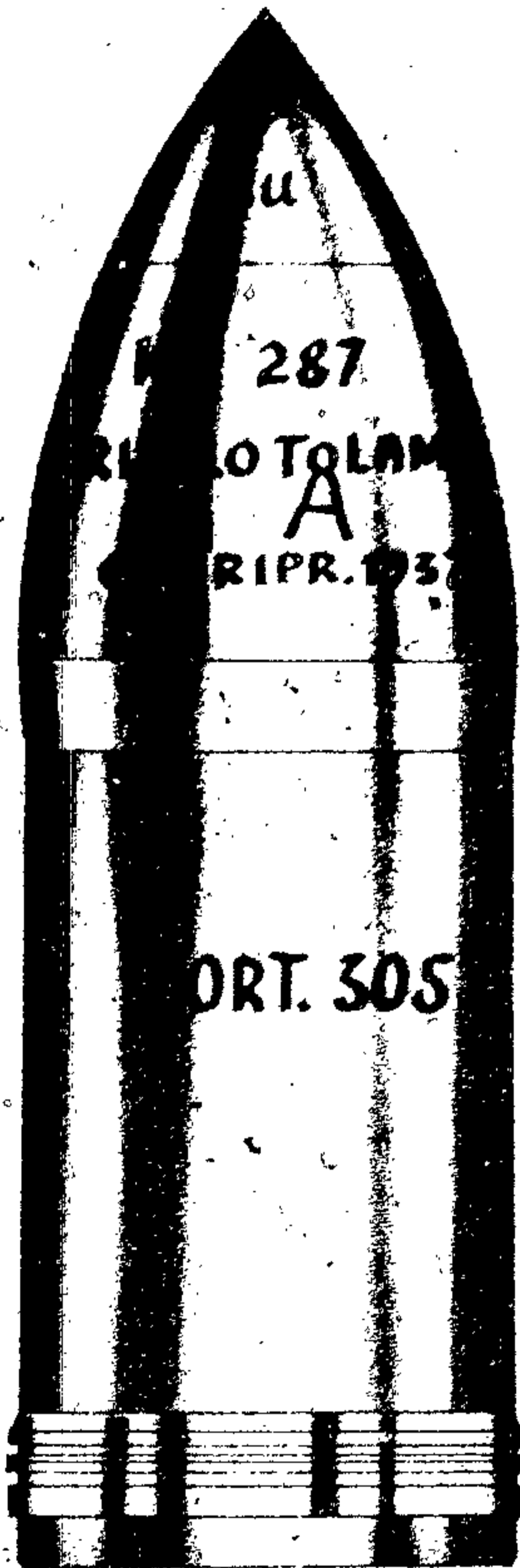
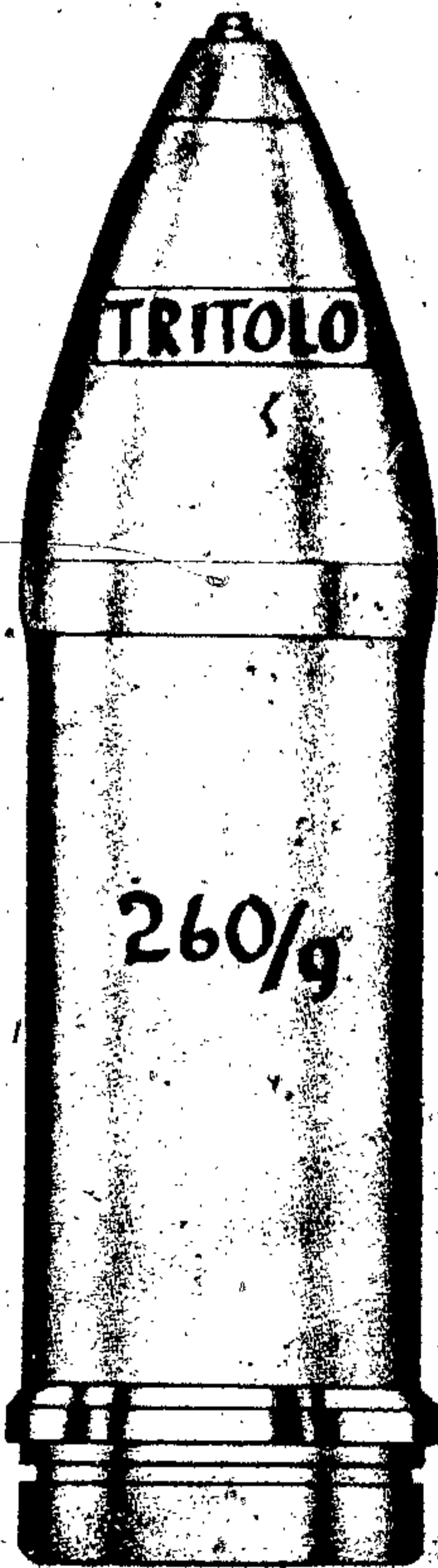

Figure 173 - 260/9-mm H.E. (Cast-Steel)

Figure 174 - 305-mm H.E. (Short)

260/9-mm H.E. (Cast-Steel)

Data

Gun used in.....	260/9-mm Field Gun
Fuzing.....	Nose Percussion Fuze M17
Over-all length.....	953 mm
Diameter at base.....	256 mm
Distance base to band.....	73 mm
Width of band.....	34 mm
Diameter at bourrelet.....	Unknown
Type of filling.....	TNT
Weight of filling.....	19.8900 kg.
Weight of loaded projectile.....	222.700 kg.
Booster.....	No. 4 M38

305-mm H.E. (Short)

Data

Gun used in.....	305/8-mm Field Howitzer
Fuzing.....	Base Fuze M09
Over-all length.....	946 mm
Diameter at base.....	203 mm
Distance base to band.....	24 mm
Width of band.....	57.5 mm
Diameter at bourrelet.....	304.4 mm
Type of filling.....	TNT
Weight of filling.....	32 kg.
Weight of loaded projectile.....	287 kg.

Remarks

The projectile is similar to 305-mm H. E. (Long).

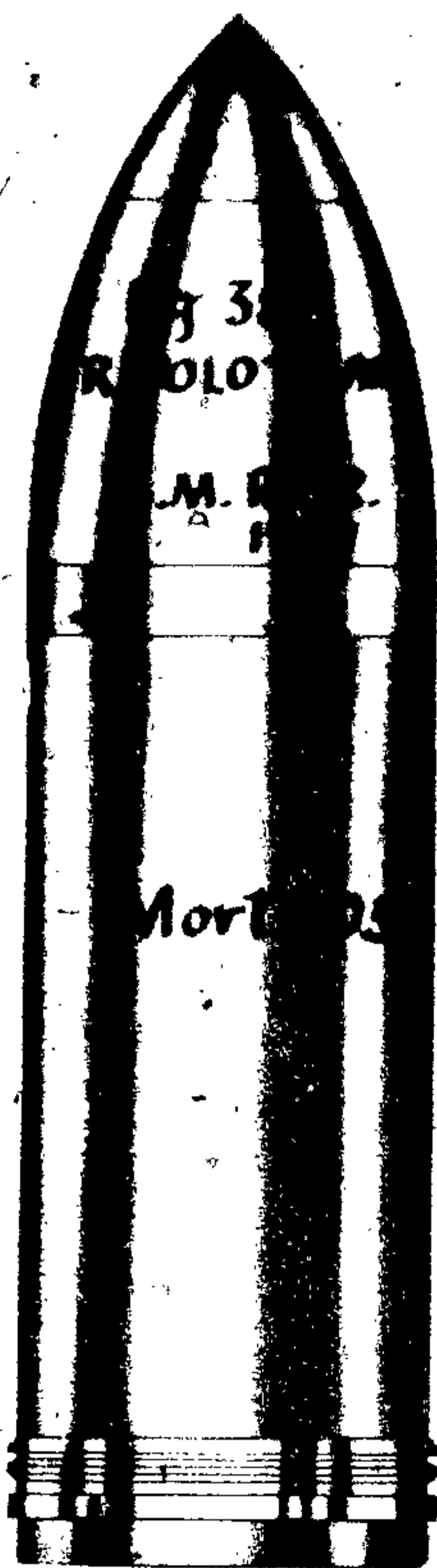

Figure 175 - 305-mm H.E. (Long)

305-mm H.E. (Long)

Data

Gun used in.....	305 8-mm Field Howitzer
Fuzing.....	Base Fuze MO9
Over-all length.....	1130 mm
Diameter at base.....	303 mm
Distance base to band.....	24 mm.
Width of band.....	57.5 mm
Diameter at bourrelet.....	304.4 mm
Type of filling.....	TNT
Weight of filling.....	34.33 kg.
Weight of loaded projectile.....	380 kg.

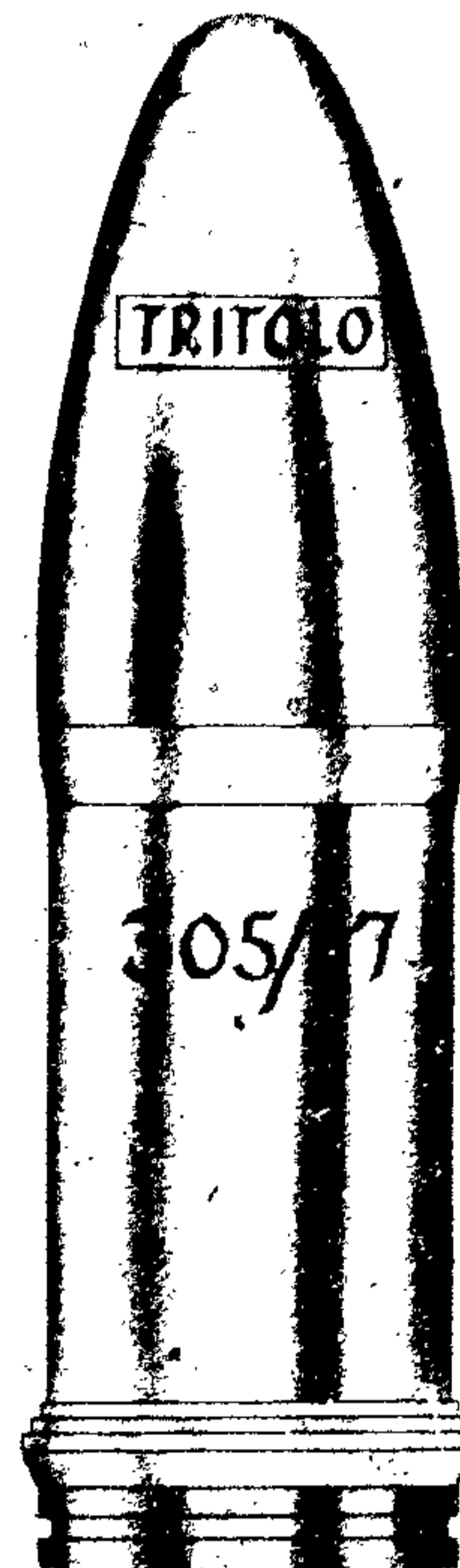

Figure 176 - 305-mm H.E. (Long and Short Light-Case)

305-mm H.E. (Long and Short Light-Case)

Data

Gun used in.....	305 /17-mm Howitzer
Fuzing.....	Base fuze M14 for 305 /17
Over-all length	
Short.....	1148 mm
Long.....	1183 mm
Diameter at base.....	302.2 mm
Distance base to band.....	56 mm
Width of band.....	50.8 mm
Diameter at bourrelet.....	303.5 mm
Type of filling.....	TNT
Weight of filling	
Short.....	33.600 kg.
Long.....	38.320 kg.
Weight of loaded projectile	
Short.....	348.0 kg.
Long.....	350 kg.

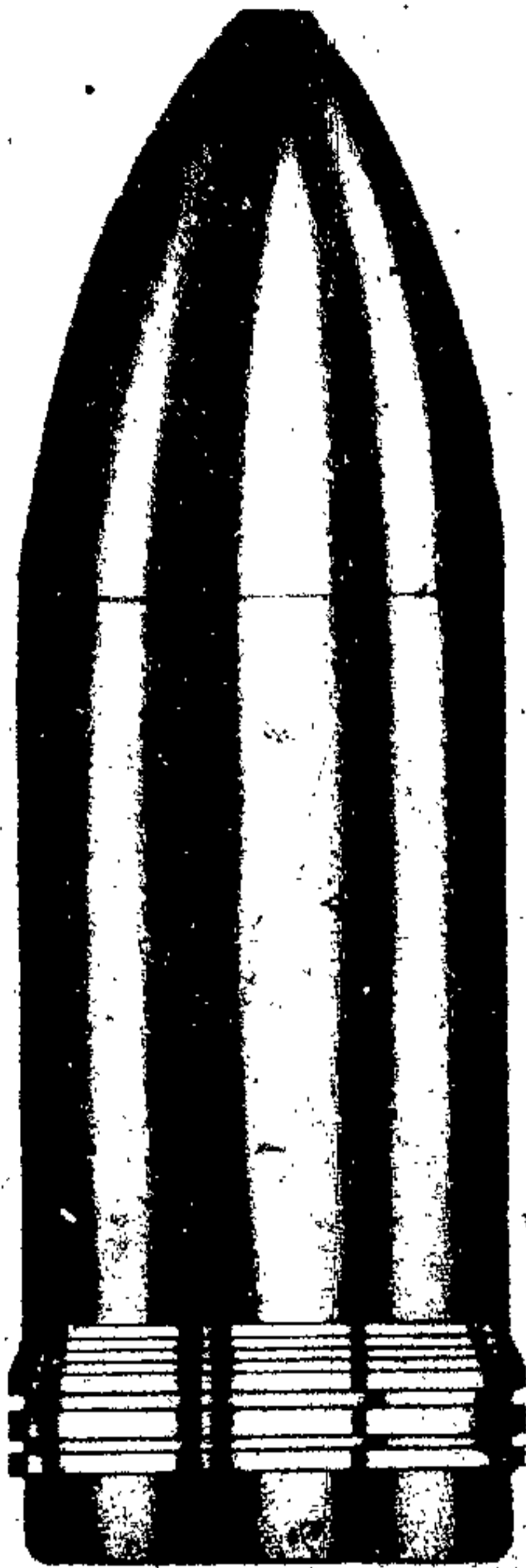

Figure 177 - 305-mm H.E. (British Short and Long)

305-mm H.E. (British Short and Long)

Data

Gun used in	305 /17-mm Howitzer
Fuzing	
Short	British Nose Fuze No. 101E
Long	British Nose Fuze 450A or Italian M17
Over-all length without fuze	
Short	975.5 mm
Long	1075.5 mm
Diameter at base	301.3 mm
Distance base to band	51 mm
Width of band	76 mm
Diameter at bourrelet	Unknown
Type of filling	Probably TNT
Weight of filling	
Short	31.400 kg.
Long	45.000 kg.
Weight of loaded projectile	
Short	340.690 kg.
Long	340.500 kg.

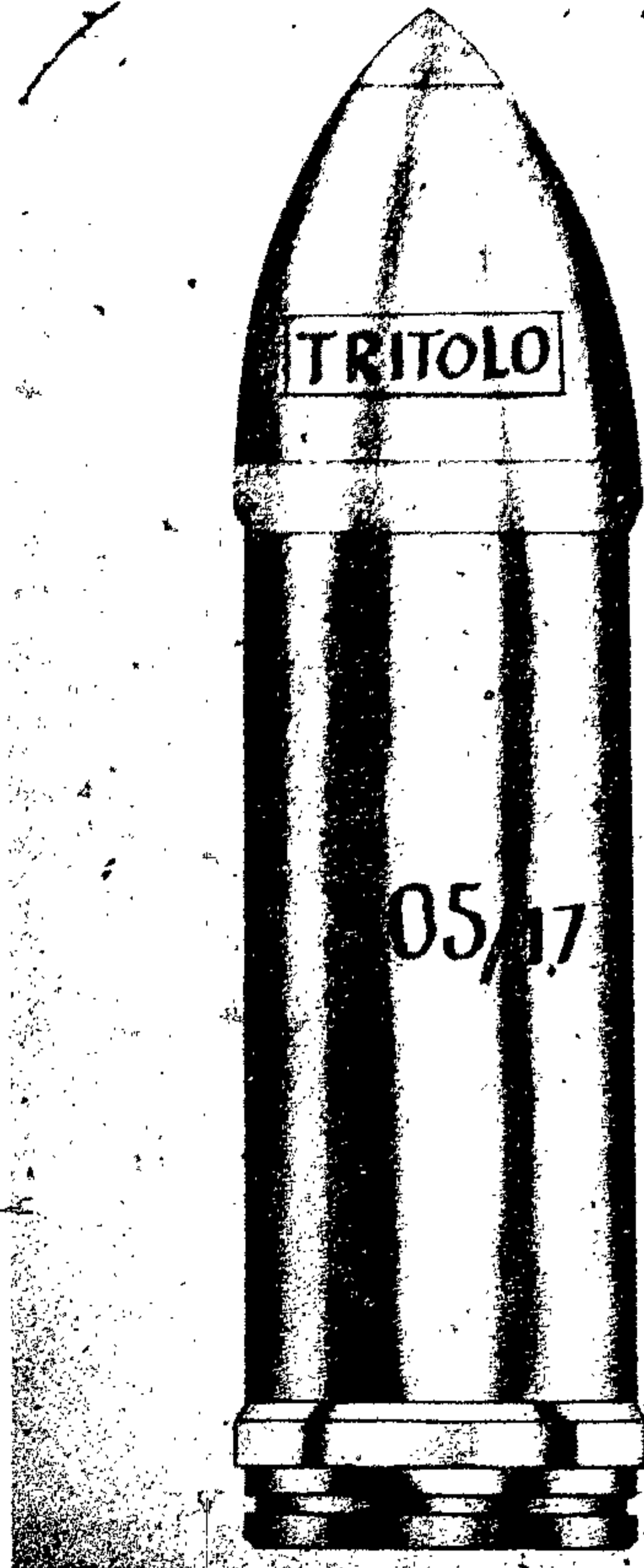

Figure 178 - 305/17-mm H.E.

305/17-mm H.E.

Data

Gun used in	305 /17-mm Howitzer
Fuzing	
Nose	Unknown
Over-all length with plug	1151 mm
Diameter at base	302.2 mm
Distance base to band	55 mm
Width of band	51.5 mm
Diameter at bourrelet	303.8 mm
Type of filling	TNT
Weight of filling	43.100 kg.
Weight of loaded projectile	348 kg.
Booster used	No. 4 M38

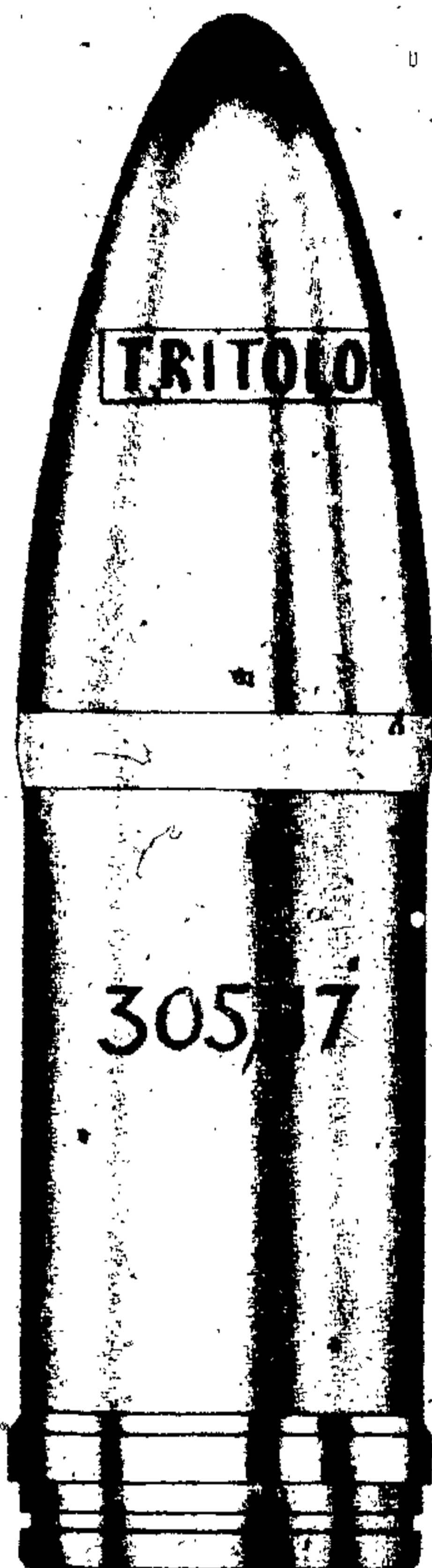

Figure 179 - 305/17-mm H.E. (Heavy)

305/17-mm H.E. (Heavy)

Data

Gun used in.....	305/17-mm Howitzer
Fuzing.....	Base Fuze M14 for 305/17
Over-all length.....	1175 mm
Diameter at base.....	302.2 mm
Distance base to band.....	55 mm
Width of band.....	51.5 mm
Diameter at bourrelet.....	303.8 mm
Type of filling.....	TNT
Weight of filling.....	19.145 kg.
Weight of loaded projectile.....	441.100 kg.

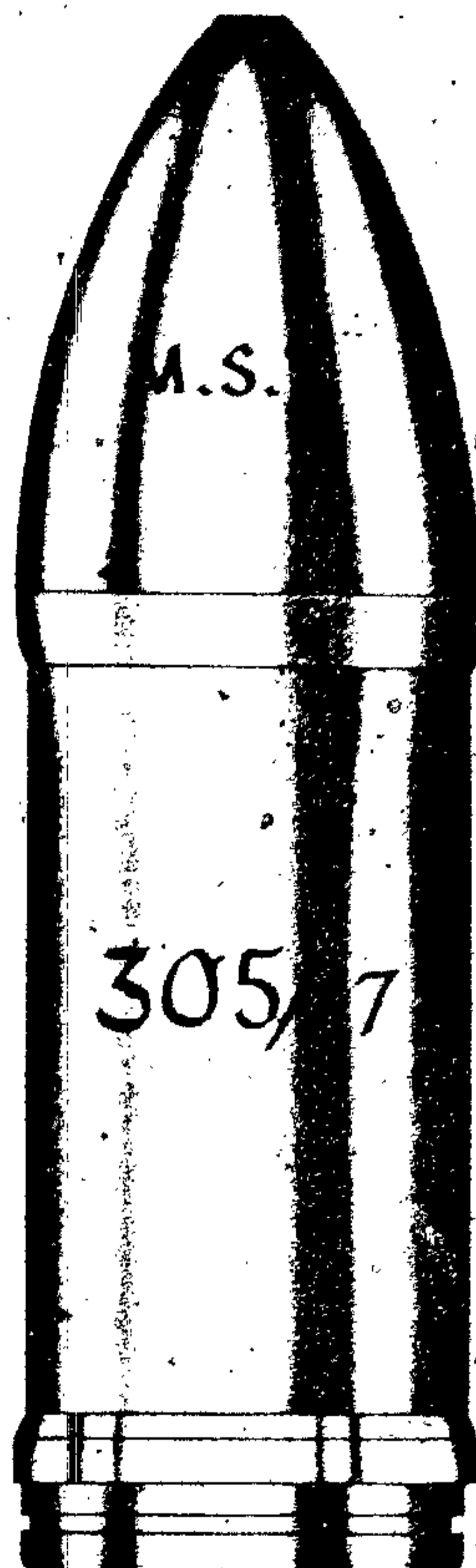

Figure 180 - 305/17-mm H.E. (Cast-Steel)

305/17-mm H.E. (Cast-Steel)

Data

Gun used in.....	305/17-mm Howitzer
Fuzing.....	Nose—Unknown
Over-all length without fuze.....	10236 mm
Diameter at base.....	302.4 mm
Distance base to band.....	55 mm
Width of band.....	51.5 mm
Diameter at bourrelet.....	303.8 mm
Type of filling.....	MST
Weight of filling.....	33.490 kg.
Weight of projectile.....	328.500 kg.
Booster.....	No. 4 M38

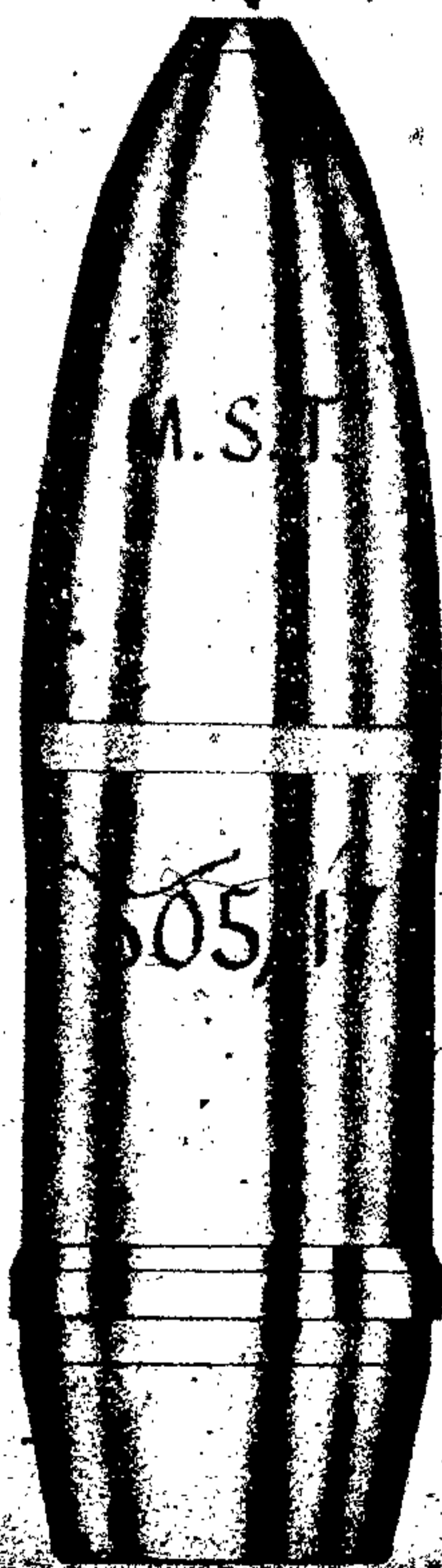

Figure 181 - 305/17-mm H.E. (One-Piece)

305/17-mm H.E. (One-Piece)

Data	
Gun used in.....	305/17-mm Howitzer
Fuzing.....	Nose Percussion Fuze M17
Over-all length without fuze.....	1130 mm
Diameter at base.....	Unknown
Distance base to band.....	177 mm
Width of band.....	51.8 mm
Diameter at bourrelet.....	303.52 mm
Type of filling.....	MST
Weight of filling.....	46.125 kg.
Weight of loaded projectile.....	259 kg.
Booster used.....	No. 4, M38

Remarks
The projectile is of one-piece construction.

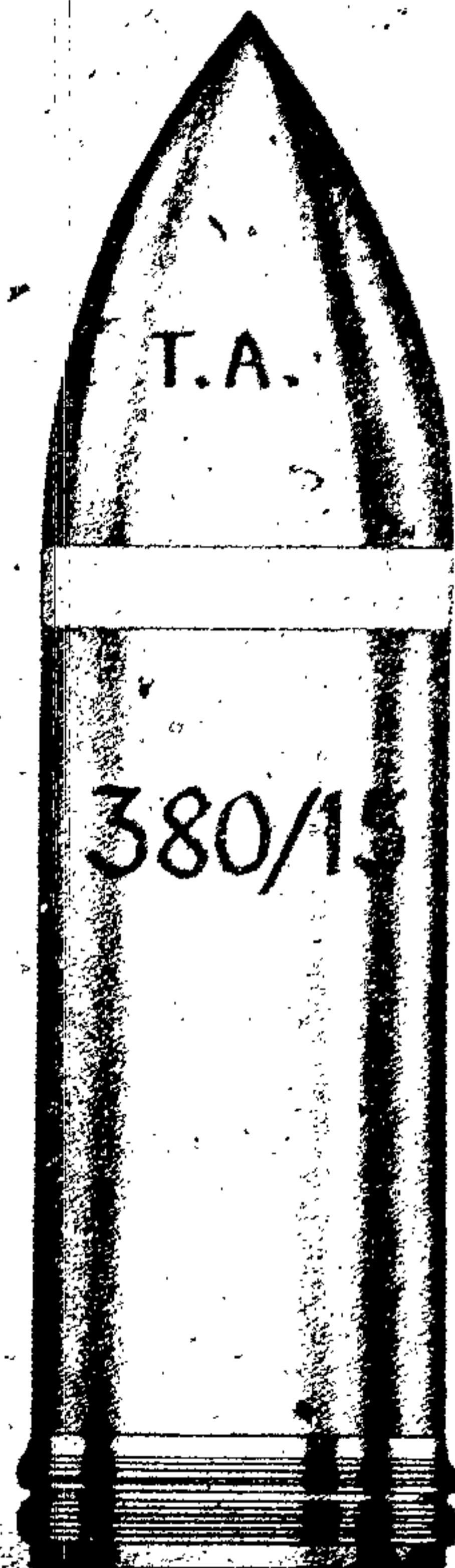

Figure 182 - 380/15-mm H.E. (Base-Fuzed)

380/15-mm H.E. (Base-Fuzed)

Data	
Gun used in.....	380/15-mm Heavy Howitzer
Fuzing.....	Base Fuze M16
Over-all length.....	1402 mm
Diameter at base.....	378 mm
Distance base to 1st band.....	25 mm
Distance base to 2nd band.....	65 mm (approx.)
Width of 1st band.....	33.6 mm
Width of 2nd band.....	32.5 mm
Diameter at bourrelet.....	379 mm
Type of filling.....	TNT
Weight of filling.....	71.49 kg.
Weight of loaded projectile.....	750 kg.

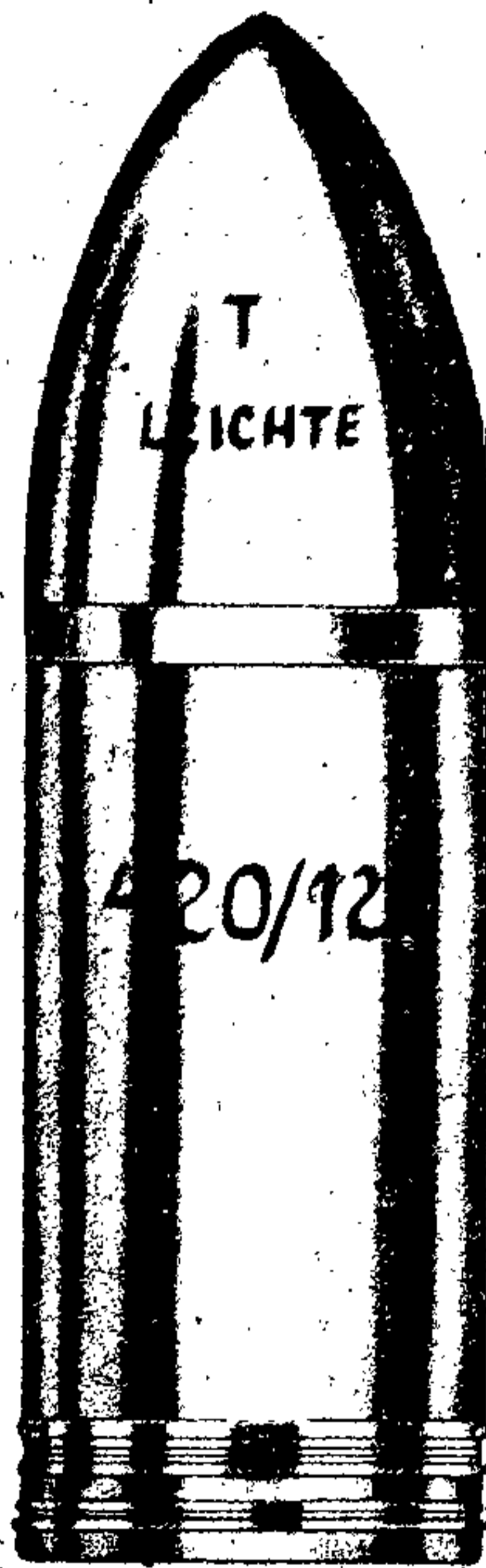

Figure 183 - 420-mm H.E. (Short and Long)

420-mm H.E. (Short and Long)

Data

Gun used in..... 420/12-mm
Heavy Howitzer

Fuzing
Base—Unknown

Over-all length
Short..... 1375 mm
Long..... 1554 mm

Diameter at base..... 485.9 mm
Distance base to 1st band..... 25 mm
Distance base to 2nd band..... 70 mm

Width of 1st band..... 25 mm
Width of 2nd band..... 40.5 mm
Diameter at bourrelet
Short..... 418.8 mm
Long..... 418.7 mm
Type of filling..... TNT
Weight of filling
Short..... 75 kg.
Long..... 90 kg.
Weight of loaded projectile
Short..... 800 kg.
Long..... 1000 kg.



Figure 184 - 240-mm (Bomba)

240-mm and 400-mm (Bomba)

Data

Equipment used in
 240-mm Mortar
 400-mm Mortar

Fuzing
 240-mm—French type M35 I. T. or Nose Fuze
 M17 or I. M38
 400-mm—French type M15 I. T.

Over-all length with fuze
 240-mm 965 mm
 400-mm 1700 mm

Length of body 672 mm
 Body Diameter 240 mm
 Type of filling TNT or Amatol
 Weight of filling Unknown
 Total weight
 240-mm 65.5 kg.
 400-mm 265 kg.
 Booster No. 4 M38

Remarks

These mortar bombs are very similar to aircraft bombs.

CARTRIDGE CASES

It is the Italian practice to have more than one weight for the normal charge for a particular equipment. These are referred to a 1st, 2nd, and 3rd normal charge. In terms of weight, these represent decreasing values. The charge may be a flashless type or nonflashless. A flashless charge is obtained by the inclusion of bags containing potassium chloride. Two types of marking and coloring systems were used.

The Old System had:

A. Colored rings on the base of the cartridge to refer to the propellant charge.

- Red 1st normal charge
- Blue 2nd normal charge
- 2 black rings 3rd normal charge
- Red and white 1st flashless charge
- Blue and white 2nd flashless charge
- 2 black half rings 3rd flashless charge
- Green and white Special charge for star shells

B. Colored triangles on the base.

- Black 1st class condition
- Green Near end of its life
- Yellow Practice

C. Other marks.

- Green circle AA
- White Star shell
- C. L. Tracer fitted

On 76/17 and smaller calibers, there is insufficient space for complete rings, and so color letters give details.

D. On the bags are following general markings relating to propellant.

1. Initial of manufacturer
2. Lot and date of manufacture
3. Place and date of proof
4. Place and date of filling

The New System.

The type of charge is indicated by a number in brackets, as follows:

- [1]—1st normal charge
- [2]—2nd normal charge
- [3]—3rd normal charge

If the charge is flashless, there is a half black ring on the base. A complete black ring indicates

a special charge for light projectiles, usually a 3rd normal-charge.

The following signs have indicated significance

- Black circle A. A.
- Black triangle 1st class condition
- Black square 2nd class condition
- Black diamond Near end of life
- Black Star Star shell
- C. L. Tracer fitted

75/13-mm Mountain Gun Cartridge Case

Data

- Over-all length 129 mm
- Over-all diameter at mouth 77.2 mm
- Width of rim 4 mm
- Diameter at rim 85 mm
- Weight of empty case 0.670 kg.



Figure 185 - 75/13-mm Mountain Gun Cartridge Case

Igniter
10 grams black powder

Primer
Percussion Primer M29 or M35

Propellant
Lightest Loading
0.12 kg. Ballistite (1 x 10 x 10)
2nd lightest loading
0.12 kg. + 0.04 kg. Ballistite (1 x 10 x 10)
Total - 0.160 kg.
3rd lightest loading
0.12 kg. + 0.04 kg. + 0.04 kg.
Total - 0.200 kg.
4th lightest loading
0.12 kg. + 0.04 kg. + 0.04 kg. + 0.04 kg.
Total - 0.240 kg.

75/18-mm Mountain Howitzer Cartridge Case

Data
Over-all length 185 mm
Over-all diameter at mouth 78.5 mm

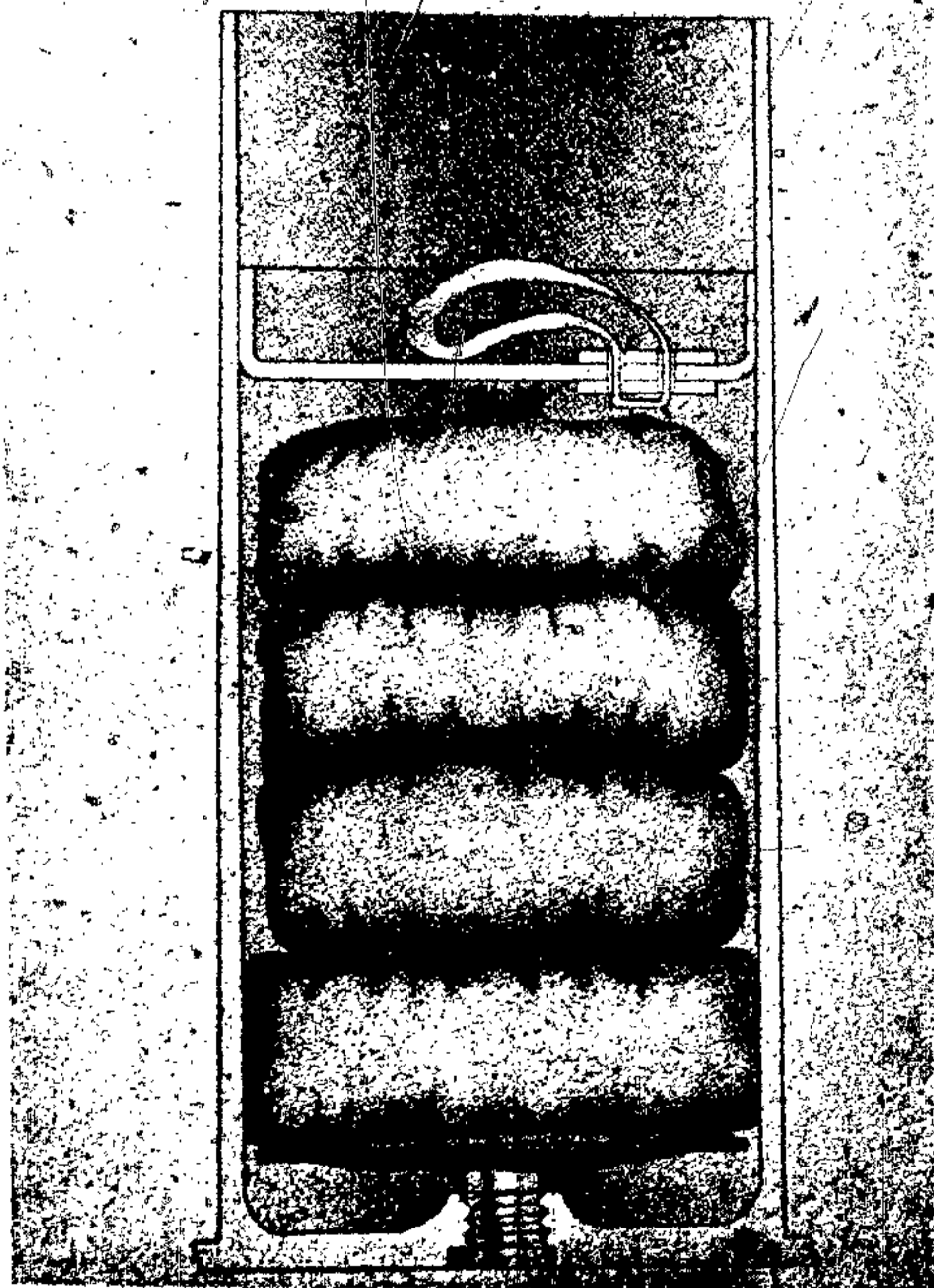

Figure 186 - 75/18-mm Mountain Howitzer Cartridge Case

Width of rim 36 mm
Diameter at rim 90.20 mm
Weight of empty case 0.830 kg.

Igniter
10 kg. black powder

Primer
Percussion Primer M29 or M35

Propellant
Lightest loading
No. 4 Normal Charge
0.075 kg. Ballistite (0.5 x 5 x 5)
2nd lightest loading
0.075 kg. + 0.087 kg. Ballistite (1.2 x 12 x 12)
Total - 0.162 grams
3rd lightest loading
0.075 kg. + two (0.087 kg.) charges
Total - 0.249 grams
4th lightest loading
0.075 kg. + three (0.087 kg.) charges
Total - 0.336 grams

75/27-mm Field Gun Cartridge Case

Data
Over-all length 185.4 mm
Over-all diameter at mouth 78.5 mm
Width of rim 36 mm
Diameter at rim 90.2 mm
Weight of empty case 0.835 kg.

Igniter
10 grams black powder

Primer
Percussion Primer M29 or M35

Propellant
Lightest loading
180 grams Ballistite (1.2 x 12 x 12)
2nd lightest loading
180 grams + 60 grams Ballistite (1.2 x 12 x 12)
Total - 240 grams
3rd lightest loading
180 grams + two 60 gram charges
Total - 300 grams
4th lightest loading
180 grams + three 60 gram charges
Total - 360 grams
5th lightest loading
180 grams + four 60 gram charges
Total 420 grams

2nd lightest loading
 0.280 kg. + 0.220 kg. Ballistite
 (2 x 20 x 20) Total 0.500 kg.

Remarks
 The case is of the type of the 75/27 mm.

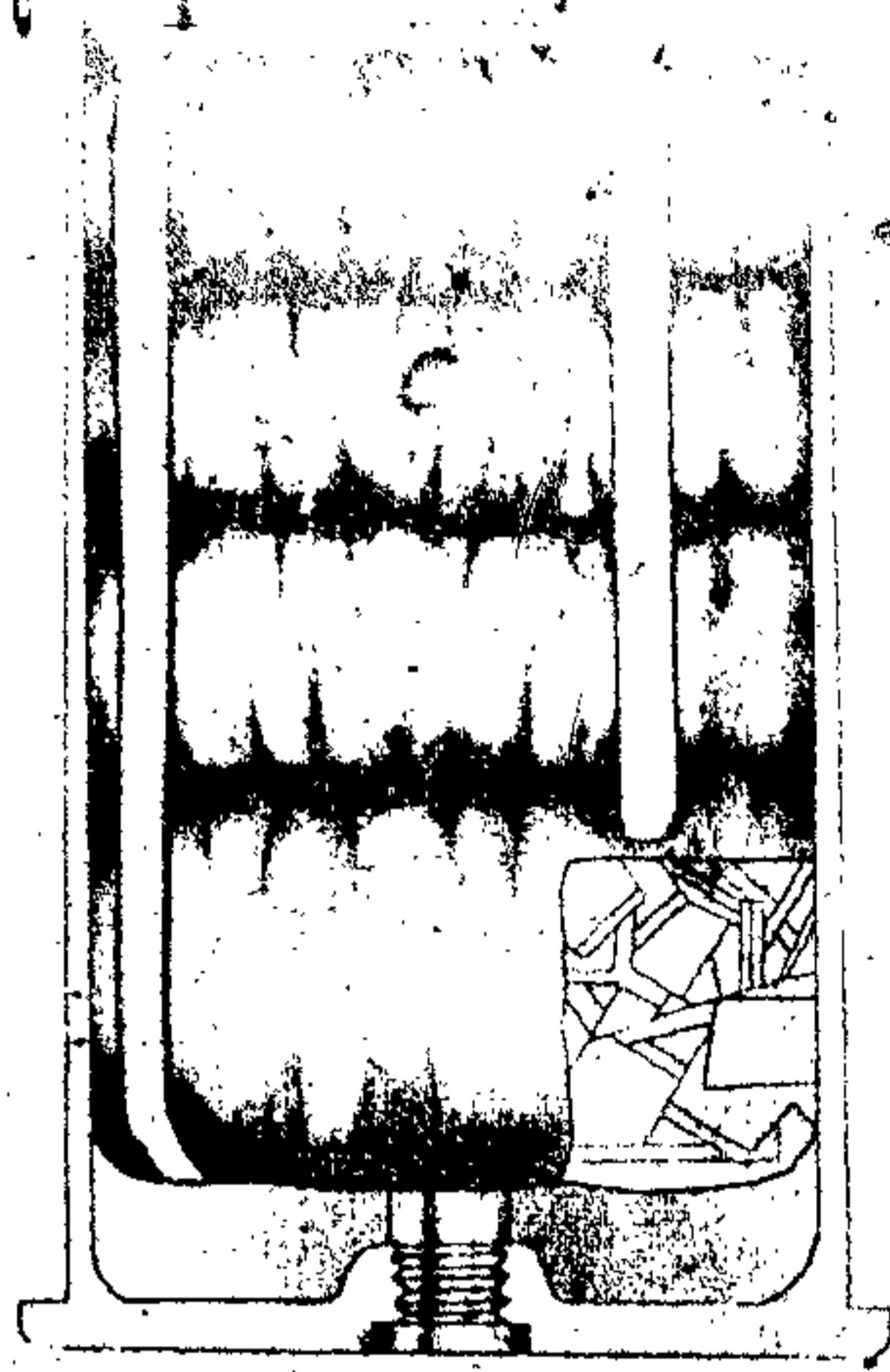

Figure 187 - 75/27-mm Field Gun Cartridge Case

75/32-mm Light Field Gun Cartridge Case

Data

Over-all length	334.1 mm
Over-all diameter at mouth	78.5 mm
Width of rim	3.6 mm
Diameter at rim	90.2 mm
Weight of empty case	1.4 kg.

Igniter

10 grams of black powder

Propellant

Type I

Lightest loading

0.280 kg. Ballistite (1.5 x 15 x 15)

Second lightest loading

0.280 kg. + 0.220 kg. Ballistite
 (2 x 20 x 20) Total—0.500 kg.

Third lightest loading

0.280 kg. + 0.220 kg. + 0.220 kg.
 Total .720 kg.

Type II

Lightest loading

0.280 kg. Ballistite (1.5 x 15 x 15)

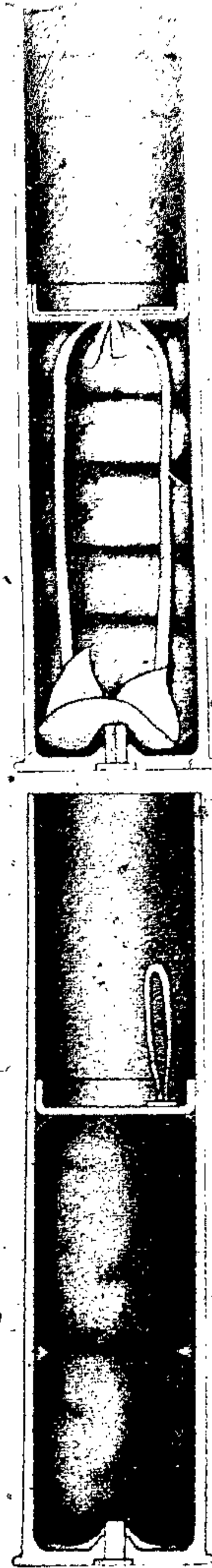

Figure 188 - 75/32-mm Light Field Gun Cartridge Case

77/28-mm Field Gun Cartridge Case

Dimensions

Unknown

Igniter

10 grams black powder

Primer

Percussion Primer MO8 P. B., 29 or 35

Propellant

Lightest loading

0.224 kg. Ballistite (1.5 x 15 x 15)

2nd lightest loading

0.224 kg. + 0.088 kg. Ballistite (1.5 x 15 x 15)

Total—0.312 kg.

3rd lightest loading

0.224 kg. + 0.088 kg. + 0.184 kg. Ballistite

(1.5 x 15 x 15)

Total—0.496 kg.

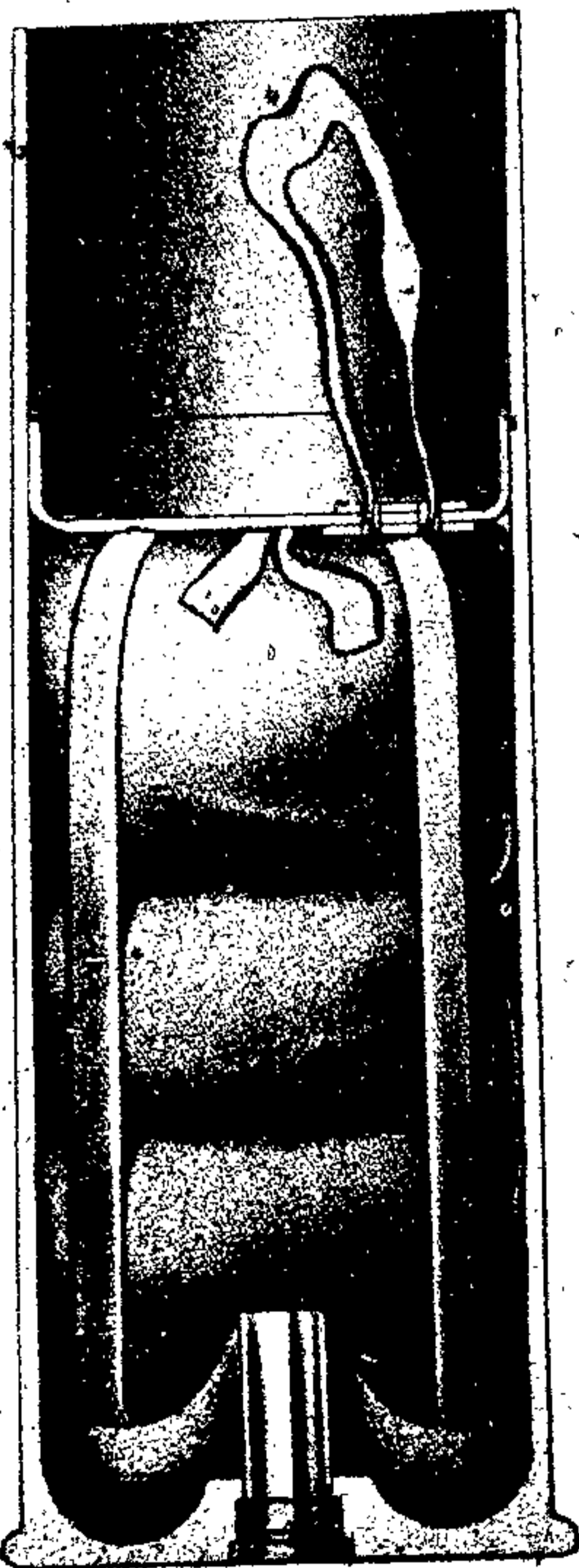

Figure 189 – 77/28-mm Field Gun Cartridge Case

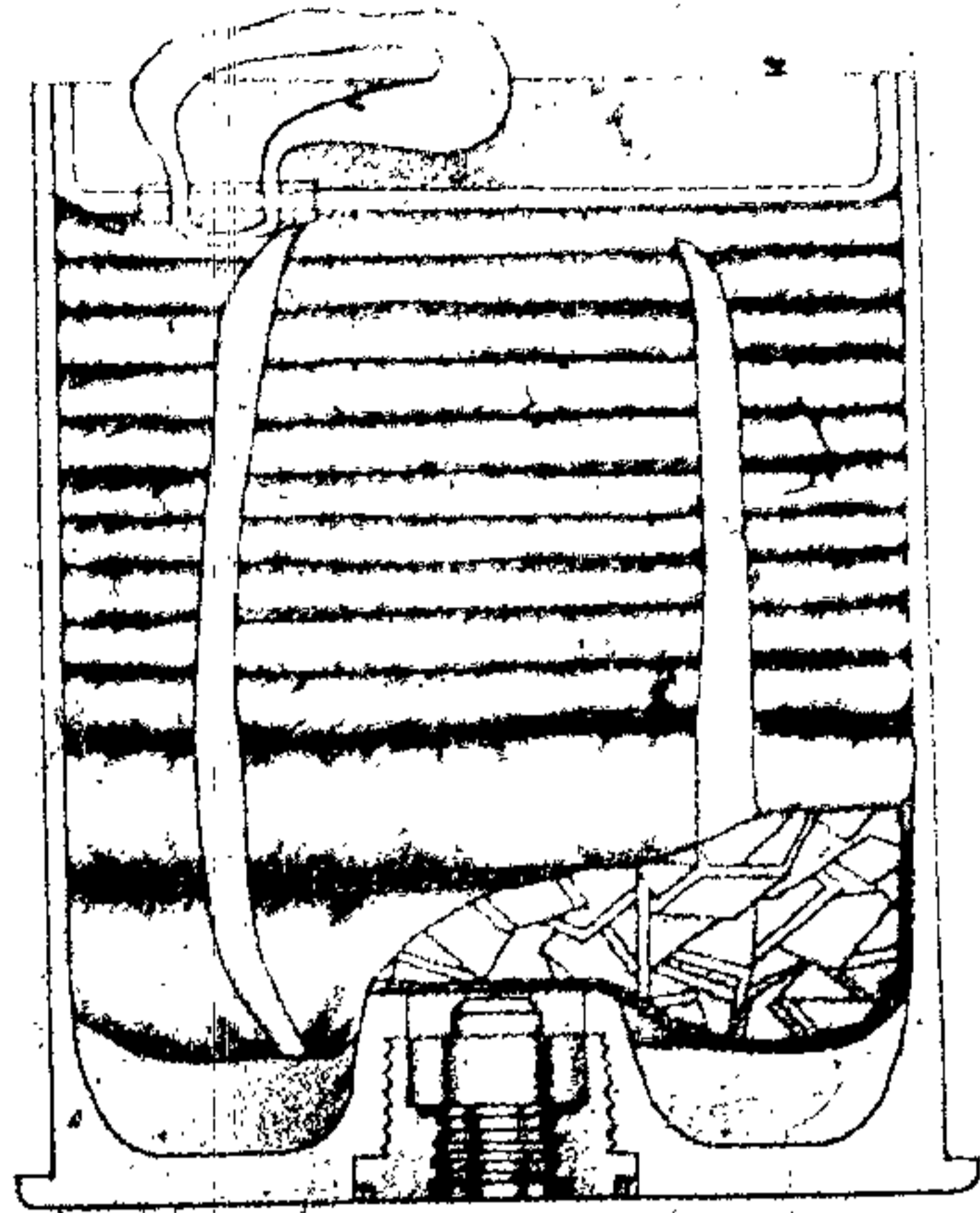

Figure 190 – 100/17-mm Light Field Howitzer Cartridge Case

100/17-mm Light Field Howitzer Cartridge Case

Data

Over-all length	132 mm
Over-all diameter at mouth	103.6 mm
Width of rim	4 mm
Diameter at rim	115 mm
Weight of empty case	1.210 kg.

Primer

Percussion Primer M29 or M35

Propellant

Lightest loading

0.28 kg. Ballistite (1.5 x 15 x 15)

2nd lightest loading

0.28 kg. + 0.07 kg. Ballistite (1.5 x 15 x 15)

Total - 0.35 kg.

3rd lightest loading

0.28 kg. + 0.07 kg. + 0.07 kg.

Total—0.42 kg.

4th lightest loading

0.28 kg. + 0.07 kg. + 0.07 kg. + 0.07 kg.

Total—0.49 kg.

5th lightest loading

0.28 kg. + 0.07 kg. + 0.07 kg. + 0.07 kg. + 0.07 kg.

Total—0.56 kg.

6th lightest loading

0.28 kg. + 0.07 kg. + 0.07 kg. + 0.07 kg. + 0.07 kg. + 0.07 kg.

Total—0.63 kg.

Remarks

This cartridge case and loadings are also used for the 100, 17-mm Mountain Howitzer.

105/14-mm Light Field Howitzer Cartridge-Case

Data

Over-all length	135 mm
Over-all diameter at mouth	110.9 mm
Diameter at rim	122 mm
Weight of empty case	1.760 kg.

Igniter

25 grams black powder

Primer

Percussion Primer M29 or M35

Propellant

Lightest loading

0.135 kg. Ballistite (0.5 x 5 x 5)

2nd lightest loading

0.135 kg. + 0.093 kg. Ballistite (1.2 x 12 x 12)

Total—0.228 kg.

3rd lightest loading

0.135 kg. + two 0.093 kg. charges

Total—0.321 kg.

4th lightest loading

Five 0.093 kg. charges

Total 0.465 kg.

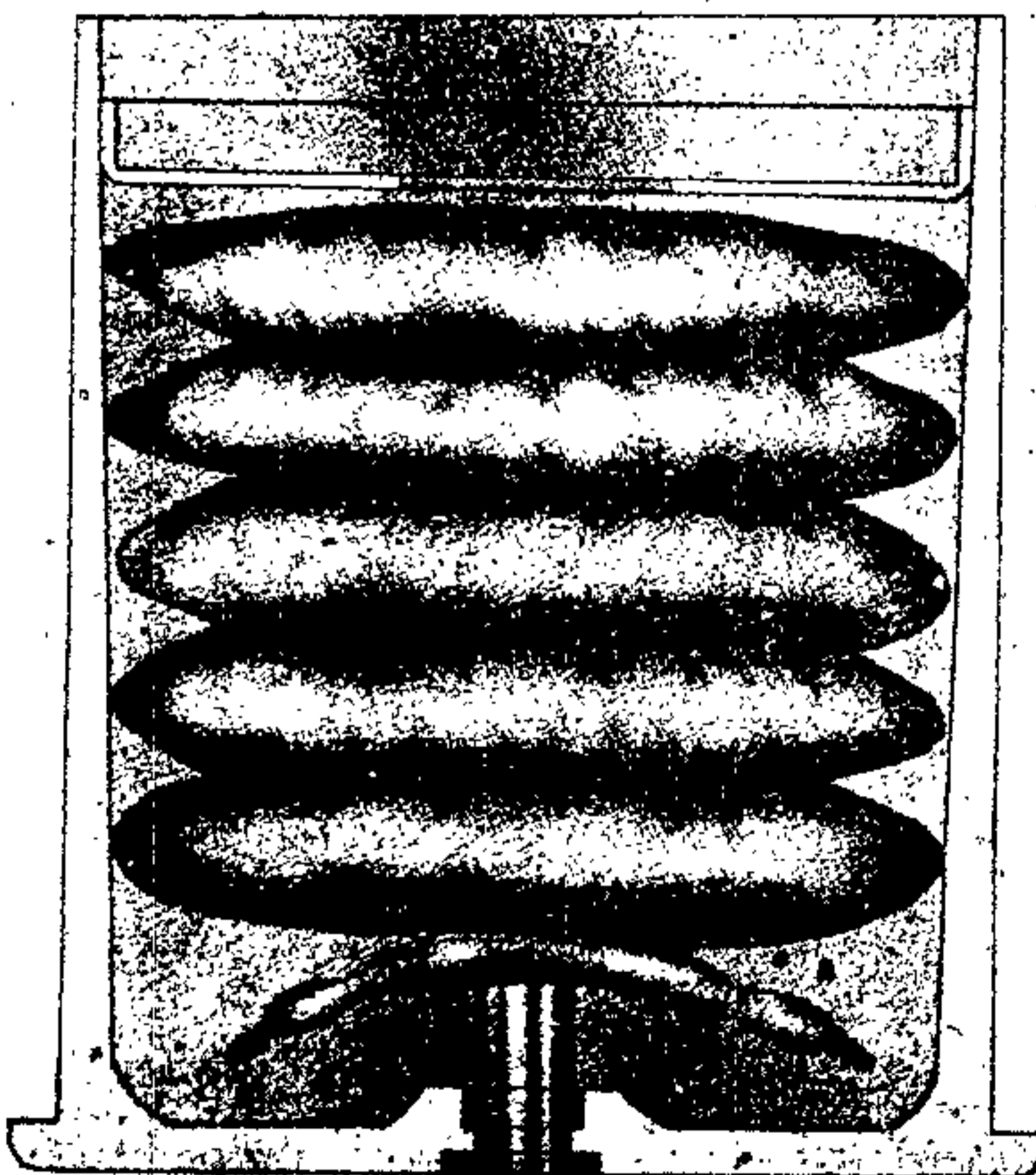

Figure 191 – 105/14-mm Light Field Howitzer Cartridge Case

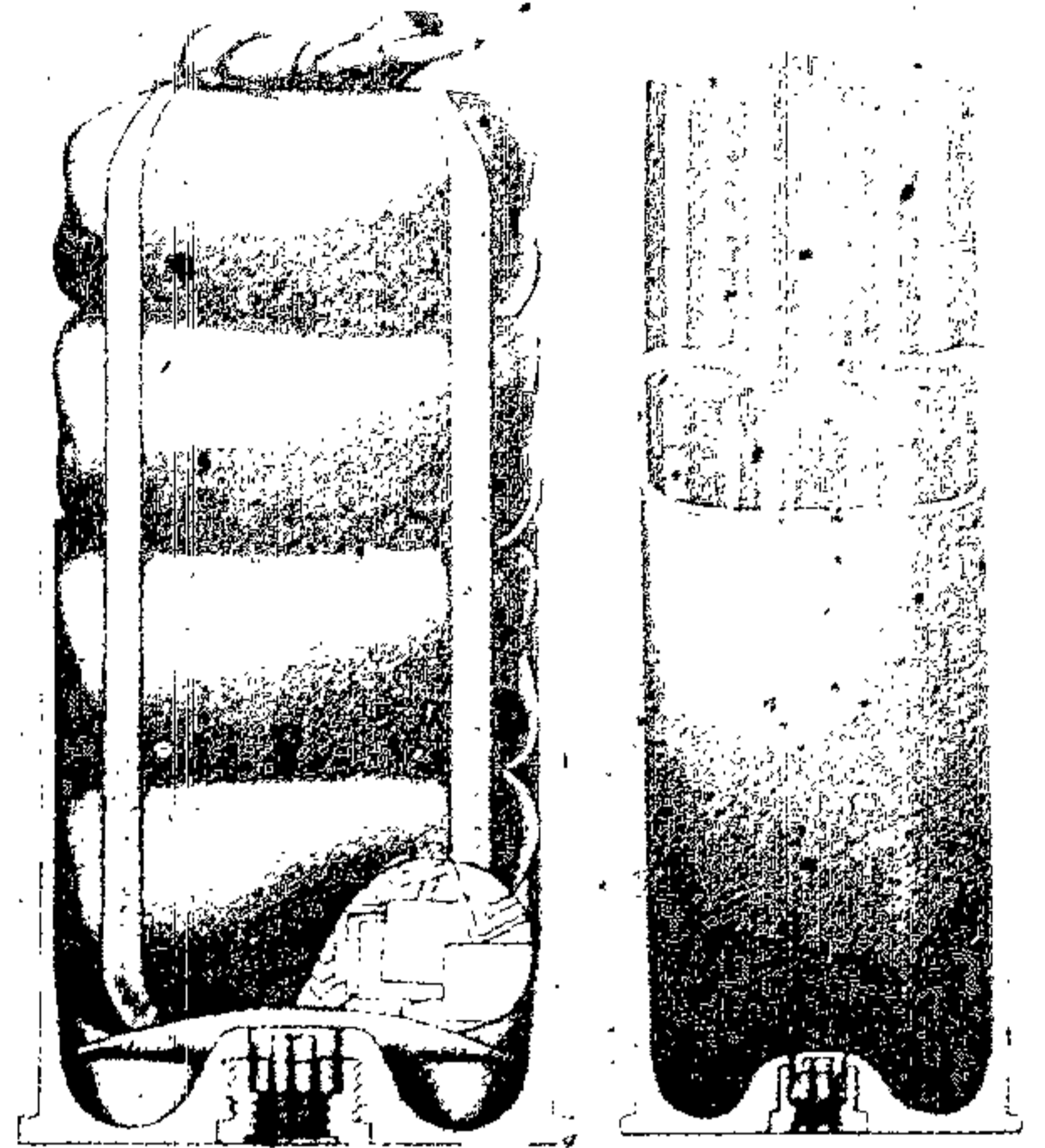

Figure 192 – 105/28-mm Gun Cartridge Case

105/28-mm Gun Cartridge Case

Data

Over-all length	135 mm
Over-all diameter at mouth	110.9 mm
Diameter at rim	122 mm
Weight of case	1.760 kg.

Igniter

25 or 30 grams black powder with 5 grams of lead foil as a de-coppering charge

Primer

Percussion Primer M29 or M35

Propellant

Type I

Lightest loading

0.68 kg. Ballistite in scroll form (1.5 x 360)

2nd lightest loading

0.68 kg. + 0.34 kg. Ballistite (1.5 x 360)

Total—1.02 kg.

3rd lightest loading

0.68 kg. + 0.34 kg. + 0.34 kg.

Total—1.36 kg.

Type II

Lightest loading

0.75 kg. Ballistite (2 x 20 x 20)

2nd lightest loading

0.75 kg. + 0.375 kg. Ballistite (2 x 20 x 20)

Total—1.125 kg.

3rd lightest loading

0.75 kg. + 0.375 kg. + 0.375 kg.

Total—1.50 kg.

Remarks

Most cases for 105-mm caliber guns are the same, but the propellant loading varies. This same type of case and loading is used for the 105/32-mm gun.

149/12-mm Heavy Field Howitzer Cartridge Case

Data

Over-all length	100 mm
Over-all diameter at mouth	157.2 mm
Diameter at rim	171 mm
Weight of empty case	1.80 kg.

Igniter

25 grams of black powder

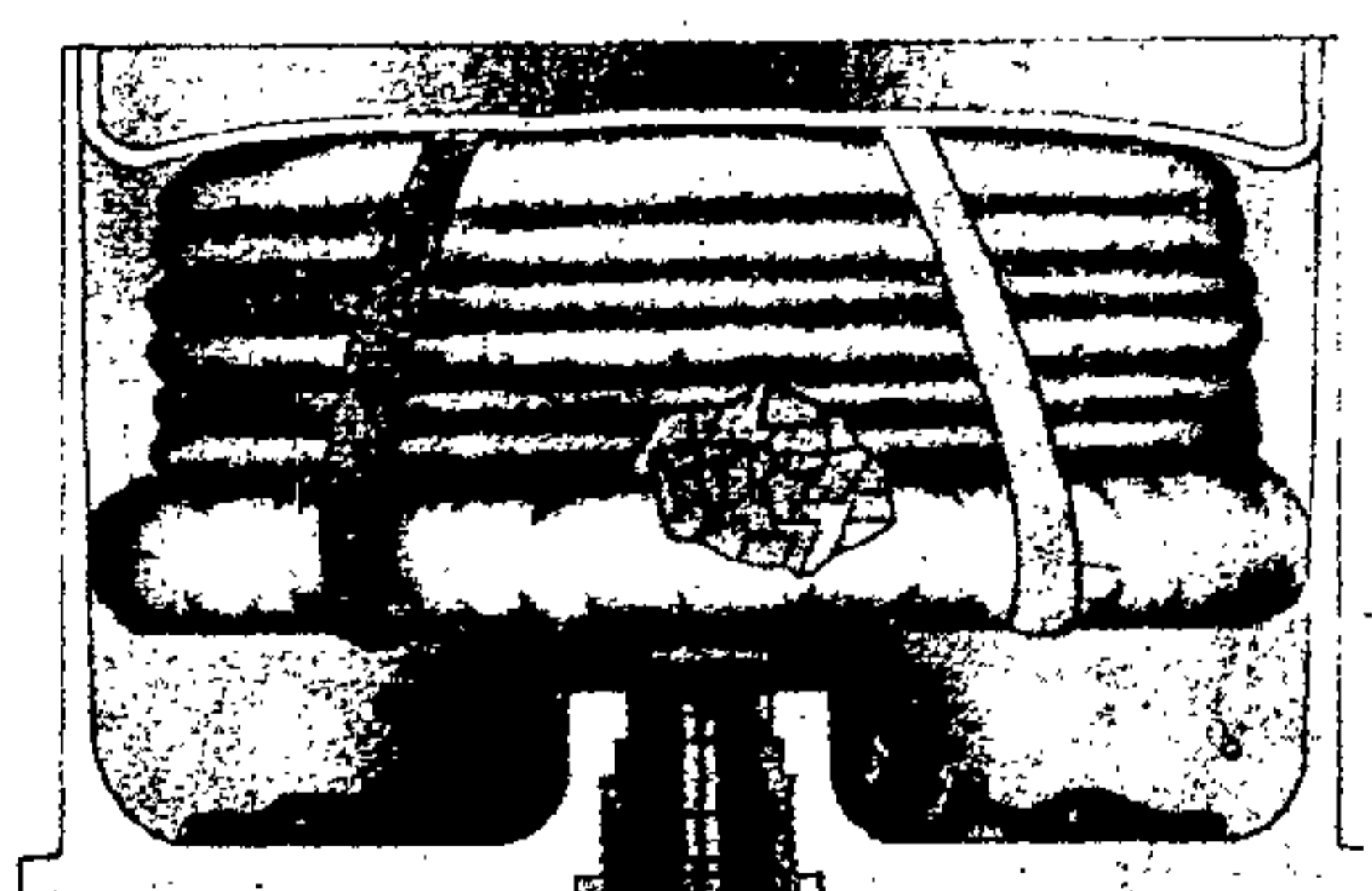
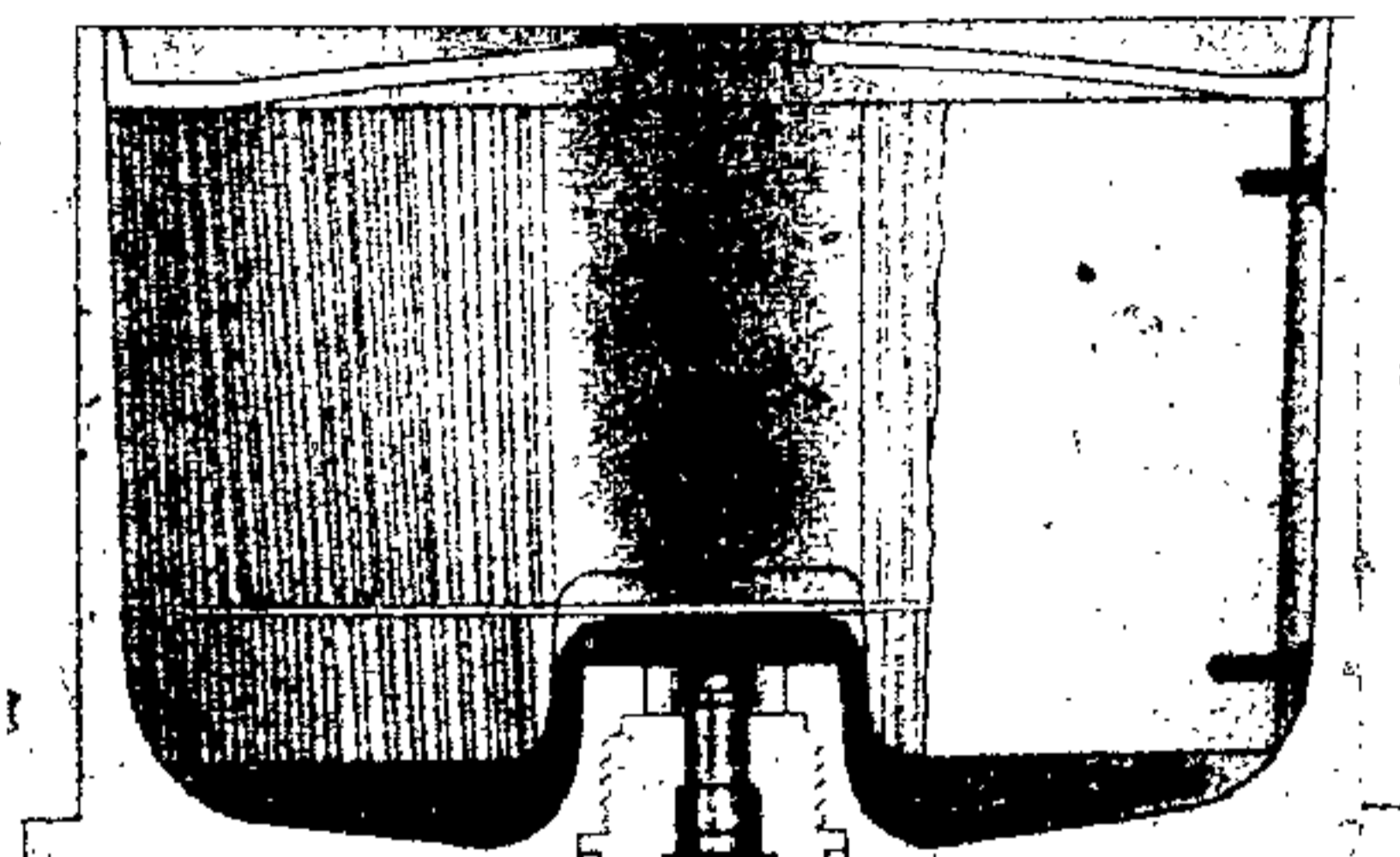
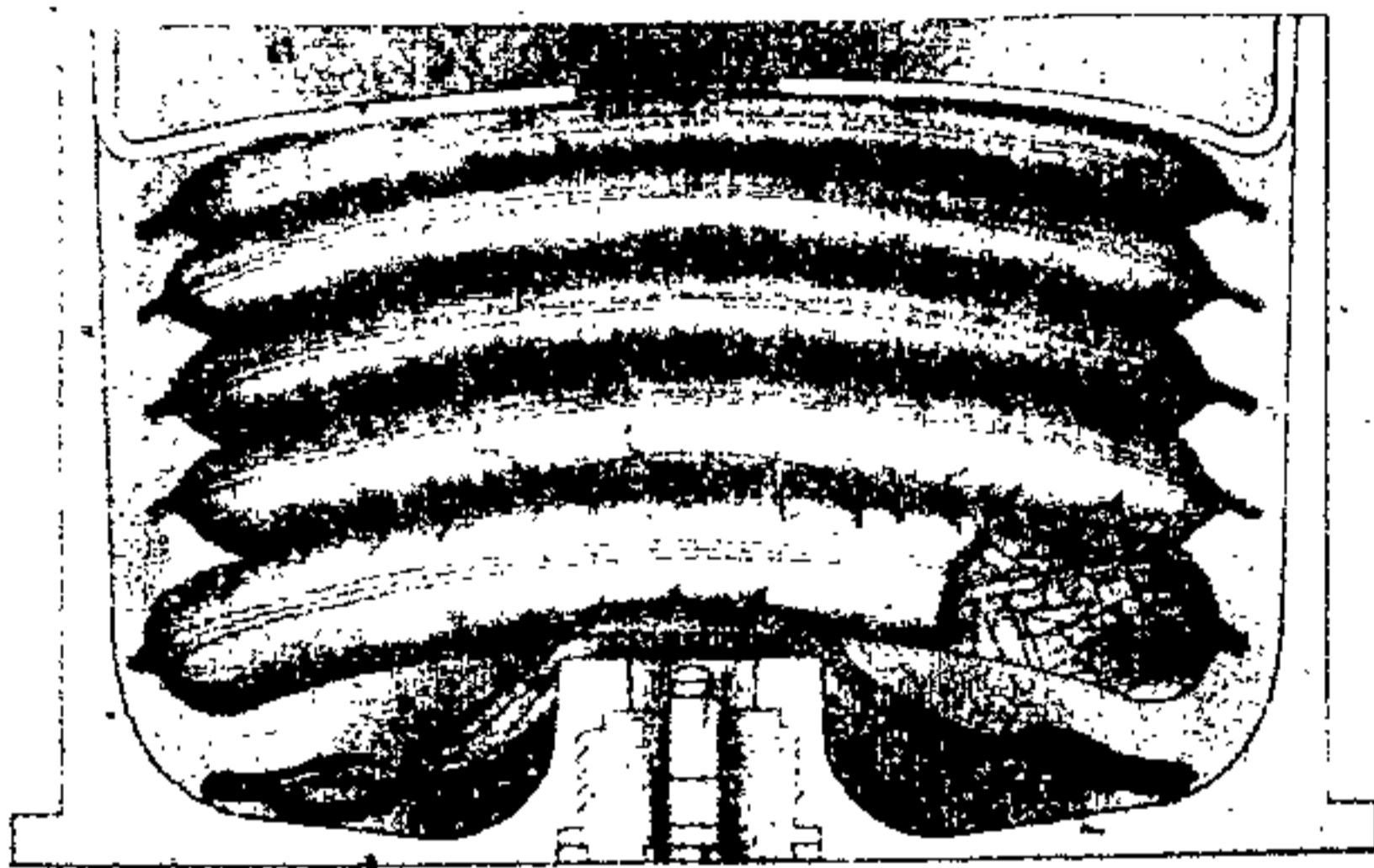

Figure 193 - 149/12-mm Heavy Field Howitzer Cartridge Case

Primer

Percussion Primer M29 or M35

Propellant

Type I *

Lightest loading

0.465 kg. Ballistite (1.5 x 15 x 15)

2nd lightest loading

0.465 kg. + 0.80 kg. Ballistite (1.5 x 15 x 15)

Total—0.545 kg.

3rd lightest loading

0.465 kg. + 0.80 kg. + 0.80 kg.

Total—0.625 kg.

4th lightest loading

0.465 kg. + 0.80 kg. + 0.80 kg. + 0.110 kg.

Ballistite (1.5 x 15 x 15)

Total—0.735 kg.

5th lightest loading

0.465 kg. + 0.80 kg. + 0.80 kg. + 0.110 kg.

+ 0.160 kg. Ballistite

Total—0.895 kg.

Type II

Lightest loading

0.420 kg. Ballistite in sheets (1.2 mm)

Other loadings

2nd—0.490 kg., 3rd—0.590 kg.

4th—0.70 kg., 5th—0.85 kg.

Type III

Lightest loading

0.660 kg. Ballistite (1.5 x 15 x 15)

2nd lightest loading

0.660 kg. + 0.220 kg. Ballistite (1.5 x 15 x 15)

Total—0.880 kg.

3rd lightest loading

0.660 kg. + 0.220 kg. + 0.220 kg.

Total—1.100 kg.

4th lightest loading

0.660 kg. + 0.220 kg. + 0.220 kg. + 0.220 kg.

Total—1.320 kg.

149/13-mm Heavy Field Howitzer Cartridge Case

Data

Over-all length	221 mm
Over-all diameter at mouth	151.9 mm
Width of rim	6.0 mm
Diameter at rim	164.7 mm

Igniter

25 grams of black powder

Primer

Percussion Primer M29 or M35

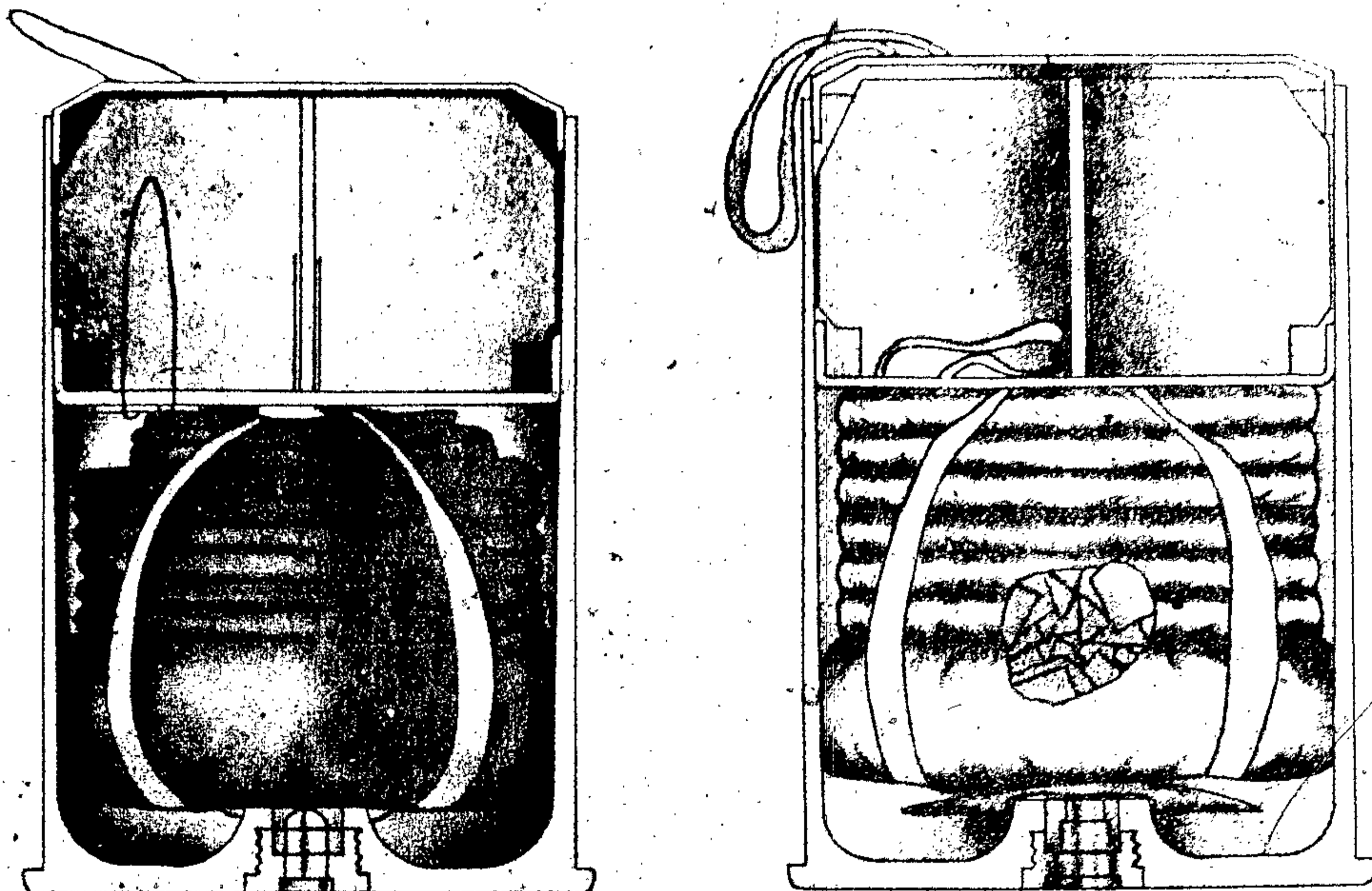

Figure 194 - 149/13-mm Heavy Field Howitzer Cartridge Case

Propellant

Type I

Lightest loading

0.66 kg. Ballistite (1.5 x 15 x 15)

2nd lightest loading

0.66 kg. + 0.22 kg. Ballistite (1.5 x 15 x 15)

Total—0.88 kg.

3rd lightest loading

0.66 kg. + 0.22 kg. + 0.22 kg.

Total—1.10 kg.

4th lightest loading

0.66 kg. + 0.22 kg. + 0.22 kg. + 0.22 kg.

Total—1.32 kg.

5th lightest loading

0.66 kg. + 0.22 kg. + 0.22 kg. + 0.22 kg.

+ 0.11 kg.

Total—1.43 kg.

Type II

Same as Type I, but does not contain the last charge of 0.110 kg. Ballistite.

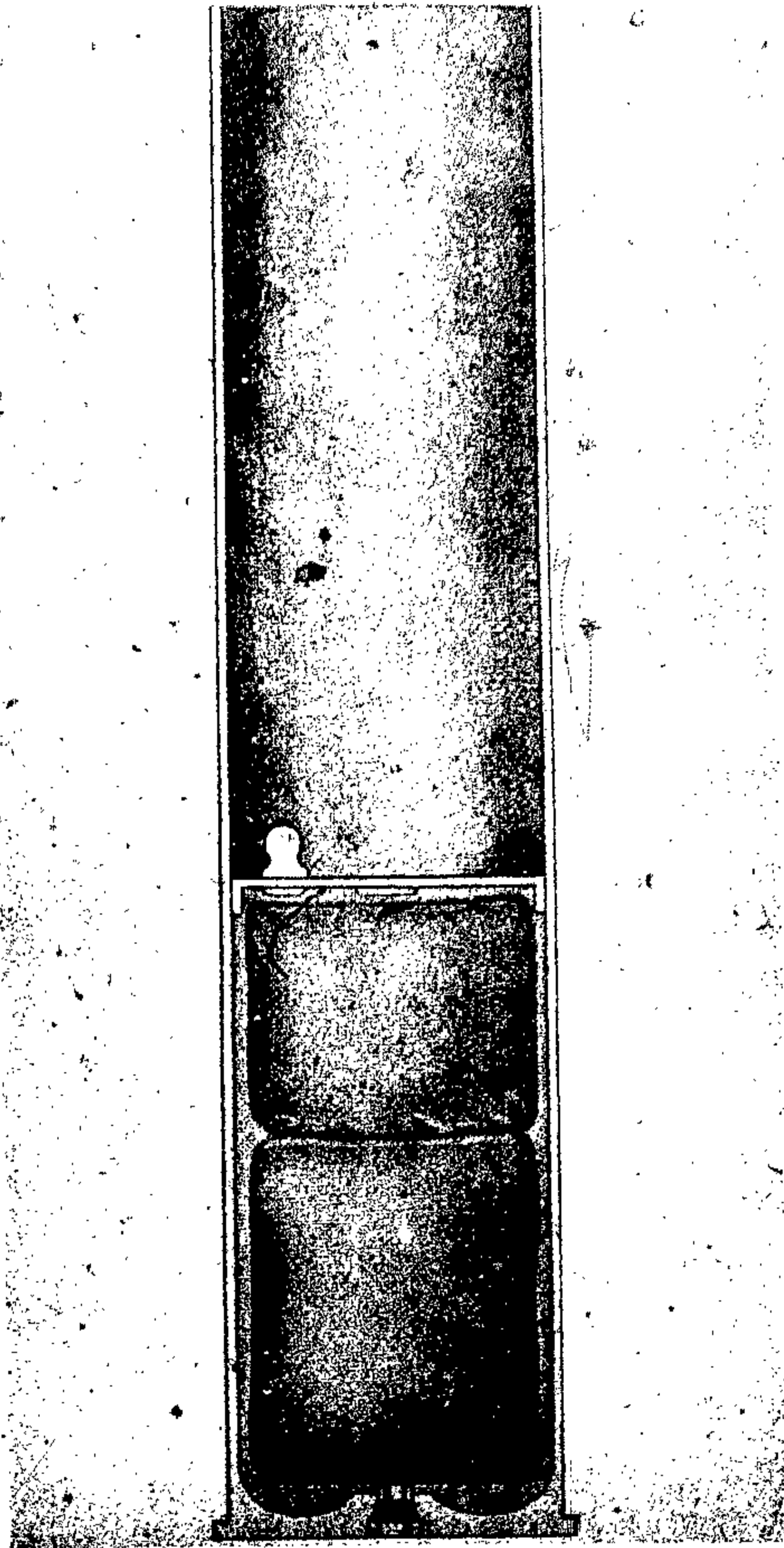

Figure 195 - 152/37-mm Gun Cartridge Case

152/37-mm Gun Cartridge Case

Data

Over-all length	767 mm
Over-all diameter at mouth	Unknown
Width of rim	Unknown
Diameter at rim	180 mm
Weight of empty case	9.720 kg.

Igniter

50 grams black powder

Primer

Percussion Primer M35

Propellant

Lightest loading

7.2 kg. Ballistite—42% Nitroglycerine
(3.5 x 35 x 35)

2nd lightest loading

9.4 kg. Ballistite—42% Nitroglycerine
(3.5 x 35 x 35)

Remarks

The charge of the propellant varies with the type of projectile used.

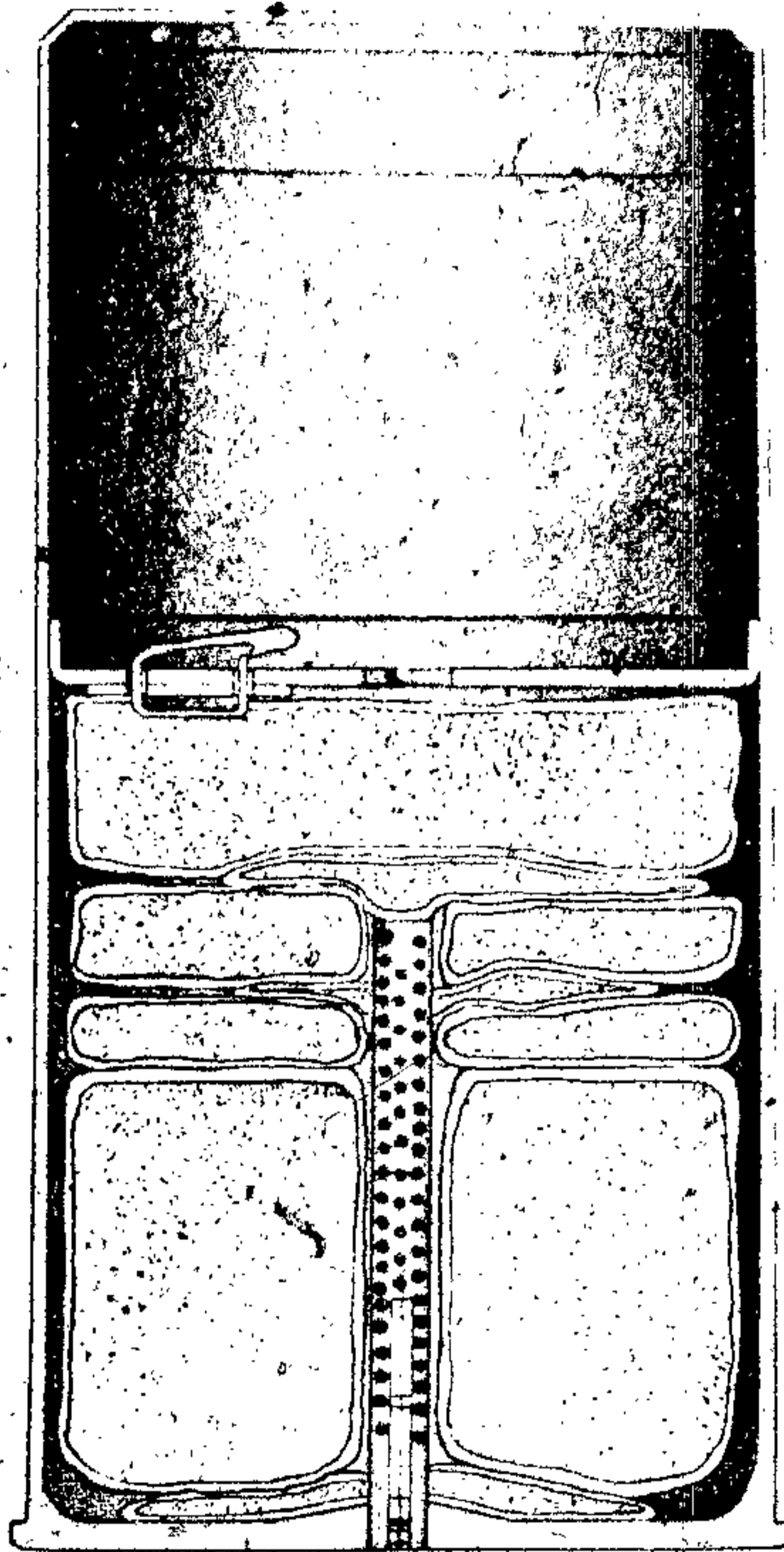

Figure 196 – 380/15-mm Heavy Howitzer Cartridge Case

380/15-mm Heavy Howitzer Cartridge Case

Data:

Over-all length	-----	855 mm
Over-all diameter at mouth	-----	390 mm
Width of rim	-----	Unknown
Diameter at rim	-----	420 mm
Weight of empty case	-----	44 kg.

Propellant

Lightest loading
23.3 kg. Ballistite (5 x 50 x 50)

2nd lightest loading

23.3 kg. + 6.2 kg. Ballistite (5 x 50 x 50)
Total—29.5 kg.

3rd lightest loading

23.3 kg. + 6.2 kg. + 7.5 kg. Ballistite
(5 x 50 x 50)
Total—37.0 kg.

4th lightest loading

23.3 kg. + 6.2 kg. + 7.5 kg. + 10.3 kg. Bal-
listite (5 x 50 x 50)
Total—47.3 kg.

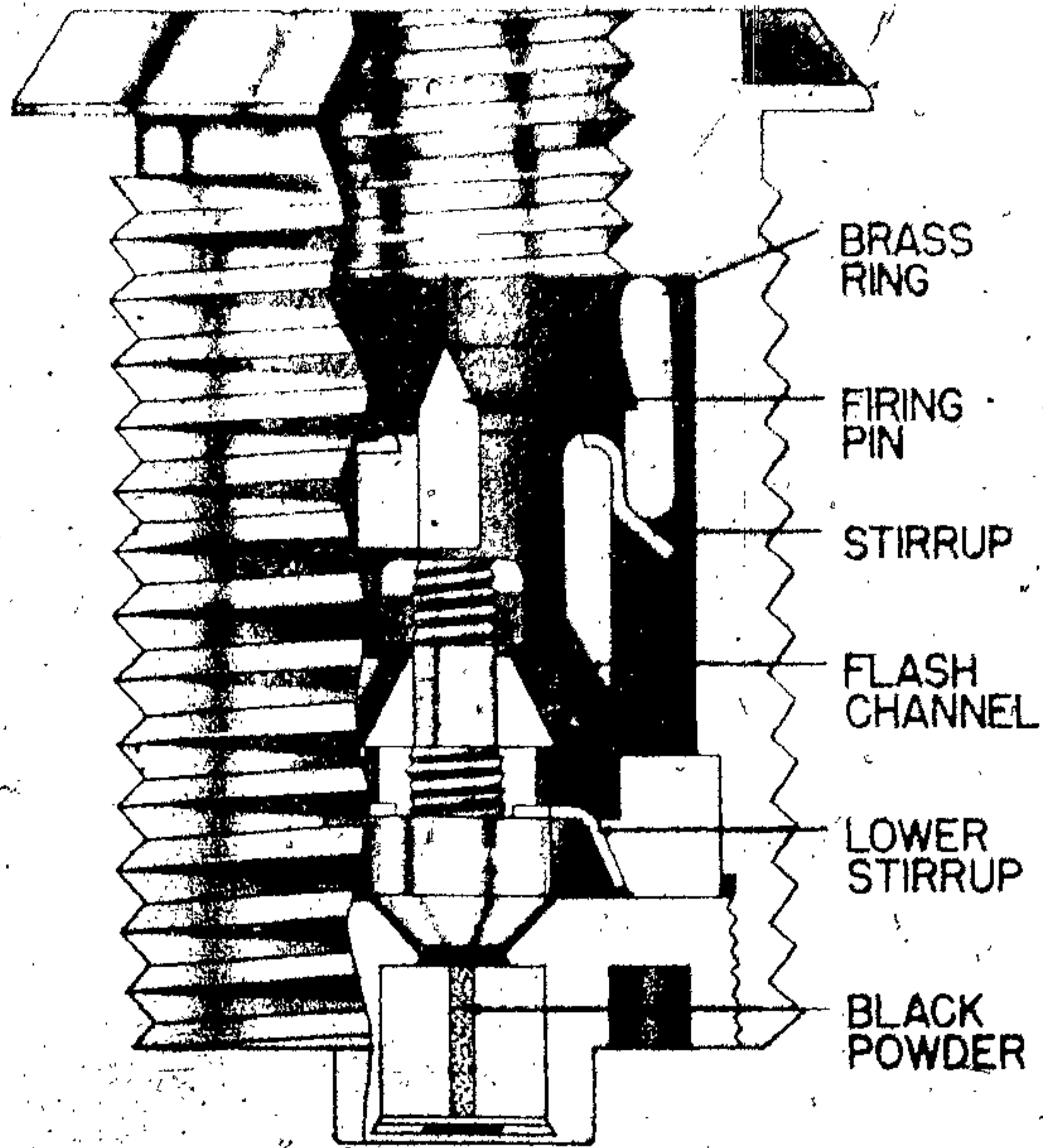

Figure 197 - Percussion Nose Fuze M10

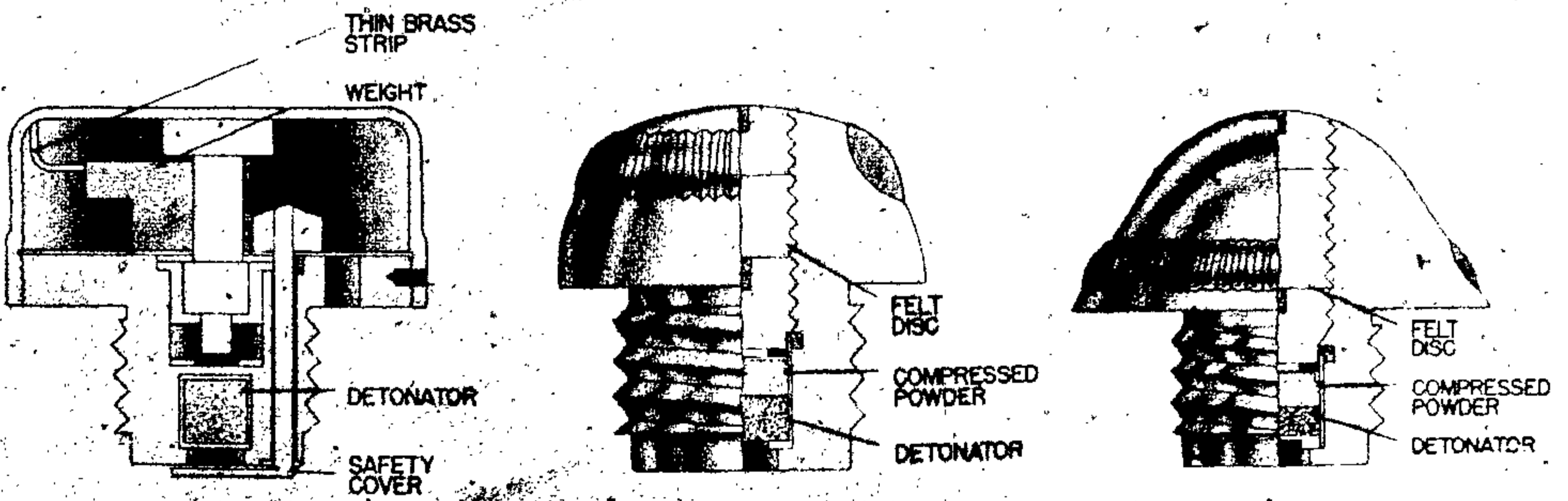

Figure 198 - Detonator M Cortese · Figure 199 - Detonator M10 (Allegenti) · Figure 200 - Detonator M10 (Allegenti)

ITALIAN PROJECTILE FUZES

Introduction

Nose Percussion Fuzes (Field Equipment)

These are known as "spoletta percussione" by the Italians. The fuzes were the most widely used in the Italian projectiles. Many of the fuze types are unmarked and, as a result, identification is often difficult.

The fuzes vary slightly in design, but all are quite simple in operation. One type has no arming operation and functions on impact. The others use set-back or centrifugal force as part of the arming operation. The following abbreviations may be encountered in nomenclature of these fuzes:

- I..... Instantaneous
- p. c..... For small caliber
- m. c..... For medium caliber
- g. c..... For large caliber
- m. c. e. g. c..... For medium and large caliber

Nose Percussion Fuzes (Naval and Coastal Defense)

These fuzes are similar in design to the fuzes for field equipment, but differ in nomenclature:

- O. K. 2S..... Krupp nose fuze with 2 safety devices
- O. K. Bo. Sc..... Krupp nose fuze with clockwork safety device
- O. Bo..... Nose fuze with clockwork

Time Fuzes (Field Equipment)

Time fuzes are of two types:

A tempo—combustion type

Meccanica a tempo—mechanical type

Time Fuze (Naval and Coastal Defense)

- O. T..... Nose Time Combustion
- O. M. T..... Nose Mechanical Time

Time and Percussion Fuze (A. D. E.)

The fuzes are very similar to the time fuzes, but have a percussion feature incorporated in them.

Percussion-Nose Fuzes M10 and M17

Projectiles Used In

Used in most Italian H. E. projectiles. The M17 was most widely used Italian fuze.

Data

	M10
Over-all length.....	1.5 in. (approx.)
Maximum diameter.....	1.0 in. (approx.)
Thread diameter.....	0.88 in. (approx.)
Markings.....	M10

	M17
Dimensions.....	Unknown
Markings.....	M17

Description

M10: The cylindrical body is 0.97 in. gauge, brass, screw-threaded with approximately 11 threads to the inch, for insertion in the shell. The flange at the head protrudes from the fuze shell. A screw-threaded hole at the head receives the detonator plug or transit plug, and leads to an interior recess containing a striker with a firing pin attached. The recess diameter increases to form a shoulder near the base to locate a retaining collar. The recess is screw-threaded below the shoulder to receive a black powder charge. The copper sealing plug seals the flash-hole and is threaded for assembly of the lower stirrup spring and attachment to the striker. In the other portion the upper stirrup spring holds the forward brass inertia ring. The striker has four flash-holes drilled. A firing pin is attached to the striker by two ribs to prevent blocking the flash-holes. Various brass detonator plugs are used, containing a detonator and a layer of gunpowder to increase the flash. The Detonator M10 and Detonator M10 (allegenti) vary only in dimensions above the screw threads. Detonator M Cortese incorporates a safety device. Under the cap is a thin brass piece, supported by a pin and distance piece, slotted to fit a weight, the pivot of which passes through the body of the detonator plug and bends over to cover the holes. On firing, the set-back bends down the brass piece and releases the weight. On deceleration, the weight swings out and uncovers the detonator hole.

Operation

On firing, the top inertia ring sets back and overcomes the upper stirrup spring. On impact, the

ITALIAN AND FRENCH EXPLOSIVE ORDNANCE

striker overcomes the lower stirrup spring, withdraws the copper-closing plug from the flash-hole, and forces the firing pin into the detonator.

Remarks

M17 is similar to the M10, but is used in projectiles of larger caliber.

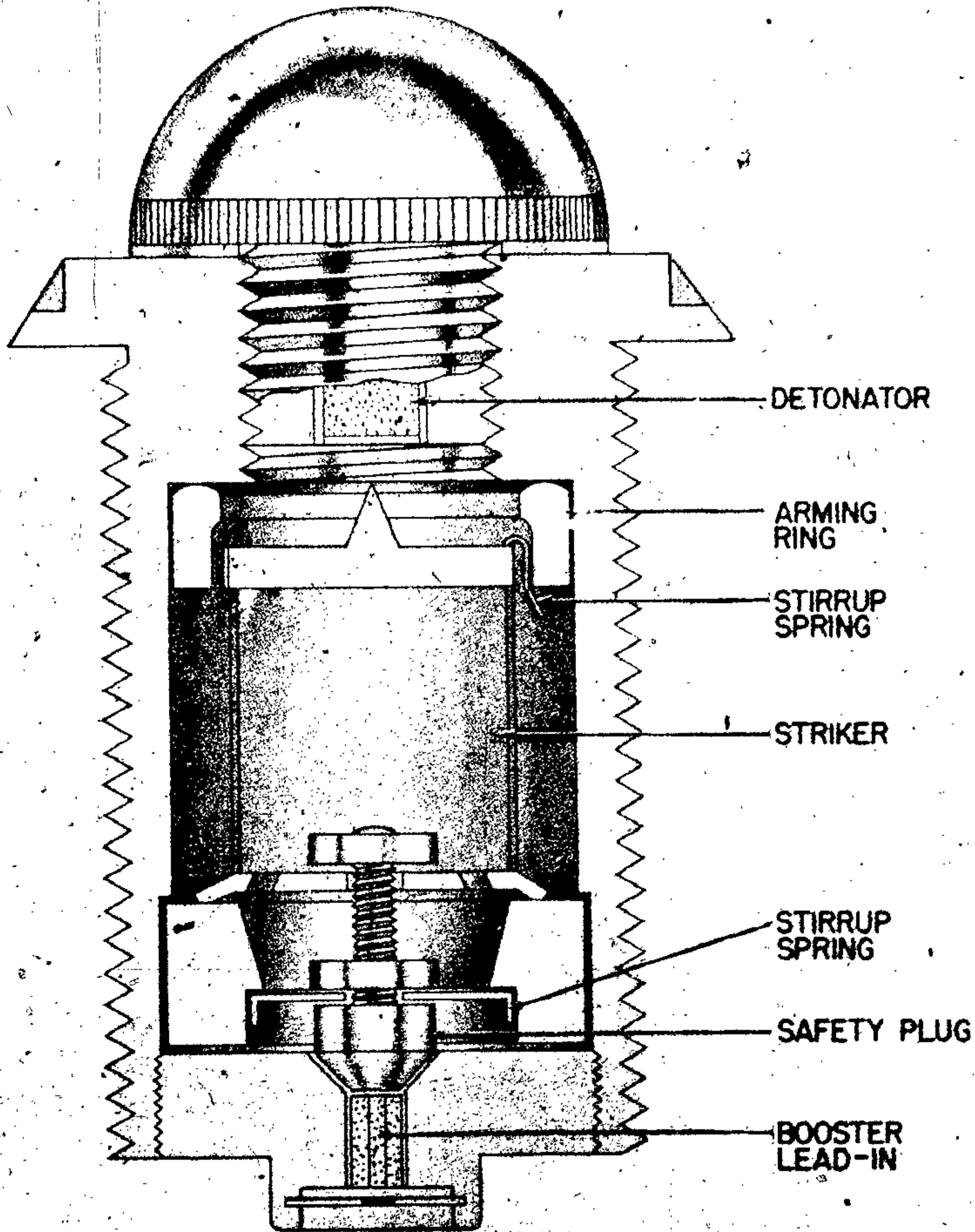

Figure 201 - Percussion Nose Fuze for 65/17 H.E.

Percussion Nose Fuze for 65/17 H.E.

Data

Over-all length.....	Unknown
Maximum diameter.....	Unknown
Thread diameter.....	Unknown
Markings.....	Unknown

Description

This fuze is very similar in appearance and operation to Percussion Fuzes M10 and M17. The cylindrical brass body is screw-threaded throughout its length for insertion in the shell and has a flange at its head, which is the only part extending from

ITALIAN PROJECTILE FUZES

the fuzed shell. A screw-threaded hole in the head receives a detonator holder and leads to the interior recess containing the striker with the firing pin attached. The diameter of this recess is increased to form a shoulder near the base which locates the retaining collar. Below the shoulder, the base is screw-threaded to receive the black-powder charge. The flash-hole is blocked by a plug with an enlarged head to seat in the chamfered upper side of the hole in the base plug. The upper portion of the plug is threaded and has a stirrup spring secured at its base in a nut. The stem also passes through the central hole in the striker and is se-

cured to it by a nut. The striker is cylindrical, with the firing pin attached at its forward end and four holes drilled through the base.

Operation

On firing, the arming ring sets back against its stirrup spring. The striker is now held by the closing plug and its stirrup. The closing plug sets back and blocks the flash channel during acceleration. On impact the striker moves forward, drawing with it the closing plug and its stirrup spring. The flash-hole is opened; the firing pin hits the detonator; and the flash passes through the striker to the flash-hole in the base.

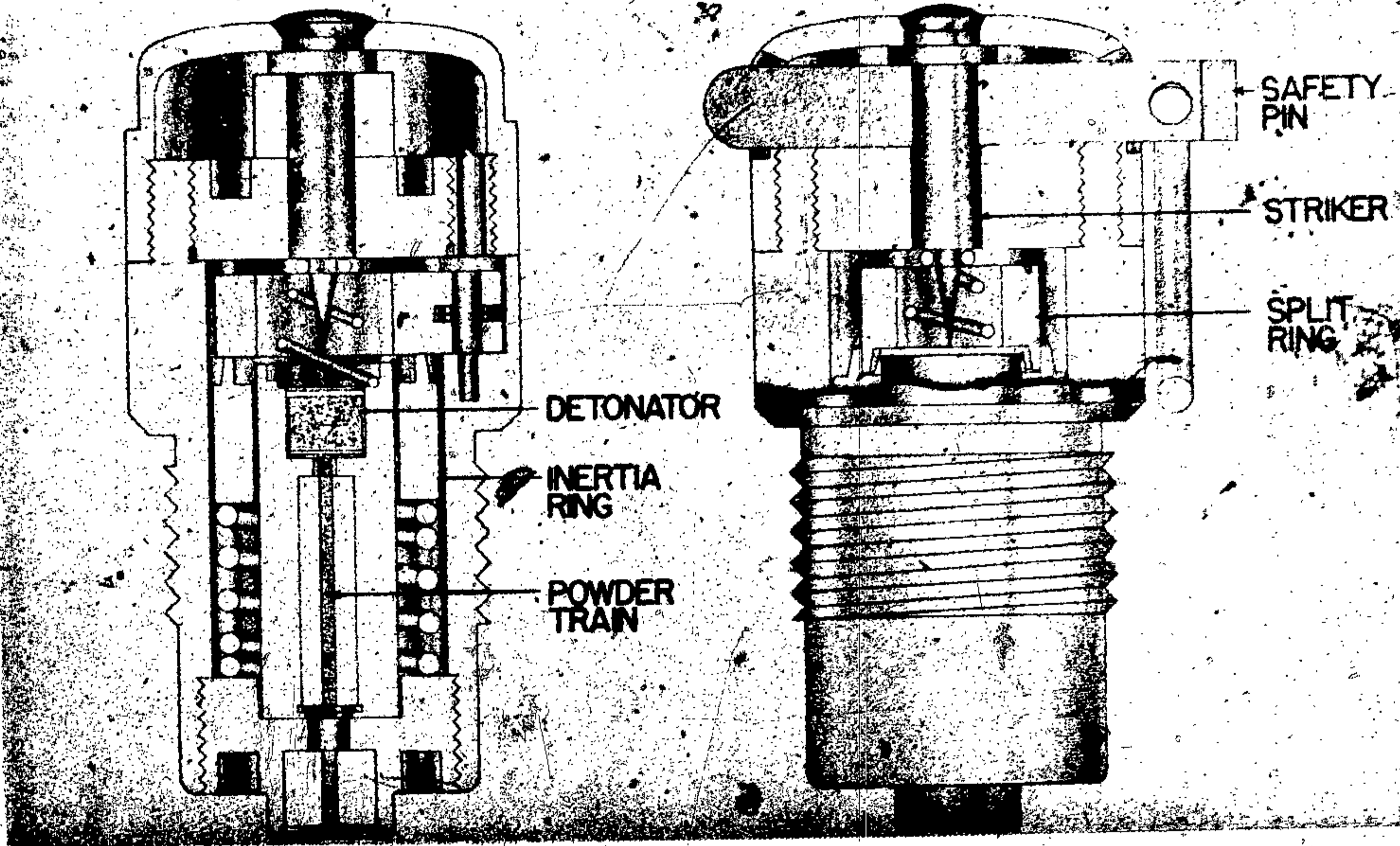

Figure 202 - Percussion Nose Fuze M10
(Guerritore) p.c.

Percussion Nose Fuzes M10 (Guerritore) P.C. and M (Guerritore) M.E.G.C.

Data

Projectile used in

M10 p. c.—Small Caliber H. E. Shell

M (Guerritore) m. e. g. c.—Medium and Large
Caliber M10 Shell

Over-all length.....	Unknown
Maximum Diameter.....	Unknown
Thread diameter.....	Unknown

Description

M10 (Guerritore): This fuze consists of a brass body which is closed at the nose by a cap holding the firing pin and closed at the base by a brass plug holding a gunpowder pellet. In the center of the fuze is the detonator holder, which contains the detonator at the top and a gunpowder flash charge at the bottom. A creep spring and a split ring keep the detonator off the needle. An inertia ring, which is held up by a spring, surrounds the detonator holder at the top. A safety pin, which is removed before firing, is also included.

ITALIAN AND FRENCH EXPLOSIVE ORDNANCE

M. (Guerritore): This fuze is similar in design and functions to the M10 (Guerritore). It differs, however, in dimensions, since it is intended for use in projectiles of medium and large caliber.

Operation

On firing, the inertia ring sets back and com-

presses its spring. During deceleration, the split ring opens, as a result of centrifugal force, to such a diameter as to allow the detonator holder to be held away from the firing pin by only the creep spring.

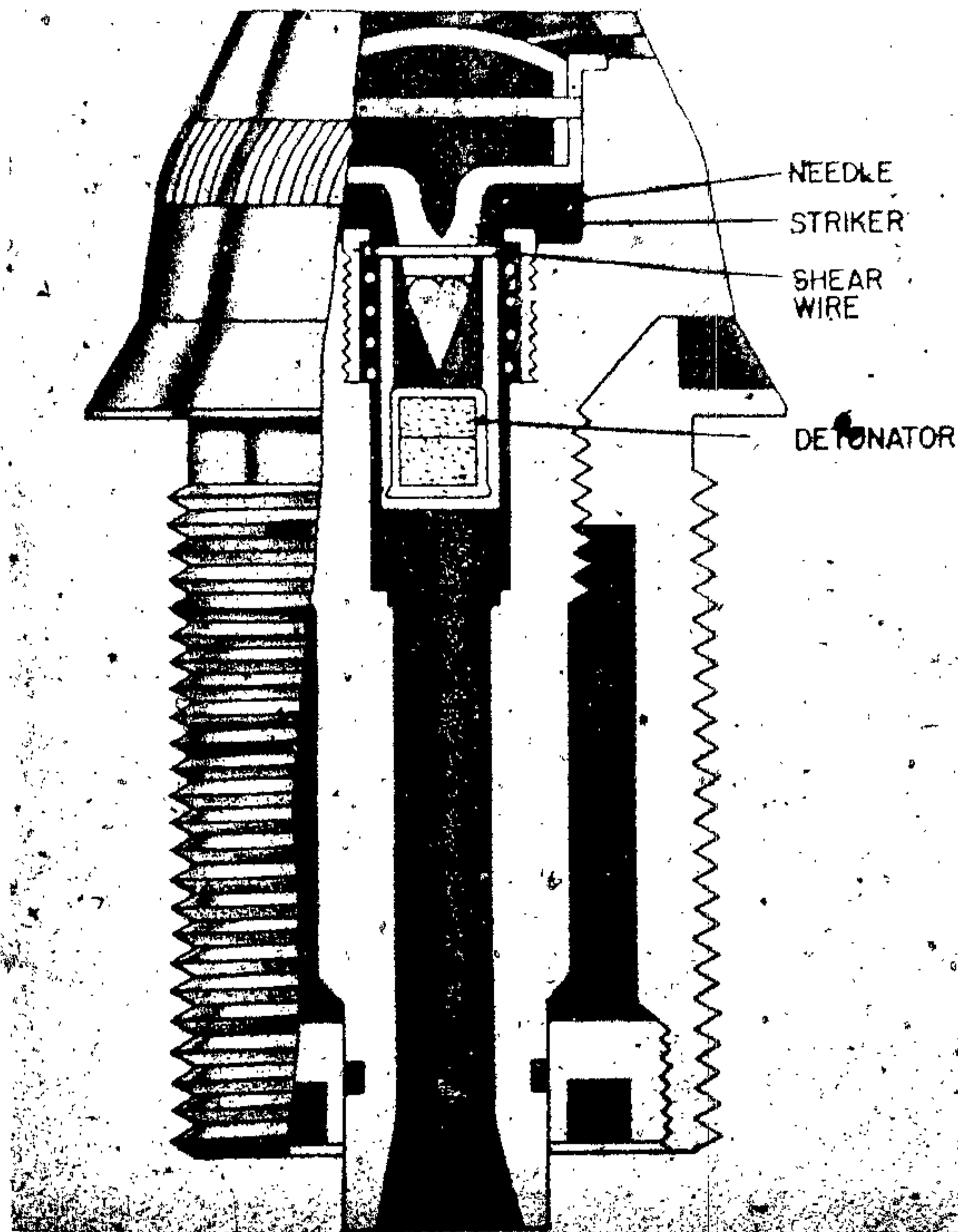

Figure 203 - Percussion Nose Fuze I. M35

Percussion Nose Fuze I. M35

Data

Projectile used in	75-mm—210-mm H. E. Shells
Over-all length	Unknown
Maximum diameter	Unknown
Thread diameter	Unknown

Description

This fuze consists of a brass body, an aluminum striker assembly, and a detonator held off the striker by a thin brass shear wire. The striker is held from moving down by three small lugs at the

top which rest in grooves at the nose of the fuze body. Also at the top, there is a split ring which keeps the striker in place. The fuze portion which threads into the projectile is very similar to that which is used for Nose Percussion Fuze M10. This particular fuze was found to have been used in many of the projectiles for which the M10 or M17 were generally used. The detonator holder has a small charge of black powder in order to obtain a greater flash to the booster. There are no setback or centrifugal safety features connected with this fuze.

Operation

This fuze was called an instantaneous type by the Italians. On impact, the striker is forced to the rear, thus shearing the lugs and shear wire. The striker is forced onto the detonator, which also moves toward the striker.

Percussion Nose Fuzes I. M38 and I. M32/38

Data

Projectiles used in

- I. M38 Type I—Small Caliber H. E. Shells
- I. M38 Type II—Medium Caliber H. E. Shells
- I. M32/38—Unknown

Over-all length..... Unknown
 Maximum diameter..... Unknown
 Thread diameter..... Unknown

Markings

- I. M38 Type I—Stamped I-38-p. c.
- I. M38 Type II—Stamped I-38-m. c.
- I. M32/38—Stamped 32-I-38

Description

These fuzes are very similar to Percussion Nose

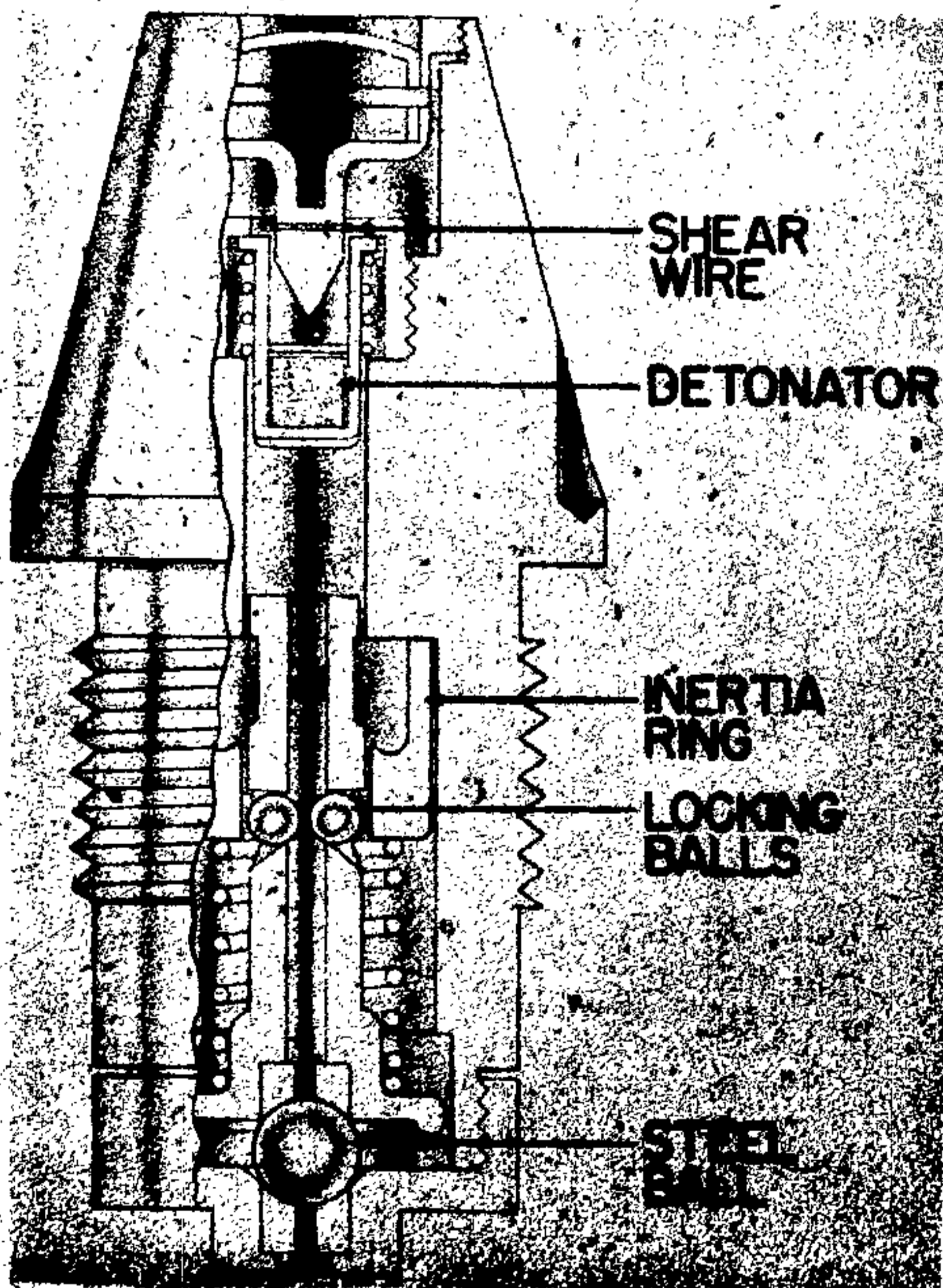

Figure 204 - Percussion Nose Fuze I. M38

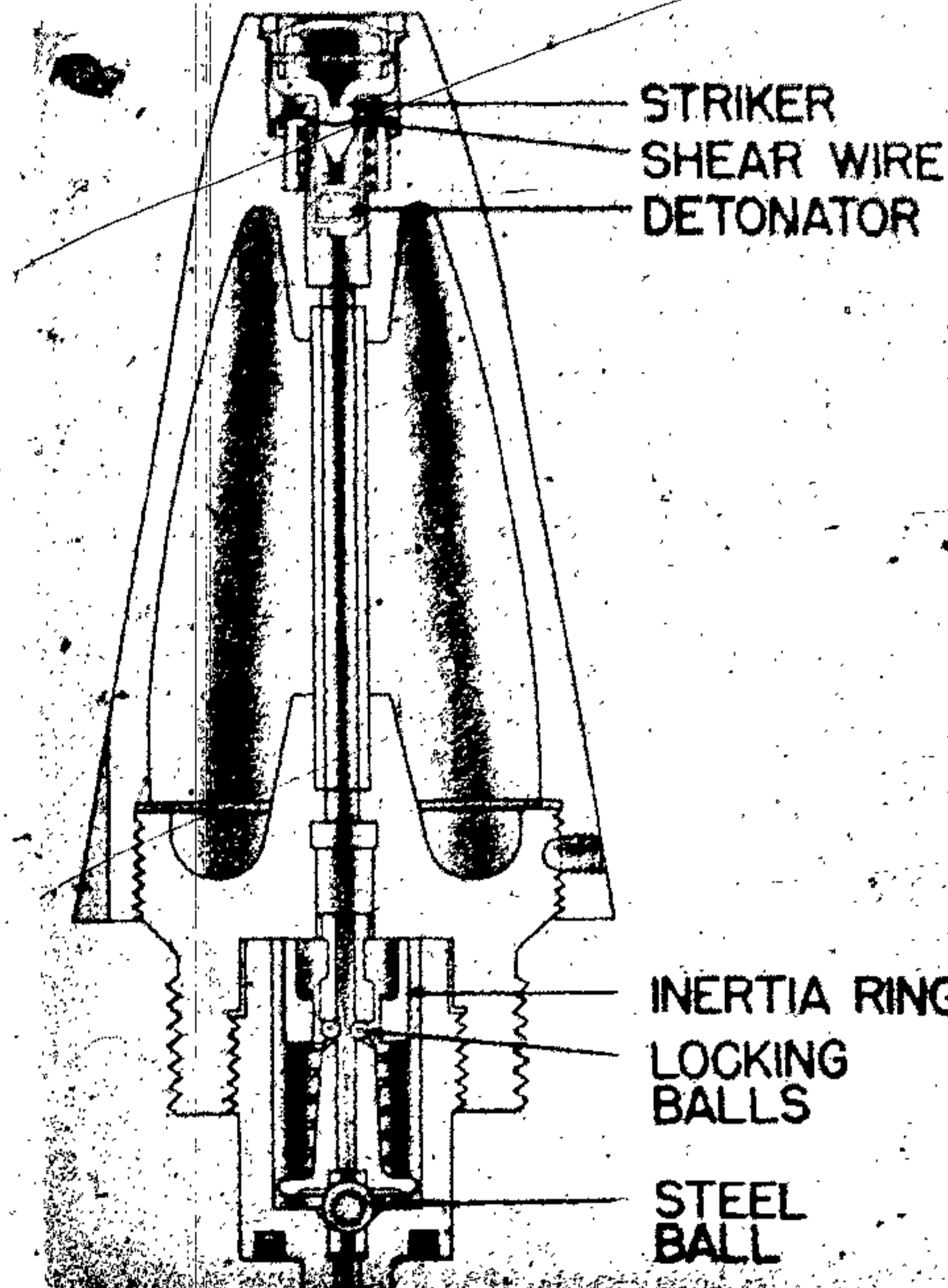

Figure 205 - Percussion Nose Fuze I. M32/38

Fuze I. M35. The main difference is that the fuzes incorporate a safety device, involving a ball which blocks the flash channel, and also that they are made of aluminum instead of brass. The striker is held in position by three lugs resting in grooves at the nose. The arming tube, which holds the ball in the flash-hole, is itself kept in position by two balls which press against an inertia ring.

Operation

On firing, the setback forces the inertia ring to rear against its spring. The two balls then fly out by centrifugal force, and jam the inertia ring in the rear position. The spring, as a result, is made inactive so that during flight the arming tube can creep forward. The ball blocking the flash-hole then moves outward due to centrifugal force. On impact, the shear wire and lugs are sheared, the striker is forced onto the detonator.

Remarks

These fuzes are similar, except for their markings and dimensions.

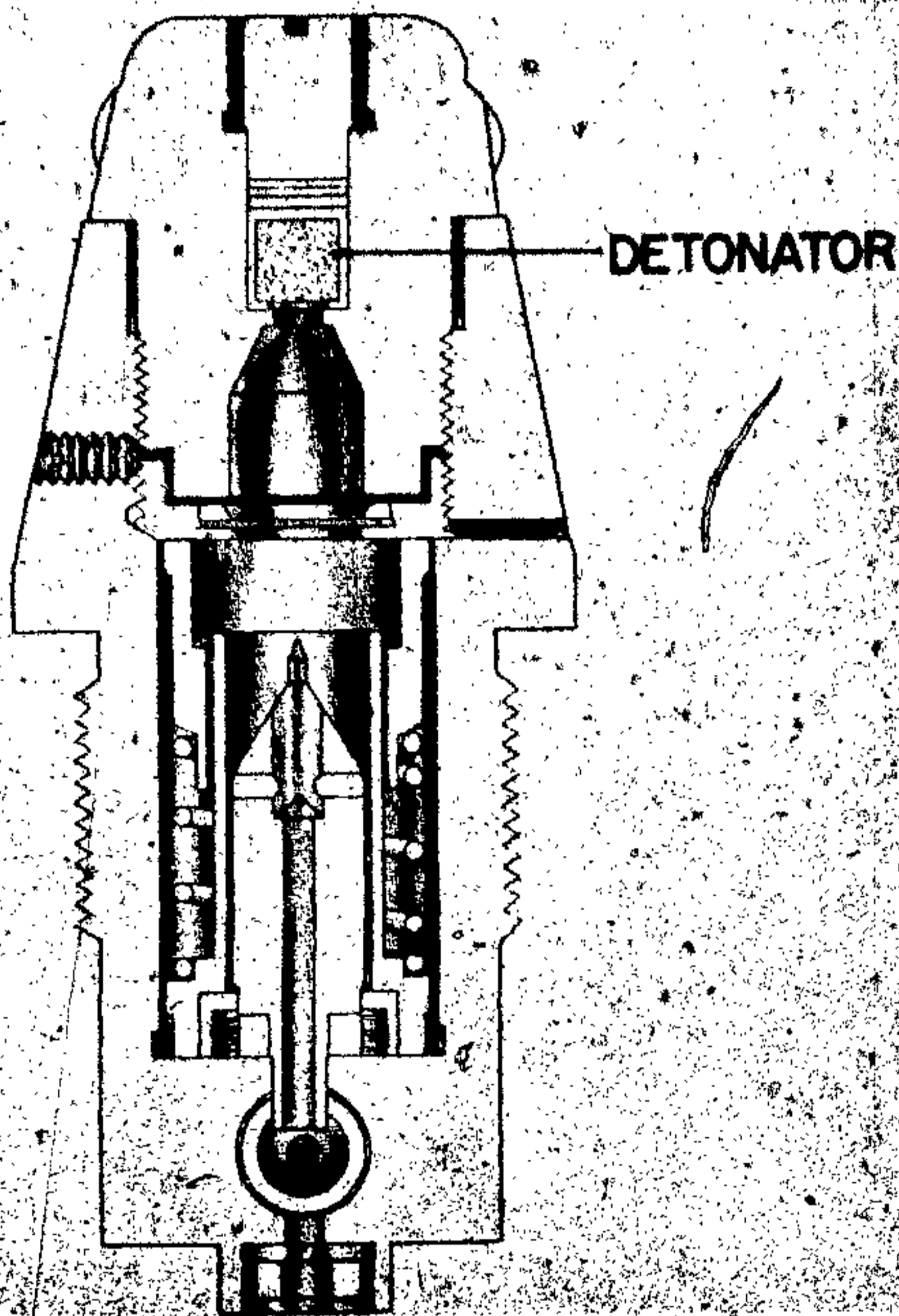

Figure 206 - Percussion Nose Fuze M40 with Detonator M40 - Ordinary

Percussion Nose Fuze M40

Data

Projectile used in	75-mm-100-mm H. E. Shells
Over-all length	Unknown
Maximum diameter	Unknown
Thread diameter	Unknown
Markings	Unknown

Description

This fuze is made of aluminum and is of recent design. It is fitted with a detonator holder which is screwed into the top. The fuze has a shipping plug used during transportation, and the detonator is screwed into the fuze before use.

The two types of detonators used were Detonator M40 Instantaneous and Detonator M40 Ordinary. The first type is made of aluminum, is colored red, and is similar in construction to Percussion Nose Fuze M35. The second type is also made of aluminum, is unpainted, and contains a detonator only.

The fuze contains a striker which is kept in the unarmed position by an arming ring and ball bearing. The arming ring is positioned by a spring. To the rear of the striker is a centrifugal bolt which is held in position by the striker. A thin metal disc separates the fuze proper from the detonator. There is no creep spring.

Operation

On firing, the arming ring sets back and compresses its spring. The single ball bearing moves out and jams the arming ring in the rear position, inactivating the spring. The striker then moves forward under the action of its spring. The centrifugal bolt which closes the flash-hole is freed and moves outward to clear the flash-hole.

On impact with Detonator M40 I, the striker in the detonator holder is forced onto the detonator. In this case, the striker in the fuze proper plays no part, except to clear the flash-hole with Detonator M40-0. The striker moves forward, the firing pin pierces the metal disc and hits the detonator in the holder.

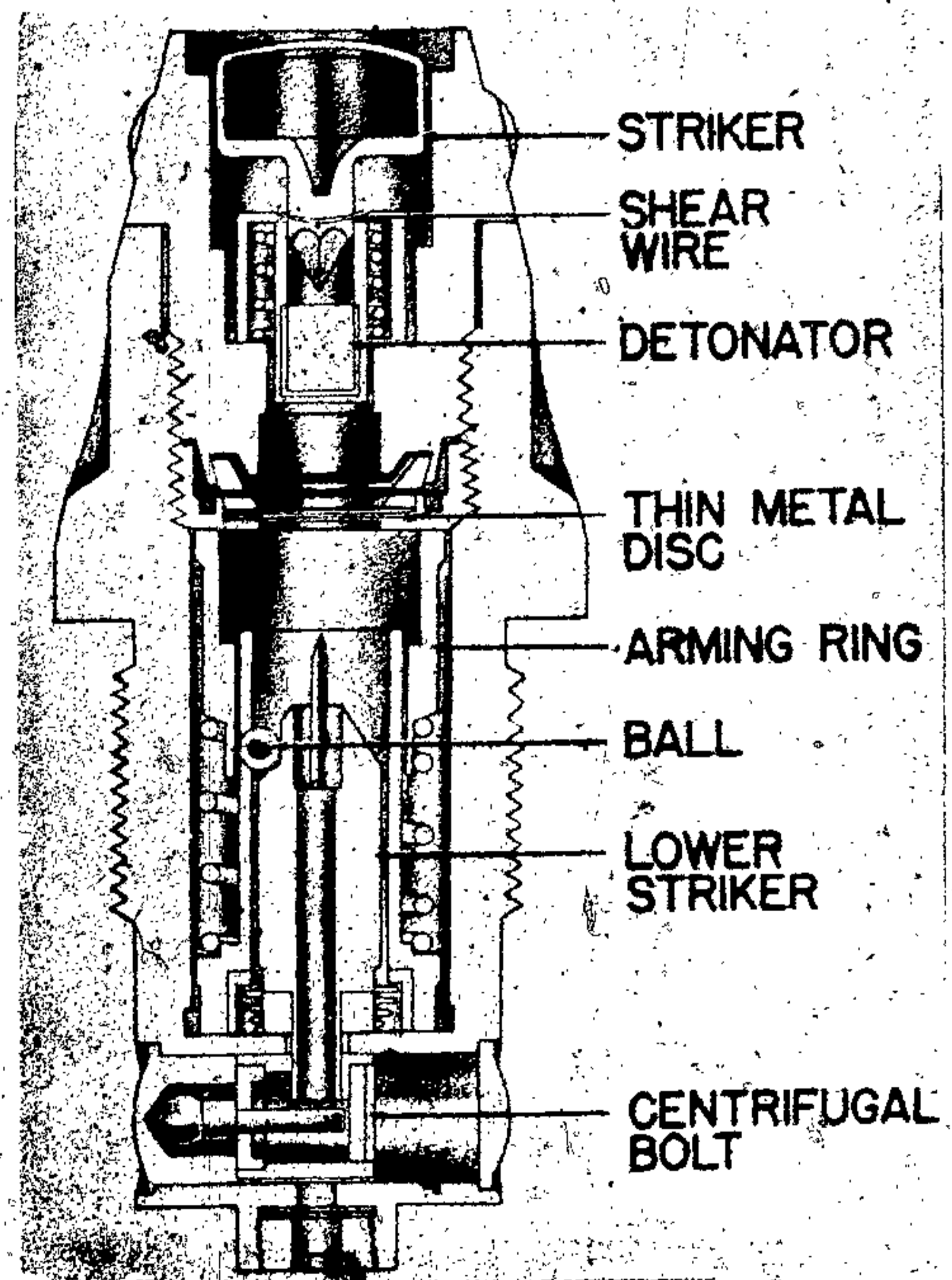

Figure 207 - Percussion Nose Fuze M40 with Detonator M40 - Instantaneous

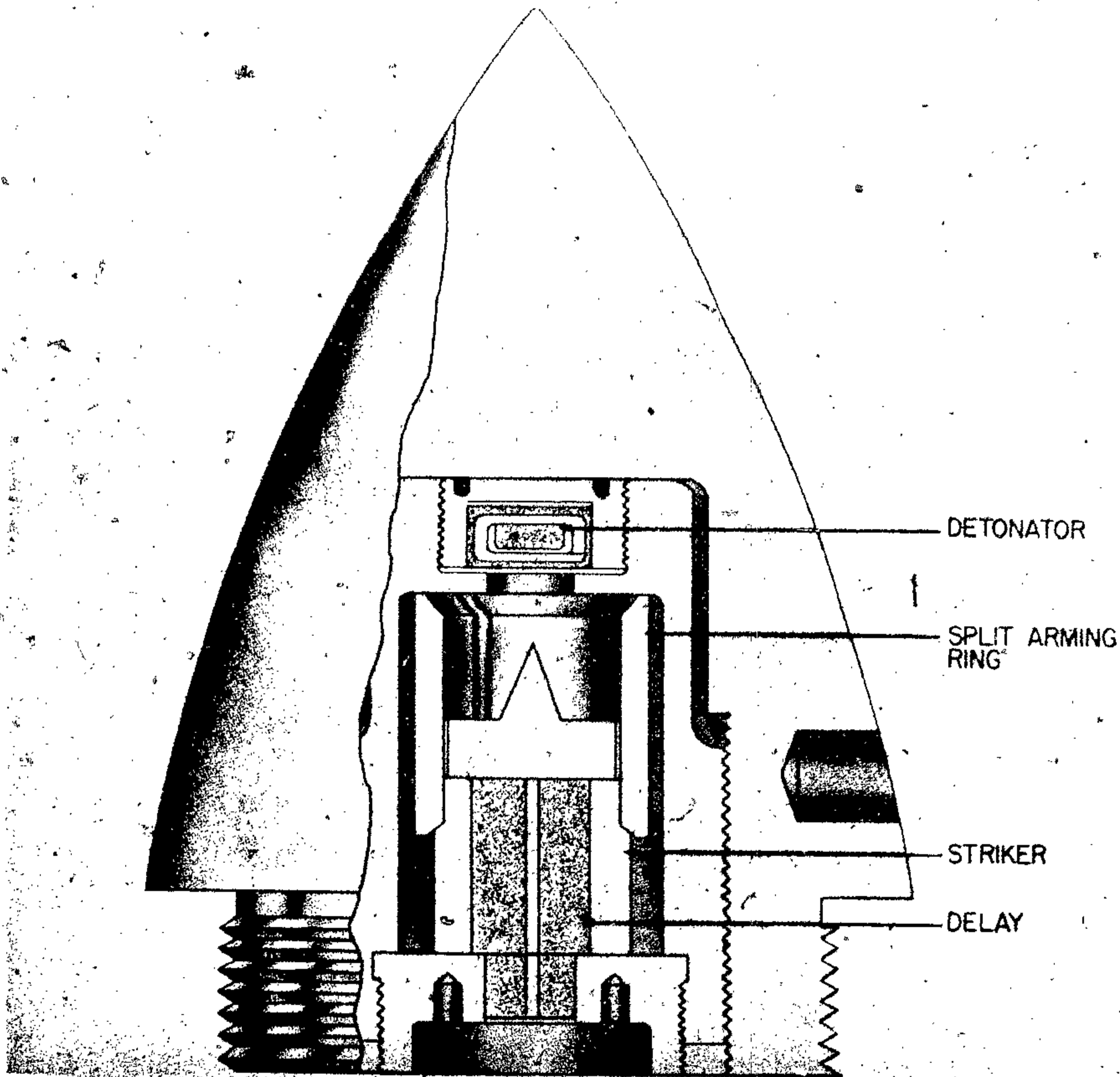

Figure 208 - Percussion Nose Fuze for 37/40 A.P.

Percussion Nose Fuze for 37/40 A.P.

Data

Over-all length.....	0.987 in.
Maximum diameter.....	Unknown
Thread diameter.....	Unknown
Markings.....	Unknown

Description

This fuze consists of a hollow brass body with a detonator holder screw-threaded in the forward end. The fuze screws internally into the steel head of the shell. Its striker is cylindrical and hollow, with a flat firing pin. The striker is held in position by a split brass arming ring. The

hollow portion of the striker is filled with gunpowder.

Operation

It has been found by test that a force of 45 lb. is required in order to force the striker through the split ring; this force requirement would be reduced in flight by the centrifugal forces acting upon the split ring. It is not known if the ring sets back over the striker during acceleration, thereby arming the fuze, or whether the striker is designed to set forward through the ring upon impact. The flash from the detonator, upon impact, is transmitted to the gunpowder pellet in the striker and to the charge in the base of the fuze.

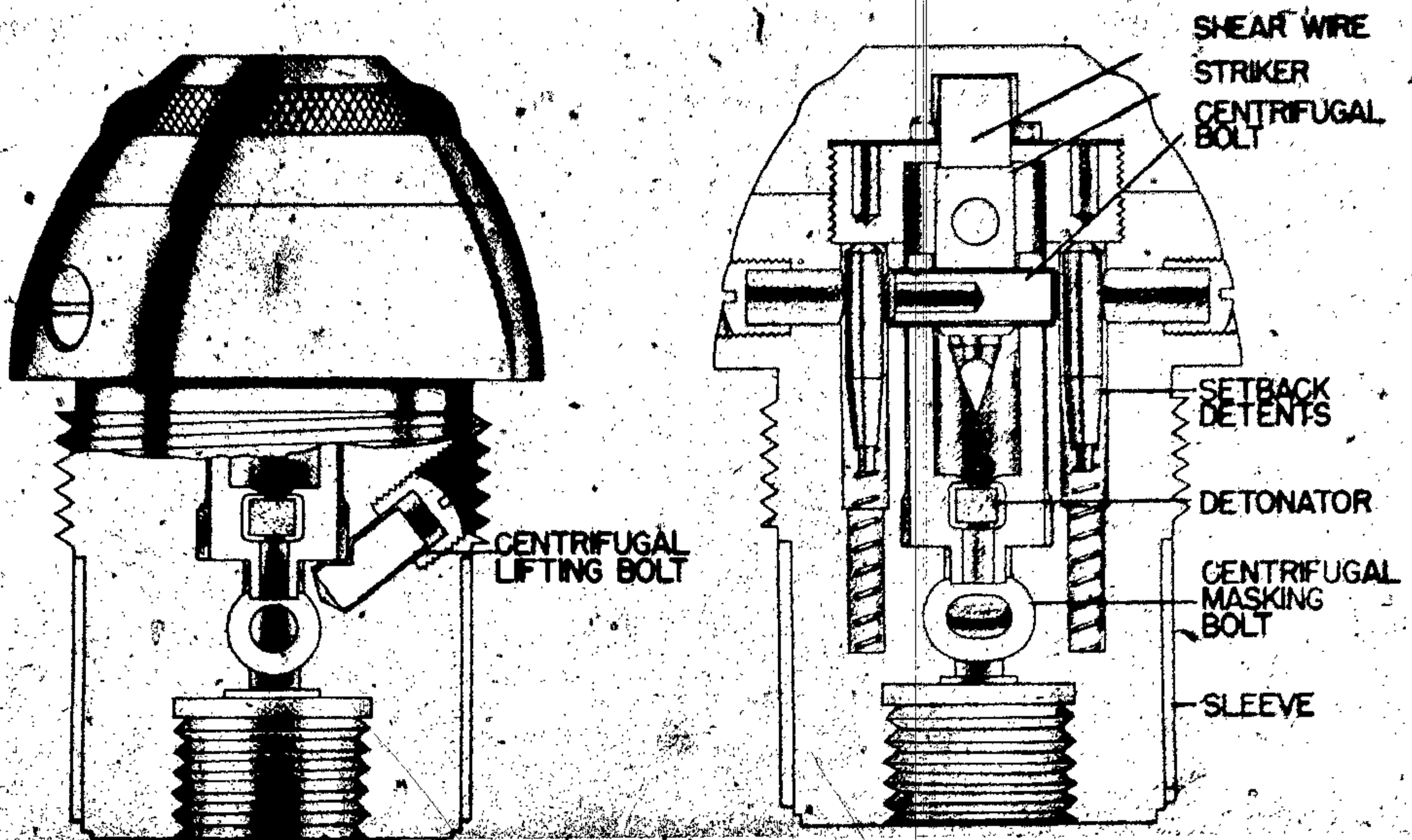

Figure 209 - Percussion Nose Fuze M39

Percussion Nose Fuze M39

Data

Projectiles used in	47/32 H. E. Shell
Over-all length	
With booster	Unknown
Without booster	3.2 in.
Maximum diameter	Unknown
Thread diameter	1.14 mm
Markings	RR 2/41

Description

The body of the fuze is screw-threaded externally at the base to receive the fuze booster. The firing pin is held in position by a centrifugal bolt which is locked by two detents which are fitted with springs. The firing pin is fitted with two shear wires.

The detonator holder fits into a centrifugal bolt which acts as a safety shutter to the flash hole. Another centrifugal bolt is fitted to perform the function of raising the detonator holder. The detonator holder is in the form of a cup, the mouth of which fits over the lower end of the firing pin.

Operation

On acceleration, the two setback detents set back, leaving the upper lateral channel clear for subsequent movement of the centrifugal locking bolt. The detents are held back during flight by the friction resulting from centrifugal force. During the period of deceleration, the centrifugal locking ball and lifting bolt are thrown outwards and the detonator holder, assisted by the lifting movement imparted by the step on the lower centrifugal bolt, creeps forward to the limit imposed by the lower shear wire, thus disengaging the recess in the masking bolt. The masking bolt is then thrown clear of the flash-hole leading to the booster. On impact, the detonator overcomes the lower shear wire, hitting the firing pin. Dependent on the resistance offered by the surface struck and the angle of the strike, the firing pin may be driven in, severing its shear wire, and piercing the detonator as the holder moves forward.

Percussion Nose Fuzes M16 (OK. 2S 912)

Data

Projectile used in	120-mm and 380-mm H. E. Shells
Over-all length	7.9 mm
Maximum diameter	6.2 mm
Thread diameter	Unknown
Markings	L11, D.Rb. B8, AGOS 36 XIV

Description

This fuze is in the shape of a truncated cone with screw-threaded brass adapter at the base to screw into the nose of the projectile. The entire fuze, apart from the brass cover plate at the nose, is painted black. The outer casing is steel; the inner housing is aluminum; and the detonator holder is brass. The detonator holder is held in position by a creep spring resting against the clock mechanism. The clockwork is similar to that used in Nose Fuze for the 37/54 H. E. Shell. A centrifugal safety bolt is horseshoe-shaped and is fitted with teeth which engage the first wheel in the series of the clock mechanism. Another centrifugal bolt at ring angles to the safety bolt is fitted within a spring and locks the safety bolt in position. The firing pin is kept in upward position

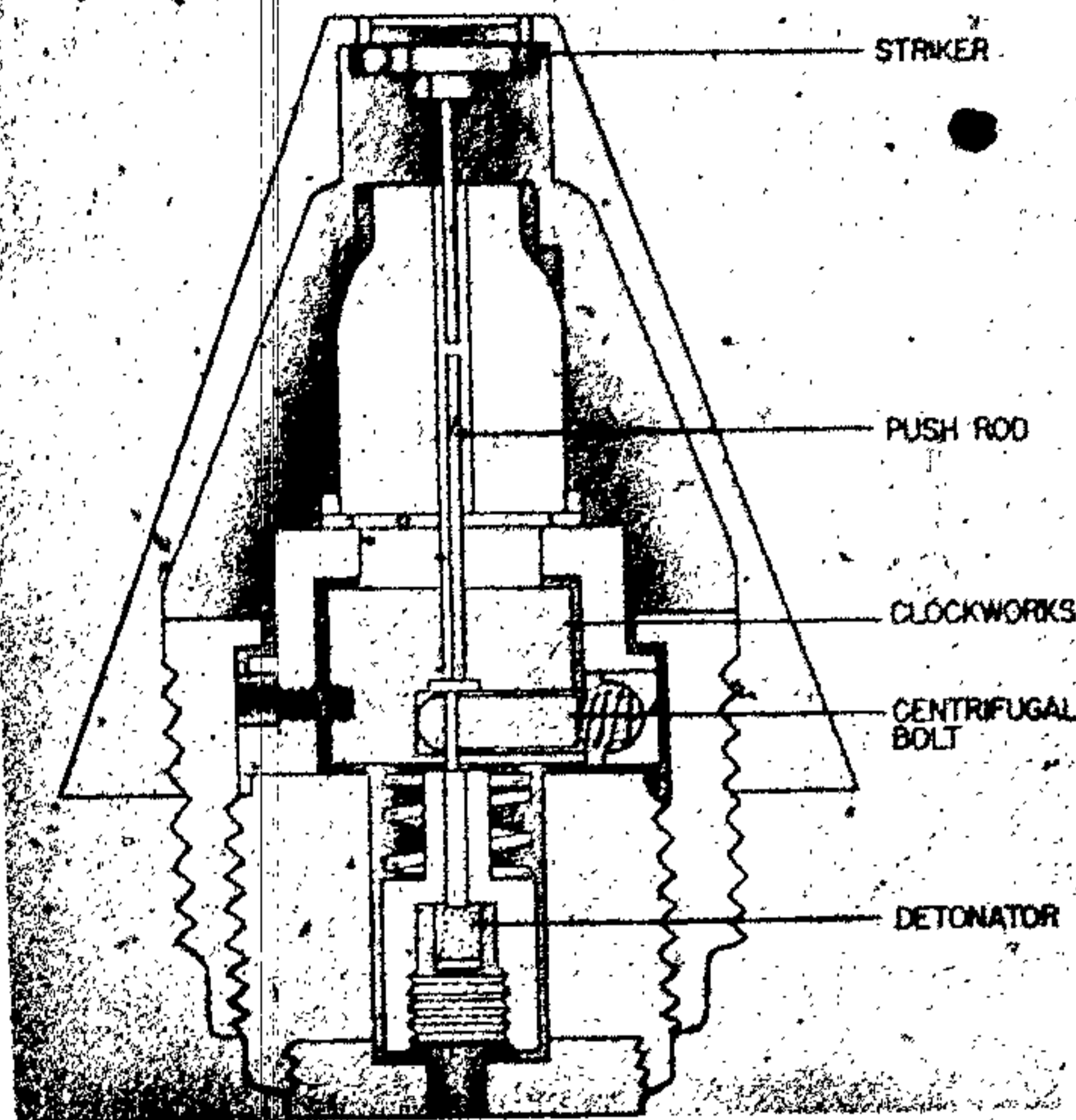

Figure 211 - Percussion Nose Fuze M16 (OK. 2S 912)

by a collar at its midpoint which rests on top of the centrifugal safety bolt. The striker fits into the outer casing and is not connected directly to the firing pin but is separated by a small connecting rod.

Operation

On firing, the centrifugal bolt immediately moves outwards, unlocking the horseshoe centrifugal which is held by clock mechanism during acceleration, since friction set up between the comparatively large surfaces of the contact of the cogwheels is sufficient to prevent outward movements of the bolt. On deceleration, however, the cogwheels set forward and separate and allow the horseshoe centrifugal bolt to move outwards, releasing the firing pin which, however, remains in position because of deceleration. On impact with a soft surface, the detonator moves forward to hit the firing pin. On impact with a hard surface, the striker is forced down, hitting the connecting rod, which in turn causes the firing pin to hit the detonator.

Remarks

The fuze OK. BO. SC. 41, differs in exterior appearance but functions exactly the same.

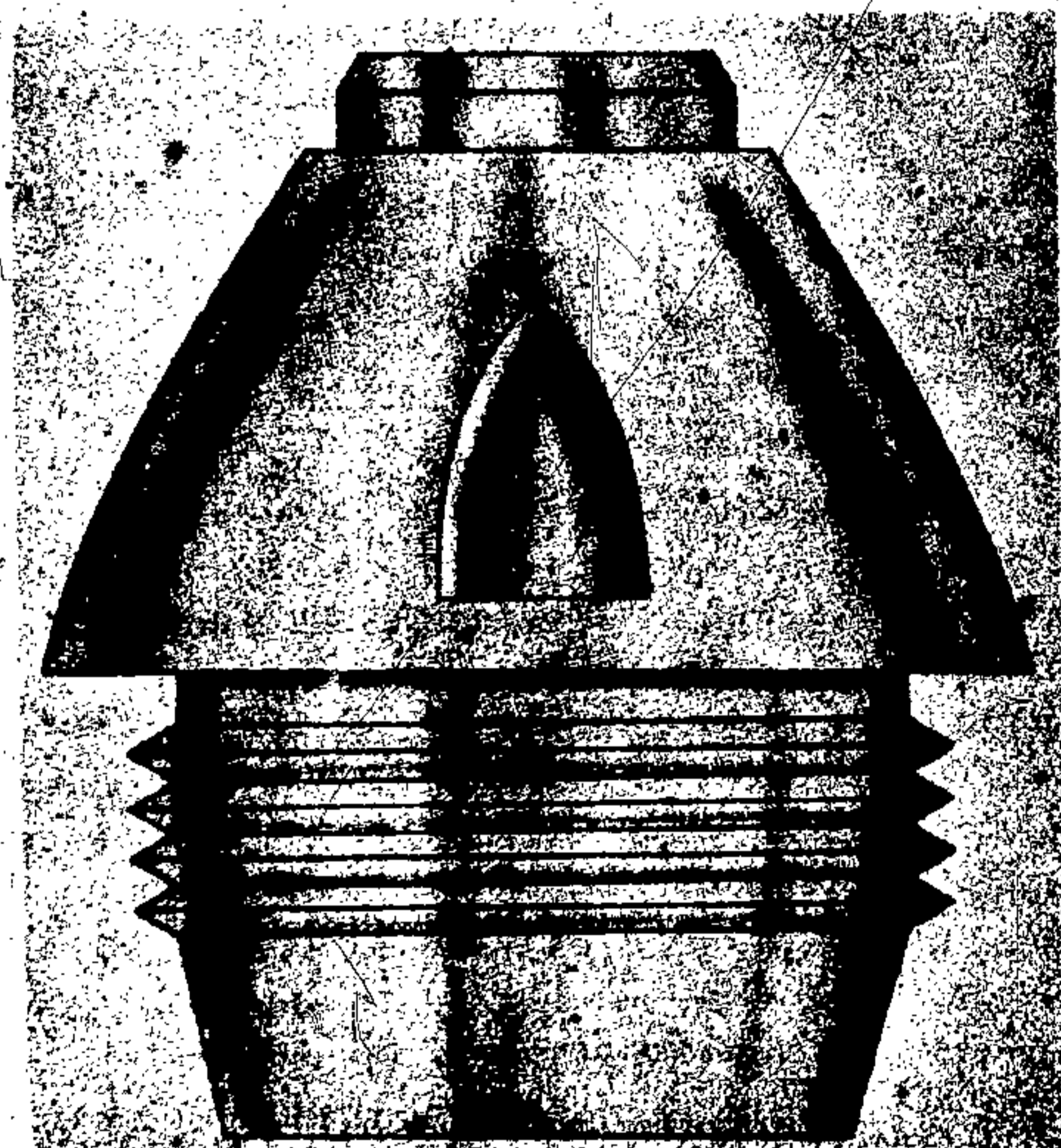

Figure 210 - Percussion Nose Fuze OK. BO. SC. 41

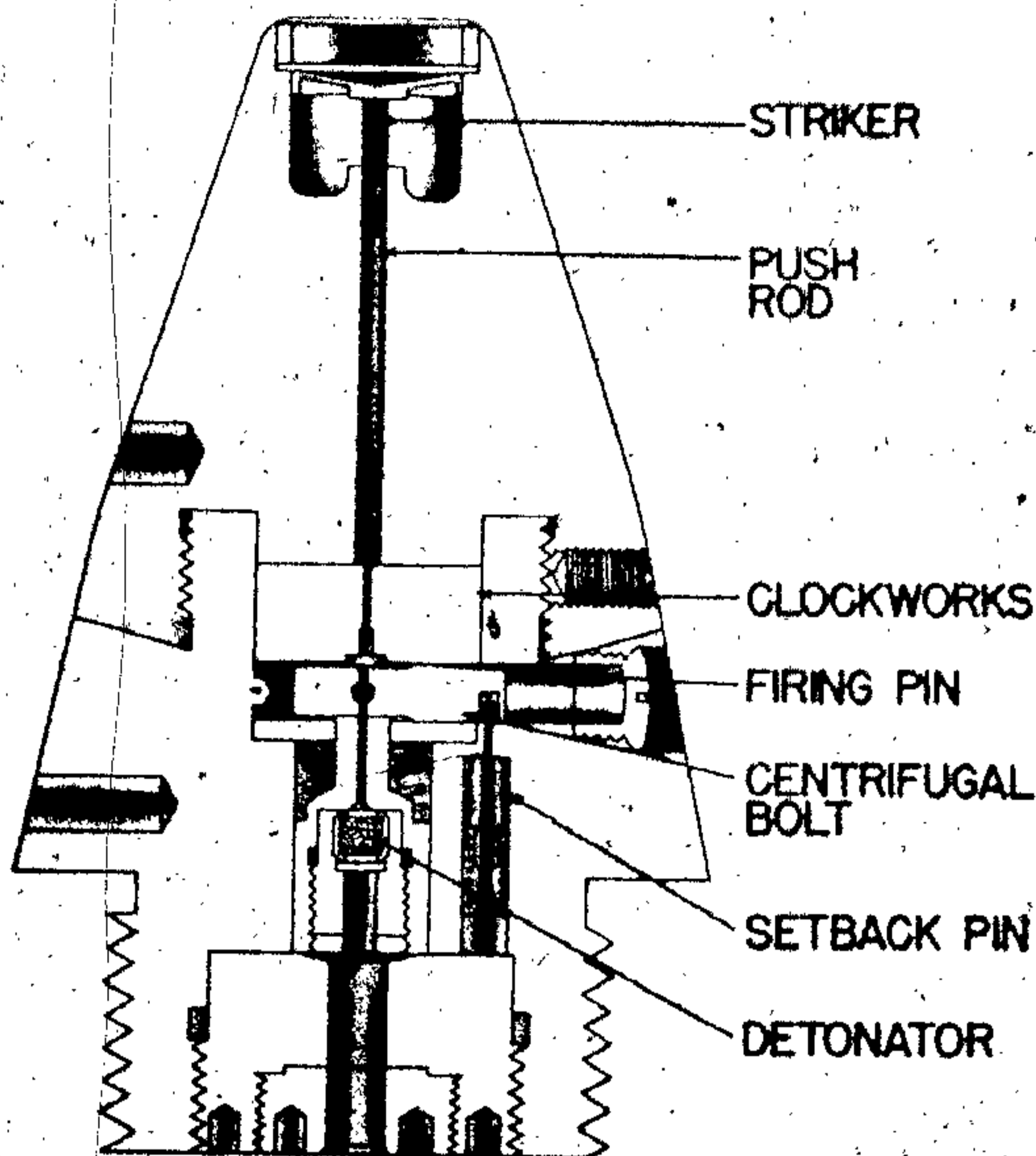

Figure 212 - Percussion Nose Fuze O. BO. 34/37

Percussion Nose Fuzes (O.BO. 34/37 and O.BO. 34/40)

Data-O.BO. 34/37

Over-all length	-----	4 in.
Maximum diameter	-----	Unknown
Thread diameter	-----	1.76 in.

Description-O.BO. 34/37

This fuze is a clock-mechanism arming type with a centrifugal safety bolt holding the firing pin and detonator apart. The fuze body is brass; the striker and centrifugal are aluminum; the detonator holder and clockwork mechanism are brass.

The clockwork mechanism has a train of four wheels, each consisting of a spur and pinion, and a balance wheel oscillator. The nose of the fuze, drilled through its center to take the striker and aluminum connecting rod, is closed against air pressure by a brass disc. The safety bolt forks at the inner end to provide two arms which pass under a collar of the firing pin to prevent the pin from moving towards the detonator. A recess to engage a detent is located on the underside of the bolt, and a hole in the center of one side engages

the stem of the spring-loaded centrifugal locking bolt. On the opposite side of the safety bolt, a toothed rack is enmeshed with the first spur of the clockwork escapement mechanism. The detonator holder is kept in position by a creep spring.

Operation

On acceleration, the detent sets back, forcing the spring past the shoulder in the sleeve, withdrawing the spring past the shoulder, and withdrawing the stem from the recess in the safety bolt. The spring then engages the detent and prevents the detent from returning to a forward position. Centrifugal force causes the locking bolt to move outwards. The safety bolt is then held only by clockwork mechanism. On deceleration, wheels separate, and the centrifugal bolt moves outwards under control of the clockwork escapement mechanism. When the fork portion of the bolt clears the collar, the firing pin is held apart from the detonator by a creep spring. On impact, the firing pin and detonator move together.

Remarks

Fuze O.BO 34/40 is identical, except that it is aluminum and has a green tip.

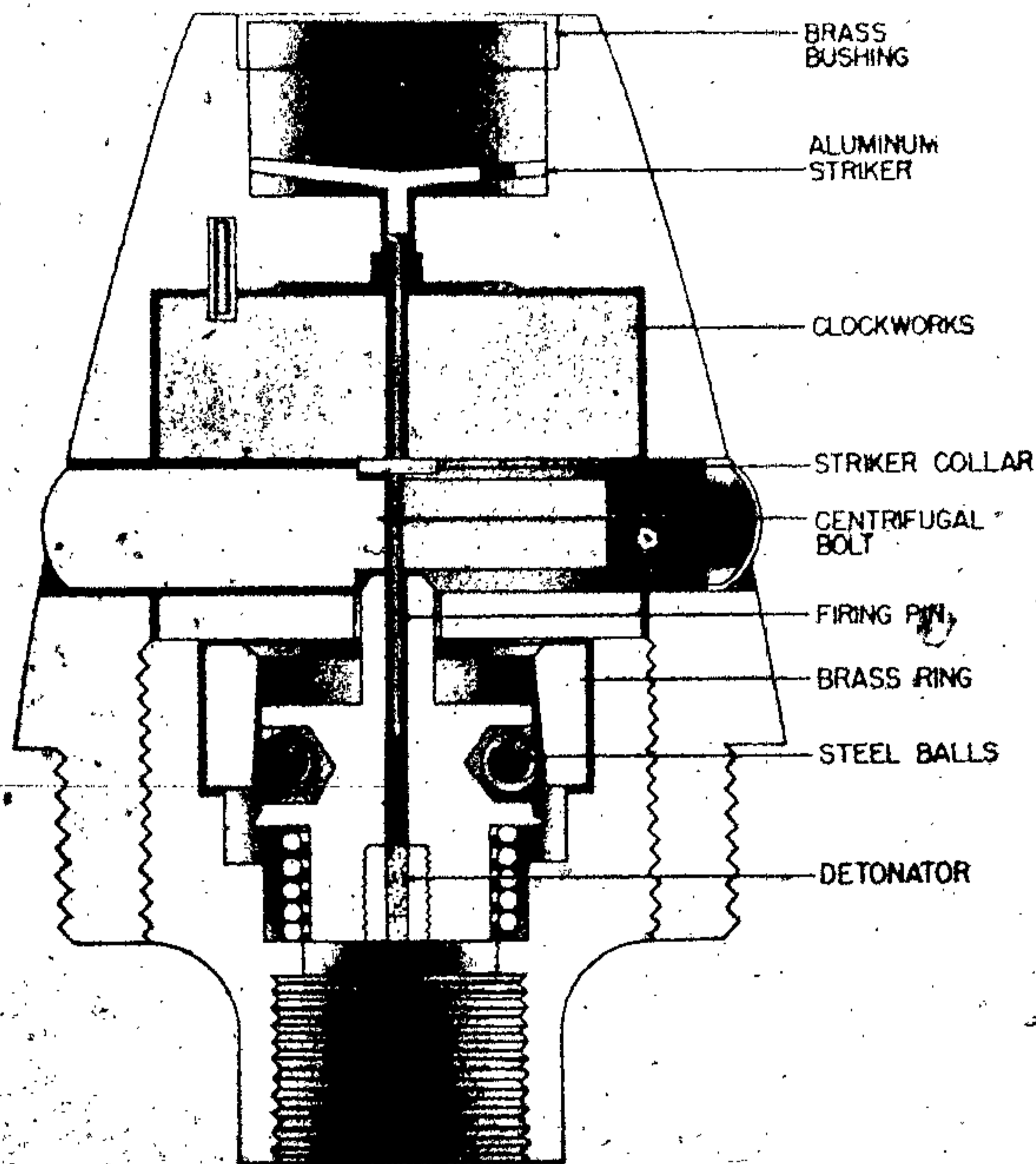

Figure 213 - Percussion Nose Fuze for 37/54 H.E. Shell

Percussion Nose Fuze for 37/54 H.E. Shell

Data	
Over-all length.....	Unknown
Maximum diameter.....	Unknown
Thread diameter.....	Unknown
Markings.....	L10, 20.1 41 XIV, OPX a 35, 11

Description

This is an aluminum fuze. In the body is a brass container which holds the clock mechanism composed of a train of four wheels and an oscillator. Passing through the body of the fuze is a centrifugal safety bolt which is fitted with a slot. This centrifugal bolt is also fitted with teeth which engage the teeth of the first wheel in the train series. Passing through the center of the brass container is a firing pin with a collar at its midpoint. The firing pin is kept in the upward position by the collar resting on the top of the centrifugal

safety bolt. In the lower part of the fuze is the detonator holder, which is fitted on the outside with ball bearings which bear against the brass ring. Below the detonator holder is a spring under compression. Screwed into the base of the fuze is a booster.

Operation

When the projectile is fired, setback prevents the centrifugal bolt from moving outwards. After the setback forces have been overcome, centrifugal force will cause the centrifugal safety bolt to move outwards under the control of the train of wheels. In the event of the projectile's hitting a target, the firing pin will be driven onto the detonator, the collar being sheared. In the event that the projectile fails to hit a target, after the centrifugal bolt has been fully withdrawn, the detonator holder will move upwards under the action of its spring, the detonator then striking the firing pin. The function of the ball bearings appears to be to act as a friction-reducing device.

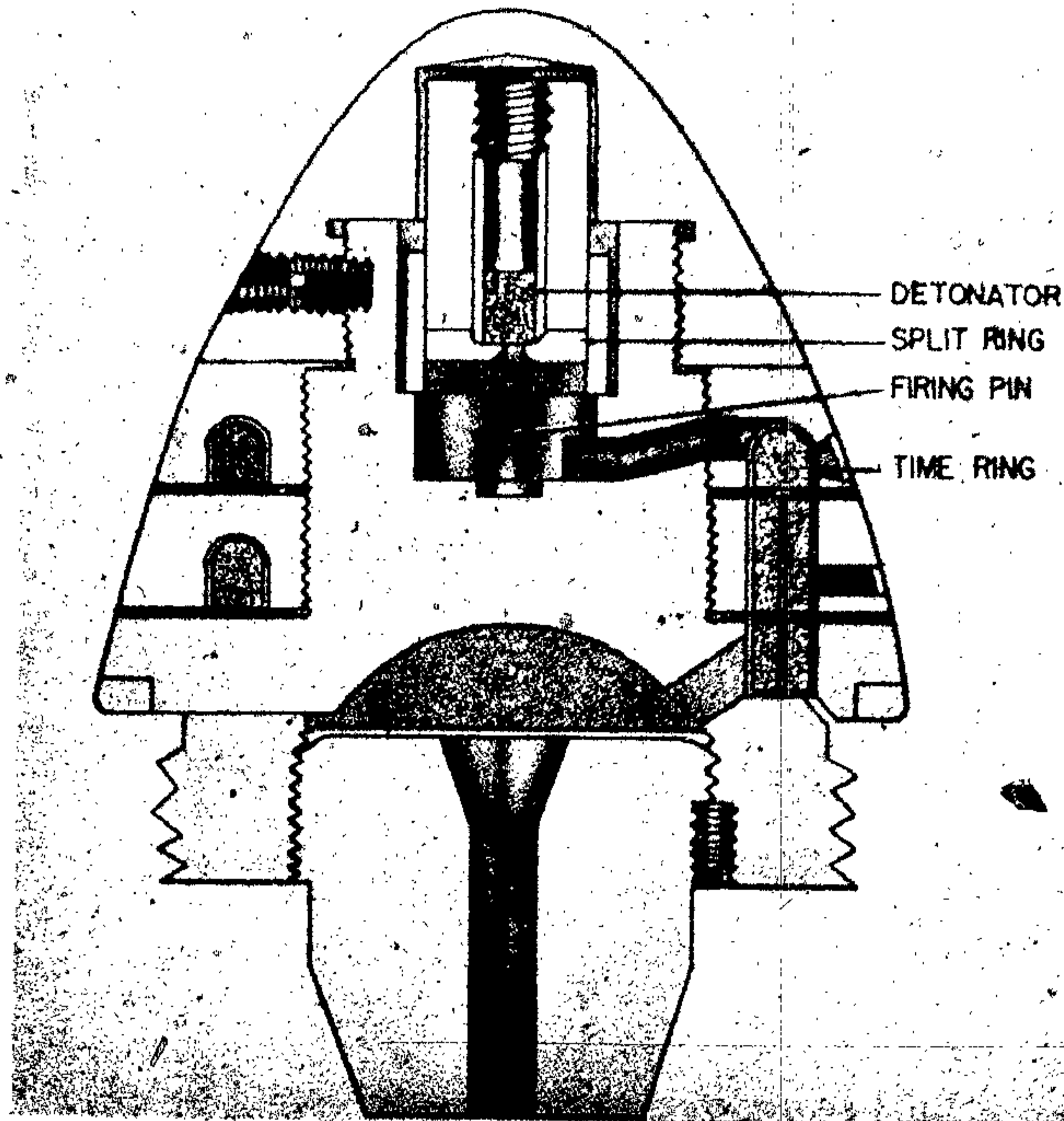

Figure 214 - Nose Time Fuze M900/14

Nose Time Fuzes M900/14 and M900/34

Data

Projectile used in	H. E. Projectiles for Field Guns
Over-all length	3 in. (approx.)
Maximum diameter	Unknown
Thread diameter	Unknown
Markings M°900/14	Unknown
M°900/34	Stenciled red cross

Description

The two fuzes are similar except for modifications. The M900/34 time rings have a small capacity, but a different burning powder is used to equal the time of burning. The fuze body is aluminum. Assembled on the body are two time rings. A tension cap screw-threads on the body to keep the time rings in position. Two semicircular recesses formed in the cylindrical part of the body coincide with similar recesses in the upper time ring to receive two locking pins which hold the upper time ring fixed. A recess in the forward end of the body contains the detona-

tor holder and striker. The detonator is held off the firing pin by a split brass ring which rests on the shoulder of the recess. The firing pin is fixed to the bottom of the recess. The upper time ring has a powder-filled groove in the underside which extends 310 degrees. Vents are provided for the escape of pressure during burning. The lower time ring also has a powder groove in the underside extending 310 degrees. A flash-hole connecting the commencement of powder groove with the upper surface of the rings contains a press powder centrally drilled to assist burning. A vegetable-paper washer with a hole to correspond to the commencement of the groove, and a felt washer perforated to correspond with the flash-hole, are used to separate the time rings.

Operation

On acceleration, the detonator sets back through the split brass ring to hit the firing pin. The flash ignites the upper time ring, which burns along the groove. Vent discs blow out due to pressure and prevent variation in the rate of burning. The

distance between the commencement of the powder groove in the upper ring and the powder-filled flash hole depends on the angle the lower ring is turned in the setting. When the powder burns around to the

flash-hole in the lower ring, the lower ring ignites and burns around to a delay in the fuze base. From the delay, the flash is passed to a solid powder pellet in the flash channel, then to the main charge.

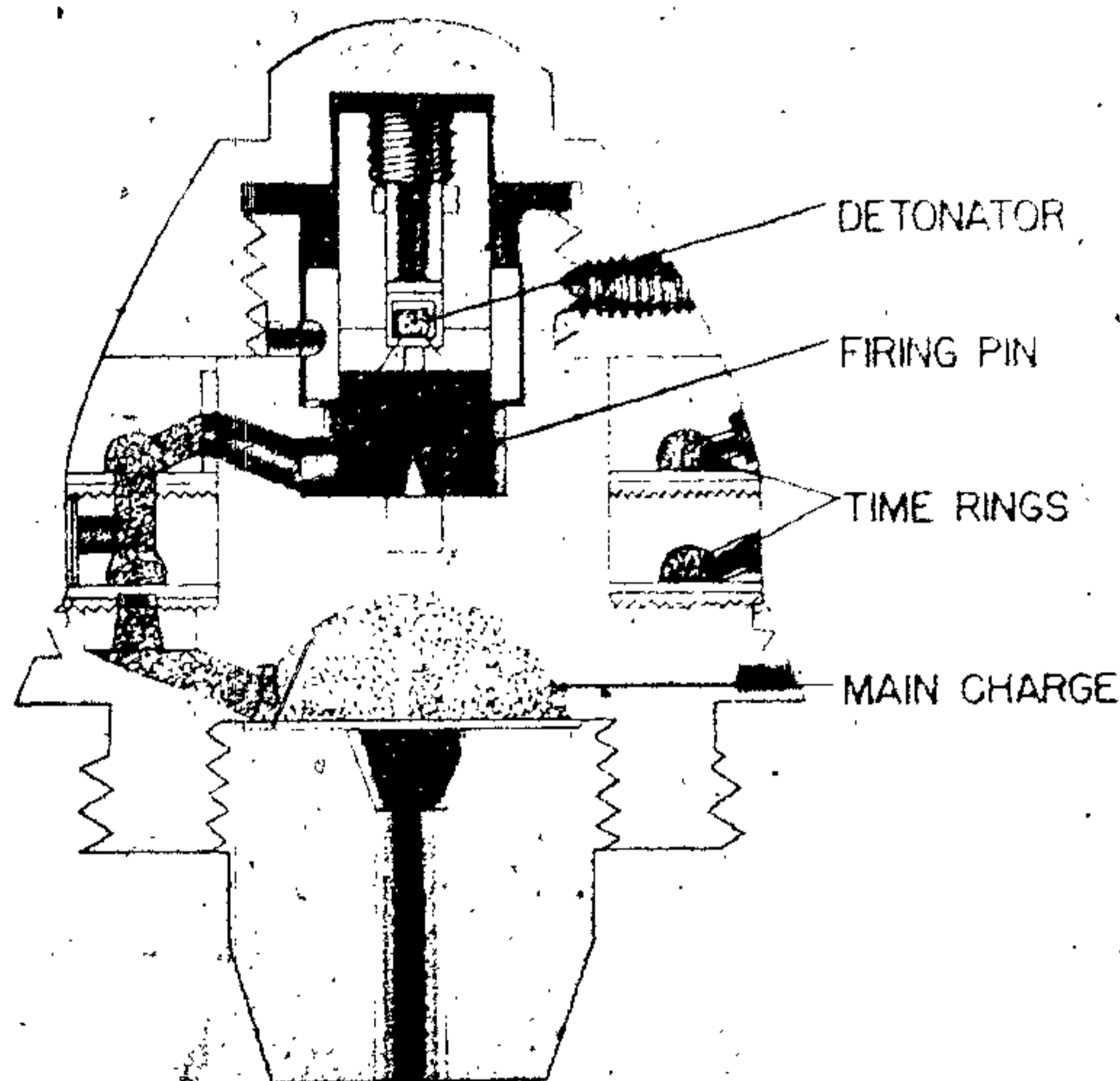
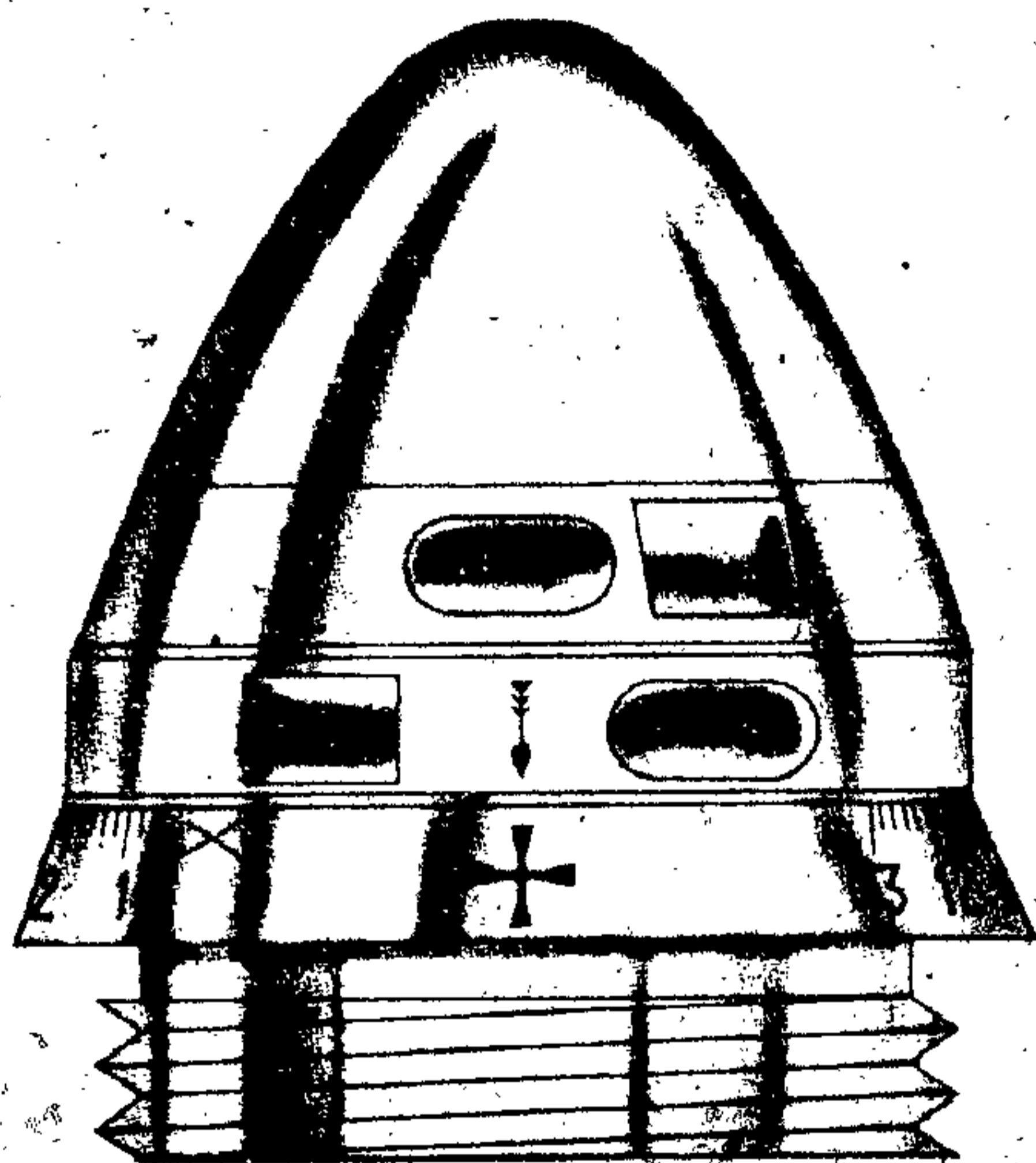

Figure 215 - Nose Time Fuze O.T. 32

Nose Time Fuze O.T. 32

Data

Projectile used in	102/35 A. A.
Over-all length	2.7 in. (approx.)
Maximum diameter	Unknown
Thread diameter	1.762 in.
Markings	632, LU, 1940

Description

This fuze is very similar to the Nose Time Fuzes M900/34 and M900/14 in shape and operation; and is only slightly different in construction. There are two types, one with a tapered projection at the base and the other with the end flash with the screw threads. Setting graduations extend from 0 to 13.2. The fuze set to 13 gave burning time of 26.6 seconds at rest. A soldered alloy cover with tear-off wire and ring is sometimes fitted to the fuze. The fuze is made of aluminum and has a locked upper time ring and lower adjustable ring for setting. Both time rings are held down by a tension cap which screws onto the forward end of the fuze. The detonator holder with a split brass ring and the firing

are located in the recess in the forward portion of the fuze.

Operation

On acceleration, detonator holder sets back through the split brass ring, and the detonator is impinged on the firing pin. The flash produced passes through the flash channel in the recess and ignites the powder in the flash channel in the upper ring, thus igniting the fuze powder which starts to burn along the groove. The pressure set up by the burning fuze powder dislodges the closing disc of the first vent, and thus prevents variation in rate of burning as the result of heat and pressure. The distance between the commencement of the powder groove in the upper ring and the powder-filled flash-hole depends on the angle through which the lower ring is turned in setting. When the fuze powder has burned around to the flash-hole in the lower ring, the lower ring ignites and burns around to the delay in the base of the fuze. From the delay, the flash is passed on to the solid powder pellet in the flash channel, and then to the main charge.

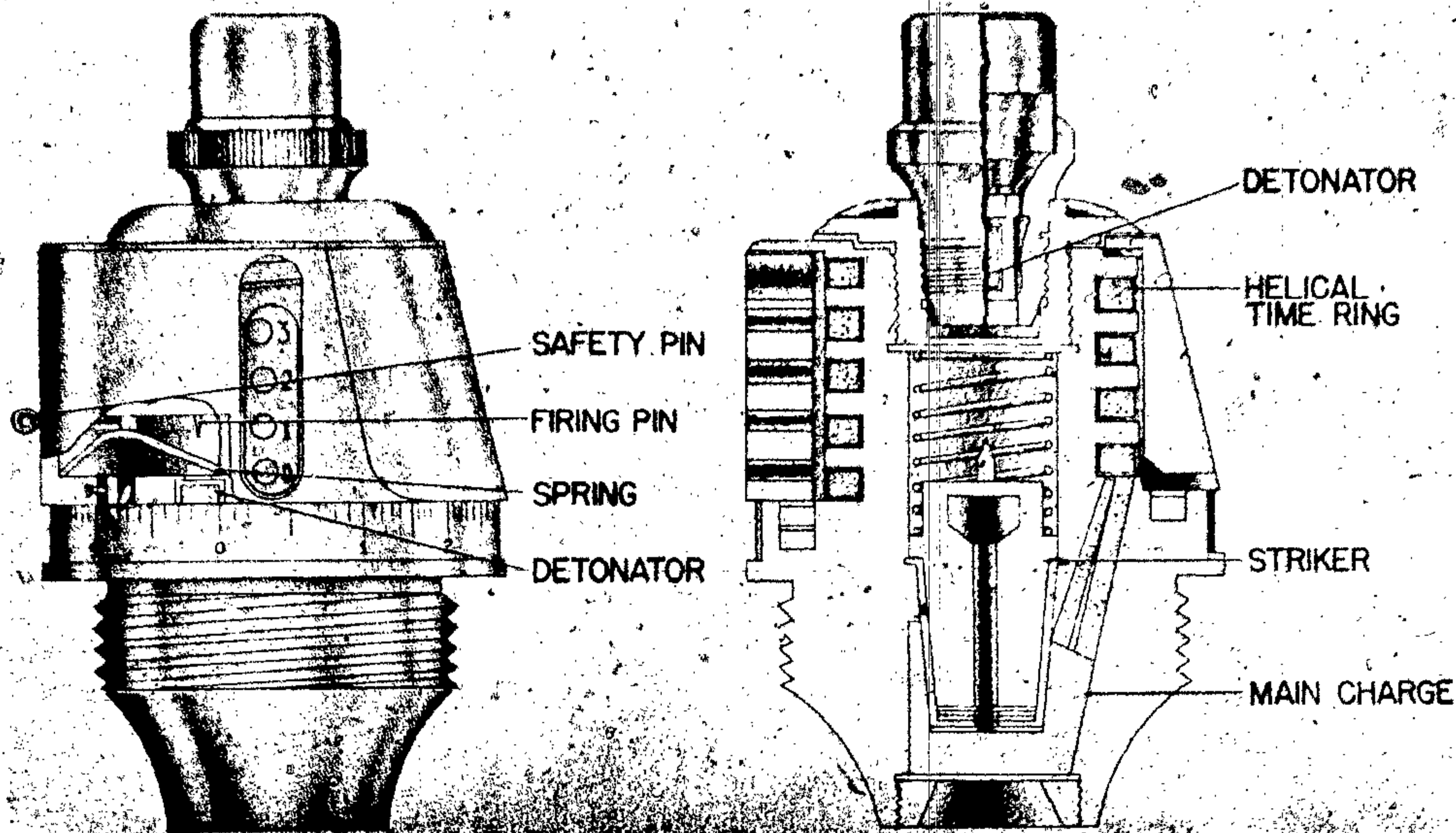

Figure 216 - Time and Percussion Nose Fuze
A.D.E. M99

Time and Percussion Nose Fuze A.D.E. M99

Data

Projectiles used in.....	Unknown
Over-all length.....	Unknown
Maximum diameter.....	Unknown
Thread diameter.....	Unknown
Markings.....	Graduated ring numbered 0-9

Description

This is a brass time and percussion fuze with an aluminum graduated ring around the center. The body is fitted within a helical time combustion ring which has four turns. The powder is protected externally by a lead cover. Over this portion fits a brass tube having a vertical window into which fits a brass piece with four perforations numbered 0 to 3. These perforations are in line with the time rings. In the side of the outer case is a long cavity having a detonator at the base. A brass firing pin fits into the cavity, being held off the detonator by a piece of spring brass. A safety pin is fitted for

further protection. The percussion mechanism, fitting centrally into the nose of the fuze, consists of a firing pin at the base and a creep spring. The detonator holder screws into the nose of the fuze. The graduated ring has a reading up to 10. This setting gives the unit figures, the 10's figures being given by the perforations in the brass piece. When the correct setting has been obtained, the time ring is punctured through the correct hole in the brass piece.

On firing, the firing pin in the side of the cover sets back against the spring to fire the detonator. By means of a longitudinal flash-hole, the flash is carried to the perforation made in the time ring. The time ring burns helically to the perforated pellet in the base of the fuze, which sets off the main charge. In the percussion mechanism, no action takes place until impact, when the striker and firing pin set forward against the creep spring and strike the detonator. The flash passes through the center of the striker to the main charge.

Nose Time Fuze MO6/17 and Time and Percussion Nose Fuze A.D.E. MO6

Data

Projectiles used in
 75/27 A. A. and Shrapnel
 77/28 Shrapnel and A. A.
 Over-all length ----- 2.5 in. (approx.)
 Maximum diameter ----- Unknown
 Thread diameter ----- Unknown
 Markings
 MO6/17 ----- Numbers 1 to 58

Description

These fuzes are combustion types with two time rings. The upper ring is fixed, and the lower setting ring is graduated to 59 and numbered to 58. The cap is aluminum. The rings and body are aluminum alloy, but the periphery of platform bearing setting index is sometimes brass. The A. D. E. MO6 has a recess in the rear portion which houses the second firing pin, creep spring, split arming ring, and detonator holder, which causes the fuze to detonate on impact, whereas the MO6/17 will not detonate on impact, but depends on a time element. In a recess in the forward position of both type fuzes, are located the detonator holder, stirrup spring, locating spring, and firing pin. The time rings are of normal design, each having tightly closed vents containing a

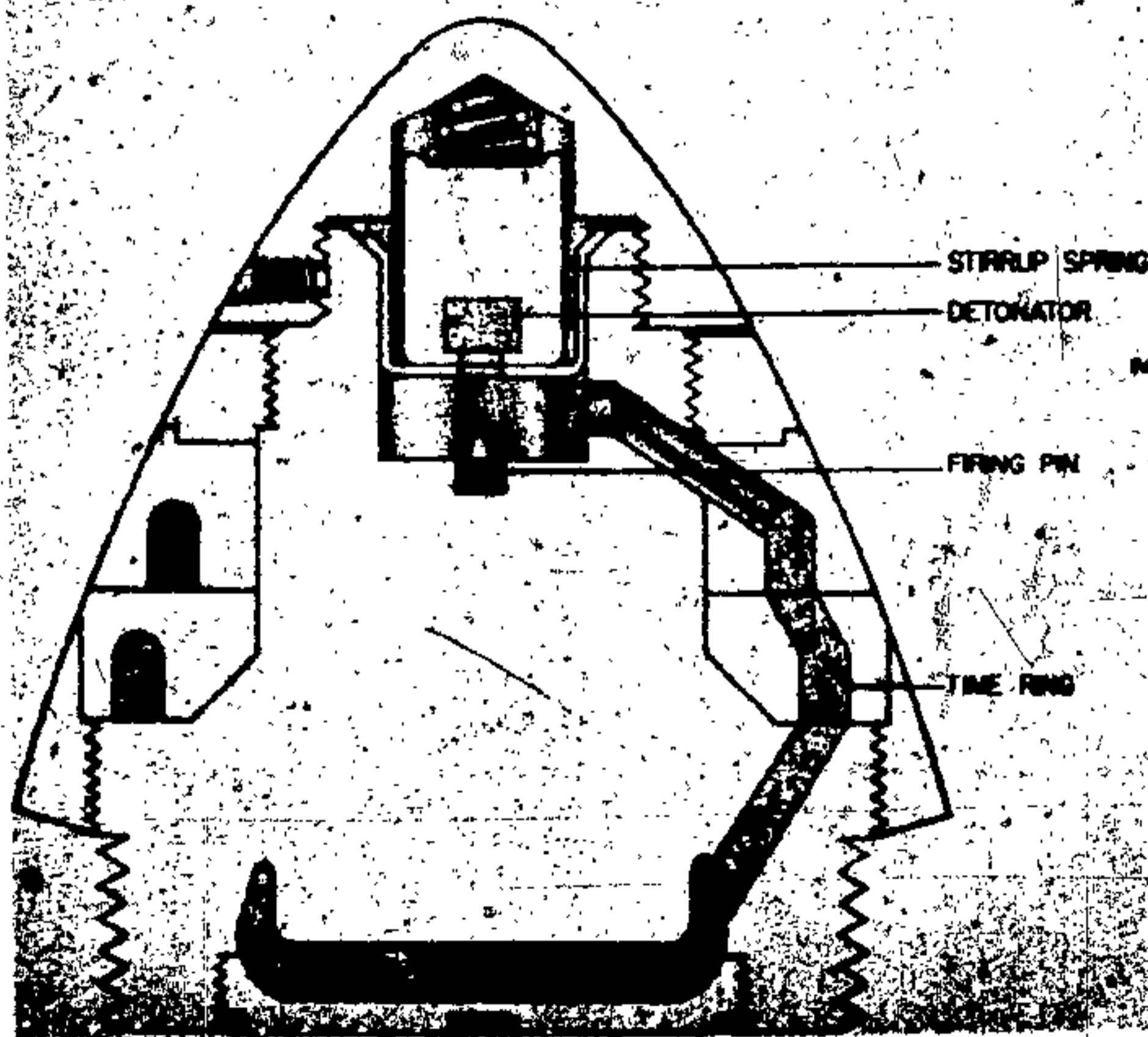

Figure 217 - Nose Time Fuze MO6/17

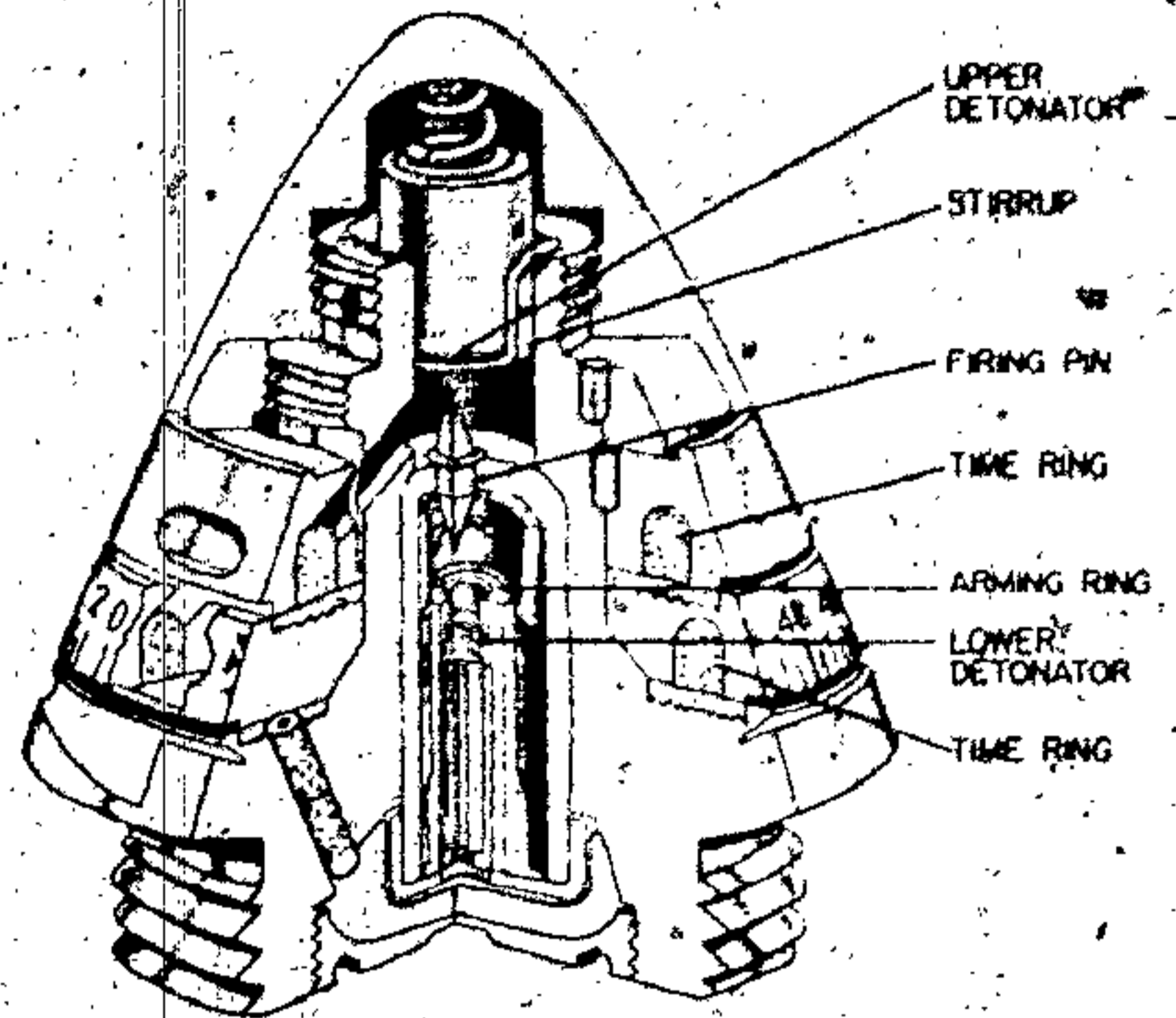

Figure 218 - Time and Percussion Nose Fuze A.D.E. MO6

perforated powder pellet at the commencement of the fuze powder train. The tension of the setting ring is adjusted at assembly by a screwed cap, secured by a setscrew.

Operation

MO6/17: On acceleration, the detonator holder overcomes the stirrup spring and sets back, carrying the detonator to the firing pin. The flash produced is transmitted to the perforated pellet in the upper time ring, starting the fuze powder burning. The fuze burns around to the perforated pellet in the lower time ring and ignites the fuze powder. The lower ring burns and ignites the pellet in the fuze base which in turn flashes to the main charge.

A. D. E. MO6: Operation for the time part of the fuze is exactly the same as MO6/17. Operation for the percussion parts differs. On setback, the split arming ring sets back and locks to position of the detonator holder. The creep spring keeps the firing pin and detonator apart. On impact, the detonator overcomes the creep spring and hits the firing pin.

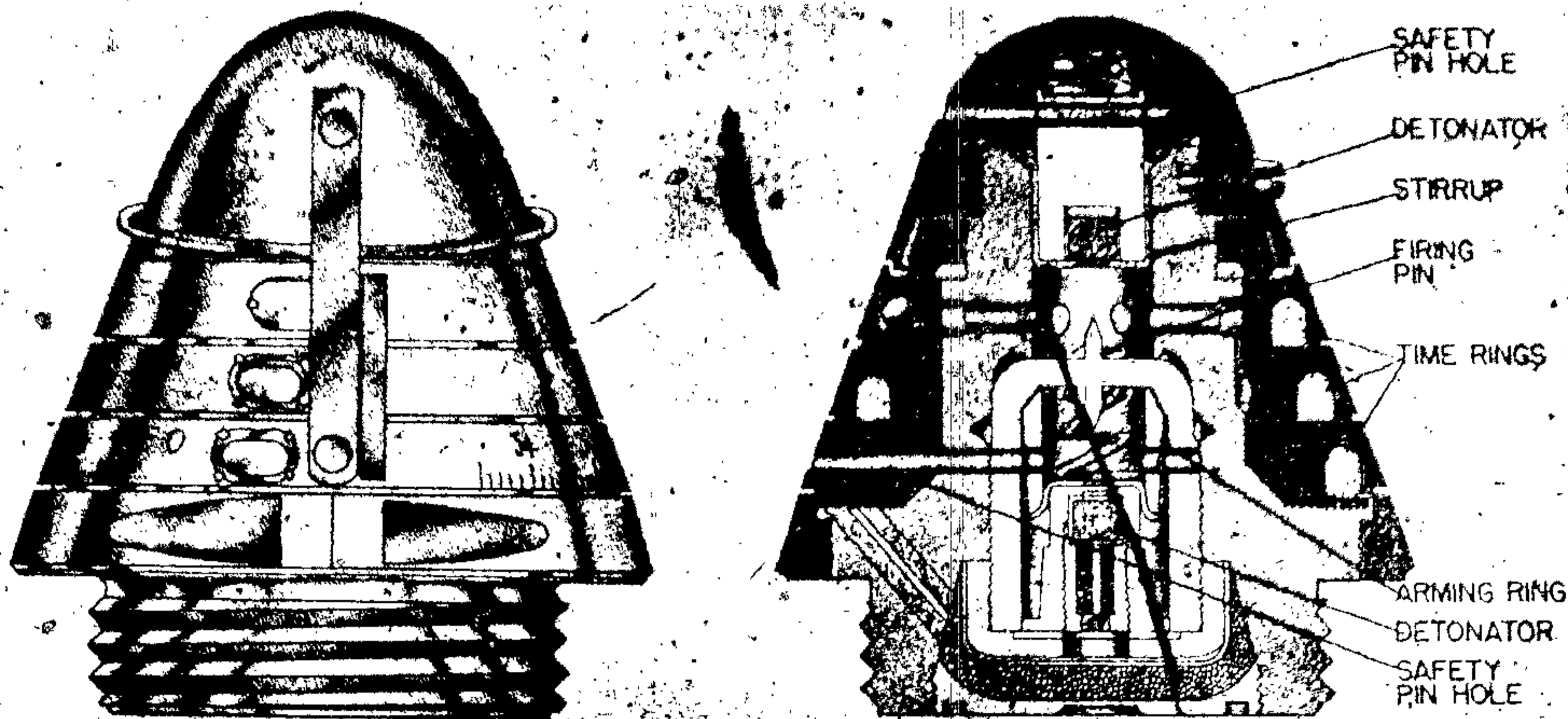

Figure 219 - Time and Percussion Nose Fuze A.D.E. M12

Time and Percussion Nose Fuze A.D.E. M12

Data

Projectiles used in	
100-mm-H. E. and Shrapnel	
149-mm-Shrapnel	
Over-all length	Unknown
Maximum diameter	Unknown
Thread diameter	Unknown
Marking	Unknown

Description

This fuze has three combustion rings, the upper and lower being movable and joined by a piece of flat metal. The center ring is fixed to the body by two small rivets. The initiating parts of the time and percussion mechanisms are fitted with safety pins which are attached to a ring. These must be removed before firing. The time mechanism is of the standard type, having the detonator holder held by a stirrup spring. The percussion mechanism has an arming ring, stirrup spring, detonator, and creep spring, all located in the base of the fuze.

Operation

Time Mechanism: On firing, the detonator sets

back against the action of the stirrup spring onto the firing pin and sends a flash to the time rings. The time rings burn to the flash pellet in the base of the fuze. This sets off the charge.

Percussion Mechanism: On firing, an arming ring sets back against a stirrup spring and frees the detonator holder, which is now held off the firing pin by a creep spring. On impact, the detonator holder moves forward and forces the detonator into the firing pin.

Nose Time Fuze M36 and Time and Percussion Nose Fuze A.D.E. M36

Data

Projectiles used in	
75-mm-H. E., 100-mm H. E., 149-mm H. E.,	
and 100-mm Shrapnel	
Over-all length	4.7 in.
Maximum diameter	2.2 in.
Thread diameter	2 in.
Markings	
M36	Mod-36, T
A. D. E. M36	Mod-36, D. E.

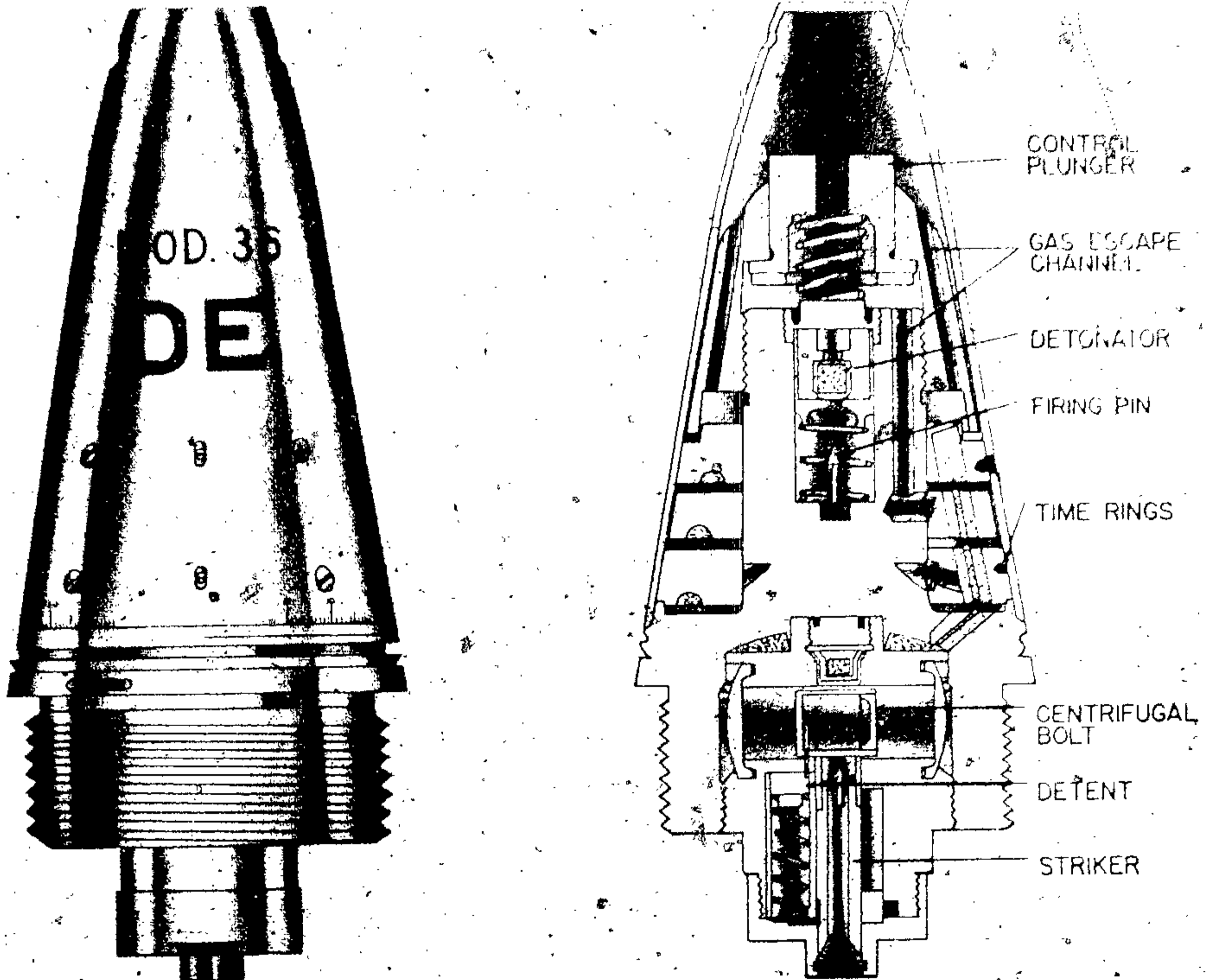

Figure 220 - Time and Percussion Nose Fuze A.D.E. M36

Description.

These two fuzes are similar except that the A. D. E. M36 has a percussion mechanism in the base consisting of detonator, centrifugal safety bolt, setback element, shear wire, and striker. The centrifugal bolt blocks the firing pin from the detonator. A spring-loaded setback detent locks the centrifugal bolt in position. These aluminum fuzes are fitted with a pull-off cover. The fuze has an outer cover under which are three time combustion rings. The middle ring is fixed; the upper and bottom rings are movable. Gases do not pass directly into the atmosphere, but collect under the cover, in which are escape holes. Over the escape channels in the fuze body is a control plunger fitted with a spring. The whole device is designed to minimize effect of changes in atmospheric pressure upon the rate of burning. In the fuze body are a locking rod, ball, and spring, to prevent any change

in setting of the line ring after firing.

Operation

M36: The fuze is set by turning the cover, which rotates the upper and lower time rings to the desired setting. On firing, the detonator holds sets back against the creep spring and stirrup spring to hit the firing pin. The flash travels to the upper time ring, which in turn burns to the middle ring then to the lower ring, and finally to the charge in the base.

A. D. E. M36: The time operation is exactly the same as the M36. The percussion mechanism functions as follows: On setback, the detent moves back, withdrawing the projection free from the centrifugal bolt, which moves outwards under influence of centrifugal force. On impact the striker breaks the shear wire and moves against the creep spring to hit the detonator, which sets off the main charge.

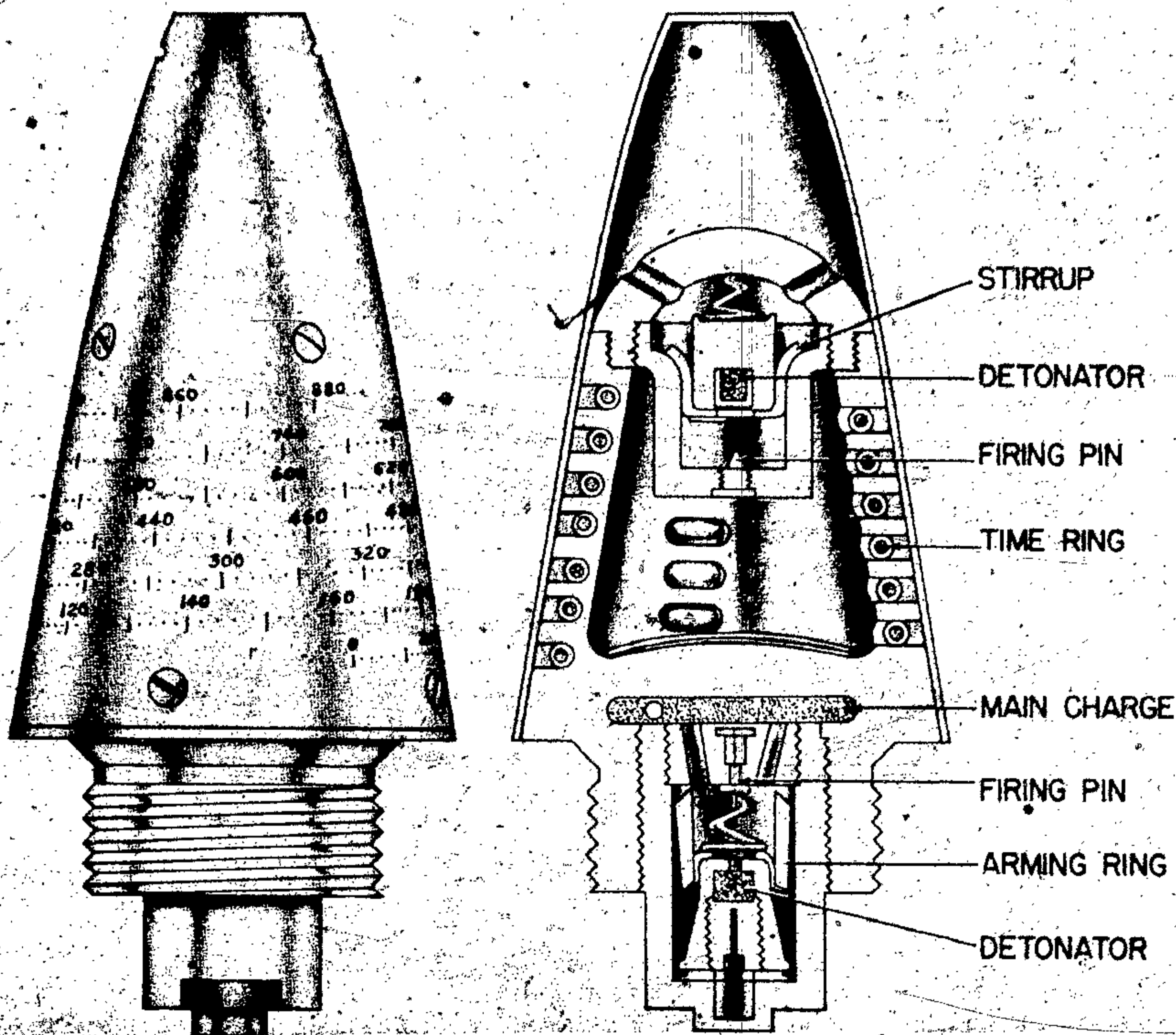

Figure 221 - Time and Percussion Nose Fuze A.D.E. M32

Time and Percussion Nose Fuze A.D.E. M32

Data

Projectile used in	100-mm H. E. M32 Shell
Over-all length	Unknown
Maximum diameter	Unknown
Thread diameter	Unknown
Markings	Unknown

Description

This fuze has an aluminum body, which is covered at the top by a thin aluminum cap graduated from 0 to 880. Screwed into the top, the aluminum cap contains a detonator holder held off from the firing pin by a stirrup spring. This initiates the rise mechanism. The time ring is helical, having nine turns and finally leading to a gunpowder main charge in the base. The percussion mechanism con-

sists of a detonator holder which is held off the firing pin by a brass arming ring, a stirrup spring, and a creep spring. To set the fuze, a hole is pierced through the cap and body against the required graduation, leaving a clear channel to the center of the fuze.

Time Mechanism

On firing, the detonator of the time mechanism sets back against its stirrup spring onto its firing pin. The flash ignites the time ring at the point of perforation. The time ring burns through to set off the main charge.

Percussion Mechanism

The arming ring sets back against its stirrup spring on firing. The detonator holder is now held by the creep spring. On impact, the detonator sets forward to hit the firing pin.

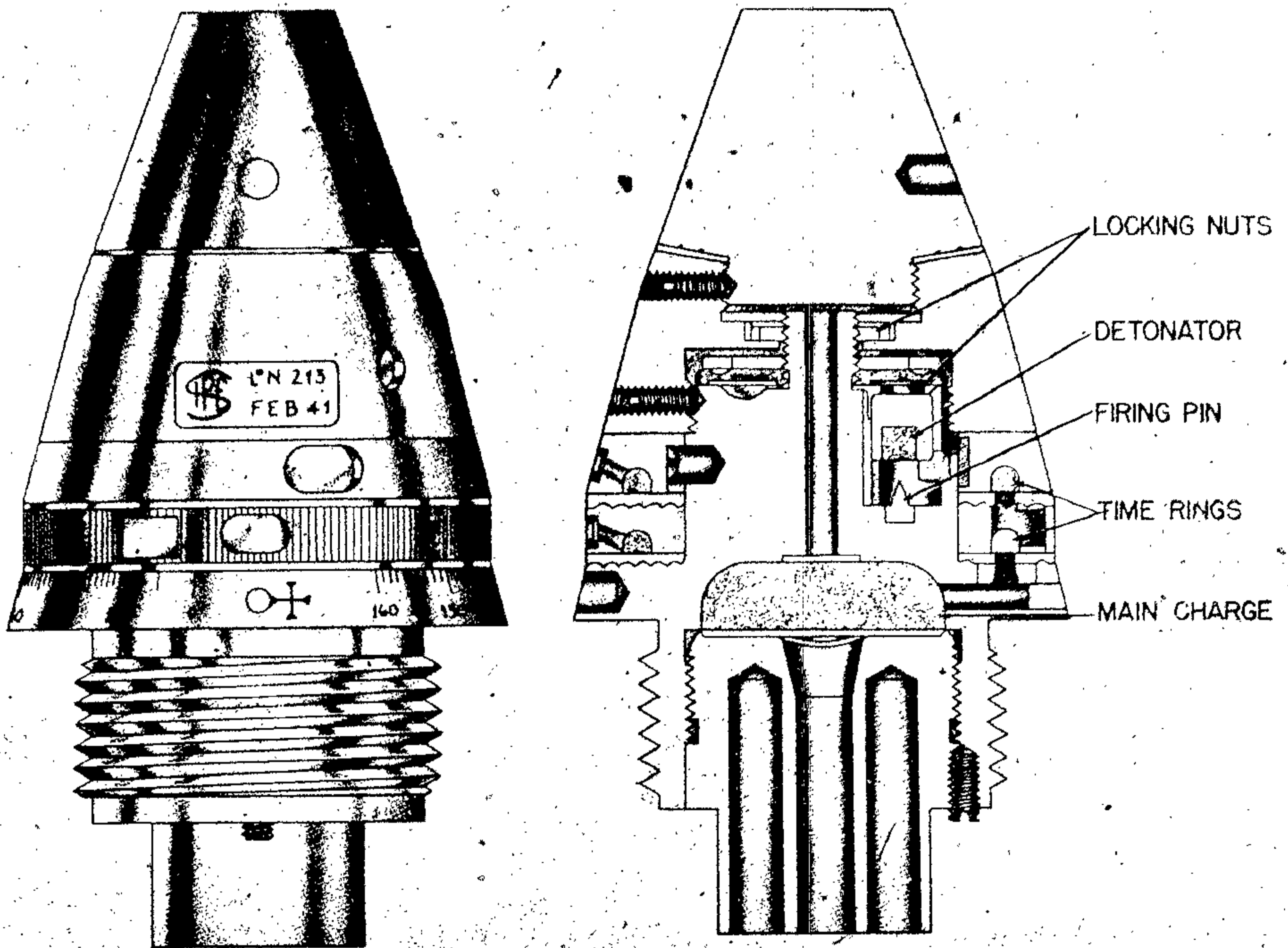

Figure 222 - Nose Time Fuze O.T. 33

Nose Time Fuze O.T. 33

Data

Projectiles used in	102/35 A. A.
Over-all length	4.7 in.
Maximum diameter	Unknown
Thread diameter	1.766 in.
Markings	LN213, FEB 41

Description

This combustion type of fuze with settings up to 160 gives a maximum time of burning of 35 seconds at low elevation and more than 50 seconds at high elevations. With the exception of a graduated brass ring, the exposed part of the fuze is made of aluminum. The lower portion which screws into the shell is brass. There are two time rings, the lower one being the milled. The upper ring is locked to the fuze body by a locking pin. A recess off the center of the fuze contains the detonator holder, its stirrup

spring, and a firing pin. The body is screw-threaded near the forward end to receive the tensioning nut and is reduced in diameter at the head to form a stem which is threaded to receive the cover plate and two locking nuts. The stop formed by the reduction in diameter at the head has in it a partly circular groove, the ends of which are connected with vertical grooves in the recess containing the detonator. A brass cover plate fits on the inside of the fuze to cover the detonator and the curved groove in the body.

Operation

On setback, the detonator moves back against its stirrup spring to hit the firing pin. The flash is passed to the upper time ring and ignites the fuze powder. The upper ring burns around to the flash pellet in the lower ring. The lower ring burns around to the flash pellet, then to the main charge in the base. This is the normal combustion time type.

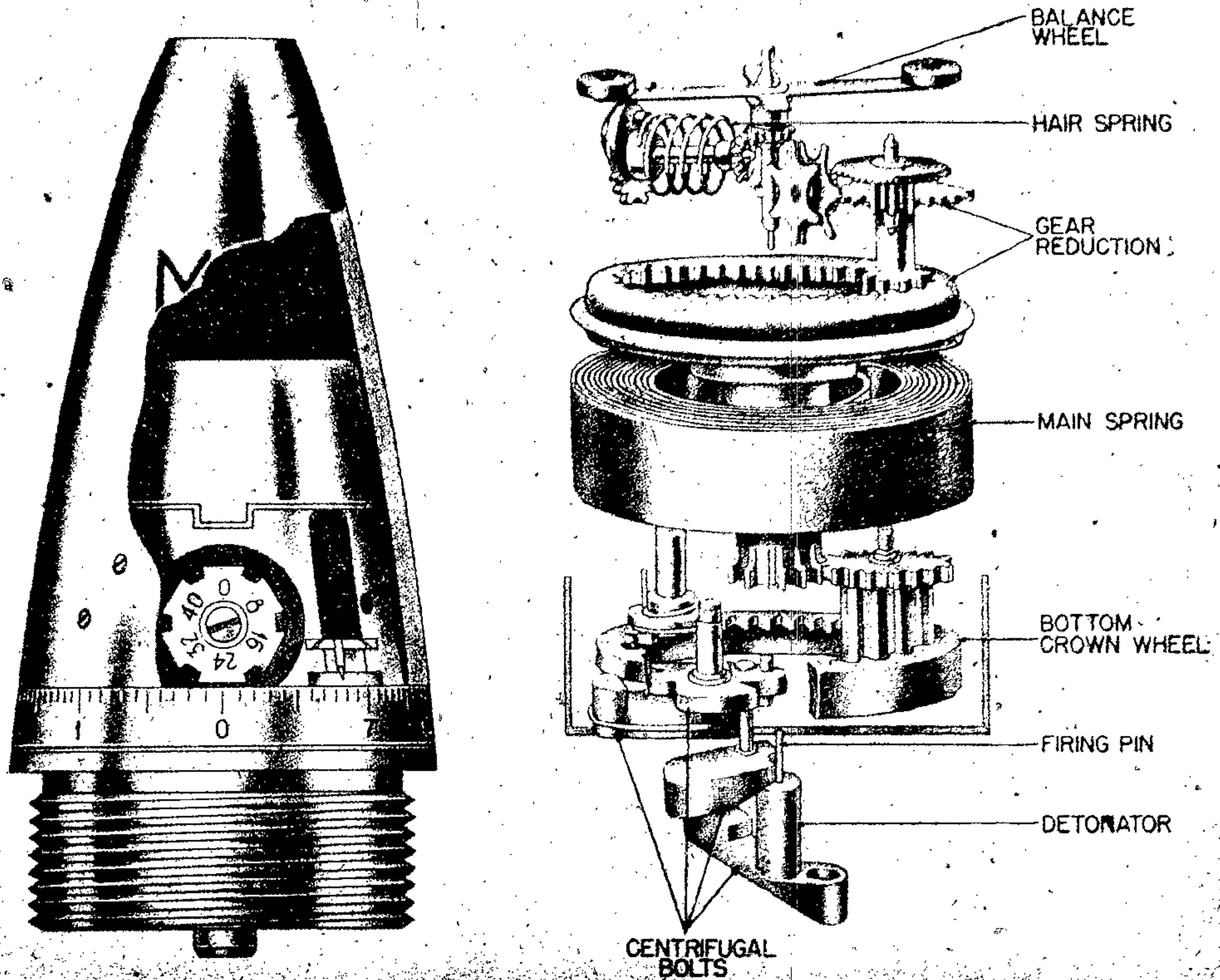

Figure 223 - Mechanical Time Nose Fuze M36

Mechanical Time Nose Fuze M36

Data

Projectiles used in	75/46-mm H. E. Shells
Over-all length	Unknown
Maximum diameter	Unknown
Thread diameter	Unknown
Markings	MT, Mob36

Description

This time fuze has a maximum time setting of 40 seconds. Its clockwork mechanism is identical to that in British Time Fuze No. 209 except for operation. The firing pin and detonator are located in a holder which rests in a groove in a centrifugal bolt; kept in position by a detent located in one end. At the other end of the bolt is a flash-hole. The

detonator holder tends to ride up the inclined plane on the lower centrifugal bolt onto the firing pin; but this is prevented by the centrifugal bolt's being immovable in an armed position by its detent, a second centrifugal bolt locked in position by a projection from a third centrifugal bolt. This third bolt is locked in position by a spring-loaded fourth centrifugal bolt, and by the bottom crown wheel. The fuze base is graduated and numbered in a circle from 0 to 7. Inside the cover is an indicator disc, showing the number of complete revolutions as seen through a small window. This disc is graduated 8, 16, 32, and 40 respectively, representing seconds. Inside the cover are four locking needles fitted into recesses and held in position by a stirrup spring. On firing; these needles setback and prevent rotation of the setting mechanism.

Operation

On firing, the detent in the first centrifugal bolt sets back and frees the bolt which, however, is unable to move, since the other bolts are locked until the slot in the bottom crown wheels comes into position and the third and fourth bolts are freed to move outwards under centrifugal force. The projection is then removed from the recess in the second bolt, which is freed to move outwards between the plate holding the firing pin and detonator. This action causes the detonator holder to rise up an inclined plane to hit the firing pin. Simultaneously, flash-holes in the first bolt, detonator holder, and base of the fuze draw into line.

Base Fuze for 47/32 A.P.

Data

Over-all length	3 in. (approx.)
Maximum diameter	1.21 in.
Thread diameter	1.21 in.

Description

This fuze has a brass body. The detonator holder is held away from the firing pin by a creep spring and a split brass ring. This ring is split throughout its entire length so as to permit expansion during setback. A brass nose plug screws into the top of the fuze body and holds the firing pin in position. This plug contains a flash hole filled with black powder to act as a delay.

The booster fits over the delay pellet and is secured to the fuze by the shoulder on the nose plug.

On setback, the split arming ring sets back over the detonator holder and leaves the detonator holder held off the firing pin by the creep spring. On impact, the detonator overcomes the resistance of the spring by its momentum and hits the firing pin. The flash produced by the detonator passes through the flash-holes in the firing pin and then ignites the delay, which in turn sets off the booster.

Base Fuze for 100/17 Hollow-Charge

Data

Over-all length	3.4 in.
Maximum diameter	Unknown
Thread diameter	1.646 in.
Markings	Unknown

Description

This fuze screws into a recess in the base of the shell cavity. The fuzes consist of a movable detonator holder, a fixed firing pin, and a centrifugal arming bolt with a setback element. In the head of the fuze is screwed the booster for the shell. The

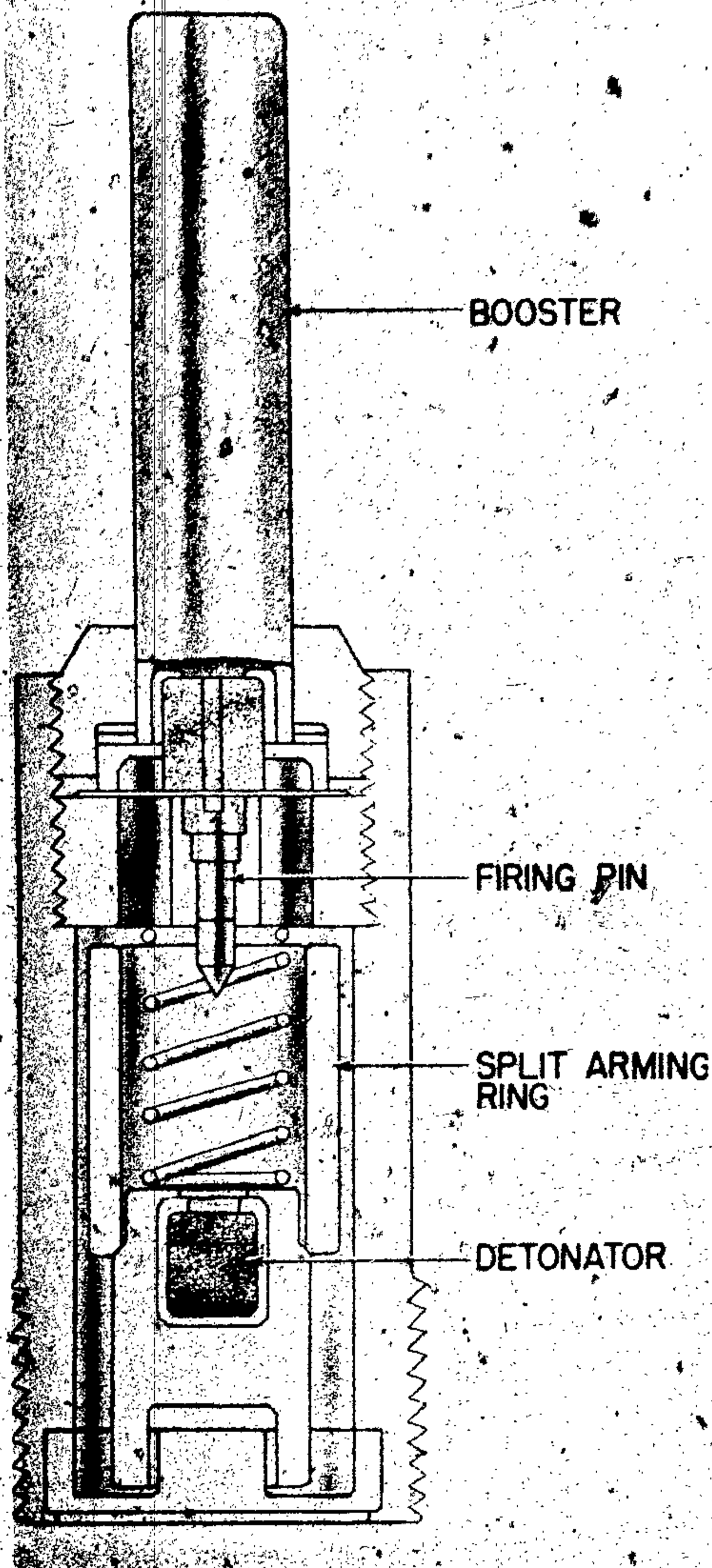

Figure 224 - Base Fuze for 47/32 A.P.

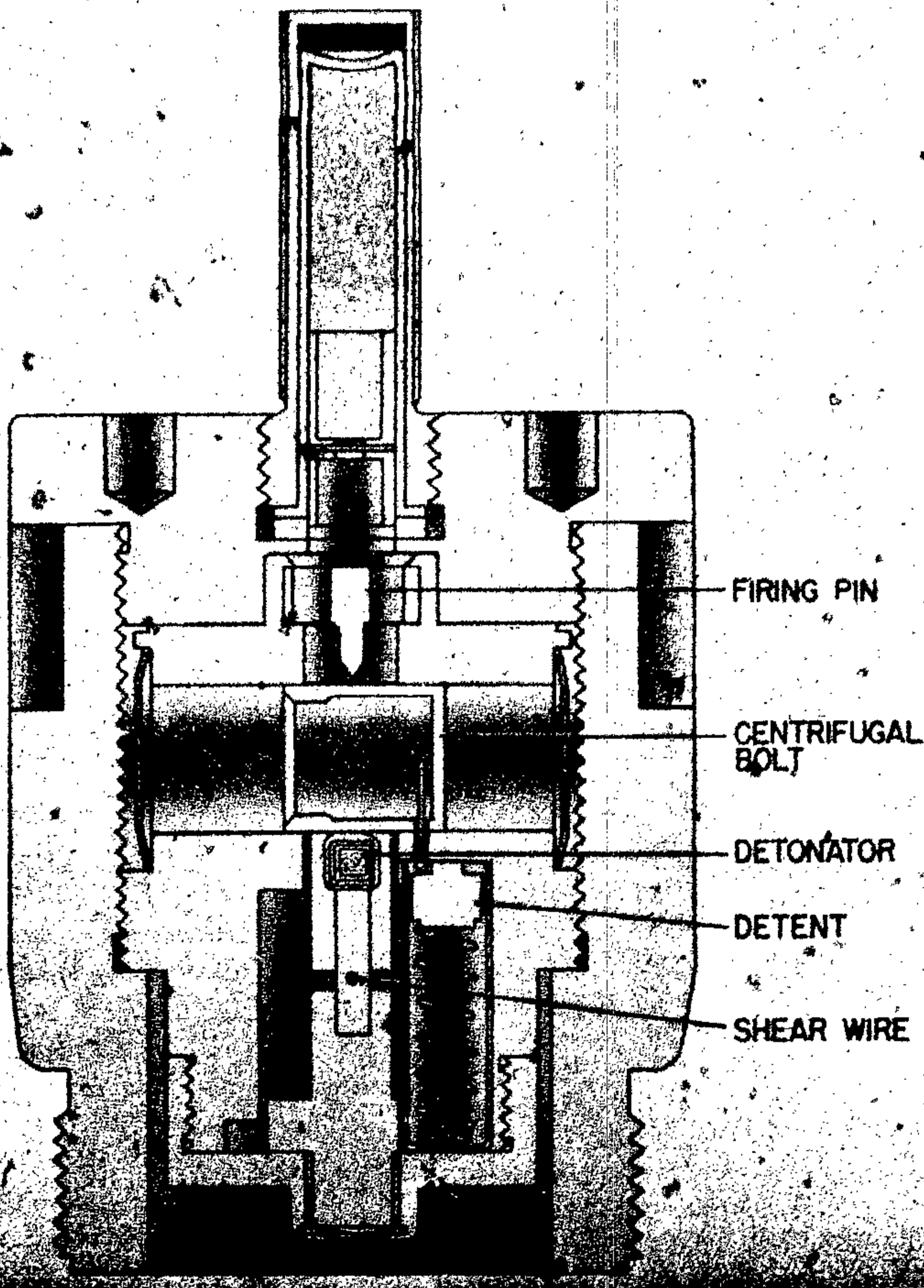

Figure 225 - Base Fuze for 100/17
Hollow-Charge

centrifugal bolt separates the detonator from the fixed firing pin, and a setback element locks this bolt in position. A protruding shear wire prevents the detonator from hitting the firing pin after the centrifugal bolt clears the channel. Two channels extending through the length of the inner body are closed at the top by aluminum discs. These channels provide escape holes for pressure if the detonator is accidentally detonated. The steel firing pin, with four flash holes formed around it, is screwed into a projection in the top of the inner body.

Operation

On acceleration, the detent sets back, thereby releasing the centrifugal bolt. During setback, the bolt is held by friction. On deceleration, the bolt is moved clear of the detonator and the firing pin by centrifugal force and causes the detonator to creep forward until its shear wire rests on the shoulder. On impact, the detonator holder breaks the shear wire and hits the firing pin. The flash produced passes through the flash-holes around the firing pin and initiates the booster.

Chapter 5

ITALIAN HAND AND MORTAR GRENADES

Italian high-explosive anti-personnel hand grenades are almost totally of the "offensive" type. Although the loading factor is usually low, the grenade bodies are not adapted for maximum fragmentation. The anti-tank grenades are adaptations of the anti-personnel grenades with an additional charge. There is no evidence of the use of shaped charges in Italian anti-tank grenades. Likewise, the chemical grenades that are not frangible are made of adapted anti-personnel grenade bodies and mechanisms with a chemical filler. The Italians did not make use of the rifle grenade, but did use a small mortar, not unlike a grenade projector, to fire a mortar grenade.

Italian grenades are of the impact type. They incorporate an "all-ways" acting fuze which arms in flight. For that reason, grenades in the armed position are very sensitive.

Breda Hand Grenades Mod 35, Mod 40, and Mod 42

Data

Over-all length	
Mod 35	3.8 in.
Mod 40	9.5 in.
Mod 42	12 in.
Maximum diameter	
Mod 35 and Mod 40	2.1 in.
Mod 42	3.62 in.
Type of filling	TNT
Weight of filling	
Mod 35 and Mod 40	2.1 ounces
Mod 42	Unknown
Color	Body red, Safety cap black
Total weight	
Mod 35	7 ounces
Mod 40	Unknown
Mod 42	2.75 lb.

Description

Types Mod 40 and Mod 42 incorporate the M35 in their construction. The Mod 40 is a Mod

35 with a hollow wooden handle attached, and the Mod 42 is a Mod 40 with a light metal globe $3\frac{5}{8}$ in. diameter screwed onto the bottom to give an additional charge for anti-tank use. The other types are for anti-personnel use.

The Mod 35 grenade is longer and thinner than the S. R. C. M. 35 grenade and has hemispherical ends. It consists of a thin aluminum case in two parts. The safety strip is in the form of an elongated U and passes through the grenade on either side of the channel-shaped safety device. The ends of the strip pass into slots in the top of a loose metal piece which is retained by a pin in the large safety cap (of light aluminum). The striker pin is attached to the heavy head.

Around the detonator tube is a perforated metal tube attached to the striker head. The spring maintains the striker away from the detonator until impact.

Operation

On withdrawal of the safety strip, the safety cap is freed. At one end it is attached to a brass strip which is wound twice around the head of the grenade, and attached at the other end to the safety device. During flight, the safety cap pulls this out, arming the grenade so that it fires on impact.

Hand Grenade O.T.O. Mod 35

Data

Over-all length	3.4 in.
Maximum diameter	2.1 in.
Color	Body red, Safety cap black
Total weight	7.4 ounces
Filling	TNT
Weight of filling	2.5 ounces

Description

This grenade is composed of a very light casing of metal, made in two parts: a flat lower cylinder, and, screwed to this, a cylinder of smaller diameter which has a truncated cone-shaped top.

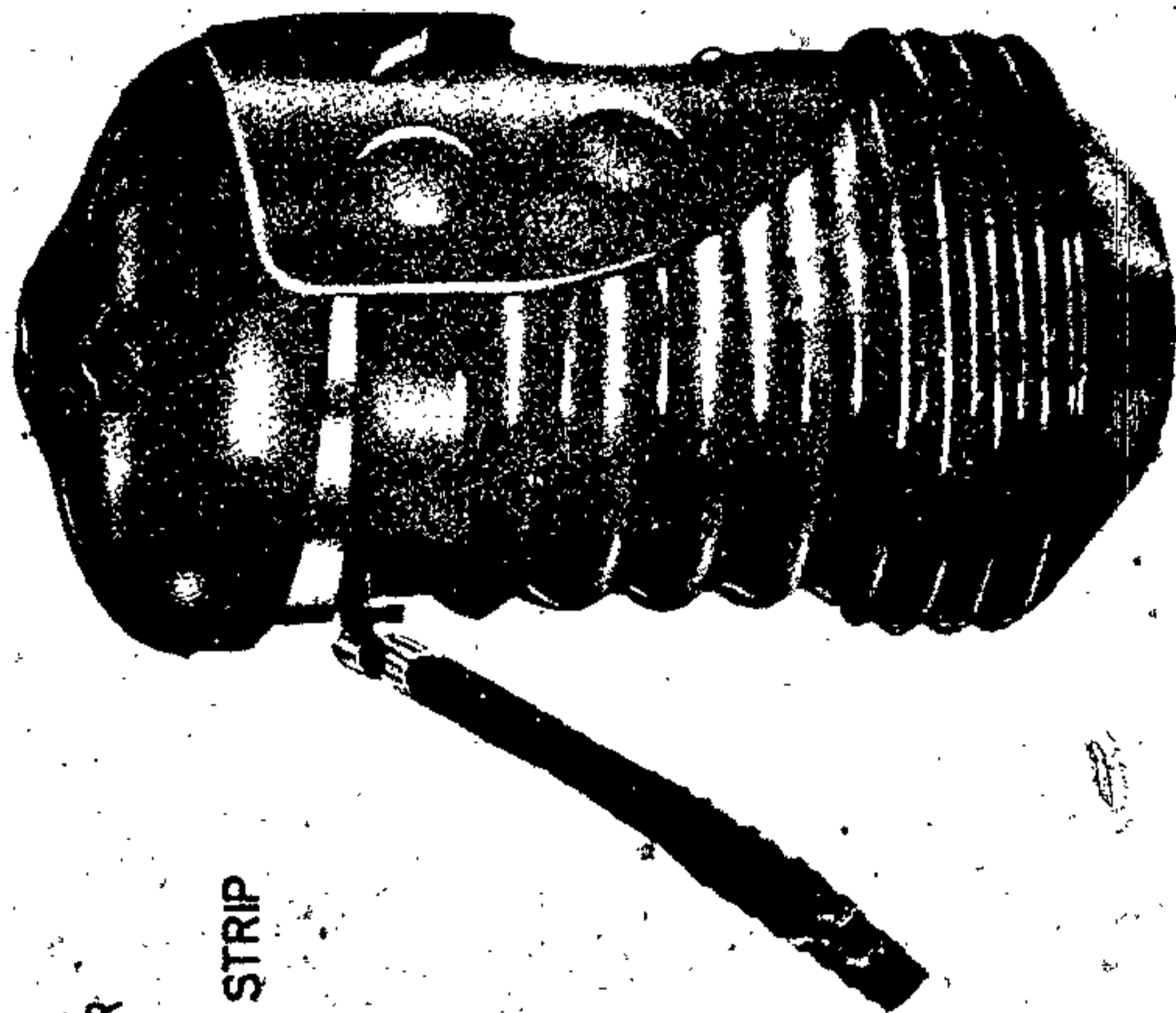
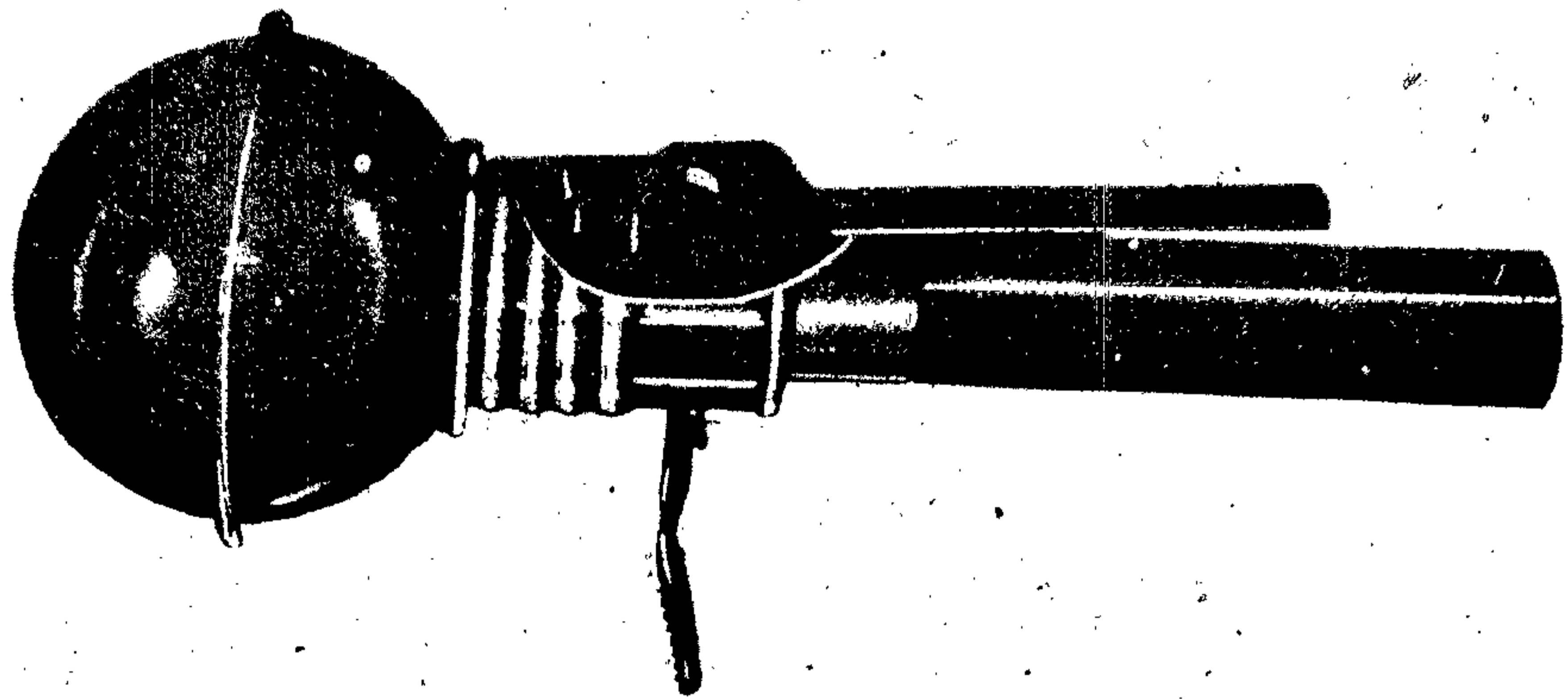
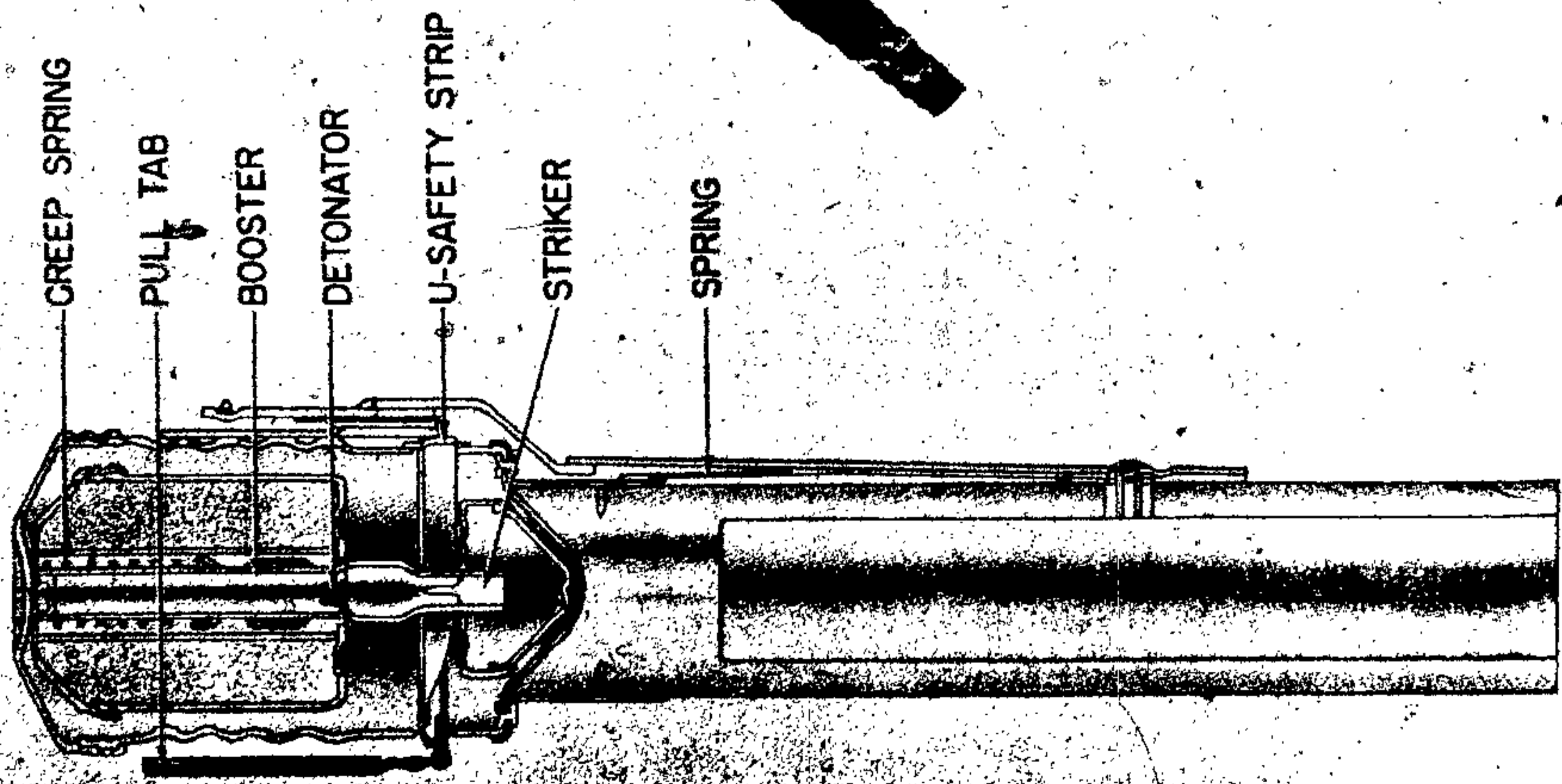

Figure 226 - Breda Hand Grenades M40, M35, and M42

ITALIAN HAND AND MORTAR GRENADES

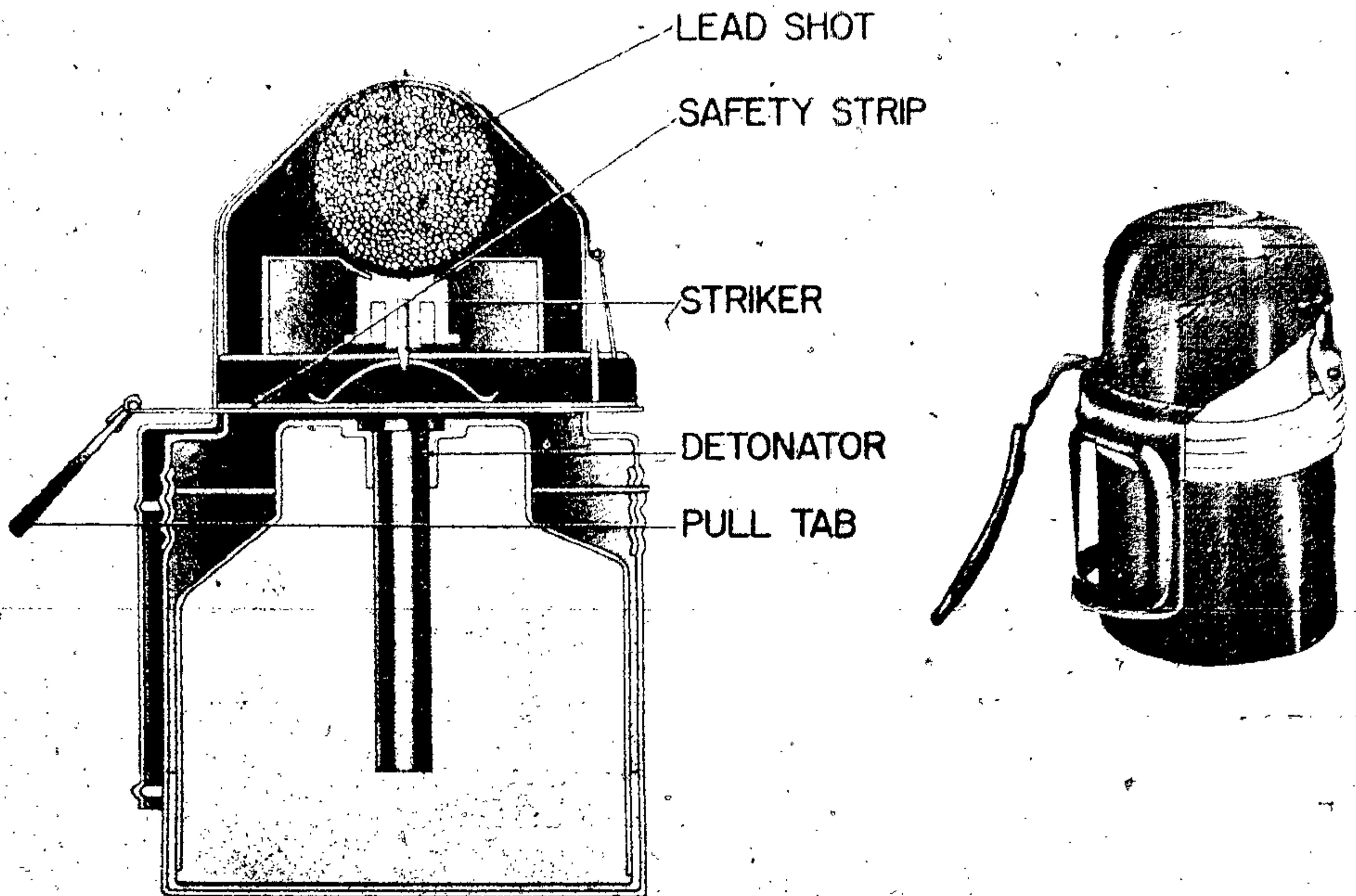

Figure 227 – Hand Grenade O.T.O. Mod 35

The safety pin consists of two long brass strips and one short brass strip. The two longer strips pass one on either side of the base of the channel-shaped safety device, and the short strip engages and locks in a slot in the body of the grenade. The striker is riveted to the cap, the top of which is shaped to take the heavy metal ball. The explosive is contained in a metal box which has a well in it for the detonator. A spring holds the striker away from the detonator.

Operation

On withdrawal of the pin, the safety cap (of light aluminum) is freed so that it becomes disengaged during flight. The cap is hinged and by its weight withdraws the channel-shaped safety device. The grenade is then armed to fire upon impact. In trial with this grenade, no ill effects were felt by men standing 25 yards from the burst. There is practically no fragmentation, and the blast is only fair.

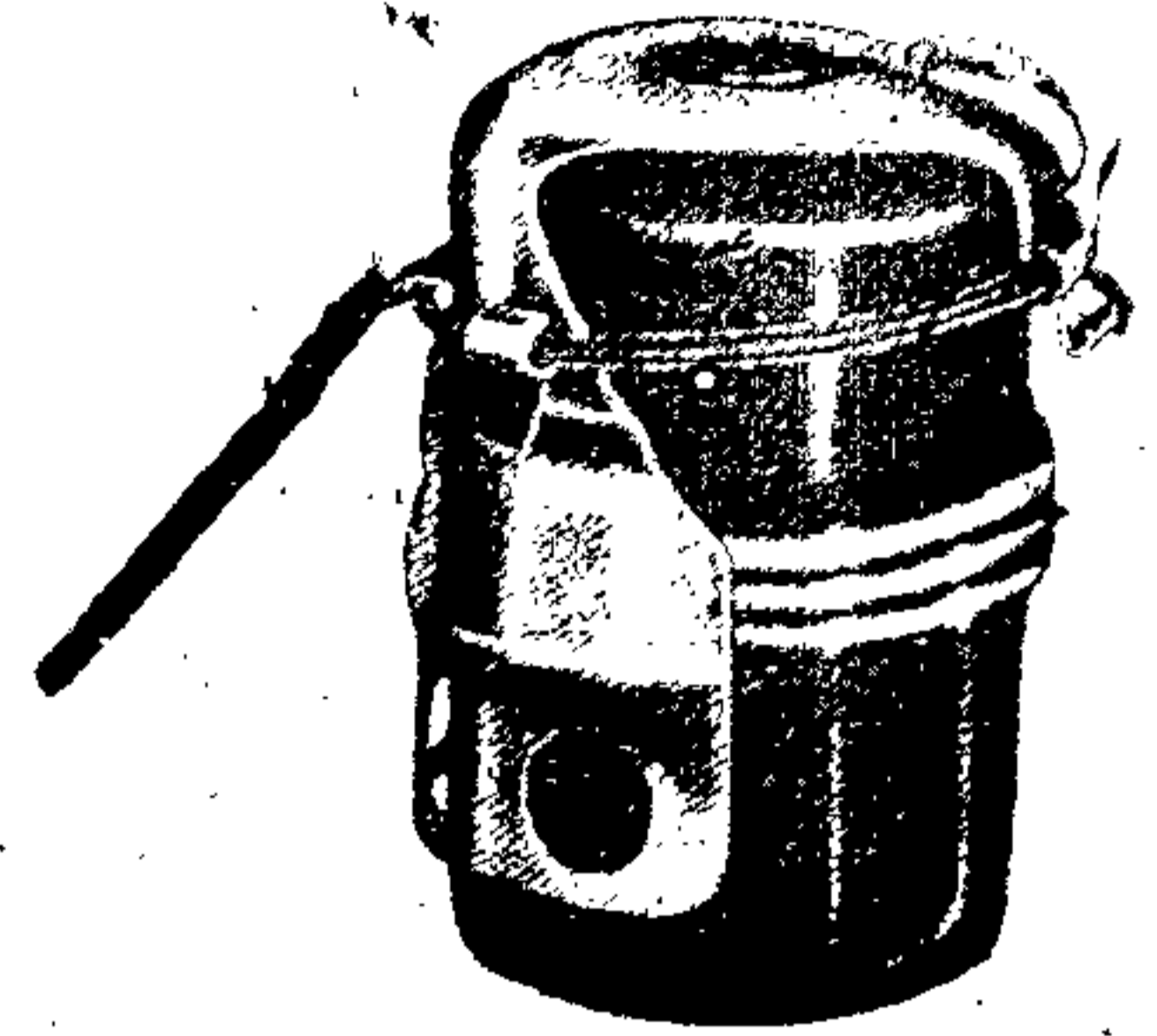
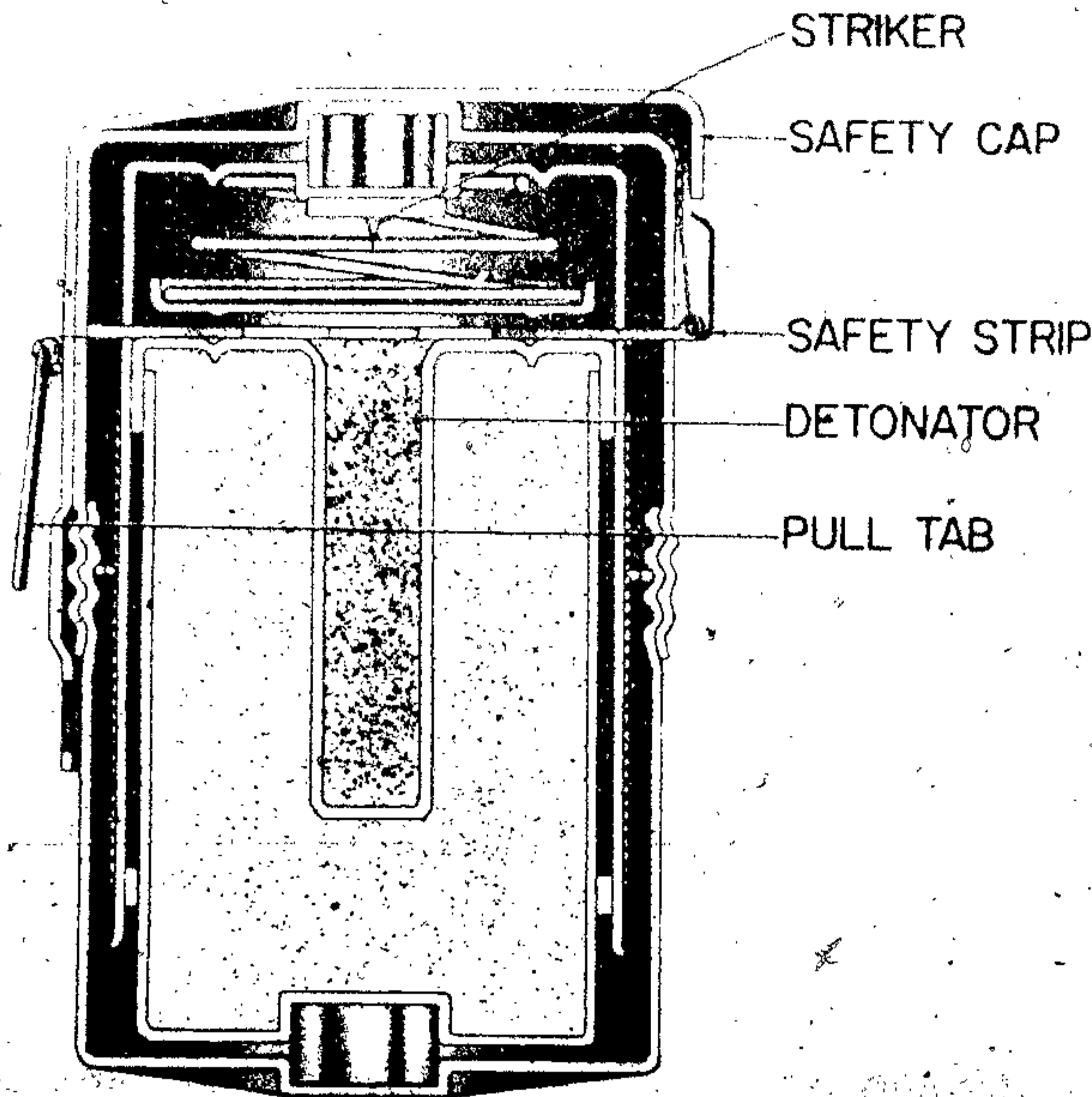

Figure 228 - Hand Grenade S.R.C.M. Mod 35

Hand Grenade S.R.C.M. Mod 35

Data

Over-all length.....	3.1 in. (8 cm)
Maximum diameter.....	2.5 in. (6.4 cm)
Color.....	Grenade red.
	Safety cap unpainted
Total weight.....	7 oz. (200 grams)
Type of filling.....	TNT
Weight of explosive.....	1.5 oz. (43 grams)

Description

The outer case is in two parts which screw together. Both parts are stamped to form a seating for the collar, and the upper part is cut to take the safety bars. Internally the grenade consists of two metal collars and two light metal cylinders. The striker is riveted to the head of the open cylinder, around the outside of which is wound some course wire to form the metal loading. The lower cylinder is a loose fit inside the upper one, and carries the explosive charge, a pressed block of impure TNT recessed to take the detonator. The cap contains the helical spring which holds the striker and detonator apart.

The safety strip passes over the ring and is bent up under it, so securing the safety cap (of light aluminum) to which the ring is attached. Between two safety strips is an elliptical metal strip, with an eccentric hole, whose ends are joined by a spring passing around the side of a cylinder. This acts as a safety shutter, and on impact one end jerks forward to a position in which the striker is centrally behind the hole in the shutter to fire the detonator. Two steel collars rest in recesses in the cylinders. If the grenade falls on its side, these are jerked from their seatings and force the cylinders together.

Operation

When the safety pin is withdrawn, the safety cap is free to disengage during flight and withdraw the second safety strip. The delay in arming is effected by means of a short chain, attached at one end to the safety cap and at the other to a safety strip. The bight of the chain is wound once around the stop. On impact, the safety shutter moves into alignment; the cylinders come together and the striker impinges upon the detonator. There is only slight fragmentation from this grenade.

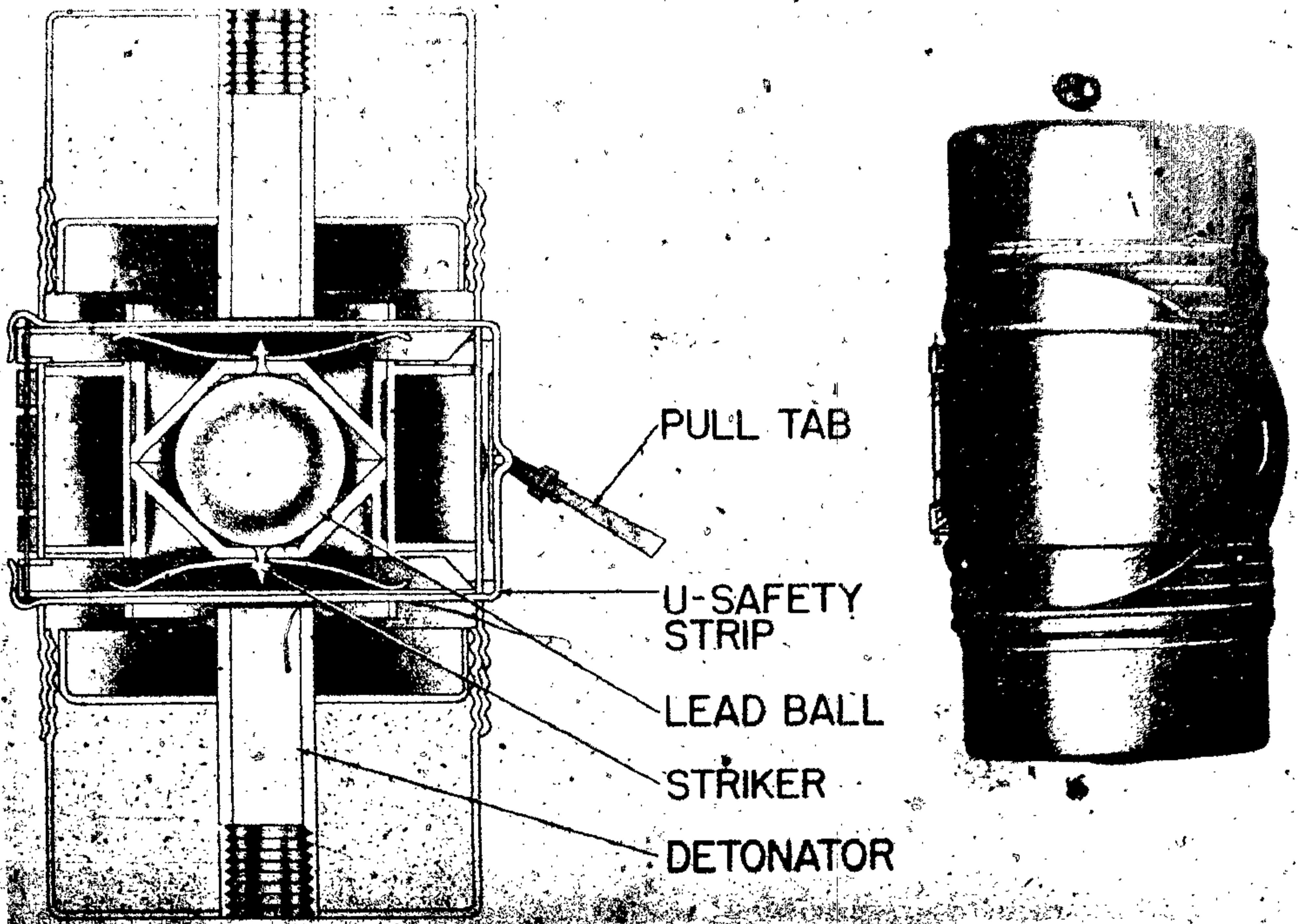

Figure 229 - P.C.R. Grenade

P.C.R. Grenade

Data

Over-all length.....	5½ in.
Maximum diameter.....	2½ in.
Color.....	Unpainted aluminum

Description

The grenade body is of three parts, the two end caps threading into the middle section. Two shallow cones of aluminum, each with a striker and the center of a four-prong stirrup spring at its apex, are contained in a 1½-in. diameter cylinder held in the middle section by two collars. One of the cones is at each end of this cylinder and, in the space formed, is a heavy lead ball 1 in. in diameter. The action of the ball in this cavity makes the fuze "all-ways" acting. The detonators are held in two cylindrical tubes, one attached to the center of each end cap. The end cap is closed by a metal cover, and the explosive filling is contained there-

in. The first safety strip consists of a rubber pull tab and a one-piece U-shaped bar of light, soft metal. Each end of this passes through an opening in the middle section, between a striker and a detonator, to protrude slightly through the opposite side of the body. The second safety strip is attached to the hinged wing-shaped safety cap which passes around the body over the middle section. There are two bars, each to pass through the body and cover a striker. Thus each striker is held from its detonator by a stirrup spring and two safety bars.

Operation

The first safety strip is removed before throwing; and, when the grenade is thrown, the wing-shaped safety cap will open and pull off, extracting the second safety strip. Then each striker is held from its detonator by the light spring only, and the grenade will fire on impact.

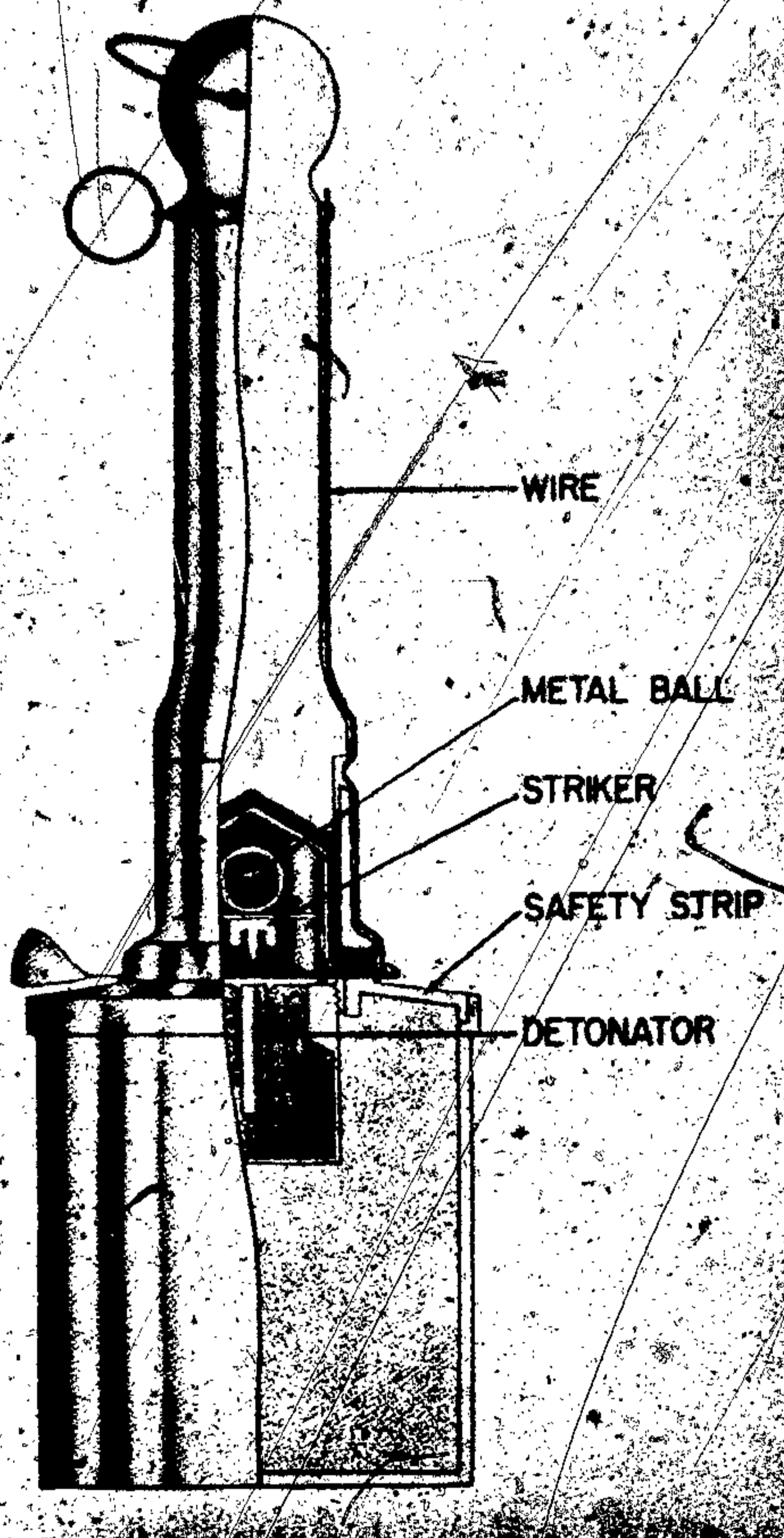

Figure 230 -- "L" Type Anti-Tank Hand Grenade

"L" Type Anti-Tank Hand Grenade

Data

Over-all length	15 in.
Maximum circumference	14 1/4 in.
Color	Body red; handle unpainted
Total weight	4 1/2 lb.
Length of handle	10 3/4 in.

Description

This grenade consists of a metal casing with a wooden throwing handle. A tab protrudes from the top of the casing. Pulling this tab removes a safety strip which, while in, blocks the striker from the detonator. There is also a small metal strip protruding from the base of the handle. This strip is held in position by a wire in the side of the handle. The wire is held in position by a piece of tape secured by a pin. The firing mechanism is always-acting, much like the O. T. O. Mod 35 Hand Grenade.

Operation

Before throwing this grenade, remove the safety strip attached to the tab. Then, holding the handle firmly, remove the pin. Be sure that the wire is held securely. When the grenade is thrown, the wire is released; this releases the small metal strip, which then moves over into a position so that the hole in it is in alignment with the striker and detonator. On impact, the striker and detonator are brought together, firing the grenade.

Remarks

This grenade was designed for use against vehicles and tanks. The grenade should be thrown at a distance of 15 to 20 meters from the target, and cover should be taken as protection against fragmentation. In the armed position, the grenade is very sensitive.

Breda Mortar Grenade

Data

Over-all length	5 1/4 in.
Maximum diameter	1 3/4 in.
Color	Body black; tail red
Type of filling	TNT

Description

The body of this grenade is steel, while the tail is of aluminum alloy. The two are screwed together. The steel cap is attached to a steel strip, and a double brass safety strip holds the cap in place. The safety strip passes through two slots near the head of the grenade, and lies in the recess of the zinc striker holder. The tail of the H. E. grenade is painted red to distinguish it from practice and instructional grenades, which have yellow and unpainted aluminum tails, respectively. It is fired from the 45-mm Light Mortar, Model 35-Brixia.

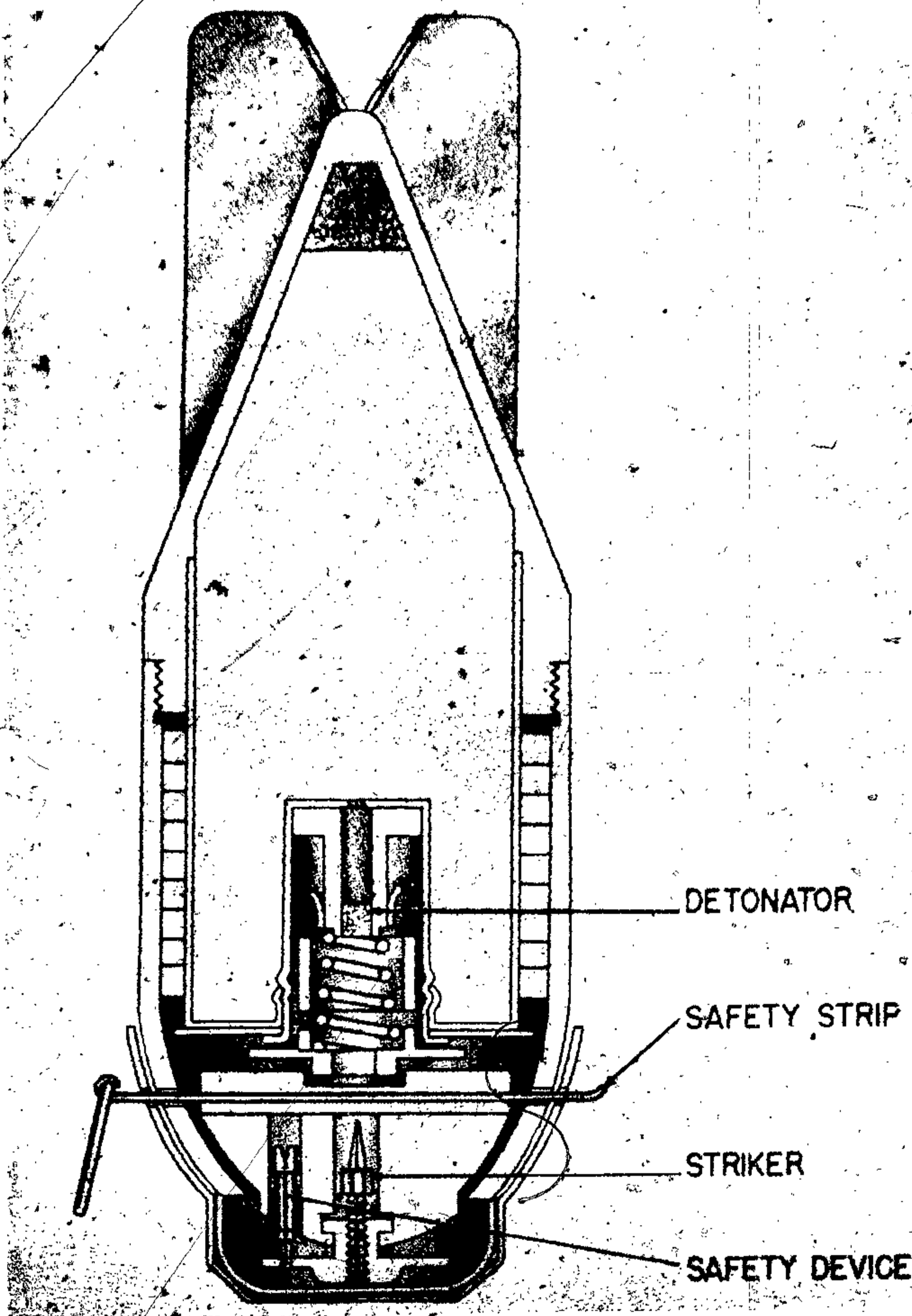

Figure 231 - Breda Mortar Grenade

Operation

On withdrawing the safety strip, the cap is freed; and, on firing, the setback causes the safety device to move down into its slot. This safety device consists of a short brass rod which projects into one of the holes in the disc and holds the disc from rotating. Four light brass spring strips hold the rod in the "setback" position. At the same time, the collar also sets back onto the firing-cap holder,

being held in position by the detent spring. The collar and holder then act as one, and can move under the influence of the spring. During flight, the disc rotates as air passes through the oblique holes near the edge of the disc. The striker, being prevented from rotating by the square shape of the portion moving in a square-shaped channel, is thus moved toward the detonator. The grenade is then armed. On impact, the detonator rides forward on the spring and hits the striker.

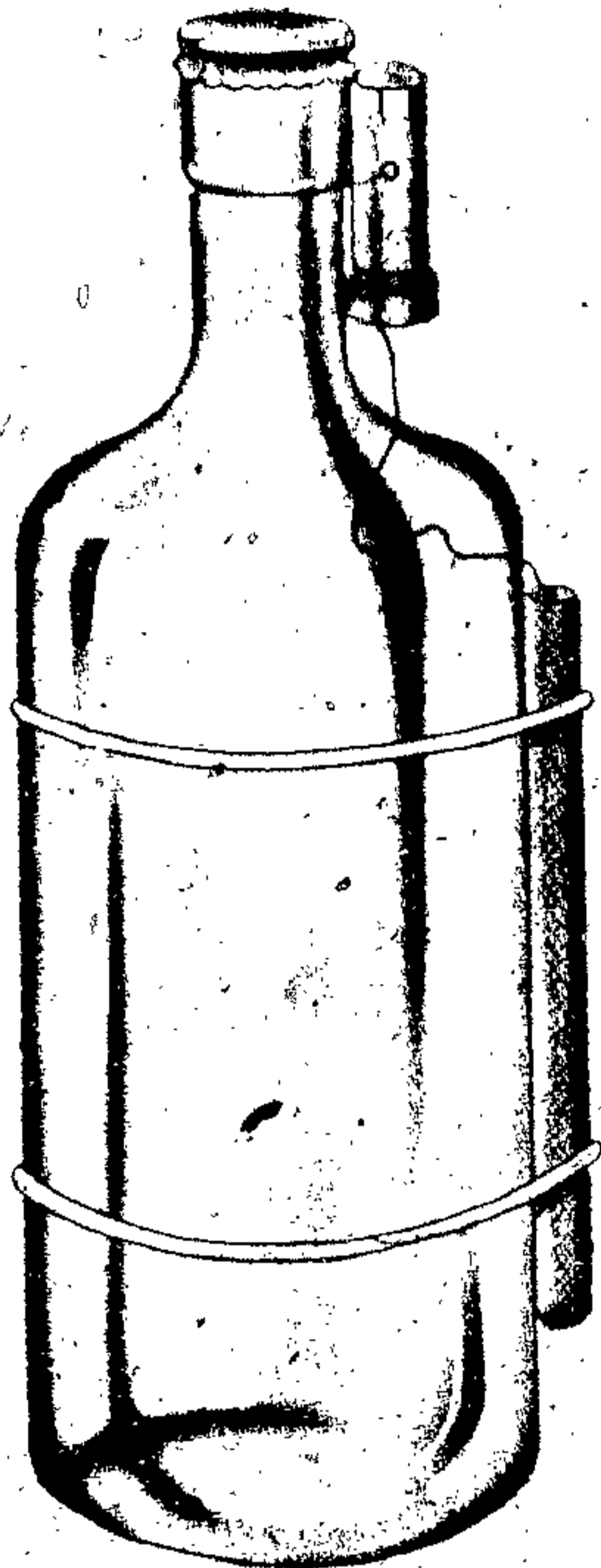

Figure 232 - Incendiary Bottle Grenade

Incendiary Bottle Grenade

Data

Bottle	-----	1-liter size
Color	-----	Transparent
Filling	-----	Inflammable liquid

Description

The incendiary grenade is made from an ordinary one-liter glass bottle, fitted with a metal pressure cap, and containing an inflammable liquid. A fuse match, protected by a canvas cover, is fixed to the side of the bottle by two rings of cord. To the top of the fuse is attached a fine cord, which, on being pulled, fires the fuse. To avoid accidental ignition by a chance drawing of the cord, the cord has a small wooden handle and is fixed to the neck of the bottle by a ring of thread.

Operation

Just before use, the wooden handle is freed by a

light pull on the ring of thread which is securing it to the neck of the bottle. The handle is then given a sharp pull, and a small flame will appear at the lower end of the fuze. The bottle should then be thrown with force against the target. If the bottle is not thrown immediately, it may burst before reaching the target. A minimum of two seconds is given between the lighting of the fuse and the bursting of the bottle. The Italians consider the grenade to be a good weapon for defense against A. F. V.'s at close quarters.

Miscellaneous Hand Grenades

SMOKE HAND GRENADES

Types

- S. R. C. M. Model 35 F
- O. T. O. Model 35 F
- Breda Model 35 F

Markings

Top part red; lower part black; white letter F (Fumogeno) on black background.

Description

These grenades are similar in construction to H. E. equivalents, but contain a liquid smoke filling, mixture of chlorosulfonic acid and sulphur trioxide. They produce a fairly dense white smoke cloud of two to three yards front, but cannot be used if wind strength is above 7 m. p. h.



Figure 233 - Breda Drill Grenade

Operation

Same as H. E. equivalents

SMOKE INCENDIARY HAND GRENADES

Types

- | | |
|---------------------|-------------|
| 1. S. R. C. M. | Model 35 FI |
| 2. O. T. O. | Model 35 FI |
| 3. Breda. | Model 35 FI |

Markings

Top part red; lower part black; letters FI on black background.

Description

Correspond to H. E. equivalents, with explosive filling replaced by a charge of white phosphorus. The burst creates a dense white smoke covering an area of about 11 by 4 yards.

Operation

Same as H. E. equivalents.

PRACTICE AND DRILL GRENADES

1. The grenade containing a small charge is white, with a 1/2-in. red band around the place where the two parts of the body join.

2. The instruction or drill grenade is unpainted or black.

3. The practice grenade with a smoke filler is yellow.

S. R. C. M. Mod 35 Practice Grenade is recognizable by six large holes cut in its body above and below the screw threads. The lower cylinder containing the H. E. charge is replaced by a brass

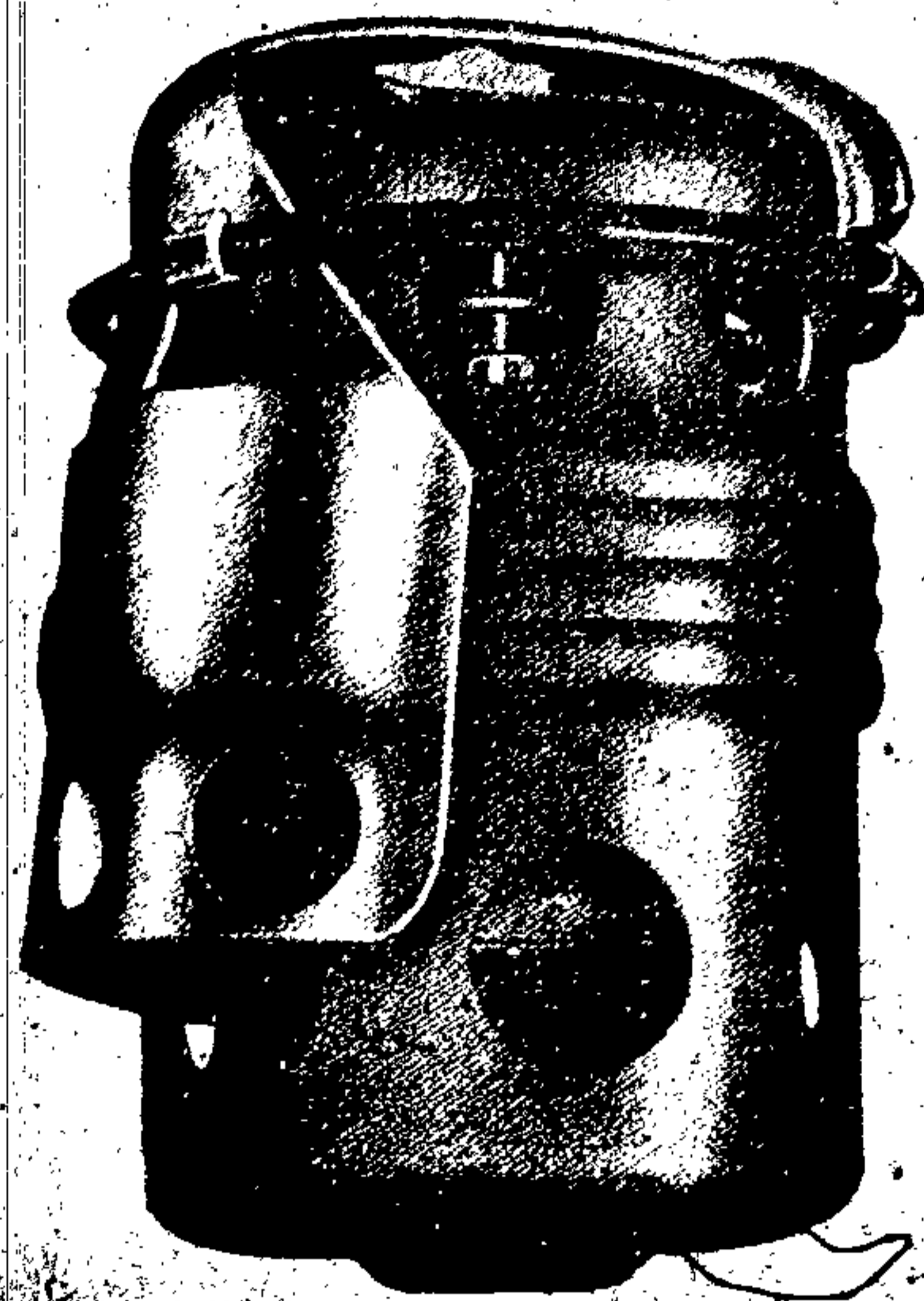

Figure 234 - S.R.C.M. Practice Grenade

cylinder having a truncated conical bottom with four holes in it. This cylinder holds smoke-producing charge in a celluloid container. The shutter is simplified so that there is no "safe" position at impact.

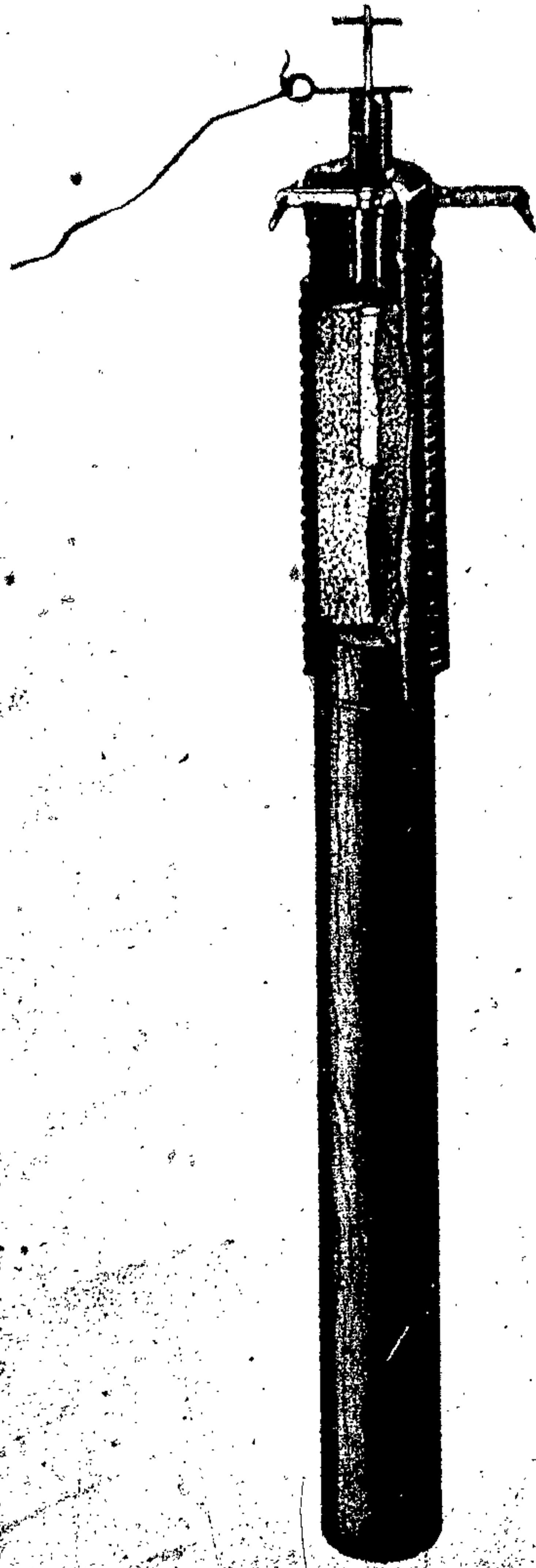

Figure 235 - Picket Mine (Anti-Personnel)

ITALIAN MINES AND TRAPS

Italian anti-personnel mines are operated by pressure or trip wires. They were often difficult to detect, especially those operated by pressure in which only a portion of the lid or igniter may appear above the ground. The Italians used bakelite and wood in the construction of some mines to prevent detection by magnetic instruments.

Anti-tank mines vary in appearance. They are tubular, rectangular, or circular in shape. Some are made of bakelite or wood to prevent detection.

Improvised mines seem to have been the Italian specialty in the field. They used a majority of the improvised mines in Abyssinia, since the supply of standard mines was apparently limited. Most of these mines were of wooden construction and used blocks of TNT for the explosive. Sometimes shells were used for explosive and shrapnel for mines.

Picket Mine—Anti-Personnel Mine**Data**

Over-all length	17.6 in. (with picket)
Over-all length	5.7 in. (without picket)
Body diameter	1.6 in.
Type of filling	TNT
Weight of filling	100 grams
Total weight	1.75 lb.

Description

The mine proper consists of a thin sheet metal cylinder around which is wound the strip metal loading. The mine is mounted on a wooden picket and contains a 100-gram cartridge of TNT. The mine is closed by a screw-on lid which carries the spring-loaded striker.

Riveted to the underside of the lid is the stirrup-shaped holder, into the center of which is pressed the detonator-locating tube. Passing diametrically through the lid, through slots in the side, is the aluminum cap holder, which is located in the armed and unarmed positions by the spring. The coiled end of the spring engages in the groove in the armed position and in the groove in the unarmed position.

The loops at the ends of the cap holders enable the cap holders to be pulled into the armed position by remote control and at the same time prevent it from being pulled out completely.

Operation

To arm the mine, the striker is pulled out, and a pin is inserted in the lower hold. A trip wire is attached to the pin. Then a detonator cap is inserted in the cap holder, and the holder pulls into the armed position.

Functioning

The trip wire is pulled, and the spring-loaded striker hits the detonator.

Mine B-4—Anti-Personnel Mine**Data**

Over-all length	8 in. (approx.)
Type of filling	TNT
Weight of filling	25 lb.
Total weight	3.0 lb.

Description

The mine consists of two cylinders, one inside the other. The space between the walls is filled with scrap metal. The outer cylinder is flattened on one side, where there are six sharp projections for attaching the mine to a tree or post. Two clips are provided with fireproof cord for securing the mine by special rings.

The cylinders are held together at their common base and by a cover at the top. Into one end of the brass moulding, screws a brass cap carrying the striker and the spring. Below this, there is the percussion cap in the holder which is inserted from the side. The lower portion of the moulding takes the detonator and the charge. The open end of the moulding is closed by the plug. The cavity between the brass moulding and the inner cylinder is filled with powdered TNT. The trip-release system consists of a trip-key having a ring at one end, to which the cords are attached.

The key is held by the grooves in the brass cap so that it can move slightly in a direction parallel to the end of the mine. This allows the key to fit

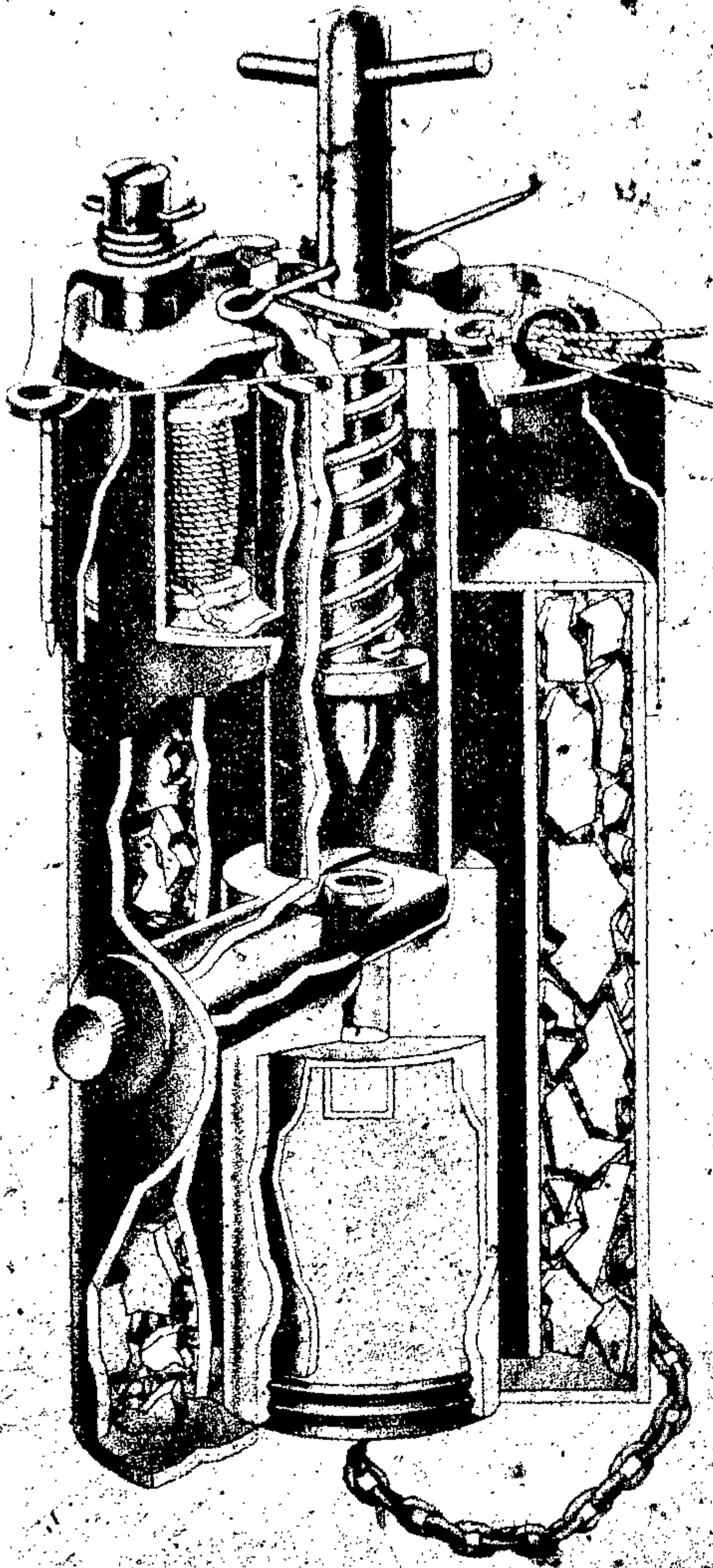

Figure 236 — Mine B-4 — Anti-Personnel Mine

into the groove on the striker when in the armed position. A ring guides the cords which are wound on a bobbin, the latter being covered by a hinged flap, held closed by the pin. The pin is used as the safety pin before setting the mine.

There is a special mechanism for detonating the mine, when a cord attached to the trip-release is cut. This mechanism is in the form of a hammer on the cover which is set by attaching the thin cord to the eye and stretching it under sufficient tension to hold the hammer at least 4 mm from the end of the trip-key. When the cord is cut, the hammer drives the trip-key forward, releasing the striker. This hammer is not provided on all B-4 mines.

**Italian Bakelite and Wooden 1-Lb. Mine—
Anti-Personnel**

Data

Over-all length	-----	5.5 in.
Over-all width	-----	2.5 in.
Over-all height	-----	1.5 in.
Type of filling	-----	TNT
Wooden	-----	.33 lb.
Total weight (wooden)	-----	1 lb.

Description

These two mines are similar except that one case is bakelite and the other is wood. The igniter used has a spring-loaded striker held in the cocked position by a trip-key, and has a cap and detonator leading into the main charge. The lid of the mine has, in one end, a slot which fits around the striker and rests on the trip-key. The mine also contains metal fragmentation plates on three sides of the charge.

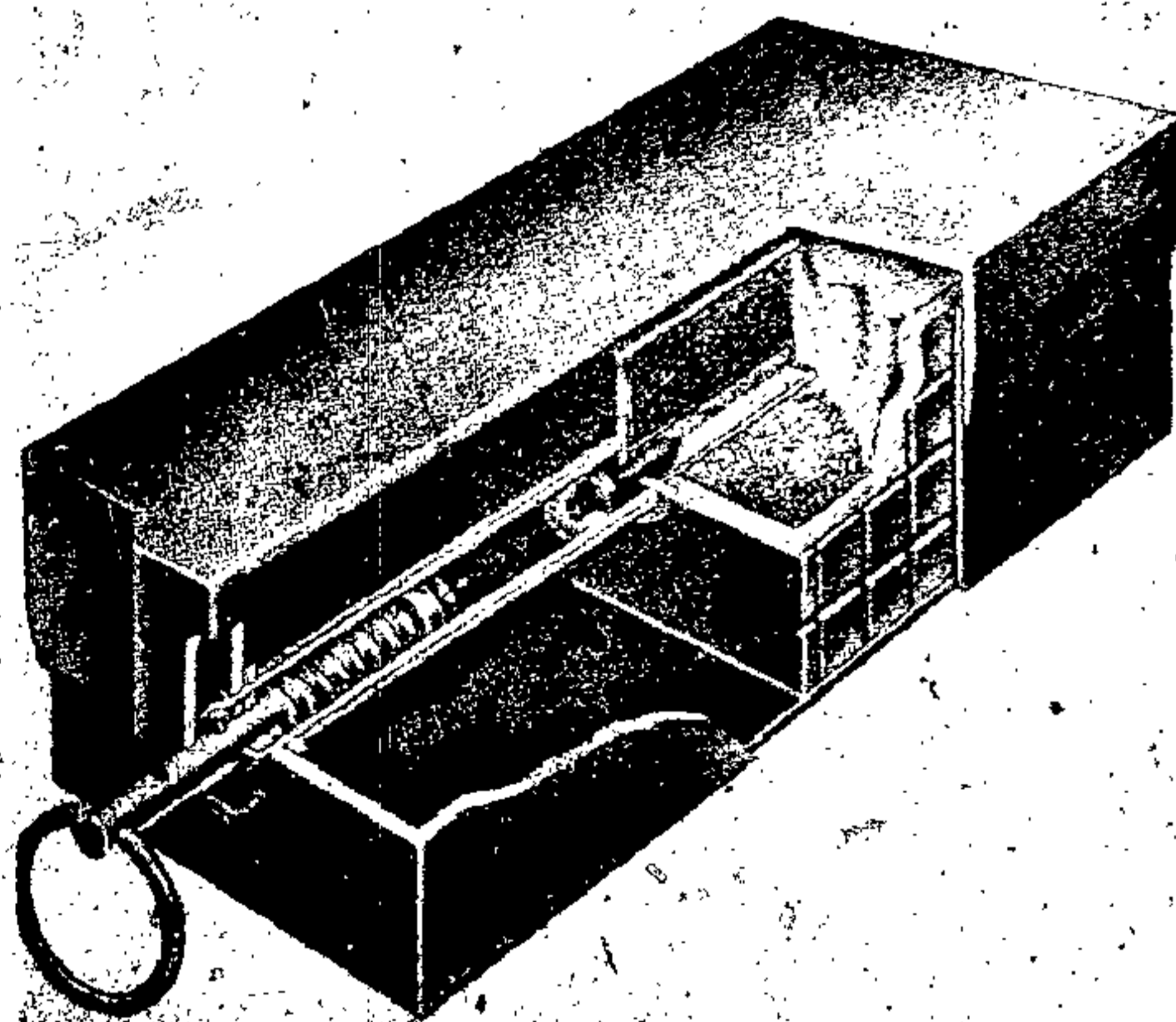

Figure 237 — Bakelite Mine — Anti-Personnel

Operation

One to five pounds pressure on the hinged lid presses the trip-key out of the hole in the striker. This action releases the striker, which is driven by the striker spring into the cap, detonating the main charge.

Ratchet Mine (Railroad Mine)

Data

Over-all length	9.1 in.
Over-all width	6.1 in.
Over-all height	11.8 in.
Type of filling	Unknown
Weight of filling	5.1 lbs.
Total weight	18 lbs.

Description

The mine consists of two parts: the explosive container and the housing for the ratchet mechanism. A hinged wooden device with the leather strap is provided for carrying the mine. The wooden base is screwed to the base of the mine, and a loop in the strap holds the ratchet winding key.

The explosive container of the mine is fitted with a short skirt which is a sliding fit over the upper portion of the housing. The two parts are attached to each other by two bolts and held apart by two springs, which are canvas-covered to insure their free movement when buried below ground. The bolt heads are protected by the covers.

Through the top of the housing, projects a spring-loaded plunger, which operates the ratchet mechanism. The striker, which initiates the detonation of the mine, is retained by a ratchet wheel having 60 teeth on its periphery. This latter may be set to release the striker after any desired number up to 59 depressions of the explosive container. The setting is made by the use of a key inserted in the hole situated below the setting observation window in the side of the mine.

The mine is designed for use under railway tracks, and the ingenious use of lead shot in the hollow spring-loaded platform insures a continuous rigid contact between the explosive container and the underside of the railway sleeper or rail. The lead shot is inserted before laying the mine by removal of the screw in the center of the platform. The platform is released, when the mine has been positioned, by removing the retaining pin.

Repeated operations of the ratchet mechanism by successive wheels of the same train is obviated by means of a delayed return of the ratchet pawl.

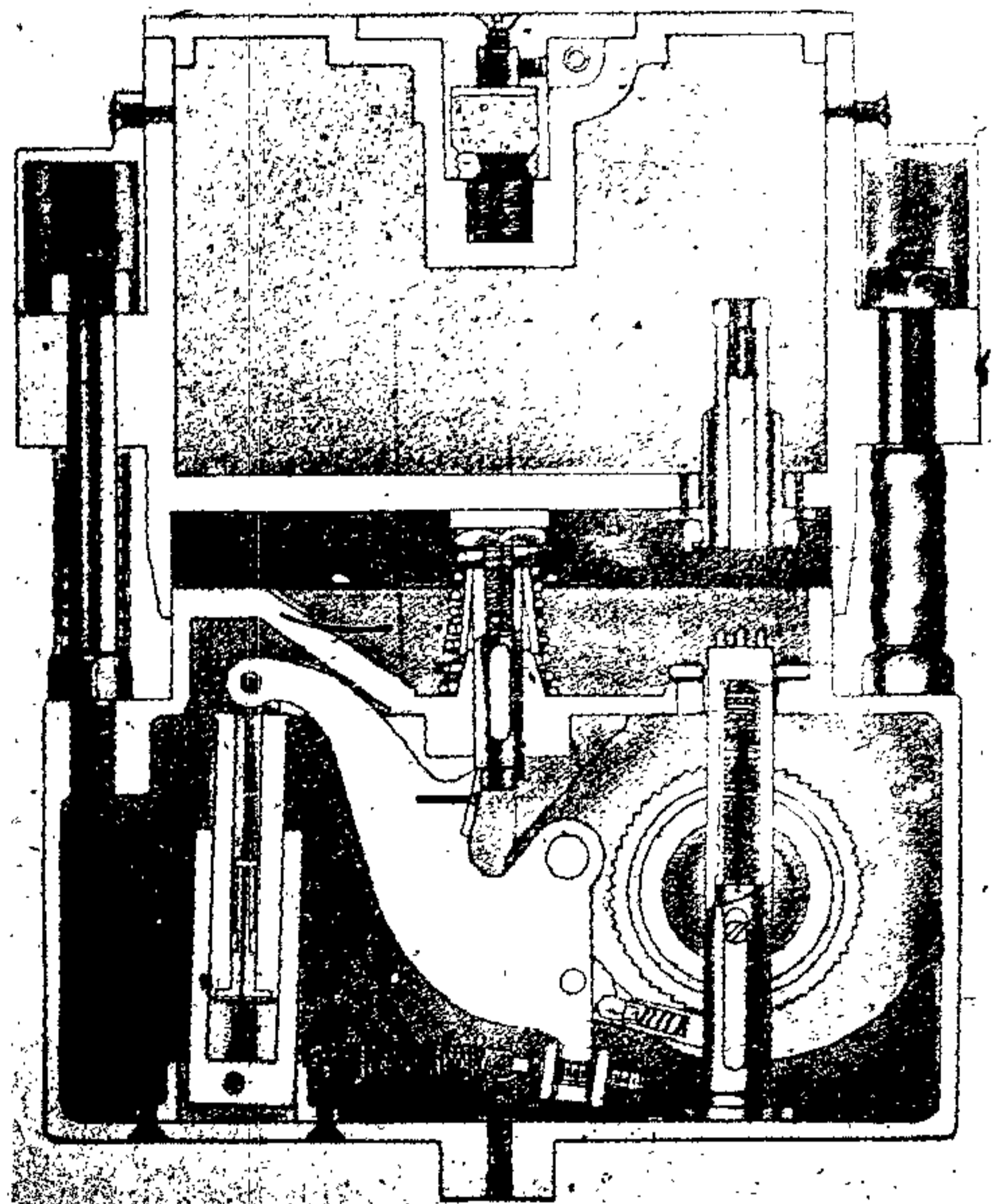
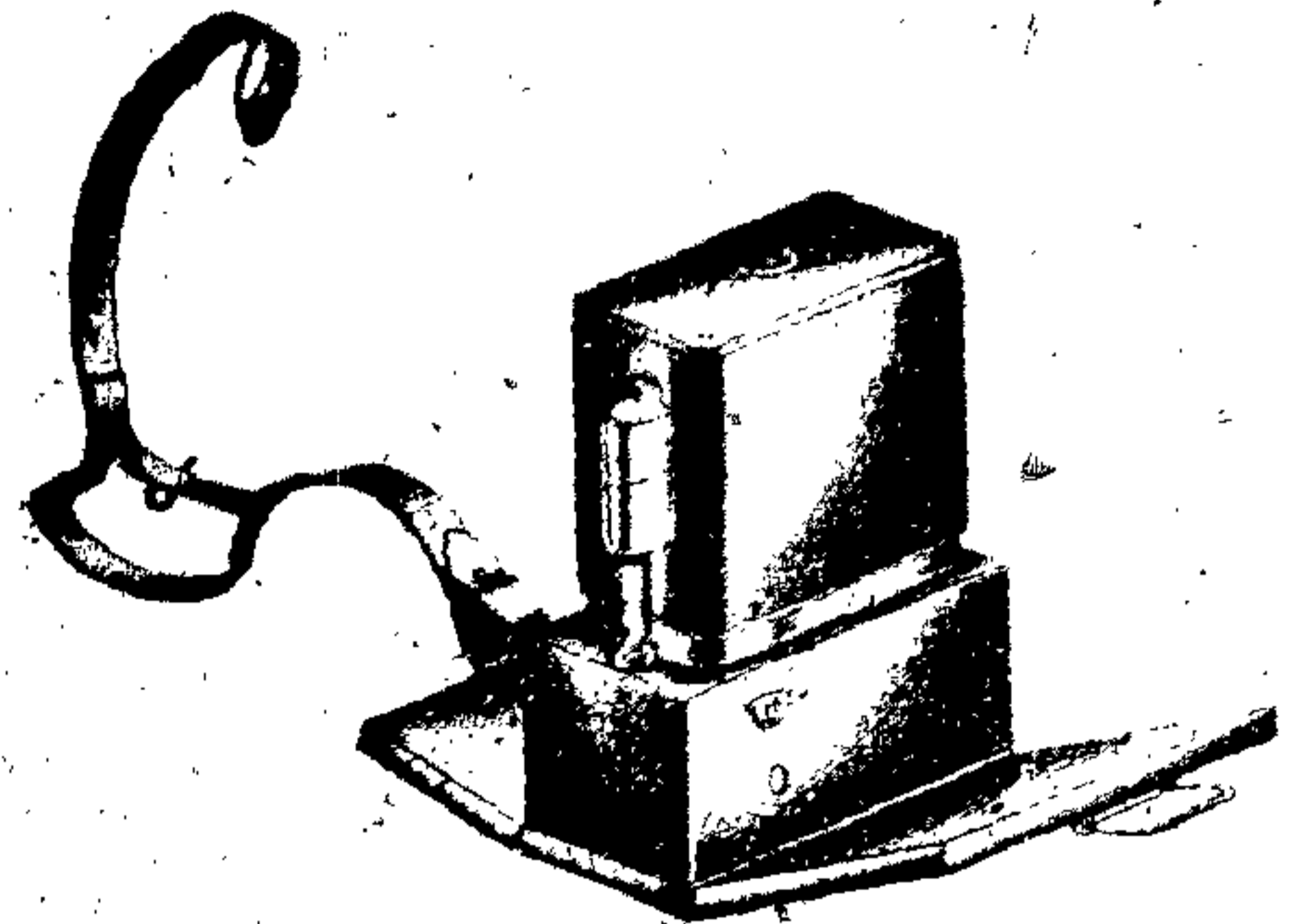

Figure 238 - Ratchet Mine (Railroad Mine)

Provision is made for the attachment of an additional igniter by the screw-threaded adapter in the side of the explosive container.

Railway Mine

Data

Over-all diameter	12 in.
Over-all height	4 in.
Type of filling	Gelignite

Description

This mine is made of a light alloy. The lid, which

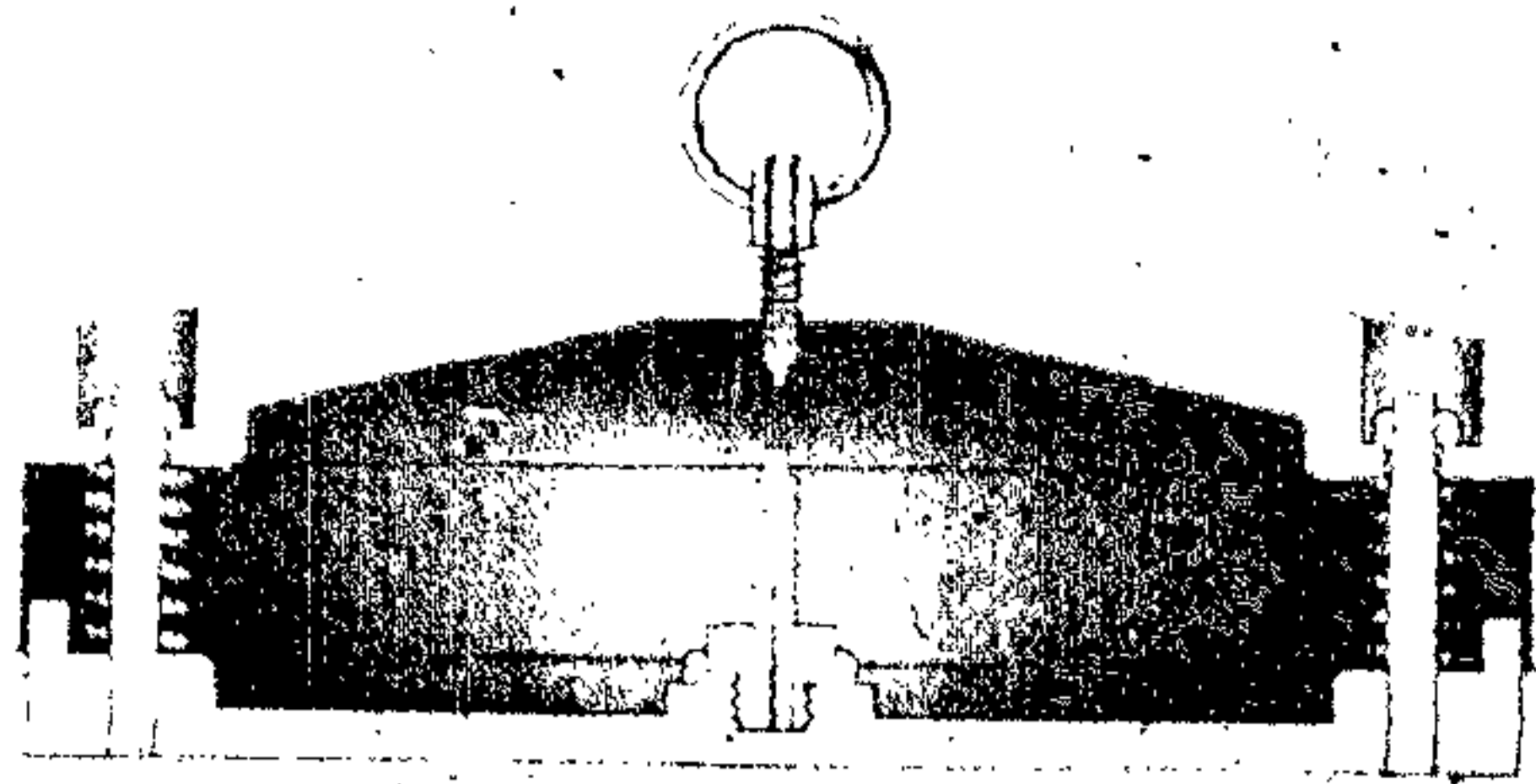

Figure 239 - Railway Mine

is attached to body by four bolts, is recessed to take the four bolts with hexagonal nuts. The lid is supported on four springs and thus holds the striker away from the detonator.

In the unarmed condition, the striker with its ring is screwed into a recess in the side of the mine. When arming the mine, the striker is placed in position over the detonator.

Operation.

Pressure on the lid forces the springs down, and the striker pierces the detonator, setting off the main charge.

Wooden Box Mine (Anti-Tank)

Data

Over-all length.....	9.5 in.
Over-all width.....	8.0 in.
Over-all height.....	3.0 in.
Type of filling.....	Gelignite
Weight of filling.....	2.5 kg.
Total weight.....	3.3 kg.

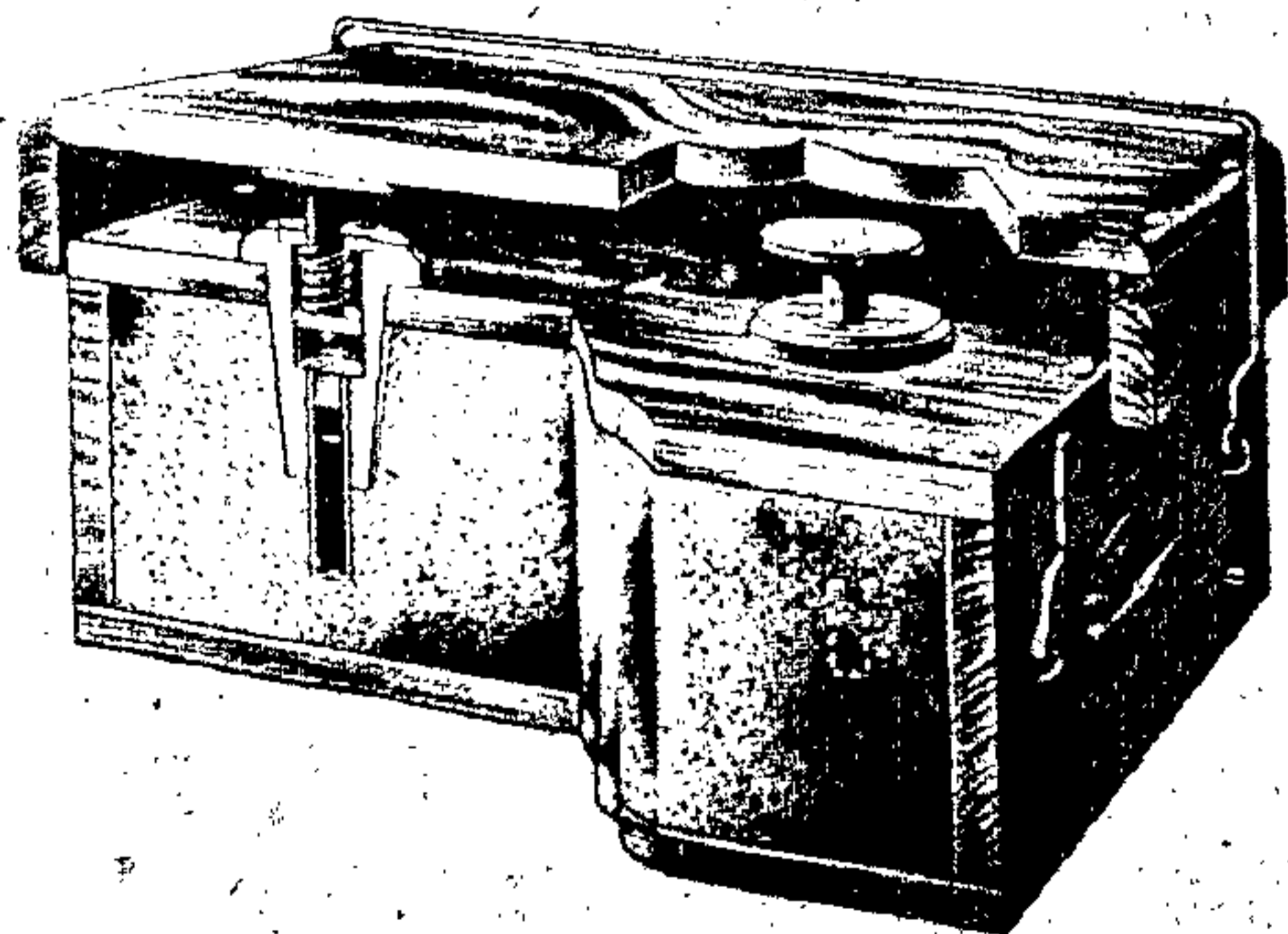

Figure 240 - Wooden Box Mine (Anti-Tank)

Description

The mine consists of a wooden box which houses the explosive charge, a false lid, two igniters, and a separate wooden cover. The explosive charge smells strongly of almonds; it consists of 24 cartridges, weighing 100 grams; is 5 in. long and 1 1/2 in. in diameter.

In the false lid are two holes, each 1/4 in. in diameter, to receive the igniters. Igniters have an aluminum alloy body which tapers slightly and has a mushroom-shaped head. The head is recessed to accommodate a steel washer, through which passes the shank of the striker. The striker spring is maintained compressed between this washer and the striker head by means of a copper shear pin.

Below the striker is the detonator, and the latter is a push-fit into the base of the igniter. On the underside of the mine cover are two metal plates, located above the igniters and intended to bear upon the strikers. The mine cover is held in position by two wire retaining straps, which can rotate about the pins, securing them to the mine body. All the parts are nailed together. The mine is crossed inside and out.

Operation

Pressure from 185 to 380 lb. on the cover shears the copper shear pins, and the springs drive the strikers onto the detonators.

Four-Igniter Mine—Anti-Tank Mine

Data

Over-all length.....	12.25 in.
Over-all width.....	10 in.
Over-all height.....	6.25 in.
Type of filling.....	TNT
Weight of filling.....	11 lb.

Description

Four holes in the lid of this box accommodate four igniters, and the mine is completed by the addition of a false lid which consists of a movable pressure platform attached to a wooden frame by means of canvas.

When assembled, the framework is secured to the mine body by four clips, and the pressure platform rests on top of the four igniters with the canvas fully stretched. The whole mine is painted for camouflage. There is a single rope carrying handle.

Two types of igniters have been used in this mine. One consists of a bakelite cone to which a bakelite lid is cemented. A projection below the cone fits into an ordinary detonator, and the latter is then pressed on. Within the cone is a small paper cylinder

containing small pieces of hard limestone mixed with a small quantity of a chlorate flash mixture. Pressure on the mine lid, the bakelite cones, and friction between the hard limestone and the chlorate mixture, produces a flash which ignites the detonators, initiating the mine. The other igniter is also bakelite, but is of more robust construction.

The base of the body is screw-threaded to take the plug which retains the detonator. The detonator contains a cap, and a thin bakelite washer is inserted above this cap to give clearance for the striker needle and to insure that the detonator is held securely by the plug.

The striker holder rests on a conical boss within the body of the igniter, and the latter is closed by a push-fit cover. The igniter functions when pressure on the lid of the mine causes the igniter body to break down and force the needle onto the cap. Trials have shown that the mine, when fitted with this igniter, functions under a static load of approximately 300 lb.

Operation

Pressure on the lid causes the igniters to function, detonating the main charge.

Anti-Tank Mine B-2

Data

Over-all length.....	3 ft. 6 in.
Over-all width.....	5 in.
Height.....	4.7 in.
Type of filling.....	TNT
Weight of filling.....	7 lb.
Total weight.....	33 lb.
Firing pressure (On each spring).....	220 lb.

Description

This mine, the latest development of older types "S. C. G." and "hinged lid," consists of a welded sheet-metal box with a metal lid resting on two springs. The lid has two openings covered by hinged flaps corresponding to the positions of the striker assembly and the wire-tensioning screw.

At the ends of the box are charges, each consisting of eight 200-gram slabs of TNT. On the underside of the lid are welded two short lengths of steel tube to fit into springs; two similar lengths of tube are welded on the base of the box; all four serve to locate the springs.

The explosive compartments and the foundation of the ignition mechanism are wood. In the center of the lid, a knife is located directly above the guides.

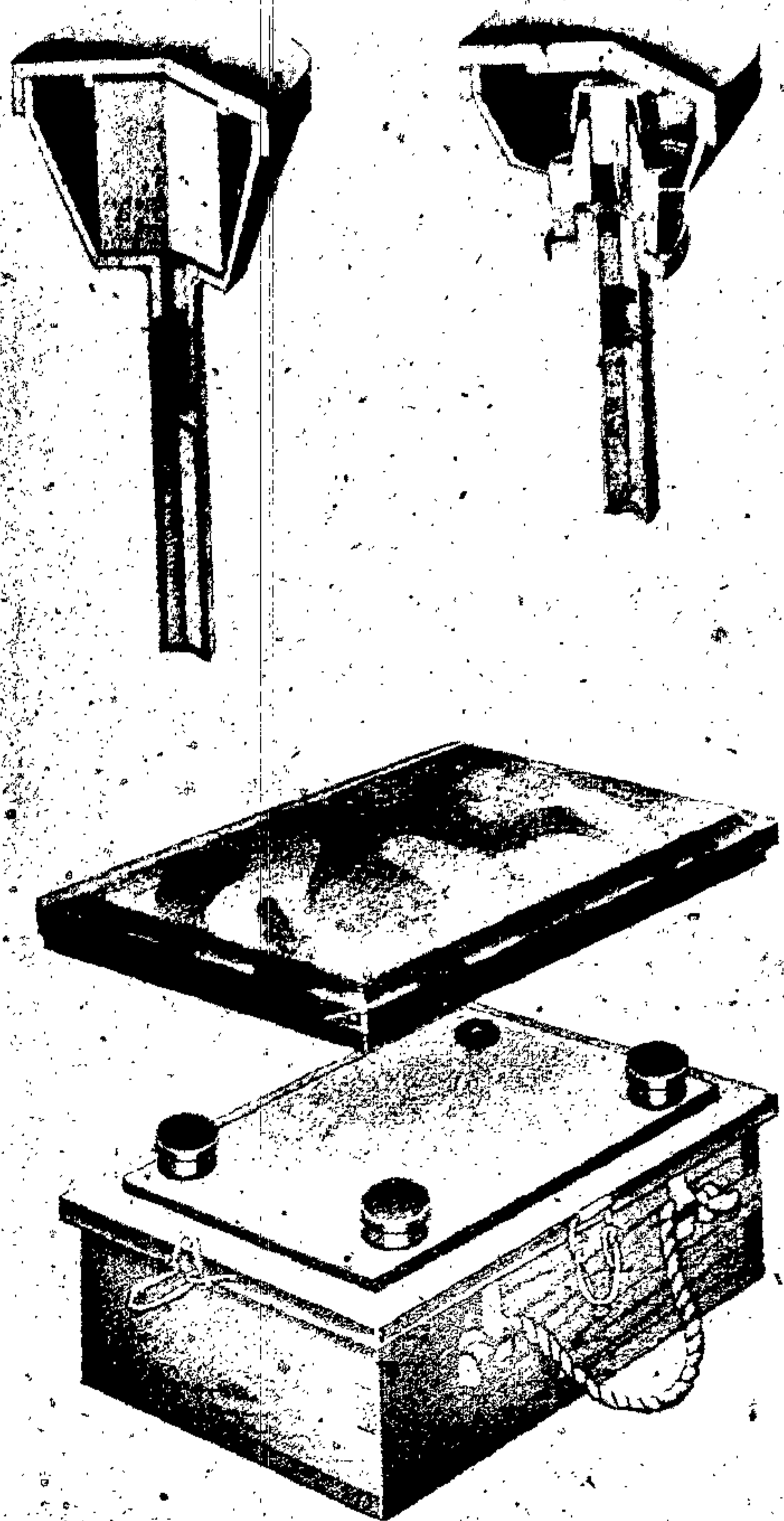

**Figure 241.— Four-Igniter Mine —
Anti-Tank Mine**

Through these guides passes a tension wire, fastening the striker to a brass adjustable hook.

The striker mechanism consists of a body with a slot for the percussion cap and holder, and the striker and spring. The nut retains one end of the spring; the thread takes the nut which retains the detonator (open and toward the percussion cap); a short length of F. I. D., and a long length of D. I. D. connecting the detonator with a second charge.

A tie-rod with a spring provides against premature firing in the event of damage to the tension wire, and, when the lid is depressed, insures normal

V-3 and V-5—Anti-Tank Mines

Data

Over-all length	3 ft. 8.9 in.
Over-all width	2.4 in.
Over-all height	2.7 in.
Type of filling	TNT
Weight of filling	16 lb.
Total weight	17 lb.

Description

V-3: The mine is made of sheet steel, its body strengthened by two partitions. The charge extends between two firing mechanisms. The cover is secured to the body by concave-headed nuts, engaging on actuating bolts positioned by springs resting between a nut on the underside of the cover and a plate covering the firing mechanism.

When the nuts beneath the lid are screwed down, the springs compress, increasing the pressure required to operate the mine. Unscrewing the nuts makes the mine more sensitive to pressure; as little as 22 lb. weight can be made to trip the striker. The underside of the cover has two knives engaging in guides provided to take copper pins. (A weight of 264 lb. is required to shear the pins.) At each end of the body are cocking grips, pulled to cock the firing pins. The mechanism is shown. When the striker spring is compressed, the flange of the striker is held by a cotter on a U-shaped spring clip. A percussion cap is accommodated in a holder which is inserted in a hole in the side of the mine. The holder passes into an annular space in the striker body, held there by a blade retaining spring engaging in the slot. The actuating pin inserted through a hole in the side of the body is the connection between an actuating bolt and the U-shaped spring clip carrying the cotter.

The pressure applied to the mine cover forces down the actuating bolt against the spring, which comes into contact with the actuating pin, causing a



Figure 243 — V-3 Anti-Tank Mine

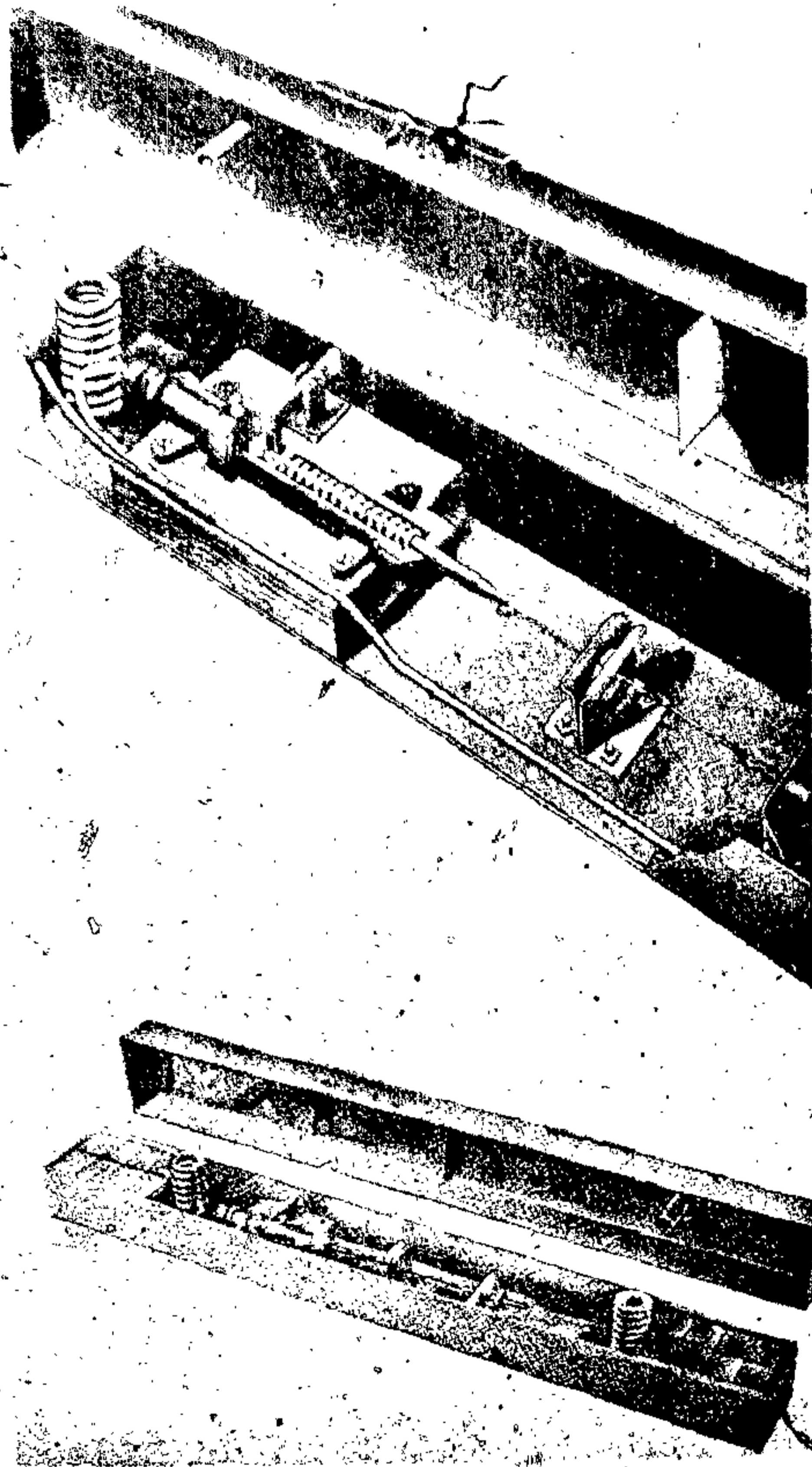

Figure 242 — Anti-Tank Mine B-2

function by pressure on the lever, which releases the detent. This additional safety device is not found on all types.

A safety pin placed on a hole in the body of the striker remains in position until the mine is loaded, the hinged flaps are closed, and the mine is covered with earth. The mine functions when pressure on the lid overcomes the resistance of springs, the cutting blade descends to sever the wire holding the striker, and the lid depresses the detent lever.

Remarks

1. Type S. C. G. differs in that the lid has only one opening and has a small charge.
2. Type (Hinged Lid) was the earliest type, was smaller, and was made of wood.

U-shaped spring clip to depress against the retaining spring. The flange thus freed allows the striker to initiate the percussion cap and fire the detonator.

V-8. Similar to V-3, except for reduction of charge to 2 pounds of cylindrical borehole charge, omission of shear wire, and inversion of parts so V-5 has appearance of V-3 upside down.

Pignone Type I and Type II—Bakelite Anti-Tank Mines

Data

	Type I	Type II
Overall diameter	13 in.	13 in.
Diameter of casing	11.87 in.	11.87 in.
Overall height	5.12 in.	5.5 in.
Weight of casing	5 lb.	5 lb.
Type of filling	TNT	TNT
Weight of filling	7 lb.	7 lb.
Activating pressure	110 lb.	300 lb.

Description

Mines are constructed of moulded bakelite; both types are of waterproof design. Metal parts in the

mines when armed are:

1. The case of the detonator
2. The brass striker pellet and its helical spring
3. The brass bush which houses the striker pellet, two steel balls, and brass shear pins
4. A perforated steel bar which slides to prevent the striker from the detonator in the inactive position.
5. Brass tumblers in the igniter locking device
6. Nine steel helical creep springs supporting the pressure plate.
7. In Type I, the steel wires supporting the pressure plate.

Type I. The casing containing the explosive is in two halves, top and bottom, being respectively $\frac{1}{32}$ in. and $\frac{1}{32}$ in. thick. They are moulded to form a central circular chamber for the explosive. The top is strengthened with ribs. The two halves are assembled with an outer circumferential conical sunk joint and an inner spigoted joint.

The outer joint has rubber sealing ring and is secured by hollow plastic rivets passing through 12 pairs of lugs. The inner joint is secured by a base

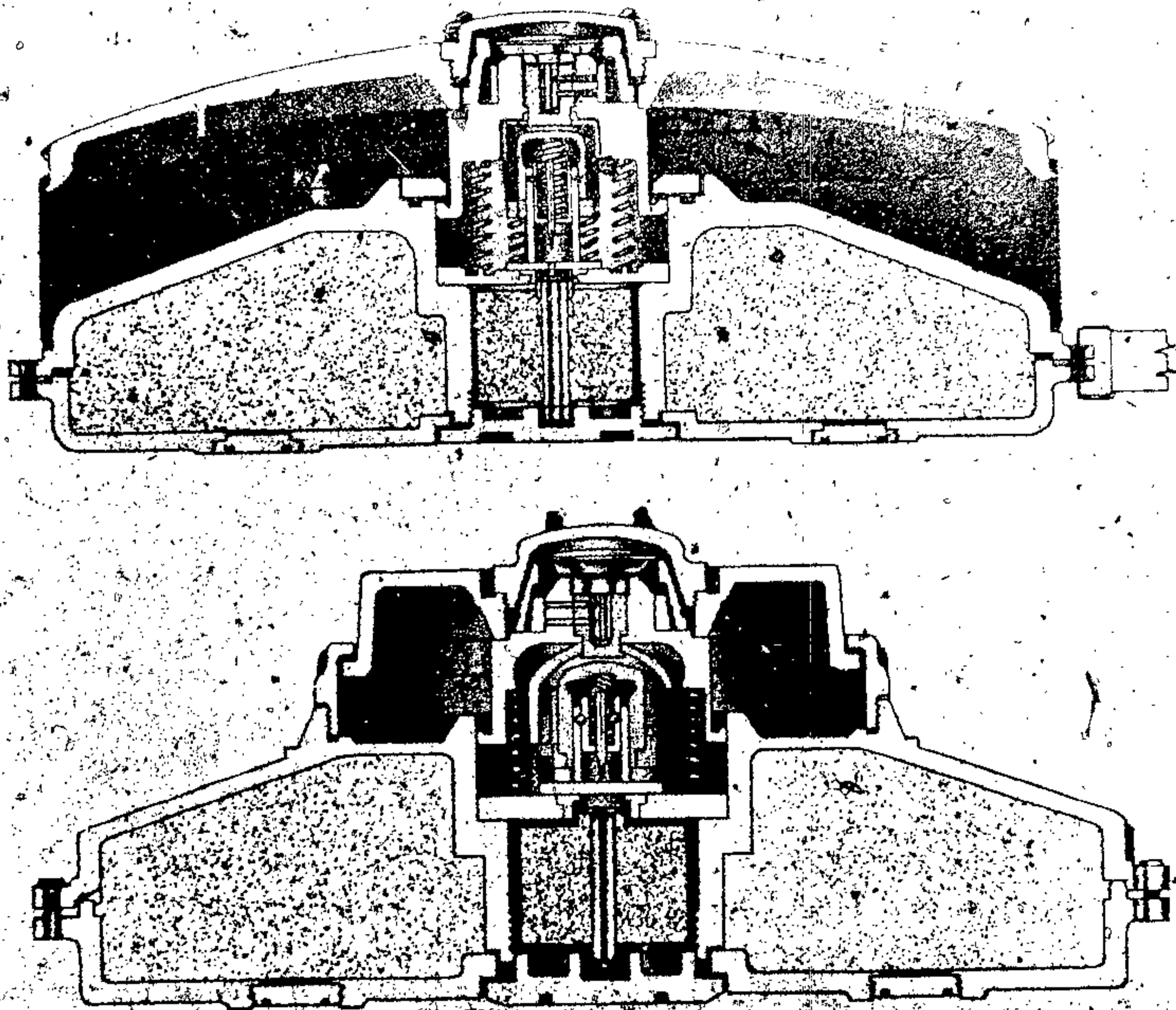

Figure 244 - Pignone Anti-Tank Mines Types I and II

ITALIAN AND FRENCH EXPLOSIVE ORDNANCE

plug threaded into the center tube formed in the top half of the casing; this joint is sealed by a rubber gasket under the flange of the plug.

The plug also gives access to the booster charge and detonator, placed in the central chamber closed at the top by the base of the igniter assembly. A webbing carrying handle is attached to the casing by wire loops which pass through the hollow rivets in two pairs of lugs. There are two filler plugs threaded into $1\frac{1}{8}$ in. diameter holes in the bottom. The holes might be adapted for anti-lifting igniters; they are, diametrically opposite, approximately $2\frac{1}{2}$ in. from the edge, but are not placed in any fixed position relative to the handle.

The igniter assembly slides in the central tube formed in the top half of the casing and is retained by a locking ring. A rubber ring seals this joint. The pressure plate, $\frac{3}{4}$ in. thick, is heavily ribbed underneath and is the full diameter of the mine casing. It rests on the top of the igniter assembly and is held in position by steel wires which are looped through four lugs, set at 90° around the mine, and fastened with two plastic rivets instead of one.

The air space between the pressure plate and the top of the main casing is closed, around the circumference, by a strip of impregnated canvas fixed by two steel wires. The igniter assembly and arming arrangement are closed by the cap screwed into the pressure plate.

TYPE II: The main casing is similar to that of Type I. The pressure plate, ribbed on the underside, is only $5\frac{1}{2}$ in. in diameter; it is $\frac{3}{8}$ in. thick. It bears on the top of the igniter assembly, as in Type I, but on the outside circumference is held by the ring which screws into a threaded socket, formed on the top of the main casing. The igniter assembly is sealed by two rubber rings, the latter making a joint due to the upward pressure from the helical creep springs in the igniter.

A third type of bakelite mine is stated to have been produced by Pignone. It was similar to Type I, but smaller and having a $1\frac{1}{2}$ kg. charge. Because of the reduced diameter, the activating pressure was about twice the figure for Type I. It is understood that this smaller type was not produced in any quantity.

Igniter

From the center of the base a brass tube projects upwards as a guide to the brass striker pellet. A steel bar slides through the tube to act as a safety device by screening the detonator in the unarmed position; in the armed position a hole in this bar is presented to the striker pin.

The striker, loaded by pressure on the helical spring, is cocked against two steel balls. The balls sit in the upper half of the striker pellet, and are retained by the sides of the cap, of tough plastic material, which slides over the brass tube. This cap is located by two brass shear pins set into the tube. It also carries a double cam-shaped collar which is free to swivel independently and control the position of the screening bar.

Added safety devices are the moulded projections, which support the cam collar in the unarmed position.

The position of the cam collar is controlled by an inverted tough plastic cup, slotted down the center to take the arming key of 'Yale' pattern, which operates against two spring-loaded double tumblers, sliding into the spindle from the side.

The key is of brass, held in a bakelite button, which is knurled at the edge and provided with an indicating nib. The nib swings between two projections on the pressure cap, marked 'S' (Sicuro-Safe) and 'A' (Armato-Armed). A bakelite collar fits over the head of the pressure cap and is slotted so that it is held by the projections to lock the arming key in the unarmed position.

ITALIAN IGNITERS

Chemical Delay Igniter

Data

Mines used in	Demolition charges
Color	Unpainted aluminum
Over-all length	2 1/8 in.
Over-all width	7/8 in.
Material	Light aluminum alloy
Position and method of fixing in mine	

Connected to charge by threads in base

Delay times

The delay time can be varied by the number of celluloid washers, and igniters of various times are differentiated by the colors of the large threads on

the upper part of body, as follows:

Screw thread unpainted aluminum—1 hour 45 min.

Screw thread painted steel grey—2 hours 20 min.

Screw thread painted red—3 hours

Colors are not seen when the igniter is armed.

Description

The body houses a steel striker retained against a compression of a steel spring by a celluloid washer which projects into a cylindrical chamber at the upper-end of the body. A detonator fitted with a flanged cap is secured to the lower end of the body by a washer and a screw-threaded adapter slotted laterally at the lower extremity to permit the

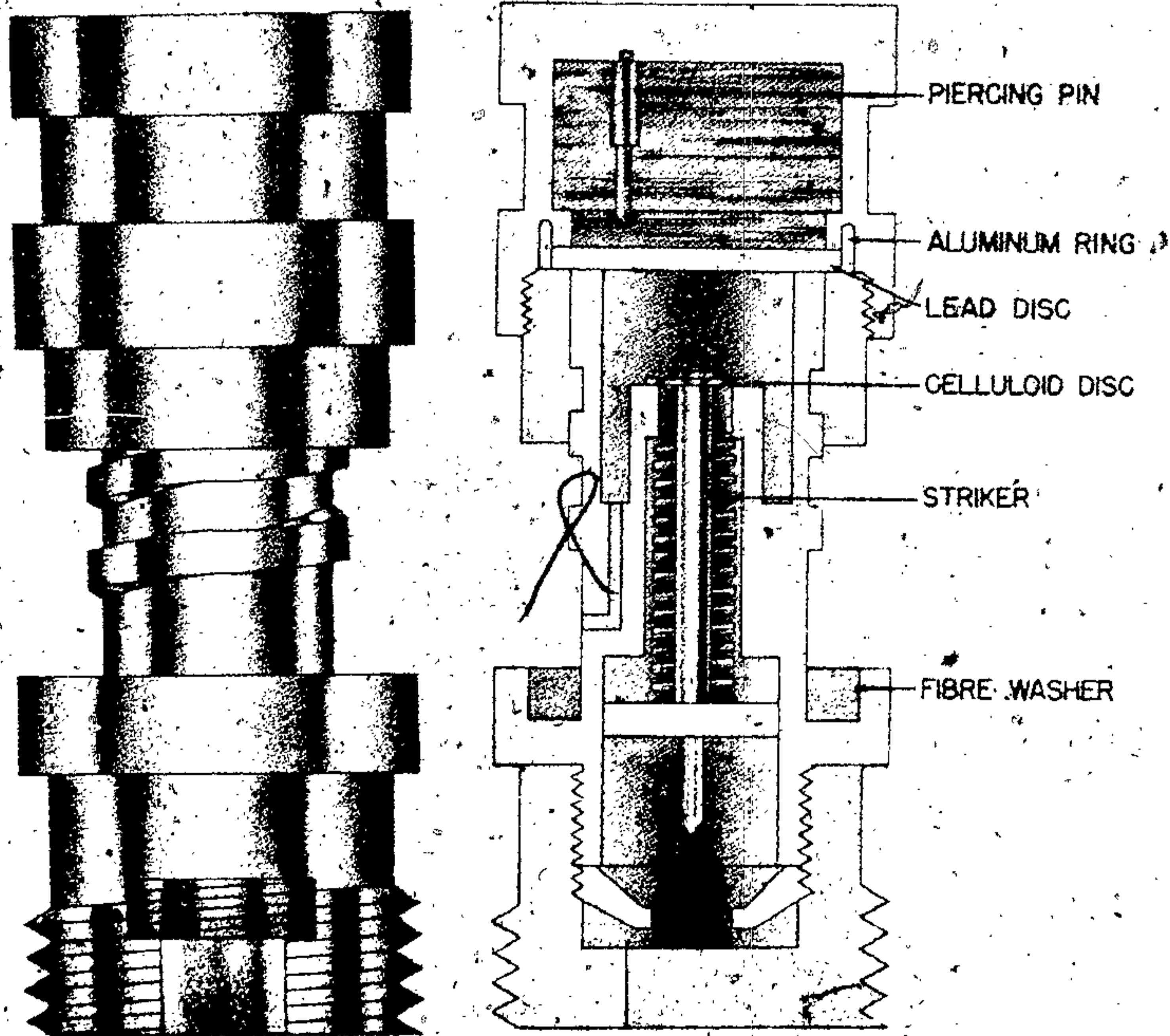

Figure 245 - Chemical Delay Igniter

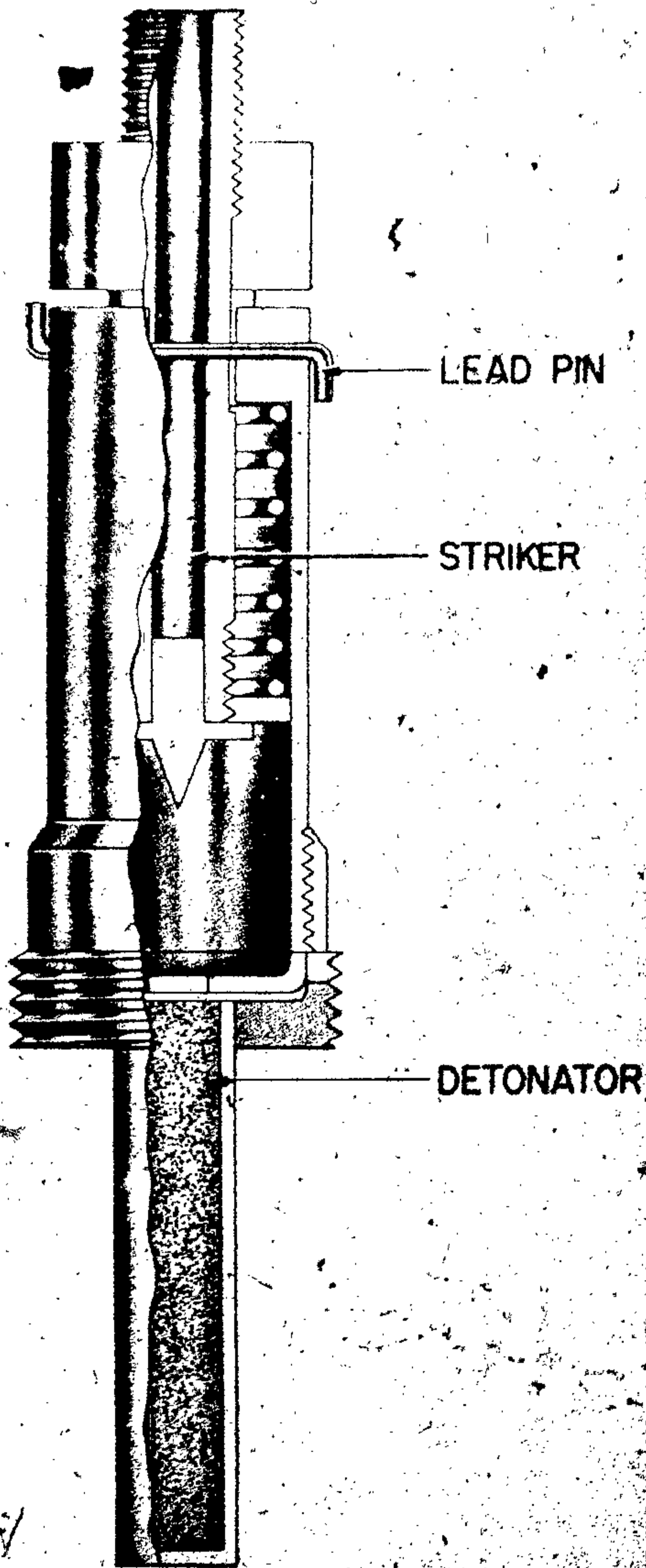

Figure 246 - Time Delay Igniter
(Lead Shear Wire)

insertion of the flanged detonator head beneath the detonator locating ring.

The exterior of the body's upper portion has a large-pitch square thread onto which screws the cap assembly with acetone sealed in the hollow-end cap by screwing the adapter collar hard-down on the aluminum ring.

The ring presses the circumference of the lead closing disc into a groove in the wall of the end-cap, as shown. For transport, the end-cap is screwed down and the long leg of the wire safety pin passed through a hole in the upper end of the body, while the short leg is passed through a hole in the collar.

Operation

The safety pin is withdrawn and the end-cap assembly screwed down. A lead closing disc, cut by the chamfered edge of the upper end of the igniter body and projection from the end-cap, permits acetone to enter the chamber and surround the celluloid washer.

Unless the arming operation is carried out with the end-cap down, the acetone leaks out the air-escape hole. When the end-cap is screwed down, the adapter collar bears hard against the fiber washer to form an effective seal. When the acetone dissolves the celluloid washer, the striker is released to initiate detonation.

Time Delay Igniter (Lead Shear Wire)

Data

Over-all length	3.5 in.
(with detonator)	(approx.)
Length of body	2.3 in.
Width of body	0.625 in.

Description

The igniter has a striker, consisting of a hollow tube threaded externally at each end, projecting through one end of the igniter casings, which is of galvanized mild steel.

Pressed into one end of the striker is a steel firing pin. The striker is surrounded by a spring which presses at one end against a screwed flange and at the other against the inside of the casing.

Rotation of a galvanized mild-steel nut retracts the striker and compresses the spring, the striker being prevented from turning by a set screw riding in a groove. The striker is provided with a flange which prevents withdrawal beyond a certain point; when this point is reached, a hole through the striker coincides with a hole in the casing, thus

permitting insertion of a $\frac{1}{8}$ -in. diameter lead shear pin.

To the other end of the igniter is screwed an aluminum adapter which is threaded externally for insertion into the charge. A detonator with a flanged percussion cap pressed into its open end is fitted into the base adapter, which for this purpose is unscrewed sufficiently to allow the flange of the cap to be inserted from the side into a slot in the adapter. The detonator and cap are then secured by screwing up the adapter.

Operation

To arm the igniter, the mild nut is unscrewed, causing the lead shear pin to retain the spring. Under the pressure of the spring, the shear pin eventually fails, allowing the striker to fire the cap and detonator. The time delay varies up to 26 hours.

Friction Delay Igniters—Micca Da 40 and 60

Data	Micca da 40	Micca da 60
Length	3.7 in.	4.5 in.
Diameter	0.25 in.	0.25 in.
Delay	10 sec.	15 sec.

Description

This prepared detonator consists essentially of a short length of safety fuse accommodated in an aluminum tube between a detonator and a friction igniter. This latter is initiated by a sharp pull on a galvanized iron wire.

Resistance to the pull is provided by a flange on the aluminum tube. The assembly may be prepared for delays of 10 or 15 seconds, and the aluminum tube is then 93 or 113 millimeters respectively in length. The exterior of the tube surrounding the detonator itself is painted red, but the remainder of the assembly is left unpainted.

Operation

The galvanized wire is pulled, igniting the friction mix and starting the safety fuse burning. After 10 to 15 seconds delay the safety fuses burn to the end and ignite the detonator.

50-Day Clock

Data	
Over-all diameter	16 in.
Over-all height	8 in. (approx.)

Description

This device consists of a dry-cell battery and an electrical clock with adjustable dial that can be set

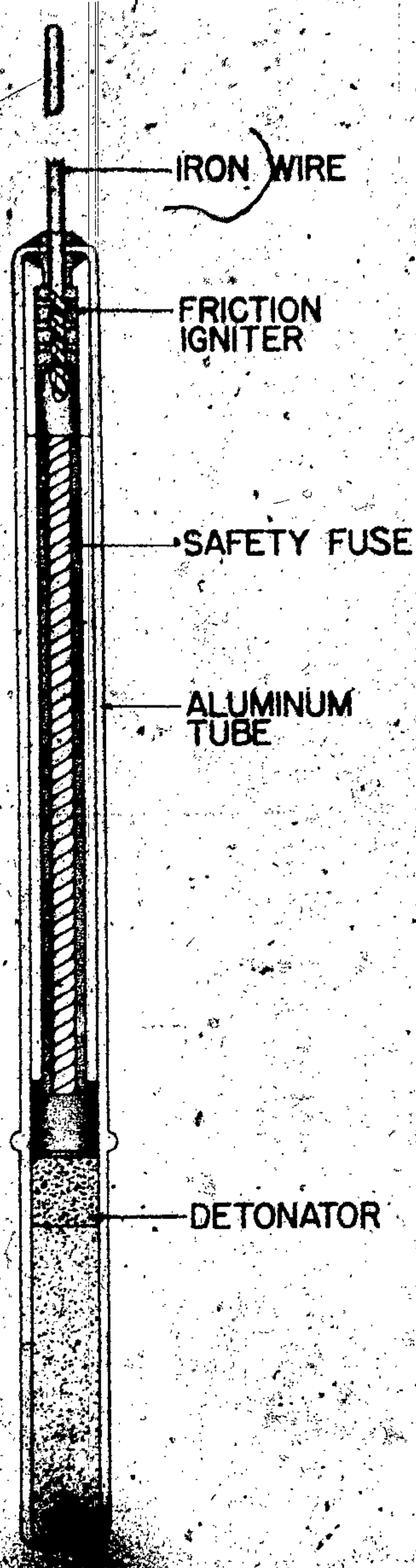

Figure 247 - Friction Delay Igniter

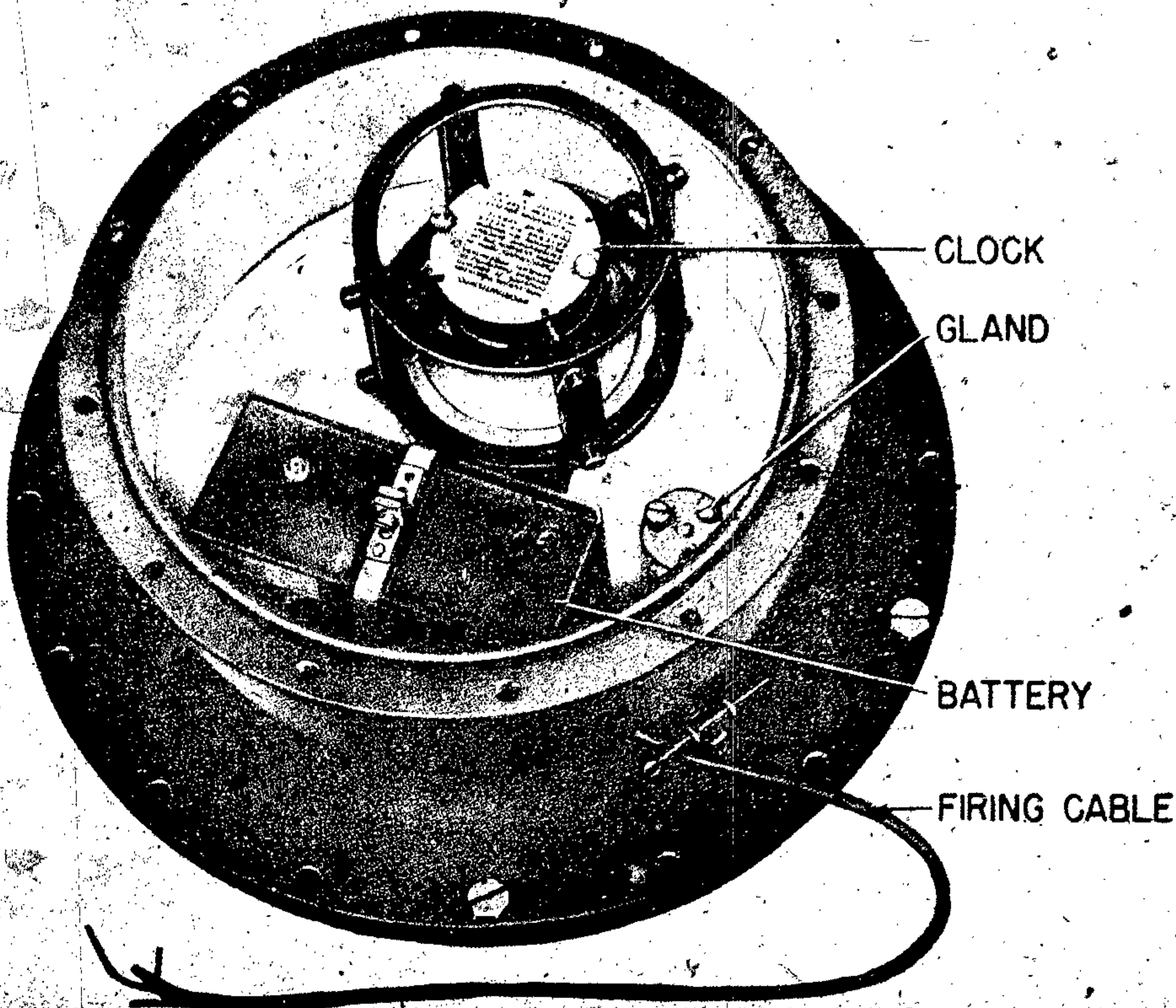

Figure 248 - 50-Day Clock

up to fifty days. By means of a solenoid, the clock is rewound every five minutes instead of being a constant drain on the battery. This accounts for the relatively long life of the battery, which will stay active an entire fifty-day period and still produce enough current to fire the detonator.

At the end of the set period, the setting dial closes the main switch which puts the detonator in

series with the battery. A block of approximately one-quarter pound of Italian explosive T-4 is hollowed out to house the detonator, and the block is inserted in the main charge in the space provided.

The main charge consists of approximately fifteen pounds of T-4 in a steel container which is bolted to the clock case. This entire unit is then attached to the sabotage charge.

Chapter 8

FRENCH BOMBS

Classes

French bombs may be divided into three classes. The bombs in each class are named according to their weight, approximately in multiples of 10 kg., and there follows a designation intended to differentiate several bombs of the weight. H. E. service bombs are made of steel-hardened, forged, or drawn steel; welded sheet or cast steel. The bomb fillings are generally as follows:

Hardened steel bombs	M Mn
Steel bombs	M Dn
Other bombs	D D

Fillings

The following fillings are used in French bombs:

M Mn—Trimonite (U. S. A.)

70% melinite (picric acid)

30% mononitronaphthalene

M Dn or MFDN

80% melinite

20% dinitronaphthalene

D D—Shellite (British)

60% melinite

40% dinitrophenol

Of these, "M Mn" is the most usual filling for cast steel anti-personnel bombs. The remainder are normally filled with "M Dn", "D D" being confined to certain types which are now considered obsolete.

Flares

Flares are normally used in reconnaissance of targets or landing grounds. They may be 10 or 30 kg. in weight and should be used at altitudes between 1,500 and 5,000 feet. The star burns for four or five minutes. The smoke bomb produces, on impact, a cloud of smoke which lasts about a minute and indicates the direction of the wind.

Coloring of Bombs

1. Service Bombs

H. E. bombs	Yellow
H. E. bombs (old pattern)	Grey
Flares	Red

Incendiary—1 kg. (old pattern)	Blue body Black tail
Incendiary—(new pattern)	Red body Green tail
Incendiary—10 kg.	Red body Green tail
Smoke	Black nose Green body and tail

2. Miscellaneous Bombs

Practice bombs	Yellow, blue band or unpainted
Instructional bombs	Grey or black Blue band
Ballast bombs	Gray or black White band

Markings on French Bombs

Markings, indicating manufacture are stamped on the nose of the bomb, either transversely near the nose-fuze pocket or in a direction parallel to the axis of the bomb.

On mild or forged steel bombs they indicate the source of the steel, the establishments which have carried out the tempering and the manufacture, a consecutive number, the lot number and year of manufacture. The letter M shows that the bomb is of rolled steel.

On bombs of cast steel, markings indicate the foundry, the lot number, the year of manufacture, and the mark of the factory.

The nature of the explosive filling is indicated by letters 0.4 inch in height, stamped on the bomb at 0.4 inch from the nose-fuze pocket.

The following markings are painted on the bombs:

IN BLACK, initials of the firm which carried out the filling, with the month and year of filling, e. g. PCFD-7-22.

Source and lot number of the explosive filling, e. g. SF-514-20.

Nature of filling.

Lot number and year of filling, e. g. 4-22.

IN RED, the inscription "F de Culot" on the same side as the other markings, in the case of bombs

ITALIAN AND FRENCH EXPLOSIVE ORDNANCE

fuzed in the tail. In addition, bombs of 100 kg. and over, carry, below all other markings, a number indicating the exact weight of the bomb, to the nearest kilogram.

FRENCH NAVY BOMBS

Little information has been found on French Navy bombs. Only the information in the following chart is available, except for the 125-kg. light-case bomb, which is included in the bomb section.

Designation	Max. Diam. of Bomb	Weight and Nature of Filling	Total Weight	Type of Fuze
14 kg. A. P.	3 $\frac{3}{4}$ in.	1 $\frac{3}{4}$ lb. picric acid and TNT	31 lb.	
222 kg. Model 1938 A. P.	10 $\frac{3}{4}$ in.	50 lb. picric acid and TNT	500 lb.	Nose Tail No. 7
410 kg. Type L A. P.	15 $\frac{3}{4}$ in.	265 lb. picric acid or picric acid and TNT.	900 lb.	Nose No. 9 Tail No. 8
438 kg. Model 1938 A. P.	11.9 in.	24 lb. picric acid	1,000 lb.	Nose Tail No. 7
224 kg. Type K	14.75 in.	240 lb. picric acid or picric acid and TNT.	490 lb.	Nose No. 10 Tail No. 8
720 kg. Type-M	20.5 in.	860 lb. TNT	1,600 lb.	Nose No. 11 Tail No. 8
73 kg. Type G2 Antisubmarine	8.66 in.	102 lb. TNT	160 lb.	Nose No. 11 Tail No. 8
150 kg. Type 12 Antisubmarine	14 in.	224 lb. TNT	330 lb.	Nose No. 11 Tail No. 8

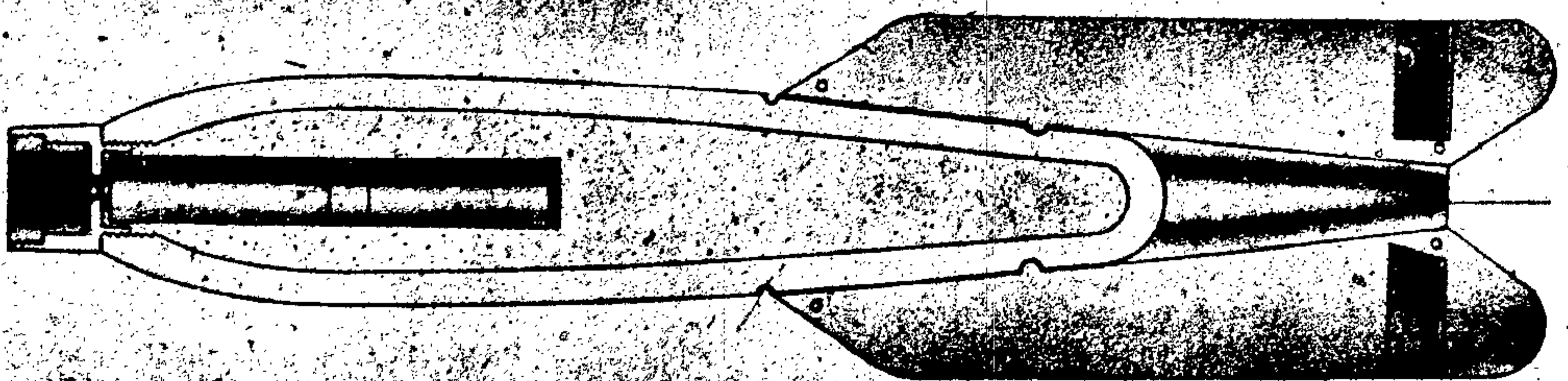

Figure 249 - 10-kg. (P.A.) Anti-Personnel Bomb

10-kg. (P.A.) Anti-Personnel Type I and Type II

Data

	Type I and Type II
Over-all length.....	21.5 in.
Body length.....	Unknown
Body diameter.....	3.54 in.
Wall thickness.....	0.5 in.
Tail length.....	9.3 in.
Tail width.....	5.5 in.
Type of filling.....	70% Picric acid, 30% Mononitronaphthalene
Weight of filling.....	2.5 lb.
Total weight.....	21.0 lb.

Fuzing

Nose only—24/31 Type H, Model 1921 R. S. A.
24/31 Model 1925 or Model 1928.

Description

The bomb casings are single-piece steel castings, internally threaded at the nose to accommodate the tapered steel fuze adaptor. Type II is similar to Type I, with the following exceptions: no struts are fitted to the tail unit, and strengthening is effected by pressing the lateral and longitudinal corrugations in each tail vane. In Type I, the tail unit is formed of four similar segments riveted together, fitted over the rear of the bomb, and secured by crimping the tail cone into an annular groove out in the bomb body.

Color and Markings

Over-all—yellow.
Stamped 0.4 in. from nose fuze pocket in letters 0.4 in. in height—nature of filling.

10-kg. (P.) Anti-Personnel Type I and Type II

Data

	Type I and Type II
Over-all length.....	21.5 in.
Length of body.....	Unknown
Body diameter.....	3.5 in.
Wall thickness.....	0.5 in.
Tail length.....	Unknown
Tail width.....	Unknown

Fuzing

Nose only—24/31 Type H 1921 R. S. A.
24/21 Model 1925 and Model 1928

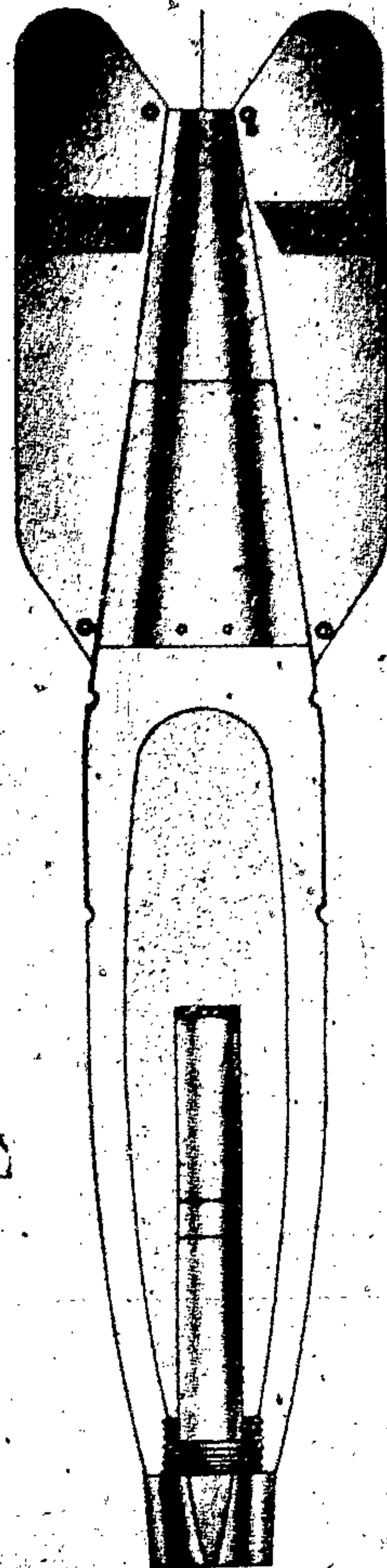

Figure 250 - 10-kg. (P) Anti-Personnel Bomb

Description

TYPE I: The bomb body consists of a converted 90-mm artillery shell. A sheet-metal extension fits over the upper end of the body and is secured to it by crimping within two annular grooves machined in the body. The tail unit is riveted to the upper half of the extension.

TYPE II: This bomb is similar to Type I, with the following exceptions: no conical extension is fitted, but a tail cone formed of a single-piece casting

ITALIAN AND FRENCH EXPLOSIVE ORDNANCE

is fitted over the upper end of the bomb and is secured to it by crimping within a single annular groove.

Color and Markings

Over-all—yellow

Stamped 0.4 in. from the nose fuze pocket in letters 0.5 in. in height—nature of filling

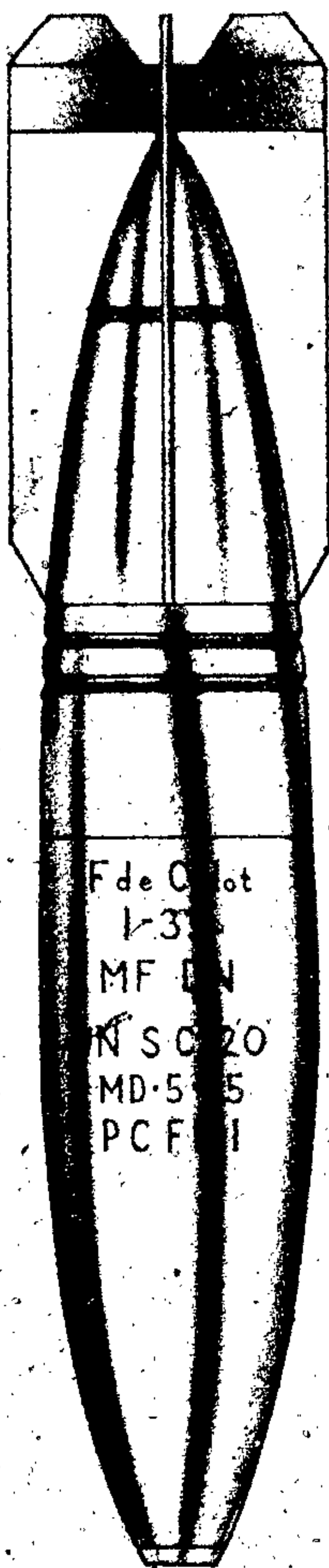

Figure 251 — 50-kg. (A) G.P.-H.E. Bomb

50-kg. (A) and 50-kg. (G.A.M.Mn) G.P.-H.E.

Data

	(A)	(G. A. M. Mn)
Over-all length	39.0 in.	46.5 in.
Body length	Unknown	Unknown
Body diameter	6.15 in.	7.85 in.
Wall thickness	0.69 in.	0.125 in.
Tail length	17.0 in.	Unknown
Tail width	7.85 in.	Unknown
Type of filling	MDn	MMn
Weight of filling	22.0 lb.	63.0 lb.
Total weight	88.0 lb.	112.0 lb.

Fuzing

(A): Nose—Type H Model 1921; Tail 3B15
(G. A. M. Mn): Tail—M. No. 2

Description

(A): The body of this bomb is a single-piece steel forging made from a rejected 155-mm artillery shell.

(G. A. M. Mn): This bomb is made of sheet steel; it has either a longitudinal or a circumferential weld.

Color and Markings

Both bombs: Over-all—yellow

Painted on bomb case—Type of filling and "F de Culot" if tail-fuzed only

50-kg. (D.T. No. 1, No. 2, and No. 3)
G.P.-H.E.

Data

	No. 1	No. 2	No. 3
Over-all length	46.5 in.	46.5 in.	46.5 in.
Body diameter	8.25 in.	7.7 in.	7.86 in.
Wall thickness	0.375 in.	Unknown	Unknown
Tail length	Unknown	21.0 in.	Unknown
Tail width	Unknown	10.2 in.	Unknown
Type of filling	MDn or DD		
Filling weight	44.0 lb.	42.0 lb.	44.0 lb.
Total weight	123.0 lb.	123.0 lb.	123.0 lb.

Fuzing

No. 1, No. 2 and No. 3: Tail only—3B15

No. 2: Nose—Type H, Model 1921, R. S. A. Model 1925, or Model 1928. Tail—Sch. R. Model 1938.

Description

These bombs are single-piece forgings; No. 1 made from converted 220-mm artillery shell, No. 3 from converted hydrogen cylinder; both made obsolete

100-kg. and 200-kg. G.P.-H.E.

Data

	100-kg.	200-kg.
Over-all length	56.0 in.	62.0 in.
Body length	Unknown	Unknown
Body diameter	10.8 in.	14.5 in.
Wall thickness	0.44 in.	0.44 in.
Tail length	18.9 in.	27.25 in.
Tail width	10.2 in.	14.5 in.
Type of filling	M108 or D40	
Weight of filling	258.0 lbs.	503.0 lbs.

Fuzing

Nose--A modified, R. S. A. 30/45, Model 1930
 Tail--3B15 (100 kg. only) Sch. R. Model 1938

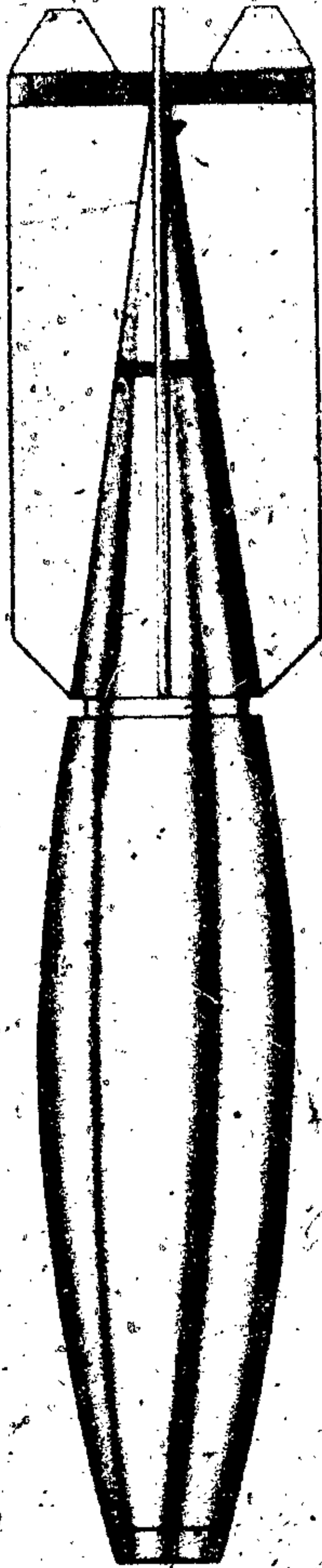

Figure 252 - 50-kg. (D.T. No. 2) G.P.-H.E. Bomb.

by the French. The tail consists of four vanes fastened to the tail cone, strengthened between the vanes by sheet metal struts.

Color and Markings

Over-all--yellow

Painted on body--Type of filling, source, year of filling, etc.

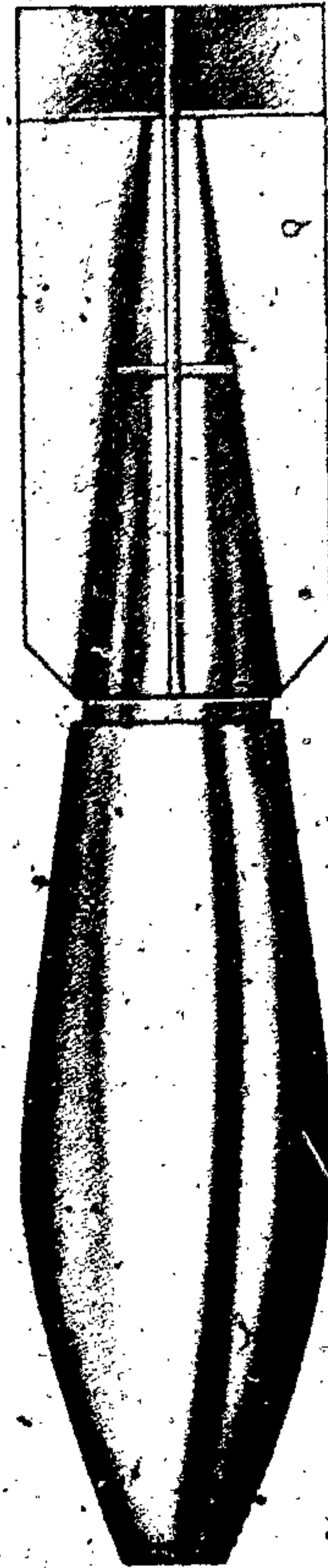

Figure 253 - 200-kg. G.P.-H.E. Bomb

ITALIAN AND FRENCH EXPLOSIVE ORDNANCE

Description

These bombs have a forged steel case. The tail assembly consists of four vanes attached to the tail cone and reinforced by struts made of strip steel.

Color and Markings

Over-all—yellow

Painted on the bomb case—Type of filling, source, etc. and "F de Culot" if tail-fuzed only

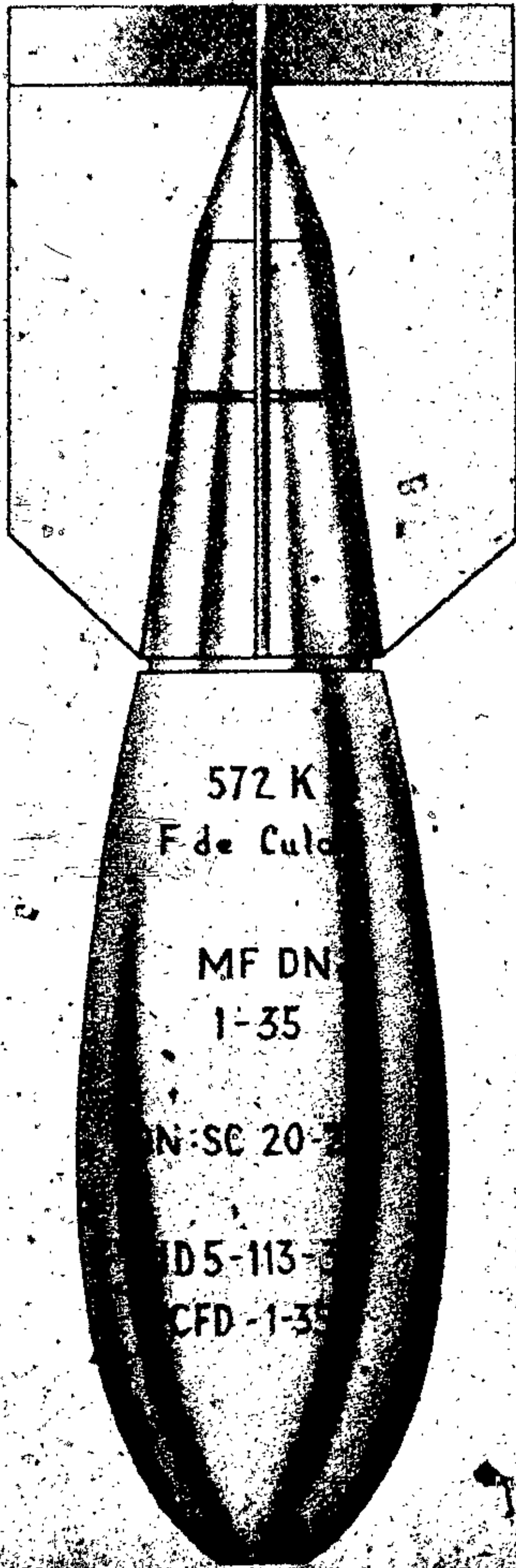

Figure 254 — 500-kg. G.P.-H.E. Bomb
Model 1930

500-kg. (Model 1930, No. 1, and No. 2) G.P.-H.E.

Data

	Model 1930	No. 1	No. 2
Over-all length	84.0 in.	83.0 in.	79.0 in.
Body length	Unknown	Unknown	Unknown
Body diameter	19.3 in.	21.4 in.	19.6 in.
Wall thickness	0.56 in.	0.44 in.	0.625 in.
Tail length	34.2 in.	Unknown	Unknown
Tail width	24.2 in.	Unknown	Unknown
Type of filling		MDn or DD	
Filling weight	600 lb.	662 lb.	595 lb.
Total weight	1285 lb.	1182 lb.	1148 lb.

Fuzing

Nose—A modified R. S. A. Mod. 1930 (except 500 kg. Model 1930)

Tail—3B15 Sch. R. 1938 (500 kg. Model 1930 only)

Description

Model 1930: Bomb case is made of a single-piece steel forging.

No. 1: This bomb is made of three sheet-steel sections welded together, presumably circumferentially.

No. 2: The bomb case is made of a single-piece steel forging.

The tail assembly of these bombs consists of a tail cone with four vanes attached.

Color and Markings

Over-all—yellow

Painted on case—Type of filling, source, etc.

125-kg. G.P.-H.E. (Naval)

Data

Over-all length	61.5 in. (without fuze)
Body length	36.0 in.
Body diameter	12.2 in.
Wall thickness	0.25 in.
Tail length	26.8 in.
Tail width	12.0 in.
Type of filling	TNT
Weight of filling	Unknown
Total weight	125 kg. (approx.)

Fuzing

Nose—Type A

Tail—No. 8

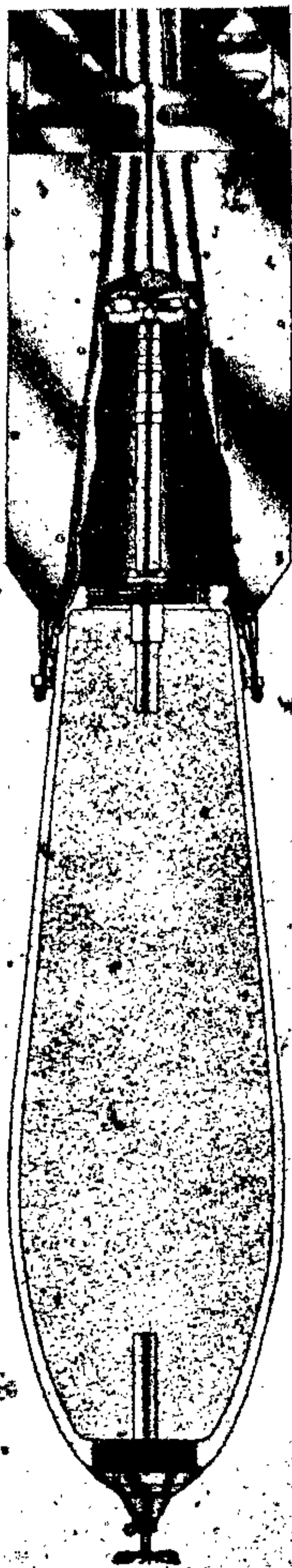

Figure 255 - 125-kg. G.P.-H.E. Bomb (Naval)

Description

This bomb is light cased. The tail assembly is secured to the bomb body by four clamping bolts which are received by four lugs on the body. The tail unit has corrugated stiffening plates for strengthening.

Color and Markings

Unknown

40-kg. Fragmentation Bomb

Data

Over-all length	35.75 in.
Body length	Unknown
Body diameter	6.25 in.
Wall thickness	Unknown
Tail length	16.75 in.
Tail width	7.75 in.
Type of filling	Unknown
Weight of filling	Unknown
Total weight	Unknown

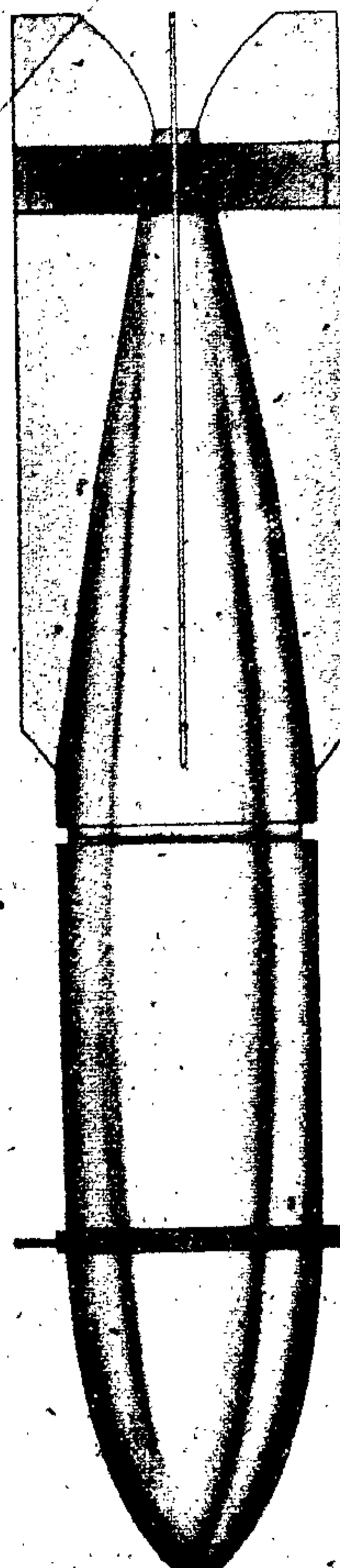

Figure 256 - 40-kg. Fragmentation Bomb

ITALIAN AND FRENCH EXPLOSIVE ORDNANCE

Fuzing

Nose—No. 3

Tail fuze—Unknown

Description

This bomb is a converted artillery shell. The tail unit is the cross-blade type, with the blade joined near the end of the bomb by a narrow strengthening band.

Color and Markings

Unknown

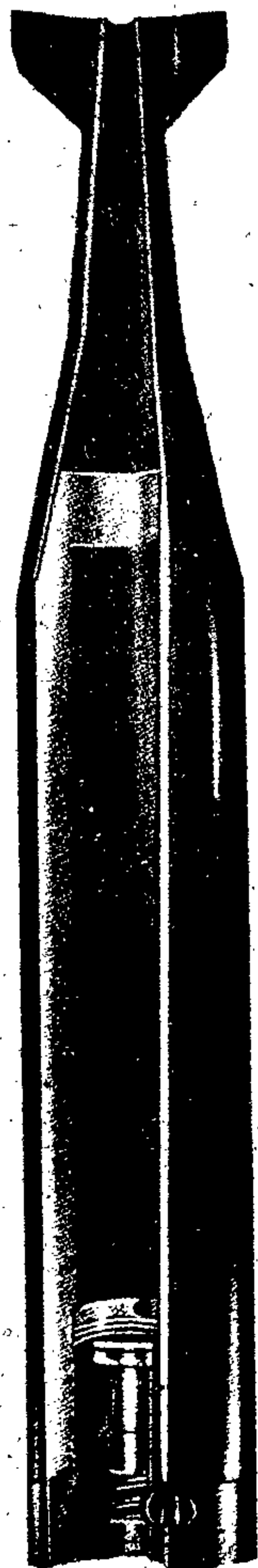

Figure 257—1-kg. Incendiary Bomb Type A

1-kg. Incendiaries Type A and Type B

Data

	Type A	Type B
Over-all length	14.5 in.	14.5 in.
Body length	9 in.	Unknown
Wall thickness	0.35 in.	0.35 in.
Tail length	4.75 in.	Unknown
Tail width	2.0 in.	2.0 in.
Type of filling	Thermite	Thermite
Total weight	1 kg.	1 kg.

Fuzing

Nose only—Fuzes for 1-kg. Incendiaries.

Description

The bomb bodies are cylindrical castings of magnesium alloy, with the nose internally threaded to take a nose fuze. Toward the nose, the bomb casing is perforated by two small vents, plugged with wax. The bombs differ in tail assemblies, with Type A consisting of three sheet-metal vanes supported at the ends by a circular ring and Type B consisting of a cast-alloy tail cone and eight vanes.

Color and Markings

Type A: Body—blue; tail—black

Type B: Body—red or blue; Tail—green or black

10-kg. (Model 1927) Incendiary

Data

Over-all length	22.1 in.
Body length	Unknown
Body diameter	3.54 in.
Wall thickness	Unknown
Tail length	10.2 in.
Tail width	5.5 in.
Type of filling	Magnesium Incendiary
Total weight	8 kg.

Fuzing

Nose only—24/31 Type H Model 1929 or
24/31 R. S. A. Model 1929

Description

The bomb consists of three parts: (1) a cast-steel nose filling sleeve and fuze adapter which screws into (2) a cast magnesium alloy body at the rear of which is screwed another (3) magnesium alloy casting in the form of a truncated cone with a base plate as an integral part of the castings. The booster tube is threaded into the nose sleeve. Plates divide the bomb into three sections; nose, central body,

10-kg. Parachute Flares, Old Type (A) and New Type (B)

Data

Over-all length.....	Type A, 10 kg.
Body length.....	45.3 in.
Body diameter.....	4.4 in.
Wall thickness.....	Unknown

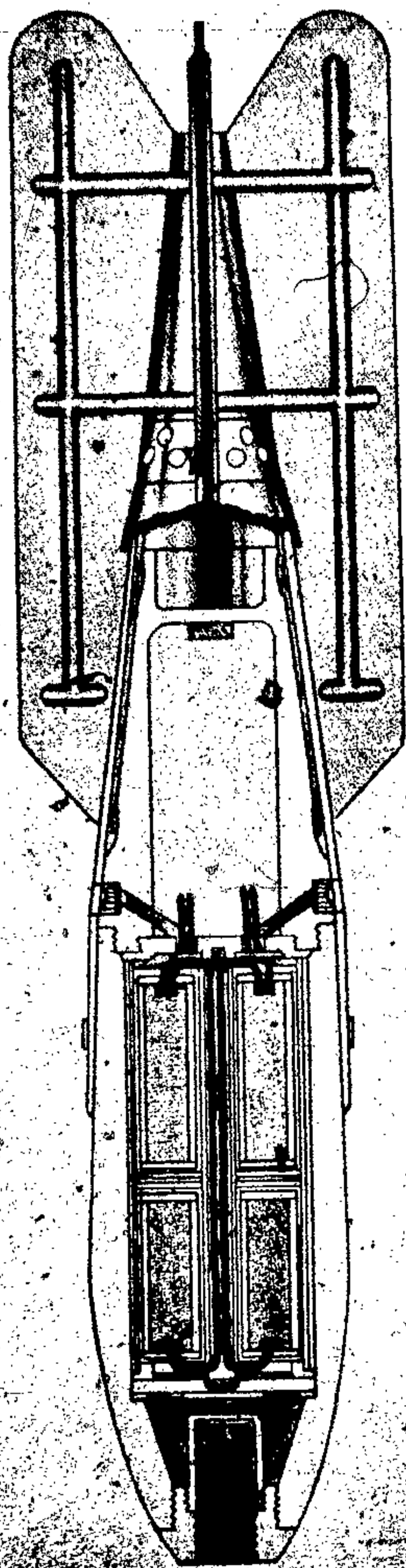

Figure 258 - 10-kg. Incendiary Bomb (Model 1927)

and tail portion. The incendiary filling is contained in twelve triangular tubes made of magnesium and filled with incendiary composition.* The tail unit also contains incendiary. All the incendiary composition is connected with wicks for ignition.

Color and Markings

- Body—red or blue
- Tail—green or black

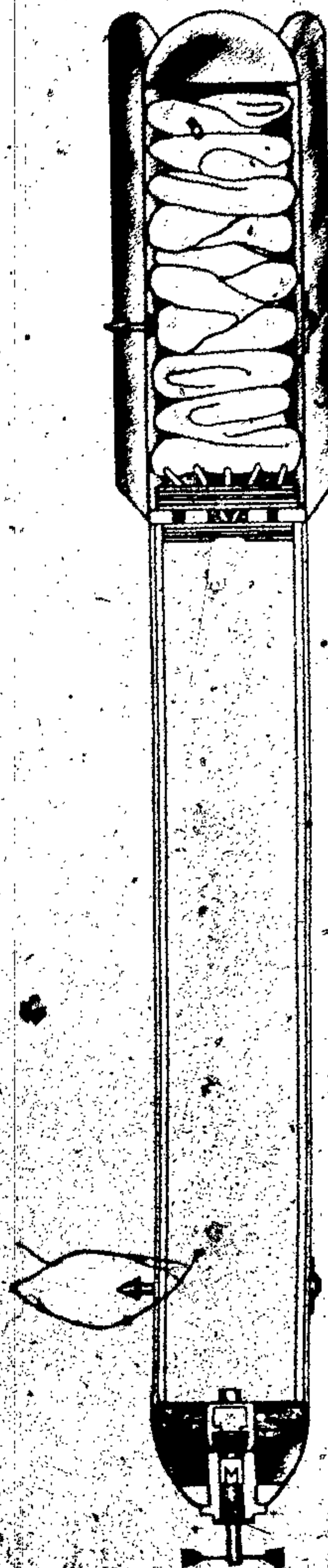

Figure 259 - 10-kg. Parachute Flare Type A

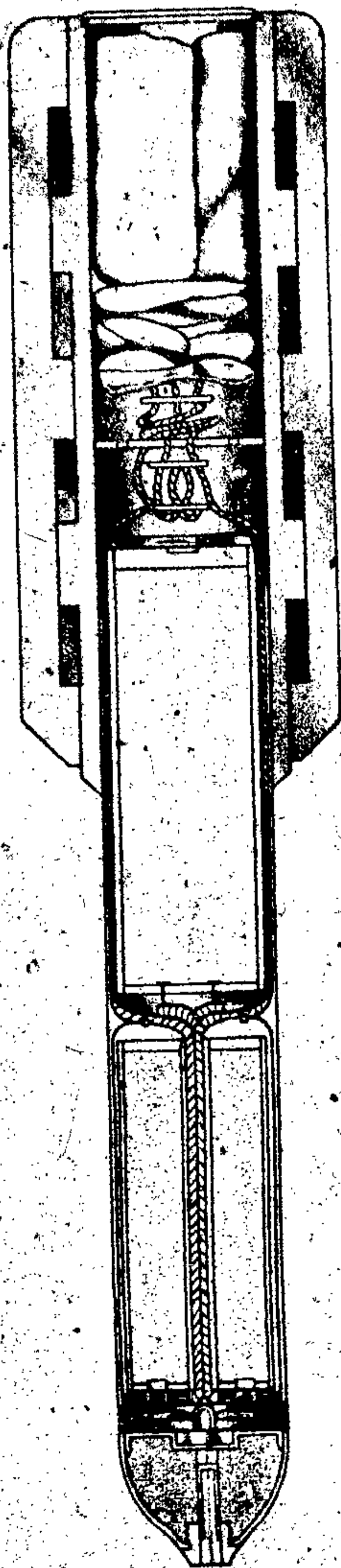

Figure 260 - 10-kg. Parachute Flare Type B

Tail length.....	Unknown
Tail width.....	Unknown
Type of filling.....	Star composition
Weight of filling.....	8 kg.
Total weight.....	13 kg.

Fuzing

Type A: Nose only—Time Fuze V. M.

Type B: Nose only—Time Fuze Model 1930

Description

These types of flares are very similar. They come in weights 10, 15, 30, and 50 kg. The Type A is the older type and B is the newer.

TYPE A: The 10-kg. flare of this type has a body of sheet iron, tin plated. When the fuze functions, it ignites the powder charge, and this, in turn, ignites the flare composition. At the same time, the gas caused by the combustion of the powder creates sufficient pressure to eject the star and parachute through the tail of the flare, the cup of which is tightly attached to the body.

TYPE B: The newer type of flare is made of aluminum. The tail cover is attached to the body by a lead strip running around the joint between the body and the tail. The expulsion of the stars and parachute is accomplished in the same manner as in the Type A. The head of the flare contains ballast, as well as the powder charge which ignites and expels the contents of the flare. The ignition of the large star is caused by the safety fuses. When the parachute opens, the six small stars hang around the large star.

Color and Markings

Type A: Over-all—red

Type B: Over-all—white; painted near the head of flare—three grey stars

Smoke Bomb

Data

Over-all length.....	9.45 in.
Body length.....	Unknown
Body diameter.....	2.75 in.
Tail length.....	4.25 in.
Tail width.....	3.15 in.
Filling.....	Titanium Tetra- chloride
Bottle content.....	100 cc.

Fuzing

None

Description

The casing is sheet aluminum, with the head pressed separately and soldered in several places to the body. A glass container fits within the casing, protected from breakage by cork at the tail, felt washers along the side of the casing, and a collar

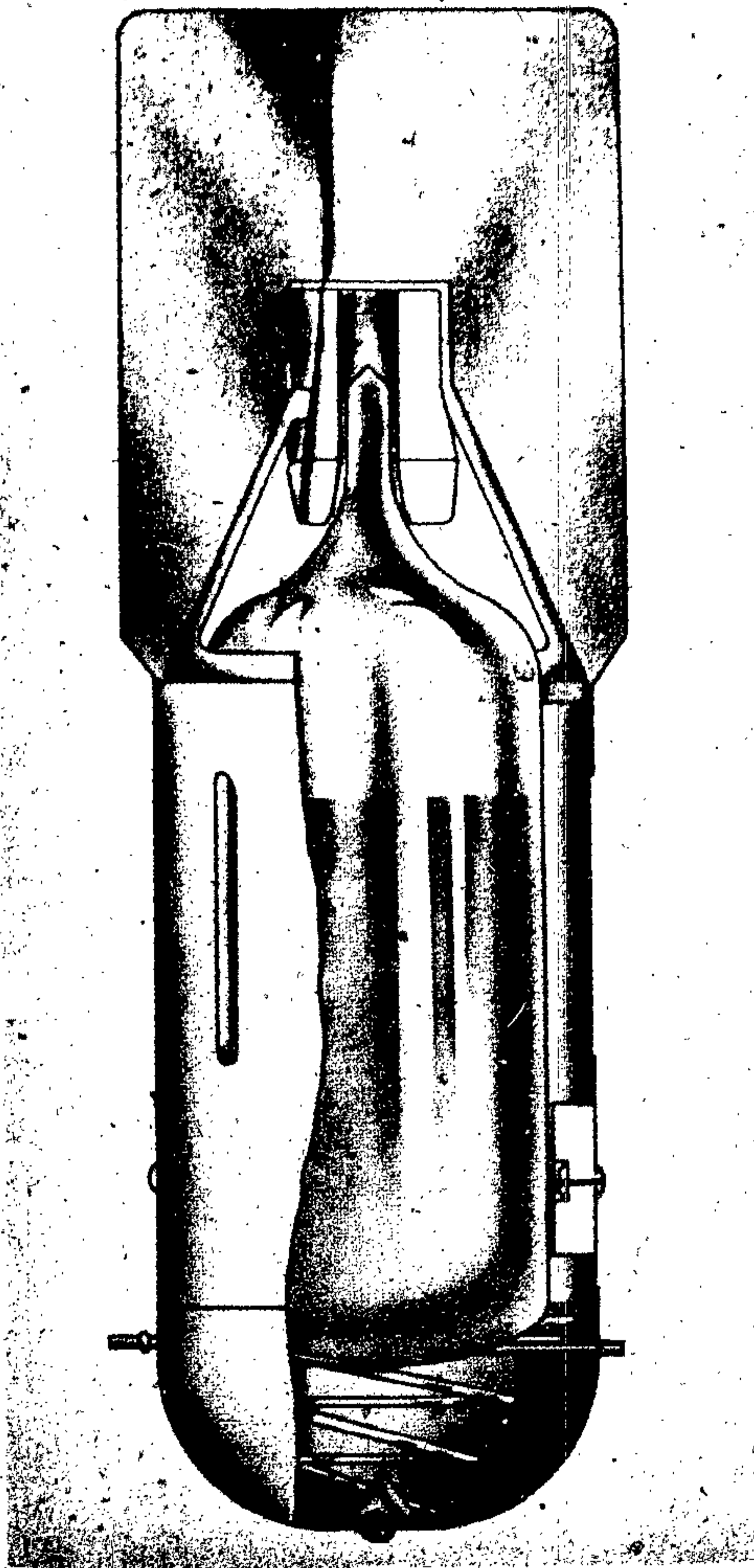

Figure 261 - Smoke Bomb

supported on a helical spring at the nose. A U-shaped safety pin holds the collar in position. On release, the safety pin is pulled, freeing the bottle in the case. On impact, the bottle moves forwards

against a spring onto four cutters in the nose of the body.

Color and Markings

Body and tail—green
Nose—black

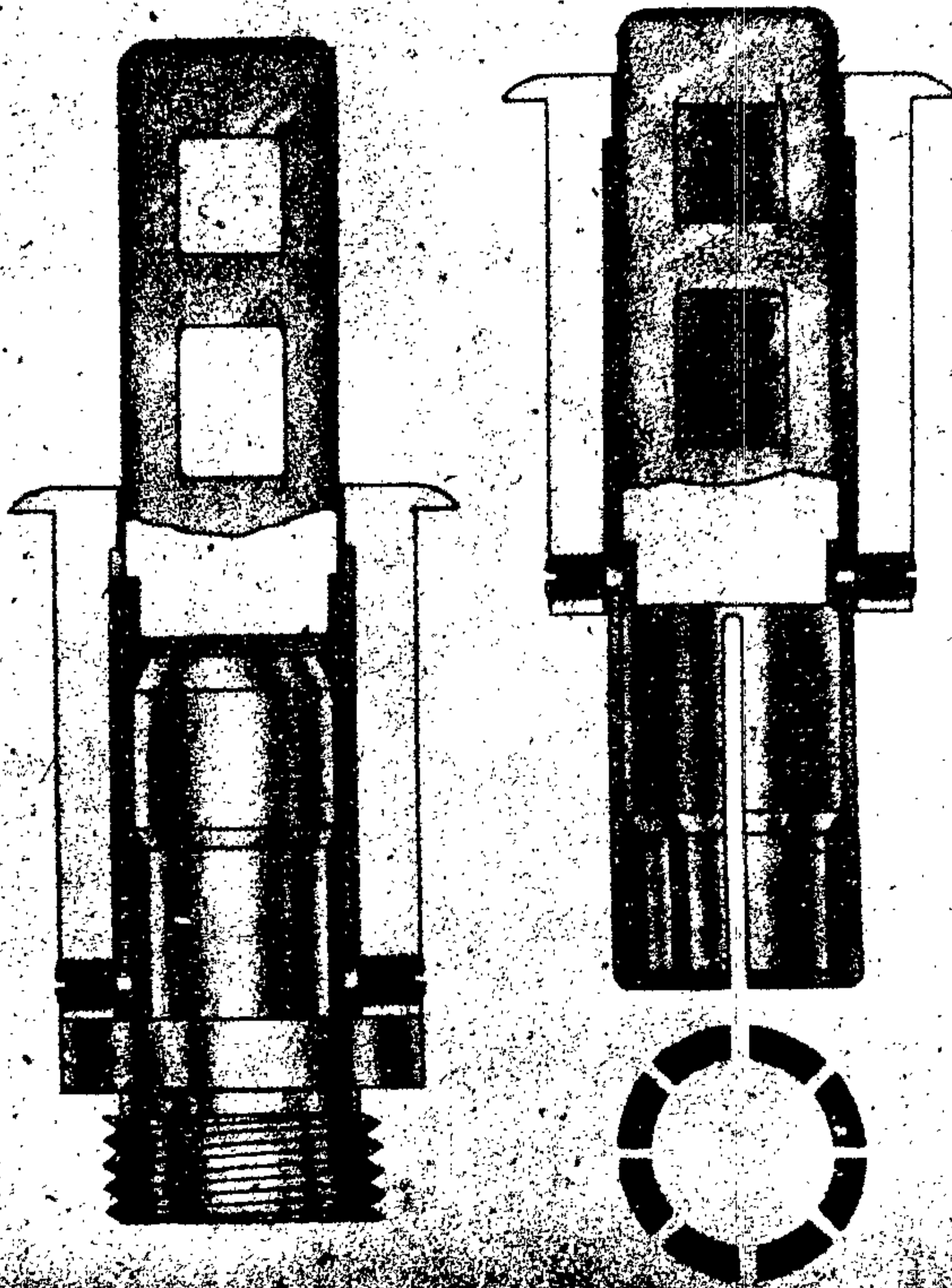
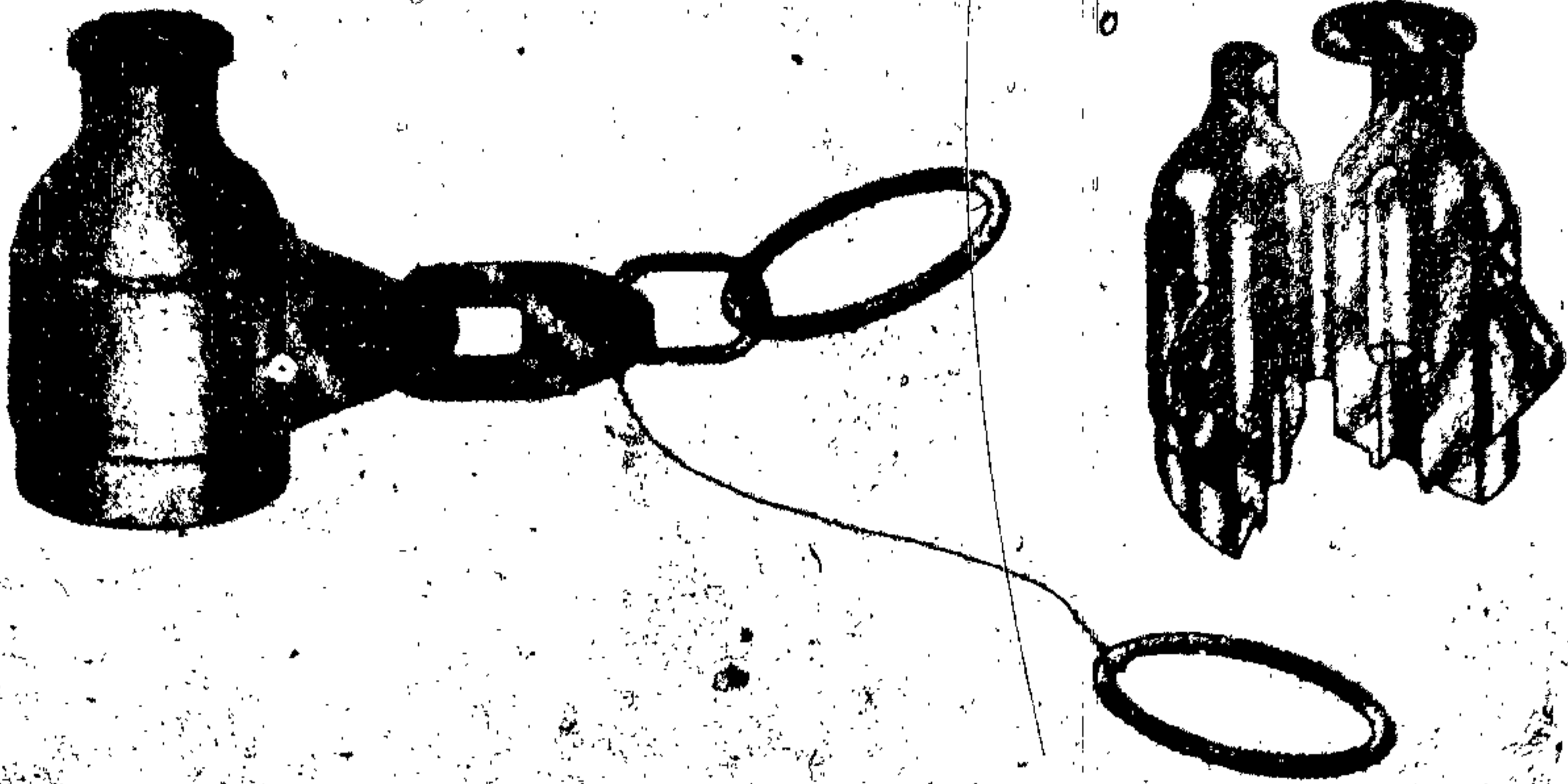

Figure 262 - Secondary Safety Devices

Chapter 9

FRENCH BOMB FUZES

Generally speaking, French bombs are fuzeed in nose or tail (or in both) with mechanical fuzes (i. e. containing strikers and detonators, and with a wind-vane arming device), somewhat similar to U. S. fuzes.

Bombs falling without initial speed and without rotation cannot become armed by employing the effects of setback or centrifugal force. On the other hand, in order to prevent premature functioning of the fuze in the vicinity of the airplane, arming must not take place until the bomb is sufficiently clear of the machine. The arrangement for arming, therefore, is also a safety arrangement, and often takes the form of a vane with screwed spindle which immobilizes the striker and holds it apart from the flash cap.

For transportation, the vane itself is held fast by a safety pin. The vanes having been freed, when the bomb is dropped, the rush of air causes the vanes to rotate. The spindle either screws down or unscrews in order to bring the striker into the functioning position, and the fuze is then armed. Fuzes (except bomb flare V. M. which acts in a special manner) act on impact either by the striker being forced onto the cap or by the effect of inertia causing a movable part to sit forward.

Types of Bomb Fuzes

There are three types of bomb fuzes:

1. Percussion fuzes: In these, the arming is effected either by the resistance of the air operating a vane (fuzes a helice) or by the speed of descent (fuzes R. S. A.).

The main feature of this R. S. A. percussion system is that there is no special means of arming this fuze. It is, in fact, armed when the bomb has acquired the requisite speed. This speed is normally attained after a fall of at least 66 feet.

2. Aerial-burst fuzes: These may operate by the action of a vane, a certain number of rotations being necessary to cause the fuze to function, or by the burning of a powder pellet, the length of the pellet determining the time.

3. Time fuzes (Clockwork Mechanisms and Fixed Time)

These types are for explosive bombs, with instantaneous action or delay of 0.05 or 0.15 seconds. In addition to the usual safety device, a supplementary security mechanism called "security largable" is used in some fuzes.

Colored Markings on Fuzes

1. On Vanes:

Vane tips all white	Instantaneous
Vane tips alternately black and white	Short delay
Vane tips all black	Long delay
Vane tips alternately red and black	Delay marked on fuze and body e. g., C. R. (short delay)

2. On body of fuze above screw threads:

All-white band	Instantaneous
Alternate black and white band	Short delay
Black band	Long delay

Removal of Fuzes

Most fuzes, if unarmed and not badly deformed by impact, may be removed from the bomb with the use of special tools.

Unexploded bombs (if armed) are dangerous to handle, as a jar in one direction, similar to the blow of impact (but much less) may make a striker pierce a detonator; or a jar in the other direction may withdraw a striker from a partially pierced but unfired detonator. The result of either form of movement or shock will probably cause detonation.

Arming vanes should not be screwed or unscrewed nor any parts pushed in or pulled out (this call for great care in the use of the probe when locating). Adhesive tape should be used to lock the fuze and arming devices before bombs are moved, provided this can be effected without movement of the parts

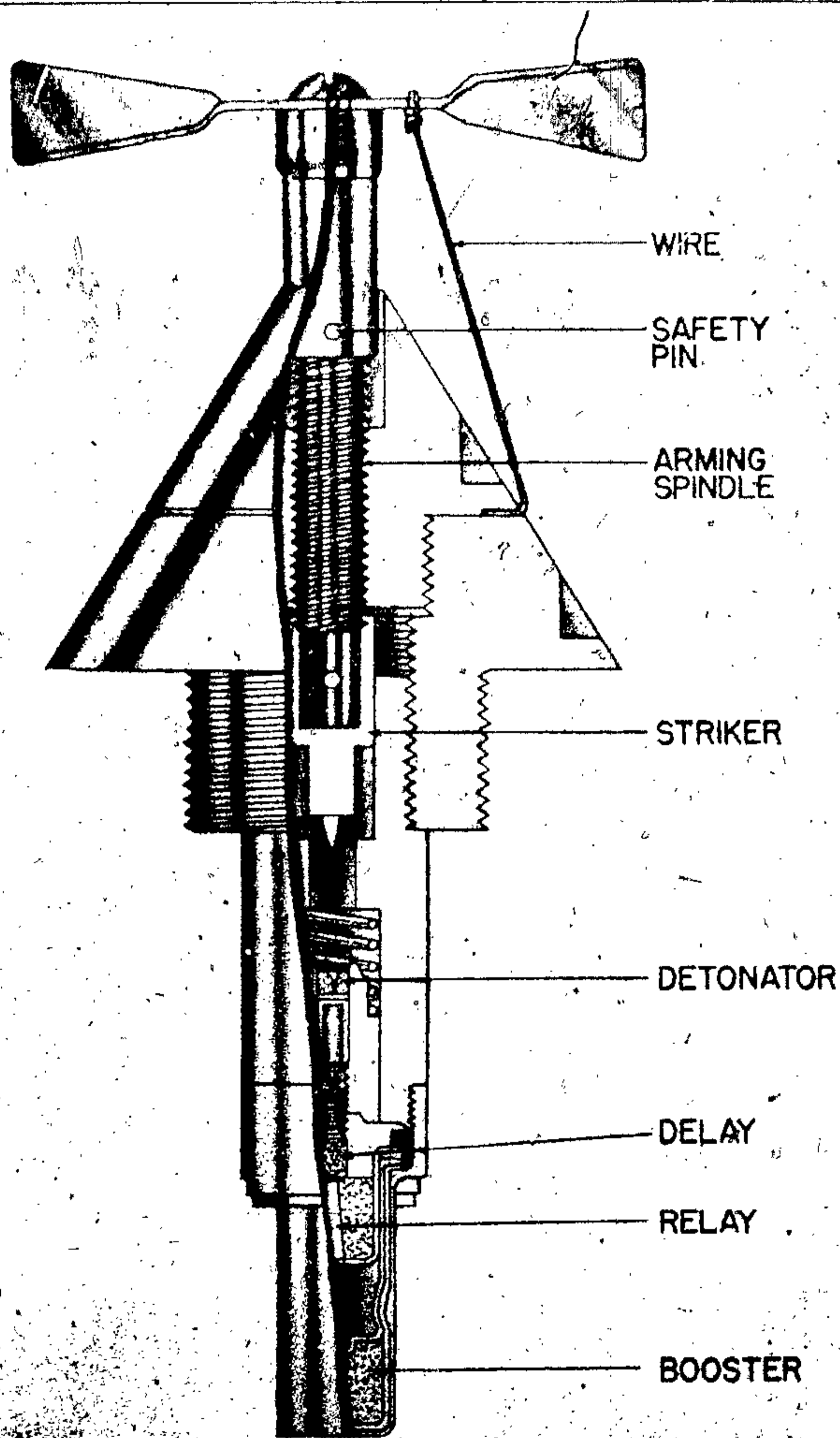

Figure 263 - Mechanical Impact Nose Fuze
Type A

Designation

French bombs may be described as follows.

1. By their type; e. g., percussion-detonating (percutante detonateur)
2. By a letter or number; e. g., H. A. 3 bis
3. By the date of the particular model; e. g., 1921, 1928, 1930

4. By a fraction indicating the dimensions of the fuze; e. g., 24/31, 36/67.5. Here the numerator indicates the diameter, in millimeters, of the threaded portion which screws into the bomb, while the denominator gives the diameter of the base; i. e., the portion which abuts onto the bomb casing.

5. By an abbreviation indicating the delay of the fuze, viz—

I.....	"instantaneous"	Instantaneous
S. R.....	"sans retard"	One or two relays, no delay
C. R.....	"court retard"	Short delay, 0.05 sec.
L. R.....	"long retard"	Long delay, 0.15 sec.
R. S. A.	"Raymondie sans armament"	Raymondie being the name of manufacturer and "sans armament" meaning without arming device.
bis.....	"bis"	Twice, encore, again

6. Also—all fuzes bear markings indicating the factory or origin, lot number, and year of manufacture, in addition to any designation symbols.

Secondary Safety Devices

Secondary safety devices are used with some French fuzes. These are known as "dispositif de securite largable", and are of three types, as follows:

1. **Safety device Model 1928:** This device is incorporated with the 1928 and 1929 Models of the R. S. A. Fuze when used for horizontal suspension of 10 and 50-kg. bombs, and is shown at the top of Figure 262. It is also used in a slightly modified form with R. S. A. Fuze Model 1925. It consists of two symmetrical steel hoods joined by a band of spring steel. The interior of these hoods is shaped to conform with the contour of the fuze head. The safety device is closed by means of a clip to which cord and a ring are attached. The latter is attached to the ball-release cord, so that the clip is pulled away when the bomb is released. The safety device then opens during the descent of the bomb and falls away.

2. **Safety device, Sch. R. ("Schneider-Raymondie"):** This device, shown in the lower portion of figure 262, is used with R. S. A. Fuze Models 1928 and 1929, for vertical suspension of 10- and 50-kg. bombs. It consists of a steel sleeve through which passes the suspension lug. Attached to the base of the latter is a spring-steel collet, each steel strip having the projection to grip the fuze head. The sleeve can slide over the collet guided by two

screws. When the bomb is released, the sleeve remains with the dropping gear by means of the projection. The collet travels with the fall of the bomb for the length of the sleeve, at which point the strips can open out sufficiently to allow the fuze head to be freed from the releasing gear.

3. **Safety device for use with the R. S. A. Fuze 30/45, Model 1930:** This is shown in figure 266. It consists of a single piece of bronzed steel in the shape of a hood. Inside of the apex of the hood is a spring which holds the head of the fuze away from the hood, and assists in the removal of the hood after the bomb is released. The hood is held in the head of the fuze by three spring-loaded pins, which pass through the lower portion of the wall of the hood, and are held in position by a spring collar. When the collar is closed by the clip, the pins are pressed into a groove on an adapter, which screws into the bomb. When the bomb is released, the clip is pulled away, the three pins are free to move, and, with the assistance of the spring, the safety hood falls away from the path of the bomb.

Mechanical Impact Nose Fuze—Type A

Data

Bombs used in	50-kg., 100-kg., 200-kg., GP-HE and 125-kg.
Fuzes used with	No. 3 Bis Tail Fuze
Over-all length	6.9 in. (with booster)
Over-all length of vanes	3.1 in.
Width of fuze body	2.6 in.

Description

The fuze consists of: (1) An upper brass conical section threaded internally to receive the arming spindle; (2) a truncated, conical section of steel which is externally threaded to screw into the bomb fuze pocket, and internally threaded to receive the upper section of the fuze; and (3) a brass tube containing the detonator.

The striker is attached to the arming spindle by a pin. The detonator is housed in a double-walled copper container which is retained in the rear position by a creep spring.

Vanes are attached to the upper end of the arming spindle by a brass screw, and are prevented from rotating by a safety pin through a slot in the body and a hole in the spindle. A second safety device consists of a copper wire secured to one vane and caught between the upper brass and steel sections of the fuze body. If the fuze is to be used for

ITALIAN AND FRENCH EXPLOSIVE ORDNANCE.

long- or short-delay action, one or more delay pellets may be fitted into the top of the detonator holder.

Operation

When the bomb is dropped, the safety wire is cut and the safety pin is withdrawn. As the vanes rotate, the arming screw advances near the detonator until the striker rests on the recess in the fuze.

On impact, the striker remains stationary, and the detonator holder overcomes the creep spring and hits the striker. The flash from the detonator passes directly to the booster or through the delay and relay pellets to the booster.

Remarks

Fuzes are marked to show the following functions:
S. R.—Instantaneous
C. R.—(Short Delay) 0.05 seconds
L. R.—(Long Delay) 0.15 seconds

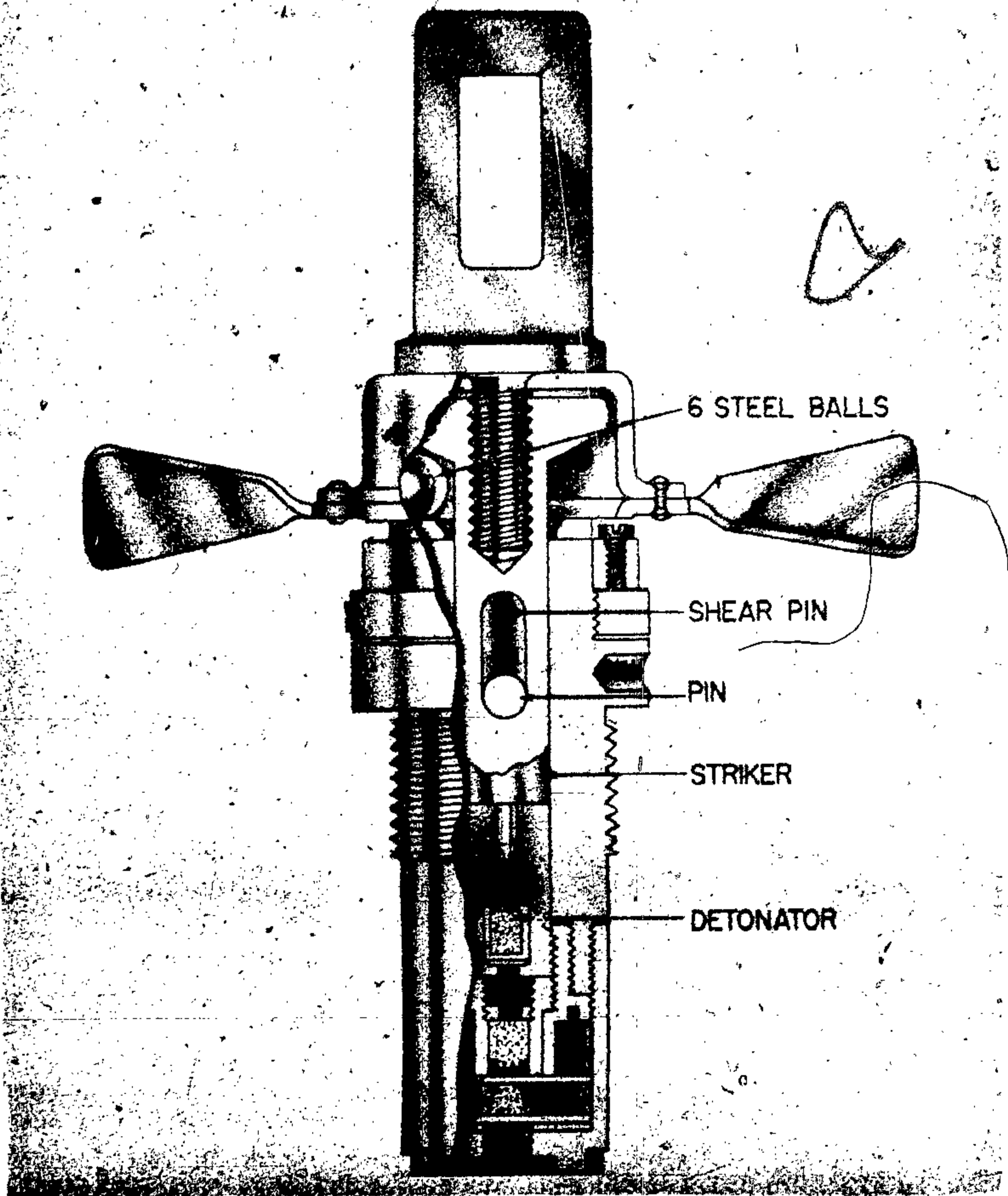

Figure 264 — Mechanical Impact Nose Fuze—
Type H

**Mechanical Impact Nose Fuzes Type H
Models 1921 and 1929**

Data

Bombs used in
 10-kg. P. A. Anti-Personnel, 50-kg. D. T. No. 2
 G. P.-H. E.
 Fuzes used with
 Alone in 10-kg. 3 Bis or Sch. R. Tail Fuze in
 50-kg.
 Over-all length
 (With booster) Model 1921 . . . 5.6 in.
 (Without booster) Model
 1929 . . . 4.6 in.
 Over-all length of vanes
 Model 1921 . . . 3.5 in.
 Model 1929 . . . 3.25 in.
 Width of fuze body
 Model 1921 . . . 1.2 in.
 Model 1929 . . . 1.3 in.
 Markings . . . 24/31-H-Mle. 21
 or 29

Description

These fuzes are similar in outward appearance, differing mainly in size and detonator assembly, but both are easily distinguished by the square eyebolt on the upper cap. Sixteen vanes are formed on a ring riveted to the cap. The base of the eyebolt has a bolt formed with it which screws into the striker. Between the striker plate and the upper locking ring of the body are six steel balls.

A brass ring is screwed over the main brass fuze body and secured by a setscrew. The striker is held in place by a steel threaded pin through the fuze body which passes through the lower portion of the slot in the striker. A brass shear pin also passes through the slot and the body.

The model 1921 has a long booster containing a detonator, a booster charge on the detonator, and delay, relay, and booster charges. The model 1929 has a short detonator holder containing a detonator cap, delay, and relay. These fuzes may give instantaneous, short-delay (0.05 sec.) or long-delay (0.15 sec.) action, depending on the delay pellet used.

Operation

As the bomb is released, the safety pin is withdrawn, freeing the vanes. When vanes have rotated sufficiently, steel balls fall out and finally the vanes completely unscrew and fall out, carrying the suspension eyebolt with them. The striker is now held only by the shear pin. On impact, the striker shears the pin and hits the detonator.

**Nose Impact Fuzes R.S.A. Models 1925,
1928, and 1929**

Data

Bombs used in
 Mle. 25—10-kg. G. P.-H. E.
 Mle. 28—10-kg. and 50 kg. G. P.-H. E.
 Mle. 29—10-kg. Incendiary Model 1927
 Fuzes used with
 Mle. 1925 and 1928—Alone
 Mle. 1929—Tail Fuze No. 3 Bis or Sch. R.
 Over-all length
 (With booster) Mle. 25 . . . 5.15 in.
 (With booster) Mle. 28 . . . 4.2 in.
 (Without booster) Mle. 29 . . . 3.4 in.
 Width of fuze body
 Mle. 25 and 29 . . . 1.2 in.
 Mle. 28 . . . 1.15 in.
 Markings
 R. S.-A. Mle. 25; or 28; or 29 24131

Description

Similar in function and appearance, these fuzes differ slightly in construction. Mle. 28 and 29 are one-piece; Mle. 25 consists of two pieces screwed together. The upper part of the body contains Raymondie (or Re'mondy) percussion-arming device, consisting of a cup with a detonator in the base and two vertical slots in the walls to receive the wings of a washer resting on top of the detonator. The striker and cup are held by a shear pin which passes through the fuze body.

Below the creep spring between the striker and washer, a central flash channel leads to the relay pellet and booster in Mle. 25; in Mle. 28, the brass fitting contains a delay pellet and relay pellet; Mle. 29 is similar to Mle. 28 that except a short booster replaces a long one sealed by lead solder, the fuze being used to ignite incendiaries.

Operation

These fuzes are used with or without secondary safety device (other than the shear pin) in the striker. The secondary safety is removed when the bomb is released; no further arming occurs until impact, when the striker and cup are forced back. The shear pin joins them, and comes to rest against the upper ledge in the fuze recess while the detonator cap sets forward against the washer in slots of the cup and against a creep spring. The detonator and washer overcome the creep spring; the detonator hits the striker, igniting the explosive system.

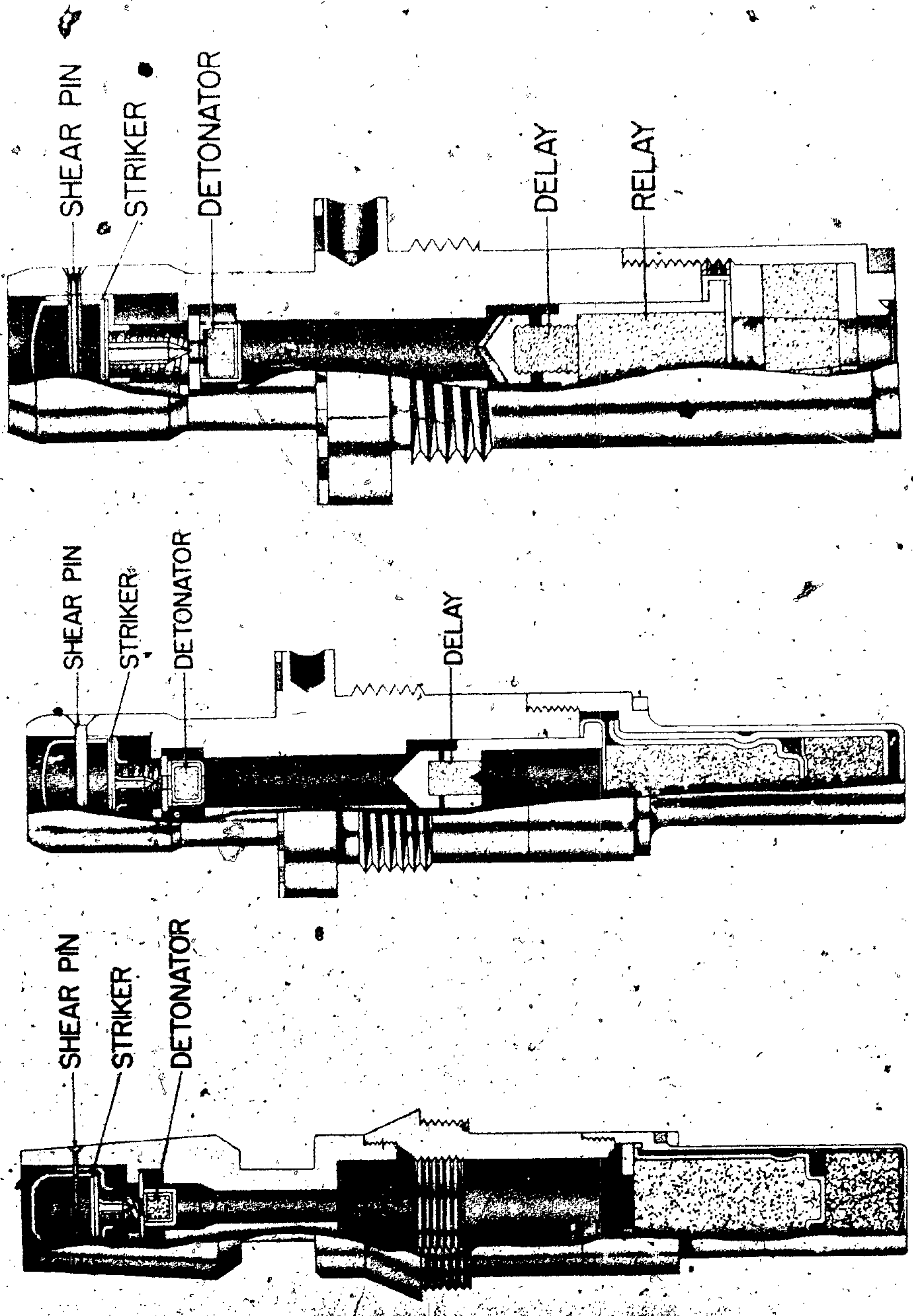

Figure 265 - Nose Impact Fuzes R.S.A. Models 1925, 1928, 1929

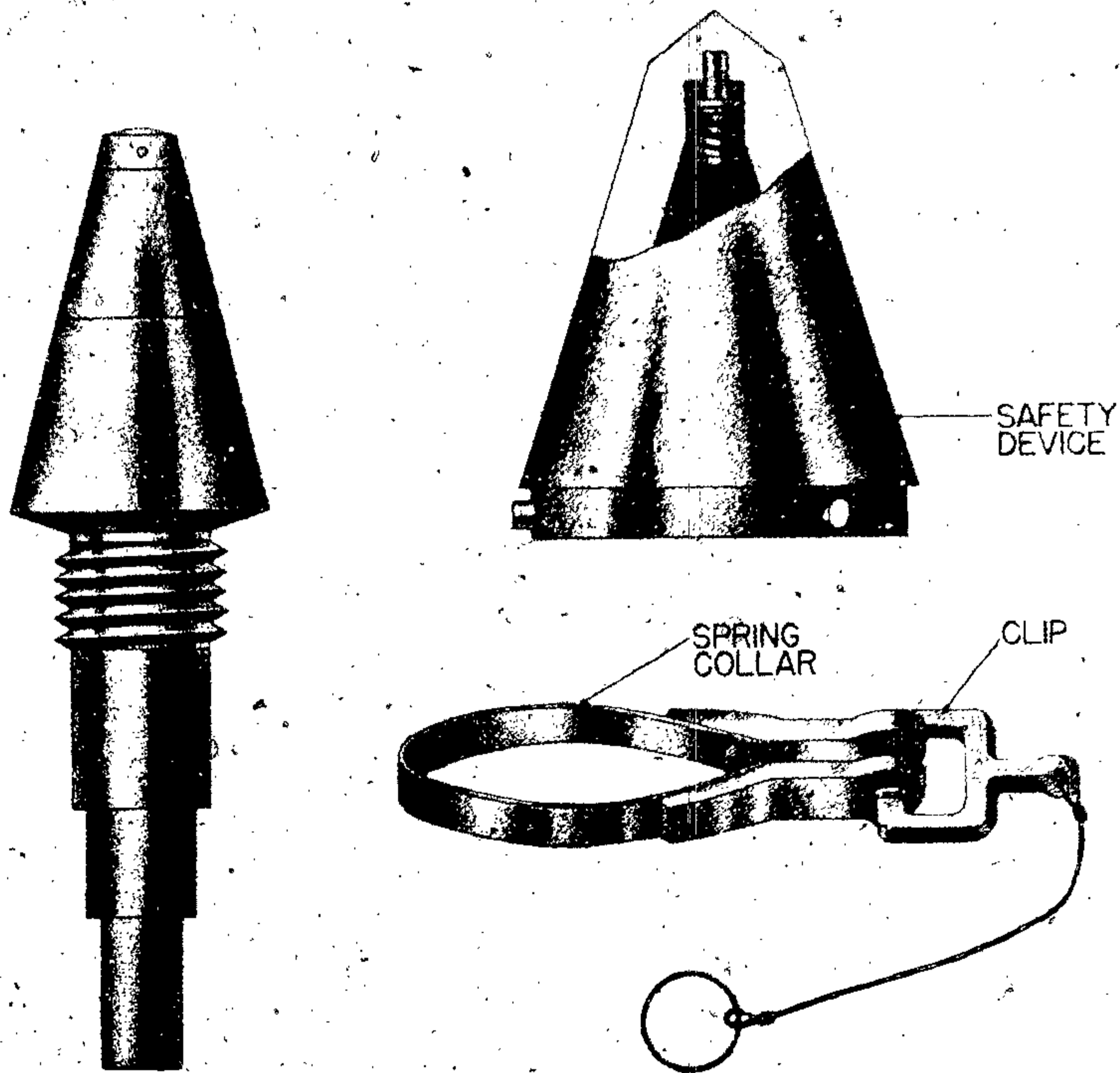

Figure 266 - Nose Impact Fuze R.S.A. Model 1930

Nose Impact Fuze R.S.A. Model 1930

Data

- Bombs used in
100-kg., 200-kg., 500-kg., (No. 2), 500-kg.
(Model 1930) G. P.-H. E. May be found in
other bombs from 100-kg. to 1,000-kg.
- Fuzes used with
No. 3 Bis. or Sch. R. Model 1938
- Over-all length..... 6.8 in.
- Width of fuze..... 1.8 in.

Description

The internal assembly of this fuze is the same as the other R. S. A. models already described. The distinguishing features are the truncated hood and the large diameter. The hood on the dome cover is set down over the regular R. S. A. fuze mechanism.

At the apex inside the dome, there is a spring which is compressed when the hood is placed on the

fuze. Around the base of the hood are three spring loaded detents. The clip fits around the base of the hood and compresses the spring-loaded detents which are pressed into the A-groove on an adapter which screws into the bomb.

Operation

When the bomb is released, the clip is pulled away, releasing the spring-loaded detents which spring out and fall away. The hood then falls off with the help of the spring. The function of the fuze then is the same as described in the R. S. A. Models 1925, 1928, and 1929.

Remarks

The usual markings to indicate the delay are found on the pin at the base of the truncated hood and are as follows:

- White—Instantaneous
- Alternate Black and White—Short delay
0.05 seconds
- Black—Long delay 0.15 second

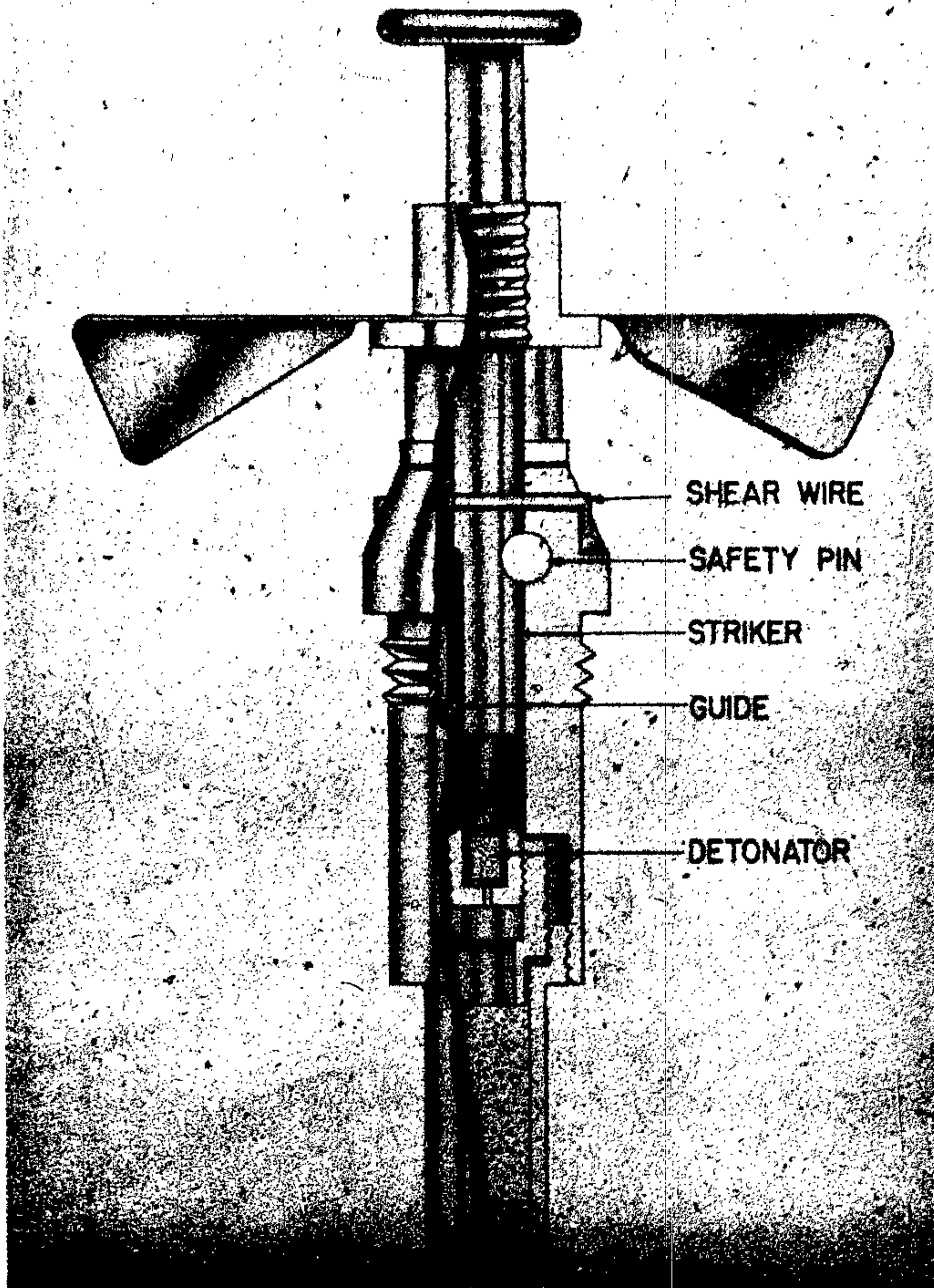

Figure 267 - Mechanical Impact Nose Fuze
M. Bis

Mechanical Impact Nose Fuze—M. Bis

Data

Bombs used in.....	10-kg. Anti-Personnel
Fuzes used with.....	Alone
Over-all length.....	5.1 in.
Over-all length of vanes....	3.4 in.
Width of fuze body.....	1.2 in.

Description

This fuze consists of a brass body and steel striker. The striker is held in place by the safety

bolt, which passes through the fuze body and engages a groove in the striker. The arming vanes, are screw-threaded on the striker. The shear wire passes through the striker and body.

Operation

When the bomb is dropped, the safety bolt is removed. The vanes rotate and rise on the striker spindle. On impact, the striker is forced down, cutting the shear pin and contacting the detonator, initiating the explosion.

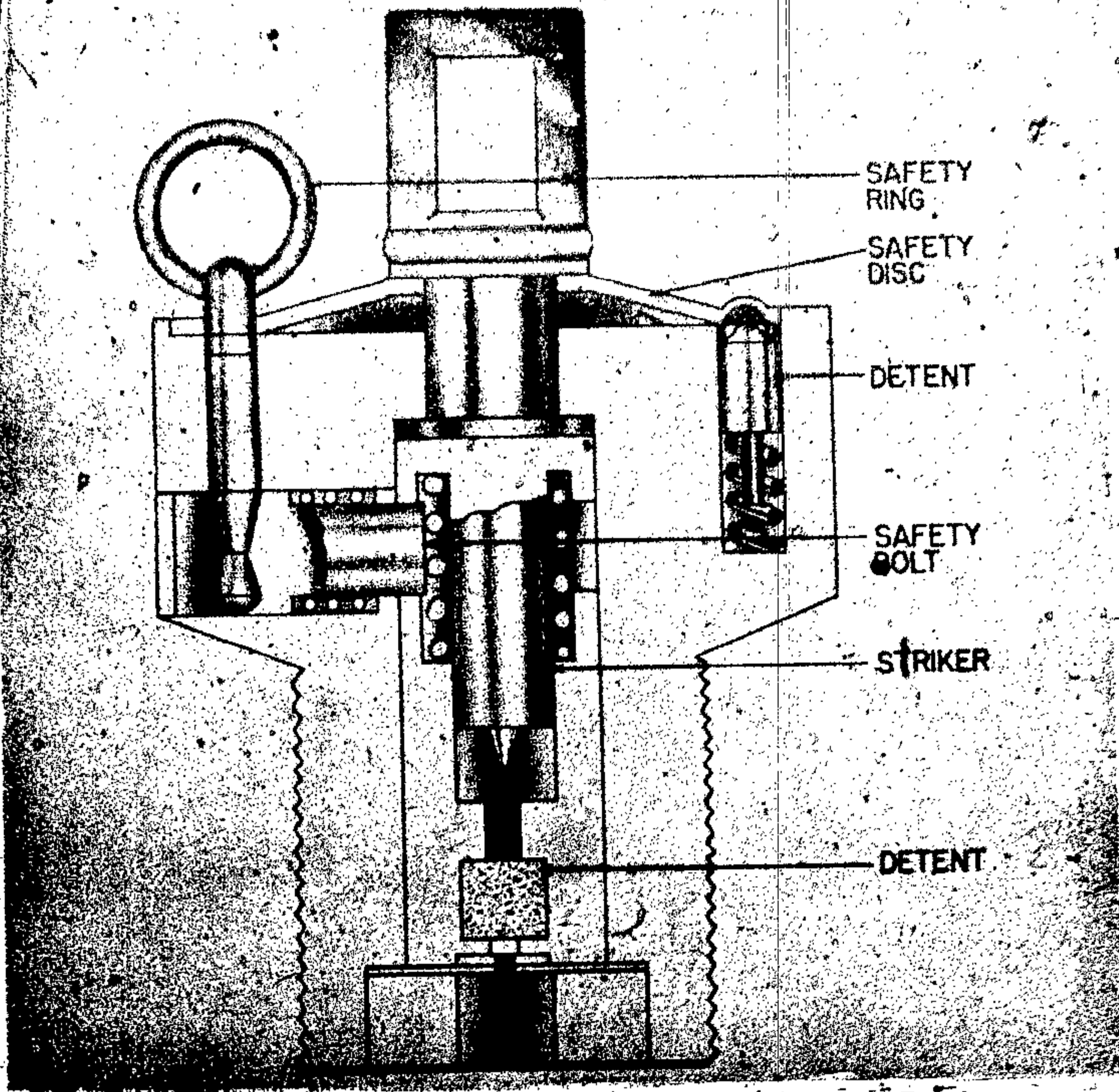

Figure 268 - Incendiary Bomb Fuze

Incendiary Bomb Fuzes Models 1925 and 1930

Data

Bombs used in	Both models 1-kg. Magnesium Incendiary Bombs
Fuzes used with	Alone
Over-all length	3.4 in. (With lug)
Width of fuze body	2.0 in.
Material of construction ..	Magnesium Alloy

Description

The main fuze body is cylindrical, tapering sharply to a smaller cylinder threaded to screw into the bomb case. The top of the fuze is covered by a domed safety cover held in place by a square suspension lug screwed onto the central pillar the base of which is flanged to fit into the striker recess of the fuze. The safety cover has two domed projections 90 degrees apart to receive the spring-loaded stop held in a recess in the body. A safety pin is located in the fuze head 180 degrees from the

spring-loaded stop and is prevented from moving by the safety cover in the safe position. There is a ring at the upper part of the safety pin. The striker block and inertia weight containing the detonator are kept apart by a creep spring and a spring-loaded safety bolt held between the two parts by the safety pin.

Operation

When the bomb is placed in the plane, the suspension lug is rotated 90 degrees, causing the safety cover to rotate also. This allows the opening in the safety cover to come beneath the safety pin, freeing the pin. When the bomb is released, the safety pin ring, which has been held by the dropping gear, is withdrawn; this allows the spring-loaded safety bolt to move from between the striker block and the inertia cap holder. On impact, the inertia cap holder "sets forward", compressing the creep spring until the striker detonates the detonator.

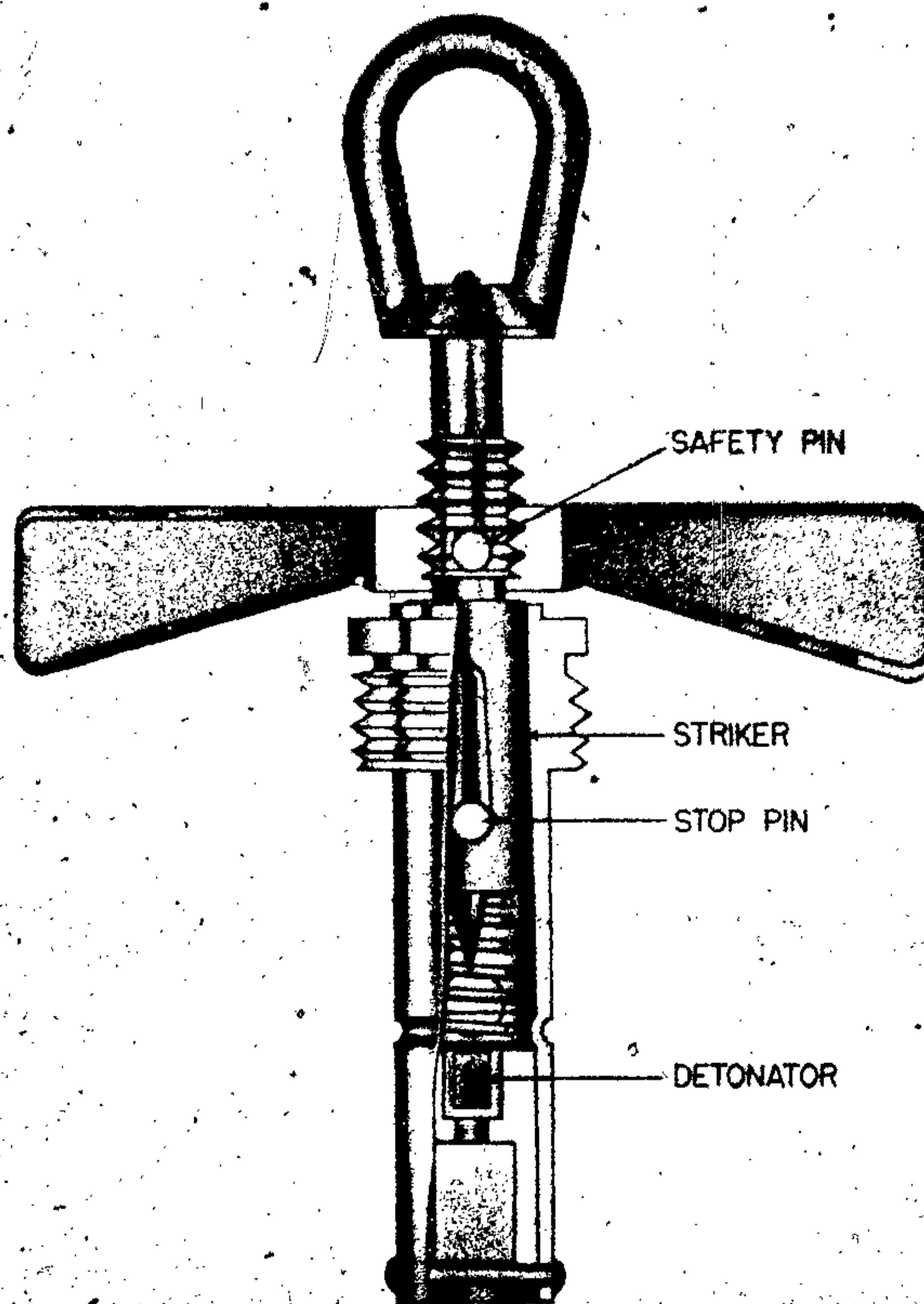

**Figure 269 – Mechanical Impact Nose Fuze
(Designation Unknown)**

Mechanical Impact Nose Fuze (Designation Unknown)

Data

Bombs used in.....	Unknown
Fuze used with.....	Alone
Over-all length.....	4.5 in.
Over-all length of vanes.....	3.2 in.
Width of fuze body.....	0.9 in.

Description

The nose of the fuze consists of a lug which is a part of the striker. The striker is threaded just below the lug in order to receive the arming vanes.

The fuze body has a narrow shoulder, immediately beneath which are the threads which screw into the nose-fuze pocket of the bomb. A stop pin inserted in a channel in the striker prevents the spindle from turning with the arming vanes. The primer cap is located in the lower part of the fuze body, with another small charge of explosives. A creep spring separates the striker from the primer.

Operation

The safety pin is withdrawn when the bomb is dropped. The vanes rotate in flight and raise the striker. The striker then rests on the creep spring. Upon impact, the striker overcomes the creep spring, contacts the primer, and initiates the explosion.

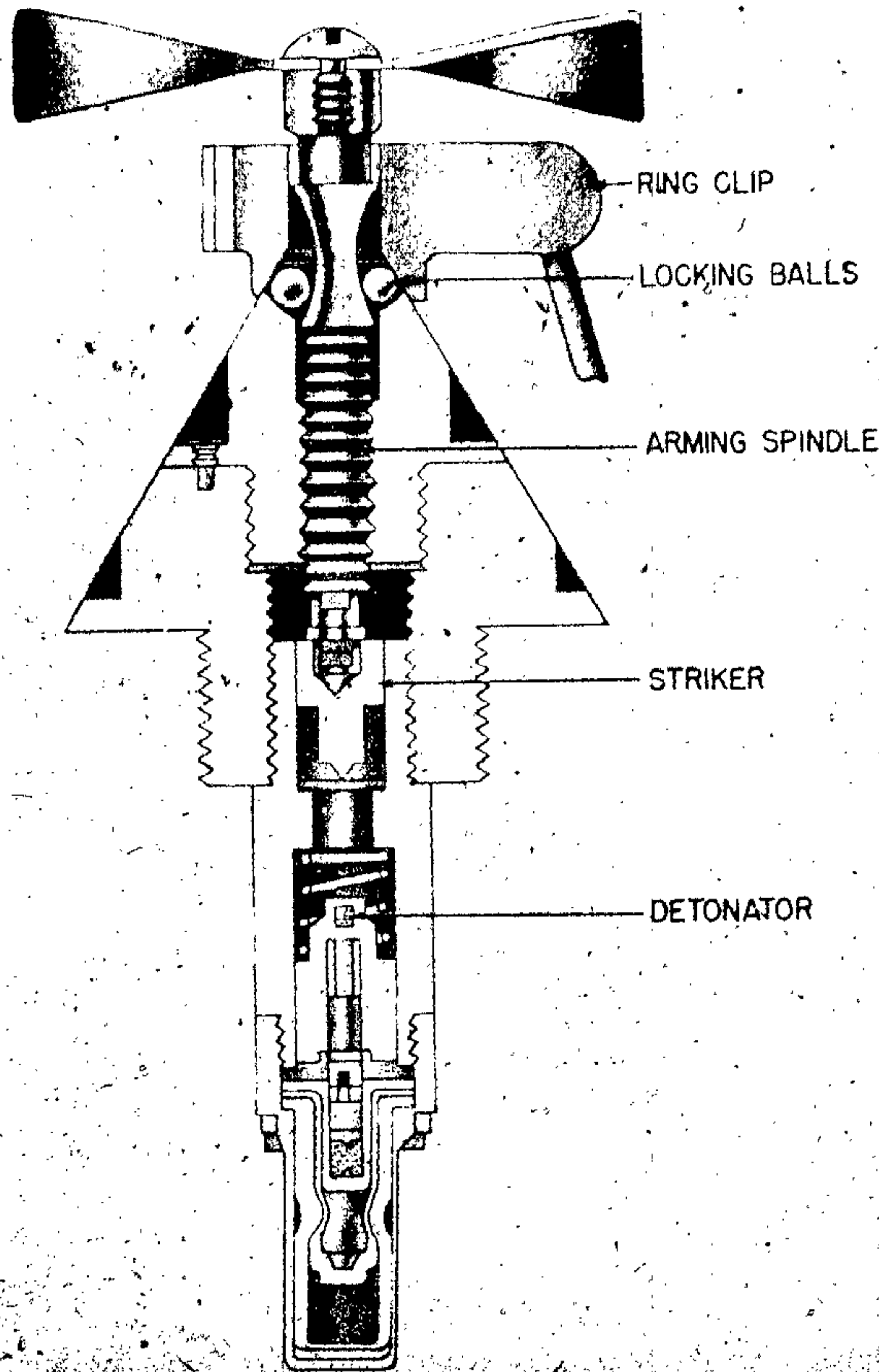

Figure 270 - Mechanical Impact Nose Fuze
No. 10

Mechanical Impact Nose Fuzes No. 9 and No. 10

Data

Bombs used in

No. 9—410-kg. Type I (Naval)

No. 10—125-kg. and 224-kg. Type K (Naval)

Over-all length (No. 10) 6.3 in.

Over-all length of vanes (No. 10) 3.0 in.

Width of fuze body (No. 10) 2.5 in.

Dimensions of No. 9 Unknown

Description

The No. 9 and No. 10 are similar in operation.

The only difference between them is that the No. 10 Fuze has a longer delay. The portion of the fuze which protrudes from the bomb is cone-shaped. A ring clip is inserted between the fuze body and the vanes. The clip retains the two steel balls which fit in the depression of the arming spindle. The striker spindle is attached to the arming spindle by a pin. The detonator is held back by a creep spring. The fuze body is threaded immediately beneath the cone to thread into the bomb-fuze pocket. The base of the fuze is threaded to receive the booster and delay element.

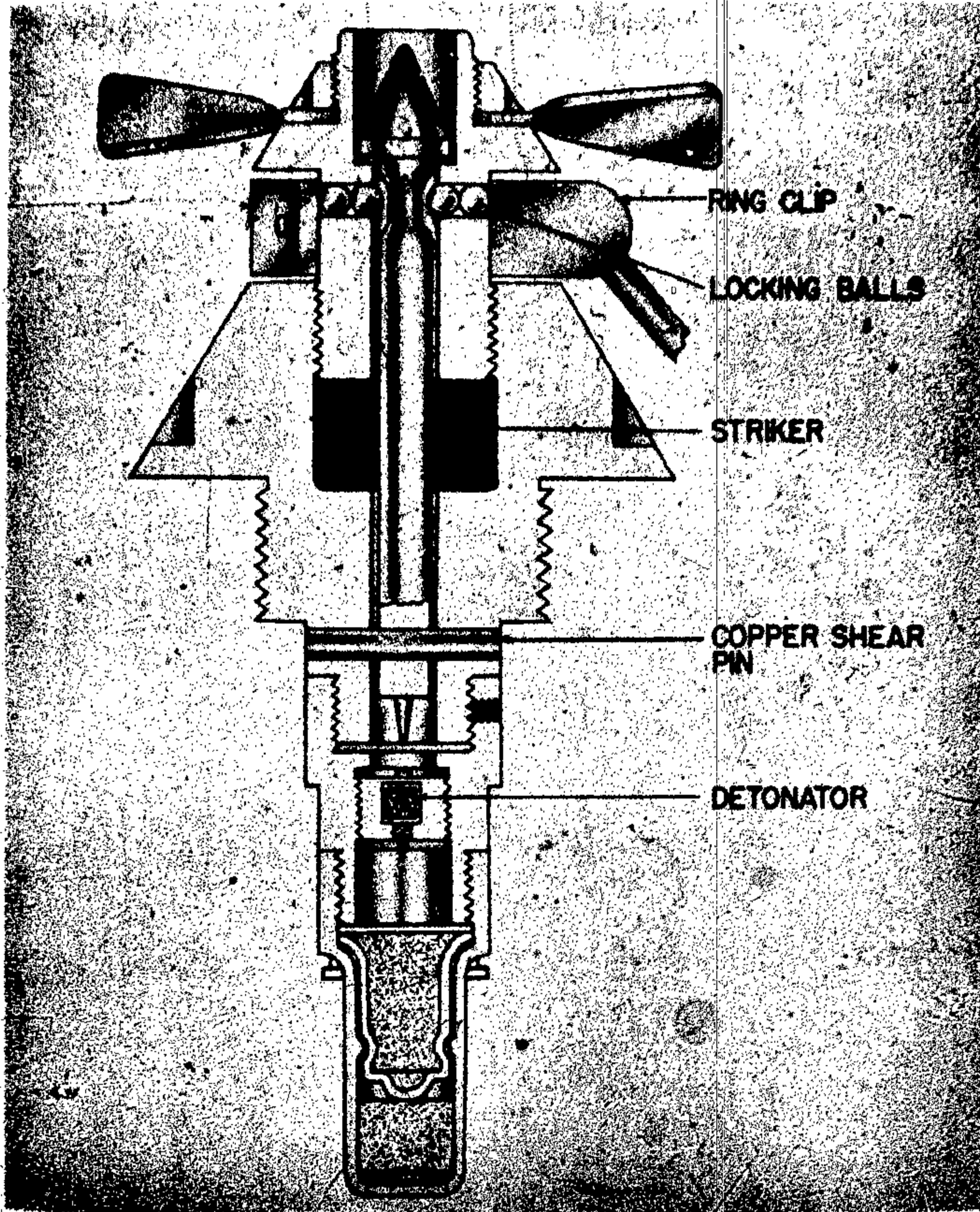

Figure 271 - Mechanical Impact Nose Fuze Type No. 11

Operation

The safety clip is withdrawn upon releasing from the plane. This releases the steel balls, which fall out, permitting the rotation of the arming spindle and vanes to lower the striker until it recesses on the shoulder in the lower part of the fuze. On impact, the detonator overcomes the creep spring and hits the striker.

Mechanical Impact Nose Fuze Type No. 11

Data

Bombs used in
73-kg. G2 (Naval)

150-kg. 12 (Naval)	
720-kg. Type M (Naval)	
Fuzes used with	Unknown
Over-all length	6.0 in. (with booster)
Over-all length	3.0 in.
Width of fuze body	2.6 in.

Description

The portion of the fuze which protrudes from the bomb is cone-shaped. The vanes and vane housing are held from the fuze body by the safety clip. The striker has a painted head which rests in the recess of the vane housing and is held in position by a

copper shear pin. The upper recess of the fuze body is threaded to receive the vane housing. The fuze body is externally threaded beneath the cone to screw into the bomb. The detonating element is contained in a small cup-shaped container which screws onto the base of the fuze.

Operation

Upon being dropped from the plane, the safety clip is withdrawn, and the balls fall out, releasing vane housing. The vanes rotate and screw the vane housing into the recess of the body which exposes the striker head. Upon impact, the striker head is forced down, shearing the copper pin and striking the detonator cap, exploding the bomb.

Mechanical Impact Tail Fuze No. 3 Bis.

Data

Bombs used in	50-kg., 100-kg., 200-kg., 500-kg. G. P.-H. E.
Fuzes used with	Type H Model 1921 R. S. A. Mle. 25, Mle. 28, and Mle. 1930
Over-all length	16.0 in. (with booster) 14.5 in. (without booster)
Over-all length of vanes	3.0 in.
Width of fuze body	0.9 in.

Description

The body is long and cylindrical, being internally threaded at the top to receive the dome-shaped brass collar. The brass collar is internally threaded to receive the arming spindle. The arming spindle is connected to the vanes, which are six in number. The arming spindle screws into the striker. Beneath the striker are the creep spring and detonator. The base of the body is externally threaded to screw into the bomb, and it also has external threads at the base to receive the booster.

Operation

A piece of copper wire prevents the vanes from rotating. Upon being released from the plane, the wire is broken, permitting the vanes to rotate, thus withdrawing the arming spindle. The vanes and spindle may fall away and free the striker to rest on the creep spring. The fuze is fully armed when the threaded spindle is withdrawn 0.5 in. Upon impact, the striker overcomes the creep spring, striking the detonator, which ignites black powder in the tube. The flash goes down the flash channel to the delay and relay elements respectively, which detonate the bomb.

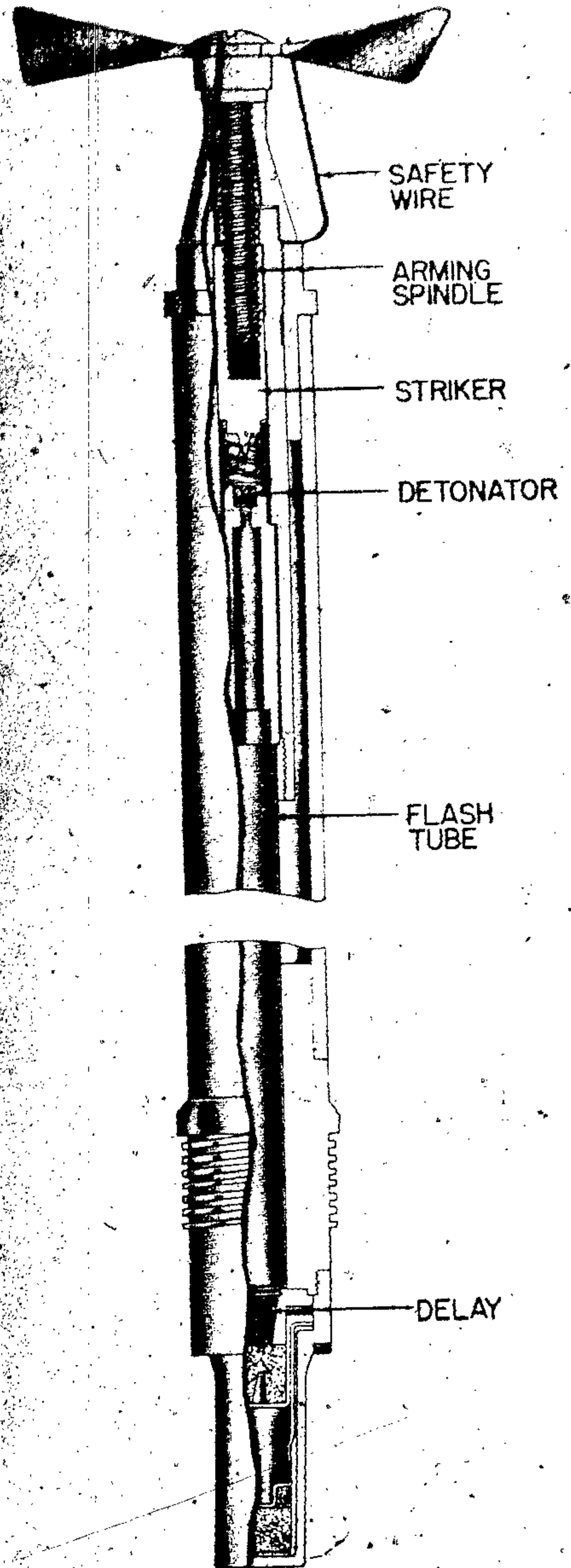

Figure 272 - Mechanical Impact Tail Fuze No. 3 Bis

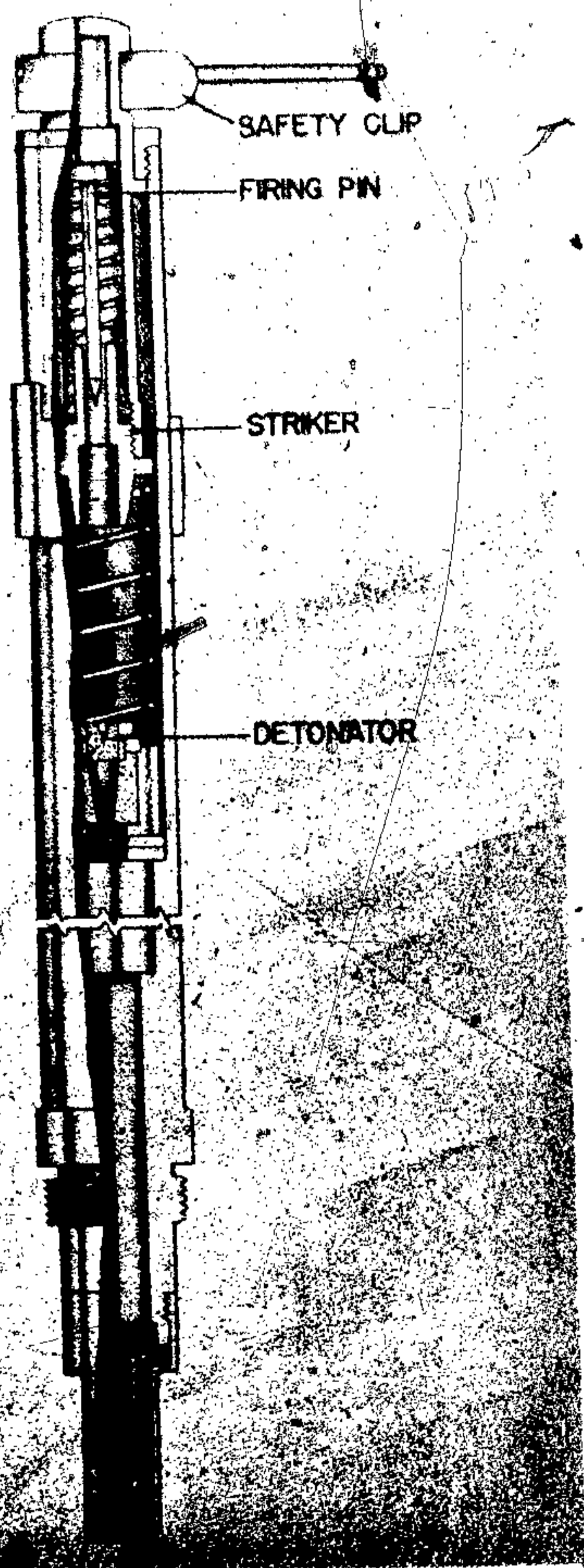

Figure 273—Mechanical Impact Tail Fuze Sch. R. Model 1938

Mechanical Impact, Tail Fuze—Sch. R. Model 1938

Data

Bombs used in	
50-kg. D. T. No. 2, 100-kg., 200-kg., 500-kg. Model 1930 G. P.-H. E.	
Fuzes used with	Unknown
Over-all length	16.0 in. (with booster)
Width of fuze body	1.15 in.

Markings 24 Mle. 1938
Sch. R.

Description

In 1939, this was the only French tail fuze in production. In the top of the fuze, fits the striker assembly, which consists of a firing pin and a creep spring held in the striker housing. A second creep spring is placed between the striker and the detonator. On the top of the striker is the spring safety ring which locks the striker assembly in position. Below the detonator flash tube leading to a lower relay and booster, a delay pellet may be placed between the upper detonator and lower relay.

Operation

When the bomb is dropped, the spring clip is withdrawn, freeing the split safety ring. There is no arming action during flight. On impact, the striker assembly is carried forward by inertia, compressing the spring until the striker comes up against the detonator holder. The firing pin then moves forward against its spring and hits the detonator. The detonation is then transmitted through the relays to the booster. For delay action, the detonator must pass through the delay pellet.

Remarks

The fuze body has a color band painted at the top of the fuze body to indicate delay time as follows:
White (S. R.)—Instantaneous
Alternate White and Black (C. R.)—Short Delay (0.05 seconds)
All Black—Long Delay (0.15 seconds)

Mechanical Impact Tail Fuzes No. 7 and No. 8

Data

Bombs used in	
No. 7—222-kg. Model 1938 and 438-kg. Model 1938	
No. 8—125-kg. and 224-kg. Type K. 410-kg. Type L, 720-kg. Type M, 73-kg., G2 and 150-kg. 12	
Fuzes used with	Unknown
Over-all length (No. 7)	16.4 in.
Over-all length of vanes (No. 7)	4.4 in.
Width of fuze body (No. 7)	1.9 in.

Description

These two fuzes are essentially similar. The arming vanes are connected to the arming spindle. The lower end of this spindle is threaded to the striker. As a safety device, the ring safety clip retains the steel balls, which are forced against the spindle to prevent rotation and withdrawal. Beneath

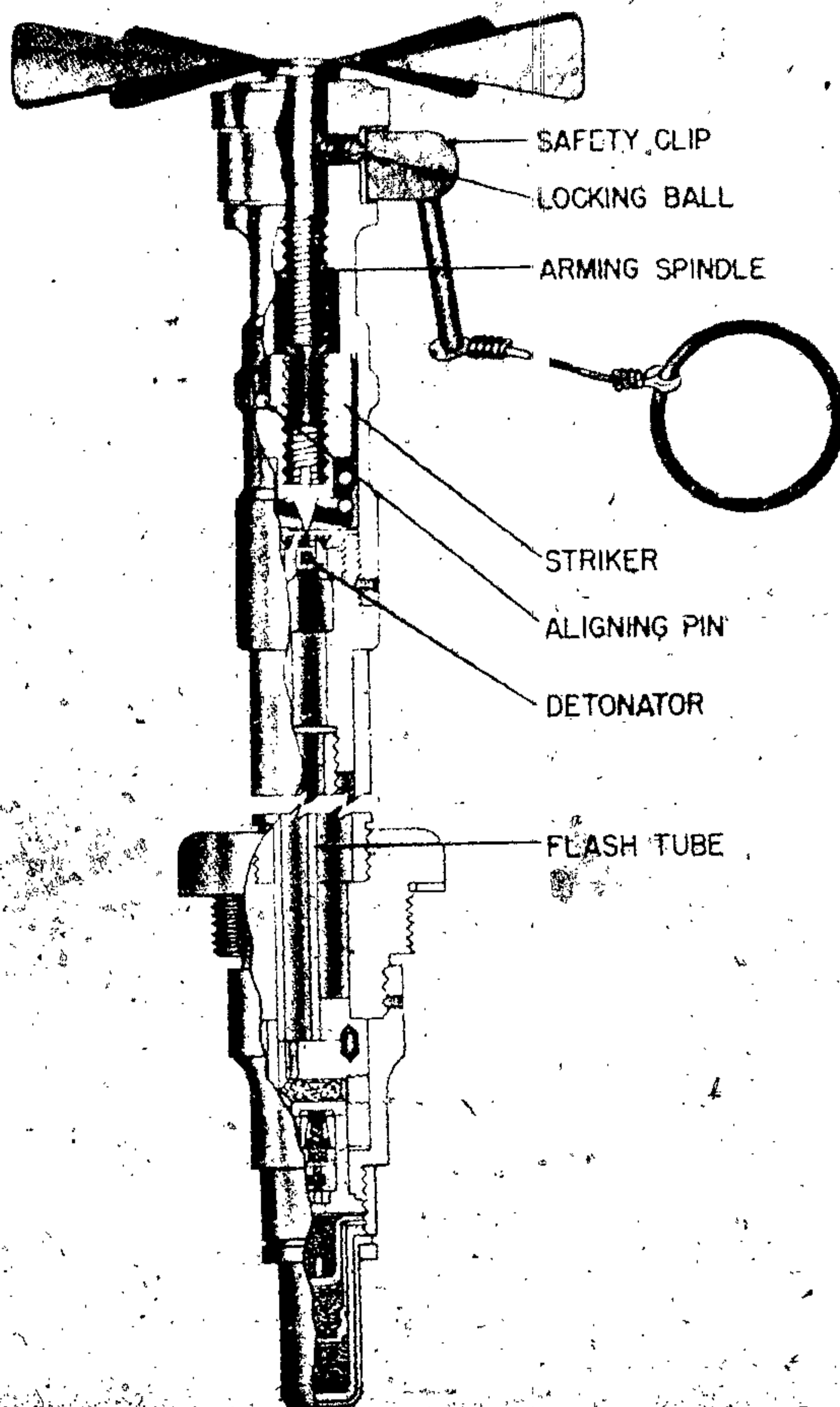

Figure 274 - Mechanical Impact Tail Fuze No. 7

the striker are the creep spring and detonator. The fuze body is threaded beneath the lower flange to screw into the bomb. The lower portion contains a long flash tube to the firing system, screwed into the base of the fuze. A small cone-shaped valve is also located in the base.

Operation

The ring clip under the head of the fuze is withdrawn when the bomb falls; the balls fall out, and the vanes rotate and raise the threaded spindle. The lower end of the spindle is also threaded, so

that the striker in which the end is housed becomes free as the screw is withdrawn upwards. The striker is then held by the creep spring. On impact the striker hits the detonator. The flash is carried down the tube to the delay pellet, which pressure builds up until it forces open the small spring cone-shaped valve. As the valve opens, the flash passes to another delay pellet, and then to the booster lead-in and booster.

Remarks

These fuzes can be set for delay ranging from 1.0 to 7.0 seconds.

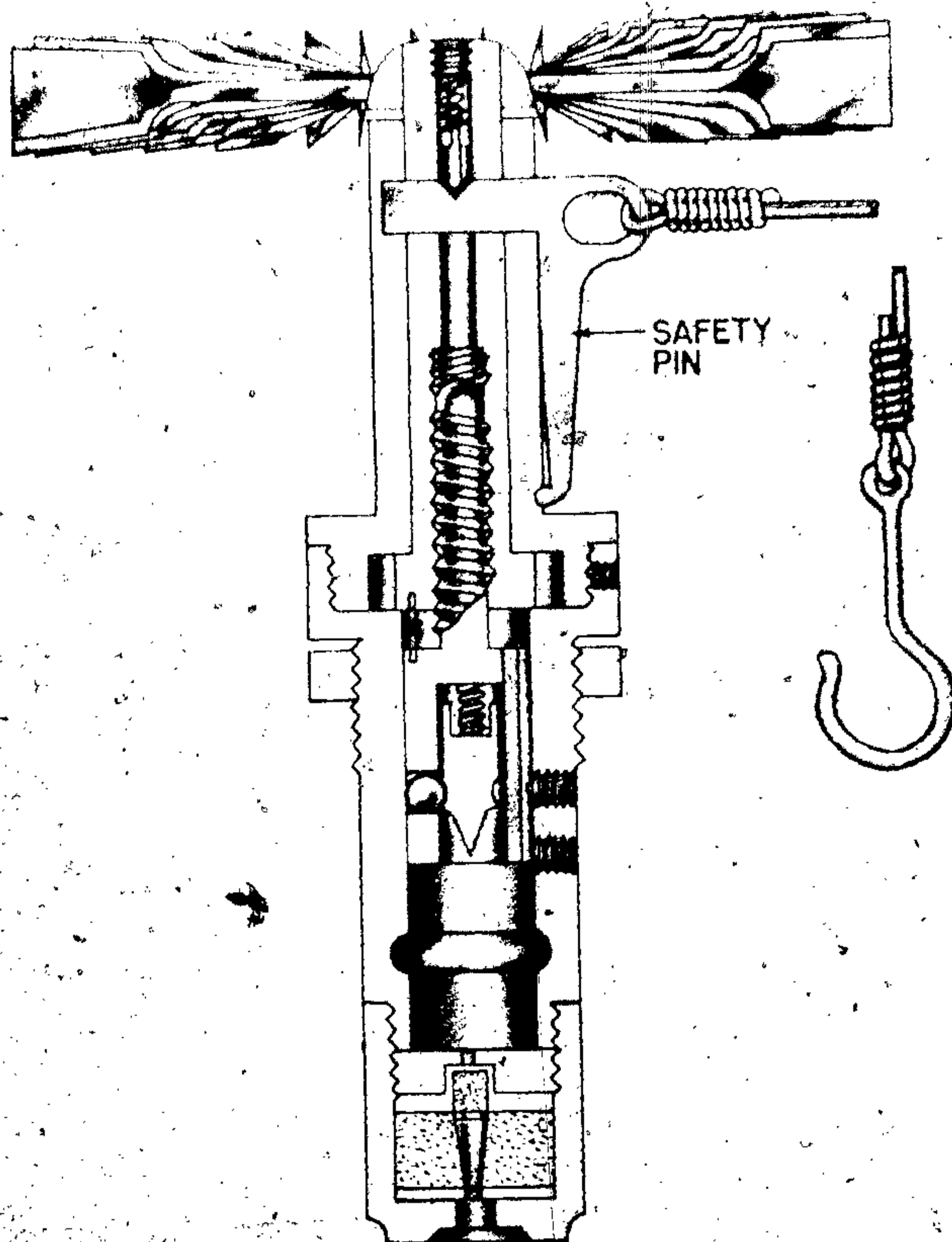

Figure 275 - Mechanical Time Fuze — Model 1930

Mechanical Time Fuze—Model 1930

Data

Bombs used in.....	Newer Type 10-kg. Parachute Flare
Fuzes used with.....	Alone
Over-all length.....	5.0 in. (with booster)
Over-all length of vanes.....	3.45 in.
Width of fuze body.....	1.25 in.

Description

The upper portion of the fuze is a cylindrical tube holding a sleeve, the lower part of which is threaded to receive an arming spindle. The vanes are secured to the domed cap screwed atop the sleeve. The L-

shaped safety bolt engaged by a spring-loaded detent prevents the rotation of the vanes. The arming screw spindle has a tubular base where the steel balls hold a spring-loaded striker. An angular groove is cut into the body just above the detonator. The booster screws onto the fuze base.

Operation

When the bomb is released, the L-shaped safety bolt is withdrawn. The vanes rotate, turning the sleeve, which causes the arming spindle to move downwards until the steel balls are freed into the angular groove in the body. The striker then moves forward because of its spring and fires the detonator. The fuze requires 3 to 4 seconds to arm and function, after release from the plane.

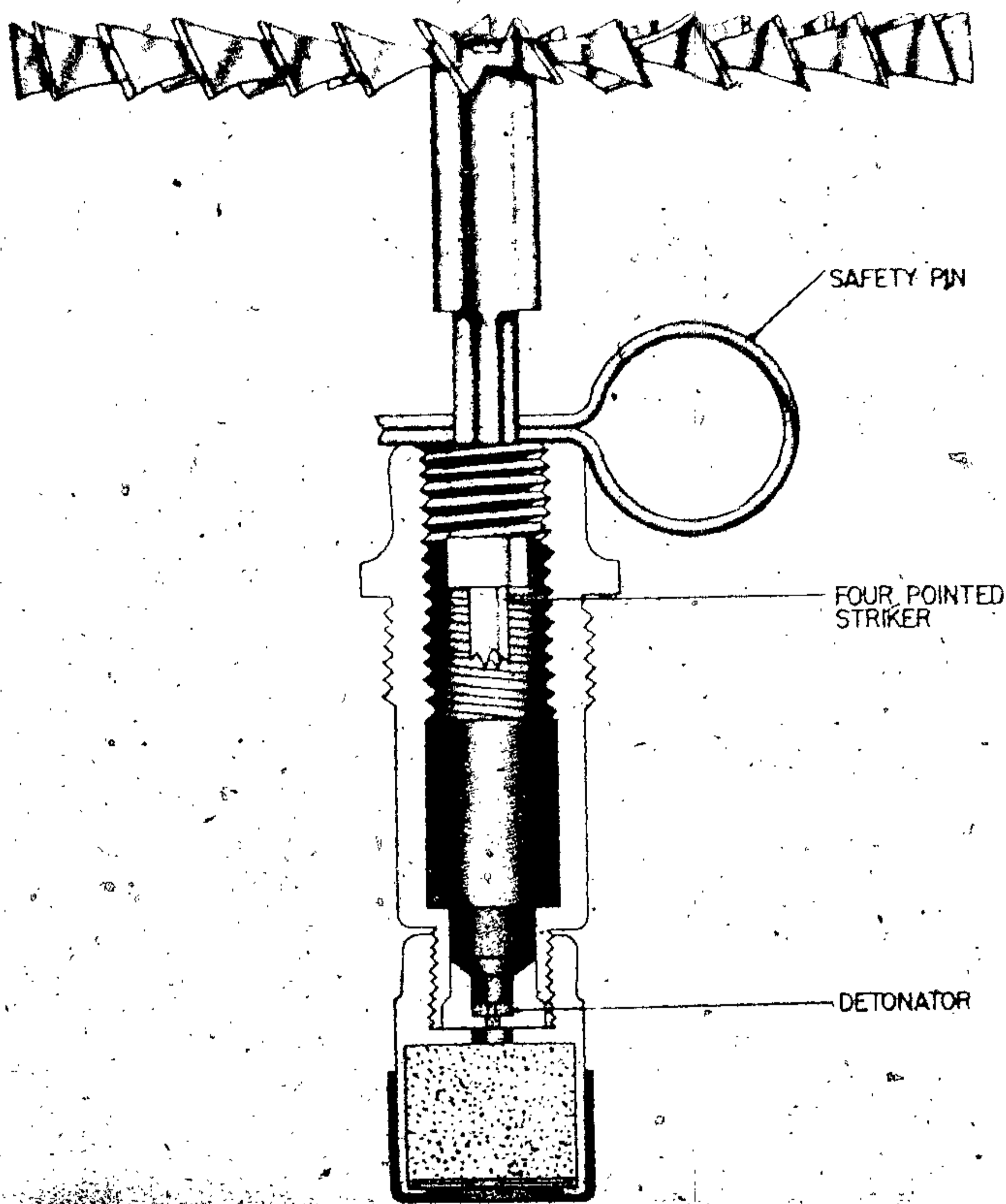

Figure 276 — Mechanical Time Fuze — V.M.

Mechanical Time Fuze—V.M.

Data

Bombs used in	Older Type 10-kg. Parachute Flare
Fuzes used with	Alone
Over-all length	5.2 in. (with booster)
Over-all length of vanes	4.2 in.
Width of fuze body	1.15 in.

Description

The fuze has 28 arming vanes secured to a striker. The fuze body is cylindrical, and externally threaded

to screw into the flare nose-piece. A brass fitting holds the detonator in the fuze base. The booster holder screws onto the base. The split safety pin penetrates the striker's upper portion to prevent rotating.

Operation

When the safety pin is withdrawn, the vanes rotate and screw the four-pointed striker down until the threaded portion disengages the threaded section of the fuze. Air pressure then forces the four-pointed striker down onto the detonator, which ignites the booster. The time for the fuze to arm and function is 2.5 to 3.0 seconds, corresponding to 100 to 150 feet of air fall.

FRENCH MINES AND TRAPS

60-mm Model 1939—Anti-Personnel Mine

Data

Over-all height	8.25 in.
Supporting plate	6.4 in. x 4 in.
Type of filling	Melinite
Weight of filling	5 oz.
Total weight	5.5 lb.

Description

The steel projector tube, of 60.3-mm bore, is closed at its upper end by a cap with a rubber sealing

washer, which is held in position by clips. At its lower end, it is closed by a machined base plate, driven into position and fixed by dowels, into which a flash tube is screwed.

An igniter adapter is screwed onto the open end of the flash tube. Located in the flash tube is a propelling charge, consisting of 0.8 gm. of black powder. Inside the projector tube, the pressed-steel cap, to which is welded the fuze holder, is a push fit over the base plate.

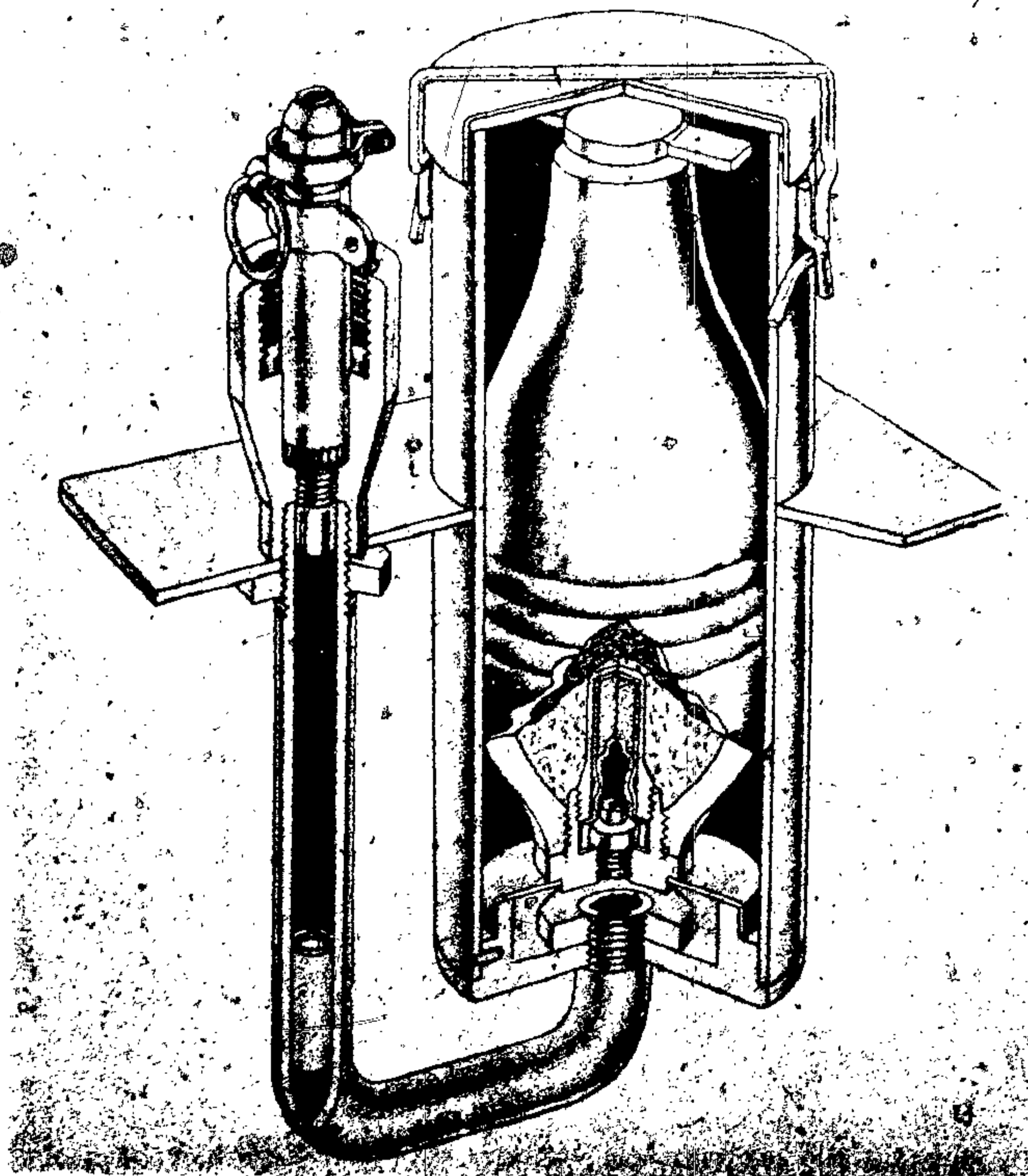

Figure 277 — 60-mm Model 1939 —
Anti-Personnel Mine

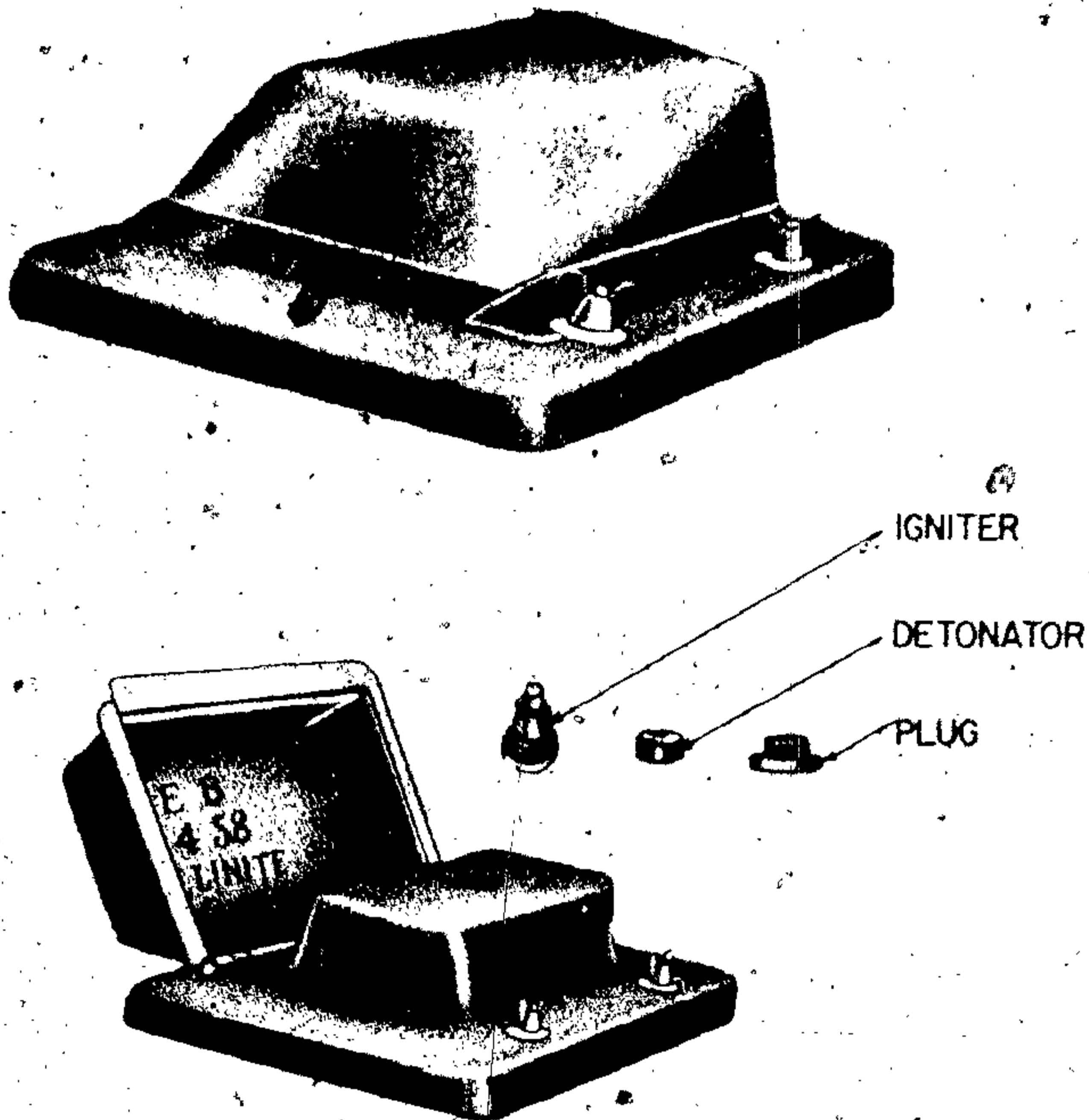

Figure 278 - Light Anti-Tank Mine

The fuze holder is threaded externally to fit into the mortar bomb and internally to take the holder containing a detonator. The bush containing a delay pellet is screwed into the fuze holder. There is a small distance piece to prevent the detonator from being screwed down onto the delay pellet. The projector tube and flash tube are fixed to a rectangular plate. This plate is designed to fit over the hole, in which the lower part of the mine is placed, to insure that the mine remains vertical and also to prevent it from sinking if it is used with a pressure igniter. A winged plug is provided to screw into the tail of the bomb to assist screwing it onto the fuze assembly.

Operation

This mine is designed to throw a 60-mm mortar bomb into the air so that it will explode at a height of between 1 ft. 7 in. and 6 ft. 6 in. The flash from the cap in the igniter fires the propelling charge. The gases produced from this charge expand into the space in the base of the projector tube and

throw up the pressed-steel cap together with the mortar bomb screwed to it. At the same time, the delay pellet is ignited and, after a delay of about $\frac{1}{3}$ second, the detonator and the bomb are exploded.

Light Anti-Tank Mine

Data

Over-all length	12 11 in.
Over-all width	8.11 in.
Over-all height	4 4 in.
Type of filling	Picric Acid
Weight of filling	6.09
Igniter	Pressure type, Models, 1935 and 1936

Color and markings

Camouflage—brown and black
 Markings on upper surface within fuze well:

ASS	
10. 39	
M. F.	
Total weight	13.41 lb.

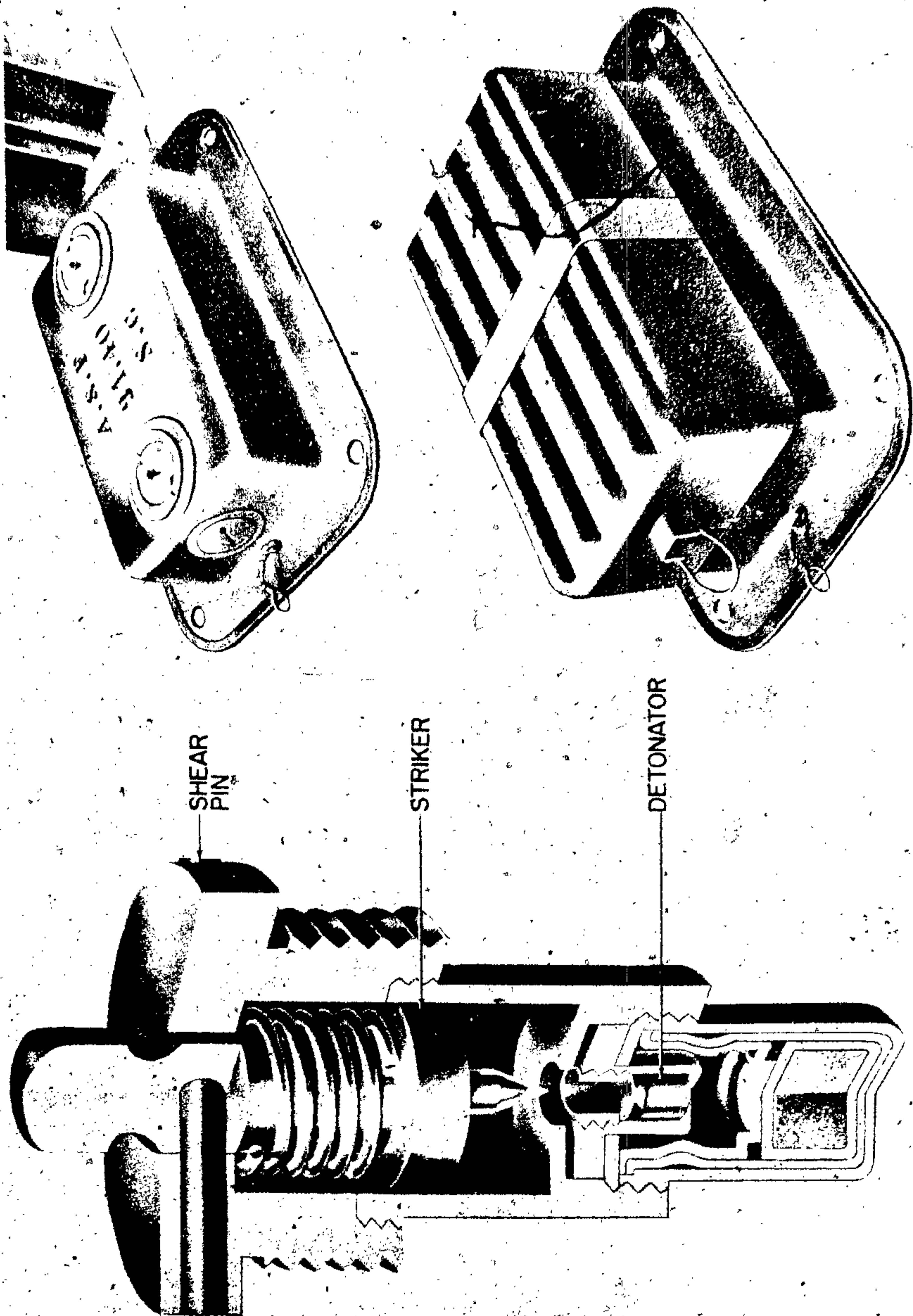

Figure 279 - Heavy Anti-Tank Mine

Description

The mine consists of a rectangular metal container loaded with picric acid. A metal cover, which fits over the loaded container, rests on two pressure-types igniters or fuzes. An aluminum safety bar prevents functioning of the igniter until removed, presumably after setting the mine in the ground.

The base plate has drilling at each corner to receive the holding-down lugs. The cover is corrugated and is strengthened internally by the two metal supports. The mine lid is held loosely in position by the mine-cover chains which are attached at either end to the base of the mine.

Heavy Anti-Tank Mine

Data

French designation	Mine allongee lourde
Over-all length	16.2 in.
Over-all width	9.85 in.
Over-all height	4.75 in.
Weight of filling	3.25 lb.
Total weight	27 lb.

Description

The mine consists of a rectangular pressed-steel base plate, to which is welded the explosive container, and a thin pressed-steel cover. In the top of the explosive container is a single socket for igniter, detonator, and primer. The lid is hinged

to the base plate along one side, while two wing nuts are provided on the opposite side to hold the lid shut. The igniter is similar to that fitted in the French light A. T. mine. Igniters of either type may therefore be fitted as follows:

MODEL 1935:

- Material of body and striker—steel
- Material of cap and detonator assembly—brass
- Diameter of shear pin—0.36 in.

MODEL 1936:

- Material of body and striker—aluminum
- Material of cap and detonator assembly—aluminum
- Diameter of shear pin—0.28 in.

In arming the mine, the plug protecting the igniter socket is removed and the primer is placed in position; this latter consists of a small circular metal container with a central hole to receive the detonator. The igniter, with detonator, is then screwed in place.

Operation

The igniter functions when a load on the mine crushes the cover and, descending onto the striker head, shears the igniter pin. A strong steel spring then forces the striker onto the cap, thus firing the detonator, primer, and mine. The igniter is normally supplied with a loose metal safety collar. This collar is placed in position on the head of the igniter body during transportation to prevent any load falling on the striker head.

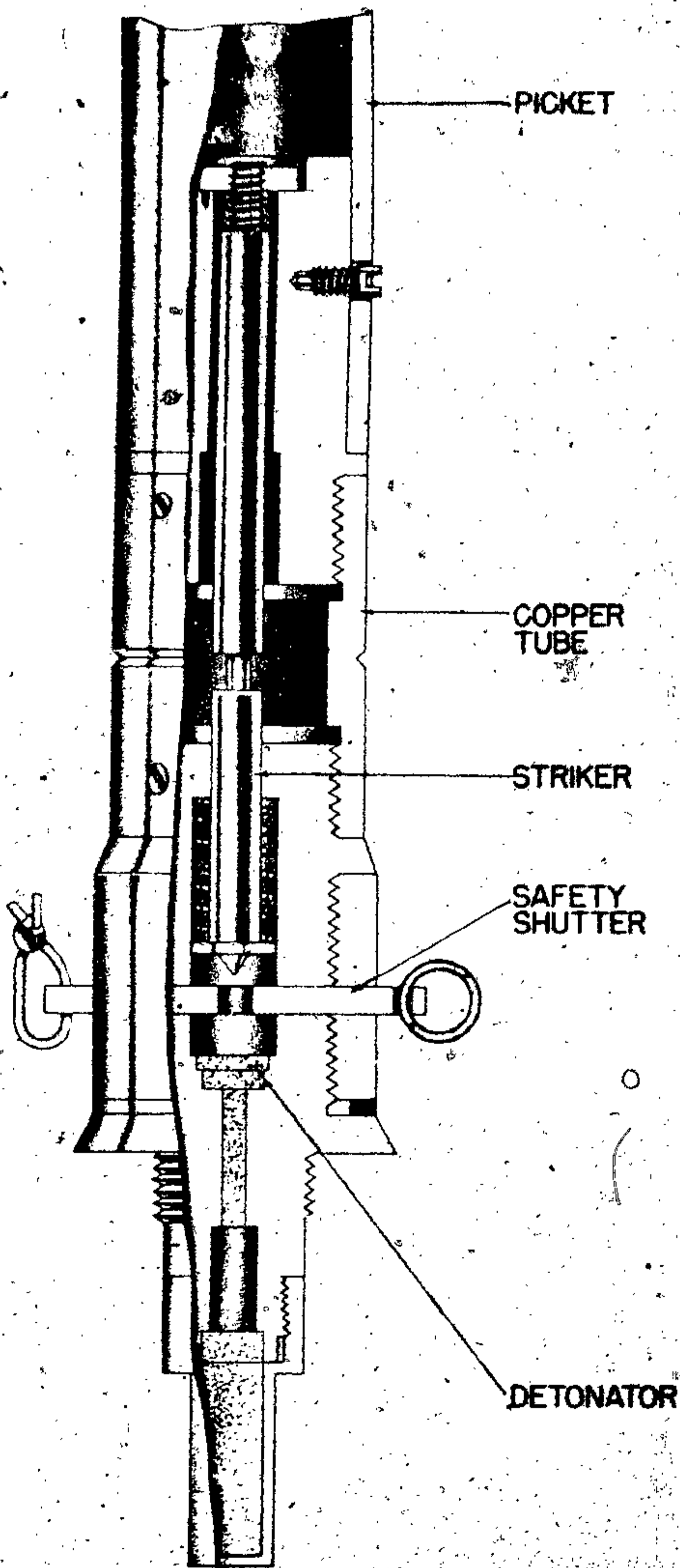

Figure 280 - Rupture Igniter

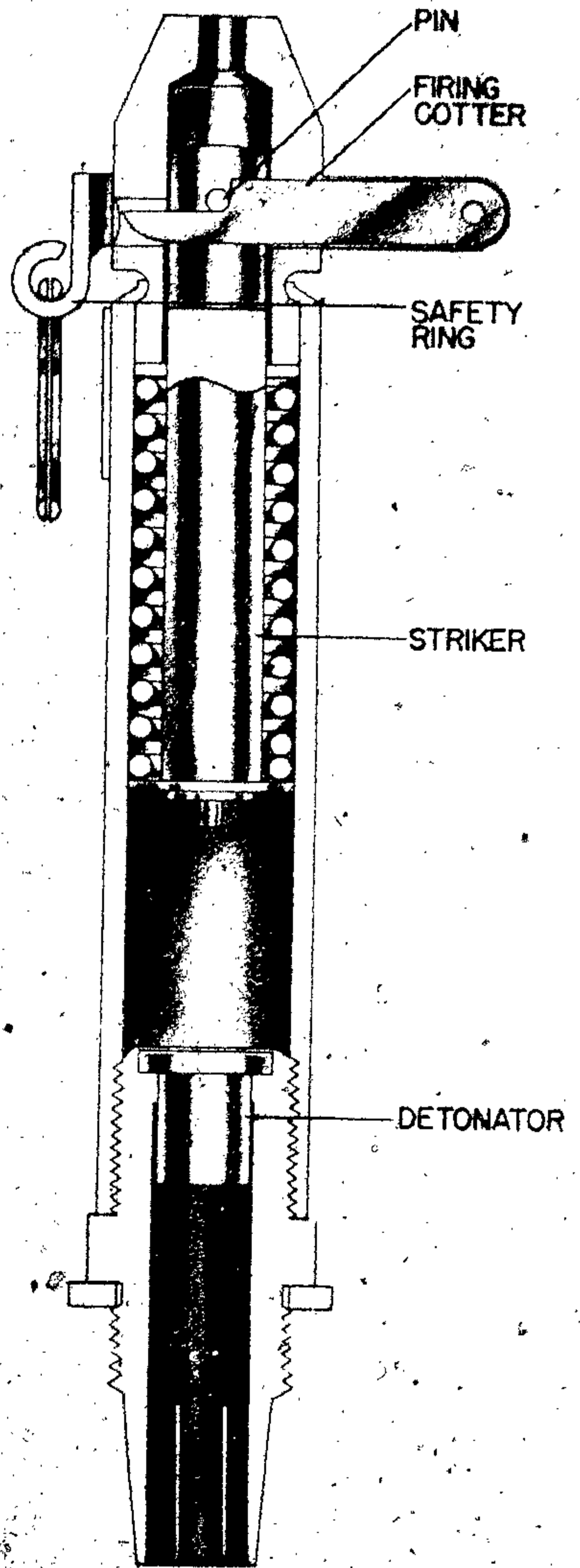

Figure 281 - Pull Igniter Model 1939

Chapter 11

FRENCH IGNITERS

Rupture Igniter

Data

Over-all length	8.65 in. (incl. detonator)
Diameter	1.75 in. (excl. safety shutter)
Pressure to actuate	52-kg.

Use

The igniter is screwed into the nose of obsolete 12- or 15-cm shells for use as improvised mines. A tubular picket is then fitted over the top of the igniter, the grub screw making a bayonet joint.

Description

The notched copper tube is fitted with the boss piece and the striker guide piece. Running through this assembly is a striker, which is held against the spring by the nut. The locking pin on the underside of the nut seats in the top of the boss piece to prevent the nut from working loose and releasing the striker.

The union, joining the cap holder to the striker guide piece, carries the safety shutter. The safety shutter cannot be withdrawn if the striker has accidentally been released, as the striker head would have entered in the hole. The detonator holder containing the detonator is screwed onto the open end of the cap holder.

Operation

The seal is broken and the safety shutter is withdrawn by means of a cord attached to the ring. A thrust applied to the top of the picket will rupture the copper tube at the circumferential notch and shear the striker at the neck. This releases the spring-loaded striker head to fire the cap, and then, through the 0.75-sec. delay pellet and the powder train, the detonator.

Pull Igniter Model 1939

Data

Over-all length	3.35 in.
Diameter of body	0.5 in.
Width, safety pin closed	1 in.
Mine used in	French A/P Mine (60-mm) Model 1939

Description

The head is free to rotate in the top of the main body. The cap holder has a collet at its lower end to enable a detonator to be pushed into it. A transit cap is fitted to protect the cap from dampness.

The striker is forked at the top to enable the firing cotter to be pushed home below the cross head pin. While in compression, the spring pushes against a metal washer and a packing washer.

A safety ring is pinned to the projecting end of the firing cotter. In the safety position this ring folds back over the head of the igniter, preventing the cotter from being withdrawn. During transit, the trip cord, fixed to the loop, is wound round the body of the igniter, to prevent movement of the safety ring.

Operation

The safety ring is unfolded from the head of the igniter. The igniter is then armed. If a pull is exerted on the safety ring, the firing cotter is pulled out, and the striker is free to descend onto the cap under the action of the spring.

If the pull is not exerted directly in line with the cotter, but, say, in line with the axis of the igniter, the cotter will pivot about its inner chamfered end, but will finally be withdrawn through the slot in the head of the igniter.

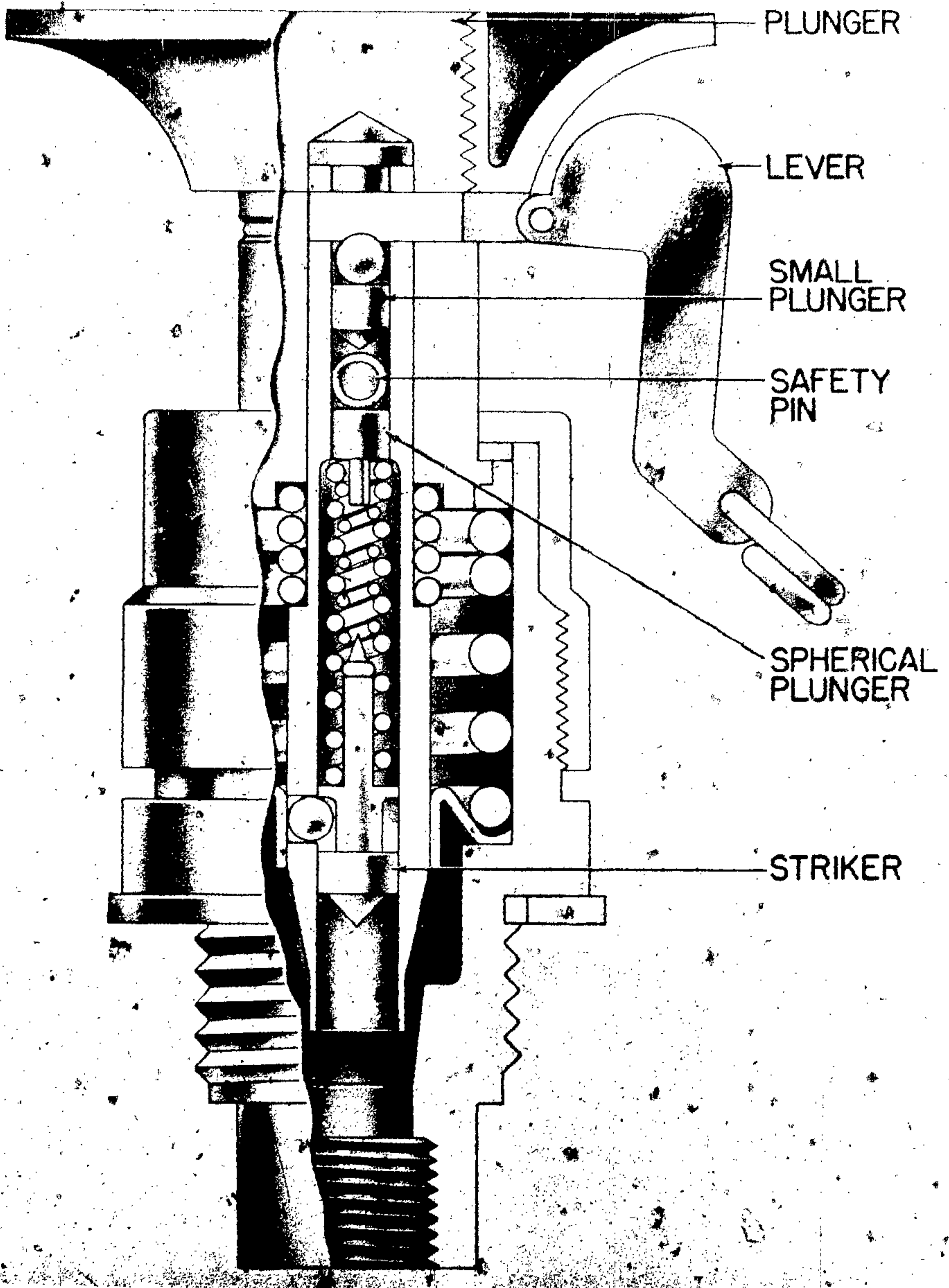

Figure 282 - Push-and-Pull Igniters

Push-and-Pull Igniters

Data

Over-all length	3.45 in.
Over-all diameter	1.95 in.
Pressure or tension	40-to 45-kg. (Pressure igniter)
Required to actuate	4-kg. (Pull igniter)
Mine used in	French A. P. Mine (60-mm) Model 1939

Description

The body is covered by a screw cap through which a pressure head is free to move against a compression spring. A striker guide is held in position inside the pressure head by a firing cotter, and, in the unarmed position, by a safety pin. The lower end of this guide is positioned in the body by a guide piece. The striker guide is finished, both internally and externally, to two different diameters, and a small spring is held in compression between the shoulder and the underside of the pressure head.

The striker is held in position against an actuating spring by a detent ball. The upper end of this spring is held against the shoulder formed by the change in diameter of the hole through the striker guide. Inside the actuating spring is a spring which holds the small spherical-headed plunger against the safety pin. Above the safety pin is a further small plunger which holds a detent ball rigidly in position in the recess in the cotter.

Pinned to the outer end of the cotter, is a fork, resting in the groove round the pressure head, and a cotter-extractor lever, carrying a ring to which the trip-wire is attached. The lower end of the body is threaded internally to receive the cap and detonator holder.

Operation

With the safety pin in position, the cotter is locked in position by the plunger and the ball. At the same time, the pressure head cannot be depressed as the safety pin rests on the screw cap.

When the safety pin is removed, the plunger rises under the action of the spring. This blocks the safety pin hole and holds the plunger and the detent ball lightly against the cotter. The igniter is then armed.

1. **PRESSURE FIRING:** A load of 90-100 lb. applied to the pressure head will force down the head against the spring. With the cotter still in position, the head and the striker guide will move as one until the striker detent ball is clear of the guide piece. This ball is then free to escape and the striker can ascend onto the cap under the action of the spring.

2. **PULL FIRING:** Under the influence of a pull on the ring, the cotter-extractor lever, which has a rocker action against the underside of the pressure head, will put out the cotter, thus freeing the striker guide from the pressure head. The spring, working between the base of the pressure head and the shoulder, will force down the guide and free the detent ball. The striker is freed and fires the cap.