



This is a digital copy of a book that was preserved for generations on library shelves before it was carefully scanned by Google as part of a project to make the world's books discoverable online.

It has survived long enough for the copyright to expire and the book to enter the public domain. A public domain book is one that was never subject to copyright or whose legal copyright term has expired. Whether a book is in the public domain may vary country to country. Public domain books are our gateways to the past, representing a wealth of history, culture and knowledge that's often difficult to discover.

Marks, notations and other marginalia present in the original volume will appear in this file - a reminder of this book's long journey from the publisher to a library and finally to you.

Usage guidelines

Google is proud to partner with libraries to digitize public domain materials and make them widely accessible. Public domain books belong to the public and we are merely their custodians. Nevertheless, this work is expensive, so in order to keep providing this resource, we have taken steps to prevent abuse by commercial parties, including placing technical restrictions on automated querying.

We also ask that you:

- + *Make non-commercial use of the files* We designed Google Book Search for use by individuals, and we request that you use these files for personal, non-commercial purposes.
- + *Refrain from automated querying* Do not send automated queries of any sort to Google's system: If you are conducting research on machine translation, optical character recognition or other areas where access to a large amount of text is helpful, please contact us. We encourage the use of public domain materials for these purposes and may be able to help.
- + *Maintain attribution* The Google "watermark" you see on each file is essential for informing people about this project and helping them find additional materials through Google Book Search. Please do not remove it.
- + *Keep it legal* Whatever your use, remember that you are responsible for ensuring that what you are doing is legal. Do not assume that just because we believe a book is in the public domain for users in the United States, that the work is also in the public domain for users in other countries. Whether a book is still in copyright varies from country to country, and we can't offer guidance on whether any specific use of any specific book is allowed. Please do not assume that a book's appearance in Google Book Search means it can be used in any manner anywhere in the world. Copyright infringement liability can be quite severe.

About Google Book Search

Google's mission is to organize the world's information and to make it universally accessible and useful. Google Book Search helps readers discover the world's books while helping authors and publishers reach new audiences. You can search through the full text of this book on the web at <http://books.google.com/>

THE
ORIFICE METER
AND
GAS MEASUREMENT

=====
BROWN AND HALL

YB 10806

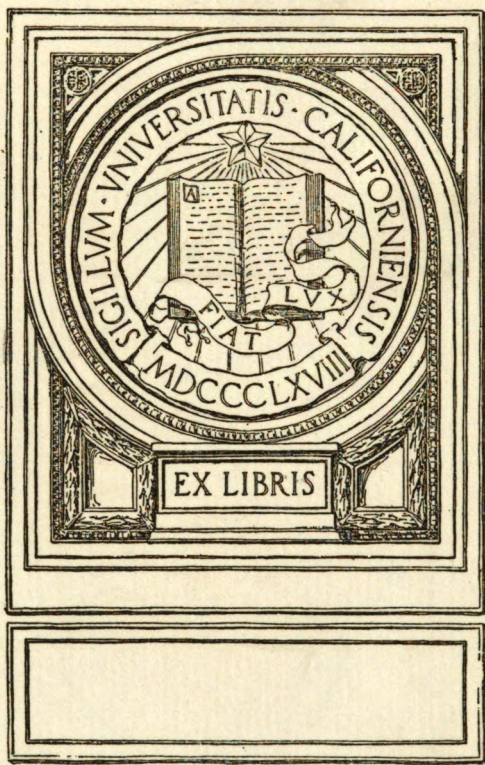



**THE ORIFICE METER AND
GAS MEASUREMENT**

THE
ORIFICE METER
AND
GAS MEASUREMENT

By
WILLIS C. BROWN
Jun. Am. Soc. M. E.

AND
MALCOLM B. HALL
Assoc. Mem. Am. Soc. M. E.

FOXBORO, MASS.
THE FOXBORO CO., INC.
NEPONSET AVENUE

Copyright, 1921
By THE FOXBORO CO., INC.

First edition, January, 1921



THE UNIVERSITY PRESS, CAMBRIDGE, MASS., U.S.A.

PREFACE

IN response to numerous enquiries, the manufacturers of the first commercial Orifice Meter for gas measurement have considered it advisable to set before the public authentic information relating to orifice coefficients and their derivation, and complete details of the mechanical construction of their own Orifice Meter.

So many business friends have helped the authors in so many ways to make these pages of practical service to gas men that a detailed statement of obligations is impossible; but their assistance is here gratefully acknowledged.

While every effort has been made to insure the accuracy of statements, tables, and formulas, the authors know how easily mistakes may occur. They will, therefore, welcome any criticism or correction of errors or suggestions for the improvement of a future edition.

THE AUTHORS.

JANUARY, 1921.

456769

CONTENTS

CHAPTER	PAGE
I. HISTORY OF THE ORIFICE METER	
Origin of Foxboro Meters	1
Determination of E Value	2
E Curve	3
Theory of the Orifice Meter	3
Flow Formula	8
II. DESCRIPTION OF THE ORIFICE METER	
Principle of Operation	10
Types of Meters	11
Standard Differential Ranges	13
Spring Type Differential Gauge	15
Mercury Float Type Differential Gauge	16
Static Recording Gauge	20
Development of Helical Movement	21
Development of Diaphragm Movement	22
Combination Differential and Static Recording Gauge	23
Standard Combination Ranges	25
Clock Movements	25
Flange Union	28
Orifice Plates	28
Piping	29
III. INSTALLATION TESTS AND MAINTENANCE	
Typical Installations	30
Meter Houses	31
Multiple-Meter Installation	35
Meters for Liquids	37
Installing and Operating	37
Testing Orifice Meters	40
Testing Static Recorders	45
Testing Proportional Meters with Orifice Meter	45
Maintenance of Orifice Meters	47
Meter Parts	50

CHAPTER	PAGE
IV. COMPUTATION OF CHARTS	
Precision of Measurement	56
Directions for Computing Charts	59
Use of Extension Tables	59
Period Method	61
Specimen Records	61, 64, 65
Planimeter Method	65
Integrator Method	68
Multiplier Tables	69
V. COEFFICIENTS	
Explanation	73
Specimen Computation	74
Fifteen-Minute Coefficients	75
Hourly Coefficient Tables	76
VI. CORRECTION FACTORS	
Specific Gravity	90, 91
Flowing Temperature	92
Pressure Base	92
Barometer	93
Temperature Base	94
VII. FLOW CURVES	
Pipe-Line Sizes 4" to 12", High Pressure	97
Pipe-Line Sizes 4" to 8", Low Pressure and Vacuum	107

HISTORY OF THE ORIFICE METER

BY THOS. R. WEYMOUTH*

WHILE the orifice is one of the oldest known devices used for the measurement of rates of flow of fluids from vessels into the open air, its use in the case of closed-pipe flows does not appear to have been developed until comparatively recent years. The beginning of the investigation that later resulted in the development of the Foxboro meter occurred in 1904 when Thos. R. Weymouth, of Oil City, Pa., installed a flange union with thin orifice plates in a line in series with a standard Pitot Tube of the Towl type, with the intention of studying its behavior and developing a simple rate-reading device to be used in measuring boiler fuel. This work was interrupted, however, and was not resumed until the fall of 1911, when it was again taken up, resulting in the development of the device now known as the Foxboro Orifice Meter.

This meter consists of a flange union of simple design, with a plate, or disc, clamped between the flange faces. The metal of this plate is either $\frac{1}{16}$ inch or $\frac{1}{8}$ inch thick, depending upon the diameter of orifice and the pipe size of the containing flanges. The orifice is in the center of the plate and is bored straight through, perfectly round and with sharp, clean edges.

The flange union is provided with pressure taps located with their centers at a fixed distance from the plate, corresponding with those for which the meter was originally calibrated.

A recording differential gauge is connected to these pressure taps, and from the downstream tap a connection is made to a recording static gauge. It is essential that this connection be made to the downstream pressure line for Foxboro Coefficients to apply. This constitutes one of the principal features of this type of orifice meter, for with this arrangement the orifice coefficient is more nearly constant over a wide range of flows than with any other method of connection.

The pressure taps are made in the flanges, close to the orifice plate, for two principal reasons. In the first place, this produces a compact self-contained meter with the connections always flush with the interior of the flanges, and with the assurance that these connections will always be made properly. In the second place, it permits advantage to be taken of the fact that the pressure difference across the orifice is always a maximum when measured at the *vena contracta*, which is

* See reference at end of chapter.

close to the orifice. That is, if the differential be measured at a point three or four pipe diameters downstream from the orifice, it will be found to be considerably less than that measured close up. The difference varies with the ratio of orifice to pipe diameters, being small for small ratios, but rapidly increasing as the orifice diameter increases until with an orifice having three-fourths the diameter of the pipe, the close-up differential is over 2.7 times the long-distance differential, corresponding to a pressure recovery of about 63 per cent. Thus, with the close-up connections the accuracy of the differential measurements is very much greater than with the long-distance connections for the same ultimate drop of pressure through the meter.

The coefficients of the original standard plates of the Foxboro meter were determined by a long and complete series of calibrations against the standard Oliphant Pitot Tubes of the Iroquois Natural Gas Company, in Buffalo, N. Y. These tubes were originally calibrated by an elaborate series of gas-holder tests, conducted between the hours of midnight and morning in order to obtain stationary temperature conditions. The accuracy of these tubes has been attested by many check measurements and calibrations of meters of various kinds that had originally been standardized by the tubes, as well as by comparative runs against many kinds of meters that were known to be accurate, such as Electric meters, Station meters, Venturi meters, etc.

A complete series of plates in flanges of various diameters was calibrated in order to determine the value of efficiency E , for various combinations. It was found that in the Foxboro meter, for all values of the ratio of orifice diameter to pipe diameter (that is, $\frac{d}{D}$) less than 0.41, the value of E is constant and equal to 0.606, and for values of $\frac{d}{D}$ from 0.41 to 0.75, E increases, as shown by the curve, Fig. 1669, and may be expressed by the equation

$$E = 0.606 + 1.25 \left(\frac{d}{D} - 0.41 \right)^2$$

Thus, by substituting the proper value of E for any meter setting in equation (9) and assigning proper values to all the known terms, equation (10) is produced, which gives the simplest form of the orifice-meter formula.

As already stated, this formula may be computed by means of periodic readings, using a book of tabular values of the radical $\sqrt{hP_2}$. A much simplified method, where it is applicable, is to obtain the average h and the average P_2 by means of a radial planimeter and then determine the value of the radical either from a table of square root values or from a book of values of $\sqrt{hP_2}$, as before. This planimeter method is not applicable, however, where the variation of either h or P_2 is extremely wide throughout the chart period, unless the

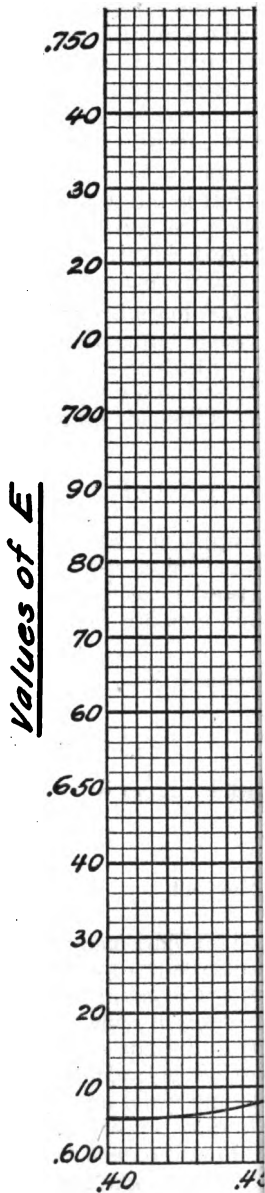

NO MORE
 ABSOLUTE

i
e
r

F
a
t
r
F
e

period is broken up into sections, each one of which will contain comparatively small variations in differential or pressure.

The Weymouth square root integrator does away with a large part of the error of the straight planimeter determination, inasmuch as it gives directly the average of the instantaneous square root values of h and P , thus reducing the error to that occasioned by multiplying together values of \sqrt{h} and $\sqrt{P_2}$ which do not strictly correspond.

The simplest and at the same time most strictly accurate method of chart computation is by means of the Weymouth compound integrator, which multiplies together the instantaneous values of h and P_2 , extracts the square root of the product, and adds together the instantaneous values of $\sqrt{hP_2}$, so that after once going over the pressure and differential charts for any period of the day through which they show a registration, the reading obtained by the device is multiplied by a constant, and the result is the quantity of gas that has passed for the period registered by the charts.

THEORY OF THE ORIFICE METER

When, as in Fig. 1656, a fluid flows steadily along a horizontal channel, of diameter D and cross-sectional area A_1 , in which there is inserted an orifice, or constriction, of diameter d , the bounding surface of the stream assumes the form shown, provided the orifice has a

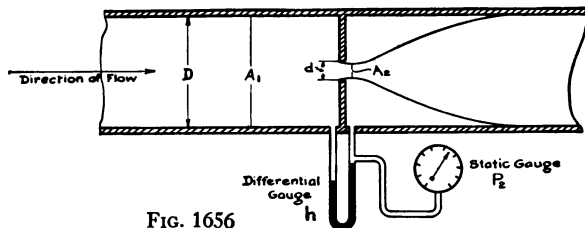

FIG. 1656

sharp entrance edge or is not shaped or beveled in any fashion to change the natural stream-line form of the jet. This jet converges as it passes the plane of the orifice until a minimum area, A_2 square feet, is reached, when it again diverges until the walls of the channel are reached. The space between the stream boundary and the wall of the channel neighboring the orifice plate on the downstream side is filled with fluid in a fairly quiescent state, forming a container or bounding channel just as the walls of the pipe might do if tapered out from the orifice diameter to that of the pipe.

When the device is built in accordance with the outline drawing Fig. 1656, it is called an Orifice Meter, the essential factors of which are the diameter of pipe, D , the diameter of orifice, d , and the pres-

tures, volumes, temperatures, and densities of the fluid in the cross sections A_1 and A_2 .

When a material is supplied to hold the stream-line shape of the fluid jet invariable, as outlined in Fig. 1656, the device is termed a Venturi Meter, the essential factors of which are precisely the same as for the Orifice Meter, except that the diameter d of the orifice is displaced by the diameter of the throat at cross section A_2 , which in this case is formed by the walls of the device.

In the case of each of these meters it is necessary to add to the theoretical discharge formula a factor, termed discharge coefficient, or Efficiency, which in the case of the Venturi Meter takes into account the frictional and other losses, and, in the case of the Orifice Meter includes not only these factors, but also the effect of the *vena contracta*, or ratio of smallest area of jet (A_2) to the area of the orifice corresponding to its diameter d .

These two meters are fundamentally the same, and the formulas derived for one may be applied equally well to the other with proper consideration of the difference in efficiencies. Accordingly, in expressing the discharge formulas, reference will be made throughout to the Orifice Meter only, wherein the cross section of the stream at its smallest diameter, corresponding to A_2 , will be spoken of as the "jet" of the orifice, just as it is designated the "throat" of the Venturi Meter.

All pressures, temperatures, etc., referring to the sections A_1 and A_2 , will be indicated by the corresponding subscripts.

It is possible to have four conditions of flow, namely:

(a) Where there is no appreciable change in density of the fluid as it passes from the full upstream cross section of the pipe to the constricted cross section of the orifice, which is the case when an incompressible fluid, or liquid, is flowing;

(b) In gas flow where the change of state of the fluid between upstream channel and orifice takes place adiabatically, that is, without the passage of heat to or from the fluid from external sources;

(c) In gas flow, where the change of state takes place isothermally, that is, with sufficient heat added to the gas from the outside to maintain constant temperature;

(d) In gas flow, where the change of state is neither adiabatic nor isothermal, but intermediate between them.

In actual practice, the flow is usually under condition (d), although more nearly adiabatic than isothermal, as a rule. Therefore, in order to express the rate of flow it is necessary to use a formula closely approximating the adiabatic. However, the formulas for conditions (a), (b), and (c) will all be given, in order that the relationships existing among them may be shown.

(a) When an incompressible fluid flows through an orifice meter in a pipe, there is practically no change in density as the fluid passes from the pipe to the orifice jet. Consequently both the temperature

and the intrinsic energy may be assumed constant, and the velocity through the orifice may be expressed theoretically by the equation $v = \sqrt{2gh_1}$, where h_1 is the head producing the velocity change, expressed in feet, of a column of the fluid at the density existing in the orifice, and g is the acceleration due to gravity. In cases where the ratio of the diameter of the orifice to that of the pipe is not small, and the fluid in the pipe has an appreciable velocity (v_1) as it approaches the orifice, a part of the actual velocity through the orifice is due to this velocity of approach, and the effective total head producing the velocity v through the orifice, instead of being h_1 is $H = h_1 + \frac{v_1^2}{2g}$. From this expression the general equations of flow of liquids are derived, and are as follows:

$$V = K_v E d^2 \sqrt{\frac{h}{G \left(1 - E^2 \frac{d^4}{D^4}\right)}} \quad \text{in units of volume per unit of time} \quad (1)$$

$$W = K_w E d^2 \sqrt{\frac{hG}{1 - E^2 \frac{d^4}{D^4}}} \quad \text{in units of weight per unit of time} \quad (2)$$

For most liquids, E may be taken equal to 0.606, and combined with the constants K_v and K_w in order to form simplified equations as follows:

$$V = M R d^2 \sqrt{\frac{h}{G}} \quad \text{volume units} \quad (3)$$

$$W = N R d^2 \sqrt{hG} \quad \text{weight units} \quad (4)$$

In the above equations,

d = Diameter of orifice, inches.

D = Diameter of pipe, inches.

E = Efficiency, or coefficient of discharge.

h = Differential pressure, inches of water head.

G = Specific gravity of flowing liquid at temperature of flow, referred to water at 60° F.

K_v and M are constants for volume units.

K_w and N are constants for weight units.

$$R = \sqrt{\frac{1}{1 - E^2 \frac{d^4}{D^4}}} = \sqrt{\frac{D^4}{D^4 - E^2 d^4}} = \text{Correction factor for velocity of approach, from Table 2.}$$

TABLE 1. CONSTANTS M AND N

	Values of M		Values of N
	For cu. ft.	For gal.	For lbs.
Per second	0.007653	0.05725	0.4773
Per minute	0.4592	3.435	28.64
Per hour	27.55	206.1	1718
Per 24 hours	661.2	4947	41240

TABLE 2. CORRECTION FACTORS (R) FOR VELOCITY OF APPROACH

$\frac{d}{D}$	R	$\frac{d}{D}$	R
0.30	1.0015	0.55	1.0170
0.35	1.0026	0.60	1.0247
0.40	1.0047	0.65	1.0348
0.45	1.0075	0.70	1.0471
0.50	1.0115	0.75	1.0637

If velocity of approach be neglected and the factor R be omitted from equations (3) and (4), the resulting flow computation will be in error by less than one-tenth of one per cent for $\frac{d}{D}$ less than 0.27; by less than one per cent for $\frac{d}{D}$ less than 0.48; and by less than two per cent for $\frac{d}{D}$ less than 0.57.

When a mercury float type differential gauge (which has been graduated in inches of water for use in measuring air or gas) is used for measuring liquids, the mercury should be covered by the liquid being measured, and the apparent value of h read on the gauge must then be multiplied by $\left(1 - \frac{G}{13.58}\right)$, or, what amounts to the same thing, the flow, computed by the observed value of h , must be multiplied by $\sqrt{1 - 0.07364G}$.

(b) Under adiabatic conditions, where no energy is added to or subtracted from the fluid, the increase in velocity required for it to pass through the orifice must be gained at the expense of the intrinsic energy of the fluid itself. In this case there is a change in

density of the fluid which must be accounted for. For adiabatic flow the expression for velocity is:

$$W = \sqrt{\frac{P_1 V_1 \frac{2gn}{n-1} \left[1 - \left(\frac{P_2}{P_1} \right)^{\frac{n-1}{n}} \right]}{1 - \left(\frac{A_2}{A_1} \right)^2 \left(\frac{P_2}{P_1} \right)^{\frac{2}{n}}} } \quad (5)$$

From equation (5), the discharge formula for flow condition (b) becomes

$$Q = 2515 Ed^2 \frac{T_s}{P_s \sqrt{T_1 G}} P_1 \left(\frac{P_2}{P_1} \right)^{\frac{1}{n}} \sqrt{\frac{1 - \left(\frac{P_2}{P_1} \right)^{\frac{n-1}{n}}}{1 - \left(\frac{A_2}{A_1} \right)^2 \left(\frac{P_2}{P_1} \right)^{\frac{2}{n}}}} \quad (6)$$

In equations (5) and (6)

Q = Cubic feet of gas per hour, based upon T_s deg. Fht. absolute, and P_s lb. per sq. in. absolute.

E = Efficiency.

d = Diameter of orifice, inches.

T_s = Absolute temp. (deg. Fht.) of the standard cu. ft. of gas.

P_s = Absolute pressure (lb. sq. in.) of the standard cu. ft. of gas.

T_1 = Absolute temperature of flowing gas at A_1 (deg. Fht.).

G = Specific Gravity of flowing gas (air = 1).

P_1 and P_2 = abs. pressure (lb. sq. in.) at A_1 and A_2 , respectively.

V_1 = Specific volume of gas at A_1 (cu. ft. per lb.).

g = Acceleration due to gravity (ft. per sec.).

n = Ratio of specific heats of gas at constant pressure and constant volume, respectively.

(c) Under isothermal conditions, where sufficient heat is supplied to maintain the same temperature at A_2 as at A_1 , the velocity at A_2 is

$$W = \sqrt{\frac{2g P_1 V_1 \log_e \frac{P_1}{P_2}}{1 - \left(\frac{A_2}{A_1} \right)^2 \left(\frac{P_2}{P_1} \right)^2}} \quad (7)$$

from which the discharge formula becomes

$$Q = 1150 Ed^2 \frac{T_s}{P_s \sqrt{T_1 G}} P_2 \sqrt{\frac{\log_e \frac{P_1}{P_2}}{1 - \left(\frac{A_2}{A_1} \right)^2 \left(\frac{P_2}{P_1} \right)^2}} \quad (8)$$

It will be observed that excepting for the differing constants, these formulas are similar in many respects, the last parts only varying characteristically in accordance with the flow conditions assumed. The denominators under the radical constitute the factor produced by the velocity of approach, and become negligible with a small ratio of orifice to pipe diameters and a high differential — that is, a small value of $\frac{P_2}{P_1}$.

(d) This represents the condition of affairs actually encountered in practice, in which there is more or less interchange of heat between the flowing gas and the pipe or orifice, but not sufficient to maintain isothermal conditions. As a matter of fact, the time interval required for the passage of the gas is so small that the departure from adiabatic flow is not great, and equation (6) very nearly represents actual conditions in commercial metering. It is found, however, that a much simplified flow formula can be developed, which in combination with the empirical value of E described heretofore, will give results well within one per cent, and which probably represent the true flow just as accurately as the adiabatic formula. This is due to the fact that in order to keep the loss of pressure within reasonable limits it is necessary to operate with a ratio of $\frac{P_2}{P_1}$ so near 1.0 that the change in density of the gas in passing through the meter is comparatively negligible, thus permitting the use of equation (1) as a starting point. This leads to the following expression for flow:

$$Q = 218.44 E d^2 \frac{T_s}{P_s \sqrt{T_1 G}} \sqrt{h P_2} = 218.44 E d^2 \frac{T_s}{P_s} \sqrt{\frac{h P_2}{T_1 G}} \quad (9)$$

When these formulas are evaluated for the same sets of values of P_1 and P_2 , it is found that the maximum deviation of formula (9) from formula (6) is comparatively small for any practical range of operations, as is shown by Table 1. Furthermore, as we stated previously, it is probable that the flow is not strictly adiabatic, although much more nearly so than it is isothermal. Accordingly it has been found possible, as described, to determine E empirically for equation (9), which makes this formula express the true flow with a probable error of well under 1 per cent, at the same time permitting the use of an exceedingly simple formula, adaptable to the employment of integrating devices for the rapid computation of meter records.

Formula (9) as used in practice is resolved to the very simple form:

$$Q = C \sqrt{h P_2} \quad (10)$$

wherein the constant C , known as the coefficient, is expressed individually for each meter setting and includes all factors depending upon orifice dimensions, gas characteristics, and pressure and tem-

perature measurement bases, as well as an assumed average temperature of flowing gas.

When an integrator is not used, the values of the radical can be obtained from published tables.

* Thos. R. Weymouth, Chief Engineer for the United Natural Gas Co., Consulting Engineer for The Foxboro Co., Inc. Reference is here made to two papers written by Mr. Weymouth and published by the American Society of Mechanical Engineers: No. 1376, Measurement of Natural Gas. No. 1349, Problems of Natural Gas Engineering.

CHAPTER II

DESCRIPTION OF THE ORIFICE METER

TWO things have been presented in the previous chapter — a brief history of orifice meters and the theory of orifice meters. The present chapter will show the connection between the modern type of orifice meter and the theory on which it is based and describe the various instruments and fittings used in the construction of an orifice meter.

The orifice meter is constructed upon the principle that by placing in the line an orifice of smaller diameter than the line itself a greater velocity will result at the orifice than in the line. This increase in velocity causes a drop in pressure on the downstream side of the plate, and this drop in pressure is directly related to, and furnishes a measure of the rate of flow.

If gas or other fluid is allowed to flow through a wide-open gate at the end of a line, the differential pressure at the meter will be at its maximum for the particular size orifice used. If the gate is closed slowly, the differential pressure will fall off because the amount of fluid passing through the orifice is reduced and consequently the velocity at the orifice is reduced. If the gate is entirely closed, the pressures equalize on the opposite sides of the orifice. There is then no flow through the orifice,

and consequently no differential pressure. This variation in rate of flow is what causes the variation in pressure differences between the upstream and downstream sides of the orifice, providing the line pressure on the upstream side remains constant.

The difference in pressure between the upstream and downstream sides of the orifice is called the differential pressure, and by obtaining the record of this and of the pressure of the fluid after it has passed through the orifice, we are able to determine the flow.

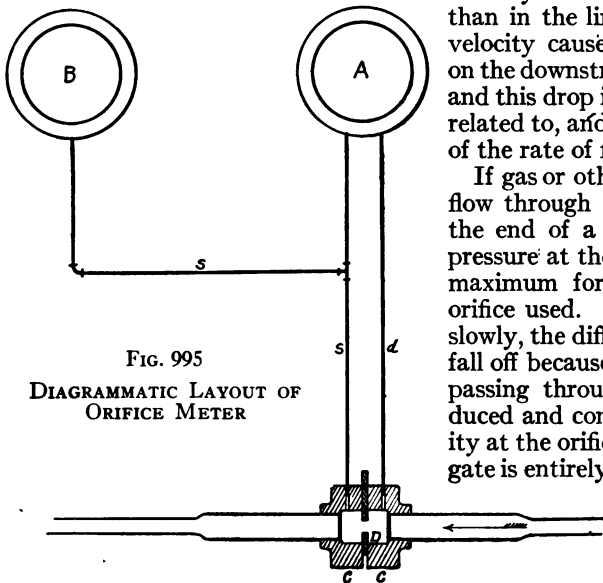

FIG. 995
DIAGRAMMATIC LAYOUT OF
ORIFICE METER

Up to the time of the development of the differential recording gauge, there was no satisfactory means of recording the difference in pressures between the upstream and downstream sides of an orifice. U-gauges were employed for test work, but this meant periodic readings and constant attention. With the development of the differential recording gauge an entirely new possibility was opened for a device to measure scientifically and accurately the flow of fluids both gaseous and liquid.

A diagrammatical layout of the orifice meter is shown in Fig. 995. It consists of (A) an instrument for recording the difference in pressure between the upstream and downstream sides of the orifice plate; (B) an instrument for recording the static or line pressures after the gas has passed through the orifice; (CC) an orifice flange union; (D) an orifice plate and (ds) the connecting pipes between the flange union and the instrument. The arrow indicates the direction of gas flow.

Foxboro Orifice Meters are of two types.

The type most commonly used is the two-instrument meter known as Type T and shown in Fig. 1661. This meter consists of a 12" diameter mercury float type differential recording gauge and a 10"

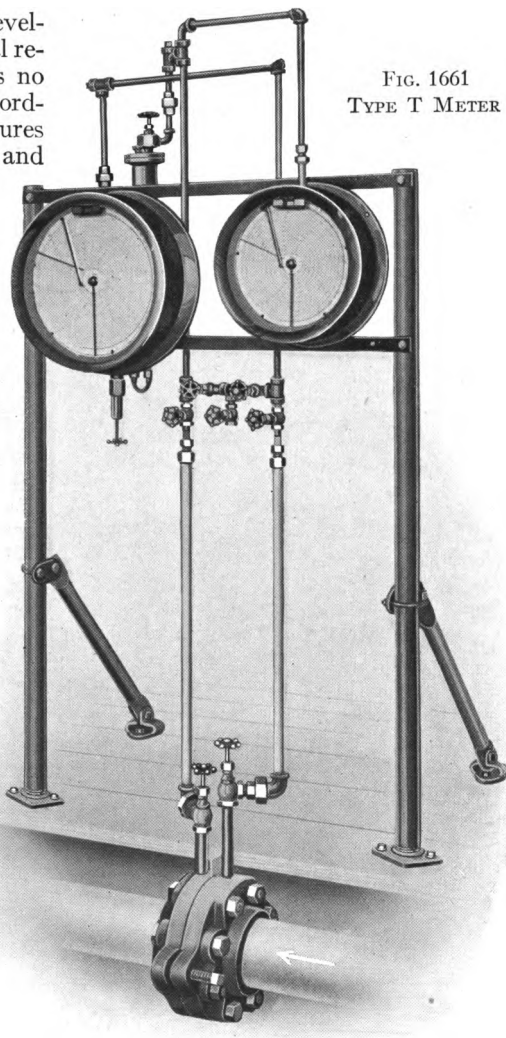

FIG. 1661
TYPE T METER

diameter static pressure recording gauge mounted upon a frame with floor braces and a patented orifice flange union between which is clamped a patented orifice plate. The connection between the instruments and flange union is made through a series of pipes, and, by means of the valves, the instruments are cut in or out of service.

In the Type T meter the records of the differential and static pressures are separate. The differential recording instrument is larger in diameter than the static recorder and consequently uses a larger diameter chart.

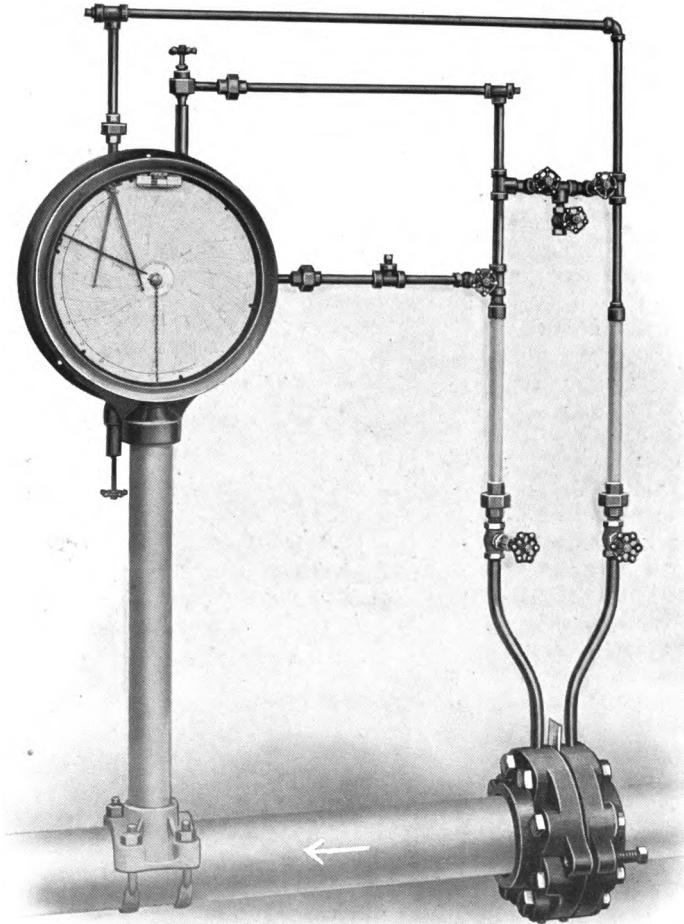

FIG. 1662. TYPE C METER

This type of meter is particularly desirable in cases where a rapidly fluctuating flow is present, for the reason that because the records are separate they cannot be confused, nor can they be obliterated by each other. Furthermore, it is not necessary to use different-colored inks to distinguish each record, as is the case with the combination meter.

The second type, or combination meter, is known as Type C and is shown in Fig. 1662. It has the static recorder movement mounted in the same case with the differential movement, so that both records are made on the same chart. This meter is more compact than the two-instrument type and is consequently more easily transported in the field. It can be mounted directly on the line pipe by use of a saddle and a short length of 2" supporting pipe.

The advantage of having both static and differential records on the same chart is obvious. Although a great many companies prefer this method, just as many others prefer to have the records on separate charts of different sizes. Where both records are made on the same chart, inks of different colors are used to distinguish the records.

In the measurement of gas by these meters the differential gauge charts are graduated in inches of water and the static pressure gauge charts in pounds per square inch or inches mercury vacuum.

After careful consideration of all points involved in the problem of gas measurement it was decided that only two differential ranges were necessary to cover all conditions of flow. Consequently the mercury float type differential recording gauge was developed in two

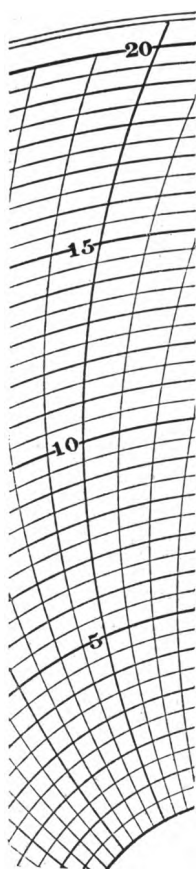

89S63

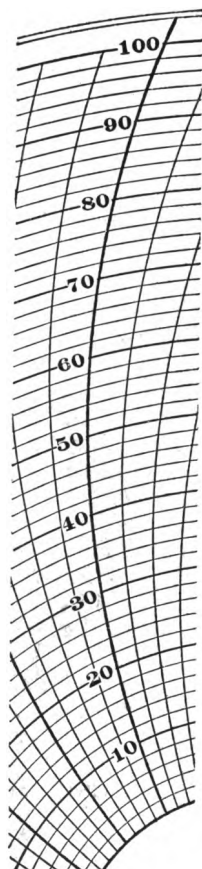

89870

ranges, namely, 0-100" of water pressure for high-pressure gas measurement, and 0-20" of water pressure for low-pressure and vacuum.

Sections of charts Nos. 89863 and 89870 show these ranges.

It would be pertinent, before discussing the details of the instrument, to explain why these two differential ranges are considered adequate to cover all conditions.

From a study of the theory of orifice meters, it will be understood that a high differential pressure means a greater loss in static pressure through the orifice than a low differential. This means that if the differential pressure reads 90" of water, the loss of static pressure at the orifice is $3\frac{1}{4}$ lbs. per square inch. This loss would be negligible if the gas were flowing under higher pressure. It might not be desirable to have this loss under low-pressure conditions, consequently, the differential range of 0-20" permits of a full scale record with a low differential pressure. The loss in static pressure at 18" differential is only approximately $\frac{5}{8}$ lbs., and it should be noted that the 18" division on chart No. 89863 corresponds to the 90" division on chart No. 89870.

Consider the measurement of casing-head gas under vacuum. It is desirable to maintain as high a vacuum at the well as conditions will permit. Flow restrictions must be reduced to a minimum in the line in order to avoid the necessity of maintaining an excessive vacuum at the plant with a consequent waste of power. The frictional loss due to line and fittings cannot be avoided, but it is possible to reduce to a minimum the loss of vacuum through the meter installation by providing a differential gauge of proper range. The 0-20" range permits an appreciable reading to be recorded, which insures an accurate measurement without excessive loss of vacuum through the orifice. Perhaps this point may be more clearly understood by the statement that, assuming the flowing conditions constant, the differential pressure will be reduced as the orifice diameter is increased. This means that larger orifices are used with the differential range of 0-20" than with a differential range of 0-100" to measure the same flow in the same size line.

For example, a differential pressure of 18" causes a static loss through the orifice of only 1.3" of mercury, and this means that if the pumps are turning up 26" vacuum, the vacuum on the well is approximately 24.7"; but it is a practice in figuring orifice sizes for low-pressure work to compute to a maximum differential of 16", and the average differential will be around 12". This means a loss of only $\frac{1}{8}$ " mercury vacuum, or a well pressure of $25\frac{1}{8}$ " vacuum, with a pump pressure of 26" vacuum, assuming that there is no loss due to line friction.

In establishing a range of 0-100" of water for high-pressure gas it is done with the purpose of covering as wide a variation in flow as is compatible with accurate measurement. With this range the flow-

variation ratio can be as great as 5 to 1 with perfect accuracy. This permits handling a greater variation of flow through the same line with fewer orifice sizes than with lower differential ranges.

DIFFERENTIAL RECORDING GAUGE

Previous to the introduction of the mercury float type differential recording gauge there had been developed the so-called spring type differential recording gauge shown in Fig. 938A.

The operating mechanism of this instrument consists of a diaphragm movement similar to Fig. 953A. This movement is inclosed by an air-tight chamber on the back of the instrument case, and mechanical connection between the diaphragm and the pen arm is made through a long, practically air-tight bearing.

The upstream side of the flange union is connected to the air-tight chamber, and the downstream side to the diaphragm movement.

The pressure inside the diaphragm tends to expand it; the pressure in the chamber surrounding the diaphragm tends to prevent this expansion; therefore the actual motion of the diaphragm is due to the difference in pressure inside and out. This design permits a range of practically any differential pressure from 0-4" of water to 0-500 lbs.

Although the development of the spring type differential recorder made the orifice meter a

commercial possibility, and although hundreds of this type of meter were put into service and were the best meter at that time, still, due to the ease with which the diaphragm movement could be damaged by mishandling, they were not entirely satisfactory.

Today the spring type differential recorder is used extensively under certain conditions, but as a part of the orifice meter for gas measuring, a much more rugged instrument was required.

This led to extensive experimenting upon a differential recording gauge of a type as nearly fool proof as possible. In the latter part

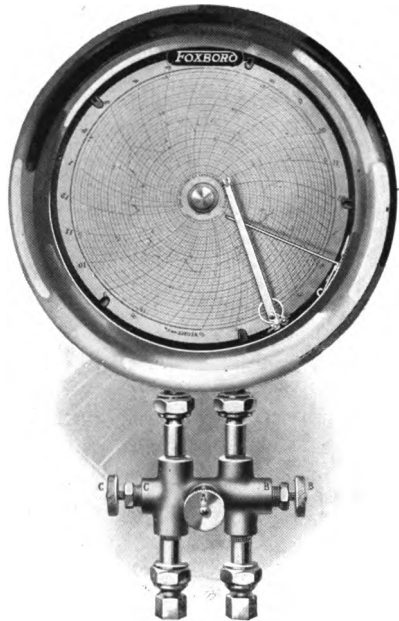

FIG. 938A

of 1917 the Foxboro Company brought out the first mercury float type differential recording gauge equipped with check valves to prevent the mercury from being blown out by over-pressure on either the high- or low-pressure chambers.

The first few of the new instruments were put to work in the gas fields under all sorts of conditions, and it was but a short time before their weaknesses began to develop. The early instruments were made with cast-iron differential chambers, but it was found that because of the porosity of cast iron and the chance for sand holes to be present, it was considered advisable to make these chambers of steel. The operation of these instruments was followed carefully, and improvements made from time to time with the idea of producing an instrument which would successfully meet all conditions.

Today the Foxboro Mercury Float Type Differential Recording Gauge is unquestionably the best instrument of its type used in connection with gas measuring. It is rugged, accurate, sensitive, and fool proof and is used with satisfactory results in measuring both low-pressure casing-head and high-pressure natural gas. It can also be adapted to the measurement of liquids, and a description of this application will be found in Chapter III.

The principle upon which the mercury float type differential recording gauge operates is that of a simple U-tube.

Reference to Fig. 1652 shows a drawing of this U-tube with the mercury at the same level in both legs, and both open to atmospheric pressure at H and L. If pressure above atmosphere is applied at H, the level in that leg will drop and the level in the L leg will rise, and the difference in level measured in inches will be equal to the pressure applied at H in equivalent inches of mercury. Now, if at the same time pressure is applied at H, an equal pressure is applied at L, the levels will not change; if the pressure at L is less than the pressure at H, the mercury will fall in H and rise in L, and

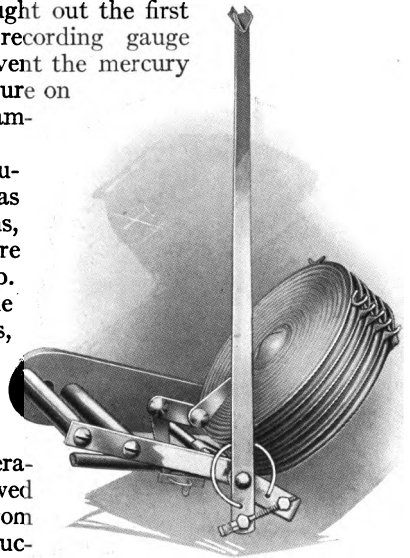

FIG. 953A

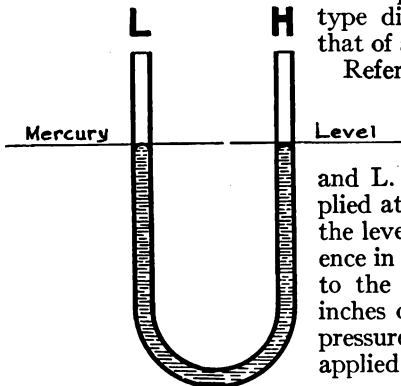

FIG. 1652

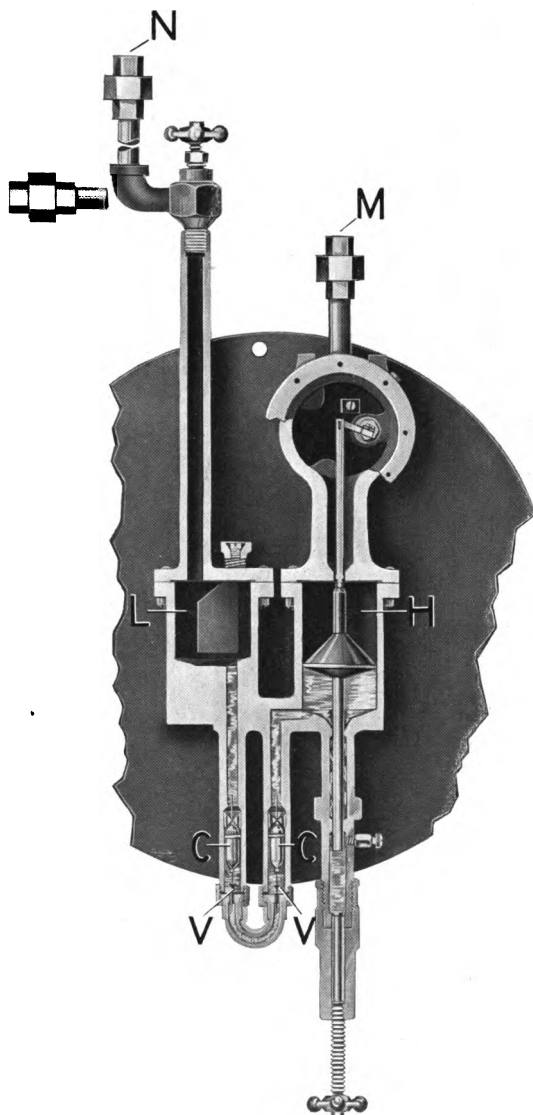

FIG. 1620

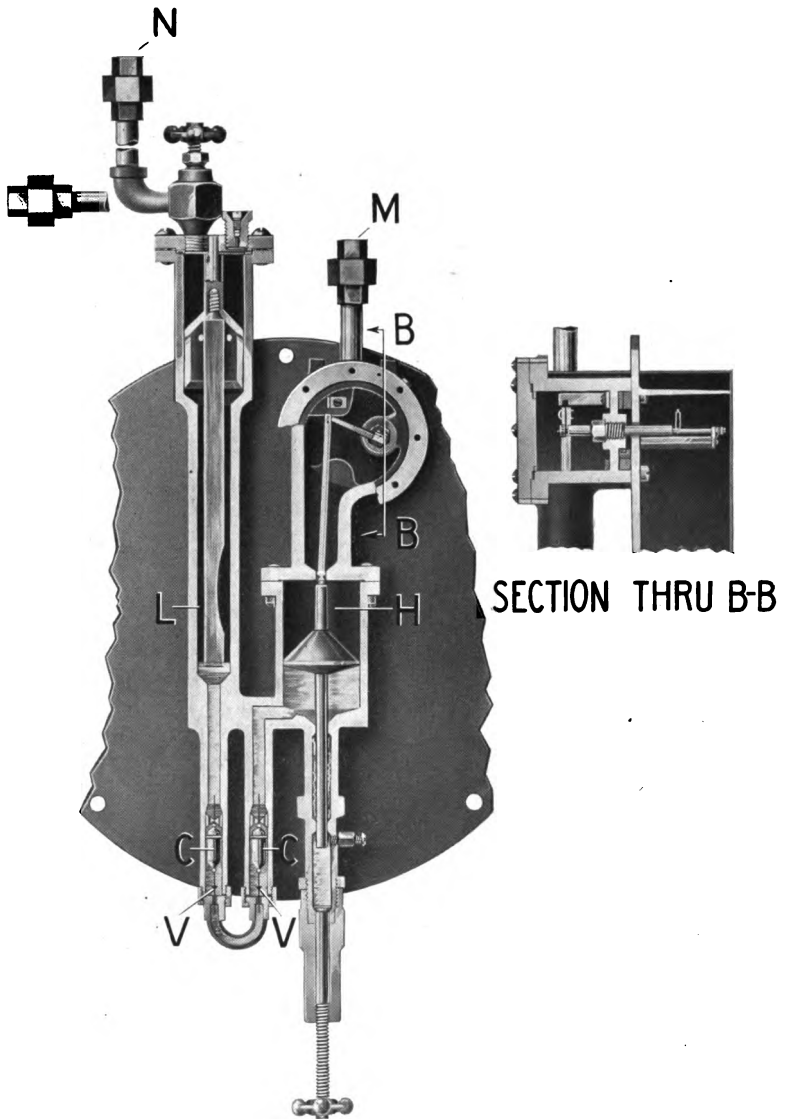

FIG. 1621

the difference in levels measured in inches will be equal to the difference in applied pressure in equivalent inches of mercury.

Figs. 1620 and 1621 show sections of the 20" and 100" differential chambers respectively, and the analogy of design between the instrument and the U-tube principle may be readily distinguished. H is the high-pressure chamber and L the low. Connection between the high-pressure chamber and the upstream side of the flange union is made through the union M, and between the low-pressure chamber and the downstream side of the flange union through the union N. As the upstream pressure is greater than the downstream, the pressure in H is greater than in L, consequently the mercury level drops in H and rises in L.

The specific gravity or density of mercury is such that most metals will float upon it. This characteristic is employed in the mercury float type instruments by using a steel float in the H chamber. This float rises and falls with a change in mercury level. By means of a mechanical connection this motion is transmitted to the pen arm.

The connection between the high and low chamber is made through a U section in each leg of which is a steel check float CC. On the bottom stem of the floats are valves VV. The buoyancy of these floats is such that the valves always remain off the valve seat as long as the velocity of flow of mercury back and forth is normal. If, however, an excessive pressure is applied suddenly in either of the chambers H and L, there is a tendency for the mercury to be forced rapidly out of the chamber to which the excess pressure is applied. This sudden increase in the velocity of the mercury overcomes the buoyancy of the float and causes it to be depressed until the valve seats and cuts off the flow. The valve remains seated during the time the excess pressure is applied, and when the pressure is relieved, the float rises and the mercury again flows normally. This entire operation is very nearly instantaneous, consequently no mercury is blown from the instrument.

The volumes of the chambers are so proportioned and the amount of mercury used is such that the pen cannot run more than slightly beyond the maximum range of the instrument, even though the flow of gas may be sufficient to cause a differential pressure greater than the range of the instrument. This feature is particularly valuable because the instrument cannot be injured by over-capacity service.

The calibration of the mercury float type differential gauge, although very delicate, is accomplished in a simple manner.

It will be seen from Figs. 1620 and 1621 that there is a strip of metal in the L chamber. These strips are shown in detail on pages 50 and 51 part numbers 5407 and 7839 and are known as calibration sticks. As the mercury rises in the L chamber a certain amount is displaced by the volume of the stick, and this displacement has a direct bearing upon the level of the mercury. This displacement is controlled by shaping the stick. Each instrument is calibrated in

this manner and the calibration sticks are not interchangeable except by coincidence. The shaping of the sticks as desired makes it possible for the pen to follow the scale more closely than commercial accuracy requires, and no instrument can get out of calibration unless mercury is added or removed. From the foregoing it will be understood more fully why the statement is made in Chapter III under "Testing and Adjusting" that it is impossible to adjust the instrument higher or lower by bending the pen arm at the friction joint. The calibration stick is shaped to give such displacement of mercury as to cause the pen to be at definite points on the chart when the mercury is at certain levels in the chamber, and if the pen does not register properly, it is due to loss or addition of mercury. This would cause a difference in displacement which can be corrected only by restoring the mercury to its former level.

As a matter of convenience the Foxboro Mercury Float Type Differential Recording Gauge has been so designed that it can be loaded with mercury and transported without danger of leaking. This is accomplished by means of valves R and S shown in Figs. 1593 and 1594. Both these valves are closed tightly before the instruments are shipped.

By reference to Figs. 1620 and 1621 it will be seen that as valve S is screwed up the stem comes in contact with the lower end of the float stem in the H chamber. The upper end of the float stem is beveled, and as the float is forced up by the stem of valve S the beveled end of the float stem bears tightly against a hardened-steel seat in the upper section of the H chamber. At the same time the extreme top end of the rod connecting the float stem with the pen-arm operating lever engages a slot in the bracket above it, and the entire mechanism is held securely against motion in transit.

In putting the meter into operation it is essential that the S valve be opened to its full capacity, so that the seat on the end of the valve stem will come tightly against the seat in the stem chamber and thus prevent mercury from escaping under pressure.

Details of the parts used in the 20" and 100" gauges will be found in Figs. 1586 and 1587 on pages 50 and 51.

STATIC RECORDING GAUGE

An essential factor in the correct measurement of a gaseous fluid by means of the orifice system is an accurate knowledge of static pressures. Here again it is necessary to employ a reliable instrument.

It was but a simple step from the old Bourdon spring indicating gauge to a Bourdon spring recording gauge, but it remained for Edgar H. Bristol* to develop successfully the helical form of tube about twenty-six years ago.

* President of The Foxboro Company.

This helical tube is in effect a series of Bourdon tubes placed end to end. The length of the helix is sufficient to give the required travel to the pen arm without employing multiplying devices. Today this form of pressure movement is used almost exclusively in recording instruments.

In the earlier design the recording pen arm was attached directly to the free end of the helix. This arrangement gave fairly satisfactory results, but, owing to the fact that the helix was supported only at its base and extended outwardly with its axis in a horizontal direction, there was a tendency for the free end to vibrate under certain conditions, which of course caused a poor record. Furthermore, it was very difficult to make the pen travel on the true time arc of the chart.



FIG. 1335

After extensive experiments Mr. Bristol developed the improved form of helical-tube movement first used in Foxboro recording instruments. This movement is illustrated in Fig. 1369.

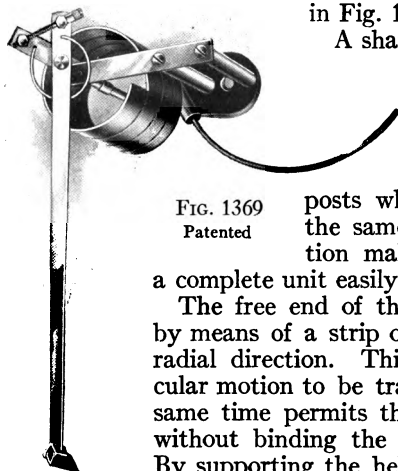

FIG. 1369
Patented

A shaft runs through the axis of the helix with one end supported from the same base as the helix and the other end supported by a plate at the free end of the helix. The plate is supported by two columns or posts which in turn are supported from the same base as the helix. This construction makes the entire pressure mechanism a complete unit easily removable from the case.

The free end of the helix is connected to the shaft by means of a strip of metal which is flexible only in a radial direction. This arrangement allows all the circular motion to be transmitted to the shaft, and at the same time permits the helical tube to expand radially without binding the shaft and causing excess friction. By supporting the helical tube in the manner described

the effect of vibration is eliminated. This results in a rugged, sensitive, and accurate movement with no parts subjected to wear.

The bracket carrying the pen arm is fastened to the shaft. This arrangement allows the pen arm to rotate about a fixed axis, which insures correct pen travel over the time arc on the chart.

The helical-tube movement is applicable to pressures from 15 to 800 lbs. per square inch.

Conditions at times may make it necessary to employ a recording gauge of a range higher than 800 lbs. In such instances the instrument is equipped with a large steel Bourdon tube movement similar to that used in hydraulic indicating gauges.

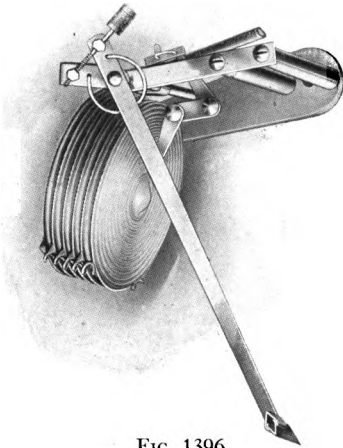

FIG. 1396

In the measurement of low-pressure gases a recording gauge is used with a so-called diaphragm tube movement.

The original diaphragm movement was developed at about the same time as the helical tube, and like the helical tube the early designs were produced with the pen arm attached directly to the outside diaphragm. Here also was an opportunity for improvement, and it remained for Benet B. Bristol* and Edgar H. Bristol to develop the improved form of diaphragm tube shown in Fig. 1396 and first used on Foxboro low-pressure and vacuum recording instruments.

The diaphragm tube consists of a series of metal diaphragms built up in the form of a bellows. The applied pressure tends to elongate this tube, and the resulting motion of one edge of the tube is multiplied by restraining the motion of the other edge through the medium of small metal helical springs shown in the illustration. The introduction of these small restraining springs has made it possible to obtain the required amount of motion with a reduced number of diaphragms and has resulted in a much more compact and rugged movement. This is one of the features that has made it possible to maintain a standard design of round-case instrument. Another decided advantage of this compact diaphragm tube is its relatively small internal volume, which means a much quicker response to pressure changes than the diaphragm tubes employing a greater number of diaphragms.

The lateral motion of the diaphragm tube is communicated to a shaft similar to that used in the helical-tube movement. This lateral motion is translated into a rotary motion of the shaft through a series

* Treasurer of The Foxboro Company.

of simple levers. The pen-arm bracket is affixed to the shaft in a manner similar to the helical-tube movement.

Occasionally, under severe service conditions, the static recording gauge will get slightly out of calibration. Chapter III contains complete information on testing and adjusting orifice-meter instruments, but in fully describing the static recording gauge here it is advisable to mention the micrometer adjustment on the pen arm, the details of which are clearly shown in Figs. 1369 and 1396.

The center of rotation of the pen arm on the bracket is directly over the axis of rotation of the entire movement, consequently, any adjustment made by means of the micrometer screw in no way affects the length of pen arm or its travel over the time arc.

Before the micrometer adjustment was developed the joint between the pen arm and the bracket was friction tight, and it was necessary to make minor adjustments by taking the pen arm between the thumb and finger and applying sufficient force to overcome friction at the joint. The liability of damage to the pen arm and movement was great, and at the same time a close adjustment was obtained only after considerable trouble.

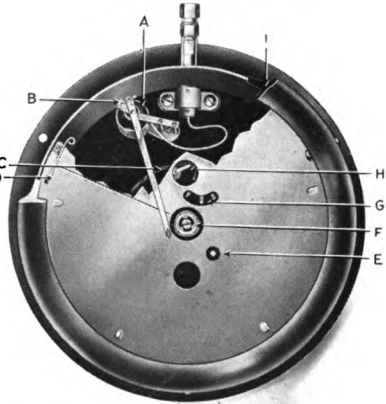

FIG. 1547

The micrometer adjustment has eliminated all this, and it is now possible to make minor adjustments with comparative ease. Any tendency to lost motion in the micrometer screw is overcome by the detent spring shown in the illustration.

A partial interior view of a static recording gauge with helical tube is shown in Fig. 1547. (A) is the helical tube, (B) micrometer adjustment, (C) clock box, (D) automatic release pen lifter, (E) clock winding spindle, (F) chart hub base, (G) clock regulator lever, (H) clock starting lever, (I) recorder ring or bezel.

COMBINATION DIFFERENTIAL AND STATIC RECORDING GAUGE

As mentioned in the first part of this chapter, the combination differential and static recording gauge is one in which the static movement is mounted in the differential gauge case. Figs. 1596 and 1591 show the interior of a combination instrument case with a helical and diaphragm tube movement respectively. These static movements are so arranged that they may be removed without in



FIG. 1596

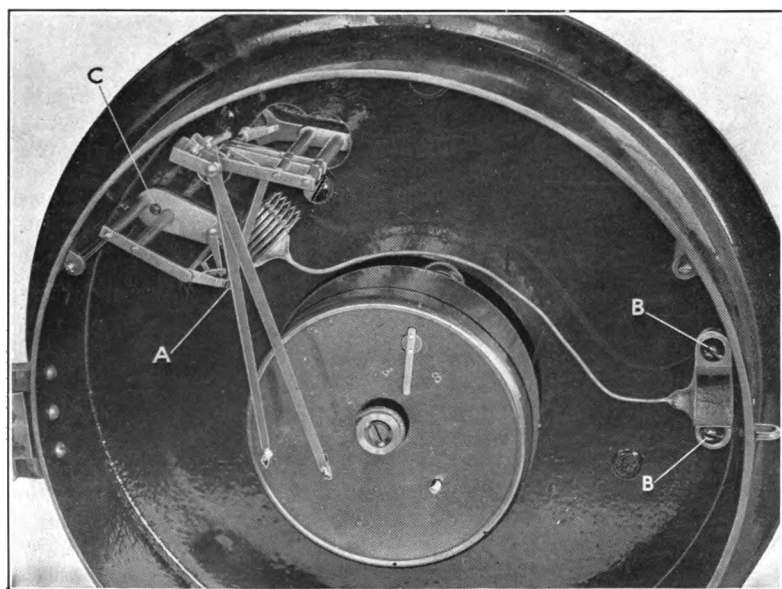

FIG..1591

any way disturbing the other mechanism simply by taking out screws at A, BB, and C. The pen arms operate on the same center of motion from separate shafts.

Owing to the fact that both records are made on the same chart it is impossible to combine all static pressure ranges with the 20" or 100" differential range. It is necessary to specify a static range such that the differential range subdivisions will be a multiple of the static range. For example, referring to section of chart 85827, page 27, it will be observed that there are 50 division lines on the entire scale. This means that on the 100" differential scale the subdivision represents 2", and on the 250 lbs. scale it represents 5 lbs.

The five combination ranges best adapted to average conditions are shown in Figs. 1654 and 1655, pages 26 and 27.

85827	— 20" differential,	30" vac.	— 0-5 lbs. static,
85833	— 20" "	30" vac.	— 0-25 lbs. "
85850	— 100" "	50 lbs. static	
85840	— 100" "	250 lbs. "	
85828	— 100" "	500 lbs. "	

Other combinations of ranges may be used if necessary, providing the proper static range is selected.

Details of the parts used in the combination meter movement may be found in Fig. 1595, page 52.

CLOCK MOVEMENTS

Reliability in any complete mechanism is entirely dependent upon the individual reliability of each unit, and the reliability of the unit is governed more or less by its design and construction.

A necessary reliable unit in the orifice meter is the clock movement which drives the chart. No matter how accurate the differential and static recording pressure units may be, they are absolutely valueless unless their records are properly related to time.

Figure 1551 illustrates a clock movement which has been designed to give that reliability of service necessary to the accurate measurement of gas. The particular feature of this movement is its three-point support, which good mechanical practice tells us is the best design for eliminating the possibility of straining the movement

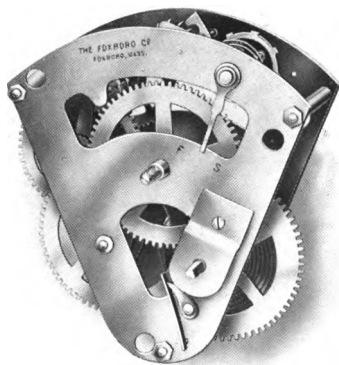

FIG. 1551

Patented

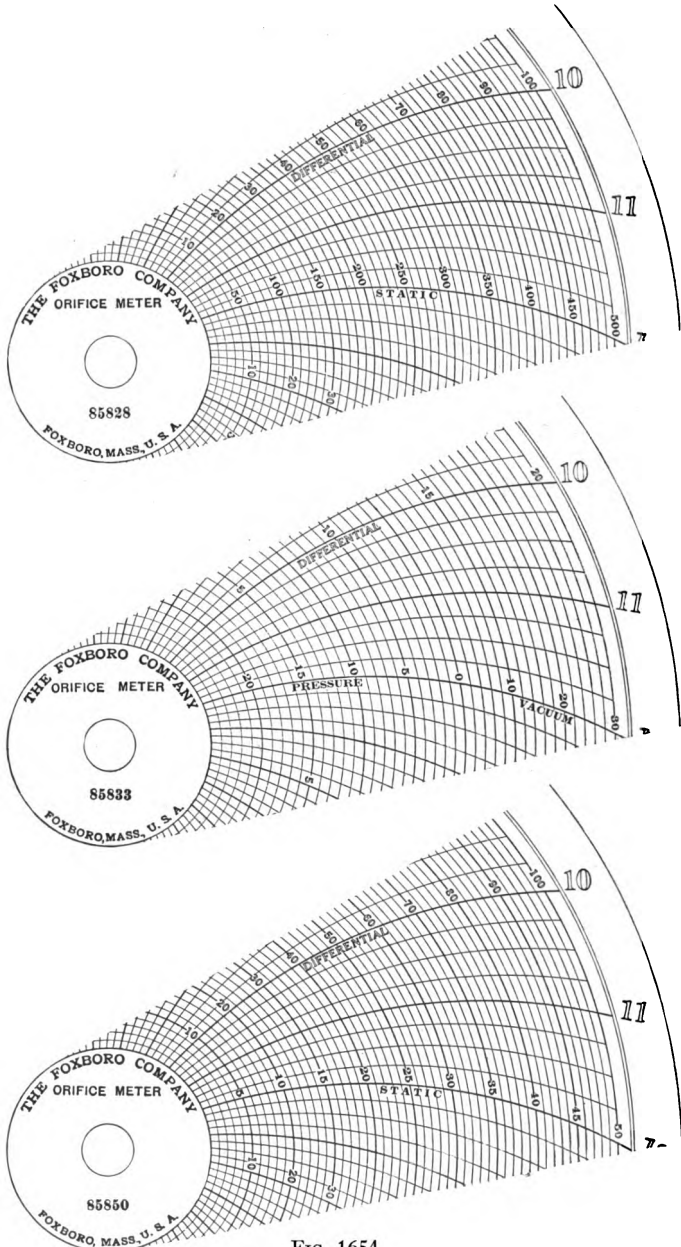

FIG. 1654

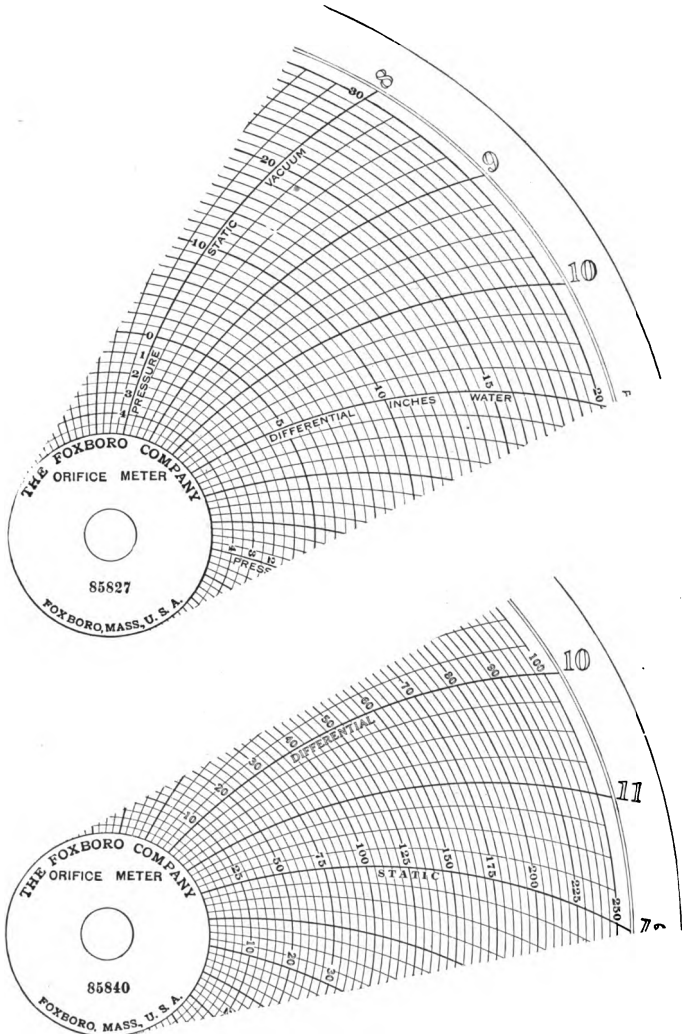

FIG. 1655

when fastening it in position. This point may be better understood by a comparison with the manner in which an automobile engine is secured to the chassis. The practice of the majority of automobile builders is to support the engine at three points, namely, the right and left

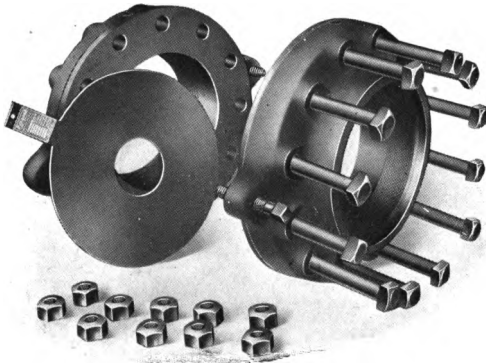

FIG. 1367
Orifice Plate and Flanges
Patented

side at the rear and the center at the front, thus no excess strains are set up in the engine structure due to weave of the chassis under rough road conditions.

In meter installations where the instrument may be subjected to extremely low temperatures the clock movement is equipped with a special jeweled escapement which overcomes the difficulty arising from congealed clock oil.

Clock movements can be supplied to give the chart one revolution in 15 or 30 minutes, 1, 2, 3, 4, 6, 8, 12, 24, and 48 hours, and 7 days.

FLANGE UNION AND ORIFICE PLATE

As stated in Chapter I, the E curve, Fig. 1669, was developed from a specific design of flange and plate with the instrument pressure connection taken at the flange a fixed distance from each face of the plate. Unless these original conditions are duplicated in each installation the E factor will not correspond to the original curve, and the result will not be correct. It is essential, therefore, that each flange and plate correspond to those used in the original development of the E values.

The flange unions may be either heavy or light weight, depending upon the pressure conditions, and they must be free from sand holes. The heavy-weight flange is designed for working pressure up to 800 lbs. and the light-weight up to 125 lbs.

Fig. 1367 illustrates the heavy-weight flange with an orifice plate.

Each flange is provided with jack screws on either side by means of which the flange is spread a sufficient distance to allow the orifice plate to be inserted or removed. It is necessary to remove only the bolts from the upper half of the flange; the remaining bolts are merely loosened.

The orifice plate is the heart of the orifice meter, and although the instruments may be accurate, correct results will not be obtained if

the orifice is not bored true to size, straight through the center of the plate, and with sharp, clean edges.

The outside diameter of the plate is such that the plate fits inside the flange bolt circle and automatically centers the orifice.

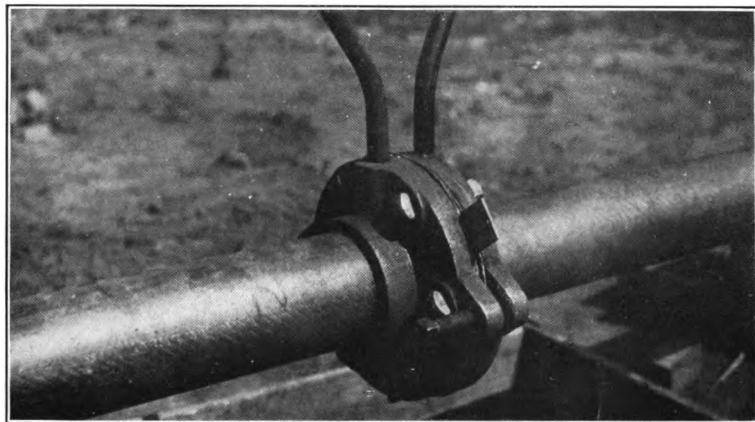

FIG. 1645

Fig. 1645 shows the light-weight orifice flange with pressure connections taken at the flange. As the flange is tapped by the manufacturer, it is impossible to get the pressure connections at an incorrect distance from the orifice plate. It is designed so that the pressure connections come flush with the interior of the pipe. These two features insure conditions in each installation exactly parallel to those under which the original coefficients were determined.

ORIFICE-METER PIPING

Reference to Figs. 1661 and 1662, pages 11 and 12, will show the Type T meter complete with piping and mounting frame, and the Type C meter complete with piping and mounted directly on the pipe line. All piping, fittings, and valves, except those shown in lighter tone, may be supplied with the meters, but it is often desirable to make up this piping in the field.

Figs. 1589, 1590, and 1616 on pages 53 and 54 illustrate the piping and frame units together with their part numbers. These are carried in stock in this form by the meter manufacturer.

A careful analysis of this chapter will enable the reader to obtain a good working knowledge of the details of the orifice-meter equipment.

CHAPTER III

INSTALLATION, TEST, AND MAINTENANCE

IN order to give the reader a clear understanding of an orifice-meter installation and the relation of the component parts, several photographs and drawings have been reproduced.

Fig. 1622 shows an installation of the Type T meter on a vacuum line handling casing-head gas. Attention is called to the fact that the orifice flange union is installed in a vertical by-pass line, directly over the main-line gate valve. This arrangement facilitates the changing of orifice plates. The by-pass gate valves are installed in

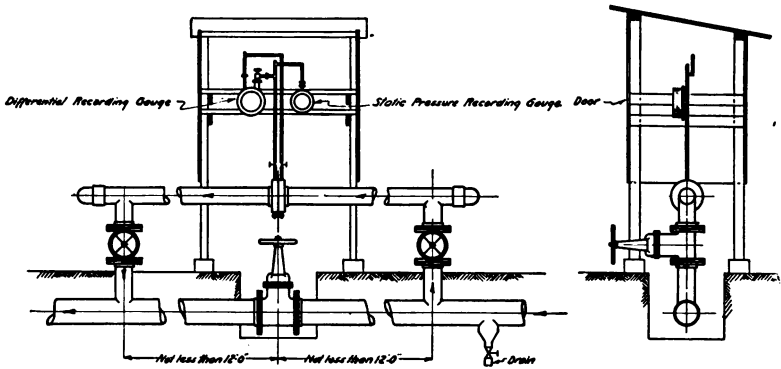

FIG. 1622

the risers, which prevents dirt from accumulating in the recesses under the gates.

Fig. 1622 shows the meter house not only enclosing the orifice meter, but also the main-line gate valve, so that no unauthorized person can tamper with the orifice meter, or pass unmetered gas through the line by opening the gate valve.

Fig. 1623 illustrates a Type T meter, installed on a vacuum line. The orifice flange in this case is placed in the main line with the by-pass around it. A drip is provided on the well side of the setting directly in the line of incoming gas flow. It effectively removes any condensate from the line immediately preceding the meter installation, and acts as a baffle as well as a reservoir for liquid.

Another outstanding feature of this setting is the neat and comparatively inexpensive meter house. This meter house encloses only the gauges. It is provided with hinged doors, front and back; the

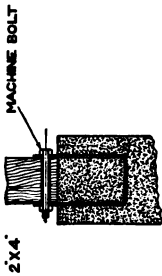

SECTION SHOWING METHOD OF ANCHERING 2x4 TO CONCRETE FOUNDATION AT POINT A

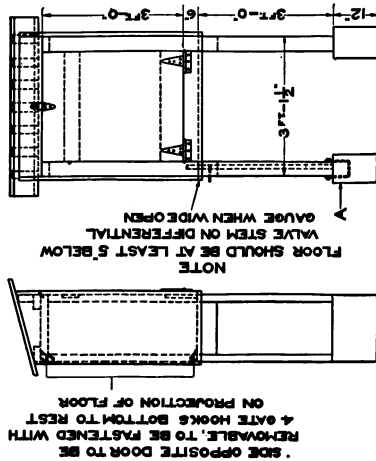

FRAME TO BE MADE OF 2x4' ROOF & SIDING TO BE MADE OF SHIPLAP

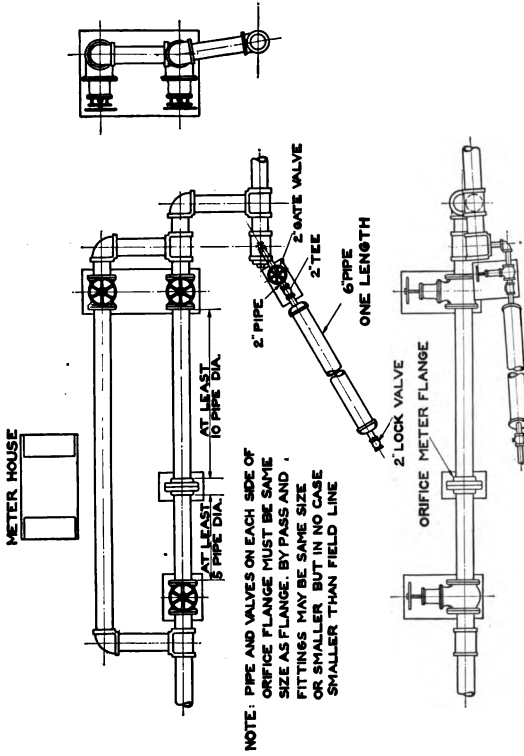

METER HOUSE AND ORIFICE METER PIPING DETAILS

COURTESY OF SINCLAIR OIL & GAS CO.

Fig. 1623

front door only is opened for the daily changing of charts, but for testing or adjusting of the meter both doors may be opened.

Figs. 1646 and 1647 illustrate an installation of the Type C meter. This particular meter measures wet casing-head gas pumped from a

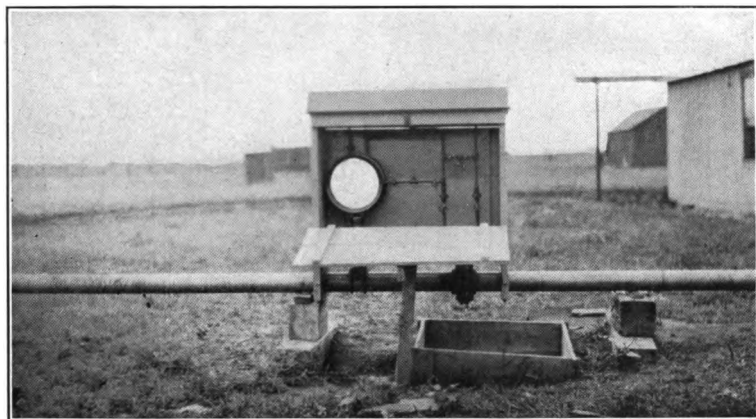

FIG. 1646

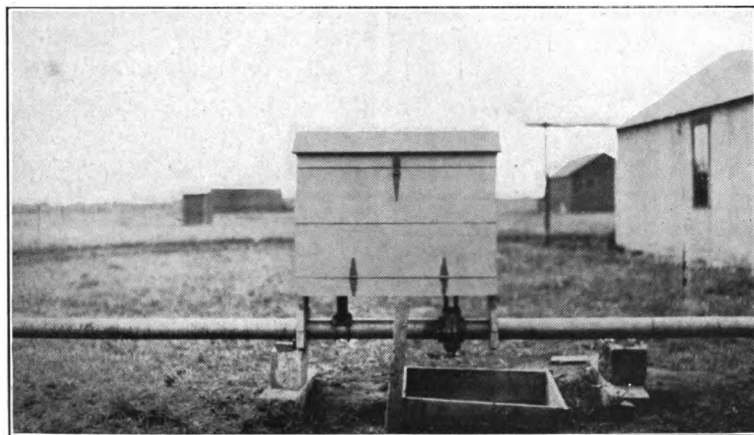

FIG. 1647

field vacuum station to the main compression gasoline plant. The piping layout is similar to the setting shown in Fig. 1622.

The meter house is large enough to enclose only the gauge and its piping. It may be opened both front and back for changing charts or adjusting meter. This type of meter house eliminates the neces-

sity of foundations, as it is directly supported on the pipe line by means of clamp blocks.

In Fig. 1624 is shown the setting prescribed by the United States Indian Department of the Department of the Interior for use in Osage County, Oklahoma. It will be noted that the same length of pipe is used on each side of the orifice flange, which makes it impos-

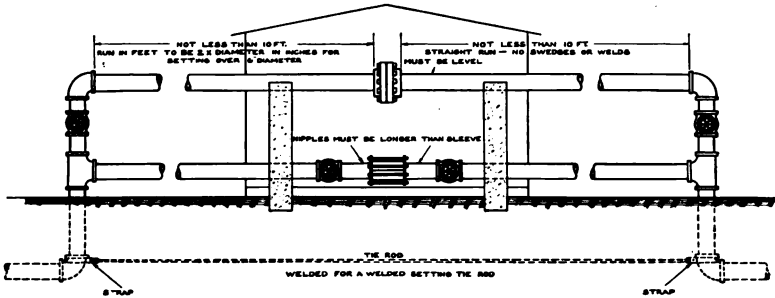

GOVERNMENT STANDARD
ORIFICE METER SETTING IN THE OSAGE

FIG. 1624

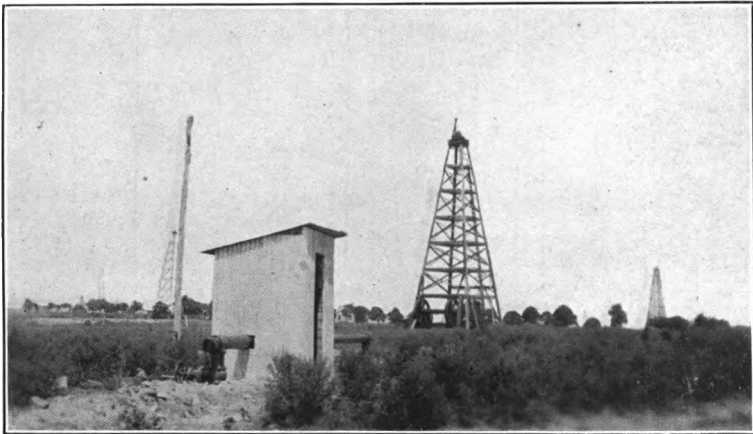
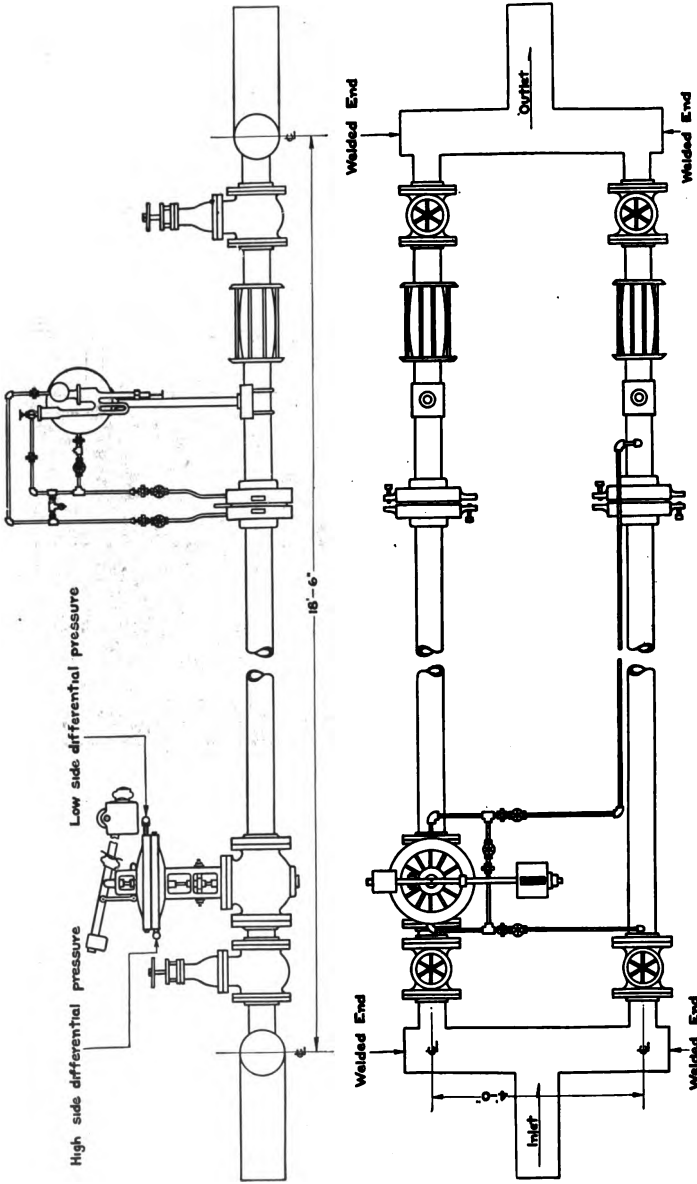

FIG. 1648

sible to assemble the setting incorrectly with respect to the direction of gas flow.

Fig. 1648 illustrates a meter setting for casing head, showing the proximity of the oil well from which the gas is flowing. On this installation a vacuum regulator is installed close to the meter on the side nearer the vacuum pump. The meter registration is not seriously affected by the action of the regulator.



DIAGRAMMATIC LAYOUT OF
MULTIPLE ORIFICE METER INSTALLATION
COURTESY OF LONE STAR GAS CO.

Fig. 1628

MULTIPLE-METER INSTALLATION

Conservatively speaking, a single orifice will handle a varying flow when the maximum flow does not exceed four and one-half times the minimum. In other words, a meter handling a minimum flow of 100,000 cubic feet daily will also handle 450,000 cubic feet daily at the same static pressure without changing the orifice size.

Occasionally in measuring gas to a town or to some industrial plant the peak consumption is so far in excess of the minimum or average flow that a single meter will not satisfactorily answer the purpose. When this condition is present, a multiple-meter installation is advisable.

In Fig. 1628 is shown a two-meter installation of this type. The

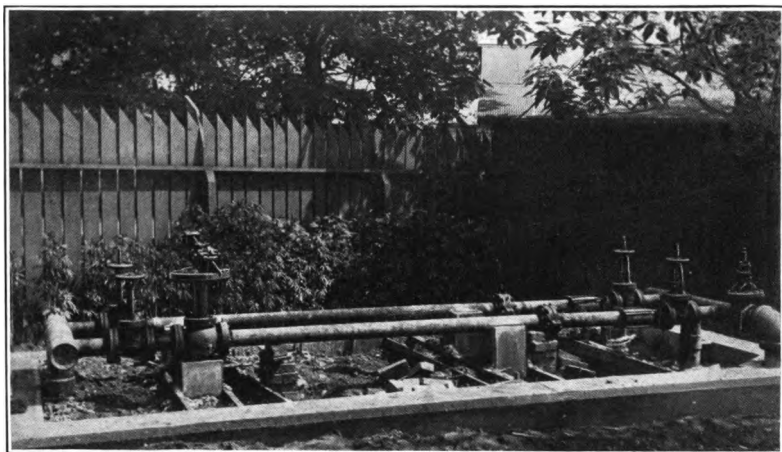

FIG. 1629

complete set-up consists of a suitable pipe manifold, two orifice meters, and a differential regulator.

Before going further with a description of the setting, it might be well to describe briefly the differential regulator. It is a balanced-type regulator with a single diaphragm operating the valve. The diaphragm chamber is tapped above and below the diaphragm for the differential pressure connections. The regulator arm is provided with a rolling weight, which, because of its automatic change in position with the movement of the arm above or below the horizontal, insures quick opening or closing of the balanced valve. The movement of the regulator arm is controlled by the differential on the diaphragm.

The regulator is installed in the line with the secondary meter.

In a multiple-meter installation the primary or pilot meter is always in service whether the flow of gas be large or small. If the quantity of gas is small, the secondary meter will be out of action because the regulator valve will be closed. As the flow increases and

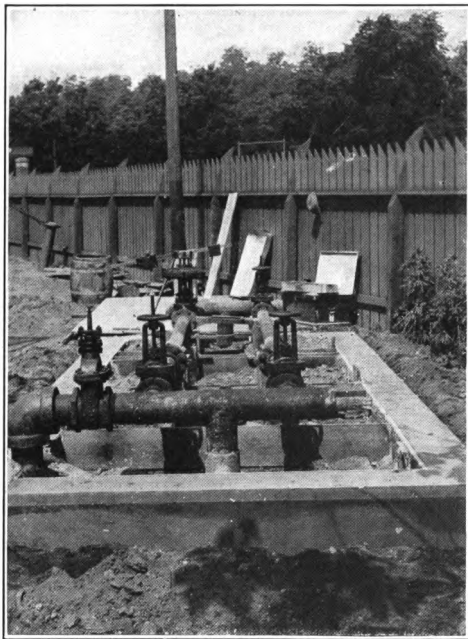

FIG. 1630

finally approaches the capacity limit of the primary meter, the differential pressure acting on the regulator diaphragm will cause the valve to trip open. This opening action is made positive by the rolling weight. The secondary meter will then automatically be put into service, thus taking care of the excess flow. If, when both meters are in service, the flow should decrease, the secondary meter will go out of action when the differential reading on the primary meter reaches a predetermined point. The high and low readings can be set by adjusting the weight-stops on the regulator arm.

Multiple-meter installations, however, are not limited to two meters. Any number of meters may be used, depending on the flow

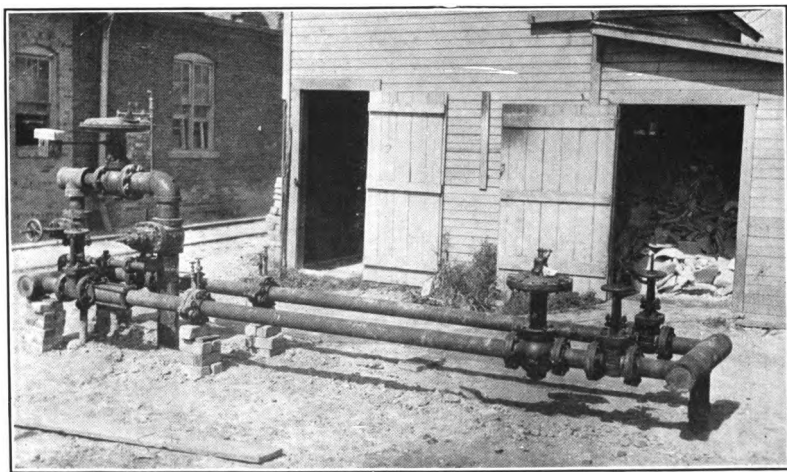

FIG. 1631

variation. It is necessary to use only one differential regulator less than the number of meters and arrange the pipe manifold accordingly.

Figs. 1629, 1630, and 1631 are photographs of good multiple-meter installations.

ORIFICE METERS FOR LIQUIDS

The mercury float type differential gauge has been used successfully in connection with the measurement of oil and other non-corrosive liquids. Coefficients have been determined for these conditions, and their derivation will be found in Chapter I.

A static gauge record is not required as a factor in determining liquid flows, because a liquid is incompressible, and its volume does not change under a varying static head.

The installation for this application is similar to that for gas with this exception: the piping should be arranged with small reservoirs made of 2" pipe tees in each leg of the connecting pipe, directly above the recorder. These reservoirs should be on the same level to insure an equal head of liquid on both legs of the differential chamber. Before putting such a meter into operation the $\frac{1}{4}$ " plug in the top of the H chamber and plug V in the L chamber should be opened to allow air to escape as the liquid is run into the piping.

INSTALLING AND OPERATING INSTRUCTIONS

Refer to Figs. 1593 and 1663

When the float type differential recording gauges are shipped, the valves R and S are closed to prevent leakage of mercury. These valves *must not* be opened until after the installation is made.

Both the Type T and Type C meters may be installed a considerable distance from the flange if necessary. Several installations have been made in the Mid-Continent Field with from 100 to 150 feet between the meter instruments and the flanges.

The orifice flange union should be screwed into the pipe line with a length of straight pipe equal to at least ten diameters on the inlet and outlet sides of the union. This pipe must be of the same size as that for which the union is tapped; that is, no reducers should be used at the union. The union may be installed at any angle, but care must be taken that the $\frac{1}{2}$ " tapped holes shall be in such a position that dirt or liquid carried by gas will not settle in them.

The flange union should always, where possible, be installed in such a manner that the plate may be changed readily when necessary, due to seasonal variations in the rate of flow. With this end in view, gates should be placed at not less than ten pipe diameters each side of the flange union. In installations where orifice plates must be changed without interruption of the flow of gas, a by-pass line with a gate in it should be provided around the flange union and the gates in the main line.

The orifice plate should be placed between the faces of the flange union with the handle projecting on the side that will be of easiest access for reading the data plate. Thin gaskets are used against both sides of the plate. They are in place when the flange is shipped from the factory. It may be necessary, however, to renew these

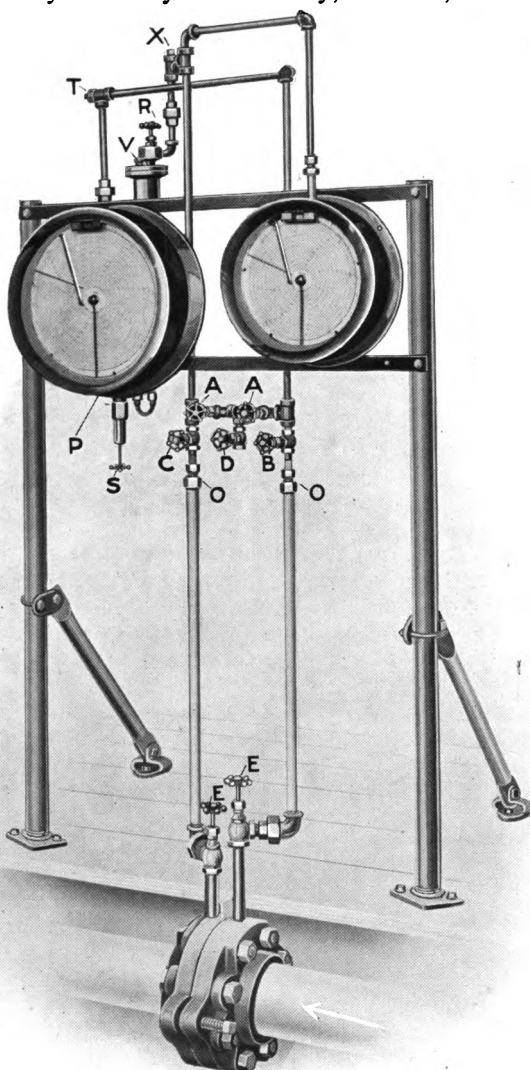

FIG. 1593

gaskets occasionally in the field, in which case care should be taken that they never extend inside the cored opening within the flange union.

Before making connections between flange union and unions O-O, see that —

- Valves B, C, and D are closed and
- Valves AA are open.

All valves turn to the right to close and are needle valves.

Connection between the flange union and the unions O-O is made in a manner similar to that shown in the figures. The arrow indicates the direction of gas flow. The upstream or high side of the flange union is to be connected to the union O on the valve B side;

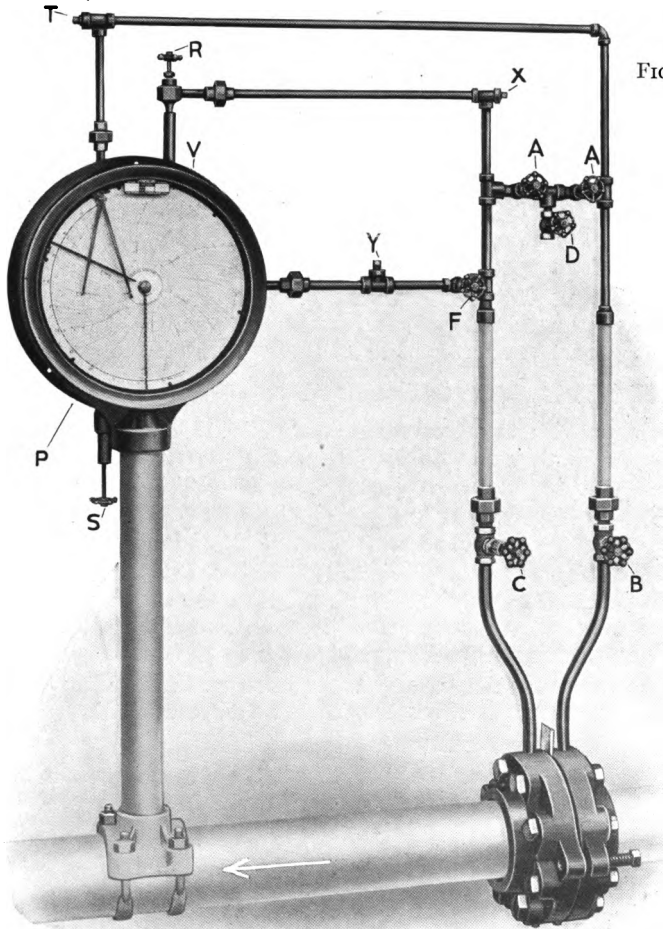

FIG. 1663

the downstream or low side of the flange union is to be connected to the union O on the valve C side.

It should be noted that the static pressure gauge connection comes off the downstream or low side of the flange union.

The only piping necessary to supply in the field when the regular meter piping is furnished is $\frac{1}{2}$ " nipples of such lengths as to locate the instruments at the desired elevation.

Care should be taken in making up piping that all joints are absolutely gas tight. They should be tested for leaks with a soap-and-water solution.

1. Place Meter in Service as follows:

Valves at flange union should be closed. Open valve R at least three or four complete turns.

Open valve S slowly, being careful to note that pen arm moves outward from chart hub toward zero point. If, after turning valve S several times, the pen does not move, tap the instrument lightly; this action should cause the pen arm to move outward as valve S is opened farther. Continue opening valve S until it reaches stop (20 to 25 turns) and is firmly seated. Remove the hand wheel from valve S after instrument is in operation.

See that all valves in pressure lines are closed except needle valves AA, which must be opened.

Turn gas into meter line and let it flow through the orifice.

2. To Place Instruments in Operation

In Fig. 1593: Open valves EE. In Fig. 1593 or 1663: Open valve B very slowly, permitting the pressure to build up, through the by-pass valves AA, on both sides of the differential gauge and on the static pressure gauge.

When the pressure has risen to its full value, open valve C.

When the pressure is fully applied, slowly close valves AA, being careful to watch the indications of the differential gauge to see that the size of plate installed is sufficiently large to measure the gas without throwing the pen beyond its range.

After valves AA are tightly closed, open valve D. If any gas is leaking through valves AA, it can be detected at D.

Valve D should remain open.

If it is found that the orifice is too small, the pressure must be shut off and a plate with a larger orifice substituted.

TESTING ORIFICE METERS

Although the orifice type of meter is the simplest, it requires intelligent care if the best results are to be obtained. It is the purpose

of this chapter to take up the various approved methods of testing and maintaining orifice meters.

Charts should be changed each day or week, according to their type. It is desirable from the office end of the work to make this change when the chart has made one complete revolution. The field man should remember that if corrections have to be made on the charts for fractional time periods, it cuts down the efficiency of the computing department.

At the time the chart is changed it is well to shut the meter down and bleed the pressure from the meter piping. This will show the field man whether or not the gauges check on zero, and provide the office with a record of the fact.

There is no definite time interval at which meters should be tested. This is determined by the conditions surrounding the installation. Meters subject to a widely varying load, and those measuring dirty or wet gas, should be tested more frequently than those measuring gas under ideal conditions. Experience alone can be the deciding factor.

Before going into details of testing, let us briefly consider the construction of the meter we have to test. In Chapter II will be found a complete description of the mechanical make-up of both Type T and Type C meters. It is brought out clearly in that chapter that the Foxboro Float Type Differential Recording Gauge is essentially a U gauge or manometer. On one column of mercury is a float which rises and falls with the mercury and transmits its movement through suitable mechanism to the pen arm which records the result. In order that an accurate registration may be obtained, there are three outstanding points to be considered: (1) The pen must rest on zero when both sides of the differential are open to atmospheric pressure. (2) The differential gauge must check accurately with a standard water or mercury column throughout its range. (3) The differential gauge must be free from any tendency to stick at any part of its range.

The pen arm on a Foxboro Float Type Differential Gauge *should never be moved at the friction joint*, because it would change its relative position with respect to the float. To determine whether or not the relation between pen and float is the same as the original adjustment, proceed as follows: Screw valve S into gauge. When it is tightly seated the pen point should rest $\frac{1}{8}$ " from the rim of the chart hub. A slight variation from this distance is of little consequence. Next unscrew valve S until it is tightly seated in the downward position. The pen should now rest on zero, providing the correct amount of mercury is in the gauge. If the pen rests out on the graduated chart, additional mercury is necessary, which may be poured in at point V, Fig. 1593. If, however, the pen rests inside the zero circle, it is evident that the float is too high, which makes it necessary to draw off sufficient mercury through the needle valve P to bring the pen on the zero line. (It may be necessary to draw off or add only a few drops of mercury to make adjustment.)

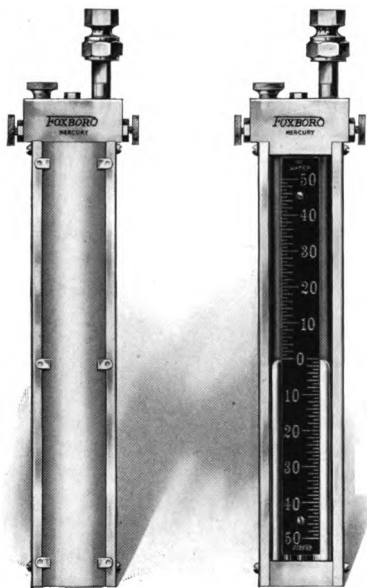

FIG. 1371

The general method employed for testing differential gauges is by the use of a U gauge, Fig. 1371, or manometer. This U gauge is connected to the meter piping by means of pipe or heavy rubber hose. The pressure or vacuum of the gas line may be used to establish a differential reading between the atmosphere and the pipe line simultaneously on both the U gauge and the differential recording gauge. If the differential recording gauge is correct, the U gauge should agree at all points on the scale. It should have a slightly greater range than the differential recorder to be tested.

In comparing the registrations of a mercury float type differential recording gauge against a standard water column, allowance should be made for the time required to bring the parts of the recording gauge to a balance at each reading. In other words, if the manometer goes from 0 to 50 inches of water almost instantaneously, the pressure should be held at this point for several seconds, in order that the recorder, which has a dampened action, may arrive at its true registration. This action can be speeded up by tapping the gauge slightly.

While a U gauge employing water as a measuring medium is rather cumbersome to carry in the field, it gives a closer reading than the mercury U gauge, due to its magnified scale.

Types T and C meters are supplied with the proper ranges for measuring gas either under pressure or vacuum. The following paragraphs outline the method of testing both types under either condition.

Type T under Pressure:

Referring to Fig. 1593:

- (1) Put meter out of service by closing valve D, opening valves AA, and closing valves B and C.
- (2) Remove plugs at X and T. Connect a U gauge of suitable range into the fitting from which plug T is removed.
- (3) Open valve B slightly until the hissing sound of escaping gas is heard at X, or until a reading of 4% of the chart range is indicated by both the recorder and the U gauge (4" on a 100" gauge, or 0.8" on a 20" gauge).

- (4) Start closing either of the valves A, thus causing pressure to be built up in the high-pressure side of the differential gauge. By further closing the valve a differential reading up to the full range of the chart can be secured with a corresponding reading indicated on the U gauge.

If the recorder reads low in comparison with the test gauge, draw off enough mercury to correct. If the recorder reads high, add mercury.

Type T under Vacuum:

Referring to Fig. 1593:

- (1) Put meter out of service by closing valve D, opening valves AA, and closing valves B and C.
- (2) Remove plugs at X and T. Connect a U gauge of suitable range into the fitting from which plug X is removed.
- (3) Open valve C slightly until the hissing sound of air is heard being drawn into the meter piping at T, or until a reading of 4% of the chart range is indicated by both the recorder and the U gauge (4" on a 100" gauge, or 0.8" on a 20").
- (4) Start closing either of the valves A, thus causing a greater vacuum to be created on the low side of the differential gauge. By further closing the valve a differential reading up to the full range of the gauge can be secured with a corresponding reading indicated on the U gauge.

If the recorder reads low in comparison with the test gauge, draw off enough mercury to correct. If the recorder reads high, add mercury.

The earlier Type T meters were equipped with a three-valve manifold, as illustrated in Fig. 1406. The following instructions cover the testing of the meter with this type of manifold.

Type T (Three-valve Manifold) under Pressure:

Referring to Fig. 1406:

- (1) Put meter out of service by opening valve A and closing valves B and C.
- (2) Remove plugs X and T. Connect a U gauge of suitable range into the fitting from which plug T is removed.
- (3) Open valve B slightly until the hissing sound of escaping gas is heard at X, or until a reading of 4% of the chart range is indicated by both the recorder and the U gauge (4" on a 100" gauge, or 0.8" on a 20" gauge).
- (4) Start closing valve A, thus causing pressure to be built up in the high-pressure side of the differential gauge. By further closing the valve a differential reading up to the full

range of the chart can be secured with a corresponding reading indicated on the U gauge.

Type T (Three-valve Manifold) under Vacuum:

Referring to Fig. 1406:

- (1) Put meter out of service by opening valve A and closing valves B and C.
- (2) Remove plugs at X and T. Connect a U gauge of suitable range into the fitting from which plug X is removed.

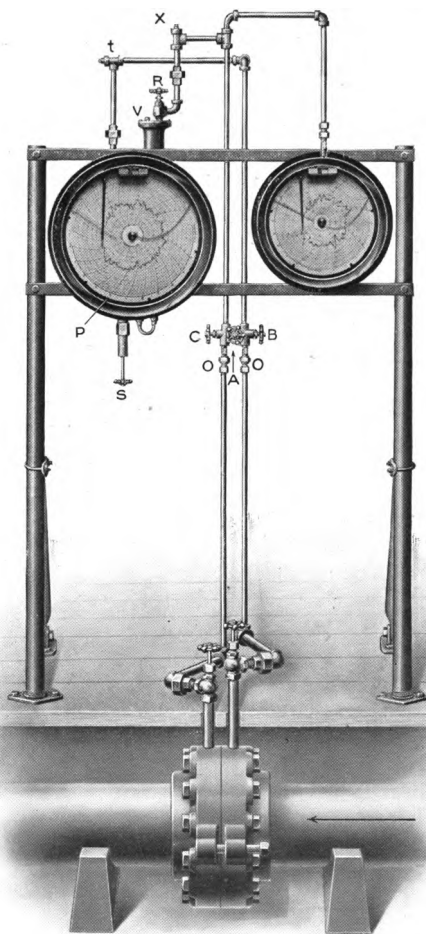

FIG. 1406

- (3) Open valve C slightly until the hissing sound of air is heard being drawn into the meter piping at T, or until a reading of 4% of the chart range is indicated by both the recorder and the U gauge (4" on a 100" gauge, or 0.8" on a 20").
- (4) Start closing valve A, thus causing a greater vacuum to be created on the low side of the differential gauge. By further closing the valve a differential reading up to the full range of the gauge can be secured with a corresponding reading indicated on the U gauge.

If the recorder reads low in comparison with the test gauge, draw off enough mercury to correct. If the recorder reads high, add mercury.

Type C Meters

In testing Type C meters the same procedure is followed as in Type T under either pressure or vacuum. By referring to Fig. 1663 and comparing it with Fig. 1593 it will be seen that the valves of the Type C meter are let-

tered to correspond with those on the Type T meter. Therefore follow the instructions under Type T and apply them to Type C.

TESTING STATIC RECORDERS

The Static Recorder may be tested with either pressure or vacuum on the line by means of a test gauge similar to that shown in Fig. 1330.

Type C Static:

Referring to Fig. 1663:

- (1) Close valve F.
- (2) Remove plug at Y and connect test gauge at this point.
- (3) Open valve F; this will check the static at line pressure.

If it is desirable to check at more points on the scale,

- (4) Close valve D.
- (5) Open valves AA.
- (6) Close valve B.
- (7) Open valve D slowly; this will relieve the pressure or vacuum in the piping.

Type T Static:

Referring to Fig. 1593:

- (1) Close D.
- (2) Open AA.
- (3) Close B and C.
- (4) Remove plug at X.
- (5) Connect test gauge at X.
- (6) Open valve C.



FIG. 1330

By slowly opening and closing valve D the pressure or vacuum is relieved or built up, and the gauge may be checked over the entire range up to the maximum line pressure.

TESTING PROPORTIONAL METERS, USING ORIFICE METER AS STANDARD*

In checking the accuracy of proportional meters it is the practice of some companies to use the orifice meter as a standard, rather than the "Funnel Meter." A complete description of such test is given below.

An orifice flange union having a length of straight pipe equal to at least ten diameters on both inlet and outlet sides, is connected in the line in series with the proportional meter. It is immaterial on which side of the proportional meter the orifice meter is inserted, but there

*Courtesy of the United Natural Gas Co.

must be no outlet or connection between the two meters in order that precisely the same quantity of gas may pass through both meters in series. A differential water U gauge, capable of standing the static pressure in the line, is connected with its two legs to the two taps in the orifice flange union. A calibrated static pressure or mercury column, depending upon the pressure in the line, is connected to the line leading from the downstream side of the orifice union to the differential water column. A thermometer is inserted in a cup in the line, preferably between the two meters, to ascertain the temperature of the flowing gas. The orifice flange union is to contain an orifice plate of proper size to give a reading of at least ten inches of water on the differential gauge with the minimum rate of flow at which the proportional meter is to be tested. If the maximum rate of flow requires a larger plate, this can readily be inserted. The atmospheric pressure at the time of the test is ascertained by means of an aneroid barometer, and the specific gravity of the gas measured must be determined by any approved method. The quantity of gas measured by the two meters is computed on the basis of 14.65 pounds absolute storage pressure and a storage temperature equal to the temperature of the gas flowing in the line. The difference in the quantities indicated by the two meters, divided by that shown by the orifice meter, is the percentage error of the proportional meter; or in other words, the error is equal to the quotient of the gas measured by the proportional meter divided by that measured by the orifice meter less 1.

To Test

With a stop watch note the time in seconds and fractions of a second required to pass 1000 (or 100) cubic feet through the meter, as registered on the dial. After starting the watch, and while the gas is passing through the meter, note in regular order the pressure of the gas passing through the meter, the differential reading on the water column, and the static pressure on the orifice meter. Make as many of these readings as possible in the time required for the gas to pass through the proportional meter. This will give an average of conditions during the test. After stopping the watch, note the temperature of the gas flowing through the line and the atmospheric pressure indicated by the barometer. Care should be taken to hold the pressure and flow as nearly constant as possible during these tests. The averages of all observations should then be obtained, and the computation of results made as follows:

Let S = the time in seconds required for the passage of 1000 (or 100) cubic feet of gas through the proportional meter.

P_m = absolute pressure in the proportional meter = the static gauge pressure + the pressure of the atmosphere.

P_s = the absolute storage pressure base of measurement = 14.65 pounds per square inch.

Q_m = the quantity of gas passing per hour through the proportional meter, based on the flowing temperature of the gas and P_s .

- Q_o = the quantity of gas passing per hour through the orifice meter based on the actual flowing temperature of the gas and P_s .
- C = the hourly coefficient of the orifice plate based on .644 gravity, 14.65 lbs. absolute storage pressure, 40° F. flowing temperature and 50° F. storage temperature.
- T = absolute flowing temperature in degrees Fahrenheit.
- G = specific gravity of gas; air = 1.
- h = differential water head in inches.
- P = absolute pressure of gas in orifice meter = static gauge pressure + atmospheric pressure.

Then Dial Rate = 1000 (or 100) $\frac{3600}{S}$ (hourly)

$$Q_m = 1000 \text{ (or 100)} \frac{3600}{S} \frac{P_m}{P_s} = 245,700 \text{ (or 24,570)} \frac{P_m}{S}$$

$$Q_o = C \frac{1465}{P_s} \frac{T}{510} \sqrt{\frac{500}{T} \frac{0.644}{G} h P} = 0.035185 C \sqrt{\frac{h P T}{G}}$$

$$\text{Error} = \frac{Q_m}{Q_o} - 1 = \frac{Q_m - Q_o}{Q_o}$$

$$\text{Per cent Error} = \left(\frac{Q_m}{Q_o} - 1 \right) 100$$

The results of a series of tests are best computed by tabulating the data obtained during the test on a sheet of paper with columns provided for the quantities to be ascertained by computation, similar to the form indicated below:

TESTS OF _____ PROPORTIONAL METER NO. _____ ORIFICE METER STANDARD. DATE _____															
Orifice Plate No. _____ Coef. C = _____				Specific Gravity of Gas = _____											
Test No.	Baro. In. Hg.	Atmos. Press. #/sq. in.	t. Deg. F.	T. 460° + t.	PROPORTIONAL METER				ORIFICE METER				Error	Per Cent Error	
					S. Sec.	Dial Rate	P _m Gauge Press.	P _s Abs.	Q _m Cu. Ft. Hr.	h Diff.	P Static	P Obs. Static			Q _o Cu. Ft. Hr.
	*		*		*		*			*	*				

* Observed Quantities

FIG. 1659

MAINTENANCE OF ORIFICE METERS

The orifice meter, like any other piece of machinery, needs reasonable attention, and this is dependent upon the service under which the meter is operating.

The simplicity of the float type differential gauge construction makes it possible to take apart and clean the instrument with comparatively little trouble, and in the interest of better service it is recommended that this be done periodically by a competent person.

The following pages are devoted to definite instructions for cleaning, repairing, and replacement of parts, together with half-tone cuts of the separate units and their corresponding part numbers. These numbers should be used in ordering parts.

Cleaning Float Type Recorder

Refer to Figs. 1586 and 1587.

After putting instrument out of service, break unions at the instrument.

From the back of instrument :

Remove chamber cap part No. 5159. Remove U pin, part No. 11896, from top of float shaft.

Using a 12" shank screw driver with $\frac{1}{4}$ " blade, remove screws holding upper and lower chambers together. This allows the entire differential chamber unit, part No. 6436 or 7835 to be removed, leaving part No. 6433 or 7834 attached to case.

Use care in handling the removed unit, so that mercury will not be spilled. Take out the float part No. 7642. Pour the mercury into a glass container. Remove cover part No. 5196 or 7790 from L chamber. The valve R, filling plug V, and calibration stick are all attached to this cover.

Remove check valve assembly, part No. 12139, using extreme care not to get the check floats interchanged, as they are each ground to their respective seats and must be replaced in their original positions.

Clean the differential chamber carefully with gasolene and wipe out.

Reassemble carefully.

In replacing check valve assembly use care to see that the upper stem of the check floats is properly inserted in the center hole of the bearing inside the tubes. These bearings not only have a center hole to guide the check float stem, but also have openings around the center hole to permit the mercury to pass through, and unless care is used, it is possible to insert the stem into the wrong hole and cause trouble.

To Replace Bearing and Shaft

Part No. 11557, Figs. 1586 and 1587. Part No. 11914, Fig. 1595.

From back of instrument:

Remove chamber cap, part No. 5159.

Remove plug, part No. 10200, on top of chamber, part No. 6433 or 7834.

Insert screw driver through plug hole and loosen screws on shaft clamp, part No. 5487 or 7856.

From front of instrument:

Remove chart disc.

Remove top plate, part No. 6214, Figs. 1586 and 1587, or if this meter is a Type C, first remove screw A, shown in Fig. 1596 or 1591, page 24, then in the following order remove parts Nos. 8991, 12325, 12322, and 12319.

With the differential pen-arm bracket between the thumb and finger of the left hand, hold a lighted match or hot soldering iron against the end of the flexible coupling, part No. 11943 or 9990.

Pull the shaft through the bearing from the front.

From the back of the instrument:

Remove the bearing by means of a special socket wrench which may be procured from the meter manufacturer.

To Remove the Entire Differential Chamber from the Case

From the front of the instrument:

Remove the chart disc.

Remove the pen arms and brackets as noted in the previous paragraph.

Take out the three cap screws, part No. 5948.

Check Valve

As explained in a previous paragraph the check valves are each ground to their respective seats and are not interchangeable, therefore, if new check floats are required, the entire assembly, part No. 12139, should be ordered.

Differential Float Assembled

If the ball joint between the float stem and extension arm is damaged, an entirely new assembly part No. 7642 should be used, as it is difficult to replace the ball joint without the proper equipment.

To Replace Static Tube in Type C Instrument

Refer to page 23 under construction of Differential and Static Recording Gauge.

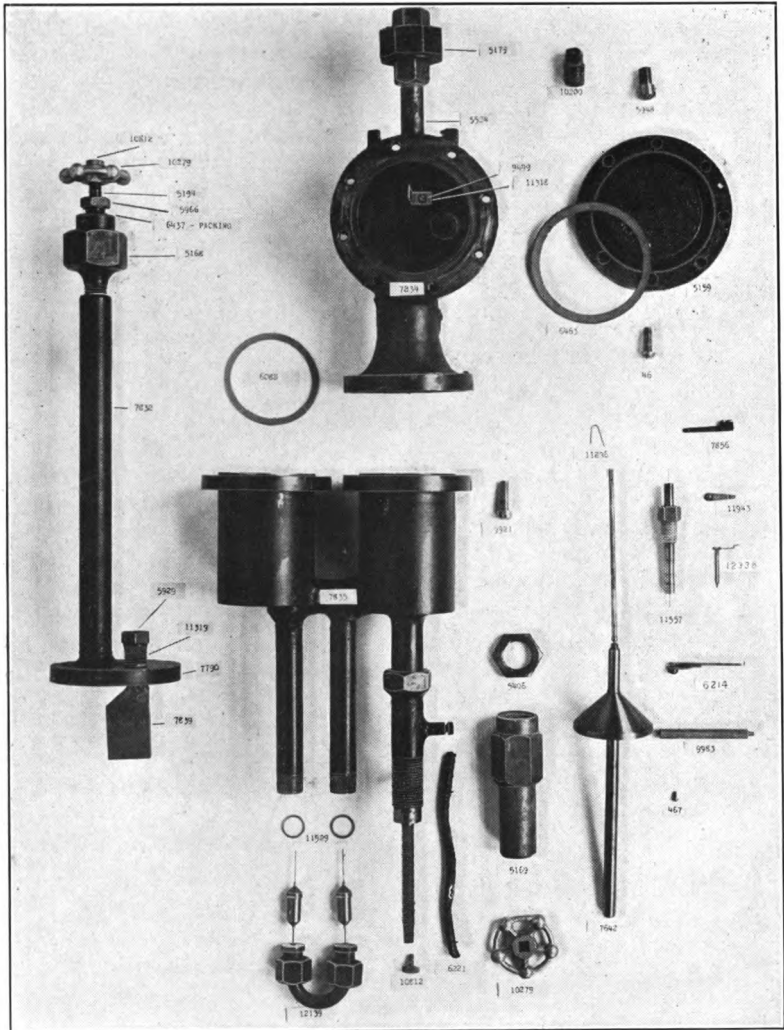

FIG. 1586

20" FLOAT TYPE DIFFERENTIAL RECORDER
Differential Chamber Parts

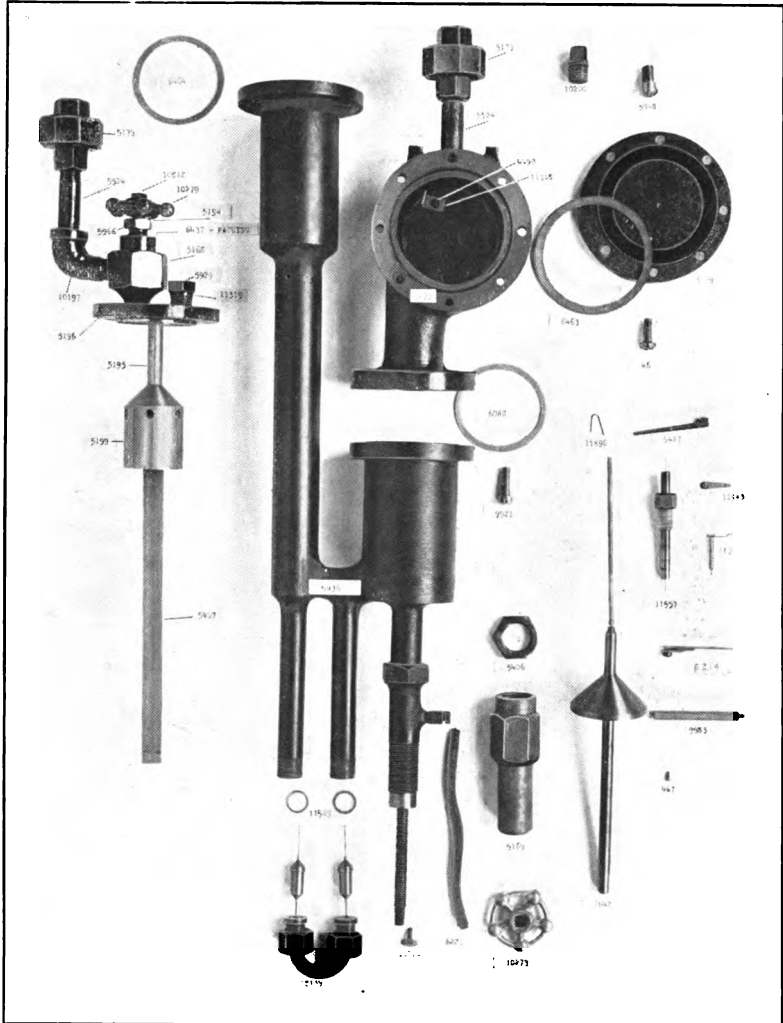

FIG. 1587

100' FLOAT TYPE DIFFERENTIAL RECORDER
Differential Chamber Parts

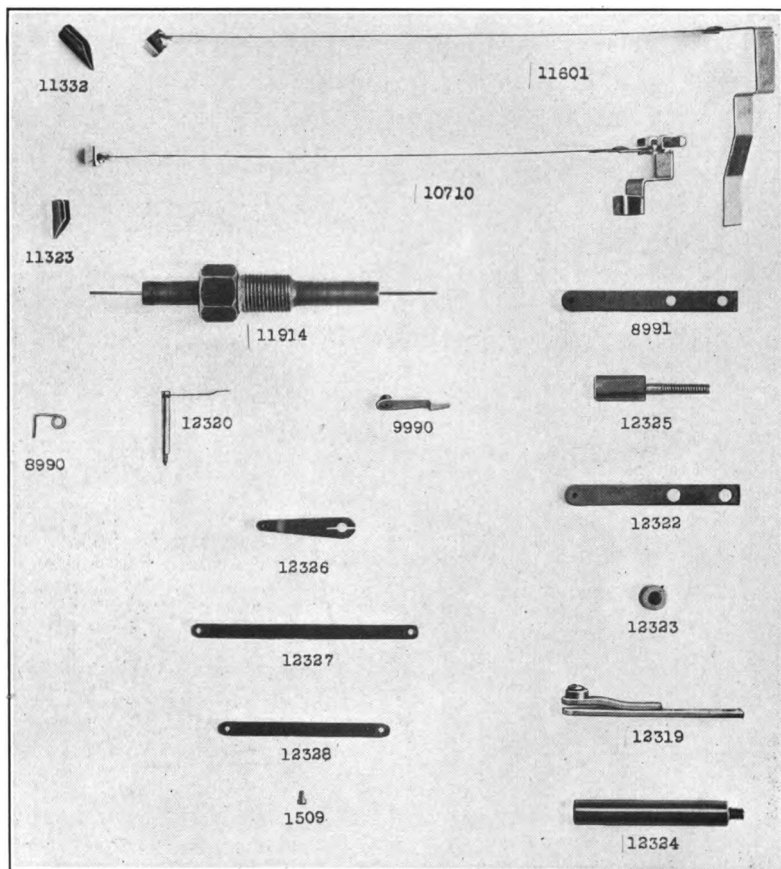
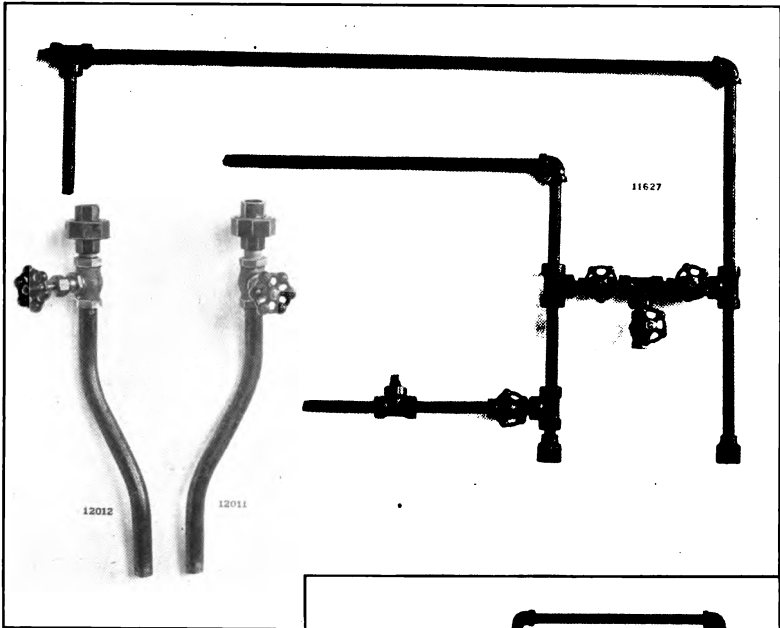
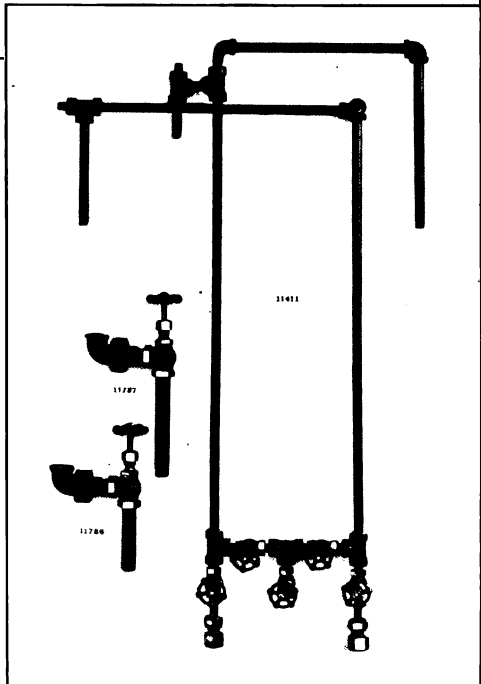

FIG. 1595

COMBINATION DIFFERENTIAL AND STATIC RECORDER
Movement Parts



(above)
FIG. 1590
TYPE C METER PIPING



(right)
FIG. 1589
TYPE T METER PIPING

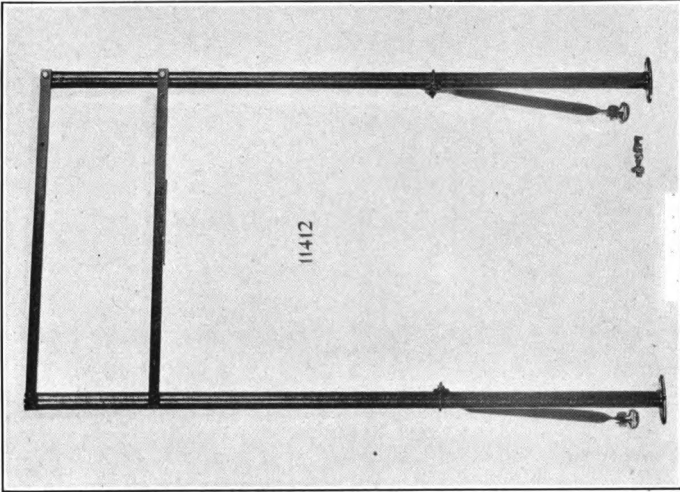

FIG. 1616
TYPE T METER FRAME

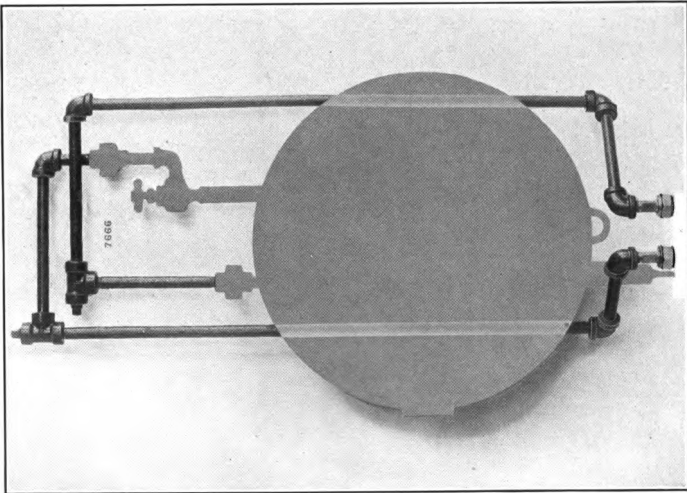

FIG. 1588
LOOP CONNECTION PIPING FOR APPLYING FLOAT TYPE
RECORDER TO SPRING TYPE METER FRAME

CHAPTER IV

COMPUTATION OF CHARTS

BEFORE taking up the details of the process involved in computing charts, let us briefly consider a point which, when thoroughly understood, will reduce to a minimum the time of figuring charts.

It is common practice in chart computing work, to carry the results of each step to five, six, or seven places of figures. For example: 1,567,925 cu. ft. The operator believes that because those seven figures, or digits, as they are known mathematically, are the correct result of the final operation in computing, they must represent the actual amount of gas passed by the meter in question. However, this is not true, for the result could be set down as 1,568,000 cu. ft. and be just as accurate an indication of the quantity of gas as the former number. This latter number contains only four significant figures, and the following paragraphs, under Precision of Measurement, will explain why it is a waste of time, and why the results are no more accurate if a greater number of significant figures are used, than the attainable accuracy of the result warrants.

PRECISION OF MEASUREMENT

A significant figure is any digit (including zero) used to denote the amount of the quantity in the place in which it stands; but when zero is used to locate the decimal point it is not significant. Thus in the number 0.02060 the first two zeros are not significant figures. That between the 2 and the 6 denotes a quantity and is therefore significant. The zero following the 6 indicates that the measurement is sufficiently accurate to indicate that the quantity in the place in which it stands is nearer to zero than to any other number, and is therefore significant. In the number 385,000, the last three zeros may or may not be significant, depending upon whether or not the quantities represented by these places of figures were measured. If they are retained merely to indicate the position of the decimal point, as is usually the case (except in abstract numbers), they are not significant.

From a study of the principles of significant figures (Computation Rules, by Silas W. Holman) it will be observed that an accuracy of one per cent or better in the final result of any computation involving the multiplication of less than twenty factors, may be assured by the use of four significant figures. It will also be seen that in any multiplication or division, the percentage accuracy of the product or quotient cannot exceed that of the factor whose percentage accuracy is least;

or in other words, if several numbers are multiplied or divided, a given percentage error in any one of them will produce the same percentage error in the result.

Furthermore, where a number is raised to any power n , the percentage error in the result is equal to n times its value in the data.

The orifice meter formula

$$Q = 218.44 \text{ Ed}^2 \sqrt{\frac{T_B}{P_B} \frac{hP}{T_f G}}$$

consists of nine factors of which the constant (218.44), the efficiency (E), the temperature base (T_B), and the pressure base (P_B) occur as the first power; the diameter of orifice (d) is raised to the second power; and the flowing temperature (T_f), specific gravity (G), differential (h), and static pressure (P) have the exponent one-half.

The constant (218.44) is derived from certain abstract numbers, in conjunction with the values of π , g , and the densities of air and water — all of which may be ascertained with a precision so far in excess of commercial needs that this constant may be considered to have no appreciable error. Likewise the temperature and pressure bases of measurement are not subject to error, being merely the standard bases to which the measurement is referred.

The deviation measure, or the accuracy, of the efficiency (E) is, for the Foxboro meter, one-half of one per cent, and as it occurs in the formula as the first power, its effect on the final result is to limit it to an accuracy of 0.5%.

The diameter (d) may be determined to 0.1% or better, with an effect of twice this amount, or 0.2% on the final result.

The flowing temperature (T_f) may readily be measured commercially to $1/2^\circ$ F., which corresponds to an accuracy of 0.1% or an effect of one-half of this amount, or 0.05% on the final result. It will be noted in this connection that where flowing temperature readings are not made, but an assumed average value for this factor is included in the orifice coefficient, the error introduced thereby in the final result at any instant is equal to one-half the percentage difference between the assumed average temperature and the actual temperature, and amounts, roughly, to one per cent for every 10° F. of difference. Over a considerable period of time, however, this error will be eliminated if the assumed average temperature is properly chosen and weighted.

The specific gravity (G) may readily be determined to one per cent, with an ultimate effect on the result of one-half per cent. This factor, like flowing temperature, is usually incorporated in the coefficient and, if there should be any wide variation in G from time to time, the final error produced will be one-half the percentage difference between the assumed and the actual gravities. This error will also be eliminated if the average gravity assumed represents the true weighted gravity of the gas flowing over a period of time.

The differential (h) may be read directly to one inch or to two inches, depending upon the total range of chart graduation of the gauge, and by estimation of tenths may be determined to one or two tenths of an inch respectively. If the minimum differential is ten inches or higher (obtained by proper selection of orifice sizes), the percentage error of observation of this quantity may be limited to one or two per cent. There may also be an error due to slight inaccuracies in the gauge, amounting to a maximum of one-half per cent. Inasmuch, however, as the average differential will usually be considerably higher than ten inches, the total error due to these two sources should never exceed one per cent with an ultimate effect upon the result of one-half of one per cent.

The static pressure is made up of two quantities; the reading of the static gauge pressure and the atmospheric pressure, or barometric reading. The gauge reading can be determined to one per cent, or 0.15 lb. at atmospheric pressure, or to 1 lb. at 100 lbs. pressure. If the atmospheric pressure is determined by actual barometer readings, it can be read to one-tenth per cent, or 0.015 lb., and therefore will have little or no effect upon the error of the static pressure determination. If, however, as is usually the case, the average barometric pressure for a given location is assumed and added to the static pressure, the maximum deviation of the actual barometer from the assumed average may be as much as 0.15 lb. per sq. in. Thus the total maximum combined error in the static pressure determination under this condition may be as much as 0.3 lb. per sq. in., or 2 per cent at atmospheric pressure; or it may be 1.15 lbs. per sq. in. or one per cent at 100 lbs. static. The average error over a period of time, however, would be considerably less than this and may safely be taken as one per cent with an ultimate effect upon the result of one-half per cent.

From the foregoing discussion it is seen that no one factor in the orifice-meter formula can produce a percentage error in the result greater than one-half of one per cent maximum, and the average effect should be considerably less than this. It would also be rare if the errors of the various factors did not tend to neutralize each other to a certain extent, so that the accumulated error in the result should never exceed one per cent and will usually be less than one-half per cent.

Therefore, in all computations for the orifice meter, it is desirable to use four places of significant figures, for the rejection error by casting off all places above four cannot possibly introduce an error of computation as great as the uncertainty of the data. On the other hand, the use of more than four places is worse than useless. It adds nothing to the accuracy of the result, although increasing materially the labor of computing, and the liability of mistakes. The use of five places instead of four nearly doubles the labor, and using six places instead of four nearly trebles it.

For the reasons outlined above, all tables of constants or factors to be used in orifice-meter computations should be carried to four, and only four, places of significant figures.

DIRECTIONS FOR COMPUTING RESULTS

The simplified formula for gas flow, as shown in Chapter I, is

$$Q = C \sqrt{hP}$$

in which

Q = quantity of gas (cu. ft.) flowing for any given period.

C = coefficient for the same period.

h = average differential pressure for that period.

P = average absolute static pressure for that period.

Chapter V contains a complete description of the coefficient C , together with a set of tables giving the hourly coefficient corresponding to various orifice sizes.

The square root of the values of h and P , as indicated in the foregoing equation, must be determined as a part of the computation, but in order to facilitate this step, reference can be made to a set of multiplier tables at the end of this chapter. These tables contain the values of the square root of h and P .

One more step which saves labor in computing is the use of Extension Tables.

A part of a page from a commonly used extension book is shown in Fig. 1674 on the next page. The cut has been arranged with the center sections of the page removed, in order to bring the figures more nearly to full size. The figures shown are approximately two-thirds size, and the actual size of a page is 9×16 .

The extension is the product of the square root of h and P , or the product of the multipliers of h and P , found in the multiplier tables at the end of this chapter.

The commonly used extension books are so arranged that each page contains the extensions for either one or five static pressures. In the foregoing illustration the page is one static pressure, namely 144 lbs. The differential pressures are the figures in the vertical columns under H and in the horizontal columns at the top and bottom of the page. With this arrangement, extensions may be found for differential pressures each tenth of an inch, although it is unnecessary to figure the differential pressures closer than 0.5 of an inch or the static pressures closer than single pounds.

The use of these Extension Tables eliminates the necessity of multiplying together the values for h and P , found in the multiplier tables, and by further confining the extension values to four significant figures the amount of labor involved is minimized.

The process of determining the flow of gas is therefore simplified to multiplying the hourly coefficient by the total extension.

Pressure, Pounds 144

H.	.0	.1	.2	.7	.8	.9	H.
0.		3.980	5.629	10.530	11.257	11.940	0.
1.	12.586	13.200	13.787	16.410	16.885	17.348	1.
2.	17.799	18.238	18.668	20.680	21.060	21.433	2.
3.	21.799	22.159	22.514	24.209	24.534	24.855	3.
4.	25.171	25.484	25.793	27.285	27.574	27.860	4.
5.	28.142	28.423	28.700	30.048	30.310	30.571	5.
6.	30.829	31.084	31.338	32.577	32.820	33.060	6.
7.	33.299	33.536	33.771	34.924	35.150	35.375	7.
8.	35.598	35.820	36.040	37.122	37.335	37.547	8.
9.	37.757	37.966	38.174	39.198	39.400	39.600	9.
10.	39.799	39.998	40.196	41.169	41.361	41.552	10.
11.	41.742	41.931	42.120	43.050	43.233	43.416	11.
12.	43.598	43.779	43.960	44.852	45.028	45.204	12.
13.	45.378	45.553	45.726	46.584	46.754	46.923	13.
14.	47.091	47.259	47.427	48.254	48.418	48.581	14.
15.	48.744	48.906	49.068	49.869	50.027	50.185	15.
16.	50.343	50.500	50.656	51.432	51.586	51.739	16.
17.	51.892	52.045	52.197	52.950	53.099	53.248	17.
18.	53.397	53.545	53.692	54.425	54.570	54.715	18.
19.	54.860	55.004	55.148	55.861	56.003	56.144	19.
20.	56.285	56.419	56.566	57.262	57.400	57.537	20.
21.	57.675	57.812	57.949	58.628	58.763	58.898	21.
22.	59.032	59.166	59.300	59.964	60.096	60.228	22.
53.	91.625	91.712	91.798	92.223	92.314	92.400	53.
54.	92.486	92.571	92.657	93.083	93.168	93.253	54.
55.	93.338	93.423	93.508	93.930	94.014	94.099	55.
56.	94.183	94.267	94.351	94.770	94.853	94.937	56.
57.	95.020	95.103	95.186	95.602	95.685	95.767	57.
58.	95.850	95.932	96.015	96.427	96.509	96.591	58.
59.	96.673	96.755	96.836	97.244	97.326	97.407	59.
60.	97.488	97.570	97.651	98.056	98.136	98.217	60.
61.	98.298	98.378	98.459	98.860	98.940	99.020	61.
62.	99.100	99.180	99.260	99.658	99.737	99.817	62.
63.	99.896	99.975	100.053	100.450	100.530	100.610	63.
64.	100.685	100.764	100.841	101.234	101.311	101.390	64.
65.	101.470	101.550	101.630	102.015	102.091	102.170	65.
66.	102.245	102.325	102.400	102.789	102.865	102.941	66.
67.	103.019	103.095	103.171	103.555	103.631	103.709	67.
68.	103.785	103.861	103.935	104.318	104.394	104.469	68.
69.	104.545	104.620	104.699	105.075	105.149	105.225	69.
70.	105.300	105.375	105.449	105.825	105.899	105.975	70.
71.	106.049	106.125	106.199	106.570	106.641	106.719	71.
72.	106.791	106.869	106.940	107.310	107.385	107.459	72.
73.	107.531	107.605	107.679	108.050	108.120	108.194	73.
74.	108.268	108.339	108.411	108.780	108.850	108.921	74.
75.	108.995	109.069	109.140	109.501	109.575	109.649	75.
H.	.0	.1	.2	7	.8	.9	H.

FIG. 1674

to Form I. In either case extreme care must be used to see that the differential and static readings are taken for corresponding periods.

The total of the extensions in either Figs. 1672 or Form I is 1628.61. Reduced to four significant figures this amount becomes 1629. If this is multiplied by an assumed hourly coefficient of 300, the result is 488,700, which is the daily flow of gas in cubic feet.

Case II. When gas is passing for twenty-four hours, but for any reason the charts are not readable for the entire period.

FORM I			
Hourly Period	h	P	Extension
A.M. 6.00- 7.00	30.	131	66.05
7.00- 8.00	31.	131	67.14
8.00- 9.00	30.5	130	66.36
9.00-10.00	30.	130	65.82
10.00-11.00	24.	140	60.87
11.00-12.00	25.5	140	62.75
P.M. 12.00- 1.00	30.	137	67.39
1.00- 2.00	34.	135	71.27
2.00- 3.00	35.5	133	72.34
3.00- 4.00	35.	133	71.83
4.00- 5.00	34.	133	70.79
5.00- 6.00	34.	132	70.55
6.00- 7.00	34.	132	70.55
7.00- 8.00	30.	133	66.50
8.00- 9.00	30.	133	66.50
9.00-10.00	30.	133	66.50
10.00-11.00	29.	134	65.60
11.00-12.00	28.5	134	65.03
A.M. 12.00- 1.00	33.	132	69.51
1.00- 2.00	34.	131	70.31
2.00- 3.00	33.5	131	69.79
3.00- 4.00	32.5	131	68.74
4.00- 5.00	32.5	131	68.74
5.00- 6.00	31.5	131	67.68
Total Extension			1628.61

It is customary to assume the average hourly flow for the readable period as average for the twenty-four hours. Read the differential and static for as many *corresponding* readable hourly periods as possible. Add their extensions. Multiply this sum by 24 and divide by the number of hourly periods for which readable values were obtained. Multiply this result by the hourly coefficient of the plate used, and the product will be the number of cu. ft. of gas passed in twenty-four hours.

Case III. When gas is passing for only a portion of twenty-four hours.

When readable values of both h and P may be obtained for each hourly period during which gas is flowing, the procedure is exactly as in Case I. The sum of the extensions for the number of periods involved, multiplied by the hourly coefficient, will give the flow of gas for that time.

When readable values cannot be obtained for each period of actual flow, proceed as in Case II, except that the sum of the extensions of the *corresponding* readable values should be multiplied by the number of hours during which gas was actually passing, and divided by the number of hourly periods for which readable values were obtained. This result, multiplied by the hourly coefficient, will give the quantity of gas passed during the actual time of flow.

Occasionally the records run so uniform that the average for the entire period may be determined at a glance without introducing a serious error. Such records are shown in Fig. 1670 on next page. The average static pressure is 144 lbs.; the average differential, 15.5". The extension for these values is 49.55. Assuming the hourly coefficient to be 415.6, then $415.6 \times 49.55 = 20,590$ cu. ft. of gas per hour, which, multiplied by 24, gives 494,200 cu. ft. of gas per day.

Charts of this type may also be computed by means of a Radial Planimeter, a popular model of which is shown in Fig. 1192.

Although considerable time can be saved by the use of a Planimeter, the operator should have a thorough understanding of its application to flow meter chart computation. It is designed to give the average radius of the records, and when this result is referred to a rating table or chart plot for the particular range involved, the average unit of pressure is determined.

In the case of gas flow measurement an equation of the second power is involved, consequently the square root of the values of h and P must be obtained. If the records vary widely, they should be divided into sections covering the high, low, and possibly the intermediate periods.

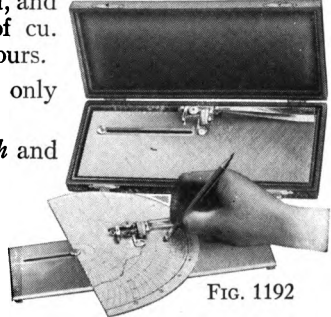

FIG. 1192

Fig. 1671 (on next page) shows a Type C meter record in which the differential pressure has a high period from 5.30 p. m. to 5.30 a. m., and a low period from 5.30 a. m. to 5.30 p. m. In using a Planimeter on a record of this type the high and low periods should be treated separately.

In the interests of accurate measurement the reason for this procedure should be explained.

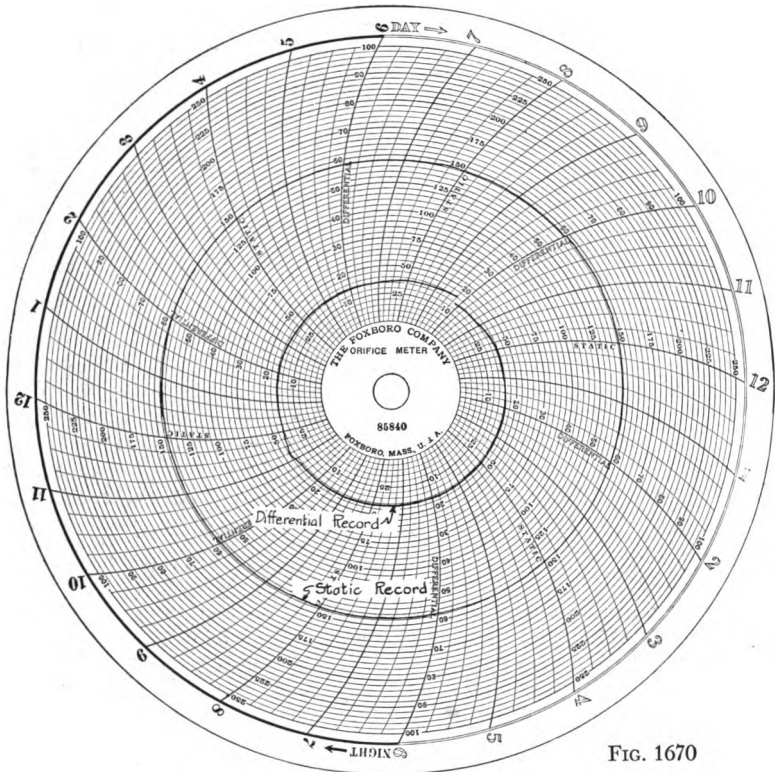

FIG. 1670

Referring to Fig. 1671, the average for the high period is approximately 72, and for the low period approximately 38. If the entire record were averaged at one operation by a Planimeter, the result would be 55, and the square root of 55 is 7.416. If, however, the periods were averaged separately and the average square root determined, the results would be the square root of 72 (8.485) plus the square root of 38 (6.164), or 14.649 divided by 2, which would give 7.325. The error in this particular case is not very large, but it would increase rapidly as the difference between the high and low periods

increased. For example, if the foregoing high period averaged approximately 90, and the low period 20, the average for the entire record would still be 55 and its square root 7.416, but the square root of 90 (9.487) plus the square root of 20 (4.472), or 13.959, divided by 2, would be 6.979. Therefore it is obvious that the desired result should be the average square root and not the square root of the average.

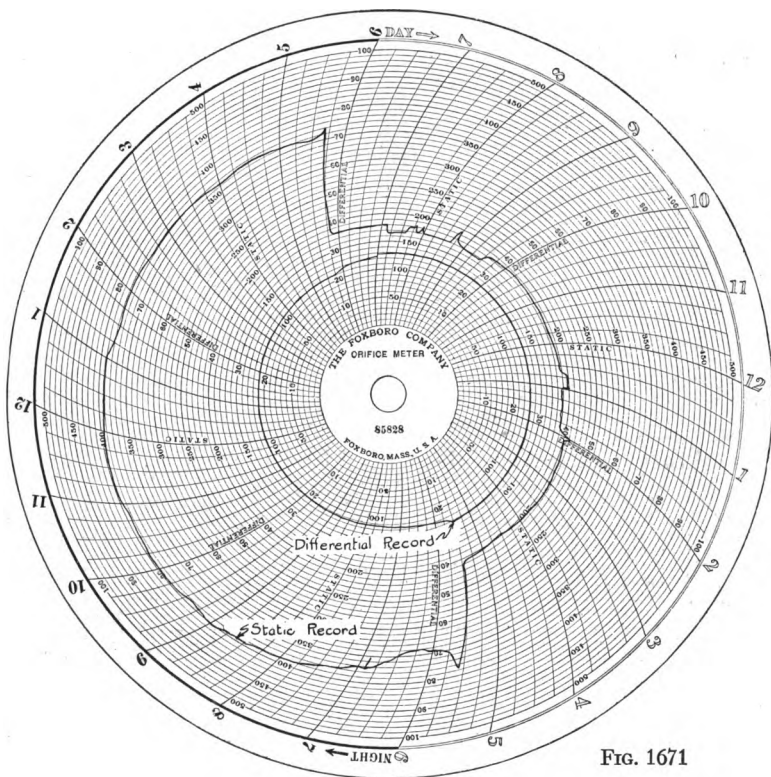

FIG. 1671

(b) PLANIMETER METHOD

Case IV. When gas is passing full twenty-four hours and chart is readable for the entire period.

Mark a starting point on any one of the time divisions. Place the chart on the hub of the planimeter and revolve it until the starting point is directly under the dot or tracing point. Raise the graduated wheel and spin it until the planimeter reads zero.

Revolve the chart in a clockwise direction, constantly keeping the dot or tracing point over the record by moving the chart in a sidewise direction. (This applies only to planimeter shown in Fig. 1192.) Make one complete revolution, stopping at the ORIGINAL STARTING POINT. Read the planimeter and note it in the space designated on the back of the chart. (See form, Fig. 1673.)

To the planimeter reading add the planimeter factor. (This factor is furnished with the planimeter, but it should be checked periodically.)

INTERMEDIATE		
H _____ P _____	Ext. _____	
Time _____ Hr. _____ Min. _____	Cu. Ft. _____	
HIGH	LOW	
H _____ P _____	H _____ F _____	Ext. _____
Time _____ Hr. _____ Min. _____	Time _____ Hr. _____ Min. _____	Cu. Ft. _____
NAME _____		
METER No. _____		
ORIFICE No. _____		
CHART ON _____ hr. _____ min. _____ M. _____ 192		
CHART OFF _____ hr. _____ min. _____ M. _____ 192		
METER OFF (Gas flowing) FROM _____		
TG. _____		
GAS OFF FROM _____		
REMARKS (Note here all occurrences affecting meter records)		

HIGH	INTERMEDIATE	LOW
No. hours gas feeding _____	No. hours gas feeding _____	No. hours gas feeding _____
No. hours reading _____	No. hours reading _____	No. hours reading _____
Inst. No. _____ Reading _____	Inst. No. _____ Reading _____	Inst. No. _____ Reading _____
Date _____	Date _____	Date _____
24 hour reading _____	24 hour reading _____	24 hour reading _____
Instrument factor _____	Instrument factor _____	Instrument factor _____
Corrected reading _____	Corrected reading _____	Corrected reading _____
Blue print reading _____	Blue print reading _____	Blue print reading _____

FIG. 1673

Refer to a blue print chart plot (see Fig. 1029 on next page) or to a rating table, and from either obtain the average pressure in pounds or the average differential in inches corresponding to the corrected planimeter reading.

Find the extension for the average readings of h and P and multiply it by the twenty-four coefficient. The resulting product will be the flow in cubic feet for twenty-four hours.

Case V. When gas is passing for twenty-four hours, but for any reason the charts are not readable for the full twenty-four hours.

Trace record for readable period, following instructions as in Case IV. Reduce the instrument reading to twenty-four hour

equivalent before adding the instrument factor, by multiplying it by a number obtained from Table A (on next page) corresponding to the actual time period during which record is readable. Then add the instrument factor and proceed as in Case IV.

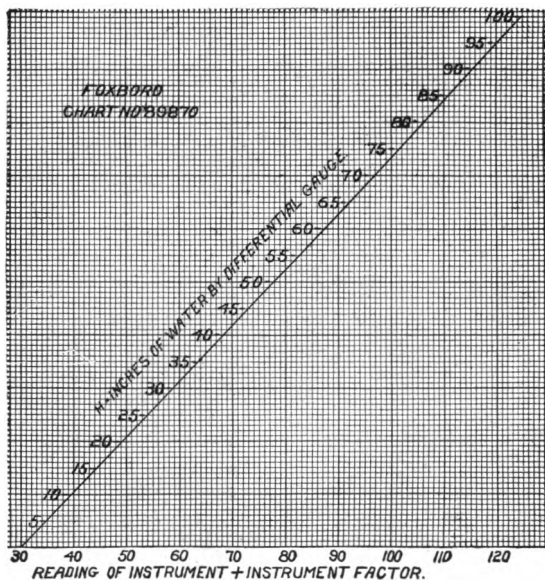

FIG. 1029

Case VI. When gas is passing for a portion of twenty-four hours.

Trace the record; reduce to a twenty-four hour reading, and proceed as in the foregoing paragraphs until the extension is obtained. Multiply the extension by the hourly coefficient, and the product will be the cubic feet of gas passing for one hour. Multiply this amount by the number of hours gas is passing, and the result will be the number of cubic feet of gas passing for that number of hours.

It may happen that the record will not be readable for the same number of hours that gas is passing. In that case, find the average pressure and flow for the number of hours that the chart is readable and proceed as outlined above until the number of cubic feet per hour is obtained. Multiply this amount by the number of hours gas is actually passing, irrespective of the number of hours of reading used to obtain the average h and P .

(c) INTEGRATOR METHOD

The Weymouth Compound Integrator is a very ingenious device by means of which the time required to compute charts is greatly reduced. In its present form it is applicable only to the Type T meter records, or where the differential and static records are on separate charts.

It is operated by two persons simultaneously; one tracing the differential record and controlling the motor speed, and the other tracing the static record. The reading after completion is the average extension or the value of \sqrt{hP} which, if multiplied by the coefficient, gives the quantity of gas passed for that period.

TABLE A

Multiply the instrument reading for a period less than twenty-four hours by the figure shown in this table opposite the number of hours for which chart is readable.

Hours		Hours		Hours		Hours	
.25	96.0000	6.25	3.8400	12.00	2.0000	18.00	1.3333
.50	48.0000	6.50	3.6920	12.25	1.9592	18.25	1.3150
.75	32.0000	6.75	3.5550	12.50	1.9200	18.50	1.2972
1.00	24.0000	7.00	3.4280	12.75	1.8823	18.75	1.2800
1.25	19.2000	7.25	3.3100	13.00	1.8461	19.00	1.2632
1.50	16.0000	7.50	3.2000	13.25	1.8113	19.25	1.2467
1.75	13.7142	7.75	3.0960	13.50	1.7777	19.50	1.2307
2.00	12.0000	8.00	3.0000	13.75	1.7454	19.75	1.2152
2.25	10.6666	8.25	2.9090	14.00	1.7143	20.00	1.2000
2.50	9.6000	8.50	2.8320	14.25	1.6842	20.25	1.1852
2.75	8.7272	8.75	2.7420	14.50	1.6550	20.50	1.1707
3.00	8.0000	9.00	2.6666	14.75	1.6271	20.75	1.1564
3.25	7.3846	9.25	2.5945	15.00	1.6000	21.00	1.1429
3.50	6.8571	9.50	2.5262	15.25	1.5737	21.25	1.1294
3.75	6.4000	9.75	2.4615	15.50	1.5480	21.50	1.1162
4.00	6.0000	10.00	2.4000	15.75	1.5238	21.75	1.1035
4.25	5.6470	10.25	2.3415	16.00	1.5000	22.00	1.0909
4.50	5.3333	10.50	2.2857	16.25	1.4769	22.25	1.0786
4.75	5.0526	10.75	2.2325	16.50	1.4545	22.50	1.0666
5.00	4.8000	11.00	2.1818	16.75	1.4328	22.75	1.0549
5.25	4.5714	11.25	2.1333	17.00	1.4115	23.00	1.0434
5.50	4.3636	11.50	2.0869	17.25	1.3913	23.25	1.0322
5.75	4.1739	11.75	2.0425	17.50	1.3714	23.50	1.0212
6.00	4.0000	17.75	1.3521	23.75	1.0105

DIFFERENTIAL PRESSURE MULTIPLIERS

h	Mult.	h	Mult.	h	Mult.	h	Mult.
1	1.000	26	5.099	51	7.141	76	8.718
2	1.414	27	5.196	52	7.211	77	8.775
3	1.732	28	5.292	53	7.280	78	8.832
4	2.000	29	5.385	54	7.348	79	8.888
5	2.236	30	5.477	55	7.416	80	8.944
6	2.449	31	5.568	56	7.483	81	9.000
7	2.646	32	5.657	57	7.550	82	9.055
8	2.828	33	5.745	58	7.616	83	9.110
9	3.000	34	5.831	59	7.681	84	9.165
10	3.162	35	5.916	60	7.746	85	9.220
11	3.317	36	6.000	61	7.810	86	9.274
12	3.464	37	6.083	62	7.874	87	9.327
13	3.606	38	6.164	63	7.937	88	9.381
14	3.742	39	6.245	64	8.000	89	9.434
15	3.873	40	6.325	65	8.062	90	9.487
16	4.000	41	6.403	66	8.124	91	9.539
17	4.123	42	6.481	67	8.185	92	9.592
18	4.243	43	6.557	68	8.246	93	9.644
19	4.359	44	6.633	69	8.307	94	9.695
20	4.472	45	6.708	70	8.367	95	9.747
21	4.583	46	6.782	71	8.426	96	9.798
22	4.690	47	6.856	72	8.485	97	9.849
23	4.796	48	6.928	73	8.544	98	9.899
24	4.899	49	7.000	74	8.602	99	9.950
25	5.000	50	7.071	75	8.660	100	10.000

STATIC PRESSURE MULTIPLIERS (Below Atmosphere)

P Ins. Vac.	Mult.	P Ins. Vac.	Mult.	P Ins. Vac.	Mult.	P Ins. Vac.	Mult.
1	3.729	8	3.237	14	2.746	20	2.145
2	3.664	9	3.161	15	2.655	21	2.027
3	3.596	10	3.082	16	2.561	22	1.903
4	3.527	11	3.002	17	2.464	23	1.769
5	3.457	12	2.919	18	2.362	24	1.625
6	3.385	13	2.834	19	2.256	25	1.466
7	3.313

STATIC PRESSURE MULTIPLIERS (Above Atmosphere)

P	Mult.	P	Mult.	P	Mult.	P	Mult.
0	3.795	11	5.040	22	6.033	33	6.885
1	3.924	12	5.138	23	6.116	34	6.957
2	4.050	13	5.235	24	6.197	35	7.029
3	4.171	14	5.329	25	6.277	36	7.099
4	4.290	15	5.422	26	6.356	37	7.169
5	4.405	16	5.514	27	6.434	38	7.239
6	4.517	17	5.604	28	6.512	39	7.308
7	4.626	18	5.692	29	6.588	40	7.376
8	4.733	19	5.779	30	6.663	41	7.443
9	4.837	20	5.865	31	6.738	42	7.510
10	4.940	21	5.950	32	6.812	43	7.576

STATIC PRESSURE MULTIPLIERS (Above Atmosphere)

P	Mult.	P	Mult.	P	Mult.	P	Mult.
44	7.642	104	10.88	164	13.36	224	15.44
45	7.707	105	10.93	165	13.40	225	15.47
46	7.772	106	10.97	166	13.43	226	15.50
47	7.836	107	11.02	167	13.47	227	15.54
48	7.899	108	11.07	168	13.51	228	15.57
49	7.962	109	11.11	169	13.54	229	15.60
50	8.025	110	11.16	170	13.58	230	15.63
51	8.087	111	11.20	171	13.62	231	15.66
52	8.149	112	11.24	172	13.65	232	15.70
53	8.210	113	11.29	173	13.69	233	15.73
54	8.270	114	11.33	174	13.73	234	15.76
55	8.331	115	11.38	175	13.76	235	15.79
56	8.390	116	11.42	176	13.80	236	15.82
57	8.450	117	11.47	177	13.84	237	15.85
58	8.509	118	11.51	178	13.87	238	15.89
59	8.567	119	11.55	179	13.91	239	15.92
60	8.626	120	11.60	180	13.94	240	15.95
61	8.683	121	11.64	181	13.98	241	15.98
62	8.741	122	11.68	182	14.02	242	16.01
63	8.798	123	11.72	183	14.05	243	16.04
64	8.854	124	11.77	184	14.09	244	16.07
65	8.911	125	11.81	185	14.12	245	16.10
66	8.967	126	11.85	186	14.16	246	16.14
67	9.022	127	11.89	187	14.19	247	16.17
68	9.077	128	11.94	188	14.23	248	16.20
69	9.132	129	11.98	189	14.26	249	16.23
70	9.187	130	12.02	190	14.30	250	16.26
71	9.241	131	12.06	191	14.33	251	16.29
72	9.295	132	12.10	192	14.37	252	16.32
73	9.349	133	12.14	193	14.40	253	16.35
74	9.402	134	12.19	194	14.44	254	16.38
75	9.455	135	12.23	195	14.47	255	16.41
76	9.508	136	12.27	196	14.51	256	16.44
77	9.560	137	12.31	197	14.54	257	16.47
78	9.612	138	12.35	198	14.57	258	16.50
79	9.664	139	12.39	199	14.61	259	16.53
80	9.716	140	12.43	200	14.64	260	16.56
81	9.767	141	12.47	201	14.68	261	16.59
82	9.818	142	12.51	202	14.71	262	16.62
83	9.869	143	12.55	203	14.74	263	16.65
84	9.920	144	12.59	204	14.78	264	16.68
85	9.970	145	12.63	205	14.81	265	16.71
86	10.02	146	12.67	206	14.85	266	16.74
87	10.07	147	12.71	207	14.88	267	16.77
88	10.12	148	12.75	208	14.91	268	16.80
89	10.17	149	12.79	209	14.95	269	16.83
90	10.22	150	12.83	210	14.98	270	16.86
91	10.27	151	12.86	211	15.01	271	16.89
92	10.32	152	12.90	212	15.05	272	16.92
93	10.36	153	12.94	213	15.08	273	16.95
94	10.41	154	12.98	214	15.11	274	16.98
95	10.46	155	13.02	215	15.15	275	17.01
96	10.51	156	13.06	216	15.18	276	17.04
97	10.56	157	13.09	217	15.21	277	17.07
98	10.60	158	13.13	218	15.24	278	17.10
99	10.65	159	13.17	219	15.28	279	17.13
100	10.70	160	13.21	220	15.31	280	17.16
101	10.74	161	13.25	221	15.34	281	17.19
102	10.79	162	13.28	222	15.37	282	17.21
103	10.84	163	13.32	223	15.41	283	17.24

STATIC PRESSURE MULTIPLIERS (Above Atmosphere)

P	Mult.	P	Mult.	P	Mult.	P	Mult.
284	17.27	301	17.76	318	18.23	335	18.69
285	17.30	302	17.79	319	18.26	336	18.72
286	17.33	303	17.81	320	18.29	337	18.74
287	17.36	304	17.84	321	18.31	338	18.77
288	17.39	305	17.87	322	18.34	339	18.80
289	17.42	306	17.90	323	18.37	340	18.82
290	17.45	307	17.93	324	18.39	341	18.85
291	17.47	308	17.95	325	18.42	342	18.88
292	17.50	309	17.98	326	18.45	343	18.90
293	17.53	310	18.01	327	18.48	344	18.93
294	17.56	311	18.04	328	18.50	345	18.96
295	17.59	312	18.07	329	18.53	346	18.98
296	17.62	313	18.09	330	18.56	347	19.01
297	17.65	314	18.12	331	18.58	348	19.04
298	17.67	315	18.15	332	18.61	349	19.06
299	17.70	316	18.18	333	18.64	350	19.09
300	17.73	317	18.20	334	18.66

MULTIPLIER TABLES FOR LOW RANGE DIFFERENTIAL AND VACUUM STATIC PRESSURES

Differential Pressure Multipliers
1-20 inches of water in tenths inches

h	Mult.	h	Mult.	h	Mult.	h	Mult.	h	Mult.
1.0	1.000	5.0	2.236	9.0	3.000	13.0	3.606	17.0	4.123
.1	1.049	.1	2.258	.1	3.017	.1	3.620	.1	4.135
.2	1.095	.2	2.280	.2	3.033	.2	3.633	.2	4.147
.3	1.140	.3	2.302	.3	3.050	.3	3.647	.3	4.159
.4	1.183	.4	2.324	.4	3.066	.4	3.660	.4	4.171
1.5	1.225	5.5	2.345	9.5	3.082	13.5	3.674	17.5	4.183
.6	1.265	.6	2.366	.6	3.098	.6	3.687	.6	4.195
.7	1.304	.7	2.387	.7	3.114	.7	3.701	.7	4.207
.8	1.342	.8	2.408	.8	3.130	.8	3.715	.8	4.219
.9	1.378	.9	2.429	.9	3.146	.9	3.728	.9	4.231
2.0	1.414	6.0	2.449	10.0	3.162	14.0	3.742	18.0	4.243
.1	1.449	.1	2.470	.1	3.178	.1	3.755	.1	4.255
.2	1.483	.2	2.490	.2	3.193	.2	3.768	.2	4.266
.3	1.517	.3	2.510	.3	3.209	.3	3.781	.3	4.278
.4	1.549	.4	2.530	.4	3.224	.4	3.794	.4	4.289
2.5	1.581	6.5	2.550	10.5	3.240	14.5	3.808	18.5	4.301
.6	1.612	.6	2.569	.6	3.256	.6	3.821	.6	4.313
.7	1.643	.7	2.588	.7	3.271	.7	3.834	.7	4.324
.8	1.673	.8	2.608	.8	3.287	.8	3.847	.8	4.336
.9	1.703	.9	2.627	.9	3.302	.9	3.860	.9	4.347
3.0	1.732	7.0	2.646	11.0	3.317	15.0	3.873	19.0	4.359
.1	1.761	.1	2.665	.1	3.331	.1	3.886	.1	4.370
.2	1.789	.2	2.683	.2	3.346	.2	3.898	.2	4.382
.3	1.817	.3	2.702	.3	3.361	.3	3.911	.3	4.393
.4	1.844	.4	2.720	.4	3.375	.4	3.924	.4	4.404
3.5	1.871	7.5	2.739	11.5	3.390	15.5	3.936	19.5	4.416
.6	1.897	.6	2.757	.6	3.405	.6	3.949	.6	4.427
.7	1.924	.7	2.775	.7	3.419	.7	3.962	.7	4.438
.8	1.949	.8	2.793	.8	3.434	.8	3.975	.8	4.449
.9	1.975	.9	2.811	.9	3.449	.9	3.987	.9	4.461
4.0	2.000	8.0	2.828	12.0	3.464	16.0	4.000	20.0	4.472
.1	2.025	.1	2.846	.1	3.478	.1	4.012
.2	2.049	.2	2.864	.2	3.492	.2	4.025
.3	2.074	.3	2.881	.3	3.506	.3	4.037
.4	2.098	.4	2.898	.4	3.521	.4	4.049
4.5	2.121	8.5	2.915	12.5	3.535	16.5	4.062
.6	2.145	.6	2.933	.6	3.549	.6	4.074
.7	2.168	.7	2.950	.7	3.563	.7	4.086
.8	2.191	.8	2.966	.8	3.577	.8	4.098
.9	2.214	.9	2.983	.9	3.592	.9	4.111

STATIC PRESSURE MULTIPLIERS (Below Atmosphere)

0-29 inches mercury vacuum in tenths inches

P	Mult.	P	Mult.	P	Mult.	P	Mult.	P	Mult.
0.0	3.795	6.0	3.384	12.0	2.917	18.0	2.358	24.0	1.616
.1	3.788	.1	3.377	.1	2.908	.1	2.347	.1	1.600
.2	3.782	.2	3.369	.2	2.899	.2	2.337	.2	1.584
.3	3.775	.3	3.362	.3	2.891	.3	2.326	.3	1.568
.4	3.769	.4	3.355	.4	2.883	.4	2.315	.4	1.552
0.5	3.762	6.5	3.348	12.5	2.874	18.5	2.305	24.5	1.536
.6	3.755	.6	3.340	.6	2.865	.6	2.294	.6	1.520
.7	3.749	.7	3.333	.7	2.857	.7	2.283	.7	1.504
.8	3.742	.8	3.326	.8	2.848	.8	2.272	.8	1.488
.9	3.736	.9	3.318	.9	2.840	.9	2.262	.9	1.472
1.0	3.729	7.0	3.311	13.0	2.831	19.0	2.251	25.0	1.456
.1	3.722	.1	3.304	.1	2.822	.1	2.240	.1	1.438
.2	3.716	.2	3.296	.2	2.813	.2	2.229	.2	1.420
.3	3.709	.3	3.289	.3	2.805	.3	2.217	.3	1.402
.4	3.703	.4	3.281	.4	2.796	.4	2.206	.4	1.384
1.5	3.696	7.5	3.274	13.5	2.787	19.5	2.195	25.5	1.367
.6	3.689	.6	3.266	.6	2.778	.6	2.184	.6	1.349
.7	3.683	.7	3.259	.7	2.769	.7	2.173	.7	1.331
.8	3.676	.8	3.251	.8	2.761	.8	2.161	.8	1.313
.9	3.670	.9	3.244	.9	2.752	.9	2.150	.9	1.295
2.0	3.663	8.0	3.236	14.0	2.743	20.0	2.139	26.0	1.277
.1	3.657	.1	3.228	.1	2.734	.1	2.127	.1	1.259
.2	3.650	.2	3.221	.2	2.725	.2	2.115	.2	1.235
.3	3.643	.3	3.213	.3	2.716	.3	2.104	.3	1.214
.4	3.636	.4	3.205	.4	2.707	.4	2.092	.4	1.193
2.5	3.629	8.5	3.196	14.5	2.698	20.5	2.080	26.5	1.172
.6	3.623	.6	3.190	.6	2.688	.6	2.068	.6	1.151
.7	3.616	.7	3.182	.7	2.679	.7	2.056	.7	1.130
.8	3.609	.8	3.174	.8	2.670	.8	2.045	.8	1.109
.9	3.602	.9	3.167	.9	2.661	.9	2.033	.9	1.088
3.0	3.595	9.0	3.159	15.0	2.652	21.0	2.021	27.0	1.067
.1	3.588	.1	3.151	.1	2.643	.1	2.009	.1	1.041
.2	3.581	.2	3.143	.2	2.633	.2	1.996	.2	1.015
.3	3.574	.3	3.135	.3	2.624	.3	1.984	.3	.989
.4	3.567	.4	3.127	.4	2.614	.4	1.971	.4	.960
3.5	3.561	9.5	3.120	15.5	2.605	21.5	1.959	27.5	.937
.6	3.554	.6	3.112	.6	2.596	.6	1.946	.6	.910
.7	3.547	.7	3.104	.7	2.586	.7	1.934	.7	.884
.8	3.540	.8	3.096	.8	2.577	.8	1.921	.8	.858
.9	3.533	.9	3.088	.9	2.567	.9	1.909	.9	.832
4.0	3.526	10.0	3.080	16.0	2.558	22.0	1.896	28.0	.806
.1	3.519	.1	3.072	.1	2.548	.1	1.883	.1	.765
.2	3.512	.2	3.064	.2	2.538	.2	1.869	.2	.724
.3	3.505	.3	3.056	.3	2.529	.3	1.856	.3	.684
.4	3.498	.4	3.048	.4	2.519	.4	1.842	.4	.644
4.5	3.491	10.5	3.040	16.5	2.509	22.5	1.829	28.5	.603
.6	3.484	.6	3.032	.6	2.499	.6	1.815	.6	.562
.7	3.477	.7	3.024	.7	2.489	.7	1.802	.7	.522
.8	3.470	.8	3.016	.8	2.480	.8	1.788	.8	.481
.9	3.463	.9	3.008	.9	2.470	.9	1.775	.9	.441
5.0	3.456	11.0	3.000	17.0	2.460	23.0	1.761	29.0	.400
.1	3.449	.1	2.992	.1	2.450	.1	1.747
.2	3.442	.2	2.983	.2	2.440	.2	1.732
.3	3.434	.3	2.975	.3	2.429	.3	1.718
.4	3.427	.4	2.967	.4	2.419	.4	1.703
5.5	3.420	11.5	2.959	17.5	2.409	23.5	1.689
.6	3.413	.6	2.950	.6	2.399	.6	1.674
.7	3.406	.7	2.942	.7	2.389	.7	1.660
.8	3.398	.8	2.934	.8	2.378	.8	1.645
.9	3.391	.9	2.925	.9	2.368	.9	1.631

CHAPTER V

COEFFICIENTS

A COEFFICIENT in its application to the computation of gas flow is a multiplier. It is a figure which multiplied by the extension obtained from the static and differential pressures gives the amount of gas passed in a certain period of time.

The numerical value of an hourly coefficient is the actual number of cubic feet of gas passed in an hour at a differential pressure of 1" and an absolute standard pressure of 1 lb. By absolute static pressure is meant the pressure above absolute vacuum.

Each size orifice has its own coefficient, and each coefficient is constant for its respective orifice under the same conditions of flow.

The coefficient tables in the following pages are arranged in two sets. The first set consists of eight tables for use in computing gas flows where the specific gravity is around .600. These tables are arranged to give the hourly coefficient for orifice diameters from $\frac{1}{4}$ " up to $8\frac{3}{4}$ " in pipe-line sizes of 4", 6", 8", 10", and 12", and the decimal equivalents of the fractional orifice sizes are given. These tables are figured on the following pressure bases: 0 oz. (14.4 absolute), 4 oz., 8 oz., 10 oz., 16 oz. (1 lb.), $1\frac{1}{2}$ lbs., 2 lbs., and 3 lbs.

The second set consists of three tables for use in computing flows of gas around 1.000 specific gravity. These tables are arranged to give the hourly coefficient for orifice diameters every $\frac{5}{100}$ of an inch from .250" to 6.00", and they are figured on pressure bases of 4 oz., 8 oz., and 10 oz.

It will be observed from the *E* curve, Fig. 1669, Chapter I, that the curve stops at an *E* value of .750 and a $\frac{d}{D}$ value of .750. This means that an orifice should never be used with a diameter greater than $\frac{3}{4}$ the diameter of the pipe. It will be observed that the coefficient will vary for the same size orifice in different size pipes, for example: The coefficient for a 3" orifice in a 4" line is 2818. For the same size orifice in a 6" line it is 2314, and for the same orifice in an 8", 10", or 12" line, the coefficient is 2278. This difference is due entirely to the *E* value, for as long as the ratio of the orifice diameter to the pipe diameter (that is, $\frac{d}{D}$) is less than .410 the value of *E* will be 0.606. But as the ratio increases, the value of *E* increases, as may be seen from the *E* curve.

For example:

$$\begin{aligned}\frac{d}{D} = \frac{3}{4} &= .750, E = .750 \\ &= \frac{2}{3} = .500, E = .616 \\ &= \frac{1}{2} = .375, E = .606\end{aligned}$$

In order to familiarize the reader with the method of figuring hourly coefficients, we give below a concrete example.

Assume the following conditions:

Size Line	(D) = 6"
Size Orifice	(d) = 2.750"
Spec. Gravity	(G) = .600
Press. Base	(P_B) = 4 oz.
Temp. Base	(T_B) = 60
Temp. Flow	(T_f) = 60.
Barometer	= 14.4
Hourly Coefficient	= C

As previously stated, all factors involving temperature and pressure are computed from an absolute base. This means that 460 must be added to the temperatures, making, in this particular example, 520. The Pressure Base is brought to an absolute value by adding to it the Barometric Pressure. In this case the Pressure Base is assumed as 4 oz., which is equivalent to .250 lbs. and this value added to the Barometric Pressure of 14.4 gives 14.65.

$$\text{The formula is } C = 218.44 E d^2 \frac{T_B}{P_B} \sqrt{\frac{1}{T_f G}} \quad (1)$$

The first step is to find the value of E . This is found from the E curve, Fig. 1669, page 2, after determining the value of $\frac{d}{D}$.

$$\frac{d}{D} = \frac{2.750}{6} = .4583, \text{ hence } E = .6088.$$

Now substituting actual numerical values in the above equation (1), we get:

$$C = 218.44 \times .6088 \times 7.563 \times \frac{520}{14.65} \times \sqrt{\frac{1}{520 \times .600}} \quad (2)$$

To solve this equation by arithmetic involves considerable work, which may be eliminated by using logarithms or a computing-machine. To a reader, however, who is not familiar with higher mathematics the following will show the arithmetical solution.

The first step is to reduce the factor under the radical to a simpler form.

$$520 \times .600 = 312, \quad \frac{1}{312} = .003205, \quad \sqrt{.003205} = .0566 \quad (3)$$

$$\text{then } \sqrt{\frac{1}{520 \times .600}} = .0566. \quad (4)$$

The next step is to reduce $\frac{520}{14.65}$ to a decimal equivalent by division.

$$\frac{520}{14.65} = 35.49. \quad (5)$$

This simplifies equation (2) to

$$C = 218.44 \times .6088 \times 7.563 \times 35.49 \times .0566. \quad (6)$$

Multiplying these factors together we get

$$C = 2022, \quad (7)$$

which is the Hourly Coefficient.

In the following tables the coefficients have been figured upon standard conditions of flow. These conditions are set down at the head of each table, and if an Hourly Coefficient is required on any conditions other than standard, the figures in these tables may be corrected by means of the Correction Factors in Chapter VI.

FIFTEEN-MINUTE COEFFICIENTS

In computing charts by the fifteen-minute reading method, it may be more convenient to have fifteen-minute coefficients. As fifteen minutes is a quarter of an hour, this coefficient is one quarter of the hourly coefficient. For example:

$$\text{Hourly Coefficient} = 2183$$

$$\text{Fifteen-Minute Coefficient} = \frac{2183}{4} = 545.75,$$

but as it is necessary to carry the coefficients only to the fourth significant figure, the last 5 can be carried over to increase the fourth figure to an 8 and the final result becomes 545.8.

From the discussion of Precision of Measurements in Chapter IV it will be understood why it is entirely unnecessary to use a coefficient with more than four significant figures.

FOXBORO**0 oz.****HOURLY COEFFICIENTS**Specific Gravity
.600*Based on the following conditions*

Barometer 14.4 Pressure Base = 0 oz. (14.4 absolute)

Temp. Flow = 60° F. Temp. Base = 60° F.

ORIFICE DIAM.		PIPE SIZES				
Fractional	Decimal	4"	6"	8"	10"	12"
1/4	.250	16.91
1/2	.375	38.06
3/4	.500	67.65	67.65
1	.625	105.7	105.7
1 1/4	.750	152.2	152.2	152.2
1 1/2	.875	207.2	207.2	207.2
1	1.000	270.6	270.6	270.6	270.6
1 1/4	.125	342.5	342.5	342.5	342.5
1 1/2	.250	422.8	422.8	422.8	422.8	422.8
1 3/4	.375	511.6	511.6	511.6	511.6
2	.500	608.9	608.9	608.9	608.9	608.9
2 1/4	.625	714.6	714.6	714.6	714.6
2 1/2	.750	829.9	828.8	828.8	828.8	828.8
2 3/4	.875	958.0	951.4	951.4	951.4
2	2.000	1100.	1083.	1083.	1083.	1083.
2 1/4	.125	1258.	1222.	1222.
2 1/2	.250	1436.	1370.	1370.	1370.	1370.
2 3/4	.375	1635.	1526.	1526.
3	.500	1856.	1691.	1691.	1691.	1691.
3 1/4	.625	2103.	1867.	1865.
3 1/2	.750	2376.	2057.	2047.	2047.	2047.
3 3/4	.875	2682.	2259.	2237.
3	3.000	3014.	2475.	2436.	2436.	2436.
3 1/4	.125	2706
3 1/2	.250	2958.	2858.	2858.	2858.
3 3/4	.375	3230.
4	.500	3523.	3320.	3315.	3315.
4 1/4	.625	3838.
4 1/2	.750	4176.	3832.	3806.	3806.
4 3/4	.875	4536.
4	4.000	4929.	4400.	4330.	4330.
4 1/4	.250	5800.	5031.	4888.	4888.
4 1/2	.500	6782.	5742.	5496.	5480.
4 3/4	.750	6539.	6147.	6106.
5	5.000	7424.	6875.	6766.
5 1/4	.250	8410.	7654.	7469.
5 1/2	.500	9503.	8510.	8227.
5 3/4	.750	10730.	9453.	9036.
6	6.000	12060.	10480.	9900.
6 1/4	.250	11600.	10830.
6 1/2	.500	12820.	11830.
6 3/4	.750	14150.	12920.
7	7.000	15600.	14090.
7 1/4	.250	17160.	15350.
7 1/2	.500	18840.	16700.
7 3/4	.750	18150.
8	8.000	19710.
8 1/4	.250	21380.
8 1/2	.500	23200.
8 3/4	.750	25110.

4 oz.**FOXBORO**Specific Gravity
.600**HOURLY COEFFICIENTS***Based on the following conditions*

Barometer 14.4 Pressure Base = 4 oz. (14.65 absolute)

Temp. Flow = 60° F. Temp. Base = 60° F.

ORIFICE DIAM.		PIPE SIZES				
Fractional	Decimal	4"	6"	8"	10"	12"
$\frac{1}{8}$.250	16.62
$\frac{1}{4}$.375	37.41
$\frac{3}{8}$.500	66.50	66.50
$\frac{1}{2}$.625	103.9	103.9
$\frac{3}{4}$.750	149.6	149.6	149.6
$\frac{7}{8}$.875	203.7	203.7	203.7
1	1.000	266.0	266.0	266.0	266.0
$\frac{1}{8}$.125	336.7	336.7	336.7	336.7
$\frac{1}{4}$.250	415.6	415.6	415.6	415.6	415.6
$\frac{3}{8}$.375	502.9	502.9	502.9	502.9
$\frac{1}{2}$.500	598.5	598.5	598.5	598.5	598.5
$\frac{3}{4}$.625	702.4	702.4	702.4	702.4
$\frac{7}{8}$.750	815.7	814.6	814.6	814.6	814.6
$\frac{15}{16}$.875	941.6	935.2	935.2	935.2
2	2.000	1081.	1064.	1064.	1064.	1064.
$\frac{1}{8}$.125	1236.	1201.	1201.
$\frac{1}{4}$.250	1411.	1347.	1347.	1347.	1347.
$\frac{3}{8}$.375	1607.	1500.	1500.
$\frac{1}{2}$.500	1824.	1663.	1663.	1663.	1663.
$\frac{3}{4}$.625	2067.	1835.	1833.
$\frac{7}{8}$.750	2335.	2022.	2012.	2012.	2012.
$\frac{15}{16}$.875	2636.	2220.	2199.
3	3.000	2963.	2433.	2394.	2394.	2394.
$\frac{1}{8}$.125	2660.
$\frac{1}{4}$.250	2908.	2810.	2810.	2810.
$\frac{3}{8}$.375	3175.
$\frac{1}{2}$.500	3463.	3263.	3259.	3259.
$\frac{3}{4}$.625	3772.
$\frac{7}{8}$.750	4011.	3767.	3741.	3741.
$\frac{15}{16}$.875	4459.
4	4.000	4845.	4325.	4256.	4256.
$\frac{1}{8}$.250	5701.	4945.	4805.	4805.
$\frac{1}{4}$.500	6666.	5644.	5403.	5386.
$\frac{3}{8}$.750	6427.	6042.	6002.
5	5.000	7297.	6758.	6650.
$\frac{1}{8}$.250	8267.	7523.	7341.
$\frac{1}{4}$.500	9341.	8365.	8086.
$\frac{3}{8}$.750	10540.	9291.	8882.
6	6.000	11850.	10300.	9731.
$\frac{1}{8}$.250	11400.	10640.
$\frac{1}{4}$.500	12600.	11630.
$\frac{3}{8}$.750	13910.	12700.
7	7.000	15330.	13850.
$\frac{1}{8}$.250	16870.	15090.
$\frac{1}{4}$.500	18520.	16420.
$\frac{3}{8}$.750	17840.
8	8.000	19380.
$\frac{1}{8}$.250	21020.
$\frac{1}{4}$.500	22800.
$\frac{3}{8}$.750	24680.

FOXBORO**4 oz.****HOURLY COEFFICIENTS**Specific Gravity
1.000*Based on the following conditions*

Barometer 14.4 Pressure Base = 4 oz. (14.65 absolute)

Temp. Flow = 60° F. Temp. Base = 60° F.

ORIFICE DIAM.	PIPE SIZES			ORIFICE DIAM.	PIPE SIZES	
	4"	6"	8"		6"	8"
0.250	12.87	12.87	12.87	3.150	2098.	2044.
.300	18.54	18.54	18.54	.200	2173.	2110.
.350	25.24	25.24	25.24	.250	2252.	2176.
.400	32.96	32.96	32.96	.300	2333.	2244.
.450	41.72	41.72	41.72	.350	2415.	2312.
0.500	51.51	51.51	51.51	3.400	2500.	2383.
.550	62.33	62.33	62.33	.450	2590.	2454.
.600	74.17	74.17	74.17	.500	2682.	2527.
.650	87.05	87.05	87.05	.550	2777.	2601.
.700	101.0	101.0	101.0	.600	2872.	2678.
0.750	115.9	115.9	115.9	3.650	2971.	2756.
.800	131.9	131.9	131.9	.700	3075.	2836.
.850	148.9	148.9	148.9	.750	3180.	2917.
.900	166.9	166.9	166.9	.800	3287.	3000.
.950	186.0	186.0	186.0	.850	3399.	3085.
1.000	206.0	206.0	206.0	3.900	3514.	3172.
.050	227.2	227.2	227.2	.950	3630.	3260.
.100	249.3	249.3	249.3	4.000	3750.	3350.
.150	272.5	272.5	272.5	.050	3878.	3443.
.200	296.7	296.7	296.7	.100	4004.	3537.
1.250	321.9	321.9	321.9	4.150	4139.	3631.
.300	348.2	348.2	348.2	.200	4273.	3729.
.350	375.5	375.5	375.5	.250	4413.	3830.
.400	403.9	403.9	403.9	.300	4556.	3933.
.450	433.2	433.2	433.2	.350	4706.	4039.
1.500	463.6	463.6	463.6	4.400	4854.	4147.
.550	495.0	495.0	495.0	.450	5009.	4257.
.600	527.5	527.5	527.5	.500	5164.	4371.
.650	560.9	560.9	560.9	.550	...	4487.
.700	595.5	595.5	595.5	.600	...	4605.
1.750	631.8	631.0	631.0	4.650	...	4727.
.800	669.5	667.6	667.6	.700	...	4850.
.850	709.1	705.2	705.2	.750	...	4979.
.900	748.2	742.1	742.1	.800	...	5106.
.950	793.0	783.5	783.5	.850	...	5238.
2.000	837.3	824.2	824.2	4.900	...	5376.
.050	884.0	865.9	865.9	.950	...	5512.
.100	932.3	908.6	908.6	5.000	...	5653.
.150	983.1	952.4	952.4	.050	...	5796.
.200	1037.	997.2	997.2	.100	...	5941.
2.250	1093.	1043.	1043.	5.150	...	6092.
.300	1151.	1090.	1090.	.200	...	6246.
.350	1213.	1138.	1138.	.250	...	6403.
.400	1276.	1187.	1187.	.300	...	6562.
.450	1342.	1237.	1237.	.350	...	6724.
2.500	1413.	1288.	1288.	5.400	...	6894.
.550	1485.	1340.	1340.	.450	...	7064.
.600	1562.	1394.	1393.	.500	...	7239.
.650	1640.	1449.	1447.	.550	...	7415.
.700	1724.	1505.	1502.	.600	...	7597.
2.750	1809.	1565.	1558.	5.650	...	7787.
.800	1899.	1626.	1615.	.700	...	7973.
.850	1993.	1688.	1674.	.750	...	8168.
.900	2090.	1751.	1733.	.800	...	8362.
.950	2191.	1817.	1793.	.850	...	8562.
3.000	2295.	1885.	1854.	5.900	...	8764.
.050	...	1954.	1917.	.950	...	8971.
.100	...	2024.	1980.	6.000	...	9180.

8 oz.**FOXBORO**Specific Gravity
.600**HOURLY COEFFICIENTS**

Based on the following conditions

Barometer 14.4 Pressure Base = 8 oz. (14.9 absolute)

Temp. Flow = 60° F. Temp. Base = 60° F.

ORIFICE DIAM.		PIPE SIZES				
Fractional	Decimal	4"	6"	8"	10"	12"
1/4	.250	16.35
1/2	.375	36.78
3/4	.500	65.38	65.38
1	.625	102.2	102.2
1 1/4	.750	147.1	147.1	147.1
1 1/2	.875	200.2	200.2	200.2
1	1.000	261.5	261.5	261.5	261.5
1 3/4	.125	331.0	331.0	331.0	331.0
2	.250	408.7	408.7	408.7	408.7	408.7
2 1/4	.375	494.5	494.5	494.5	494.5
2 1/2	.500	588.5	588.5	588.5	588.5	588.5
2 3/4	.625	690.6	690.6	690.6	690.6
3	.750	802.0	801.0	801.0	801.0	801.0
3 1/4	.875	925.8	919.5	919.5	919.5
2	2.000	1063.	1046.	1046.	1046.	1046.
2 1/2	.125	1216.	1181.	1181.
3	.250	1387.	1324.	1324.	1324.	1324.
3 1/4	.375	1580.	1475.	1475.
3 1/2	.500	1794.	1635.	1635.	1635.	1635.
3 3/4	.625	2032.	1805.	1802.
4	.750	2296.	1988.	1978.	1978.	1978.
4 1/4	.875	2592.	2183.	2162.
3	3.000	2913.	2392.	2354.	2354.	2354.
3 1/2	.125	2616.
4	.250	2859.	2762.	2762.	2762.
4 1/4	.375	3122.
4 1/2	.500	3405.	3208.	3204.	3204.
4 3/4	.625	3709.
5	.750	4036.	3703.	3647.	3647.
5 1/4	.875	4384.
4	4.000	4763.	4254.	4185.	4185.
4 1/2	.250	5605.	4862.	4724.	4724.
5	.500	6555.	5550.	5312.	5296.
5 1/4	.750	6319.	5941.	5901.
5	5.000	7175.	6644.	6538.
5 1/2	.250	8061.	7397.	7219.
6	.500	9184.	8225.	7951.
6 1/4	.750	10370.	9135.	8733.
6	6.000	11650.	10130.	9568.
6 1/2	.250	11210.	10460.
7	.500	12390.	11440.
7 1/4	.750	13670.	12490.
7	7.000	15070.	13620.
7 1/2	.250	16590.	14840.
8	.500	18210.	16140.
8 1/4	.750	17540.
8	8.000	19050.
8 1/2	.250	20660.
9	.500	22420.
9 1/4	.750	24270.

FOXBO

8 oz.

HOURLY COEFFICIENTS

Specific Gravity
1.000

Based on the following conditions

Barometer 14.4 Pressure Base = 8 oz. (14.9 absolute)

Temp. Flow = 60° F. Temp. Base = 60° F.

ORIFICE DIAM.	PIPE SIZES			ORIFICE DIAM.	PIPE SIZES	
	4"	6"	8"		6"	8"
0.250	12.66	12.66	12.66	3.150	2063.	2010.
.300	18.23	18.23	18.23	.200	2137.	2075.
.350	24.82	24.82	24.82	.250	2214.	2140.
.400	32.41	32.41	32.41	.300	2294.	2207.
.450	41.02	41.02	41.02	.350	2375.	2273.
0.500	50.65	50.65	50.65	3.400	2458.	2343.
.550	61.29	61.29	61.29	.450	2547.	2413.
.600	72.93	72.93	72.93	.500	2637.	2485.
.650	85.60	85.60	85.60	.550	2731.	2558.
.700	99.31	99.31	99.31	.600	2824.	2633.
0.750	114.0	114.0	114.0	3.650	2921.	2710.
.800	129.7	129.7	129.7	.700	3024.	2789.
.850	146.4	146.4	146.4	.750	3127.	2868.
.900	164.1	164.1	164.1	.800	3232.	2950.
.950	182.9	182.9	182.9	.850	3342.	3033.
1.000	202.6	202.6	202.6	3.900	3455.	3119.
.050	223.4	223.4	223.4	.950	3569.	3206.
.100	245.1	245.1	245.1	4.000	3687.	3294.
.150	267.9	267.9	267.9	.050	3813.	3386.
.200	291.7	291.7	291.7	.100	3937.	3478.
1.250	316.5	316.5	316.5	4.150	4070.	3570.
.300	342.4	342.4	342.4	.200	4202.	3667.
.350	369.2	369.2	369.2	.250	4339.	3766.
.400	397.2	397.2	397.2	.300	4480.	3867.
.450	426.0	426.0	426.0	.350	4627.	3972.
1.500	455.9	455.9	455.9	4.400	4773.	4078.
.550	486.7	486.7	486.7	.450	4925.	4186.
.600	518.7	518.7	518.7	.500	5078.	4298.
.650	551.5	551.5	551.5	.550	4412.
.700	585.6	585.6	585.6	.600	4528.
1.750	621.2	620.5	620.5	4.650	4648.
.800	658.3	656.5	656.5	.700	4769.
.850	697.3	693.4	693.4	.750	4896.
.900	735.7	729.7	729.7	.800	5021.
.950	779.8	770.4	770.4	.850	5151.
2.000	823.3	810.4	810.4	4.900	5286.
.050	869.2	851.4	851.4	.950	5420.
.100	916.7	893.4	893.4	5.000	5559.
.150	966.7	936.5	936.5	.050	5699.
.200	1019.	980.5	980.5	.100	5842.
2.250	1075.	1026.	1026.	5.150	5990.
.300	1132.	1072.	1072.	.200	6142.
.350	1193.	1119.	1119.	.250	6296.
.400	1255.	1167.	1167.	.300	6452.
.450	1320.	1216.	1216.	.350	6612.
2.500	1389.	1266.	1266.	5.400	6779.
.550	1460.	1318.	1318.	.450	6946.
.600	1536.	1371.	1370.	.500	7118.
.650	1613.	1425.	1423.	.550	7291.
.700	1695.	1480.	1477.	.600	7470.
2.750	1779.	1539.	1532.	5.650	7657.
.800	1867.	1599.	1588.	.700	7840.
.850	1960.	1660.	1646.	.750	8032.
.900	2055.	1722.	1704.	.800	8222.
.950	2154.	1787.	1763.	.850	8419.
3.000	2257.	1854.	1823.	5.900	8618.
.050	1921.	1885.	.950	8821.
.100	1990.	1947.	6.000	9027.

10 oz.		FOXBORO				
Specific Gravity .600		HOURLY COEFFICIENTS				
		Based on the following conditions				
		Barometer 14.4 Pressure Base = 10 oz. (15.025 absolute)				
		Temp. Flow = 60° F. Temp. Base = 60° F.				
ORIFICE DIAM.		PIPE SIZES				
Fractional	Decimal	4"	6"	8"	10"	12"
1/4	.250	16.21
1/2	.375	36.48
3/4	.500	64.84	64.84
1	.625	101.3	101.3
1 1/4	.750	145.9	145.9	145.9
1 1/2	.875	198.6	198.6	198.6
1	1.000	259.3	259.3	259.3	259.3
1 1/8	.125	328.3	328.3	328.3	328.3
1 1/4	.250	405.2	405.2	405.2	405.2	405.2
1 1/2	.375	490.3	490.3	490.3	490.3
1 3/4	.500	583.6	583.6	583.6	583.6	583.6
2	.625	684.9	684.9	684.9	684.9
2 1/4	.750	795.4	794.3	794.3	794.3	794.3
2 1/2	.875	918.1	911.8	911.8	911.8
2	2.000	1054.	1038.	1038.	1038.	1038.
2 1/8	.125	1206.	1171.	1171.
2 1/4	.250	1376.	1313.	1313.	1313.	1313.
2 1/2	.375	1567.	1463.	1463.
2 3/4	.500	1779.	1621.	1621.	1621.	1621.
3	.625	2016.	1789.	1787.
3 1/4	.750	2277.	1971.	1962.	1962.	1962.
3 1/2	.875	2570.	2165.	2144.
3	3.000	2889.	2372.	2335.	2335.	2335.
3 1/8	.125	2593.
3 1/4	.250	2835.	2739.	2739.	2739.
3 1/2	.375	3096.
3 3/4	.500	3376.	3182.	3177.	3177.
4	.625	3678.
4 1/4	.750	4002.	3673.	3648.	3648.
4 1/2	.875	4347.
4	4.000	4724.	4217.	4150.	4150.
4 1/8	.250	5559.	4822.	4685.	4685.
4 1/4	.500	6500.	5503.	5267.	5252.
4 1/2	.750	6267.	5891.	5852.
5	5.000	7115.	6589.	6485.
5 1/8	.250	8060.	7336.	7158.
5 1/4	.500	9108.	8156.	7885.
5 1/2	.750	10280.	9060.	8660.
6	6.000	11560.	10040.	9488.
6 1/8	.250	11120.	10380.
6 1/4	.500	12290.	11340.
6 1/2	.750	13560.	12380.
7	7.000	14950.	13500.
7 1/8	.250	16450.	14710.
7 1/4	.500	18060.	16010.
7 1/2	.750	17390.
8	8.000	18890.
8 1/8	.250	20490.
8 1/4	.500	22230.
8 1/2	.750	24070.

FOXBORO

10 oz.

HOURLY COEFFICIENTS

Specific Gravity
1.000

Based on the following conditions

Barometer 14.4 Pressure Base = 10 oz. (15.025 absolute)

Temp. Flow. = 60° F. Temp. Base = 60° F.

ORIFICE DIAM.	PIPE SIZES			ORIFICE DIAM.	PIPE SIZES	
	4"	6"	8"		6"	8"
0.250	12.55	12.55	12.55	3.150	2046.	1993.
.300	18.08	18.08	18.08	.200	2119.	2057.
.350	24.61	24.61	24.61	.250	2196.	2122.
.400	32.14	32.14	32.14	.300	2275.	2188.
.450	40.68	40.68	40.68	.350	2355.	2254.
0.500	50.22	50.22	50.22	3.400	2437.	2323.
.550	60.77	60.77	60.77	.450	2525.	2393.
.600	72.32	72.32	72.32	.500	2615.	2464.
.650	84.87	84.87	84.87	.550	2709.	2536.
.700	98.47	98.47	98.47	.600	2800.	2611.
0.750	113.0	113.0	113.0	3.650	2897.	2687.
.800	128.6	128.6	128.6	.700	2998.	2765.
.850	145.2	145.2	145.2	.750	3100.	2844.
.900	162.7	162.7	162.7	.800	3205.	2925.
.950	181.3	181.3	181.3	.850	3314.	3008.
1.000	200.8	200.8	200.8	3.900	3426.	3093.
.050	221.5	221.5	221.5	.950	3539.	3178.
.100	243.1	243.1	243.1	4.000	3656.	3266.
.150	265.7	265.7	265.7	.050	3781.	3357.
.200	289.3	289.3	289.3	.100	3904.	3449.
1.250	313.9	313.9	313.9	4.150	4036.	3540.
.300	339.5	339.5	339.5	.200	4166.	3636.
.350	366.1	366.1	366.1	.250	4303.	3734.
.400	393.8	393.8	393.8	.300	4442.	3835.
.450	422.4	422.4	422.4	.350	4588.	3938.
1.500	452.0	452.0	452.0	4.400	4733.	4043.
.550	482.6	482.6	482.6	.450	4884.	4151.
.600	514.3	514.3	514.3	.500	5035.	4262.
.650	546.9	546.9	546.9	.550	5192.	4375.
.700	580.6	580.6	580.6	.600	5355.	4490.
1.750	616.0	615.2	615.2	4.650	5524.	4609.
.800	652.8	650.9	650.9	.700	5700.	4729.
.850	691.4	687.6	687.6	.750	5884.	4855.
.900	729.5	723.5	723.5	.800	6075.	4978.
.950	773.2	763.9	763.9	.850	6274.	5107.
2.000	816.4	803.6	803.6	4.900	6481.	5242.
.050	861.9	844.3	844.3	.950	6695.	5374.
.100	909.0	885.9	885.9	5.000	6917.	5512.
.150	958.5	928.6	928.6	.050	7147.	5651.
.200	1011.	972.3	972.3	.100	7385.	5792.
2.250	1066.	1017.	1017.	5.150	7631.	5940.
.300	1122.	1063.	1063.	.200	7885.	6090.
.350	1183.	1110.	1110.	.250	8147.	6243.
.400	1244.	1157.	1157.	.300	8417.	6398.
.450	1308.	1206.	1206.	.350	8695.	6556.
2.500	1378.	1256.	1256.	5.400	8981.	6722.
.550	1448.	1306.	1306.	.450	9274.	6887.
.600	1523.	1359.	1358.	.500	9575.	7058.
.650	1599.	1413.	1411.	.550	9884.	7230.
.700	1681.	1467.	1464.	.600	10201.	7407.
2.750	1764.	1526.	1519.	5.650	10535.	7592.
.800	1852.	1585.	1575.	.700	10877.	7774.
.850	1943.	1646.	1632.	.750	11227.	7964.
.900	2038.	1707.	1690.	.800	11585.	8153.
.950	2136.	1772.	1748.	.850	11951.	8348.
3.000	2238.	1838.	1808.	5.900	12325.	8545.
.050	...	1905.	1869.	.950	12707.	8747.
.100	...	1973.	1930.	6.000	13100.	8950.

16 oz.**FOXBORO**Specific Gravity
.600**HOURLY COEFFICIENTS***Based on the following conditions*

Barometer 14.4 Pressure Base = 1 lb. (15.4 absolute)

Temp. Flow = 60° F. Temp. Base = 60° F.

ORIFICE DIAM.		PIPE SIZES				
Fractional	Decimal	4"	6"	8"	10"	12"
	1/4	15.81
	3/8	35.59
	1/2	63.26	63.26
	5/8	98.84	98.84
	3/4	142.3	142.3	142.3
	7/8	193.8	193.8	193.8
1	1.000	253.0	253.0	253.0	253.0
	1/8	.125	320.3	320.3	320.3
	1/4	.250	395.4	395.4	395.4	395.4
	3/8	.375	478.4	478.4	478.4
	1/2	.500	569.4	569.4	569.4	569.4
	5/8	.625	668.2	668.2	668.2
	3/4	.750	776.0	775.0	775.0	775.0
	7/8	.875	895.8	889.7	889.7
2	2.000	1029.	1013.	1013.	1013.	1013.
	1/8	.125	1176.	1143.	1143.
	1/4	.250	1343.	1281.	1281.	1281.
	3/8	.375	1529.	1427.	1427.
	1/2	.500	1736.	1581.	1581.	1581.
	5/8	.625	1967.	1746.	1744.
	3/4	.750	2222.	1924.	1914.	1914.
	7/8	.875	2508.	2112.	2092.
3	3.000	2818.	2314.	2278.	2278.	2278.
	1/8	.125	2530.
	1/4	.250	2766.	2673.	2673.
	3/8	.375	3020.
	1/2	.500	3294.	3105.	3100.
	5/8	.625	3589.
	3/4	.750	3905.	3583.	3559.
	7/8	.875	4242.
4	4.000	4609.	4114.	4049.	4049.
	1/8	.250	5424.	4571.	4571.
	1/4	.500	6342.	5369.	5139.
	3/4	.750	6115.	5748.
5	5.000	6942.	6429.	6327.
	1/8	.250	7864.	7157.
	1/4	.500	8886.	7958.
	3/4	.750	10030.	8840.
6	6.000	11280.	9800.	9257.
	1/8	.250	10850.	10130.
	1/4	.500	11990.	11060.
	3/4	.750	13230.	12080.
7	7.000	14590.	13180.
	1/8	.250	16050.	14350.
	1/4	.500	17620.	15620.
	3/4	.750	16970.
8	8.000	18430.
	1/8	.250	19990.
	1/4	.500	21690.
	3/4	.750	23480.

FOXBORO**1½ lbs.****HOURLY COEFFICIENTS**Specific Gravity
.600

Based on the following conditions

Barometer 14.4 Pressure Base = 1½ lbs. (15.9 absolute)

Temp. Flow = 60° F. Temp. Base = 60° F.

ORIFICE DIAM.		PIPE SIZES				
Fractional	Decimal	4"	6"	8"	10"	12"
¼	.250	15.32
⅕	.375	34.47
⅙	.500	61.27	61.27
⅚	.625	95.73	95.73
¾	.750	137.8	137.8	137.8
⅞	.875	187.7	187.7	187.7
1	1.000	245.1	245.1	245.1	245.1
¼	.125	310.2	310.2	310.2	310.2
⅕	.250	382.9	382.9	382.9	382.9	382.9
⅙	.375	463.4	463.4	463.4	463.4	463.4
⅚	.500	551.5	551.5	551.5	551.5	551.5
¾	.625	647.2	647.2	647.2	647.2	647.2
⅞	.750	751.6	750.6	750.6	750.6	750.6
⅞	.875	867.7	861.7	861.7	861.7	861.7
2	2.000	996.3	980.9	980.9	980.9	980.9
¼	.125	1139.	1107.	1107.
⅕	.250	1301.	1241.	1241.	1241.	1241.
⅙	.375	1481.	1382.	1382.
⅚	.500	1681.	1532.	1532.	1532.	1532.
¾	.625	1905.	1691.	1689.
⅞	.750	2152.	1863.	1854.	1854.	1854.
⅞	.875	2429.	2046.	2026.
3	3.000	2730.	2242.	2206.	2206.	2206.
¼	.125	2451.
⅕	.250	2679.	2588.	2588.	2588.
⅙	.375	2925.
⅚	.500	3191.	3007.	3002.	3002.
¾	.625	3476.
⅞	.750	3782.	3471.	3447.	3447.
⅞	.875	4108.
4	4.000	4464.	3985.	3922.	3922.
¼	.250	5253.	4557.	4427.	4427.
⅕	.500	6142.	5201.	4978.	4963.
⅙	.750	5922.	5567.	5530.
5	5.000	6724.	6227.	6128.
¼	.250	7617.	6932.	6765.
⅕	.500	8607.	7708.	7451.
⅙	.750	9718.	8562.	8184.
6	6.000	10920.	9492.	8966.
¼	.250	10510.	9809.
⅕	.500	11610.	10710.
⅙	.750	12820.	11700.
7	7.000	14130.	12760.
¼	.250	15540.	13900.
⅕	.500	17060.	15130.
⅙	.750	16440.
8	8.000	17850.
¼	.250	19360.
⅕	.500	21010.
⅙	.750	22740.

2 lbs.**FOXBORO**Specific Gravity
.600**HOURLY COEFFICIENTS***Based on the following conditions*

Barometer 14.4 Pressure Base = 2 lbs. (16.4 absolute)

Temp. Flow = 60° F. Temp. Base = 60° F.

ORIFICE DIAM.		PIPE SIZES				
Fractional	Decimal	4"	6"	8"	10"	12"
1/4	.250	14.85
1/2	.375	33.42
3/4	.500	59.40	59.40
1	.625	92.82	92.82
1/4	.750	133.6	133.6	133.6
1/2	.875	181.9	181.9	181.9
1	1.000	237.6	237.6	237.6	237.6
1/4	.125	300.7	300.7	300.7	300.7
1/2	.250	371.3	371.3	371.3	371.3	371.3
3/4	.375	449.2	449.2	449.2	449.2
1	.500	534.7	534.7	534.7	534.7	534.7
1/4	.625	627.5	627.5	627.5	627.5
1/2	.750	728.7	727.8	727.8	727.8	727.8
3/4	.875	841.2	835.4	835.4	835.4
2	2.000	965.9	951.0	951.0	951.0	951.0
1/4	.125	1105.	1073.	1073.
1/2	.250	1261.	1203.	1203.	1203.	1203.
3/4	.375	1436.	1340.	1340.
1	.500	1630.	1485.	1485.	1485.	1485.
1/4	.625	1847.	1639.	1638.
1/2	.750	2086.	1806.	1797.	1797.	1797.
3/4	.875	2355.	1984.	1964.
3	3.000	2647.	2173.	2139.	2139.	2139.
1/4	.125	2376.
1/2	.250	2597.	2510.	2510.	2510.
3/4	.375	2836.
1	.500	3094.	2915.	2911.	2911.
1/4	.625	3370.
1/2	.750	3667.	3365.	3342.	3342.
3/4	.875	3983.
4	4.000	4328.	3864.	3802.	3802.
1/4	.250	5093.	4418.	4292.	4292.
1/2	.500	5955.	5042.	4826.	4812.
3/4	.750	5742.	5398.	5362.
5	5.000	6519.	6037.	5941.
1/4	.250	7385.	6721.	6559.
1/2	.500	8345.	7473.	7224.
3/4	.750	9422.	8301.	7935.
6	6.000	10590.	9202.	8693.
1/4	.250	10190.	9510.
1/2	.500	11260.	10390.
3/4	.750	12430.	11350.
7	7.000	13700.	12370.
1/4	.250	15070.	13480.
1/2	.500	16540.	14660.
3/4	.750	15940.
8	8.000	17310.
1/4	.250	18770.
1/2	.500	20370.
3/4	.750	22050.

FOXBORO

3 lbs.

HOURLY COEFFICIENTS

Specific Gravity
.600

Based on the following conditions

Barometer 14.4 Pressure Base = 3 lbs. (17.4 absolute)

Temp. Flow = 60° F. Temp. Base = 60° F.

ORIFICE DIAM.		PIPE SIZES				
Fractional	Decimal	4"	6"	8"	10"	12"
1/8	.250	13.99
1/8	.375	31.50
1/8	.500	55.99	55.99
1/8	.625	87.48	87.48
1/8	.750	126.0	126.0	126.0
1/8	.875	171.5	171.5	171.5
1	1.000	223.9	223.9	223.9	223.9
1/8	.125	283.5	283.5	283.5	283.5
1/8	.250	349.9	349.9	349.9	349.9	349.9
1/8	.375	423.4	423.4	423.4	423.4	423.4
1/8	.500	503.9	503.9	503.9	503.9	503.9
1/8	.625	591.4	591.4	591.4	591.4	591.4
1/8	.750	686.8	685.9	685.9	685.9	685.9
1/8	.875	792.8	787.4	787.4	787.4	787.4
2	2.000	910.4	896.3	896.3	896.3	896.3
1/8	.125	1041.	1011.	1011.
1/8	.250	1188.	1134.	1134.	1134.	1134.
1/8	.375	1353.	1263.	1263.
1/8	.500	1536.	1399.	1399.	1399.	1399.
1/8	.625	1740.	1545.	1543.
1/8	.750	1966.	1702.	1694.	1694.	1694.
1/8	.875	2220.	1870.	1851.
3	3.000	2494.	2048.	2016.	2016.	2016.
1/8	.125	2239.
1/8	.250	2448.	2365.	2365.	2365.
1/8	.375	2673.
1/8	.500	2916.	2748.	2743.	2743.
1/8	.625	3176.
1/8	.750	3456.	3171.	3150.	3150.
1/8	.875	3754.
4	4.000	4079.	3641.	3584.	3584.
1/8	.250	4800.	4164.	4045.	4045.
1/8	.500	5613.	4752.	4548.	4535.
1/8	.750	5412.	5087.	5053.
5	5.000	6144.	5690.	5600.
1/8	.250	6960.	6334.	6181.
1/8	.500	7865.	7043.	6809.
1/8	.750	8880.	7823.	7478.
6	6.000	9981.	8673.	8193.
1/8	.250	9600.	8963.
1/8	.500	10610.	9791.
1/8	.750	11710.	10690.
7	7.000	12910.	11660.
1/8	.250	14200.	12700.
1/8	.500	15590.	13820.
1/8	.750	15020.
8	8.000	16310.
1/8	.250	17690.
1/8	.500	19200.
1/8	.750	20780.

CHAPTER VI

CORRECTION FACTORS

THE coefficients in the preceding tables have been figured on standard conditions of flow, but as the flowing conditions vary from time to time — particularly the flowing temperature and the specific gravity — it is necessary to make corrections for the new determinations.

The following tables of factors have been carefully prepared to simplify the actual computation required to make any corrections, and they cover every variable factor of the coefficient equation.

SPECIFIC GRAVITY

There are two tables for Specific Gravity Correction, one table is based on a gravity of .600 and the other on 1.000, and each is arranged for .005 gravity change. This is sufficiently close for commercial accuracy, and if gravity determination shows a result closer than .005, the factor corresponding to the gravity nearest to the determination, should be supplied. For example, if a determination shows a gravity of .642, apply the factor for gravity .640.

The formula for Gravity Correction is as follows:

$$C_n = C_o \sqrt{\frac{G_o}{G_n}}$$

in which

C_o = original coefficient, C_n = new or corrected coefficient, G_o = gravity of original coefficient, G_n = new gravity,

and the value of $\sqrt{\frac{G_o}{G_n}}$ is the factor. (Tables on pages 90 and 91.)

FLOWING TEMPERATURE

The Flowing Temperature Correction Factor Table is based on 60° F. and is arranged for 1° changes in temperature from 40° to 90°.

The formula for Flowing Temperature Correction is as follows:

$$C_n = C_o \sqrt{\frac{T_{fo}}{T_{fn}}}$$

in which

C_o = original coefficient, C_n = new or corrected coefficient, T_{fo} = temperature of original coefficient (absolute), T_{fn} = new temperature (absolute),

and the value of $\sqrt{\frac{T_{fo}}{T_{fn}}}$ is the factor. (Table page 92.)

The absolute temperature is obtained by adding 460 to the Fahrenheit thermometer reading.

PRESSURE BASE

The Pressure Base Correction Factor Table is based on 4 oz. at a barometric pressure of 14.4. This table is arranged for pressure base changes of 2 oz. from 0 to 48.

The formula for Pressure Base Correction is

$$C_n = C_o \frac{P_{Bo}}{P_{Bn}}$$

in which

C_o = original coefficient, C_n = new or corrected coefficient, P_{Bo} = pressure base of original coefficient (absolute), P_{Bn} = new pressure base (absolute),

and the value of $\frac{P_{Bo}}{P_{Bn}}$ is the factor. (Table page 92.)

The absolute pressure is obtained by adding the barometric pressure to the pressure base. Each should be in lbs. per sq. in.

BAROMETER

The Barometric Pressure Correction Table is based on 14.4 lbs. per sq. in. at pressure bases of 0 oz., 4 oz., 8 oz., 10 oz., 16 oz. (1 lb.), $1\frac{1}{2}$ lbs., 2 lbs., and 3 lbs.

The formula for Barometric Pressure Correction is

$$C_n = C_o \frac{Baro_o + P_{Bo}}{Baro_n + P_{Bo}}$$

in which

C_o = original coefficient, C_n = new or corrected coefficient, $Baro_o$ = original barometric pressure, $Baro_n$ = new barometric pressure, P_{Bo} = pressure base of original coefficient. (Table page 93.)

TEMPERATURE BASE

A correction for temperature base would seldom be used, but for convenience the following table gives the Temperature Base Correction Factors from 40° to 90° by 1° changes and is based on 60° F.

The formula for this correction is

$$C_n = C_o \frac{T_{Bn}}{T_{Bo}}$$

in which

C_o = original coefficient, C_n = new or corrected coefficient, T_{Bo} = temperature base of original coefficient (absolute), T_{Bn} = new temperature base (absolute),

and the value of $\frac{T_{Bn}}{T_{Bo}}$ is the factor. (Table page 94.)

SPECIFIC GRAVITY (G) CORRECTION FACTORS

Base 1.000

Specific Gravity	Factor	Specific Gravity	Factor	Specific Gravity	Factor
.800	1.118	1.050	.9756	1.300	.8772
.805	1.115	1.055	.9735	1.305	.8757
.810	1.111	1.060	.9718	1.310	.8741
.815	1.107	1.065	.9695	1.315	.8718
.820	1.104	1.070	.9671	1.320	.8696
.825	1.101	1.075	.9648	1.325	.8685
.830	1.098	1.080	.9625	1.330	.8673
.835	1.094	1.085	.9602	1.335	.8658
.840	1.091	1.090	.9578	1.340	.8643
.845	1.088	1.095	.9657	1.345	.8624
.850	1.085	1.100	.9533	1.350	.8606
.855	1.082	1.105	.9515	1.355	.8591
.860	1.078	1.110	.9497	1.360	.8576
.865	1.075	1.115	.9475	1.365	.8562
.870	1.072	1.120	.9452	1.370	.8547
.875	1.069	1.125	.9430	1.375	.8533
.880	1.066	1.130	.9407	1.380	.8518
.885	1.063	1.135	.9385	1.385	.8500
.890	1.060	1.140	.9363	1.390	.8482
.895	1.057	1.145	.9344	1.395	.8468
.900	1.054	1.150	.9328	1.400	.8453
.905	1.051	1.155	.9307	1.405	.8439
.910	1.048	1.160	.9285	1.410	.8425
.915	1.045	1.165	.9264	1.415	.8407
.920	1.042	1.170	.9242	1.420	.8389
.925	1.040	1.175	.9226	1.425	.8373
.930	1.037	1.180	.9208	1.430	.8361
.935	1.034	1.185	.9187	1.435	.8347
.940	1.031	1.190	.9166	1.440	.8333
.945	1.029	1.195	.9149	1.445	.8320
.950	1.026	1.200	.9132	1.450	.8306
.955	1.024	1.205	.9112	1.455	.8291
.960	1.021	1.210	.9091	1.460	.8278
.965	1.018	1.215	.9074	1.465	.8265
.970	1.015	1.220	.9058	1.470	.8251
.975	1.013	1.225	.9037	1.475	.8234
.980	1.010	1.230	.9017	1.480	.8217
.985	1.008	1.235	.9001	1.485	.8204
.990	1.005	1.240	.8985	1.490	.8190
.995	1.003	1.245	.8964	1.495	.8177
1.000	1.000	1.250	.8944	1.500	.8163
1.005	.9975	1.255	.8928
1.010	.9950	1.260	.8913
1.015	.9923	1.265	.8893
1.020	.9900	1.270	.8873
1.025	.9876	1.275	.8858
1.030	.9852	1.280	.8842
1.035	.9828	1.285	.8823
1.040	.9804	1.290	.8802
1.045	.9780	1.295	.8787

SPECIFIC GRAVITY (G) CORRECTION FACTORS

Base .600

Specific Gravity	Factor	Specific Gravity	Factor	Specific Gravity	Factor	Specific Gravity	Factor
.540	1.054	.790	.8715	1.040	.7596	1.290	.6820
.545	1.049	.795	.8687	1.045	.7577	1.295	.6807
.550	1.044	.800	.8660	1.050	.7559	1.300	.6793
.555	1.040	.805	.8633	1.055	.7541	1.305	.6780
.560	1.035	.810	.8607	1.060	.7524	1.310	.6768
.565	1.031	.815	.8580	1.065	.7506	1.315	.6755
.570	1.026	.820	.8554	1.070	.7488	1.320	.6743
.575	1.022	.825	.8528	1.075	.7471	1.325	.6729
.580	1.017	.830	.8502	1.080	.7454	1.330	.6717
.585	1.013	.835	.8477	1.085	.7436	1.335	.6704
.590	1.008	.840	.8451	1.090	.7419	1.340	.6692
.595	1.004	.845	.8426	1.095	.7402	1.345	.6679
.600	1.000	.850	.8402	1.100	.7386	1.350	.6665
.605	.9958	.855	.8377	1.105	.7369	1.355	.6654
.610	.9918	.860	.8353	1.110	.7352	1.360	.6642
.615	.9877	.865	.8328	1.115	.7336	1.365	.6630
.620	.9837	.870	.8305	1.120	.7319	1.370	.6618
.625	.9798	.875	.8281	1.125	.7303	1.375	.6606
.630	.9759	.880	.8257	1.130	.7287	1.380	.6594
.635	.9720	.885	.8234	1.135	.7271	1.385	.6582
.640	.9682	.890	.8211	1.140	.7255	1.390	.6570
.645	.9645	.895	.8188	1.145	.7239	1.395	.6558
.650	.9608	.900	.8165	1.150	.7223	1.400	.6547
.655	.9571	.905	.8142	1.155	.7208	1.405	.6535
.660	.9535	.910	.8120	1.160	.7192	1.410	.6523
.665	.9499	.915	.8098	1.165	.7177	1.415	.6512
.670	.9463	.920	.8076	1.170	.7161	1.420	.6500
.675	.9428	.925	.8054	1.175	.7146	1.425	.6489
.680	.9393	.930	.8032	1.180	.7131	1.430	.6478
.685	.9359	.935	.8011	1.185	.7116	1.435	.6466
.690	.9325	.940	.7989	1.190	.7101	1.440	.6455
.695	.9291	.945	.7968	1.195	.7086	1.445	.6444
.700	.9258	.950	.7947	1.200	.7071	1.450	.6433
.705	.9225	.955	.7926	1.205	.7056	1.455	.6422
.710	.9193	.960	.7906	1.210	.7042	1.460	.6410
.715	.9161	.965	.7885	1.215	.7019	1.465	.6400
.720	.9129	.970	.7865	1.220	.7013	1.470	.6389
.725	.9097	.975	.7845	1.225	.6998	1.475	.6378
.730	.9066	.980	.7825	1.230	.6984	1.480	.6367
.735	.9035	.985	.7805	1.235	.6970	1.485	.6356
.740	.9005	.990	.7785	1.240	.6956	1.490	.6346
.745	.8974	.995	.7765	1.245	.6942	1.495	.6335
.750	.8944	1.000	.7746	1.250	.6928
.755	.8915	1.005	.7727	1.255	.6914
.760	.8885	1.010	.7707	1.260	.6901
.765	.8856	1.015	.7689	1.265	.6887
.770	.8827	1.020	.7670	1.270	.6873
.775	.8799	1.025	.7651	1.275	.6860
.780	.8771	1.030	.7632	1.280	.6847
.785	.8743	1.035	.7614	1.285	.6833

FLOWING TEMPERATURE (T_f) CORRECTION FACTORS

Base 60 deg. Fahr.

Temp.	Factor	Temp.	Factor	Temp.	Factor
40	1.020	60	1.000	80	.9811
41	1.019	61	.9986	81	.9802
42	1.018	62	.9977	82	.9795
43	1.017	63	.9970	83	.9786
44	1.016	64	.9959	84	.9777
45	1.015	65	.9952	85	.9765
46	1.014	66	.9943	86	.9756
47	1.013	67	.9929	87	.9747
48	1.012	68	.9923	88	.9740
49	1.011	69	.9913	89	.9731
50	1.010	70	.9904	90	.9722
51	1.009	71	.9895
52	1.008	72	.9884
53	1.007	73	.9875
54	1.006	74	.9866
55	1.005	75	.9856
56	1.004	76	.9850
57	1.003	77	.9840
58	1.002	78	.9831
59	1.001	79	.9820

To correct an hourly coefficient that is on a flowing temperature base of 60° to any flowing temperature within the range of the above table, multiply that coefficient by the factor corresponding to the new flowing temperature.

If the hourly coefficient is on any flowing temperature base other than 60°, find the hourly coefficient on a base of 60° from the coefficient tables and multiply this coefficient by the factor corresponding to the new flowing temperature in the table above.

PRESSURE BASE (P_B) CORRECTION FACTORS

Base 4 oz.

Barometer 14.4

Pressure Base	Factor	Pressure Base	Factor	Pressure Base	Factor
0 oz.	1.018	(1 lb.) 16 oz.	.9515	(2 lbs.) 32 oz.	.8933
2 "	1.009	18 "	.9436	34 "	.8865
4 "	1.000	20 "	.9361	36 "	.8799
6 "	.9914	22 "	.9288	38 "	.8733
8 "	.9833	24 "	.9214	40 "	.8668
10 "	.9750	26 "	.9142	42 "	.8604
12 "	.9676	28 "	.9071	44 "	.8542
14 "	.9591	30 "	.9001	46 "	.8481
....	(3 lbs.) 48 "	.8420

To correct an hourly coefficient for any pressure base find the hourly coefficient corresponding to the same orifice diameter in the 4 oz. coefficient tables. Multiply the coefficient thus found by the factor in the table above corresponding to the new pressure base.

BAROMETRIC CORRECTION FACTORS

Base 14.4

Pressure Base	Barometer Base				
	14.0	14.1	14.2	14.3	14.5
0 oz.	1.029	1.021	1.014	1.007	.9931
4 "	1.028	1.021	1.013	1.007	.9932
8 "	1.028	1.021	1.013	1.007	.9933
10 "	1.027	1.021	1.013	1.007	.9934
16 "	1.027	1.020	1.013	1.007	.9935
1½ lbs.	1.026	1.019	1.013	1.007	.9937
2 "	1.025	1.018	1.013	1.006	.9939
3 "	1.023	1.017	1.012	1.006	.9943

Pressure Base	Barometer Base				
	14.6	14.7	14.8	14.9	15
0 oz.	.9836	.9796	.9730	.9665	.9600
4 "	.9865	.9801	.9734	.9670	.9606
8 "	.9868	.9803	.9737	.9675	.9613
10 "	.9869	.9804	.9741	.9676	.9616
16 "	.9872	.9808	.9747	.9685	.9625
1½ lbs.	.9876	.9815	.9754	.9695	.9636
2 "	.9880	.9820	.9762	.9704	.9649
3 "	.9886	.9830	.9775	.9720	.9667

To correct an hourly coefficient that is on a barometer base of 14.4 to any of the barometer bases in the above table, multiply that hourly coefficient by the factor in the new barometer base column and corresponding to the pressure base of the hourly coefficient.

TEMPERATURE BASE (T_B) CORRECTION FACTORS

Base 60 deg. Fahr.

Temperature	Factor	Temperature	Factor
40	.9615	65	1.010
41	.9634	66	1.011
42	.9653	67	1.013
43	.9673	68	1.015
44	.9692	69	1.017
45	.9711	70	1.019
46	.9730	71	1.021
47	.9750	72	1.023
48	.9769	73	1.025
49	.9788	74	1.027
50	.9807	75	1.029
51	.9827	76	1.031
52	.9846	77	1.033
53	.9865	78	1.035
54	.9884	79	1.036
55	.9903	80	1.038
56	.9923	81	1.040
57	.9942	82	1.042
58	.9961	83	1.044
59	.9980	84	1.046
60	1.000	85	1.048
61	1.002	86	1.050
62	1.004	87	1.052
63	1.006	88	1.054
64	1.008	89	1.056
..	90	1.058

To correct an hourly coefficient that is on a temperature base of 60° to any other temperature base within the range of the above table, multiply that coefficient by the factor corresponding to the new temperature base.

If the hourly coefficient is on any temperature base other than 60°, find the hourly coefficient for 60° from the coefficient tables and multiply it by the factor in table above corresponding to the new temperature base.

CHAPTER VII

FLOW CURVES

IN a proposed meter installation it is essential to know the approximate maximum amount of gas that the meter will be called upon to handle, and from this knowledge the approximate orifice size may be determined. It is further necessary to know that the selected orifice will handle the minimum as well as the maximum flow.

The source of this information could be developed in a series of tables which at best would not only be cumbersome, but inflexible.

The flow curves in the following pages were developed to give all the information necessary in determining the size orifice. At the same time the flow at any differential pressure within the range of the instrument may be approximated. This latter point should be of particular interest, for it is then possible to get a rough check on the amount of gas being passed at any time.

For example:

Assume the differential reading to be 40" and the static reading at the same time 50 lbs., and further assume that the orifice diameter is $1\frac{1}{2}$ " and the pipe line 4".

Refer to plate on page 99.

Find the point of intersection of the 40" differential line and the 50 lb. static. (The Static scale will be found above the base line and the Flow scale below.) From the intersection run in a horizontal direction to the $1\frac{1}{4}$ " orifice line. From this point drop vertically to the base line and read the Flow from the lower scale, which in this case is 21,000 cu. ft. per hr. Work this problem over two or three times by marking the sheet with a soft pencil, and the simplicity of the operation will become apparent.

To find the size orifice necessary to pass a certain amount of gas, the process is reversed.

For example:

Assume a flow of 100,000 cu. ft. per hr. at a static pressure of 120 lbs. Assume further the pressure base of measurement to be 8 oz. (which is the base upon which these curves have been figured), and the pipe-line size 6".

Find the intersection of the 80" differential and the 120 lb. static lines. Run from this intersection in a horizontal direction to an intersection with the 100,000 flow line and select the orifice from the orifice line nearer this intersection.

If the flow is to be on any pressure base other than 8 oz., it is necessary to make correction for the desired base before referring to the curves.

For example:

Assume the flow to be 200,000 cu. ft., on a 16 oz. base.

Refer to Pressure Base Correction Factors, page 92. The factor for 16 oz. is .9515. The assumed flow must be divided by .9515, which will give the flow on a 4 oz. base; then multiply this result by the factor for 8 oz. base (.9833). The flow is now corrected for an 8 oz. base, and the size orifice may be determined as outlined in a previous paragraph.

There is one point in particular to be considered in determining the size orifice required. If the flow is to be fairly uniform, a differential should be assumed, covering approximately the middle of the scale, which on a 100" range would be 50", and on a 20" range 10" or 12", otherwise use 80" and 16" respectively for 100" and 20" ranges.

In order to determine the minimum and maximum capacity of an orifice, proceed in the following manner:

Refer to plate on page 108.

Assume a maximum differential of 16" and minimum of 2", a static of 10" mercury vacuum and an orifice of 2.000".

From the intersection of the 10" static and 16" differential line run horizontally to the 2.000" orifice line, then drop vertically to the base line and the maximum flow at 16" differential will be found as 10,300 cu. ft. per hr. From the intersection of the 10" static and the 2" differential line run horizontally to the 2.000" orifice line, then drop vertically to the base line, and the minimum flow at 2" differential will be found as 3450 cu. ft. per hr.

If, after an orifice plate is installed, it is found that the differential is too small, the size orifice necessary to give approximately the desired differential may be determined from the flow curves in the following manner:

Assume that an orifice creates a differential of only 10", and the desired differential is approximately 50".

Find the intersection of the orifice line with the 10" differential line; run vertically from this point of intersection to the 50" differential line, and find the orifice line nearer this last point.

The flexibility of these curves will be better appreciated the more they are used.

Spec. Grav. .600
Press. Base 8 Oz.
Temp. Base 60° F.
Temp. Flow 60° F.
Barometer 14.4

FOXBORO

FLOW CURVES

SIZE LINE **6"**

0-100' Diff.
0-300 lbs. Static

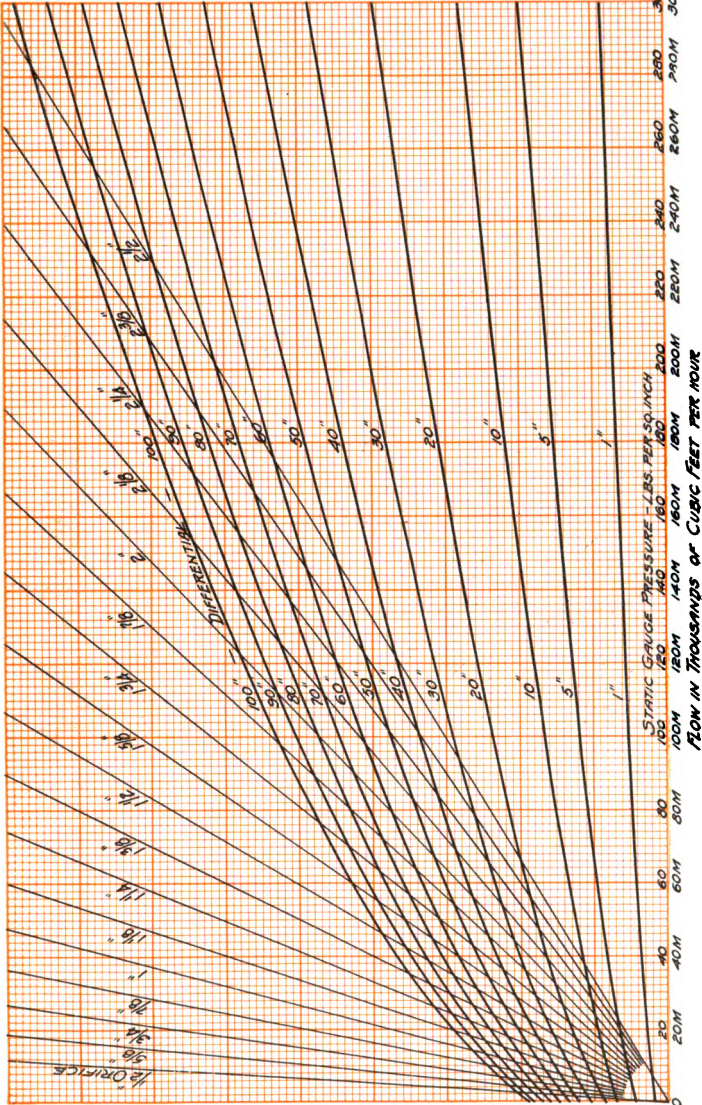

Spec. Grav. .600
Press. Base 8 Oz.
Temp. Base 60° F.
Temp. Flow 60° F.
Barometer 14.4

FOXBORO

FLOW CURVES

SIZE LINE **12"**

0-100" Diff.
0-300 lbs. Static

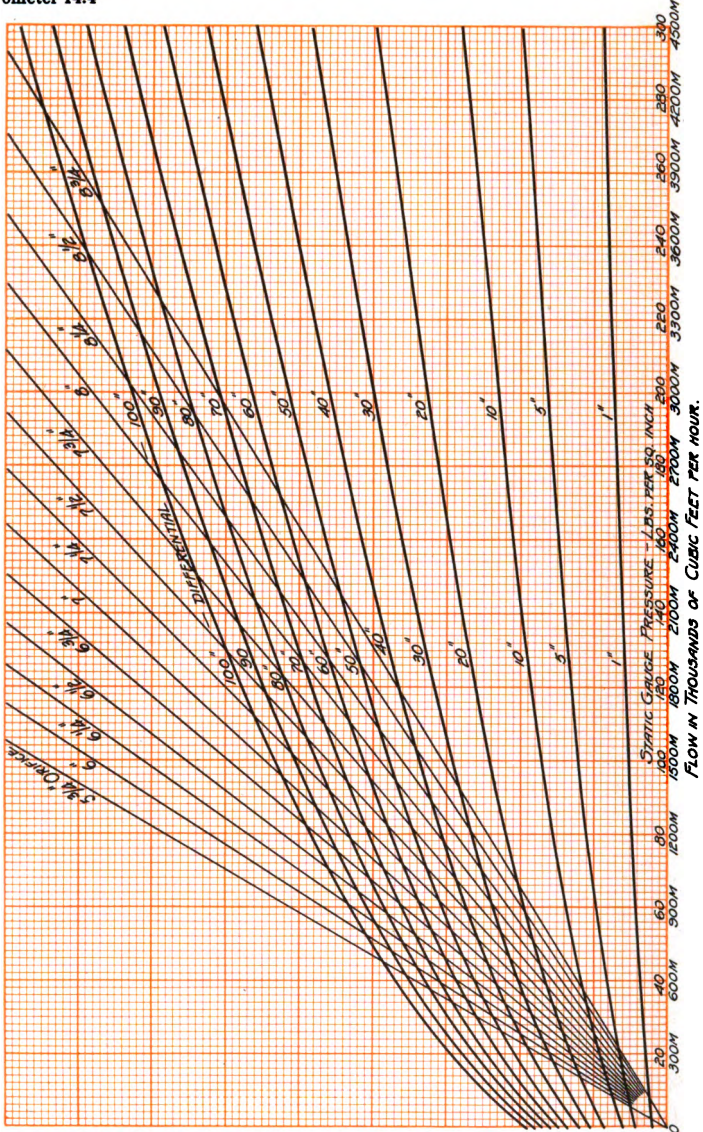

STATIC GAUGE PRESSURE - LBS. PER SQ. INCH
100 80 70 60 50 40 30 20 10 5 1
1500 1800 2100 2400 2700 3000 3300 3600 3900 4200
FLOW IN THOUSANDS OF CUBIC FEET PER HOUR.

Spec. Grav. 1.000
Press. Base 4 Oz.
Temp. Base 60° F.
Temp. Flow 60° F.
Barometer 14.4

FOXBORO

FLOW CURVES

SIZE LINE **4"**

0-20" Diff.
30"-0-20 lbs. Static

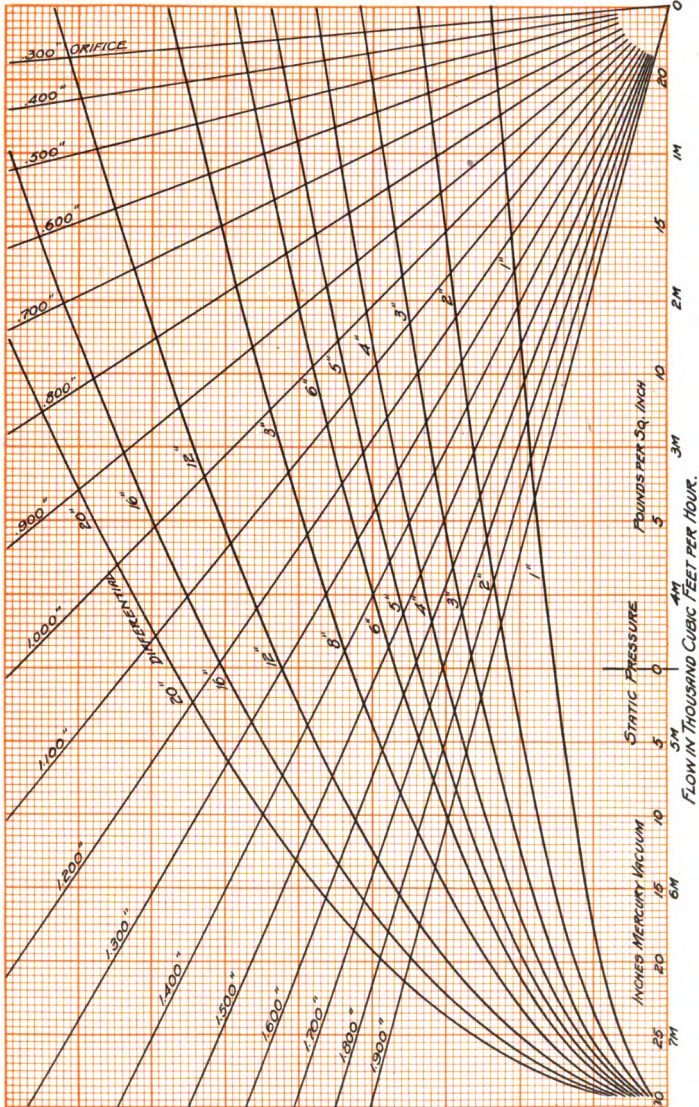

YB 10806

350
10

U.C. BERKELEY LIBRARIES



C006725768

456769

TH7940

B7

UNIVERSITY OF CALIFORNIA LIBRARY

FOXBORO
TRADE MARK